

YAKIMA

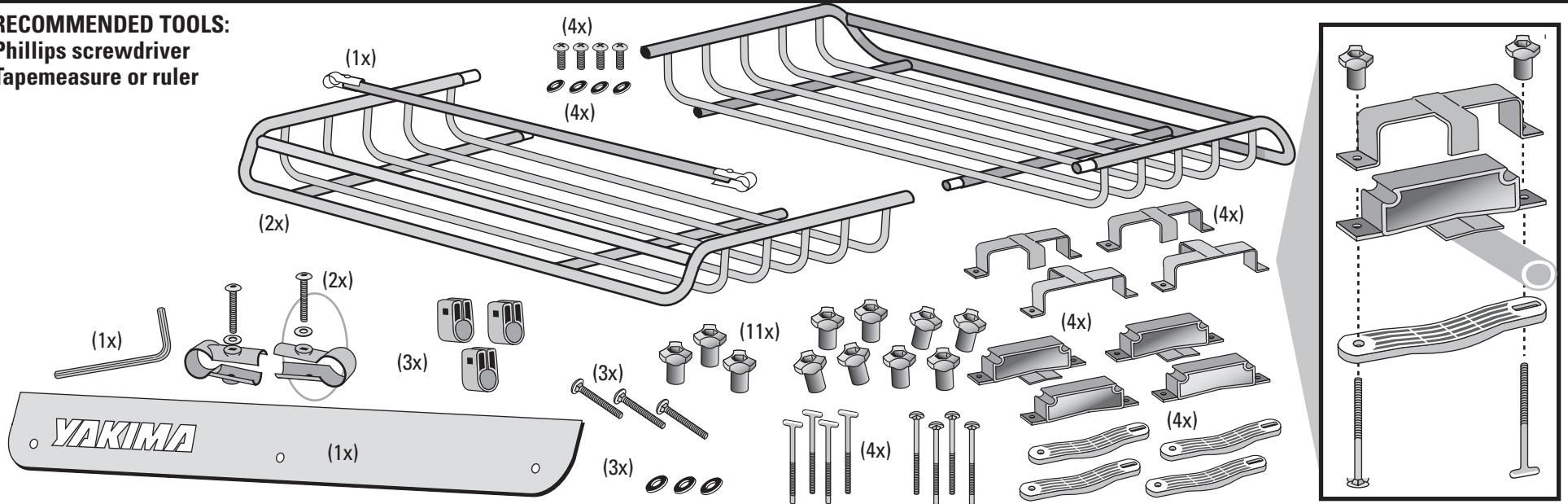

MEGA WARRIOR

RECOMMENDED TOOLS:
Phillips screwdriver
Tapemeasure or ruler



US  **LOAD LIMITS:**

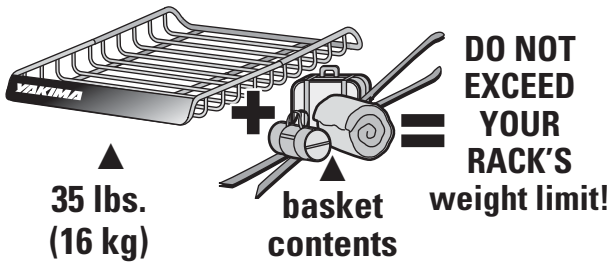

 **DO NOT EXCEED BASKET CONTENT WEIGHT LIMIT: 130 LBS. (60 KG)**

Always tie down long loads at front and rear.

•IF YOU HAVE FIXED BARS:

1

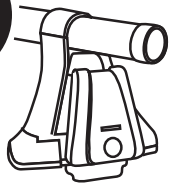

IF YOU HAVE "Q TOWERS"
OR BARS THAT CANNOT MOVE...
Continue to STEP 2.



**Q TOWER OWNERS:
NEVER REPOSITION THE Q TOWERS!**

•IF YOUR BARS MOVE:

IF YOU HAVE BARS THAT CAN BE MOVED...
Move the bars to minimum 30" (76cm) apart.



**TIGHTEN YOUR CROSSBARS
IF YOU LOOSENED THEM.**

2 ASSEMBLE THE BASKET.

• Remove the machine screws from the ends of the LoadWarrior tubes.

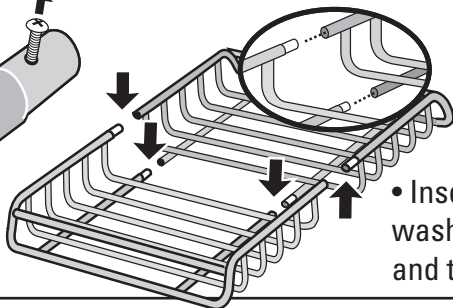
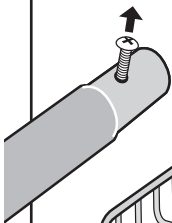

• Insert screws with washers into each joint and tighten them.

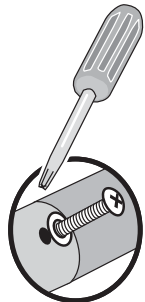

3 ATTACH FAIRING TO EITHER END OF BASKET.

Pry open the SnapArounds, attach them to the LOWER FRONT BAR.

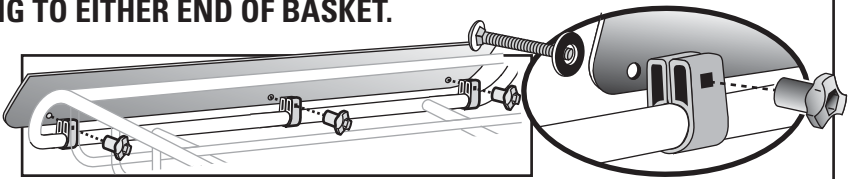
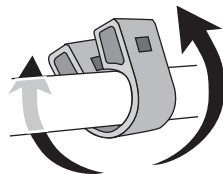

- Insert bolts through washers, fairing and SnapArounds.
- Attach knobs and TIGHTEN.

NOTE: The fairing can fold down when carrying accessories and long loads.

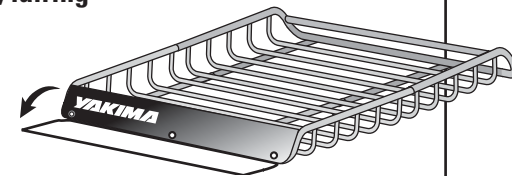

4 LOAD BASKET ONTO RACKS.

Center basket over your rack's crossbars.

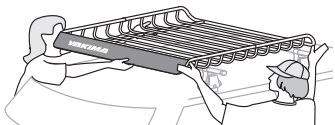

A friend would make this easier.



DO NOT ATTACH BRACKETS TO UNSTABLE POINTS.



(SIDE VIEW)

Do not attach brackets at these locations.

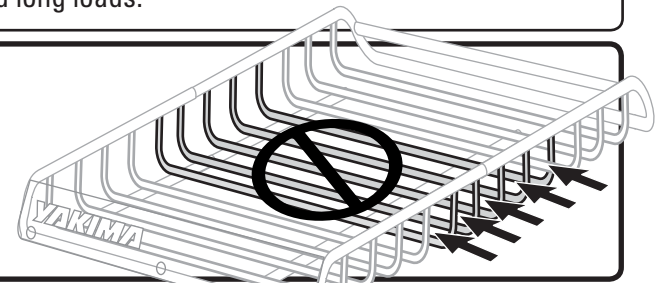

5 Position the support brackets above your vehicle's crossbars.

- Place the brackets **OUTSIDE** of the basket frame.
- Tabs on brackets face **INBOARD**.

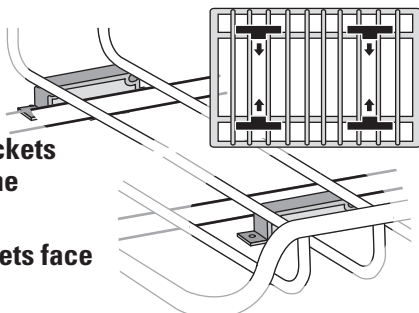

KEEP BAR BELOW TAB!

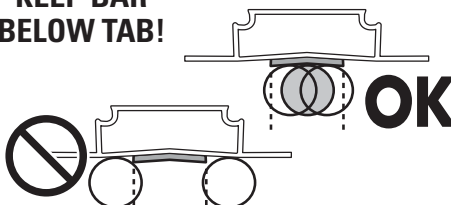

It may be necessary to move the bracket to a new position, or to adjust the basket position.

6 POSITION THE COVER BRACKETS.

Position cover bracket onto installed support brackets.

Hooked tab should cover the larger support bar.

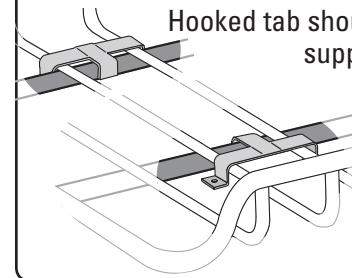

Arrow points inboard to center of vehicle.

7 ATTACH BOLTS.
Insert bolt into round hole, and T-bolt into slotted hole.

8 ATTACH THE KNOBS:
Engage the threads of the bolts.

9 SECURE THE BASKET TO THE BARS.
Lock the T-Bolts.

T-BOLT IS LOCKED when the "T" of the bolt is turned inside the hole:

90°

10 TIGHTEN THE KNOBS.

11 ATTACH LOAD BAR.
With a washer on the bolt, align the end clamps to the hole in the bar. Thread the bolts into the embedded nuts.

DO NOT COVER JOINT SCREWS WITH END CLAMPS.

12 REFER TO THE DRAWINGS BELOW FOR BAR PLACEMENT, or to determine if the bar is required.

13 Tighten bolts while pushing the end clamps together.

14 ACCESSORIES MUST BE ATTACHED TO THE FRONT OF THE BASKET (FRONT OF VEHICLE).

<p>BIKES</p> <ul style="list-style-type: none"> • Attach carrier at front of basket and to load bar. • Adjust the bar for load stability. 	<p>BOATS</p> <ul style="list-style-type: none"> • For shorter boats, attach accessory at front of basket and to load bar. • Longer loads, such as canoes or sea kayaks, require the load bar to be removed. 	<p>SKIS</p> <ul style="list-style-type: none"> • Attach accessory at front of basket and to load bar.
--	--	---

15 CHECK INSTALLATION:
Make sure installation is secure by tugging at basket.

The basket should NOT SLIDE on the bars.

Tighten knobs.

TO REMOVE THE BASKET, DO NOT DISASSEMBLE THE HARDWARE.

- Loosen the knobs until barely attached.
- Unlock the T-bolts and let curved brackets swing freely.
- Remove basket.

USE CAUTION WHEN OPENING YOUR HATCH.

On some vehicles, hatch interference is unavoidable.

Always tie down long loads to front and rear of vehicle.