



REAL POWER
UNREAL PERFORMANCE

CAUTION! PLEASE READ!



Do Not Over-tighten Terminal Screws!

The tightening torque should never exceed 44in-lbs(3.66 ft-lbs) max on any cap!



FEATURES

- Made in USA
- Weldable screw terminals
- Highest power performance available
- RoHS compliant
- Long life
- Extreme temperature operating range

APPLICATIONS

- High power
- High rate cycling
- High cycle life (>1,000,000 cycles)
- System prototyping/testing with available integration kit

MARKETS

- Automotive subsystem
- Engine starting
- Regen energy capture
- Backup power
- Grid/power correction
- UPS/ride through power

MARKING

Products are marked with the following: Rated capacitance, rated voltage, product number, name of manufacturer, positive and negative terminal marking.

OPERATING

Voltage, Rated	2.7V
Voltage, Surge	2.85V
Capacitance Tolerance	-0%

TEMPERATURE

Range, Operational	-40°F to 149°F
Range, Storage	-40°F to 158°F

LIFE

DC	10 years, rated voltage, 77°F
	$\Delta C < 20\%$ decrease, ESR < 100% increase
Endurance	1000 hrs, rated voltage, 149°F
	$\Delta C < 20\%$ decrease, ESR < 100% increase
Shelf	1000 hrs, no voltage, 158°F
	$\Delta C < 20\%$ decrease, ESR < 100% increase
Cycle	>1,000,000 cycles, Rated to half rated voltage, 77°F
	$\Delta C < 20\%$ decrease, ESR < 100% increase

SUPERCELL SPEC

Capacitance (F)	3000
ESR, DC \leq (m Ω) [10ms]	0.26
ESR, AC 1kHz \leq (m Ω)	0.20
Inductance \pm 20(nH)	60
72hr Leakage \leq (mA)	5

CYCLING

Current, Peak [1s] (A)	2200
Continuous Current (A)*	145
Current, Short Circuit (A)	10,000

THERMAL

Resistance, Thermal ($^{\circ}$ C/W)	4
---------------------------------------	---

ENERGY/POWER

E _{max} (Whr)	3.04
E _{max} (Whr/kg)	6.0
E _{max} (Whr/L)	7.7
P _{max} (kW/kg)	14
P _{max} (kW/L)	18
P _d (kW/kg)	6.6

STANDARDS COMPLIANCE

RoHS UL810a BS EN (IEC) 60068-2-6,14,27
SAE J2380 ISO 16750-3 (T14) Chinese RoHS

ADDITIONAL TECHNICAL INFORMATION

Product specification test methods available in separate document.
*Rated current = continuous current with 68 $^{\circ}$ F temperature rise.

PHYSICAL

D1 (mm) +/-0.3	60.2
D2 (mm) +/-0.7	60.7
L (mm) +/-0.5	144
Mass (kg)	0.51
Volume (L)	0.397
Volume of ACN (L)	0.240
Screw Threads	M6X1
Max Torque	5Nm or 44In•Lb

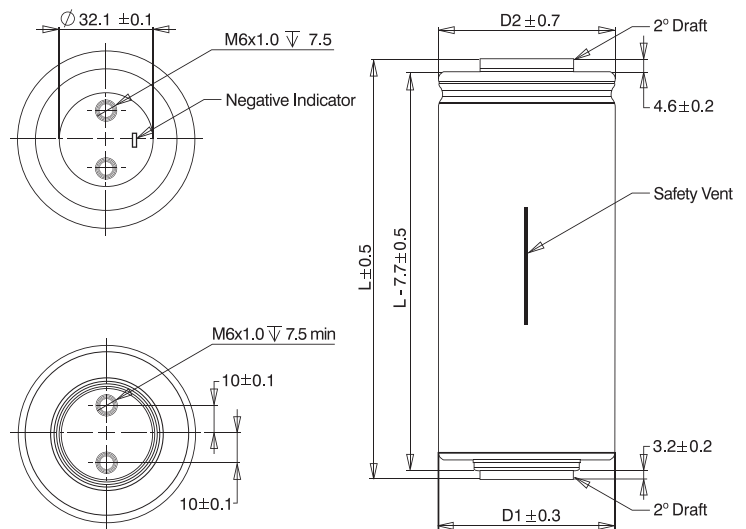

Ultracapacitors must be recycled!

Recycle used batteries in accordance with local, state, and federal law at an authorized recycling center.

**DO NOT
OPEN VENT
VALVES!**

