



Rock Crawler LED Kit

Warranty and Disclaimer

The LED light pod, remote control unit (including control box & key fob) and any other plastic/chrome part failures are covered for one year from date of purchase.

Installation of this product must be performed by a licensed professional. Should the failure of the product be the result of damage occurring as a result of improper installation, alteration of the product or an act of omission on the part of the consumer, this warranty is void. XKGLOW Lighting shall not be responsible for any consequential damages which arise from the use and/or installation of the product. If the kit is installed in any manner other than specified, XKGLOW Lighting reserves the right to deny any warranty claims at the discretion of the technical support team. Any product return must include the original packaging and invoice, a statement of the alleged defect and an R/A number. Upon receipt of the returned product, XKGLOW will test the product for defect. If the results of the testing do not support the warranty claim, do not reveal any defect or indicate consumer negligence in the installation and handling of the product, then the product will be returned to you and you will be charged a reshipping fee. If the product is returned from an address within the continental United States, within the first 14 days after purchase, and is found to be defective, XKGLOW will exchange or refund the original purchase expense. This offer does not extend to the cost for shipping charges on any international packages.

Additional Disclaimer Terms

Lights are for show purposes only; please check your local and state laws for the proper use of this product.

- Improper installation of electricity-using products such as lighting may cause damage to any vehicle or device to which the improperly handled or installed lighting is attached.
- Improperly installed products may expose individuals to electrical injury or even death.
- It is recommended that the kit be installed by a licensed professional.
- XKGLOW assumes no liability for the installation of the product.
- Warranty or liability will not exceed the product purchase price which shall be buyers sole and exclusive remedy.

Premium Remote Control Rock Crawler LED kit					
Control Module Input Voltage	Control Module Output Current	LED Model	6-LED Pod Input Current	Fuse Max Current	Total LED Amount
DC 12V	5A	3528 Wide Angle LED	0.04A	10A	60
Main Components 6LED Pods; Adjustable Mounting Bracket Remote Control Module Switch 4-Key Metal Key Fob			Accessories Crimping Connector Zip Tie Extension Wire Crimping Wire Terminal Wire Clip 3M Tape Waterproof Tape Splitter Extension Connector		

NOTE: NEVER directly mount lights on extremely hot areas such as, engine and exhaust pipes. Make sure the mounting locations have been thoroughly cleaned and the wires and lights are securely fixed on the mounting surface. Remote control block and switch must be installed in a dry and cool location. Although we sealed these two parts with waterproof adhesive, having them exposed to water might cause the kit’s controller to fail, long term. Any water damage or corrosion to this part will VOID all warranties. XKGLow is not responsible for any damage caused by inappropriate installation. For those individuals that are not technically inclined, we would strongly recommend that you take your vehicle to your local mechanic or installer and have them install the part or parts for you.

Please check your state and local laws before installing the kit. Every state has different policies and procedures for aftermarket accessories. XKGLow is not responsible for any fines that you may receive while using the light kit. This kit is for off road use only. The installation of this kit is strongly recommended to be installed by a licensed professional. The improper installation of this kit will void all warranties.

RECOMMENDED TOOLS FOR INSTALLATION:

- ✓ Pliers for cutting wires and zip ties. It can also be used for crimping connectors if you don’t have a crimper.
- ✓ Stripper for stripping wires. It’s best to have a stripper with crimping functions.
- ✓ Screw driver, adjustable wrench and hex wrench for removing vehicle parts for light installation.

Installation Guide

Warning: The following instructions demonstrate the general steps of mounting the kit. Details regarding how to use provided accessories are listed on the reverse side of this page.

1. Before installation, please test each pod on the 12V battery to see if they would work: Touch the wire with dashed lines to the battery positive "+", and touch the solid black wire to the battery negative "-". Exam if all six LEDs light up once the wires are connected to the battery.
2. Disconnect the vehicle's battery and remove any body work that will have the LED PODs located behind them. Use a clean shop rag and a little elbow grease to get the mounting spots perfectly clean and as smooth as possible. LOOSELY mount the LED PODs using double sided tape (not included) or plastic zip ties in the desired locations. Use 90 degree brackets if you want to change the light direction (DO NOT firmly attach the lights in this step.)

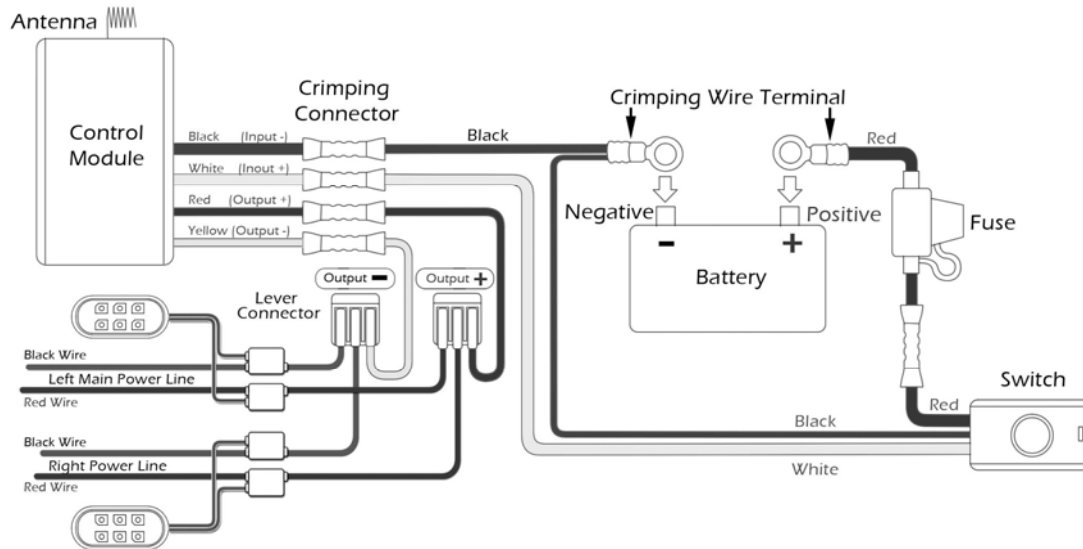

3. Connect the WHITE wire from control module to the WHITE wire from switch; Connect the BLACK wire from control module with BLACK wire from switch, then fix them in the crimping wire terminal.
4. Connect the RED wire from the switch to the fuse holder wire; Fix the other end of the fuse holder wire in another crimping wire terminal. (Make sure the fuse inside the fuse holder is removed until the installation is complete.)
5. Connect the RED wire from control module to a lever connector. This lever connector is used for connecting all positive wires from the light pods. Insert two long RED main power wires into this connector and fix them.
6. Connect the YELLOW wire from control module to ANOTHER lever connector. This lever connector is used for connecting all negative wires from the light pods. Insert two long BLACK main power wires into this connector and fix them.
7. These four long wires will power the pods mounted around the vehicle. Arrange a pair of wires (one RED and one BLACK) at each side of the vehicle. Make sure the wires go through all mounting spots. Firmly mount the wires with zip ties and small white wire hooks.
8. Connect each pod to the main power wires: Use the provided red Extension Connectors to clip the positive wire of each LED pod (**wire with DASHED LINES**) onto the RED main power line. And then clip the negative wire of each LED pod (**SOLID BLACK wire**) onto the BLACK main power line with the same method.
9. Use provided zip ties and wire hooks to neatly mount and hide any loose wires. Make sure they are not near any hot parts. Locate the ON/OFF switch in a convenient location. Connect the crimping wire terminals to the positive and negative poles of the battery (see above diagram). Install the fuse into the fuse holder. Turn on the kit and adjust the light pods for best lighting effect. Firmly attach the light pods or brackets with 3M double side tape. Use zip ties to secure the pods/wires if necessary.
10. Tightly wrap waterproof tapes around all red Extension Connectors and level connectors to protect the lights against water and moisture.

Accessories User Guide

Crimping Connector

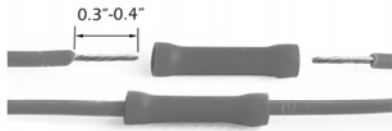

1 Insert the stripped wires into the crimping connector.



2

It is best to use a crimping tool to crimp the wires. If you don't have one, use regular plier to flatten the inner metal tube of the connector. Do not use too much force or damage to the connector will occur.



3

Make sure the wire is tightly fixed with the connector. Apply the waterproof tape around the connection.

Crimping Wire Terminal

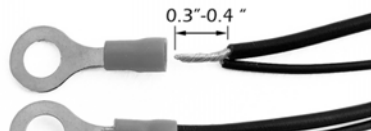

1

Insert the stripped wire into the crimping wire terminal



2

It is best to use a crimping tool to crimp the wires. If you don't have one, use regular plier to flatten the inner metal tube of the connector. Do not use too much force or damage to the connector will occur.



3

Make sure the wire is tightly fixed with the terminal tube.

Waterproof Tape

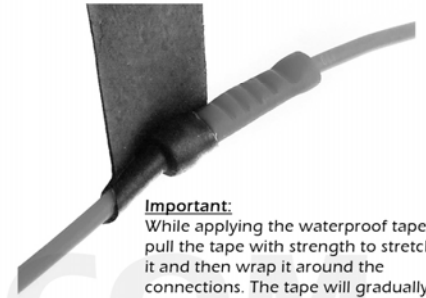

Important:

While applying the waterproof tape, pull the tape with strength to stretch it and then wrap it around the connections. The tape will gradually shrink later to seal the connection tightly.

Wire Clip



You can use the wire clip to attach wires along the bike frame or any appropriate surface. NEVER directly attach it onto extremely hot areas such as engine and exhaust pipes.

How To Use Splitter

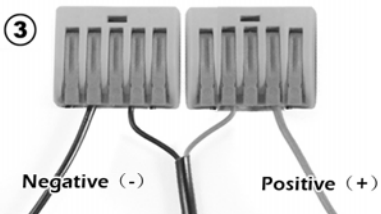
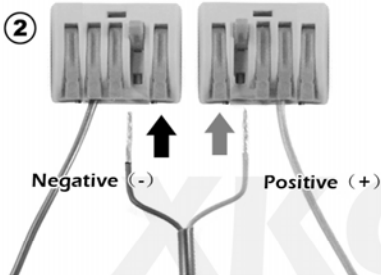
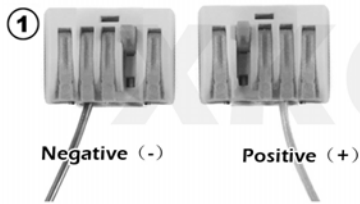

Use the Lever Connector to easily attach wires with same pole. NEVER connect different pole wires in one connector.

How To Use Extension Connector

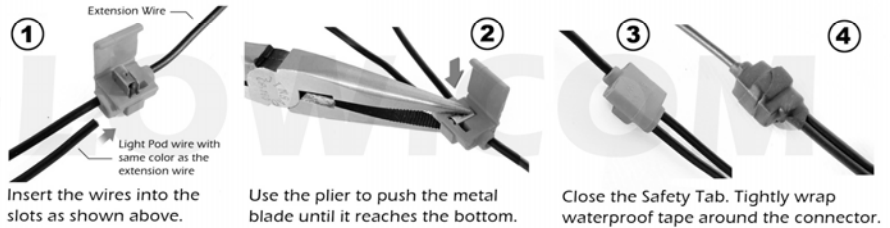

Usages of 90 Degree Mounting Bracket

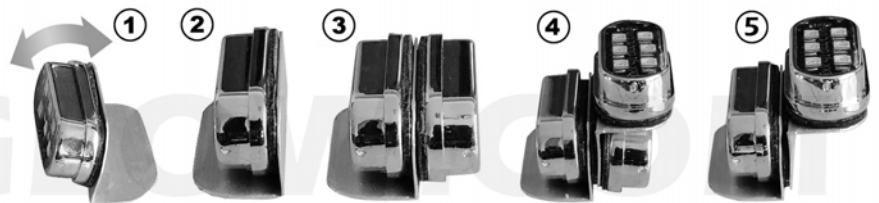

Upgrade Option: Remote Control Module (Not Included)

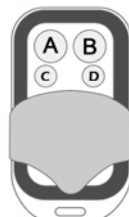

- A) Auto Cycle Pattern
- B) Strobe Pattern
- C) Breath Pattern
- D) ON/OFF

This control module is built with a special circuit design that outputs 8A MAX. Current, this feature gives you plenty of room for upgrading light pods and strips.

- 1) SOLID: All LED lights stay steady on.
- 2) STROBE: All lights wildly strobe and definitely make your bike stand out.
- 3) BREATH: The remote control slowly decreases the LEDs from full brightness down to dim then slowly increases the LED intensity back to full brightness and then repeats. With this function the bike will appear to be "breathing".
- 4) Automatically cycle between strobe mode and breath mode.