



Weasler®

*AFTERMARKET
PRODUCT GUIDE*

***NORTH AMERICAN
DRIVELINES & COMPONENTS***

***N.A. DRIVELINE
& COMPONENTS***

SAFETY SECTION

WARNING!

- Be certain to disengage PTO shaft and to turn off the tractor before making any operational maintenance inspections or repairs. Keep clear of the machine until all parts have stopped moving.
- NEVER operate an implement with driveline guards missing or in a damaged condition.
- Guards must rotate freely on the yokes.

SAFETY DECALS



PART NO.: 13-10022

IMPORTANT

- CHECK THAT *GUARD MISSING DECAL* ON STEEL TUBE UNDER INNER GUARD AND *ROTATING DRIVELINE DECAL* ON OUTER GUARD ARE FIRMLY AFFIXED, UNDAMAGED AND READABLE - **IF NOT, REPLACE.**
- GUARDS MUST ROTATE FREELY ON YOKES



PART NO.: 13-10021

FOR USE ON
IMPLEMENT END
ONLY



ALL CLUTCHES MUST BE USED ON THE IMPLEMENT END ONLY
Yellow decal is provided on clutch.

SAFETY MANUAL -

The *Agricultural Driveline Manufacturers Association (ADMA)* has printed a Safety Manual for owners and operators of agricultural machinery. Copies can be ordered from Weasler.
PART NO.: 56-15123

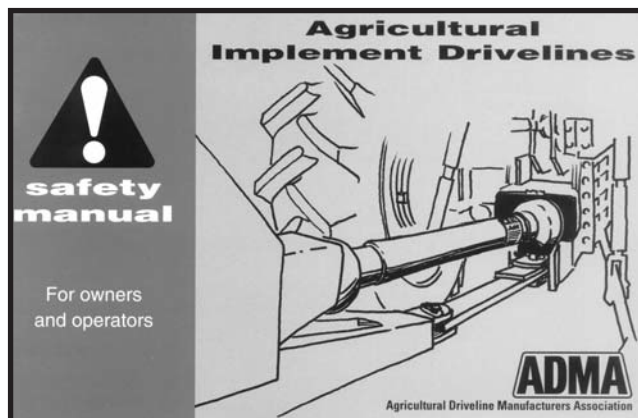

EASY LOCK GUARD SYSTEM

INSTRUCTIONS FOR REMOVAL AND INSTALLATION OF EASY LOCK GUARDS

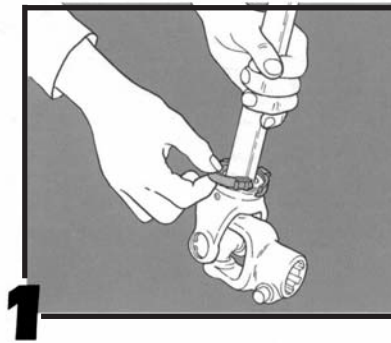
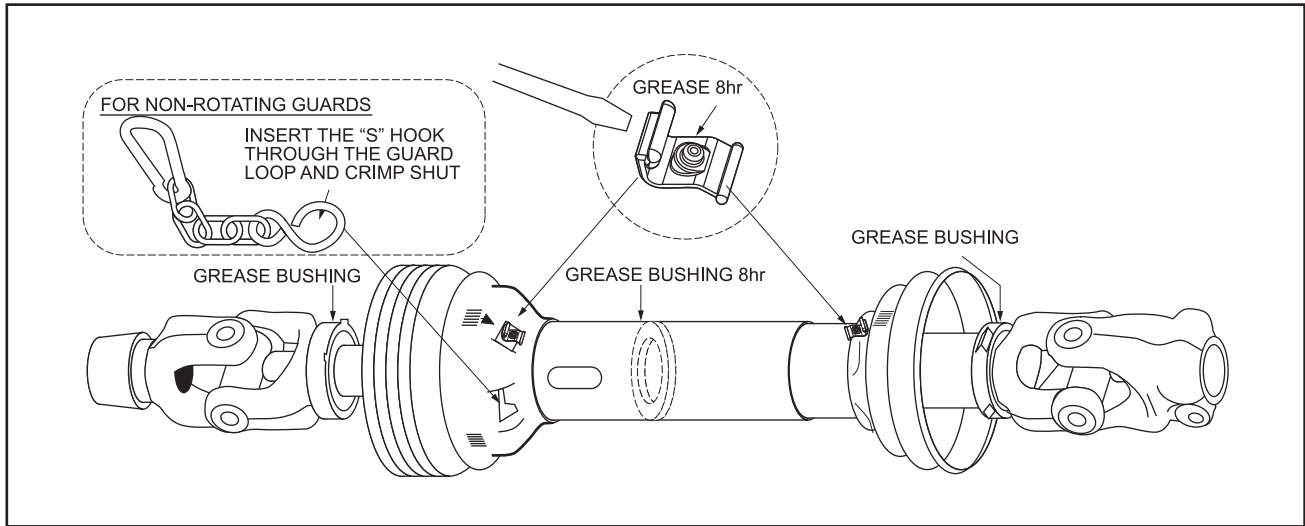

1 Clean and grease bearing raceway before the nylon bearing is placed in the groove. Grease any remaining nylon bearings in guard.

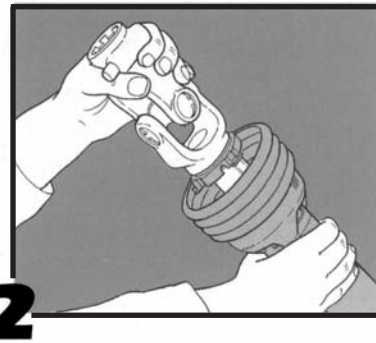

2 Slide guard half over driveline and insert nylon bearing tabs into the openings in the guard.

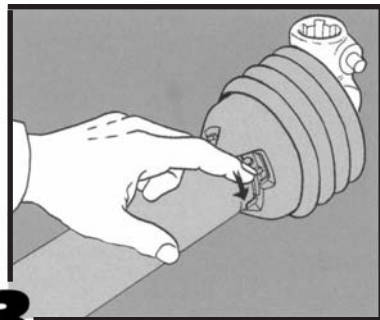

3 Turn the nylon bearing until it engages into the guard.

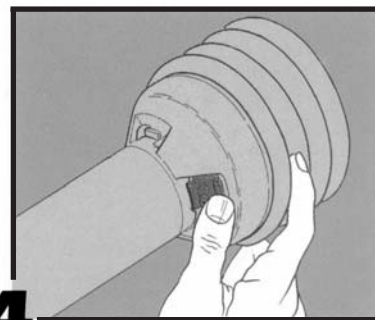

4 Push *Easy Lock* clip into position. The nylon bearing and guard are now secure. **GUARDS MUST ROTATE FREELY ON YOKES.**

5 **TO REMOVE GUARD** - Use screwdriver to release *Easy Lock* clip. Turn the nylon bearings to disengage from the guard and remove guard.

GREASING RECOMMENDATIONS

Be certain to follow greasing instructions as identified below:

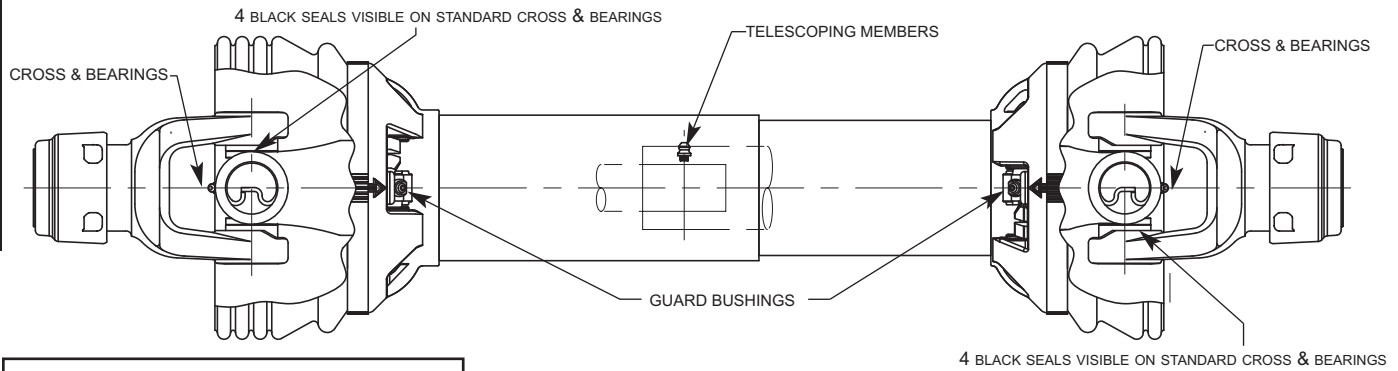

TELESCOPING DRIVELINES

LUBRICATE ALL FITTINGS WITH A GOOD QUALITY LITHIUM SOAP COMPATIBLE E.P. GREASE MEETING THE N.L.G.I. #2 SPECIFICATIONS AND CONTAINING NO MORE THAN 1% MOLYBDENUM DISULFIDE.

AN E.P. GREASE MEETING THE N.L.G.I. #2 SPECIFICATIONS AND CONTAINING 3% MOLYBDENUM DISULFIDE MAY BE SUBSTITUTED IN THE TELESCOPING MEMBERS ONLY.

LOCATION	STANDARD INTERVAL	EXTENDED LUBE INTERVAL	LEVER ACTION PUMPS
CROSS & BEARINGS	*8 HRS.	50 HRS.	2-3
TELESCOPING MEMBERS	8 HRS.	50 HRS.	8-10
CE & NON-ROTATING GUARD BUSHINGS (1000 RPM MAX.)	8 HRS.	50 HRS.	2

ROTATING GUARD BUSHINGS SHOULD BE LUBRICATED UPON REPLACEMENT

*CONSTANT ANGLE APPLICATIONS MAY REQUIRE A LUBE INTERVAL OF 4 HOURS

CAUTION!! REPLACEMENT PARTS ARE NOT LUBRICATED

REPLACEMENT PARTS MUST BE LUBRICATED AT TIME OF ASSEMBLY AND DURING USE PER THE LUBE RECOMMENDATIONS

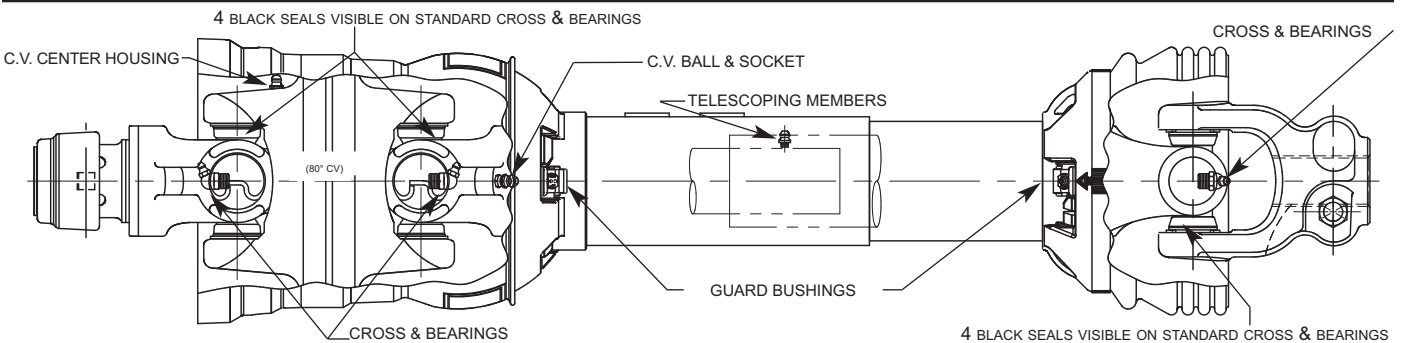

80° CONSTANT VELOCITY DRIVELINES

LUBRICATE ALL FITTINGS WITH A GOOD QUALITY LITHIUM SOAP COMPATIBLE E.P. GREASE MEETING THE N.L.G.I. #2 SPECIFICATIONS AND CONTAINING NO MORE THAN 1% MOLYBDENUM DISULFIDE.

AN E.P. GREASE MEETING THE N.L.G.I. #2 SPECIFICATIONS AND CONTAINING 3% MOLYBDENUM DISULFIDE MAY BE SUBSTITUTED IN THE TELESCOPING MEMBERS ONLY.

LOCATION	STANDARD INTERVAL	EXTENDED LUBE INTERVAL	LEVER ACTION PUMPS
CROSS & BEARINGS	*8 HRS.	50 HRS.	2-3
TELESCOPING MEMBERS	8 HRS.	50 HRS.	8-10
CV BALL & SOCKET	*8 HRS.	50 HRS.	4-6
CV CENTER HOUSING	24 HRS.	50 HRS.	12-15
CE & NON-ROTATING GUARD BUSHINGS (1000 RPM MAX.)	8 HRS.	50 HRS.	2

ROTATING GUARD BUSHINGS SHOULD BE LUBRICATED UPON REPLACEMENT

*CONSTANT ANGLE APPLICATIONS MAY REQUIRE A LUBE INTERVAL OF 4 HOURS

CAUTION!! REPLACEMENT PARTS ARE NOT LUBRICATED

REPLACEMENT PARTS MUST BE LUBRICATED AT TIME OF ASSEMBLY AND DURING USE PER THE LUBE RECOMMENDATIONS

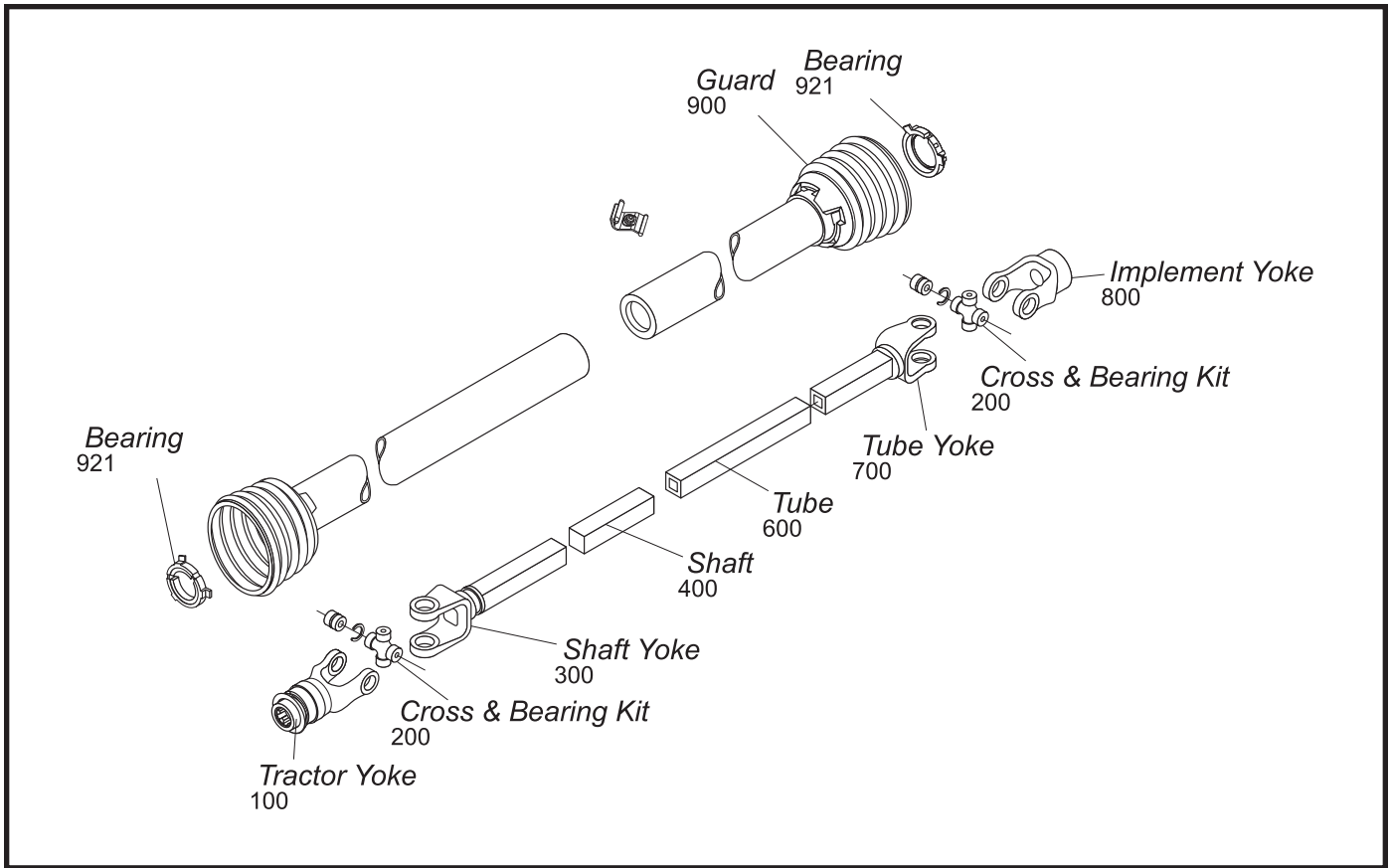

Each series has an exploded view for identification purposes. The drawing illustrates the components in the same sequence as an implement input driveline transmitting power from tractor to implement. Each component of the exploded view is identified by an eight digit stock number to insure correct identification of each component.

Example: 100 prefix denotes a Spring-Lok Tractor Yoke on the exploded view.
 [When ordering a tractor yoke, be sure the stock number begins with 100.]

Number Identification Examples:

102 - 06 06
 6 Spline
 6 Series
 QD Yoke
 Tractor Yoke

200 - 06 00
 6 Series
 Cross & Bearing Kit

300 - 12 00
 12 Series
 Shaft Weld Yoke

400 - 16 -18
 *1 1/8"
 *1"
 Shaft

500 - 35 00
 35 Series
 Slip Sleeve

602 - 44 00
 44 Series
 Tube

701 - 44 00
 44 Series
 Tube Weld Yoke

800 - 35 24
 *1 1/2" Round Bore
 35 Series
 Implement Yoke

900 - 45 48
 For 48" O.A. Driveline
 Guard Type
 Plastic Guard

(* Expressed in 1/16th inches)

TRANSPARENCY IDENTIFICATION SYSTEM

for Driveline Components
(Stock No. 12002500)

The individual transparency cards will allow the user to easily identify driveline components. Cross and Bearing Kits may be identified by the bearing cap outside diameter and the width of the cross. Yokes may be identified by the hole in the ear and profile. Tubes and shafts may be identified by the end sections.

How to use the Transparency Identification System:

1. Match the part to be replaced with the corresponding transparency card for identification.
2. Select the proper stock number for the replacement part.

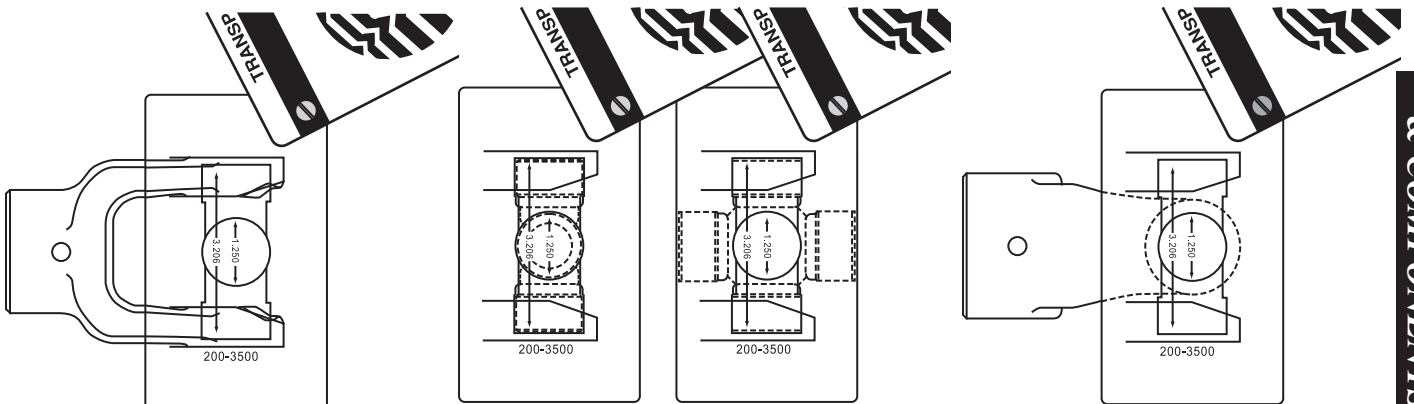
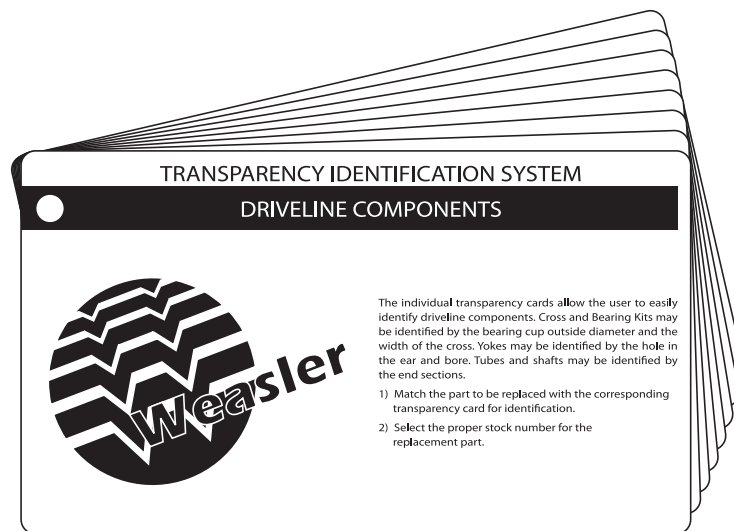

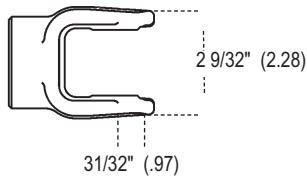

6 Series

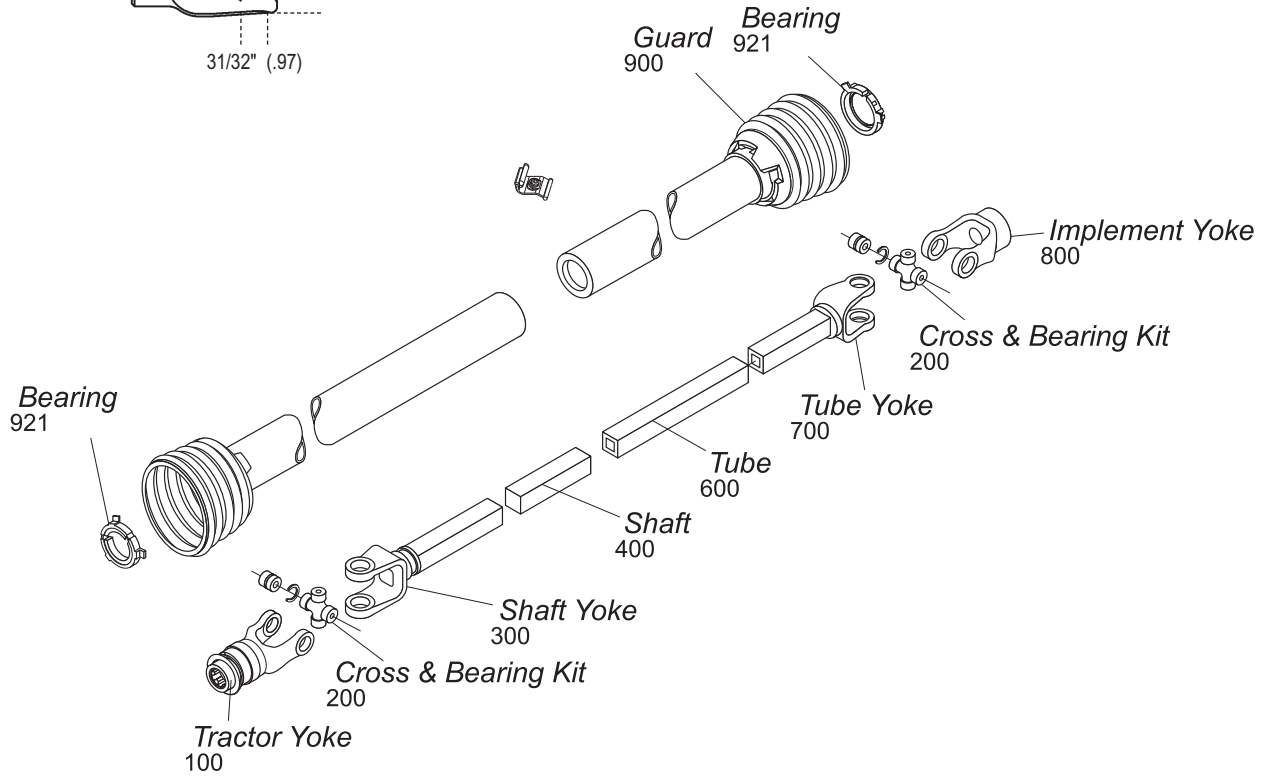

Tractor Yoke

Spring-Lok

Repair Kit — Page 83

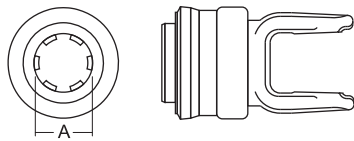

Stock Number	Dim. "A" Bore
100-0606	1 3/8" x 6 Spl.
100-0621	1 3/8" x 21 Spl.

Spring-Lok (metal collar)

Repair Kit — Page 83

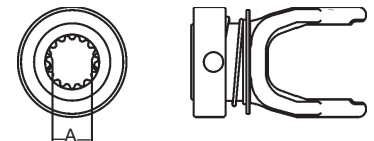

Stock Number	Dim. "A" Bore
105-0610	.98" x 10 Spl.
105-0615	1" x 15 Spl.

Auto-Lok

Repair Kit — Page 83

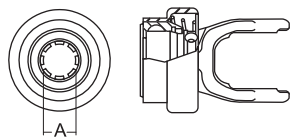

Stock Number	Dim. "A" Bore
101-0610	.981" x 10 Spl.
101-0615	1" x 15 Spl.

Male Spline

Lawn & Garden

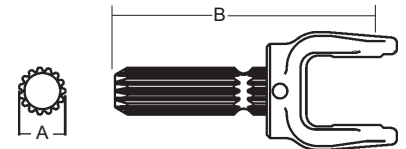

Stock Number	Dim. "A"	Dim. "B"
106-0615	1" x 15 Spl.	5.38

Quick Disconnect

Repair Kit — Page 83

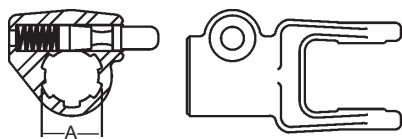

Stock Number	Dim. "A" Bore
102-0606	1 3/8" x 6 Spl.
102-0621	1 3/8" x 21 Spl.

Cross & Bearing Kit (R-Kit)

Snap Ring Located in Bushing

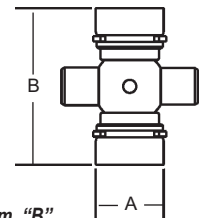

Stock Number	Dim. "A"	Dim. "B"
200-0600	31/32"	2 9/32"

Extended Lubrication Cross & Bearing Kit (E-Kit)

Snap Ring Located in Bushing

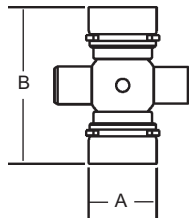

Stock Number	Dim. "A"	Dim. "B"
201-0600	3 1/32"	2 9/32"

Shaft Weld Yoke

With Bearing Groove
(Guard must rotate freely on yoke)

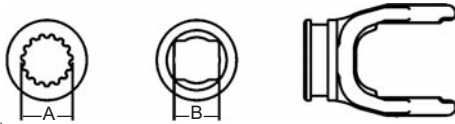

Stock Number	Dim. "A" Bore	Dim. "B" Bore	
300-0600		3/4" x 7/8"	(2 1/2" CL)
302-0600	1" x 15 Spl.		
303-0600		3/4" x 7/8"	(2 1/4" CL)

Without Bearing Groove

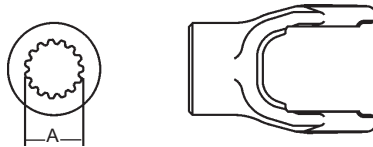

Stock Number	Dim. "A" Bore
301-0600	1" x 15 Spl.

Shaft

3/4" x 7/8" Rectangular

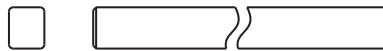

Stock Number	Length
400-1214	6'
401-1214	10'
404-1214	3'

1" x 15 Spline
(Induction Hardened)



Stock Number	Length
404-1615H	3'

Slip Sleeve

With Grease Groove

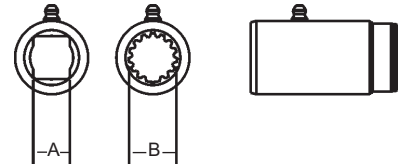

Stock Number	Length	Dim. "A" Bore	Dim. "B" Bore	Fits Tube Size
510-0600	4"	3/4" x 7/8" Rect		1 1/2" (.065 Wall)
510-0615	3"		1" x 15 Spl.	1 1/2" (.065 Wall)

Tube

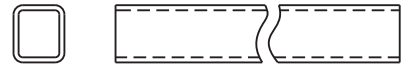

1" x 1 1/8" Rectangular O.D.

Stock Number	Length	Fits Shaft
600-1618	6'	3/4" x 7/8"
601-1618	10'	3/4" x 7/8"
604-1618	3'	3/4" x 7/8"

1 1/2" Round (.065 Wall) O.D.



Stock Number	Length
602-0600	6'
604-0600	3'

Tube Weld Yoke

With Bearing Groove
(Guard must rotate freely on yoke)

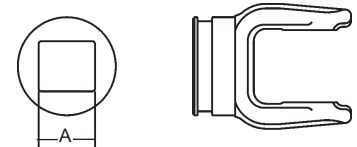

Stock Number	Dim. "A" Bore	Fits Tube Size
700-0600	1" x 1 1/8"	
701-0600		1 1/2" (.065 Wall)

(Guard must rotate freely on yoke)

Stock Number	Fits Tube Size
702-0600 (without Bearing Groove)	1 1/2" (.065 Wall)
703-0600 (with Groove)	1 1/2" (.065 Wall)

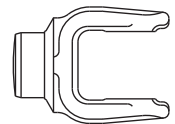

6 Series (cont'd.)

Implement Yoke

Round Bore

With Keyway & Set Screw

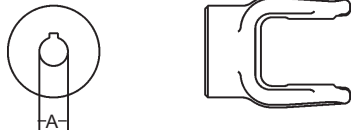

Stock Number	Dim. "A" Bore	Standard Keyway
800-0610	5/8"	3/16"
800-0612	3/4"	3/16"
800-0613	13/16"	3/16"
800-0614	7/8"	3/16"
800-0615	15/16"	1/4"
800-0616	1"	1/4"
800-0618	1 1/8"	1/4"
800-0619	1 3/16"	1/4"
800-0620	1 1/4"	1/4"

Square Bore

With Set Screw

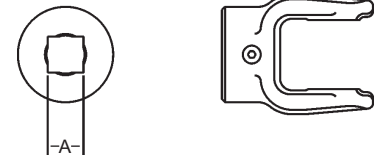

Stock Number	Dim. "A" Bore
804-0612	3/4"
804-0614	7/8"
804-0616	1"
804-0618	1 1/8"
804-0620	1 1/4"

Spline Bore

With 1/4" Pin Hole

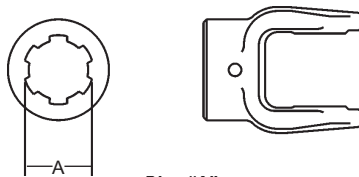

Stock Number	Dim. "A" Bore
801-0606	1 3/8" x 6 Spl.
801-0618	1 1/8" x 6 Spl.

Round Bore

Double Keyway & Set Screw

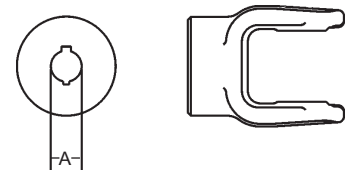

Stock Number	Dim. "A" Bore	Double Keyway
806-0612	3/4"	3/16" & 1/4"
806-0613	13/16"	3/16" & 1/4"
806-0614	7/8"	3/16" & 1/4"
806-0616	1"	3/16" & 1/4"
806-0618	1 1/8"	1/4" & 5/16"
806-0619	1 3/16"	1/4" & 5/16"
806-0620	1 1/4"	1/4" & 5/16"

Shear Pin

With 1/4" Pin Hole

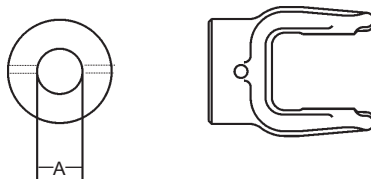

Stock Number	Dim. "A" Bore
802-0616	1"
802-0618	1 1/8"
802-0620	1 1/4"

Clamp Yoke

With Bolt Hole & Set Screw

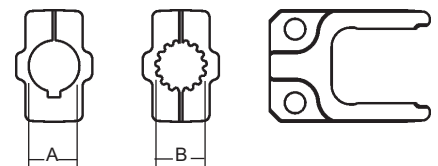

Stock Number	Dim "A" Bore	Dim "B" Bore	Keyway
807-0614	7/8"		3/16"
807-0615		1" x 15 Spl.	
807-0616	1"		1/4"

Stock Bore

With Hub O. D. Turned

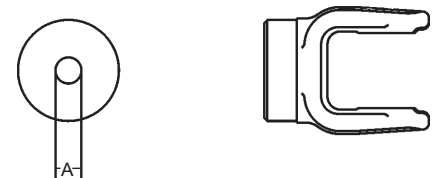

Stock Number	Dim "A" Bore
809-0608	1/2"

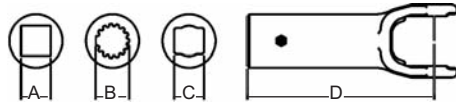

Slip Sleeve Yoke

Stock Number	Dim. "A" Bore	Dim. "B" Bore	Dim. "C" Bore	Dim "D" Length
808-0612	3/4" Sq.			5 1/2"
808-0614	7/8" Sq.			5 1/2"
812-0615		1" x 15 Spl.		5 1/2"
813-0600			3/4" x 7/8" Rect.	5 1/2"

Yoke & Tube Assembly

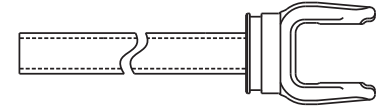

1" x 1 1/8" Tube

Stock Number	Fits Shaft	Centerline to End of Tube Dimension
11000648	3/4" x 7/8"	38.75"

Yoke & Shaft Assembly

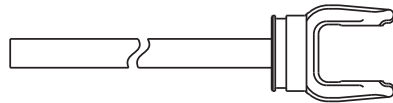

Stock Number	Shaft Size	Centerline to End of Shaft Dimension
10000610	1" x 15 Spl.	12.50"
10000648	3/4" x 7/8"	38.75"

Guard

Order Bushings As Required

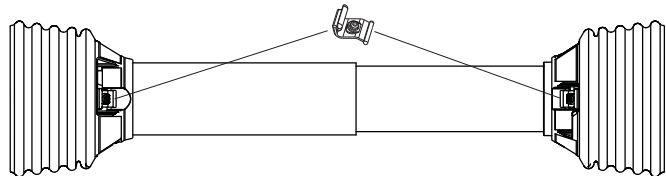

Stock Number	Overall Driveline Length	Bearing Kit (4-per kit)
900-2548	48"	921-0600
900-2560	60"	921-0600

Assembly instructions included with guard

Note: When installing Guards observe the following:

- 1) Install proper nylon bearing (See Page 13)
- 2) Guards must rotate freely on yokes

Easy Lock™ Replacement Kit

Part Number: 13005000 (4-per Kit)



6 Series (cont'd.)

Universal Joints

Round To Round

Furnished with Keyway & Set Screw



Stock Number	Dim. "A" Bore
15120612	3/4"
15160616	1"

Drivelines

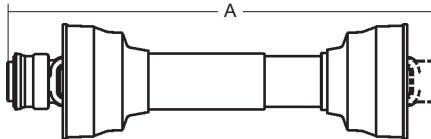

Drivelines are furnished without Cross & Bearing Kit and Implement Yoke. Select kit and Implement Yoke as required. When Cross & Bearing Kit and Implement Yoke are assembled, the overall compressed length of the driveline will be 48".

Stock Number	Tractor Yoke	Overall Compressed Length Dim. "A"
14000648	1 3/8" x 6 Spl. Spring Lok	48"

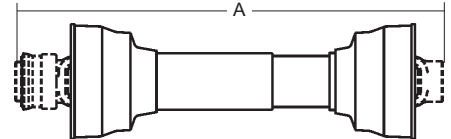

Drivelines are furnished without Cross & Bearing Kit and Outboard Yokes. Select kit and outboard yokes as required. When Cross & Bearing Kit and outboard yokes are assembled, the overall compressed length of the driveline will be 48".

Stock Number	Overall Compressed Length Dim. "A"
14010648	48"

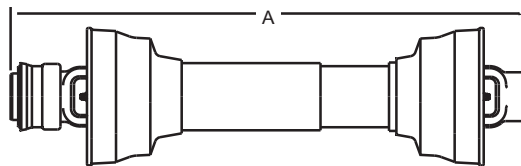

Stock Number	Tractor Yoke	Implement Yoke	Overall Compressed Length Dim. "A"	Application
14000600	1 3/8" x 6 Spl. Spring Lok	1" Round with 1/2" Pin Hole	39"	Finishing Mower
14000605	1 3/8" x 6 Spl. Spring Lok	1" Round with 5/16" Pin Hole	39"	All Purpose
14000616	1 3/8" x 6 Spl. Spring Lok	1" Round 1/4" Keyway	48"	Auger
14000620	1 3/8" x 6 Spl. Spring Lok	1 3/8" x 6 Spl. Spring Lok	27 1/4"	Fertilizer Spreader
14000638	1 3/8" x 6 Spl. Q.D.	1" Round with Pinhole	38"	All Purpose

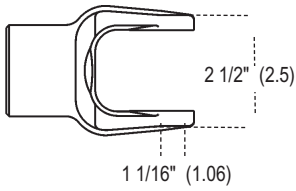

12 Series

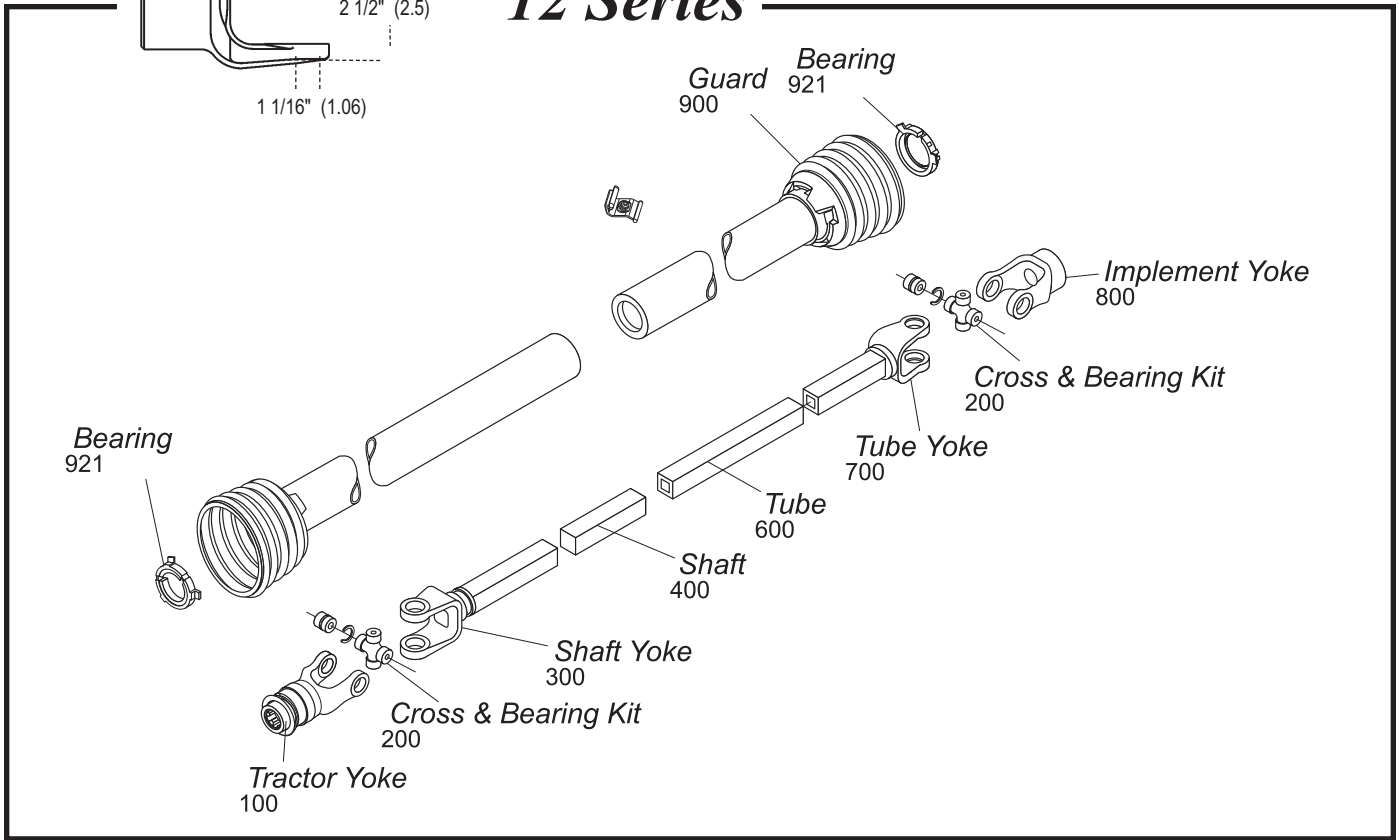

Tractor Yoke

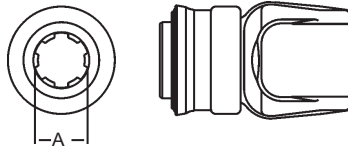

Spring-Lok
Repair Kit — Page 83

Stock Number	Dim. "A" Bore
100-1206	1 3/8" × 6 Spl.
100-1221	1 3/8" × 21 Spl.

Ball Shear Device
With Spring-Lok
Repair Kit — Page 83

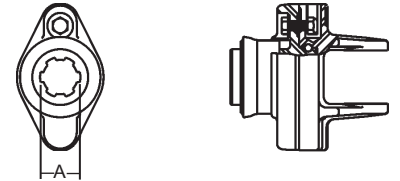

Stock Number	Dim. "A" Bore	Shear Bolt
104-1206	1 3/8" × 6 Spl.	5/16" - 18 Gr. 5
104-1221	1 3/8" × 21 Spl.	5/16" - 18 Gr. 5

Quick Disconnect
Repair Kit — Page 83

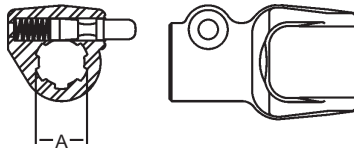

Stock Number	Dim. "A" Bore
102-1206	1 3/8" × 6 Spl.
102-1221	1 3/8" × 21 Spl.

Cross & Bearing Kit (R-Kit)

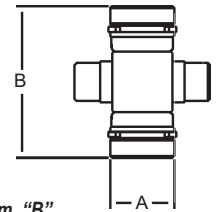

Snap Ring Located in Bushing

Stock Number	Dim. "A"	Dim. "B"
200-1200	1 1/16"	2 1/2"

Extended Lubrication Cross & Bearing Kit (E-Kit)

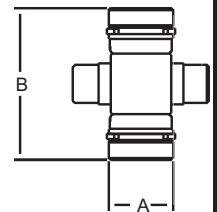

Snap Ring Located in Bushing

Stock Number	Dim. "A"	Dim. "B"
201-1200	1 1/16"	2 1/2"

12 Series (cont'd.)

Shaft Weld Yoke

With bearing groove
(Guard must rotate freely on yoke)

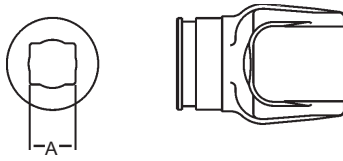

Stock Number	Dim. "A" Bore
300-1200	1" x 1 1/8"
301-1200	15/16" Sq.

Tube Weld Yoke

With bearing groove
(Guard must rotate freely on yoke)

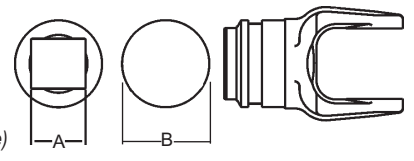

Stock Number	Dim. "A" Bore	Dim. "B" Fits Tube Size
700-1200	1 1/4" x 1 3/8"	
701-1200		2" (.083 Wall)
702-1200	15/16" Sq.	

Shaft



1" x 1 1/8" Rectangular

Stock Number	Length
400-1618	6'
401-1618	10'
404-1618	3'

Implement Yoke

Round Bore
With Keyway & Set Screw

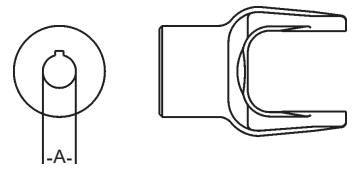

Stock Number	Dim. "A" Bore	Standard Keyway
800-1212	3/4"	3/16"
800-1214	7/8"	3/16"
800-1215	15/16"	1/4"
800-1216	1"	1/4"
800-1218	1 1/8"	1/4"
800-1219	1 3/16"	1/4"
800-1220	1 1/4"	1/4"
800-1222	1 3/8"	5/16"
800-1224	1 1/2"	3/8"

Slip Sleeve

With Grease Groove

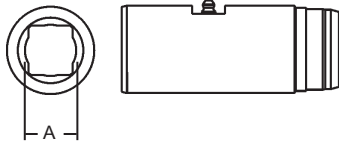

Stock Number	Dim. "A" Bore	Length	Fits Tube Size
500-1400	1" x 1 1/8" Rect.	5"	2" (.083 Wall)

Tube

1 1/4" x 1 3/8"
Rectangular O.D.



Stock Number	Length	Fits Shaft
600-2022	6'	1" x 1 1/8"
601-2022	10'	1" x 1 1/8"
604-2022	3'	1" x 1 1/8"

Spline Bore

With 21/64" Pin Hole

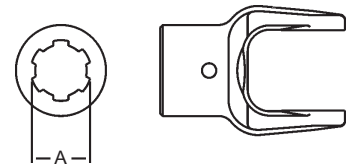

Stock Number	Dim. "A" Bore
801-1206	1 3/8" x 6 Spl.
801-1210*	1 3/16" x 10 Spl.
801-1213	.90" x 13 Spl. w/Set Screw
801-1218	1 1/8" x 6 Spl.
801-1221	1 3/8" x 21 Spl.

*No Pin Hole

2" (.083 Wall)



Stock Number	Length
602-1400	6'
603-1400	10'
604-1400	3'

Shear Pin

With 1/4" Pin Hole

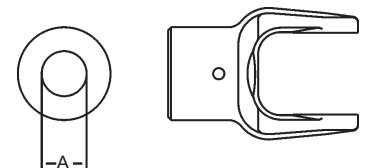

Stock Number	Dim. "A" Bore
802-1216	1"
802-1218	1 1/8"
802-1220	1 1/4"
802-1222	1 3/8"

Square Bore
With Set Screw

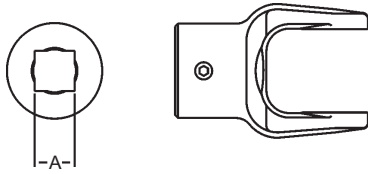

Stock Number	Dim. "A" Bore
804-1214	7/8"
804-1216	1"
804-1218	1 1/8"
804-1220	1 1/4"

Slip Yoke

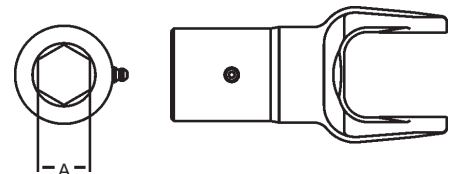

Stock Number	Dim. "A" Bore
808-1216	1" Sq.
810-1216	1" Rd. w/1/4" Keyway
810-1218	1 1/8" Rd. w/5/16" Keyway
811-1218	1 1/8" Hex

Hexagon Bore
With Set Screw

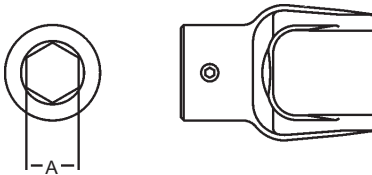

Stock Number	Dim. "A" Bore
805-1218	1 1/8"

Yoke & Shaft Assembly

1" x 1 1/8"
Rectangular Shaft

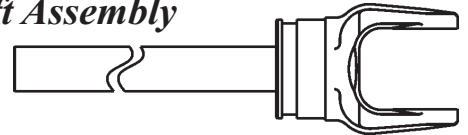

Stock Number	Centerline to End of Shaft Dimension
10001248	37.38"
10001260	49.38"

Round Bore
Double Keyway & Set Screw

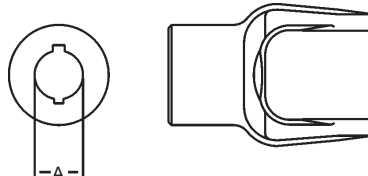

Stock Number	Dim. "A" Bore	Double Keyway
806-1216	1"	1/4" & 3/16"
806-1218	1 1/8"	1/4" & 5/16"
806-1220	1 1/4"	1/4" & 5/16"

Yoke & Tube Assembly

1 1/4" x 1 3/8" Tube

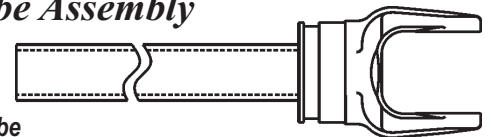

Stock Number	Fits Shaft	Centerline to End of Tube Dimension
11001248	1" x 1 1/8"	37.38"
11001260	1" x 1 1/8"	49.38"

Stock Bore
With Hub O.D. Turned

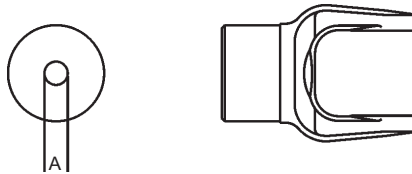

Stock Number	Dim. "A" Bore
809-1208	1/2"

Guard

Order Bearings as Required

Stock Number	Overall Driveline Length	Bearing Kit (4-per kit)
900-2548	48"	921-1200
900-2560	60"	921-1200

Assembly instructions included with guard

Note: When installing Guards observe the following:

- 1) Install proper nylon bearing (See Page 13)
- 2) Guards must rotate freely on yokes

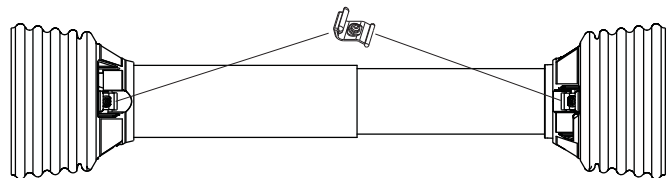

Easy Lock™ Replacement Kit

Part Number: 13005000 (4-per Kit)



12 Series (cont'd.)

Universal Joint



Spring Lok to Shaft Weld Yoke

Repair Kit — Page 83

Stock Number	Dim. "A" Bore	Dim. "B" Bore
15061200	1 3/8" x 6 Spl.	1" x 1 1/8" Rect.

Drivelines

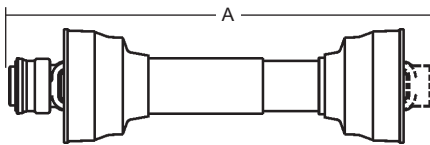

Drivelines are furnished without Cross & Bearing Kit and Implement Yoke. Select kit and implement yoke as required. When Cross & Bearing Kit and Implement Yoke are assembled, the overall compressed length of the driveline will be 48" or 60".

Stock Number	Tractor Yoke	Overall Compressed Length Dim. "A"
14001248	1 3/8" x 6 Spl. Spring-Lok	48"
14001260	1 3/8" x 6 Spl. Spring-Lok	60"

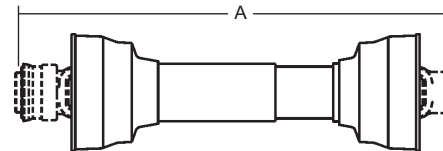

Drivelines are furnished without Cross & Bearing Kit and Outboard Yokes. Select kit and outboard yokes as required. When Cross & Bearing Kit and outboard Yokes are assembled, the overall compressed length of the driveline will be 48" or 60".

Stock Number	Overall Compressed Length Dim. "A"
14011248	48"
14011260	60"
14021248 (With crosses installed)	48"
14031248 (With 15/16" Sq. Shaft)	48"

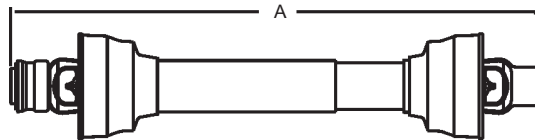

Stock Number	Tractor Yoke	Implement Yoke	Overall Compressed Length Dim. "A"	Application
14001200	1 3/8" x 6 Spl Q.D.	1 1/4" Rd 1/4" Keyway	48"	Post Hole Digger
14001220	1 3/8" x 6 Spl. Spring Lok	1 1/4" Rd 1/4" Keyway	48"	Augers

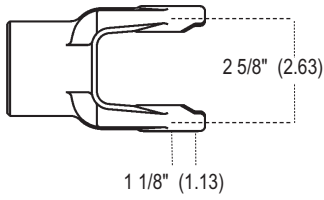

14 Series

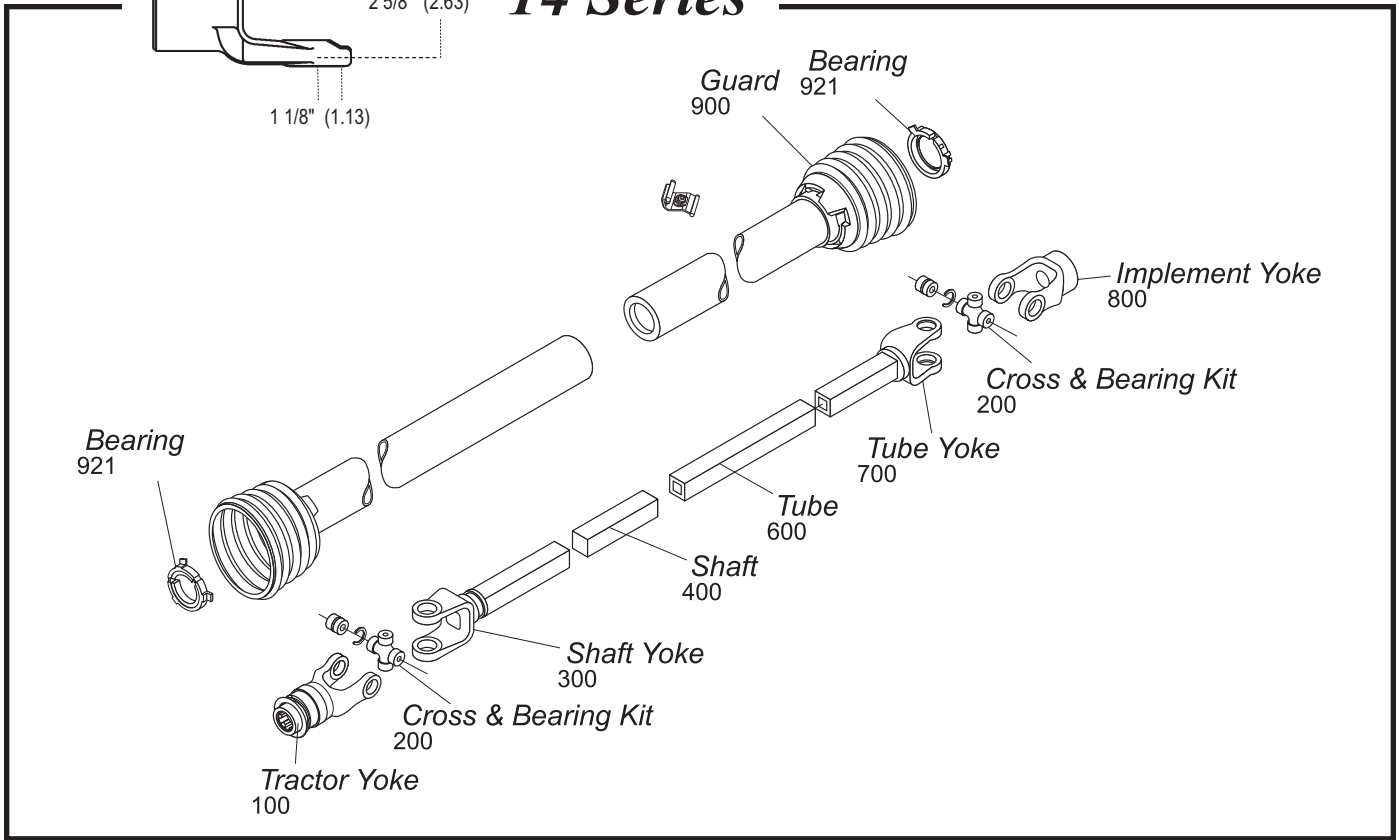

Tractor Yoke

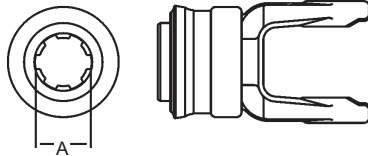

Spring-Lok
Repair Kit — Page 83

Stock Number	Dim. "A" Bore
100-1406	1 3/8" × 6 Spl.
100-1421	1 3/8" × 21 Spl.

Quick Disconnect
Repair Kit — Page 83

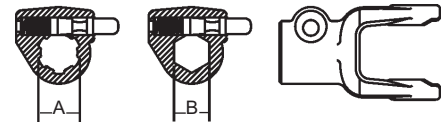

Stock Number	Dim. "A" Bore	Dim. "B" Bore
102-1406	1 3/8" × 6 Spl.	
102-1418		1 1/8" Hex
102-1421	1 3/8" × 21 Spl.	

Safety Slide Lock
Repair Kit — Page 83

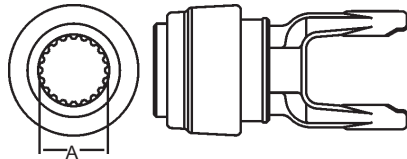

Stock Number	Dim. "A" Bore
101-1420	1 3/4" × 20 Spl.

Ball Shear Device
With Spring-Lok
Repair Kit — Page 83

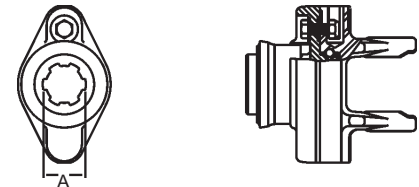

Stock Number	Dim. "A" Bore	Shear Bolt
104-1406	1 3/8" × 6 Spl.	5/16" - 18 Gr. 5
104-1421	1 3/8" × 21 Spl.	5/16" - 18 Gr. 5

14 Series (cont'd.)

Cross & Bearing Kit (R-Kit)

Snap Ring Located in Yoke

Stock Number	Dim. A	Dim. B
200-1400	1 1/8"	2 5/8"

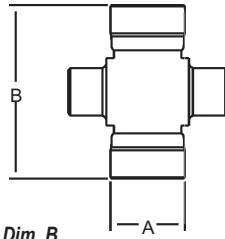

Extended Lubrication Cross & Bearing Kit (E-Kit)

Snap Ring Located in Yoke

Stock Number	Dim. A	Dim. B
201-1400	1 1/8"	2 5/8"

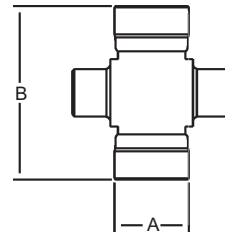

Shaft Weld Yoke

With Bearing Groove
(Guard must rotate freely on yoke)

Stock Number	Dim. "A" Bore	Dim. "B" Bore
300-1400	1" x 1 1/8"	
301-1400		1 5/16" x 20 Spl.

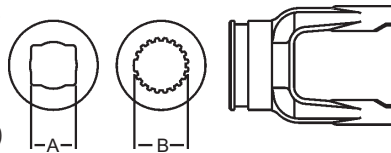

Shaft

1" x 1 1/8" Rectangular

Stock Number	Length
400-1618	6'
401-1618	10'
404-1618	3'



1 5/16" x 20 Spline
Induction Hardened

Stock Number	Length	Major Dim.
404-2120	3'	1.380/1.375



Slip Sleeve

1" x 1 1/8" Rectangular
With Grease Groove

Stock Number	Length	Fits Tube Size
500-1400	5"	2" (.083 Wall)

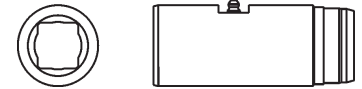

1 5/16" x 20 Spline
With Grease Reservoir

Stock Number	Length	Fits Tube Size
501-1400	8"	2" (.083 Wall)

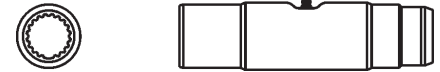

Tube

1 1/4" x 1 3/8"
Rectangular O.D.

Stock Number	Length	Fits Shaft
600-2022	6'	1" x 1 1/8"
601-2022	10'	1" x 1 1/8"
604-2022	3'	1" x 1 1/8"



2" Round (.083 Wall)

Stock Number	Length
602-1400	6'
603-1400	10'
604-1400	3'



Tube Weld Yoke

With Bearing Groove
(Guard must rotate freely on yoke)

Stock Number	Dim. "A" Bore	Dim. "B" Fits Tube Size
700-1400	1 1/4" x 1 3/8"	
701-1400		2" (.083 Wall)

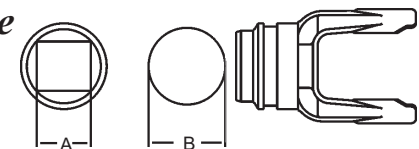

Implement Yoke

Round Bore
With Keyway & Set Screw

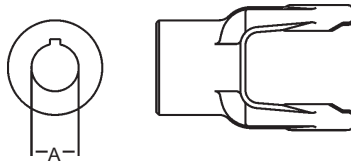

Stock Number	Dim. "A" Bore	Standard Keyway
800-1416	1"	1/4"
800-1418	1 1/8"	1/4"
800-1419	1 3/16"	1/4"
800-1420	1 1/4"	1/4"
800-1422	1 3/8"	5/16"
800-1423	1 7/16"	3/8"
800-1424	1 1/2"	3/8"

Square Bore
With Set Screw



Stock Number	Dim. "A" Bore
804-1414	7/8"
804-1416	1"
804-1418	1 1/8"
804-1419	1 3/16"
804-1420	1 1/4"

Spline Bore
With 21/64" Pin Hole

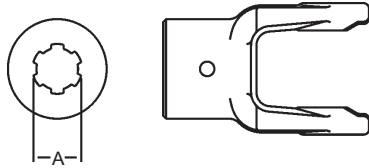

Stock Number	Dim. "A" Bore
801-1406	1 3/8" x 6 Spl.
801-1418	1 1/8" x 6 Spl.
801-1420	1 1/4" x 6 Spl.
801-1421	1 3/8" x 21 Spl.

Hexagon Bore
With Set Screw

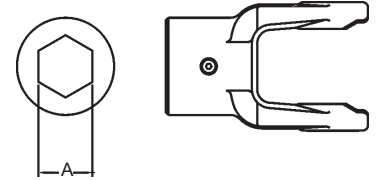

Stock Number	Dim. "A" Bore
805-1418	1 1/8"
805-1420	1 1/4"

Shear Pin
With 1/4" Pin Hole

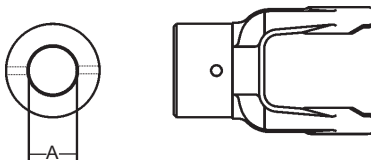

Stock Number	Dim. "A" Bore
802-1418	1 1/8"
802-1420	1 1/4"
802-1422*	1 3/8"
802-1424	1 1/2"

* with 1/4" and 1/2" Pin Hole.

Round Bore
Double Keyway & Set Screw

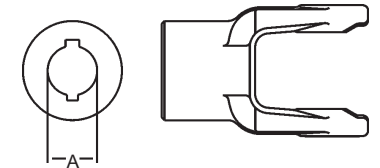

Stock Number	Dim. "A" Bore	Double Keyway
806-1418	1 1/8"	1/4" & 5/16"
806-1419	1 3/16"	1/4" & 5/16"
806-1420	1 1/4"	1/4" & 5/16"

Torque Limiter Flange
(Interchanges with Great Lakes Clutch)

Stock Number
803-1400

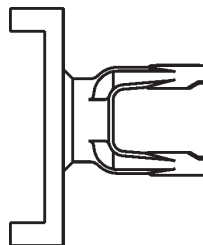

Stock Bore
With Hub O. D. Turned

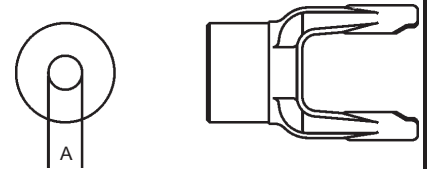

Stock Number	Dim. "A" Bore
809-1412	3/4"

14 Series (cont'd.)

Guard

Order Bearings As Required

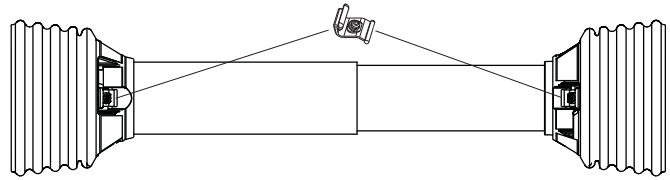

Stock Number	Overall Driveline Length	Bearing Kit (4-per kit)
900-2548	48"	921-1200
900-2560	60"	921-1200

Assembly instructions included with guard

Note: When installing Guards observe the following:

- 1) Install proper nylon bearing (See Page 13)
- 2) Guards must rotate freely on yokes

Easy Lock™ Replacement Kit

Part Number: 13005000 (4-per Kit)



Yoke & Shaft Assembly

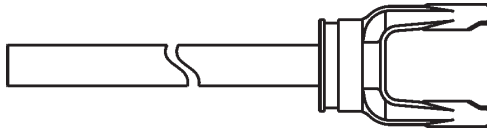

1" x 1 1/8" Shaft

Stock Number	Centerline to End of Shaft Dimension
10001438	26.12"
10001448	35.62"
10001460	47.62"

Universal Joint

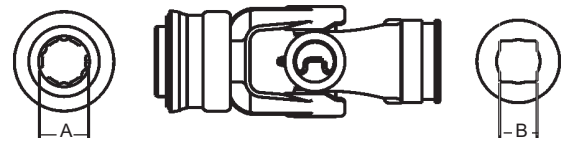

Spring-Lok to Shaft Weld Yoke

Repair Kit — Page 83

Stock Number	Dim. "A" Bore	Dim. "B" Bore
15061400	1 3/8" x 6 Spl.	1" x 1 1/8" Rect.

Yoke, Tube & Sleeve Assembly

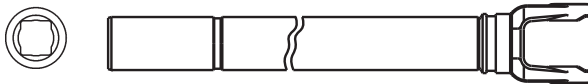

1" x 1 1/8" Rectangular

Stock Number	Centerline to End of Tube Dimension
11001438	26.12"
11001448	36.12"
11001460	48.12"

Drivelines

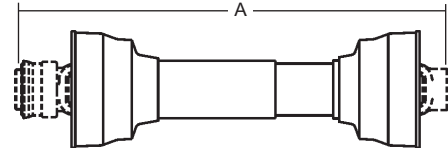
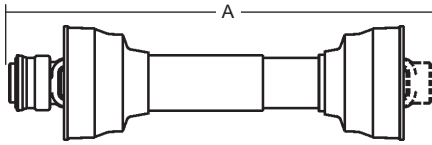

Drivelines are furnished without Cross & Bearing Kit and Implement Yoke. Select kit and implement yoke as required. When Cross & Bearing Kit and Implement Yoke are assembled, the overall compressed length of the driveline will be 48" or 60".

Drivelines are furnished without Cross & Bearing Kit and Outboard Yokes. Select kit and outboard yokes as required. When cross & bearing kit and outboard Yokes are assembled, the overall compressed length of the driveline will be 48" or 60".

Stock Number	Tractor Yoke	Overall Compressed Length Dim. "A"
14001448	1 3/8" x 6 Spl. Spring Lok	48"
14001460	1 3/8" x 6 Spl. Spring Lok	60"

Stock Number	Overall Compressed Length Dim. "A"
14011448	48"
14011460	60"
14021448 (With crosses installed)	48"

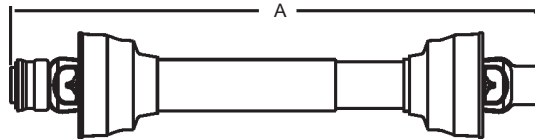

Stock Number	Tractor Yoke	Implement Yoke	Overall Compressed Length Dim. "A"	Application
14001404	1 3/8" x 6 Spl. Spring-Lok	1 3/8" Round 1/2" Shear Pin Hole	30 3/16"	4 ft. Lift Type Rotary Cutter
14001405	1 3/8" x 6 Spl. Spring-Lok	1 3/8" Round 1/2" Shear Pin Hole	37 3/16"	5 ft. Lift Type Rotary Cutter
14001406	1 3/8" x 6 Spl. Spring-Lok	1 3/8" Round 1/2" Shear Pin Hole	56 3/16"	5 & 6 ft. Pull Type Rotary Cutter
14001420	1 3/8" x 6 Spl. Spring-Lok	1 1/4" Round 1/4" Keyway	48"	Auger

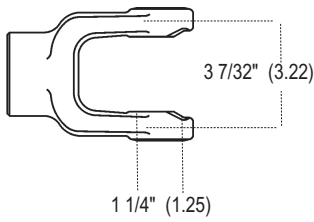

35 Series

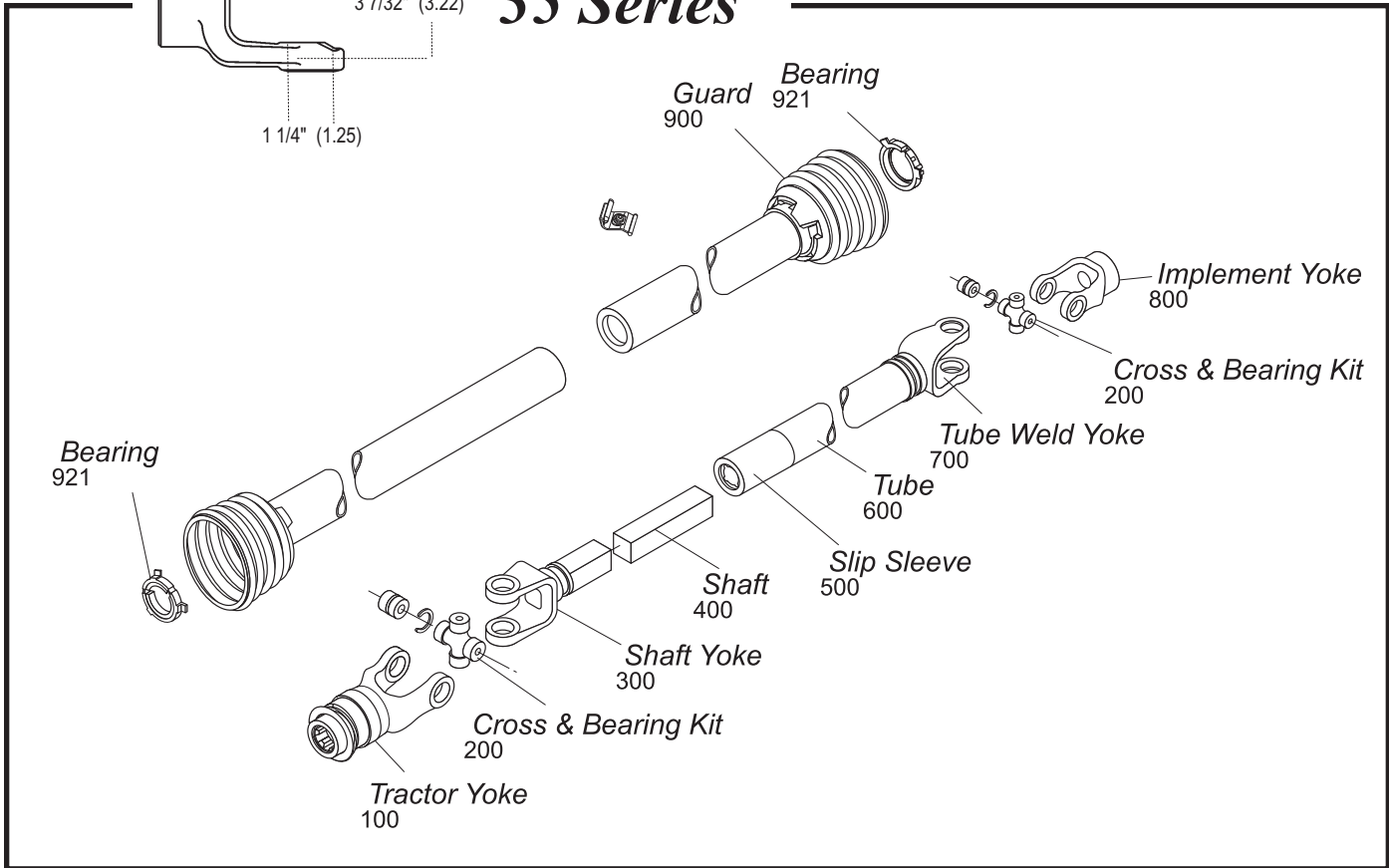

Tractor Yoke

Safety Slide Lock
Repair Kit — Page 83

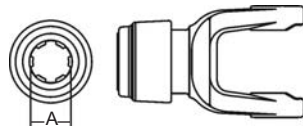

Stock Number	Dim. "A" Bore
101-3506	1 3/8" x 6 Spl.
101-3520	1 3/4" x 20 Spl.
101-3521	1 3/8" x 21 Spl.

Ball Shear Device
With Safety Slide Lock
Repair Kit — Page 83

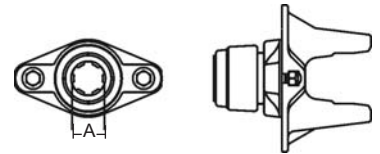

Stock Number	Dim. "A" Bore	Shear Bolt
104-3506	1 3/8" x 6 Spl.	(2) 3/8" - 16 Gr. 5
104-3520	1 3/4" x 20 Spl.	(2) 3/8" - 16 Gr. 5
104-3521	1 3/8" x 21 Spl.	(2) 3/8" - 16 Gr. 5
104-3524	1 1/2" Rd 3/8 KwY	(2) 3/8" - 16 Gr. 5

Quick Disconnect
Repair Kit — Page 83

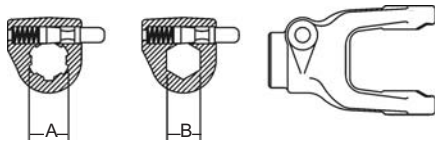

Stock Number	Dim. "A" Bore	Dim. "B" Bore
102-3505		1 1/4" Hex
102-3506	1 3/8" x 6 Spl.	
102-3518		1 1/8" Hex
102-3520	1 3/4" x 20 Spl.	
102-3521	1 3/8" x 21 Spl.	
102-3528	1 3/4" x 6 Spl.	

Auto-Lok
Repair Kit — Page 83

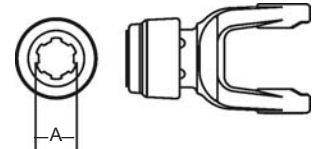

Stock Number	Dim. "A" Bore
110-3506	1 3/8" x 6 Spl.
110-3520	1 3/4" x 20 Spl.
110-3521	1 3/8" x 21 Spl.

Cross & Bearing Kit (R-Kit)

Snap Ring Located in Yoke

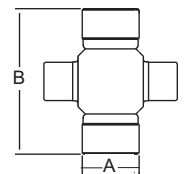

Stock Number	Dim. "A"	Dim. "B"
200-3500	1 1/4"	3 7/32"

Extended Lubrication Cross & Bearing Kit (E-Kit)

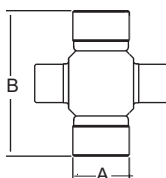

Snap Ring Located in Yoke

Stock Number	Dim. "A"	Dim. "B"
201-3500	1 1/4"	3 7/32"

Slip Sleeve

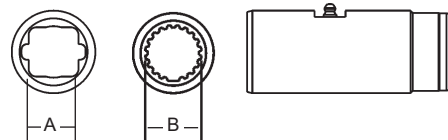

With Grease Groove

Stock Number	Length	Dim. "A" Bore	Dim. "B" Bore	Fits Tube Size
500-3500	5"	1 3/16" Sq.		2 1/8" (.120 Wall)
501-3500	5"	1 3/16" Sq.		2 1/8" (.083 Wall) & 2 1/4" (.120 Wall)
504-3500	8"	1 5/16" Sq.		2 1/2" (.120 Wall)
505-3500	5"		1 11/16" x 20 Spl.	2 1/2" (.120 Wall)

Shaft Weld Yoke

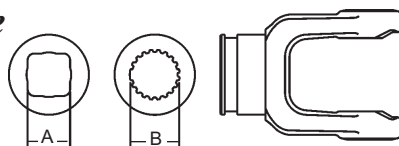

With Bearing Groove

(Guard must rotate freely on yoke)

Stock Dim. Number	"A" Dim. Bore	"B" Bore
300-3500	1 3/16" Sq.	
301-3500		1 5/16" x 20 Spl.
*302-3500		1 11/16" x 20 Spl.

* For use with 921-4400 Nylon Bearing Kit

Spline Sleeve

With Grease Reservoir

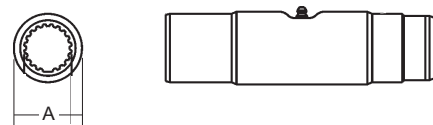

Stock Number	Length	Dim. "A" Bore	Fits Tube Size
502-3500	8"	1 5/16" x 20 Spl.	2 1/8" (.120 Wall)
503-3500	8"	1 11/16" x 20 Spl.	2 1/2" (.120 Wall)

Shaft

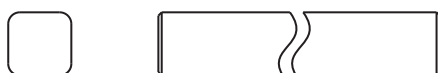

1 3/16" Square

Stock Number	Length
400-0019	6'
401-0019	10'
404-0019	3'

Tube

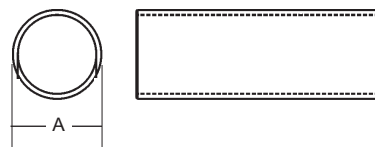

Stock Number	Dim. "A" Size	Length
602-3500	2 1/8" (.120 Wall)	6'
602-3501	2 1/8" (.083 Wall)	6'
603-3500	2 1/8" (.120 Wall)	10'
604-3500	2 1/8" (.120 Wall)	3'

Spline Shaft

Induction Hardened



Stock Number	Dim. "A" Size	Length	Major Dim.
404-2120	1 5/16" x 20 Spl.	3'	1.380/1.375
404-2720	1 11/16" x 20 Spl.	3'	1.790/1.785

Tube Weld Yoke

With Bearing Groove

(Guard must rotate freely on yoke)

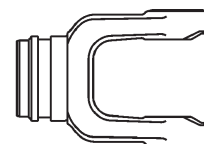

Stock Number	Fits Tube Size
701-3500	2 1/8" (.120 Wall)
702-3500	2 1/8" (.083 Wall)
703-3500 with Bore**	2 1/4" (.120 Wall)
704-3500 with Bore**	2 1/2" (.120 Wall)
705-3500 with Bore**	2 1/8" (.120 Wall)

** Bore through for telescoping shaft

35 Series (cont'd.)

Implement Yoke

Round Bore

With Keyway & Set Screw

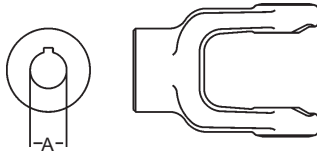

Stock Number	Dim. "A" Bore	Standard Keyway
800-3516	1"	1/4"
800-3518	1 1/8"	1/4"
800-3519	1 3/16"	1/4"
800-3520	1 1/4"	1/4"
800-3522	1 3/8"	5/16"
800-3523	1 7/16"	3/8"
800-3524	1 1/2"	3/8"
8003524H	1 1/2"	3/8" with Pinhole
800-3528	1 3/4"	3/8"

Square Bore

With Set Screw

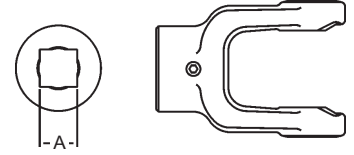

Stock Number	Dim. "A" Bore
804-3516	1"
804-3518	1 1/8"
804-3519	1 3/16"
804-3520	1 1/4"
804-3524	1 1/2"

Spline Bore

With 21/64" Pin Hole

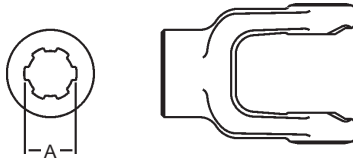

Stock Number	Dim. "A" Bore
801-3506	1 3/8" x 6 Spl.
801-3521	1 3/8" x 21 Spl.

Round Bore

Double Keyway & Set Screw

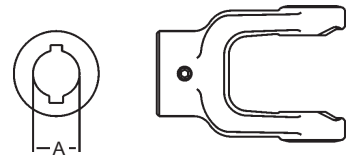

Stock Number	Dim. "A" Bore	Double Keyway
806-3519	1 3/16"	1/4" & 5/16"
806-3520	1 1/4"	1/4" & 5/16"
806-3522	1 3/8"	5/16" & 3/8"

Shear Pin

With 1/4" Pin Hole

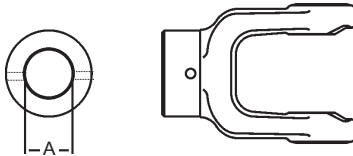

Stock Number	Dim. "A" Bore
802-3520	1 1/4"
802-3522*	1 3/8"
802-3524	1 1/2"

* With 1/2" Pin Hole.

Clamp Yoke

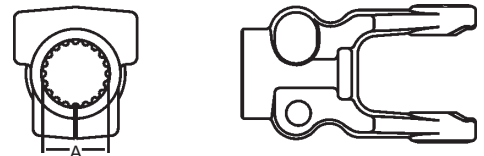

Stock Number	Dim. "A" Bore
807-3506	1 3/8" x 6 Spl.
807-3520	1 3/4" x 20 Spl.
807-3521	1 3/8" x 21 Spl.
807-3527	1 3/4" x 27 Spl.

Torque Limiter Flange

(Interchanges with Great Lakes Clutch)

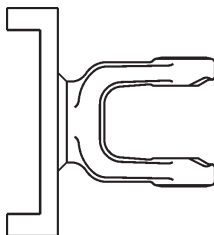

Stock Number
803-3500

Stock Bore

With Hub O. D. Turned



Stock Number	Dim. "A" Bore
809-3516	1"

Guard

Order Bearings As Required

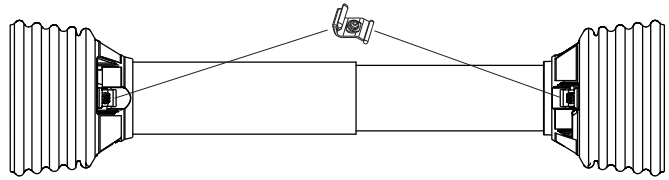

Stock Number	Overall Driveline Length	Bearing Kit (4-per kit)
900-2548	48"	921-1200
900-2560	60"	921-1200

Assembly instructions included with guard

Note: When installing Guards observe the following:

- 1) Install proper nylon bearing (See Page 13)
- 2) Guards must rotate freely on yokes

Easy Lock™ Replacement Kit

Part Number: 13005000 (4-per Kit)



Yoke & Shaft Assembly

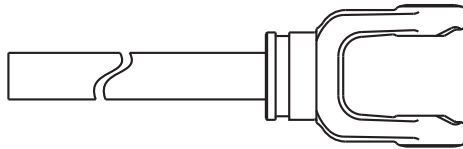

1 3/16" Square Shaft

Stock Number	Centerline to End of Shaft Dimension
10003531	17.69"
10003535	21.69"
10003542	28.69"
10003548	33.19"
10003560	44.94"

Universal Joint

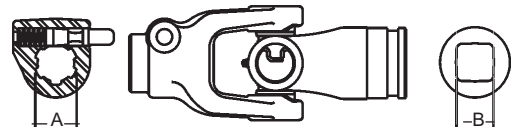

Quick Disconnect to Shaft Weld Yoke

Repair Kit — Page 83

Stock Number	Dim. "A" Bore	Dim. "B" Bore
15063500	1 3/8" x 6 Spl.	1 3/16" Sq.

Yoke, Tube & Sleeve Assembly

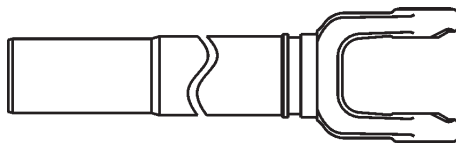

1 3/16" Square

Stock Number	Centerline to End of Tube Dimension
11003531	17.69"
11003535	21.69"
11003543	29.69"
11003548	34.69"
11003560	46.69"

35 Series (cont'd.)

Drivelines

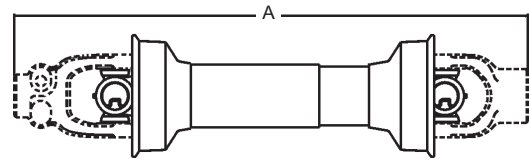
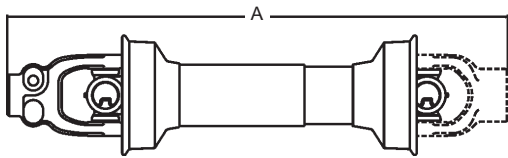

Drivelines are furnished without Cross & Bearing Kit and Implement Yoke. Select kit and yoke as required. When cross & bearing kit and yoke are assembled, the overall compressed length of the driveline will be 31", 35", 48" or 60".

Drivelines are furnished without Cross & Bearing Kit and Outboard Yokes. Select kit and outboard yokes as required. When cross & bearing kit and outboard yokes are assembled, the overall compressed length of the driveline will be 39", 48" or 60".

Stock Number	Tractor Yoke	Overall Compressed Length Dim. "A"
14003531	1 3/8" x 6 Spl. Q.D.	31"
14003535	1 3/8" x 6 Spl. Q.D.	35"
14003548	1 3/8" x 6 Spl. Q.D.	48"
14003560	1 3/8" x 6 Spl. Q.D.	60"

Stock Number	Overall Compressed Length Dim. "A"
14013548	48"
14013560	60"
14023539 with crosses installed	39"
14023548 with crosses installed	48"

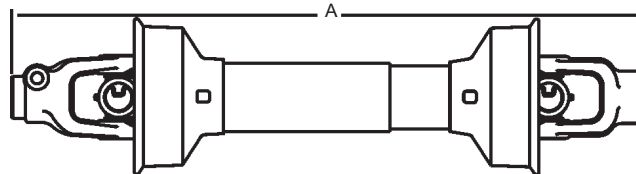

Stock Number	Tractor Yoke	Implement Yoke	Overall Compressed Length Dim. "A"	Application
14003507	1 3/8" x 6 Spl. Q.D.	1 3/8" Round 1/2" Shear Pin Hole	64 7/8"	7 ft. Pull Type Rotary Cutter
14003524	1 3/8" x 6 Spl. Q.D.	1 1/2" Round 3/8" Keyway	48"	Pumps
14003536	1 3/8" x 6 Spl. Safety Slide Lock	1 3/8" x 6 Spl. Safety Slide Lock	36"	All Purpose
14013531	1 3/8" x 21 Spl. Safety Slide Lock	1 1/8" Hex Clamp	31"	Combine Header
14013533	1 3/8" x 21 Spl. Safety Slide Lock	1 1/8" Hex Clamp	33"	Combine Header

44 Series

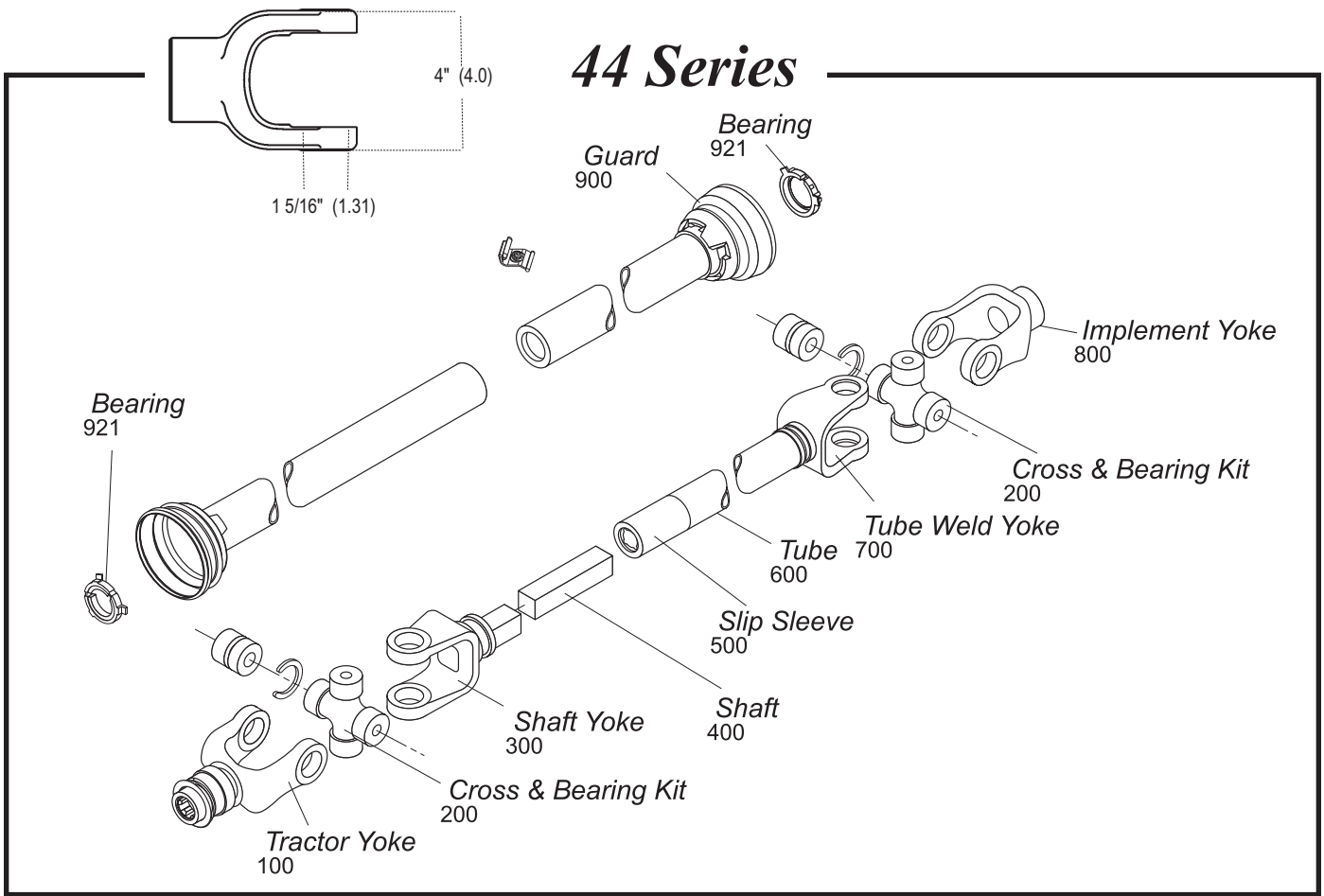

Tractor Yoke

Safety Slide Lock Repair Kit — Page 83

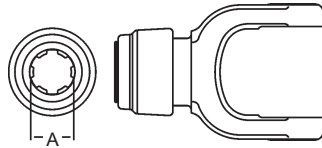

Stock Number	Dim. "A" Bore
101-4406	1 3/8" × 6 Spl.
101-4420	1 3/4" × 20 Spl.
101-4421	1 3/8" × 21 Spl.

Ball Shear Device With Safety Slide Lock Repair Kit — Page 83

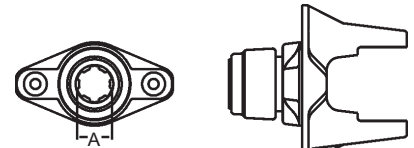

Stock Number	Dim. "A" Bore	Shear Bolt
104-4406	1 3/8" × 6 Spl.	(2) 3/8" × 16 Gr. 5
104-4420	1 3/4" × 20 Spl.	(2) 3/8" × 16 Gr. 5
104-4421	1 3/8" × 21 Spl.	(2) 3/8" × 16 Gr. 5

Quick Disconnect Repair Kit — Page 83

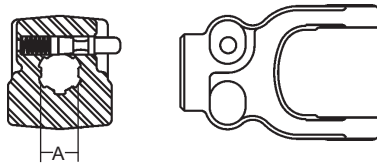

Stock Number	Dim. "A" Bore
102-4406	1 3/8" × 6 Spl.
102-4420	1 3/4" × 20 Spl.
102-4421	1 3/8" × 21 Spl.

Auto-Lok Repair Kit — Page 83

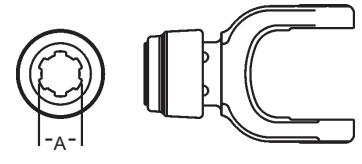

Stock Number	Dim. "A" Bore
110-4406	1 3/8" × 6 Spl.
110-4420	1 3/4" × 20 Spl.
110-4421	1 3/8" × 21 Spl.

44 Series (cont'd.)

Cross & Bearing Kit (R-Kit)

Snap Ring Located in Bushing

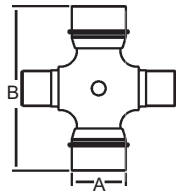

Stock Number	Dim. "A"	Dim. "B"
200-4400	1 5/16"	4"

Extended Lubrication Cross & Bearing Kit (E-Kit)

Snap Ring Located in Bushing

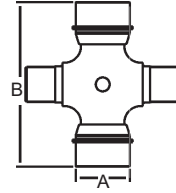

Stock Number	Dim. "A"	Dim. "B"
201-4400	1 5/16"	4"

Shaft Weld Yoke

With Bearing Groove
(Guard must rotate freely on yoke)

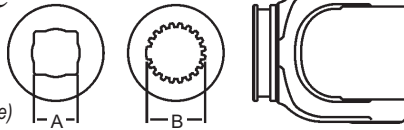

Stock Number	Dim. "A" Bore	Dim. "B" Bore
300-4400	1 5/16" Sq.	
302-4400		1 11/16" x 20 Spl.

Shaft

1 5/16" Square



Stock Number	Length
400-0021	6'
401-0021	10'
404-0021	3'

Slip Sleeve

With Grease Groove

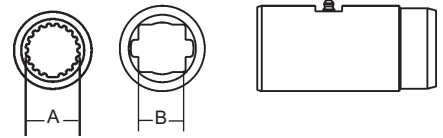

Stock Number	Length	Dim. "A"	Dim. "B"	Fits Tube Size
500-4400	5"		1 5/16" Sq.	2 1/2" (.120 Wall)
505-3500	5"	1 11/16" x 20 Spl.		2 1/2" (.120 Wall)

With Grease Reservoir

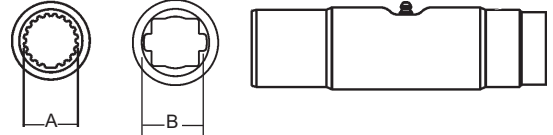

Stock Number	Dim. "A"	Dim. "B"	Length	Fits Tube Size
502-3500	1 5/16" x 20 Spl.		8"	2 1/8" (.120 Wall)
503-3500	1 11/16" x 20 Spl.		8"	2 1/2" (.120 Wall)
504-3500		1 5/16" Sq.	8"	2 1/2" (.120 Wall)

Tube

2 1/2" (.120 Wall)



Stock Number	Length
602-4400	6'
603-4400	10'
604-4400	3'

Tube Weld Yoke

With Bearing Groove
(Guard must rotate freely on yoke)

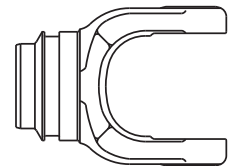

Stock Number	Fits Tube Size
701-4400	2 1/2" (.120 Wall)
*702-4400 (with bore)	2 1/2" (.120 wall)

* Bore through for Telescoping

Spline Shaft Induction Hardened

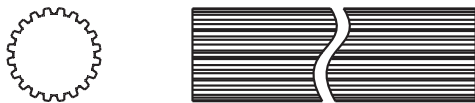

Stock Number	Dim. "A"	Length	Major Dim.
404-2120	1 5/16" x 20 Spl.	3'	1.380/1.375
404-2720	1 11/16" x 20 Spl.	3'	1.790/1.785

Implement Yoke

Round Bore

With Keyway & Set Screw

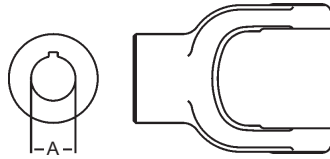

Stock Number	Dim. "A" Bore	Standard Keyway
800-4420	1 1/4"	1/4"
800-4422	1 3/8"	5/16"
800-4423	1 7/16"	3/8"
800-4424	1 1/2"	3/8"
800-4426	1 5/8"	3/8"
800-4428	1 3/4"	3/8"
800-4432	2"	1/2"

Round Bore

Double Keyway & Set Screw



Stock Number	Dim. "A" Bore	Double Keyway
806-4420	1 1/4"	5/16" & 1/4"
806-4422	1 3/8"	5/16" & 1/4"
806-4424	1 1/2"	5/16" & 3/8"

Spline Bore

With 21/64" Pin Hole

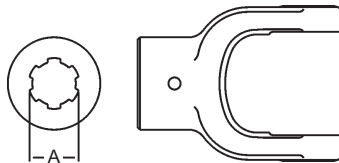

Stock Number	Dim. "A" Bore
801-4406	1 3/8" x 6 Spl.
801-4421	1 3/8" x 21 Spl.

Clamp Yoke

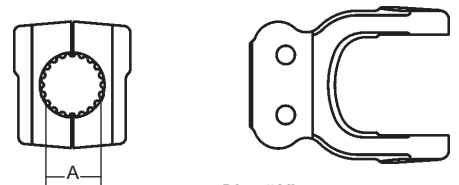

Stock Number	Dim. "A" Bore
807-4406	1 3/8" x 6 Spl.
807-4420	1 3/4" x 20 Spl.
807-4421	1 3/8" x 21 Spl.
807-4427	1 3/4" x 27 Spl.

Torque Limiter Flange

(Interchanges with Great Lakes Clutch)

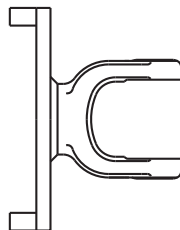

Stock Number
803-4400

Stock Bore

With Hub O. D. Turned

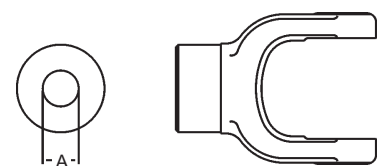

Stock Number	Dim. "A" Bore
809-4416	1"

Square Bore

With Set Screw

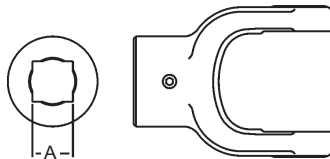

Stock Number	Dim. "A" Bore
804-4418	1 1/8"

44 Series (cont'd.)

Guard

* Order Bearings as Required

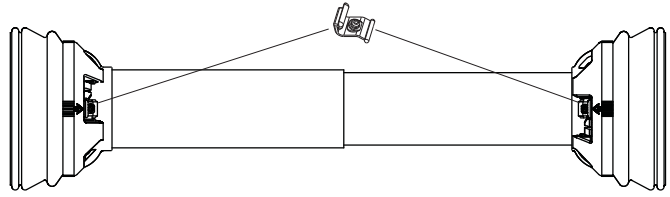

Stock Number	Overall Driveline Length	Bearing Kit (4-per kit)
902-3548	48"	921-4400
902-3560	60"	921-4400

Assembly instructions included with guard

Note: When installing Guards observe the following:

- 1) Install proper nylon bearing (See Page 13)
- 2) Guards must rotate freely on yokes

Easy Lock™ Replacement Kit

Part Number: 13005000 (4-per Kit)



Yoke & Shaft Assembly

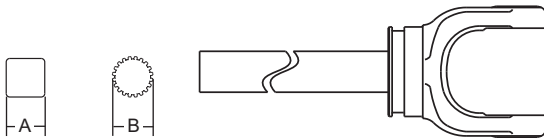

Stock Number	Dim. "A"	Dim. "B"	Centerline to End of Shaft Dimension
10004448	1 5/16" Sq.		33.12"
10004460	1 5/16" Sq.		45.12"
10014448		1 11/16" x 20 Spl.	33.12"

Yoke, Tube & Sleeve Assembly

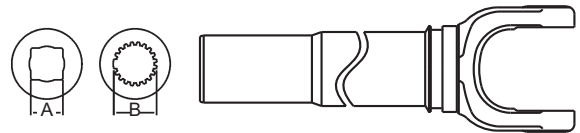

Stock Number	Dim. "A" Bore	Dim. "B" Bore	Centerline to End of Tube Dimension
11004448	1 5/16" Sq.		35.62"
11004460	1 5/16" Sq.		45.62"
11014448		1 11/16" x 20 Spl.	33.63"

Drivelines

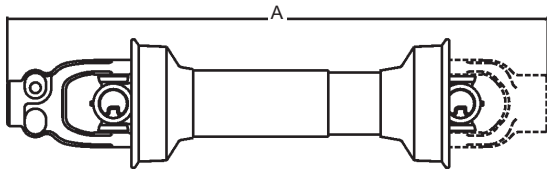

Drivelines are furnished without Cross & Bearing Kit and Implement Yoke. Select kit and yoke as required. When cross & bearing kit and yoke are assembled, the overall compressed length of the driveline will be 48" or 60".

Stock Number	Shaft Size	Tractor Yoke	Overall Compressed Length Dim. "A"
14004448	1 5/16"	1 3/8" x 6 Spl. Q.D.	48"
14004460	1 5/16"	1 3/8" x 6 Spl. Q.D.	60"
14044448	1 11/16" x 20 Spl.	1 3/8" x 6 Spl. Q.D.	48"

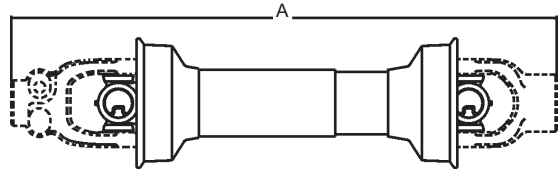

Drivelines are furnished without Cross & Bearing Kit and Outboard Yokes. Select kit and outboard yokes as required. When cross & bearing kit and outboard yokes are assembled, the overall compressed length of the driveline will be 48" or 60".

Stock Number	Shaft	Overall Compressed Length Dim. "A"
14014448	1 5/16"	48"
14014460	1 5/16"	60"
14054448	1 11/16" x 20 Spl.	48"

55 Series

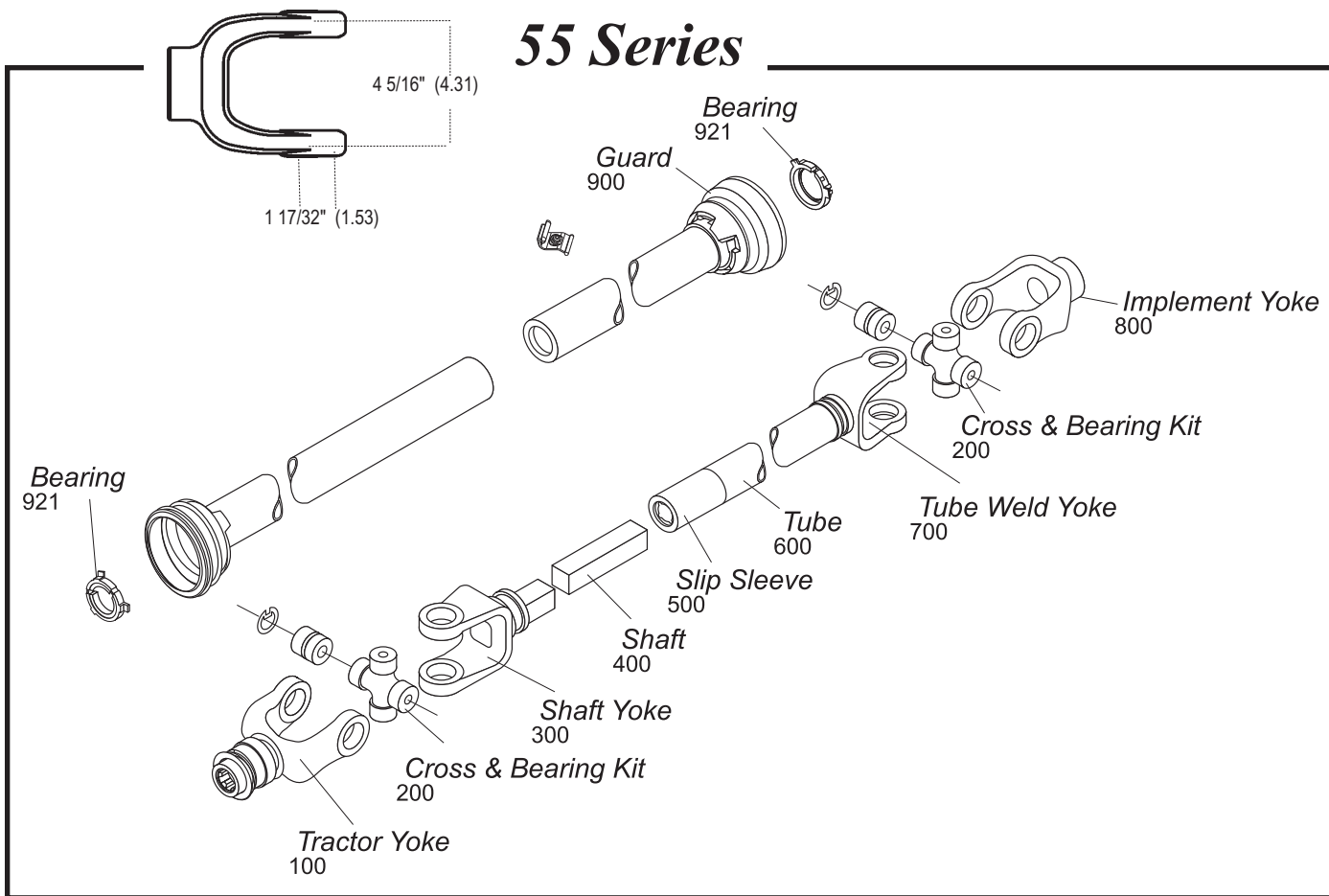

Tractor Yoke

Safety Slide Lock
Repair Kit — Page 83

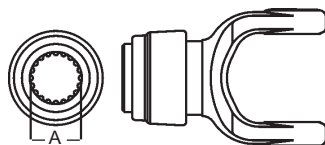

Stock Number	Dim. "A" Bore
101-5506	1 3/8" x 6 Spl.
101-5520	1 3/4" x 20 Spl.
101-5521	1 3/8" x 21 Spl.

Ball Shear Device
With Safety Slide Lock
Repair Kit — Page 83

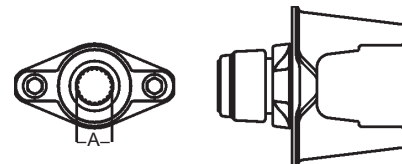

Stock Number	Dim. "A" Bore	Shear Bolt
104-5506	1 3/8" x 6 Spl.	(2) 3/8" x 16 Gr. 5
104-5520	1 3/4" x 20 Spl.	(2) 3/8" x 16 Gr. 5
104-5521	1 3/8" x 21 Spl.	(2) 3/8" x 16 Gr. 5

Quick Disconnect
Repair Kit — Page 83

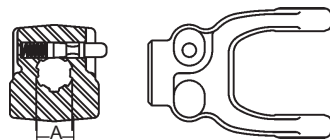

Stock Number	Dim. "A" Bore
102-5506	1 3/8" x 6 Spl.
102-5521	1 3/8" x 21 Spl.
102-5520	1 3/4" x 20 Spl.
102-5528	1 3/4" x 6 Spl.

Auto-Lok
Repair Kit — Page 83

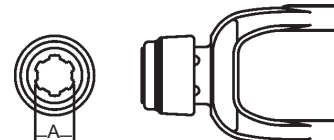

Stock Number	Dim. "A" Bore
110-5506	1 3/8" x 6 Spl.
110-5520	1 3/4" x 20 Spl.
110-5521	1 3/8" x 21 Spl.

**Cross & Bearing Kit
(R-Kit)**

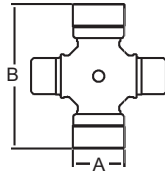

Snap Ring Located in Yoke

Stock Number	Dim. "A"	Dim. "B"
200-5500	1 17/32"	4 5/16"

Spline Shaft

Induction Hardened



Stock Number	Dim. "A"	Length	Major Dim.
404-2720	1 11/16" x 20 Spl.	3'	1.790/1.785

**Extended Lubrication
Cross & Bearing Kit
(E-Kit)**

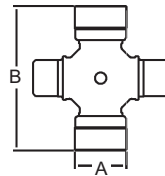

Snap Ring Located in Yoke

Stock Number	Dim. "A"	Dim. "B"
201-5500	1 17/32"	4 5/16"

Slip Sleeve

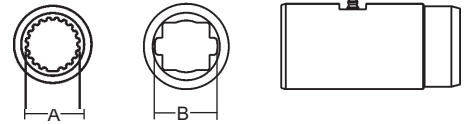

With Grease Groove

Stock Number	Dim. "A" Bore	Dim. "B" Bore	Length	Fits Tube Size
500-4400		1 5/16" Sq.	5"	2 1/2" (.120 Wall)
505-3500	1 11/16" x 20 Spl.		5"	2 1/2" (.120 Wall)

Shaft Weld Yoke

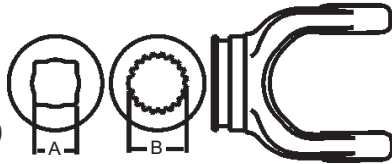

With Bearing Groove
(Guard must rotate freely on yoke)

Stock Number	Dim. "A" Bore	Dim. "B" Bore
300-5500	1 5/16" Sq.	
301-5500*	1 3/16" Sq.	
302-5500		1 11/16" x 20 Spl.

*Use 04-15155 Nylon Bearing

With Grease Reservoir

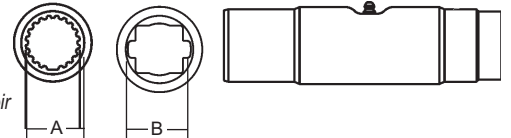

Stock Number	Dim. "A" Bore	Dim. "B" Bore	Length	Fits Tube Size
503-3500	1 11/16" x 20 Spl.		8"	2 1/2" (.120 Wall)
504-3500		1 5/16" Sq.	8"	2 1/2" (.120 Wall)

Shaft



1 5/16" Square

Stock Number	Length
400-0021	6'
401-0021	10'
404-0021	3'

Tube



2 1/2" (.120 Wall)

Stock Number	Length
602-4400	6'
603-4400	10'
604-4400	3'

55 Series (cont'd.)

Tube Weld Yoke

With Bearing Groove
(Guard must rotate freely on yoke)

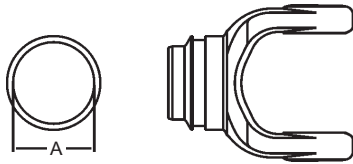

Stock Number	Fits Tube Size
701-5500	2 1/2" (.120 wall)
*704-5500 (with bore)	2 1/2" (.120 wall)

* Bore through for Telescoping

Clamp Yoke



Stock Number	Dim. "A" Bore
807-5506	1 3/8" x 6 Spl.
807-5520	1 3/4" x 20 Spl.
807-5521	1 3/8" x 21 Spl.
807-5527	1 3/4" x 27 Spl.

Implement Yoke

Round Bore

With Keyway & Set Screw

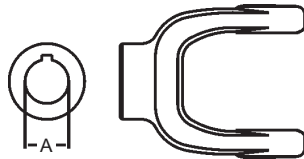

Stock Number	Dim. "A" Bore	Standard Keyway
800-5522	1 3/8"	5/16"
800-5524	1 1/2"	3/8"
800-5526	1 5/8"	3/8"
800-5528	1 3/4"	3/8"
800-5532	2"	1/2"

Stock Bore

With Hub O. D. Turned

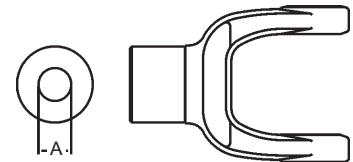

Stock Number	Dim. "A" Bore
809-5516	1"

Spline Bore

With 21/64" Pin Hole

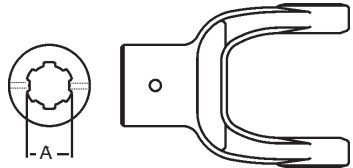

Stock Number	Dim. "A" Bore
801-5506	1 3/8" x 6 Spl.
801-5521	1 3/8" x 21 Spl.

Guard

Order Bearings as Required

Stock Number	Overall Driveline Length	Bearing Kit (4-per kit)
902-3548	48"	921-4400
902-3560	60"	921-4400

Assembly instructions included with guard

Note: When installing Guards observe the following:

- 1) Install proper nylon bearing (See Page 13)
- 2) Guards must rotate freely on yokes

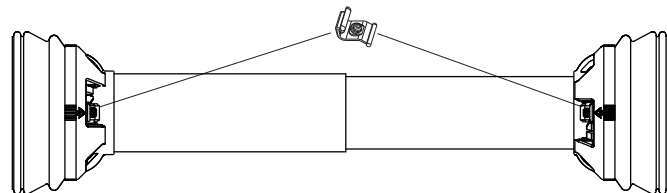

Easy Lock™ Replacement Kit

Part Number: 13005000 (4-per Kit)



Yoke & Shaft Assembly

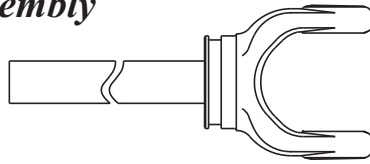

Stock Number	Shaft Size	Centerline to End of Shaft Dimension
10005548	1 5/16"	32.75"
10005560	1 5/16"	44.88"
10015548	1 11/16" x 20 Spl.	32.75"

Yoke, Tube & Sleeve Assembly

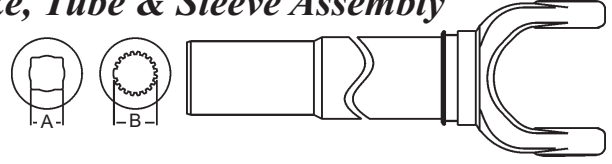

Stock Number	Dim. "A" Bore	Dim. "B" Bore	Centerline to End of Tube Dimension
11005548	1 5/16" Sq.		33.38"
11005560	1 5/16" Sq.		45.38"
11015548		1 11/16" x 20 Spl.	33.38"

Drivelines

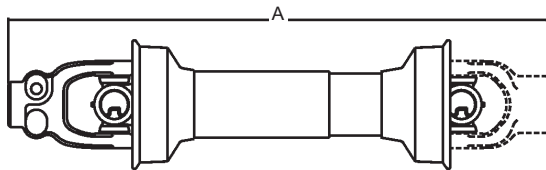

Drivelines are furnished without Cross & Bearing Kit and Implement Yoke. Select kit and yoke as required. When cross & bearing kit and yoke are assembled, the overall compressed length of the driveline will be 48" or 60".

Stock Number	Shaft Size	Tractor Yoke	Overall Compressed Length Dim. "A"
14005548	1 5/16"	1 3/8" x 6 Spl. Q.D.	48"
14005560	1 5/16"	1 3/8" x 6 Spl. Q.D.	60"
14045548	1 11/16" x 20 Spl.	1 3/8" x 6 Spl. Q.D.	48"

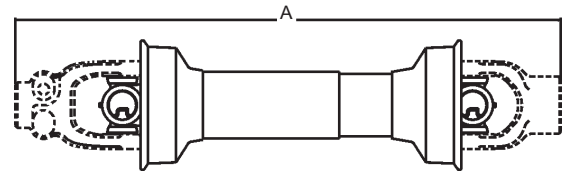

Drivelines are furnished without Cross & Bearing Kit and Outboard Yokes. Select kit and outboard yokes as required. When cross & bearing kit and outboard yokes are assembled, the overall compressed length of the driveline will be 48", 58" or 60".

Stock Number	Shaft	Overall Compressed Length Dim. "A"
14015548	1 5/16" Sq.	48"
14015560	1 5/16" Sq.	60"
14055548	1 11/16" x 20 Spl.	48"
14055558	1 11/16" x 20 Spl.	58"

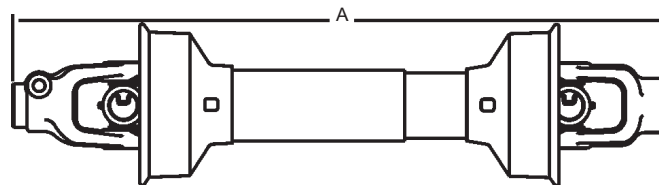

Stock Number	Tractor Yoke	Implement Yoke	Overall Compressed Length Dim. "A"	Application	Shaft Size
14005537	1 3/8" x 6 Spl. Safety Slide Lock	1 3/8" x 6 Spl. Safety Slide Lock	37"	All Purpose	1 5/16" Sq.
14005546	1 3/4" x 20 Spl. Safety Slide lock	1 3/4" Rd. w/ Keyway and (2) Set Screws	46"	All Purpose	1 11/16" x 20 Spl.

W Series

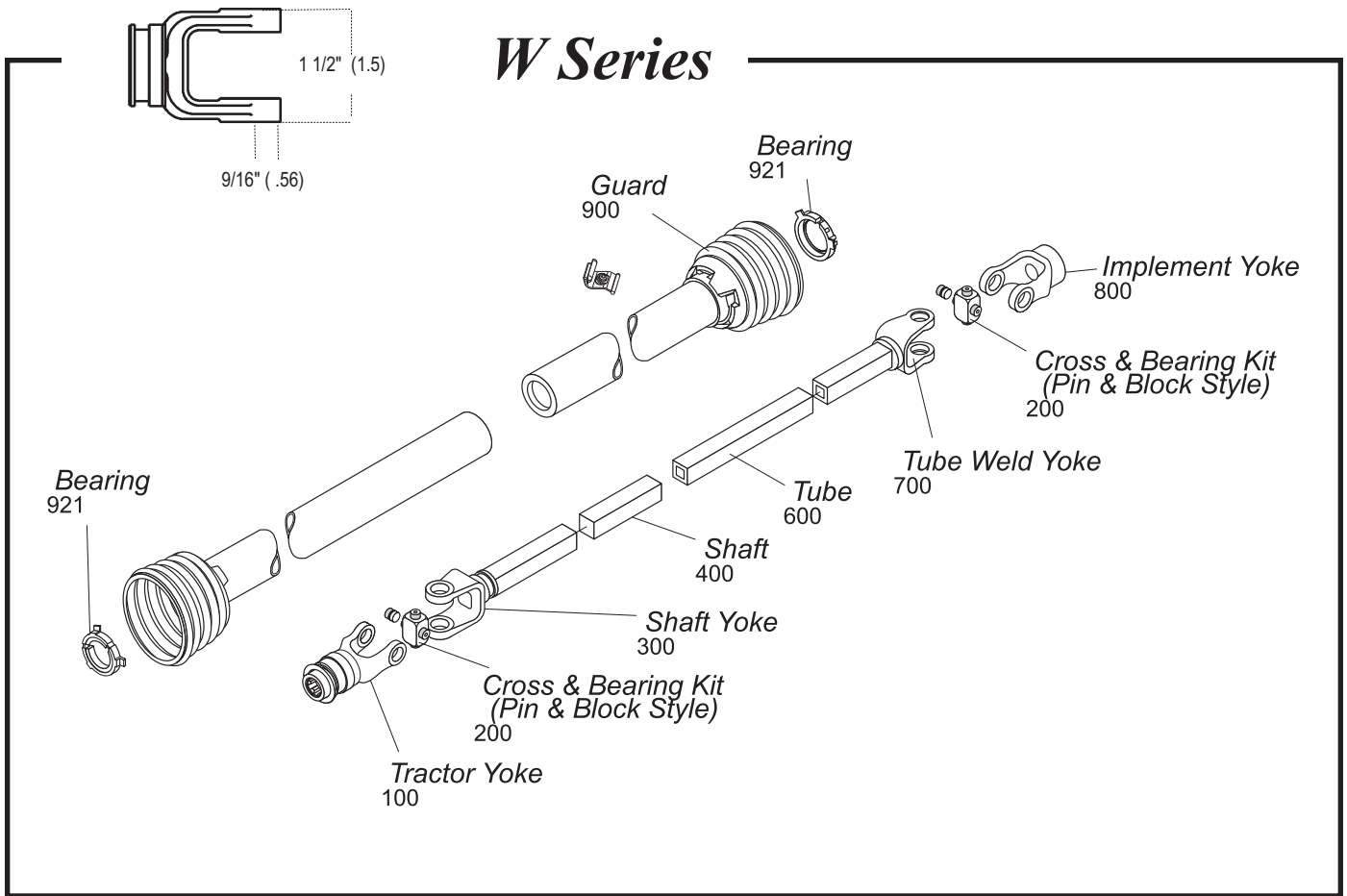

Cross & Bearing Kit (Pin & Block Style)

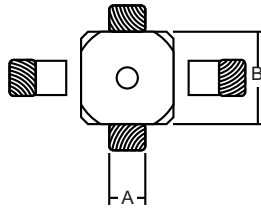

Zerk Located in Block

Stock Number	Dim. "A"	Dim. "B"
200-0700	9/16"	1 1/2"

Tube



1 1/4" Square O.D.

Stock Number	Length	Fits Shaft
600-0015	6'	15/16" Sq.

Shaft



15/16" Square

Stock Number	Length	Fits Tube
400-0015	6'	1 1/4" Sq.

Guard

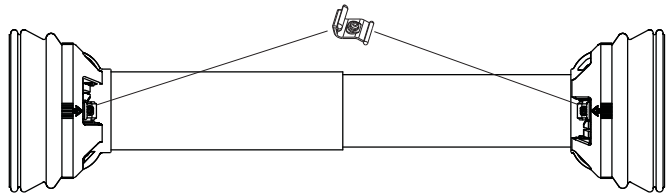

Stock Number	Overall Driveline Length	Bearing Kit (4-per kit)
900-2548	48"	921-5170

Assembly instructions included with guard
 Note: When installing Guards observe the following:
 1) Install proper nylon bearing (See Page 13)
 2) Guards must rotate freely on yokes

Easy Lock™ Replacement Kit

Part Number: 13005000 (4-per Kit)



Drivelines

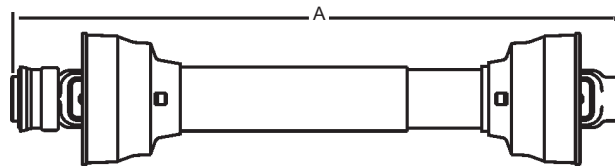

Use 12 Series driveline for all "W" Series replacement drivelines. See 12 Series (Page 52) for drivelines.

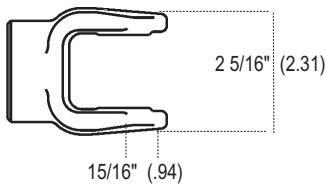

0675 Series

Interchanges with Neapco

Tractor Yoke

Spring-Lok
Repair Kit — Page 83

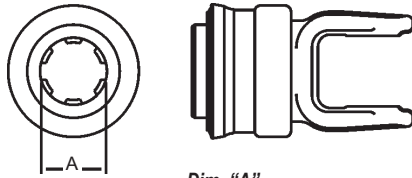

Stock Number	Dim. "A" Bore
100-0506	1 3/8" x 6 Spl.

Implement Yoke

Round Bore
With Keyway & Set Screw

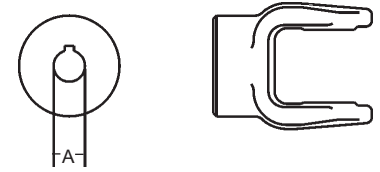

Stock Number	Dim. "A" Bore	Standard Keyway
800-0512	3/4"	3/16"

Quick Disconnect
Repair Kit — Page 83

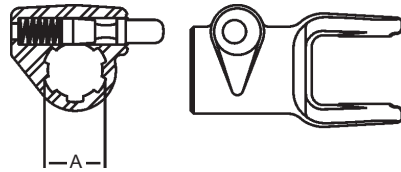

Stock Number	Dim. "A" Bore
102-0506	1 3/8" x 6 Spl.

Spline Bore
With 21/64" Pin Hole

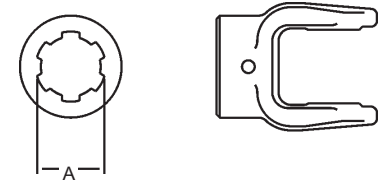

Stock Number	Dim. "A" Bore
801-0506	1 3/8" x 6 Spl.

Cross & Bearing Kit

Snap Ring Located in Bushing

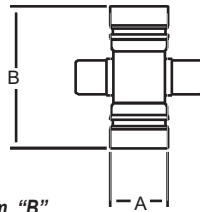

Stock Number	Dim. "A"	Dim. "B"
200-0675	15/16"	2 5/16"

Square Bore
With Set Screw



Stock Number	Dim. "A" Bore
804-0512	3/4"
804-0514	7/8"
804-0516	1"

Shaft Weld Yoke

With Bearing Groove
(Guard must rotate freely on yoke)

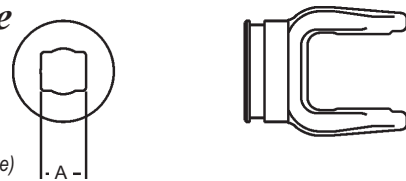

Stock Number	Dim. "A" Bore
300-0500	3/4" x 7/8"

Round Bore
With Double Keyway & Set Screw

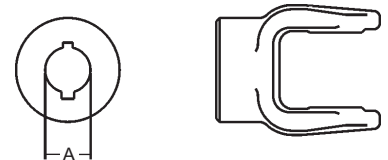

Stock Number	Dim. "A" Bore	Double Keyway
806-0514	7/8"	3/16" & 1/4"
806-0516	1"	3/16" & 1/4"
806-0518	1 1/8"	1/4" & 5/16"
806-0520	1 1/4"	1/4" & 5/16"

Tube Weld Yoke

With Bearing Groove
(Guard must rotate freely on yoke)

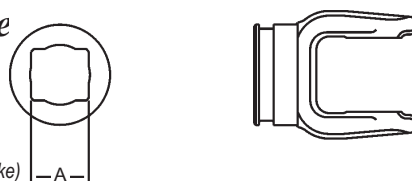

Stock Number	Dim. "A" Bore
700-0500	1" x 1 1/8"

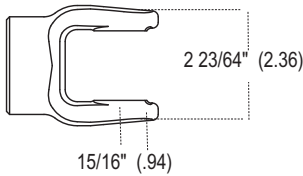

1000 Series

Interchanges with Spicer and Neapco

Tractor Yoke

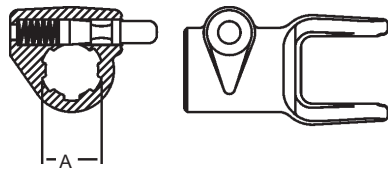

Quick Disconnect
Repair Kit — Page 83

Stock Number	Dim. "A" Bore
102-1006	1 3/8" × 6 Spl.

Cross & Bearing Kit

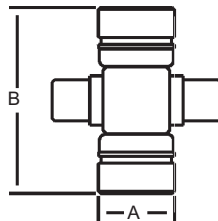

Snap Ring Located in Bushing

Stock Number	Dim. "A"	Dim. "B"
200-1000	15/16"	2 23/64"

Shaft Weld Yoke

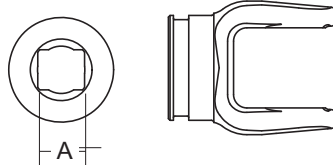

with Bearing Groove
(Guard must rotate freely on yoke)

Stock Number	Dim. "A" Bore
300-1000	3/4" × 7/8" Rect.

Tube Weld Yoke

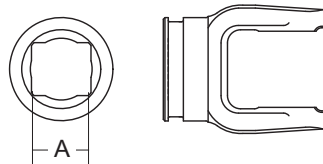

with Bearing Groove
(Guard must rotate freely on yoke)

Stock Number	Dim. "A" Bore
700-1000	1" × 1-1/8"

Implement Yoke

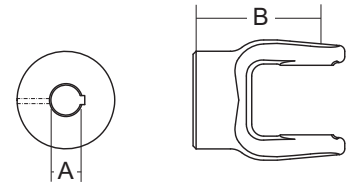

Round Bore
Keyway & Set Screw

Stock Number	Dim. "A" Bore	Keyway	Dim. "B" Centerline
800-1010	5/8"	3/16" (.19)	2 1/2" (2.50)
10001-1044	5/8"	3/16" (.19)	1 11/16" (1.69)
10001-1045	3/4"	3/16" (.19)	2 1/2" (2.50)
10001-1038	3/4"	3/16" (.19)	1 11/16" (1.69)
10001-1056	3/4"	1/4" (.25)	2 1/2" (2.50)
800-1013	13/16"	1/4" (.25)	2 1/2" (2.50)
10001-1039	13/16"	1/4" (.25)	1 11/16" (1.69)
10001-1057	7/8"	3/16" (.19)	2 1/2" (2.50)
10001-1049	7/8"	1/4" (.25)	2 1/2" (2.50)
10001-1048	7/8"	1/4" (.25)	2 1/2" (2.50)
10001-1040	7/8"	1/4" (.25)	1 11/16" (1.69)
800-1015	15/16"	1/4" (.25)	2 1/2" (2.50)
800-1016	1"	3/16" (.19)	2 1/2" (2.50)
10001-1051	1"	1/4" (.25)	2 1/2" (2.50)
10001-1033	1"	1/4" (.25)	2 1/2" (2.50)
10001-1041	1"	1/4" (.25)	1 11/16" (1.69)
800-1017	1-1/16"	1/4" (.25)	2 1/2" (2.50)
10001-1053	1-1/8"	1/4" (.25)	2 1/2" (2.50)
10001-1052	1-1/8"	5/16" (.31)	2 1/2" (2.50)
800-1019	1-3/16"	5/16" (.31)	2 1/2" (2.50)
10001-1058	1-1/4"	1/4" (.25)	2 1/2" (2.50)
10001-1055	1-1/4"	5/16" (.31)	2 1/2" (2.50)
10001-1054	1-1/4"	5/16" (.31)	2 1/2" (2.50)
10001-1060	1-3/8"	5/16" (.31)	2 1/2" (2.50)
800-1022	1 3/8"	3/8"	2 1/2" (2.50)

Spline Bore
with Set Screw

Stock Number	Dim. "A" Bore	Dim. "B" Centerline
801-1013	.901" × 13 Spl.	2-1/2" (2.50)
801-1018	1-1/8" × 6 Spl.	2-1/2" (2.50)

Shear Pin

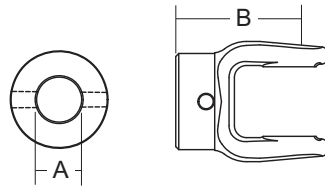

Stock Number	Dim. "A" Bore	Dim. "B" Centerline	Pinhole Size
802-1015	15/16"	2 1/2" (2.50)	11/32" (.34) #6 Taper
802-1016	1"	2 1/2" (2.50)	1/4" (.25)
10001-1059	1"	2 1/2" (2.50)	3/8" (.38)
802-1020	1 1/4"	2 1/2" (2.50)	5/16" (.31)
802-1024	1 1/2"	2 1/2" (2.50)	9/32" (.28)
10001-1034	1 1/2"	2 1/2" (2.50)	17/64" (.27)

Round Bore

Double Keyway & Set Screw

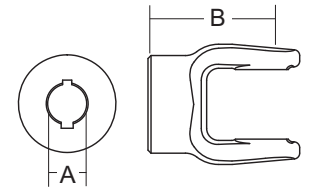

Stock Number	Dim. "A" Bore	Double Keyway	Dim. "B" Centerline
806-1012	3/4"	3/16" & 1/4"	2 1/2" (2.50)
806-1013	13/16"	3/16" & 1/4"	2 1/2" (2.50)
806-1014	7/8"	3/16" & 1/4"	2 1/2" (2.50)
806-1016	1"	3/16" & 1/4"	2 1/2" (2.50)
806-1018	1 1/8"	3/16" & 1/4"	2 1/2" (2.50)
10001-1061	1 1/8"	1/4" & 5/16"	2 1/2" (2.50)
806-1020	1 1/4"	1/4" & 5/16"	2 1/2" (2.50)
806-1019	1 3/16"	1/4" & 5/16"	2 1/2" (2.50)

Square Bore

with Set Screw

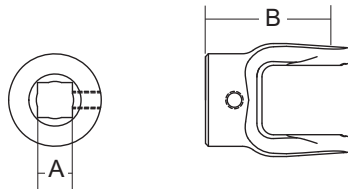

Stock Number	Dim. "A" Bore	Dim. "B" Centerline
804-1012	3/4"	2 1/2" (2.50)
10001-1042	3/4"	1 11/16" (1.69)
804-1014	7/8"	2 1/2" (2.50)
10001-1043	7/8"	1 11/16" (1.69)
804-1016	1"	2 1/2" (2.50)
804-1018	1 1/8"	2 1/2" (2.50)
10001-1037	1 1/8"	2 1/2" (2.50)

Hexagon Bore

with Set Screw

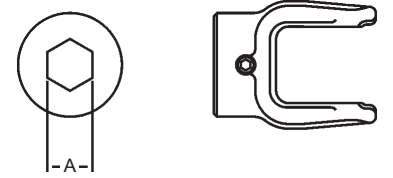

Stock Number	Dim. "A" Bore
805-1014	7/8"
805-1018	1 1/8"

Square Bore

with Pinhole

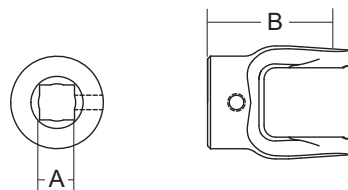

Stock Number	Dim. "A" Bore	Dim. "B" Centerline	Pinhole Size
10001-1035	3/4"	2 1/2" (2.50)	5/16" (.312)
10001-1036	1"	2 1/2" (2.50)	3/8" (3.75)

Slip Sleeve Yoke

Square

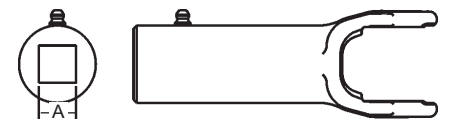

Stock Number	Dim. "A" Bore
808-1012	3/4"
808-1014	7/8"
808-1016	1"

Slip Sleeve Yoke cont...

Round

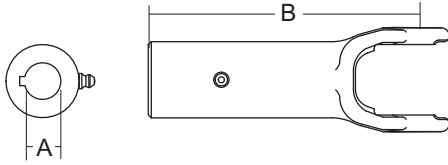

Stock Number	Dim. "A" Bore	Keyway	Dim. "B" Centerline
810-1012	3/4"	3/16"	5 1/2" (5.50)
810-1013	13/16"	1/4"	5 1/2" (5.50)
810-1014	7/8"	1/4"	5 1/2" (5.50)
810-1016	1"	1/4"	5 1/2" (5.50)
810-1018	1 1/8"	1/4"	5 1/2" (5.50)
10001-1062	1 1/8"	5/16"	5 1/2" (5.50)
810-1020	1 1/4"	1/4"	5 1/2" (5.50)
10001-1013	1 1/4"	5/16"	5 1/2" (5.50)
10001-1066	1 1/8"	1/4"	5 1/2" (5.50)

Spline

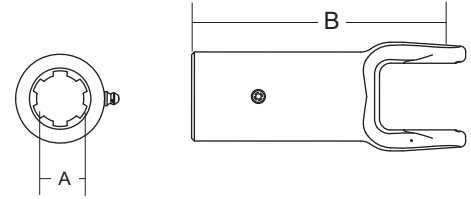

Stock Number	Dim. "A" Bore	Dim. "B" Centerline
812-1018	1 1/8" x 10 Spl.	5 1/2" (5.50)
812-1020	1 1/4" x 6 Spl.	5 1/2" (5.50)

Hex

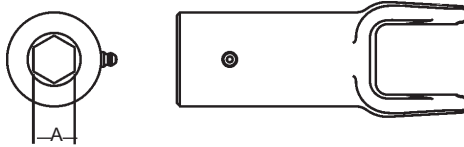

Stock Number	Dim. "A" Bore
811-1014	7/8"
811-1018	1 1/8"

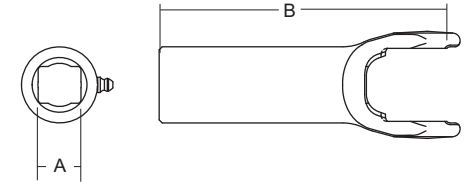

Stock Number	Dim. "A" Bore	Dim. "B" Centerline
813-1012	3/4" x 7/8"	5-1/2" (5.50)
10001-1014	7/8"	5-1/2" (5.50)
10001-1015	1"	5-1/2" (5.50)

Guard

Order Bearings As Required

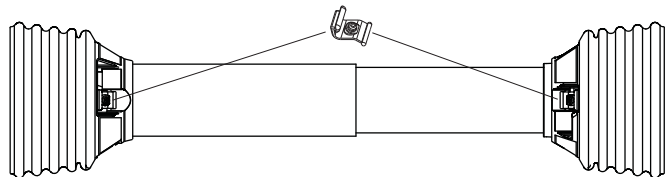

Stock Number	Overall Driveline Length	Bearing Kit (4-per kit)
900-2548	48"	921-0600
900-2560	60"	921-0600

Assembly instructions included with guard

Note: When installing Guards observe the following:

- 1) Install proper nylon bearing (See Page 13)
- 2) Guards must rotate freely on yokes

Easy Lock™ Replacement Kit

Part Number: 13005000 (4-per Kit)



1800 Series

Interchanges with Neapco

Cross & Bearing Kit

Snap Ring Located in Bushing

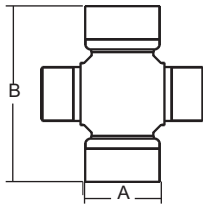

Stock Number	Dim. "A"	Dim. "B"
200-1875	1"	3 7/32"

Vehicular Cross & Bearing Kit

Interchanges with Spicer

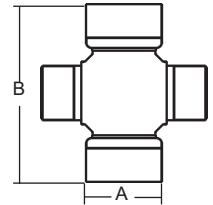

Stock Number	Spicer U - Joint Series	Dim. "A"	Dim. "B"
200-0310	1310	1 1/16"	3 7/32"
200-0350	1350	1 3/16"	3 5/8"
200-0410	1410	1 3/16"	4 3/16"

1 FR Series

Cross & Bearing Kit

Snap Ring Located in Yoke

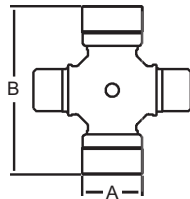

Stock Number	Dim. "A"	Dim. "B"
200-0100	7/8"	2 15/16"

14 Series

Cross & Bearing Kit

Interchanges with Howse
Snap Ring Located in Bushing

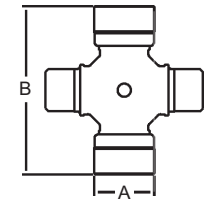

Stock Number	Dim. "A"	Dim. "B"
200-1401	1 1/8"	3 5/32"

3 DR Series

Cross & Bearing Kit

Snap Ring Located in Yoke

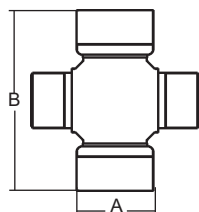

Stock Number	Dim. "A"	Dim. "B"
200-0300	1"	3 15/16"

35 Series

Cross & Bearing Kit

Interchanges with Howse
Snap Ring Located in Bushing

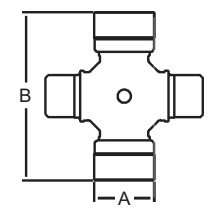

Stock Number	Dim. "A"	Dim. "B"
200-3501	1 1/4"	3 7/32"

2600 Series

Interchanges with Neapco & Walterscheid 1480

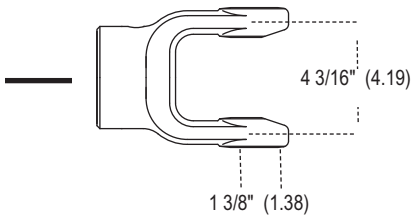

Tractor Yoke

Quick Disconnect
Repair Kit — Page 83

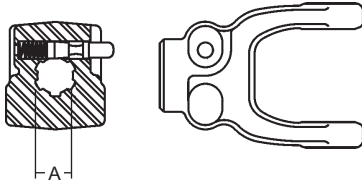

Stock Number	Dim. "A" Bore
102-2606	1 3/8" x 6 Spl.
102-2620	1 3/4" x 20 Spl.
102-2621	1 3/8" x 21 Spl.

Shaft

1 5/16" Square



Stock Number	Length
400-0021	6'
401-0021	10'
404-0021	3'

Cross & Bearing Kit

Snap Ring Located in Yoke

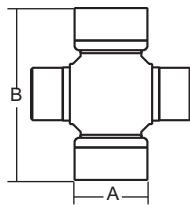

Stock Number	Dim. "A"	Dim. "B"
200-2600	1 3/8"	4 3/16"

Slip Sleeve

1 5/16" Square
With Grease Groove

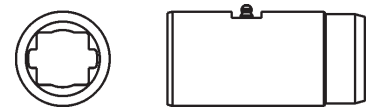

Stock Number	Length	Fits Tube Size
500-2600	5"	2 3/4" (.109 Wall)

Shaft Weld Yoke

With Bearing Groove
(Guards must rotate freely on the yoke)

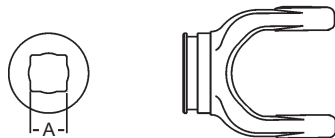

Stock Number	Dim. "A" Bore
300-2600	1 5/16" Sq.

Tube

2 3/4" (.109 Wall)



Stock Number	Length
602-2600	6'

2600 Series (cont'd.)

Tube Weld Yoke

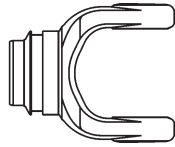

With Bearing Groove
(Guards must rotate freely on the yoke)

Stock Number	Fits Tube Size
701-2600	2 3/4" (.109 Wall)

Implement Yoke

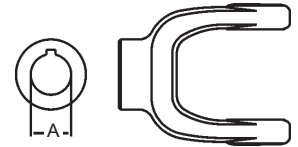

Round Bore
With Keyway & Set Screw

Stock Number	Dim. "A" Bore	Standard Keyway
800-2622	1 3/8"	5/16"
800-2624	1 1/2"	3/8"
800-2628	1 3/4"	3/8"

NORTH AMERICAN SHAFTING & TUBING

North American Shaft



Stock

Number	Size	Length
400-0012	3/4" Sq.	6'
400-0014	7/8" Sq.	6'
400-0015	15/16" Sq.	6'
400-0016	1" Sq.	6'
400-0019	1 3/16" Sq.	6'
400-0020	1 1/4" Sq.	6'
400-0021	1 5/16" Sq.	6'
400-1214	3/4" x 7/8" Rect.	6'
400-1618	1" x 1 1/8" Rect.	6'
401-0019	1 3/16" Sq.	10'
401-0021	1 5/16" Sq.	10'
401-1214	3/4" x 7/8" Rect.	10'
401-1618	1" x 1 1/8" Rect.	10'
402-0014	7/8" Hex	6'
402-0016	1" Hex	6'
402-0018	1 1/8" Hex	6'
402-0020	1 1/4" Hex	6'
404-0019	1 3/16" Sq.	3'
404-0021	1 5/16" Sq.	3'
404-1214	3/4" x 7/8" Rect.	3'
404-1615H	1" x 15 Spl. (Induction Hardened)	3'
404-1618	1" x 1 1/8" Rect.	3'
404-2120	1 5/16" x 20 Spl. (Induction Hardened)	3'
404-2720	1 11/16" x 20 Spl. (Induction Hardened)	3'

North American Tube



Stock

Number	Size	Length
600-0012	1" Sq. Fits Shaft 3/4" Sq.	6'
600-0015	1 1/4" Sq. (.120 Wall) Fits Shaft 15/16"	6'
600-0016	1 1/4" Sq. (.109 Wall) Fits Shaft 1" Sq.	6'
600-0020	1 5/8" Sq. Fits Shaft 1.25" Sq.	6'
600-1618	1" x 1 x 1/8" Rect.O.D - Fits Shaft 3/4" x 7/8"	6'
600-2022	1 1/4" x 1 3/8" Rect.O.D - Fits Shaft 1" x 1 1/8"	6'
601-1618	1" x 1 1/8" Rect.O.D - Fits Shaft 3/4" x 7/8"	10'
601-2022	1 1/4" x 1 3/8" Rect.O.D - Fits Shaft 1" x 1 1/8"	10'
602-0600	1 1/2" Rd. (.065 Wall) O.D.	6'
602-1400	2" Rd. (.083 Wall) O.D.	6'
602-2600	2 3/4" Rd. (.109 Wall) O.D.	6'
602-3500	2 1/8" Rd. (.120 Wall) O.D.	6'
602-3501	2 1/8" Rd. (.083 Wall) O.D.	6'
602-4400	2 1/2" Rd. (.120 Wall) O.D.	6'
603-1400	2" Rd. (.083 Wall) O.D.	10'
603-3500	2 1/8" Rd. (.120 Wall) O.D.	10'
603-4400	2 1/2" Rd. (.120 Wall) O.D.	10'
604-0600	1 1/2" Rd. (.065 Wall) O.D.	3'
604-1400	2" Rd. (.083 Wall) O.D.	3'
604-1618	1" x 1 1/8" Rect.O.D - Fits Shaft 3/4" x 7/8"	3'
604-2022	1 1/4" x 1 3/8" Rect. O.D - Fits Shaft 1" x 1 1/8"	3'
604-3500	2 1/8" Rd. (.120 Wall) O.D.	3'
604-4400	2 1/2" Rd. (.120 Wall) O.D.	3'

Shock Absorbing Flexible Coupling Disc

6" O.D.

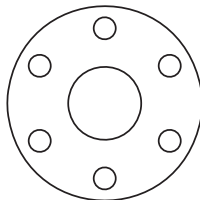

Stock Number	Description
970-2110	Disc only w/ 5/8" Holes
970-2108	Disc only w/ 1/2" Holes

Spider

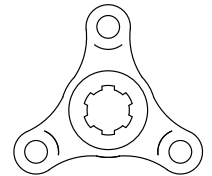

Stock Number	Description
81011-1016	1 3/8" x 6 Spl. with 5/8" Bolt Hole
81013-1053	1 3/8" x 6 Spl. with 21/64" Pinholes & 5/8" Bolt Hole
81021-1097	1 3/4" Rd. with 3/8" Keyway & 5/8" Bolt Hole

Nylon Bearing Repair Kit

(Kit includes nylon bearing and retainer)

NOTE!

Not all guard and bearing systems are interchangeable. When purchasing shaft weld and tube weld yokes or guards, make certain there is a proper fit between nylon bearing raceway in yoke and guard.

It is essential that the proper nylon bearing is identified and installed to insure proper performance and safety. To assist in ordering the proper nylon bearing, listed below are stock numbers and dimensions for our standard aftermarket and OEM nylon bearings.

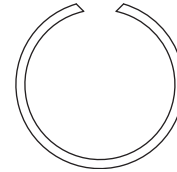
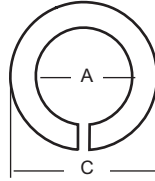
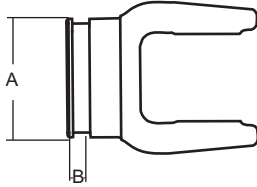

Stock Number	Dim. "A" Yoke Raceway O.D. Nylon Bearing I.D.	Dim. "B" Yoke Raceway Width Nylon Bearing Width	Dim. "C" Nylon Bearing O.D.
920-0017	2 1/8" (2.125")	3/8" (.375")	2 3/4" (2.75")
920-0069	1 3/4" (1.75")	3/8" (.375")	2 3/4" (2.75")
920-0085	2" (2.0")	3/8" (.375")	2 3/4" (2.75")
920-0102	1 3/8" (1.375")	11/32" (.3437")	2" (2.0")
920-0141	1 5/8" (1.625")	11/32" (.3437")	2 3/4" (2.75")
920-0165	2 1/8" (2.125")	3/8" (.375")	3 1/4" (3.25")
920-0195	1 3/4" (1.75")	3/8" (.375")	2 1/2" (2.50")
920-0254	1 5/8" (1.625")	11/32" (.3437")	2 1/4" (2.25")
920-0259	2" (2.0")	3/8" (.375")	3 1/4" (3.25")
920-0260	2 17/32" (2.530")	33/64" (.358")	2 49/64" (2.770")
920-0600	1 13/16" (1.825")	9/32" (.2812")	2 3/4" (2.75")
920-1200	2 1/16" (2.0625")	11/32" (.3437")	2 3/4" (2.75")
920-2600	2 7/8" (2.875")	11/32" (.3437")	3 9/16" (3.5625")
920-3500	2 1/16" (2.0625")	11/32" (.3437")	2 3/4" (2.75")
920-4400	2 5/8" (2.625")	3/8" (.375")	3 1/4" (3.25")
920-5071	2 1/32" (2.021")	11/32" (.358")	2 3/4" (2.76")
920-5084	2 5/32" (2.146")	11/32" (.358")	2 3/4" (2.76")

NOTE!

All Series North American guards are provided without nylon bearings. To help assure the proper set of nylon bearings are installed, one nylon bearing set will be exactly the same (nylon bearing raceway dimensions) as has always been provided in our aftermarket guards. The other set will be dimensioned to retrofit the Weasler OEM raceway. Assembly instructions included with these nylon bearing kits.

Locking Device

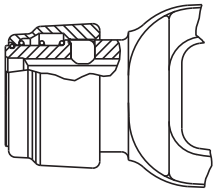

Safety Slide Lock*

An exclusive Weasler replacement component, the Safety Slide Lock* yoke is locked in place by two hardened pawls with compound radii that conform to the groove

in the shaft for full contact. The device is particularly applicable where there is appreciable end thrust.

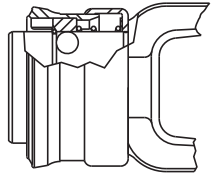

Spring-Lok*

The collar is spring loaded for ease of installation and positive locking to tractor shaft.

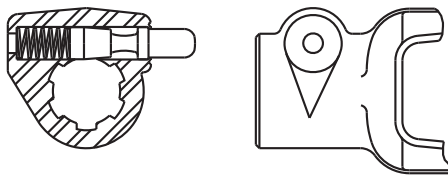

Quick Disconnect

A smooth plunger eliminates sharp projections such as x-washers. Trails rather than leads rotation.

Locking Device Repair Kit

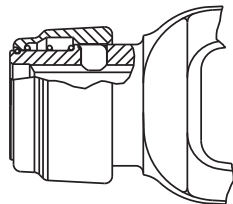

*Auto-Lok/Safety Slide Lock

Stock No. 13004000

Repair Kit for Weasler Auto-Lok and Safety Slide Lock
6 Spline & 21 Spline

Stock No. 13004020

Repair Kit for Weasler Auto-Lok and Safety Slide Lock
20 Spline

Stock No. 13004015

Repair Kit for 1" x 15 Spl.

* This repair kit contains both balls & pawls. When repairing the "Safety Slide Lock" use the pawls only and discard the balls. When repairing the "Auto-Lok" use both the balls and the pawls.

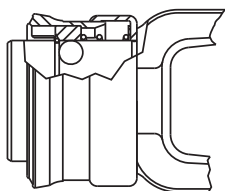

Spring-Lok

Stock No. 13003100

Repair Kit for Weasler Spring-Lok
6 Spline & 21 Spline

Stock No. 13003115

1" x 15 Spline

Quick Disconnect

Stock No. 13002006

Repair Kit for Weasler
and Rockwell 6 Spline
Repair Kit for 1 3/4" x 6 Spl.

Stock No. 13002806

Stock No. 13002021

Weasler 21 Spline and
Hex Quick Disconnect

Stock No. 13002020

Weasler 20 Spline

