



JAKD

Action-Sports Camera

User Manual

Please read through the complete User Manual before using your JAKD Action-Sports Camera, and hold onto the manual for future use. Please operate the camera on basis of full understanding of the manual and camera. Any alteration of product appearance and specification below are without further notice.

Precautions

Please read through the following guidelines before operating your JAKD Action-Sports Camera.

- * Refer to manual instructions on how to operate the camera properly. Incorrect operation may cause damage to internal camera components.
- * Avoid dropping or hitting the camera, it may cause damage to the internal components.
- * To avoid accidents, please keep camera out of reach from children and animals.
- * Do not place the camera in a damp or dusty location for extended periods of time. This may cause a fire or an electrical shock.
- * Do not leave the camera in places exposed to extremely high temperatures or in direct sunlight for extended periods of time. This may affect the camera housing and internal components.
- * We recommend using battery in temperatures between 0 and 40 °C
- * Turn off the camera before removing its memory card, in case of damage to card or stored data.
- * The temperature of the camera may become warmer, if it is used for an extended period of time. Do not be alarmed; this is normal during long periods of camera operation.
- * Do not touch the lens while camera is recording video or photos, it may influence recording quality.
- * Please use a camera specific compressed air cleaner or cleaning cloth to clean fingerprint and dust on surface of camera lens.

Accessories

USB cable

Helmet Mount

Quick-release buckle

Screw Mount Adapter

Long screw

Nylon strap

AC charger

Waterproof Camera Casing

Rechargeable Lithium-ion battery

User manual

3M sticky pads

Rubber pads

Rotating handlebar mount



Operating Interface Introduction

1. Battery cover
2. LED lights
3. Infrared (IR) lamps
4. Camera Lens
5. Charging indicator
6. Operation (recording) indicator
7. LCD 2-inch Touchscreen
8. Built-in Microphone
9. Power ON/OFF button
10. Mode Selection key (Photo mode / Video mode / Car mode)
11. Shutterbutton
12. USB port
13. IR and LED selection key (high beam / low beam / OFF / IR)
14. Micro-SD card slot

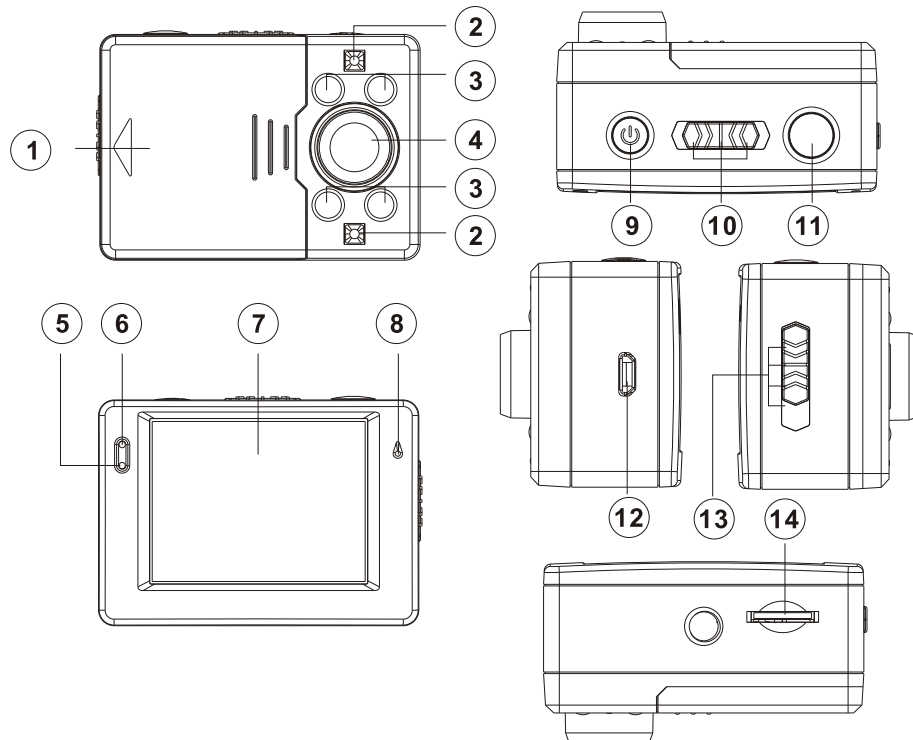

Mounting Tutorial

A JAKD action-sports camera may be mounted in many ways. Here are some mounting suggestions:

1. Helmet Mount

- * Thread the nylon strap into helmet mount
- * Pull strap through helmet and fasten
- * Affix mount firmly using included 3M sticker pads (refer to images below)



Pic. 1



Pic. 2



Pic. 3



Pic. 4

2. Rotating Handlebar Mount

- * Screw camera into rotating handlebar mount
- * Install mount onto motorcycle, bicycle or other circular bar / tubing.



Inserting and removing the Micro SD-Card

1. Insert Micro-SD card so that the connections are facing towards rear of camera.
2. Removing the Micro SD-Card:
 - * Turn OFF camera
 - * Press on edge of the storage card slightly, it will eject automatically.

Notice: *Please ensure you install the Mirco-SD card correctly. Reversed inserting may cause damage to camera and SD card.*

Charging the battery

Connect camera and power supply using the included USB cable and wall charger. During charging, the indicator is red. When battery is fully charged, the indicator will off.

Estimated charging time: about 2 hours.

Notice: *To improve charging efficiency, please turn OFF camera during charging.*

Button Functions

- * Power button turns camera ON and OFF
- * Mode Selection key: switches between Photo mode, video mode or car mode
- * Shutter button: Snaps a photo and starts/stops video recording.
- * While in Standby mode, Hold down Shutter button for 3 seconds to switch to Photo mode or video mode. (This allows user to switch to Photo and video mode freely when underwater and using the waterproof case.)
- * LED light key: turns the LED light ON/OFF, choose IR lamp and adjust brightness of lighting function.

Turning camera ON/OFF

- * Turning ON camera: press and hold  for 3 seconds to turn ON camera. *(While using Carmode and power is turned ON, the camera begins recording automatically after 3 seconds.)*
- * Turning OFF camera: under Standby mode, press and hold Power button for 3 seconds.
- * Auto-Screen-OFF: If there is no operation to the camera when it's in Standby mode, or while recording video for 1 minute, the LCD screen will turn OFF automatically to save battery power.
- * Auto-Power-OFF: If there is no operation to the camera for 5 minutes while in Standby mode, the camera will automatically turn OFF.
- * Power-OFF: when battery power is low, the battery icon on the LCD screen will show an empty grid. Insert USB cable and recharge. If battery icon is showing an "X" and flickering, the screen will read "Low battery" and turn off automatically.

LED lights

While in Standby mode or during recording, switch the LED key on the right side of camera to turn ON/OFF the LED lights. There are four options:

1. **Top switch:** High beam LED
2. **Second switch:** Low beam LED
3. **Third switch:** OFF Status for LED and IR
4. **Bottom switch:** IR lamp ON.

Setting language and time

* Setting time on camera: Click on the Clock icon on LCD screen, it will display a setting interface.

* Click to adjust year (2013-2050), month(01-12), date (01-31), hour (0-23), and minute (00-59). Press Shutter button to exit.

(Please note: When adjusting time settings, you can only increase time and date numbers.)

* Setting language on camera: Click icon  , it will display Language interface. Select preferred language and then press Shutter button to confirm and exit.

LCD screen icons and functions

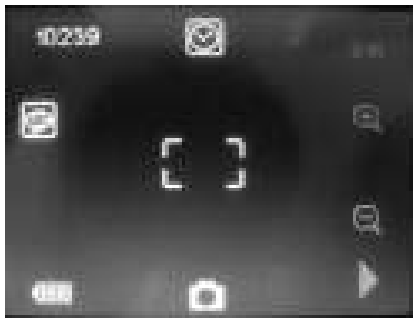

 Counter: indicates remaining the No. Of photos.



Language icon: Select language ENGLISH



Battery icon: Indicates remaining battery power



Time setting icon: Set the time



Virtual shutter: Click to record picture/video instead of pressing Shutter button



Photo icon: Indicates that camera is now in Photo mode



Picture size: Select 3 or 5 Megapixel (MP) photo quality



Zoom icon: Press this to zoom in when recording photos/ videos



Zoom Value icon: Indicates Zoom value



Zoom out icon: press this icon to zoom out

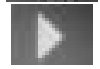

Review icon: Switches camera to playback mode for reviewing recorded photos/videos



Recording timer: indicates remaining recording time



Video mode icon: Indicates that camera is ready to record video



Video resolution: Current HD video quality (FHD - 1920x1080p25fps, HD - 1280x720p/30fps, or VGA - 640x480p30fps)



Car mode icon: Indicates camera is in Car mode



Loop recording mode: select loop record by 2 minutes or 5 minutes

Video mode

1. Normal recording mode:

- * Switch the Mode Selection key on the top of camera to the middle position.
- * Press Shutter button or click Virtual Shutter in middle of LCD screen to start recording HD video. During recording, the LED light will flash green.
- * Camera will automatically save out video every 10 minutes and continues recording automatically.
- * Press Shutter button again to stop.
- * If memory card is full, or battery is low, video recording stops and camera powers OFF automatically.

2. Loop-recording-Car mode:

- * Switch Mode Selection key on top of camera to the right position, press Shutter button or click Virtual Shutter in middle of LCD screen to start recording.

- * During recording, green light flashes. Camera will record videos every 2/5 minutes and continues recording automatically.
 - * When the memory card is full, it will overwrite the first video footage automatically and continue recording, and so on.
- Please note: Screen will turn OFF automatically during recording to save more power. Press on anywhere on LCD screen or the Power button to restore display.*

Photo mode

Switch Mode Selection key on top of camera to the left position, press Shutter button or click Virtual Shutter in middle of LCD screen to take photo.

Playback mode

1. Playback interface icons



Under Standby mode: click on the 'Play' icon  on the bottom right of the LCD screen to switch to Playback mode.



Indicates video file is in AVI format



Indicates a Photo file



Indicates numbers of photos/videos taken



Indicates video resolution



Indicates photo file size







Enter into next file

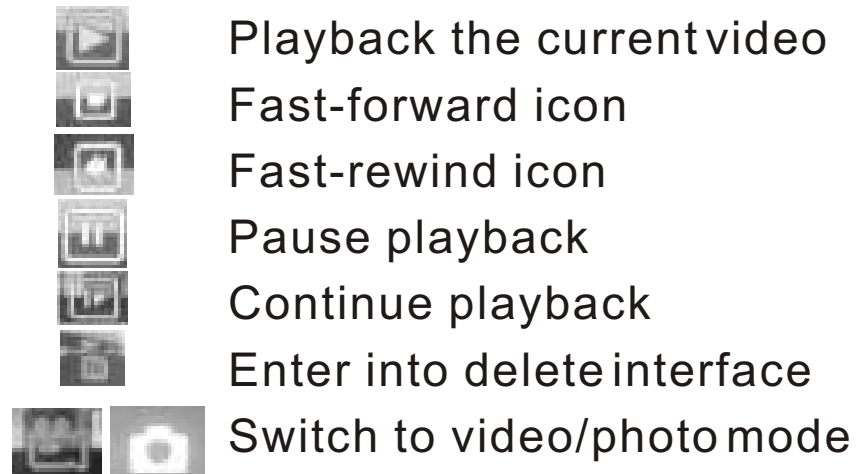

Enter into last file



2. Video Playback

Under standby mode: click  to enter into playback mode, then click  to start playback,  to fast forward,  to fast backward. During fast forward /backward, click  to pause and click it again to come back to normal playback.

3. Delete/format files

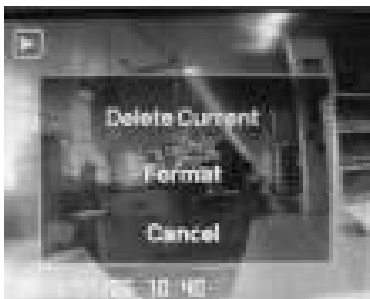

- * Under playback mode, click  to enter into the interface 1, select “Delete current”, “Format” or “Cancel.”
- * If user selects “Delete current” it will enter into interface 2. Click “OK” to delete the current file.
- * If “Format” is selected, camera will enter into interface 3. Click “OK” to delete all files. Click “Cancel” to return to playback mode.

Playback video footage on PC

- * Connect PC to camera using USB cable. LCD screen displays Mass Storage/PC Camera.
- * To browse photo and video files, choose “Mass Storage” and press Shutter button to confirm.
- * Open “My Computer”- “Removable Disk” -“DCIM” - “100MEDIA” folder to check files.
- * To start PC camera, choose “PC Camera” and press Shutter button to confirm. Open “My computer” and click icon  to start PC.

Technical specifications

Sensor:	5 Megapixel CMOS
Video Resolution:	1080p 25fps 720p 30fps VGA 30fps
Photo size:	3Megapixel (2048x1536) 5Megapixel (2592x1944)
Lens:	130 degree, all glass
External Memory:	Micro SD card slot, supports up to 32G
Format:	JPEG/AVI
Zoom in /out:	4 x zoom
Audio:	Built-in Microphone / buzzer
Screen:	2-inch LCD touch screen
Port:	USB2.0、
Waterproof:	Down to 30 metres (98 feet)
Battery:	Built-in 800mAh Lithium battery
PC-function:	Valid
Lights:	4 x IR lamps, 2x LED Lights