



INSTALLATION INSTRUCTIONS MULTI-MOUNT KIT

Part Number: 75330

Application: Warn HP PowerPlant P/N 71800

Your safety, and the safety of others, is very important. To help you make informed decisions about safety, we have provided installation and operating instructions and other information on labels and in this guide. This information alerts you to potential hazards that could hurt you or others. It is not possible to warn you about all potential hazards associated with this product, you must use your own good judgment.

CARELESS INSTALLATION AND OPERATION CAN RESULT IN SERIOUS INJURY OR EQUIPMENT DAMAGE. READ AND UNDERSTAND ALL SAFETY PRECAUTIONS AND OPERATING INSTRUCTIONS BEFORE INSTALLING AND OPERATING THIS PRODUCT.

This guide identifies potential hazards and has important safety messages that help you and others avoid personal injury or death. **WARNING** and **CAUTION** are signal words that identify the level of hazard. These signal words mean:

WARNING signals a hazard that could cause serious injury or death, if you do not follow recommendations.

CAUTION signals a hazard that may cause minor to moderate injury, if you do not follow recommendations.

This guide uses **NOTICE** to call attention to important mechanical information, and **Note**: to emphasize general information worthy of special attention.

WARNING

INJURY HAZARD

Failure to observe these instructions could lead to severe injury or death.

- q **Always** use extreme caution when drilling on any vehicle. Make sure that all fuel lines, brake lines, electrical wires, and other objects are not punctured or damaged when/if drilling on the vehicle. Thoroughly inspect the area to be drilled (on both sides of material) prior to drilling, and relocate any objects that may be damaged. Failure to inspect the area to be drilled may result in vehicle damage, electrical shock, fire or personal injury.
- q **Always** wear safety glasses when installing this kit. A drilling operation will cause flying metal chips. Flying chips can cause eye injury.
- q **Always** use extreme caution when cutting and trimming during fitting.
- q **Always** remove jewelry and wear eye protection.
- q **Never** lean over battery while making connections.
- q **Never route electrical cables:**
 - o Across any sharp edges.
 - o Through or near moving parts.
 - o Near parts that become hot.
- q **Always** insulate and protect all exposed wiring and electrical terminals.
- q **Always** install terminal boots as directed in installation instructions.
- q **Always** inspect the quick connect polarity on the cable from the battery AND the cable from the [winch](#).
- q **Always** use appropriate and adequate care in lifting components into place.
- q **Always** insure components will remain secure during installation and operation.
- q **Always** tighten all nuts and bolts securely, per the installation instructions.
- q **Always** stay clear of moving parts and joints. Always keep others away when operating or adjusting plow.
- q **Always** replace all worn or damaged parts before operating.
- q **Never** operate this WARN product with damaged or missing parts.

CAUTION

MOVING PARTS ENTANGLEMENT HAZARD

Failure to observe these instructions could lead to minor or moderate injury.

- q **Always** take time to fully read and understand the installation and Operations Guide included with this product.
 - q **Never** operate this product if you are under 16 years of age.
 - q **Never** operate this product when under the influence of drugs, alcohol or medications.
- Read installation and operating instructions thoroughly.**

NOTICE	
EQUIPMENT DAMAGE	
q	Always refer to the Installation and Specification Guide, supplied in the winch kit, for all wiring schematics and specific details on how to wire this WARN product to your vehicle. Read installation and operating instructions thoroughly.

PARTS LIST

<u>Part Number</u>	<u>Qty</u>	<u>Description</u>
75240	1	Multi-Mount Frame Kit
63063	1	Hitch Pin and Clip
69847	1	Plug, Quick Disconnect
30510	1	Quick Disconnect Cable, 36" Winch
26405	1	Quick Disconnect Cable, 90" Battery

TOOLS REQUIRED

7/16" Wrench (2)	1 1/16" Socket Wrench
1/2" Wrench	1/4" Drill bit and Drill motor
9/16" Wrench	Correct wrenches for connection to battery terminal
5/8" Wrench	Safety Glasses

TORQUE SPECIFICATIONS

1/4	8 lb. ft. (10.8 N-m)
3/8	30 lb. ft. (40.7 N-m)
7/16	50lb. ft. (67.8 N-m)

BEFORE YOU BEGIN

The WARN Multi-Mount PowerPlant System is to be used only with a WARN Multi-Mount Front Receiver or a class 3 receiver hitch. When the winch is used at the rear hitch of a vehicle, use a 20' (p/n 32963) or 24' (p/n 32966) WARN Quick Connect Power Cable to extend forward to the vehicle battery.

1. Before bolting the winch to Multi-Mount Frame, it is necessary to attach the Quick Connect Cable to the PowerPlant in place of the long red and black battery cables. **See Figure 1**

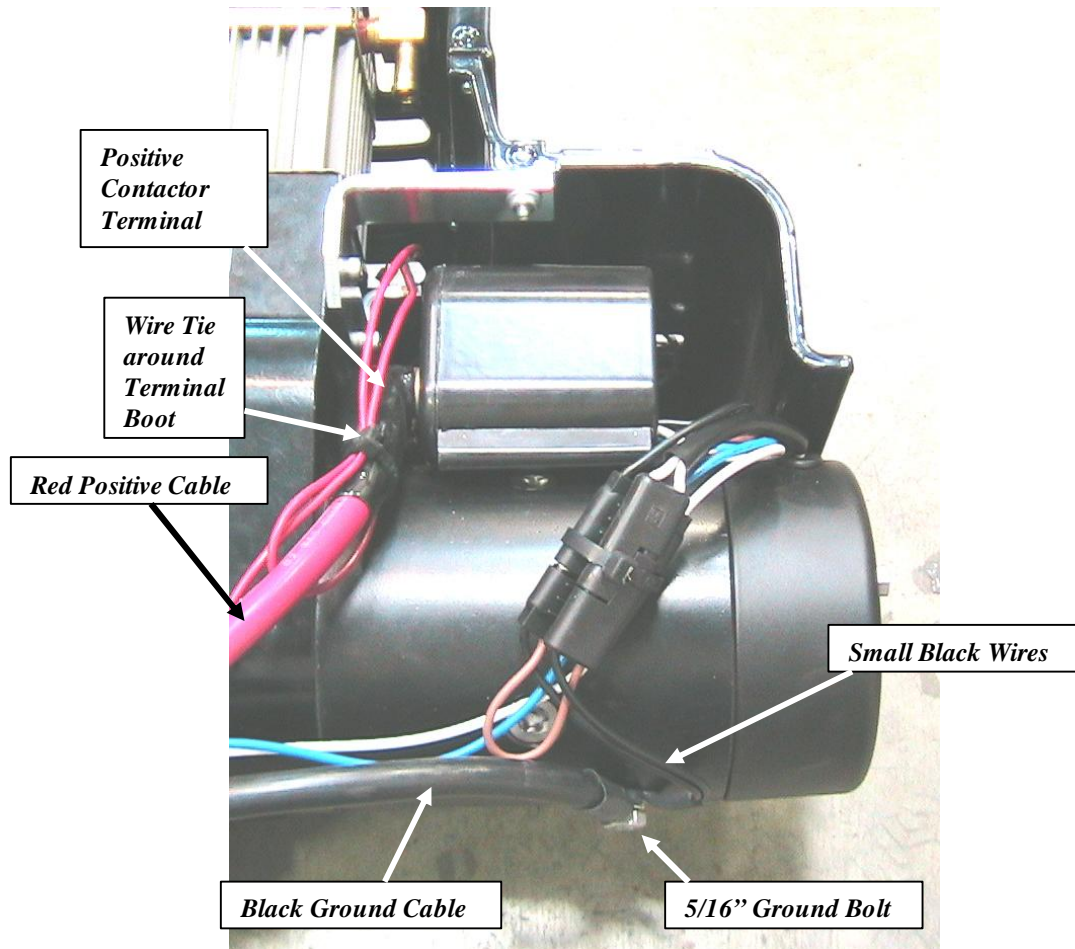

Figure 1

Remove the 5/16" bolt securing the ground cable to the bottom of the motor. Note the small black wires secured by the same bolt. Be sure to reconnect these in the same position when the new ground cable is installed.

Cut the wire tie securing wires to the terminal boot on the positive cable. Slide the boot down the cable and remove the nut securing the positive cable to the contactor terminal. Note the small red wire secured by the same nut. Be sure to reconnect this in the same position when the new positive cable is installed.

Carefully remove the boot from the positive cable. It will be reinstalled on the new cable.

Find the 36" twin lead Quick Connect Cable and slide the terminal boot over the positive cable. The positive cable is identified by the white stripe and the "+" symbol printed on the insulation. Connect the cable and the small red wire to the contactor terminal and tighten the nut. Slide the terminal boot over the terminal and with one of the wire ties provided, tie the small red wires around the boot. **See Figure 2**

Connect the other "leg" of the 36" Quick Connect Cable (negative or ground cable) to the motor. Remember to install the small black wire. Tighten the bolt.

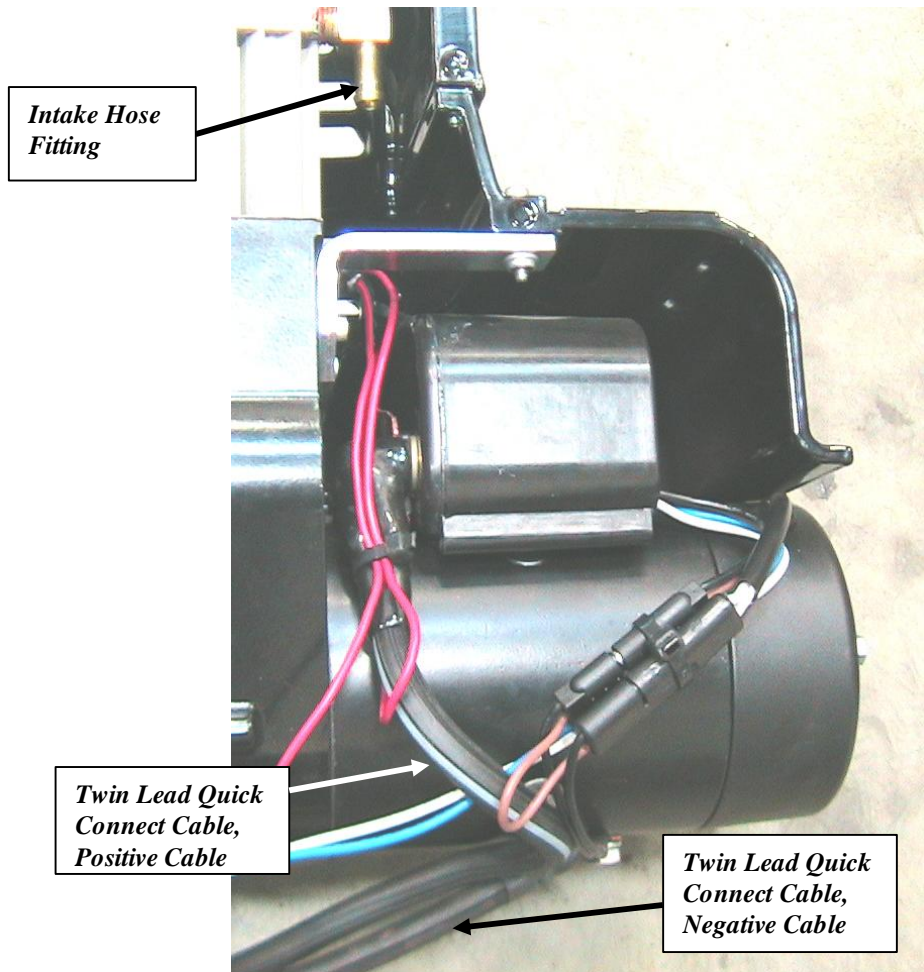

Figure 2

2. Install the air intake hose and filter per the PowerPlant Operator's Manual. The filter should be located where the possibility of water or mud entry is minimal. The hose may be shortened if necessary or it can be used full length and positioned in a protected location when in use.
3. Install the fairlead on the front of the Multi-Mount Frame. **See Figure 3**

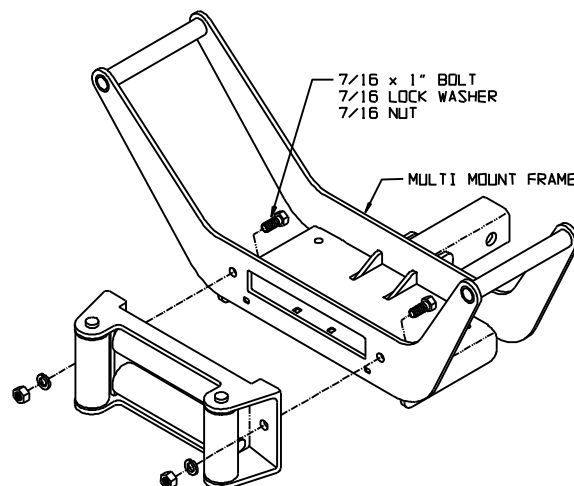

Figure 3

- Mount the PowerPlant to the Multi-Mount Frame using the instructions and fasteners provided with the PowerPlant.

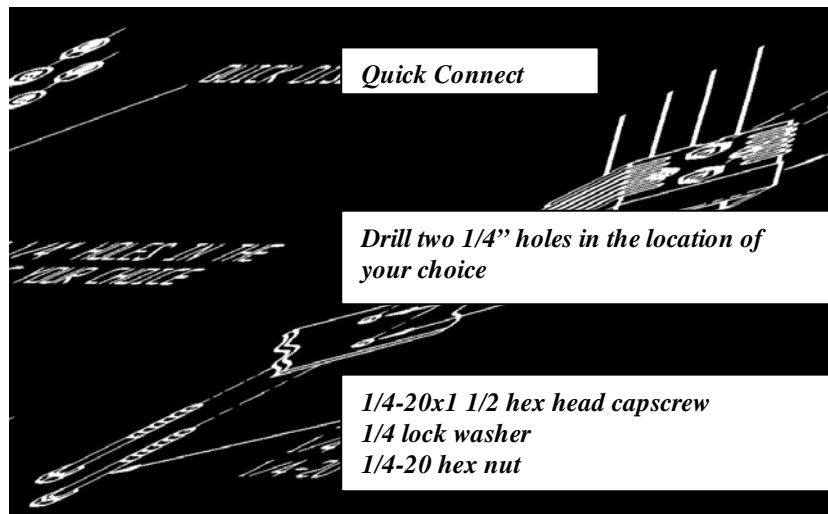





FIGURE 4

- Mount the Quick Connect from the long cable to a suitable location on the vehicle, within reach of the PowerPlant cable Quick Connect. **When routing the cables note the Injury Hazard Warnings referring to electrical cable routing at the beginning of these instructions.**

A plug is furnished to keep the vehicle Quick Connect clean when not in use. The lanyard can be attached to one of the cables or to a location of your choice.

WARNING: Always inspect the quick connect polarity on the cable from the battery AND the cable from the PowerPlant, before connecting the cables to the battery. Make sure the positive (+) cable exits the side of the plug marked with a “+” symbol, and the negative (-) ground cable exits the side of the plug marked with a “-” symbol. The positive cable can be identified by the white stripe and the “+” symbols printed on the insulation. Some positive cables have red insulation. The ground cable is black.

 WARNING	
	
<p>CHEMICAL AND FIRE HAZARD</p> <p>Failure to observe these instructions could lead to severe injury or death.</p> <ul style="list-style-type: none"> • Always inspect the quick connect polarity on the cable from the battery AND the cable from the PowerPlant. 	

- Connect positive (+) power cable lead (white stripe) to the battery positive (+) terminal and the (-) lead to the negative (-) terminal. To make battery connection easier Warn has battery bolt kits available for General Motors vehicles with side terminal batteries (p/n 73761) and late model Ford vehicles with small terminal bolts (p/n 72720).

- Upon completion of the installation, check PowerPlant for proper operation.



WARNING

INJURY HAZARD

Failure to observe these instructions could lead to severe injury or death.

- q **Always** take time to fully read and understand the vehicle's operator manual, PowerPlant operator manual and warning labels prior to operation of PowerPlant.



WARNING

INJURY HAZARD

Failure to observe these instructions could lead to severe injury or death.

- q **Always** securely tighten all bolts on the Multi-Mount Frame, PowerPlant, and fairlead prior to operation of PowerPlant.

MAINTENANCE/CARE

1. Inspect all parts on the PowerPlant, Multi-Mount Frame, and related hardware prior to each use. Replace all hardware that appears rusted or deformed.
2. Inspect all nuts and bolts on the PowerPlant, Multi-Mount Frame, and related hardware prior to each use. Tighten all nuts that appear to be loose. Stripped, fractured, or bent bolts or nuts need to be replaced.
3. Check all cables prior to use. Replace cables that look worn or frayed.
4. Check all moving or rotating parts. Remove debris that may inhibit the part from moving freely.



WARNING

INJURY HAZARD

Failure to observe these instructions could lead to severe injury or death.

- q **Always** perform regular inspections on the PowerPlant, Multi-Mount Frame, and related hardware.
- q **Always** replace all worn or damaged parts before operating.
- q **Never** operate this WARN product with damaged or missing parts.