

Warehouse Use Only

Part #	QUANTITY
--------	----------

D069	1
------	---

D115	1
------	---

G004	4
------	---

M13W	4
------	---

A286-72W	2
----------	---

BG572	2
-------	---

Z286	4
------	---

Part #:	J1020W
---------	--------

Dimensions:	6" X 6" X 73" (Telescopic)
-------------	----------------------------

Weight:	???
---------	-----

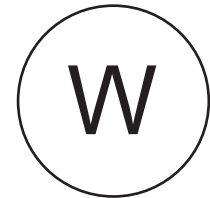

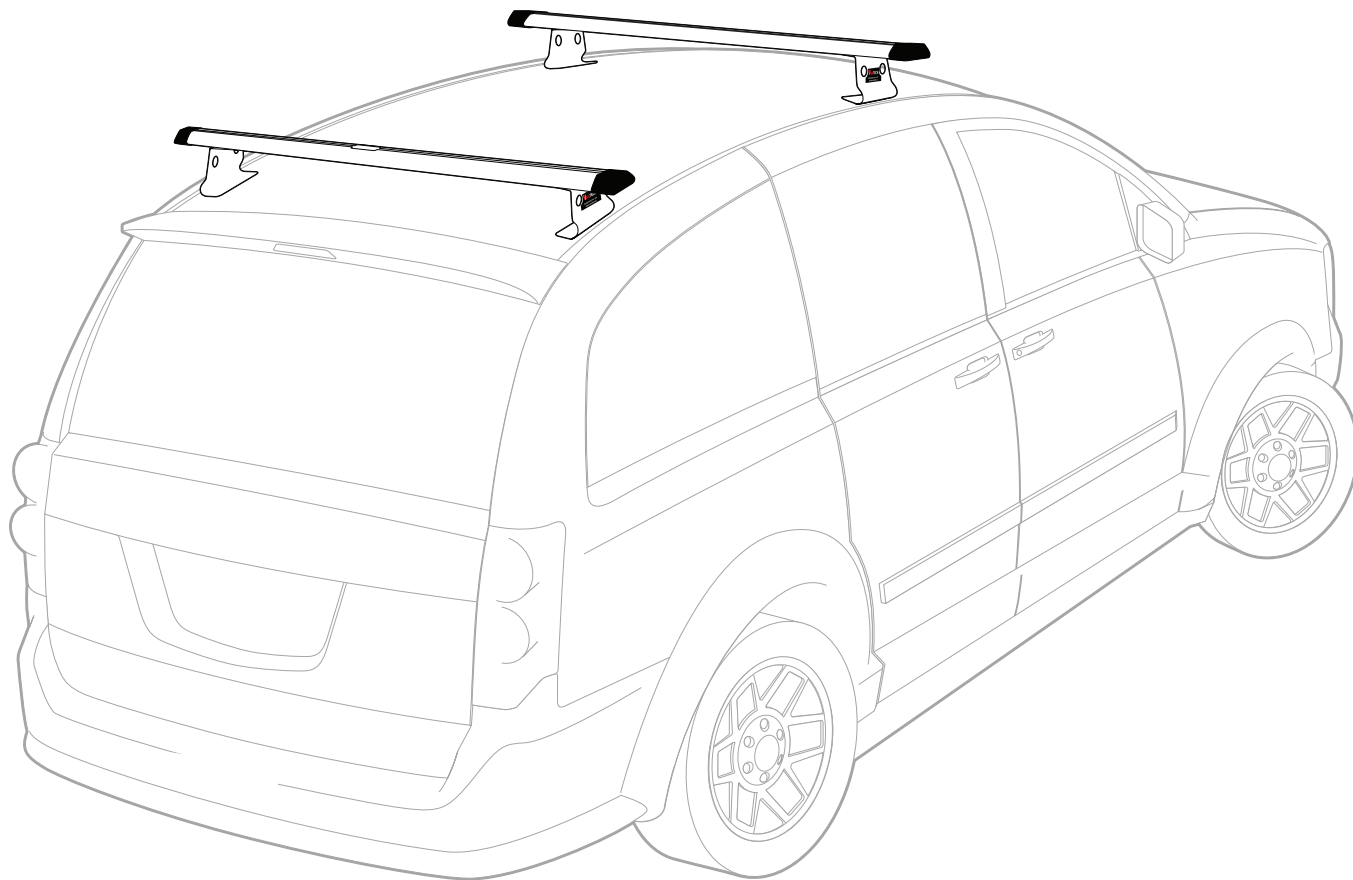

PRODUCT INFO

Part #: J1020W
System: J1000
Material: Aluminum
Fitment: Universal (Drilling Required)
Color: White

REQUIRED TOOLS

Power Tool With 5/16" Drill Bit

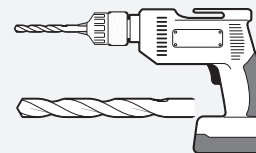



1/2" Wrench



Marker

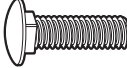

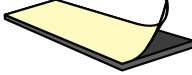
PART #	DESCRIPTION	QTY	ITEM ITEM NOT DRAWN TO SCALE
S052	DOUBLE SLIDER 2" BOLT TO BOLT	4	
W008	5/16" X 3/4" WASHER	16	
B016	5/16" X 1 1/4" CARRIAGE BOLT	8	
N005	5/16" NYLON NUT	16	
M13	MOUNTING BASE	4	
M07	INTERIOR PLATE	4	
A286-72	3" X 1.5" X 72" CROSS BAR	2	
G004	POLYFOAM GASKET 1.5" X 4"	4	
BG572	RUBBER BAR GUARD 72"	2	
Z286	ENDCAP	4	

RUBBER BAR GUARDS

- Press the rubber bar guard into the channels of cross bars

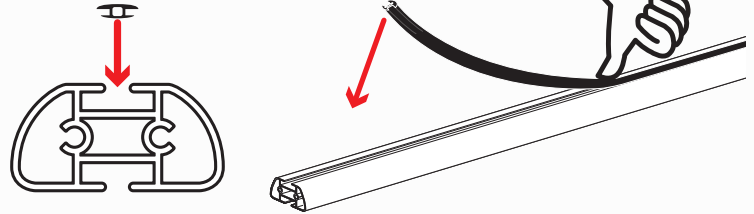

SYSTEM PLACEMENT MUST BE PLACED IN THIS ORDER

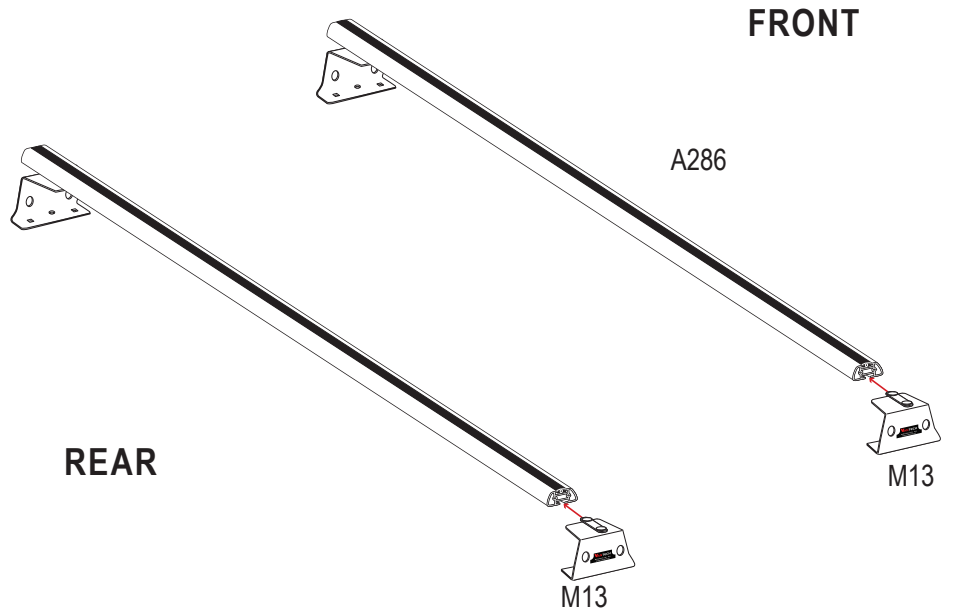
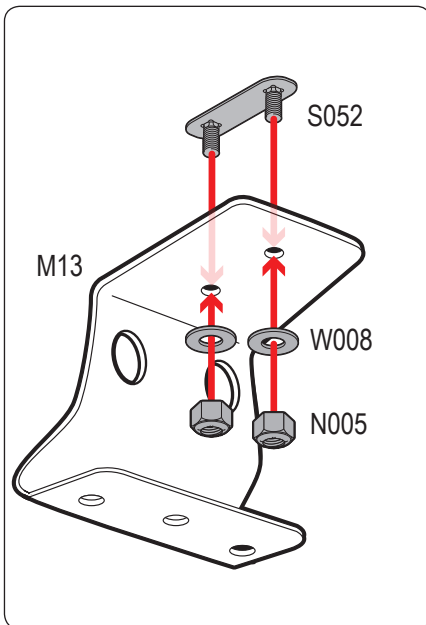

Do not tighten hardware

