

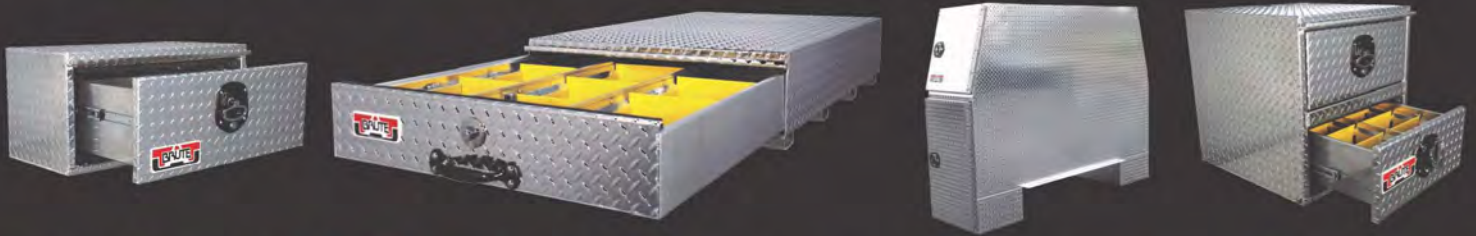

2017-2018  
HD Catalog



**COMMERCIAL CLASS  
CARGO MANAGEMENT EQUIPMENT**



# TABLE OF CONTENTS

At Unique Truck Accessories, we are no stranger to building tool boxes for the heavy truck industry. We've been building "Private Label" HD boxes for over a decade. Also, we have and continued to build class 1-5 truck boxes for a decade before that.

When we say "We Do Work" it means we have been building truck boxes for the working truck. Our products can withstand the harsh environment that professional truckers and contractors live and work in every day. We are domestically manufacturing at our plant in Sturgis Michigan since 1992.

We are now proud to introduce our BRUTE HD products for heavy trucks. Something we know a lot about. And for those of you who know heavy trucks...you immediately notice the attention to detail in the way we produce and assemble these boxes. Starting with the smart design and reinforced corners then moving on to the hinges and top notch locking hardware.

Unique Truck Accessories and BRUTE products have always been innovative and sensible designs. We welcome you to compare these boxes to any brand you are comfortable with. We know the least we will do is come toe to toe with the best in the business.

Product	Page
What's New?	3
Under Body w/ Single Drawer	4
Under Body w/ Top Drawer	5
Under Body Double Drawers	6
Under Body Drop Down Door	7-10
Under Body Barn / Swing Door	11-13
Top Siders w/ Drawers Flat Bed	14-15
Top Siders H.C. w/ Flip Up Door	16
Top Siders w/ Flip Up Door	17
Back Packs	18-19
Step Boxes	20
Light Boxes	21
BedSafe™ Roller Drawer Boxes	22-27







New Longer Sizes

72" & 60"

Pages 23-24



New Full Package Aluminum Flatbeds

Extruded Aluminum Flatbeds—Request Flatbed Specific Literature





**UNDER BODY WITH SINGLE DRAWER**



**MODEL HD141424**

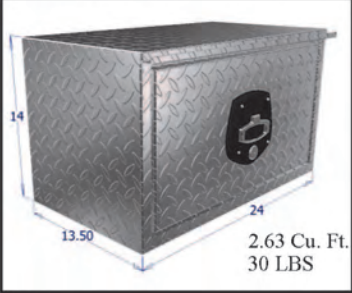

**MODEL HD141430**

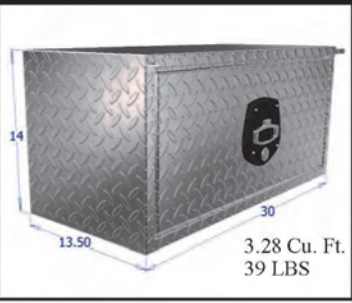

**MODEL HD141824**



**MODEL HD141830**



Compression Handle



Roller Cam Latch

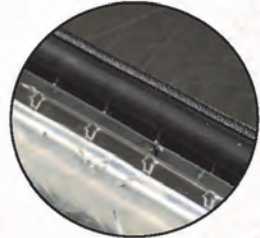

Genuine Trim-Lock Bulb Seal

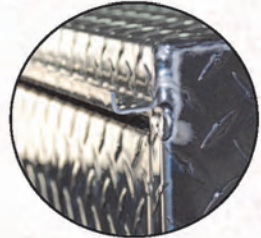

Overhead Rain Gutter

- .100 Thick Diamond Tread Aluminum Construction
- .080 Smooth Aluminum Drawer Interiors

- Drawer w/ Adjustable Dividers
- STRATTEC High Quality Key Cylinder
- Free Turning Handle When Locked
- Full Wrap One Piece Body Design
- Full HD Aluminum Lock Cover Protection





**UNDER BODY WITH TOP DRAWER**



Overhead Rain Gutter



Reinforced Bottom Corners



Compression Handle



Roller Cam Latch

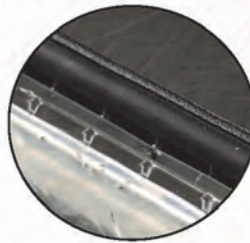

Genuine Trim-Lock Bulb Seal

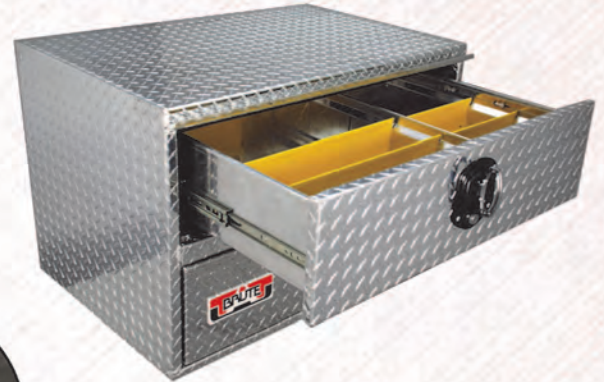

**MODEL HD2124**

21  
18 24  
5.25 Cu. Ft.  
62 LBS

**MODEL HD2130**

21  
18 30  
6.56 Cu. Ft.  
70 LBS

**MODEL HD2136**

21  
18 36  
7.88 Cu. Ft.  
79 LBS

**MODEL HD2148**

21  
18 48  
10.5 Cu. Ft.  
90 LBS

- Top Drawers w/ Adjustable Dividers
- Bottom Compartment
- STRATTEC High Quality Key Cylinder
- Free Turning Handle When Locked
- Full Wrap One Piece Body Design
- Full HD Aluminum Lock Cover Protection

- .100 Thick Diamond Tread Aluminum Construction
- .125 Thick Smooth Aluminum Bottom Corner Reinforcement
- .080 Smooth Aluminum Drawer Interiors





**UNDER BODY WITH DRAWERS**



Overhead Rain Gutter

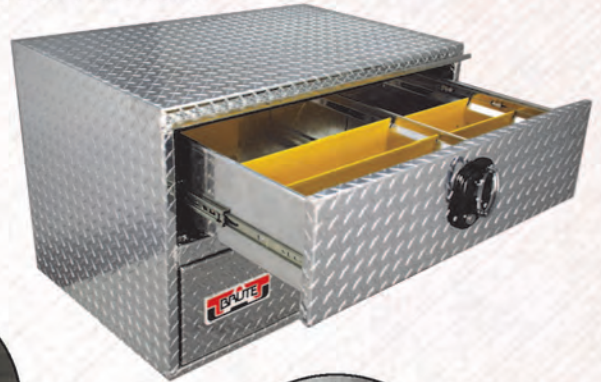

Compression Handle



Roller Cam Latch

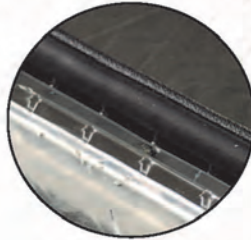

Genuine Trim-Lock Bulb Seal



Reinforced Bottom Corners

- .100 Thick Diamond Tread Aluminum Construction
- .125 Thick Smooth Aluminum Bottom Corner Reinforcement
- Top & Bottom Drawers w/ Adjustable Dividers
- STRATTEC High Quality Key Cylinder
- Free Turning Handle When Locked
- Full Wrap One Piece Body Design
- Full HD Aluminum Lock Cover Protection
- .080 Smooth Aluminum Drawer Interiors



**MODEL HDD24**

24  
24  
24

9.4 Cu. Ft.  
68 LBS

**MODEL HDD30**

24  
30  
24

10 Cu. Ft.  
95 LBS

**MODEL HDD36**

24  
36  
24

13.74 Cu. Ft.  
101 LBS





## UNDER BODY BOX-DROP DOOR



Overhead Rain Gutter

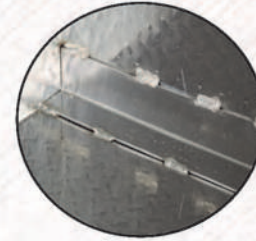

Reinforced Bottom Corners

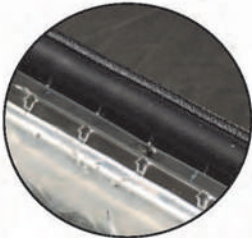

Genuine Trim-Lock Bulb Seal



Roller Cam Latch



Compression Handle

- .100 Thick Diamond Tread Aluminum Construction
- .125 Thick Smooth Aluminum Bottom Corner Reinforcement
- Welded Gussets in Each Corner of Door Frame
- STRATTEC High Quality Key Cylinder
- Free Turning Handle When Locked
- Full Wrap One Piece Body Design
- Full HD Aluminum Lock Cover Protection
- Stainless Steel Support Cables







**UNDER BODY BOX MODELS**

**14" Drop Down Door Models Below**

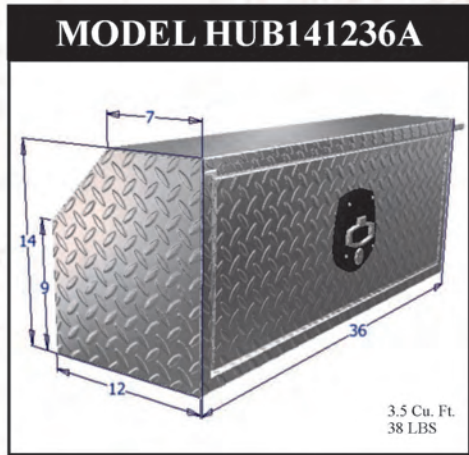

Models w/ top rear angles are used to avoid the fuel fill tube when installing on a "Bed Delete" flatbed truck.







**UNDER BODY BOX MODELS**

**18" x 18" Drop Down Door Models Below**

**MODEL HUB1818**

18  
18  
18

4.4 Cu. Ft.  
31 LBS

**MODEL HUB1824**

18  
18  
24

5.72 Cu. Ft.  
33 LBS

**MODEL HUB1830**

18  
18  
30

7.04 Cu. Ft.  
42 LBS

**MODEL HUB1836**

18  
18  
36

8.36 Cu. Ft.  
45 LBS

**MODEL HUB1848**

18  
18  
48

11 Cu. Ft.  
56 LBS

**MODEL HUB1860**

18  
18  
60

13.63 Cu. Ft.  
70 LBS

**OPTIONAL .25 ALUMINUM MOUNTING BRACKETS**

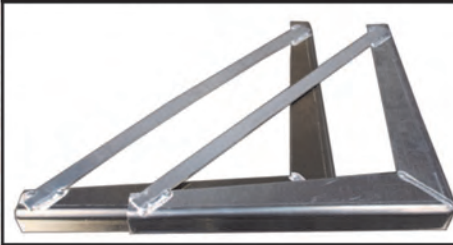

MODEL	SIZE
HBK18	18" X 18" 6 LBS
HBK24	24" X 24" 10 LBS

Sold in Pairs





**UNDER BODY BOX MODELS**

**24" x 24" Drop Down Door Models Below**

**MODEL HUB2418**

24  
24  
18  
7.52 Cu. Ft.  
48 LBS

**MODEL HUB2424**

24  
24  
24  
9.78 Cu. Ft.  
50 LBS

**MODEL HUB2430**

24  
24  
30  
12.04 Cu. Ft.  
58 LBS

**MODEL HUB2436**

24  
24  
36  
14.29 Cu. Ft.  
72 LBS

**MODEL HUB2448**

24  
24  
48  
18.81 Cu. Ft.  
84 LBS

**MODEL HUB2460**

24  
24  
60  
23.32 Cu. Ft.  
96 LBS

**MODEL HUB2472**

24  
24  
72  
27.84 Cu. Ft.  
107 LBS

**OPTIONAL .25 ALUMINUM MOUNTING BRACKETS**

MODEL	SIZE	WEIGHT
HBK18	18" X 18"	6 LBS
HBK24	24" X 24"	10 LBS

Sold in Pairs





**UNDER BODY BOX-SWING DOOR**

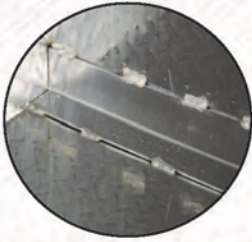

Reinforced Bottom Corners



1/4" Stainless Hinge Pin

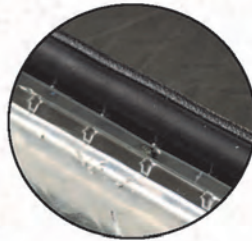

Genuine Trim-Lock Bulb Seal

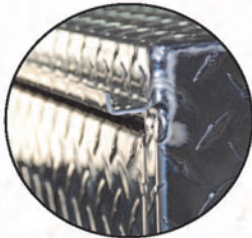
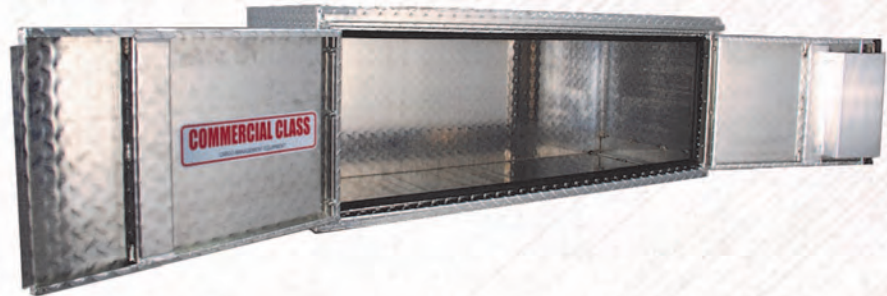

Overhead Rain Gutter

- .100 Thick Diamond Tread Aluminum Construction
- .125 Thick Smooth Aluminum Bottom Corner Reinforcement
- Welded Gussets in Each Corner of Door Frame
- Three Point Latches Standard on 36", 48" & 60" Models
- STRATTEC High Quality Key Cylinder
- Free Turning Handle When Locked
- Full Wrap One Piece Body Design
- Full HD Aluminum Lock Cover Protection
- Stainless Steel Bolted Hinge



Compression Handle

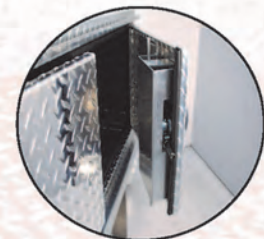

Compression Latch Shown w/ 3 Pt. System





**UNDER BODY SWING / BARN DOOR MODELS**

**18" x 18" Swing / Barn Door Models Below**

**MODEL HBD1818**

4.4 Cu. Ft.  
25 LBS

**MODEL HBD1824**

5.72 Cu. Ft.  
33 LBS

**MODEL HBD1830**

7.04 Cu. Ft.  
39 LBS

**MODEL HBD1836**

8.36 Cu. Ft.  
45 LBS

**MODEL HBD1848**

11 Cu. Ft.  
58 LBS

**MODEL HBD1860**

13.63 Cu. Ft.  
71 LBS

**OPTIONAL .25 ALUMINUM MOUNTING BRACKETS**



MODEL	SIZE
HBK18	18" X 18" 6 LBS
HBK24	24" X 24" 10 LBS

Sold in Pairs





**UNDER BODY SWING / BARN DOOR BOX MODELS**

**24" x 24" Swing Door Models Below**



**OPTIONAL .25 ALUMINUM MOUNTING BRACKETS**



MODEL	SIZE
HBK18	18" X 18" 6 LBS.
HBK24	24" X 24" 10 LBS.

Sold in Pairs





**DRAWER FLATBED TOP SIDER**

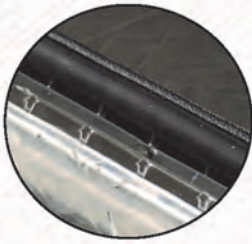

Neoprene D Seal

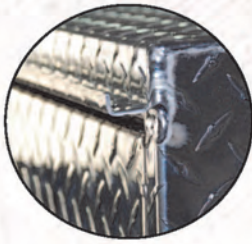

Overhead Rain Gutter



Compression Handle



Roller Cam Latch

- .100 Thick Diamond Tread Aluminum Construction
- Welded Gussets in Each Corner of Door Frame
- STRATTEC High Quality Key Cylinder
- Drawers w/ Dividers
- Free Turning Handle When Locked
- Full Wrap One Piece Body Design
- Full HD Aluminum Lock Cover Protection
- Mounting Hardware Included

**MODEL HTD48**

5.33 Cu. Ft.  
64 LBS

**MODEL HTD72**

8 Cu. Ft.  
81 LBS

**MODEL HTD88**

9.78 Cu. Ft.  
122 LBS





**DRAWER FLATBED TOP SIDER**

This drawer box is very versatile. Shown here with the drawer box up against the bulkhead for easy access from either side of the truck. This application would work well for pulling a gooseneck or for the person who needs to haul on the flatbed but needs added storage. Also shown with a drawer underbody—New Item!



Shown here with another possibility. These boxes are very modular, we attached a High Capacity Top Sider w/ flip up door (see page 16) to maximize storage. These two boxes together make a great contractor package. See pages 18-19 for all the configuration packages you can imagine.



**Industry  
Exclusive**





**TOP SIDER-HIGH CAPACITY**

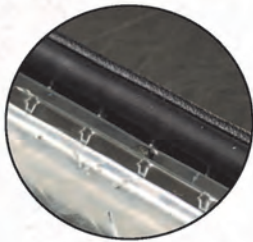

Genuine Trim-Lock Bulb Seal



Overhead Rain Gutter



Compression Handle



Roller Cam Latch

- .100 Thick Diamond Tread Aluminum Construction
- Welded Gussets in Each Corner of Door Frame
- STRATTEC High Quality Key Cylinder
- Gas Shocks to Lift & Hold Door(s), Industry Exclusive
- Free Turning Handle When Locked
- Full Wrap One Piece Body Design
- Full HD Aluminum Lock Cover Protection
- Mounting Hardware Included

**MODEL HTB72C**

14.65 Cu. Ft.  
77 LBS

**MODEL HTB88C**

17.81 Cu. Ft.  
95 LBS

**MODEL HTB96C**

19.40 Cu. Ft.  
102 LBS





**TOP SIDER**

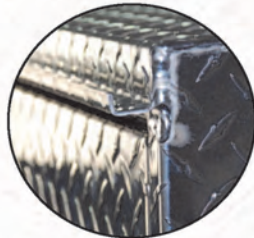
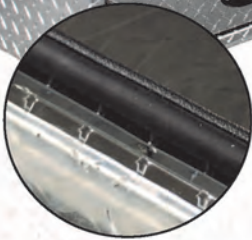

Genuine Trim-Lock Bulb Seal

Overhead Rain Gutter

Compression Handle

Roller Cam Latch

- .100 Thick Diamond Tread Aluminum Construction
- Welded Gussets in Each Corner of Door Frame
- STRATTEC High Quality Key Cylinder
- Gas Shocks to Lift & Hold Door(s), Industry Exclusive
- Free Turning Handle When Locked
- Full Wrap One Piece Body Design
- Full HD Aluminum Lock Cover Protection
- Mounting Hardware Included







**BACK PACKS**



Includes U Bolt Mounting Kit



Roller Cam Latch



Compression Handle

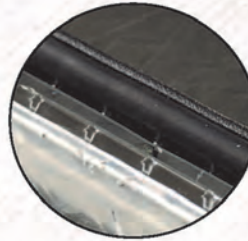

Genuine Trim-Lock Bulb Seal



- .125 Thick Aluminum Diamond Tread Body
- .190 Thick Smooth Aluminum Floor
- .375 Thick Pre-punched Mounting Angle
- Rain Gutter Door Openings To Channel Water
- Pinch Weld Bulb Seal On All Doors
- Stainless Steel Folding / Locking T Handles
- 4 Folding J Hooks—Driver Side

Turn the Back Pack into an L Pack by adding the HPB141624.

Includes a mounting kit to attach to the Back Pack

**MODEL HPB141624**

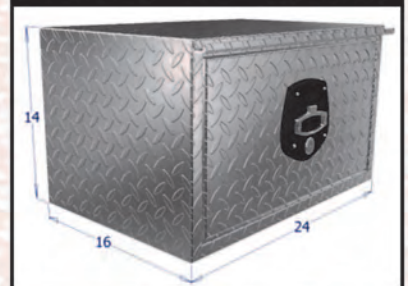



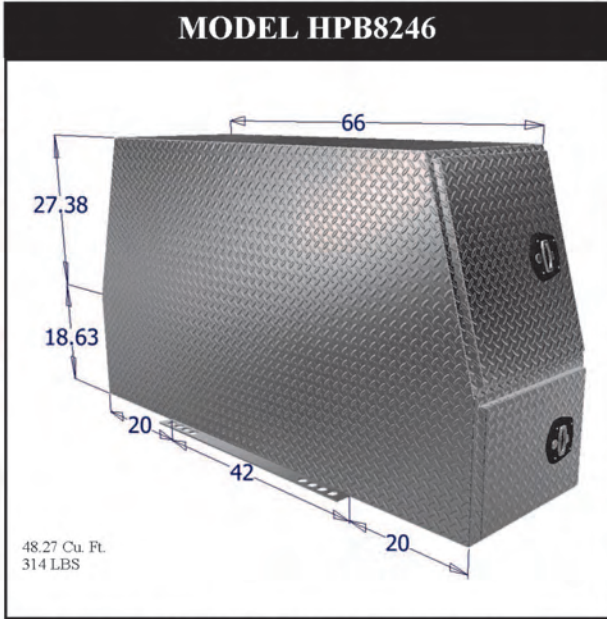

1 Fixed Shelf (.125 Thick Smooth Aluminum)

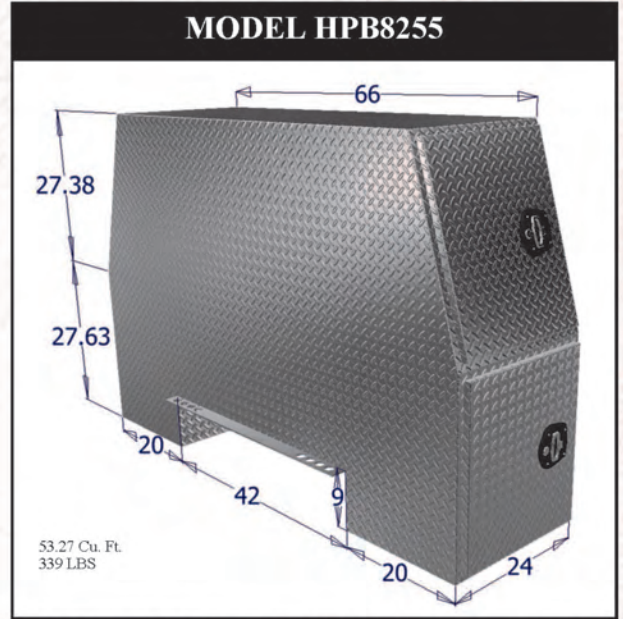

2 Fixed Shelves (.125 Thick Smooth Aluminum)

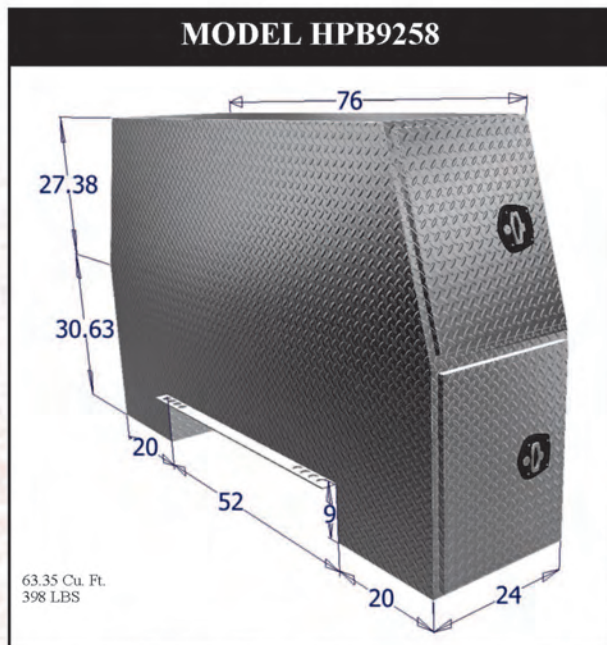

2 Fixed Shelves (.125 Thick Smooth Aluminum)

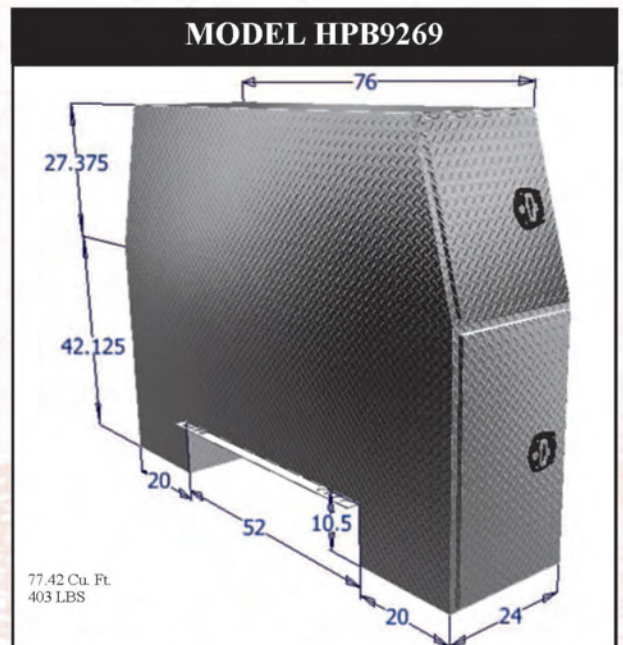

2 Fixed Shelves (.125 Thick Smooth Aluminum)





**STEP BOX**



**MODEL HSB12**

5.87 Cu. Ft.  
36 LBS

**MODEL HSB18**

8.39 Cu. Ft.  
46 LBS



Folding / Locking T Handle

**MODEL HSB24**

10.91 Cu. Ft.  
56 LBS

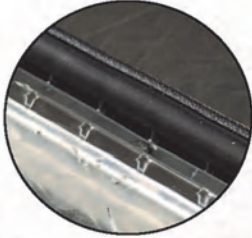

Genuine Trim-Lock Bulb Seal

**MODEL HSB30**

13.43 Cu. Ft.  
66 LBS

- .125 Thick Smooth Aluminum Body
- .100 Thick Aluminum Diamond Tread Door
- .080 Thick Perforated Aluminum Steps
- Angle Reinforced Back Corners Assist In Mounting
- Center Reinforced Top Step
- Welded Aluminum Construction
- Gusseted Door Openings
- Mount to Virtually Any Semi Tractor Chassis
- Integrated Tool Box Cavity
- Stainless Steel Locking Handle





**LIGHT BOXES**

- Diamond Tread or Smooth Aluminum Construction
- Standard Hole Sizes
- Available in a Variety of Sizes
- For Use on Trucks and Trailers
- Can be Used on Headache Racks
- Size Chart Below



Please Note: Lights are sold separately

Model No.	Description	Box Size			Hole Size		Side Light
		Length	Height	Depth	Width	Height	Size
LB001	Single Oval Light Box Diamond Tread	8.25"	3.75"	3"	6.75"	2.63"	n/a
LB002	Double Oval Light Box Diamond Tread	16.5"	3.75"	3"	6.75"	2.63"	n/a
LB003	Single Round Light Box Diamond	6"	6"	3"	4.25"	4.25"	n/a
LB004	Triple Oval Light Box Diamond Tread	25"	3.75"	3"	6.75"	2.63"	n/a
LB005	Single Oval Light Box Smooth Mill Finish	8.25"	3.75"	3"	6.75"	2.63"	n/a
LB006	Double Oval Light Box Smooth Mill Finish	16.5"	3.75"	3"	6.75"	2.63"	n/a
LB007	Single Round Light Box Smooth Mill Finish	6"	6"	3"	4.25"	4.25"	n/a
LB008	Single Oval w / Side Light Hole Light box Diamond Tread	8.25"	3.75"	3"	6.75"	2.63"	2.25" Round
LB009	Double Round Lightbox Diamond Tread	12"	6"	3"	4.25"	4.25"	n/a
LB010	Triple Round Light Box Diamond Tread	18"	6"	3"	4.25"	4.25"	n/a
LB011	Double Oval w / Side Light Hole Diamond Tread	16.5"	3.75"	3"	6.75"	2.62"	2.25" Round
LB012	Single Round w / Side Light Hole Diamond Tread	6"	6"	3"	4.25"	4.25"	2.25" Round





**BED SAFE**

## **BRUTE** BedSafe™

All Aluminum Heavy Duty Roller Drawer Box

Fits the beds of pickups, service bodies, and vans alike.



# 50% Lighter Than Steel



- .100" Thick Aluminum Diamond Tread Case, Reinforced
- .125" Thick Smooth Mill Finish Drawer
- Aluminum Moveable Dividers
- Single Touch Safety Plunger Latch
- Stainless Steel Push Button Lock
- Overhead Rain Gutter
- 3/16" Thick Bottom Reinforcement Channels
- Weather Resistant
- 500 Lbs. Top & Side Load Capacity (evenly distributed)
- 350 Lbs. Drawer Capacity (evenly distributed)
- Plus Nut Mounting





**MODEL HBS340**

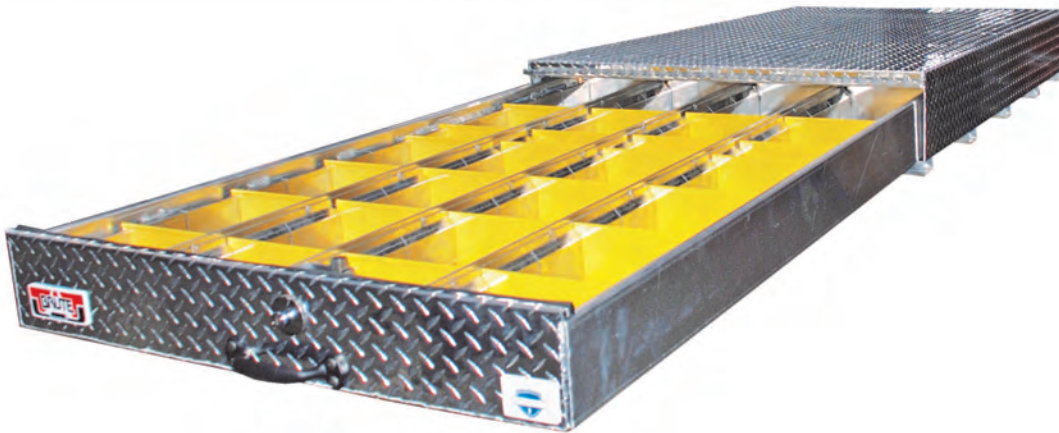

**MODEL HBS341**

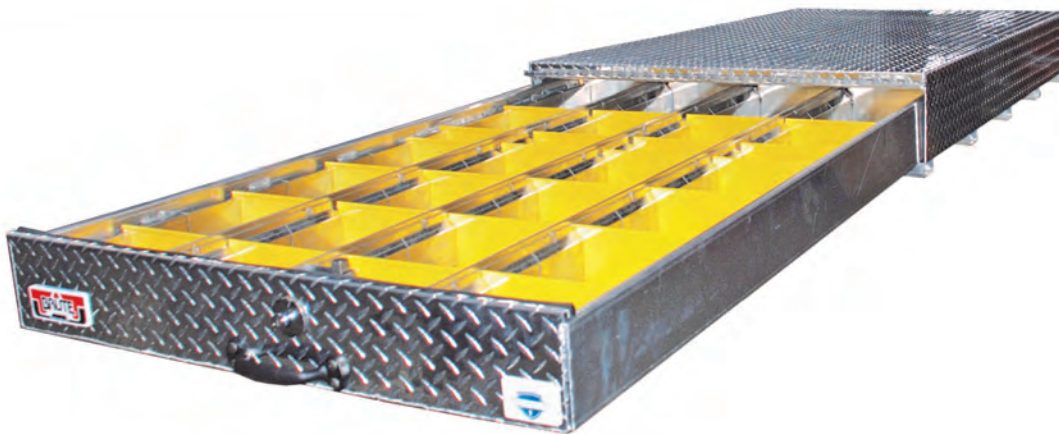





**MODEL HBS340**

15.6 Cu. Ft.  
220 LBS

- LONG MODEL HBS340**
- One Drawer
  - Four Compartments
  - Twenty Four Dividers
  - One Handle
  - One Push Button Lock
  - 500 Lbs. Load Rating On Top (evenly distributed)
  - 350 Lbs. Load Rating In Drawer (evenly distributed)

**MODEL HBS340**

13 Cu. Ft.  
184 LBS

- LONG MODEL HBS341**
- One Drawer
  - Four Compartments
  - Eighteen Dividers
  - One Handle
  - One Push Button Lock
  - 500 Lbs. Load Rating On Top (evenly distributed)
  - 350 Lbs. Load Rating In Drawer (evenly distributed)





**BED SAFE**



**MODEL HBS306**



**MODEL HBS312**



**MODEL HBS307**

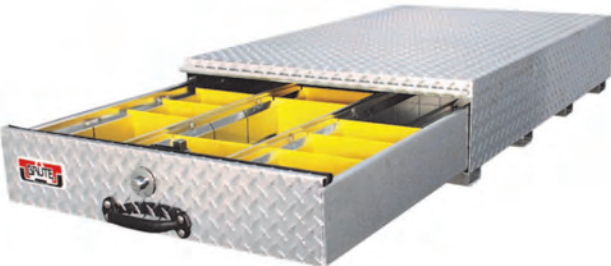

**MODEL HBS336**



**MODEL HBS308**



**MODEL HBS338**







**BED SAFE**



### MODEL HBS306

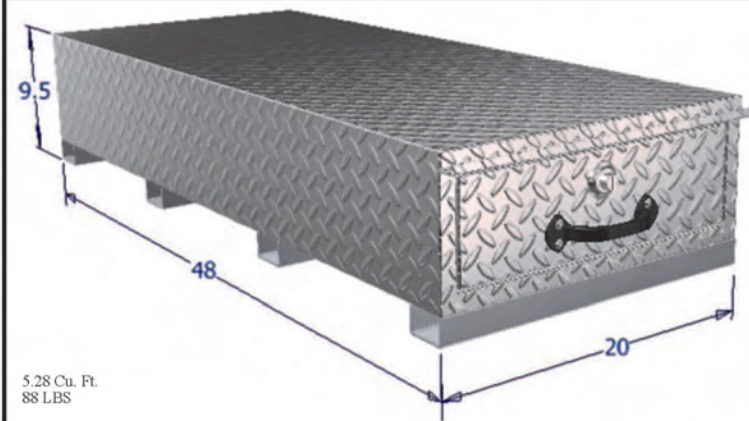

5.28 Cu. Ft.  
88 LBS

#### STANDARD MODEL HBS306

- One Drawer
- Two Compartments
- Ten Dividers
- One Handle
- One Push Button Lock
- 500 Lbs. Load Rating On Top (evenly distributed)
- 350 Lbs. Load Rating In Drawer (evenly distributed)

### MODEL HBS307



7.92 Cu. Ft.  
115 LBS

#### STANDARD MODEL HBS307

- One Drawer
- Three Compartments
- Twelve Dividers
- One Handle
- One Push Button Lock
- 500 Lbs. Load Rating On Top (evenly distributed)
- 350 Lbs. Load Rating In Drawer (evenly distributed)

### MODEL HBS308



10.56 Cu. Ft.  
157 LBS

#### STANDARD MODEL HBS308

- One Drawer
- Four Compartments
- Sixteen Dividers
- One Handle
- One Push Button Lock
- 500 Lbs. Load Rating On Top (evenly distributed)
- 350 Lbs. Load Rating In Drawer (evenly distributed)





**MODEL HBS312**

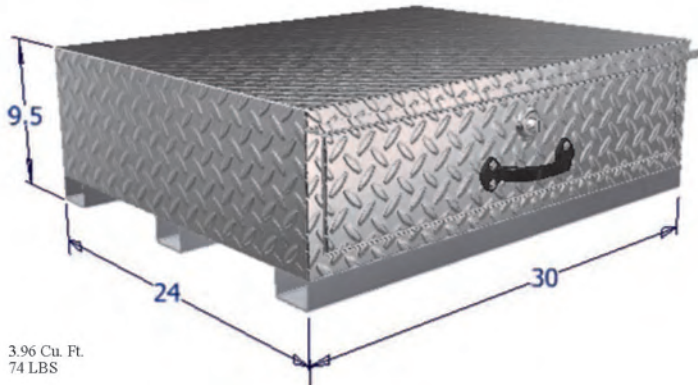

3.96 Cu. Ft.  
74 LBS

**SHORT MODEL HBS312**

- One Drawer
- Three Compartments
- 9 Dividers
- One Handle
- One Push Button Lock
- 500 Lbs. Load Rating On Top (evenly distributed)
- 350 Lbs. Load Rating In Drawer (evenly distributed)

**MODEL HBS336**

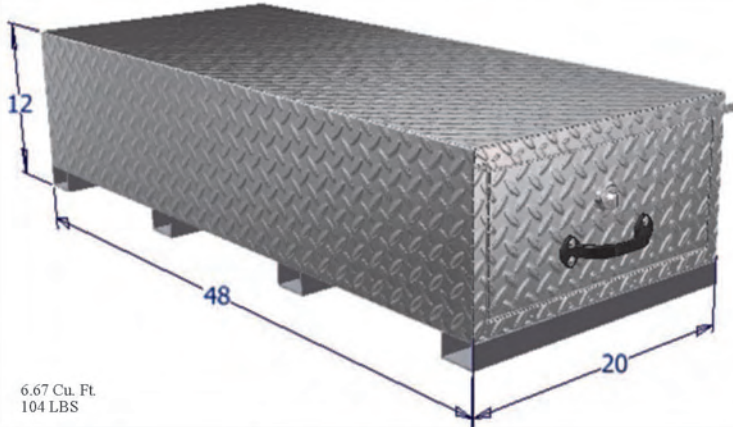

6.67 Cu. Ft.  
104 LBS

**STANDARD MODEL HBS336**

- One Drawer
- Two Compartments
- Ten Dividers
- One Handle
- One Push Button Lock
- 500 Lbs. Load Rating On Top (evenly distributed)
- 350 Lbs. Load Rating In Drawer (evenly distributed)

**MODEL HBS338**

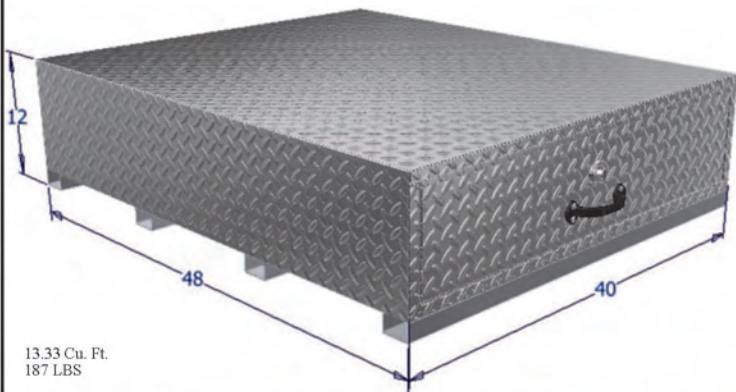

13.33 Cu. Ft.  
187 LBS

**STANDARD MODEL HBS338**

- One Drawer
- Four Compartments
- Sixteen Dividers
- One Handle
- One Push Button Lock
- 500 Lbs. Load Rating On Top (evenly distributed)
- 350 Lbs. Load Rating In Drawer (evenly distributed)