



Top Product
Catalog

2020





OUR SIGNATURE STOP/TURN/TAIL JUST GOT AN UPGRADE

*as seen on the front cover

6-diode Super 44[®] S/T/T | pg. 6



IMPROVED OPTICS

- UNIFORM OPTICS PROVIDE A STREAMLINED APPEARANCE



SLIM PROFILE

- CONSOLIDATED DESIGN OF DRIVER BOARD & LEDs



LOWER CURRENT DRAW

- STOP/TURN: 0.107A - 0.166A @ 13.5V
- TAIL: 0.015A - 0.035A @ 13.5V



Electrical Harness Service Tool | pg. 67



Heated 5x7 Inch Headlight | pg. 40



Model 60 Front Park Turn | pg. 18



Super 44 Stop/Turn/Tail & Backup Additions | pg. 8-9



Multi-Frequency Backup Alarms | pg. 68-69



Model 33 Hooded Grommet | pg. 52



Heated 5x7 Inch Snow Plow Kit | pg. 41

Symbols that appear in this catalog

We invite you to take a moment to read about the meaning of each symbol to help guide you in making the right purchase decision.

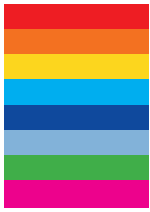

Product Sections

This catalog is divided into sections by product category as outlined in the table of contents found on the following page. Each section is easily identified by the colored tabs on the side of each page.



Limited Warranty

Truck-Lite extends a limited warranty on a variety of products throughout the catalog. Warranties are identified within the product element.



New Tag





































Pages containing new products have this icon below the category tabs on the side of each page. A matching red dot is next to a part number that indicates a new product.



Signal-Stat Products

Signal-Stat products are identified throughout the catalog with the logo in the product group.

Common connector types we offer

PL-10 	19 Series Male Pin 	Right Angle PL-3 	Fit 'N Forget S.S. 	Fit 'N Forget M/C 	Right Angle PL-2 	Straight PL-2 	Straight PL-3 	Female Fit 'N Forget S.S. 	Female PL-10 
Female PL-3 	Female PL-2 	Super 21 Plug 	M/C Self Seal 	Male Pin 	Female Male Pin 	19 Series Hot Wire 	Female Right Angle .180 Bullet Terminal 	Female H4 Connector 	H13 Connector 
H5 Connector 	Male H4 Connector 	Ring Terminal with .180 Bullet 	Female .180 Bullet 	Deutsch Connector 	Molded Four Position .180 	2 Position .180 Bullet 	Heat Shrink Splice 	Female TA-1415 	.156 Bullet Shunt 
.180 Bullet / Ring Terminal 	.180 Bullet 	Ring Terminal / Stripped End 	Stripped End 	.156 Bullet 	Female .156 Bullet 	Blunt Cut 			

FYI: Common Abbreviations

S.S. = SURE SEAL / PC = POLYCARBONATE / AC = ACRYLIC

Stop Lighting		6-15
4 inch		6-11
2 x 6 inch		11-13
3 x 5 inch		13-14

Signal Lighting		16-21
4 inch		16-17
2 x 6 inch		18-20
3 x 5 inch		20
Pedestal Light		21

Marker & Clearance Lighting		22-33
2 inch		22-24
2.5 inch		24-25
.75 inch		26-27
1 x 2 inch		27-28
1 x 4 inch		29-30
2 x 3 inch		30
2 x 4 inch		32
2 x 6 inch		32-33

License & Back-up		34-37
License Lighting		34-36
Back-up Lighting		36-37

Work Lighting		38-39
----------------------	--	--------------

Headlights & Fog Lights		40-43
Headlights		40
Fog & Driving Lights		41
Snow Plow Lights		41-43

Interior Utility & Dome Lights		44-45
Adhesive Mount		44
Bracket Mount		45

Light Mounting		46-53
Brackets & Flanges		46-50
Grommets		50-53

Harness Systems & Accessories		54-59
Plugs		54-58
Sockets		58
Accessories		58-59
Conductors		59

Mirrors		60-61
West Coast		60
Convex		61

Reflector Systems		62-65
Reflectors		62-65
Reflective Tape		65

Maintenance		66-67
Anti-Corrosion Compounds		66-67
Accessories		67

Back-Up Alarms		68-69
-----------------------	--	--------------

STOP LIGHTING

common size	pages
4"	6 -11
2" x 6"	11-13
3" x 5"	13-14

LED

SUPER 44

SUPER 44[®], LED, 6 DIODES, 4" ROUND, GROMMET MOUNT / KIT



44302R



44030R - KIT

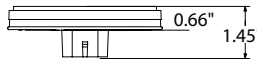

- Faster illumination offers significant safety benefit for following drivers to react more quickly, resulting in an average distance of 3' reaction time advantage for every 10 mph
- LEDs have no filament, therefore are extremely resistant to shock & vibration
- Less current draw, resulting in increased battery & alternator life while allowing more power for other vehicle requirements



Part Number	Lamp Connector	Plug Side 1	Plug Side 2	Lens Material	Mount Color	Volts	Amps Major/Minor	Kit Includes
44302R	Fit 'N Forget S.S.	-	-	PC	-	12	0.24 / 0.03	-
44030R	Fit 'N Forget S.S.	Fit 'N Forget S.S.	Straight Female PL-3	PC	Black	12	0.24 / 0.03	40700 grommet, 44302R lamp, 94706 plug

SUPER 44[®], LED, 6 DIODES, 4" ROUND, FLANGE MOUNT / KIT



- Faster illumination offers significant safety benefit for following drivers to react more quickly, resulting in an average distance of 3' reaction time advantage for every 10 mph
- Mounts are affixed to lamp
- LEDs are extremely resistant to shock & vibration
- Less current draw, resulting in increased battery & alternator life while allowing more power for other vehicle requirements

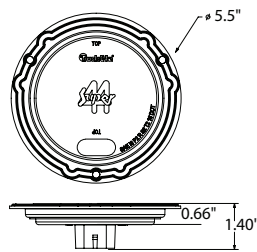

44032R - KIT



44322R

Part Number	Lamp Connector	Plug Side 1	Plug Side 2	Lens Material	Mount Color	Volts	Amps Major/Minor	Kit Includes
44322R	Fit 'N Forget S.S.	-	-	PC	Gray	12	0.24 / 0.03	-
44032R	Fit 'N Forget S.S.	Fit 'N Forget S.S.	Straight Female PL-3	PC	Gray	12	0.24 / 0.03	44322R lamp, 94706 plug

THE ORIGINAL.

Truck-Lite's 6-diode Super 44[®] Stop/Turn/Tail puts industry-leading design, engineering and manufacturing to work every day – for life.

Using only the highest-quality LEDs and electronics, the Super 44[®] is built to go the distance. **Just look for the iconic pentastar light pattern at your nearest distributor.**



TESTED. TRUSTED. TOUGH.

LED

SUPER 44

LED
SUPER 44
NEW

SUPER 44[®], LED, 8 DIODES, 4" ROUND, GROMMET MOUNT, S/T/T + BACK-UP COMBO / HARDWIRED



44557R

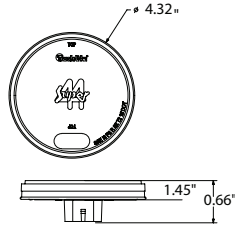

44556R -
HARDWIRED

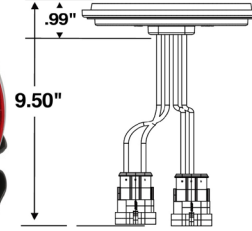

- Offers the same safety and low-maintenance benefits of existing LED S/T/T and BU lights now in one package
- Complies with FMVSS requirement for minimum of 75 cm² of luminous red area
- Saves space in inventory when stocking a two-in-one product
- New combination lamps are the same size as existing Truck-Lite Model 44 lights, so they fit into existing mounting holes
- Lower-cost system when replacing other hardwired 44 products

Part Number	Lamp Connector	Plug Side 1	Plug Side 2	Lens Material	Lens Color	Volts	Amps Major/Minor
44557R	Fit 'N' Forget 4-Pin	-	-	PC	Red Clear	12	0.33 / 0.02
44556R	Hardwired	Hardwired	Fit 'N' Forget S.S.	PC	Red Clear	12	0.33 / 0.02

LED
SUPER 44

SUPER 44[®], LED, 8 DIODES, 4" ROUND, FLANGE MOUNT, S/T/T + BACK-UP COMBO, HARDWIRED

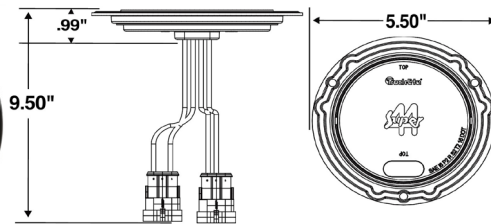

- Offers the same safety and low-maintenance benefits of existing LED S/T/T and BU lights now in one package
- Complies with FMVSS requirement for minimum of 75 cm² of luminous red area
- Saves space in inventory when stocking a two-in-one product
- New combination lamps are the same size as existing Truck-Lite Model 44 lights, so they fit into existing mounting holes
- Lower-cost system when replacing other hardwired 44 products



Part Number	Lamp Connector	Plug Side 1	Plug Side 2	Lens Material	Lens Color	Mount Color	Volts	Amps Major/Minor
44550R	Hardwired	Hardwired	Fit 'N' Forget S.S.	PC	Red Clear	Black	12	0.24 / 0.03
44551R	Hardwired	Hardwired	Fit 'N' Forget S.S.	PC	Red Clear	Gray	12	0.24 / 0.03

SUPER 44[®], LED, 8 DIODES, 4" ROUND, SURFACE MOUNT, S/T/T + BACK-UP COMBO



- Offers the same safety and low-maintenance benefits of existing LED S/T/T and BU lights now in one package
- Complies with FMVSS requirement for minimum of 75 cm2 of luminous red area
- Saves space in inventory when stocking a two-in-one product
- New combination lamps are the same size as existing Truck-Lite Model 44 lights, so they fit into existing mounting holes
- Lower-cost system when replacing other hardwired 44 products

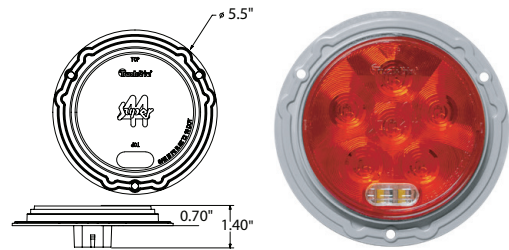

Part Number	Lamp Connector	Plug Side 1	Plug Side 2	Lens Material	Lens Color	Mount Color	Volts	Amps Major/Minor
44555R	Fit N' Forget 4-Pin	-	-	PC	Red Clear	Black	12	0.24 / 0.03

SUPER 44[®], LED, 8 DIODES, 4" ROUND, FLANGE MOUNT, S/T/T + BACK-UP COMBO



- Offers the same safety and low-maintenance benefits of existing LED S/T/T and BU lights now in one package
- Complies with FMVSS requirement for minimum of 75 cm2 of luminous red area
- Saves space in inventory when stocking a two-in-one product
- New combination lamps are the same size as existing Truck-Lite Model 44 lights, so they fit into existing mounting holes
- Lower-cost system when replacing other hardwired 44 products

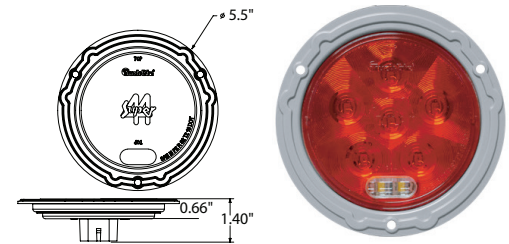

Part Number	Lamp Connector	Plug Side 1	Plug Side 2	Lens Material	Lens Color	Mount Color	Volts	Amps Major/Minor
44552R	Fit N' Forget 4-Pin	-	-	PC	Red Clear	Black	12	0.24 / 0.03
44553R	Fit N' Forget 4-Pin	-	-	PC	Red Clear	Gray	12	0.24 / 0.03

SIGNAL-STAT, LED, 10 DIODES, 4" ROUND, GROMMET MOUNT



- Uses standard PL-3 connector
- When properly mounted, exceeds FMVSS-P2 DOT requirements for marker/clearance performance
- Designed with impact-resistant acrylic material
- Sealed lens and housing locks moisture out
- Snap fit grommet requires no screws for installation
- LEDs do not have a filament, therefore are not susceptible to shock and vibration damage major cause of failure for lamps with an incandescent bulb
- Epoxy encapsulated electronics prevents damage from moisture and corrosion

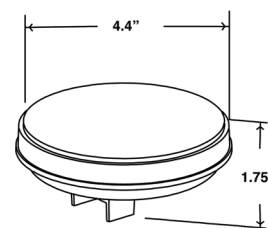

Part Number	Lamp Connector	Lens Material	Volts	Amps Major/Minor
4058	PL-3	AC	12	0.12 / 0.02

LED

SUPER 44

NEW

LED

SUPER 44

NEW

LED

SIGNAL-STAT

LED

SIGNAL-STAT

SIGNAL-STAT, LED, 24 DIODES, 4" ROUND, GROMMET MOUNT

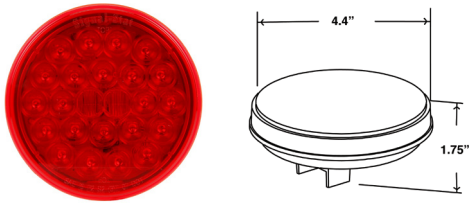

- Epoxy-encapsulated electronics prevents damage from moisture & corrosion
- Unique LED array displays a full pattern light output design
- Uses standard right-angle connection



Part Number	Lamp Connector	Lens Material	Lens Color	Volts	Amps Major/Minor
4050	PL-3	PC	Red	12	0.14 / 0.01
4051	PL-3	PC	Red Clear	12	0.14 / 0.01

INCANDESCENT

40 SERIES

40[®] SERIES, INCANDESCENT, 1 BULB, 4" ROUND, GROMMET MOUNT / KIT / REFLECTORIZED



- Flush-mount grommets are designed for mounting in a 4-1/2" hole
- Heavy-duty bulb lasts longer
- Uniquely designed shock-mount extends lamp life



Part Number	Lamp Connector	Plug Side 1	Plug Side 2	Lens Material	Mount Color	Volts	Amps Major/Minor	Reflectorized	Kit Includes
40202R	PL-3	-	-	PC	-	12	2.1/0.48	-	-
40002R	PL-3	Right Angle PL-3	Stripped End/Ring Terminal	PC	Black	12	2.1/0.48	-	40700 grommet, 94993 plug, 40202R lamp
40215R	PL-3	-	-	PC	-	12	2.1/0.48	Yes	-

INCANDESCENT

40 ECONOMY

40[®] ECONOMY, INCANDESCENT, 1 BULB, 4" ROUND, GROMMET MOUNT

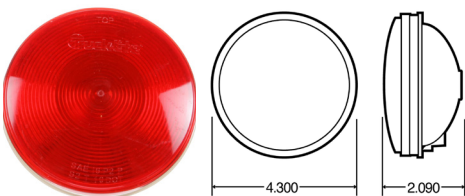

- Grommet kit features flush mounting in a 4-1/2" hole
- High-impact plastic affixed to lamp



Part Number	Lamp Connector	Lens Material	Volts	Amps Major/Minor
40282R	PL-3	PC	12	2.1/0.48

40[®] ECONOMY, INCANDESCENT, 1 BULB, 4" ROUND, FLANGE MOUNT



- Flange kits feature a high impact plastic affixed to lamp
- High-impact plastic affixed to lamp

Part Number	Lamp Connector	Lens Material	Volts	Amps Major/Minor
40229R	PL-3	PC	12	2.16/0.47

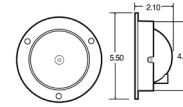

INCANDESCENT

40 ECONOMY

SUPER 40[®], INCANDESCENT, 1 BULB, 4" ROUND, GROMMET MOUNT



- Uniquely designed shock-mount extends lamp life

Part Number	Lamp Connector	Lens Material	Volts	Amps Major/Minor
40242R	PL-3	PC	12	2.16/0.47

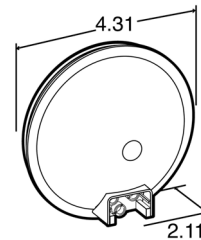

INCANDESCENT

SUPER 40

60[®] SERIES, LED, 8 DIODES, 2" X 6" OVAL, GROMMET MOUNT, S/T/T + BACK-UP COMBO / HARDWIRED



- Offers the same safety and low maintenance benefits of existing LED S/T/T and BU lights now in one package
- Not orientation dependent; complies with FMVSS 108 vertically or horizontally
- Save space in inventory
- Lower-cost system
- Lamps are the same size as existing Truck-Lite Model 60 lights, which means they fit into existing mounting holes

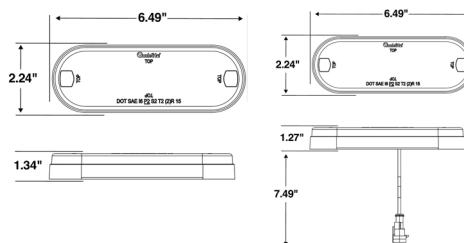

LED

60 SERIES

Part Number	Lamp Connector	Plug Side 1	Plug Side 2	Lens Material	Lens Color	Volts	Amps Major/Minor	Diamond Shell
60557R	Fit 'N Forget 4 Pin S.S.	-	-	PC	Red Clear	12	0.24/0.02	No
60556R	Hardwired	Hardwired	Fit 'N Forget S.S.	PC	Red Clear	12	0.24/0.02	No

LED

60[®] SERIES, LED, 8 DIODES, 2" X 6" OVAL, SURFACE MOUNT, S/T/T + BACK-UP COMBO / HARDWIRED

60 SERIES

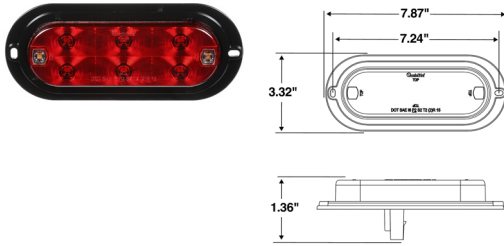

- Offers the same safety and low maintenance benefits of existing LED S/T/T and BU lights now in one package
- Not orientation dependent; complies with FMVSS 108 vertically or horizontally
- Save space in inventory
- Lower-cost system
- Lamps are the same size as existing Truck-Lite Model 60 lights, which means they fit into existing mounting holes



Part Number	Lamp Connector	Plug Side 1	Plug Side 2	Lens Material	Lens Color	Mount Color	Volts	Amps Major/Minor	Diamond Shell
60555R	Fit 'N Forget 4 Pin S.S.	-	-	PC	Red Clear	Black	12	0.24/0.02	No
60554R	Hardwired	Hardwired	Fit 'N Forget S.S.	PC	Red Clear	Black	12	0.24/0.02	No

LED

60[®] SERIES, LED, 8 DIODES, 2" X 6" OVAL, FLUSH MOUNT, S/T/T + BACK-UP COMBO / HARDWIRED

60 SERIES

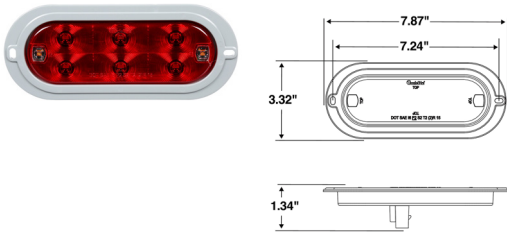

- Offers the same safety and low maintenance benefits of existing LED S/T/T and BU lights now in one package
- Not orientation dependent; complies with FMVSS 108 vertically or horizontally
- Save space in inventory
- Lower-cost system
- The new combination lamps are the same size as existing Truck-Lite Model 60 lights, so they fit into existing mounting holes



Part Number	Lamp Connector	Plug Side 1	Plug Side 2	Lens Material	Lens Color	Mount Color	Volts	Amps Major/Minor	Diamond Shell
60552R	Fit 'N Forget 4 Pin S.S.	-	-	PC	Red Clear	Black	12	0.24/0.02	No
60553R	Fit 'N Forget 4 Pin S.S.	-	-	PC	Red Clear	Gray	12	0.24/0.02	No
60550R	Hardwired	Hardwired	.180 Bullet	PC	Red Clear	Black	12	0.24/0.02	No
60551R	Hardwired	Hardwired	Fit 'N Forget S.S.	PC	Red Clear	Gray	12	0.24/0.02	No
60559R	Hardwired	Hardwired	Fit 'N Forget S.S.	PC	Red Clear	Black	12	0.24/0.02	No

LED

60[®] SERIES, LED, 26 DIODES, 2" X 6" OVAL, GROMMET MOUNT

60 SERIES

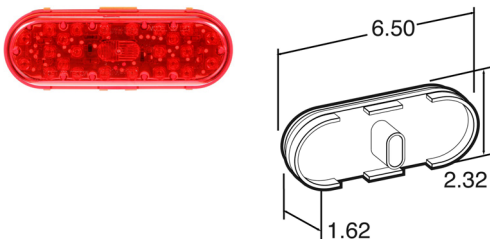

- Faster illumination offers significant safety benefit for following drivers to react quicker, resulting in average 3' reaction time advantage for every 10 mph



Part Number	Lamp Connector	Lens Material	Volts	Amps Major / Minor	Diamond Shell
60250R	Fit 'N Forget S.S.	PC	12	0.34/0.04	No

SIGNAL-STAT, LED, 24 DIODES, 2"X 6" OVAL, GROMMET MOUNT



- Epoxy-encapsulated electronics prevents damage from moisture & corrosion
- Unique LED array displays full pattern light output design
- Uses standard right-angle plug

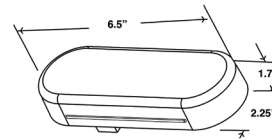

Part Number	Lamp Connector	Lens Material	Lens Color	Volts	Amps Major / Minor
6050	PL-3	PC	Red	12	0.26/0.02

LED
SIGNAL-STAT

SUPER 60®, INCANDESCENT, 1 BULB, 2"X 6" OVAL, GROMMET MOUNT / KIT



- Mounts horizontally or vertically
- Right-angle plug assembly

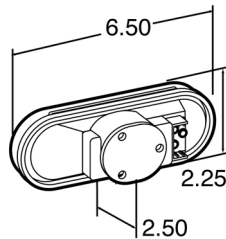

60020R - KIT

60202R

Part Number	Lamp Connector	Plug Side 1	Plug Side 2	Lens Material	Mount Color	Volts	Amps Major/Minor	Kit Includes
60202R	PL-3	-	-	PC	-	12	2.1/0.48	-
60002R	PL-3	PL-3	Stripped End/ Ring Terminal	PC	Black	12	2.1/0.48	60700 grommet, 60202R lamp, 94993 plug

INCANDESCENT

SUPER 60

SIGNAL-STAT, LED, 24 DIODES, 3"X 5" RECTANGULAR, GROMMET MOUNT



- 24 diode pattern
- Unique LED array displays full pattern light output
- Uses standard right-angle PL-3 connection

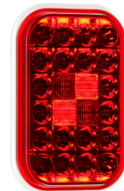
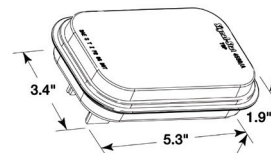

Part Number	Lamp Connector	Lens Material	Volts	Amps Major/Minor
4550	PL-3	AC	12	0.38 / 0.03

LED
SIGNAL-STAT

LED

SIGNAL-STAT

SIGNAL-STAT, LED, 10 DIODES, 3"X 5" RECTANGULAR, GROMMET MOUNT

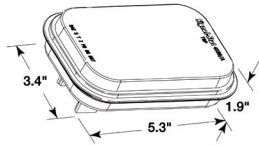
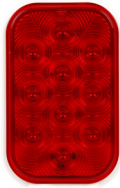

- Uses standard right angle PL-3 connection
- Unique LED array displays full pattern light output
- Epoxy-encapsulated electronics



Part Number	Lamp Connector	Lens Material	Volts	Amps Major/Minor
4558	PL-3	AC	12	0.28 / 0.03

INCANDESCENT

SUPER 45

SUPER 45®, INCANDESCENT, 1 BULB, 3"X 5", RECTANGULAR, GROMMET MOUNT

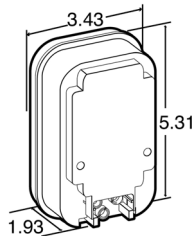

- Heavy-duty dual-filament cartridge bulb
- Mount horizontally or vertically
- Unique shock mount absorbs shock & vibration



Part Number	Lamp Connector	Lens Material	Volts	Amps Major/Minor
45202R	PL-3	PC	12	2.16/0.47

INCANDESCENT

SUPER 45

45® SERIES, INCANDESCENT, 1 BULB, 3"X 5", RECTANGULAR, GROMMET MOUNT, KIT

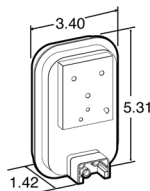

- Direct replacement for approved lamps on United States Postal Service LLV (Long Life Vehicle)
- Designed for mounting on a 7-11 degree rollback from the vertical plane
- Three versions: each features turn and hazard functions, stop and tail functions or back-up functions



Part Number	Lamp Connector	Plug Side 1	Plug Side 2	Lens Material	Mount Color	Volts	Amps Major/Minor	Diamond Shell	Kit Includes
45022R	PL-3	Right Angle PL-3	Packard Connector	PC	Black	12	2.1/0.58	No	94841 harness, 45202R lamp, 45701 grommet



EVERYTHING YOU EXPECT AND MORE.

Truck-Lite's multi-purpose maintenance spray does everything you expect from a multi-purpose spray while also being dielectric and non-corrosive – so it's safe to use on or around electronics, plastics, rubber and silicone.

You can find our maintenance spray on page 67.



SIGNAL LIGHTING

common size	pages
4"	16 - 17
2" x 6"	18 - 20
3" x 5"	20
pedestal	21

SIGNAL-STAT, LED, 24 DIODES, 4" ROUND, GROMMET MOUNT



- Popular on owner/operator show trucks
- Uses standard right-angle connection
- Unique LED array displays a full pattern light output design
- Epoxy-encapsulated electronics prevents damage from moisture and corrosion
- Less current draw, resulting in increased battery and alternator life while allowing more power for other vehicle requirements
- LEDs do not have a filament, therefore are not susceptible to damage from shock and vibration

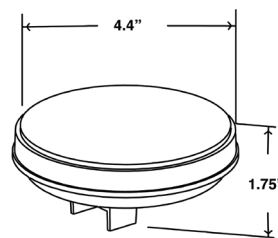

Part Number	Lamp Connection	Lens Material	Lens Color	Volts	Amps Major/Minor	Diamond Shell
4050A	PL-3	PC	Yellow	12	0.03/0.38	No
4051A	PL-3	PC	Clear Yellow	12	0.03/0.38	No

SUPER 40[®], INCANDESCENT, 1 BULB, 4" ROUND, GROMMET MOUNT



- Uniquely designed shock mount extends lamp life
- Diamond Shell versions available for additional protection
- Available with or without reflectorized lens
- 8 square inch (illuminating) stop/turn lens area for vehicles under 80 inches wide
- Meets reflex, tail or clearance function for vehicles over 80 inches wide (Use part# 40248R)
- Upgrade to LED Lighting Systems using Truck-Lite's Super 44 series.

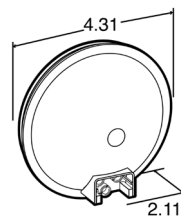

INCANDESCENT

SUPER 40

Part Number	Lamp Connection	Lens Material	Lens Color	Volts	Amps Major/Minor
40242Y	PL-3	PC	Yellow	12	2.1 / 0.48

40[®] SERIES, INCANDESCENT, 1 BULB, 4" ROUND, GROMMET MOUNT / KIT



- Heavy-duty bulb for long-lasting life
- Uniquely designed shock mount extends lamp life
- Available with or without reflectorized lens
- Flush-mount grommets are designed for mounting in a 4 1/2" hole
- 8 square inch (illuminating) stop/turn lens area for vehicles under 80 inches wide
- Meets reflex, tail or clearance function for vehicles over 80 inches wide
- Upgrade to LED lighting systems using Truck-Lite's Super 44 series of products

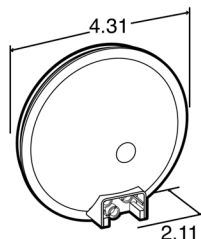

40002Y - KIT



40202Y

INCANDESCENT

40 SERIES

Part Number	Lamp Connection	Plug Side 1	Plug Side 2	Lens Material	Lens Color	Mount/Trim Color	Volts	Amps Major/Minor	Kit Includes
40202Y	PL-3	-	-	PC	Yellow	-	12	2.1 / 0.48	-
40002Y	PL-3	Right Angle PL-3	Stripped End/Ring Terminal	PC	Yellow	Black	12	2.1 / 0.48	40202Y light, 94993 plug, 40700 grommet

40[®] ECONOMY, INCANDESCENT, 1 BULB, 4" ROUND, GROMMET MOUNT



- Grommet kit features flush mounting in a 4 1/2" hole
- Flange kits feature a high-impact plastic affixed to lamp
- 8 square inch (illuminating) stop/turn lens area for vehicles under 80 inches wide
- Meets reflex, tail or clearance function for vehicles over 80 inches wide
- Upgrade to LED lighting systems using Truck-Lite's LED 44 Series lighting products

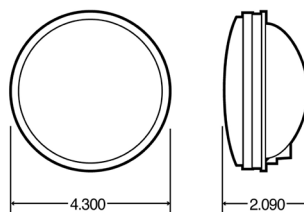

INCANDESCENT

40 ECONOMY

Part Number	Lamp Connection	Lens Material	Lens Color	Volts	Amps Major/Minor
40282Y	PL-3	PC	Yellow	12	2.1 / 0.48

LED
60 SERIES
NEW

60[®] SERIES, LED, 8 DIODES, 2" X 6" OVAL, GROMMET MOUNT

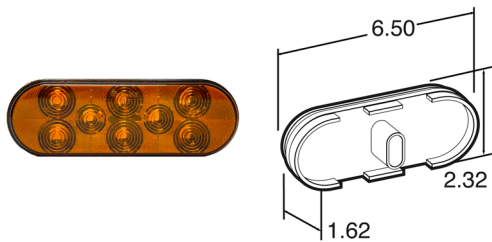

- Low-diode design – 8 LEDs
- Faster illumination offers significant safety benefit for following drivers to react quickly, resulting in an average of 3' reaction time advantage for every 10 m.p.h.
- Meets stringent Front, Park and Turn requirements
- LEDs do not have a filament, therefore are not susceptible to damage from shock and vibration
- Less current draw, resulting in increased battery and alternator life while allowing more power for other vehicle requirements



Part Number	Lamp Connection	Lens Material	Lens Color	Volts	Amps Major/Minor	Diamond Shell
60377Y	Fit 'N Forget S.S.	PC	Yellow	12	0.55 / 0.08	No

LED
60 SERIES
NEW

60[®] SERIES, LED, 8 DIODES, 2" X 6" OVAL, FLANGE MOUNT

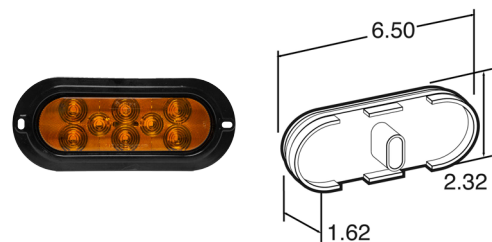

- Low-diode design – 8 LEDs
- Faster illumination offers significant safety benefit for following drivers to react quickly, resulting in an average of 3' reaction time advantage for every 10 m.p.h.
- Meets stringent Front, Park and Turn requirements
- LEDs do not have a filament, therefore are not susceptible to damage from shock and vibration
- Less current draw, resulting in increased battery and alternator life while allowing more power for other vehicle requirements



Part Number	Lamp Connection	Lens Material	Lens Color	Mount Color	Volts	Amps Major/Minor	Diamond Shell
60351Y	Fit 'N Forget S.S.	PC	Yellow	Black	12	0.55 / 0.08	No
63052Y	Fit 'N Forget S.S.	PC	Yellow	White	12	0.55 / 0.08	No

LED
60 SERIES

60[®] SERIES, LED, 44 DIODES, 2" X 6" OVAL, GROMMET MOUNT

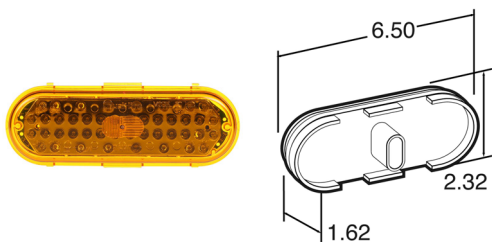

- Faster illumination offers significant safety benefit for following drivers to react quickly, resulting in an average of 3' reaction time advantage for every 10 m.p.h.
- Meets stringent Front, Park and Turn requirements
- LEDs do not have a filament, therefore are not susceptible to damage from shock and vibration
- Less current draw, resulting in increased battery and alternator life while allowing more power for other vehicle requirements



Part Number	Lamp Connection	Lens Material	Lens Color	Volts	Amps Major/Minor	Diamond Shell
60290Y	Fit 'N Forget S.S.	PC	Yellow	12	0.55 / 0.08	No

SIGNAL-STAT, LED, 24 DIODES, 2" X 6" OVAL, GROMMET MOUNT



- Popular for owner/operator show trucks
- Uses standard right-angle plug
- Unique LED array displays full pattern light output design
- Epoxy-encapsulated electronics prevents damage from moisture and corrosion

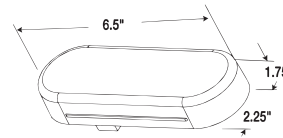

Part Number	Lamp Connection	Lens Material	Lens Color	Volts	Amps Major/Minor	Diamond Shell
6050A	PL-3	PC	Yellow	12	0.38 / 0.03	No

LED

SIGNAL-STAT

22[®] SERIES, 1 BULB, SIDE TURN, 2"X 6" RECTANGULAR, 2 SCREW MOUNT, KIT



- Features dual contact marker/clearance and side turn or auxiliary turn functions
- Mounts on surface of vehicle or with "L" bracket

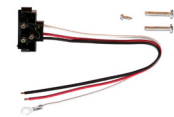
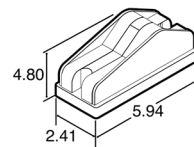

Part Number	Lamp Connector	Plug Side 1	Plug Side 2	Lens Material	Lens Color	Volts	Amps Major/Minor	Kit Includes
22002R	PL-3	Right Angle PL-3	Stripped End/Ring Terminal	PC	Red	12	2.1/0.49	22202R light, 94993 plug
22002Y	PL-3	Right Angle PL-3	Stripped End/Ring Terminal	PC	Yellow	12	2.1/0.49	22202Y light, 94993 plug
22004R	PL-3	Right Angle PL-3	Stripped End/Ring Terminal	PC	Red	12	2.1/0.49	22006R light, 94993 plug
22004Y	PL-3	Right Angle PL-3	Stripped End/Ring Terminal	PC	Yellow	12	2.1/0.49	22006Y light, 94993 plug

INCANDESCENT

22 SERIES

Keep Your Connections Safe. Don't Forget Your Dielectric Gel.

Dielectric gel protects your lights by protecting the points of contact between elements of your lighting and harness system. Our dielectric compounds prevent arcing and corrosion and keep your lights performing as they should.

You can find our dielectric products on page 66.



INCANDESCENT

60 SERIES

60[®] SERIES, 1 BULB, SIDE TURN, 2" X 6" OVAL, GROMMET MOUNT / KIT



- Features side indicator, marker/clearance and reflector functions
- Narrow width facilitates horizontal mounting
- Red lamp should be used only for rear vehicle applications
- Meets SAE J2039 recommendation for side turn signal
- Upgrade to Truck-Lite LED lighting systems using Super 60 LED products



Part Number	Lamp Connector	Plug Side 1	Plug Side 2	Lens Material	Lens Color	Mount Color	Volts	Amps Major/Minor	Kit Includes
60215Y	PL-3	-	-	PC	Yellow		12	2.1/0.49	-
60217Y	PL-3	-	-	PC	Yellow		24	1/0.36	-
60015R	PL-3	Right Angle PL-3	Stripped End/Ring Terminal	PC	Red	Black	12	2.1/0.49	60215R, 94993 plug, 60700 grommet
60015Y	PL-3	Right Angle PL-3	Stripped End/Ring Terminal	PC	Yellow	Black	12	2.1/0.49	60215Y, 94993 plug, 60700 grommet

INCANDESCENT

SUPER 60

SUPER 60[®], INCANDESCENT, 1 BULB, 2" X 6" OVAL, GROMMET MOUNT / KIT



- Mount horizontally or vertically
- Right angle plug assembly
- Upgrade to Truck-Lite LED lighting systems using Super 66 or 60 Series LED products



Part Number	Lamp Connection	Plug Side 1	Plug Side 2	Lens Material	Lens Color	Mount/Trim Color	Volts	Amps Major/Minor	Kit Includes
60202Y	PL-3	-	-	PC	Yellow	-	12	2.1 / 0.48	-
60002Y	PL-3	Right Angle PL-3	Stripped End/Ring Terminal	PC	Yellow	Black	12	2.1 / 0.48	60202Y light, 94993 plug, 60700 grommet

LED

SIGNAL-STAT

SIGNAL-STAT, LED, 10 DIODES, 3" X 5" RECTANGULAR, GROMMET MOUNT

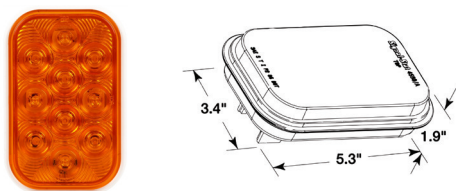

- Uses standard right angle PL-3 connection
- Unique LED array displays full pattern light output
- Epoxy encapsulated electronics



Part Number	Lamp Connector	Lens Material	Volts	Amps Major/Minor
4558A	PL-3	AC	12	0.28 / 0.03

SUPER 45[®], INCANDESCENT, 1 BULB, 3"X 5" RECTANGULAR, GROMMET MOUNT



- Mount horizontally or vertically
- Heavy-duty, dual-filament cartridge bulb
- Unique shock mount absorbs shock and vibration
- Upgrade to LED lighting systems using Truck-Lite's Super 45 LED series product line

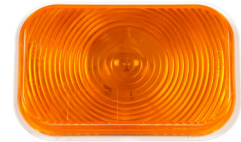
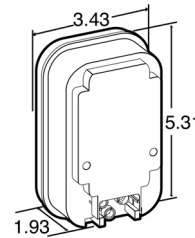

INCANDESCENT

45 SERIES

Part Number	Lamp Connection	Lens Material	Lens Color	Mount/Trim Color	Volts	Amps Major/Minor
45202Y	PL-3	PC	Yellow	Black	12	2.16 / 0.47

DUAL FACE, LED, 24 DIODE, 3 WIRES, ROUND, 1 STUD MOUNT



- Ideal for show trucks, highway, mowing, municipal and farm equipment
- Chrome-plated housing

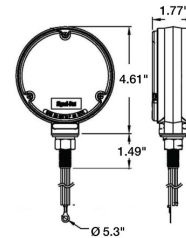

LED

DUAL FACE

Part Number	Lamp Connector	Plug Side 1	Plug Side 2	Lens Color	Housing Material	Housing Color	Volts	Amps Major/Minor
2750	Hardwired	Hardwired	Stripped End/Ring Terminal	Red Yellow	Zinc	Chrome	12	0.73/0.05



MASTER TRAINING

The Truck-Lite Training Institute offers lighting and harness education to technicians. Online courses are FREE and available 24/7.



MARKER & CLEARANCE LIGHTS

common size	pages
2"	22 - 24
2.5"	24 - 25
.75"	26 - 27
1" x 2"	27 - 28

common size	pages
1" x 4"	29 - 30
2" x 3"	30
2" x 4"	32
2" x 6"	32 - 33

30[®] SERIES, LED, 2" ROUND, GROMMET MOUNT

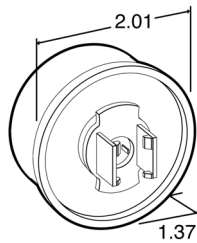

- Most advanced and cost-effective 2" clearance and marker lamp.



Part Number	Lens Color	Lamp Connector	Volts	Amps	Diodes	Lighting Codes
30250R	Red	Fit 'N Forget M/C	12	0.05	2	P2 P3
30250Y	Yellow	Fit 'N Forget M/C	12	0.05	2	P2 P3

LED

30 SERIES

SIGNAL-STAT, LED, 2" ROUND, GROMMET MOUNT



- Standard connection
- Unique 10 diode starburst light output
- Encapsulated electronics
- Not suitable for PC requirements



Part Number	Lens Color	Lamp Connector	Volts	Amps	Diodes	Lighting Codes
3050	Red	PL-10	12	0.05	10	P2
3050A	Yellow	PL-10	12	0.05	10	P2
3051	Clear/Red	PL-10	12	0.05	10	P2
3051A	Clear/Yellow	PL-10	12	0.05	10	P2
3059	Yellow	PL-10	12	0.05	10	P2

LED
2 IN ROUND

30[®] SERIES, INCANDESCENT, 2" ROUND, GROMMET MOUNT



- Wabash and Monon replacement
- "ABS" version complies with FMVSS 108 requirement for ABS malfunction indicator lamp on trailer and ABS braking systems
- 12 volt, 15,000-hour-rated bulb life
- Lamp designed for PC requirements on a 45-degree angle in mounting devices #30720, #00801, #00803, #00804 or surface-mount flange



Part Number	Lens Color	Lamp Connector	Volts	Amps	Bulbs	Lighting Codes
30200B	Blue	PL-10	12	0.33	1	P2 P3 PC
30200G	Green	PL-10	12	0.33	1	P2 P3 PC
30200R	Red	PL-10	12	0.33	1	P2 P3 PC
30200Y	Yellow	PL-10	12	0.33	1	P2 P3 PC
30230Y	Yellow	PL-10	12	0.33	1	P2 P3 PC
30257Y	Yellow	PL-10	12	0.33	1	P2 P3 PC

INCANDESCENT
30 SERIES

30[®] SERIES, INCANDESCENT, 2" ROUND, FLUSH MOUNT



- Flanges are permanently affixed to lamp
- 12 volt, 15,000-hour-rated bulb
- Flush mount is not suitable for PC requirements

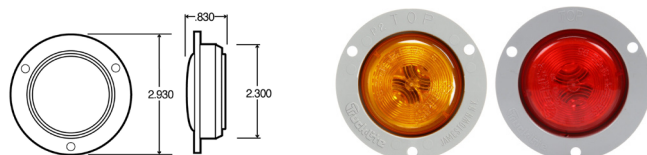

Part Number	Lens Color	Mount Color	Lamp Connector	Volts	Amps	Bulbs	Lighting Codes
30221R	Red	Gray	PL-10	12	0.33	1	P2
30221Y	Yellow	Gray	PL-10	12	0.33	1	P2

INCANDESCENT
30 SERIES

LED

2 IN BEEHIVE

SIGNAL-STAT, LED, 2" ROUND, GROMMET MOUNT, BEEHIVE



- Popular replacement for cab marker or corner trailer applications.
- Standard PL-10 connection.



Part Number	Lens Color	Mount Color	Lamp Connector	Volts	Amps	Diodes	Lighting Codes
3075	Red	Gray	PL-10	12	0.33	10	P2
3075A	Yellow	Gray	PL-10	12	0.33	10	P2

INCANDESCENT

30 SERIES

30[®] SERIES, INCANDESCENT, 2" ROUND, GROMMET MOUNT, BEEHIVE

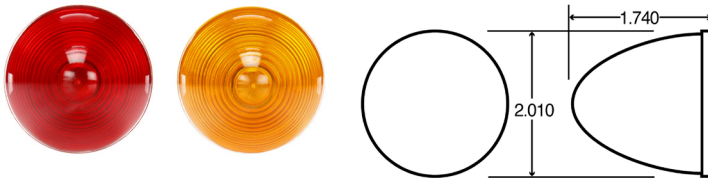

- Features a beehive lens designed for cab marker use
- Lens and housing are sonically sealed
- High-impact polycarbonate construction
- 12, volt 15,000-hour-rated bulb
- Suitable for PC requirements on a 45° angle



Part Number	Lens Color	Lamp Connector	Volts	Amps	Bulbs	Lighting Codes
30201R	Red	PL-10	12	0.33	1	P2 PC
30201Y	Yellow	PL-10	12	0.33	1	P2 PC

LED

10 SERIES

10[®] SERIES, LED, 2.5" ROUND, GROMMET MOUNT



- Most advanced and cost-effective 2-1/2" clearance and marker lamp
- Completely sealed electronics resist corrosion and moisture
- Less current draw, resulting in increased battery and alternator life while allowing more power for other vehicle requirements
- Polycarbonate lens



Part Number	Lens Color	Lamp Connector	Volts	Amps	Diodes	Lighting Codes
10250R	Red	Fit 'N Forget M/C	12	0.03	2	P2
10250Y	Yellow	Fit 'N Forget M/C	12	0.08	2	P2

SIGNAL-STAT, LED, 2.5" ROUND, GROMMET MOUNT / REFLECTORIZED



- Popular on owner/operator and show trucks
- Standard PL-10 connection
- Unique 13 diode starburst light output
- Encapsulated electronics prevent damage from moisture and corrosion

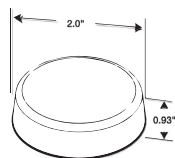

Part Number	Lens Color	Lamp Connector	Volts	Amps	Diodes	Lighting Codes	ReflectORIZED
1050	Red	PL-10	12	0.01	13	P2	-
1050A	Yellow	PL-10	12	0.01	13	P2	-
1052	Red	PL-10	12	0.01	4	P2	Yes
1052A	Yellow	PL-10	12	0.01	4	P2	Yes

LED

2.5 IN ROUND

10[®] SERIES, INCANDESCENT, 2.5" ROUND, GROMMET MOUNT / REFLECTORIZED



- Lens and housing are sonically sealed
- High-impact polycarbonate construction
- 15,000-hour-rated bulb life
- Available in either 12 volt or 24 volt
- Meets PC requirement on a 45° angle in mounting devices #10708, #10720, #00803 or #00804
- Replaces Signal-Stat 1010 and 1011 series

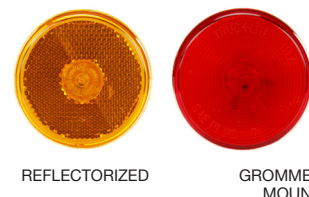
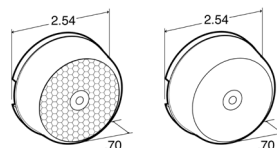

Part Number	Lens Color	Lamp Connector	Volts	Amps	Bulbs	Lighting Codes	ReflectORIZED
10202R	Red	PL-10	12	0.33	1	P2 PC	-
10202Y	Yellow	PL-10	12	0.33	1	P2 PC	-
10205R	Red	PL-10	12	0.33	1	A P2 PC	Yes
10205Y	Yellow	PL-10	12	0.33	1	A P2 PC	Yes

INCANDESCENT

10 SERIES

SUPER 10[®], INCANDESCENT, 2.5" ROUND, GROMMET MOUNT / REFLECTORIZED



- Unique shock-mount extends bulb life
- 15,000-hour-rated bulb life
- Sealed polycarbonate lens and housing
- Meets PC requirements on a 45° degree angle using all mounting devices



Part Number	Lens Color	Lamp Connector	Volts	Amps	Bulbs	Lighting Codes	ReflectORIZED
10212Y	Yellow	PL-10	12	0.33	1	P2 PC	-
10213Y	Yellow	PL-10	12	0.33	1	P2 PC	-
10208R	Red	PL-10	12	0.33	1	A P2 PC	Yes
10208Y	Yellow	PL-10	12	0.33	1	A P2 PC	Yes

INCANDESCENT

SUPER 10 SERIES

LED

33 SERIES

33[®] SERIES, LED, .75" ROUND, SINGLE FUNCTION, GROMMET MOUNT / KIT



AVAILABLE CONNECTORS

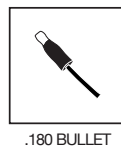

- World's smallest LED marker lamp for the transportation industry
- Exceeds legal requirements
- Hardwired lamp design is easily retrofitted
- LEDs draw less current, allowing more power for other vehicle requirements
- Electronics completely sealed in epoxy to resist corrosion and moisture
- Offers trailer engineers and manufacturers new trailer and rear door structure design flexibility
- Requires 3/4" mounting hole
- Reduces lighting costs due to and heat entrapment.



Part Number	Lens Color	Lamp Connector	Plug Side 1	Plug Side 2	Volts	Amps Major/Minor	Diodes	Lighting Codes	Kit Includes
33050R	Red	Hardwired	Hardwired	.180 Bullet	12	0.05	1	P2	33250R light, 33700 grommet
33050Y	Yellow	Hardwired	Hardwired	.180 Bullet	12	0.05	1	P2	33250Y light, 33700 grommet
33075R	Red	Hardwired	Hardwired	.180 Bullet	12	0.14	1	PC	33275R light, 33700 grommet
33075Y	Yellow	Hardwired	Hardwired	.180 Bullet	12	0.14	1	PC	33275Y light, 33700 grommet
33250R	Red	Hardwired	Hardwired	.180 Bullet	12	0.05	1	P2	-
33250Y	Yellow	Hardwired	Hardwired	.180 Bullet	12	0.05	1	P2	-

LED

33 SERIES

33[®] SERIES, LED, .75" ROUND, DUAL FUNCTION, GROMMET MOUNT, KIT



AVAILABLE CONNECTORS



- World's smallest LED marker lamp for the transportation industry
- Provides increased visibility when braking or turning
- Functions as a marker, auxiliary turn and auxiliary stop when properly installed
- Best-in-class auxiliary brake function is seven times brighter than marker function
- Requires a 3/4" mounting hole
- Hardwired lamp with .180 male bullet design can be easily retrofitted



Part Number	Lens Color	Lamp Connector	Plug Side 1	Plug Side 2	Volts	Amps Major/Minor	Diodes	Lighting Codes	Kit Includes
33203R	Red	Hardwired	Hardwired	.180 Bullet	12	0.17/0.02	1	P2	33700 grommet
33203Y	Yellow	Hardwired	Hardwired	.180 Bullet	12	0.12/0.02	1	P2	33700 grommet
33204R	Red	Hardwired	Hardwired	.180 Bullet	12	0.17/0.02	1	P2	33700 grommet
33204Y	Yellow	Hardwired	Hardwired	.180 Bullet	12	0.12/0.03	1	P2	33700 grommet
33205R	Red	Hardwired	Hardwired	.180 Bullet	12	0.17/0.02	1	P2	33700 grommet
33205Y	Yellow	Hardwired	Hardwired	.180 Bullet	12	0.12/0.03	1	P2	33700 grommet
33206R	Red	Hardwired	Hardwired	.180 Bullet	12	0.17/0.02	1	P2	33700 grommet
33206Y	Yellow	Hardwired	Hardwired	.180 Bullet	12	0.12/0.03	1	P2	33700 grommet
33209Y	Yellow	Hardwired	Hardwired	.180 Bullet	12	0.12/0.03	1	P2	33700 grommet

33 SERIES, LED, .75" ROUND, DUAL FUNCTION, FLANGE MOUNT, KIT



- World smallest LED marker lamp for the transportation industry
- Provides increased visibility when braking or turning
- Functions as a marker, auxiliary turn and auxiliary stop when properly installed
- Best-in-class auxiliary brake function is seven times brighter than marker function
- Marker function exceeds P2 legal requirements
- Requires a 3/8" mounting hole
- Hardwired lamp with .180 male bullet design can be easily retrofitted
- LEDs draw less current, allowing more power for other vehicle requirements
- LEDs do not have a filament, therefore are not susceptible to damage from shock and vibration
- Engineered to withstand the toughest working environments
- Electronics sealed in epoxy to resist corrosion and moisture
- Complies with FMVSS-108 marker/clearance requirements

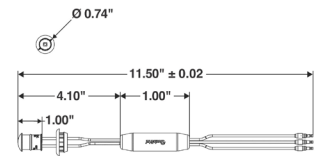

Part Number	Lens Color	Mount Color	Lamp Connector	Plug Side 1	Plug Side 2	Volts	Amps Major/Minor	Diodes	Lighting Codes	Kit Includes
33207R	Red	Black	Hardwired	Hardwired	.180 Bullet	12	0.17/0.02	1	P2	33800 flange
33207Y	Yellow	Black	Hardwired	Hardwired	.180 Bullet	12	0.12/0.03	1	P2	33800 flange
33208R	Red	Chrome	Hardwired	Hardwired	.180 Bullet	12	0.17/0.02	1	P2	33810 flange
33208Y	Yellow	Chrome	Hardwired	Hardwired	.180 Bullet	12	0.12/0.03	1	P2	33810 flange

36 SERIES, LED, 1" X 2" RECTANGULAR, ADHESIVE MOUNT



- Provides a clearance/marker solution that requires no mounting brackets or installation screws
- Lamps adhere directly to application surface through the use of heavy-duty adhesive backing
- Easy-to-install, peel-off liner
- Hardwired lamp design is easily retrofitted
- Rear exit wire version requires a 3/8 mounting hole, and self-seals hole upon installation
- Side mount options can be mounted without any mounting holes
- LEDs draw much less current, allowing more power for other vehicle requirements
- Electronics are completely sealed in epoxy to resist damage caused by moisture and corrosion
- Reduces lighting costs caused by heat entrapment.

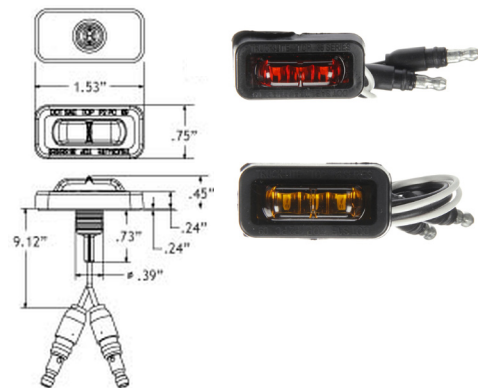

Part Number	Lens Color	Mount Color	Lamp Connector	Plug Side 1	Plug Side 2	Volts	Amps Major/Minor	Diodes	Lighting Codes
36115R	Red	Black	Hardwired	Hardwired	.180 Bullet	12	0.03	3	P2 PC
36115Y	Yellow	Black	Hardwired	Hardwired	.180 Bullet	12	0.05	3	P2 PC

LED
33 SERIES

LED
36 SERIES

LED

36 SERIES

36 SERIES, LED, 1" X 2" RECTANGULAR, ADHESIVE MOUNT, WINGED

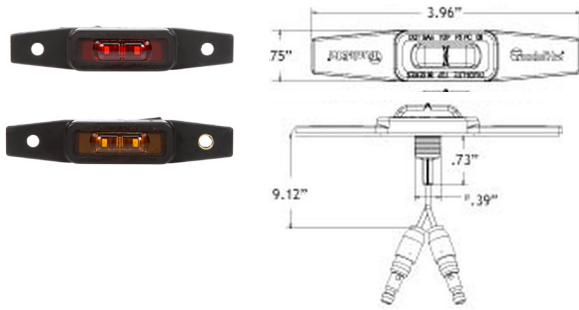

- Winged housing provides option for mounting around corners on a radius
- Provides a clearance/marker solution that requires no mounting brackets or installation screws
- Lamps adhere directly to application surface through the use of heavy-duty adhesive backing
- Easy-to-install, peel-off liner
- Hardwired lamp design is easily retrofitted
- Rear exit wire version requires a 3/8" mounting hole and self-seals hole upon installation
- Side-mount options can be mounted without any mounting holes
- LEDs draw much less current, allowing more power for other vehicle requirements
- Electronics are completely sealed in epoxy



Part Number	Lens Color	Mount Color	Lamp Connector	Plug Side 1	Plug Side 2	Volts	Amps Major/Minor	Diodes	Lighting Codes
36130R	Red	Black	Hardwired	Hardwired	.180 Bullet/ Female .180 Bullet	12 24	0.05	3	P2 PC
36130Y	Yellow	Black	Hardwired	Hardwired	.180 Bullet/ Female .180 Bullet	12 24	0.05	3	P2 PC

LED

1X2 IN RECTANGULAR

SIGNAL-STAT, LED, 1" X 2" RECTANGULAR, GROMMET MOUNT



- Popular on owner/operator and show trucks
- Standard connection
- 2 Diode (red), 3 diode (yellow) LED pattern
- Encapsulated electronics prevent damage from moisture and corrosion
- Not suitable for PC requirements



Part Number	Lens Color	Lamp Connector	Volts	Amps	Diodes	Lighting Codes
1560	Red	PL-10	12	0.05	2	P2
1560A	Yellow	PL-10	12	0.05	3	P2

INCANDESCENT

15 SERIES

15[®] SERIES, INCANDESCENT, 1" X 2" RECTANGULAR, BRACKET MOUNT



- Fits in most narrow header rails
- Mounts vertically or horizontally
- Long-life, 15,000-hour bulb
- Snap-lock tabs allow quick and easy installation
- Suitable for PC requirements on a 45° angle



Part Number	Lens Color	Lamp Connector	Volts	Amps	Bulbs	Lighting Codes
15200R	Red	PL-10	12	0.33	1	P2 PC
15200Y	Yellow	PL-10	12	0.33	1	P2 PC

19[®] SERIES, LED, 1" X 4" RECTANGULAR, BRACKET MOUNT

- Innovative optic design allows combination lamp to function as two
- Draws less current, allowing more power for other vehicle requirements
- Designed to fit applications requiring minimal space
- Must be mounted horizontally
- PC-rated lamps meets requirements when mounted on a 45 degree angle
- Standard red lamps have 2-diode pattern
- PC-rated red lamps and standard yellow lamps have 4-diode pattern
- PC-rated yellow lamps have 6-diode pattern

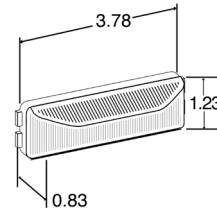

Part Number	Lens Color	Lamp Connector	Volts	Amps	Diodes	Lighting Codes	Warranty
19250R	Red	19 Series Male Pin	12	0.05	2	P2 PC	3-year
19250Y	Yellow	19 Series Male Pin	12	0.05	4	P2 PC	3-year
19350R	Red	Fit 'N Forget M/C	12	0.05	2	P2 PC	LIFETIME
19350Y	Yellow	Fit 'N Forget M/C	12	0.05	4	P2 PC	LIFETIME

35[®] SERIES, LED, 1" X 4" RECTANGULAR, 2 SCREW / KIT



- Slim 3/4" wide design makes lamp perfect solution for narrow rail designs
- Must be mounted horizontally
- Optional gasket to improve seal between lamp and body
- Not suitable for PC requirements

AVAILABLE CONNECTORS

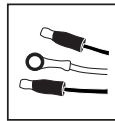

.180 BULLET/RING TERMINAL

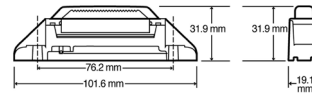

Part Number	Lens Color	Mount Color	Lamp Connector	Plug Side 1	Plug Side 2	Volts	Amps	Diodes	Lighting Codes	Kit Includes
35200R	Red	Red	Fit 'N Forget M/C	-	-	12	0.05	1	P2 PC	-
35200Y	Yellow	Yellow	Fit 'N Forget M/C	-	-	12	0.05	2	P2 PC	-
35375R	Red	Red	Fit 'N Forget M/C	-	-	12	0.12	5	P2 PC	-
35375Y	Yellow	Yellow	Fit 'N Forget M/C	-	-	12	0.12	5	P2 PC	-
35001R	Red	Red	Fit 'N Forget M/C	Fit 'N Forget M/C	.180 Bullet/Ring Terminal	12	0.05	1	P2 PC	35200R light, 94862 plug
35001Y	Yellow	Yellow	Fit 'N Forget M/C	Fit 'N Forget M/C	.180 Bullet/Ring Terminal	12	0.05	1	P2 PC	35200Y light, 94862 plug

SIGNAL-STAT, LED, 1" X 4" RECTANGULAR, BRACKET MOUNT



- Popular in owner/operator and show trucks
- Standard connection
- 4 diode LED pattern
- Encapsulated electronics
- Not recommended for PC applications

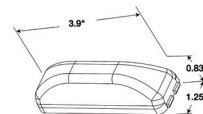

Part Number	Lens Color	Lamp Connector	Volts	Amps	Diodes	Lighting Codes
1960	Red	Male Pin	12	0.05	4	P2
1960A	Yellow	Male Pin	12	0.05	4	P2

LED

19 SERIES

LED

35 SERIES

LED

1X4 IN RECTANGULAR

INCANDESCENT

19[®] SERIES, INCANDESCENT, 1" X 4" RECTANGULAR, BRACKET MOUNT

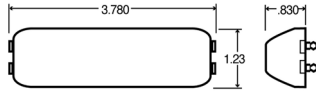

- Designed to fit in limited mounting areas
- Fits in most narrow header rails
- Can be mounted vertically or horizontally
- Snap-lock tabs allow quick and easy installation
- Replaces Signal-Stat 1900 series



19 SERIES

Part Number	Lens Color	Lamp Connector	Volts	Amps	Bulbs	Lighting Codes
19200R	Red	19 Series Male Pin	12	0.33	2	P2 P3 PC
19200Y	Yellow	Fit 'N Forget M/C	12	0.33	2	P2 P3 PC

INCANDESCENT

19[®] SERIES, INCANDESCENT, 1" X 4" RECTANGULAR, 2 SCREW, KIT

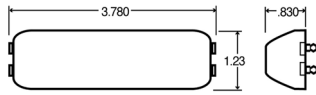

- Features unique plug-in design for ease of installation
- Low-profile extra-strength base
- Suitable for PC requirements on a 45° angle



19 SERIES

Part Number	Lens Color	Lamp Connector	Plug Side 1	Plug Side 2	Volts	Amps	Bulbs	Lighting Codes	Kit Includes
19002R	Red	Hardwired	Hardwired	Stripped End	12	0.33	2	P2 PC	19200R light, 19721 bracket
19002Y	Yellow	Hardwired	Hardwired	Stripped End	12	0.33	2	P2 PC	19200Y light, 19721 bracket

INCANDESCENT

14 SERIES, INCANDESCENT, 2" X 3" RECTANGULAR, GROMMET MOUNT, REFLECTORIZED

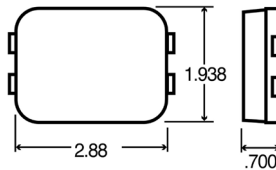
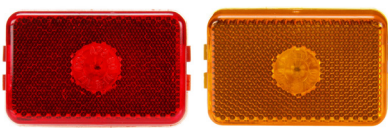

- Sonically sealed lens and housing
- Features snap-in lamp with reflector
- Long-life, 15,000-hour, 12 volt bulb
- Grommets flush-mount the lamp to vehicle
- Not suitable for PC requirements
- Replaces Signal-Stat 1017/1017A and 9138



14 SERIES

Part Number	Lens Color	Lamp Connector	Volts	Amps	Bulbs	Lighting Codes
14200R	Red	PL-10	12	0.33	1	A P2
14200Y	Yellow	PL-10	12	0.33	1	A P2



**TESTED.
TRUSTED.
TOUGH.**



LED

2X4 IN RECTANGULAR

SIGNAL-STAT, LED, 2" X 4" RECTANGULAR, 2 SCREW

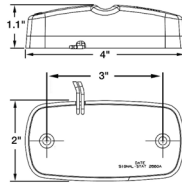

- Hardwired design eliminates pin corrosion to body of vehicle
- 16 diode double bullseye LED pattern



Part Number	Lens Color	Lamp Connector	Volts	Amps	Diodes	Lighting Codes
2660	Red	Hardwired	12	0.08	16	P2
2660A	Yellow	Hardwired	12	0.08	16	P2

INCANDESCENT

2X4 IN RECTANGULAR

SIGNAL-STAT, INCANDESCENT, 2" X 4", RECTANGULAR, BRACKET MOUNT, KIT

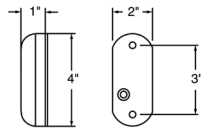

- High-impact polycarbonate housing protects against rust and corrosion
- Snap-on lens permits easy bulb and lens replacement
- Two bulb design - if one burns out, the other remains lighted
- Not suitable for PC requirements
- Optional mounting gasket available to improve seal between lamp and body
- Replaces Truck-Lite 26301 Series



Part Number	Lens Color	Lamp Connector	Plug Side 1	Plug Side 2	Volts	Amps	Bulbs	Lighting Codes	Kit Includes
1211	Red	Hardwired	Hardwired	Blunt Cut	12	0.33	2	P2	9523 pad, 9007 light
1211A	Yellow	Hardwired	Hardwired	Blunt Cut	12	0.33	2	P2	9523 pad, 9007A light
1259	Red	Hardwired	Hardwired	Stripped End	12	0.27	2	P2	9522 pad, 9093 light
1259A	Yellow	Hardwired	Hardwired	Stripped End	12	0.27	2	P2	9522 pad, 9093A light

LED

21 SERIES

21[®] SERIES, LED, 2" X 6" RECTANGULAR, 2 SCREW, REFLECTORIZED

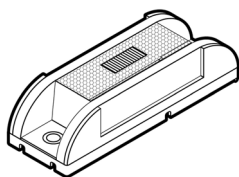

- Innovative optic design allows one PC-rated lamp the ability to function as two
- Draws less current, allowing more power for other vehicle requirements
- Uses standard mounting holes and accessories



Part Number	Lens Color	Mount Color	Lamp Connector	Volts	Amps	Diodes	Lighting Codes
21251R	Red	Red	Fit 'N Forget M/C	12	0.1	1	A P2
21251Y	Yellow	Yellow	Fit 'N Forget M/C	12	0.1	2	A P2

SIGNAL-STAT, LED, 2" X 6" RECTANGULAR, 2 SCREW, REFLECTORIZED



- ReflectORIZED lens on colored lens versions
- Optional mounting and sealing gaskets available to improve seal between lamps
- Less susceptible to shock and vibration

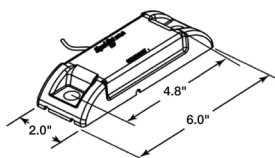

Part Number	Lens Color	Lamp Connector	Volts	Amps	Diodes	Lighting Codes
2150	Red	Hardwired	12	0.12	8	A P2
2150A	Yellow	Hardwired	12	0.12	8	A P2

LED
2X6 IN RECTANGULAR

SUPER 21® SERIES, INCANDESCENT, 2" X 6" RECTANGULAR 2 SCREW, KIT / REFLECTORIZED



- Available with standard or reflectORIZED lens
- Suitable for PC requirements on a 45-degree angle with additional reflectors
- Version available for ABS requirements
- Optional gaskets available to improve seal between lamp and body
- Kits with extension brackets are a direct replacement for Utility Trailer #03-5100-0-097/8

AVAILABLE CONNECTORS

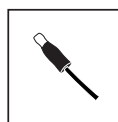

.180 BULLET

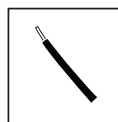

STRIPPED END

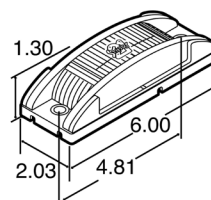

Part Number	Lens Color	Lamp Connector	Plug Side 1	Plug Side 2	Volts	Amps	Bulbs	Lighting Codes	ReflectORIZED	Kit Included
21001R	Red	Super 21 Plug	Super 21 Plug	Stripped End	12	0.17	1	P2 PC	-	21200R light, 96930 plug
21001Y	Yellow	Super 21 Plug	Super 21 Plug	Stripped End	12	0.17	1	P2 PC	-	21200Y light, 96930 plug
21002R	Red	Super 21 Plug	Super 21 Plug	Stripped End	12	0.33	1	A P2	Yes	21201R light, 96930 plug
21002Y	Yellow	Super 21 Plug	Super 21 Plug	Stripped End	12	0.33	1	A P2	Yes	21201Y light, 96930 plug

INCANDESCENT

SUPER 21 SERIES

Keep Your Connections Safe. Don't Forget Your Dielectric Gel.

Dielectric gel protects your lights by protecting the points of contact between elements of your lighting and harness system. Our dielectric compounds prevent arcing and corrosion and keep your lights performing as they should.

You can find our dielectric products on page 66.



LICENSE & BACK-UP LIGHTS

category	pages
License	34 - 36
Back-up	36 - 37

LED

15 SERIES

15[®] SERIES, LED, 3 DIODE, 1"x 2", BRACKET MOUNT / KIT

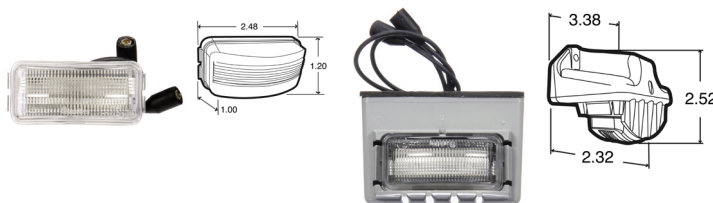

15205

15040-KIT

- Meets SAE J587 and European ECE Regulations 4
- Hardwired design with adapter plug for quick changeover without rewiring
- Functions as utility lamp or license lamp when properly mounted using license plate brackets #00820, #15729, #15730, #15732 or #15736



Part Number	Lamp Connector	Plug Side 1	Plug Side 2	Lens Color	Lens Material	Mount Color	Volts	Amps	Kit Includes
15205	Hardwired	Hardwired	Female PL-10	Clear	PC	-	12	0.03	-
15040	Hardwired	Hardwired	Female PL-10	Clear	PC	Gray	12	0.03	15205 light, 15729 bracket mount, 97032 gasket

15[®] SERIES, INCANDESCENT, 1 BULB, 1"x 2", BRACKET MOUNT / KIT



- High-impact polycarbonate, sonically sealed lens and housing
 - Available in 12 or 24-volt versions
 - Features 15,000-hour-long life
 - Must be used with Model 15 mounting brackets
 - Replaces Signal-Stat 1502W
 - Upgrade to LED lighting systems using Truck-Lite's 15 Series LED license lamps
- 15011 - KIT
- Features snap-fit mount for quick installation and easy replacement
 - Bracket may be surface mounted

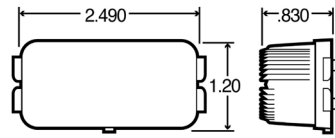

15208

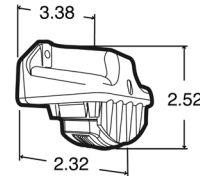

15011 - KIT

Part Number	Lamp Connector	Lens Color	Lens Material	Mount Color	Volts	Amps	Kit Includes	Warranty
15208	PL-10	Clear	PC	-	12	0.33	-	one year
15011	PL-10	Clear	PC	Gray	12	0.33	15208 light, 15729 bracket 97032 grommet	lifetime

19[®] SERIES, INCANDESCENT, 2 BULB, 2", BRACKET MOUNT



- Fruehauf replacement lamp
- High-impact polycarbonate, sonically sealed lens and housing
- Long-life, 15,000-hour bulbs
- License or utility applications
- Replaces Signal-Stat 1901W

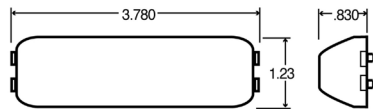

Part Number	Lamp Connector	Lens Color	Lens Material	Volts	Amps
19206	19 Series Male Pin	Clear	PC	12	0.33

26 SERIES, INCANDESCENT, 1 BULB, 1", GROMMET MOUNT, ROUND



- Features chrome-plated brass housing
- Snap-fit design uses standard 1-1/4" diameter hole
- Commonly used to illuminate a license plate on step bumpers
- Two units required for license illumination
- Ideal for courtesy, map, instrument, license or step lighting
- Snaps securely into any panel thickness up to .187"
- Replaces Signal-Stat 430W

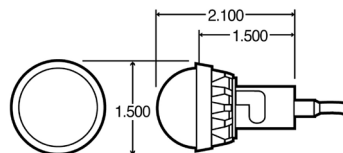

Part Number	Lamp Connector	Plug Side 1	Plug Side 2	Lens Color	Lens Material	Mount Color	Volts	Amps
26331	Hardwired	Hardwired	.180 Bullet	Clear	PC	Chrome	12	0.59

INCANDESCENT

15 SERIES

INCANDESCENT

19 SERIES

INCANDESCENT

26 SERIES

INCANDESCENT

26 SERIES, INCANDESCENT, 1 BULB, 2 SCREW BRACKET MOUNT

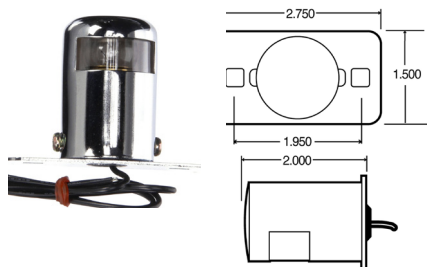

- Extra-rugged, cadmium-plated steel housing
- Screw lock cover cams on/off for easy bulb replacement
- Ideal for license, instrument or step lighting
- Surface mounts, grounds through screw
- Replaces Signal-Stat 431W
- 1/4" screw hole diameter



26 SERIES

Part Number	Lamp Connector	Plug Side 1	Plug Side 2	Lens Color	Lens Material	Mount Color	Volts	Amps
26330	Hardwired	Hardwired	Stripped End	Clear	PC	Chrome	12	0.59

INCANDESCENT

26 SERIES, INCANDESCENT, 1 BULB, BRACKET MOUNT, KIT

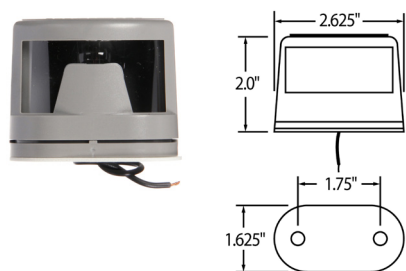

- Features high-impact housing with aerodynamic design
- Mounts on 1-3/4" hole centers
- Replaces Signal-Stat 420W and 423W



26 SERIES

Part Number	Lamp Connector	Plug Side 1	Plug Side 2	Lens Color	Lens Material	Mount Color	Volts	Amps	Kit Includes
26335	Hardwired	Hardwired	Stripped End	Clear	PC	Gray	12	0.59	26380 hood

LED

SIGNAL-STAT, LED, 24 DIODE, 4", GROMMET MOUNT, ROUND

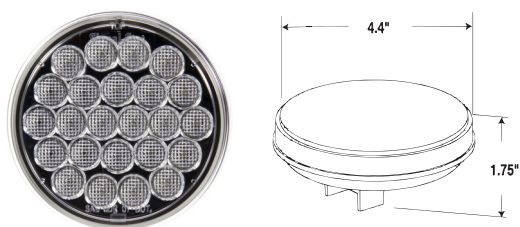

- Popular on owner/operator show trucks
- Uses standard right-angle connection
- Unique LED array displays a full pattern light output design
- Epoxy-encapsulated electronics resist damage from moisture and corrosion
- Less current draw, resulting in increased battery and alternator life while allowing more power for other vehicle requirements
- Two lamps required for back-up
- LEDs do not have a filament, therefore are not susceptible to damage from shock and vibration



SIGNAL-STAT

Part Number	Lamp Connector	Lens Color	Lens Material	Volts	Amps
4060C	PL-2	Clear	PC	12	0.13

40 SERIES, INCANDESCENT, 1 BULB, 4", GROMMET MOUNT



- Polycarbonate lens and housing are sonically sealed
- Bulb is shock-mounted for extended life
- Legal only for back-up function
- Not recommended for dome lamp use
- Replaces Signal-Stat 4041W and 4047W
- Upgrade to LED lighting systems using Truck-Lite's Super 44 series products

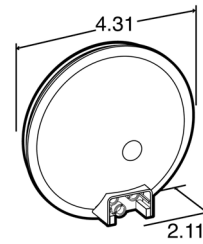

Part Number	Lamp Connector	Lens Color	Lens Material	Volts	Amps	Housing Color
40204	PL-2	Clear	PC	12	2.1	White

INCANDESCENT

40 SERIES

SUPER 40®, INCANDESCENT, 1 BULB, 4", GROMMET MOUNT



- Uniquely designed shock mount extends lamp life
- Sealed polycarbonate lens and housing resist heat and impact
- Flange and flush mount grommets designed for mounting in a 4-1/2" hole
- Not recommended for dome lamp use
- Upgrade to LED Lighting Systems using Truck-Lite's Super 44 Series products

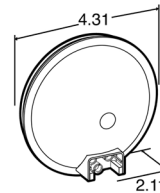

Part Number	Lamp Connector	Lens Color	Lens Material	Volts	Amps
40244	PL-2	Clear	PC	12	2.1

INCANDESCENT

SUPER 40

SIGNAL-STAT, LED, 24 DIODE, 2"X 6", GROMMET MOUNT, OVAL



- Popular on owner/operator show trucks
- Uses standard right-angle connection
- 24-diode pattern
- Unique LED array displays a full pattern light output design
- Epoxy-encapsulated electronics resist damage from moisture and corrosion
- Less current draw, resulting in increased battery and alternator life while allowing more power for other vehicle requirements
- LEDs do not have a filament, therefore are not susceptible to damage from shock and vibration
- Two lamps required for back-up
- Legal mounted horizontally or vertically

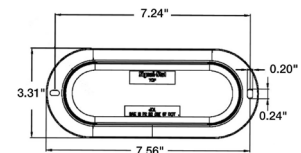

Part Number	Lamp Connector	Lens Color	Lens Material	Volts	Amps
6060C	PL-2	Clear	PC	12	0.25

LED

SIGNAL-STAT

WORK LIGHTING

category	pages
LED	38
Incandescent	39

LED

RIGID

RIGID, LED, 1"X 2", RECTANGULAR, PERIMETER WORK LIGHT



- 65° horizontal spread X 69° vertical spread
- Flat mounting surface
- Available with cool white LEDs
- IP68 compliant
- Variety of mounting applications
- Limited lifetime warranty

RIGID



Part Number	Housing Color	Lumens	Diodes	Lamp Connection	Plug Side 1	Plug Side 2	Volts	Amps
84715	Black	1100	3	Hardwired	Hardwired	.180 Bullet	12 24 36	0.8

RIGID

**LIGHT WHERE YOU NEED IT,
WHEN YOU NEED IT.**



SIGNAL-STAT, LED, 3" X 3", SQUARE, WORK LIGHT



- Heavy-duty, die-cast aluminum housing
- Lens manufactured with impact-resistant acrylic material
- Rear fins keep heat away from LEDs and lamp circuitry, allowing for increased light output and light longevity
- White LEDs offer daylight-like visibility, cleaner and clearer than other light source options
- Current regulated switching circuit
- EMC protection
- Includes stainless steel bracket mount

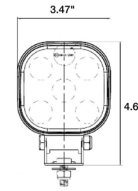

Part Number	Housing Color	Lumens	Diodes	Lamp Connection	Plug Side 1	Plug Side 2	Volts	Amps
8192	Black	1200	5	Hardwired	Hardwired	Blunt Cut	12 24	.58

LED

SIGNAL-STAT

SIGNAL-STAT, LED, 4" X 6", OVAL, WORK LIGHT



- Heavy-duty, die-cast aluminum housing
- Lens manufactured with impact-resistant acrylic material
- Rear fins keep heat away from LEDs and lamp circuitry, allowing for increased light output and light longevity
- White LEDs offer daylight-like visibility, cleaner and clearer than other light source options
- Current-regulated switching circuit
- EMC protection

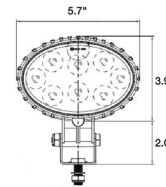

Part Number	Housing Color	Lumens	Diodes	Lamp Connection	Plug Side 1	Plug Side 2	Volts	Amps
8193	Black	1900	8	Deutsch Connector	Deutsch Connector	Stripped End	12 24	1.21

LED

SIGNAL-STAT

INCANDESCENT, 5", ROUND, PAR 36, WORK LIGHT



- Durable synthetic rubber housing resists corrosion
- Includes mounting hardware
- Contains one clear Par 36 sealed trapezoid beam with multipurpose terminals
- Fluted lens disperses light evenly
- Mounts on one 5/16"-18 stud

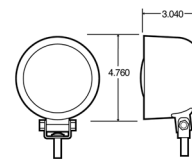

Part Number	Housing Color	Bulbs	Lamp Connection	Plug Side 1	Plug Side 2	Volts	Amps
80361	Black	1	Hardwired	Hardwired	Blunt Cut	12	2.9
80360	Black	1	Hardwired	Hardwired	Stripped End	12	2.9

INCANDESCENT

5 IN

HEADLIGHTS & FOG LIGHTS

category	pages
Headlights	40
Snow Plow Kits	41
Fog & Driving Lights	41 - 43

LED

5 IN X 7 IN HEATED HEADLIGHT

NEW

HEADLIGHT, LED, 5"X 7", HEATED LENS



- Headlight heats constantly under 10°C/50°F
- When properly mounted, the lamp is designed to conform to the requirements listed in the Department of Transportation (DOT), FMVSS-108 and Transport Canada (TC), CMVSS-108
- Unique heat pattern is designed to prevent ice, slush and snow buildup on the lens
- Excellent option for light, medium and heavy-duty trucks and off-road vehicles that are frequently exposed to extreme weather conditions
- Metalized reflector optics provide a lighting experience that smooth and clean across the driving surface
- Provides a brighter, crisper and whiter light output, closer to the color temperature of daylight
- Durability and dependability of LED lighting provides a solid-state, bulb-free headlight design that is impervious to damage from shock and vibration
- Military-grade, die-cast aluminum housing and non-yellowing, polycarbonate heated lens offer optimum protection against damage from impact, roadside debris and other hazards
- Electronics are sealed in epoxy to resist damage caused by corrosion or moisture
- Advanced circuitry protects against voltage spikes up to 600V
- Drop-in replacement for #6014, 6015, 6016, H6024 and Par 56 headlight designs
- Uses standard, H4, 3-blade wiring connector

Part Number	Lamp Connection	Plug Side 1	Plug Side 2	Volts	Current Major/Minor	Diodes	Lens Material	Housing Material	Beam Pattern
27455C	Hardwired	Hardwired	H4 Connector	12 24	2.95/1.45	2	PC	E-Coat Aluminum	High Low

SNOW PLOW LIGHT, LED, 5" X 7" & 7", 1 STUD MOUNT, HEATED LENS, KIT



- Headlight heats constantly under 10°C/50°F
- A robust, LED, solid-state solution that can withstand shock and vibration, replacing headlights and turn signal lights blocked by the plow assembly
- 80985 Utilizes Truck-Lite's 27275C 5x7 inch heated headlight
- 80990 Utilizes Truck-Lite's 27275C 7 inch heated headlight
- Heated lens prevents snow, ice, and slush buildup
- LED design draws less current, allowing more power for other vehicle requirements
- DOT-compliant LED headlight provides a brighter, crisper and whiter light output, closer to the color temperature of daylight, dramatically improving light projection distance and increasing visibility
- Advanced white LED technology reduces concerns with EMI and offers substantially longer life than comparable incandescent lights
- Pedestal light (front/park/turn) features a unique LED diode array with a full pattern appearance
- Lights are hardwired with fully encapsulated electronics to protect from damage caused by corrosive elements
- Corrosion-resistant, powder-coated aluminum housing dissipates heat efficiently
- Impact-resistant polycarbonate lenses protect against damage caused by debris and other hazards

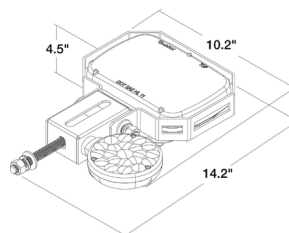

80985 Kit Includes
80983 light, 80984 light, 80988 harness

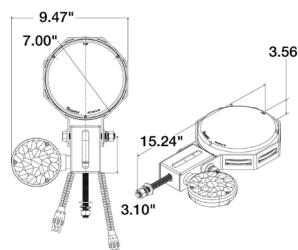

80990 Kit Includes
80988 light, 80989 light, 80988 harness

Part Number	Lens Color	Lens Material	Lamp Connection	Plug Side 1	Plug Side 2	Volts	Maps Major/Minor	Mount Material	Mount Color	Housing Material
80985 (5"x7")	Clear	PC	Hardwired	Hardwired	Packard Connector 12020829	12 24	3.6/1.8	Steel	Black	Aluminum/ Die Cast Zinc
80990 (7")	Clar	PC	Hardwired	Hardwired	Packard Connector 12020829/ Packard Connector 12015793	12 24	3.8 / 2.1	Steel	Black	Die-Cast Aluminum

RIGID INDUSTRIES, D-SERIES, SAE FOG LIGHT, LED, 3" X 3", BRACKET MOUNT, KIT, FREIGHTLINER



- Designed as a direct replacement for 2007-2016 Freightliner Cascadia fog lights
- Waterproof H11 Deutsch adapter plugs directly into factory harness
- SAE J583 compliant fog lights project high-intensity, crisp light
- Pure white light output is closer to the color temperature of daylight, dramatically improving overall visibility
- Built as a low-profile, solid-state design
- Durable die-cast housing and polycarbonate lens offer a robust package to combat damage caused by shock and vibration
- Low power draw
- Lifespan up to 50,000+ hours



Part Number	Lamp Connection	Plug Side 1	Plug Side 2	Volts	Current	Diodes	Lens Color	Mount Material	Lens Material
84760	Hardwired	Hardwired	Deutsch Connector	12 24 36	2.29	4	Clear	Steel	PC

LED
HEATED SNOW PLOW
NEW

LED
RIGID FOG LIGHT

LED

RIGID FOG LIGHT

RIGID INDUSTRIES, D-SERIES, SAE FOG LIGHT, LED, 3"X 3", BRACKET MOUNT, KIT, VOLVO



- Designed as a direct replacement for 20013-2017 Volvo® VN® fog lights
- Waterproof H11 to Deutsch adapter plugs directly into factory harness
- SAE J583 compliant fog lights project high-intensity, crisp light
- Pure white light output is closer to the color temperature of daylight, dramatically improving overall visibility
- Built as a low-profile, solid-state design
- Durable die-cast housing and polycarbonate lens offer a robust package to combat damage caused by shock and vibration
- Low power draw
- Lifespan up to 50,000+ hours



Part Number	Lamp Connection	Plug Side 1	Plug Side 2	Volts	Current	Diodes	Lens Color	Mount Material	Lens Material
84780	Hardwired	Hardwired	Deutsch Connector	12 24 36	1.5	4	Clear	Steel	PC

LED

RIGID FOG LIGHT

RIGID INDUSTRIES, D-SERIES, SAE FOG LIGHT, LED, 3"X 3", BRACKET MOUNT, KIT, INTERNATIONAL



- Designed as a direct replacement for 2008-2017 International® ProStar® fog lights
- Waterproof H11 to Deutsch adapter plugs directly into factory harness
- SAE J583 compliant fog lights project high-intensity, crisp light
- Pure white light output is closer to the color temperature of daylight, dramatically improving overall visibility
- Built as a low-profile, solid-state design
- Durable die-cast housing and polycarbonate lens offer a robust package to combat damage caused by shock and vibration
- Low power draw
- Lifespan up to 50,000+ hours



Part Number	Lamp Connection	Plug Side 1	Plug Side 2	Volts	Current	Diodes	Lens Color	Mount Material	Lens Material
84770	Hardwired	Hardwired	Deutsch Connector	12 24 36	1.5	4	Clear	Steel	PC

LED

RIGID FOG LIGHT

RIGID INDUSTRIES, D-SERIES, SAE FOG LIGHT, LED, 3"X 3", BRACKET MOUNT, KIT, KENWORTH



- Designed as a direct replacement for 20013-2017 Kenworth® T680® fog lights
- Waterproof H11 to Deutsch adapter plugs directly into factory harness
- SAE J583 compliant fog lights project high-intensity, crisp light
- Pure white light output is closer to the color temperature of daylight, dramatically improving overall visibility
- Built as a low-profile, solid-state design
- Durable die-cast housing and polycarbonate lens offer a robust package to combat damage caused by shock and vibration
- Low power draw
- Lifespan up to 50,000+ hours



Part Number	Lamp Connection	Plug Side 1	Plug Side 2	Volts	Current	Diodes	Lens Color	Mount Material	Lens Material
84761	Hardwired	Hardwired	Deutsch Connector	12 24 36	1.5	4	Clear	Steel	PC

RIGID INDUSTRIES, D-SERIES, SAE FOG LIGHT, LED, 3"X 3", BRACKET MOUNT, KIT



- Designed as an aftermarket fog light kit for D-Series Universal fog lights
- Full XL harness with switch included
- SAE J583 compliant fog lights project high-intensity, crisp light
- Pure white light output is closer to the color temperature of daylight, dramatically improving overall visibility
- Built as a low-profile, solid-state design
- Durable die-cast housing and polycarbonate lens offer a robust package to combat damage caused by shock and vibration
- Low power draw
- Lifespan up to 50,000+ hours



Part Number	Lamp Connection	Plug Side 1	Plug Side 2	Volts	Current	Diodes	Lens Color	Mount Material	Lens Material
84764	Hardwired	Hardwired	Deutsch Connector	12 24 36	1.5	4	Clear	Steel	PC

LED

RIGID FOG LIGHT

RIGID INDUSTRIES, SR-SERIES, SAE FOG LIGHT, LED, 6", BRACKET MOUNT, KIT



- Designed as a universal aftermarket LED fog light kit using SR-Series lights
- Full XL harness with switch included
- SAE J583 compliant fog lights project high-intensity, crisp light
- Pure white light output is closer to the color temperature of daylight, dramatically improving overall visibility
- Built as a low-profile, solid-state design
- Durable die-cast housing and polycarbonate lens offer a robust package to combat damage caused by shock and vibration
- Low power draw
- Lifespan up to 50,000+ hours



Part Number	Lamp Connection	Plug Side 1	Plug Side 2	Volts	Current Major/Minor	Diodes	Lens Color	Mount Material	Lens Material
84740	Deutsch Connector	Deutsch Connector	Ring Terminal	12 24 36	2.29	6	Clear	Steel	PC

LED

RIGID FOG LIGHT

RIGID INDUSTRIES, E-SERIES, SAE DRIVING LIGHT, LED, 6", BRACKET MOUNT, KIT



- Designed as a universal aftermarket LED auxiliary highbeam kit using E-Series lights
- Full XL harness with switch included
- SAE J583 compliant fog lights project high-intensity, crisp light
- Pure white light output is closer to the color temperature of daylight, dramatically improving overall visibility
- Built as a low-profile, solid-state design
- Durable die-cast housing and polycarbonate lens offer a robust package to combat damage caused by shock and vibration
- Low power draw
- Lifespan up to 50,000+ hours



Part Number	Lamp Connection	Plug Side 1	Plug Side 2	Volts	Current	Diodes	Lens Color	Mount Material	Lens Material
84720	Deutsch Connector	Deutsch Connector	Ring Terminal	12 24 36	1.5	12	Clear	Steel	PC

LED

RIGID FOG LIGHT

INTERIOR UTILITY & DOME LIGHTS

category	pages
Adhesive Mount	44
Bracket Mount	45

LED

SUPER 33

36 SERIES, LED, 3 DIODE, 1" X 2", ADHESIVE MOUNT



- Provides robust LED white lighting solution that does not require mounting brackets or installation screws
- Light adheres directly to mounting surface with heavy-duty adhesive backing, with an easy-to-install, peel-off liner
- OmniVolt design makes the 36 Series auxiliary light perfect for any type of vehicle system
- Small profile makes it ideal for interior, tool box, storage, under cabinet, and other small spaces
- Perfect for rock lights in off-road application
- Electronics are completely sealed in epoxy to resist damage caused by moisture, corrosion, shock and vibration

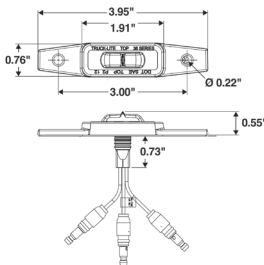

36214C / 36215C

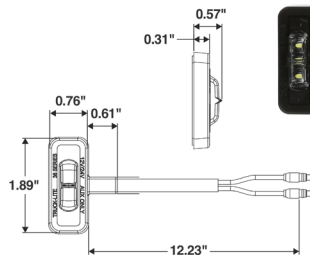

36204C / 36205C

Part Number	Lamp Connector	Plug Side 1	Plug Side 2	Lens Color	Lens Material	Mount Color	Volts	Amps	Wire Location
36204C	Hardwired	Hardwired	.180 Bullet	Clear	PC	Black	12 24	0.05	Rear Exit
36205C	Hardwired	Hardwired	.180 Bullet	Clear	PC	Black	12 24	0.05	Side Exit
36214C	Hardwired	Hardwired	.180 Bullet	Clear	PC	Black	12 24	0.05	Rear Exit
36215C	Hardwired	Hardwired	.180 Bullet	Clear	PC	Black	12 24	0.05	Side Exit

15[®] SERIES, INCANDESCENT, 1 BULB, 1" x 2", BRACKET MOUNT



- High-impact polycarbonate construction
- Lens and housing are sonically sealed
- 15,000 hour rated 12V bulb life
- Replaces Signal-Stat 1500W
- Utility lamp

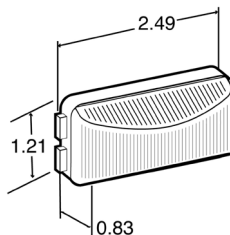

Part Number	Lamp Connector	Lens Color	Lens Material	Volts	Amps
15200C	PL-10	Clear	PC	12	0.33

INCANDESCENT

15 SERIES

19[®] SERIES, INCANDESCENT, 2 BULB, 1" x 4", BRACKET MOUNT



- High-impact polycarbonate construction
- Lens and housing are sonically sealed
- 15,000 hour rated 12V bulb life
- Utility lamp

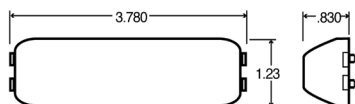

Part Number	Lamp Connector	Lens Color	Lens Material	Volts	Amps
19200C	19 Series Male Pin	Clear	PC	12	0.33

INCANDESCENT

19 SERIES

30[®] SERIES, INCANDESCENT, 1 BULB, 2", 2 SCREW BRACKET MOUNT



- High-impact polycarbonate construction
- Lens and housing are sonically sealed
- 15,000 hour rated 12V bulb life
- Replaces Signal-Stat 1030W
- Utility lamp

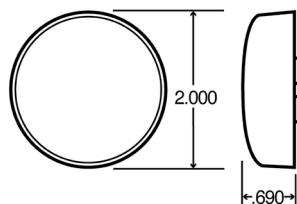

Part Number	Lamp Connector	Plug Side 1	Plug Side 2	Lens Color	Lens Material	Volts	Amps
30200C	PL-10	No Plug	No Plug	Clear	PC	12	0.33
30206C	PL-10	No Plug	No Plug	Clear	PC	24	0.17

INCANDESCENT

30 SERIES

LIGHT MOUNTING

category	pages
Bracket & Flange	46 - 50
Grommet Mount	50 - 52

10 SERIES

10[®] SERIES, BRACKET MOUNT, 2 SCREW

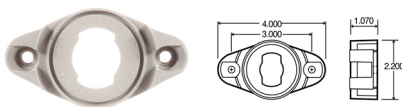

- High-impact plastic mount
- Branch deflector cams-on 2 and 2 1/2" lamps
- Requires 94924 side entry plug
- Suitable for PC requirements on a 45-degree angle when using LED or incandescent PC rated/combo lamps
- Not recommended for use with Signal-Stat LED products
- Replaces Signal-Stat 9390



Part Number	Mount Material	Mount Color	Back
10728	PC	Gray	Rib Back

10 SERIES

10[®] SERIES, BRACKET MOUNT, 2 SCREW

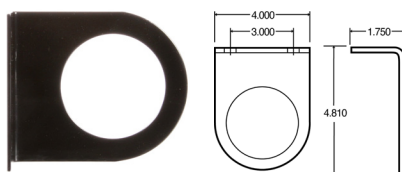

- Black epoxy-painted heavy-gauge steel
- 10729 is designed for mounting grommets: #10700, #10701, #10713, #10714 and #10708
- 10730 is designed for mounting grommets: #10704 and #10706



Part Number	Mount Material	Mount Color
10729	Steel	Black

10[®] SERIES, BRACKET MOUNT, 2 SCREW, KIT



- High-impact plastic mount
- Branch deflector cams-on 2 and 2 1/2" lamps
- Requires 94924 side entry plug
- Suitable for PC requirements on a 45-degree angle when using LED or incandescent PC rated/combination lamps
- Not recommended for use with Signal-Stat LED products
- Replaces Signal-Stat 9390

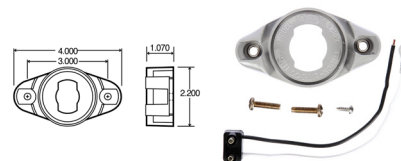

10 SERIES

Part Number	Mount Material	Mount Color	Lamp Connection	Plug Side 1	Plug Side 2	Kit Includes
10410	PC	Gray	PL-10	PL-10	Stripped End/Ring Terminal	10728 bracket, 94924 plug

10[®] SERIES, BRACKET MOUNT, 2 SCREW, KIT



- High-impact plastic deflector mount
- Design allows surface mounting of 2-1/2" lamps
- Suitable for PC requirements on a 45-degree angle when using LED or incandescent PC rated/combination lamps

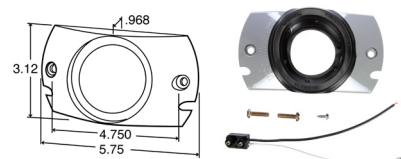

10 SERIES

Part Number	Mount Material	Mount Color	Lamp Connection	Plug Side 1	Plug Side 2	Kit Includes
10414	PC	Gray	PL-10	PL-10	Stripped End/Ring Terminal	10725 bracket, 10700 grommet, 94902 plug

10[®] SERIES, DEFLECTOR MOUNT, 2 SCREW



- High-impact plastic deflector mount
- Design allows surface mounting of 2-1/2" lamps
- Suitable for PC requirements on a 45-angle when using LED or incandescent PC rated/combination lamps

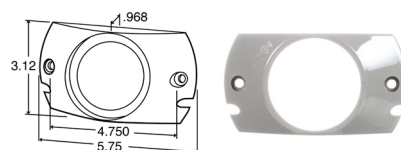

10 SERIES

Part Number	Mount Material	Mount Color
10725	PC	Gray

15[®] SERIES, BRACKET MOUNT, 2 SCREW



- Features snap-fit mount for quick installation and easy replacement
- Bracket may be surface mounted
- Recommended mounting locations available

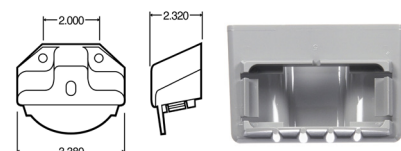

15 SERIES

Part Number	Mount Material	Mount Color
15729	PC	Gray

19 SERIES

19[®] SERIES, BRACKET MOUNT, 2 SCREW

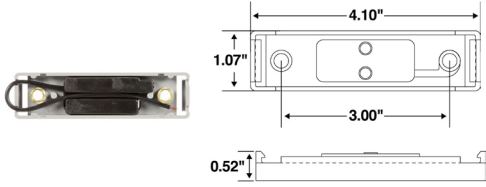

- Features unique plug-in design for ease of installation
- Low-profile, extra-strength base
- Suitable for PC requirements on a 45-degree angle



Part Number	Mount Material	Mount Color	Lamp Connection	Plug Side 1	Plug Side 2
19721	PC	Gray	Hardwired	Hardwired	Stripped End

30 SERIES

30[®] SERIES, BRACKET MOUNT, 3 SCREW

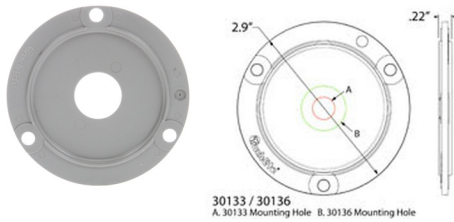

- Mounting plates can be installed into any 2" round mounting holes
- Provides an easy way to upgrade 2" round incandescent lamps or problematic LED lamps to high quality Truck-Lite 33 Series M/C lamps
- Adapters plates utilize the same mounting holes of standard 2" and 2.5" mounting flanges
- Constructed of impact-resistant polycarbonate for added strength and reliability



Part Number	Mount Material	Mount Color	Exit Hole
30133	PC	Gray	0.74in

33 SERIES

33[®] SERIES, FLANGE MOUNT

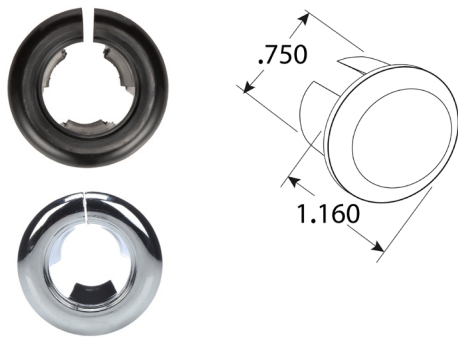

- Flush mounts, 3/4" diameter lamps to vehicle with snap fit, no screws required
- Sealing grommets secure lamps to vehicle, while assuring a 99.9 percent leak-proof seal
- Chrome-plated flange improves the appearance on vehicle
- Suitable for PC requirements when using LED PC rated/combination lamps
- Security ring can be installed onto flange mount installations to prevent lamps from theft (US Patent 7,572,043)



Part Number	Mount Material	Mount Color
33800	Nylon	Black
33810	Nylon	Chrome

40® SERIES, BRACKET MOUNT, 2 SCREW



- Features black painted reinforced steel
- Designed with 4-1/2" hole for mounting 4" lamps

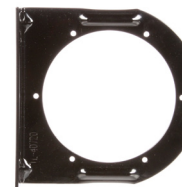
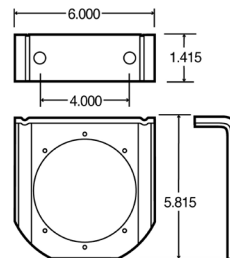

Part Number	Mount Material	Mount Color
40720	Steel	Black

40 SERIES

LICENSE BRACKET MOUNT, 1" X 2", 2 SCREW



- Designed for universal mounting applications
- Features extra-strong steel construction
- Intended for use with Model 15 license lamps

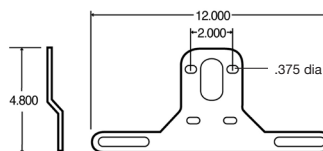

Part Number	Mount Material	Mount Color
42722	Steel	Black

1 IN X 2 IN

60® SERIES, BRACKET MOUNT, 2" X 6", 2 SCREW



- Designed for 60 series products with grommet or flange mounts

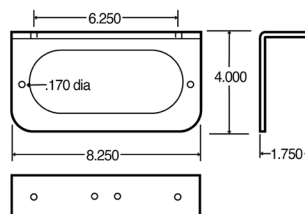

Part Number	Mount Material	Mount Color
60720	Steel	Black

2 IN X 6 IN

60® SERIES, LIGHT COVER, 2" X 6", 2 SCREW



- Grommet cover features chrome-plated plastics to enhance appearance of lamps
- Flange cover provides improved theft resistance of LED lamps
- Two screws required

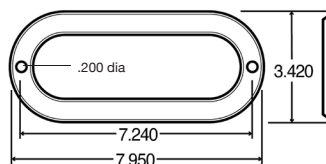

Part Number	Mount Material	Mount Color
60718	Stainless Steel	Silver

2 IN X 6 IN

4 IN

FLANGE COVER, 4"

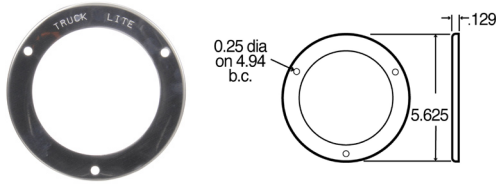

- Designed to enhance the appearance of lamps
- Flange cover offers improved theft resistance
- Three screws required



Part Number	Mount Material	Mount Color
44705	Stainless Steel	Silver

10 SERIES

10[®] SERIES, 2.5", OPEN BACK GROMMET

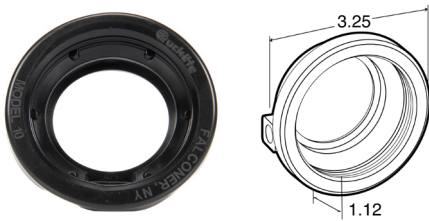

- Flush mounts 2-1/2" diameter lamps
- Wide groove for panel thickness up to .250"
- Narrow groove for panel thickness up to .125"
- Suitable for PC requirements on a 45-degree angle when using LED or incandescent PC-rated/combo lamps
- Closed back versions recommended for open installation where splash plate is not used
- Replaces Signal-Stat 9119 and 9156



Part Number	Mount Material	Mount Color	Groove
10700	PVC	Black	Wide
10704	PVC	Black	Normal
10708	Rubber	Black	Normal

10 SERIES

10[®] SERIES, 2.5", OPEN BACK GROMMET, KIT



- Flush mounts 2-1/2" diameter lamps
- Wide groove for panel thickness up to .250"
- Suitable for PC requirements on a 45-degree angle when using LED or incandescent PC-rated/combo lamps



Part Number	Mount Material	Mount Color	Lamp Connection	Plug Side 1	Plug Side 2	Kit Includes
10401	PVC	Black	PL-10	PL-10	Stripped End/Ring Terminal	94902 plug

10[®] SERIES, 2.5", CLOSED BACK GROMMET



- Flush mounts 2-1/2" diameter lamps
- Wide groove for panel thickness up to .250"
- Recommended hole diameter, 2.781"
- Suitable for PC requirements on a 45-degree angle when using LED or incandescent PC-rated/combination lamps
- Closed-back versions recommended for open installation where splash plate is not used

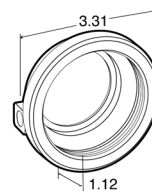

10 SERIES

Part Number	Mount Material	Mount Color	Groove
10702	PVC	Black	Wide

15[®] SERIES, 1"X 2", OPEN BACK GROMMET



- Flush mount vinyl PVC grommet
- Mounts in panel thickness up to .250"
- Suitable for PC requirements on a 45-degree angle with incandescent lamps
- Replaces Signal-State 9362

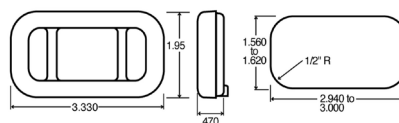

15 SERIES

Part Number	Mount Material	Mount Color
15702	PVC	Black

30[®] SERIES, 2", OPEN BACK GROMMET



- Flush mounts 2" diameter lamps
- Wide groove for panel thickness up to .250"
- Suitable for PC requirements when using LED or incandescent PC-rated/combination lamps
- Replaces Signal-Stat 9139



30 SERIES

Part Number	Mount Material	Mount Color
30700	PVC	Black

30[®] SERIES, 2", OPEN BACK GROMMET, KIT



- Flush mounts 2" diameter lamps
- Wide groove for panel thickness up to .250"
- Suitable for PC requirements when using LED or incandescent PC-rated/combination lamps



30 SERIES

Part Number	Mount Material	Mount Color	Lamp Connection	Plug Side 1	Plug Side 2	Kit Includes
30401	PVC	Black	PL-10	PL-10	Stripped End/Ring Terminal	30700 grommet, 94902 plug

30 SERIES

30[®] SERIES, 2", CLOSED BACK GROMMET

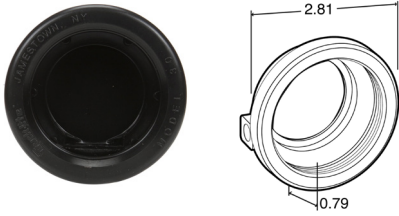

- Flush mounts 2" diameter lamps
- Wide groove for panel thickness up to .250"
- Suitable for PC requirements when using LED or incandescent PC-rated/combination lamps
- Closed-back versions recommended for open installation where splash plate is not used



Part Number	Mount Material	Mount Color	Exit Hole
30702	PVC	Black	0.75 in

33 SERIES

33[®] SERIES, 0.75", OPEN BACK

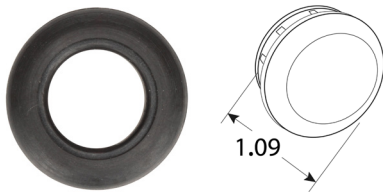

- Flush mounts 3/4" diameter lamps to vehicle with snap fit
- No screws required
- Sealing grommets secure lamps to vehicle while assuring a 99.9 percent leak-proof seal
- Chrome-plated flange improves the appearance on vehicle
- Suitable for PC requirements when using LED PC-rated/combination lamps
- Security ring can be installed onto flange mount installations to prevent lamps from theft (US Patent 7,572,043)



Part Number	Mount Material	Mount Color
33700	Rubber	Black

33 SERIES

33[®] SERIES, 0.75", OPEN BACK GROMMET



- Flush mounts, 3/4" diameter lamps to vehicle with snap fit
- No screws required
- Sealing grommets secure lamps to vehicle while assuring a 99.9% leakproof seal
- Chrome-plated flange improves the appearance on vehicle
- Suitable for PC requirements when using LED PC-rated/combination lamps
- Security ring can be installed onto flange mount installations to prevent lamps from theft (US Patent 7,572,043)



Part Number	Mount Material	Mount Color
33702	PVC	Black

33 SERIES

33[®] SERIES, HOODED GROMMET

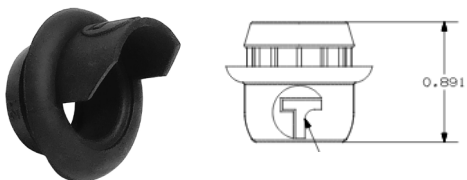

- Supplement to existing license light grommet (33705)
- Requires only 3/4" hole vs. previous 1 3/16"
- Benefit to OE assembly lines – smaller mounting hole to drill



Part Number	Mount Material	Mount Color
33703	Rubber	Black

NEW

40[®] SERIES, 4", OPEN BACK GROMMET



- Flush mounts 4" diameter lamps in a 4 1/2" hole
- Designed to provide additional shock absorbency to extend lamp life



40 SERIES

Part Number	Mount Material	Mount Color
40700	PVC	Black

45[®] SERIES, 3"X 5", OPEN BACK GROMMET



- Designed for flush mounting 45 Series lamps
- Standard grommet mounts in plate thickness of .06" to .375

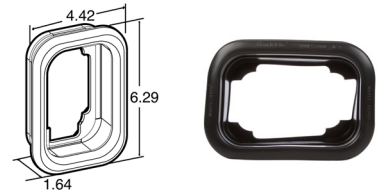

45 SERIES

Part Number	Mount Material	Mount Color	Grommet Type
45700	PVC	Black	Standard

60[®] SERIES, 2"X 6", OPEN BACK GROMMET



- Flush mounts the 60 Series lamps
- Provides lamps with additional shock absorbency to extend lamp life

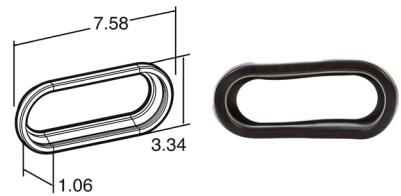

60 SERIES

Part Number	Mount Material	Mount Color
60700	PVC	Black

HARNESS SYSTEMS & ACCESSORIES

category	pages
Plugs	54 - 58
Sockets	58
Accessories	58 - 59
Conductors	59

GPT - General Purpose, Thermoplastic Insulated
> Normal resistance to heat/abbrasion

SXL - Standard-Duty, Cross-linked Polyolefin Insulated
> High resistance to heat/abbrasion

PLUGS

PLUG, FIT 'N FORGET 4 PIN S.S.

NEW

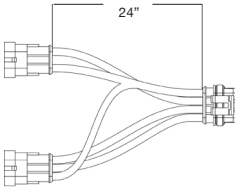
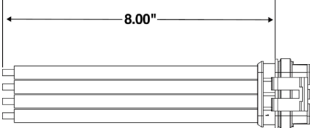
	Part Number	Plug Side 2	Length	Number of Wires	Wire Type	Warranty
	94966	LED Super Seal/ 3 Position Connector 282105	24in	4	GPT	1-Year
	94831	Stripped End	8in	4	GPT	1-Year

PLUGS

PLUG, FEMALE PL-3

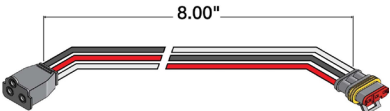
	Part Number	Plug Side 2	Wire Length	Number of Wires	Wire Type	Warranty
	94706	Fit 'N Forget S.S.	8in	3	GPT	Lifetime

HOW TO SELECT SIZE OF ELECTRIC CABLE

Voltage drop is the primary consideration in selecting the proper electrical wire size. The length of wire in a circuit is the major contributing factor to voltage drop. The table below may be used in determining adequate wire gauge sizes for specific lengths of cable when the amperage requirements are known.

Example: A lamp is 38 ft. from the power source and requires 10 amperes. This figure, when rounded upwards to the nearest column heading given in the table, is 40 ft. The wire gauge in the "40-ft. Column" corresponding to 10 amperes is No. 12.

Total length of cable in circuit from battery to most distant lamp

12 Volt System

Amperes (Approx.)	Up To 30 Feet	40 Feet	50 Feet	60 Feet	80 Feet	100 Feet	120 Feet
	Gauge	Gauge	Gauge	Gauge	Gauge	Gauge	Gauge
1.0	14	14	14	14	14	14	14
2	14	14	14	14	14	14	14
3	14	14	14	14	14	14	12
4	14	14	14	14	14	12	12
5	14	14	14	14	12	12	12
6	14	14	14	14	12	12	10
7	14	14	14	12	12	10	10
8	14	14	12	12	10	10	10
10	14	12	12	12	10	10	8
11	14	12	12	10	10	8	8
12	14	12	12	10	10	8	8
15	12	12	10	10	8	8	8
18	12	10	10	8	8	8	8
20	12	10	10	8	8	8	6
25	12	10	8	8	8	6	6
30	12	10	8	8	8	6	6
35	12	10	8	8	6	6	6

*Recommended minimum wire gauge size for stop light and ground circuits.

- Single trailer (up to 50' length)
- Doubles trailer (2-28' lengths)
- Doubles trailer (2-40' lengths)
- Triples trailer (3-28' lengths)

- | | |
|-------------------------|-----------------------|
| <i>Stop Light (Red)</i> | <i>Ground (White)</i> |
| 12 Gauge | 10 Gauge |
| 12 Gauge | 10 Gauge |
| 10 Gauge | 8 Gauge |
| 10 Gauge | 8 Gauge |

Cable size gauge no. (Copper)	length of wire in feet	Maximum current carrying capacity with 0.5 volt drop	wire resistance ohms (Ω) per foot
20 Ga.	10 Ft.	4.74 Amps	0.01054 Ω /ft.
18 Ga.	10 Ft.	7.53 Amps	0.00663 Ω /ft.
16 Ga.	10 Ft.	11.98 Amps	0.00417 Ω /ft.
14 Ga.	10 Ft.	19.05 Amps	0.00262 Ω /ft.
12 Ga.	10 Ft.	30.30 Amps	0.00165 Ω /ft.
10 Ga.	10 Ft.	48.16 Amps	0.00103 Ω /ft.
8 Ga.	10 Ft.	76.59 Amps	0.00065 Ω /ft.

SAE J560 Standards Conductor Identification

	Wire Color	Lamp and Signal Circuits
Wht	White	Ground return to towing vehicle
Blk	*Black	Clearance, side marker & license plate lamps
Yel	Yellow	Left hand turn signal & hazard signal lamps
Red	Red	Stop lamps and antilock devices
Grn	Green	Right hand turn signal & hazard signal lamps
Brn	*Brown	Tail, clearance, side marker lamps & identification lamps
Blu	Blue	Auxiliary/ABS power

Note: This table gives you the resistance of wire per foot so with ohms law $V=I \times R$ you can calculate voltage drops on any of the above wire gauges at any current level and length. For example, voltage drop in 50 ft. 10 AWG wire with 20 amp load is $V=20 \text{ amp} \times (0.00103 \Omega / \text{ft.}) \times 50 \text{ ft.} = 1.03 \text{ volts}$. Be sure to include both the positive and negative leads when calculating total wire length.

*It is recommended to balance the circuits as practicable.

Voltage Drop/Foot/Ampere

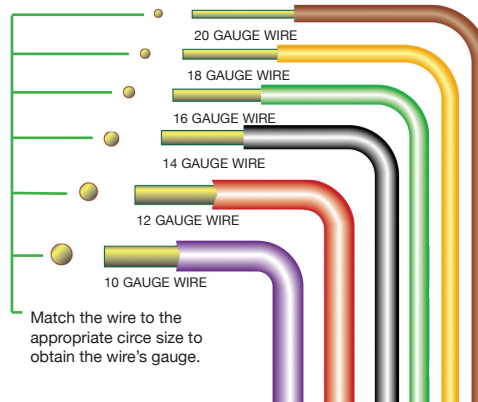
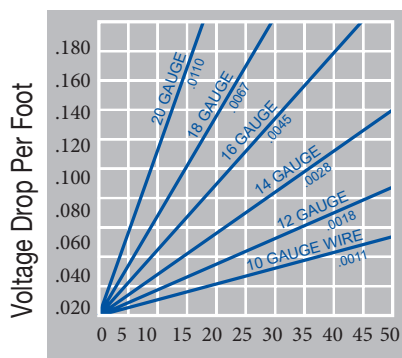

Wire Size

24 VOLT SYSTEM (AMPERES)	12 VOLT SYSTEM (AMPERES)	TOTAL FOOTAGE OF WIRE FROM POWER SOURCE TO THE MOST DISTANT ELECTRIC LAMP												
		10'	20'	30'	40'	50'	60'	70'	80'	90'	100'			
2.0	1.0	18	18	18	18	18	18	18	18	18	18	18	18	18
3.0	1.5	18	18	18	18	18	18	18	18	18	18	18	18	18
4.0	2.0	18	18	18	18	18	18	18	18	18	18	18	18	18
6.0	3.0	18	18	18	18	18	18	18	16	16	16	14	14	14
8.0	4.0	18	18	18	16	16	16	16	14	14	14	14	14	12
10.0	5.0	18	18	18	16	16	14	14	14	12	12	12	12	12
12.0	6.0	18	18	16	16	14	14	12	12	12	12	12	12	12
14.0	7.0	18	18	16	14	14	12	12	12	10	10	10	10	10
16.0	8.0	18	16	16	14	12	12	12	10	10	10	10	10	10
20.0	10.0	18	16	14	12	12	12	10	10	10	10	10	10	10
22.0	11.0	18	16	14	12	12	10	10	10	10	10	10	10	8
24.0	12.0	18	16	14	12	12	10	10	10	8	8	8	8	8
30.0	15.0	18	14	12	12	10	10	10	8	8	8	8	8	8
36.0	18.0	16	14	12	10	10	8	8	8	8	8	8	8	8
40.0	20.0	16	12	12	10	10	8	8	8	8	8	8	8	6

PLUGS

PLUG, FIT 'N FORGET S.S.

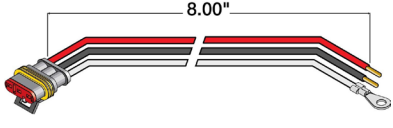
	Part Number	Plug Side 2	Wire Length	Number of Wires	Wire Type	Warranty
	94707	Stripped End,Ring Terminal	8in	3	GPT	Lifetime

PLUGS

PLUG, RIGHT ANGLE PL-3

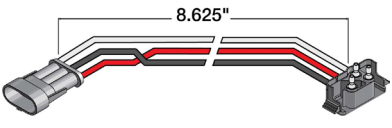
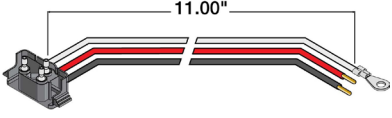
	Part Number	Plug Side 2	Wire Length	Number of Wires	Wire Type	Warranty
	94768	PL-3	8.63in	3	GPT	Lifetime
	94993	Stripped End Ring Terminal	11in	3	GPT	1-Year

PLUGS

PLUG, RIGHT ANGLE PL-2

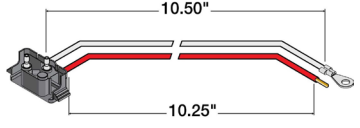
	Part Number	Plug Side 2	Wire Length	Number of Wires	Wire Type	Warranty
	94992	Stripped End,Ring Terminal	11in	2	GPT	1-Year

PLUGS

PLUG, STRAIGHT PL-3

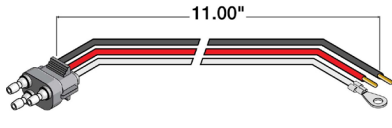
	Part Number	Plug Side 2	Wire Length	Number of Wires	Wire Type	Warranty
	94926	Stripped End,Ring Terminal	11in	3	GPT	1-Year

PLUG, FEMALE .180 BULLET

PLUGS

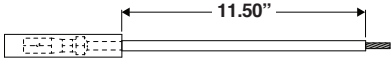
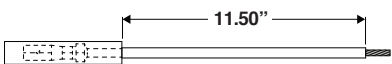
	Part Number	Plug Side 2	Wire Length	Number of Wires	Wire Type	Warranty	Wire Color
	95121	Stripped End	11.5in	1	SXL	1-Year	Black
	95122	Stripped End	11.5in	1	SXL	1-Year	White

PLUG, PL-10

PLUGS

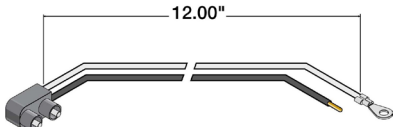
	Part Number	Plug Side 2	Wire Length	Number of Wires	Wire Type	Warranty
	94902	Stripped End, Ring Terminal	7in	2	GPT	1-Year
	94909	Stripped End, Ring Terminal	12in	2	GPT	1-Year

PLUG, RIGHT ANGLE PL-10

PLUGS

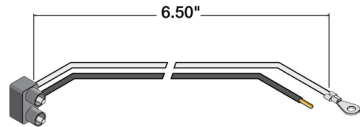
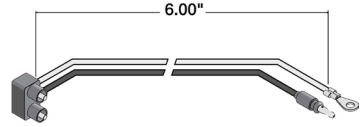
	Part Number	Plug Side 2	Wire Length	Number of Wires	Wire Type	Warranty
	94924	Stripped End, Ring Terminal	6.65in	2	GPT	1-Year
	94964	.156 Bullet, Ring Terminal	6in	2	GPT	1-Year

PLUG, SUPER 21 PLUG

PLUGS

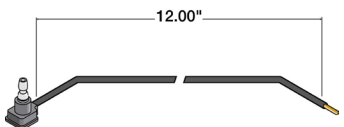
	Part Number	Plug Side 2	Wire Length	Number of Wires	Wire Type	Warranty
	96930	Stripped End	12in	1	GPT	1-Year

PLUGS

PLUG, FIT 'N FORGET M/C

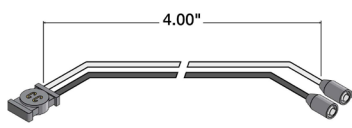
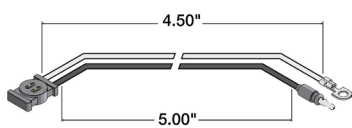
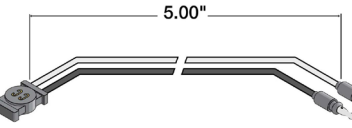
	Part Number	Plug Side 2	Wire Length	Number of Wires	Wire Type	Warranty
	93745	Female PL-10	4in	2	GPT	Lifetime
	94718	.180 Bullet Ring Terminal	5in	2	GPT	Lifetime
	97005	.180 Bullet	5in	2	GPT	Lifetime

SOCKET

194 BULB

SOCKET, 194 COMPATIBLE BULB

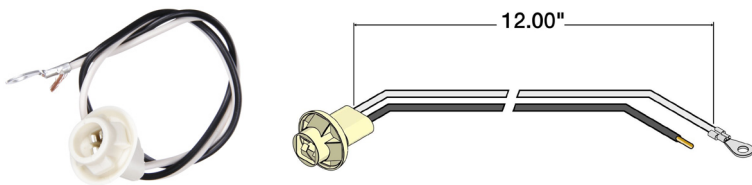

- For use with 18300R/Y and 25760 bulb replaceable lamps
- Bulb not included
- 18 gauge wires
- Available with black or white socket



Part Number	Plug Side 2	Length	Compatible Bulbs
94940	Stripped End / Ring Terminal	12in	194

JUNCTION BOXES

SUPER 50

SUPER 50, SURFACE MOUNT, ROUND, KIT



50400 - KIT 50800 50850

- 50400 - Contains 50800 junction box, 50816 junction box cap, 50820 terminal block, four 50830 filler plugs and mounting and assembly screws.



Part Number	Housing Color	Housing Material	Number of Ports	Terminal Connections	Kit Includes
50400	Gray	Plastic	8	8	50800 junction box, 50816 junction box cap, 50850 terminal block

50 SERIES, FILLER PLUG



- For use in 50 series junction box

Part Number	Housing Color
50830	Gray



FILLER PLUG

50 SERIES

50 SERIES, JAM NUT



- Use for installation of 3-part compression fittings in areas other than in the junction boxes
- 1-1/8" clearance hole required

Part Number	Housing Color
50845	Gray



JAM NUT

50 SERIES

2 CONDUCTOR, COMPRESSION FITTING, PVC, 0.375"



- 3-part fitting consisting of a pre-tapped cap, threaded base and black PVC grommet that is available with 6 different hole sizes to accommodate various conductor cables

Part Number	# of Cables Per Fitting	Material Color
50840	1	Gray



SUPER 50

4 TO 5 CONDUCTOR, COMPRESSION FITTING, PVC, 0.485"



- 3-part fitting consisting of a pre-tapped cap, threaded base and black PVC grommet that is available with 6 different hole sizes to accommodate various conductor cables

Part Number	# of Cables Per Fitting	Material Color
50841	1	Gray

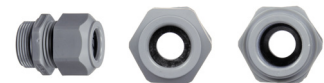

SUPER 50

6 TO 7 CONDUCTOR, COMPRESSION FITTING, PVC, 0.709"



- 3-part fitting consisting of a pre-tapped cap, threaded base and black PVC grommet that is available with 6 different hole sizes to accommodate various conductor cables

Part Number	# of Cables Per Fitting	Material Color
50842	1	Gray



SUPER 50

MIRRORS

category	pages
West Coast Mirrors	60
Convex Mirrors	61

6 IN X 16 IN

6" X 16" RECTANGULAR, WEST COAST

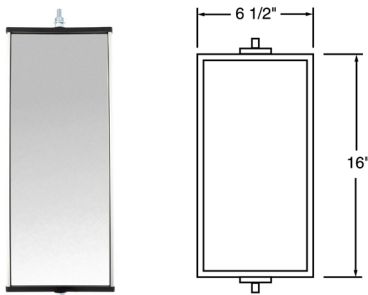

- Rod through construction
- Steel end caps for strength
- 5/16" stud diameter with center rod
- Durable, economical replacement heads
- Electrostatic-applied paint provides additional corrosion protection
- Full vinyl gasket insulated mirror glass



Part Number	Housing Color	Housing Material	Mounting Bracket
97628	White	Aluminum	West Coast Rigid Bracket
97627	Silver	Aluminum	West Coast Rigid Bracket
97629	Black	Aluminum	West Coast Rigid Bracket

SIGNAL-STAT, 2" ROUND, CONVEX



- Eliminates blind spots
- Adhesive back mirrors will mount on any clean flat surface
- Triples viewing area
- Black plastic housing
- Enhances viewing area for rectangular and square OEM side view mirrors



2 IN ROUND

Part Number	Housing Color	Housing Material	Type
7038	Black	Plastic	Convex

SIGNAL-STAT, 3" ROUND, CONVEX



- Eliminates blind spots
- Adhesive back mirrors will mount on any clean flat surface
- Triples viewing area
- Black plastic housing
- Enhances viewing area for rectangular and square OEM side view mirrors



3 IN ROUND

Part Number	Housing Color	Housing Material	Type
7039	Black	Plastic	Convex

7.5" ROUND, CONVEX

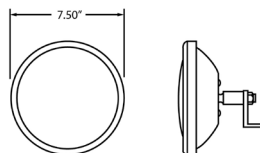

- Includes L-bracket
- Mounting: 5/16" female adjustable ball stud and bolt

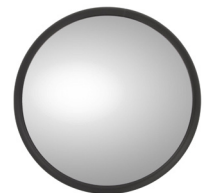

7.5 IN ROUND

Part Number	Housing Color	Housing Material	Mounting Bracket	Type
97817	Silver	Stainless Steel	L Bracket	Convex

8.5" ROUND, CONVEX

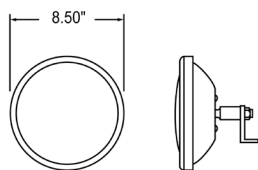

- Popular school bus convex head
- Center stud
- Includes L-bracket
- Mounting: 5/16" female adjustable ball stud and bolt



8.5 IN ROUND

Part Number	Housing Color	Housing Material	Mounting Bracket	Type
97803	Silver	Steel	L Bracket	Convex

REFLECTORS & REFLECTIVE TAPE

category	pages
Reflectors	62 - 65
ReflectiveTape	65

REFLECTORS

SIGNAL-STAT, ROUND, 2", ADHESIVE MOUNT, ACRYLIC

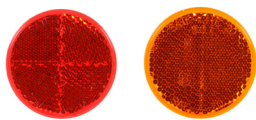

- Permanent adhesive backing
- Mounts on any clean flat surface
- Smaller diameter for applications where space is limited
- Replaces Truck-Lite 98008 series

Part Number	Reflector Color
45	Red
45A	Yellow



REFLECTORS

SIGNAL-STAT, ROUND, 2", 1 SCREW, NAIL, RIVET, ACRYLIC



- Fast, permanent installation with nail, screw or rivet
- Designed to take extra force in center
- Use one #10 screw- 1/4" hole

Part Number	Reflector Color
52	Red
52A	Yellow



SIGNAL-STAT, ROUND, 3", ADHESIVE MOUNT, ACRYLIC



Part Number	Reflector Color	
47	Red	
47A	Yellow	
47DB	Red	
47ADB	Yellow	

- Permanent adhesive backing
- Mounts on any clean flat surface



REFLECTORS

ROUND, 3", ADHESIVE MOUNT, TAPE



Part Number	Reflector Color	
98175RB	Red	Basket
98175R	Red	
98175YB	Yellow	Basket
98175Y	Yellow	

- Economical, reduced labor costs, no time installing screw-on reflectors, molded reflectors
- Easy to apply – simply bend, peel and apply
- No drilling or mechanical fasteners needed
- Meets and exceeds DOT and SAE requirements
- Application temperature range 40 degrees to 100 degrees Fahrenheit

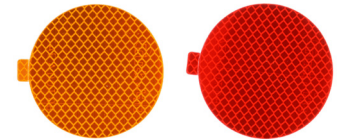

REFLECTORS

ROUND, 3", 1 SCREW, NAIL, RIVET, ACRYLIC



Part Number	Reflector Color	
98006C	Clear	
98006R	Red	
98006Y	Yellow	

- Fast, permanent installation with nail, screw or rivet
- Designed to take extra force in center
- Use one #10 screw

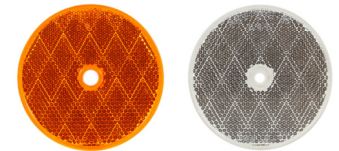

REFLECTORS

RECTANGLE, 1"X 4", 2 SCREW, ADHESIVE MOUNT, ACRYLIC



Part Number	Reflector Color	
98003R	Red	
98003Y	Yellow	
98003RB	Red	Basket
98003YB	Yellow	Basket

- Features acrylic lens
- Mounts with adhesive backing or screws

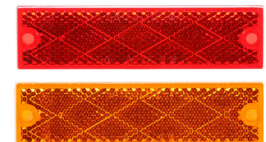

REFLECTORS

RECTANGLE, 2 SCREW, ADHESIVE MOUNT, ACRYLIC

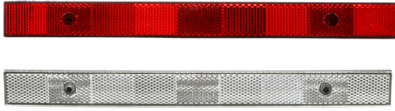

Part Number	Reflector Color	Size
98153	Clear	1in x 12in
98154R	Red	1in x 12in
98155	Clear	1in x 11in



- Meets requirements of final NHTSA ruling - see Federal Regulations Charts for details
- Ideal for use in areas where mounting clearance is limited
- Adhesive backing or screw-on mounting
- Hermetically sealed construction
- 11" version has optics for vertical mounting

RECTANGLE, 2"X 3.5", ADHESIVE MOUNT, TAPE

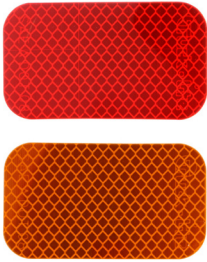

- Easy to apply—simply bend, peel and apply
- No drilling or mechanical fasteners needed
- Economical, reduced labor costs, no time installing screw-on reflectors
- Meets and exceeds DOT and SAE requirements
- Application temperature range 40 degrees to 100° Fahrenheit

Part Number	Reflector Color
98176RB	Red
98176R	Red
98176YB	Yellow
98176Y	Yellow

60 SERIES, OVAL, 2"X 6", 2 SCREW, POLYCARBONATE



- Reflector cap best utilized in conjunction with the S/T/T & BU lamps to economically transform a four-lamp system into a two-lamp system by fitting into existing mounting hole

Part Number	Reflector Color	Mount/Trim Color
60558R	Red	Black



NEW

SIGNAL-STAT, OVAL, 2"X 4", 2 SCREW, ADHESIVE MOUNT, ACRYLIC

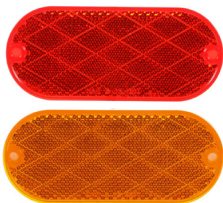

- Can be used as stick-on by peeling off back paper

Part Number	Reflector Color
54	Red
54A	Yellow



OVAL, 2"X 4", 2 SCREW, ADHESIVE MOUNT, ACRYLIC



Part Number	Reflector Color
98001R	Red
98001Y	Yellow

- Actual size: 1.93"x4.43"
- Acrylic or polycarbonate reflector with adhesive backing

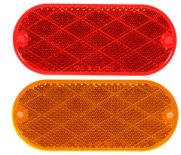

REFLECTORS

PREMIUM REFLECTIVE MARKING TAPE



Part Number	Reflector Color	Size
98100	White	2"x150'
98101	Red White	2"x150'
98102	Red White	3"x150'
98104	Red White	2"x18"
98105	White	2"x12"
98107	Red White	1.5"x150'
98108	Red White	2"x54"
98113	Red White	2"x2'

- Premium grade, durable and rigid non-corroding conspicuity marking tape resistant to weather, dirt, aging and cracking
- Tough, durable film prevents lifting to look like new, with aggressive adhesion to last long after application
- Typically 1,000 candle power (white) for maximum long side detection distance performance, exceeding minimum requirements by four times
- Vivid, bright white color assures maximum reflectivity and superior daytime color, blending nicely with trailer skin
- Impact resistant, withstanding a blow from a forklift or loading dock and still retro-reflects
- Exceeds NHTSA and FHWA specifications
- Reflects light at all application angles on the roadway
- Quick application with an easy-release liner



REFLECTIVE TAPE

PREMIUM

SIGNAL-STAT ECONOMY REFLECTIVE MARKING TAPE



Part Number	Reflector Color	Size
37	Red White	2"x150'

- Tough, durable films resists cracking and lifting to look like new, long after application
- .010 thin tape with no open cell construction
- Impact-resistant, withstanding a blow from a forklift or loading dock and still retro-reflects
- Exceeds FHWA specifications, with DOT-C2 marking
- Reflects light at all application angles on the roadway



REFLECTIVE TAPE

CELEBRATING 65 YEARS OF INNOVATION AROUND THE WORLD.





MAINTENANCE

category	pages
Anti-corrosion Compounds	66 - 67
Accessories	67

NYK-77, CORROSION PREVENTATIVE COMPOUND

- Corrosion preventive compound for electrical contacts, switches and junction boxes
- For periodic use with all electrical contact not using Fit 'N Forget connectors
- Available in a variety of sizes



Part Number	Container Type	Container Volume	
97940	Can	8 oz	
97944	Tube	2 oz	
98013	Tube	5 oz	



MULTI-PURPOSE MAINTENANCE SPRAY



- Quickly loosens frozen or seized parts
- Invades hard-to-reach crevices and creeps through the tightest seams
- Displaces moisture
- Corrosion Control: Forms a protective thin film barrier to stop oxidation and prevent rust from spreading
- Dissolves corrosion oxide - stops rust on contact
- Maintains lubricity under high loads for superior reduction of friction, heat and noise
- Prevents and removes corrosion build-up
- High dielectric insulation against electrolysis
- Extreme pressure lubricant
- For use on connectors including ABS, 4-13 way plugs and sockets, battery terminals and more
- Use on fifth wheel springs and rails, glad hands, control linkages, roll-up doors, hinges and latches, chains and pulleys and more



MAINTENANCE SPRAY

Part Number	Container Type	Container Volume
97946	Can	14 oz

DOCUMENT POUCH



- Secures documents with zipper



Part Number
50



POUCH

DOCUMENT HOLDER



Part Number
97960

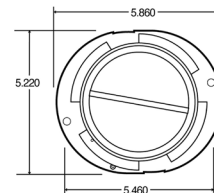
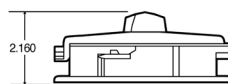

DOCUMENT HOLDER

ELECTRICAL HARNESS SERVICE CRIMPER, KIT



- Easy handling
- Suitable for different contacts and cross sections
- Precise radial closing motion/guide tracking ensures a high-quality application
- Interchangeable crimp dies: easy and accurate exchange and positioning of the crimp die sets
- Releasable ratchet ensures a complete crimp process



Part Number	Materials
97851	Heat-treated, high-tempered steel

ELECTRICAL HARNESS SERVICE TOOL

NEW

BACK-UP ALARMS

category	pages
Bracket Mount	68 - 69

2 SCREW BRACKET MOUNT, SINGLE MULTI-FREQUENCY

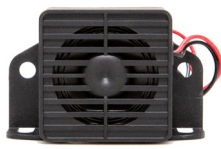

92932



92933

- Uses multi-frequency, narrow-band technology
- Unique sound is perceived to dissipate quickly
- Encapsulated electronics extend product life - sealed in epoxy to protect against dust, moisture and vibration
- “Narrow-band” technology
- Meets J994 Type C requirement
- Operates by emitting sound at multiple frequencies about 4,000Hz so sound dissipates more quickly than pure-tone alarm
- Compact size and universal mounting bracket maximizes location options



Part Number	DB Level Min	Housing Material	Connection	Volts	Steam Cleanable	Standards Met	Steam Cleanable
• 92932	87	Glass Nylon	Stripped End	12 24	Yes	J994	Yes
• 92933	97	Glass Nylon	Stripped End	12 24	Yes	J994	Yes

BRACKET MOUNT, SELF ADJUSTING MULTI-FREQUENCY



- Uses multi-frequency, narrow-band technology
- Unique sound is perceived to dissipate quickly
- Encapsulated electronics extend product life - sealed in epoxy to protect against dust, moisture and vibration
- “Narrow-band” technology
- Meets J994 Type C requirement
- Operates by emitting sound at multiple frequencies about 4,000Hz so sound dissipates more quickly than pure-tone alarm



BACK-UP ALARM

NEW

Part Number	DB Level Min	Housing Material	Connection	Volts	Steam Cleanable	Standards Met	Steam Cleanable
• 92934	107	Glass Nylon	Stripped End	12 24	Yes	J994	Yes

CUT THROUGH NOISE POLLUTION



A SAFE ALTERNATIVE TO PURE-TONE ALARMS

Maintains a safe warning signal for those in the danger zone of backing vehicles.



D-Series, SAE Fog Light Kit | pg. 41

LED Fog Light Kits for Class 8 Vehicles

- Freightliner Cascadia*
- Volvo VN
- International ProStar
- Kenworth T680



* Freightliner Cascadia shown above & below in comparison shot.

RIGID



D.O.T.





LET US BREAK THE ICE

New Heated 5 X 7 Inch Headlight | pg. 40



Learn more about electrical parts on our website.