

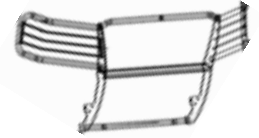

Grille Guard

Part No. E0018S/B



Fits: 2006 - 2015

Toyota Rav4



60-180 min

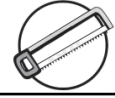

Cutting Required



Drilling Not Required



REMOVE CONTENTS FROM BOX. VERIFY ALL PARTS ARE PRESENT.



READ INSTRUCTIONS CAREFULLY BEFORE STARTING INSTALLATION.

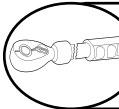

DO NOT OVER TORQUE. STANDARD OPERATING LOAD FOR TIGHTEN BODY MOUNT NUTS & BOLTS VARIES FROM 45 TO 65 FOOT POUND.

PARTS LIST:

Qty	Part Description	Qty	Part Description
1	Grille Guard	12	12mm x 32mm OD x 3mm Flat Washers
1	Driver/Left Frame Mounting Bracket	6	12mm Lock Washers
1	Passenger/Right Frame Mounting Bracket	6	12mm Hex Nuts
2	Bent Top Support Brackets (06-12 only)	2	6-1.0mm x 30mm Hex Bolts
1	Driver/Left Flat Top Support Bracket (2013 only)	2	6-1.0mm x 25mm Button Head Screws
1	Passenger/Right Flat Top Support Bracket (2013 only)	2	6mm x 22mm OD x 2mm STD Flat Washers
2	6mm Nut Plates	2	6mm x 12mm OD x 1.6mm Small Flat Washers
6	12-1.75mm x 35mm Hex Bolts	4	6mm Lock Washers

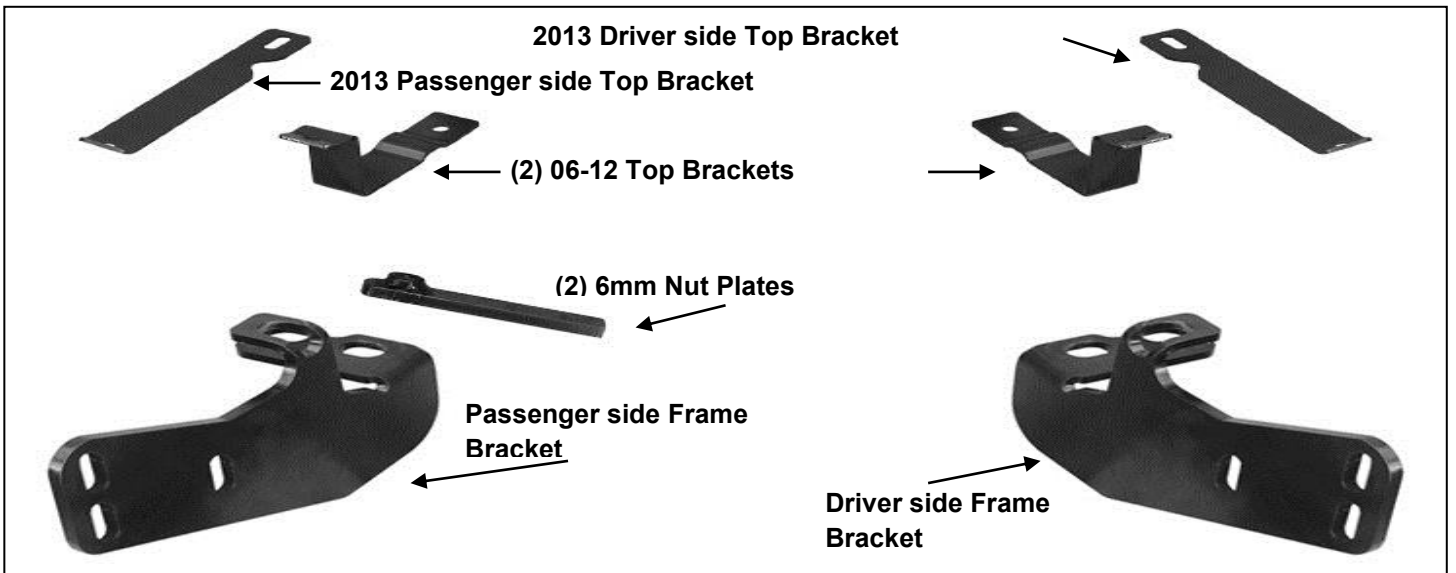

INSTALLATION PROCEDURE:

- Starting under the front of the vehicle, remove the plastic splash guard and place it on a clean, stable work area. **IMPORTANT:** Pay close attention to the location of all of the two-piece plastic clips and screws to make reinstallation easier. Use a small flat blade screwdriver to gently pry up the plastic center pin to release the clips and remove the center pin and the plastic housing.
- Locate the (4) factory hex bolts securing each end of the crossmember to the frame, (Figure 1). **NOTE:** Only install one Mounting Bracket at a time and only remove the (3) factory hex bolts required for Bracket installation, (Figure 1). Select the driver side Frame Mounting Bracket, (Figure 2A). Bolt the Bracket in position using the factory hex bolts, (Figure 2B). Snug the hardware but do not tighten at this time. Repeat this **Step** for the passenger side Mounting Bracket installation.

3. Open the front hood. Select the correct procedure for model year.

06 – 12 Models:

Move to the top of the grille and remove the plastic panel covering the opening between the grille and the radiator, **(Figure 3)**. **NOTE:** See **Figure 4A & 4B** to determine the correct procedure to release the retaining clips on the plastic panel.

2006 – 08 Models: Use a small flat blade screwdriver to gently pry up the center pin to release, **(Figure 4A)**.

2009 – 12 Models: Press the center button down to release, **(Figure 4B)**.

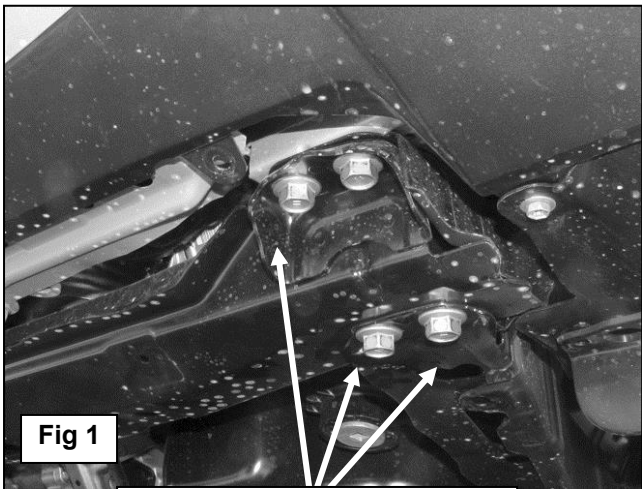

Fig 1

Remove (3) factory hex bolts



Fig 2A



(Fig 2B) Driver/left side Frame Mounting Bracket pictured

06 – 12: Remove the plastic cover

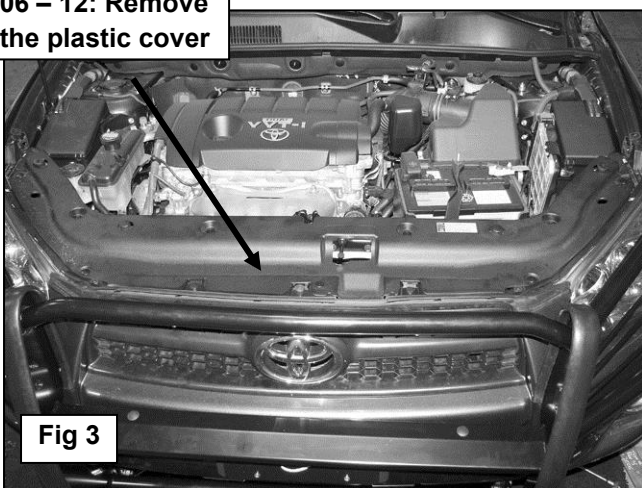

Fig 3

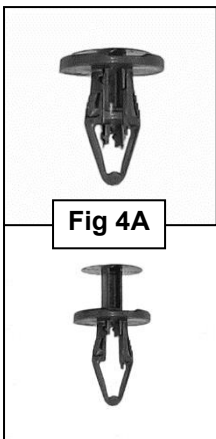

Fig 4A

For pop-up style clips: Use a small flat bladed screwdriver to gently pry up the center pin to release clip.

Reset center pin to reinstall

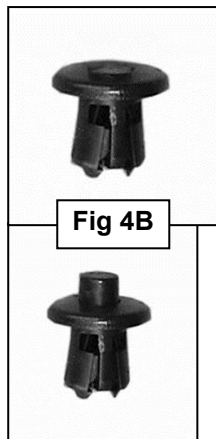

Fig 4B

For push button style clips: Use a small flat bladed screwdriver to gently push the center pin down to release clip.

Reset center pin to reinstall

Pictured for example only, actual clips may vary

Remove the plastic clip attaching the grille to the steel crossmember. Select (1) Bent Top Support Bracket, (**Figure 5A**). Cover any surface on the Bracket with removable tape, (masking tape for example), that may contact the vehicle to protect the finish.

Slide the Top Support Bracket under the rubber hood seal, (**Figure 5C**). Line up the hole in the Bracket with the hole in the grille crossmember. Insert (1) 6mm Nut Plate, (**Figure 5B**), down and into the opening behind the grille and hold it up against the underside of the steel crossmember, (**Figure 5C**).

Line up the threaded hole in the Nut Plate with the hole in the Support Bracket. Bolt the Bracket to the Nut Plate with (1) 6mm x 25mm Hex Bolt, (1) 6mm Lock Washer and (1) 6mm x 22mm OD x 2mm STD Flat Washer, (**Figure 6**). Repeat this Step for the passenger side Top Support Bracket installation.

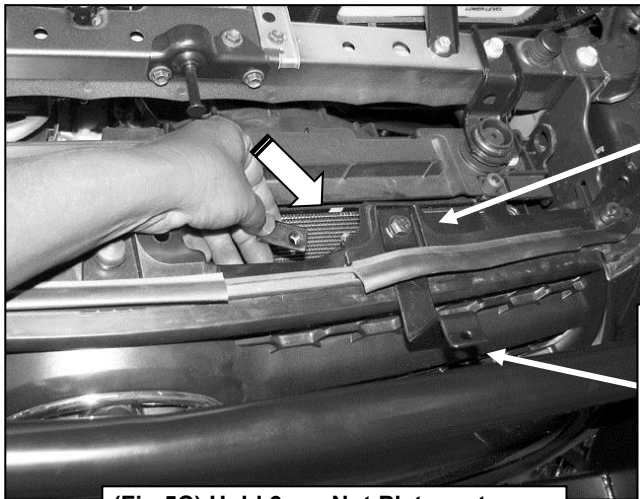

(Fig 5C) Hold 6mm Nut Plate up to underside of metal crossmember. Bolt Top Bracket to Nut Plate

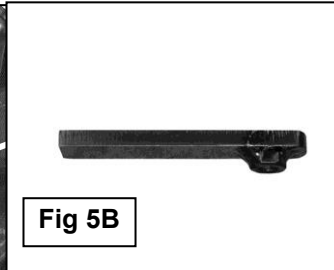

Fig 5B

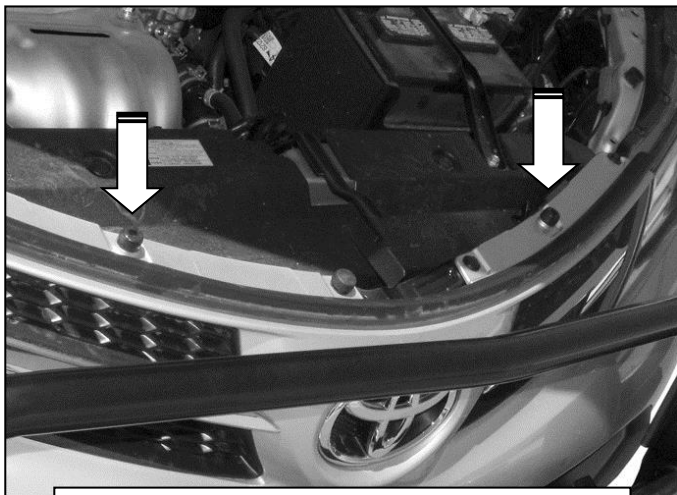

Fig 5A

6mm x 25mm Hex Bolt
6mm Lock Washer
6mm x 22mm OD x 2mm
STD Flat Washer



(Fig 6) 06 - 12 Models: Use the Bent Support Bracket



(Fig 7) 2013- Remove (2) rubber bumpers

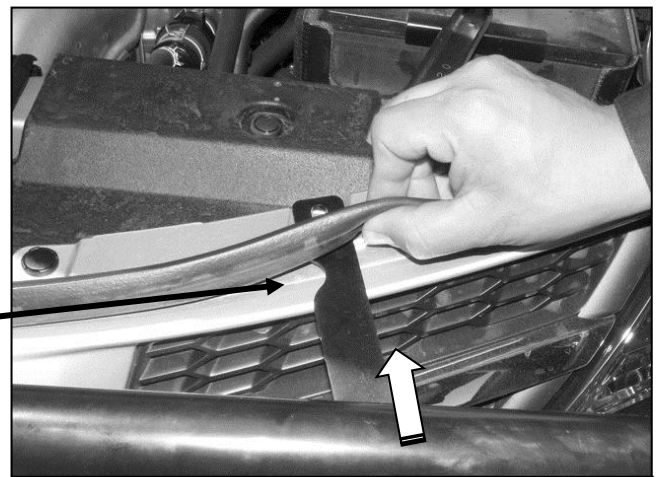

(Fig 8B) 2013 Models: Use the Flat Top Bracket



2013 Models:

Remove the screw-on rubber bumper from the top of the grille on the driver side, **(Figure 7)**. Select the driver side Flat Top Support Bracket, **(Figure 8A)**. Cover any surface on the Bracket with removable tape, (masking tape for example), that may contact the vehicle to protect the finish. Slide the Top Support Bracket under the rubber hood seal and line up the hole in the Bracket with the threaded hole in the top of the grille, **(Figure 8B)**.

Bolt the Top Bracket to the top of the grille with (1) 6mm x 25mm Hex Bolt, (1) 6mm Lock Washer and (1) 6mm x 22mm OD x 2mm STD Flat Washer, **(Figure 9)**. Repeat this Step for the passenger side Top Support Bracket installation.

4. With assistance, place the Grille Guard face down on a clean surface in front of the vehicle, **(Figure 10)**. **NOTE:** Use the packing materials to protect the finish on the Grille Guard. Slide the Grille Guard up to the outside of the Frame Mounting Brackets. Attach the Grille Guard to the rear holes in the Frame Mounting Brackets with (2) 12mm x 35mm Hex Bolts, (4) 12mm Flat Washers, (2) 12mm Lock Washers and (2) 12mm Hex Nuts, **(Figure 10)**. Tilt the Grille Guard up and into position. Insert the remaining (4) 12mm x 35mm Hex Bolts, (8) 12mm Flat Washers, (4) 12mm Lock Washers and (4) 12mm Hex Nuts into the Grille Guard and Frame Mounting Brackets. Snug hardware but do not fully tighten at this time.
5. Next, push the Grille Guard into position to meet the Top Support Brackets. Secure the Grille Guard to the Top Support Brackets with (2) 6mm x 25mm Button Head Screws, (2) 6mm x 12mm Small Flat Washers and (2) 6mm Lock Washers. **(Figure 11)**.
6. Level and adjust the Grille Guard and tighten all Frame Bracket to chassis hardware only. Temporarily remove the Grille Guard. Hold the plastic splash guard up into position against the Frame Brackets. Mark the location of the Brackets onto the cover. Carefully cut the splash guard only enough to clear the Frame Brackets, **(Figure 12)**. Do not cut completely through the front edge of the cover. Do not cut off any mounting locations from the cover. To maintain strength, cut only material that is required to clear the Frame Mounting Brackets. Once cut and trimmed for clearance, slide the splash guard over the Brackets but do not reinstall.
7. Reinstall the Grille Guard as described in **Steps 4 – 6**. Adjust and fully tighten all hardware. Reattach the lower splash guard using the factory hardware.
8. Slowly close the hood to check for clearance between the Grille Guard, Top Support Brackets and the hood. Align and adjust as required to completely close the hood. **NOTE:** It may be necessary to remove the Top Support Brackets and adjust the bends to fit properly. Once completely adjusted, tighten all hardware at this time.
06 – 12 only: Once the hood and/or Brackets are properly adjusted, reinstall the plastic panel between the grille and the radiator using the factory hardware, **(Figure 3)**.
9. Do periodic inspections to the installation to make sure that all hardware is secure and tight.

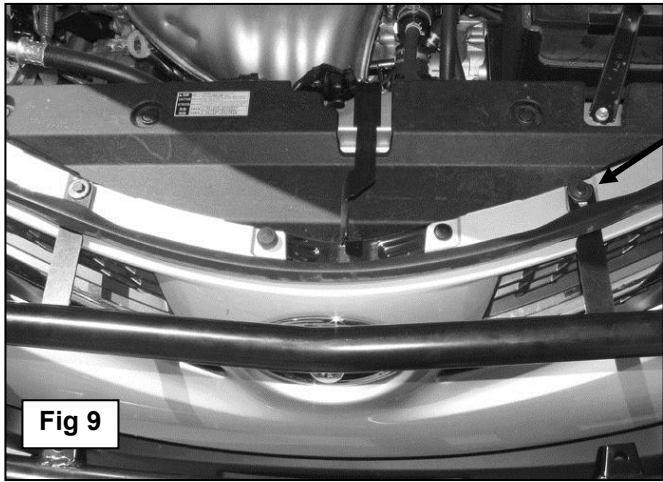

Fig 9

6mm x 25mm Hex Bolt
 6mm Lock Washer
 6mm x 22mm OD x 2mm
 STD Flat Washer

(1) 12mm x 35mm Hex Bolt
 (2) 12mm Flat Washers
 (1) 12mm Lock Washer
 (1) 12mm Hex Nut

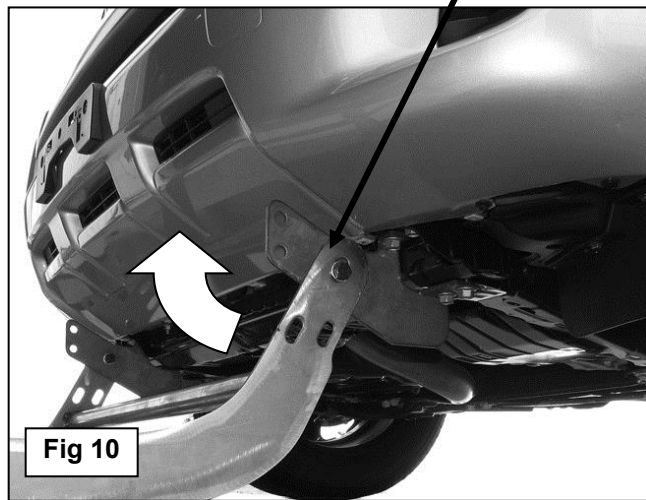
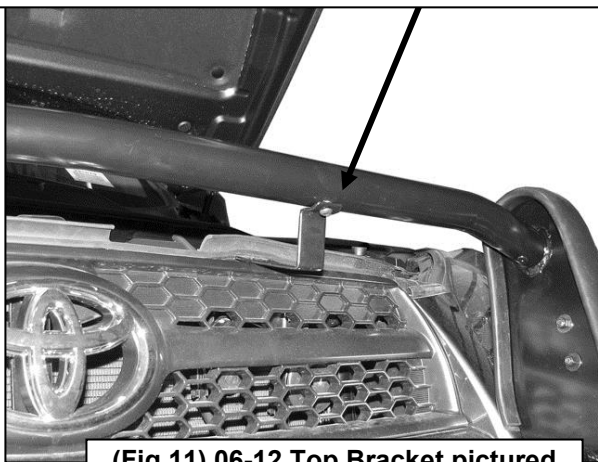

Fig 10

Once secured, tilt Grille Guard up into position

6mm x 25mm Button Head Screw
 6mm x 12mm OD x 1.6mm Small Flat Washer
 6mm Lock Washer



(Fig 11) 06-12 Top Bracket pictured

Driver Side Ins

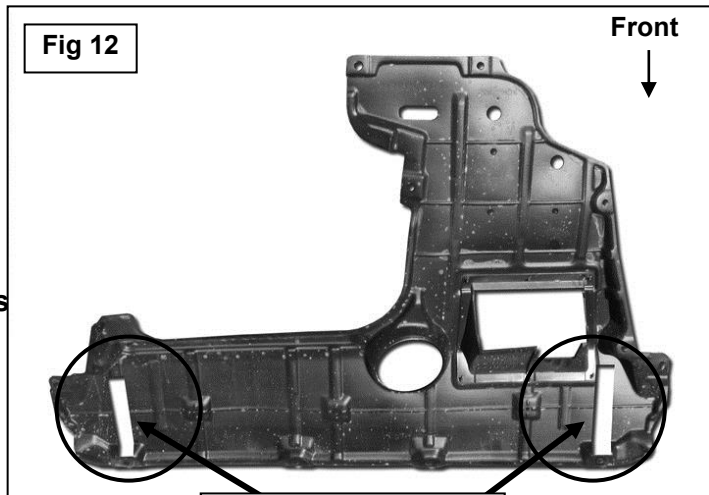

Fig 12

Cut out these areas

Figure 12 illustration is for example only.
 To maintain the strength of the splash guard, only trim away enough material to clear the Mounting Brackets



Complete installation