

# **ADDING FUN AND FUNCTION TO EVERY ADVENTURE**



**2022 PRODUCT CATALOG**



**STROMBERG CARLSON  
PRODUCTS INC.**



# IT PAYS TO BE STROMBERG STRONG.

At Stromberg Carlson, we're celebrating over 60 years of delivering what your customers demand most. Namely, confidence, convenience, durability and value that lasts a long way down the road.

Since 1959, when our grandfather David Stromberg started the business, we've remained committed to a level of quality and innovation that has made us one of the most trusted names in the industry. Which means when you work with us, we're behind you and your business for the long haul.

## ARE YOU STROMBERG STRONG?



# GET A GRIP.

# STROMBERG RAILS



Standard



Mini



## Lend-A-Hand



- Folds in either direction
- Aluminum rail to resist rust
- Foam grip for easier handling
- Made in the USA

- AM-200\* White Finish
- AM-300\* Silver Sparkle Finish
- AM-800\* Black Finish
- AM-250\* White Finish (Mini)
- AM-255\* Black Finish (Mini)
- FP-1001-R\* Original Foam Grip
- FP-1002-R\* Replacement Grip Wrap



## Rail Mate



- Maximum support for safe entry/exit
- Easily removable
- Stores during travel
- Lightweight, easy to install
- Large, 38" handle easy to reach and use
- Rail extends 25" from coach for added safety
- Designed for double, triple, quad entry manual steps
- Made in the USA

AP-101\* Rail Mate



New adjustable bracket



## Soft Touch



- Easy-to-grab, soft-touch handle
- Greater convenience/safety than strap
- Made in the USA

- AH-100\* White Handle
- AH-150\* Black Handle

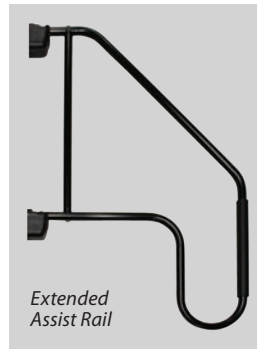

Extended Assist Rail

## Lend-A-Hand Extended Assist Rail



- Designed with same footprint as standard Lend-A-Hand
- Extends additional 10" out and 13.5" down for better user balance
- Self stores outside coach for ready use
- Made in the USA

AM-533\* Black Finish

**WARNING:** Cancer and Reproductive Harm

# LOCKING COMMERCIAL RAILS

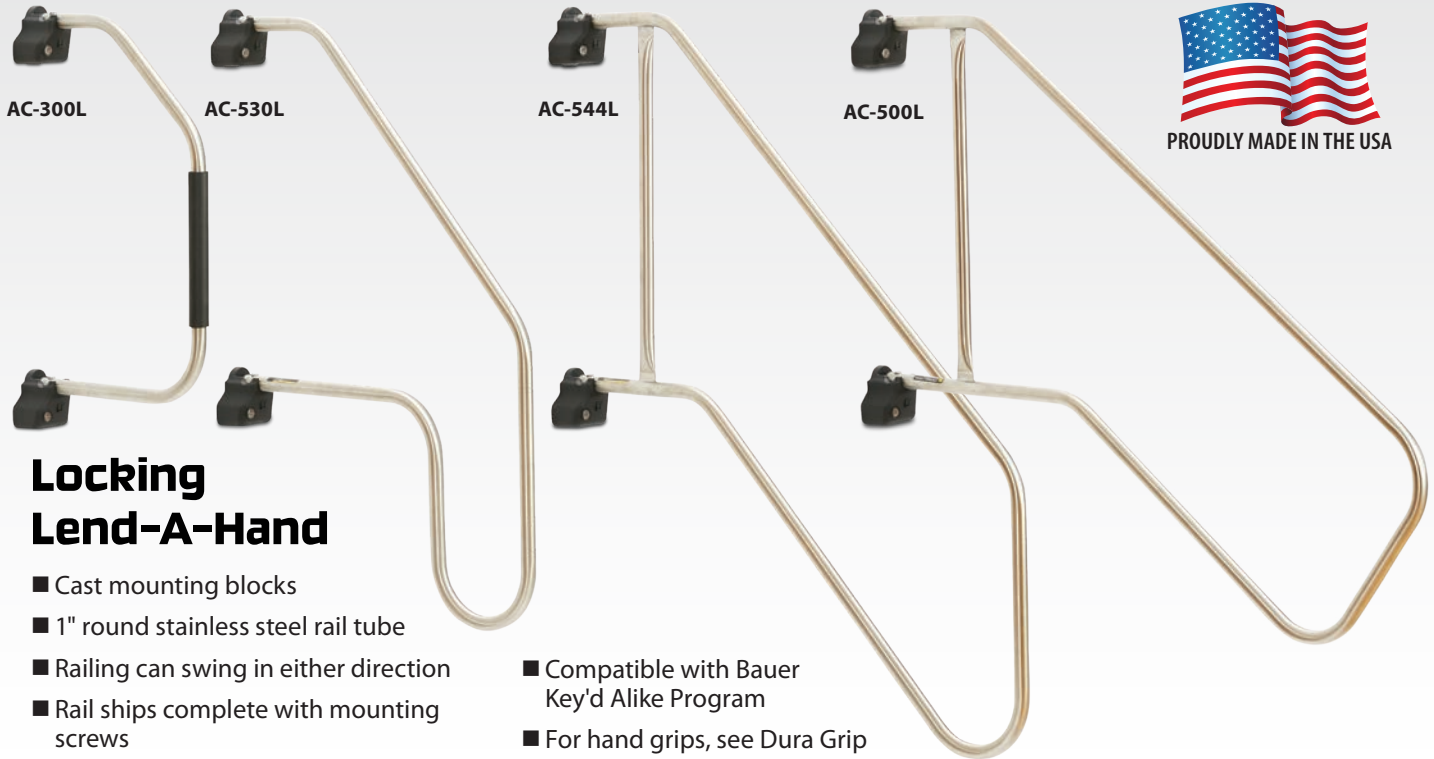

## Locking Lend-A-Hand

- Cast mounting blocks
- 1" round stainless steel rail tube
- Railing can swing in either direction
- Rail ships complete with mounting screws
- Backer plate kit available AM-030L (hardware for one complete rail)
- AC-300L and AC-530L have the same footprint as standard and extended Lend-A-Hand rails

- Compatible with Bauer Key'd Alike Program
- For hand grips, see Dura Grip and Zip Grip
- Made in the USA

AC-300L\*    AC-544L\*  
AC-530L\*    AC-500L\*

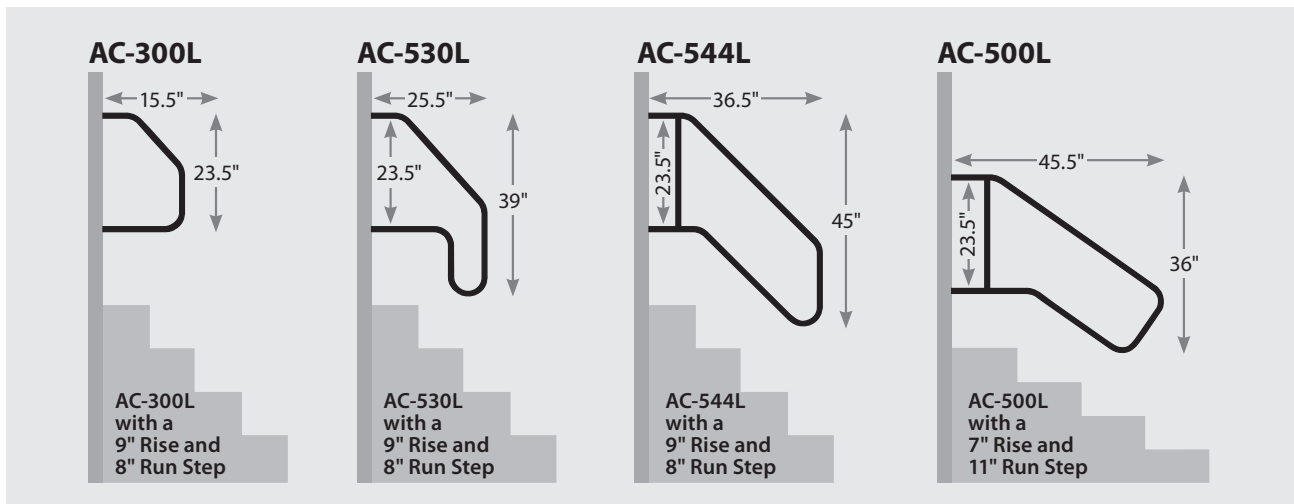

**WARNING:** Cancer and Reproductive Harm

\*While none of our products directly represent a risk of cancer or birth defect, many fasteners and finishes could if oral contact occurs.

# HAND RAIL GRIPS



AM-ZIP39C\* Charcoal  
 AM-ZIP39B\* Blue  
 AM-ZIP39T\* Tan  
*Fits AM-200, 300 & 800,  
 AC-300L, 39" long*

AM-ZIP2239C\* Charcoal  
 AM-ZIP2239B\* Blue  
 AM-ZIP2239T\* Tan  
*Fits AM-533, AC-500L,  
 AC-530L, AC-544L,  
 two pc., 39" long & 22" long*

AM-ZIP22C\* Charcoal  
 AM-ZIP22B\* Blue  
 AM-ZIP22T\* Tan  
*Fits AM-250 & 255, 22" long*

## Zip Grip

- Keep your hand comfortable and cool with our colorful Zip Grip.
- Made of UV resistant neoprene with a rubber backing material
- 3 colors available, Charcoal, Blue, and Tan to match your coach
- Nylon zipper has a 2 year warranty
- Pockets available for zip ties to secure it to your handle

## Other Replacement Hand Rail Grips

- FP-1001-R\* Original Foam Grip
- FP-1002-R\* Replacement Grip Wrap



## Dura Grip



- Easy snap and lock installation
- Soft rubber grip for comfort
- Durable and rot resistant
- For 1" D rails
- 2 year warranty
- Made in the USA

AM-01\* Dura Grip

 **WARNING:** Cancer and Reproductive Harm

# Base Pad Extreme

For a lifetime of use



- Improves stability of your parked and leveled RV
- 6000 lb capacity, 3500 lb when two are stacked
- Side panel finger hole for ease of carrying and retrieving
- Dimensions: 10" across top, 12" across bottom, 7" tall, or 12-3/8" stacked
- Can be used with 1" or 2" thick Base Pads on soft surfaces – like hot asphalt or sand

- Light weight polycarbonate materials – like bullet proof glass
- 1" shorter than other brands to be used in unlevel conditions at all six points
- No magnets
- Made in the USA

- JBP-712.1\* Single Pack
- JBP-712.2\* 2 Pack
- JBP-712.4\* 4 Pack
- JBP-712.6\* 6 Pack



## Trucker-Style Wheel Chock



- Tough enough to hold even large motor coach tires in place
- Molded EPDM rubber (not crumb rubber) will not split, shred, crack or break
- Resistant to UV, water, mold and corrosion
- Provides reliable support for your RV – on any surface
- Easy to clean and store
- Made in the USA



JBP-C256\* Single Pack

## Base Pads Available in 4 sizes



- Can be used on landing gear feet, scissor jack bases and tongue jacks
- Molded EPDM rubber (not crumb rubber) will not split, shred, crack or break
- Resistant to UV, water, mold and corrosion
- Provides reliable support for your RV – on any surface
- Easy to clean and store
- Interlock Base Pads to ramp up to level
- Made in the USA

- JBP-69.625\* (6"x9"x.625") 4 Pack
- JBP-1011.1\* (10"x11"x1") 2 Pack
- JBP-1214.1\* (12"x14"x1") 2 Pack
- JBP-1214.2\* (12"x14"x2") Single Pack

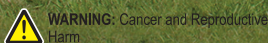

\*While none of our products directly represent a risk of cancer or birth defect, many fasteners and finishes could if oral contact occurs.

# STABILIZE AND LEVEL

## T-Chock FOR TANDEM AXLES



- Pressure against each tire and axle helps your vehicle stay put
- Fits tires spaced 2" to 17" apart
- Rust-resistant coating
- Handle included on all models



JBP-T217.1\*  
Single Pack

JBP-T217.2\*  
2 Pack

JBP-T217.W\*  
Replacement  
Wrench

## Base Pad Shoe Jack Pads that stay attached!



- Molded EPDM rubber (not crumb rubber)
- 9" Shoe fits Lippert's 4 and 6 point leveling systems
- 9" Shoe fits round footpads made by Lippert, Pac Rim or Venture
- 10" Shoe fits Equalizer Systems round and octagonal 4 and 6 point leveling systems
- Stays attached — no need to store
- Unique bottom increases ground stability — more surface area
- Protects footpads from rocks and roots
- Protects RV pad from rust stains
- Can support a 100,000 lb coach with 4 and 6 point leveling systems
- Ensures a maintenance free future when you add a fresh coat of paint to your footpads prior to installation
- Made in the USA

- |           |                |            |                 |
|-----------|----------------|------------|-----------------|
| JBP-S9.1* | 9" Single Pack | JBP-S10.1* | 10" Single Pack |
| JBP-S9.2* | 9" 2 Pack      | JBP-S10.2* | 10" 2 Pack      |
| JBP-S9.4* | 9" 4 Pack      | JBP-S10.3* | 10" 3 Pack      |
| JBP-S9.6* | 9" 6 Pack      | JBP-S10.4* | 10" 4 Pack      |



## Base Pad Peak



- Blocks your scissor or stab jacks
- Light weight polycarbonate material
- 4000 lb capacity
- 5" x 8" Stabilizer pad, 10-1/4" x 12-7/8" footprint, 8" tall or 14" stacked
- Made in the USA

- |            |             |
|------------|-------------|
| JBP-813.1* | Single Pack |
| JBP-813.2* | 2 Pack      |
| JBP-813.4* | 4 Pack      |
| JBP-813.5* | 5 Pack      |

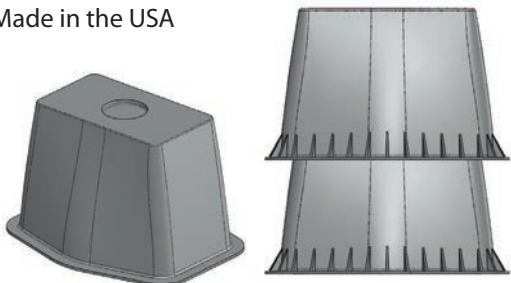

## Base Pad Leveler With Chock and Anti-Slip Mat



- Adds up to 4" lift
- Includes leveler, chock and anti-slip mat
- Light weight material — like bullet proof glass
- Curved edges for easier removal between wheels

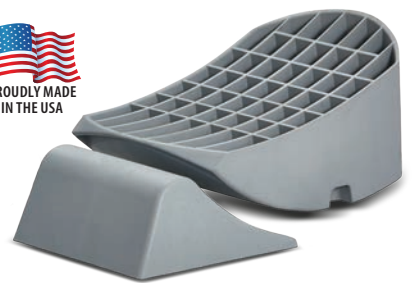

- Leveler dimensions: 11" long, 7" wide, 4-1/4" tall

- Made in the USA

JBP-C300\* Single Pack JBP-C302\* 2 Pack



# WE KNOW JACK. AND THEN SOME.

## ELECTRIC TONGUE JACKS



### Electric Tongue Jacks

- Available in 2500, 3500, 4500 and 5000 lb capacities
- Ball screw mechanism (4500 lb model)
- 18" travel
- 5" drop down foot (3500, 4500, 5000 lb models)

2500 Pound Capacity  
JET-2500\*

3500 Pound Capacity  
JET-3755\* Black  
JET-3555\* White

4500 Pound Capacity  
JET-4500\*

5000 Pound Capacity  
JET-5000\*

**FEATURES:**  
BALL SCREW TECHNOLOGY  
ON 4500 LB MODEL



### Electric Tongue Jack Cover

This cover keeps the weather off of and out of your electric tongue jack while you are parked or traveling. Fits all electric tongue jacks.



JET-01\*

**ALL BACKED BY A  
LIMITED TWO-YEAR WARRANTY**

### The Hitching Post

Keep your trailer connections clean for better performance.

- Plug cover keeps out water, mud and dirt
- Chains snap in easily
- Fits manual or electric jacks
- Mounts on 2" to 2-5/16" jack posts  
JET-30\*



### Scissor Jacks

- Keeps your coach level and stable
- Holds up to 5000 lb
- Bowtie base sits well on hard and soft surfaces

#### 24" SCISSOR JACK

JSC-24\*  
Pair of jacks & handle

JSC-24-IND\*  
Single jack only

*Expands from 4" to 24" in height*

#### 30" SCISSOR JACK

JSC-30\*  
Pair of jacks & handle

JSC-30-IND\*  
Single jack only

*Expands from 5" to 30" in height  
Identical bowtie hole pattern as 24" Scissor Jack*



**WARNING:** Cancer and Reproductive Harm

\*While none of our products directly represent a risk of cancer or birth defect, many fasteners and finishes could if oral contact occurs.



# 5TH WHEEL LANDING GEAR



## Electric Landing Gear

- LG-1\* 29-1/2" Leg, 5500 lb Motor
- LG-2\* 33-1/2" Leg, 5500 lb Motor
- LG-3\* 29-1/2" Leg, 6500 lb Motor
- LG-4\* 33-1/2" Leg, 6500 lb Motor

## Manual Landing Gear

- LG-183708\* 29-1/2" Leg



LG-179013\*  
29-1/2" Lead Leg  
Drop Leg and Pin

LG-179014\*  
29-1/2" Follow Leg  
Drop Leg and Pin

LG-177202\*  
33-1/2" Lead Leg  
Drop Leg and Pin

LG-177201\*  
33-1/2" Follow Leg  
Drop Leg and Pin

LG-146059\*  
Lead Leg Repair Kit  
Venture only

LG-146060\*  
Follow Leg Repair Kit  
Venture only

LG-142178\*  
Standard  
Motor  
5000 lb, 30A,  
80 RPM

LG-196308\*  
HS Motor  
5000 lb, 30A,  
150 RPM

LG-217884\*  
Standard  
Motor  
and IP  
Rated  
Switch\*\*

LG-242728\*  
HS Motor and IP  
Rated Switch

LG-145236\*  
IP Rated Switch

LG-179015\*  
Aluminum Gear Box

LG-119226\*  
Manual Crank Handle

LG-119225\*  
Foot and Pin  
(rectangle)

LG-XS\*  
1"x1" and 3/4" x 3/4"  
Telescoping Tubes

LG-Brackets\*  
Weld-on Brackets  
Set of 2

LG-5\*  
Dual Power  
Conversion Kit  
29-1/2" Leg  
5500 lb Motor

LG-6\*  
Dual Power  
Conversion Kit  
33-1/2" Leg  
5500 lb Motor

\*\* Replacement motors and landing gear legs are compatible/interchangeable with both Venture and Lippert landing gear

**WARNING:** Cancer and Reproductive Harm

# STEP RIGHT UP. SAFELY.

## STEPS AND STOOLS

### Platform Steps



### Die Cast Aluminum Step

- Platform size 19" x 14"
- Platform height 8-1/8"
- Can be used folded—height 3-1/8"
- Solid foot bottom won't cut rubber non-skid pad
- Step supports 1000 lb

PA-150\* Die Cast Aluminum Step

### Die Cast Adjustable Aluminum Step

- Platform size 19" x 14"
- Minimum height 7-3/16", maximum height 8-9/16"
- 3 different settings per leg
- Pull to adjust
- Solid foot bottom won't cut rubber non-skid pad
- Step supports 1000 lb

PA-275\* Die Cast Adjustable Aluminum Step

### Steel Step

- Adjusts to 4" and 8"
- Maximum load 300 lb
- Rubber anti-skid foot

S-150\* Steel Platform

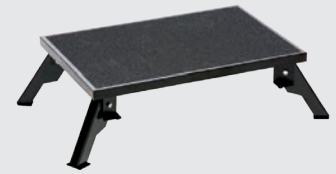

### Plastic Step



- Adjusts to 4" and 8"
- NOT pet friendly
- Maximum load 500 lb
- Rubber anti-skid foot
- Made in the USA

P-102\* Plastic Platform



### Econo Porch



- Interchangeable handrail for left or right hand usage
- 2 and 3 step models available
- Landing platform: 27" wide x 16" deep
- 27" wide x 9" deep steps
- 2 step platform height: 21" (with 7" rise)  
3 step platform height: 28" (with 7" rise)
- Porch supports 300 lb
- Made in the USA

EHS-102-R\*  
EHS-103-R\*

**WARNING:** Cancer and Reproductive Harm



EHS-103-R



EHS-102-R

\*While none of our products directly represent a risk of cancer or birth defect, many fasteners and finishes could if oral contact occurs.

# MANUAL RV STEPS

## Manual Steps by Flexco



- Replaces any step on the market
- "Low profile" single steps available
- Extremely sturdy
- Made in the USA



- SMFP-1100\* 24" W Single, 7-1/2" Rise
- SMFP-1120\* 20" Single, 7-1/2" Rise
- SMFP-1200\* 24" Single, 2-3/4" Rise
- SMFP-1220\* 20" Single, 2-3/4" Rise
- SMFP-2100\* 24" Double, 8" Rise
- SMFP-2120\* 20" Double, 8" Rise
- SMFP-3100\* 24" Triple, 8" Rise
- SMFP-3200L\* 24" Triple, 9-1/2" Rise
- SMFP-4400\* 24" Quad, 8" Rise

## Stabil-Step



- Eliminates sway for safe entry/exit
- Supports up to 750 lb

- JSS-4\* Adjusts 4-3/4" to 7-3/4"
- SS-7\* Adjusts 8" to 13-3/4"
- JSS-85\* Adjusts 8-1/2" to 15-1/2"

## Jack-In-A-Box

The surprise in this Jack-in-a-Box is that it stabilizes more than 10,000 lb **QUICKLY!**

- Two jacks per carton
- Used to stabilize slide outs
- Removable U-top fits most frames
- All parts are powder-coated or zinc-plated for corrosion resistance
- Adjusts between 20"- 46"
- Easy snap and lock adjustment
- Supports 5000 lb per jack
- Foldable handle for compact storage



## Tire Carriers



TR-1 Universal Rigid

TR-2 Universal Folding

The Stromberg Carlson universal tire carrier works great on travel trailers and fifth wheel travel trailers with no welds to break. The formed column is flanged and gusseted to reduce tire vibration. The folding carrier has a built in stop so the tire won't fall when tilted down, giving you access to rear storage.

- TR-1\* Universal Rigid
- TR-2\* Universal Folding



# MORE WAYS TO CARRY ON AND CLIMB ABOARD.

## RV LADDERS



### Universal Exterior RV Ladder

- Can go on the rear of any RV – straight or contoured
- Rugged construction
- 250 lb maximum

LA-401\* Exterior Ladder Silver  
LA-401BA\* Exterior Ladder Black

*Hinged feature for non-straight/contoured or flat rear walls*



### Starter Ladders

- 48" starter ladder
  - 250 lb maximum
- LA-148\* Starter Ladder Silver



### Bunk Ladder

- Provides small feet easier access to beds or larger feet easier access to stored materials
- Rubber tread covers to provide comfort
- Available in multiple lengths and colors
- 250 lb maximum

LA-460\* 60" Ladder Silver  
LA-466\* 66" Ladder Silver  
LA-460B\* 60" Ladder Black  
LA-466B\* 66" Ladder Black

### Roof Rail

- Universal roof rail adjusts to fit all RVs
- Seven roof stanchions included
- Bright anodized finish

LA-500\* Roof Rail Silver



### Ladder Chair Rack

- The strap and buckle secure your chairs as you travel
- No rattling
- Made from aluminum
- 50 lb maximum

LA-104\* Ladder Chair Rack

### Ladder Bike Rack

- No rattling
- Carries up to two bikes
- Made from aluminum
- 50 lb maximum

LA-102\* Ladder Bike Rack



 **WARNING:** Cancer and Reproductive Harm

\*While none of our products directly represent a risk of cancer or birth defect, many fasteners and finishes could if oral contact occurs.

## LADDER REPLACEMENT PARTS



### RV Bunk Ladder Replacement Parts

- 1. 2460-A\* Hooks for bunk ladders. Both styles in 1 bag
- 2. 8532-CP\* Rubber Feet for Bunk Ladders, 2 per bag
- 3. 8510-CP\* Rubber tread cover for Bunk Ladders, 1 per bag
- 4. 8539-CP\* Push in end cap



### Universal Exterior RV Ladder Replacement Parts

- 1. 8535\*  
8535-B\* (black) Aftermarket Standoff assembly  
5" long, rectangular base  
1 per bag (Stromberg, Top Line, Surco)
- 2. 8531\*  
8531-B\* (black) OEM Standoff assembly. Shipped 12" long,  
trim to length, Round base. 1 per bag  
(Christianson Industries, Atwood and others)
- 3. 8521-BK\* Roof Mounting Bracket for LA-401 and  
LA-401BA (black), 1 per bag
- 4. 8525-BK\* Swivel Castings for LA-401 and  
LA-401BA (black), 1 per bag
- 5. 8535-CP\* (black) U-shaped cradle and bolt for standoff



### Replacement Parts for all Stromberg Ladders

- FST-9975\* Standoff Nut only Used  
in the top of bunk ladders  
and in standoffs, 1 per bag
- 8540-NT\*  
8540-NTB\* (black) Replacement treads can be  
installed without disassembling  
ladder, 1 per bag
- 8540-CP\* Screw-in end cap only, 1 per bag

 **WARNING: Cancer and Reproductive Harm**

# WE THOUGHT OF ALMOST EVERYTHING.

## Extend-A-Shower

- Pivots into your shower stall when not needed
- Can be used to drip dry laundry over your shower basin

EXT-3542\*  
Fits tubs 35"- 42" wide, White Finish

EXT-3542S\*  
Fits tubs 35"- 42" wide, Satin Finish

EXT-5460C\*  
Fits tubs 54"- 60" wide, Chrome Finish

54"-60" available in limited finishes and quantities

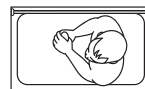

Current Shower

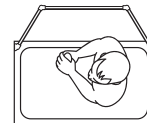

Extend-A-Shower

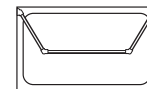

Stored Position

## The Hot Stick

- Non-conductive wooden handle stays cool to the touch and accommodates 2-handed grip
- Rust resistant stainless steel shaft
- 42" long poker to maintain safe distance from fire
- Hooked shaft end to maneuver firewood and stoke embers

FP-42\* The Hot Stick



## Stake & Grill

- Grill measures 15" wide x 22" long
- Stake measures 36" long
- Adjusts on stake to desired heat
- Upturned edges will keep hot dogs on the grill
- Rotates 360 degrees
- Chrome finish cleans easily
- Nylon bag included to keep neat and tidy

GR-1522\*

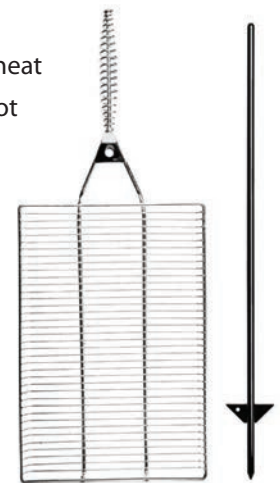

**WARNING:** Cancer and Reproductive Harm

\*While none of our products directly represent a risk of cancer or birth defect, many fasteners and finishes could if oral contact occurs.

# OUR EXTENDED PRODUCT LINE



## Extend-A-Line



- Six independent arms that can carry up to 60 lb of towels, suits and clothes on hangers
- Easily mounts to a 1" or 1-1/2" exterior ladder or can be wall, bumper or A-frame mounted if no ladder is available (with available additional accessories)
- Made in the USA

CL-12\* (12" usable line space)  
 CL-27\* (27" usable line space)  
 CL-36\* (39" usable line space)

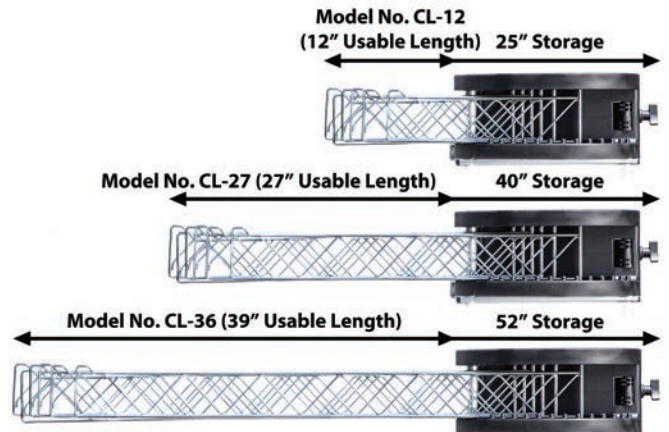

## Bumper Mounts

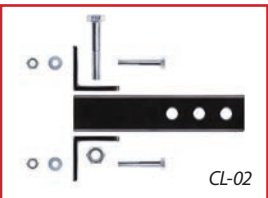

CL-02\* allows CL-01 to be used in a 2" hitch



CL-01\* attached on 4" square bumpers or 2" x 6" A frame

## Bumper Mount Clothes Line

- 48" long aluminum uprights
- Can be mounted up to 7' apart
- Strong and durable
- Can be removed for travel without tools

CL-100\*  
 Bumper Mounted Clothes Line



**WARNING:** Cancer and Reproductive Harm

# OKAY, WE DID THINK OF EVERYTHING.



## Trailer Tray

- Adjusts to fit most A-frame trailers
  - Positioned to provide softest ride
  - Supports up to 300 lb
- CC-255\* Trailer Tray



## RV Bumper Receiver

- Can be used with most hitch-mounted accessories
  - Fits up to 4-3/8" square bumpers
  - Provides 2" receiver opening
  - Supports up to 200 lb (Refer to bumper rating capacity)
  - Heavy steel construction and zinc-plated hardware
  - CANNOT be used for towing
- BA-100\* RV Bumper Receiver



## Bike Bunk

- Raised receiver on A-frame
- For bike racks with a 2" receiver
- Supports up to 100 lb

CC-275\* Bike Bunk

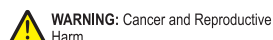

## Adjustable Accessory Hitch

- 2" Hitch for Travel Trailers and Fifth Wheels
- Bolts on as Class I or welds on as Class II hitch to frame
- Can mount to side wall of frame or horizontal wall of "C" channel or "I" Beam with angled hardware
- 77" maximum extension to flat wall frame, 80" maximum extension to horizontal surface of "C" channel or "I" Beam
- For use with bike racks, cargo carriers and other accessories
- Not to be used pulling cars or boats in Class 1 configuration

CC-300\* Adjustable Accessory Hitch

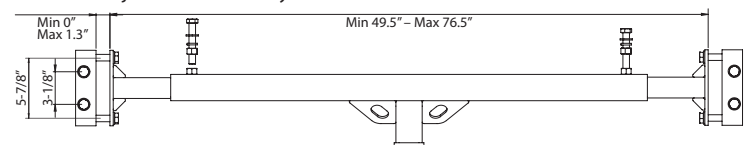

\*While none of our products directly represent a risk of cancer or birth defect, many fasteners and finishes could if oral contact occurs.



## CARGO PRODUCTS



### Hose/Cord Caddy



- 17" wide, 6-1/2" tall
  - Holds up to 75' of fresh water hose or 50' of 30 AMP cord
  - Stores hose accessories
  - Each hose end unwinds, bulk of hose remains in caddy
  - Made in the USA
- HC-75\* Hose Caddy



### Cargo Caddy

- Fits standard 2" receiver
- Inside dimensions 23.3" x 59.7"
- Supports up to 500 lb of evenly loaded cargo
- Powder coated to resist rust

CC-100\* Cargo Caddy

CC-125\* Cargo Caddy Bike Rack fits up to 2-1/4" tire

Hardware for 2 bikes included

 **WARNING:** Cancer and Reproductive Harm

# RACK & RIDE.

## BIKE CARRIERS



### NEW & IMPROVED

## Two Bike Carrier

- BC-202BA fits 4" and 4-1/2 square bumpers
- Tilts down for access to vehicle
- Wheel mounts adjust to any size frame
- Weight capacity 80 lb

BC-202BA\* Two Bike Carrier  
(Bumper Accessory Hitch included)

BC-2FT\* Fat Tire Adaptor

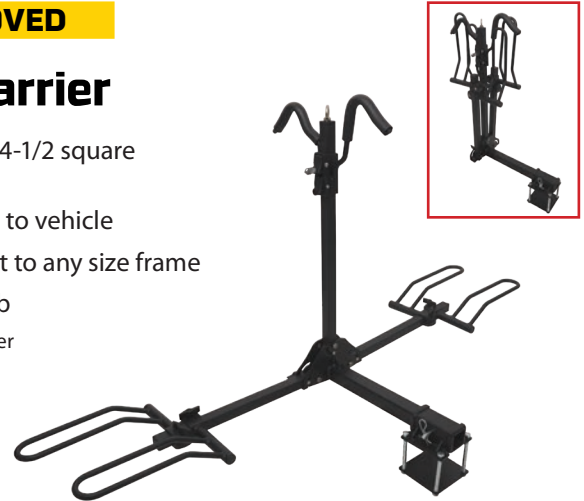

### NEW & IMPROVED

## Four Bike Carrier

- Fits 2" receiver
- Tilts down for access to vehicle
- Wheel mounts adjust to any size frame
- Weight capacity 160 lb

BC-204\*  
Four Bike Carrier

BC-2FT\*  
Fat Tire Adaptor



## Four Bike Carrier

- BC-108 fits 1-1/4" or 2" receiver
- Tilts down for access to vehicle
- Arms fold down for parking and storage
- Weight capacity 120 lb

BC-108\* Four Bike Carrier



## Bike Carrier

- Fits 2" receiver
- Tilts down for access to vehicle
- BC-102 Weight capacity 60 lb
- BC-104 Weight capacity 120 lb

BC-102\* Two Bike Carrier

BC-104\* Four Bike Carrier



 **WARNING:** Cancer and Reproductive Harm

\*While none of our products directly represent a risk of cancer or birth defect, many fasteners and finishes could if oral contact occurs.

# DURABILITY YOU CAN TRUST DOWN THE ROAD.

## VENTED TAILGATES



Visit our website for the most up to date fits

### 100 Series Gate

Durable steel design, vented to maximize air flow



- Open design improves vision
- Custom fitted
- 100 lb weight limit
- For full size trucks only
- 1 year limited warranty
- Made in the USA

### 4000 Series Gate

Lightweight, durable glass-filled composite gate with louvers that will never rust.



- Gate improves vision, reduces drag
- Accessory louvers and privacy insert available
- Rotary latches and cables included
- Key locks gate onto truck
- Single-handed release
- 2 year limited warranty
- Made in the USA

	FORD 2020 - 2022 no current fits		GM / CHEVY 2019 - 2022 no current fits		DODGE 2019 - 2022 no current fits		TOYOTA-TUNDRA	
150 1500	1987-1996	VG-100*	1988-1998 & 1999-2000 (OB)	VGM-88-100*	1995-2001	VGD-94-101*	2007-2013 & 2014-2020**	VGT-70-4000* VGT-70-100*
	1997-2003 & 2004 (HE)	VG-97-4000* VG-97-100*	1999-2006 (CB)	VGM-99-4000* VGM-99-100*	2002-2008 & 2009*	VGD-02-4000* VGD-02-100*		
	2004* & 2005-2014	VG-04-4000* VG-04-100*	2007-2013	VGM-07-4000* VGM-07-100*	2010-2018	VGD-10-4000* VGD-10-100*		
	2015-2019	VG-15-4000* VG-15-100*	2014-2018	VGM-14-4000* VGM-14-100*				
250 2500	1987-1997	VG-100*	1988-1998 & 1999-2000 (OB)	VGM-88-100*	1995-2002	VGD-94-101*	(HE) = Heritage Edition (LD) = Light Duty (CB) = Classic Body Style (OB) = Old Body Style ** Functional Fit Only	
	1997-1999 (LD) & 1999-2016	VG-97-4000* VG-97-100*	1999-2007 (CB)	VGM-99-4000* VGM-99-100*	2003-2009	VGD-02-4000* VGD-02-100*		
	2017-2019	VG-15-4000* VG-15-100*	2008-2013	VGM-07-4000* VGM-07-100*	2010-2018	VGD-10-4000* VGD-10-100*		
		2014-2018	VGM-14-4000* VGM-14-100*					
350 3500	1987-1997	VG-100*	1988-1998 & 1999-2000 (OB)	VGM-88-100*	1995-2002	VGD-94-101*		
	1999-2016	VG-97-4000* VG-97-100*	1999-2007 (CB)	VGM-99-4000* VGM-99-100*	2003-2009	VGD-02-4000* VGD-02-100*		
	2017-2019	VG-15-4000* VG-15-100*	2008-2013	VGM-07-4000* VGM-07-100*	2010-2018	VGD-10-4000* VGD-10-100*		
			2014-2018	VGM-14-4000* VGM-14-100*				



# DOING MORE TO GROW YOUR SALES.

## Tongue Jack Display



### PRODUCT DISPLAY SIGN

DSP-TJ01\* | 30" x 36"  
 DSP-TJ02\* | 30" x 48"



### DISPLAY SIGN CLIPS

DSP-SC03\*  
 For a fast and easy installation  
 and an extremely secure hold

### DISPLAY SHELF

DSP-TJ04\*  
 Powder coated metal shelf  
 with U-rings to secure  
 product

**STROMBERG CARLSON**  
**PRODUCTS INC.**

### LOGO DECAL

DSP-TJ07\*  
 12" x 30"

### Product Bill of Material - 4' display shown

- |              |                               |
|--------------|-------------------------------|
| (1) JET-2500 | (1) KIT-TJ04 (4' display)**   |
| (1) JET-3555 | (1) KIT-TJ03 (3' display)**   |
| (1) JET-3755 | **Product not included in kit |
| (1) JET-5000 |                               |
| (6) JET-30   |                               |

 **WARNING:** Cancer and Reproductive Harm

\*While none of our products directly represent a risk of cancer or birth defect, many fasteners and finishes could if oral contact occurs.

# DEALER POINT-OF-SALE DISPLAYS

## Lend-A-Hand & Platform Steps



**SIGN HEADER**  
DSP-LH02\*  
36" x 8"

### Product Bill of Material

- |                   |                     |                              |                         |                       |
|-------------------|---------------------|------------------------------|-------------------------|-----------------------|
| (3) AM-800 Black  | (2) PA-202 Two Step | (1) DISP-AC530L              | (2) AH-100 Handle White | (4) AM Foam Wrap      |
| (3) AM-200 White  | (1) DSP-SH01 Header | (3) PA-150 Platform Step     | (2) AH-150 Handle Black | (3) AM-250 Mini White |
| (2) AM-300 Silver | (1) DISP-AM Rails   | (3) PA-275 Adj Platform Step | (6) AM-01 Dura Grip     | (3) AM-255 Mini Black |

## Sign Header

### SIGN HEADER HARDWARE

DSP-SH02\*  
Clear PVC grips signs securely and are easy to relocate

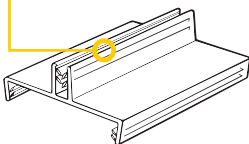

### FRONT



### BACK



**SIGN HEADER**  
DSP-SH01\*  
8" x 36"

**WARNING:** Cancer and Reproductive Harm

# A SMARTER POINT-OF-SALE SYSTEM

## Stake-And-Grill

**PRODUCT DISPLAY SIGN**  
DSP-GR01\*  
8.5" x 11"

**RARE.**  
**MEDIUM RARE.**  
**SHOE LEATHER.**  
**YOUR CHOICE.**  
**STROMBERG STRONG**



**DISPLAY SIGN CLIPS**  
DSP-GR02\*  
Nylon adhesive back ratchet clip, adjustable cable clamp

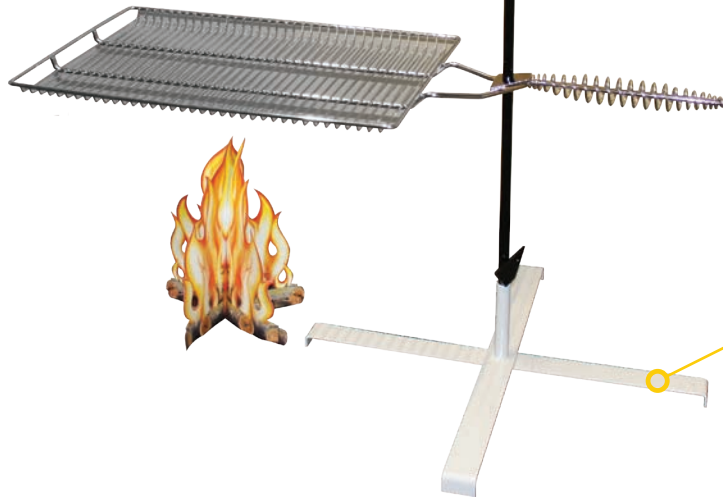

**DISPLAY STAND**  
DISP-GR1522\*  
20" x 14" x 4"

## Extend-A-Line

**DISPLAY DECAL**  
DSP-EL01\*  
17" x 11.5"



**SUNSHINE.**

**FRESH AIR.**

**COOL BREEZES.**

**WHO NEEDS A DRYER?**

**THERE'S MOTHER NATURE.**

**AND STROMBERG.**



**SIGNAGE SLEEVES**  
DSP-EL02\*  
10" x 3.75" x 1"  
assembled size

**WARNING: Cancer and Reproductive Harm**

\*While none of our products directly represent a risk of cancer or birth defect, many fasteners and finishes could if oral contact occurs.

# DEALER POINT-OF-SALE DISPLAYS

## Hose Caddy Sign

**RELAX. UNWIND.**  
Hose/Cord Caddy

Eliminate kinks and knots for easy use and storage plus extended hose life.

- Connects fresh water inlet to water supply
- 17" wide, 6 1/2" tall
- Holds up to 75' of hose
- Stores hose accessories

STROMBERG STRONG

STROMBERG CARLSON PRODUCTS INC. [StrombergCarlson.com](http://StrombergCarlson.com)

**PRODUCT DISPLAY SIGN**

DSP-HC1\*  
36" x 30"

## Shelf Talkers

**CARGO CADDY SHELF TALKER**

DSP-ST01\*  
3" x 3" each

**CAN'T PACK IT?  
STACK IT.**

**LEND-A-HAND SHELF TALKER**

DSP-ST02\*  
3" x 3" each

**COME ON,  
GET A GRIP**

**STEP STOOL SHELF TALKER**

DSP-ST03\*  
3" x 3" each

**STEP RIGHT UP.  
SAFELY.**

**TONGUE JACK SHELF TALKER**

DSP-ST04\*  
3" x 3" each

**A BETTER  
SUPPORT JACK?  
NO SWAY!**

**EXTEND-A-SHOWER SHELF TALKER**

DSP-ST05\*  
3" x 3" each

**SHOWER WITH  
MORE ELBOW  
(AND EVERYTHING)  
ROOM**

**SHELF TALKER HOLDER**

DSP-ST06\*  
Clips securely hold all types of signs in flag position

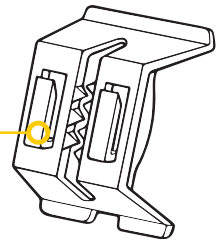

**WARNING:** Cancer and Reproductive Harm

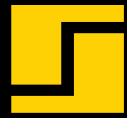

# STROMBERG CARLSON PRODUCTS INC.

## NEW PRODUCTS

### Base Pad Shoe

Jack Pads that stay attached!

- Molded EPDM rubber (not crumb rubber)
- 9" Shoe fits Lippert's 4 and 6 point leveling systems
- 9" Shoe fits round footpads made by Lippert, Pac Rim or Venture
- 10" Shoe fits Equalizer Systems round and octagonal 4 and 6 point leveling systems
- Stays attached — no need to store
- Unique bottom increases ground stability — more surface area
- Protects footpads from rocks and roots
- Protects RV pad from rust stains
- Can support a 100,000 lb coach with 4 and 6 point leveling systems
- Ensures a maintenance free future when you add a fresh coat of paint to your footpads prior to installation
- Made in the USA



JBP-S9.1\* 9" Single Pack  
 JBP-S9.2\* 9" 2 Pack  
 JBP-S9.4\* 9" 4 Pack  
 JBP-S9.6\* 9" 6 Pack  
 JBP-S10.1\* 10" Single Pack  
 JBP-S10.2\* 10" 2 Pack  
 JBP-S10.3\* 10" 3 Pack  
 JBP-S10.4\* 10" 4 Pack



### T-Chock

For Tandem Axles



- Pressure against each tire and axle helps your vehicle stay put
- Fits tires spaced 2" to 17" apart
- Rust-resistant coating
- Handle included on all models

JBP-T217.1\* Single Pack  
 JBP-T217.2\* 2 Pack  
 JBP-T217.W\* Replacement Wrench

### Base Pad Leveler

With Chock and Anti-Slip Mat

Simplify the leveling challenge!

- Adds up to 4" lift
- Includes leveler, chock and anti-slip mat
- Light weight material – like bullet proof glass
- Curved edges for easier removal between wheels
- Leveler dimensions: 11" long, 7" wide, 4-1/4" tall
- Made in the USA



JBP-C300\* Single Pack  
 JBP-C302\* 2 Pack

⚠ WARNING: Cancer and Reproductive Harm



### Base Pad Peak



- Blocks your scissor or stab jacks
- Light weight polycarbonate material
- 4000 lb capacity
- 5" x 8" Stabilizer pad, 10-1/4" x 12-7/8" footprint, 8" tall or 14" stacked
- Made in the USA

JBP-813.1\* Single Pack  
 JBP-813.2\* 2 Pack  
 JBP-813.4\* 4 Pack  
 JBP-813.5\* 5 Pack

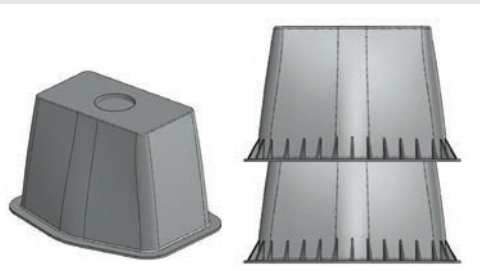

\*While none of our products directly represent a risk of cancer or birth defect, many fasteners and finishes could if oral contact occurs.



Discover other truck bed accessories on our website.