

Steinjäger

Suspensions & Accessories for Jeep® Wrangler®



November 2020



CJ-7 >
1976-1986



CJ-8 >
1981-1986



YJ >
1987-1995



XJ >
1984-2001



TJ >
1997-2006



JK/JKU >
2007-2017



JL/JLU >
2018-present

































GLADIATOR >
2019-present



Steinjäger

Suspensions & Accessories

	CJ-7	JK	JL	JT	TJ	XJ	YJ
 Bumpers		42-43	12	12	58-59		
 Cargo Nets & Covers		33			64		74
 Crossover Steering Kits		44			67	77	
 D-Ring Shackles & Mounts	14	14,39	14	14	14,58	14	14
 Dead Pedals & Stirrup Steps	28	28	28	28	28	28	28
 Differential Covers		21	21	21	21	21	21
 Doors, Tubular and Flag Style	72	18-19	4-5	4-5	54	76	72
 Door Hangers and Holders		7	7	7	55		
 Door Handle Inserts		31					
 Inserts for Tube Doors	72	22-23	6	6	56		72
 Fender Deletes		39					
 Flag Poles, Holders & Hitches	20	20	20	20	20	20	20
 Foot Pegs	62	13	13	13	62		62
 Grab Handles		26-27			61		
 Harness Bar		40			58		
 High Lift Jack Holders		29			63		75
 Hood Latches		30			60		73
 LED Brackets		36-37			58		
 License Plate Relocate Kit		38	9				
 Lift Kits & Springs & Ctrl Arms		48-53	15,17		69-71		75
 Limb Risers		30			66		
 Mirrors & Mirror Brackets	57	8,24	8	8	57		57
 Organizers	32	32	32	32	32	32	32
 Rock Sliders		41	13				
 Spare Tire Delete Plates		44	9		60		
 Sway Bars & End Links		45	16	16	66	76	
 Teddy® Tops		34-35	11	10	65		73
 Tire Carrier		25					
 Track Bar, Tie Rod, Drag Link		46	16	16	68	68-69	75
 Transfer Case Shifter Cable					61	77	

Why Steinjäger?

Made in the USA: Vertical Integration

Over 98% of Steinjäger's accessories for Jeeps are ALL made in the same factory in Bushnell, Illinois, USA, including our Grab Handles, Lift Kits, Tube Doors, Rock Sliders, Teddy® Tops, Bumpers and more. Our suspension bushings are even molded in the same building where we make our Teddy® Tops. Look for the 'Made in the USA' image to denote our American made products.



Customer Service & Focus

Whether you buy the product from us, from one of our retail/installer dealers, or from one of our online dealers, if you have any questions or service issues, we want you to contact us DIRECT. We enjoy servicing our customers and will do everything we can to help you enjoy your Steinjäger products. We take a sincere interest in our customers: what you've purchased, the type of Jeeps you own, how you accessorize your Jeep, what events you go to, your accent colors... these are all important to us and we will do our best to personalize your experience with us.



Great Value

We focus a lot on creating value for you. Before we start work on a project, we make sure that our finished design is going to give a better value than offshore and domestic alternatives. This 'Great Value' principle of Steinjäger stems from our belief that American companies that understand their manufacturing niche, can manufacture high quality, great value, and globally competitive products *in the USA*. We want you to know that when you buy a Steinjäger accessory for your Jeep, you are buying the best an American manufacturer has to offer.

Flag Doors



Made in the USA from 3/16 thick steel, these Steinjäger doors come in a variety of powder coated color options. Arm Rest is integral to the door. Price includes our premium latch and limit straps. Fits both the JT and the JL

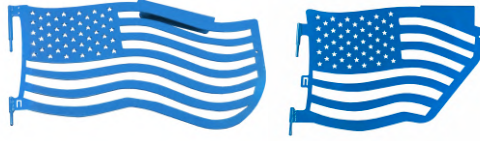

Front Doors (pair)

Rear Doors (pair)

	Bare Metal	J0049351		J0049417
	Black	J0049352		J0049418
	Texturized Black	J0049362		J0049428
	Southwest Blue	J0049355		J0049421
	Playboy Blue	J0049356		J0049422
	Neon Green	J0049358		J0049424
	Fluorescent Orange	J0049353		J0049419
	Locas Green	J0049360		J0049426
	Military Beige	J0049361		J0049427
	Pinky	J0049359		J0049425
	Lemon Peel	J0049357		J0049423
	Red Baron	J0049354		J0049420
	Sinbad Purple	J0049364		J0049430
	Cloud White	J0049365		J0049431
	Gray Hammer'tn	J0049363		J0049429
	Gecko Green	J0049367		J0049433
	Hot Pink	J0049368		J0049434
	Neon Yellow	J0049366		J0049432

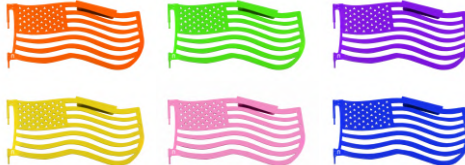

WARNING: Cancer and Reproductive Harm

Tubular Trail Doors

Made in the USA

JL/JT

Tubular Doors

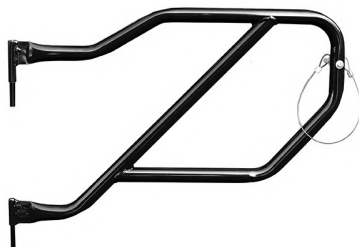
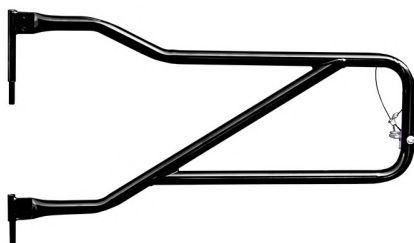

Front Doors

Rear Doors

	Bare Metal	J0048305
	Black	J0048306
	Texturized Black	J0048316
	Southwest Blue	J0048309
	Playboy Blue	J0048310
	Neon Green	J0048312
	Fl'rescent Orange	J0048307
	Locas Green	J0048314
	Military Beige	J0048315
	Pinky	J0048313
	Lemon Peel	J0048311
	Red Baron	J0048308
	Sinbad Purple	J0048318
	Cloud White	J0048319
	Gray Hammer'tn	J0048317
	Gecko Green	J0048321
	Hot Pink	J0048322
	Neon Yellow	J0048320

	J0048323
	J0048324
	J0048334
	J0048327
	J0048328
	J0048330
	J0048325
	J0048332
	J0048333
	J0048331
	J0048329
	J0048326
	J0048336
	J0048337
	J0048335
	J0048339
	J0048340
	J0048338

Steinjäger's Tube Doors come ready to install. First time assembly and installation takes less than 10 minutes. Check out our installation video on [YouTube](#) by searching for 'Steinjäger'. Installation may require a minor adjustment to the striker latch. Kits include all attaching hardware. Doors are made in the USA from 1.25" OD tubing.



WARNING: Cancer and Reproductive Harm

Door Covers



Made in the USA. Fits Steinjäger tube doors. Prices include bungees.

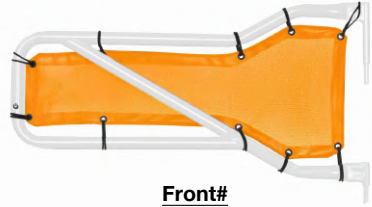

<u>Color</u>	<u>Rear#</u>	<u>Front#</u>
Black	J0048371	J0048359
Blue	J0048376	J0048364
Burgundy	J0048380	J0048368
Gray	J0048377	J0048365
Green	J0048378	J0048366
Dark Green	J0048373	J0048361
Mauve	J0048381	J0048369
Orange	J0048379	J0048367
Red	J0048374	J0048362
Tan	J0048382	J0048370
White	J0048375	J0048363
Yellow	J0048372	J0048360



Door Nets (JL)

Made in the USA. Fits Steinjäger tube doors. Prices include bungees.

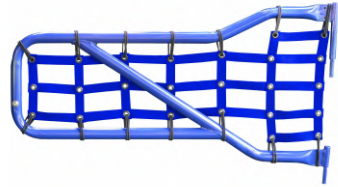
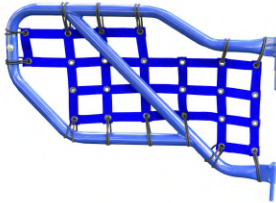

<u>Color</u>	<u>Rear Set</u>	<u>Front Set</u>
Black	J0048420	J0048414
Orange	J0048421	J0048415
Gray	J0048422	J0048416
Red	J0048423	J0048417
Blue	J0048424	J0048418
Green	J0048425	J0048419



WARNING: Cancer and Reproductive Harm

Door Holders & Hangers

Made in the USA

JL/JK

Four Door Holder Stand (fits JLU & JKU)

Holds Four Doors

J0048005



This unique product can be used to store factory doors or tubular doors in the field, in the showroom, or in your hotel room. Knocks down quickly for travel, but rugged enough for dealer showrooms. Powder Coated. Made in the USA.

Wall Mounted Door Hanger

Holds Two Doors



Works for JT,
JL and JK

Mounts to wall studs and holds factory and tubular doors. Made in the USA.

Steinjäger Latch Upgrade



These handy latch upgrades make our great tube doors even better!

Part#	# of Pins
J0043481	1
J0043482	2
J0043483	4

	Bare Metal	J0048006
	Black	J0048003
	Texturized Black	J0048016
	Southwest Blue	J0048009
	Playboy Blue	J0048010
	Neon Green	J0048012
	Fluorescent Orange	J0048007
	Locas Green	J0048014
	Military Beige	J0048015

	Pinky	J0048013
	Lemon Peel	J0048011
	Red Baron	J0048008
	Sinbad Purple	J0048018
	Cloud White	J0048019
	Gray Hammer'tn	J0048017
	Gecko Green	J0048021
	Hot Pink	J0048022
	Neon Yellow	J0048020



WARNING: Cancer and Reproductive Harm

Mirror Legs & Mirror Heads

fits JL, JLU, JK and JKU

Mirror Legs



Pick your mirror legs, and then your mirrors. Mirror legs made in the USA. Each kit includes 2 mirror legs and hardware. Mirrors sold separately.



Legs for Tube Doors

Door Hinge Legs

Isolated Hinge Legs

	Bare	J0048397	J0046296	J0045998
	Black	J0048383	J0046185	J0045997
	Text Black	J0048396	J0046199	J0046008
	SW Blue	J0048395	J0046198	J0046001
	Playboy Blue	J0048392	J0046195	J0046002
	Neon Green	J0048390	J0046193	J0046004
	Fluor' Orange	J0048385	J0046188	J0045999
	Locas Green	J0048388	J0046191	J0046006
	Military Beige	J0048389	J0046192	J0046007
	Pinky	J0048391	J0046194	J0046005
	Lemon Peel	J0048387	J0046190	J0046003
	Red Baron	J0048393	J0046196	J0046000
	Sinbad Purple	J0048394	J0046197	J0046010
	Cloud White	J0048384	J0046187	J0046011
	Gray Hammer	J0048386	J0046189	J0046009
	Gecko Green	J0048399	J0046591	J0046585
	Hot Pink	J0048400	J0046592	J0046586
	Neon Yellow	J0048398	J0046590	J0046584

Features

Fits Steinjäger Tube Doors

Fits Door Hinge

*Patented Design
Fits Door Hinge. US Patent# 9,475,432*

Mirrors

2 Mirrors J0046184

2 Mirrors J0041326



WARNING: Cancer and Reproductive Harm

License Plate Relocator

Spare Tire Delete Plates

JL

Rear License Plate Relocator



If you have removed your 3rd brake light and factory spare tire carrier in preparing your Jeep for off road use, you can use this kit to hide the unsightly openings in the factory tailgate. Made in the USA.



	Bare Metal	J0048637
	Black	J0048638
	Texturized Black	J0048648
	Southwest Blue	J0048641
	Playboy Blue	J0048642
	Neon Green	J0048644
	Fluorescent Orange	J0048639
	Locas Green	J0048646
	Military Beige	J0048647

	Pinky	J0048645
	Lemon Peel	J0048643
	Red Baron	J0048640
	Sinbad Purple	J0048650
	Cloud White	J0048651
	Gray Hammer'tn	J0048649
	Gecko Green	J0048653
	Hot Pink	J0048654
	Neon Yellow	J0048652

Spare Tire Delete Plates



If you have removed your back up camera, third brake light, and factory spare tire in preparing your Jeep for off road use, you can use this product to hide the unsightly openings in the factory tailgate. 1/8" steel plate. Made in the USA.



	Bare Metal	J0048209
	Black	J0048210
	Texturized Black	J0048220
	Southwest Blue	J0048213
	Playboy Blue	J0048214
	Neon Green	J0048216
	Fluorescent Orange	J0048211
	Locas Green	J0048218
	Military Beige	J0048219

	Pinky	J0048217
	Lemon Peel	J0048215
	Red Baron	J0048212
	Sinbad Purple	J0048222
	Cloud White	J0048223
	Gray Hammer'tn	J0048221
	Gecko Green	J0048225
	Hot Pink	J0048226
	Neon Yellow	J0048224



WARNING: Cancer and Reproductive Harm

Trashy Teddy®



Little Trashy: has a single strap. Carry or hang from your seat head rest.

Trashy Teddy®: carry as a beach bag, or hang on your spare tire. Carabiner bungee sold separately.

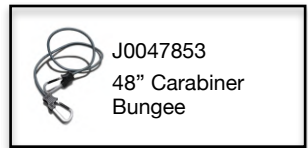

Color	Little Trashy	Trashy Teddy
Black	J0048072	J0047812
Blue	J0048075	J0047815
Burgundy	J0048081	J0047821
Gray	J0048076	J0047816
Green	J0048078	J0047818
Dark Green	J0048082	J0047822
Mauve	J0048082	J0047823
Orange	J0048073	J0047813
Red	J0048080	J0047820
Tan	J0048077	J0047817
White	J0048074	J0047814
Yellow	J0048079	J0047819

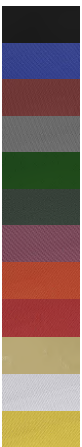

Black	J0049320
Blue	J0049323
Burgundy	J0049329
Gray	J0049324
Green	J0049326
Dark Green	J0049330
Mauve	J0049331
Orange	J0049321
Red	J0049328
Tan	J0049325
White	J0049322
Yellow	J0049327

Teddy® Top for JT



WARNING: Cancer and Reproductive Harm

Solar Teddy® Tops

Solar Covers - Made in the USA

JL

Front Seat Teddy@ (JL/JLU)



Our Teddy® Top Solar Screen Cover easily installs in minutes with the supplied bungee balls. Compatible with the JL's hard top and soft top, please note the center strap will need to be unclipped when installing the Freedom Panels.



Black J0048401



Green J0048408



Orange J0048409



Yellow J0048402



White J0048405



Red J0048404



Blue J0048406



Burgundy J0048410



Gray J0048407



Dark Green J0048403



Tan J0048412



Mauve J0048411

Teddy@ Tops (fits JLU)



Our Teddy® Top Solar Screen Cover easily installs in minutes with the supplied bungee balls. Compatible with the JL's hard top and soft top, please note that the front section will need folded back when the Freedom Panels are installed.



Black J0048106

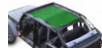

Green J0048112



Orange J0048107

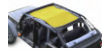

Yellow J0048113



White J0048108

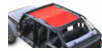

Red J0048114

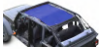

Blue J0048109

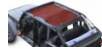

Burgundy J0048115



Gray J0048110

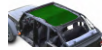

Dark Green J0048116



Tan J0048111



Mauve J0048117



WARNING: Cancer and Reproductive Harm

Rear Bumper with D-Ring Mounts

Steinjäger's Rear Bumper gives your JL a fresh look, hiding the unsightly frame rails. Made from 3/16" steel with D-ring mounts included. End Caps are sold separately. Made in the USA.



Bumper will NOT work with the ParkSense Rear Park-Assist System.

End Caps are made from 3/16" steel and bolt directly to the frame rails. Made in the USA. Sold separately from Bumpers.



Bumper



End Caps (Pair)

	Bare Metal	J0048617		J0048588
	Black	J0048618		J0048589
	Texturized Black	J0048628		J0048599
	Southwest Blue	J0048621		J0048592
	Playboy Blue	J0048622		J0048593
	Neon Green	J0048624		J0048595
	Fluorescent Orange	J0048619		J0048590
	Locas Green	J0048626		J0048597
	Military Beige	J0048627		J0048598
	Pink	J0048625		J0048596
	Lemon Peel	J0048623		J0048594
	Red Baron	J0048620		J0048591
	Sinbad Purple	J0048630		J0048601
	Cloud White	J0048631		J0048602
	Gray Hammer'tn	J0048629		J0048600
	Gecko Green	J0048633		J0048604
	Hot Pink	J0048634		J0048605
	Neon Yellow	J0048632		J0048603

End Caps...



WARNING: Cancer and Reproductive Harm

Rock Sliders & Foot Pegs

Made in the USA

JL



Steinjäger Rock Sliders are made in the USA from 1.75" OD tubing. Simple installation. All hardware included.



	Bare Metal	J0049205
	Black	J0049188
	Texturized Black	J0049198
	Southwest Blue	J0049191
	Playboy Blue	J0049192
	Neon Green	J0049194
	Fluorescent Orange	J0049189
	Locas Green	J0049196
	Military Beige	J0049197

	Pinky	J0049195
	Lemon Peel	J0049193
	Red Baron	J0049190
	Sinbad Purple	J0049200
	Cloud White	J0049201
	Gray Hammer'tn	J0049199
	Gecko Green	J0049203
	Hot Pink	J0049204
	Neon Yellow	J0049202

Foot Pegs (fits JK, JKU, JL, JT & JLU)

Steinjäger's patented Foot Pegs are made in the USA of powder coated metal and an internal nonmetallic molded insert that protects your hinge while giving a snug fit for the Peg. US Patent# 9,475,432.



	Black	J0048043
	Texturized Black	J0048054
	Southwest Blue	J0048044
	Playboy Blue	J0048045
	Neon Green	J0048046
	Fluorescent Orange	J0048047
	Locas Green	J0048048
	Military Beige	J0048049
	Pinky	J0048050

	Lemon Peel	J0048051
	Red Baron	J0048052
	Sinbad Purple	J0048055
	Cloud White	J0048056
	Gray Hammer'tn	J0048053
	Gecko Green	J0048058
	Hot Pink	J0048059
	Neon Yellow	J0048057



WARNING: Cancer and Reproductive Harm



D-Ring Shackles



Our 3/4" D-Rings have a working load limit of 4.75 tons. Solid forged steel design. Imported forging, but powder coated in the USA.



1 Pack



2 Pack



4 Pack

	Zinc Plated	J0045662	J0049554	J0049574
	Black	J0045648	J0049555	J0049575
	Text Black	J0045658	J0049565	J0049585
	SW Blue	J0045651	J0049558	J0049578
	Playboy Blue	J0045652	J0049559	J0049579
	Neon Green	J0045654	J0049561	J0049581
	Fluor Orange	J0045649	J0049556	J0049576
	Locas Green	J0045656	J0049563	J0049583
	Military Beige	J0045657	J0049564	J0049584
	Pinky	J0045655	J0049562	J0049582
	Lemon Peel	J0045653	J0049560	J0049580
	Red Baron	J0045650	J0049557	J0049577
	Sinbad Purple	J0045660	J0049567	J0049587
	Cloud White	J0045661	J0049568	J0049588
	Gray Hammer	J0045659	J0049566	J0049586
	Gecko Green	J0046440	J0049570	J0049590
	Hot Pink	J0046441	J0049571	J0049591
	Neon Yellow	J0046439	J0049569	J0049589
	Tiffany Blue	J0048484	J0049572	J0049592
	Teal	J0048548	J0049573	J0049593

D-Ring Isolators

to fit 1-D Ring

to fit 2 D-Rings

to fit 4 D-Rings



Side Isolators J0045984

J0049937

J0045984



Base Isolator J0045982

J0049939

J0049940



Base Isolator J0047692

J0049941

J0049942



WARNING: Cancer and Reproductive Harm

Control Arms

Made in the USA

JL

Control Arms



Made in the USA
Double Adjustable
DOM Tubing



Part # format is J00xxxxx	Front Lower Control arms	Front Upper Control Arms	Rear Lower Control Arms	Rear Upper Control Arms
------------------------------	-----------------------------	-----------------------------	----------------------------	----------------------------

	Bare Metal	49332	49130	49243	49225
	Black	49333	49131	49244	49226
	Texturized Black	49343	49141	49254	49236
	Southwest Blue	49336	49134	49247	49229
	Playboy Blue	49337	49135	49248	49230
	Neon Green	49339	49137	49250	49232
	Fluorescent Orange	49334	49132	49245	49227
	Locas Green	49341	49139	49252	49234
	Military Beige	49342	49140	49253	49235
	Pinky	49340	49138	49251	49233
	Lemon Peel	49338	49136	49249	49231
	Red Baron	49335	49133	49246	49228
	Sinbad Purple	49345	49143	49256	49238
	Cloud White	49346	49144	49257	49239
	Gray Hammer'tn	49344	49142	49255	49237
	Gecko Green	49348	49146	49259	49241
	Hot Pink	49349	49147	49260	49242
	Neon Yellow	49347	49145	49258	49240

DOM Tubing Size	1.750 x 0.120	1.500 x 0.120	1.750 x 0.120	1.500 x 0.120
Features	Double Adj Poly Bushings & Rebuildable Rod End	Double Adj Heim Joints	Double Adj Rebuildable Rod Ends	Double Adj Poly Bushings & Heim Joints



WARNING: Cancer and Reproductive Harm

Front Track Bar

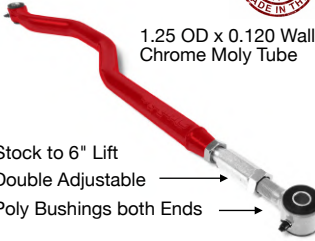

1.25 OD x 0.120 Wall
Chrome Moly Tube

Stock to 6" Lift

Double Adjustable

Poly Bushings both Ends

Chrome Moly
Track Bar

Rear Panhard Bar

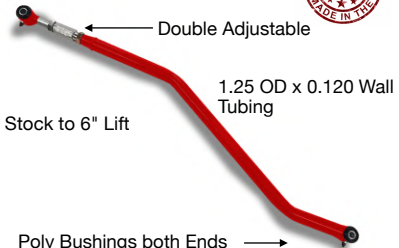

Double Adjustable

1.25 OD x 0.120 Wall
Tubing

Stock to 6" Lift

Poly Bushings both Ends

DOM
Rear Panhard Bar

Chrome Moly
Rear Panhard Bar

	Bare	J0048795	J0048740	J0048758
	Black	J0048796	J0048741	J0048759
	Text Black	J0048806	J0048751	J0048769
	SW Blue	J0048799	J0048744	J0048762
	Playboy Blue	J0048800	J0048745	J0048763
	Neon Green	J0048802	J0048747	J0048765
	Fluor' Orange	J0048797	J0048742	J0048760
	Locas Green	J0048804	J0048749	J0048767
	Military Beige	J0048805	J0048750	J0048768
	Pinky	J0048803	J0048748	J0048766
	Lemon Peel	J0048801	J0048746	J0048764
	Red Baron	J0048798	J0048743	J0048761
	Sinbad Purple	J0048808	J0048753	J0048771
	Cloud White	J0048809	J0048754	J0048772
	Gray Hammer	J0048807	J0048752	J0048770
	Gecko Green	J0048811	J0048756	J0048774
	Hot Pink	J0048812	J0048757	J0048775
	Neon Yellow	J0048810	J0048755	J0048773

Front End Links



J0049148

Quick Disconnect
Style

Rear End Links



Stainless Ball Joints
Stainless
Heim Joints



J0049268 0-1" Lift
J0049269 1.5-3.0"
J0049270 3.5-5.0"



3.5" Lift Kits

Made in the USA

JL

3.5" Lift Kits

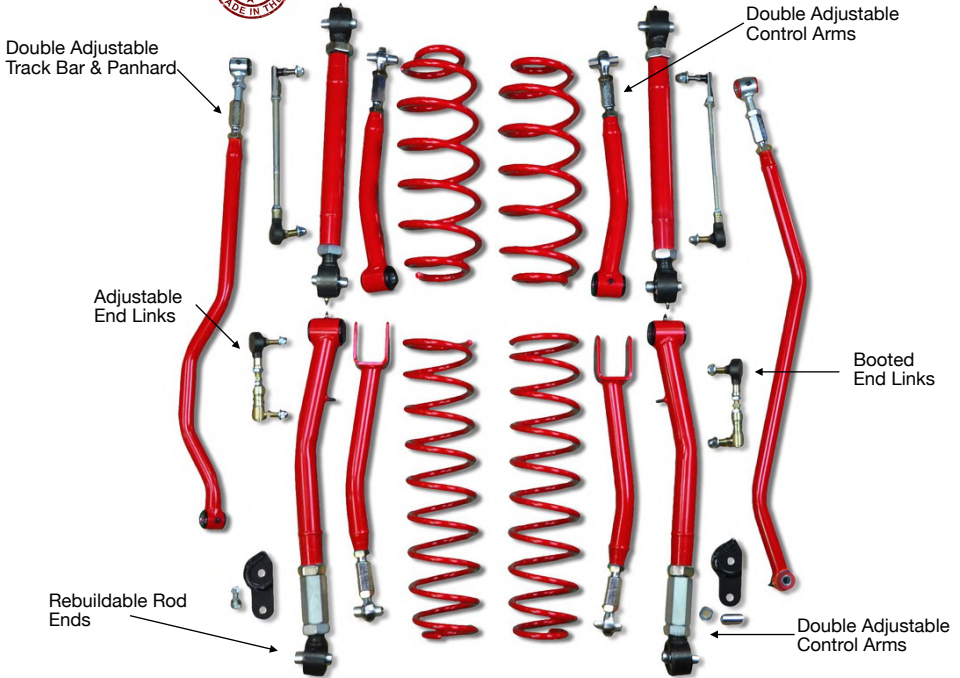

	Bare Metal	J0049453
	Black	J0049454
	Texturized Black	J0049464
	Southwest Blue	J0049457
	Playboy Blue	J0049458
	Neon Green	J0049460
	Fluorescent Orange	J0049455
	Locas Green	J0049462
	Military Beige	J0049463

	Pinky	J0049461
	Lemon Peel	J0049459
	Red Baron	J0049456
	Sinbad Purple	J0049466
	Cloud White	J0049467
	Gray Hammer'tn	J0049465
	Gecko Green	J0049469
	Hot Pink	J0049470
	Neon Yellow	J0049468

Bulk Powder Paint

WARNING: Cancer and Reproductive Harm



Steinjäger color matched powder coat paint powders are available online in 1 pound increments.

Premium Flag Doors



Front Doors

	Bare Metal	J0050166
	Black	J0050167
	Texturized Black	J0050177
	Southwest Blue	J0050170
	Playboy Blue	J0050171
	Neon Green	J0050173
	Fluorescent Orange	J0050168
	Locas Green	J0050175
	Military Beige	J0050176
	Pinky	J0050174
	Lemon Peel	J0050172
	Red Baron	J0050169
	Sinbad Purple	J0050179
	Cloud White	J0050180
	Gray Hammer'tn	J0050178
	Gecko Green	J0050182
	Hot Pink	J0050183
	Neon Yellow	J0050181

Rear Doors

	J0050184
	J0050185
	J0050195
	J0050188
	J0050189
	J0050191
	J0050186
	J0050193
	J0050194
	J0050192
	J0050190
	J0050187
	J0050197
	J0050198
	J0050196
	J0050200
	J0050201
	J0050199

Made in the USA from 3/16 thick steel, these Steinjäger doors come in a variety of powder coated color options. Arm Rest is integral to the door. Price includes our premium latch and limit straps.



WARNING: Cancer and Reproductive Harm

Tubular Trail Doors

Made in the USA

JK

Tubular Trail Doors



Front Doors



Rear Doors

Bare Metal	J0041322
Black	J0031026
Texturized Black	J0041015
Southwest Blue	J0040944
Playboy Blue	J0040945
Neon Green	J0040946
Fl'rescent Orange	J0040947
Locas Green	J0040948
Military Beige	J0040949
Pinky	J0040950
Lemon Peel	J0040951
Red Baron	J0040952
Sinbad Purple	J0042643
Cloud White	J0042646
Gray Hammer'tn	J0041339
Gecko Green	J0046380
Hot Pink	J0046381
Neon Yellow	J0046379

Black	J0041323
Black	J0031027
Black	J0041259
Southwest Blue	J0040954
Playboy Blue	J0040955
Neon Green	J0040956
Fl'rescent Orange	J0040957
Locas Green	J0040958
Military Beige	J0040959
Pinky	J0040960
Lemon Peel	J0040961
Red Baron	J0040962
Sinbad Purple	J0042644
Cloud White	J0042647
Gray Hammer'tn	J0041340
Gecko Green	J0046383
Hot Pink	J0046384
Neon Yellow	J0046382

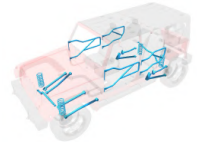

Steinjäger's Tube Doors come ready to install. First time assembly and installation takes less than 10 minutes. Check out our installation video on YouTube by searching for 'Steinjäger'. Installation may require a minor adjustment to the striker latch. Kits include all attaching hardware. Doors are made in the USA from 1.25" OD tubing.

Steinjäger Latch Upgrade



Part#	# of Pins	MSRP
J0043481	1	
J0043482	2	
J0043483	4	

These handy latch upgrades make our great tube doors even better!



WARNING: Cancer and Reproductive Harm

Hitch Mounted Pole Holders & Flag Poles



Our Flag Holder fits any class 3 vehicle hitch. 3 offset holes allow for plenty of adjustment. Accepts flag poles of 1" or less diameter. Made in the USA.



Part # format is
J00xxxxx

44" Flag Poles

60" Flag Poles

Single
Pole Holder

Double
Pole Holder

Bare Metal	45709	45723	47515	45890
Black	45710	45724	47516	45891
Southwest Blue	45713	45727	47519	45894
Playboy Blue	45714	45728	47520	45895
Neon Green	45716	45730	47522	45897
Fluorescent Orange	45711	45725	47517	45892
Locas Green	45718	45732	47524	45899
Military Beige	45719	45733	47525	45900
Pinky	45717	45731	47523	45898
Lemon Peel	45715	45729	47521	45896
Red Baron	45712	45726	47518	45893
Sinbad Purple	45721	45735	47528	45903
Cloud White	45722	45736	47529	45904
Gray Hammer'tn	45720	45734	47527	45902
Gecko Green	46449	46452	47531	46434
Hot Pink	46450	46453	47532	46435
Neon Yellow	46448	46451	47530	46433

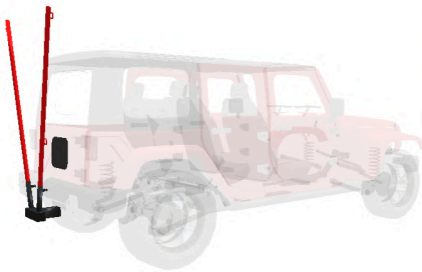

holds $\leq 1"$ diameter poles

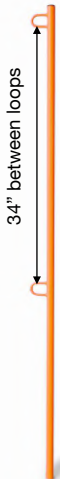

WARNING: Cancer and Reproductive Harm

Diff Covers & Hard Top Knobs

Hinge Bushings, Door Alignment Pins

JK

Differential Covers



J0050259



The Steinjäger Diff Cover is a simple upgrade to your 1-ton swap. Made in the USA from 1/4" plate steel, and comes with weld-in fill bung and plug. Our DIY Diff Cover comes in **FLAT FORM**. Bending and Welding will be required.

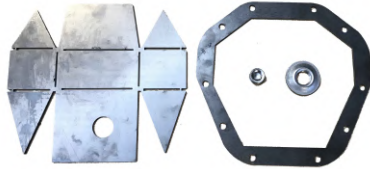

Door Hinge Bushing Set

J0049272

2 Door Set



J0049271

4 Door Set



Door Alignment Pins



J0049150



Our door alignment pins will assist you when putting your stock doors in the upper pin. Made from UV resistant thermoplastic polymer.

Hard Top Knobs



J0049087



Targa Top Knobs

Replacement Knob for your Targa top

J0049936 1 pc

J0050284 10 pack



Kit includes 6 knobs. Made from UV resistant thermoplastic polymer and paired with stainless hardware. Made in the USA



WARNING: Cancer and Reproductive Harm

Mesh Inserts



Made in the USA. Fits Steinjäger tube doors. Prices include bungees.



		Color	Rear#	Front#
		Black	J0041085	J0041050
		Orange	J0041355	J0041366
		White	J0041356	J0041367
		Royal Blue	J0041357	J0041368
		Gray	J0041358	J0041369
		Tan	J0041359	J0041370
		Green	J0041360	J0041371
		Lemon Yellow	J0041361	J0041372
		Red	J0041362	J0041373
		Burgundy	J0043601	J0043603
		Dark Green	J0043602	J0043604
		Mauve	J0043855	J0043856

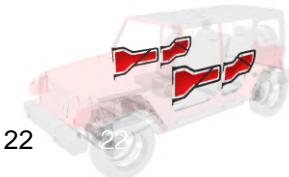

WARNING: Cancer and Reproductive Harm

Tube Door Accessories

Nets, Arms Rests, Limiting Straps

JK

DOOR NETS



Made in the USA. Fits Steinjäger tube doors. Prices include bungees.

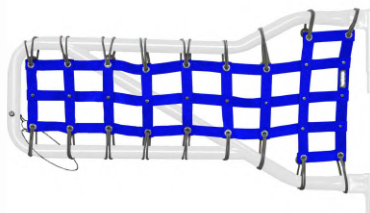
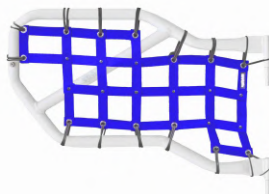

Color **Rear Set**
Black J0043597

Front Set
J0043596



Orange J0043661

J0043657



Gray J0043662

J0043658



Red J0043663

J0043659



Blue J0043664

J0043660

Arm Rests



Made in the USA. Fits Steinjäger tube doors.

2 per kit



Black J0041031



Red J0046098



Blue J0046104

Door Limiting Straps



For Steinjäger Tube Doors

Front Doors J0041622

Rear Doors J0041623

Bungees, 6" Long



8 pack J0043458

10 pack J0041051



WARNING: Cancer and Reproductive Harm

A-Pillar Mirror Legs

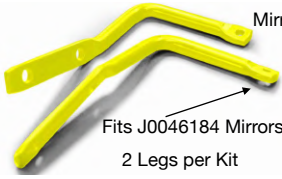

Mirrors sold Separately



Fits J0046184 Mirrors
2 Legs per Kit

Tube Door Mirrors



Fits J0041326 Mirrors

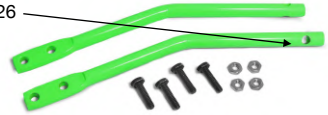

Bare Metal	J0046715
Black	J0046716
Texturized Black	J0046726
Southwest Blue	J0046719
Playboy Blue	J0046720
Neon Green	J0046722
Fl'rescent Orange	J0046717
Locas Green	J0046724
Military Beige	J0046725
Pinky	J0046723
Lemon Peel	J0046721
Red Baron	J0046718
Sinbad Purple	J0046728
Cloud White	J0046729
Gray Hammer'tn	J0046727
Gecko Green	J0046731
Hot Pink	J0046732
Neon Yellow	J0046730

Bare Metal	J0046295
Black	J0040967
Texturized Black	J0046213
Southwest Blue	J0046212
Playboy Blue	J0046209
Neon Green	J0046207
Fl'rescent Orange	J0046202
Locas Green	J0046205
Military Beige	J0046206
Pinky	J0046208
Lemon Peel	J0046204
Red Baron	J0046210
Sinbad Purple	J0046211
Cloud White	J0046201
Gray Hammer'tn	J0046203
Gecko Green	J0046594
Hot Pink	J0046595
Neon Yellow	J0046593

Mirrors 2 Mirrors J0046184



Vent Mirrors

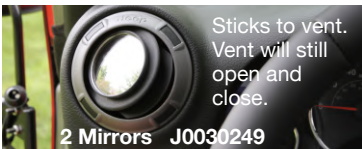

Sticks to vent. Vent will still open and close.

2 Mirrors J0030249

Magnetic Legs



Patented Design

2 Legs J0041001

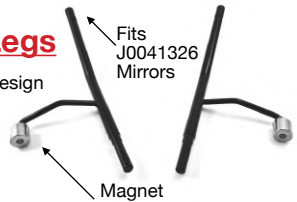

Fits J0041326 Mirrors

Magnet

Mirrors

2 Mirrors J0041326



WARNING: Cancer and Reproductive Harm

Internal Tire Carrier

Made in the USA

JK

Winch Hook Straps

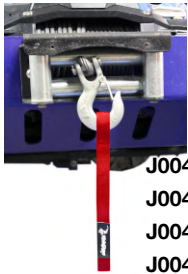

Our Winch Hook Straps are designed for a non-slip grip to making pulling the winch cable easier.

- J0043803 Black
- J0043805 Blue
- J0043807 Red
- J0043809 Orange
- J0043811 Gray



Vacuum Pump Relocator



J0041007

When installing an aftermarket bumper, it may be necessary to move your vacuum pump. This handy kit comes with all the needed hardware to complete this job. The vacuum pump is moved from behind the bumper to under the hood.

Internal Tire Carrier for 2 Door JK Wrangler



Holds 35" Tire
2 Door JK only



	Bare Metal	J0045491
	Black	J0041055
	Texturized Black	J0045501
	Southwest Blue	J0045494
	Playboy Blue	J0045495
	Neon Green	J0045497
	Fluorescent Orange	J0045492
	Locas Green	J0045499
	Military Beige	J0045500

	Pinky	J0045498
	Lemon Peel	J0045496
	Red Baron	J0045493
	Sinbad Purple	J0045503
	Cloud White	J0045504
	Gray Hammer'tn	J0045502
	Gecko Green	J0046573
	Hot Pink	J0046574
	Neon Yellow	J0046572



WARNING: Cancer and Reproductive Harm

Front Rigid Grab Handles



Steinjäger Front Rigid Grab Handles are made from steel and are powder coated a variety of colors. Our handles' original and unique design gives you a great grab handle without interference with the Jeep's visor. Made in the USA.



	Bare Metal	J0041455
	Black	J0041052
	Texturized Black	J0041248
	Southwest Blue	J0041241
	Playboy Blue	J0041242
	Neon Green	J0041244
	Fl'rescent Orange	J0041239
	Locas Green	J0041246
	Military Beige	J0041247
	Pinky	J0041245
	Lemon Peel	J0041243
	Red Baron	J0041240
	Sinbad Purple	J0043589
	Cloud White	J0043592
	Gray Hammer'tn	J0041351
	Gecko Green	J0046504
	Hot Pink	J0046505
	Neon Yellow	J0046503
	Tiffany Blue	J0048817
	Teal	J0048820



Design your dream Jeep
with our free online
3D Configurator

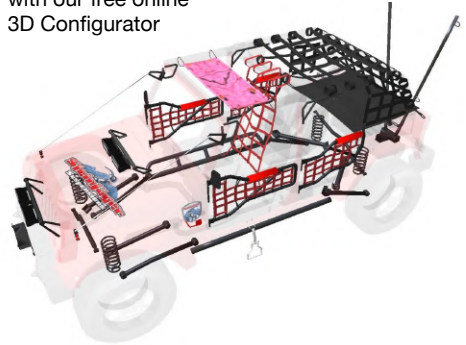

WARNING: Cancer and Reproductive Harm

Rear Grab Handles

for the JK and JKU

JK



Rear Rigid Grab Handles

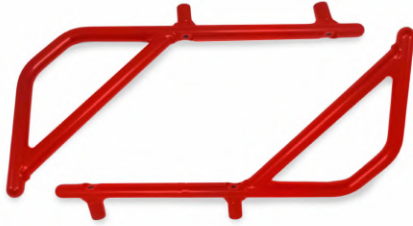

Made from steel and powder coated a variety of colors, our rear handles come in two different designs to allow for differences between the 2 door (JK) and 4 door (JKU) models. Made in the USA.

	<u>2 Door JK</u>	<u>4 Door JKU</u>	<u>Front & Rear for 4 Door JKU</u>
Bare Metal	J0043508	J0041454	J0041456
Black	J0043494	J0040941	J0041054
Texturized Black	J0043504	J0041238	J0041258
Southwest Blue	J0043497	J0041231	J0041251
Playboy Blue	J0043498	J0041232	J0041252
Neon Green	J0043500	J0041234	J0041254
Fluorescent Orange	J0043495	J0041229	J0041249
Locas Green	J0043502	J0041236	J0041256
Military Beige	J0043503	J0041237	J0041257
Pinky	J0043501	J0041235	J0041255
Lemon Peel	J0043499	J0041233	J0041253
Red Baron	J0043496	J0041230	J0041250
Sinbad Purple	J0043506	J0043590	J0043591
Cloud White	J0043507	J0043593	J0043594
Gray Hammer'tn	J0043505	J0041350	J0041352
Gecko Green	J0046498	J0046507	
Hot Pink	J0046499	J0046508	
Neon Yellow	J0046497	J0046506	



WARNING: Cancer and Reproductive Harm

JK

Stirrup Step & Dead Pedal

Made in the USA

Stirrup Steps (fits TJ & JK)



Dead Pedals (JK & JKU)



Convenience for getting into your lifted Jeep. The Stirrup fits easily under the seat when not in use.

Need a comfortable place to rest your foot while driving? Use the Steinjäger Dead Pedal.



Installation is simple and allows you to keep your door limit straps.



Bare Metal	J0045861
Black	J0045860
Texturized Black	J0045871
Southwest Blue	J0045864
Playboy Blue	J0045865
Neon Green	J0045867
Fl'orescent Orange	J0045862
Locas Green	J0045869
Military Beige	J0045870
Pinky	J0045868
Lemon Peel	J0045866
Red Baron	J0045863
Sinbad Purple	J0045873
Cloud White	J0045874
Gray Hammer'tn	J0045872
Gecko Green	J0046458
Hot Pink	J0046459
Neon Yellow	J0046457

Bare Metal	J0046247
Black	J0046233
Texturized Black	J0046243
Southwest Blue	J0046236
Playboy Blue	J0046237
Neon Green	J0046239
Fl'orescent Orange	J0046234
Locas Green	J0046241
Military Beige	J0046242
Pinky	J0046240
Lemon Peel	J0046238
Red Baron	J0046235
Sinbad Purple	J0046245
Cloud White	J0046246
Gray Hammer'tn	J0046244
Gecko Green	J0046464
Hot Pink	J0046465
Neon Yellow	J0046463

Fits JK, JKU, TJ and LJ

Fits JK & JKU with automatic transmissions



WARNING: Cancer and Reproductive Harm

High Lift Accessories

Made in the USA

JK

High Lift Roll Bar Mount Kit



Easy to bolt-on kit to attach your High Lift Jack to the factory Roll Bar. Made in the USA.

Powder Coated

Stainless Steel Male Post



	JK (2 Door)
Bare Metal	J0047589
Black	J0047590
Texturized Black	J0047600
Southwest Blue	J0047593
Playboy Blue	J0047594
Neon Green	J0047596
Fluorescent Orange	J0047591
Locas Green	J0047598
Military Beige	J0047599
Pinky	J0047597
Lemon Peel	J0047595
Red Baron	J0047592
Sinbad Purple	J0047602
Cloud White	J0047603
Gray Hammer'tn	J0047601
Gecko Green	J0047605
Hot Pink	J0047606
Neon Yellow	J0047604

	JKU (4 Door)
	J0047571
	J0047572
	J0047582
	J0047575
	J0047576
	J0047578
	J0047573
	J0047580
	J0047581
	J0047579
	J0047577
	J0047574
	J0047584
	J0047585
	J0047583
	J0047587
	J0047588
	J0047586



Molded Handle Holder

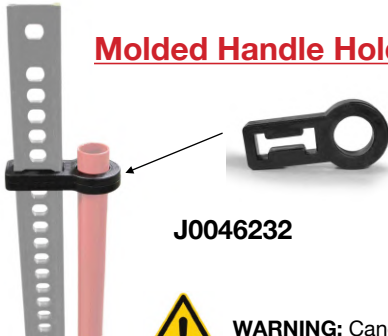

J0046232

Molded in the USA from high grade polyurethane, this Holder fits the Hi-Lift Jack Handle and is the perfect accessory for keeping your handle from rattling.



WARNING: Cancer and Reproductive Harm

Limb Riser Kits



Non-Metallic Jacket
Protects from Scratching



J0040942

Double Adjustable, Quick Disconnect
Made in the USA

DiY Limb Riser Bracket Kit



J0045633



Hood Latch Kits



J0041024



J0041036



J0043480



J0049933



J0049934



J0049935



WARNING: Cancer and Reproductive Harm

DiY Limb Riser Cables

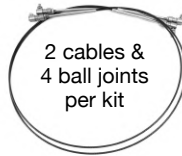

2 cables &
4 ball joints
per kit

Stud-to-Stud Lengths...

J0045638	52.5"
J0045640	54.5"
J0045641	55.5"
J0045642	56.5"
J0045643	57.5"
J0045644	58.5"
J0045645	59.5"
J0045646	61.5"
J0045647	63.5"
J0048504	66.5"

A-Pillar Adaptor Kit



J0047534

Brackets
and
Cables fit
our LED
Brackets.

Chrome Moly Steel (dry climates only). Requires 33/64 drill bit and basic hand tools for installation

Black Poly. Installation requires masking tape, 2 pairs of locking pliers and 2 phillips screw drivers. 2 per kit. Made in the USA.

Red Poly. Installation requires masking tape, 2 pairs of locking pliers and 2 phillips screw drivers. 2 per kit. Made in the USA.

Durable Black Hood Latch Assembly

Factory Replacement Hood Latch. One Latch - fits either side.

Locking Hood Latch Kit

PRICES INCLUDE
DELIVERY



Door Handle Accents

Made in the USA

JK

Door Handle Accents

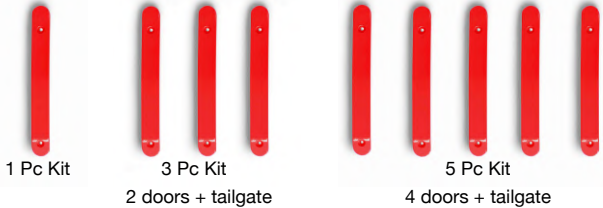

Add a splash of color and style to your factory door handles with the addition of these easy to install Door Handle Accents. Simply mark the hole locations using the accent piece as your template and pre-drill a 3/32" pilot hole. Made in the USA.

1 Pc Kit

3 Pc Kit

5 Pc Kit

Bare Metal	J0045425
Black	J0045426
Textured Blk	J0045436
SW Blue	J0045429
Playboy Blue	J0045430
Neon Green	J0045432
Fir Orange	J0045427
Locas Green	J0045434
Military Beige	J0045435
Pinky	J0045433
Lemon Peel	J0045431
Red Baron	J0045428
SB Purple	J0045438
Cloud White	J0045439
Gray Hammer	J0045437
Gecko Green	J0046710
Hot Pink	J0046711
Neon Yellow	J0046709

J0045402
J0044792
J0044802
J0044795
J0044796
J0044798
J0044793
J0044800
J0044801
J0044799
J0044797
J0044794
J0044804
J0044805
J0044803
J0046549
J0046550
J0046548

J0045403
J0044806
J0044816
J0044809
J0044810
J0044812
J0044807
J0044814
J0044815
J0044813
J0044811
J0044808
J0044818
J0044819
J0044817
J0046552
J0046553
J0046551

Magnetic Can Holders



J0030968

Top Mount: Poly encased magnet holds a standard 12 oz can with a 2.75" OD.



J0031228

Poly encased magnet holds a standard 12 oz can with a 2.75" OD



WARNING: Cancer and Reproductive Harm



Pistol Holder



J0045472

This handy device is made from stainless steel rod in the USA and hangs below the steering column.

It is your responsibility to follow all local, state and federal laws relevant to gun transport and use.



Overhead Organizers



STORE SMALL ITEMS IN POCKETS OVERHEAD



Our overhead organizer has 4 pockets. Fits any top - stock or aftermarket. Made in the USA. Fits JK, JKU and T.J.



Coat Hook Kit



J0045737

This simple metal loop and strap attaches to the rear roll bar and gives you a place to hang your jacket. Fits JK, JKU, T.J, YJ, C.J-7, C.J-8.

2 Hooks



J0043921
Camo



J0045849
Pink Snowfall



J0045850
Black



J0045851
Royal Blue



J0045852
Red

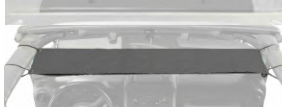

J0045853
Charcoal

Gun Magnet



J0030792



Poly encased magnet sticks to metal, creating a handy place to lean your unloaded shotgun.



WARNING: Cancer and Reproductive Harm

Cargo Nets

Made in the USA

JK

JK- Premium Cargo Nets



Black J0045964



Blue J0047014



Gray J0047015



Orange J0047016



Red J0047017

JKU - Premium Nets



Black J0046253



Blue J0047022



Gray J0047023



Orange J0047024



Red J0047025

Our Teddy® Top Cargo Nets cover the back half and sides of your Jeep, and can remain on your Jeep long term as they are compatible with factory hard tops, soft tops, Steinjäger Teddy® Fabric Tops and Teddy® Cargo Nets. The open design allows for great visibility while keeping your cargo inside of the vehicle. Made in the USA. Installation can be done by one person in 15 minutes.

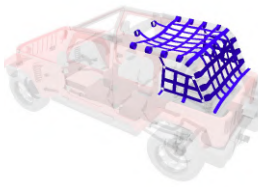
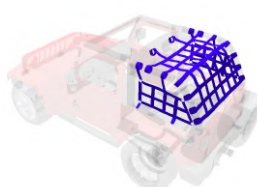

WARNING: Cancer and Reproductive Harm

JK

Solar Fabric Teddy® Tops Made in the USA

Covers FRONT Seat



Our Teddy® Top Solar Screens reduce direct sunlight, keeping both you and your Jeep cooler, and can remain on your Jeep long term as they are compatible with factory hard tops, soft tops, Steinjäger Teddy® Cargo Covers and Teddy® Cargo Nets. Made in the USA.



JK/JKU 2007-2009

JK/JKU 2010-2018

	Black	J0043976	J0043993
	Blue	J0043979	J0043996
	Burgundy	J0043985	J0044002
	Gray	J0043980	J0043997
	Green	J0043982	J0043999
	Green, Dark	J0043986	J0044003
	Mauve	J0043987	J0044004
	Orange	J0043977	J0043994
	Red	J0043984	J0044001
	Tan	J0043981	J0043998
	White	J0043978	J0043995
	Yellow	J0043983	J0044000

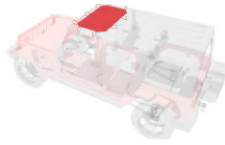
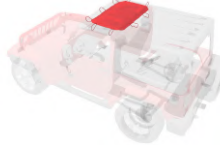

Cargo Covers for JK (2 Door)



Our Cargo Covers install in under 5 minutes and help keep your cargo inside your Jeep when you have your soft top down or your hard top off. Made in the USA.

For JKU (4 Door)



WARNING: Cancer and Reproductive Harm

Solar Fabric Teddy® Tops













Made in the USA

JKU

Covers Front AND Back Seats



Our Teddy® Top Solar Screens reduce direct sunlight, keeping both you and your Jeep cooler. Our Teddy® Top Solar Screen can remain on your Jeep long term as it is compatible with factory hard tops, soft tops, Steinjäger Teddy® Cargo Covers and Teddy® Cargo Nets. Made in the USA. Installation can be done by one person in 15 minutes.

	2 Door JK 2007-2018	4 Door JKU 2007-2009	4 Door JKU 2010-2018
 Black	J0041662	J0041463	J0041320
 Blue	J0043717	J0043697	J0043731
 Burgundy	J0043723	J0043703	J0043693
 Gray	J0043718	J0043698	J0043732
 Green	J0043720	J0043700	J0043734
 Green, Dark	J0043724	J0043704	J0043694
 Mauve	J0043725	J0043705	J0043695
 Orange	J0041663	J0041464	J0041465
 Red	J0043722	J0043702	J0043736
 Tan	J0043719	J0043699	J0043733
 White	J0043716	J0043696	J0043730
 Yellow	J0043721	J0043701	J0043735

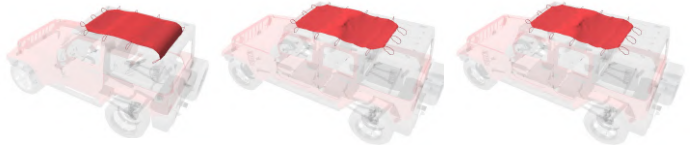

WARNING: Cancer and Reproductive Harm

LED Brackets

LED Lights available online



	Lower Windshield A	Lower Windshield B	Hood Mounted
 Bare	J0049152	J0041660	J0041441
 Black	J0049153	J0040929	J0041042
 Text Black	J0049163	J0041571	J0041439
 SW Blue	J0049156	J0041564	J0041432
 Playboy Blue	J0049157	J0041565	J0041433
 Neon Green	J0049159	J0041567	J0041435
 Fluor' Orange	J0049154	J0041562	J0041430
 Locas Green	J0049161	J0041569	J0041437
 Military Beige	J0049162	J0041570	J0041438
 Pinky	J0049160	J0041568	J0041436
 Lemon Peel	J0049158	J0041566	J0041434
 Red Baron	J0049155	J0041563	J0041431
 Sinbad Purple	J0049165	J0043974	J0043607
 Cloud White	J0049166	J0043975	J0043609
 Gray Hammer	J0049164	J0041572	J0041440
 Gecko Green	J0049168	J0046392	J0046510
 Hot Pink	J0049169	J0046393	J0046511
 Neon Yellow	J0049167	J0046391	J0046509
	3/8" Mounting Hole makes this compatible with almost every LED on the market.	1/2" Mounting Hole makes this compatible with almost every LED on the market.	Adjustable Tube Angle



WARNING: Cancer and Reproductive Harm

LED Brackets

Made in the USA

JK

LED Brackets



LED Lights available online



A-Pillar

Front Grill

Bumper Light Bar

	Bare	J0047358	J0041402	J0045700
	Black	J0047359	J0041388	J0045688
	Text Black	J0047369	J0041401	J0045699
	SW Blue	J0047362	J0041393	J0045691
	Playboy Blue	J0047363	J0041394	J0045692
	Neon Green	J0047365	J0041396	J0045694
	Fluor' Orange	J0047360	J0041391	J0045689
	Locas Green	J0047367	J0041398	J0045696
	Military Beige	J0047368	J0041399	J0045697
	Pinky	J0047366	J0041397	J0045695
	Lemon Peel	J0047364	J0041395	J0045693
	Red Baron	J0047361	J0041392	J0045690
	Sinbad Purple	J0047371	J0044773	J0046852
	Cloud White	J0047372	J0044774	J0046853
	Gray Hammer	J0047370	J0041400	J0045698
	Gecko Green	J0047374	J0046395	J0046850
	Hot Pink	J0047375	J0046396	J0046851
	Neon Yellow	J0047373	J0046394	J0046849



Compatible with winches, our Bracket has two slots that measure 0.300" high x 7.800" long onto which you can mount your LEDs.

See mounting point dimensions online



WARNING: Cancer and Reproductive Harm

License Plate Relocator

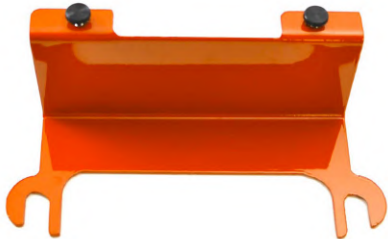

License Plate Relocator



Bare Metal	J0045831
Black	J0045832
Texturized Black	J0045842
Southwest Blue	J0045835
Playboy Blue	J0045836
Neon Green	J0045838
Fl'orescent Orange	J0045833
Locas Green	J0045840
Military Beige	J0045841
Pinky	J0045839
Lemon Peel	J0045837
Red Baron	J0045834
Sinbad Purple	J0045844
Cloud White	J0045845
Gray Hammer'tn	J0045843
Gecko Green	J0046446
Hot Pink	J0046447
Neon Yellow	J0046445

Bare Metal	J0049068
Black	J0049069
Texturized Black	J0049079
Southwest Blue	J0049072
Playboy Blue	J0049073
Neon Green	J0049075
Fl'orescent Orange	J0049070
Locas Green	J0049077
Military Beige	J0049078
Pinky	J0049076
Lemon Peel	J0049074
Red Baron	J0049071
Sinbad Purple	J0049081
Cloud White	J0049082
Gray Hammer'tn	J0049080
Gecko Green	J0049084
Hot Pink	J0049085
Neon Yellow	J0049083

When you need to remove your license plate in order to use your winch, simply remove the thumbscrews and place in a safe location. Loosen, not remove, the fairlead and slip the bracket behind. There is no need to remove your hook or safety thimble. Made in the USA.

If you have removed your 3rd brake light and factory spare tire carrier in preparing your Jeep for off road use, you can use this kit to hide the unsightly openings in the factory tailgate. Made in the USA.

Fits TJ, LJ, JK and JKU

Fits JK and JKU



WARNING: Cancer and Reproductive Harm

Fender Deletes & D-Ring Mounts

Made in the USA









JK

Front Fender Deletes



Steinjäger Front Fender Deletes give you the extra room for large tire clearance while still giving you a finished look. Made from 3/16" steel in the USA. Stainless hardware included. Bolt-on installation.



	Bare Metal	J0048777
	Black	J0048778
	Texturized Black	J0048788
	Southwest Blue	J0048781
	Playboy Blue	J0048782
	Neon Green	J0048784
	Fluorescent Orange	J0048779
	Locas Green	J0048786
	Military Beige	J0048787









	Pinky	J0048785
	Lemon Peel	J0048783
	Red Baron	J0048780
	Sinbad Purple	J0048790
	Cloud White	J0048791
	Gray Hammer'tn	J0048789
	Gecko Green	J0048793
	Hot Pink	J0048794
	Neon Yellow	J0048792

D-Ring Mounts



Our D-Ring Mounts can be mounted to any bumper utilizing 1/2" bolt holes with a 5.1" x 2.5" bolt pattern. Kit includes 4 stainless steel allen head bolts with 1/2-13 threads.



	Bare Metal	J0045341
	Black	J0045327
	Texturized Black	J0045337
	Southwest Blue	J0045330
	Playboy Blue	J0045331
	Neon Green	J0045333
	Fluorescent Orange	J0045328
	Locas Green	J0045335
	Military Beige	J0045336

	Pinky	J0045334
	Lemon Peel	J0045332
	Red Baron	J0045329
	Sinbad Purple	J0045339
	Cloud White	J0045340
	Gray Hammer'tn	J0045338
	Gecko Green	J0046407
	Hot Pink	J0046408
	Neon Yellow	J0046406



WARNING: Cancer and Reproductive Harm

Harness Bar Kit



Our Harness Bars are designed to not only stiffen up the pillars, but also to give you a solid place to attach your shoulder harness straps. Installation is simple, but requires a few hand tools and a drill. Made in the USA.

Part # format is J00xxxxx	2 Door JK Front Seat	2 Door JK Rear Seat	4 Door JKU Front Seat	4 Door JKU Rear Seat
Bare Metal	48506	48264	47552	48462
Black	48507	48265	47553	48463
Texturized Black	48517	48275	47563	48473
Southwest Blue	48510	48268	47556	48466
Playboy Blue	48511	48269	47557	48467
Neon Green	48513	48271	47559	48469
Fluorescent Orange	48508	48266	47554	48464
Locas Green	48515	48273	47561	48471
Military Beige	48516	48274	47562	48472
Pinky	48514	48272	47560	48470
Lemon Peel	48512	48270	47558	48468
Red Baron	48509	48267	47555	48465
Sinbad Purple	48519	48277	47565	48475
Cloud White	48520	48278	47566	48476
Gray Hammer'tn	48518	48276	47564	48474
Gecko Green	48522	48280	47568	48478
Hot Pink	48523	48281	47569	48479
Neon Yellow	48521	48279	47567	48477



<- 2 Door JK Front Seat



<- 2 Door JK Rear Seat

4 Door JKU -> Rear Seat



WARNING: Cancer and Reproductive Harm

Rock Sliders

Made in the USA

JK

Rock Sliders



These simple to install rock sliders utilize the three body mounts on each side. Simply remove the body bolts and install the rock sliders with the new hardware supplied.

Made in the USA from 1.75" OD ASTM 513 Type 1 Tubing.



2 Door JK

4 Door JKU

Bare Metal	J0046840	J0046880
Black	J0044820	J0043899
Texturized Black	J0044830	J0043931
Southwest Blue	J0044823	J0043924
Playboy Blue	J0044824	J0043925
Neon Green	J0044826	J0043927
Fluorescent Orange	J0044821	J0043922
Locas Green	J0044828	J0043929
Military Beige	J0044829	J0043930
Pinky	J0044827	J0043928
Lemon Peel	J0044825	J0043926
Red Baron	J0044822	J0043923
Sinbad Purple	J0044832	J0043933
Cloud White	J0044833	J0043934
Gray Hammer'tn	J0044831	J0043932
Gecko Green	J0046398	J0046389
Hot Pink	J0046399	J0046390
Neon Yellow	J0046397	J0046388



Rock Sliders with Steinjäger Tube Doors, Door Nets, D-Rings, and LED Brackets



Phantom Style Available online



WARNING: Cancer and Reproductive Harm



Front Tubular Bumper



Rear Tubular Bumper

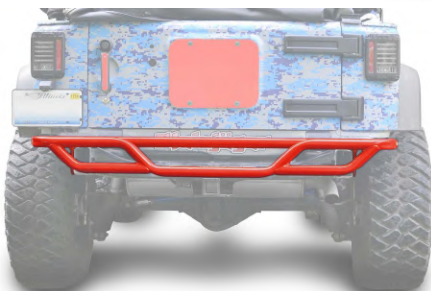

	Bare Metal	J0048118
	Black	J0048119
	Texturized Black	J0048129
	Southwest Blue	J0048122
	Playboy Blue	J0048123
	Neon Green	J0048125
	Fl'rescent Orange	J0048120
	Locas Green	J0048127
	Military Beige	J0048128
	Pinky	J0048126
	Lemon Peel	J0048124
	Red Baron	J0048121
	Sinbad Purple	J0048131
	Cloud White	J0048132
	Gray Hammer'tn	J0048130
	Gecko Green	J0048134
	Hot Pink	J0048135
	Neon Yellow	J0048133

	Bare Metal	J0048157
	Black	J0048158
	Texturized Black	J0048168
	Southwest Blue	J0048161
	Playboy Blue	J0048162
	Neon Green	J0048164
	Fl'rescent Orange	J0048159
	Locas Green	J0048166
	Military Beige	J0048167
	Pinky	J0048165
	Lemon Peel	J0048163
	Red Baron	J0048160
	Sinbad Purple	J0048170
	Cloud White	J0048171
	Gray Hammer'tn	J0048169
	Gecko Green	J0048173
	Hot Pink	J0048174
	Neon Yellow	J0048172

The Steinjäger Tubular Bumper is made in the USA from 1.750" OD x 0.120" W Tubing, and comes with a standard 4x10 winch plate along with fairlead mounting points. Stainless Hardware is included. Note: some Jeeps will require a vacuum pump relocation kit.



WARNING: Cancer and Reproductive Harm

Rear Bumpers

Made in the USA

JK

Rear Bumper



with D-Ring Mounts



	Bare Metal	J0047859
	Black	J0047860
	Texturized Black	J0047870
	Southwest Blue	J0047863
	Playboy Blue	J0047864
	Neon Green	J0047866
	Fluorescent Orange	J0047861
	Locas Green	J0047868
	Military Beige	J0047869
	Pinky	J0047867
	Lemon Peel	J0047865
	Red Baron	J0047862
	Sinbad Purple	J0047872
	Cloud White	J0047873
	Gray Hammer'tn	J0047871
	Gecko Green	J0047875
	Hot Pink	J0047876
	Neon Yellow	J0047874

	Bare Metal	J0048136
	Black	J0048137
	Texturized Black	J0048147
	Southwest Blue	J0048140
	Playboy Blue	J0048141
	Neon Green	J0048143
	Fluorescent Orange	J0048138
	Locas Green	J0048145
	Military Beige	J0048146
	Pinky	J0048144
	Lemon Peel	J0048142
	Red Baron	J0048139
	Sinbad Purple	J0048149
	Cloud White	J0048150
	Gray Hammer'tn	J0048148
	Gecko Green	J0048152
	Hot Pink	J0048153
	Neon Yellow	J0048151

The Steinjäger Rear Bumper will give your Jeep a fresh new look. The sleek design covers up and caps the unsightly frame rails and tucks tightly to the body. Made of 3/16" thick steel plate. Made in the USA.



WARNING: Cancer and Reproductive Harm

Crossover Steering Kit



Spare Tire Delete Plates



Made in the USA from 1/8" steel. Uses factory bolts. Available with custom laser images or private labeling.

Use our Delete Plate to clean up the look of your Jeep.

Bare Metal	J0050264
Black	J0050265
Texturized Black	J0050275
Southwest Blue	J0050268
Playboy Blue	J0050269
Neon Green	J0050271
Fluorescent Orange	J0050266
Locas Green	J0050273
Military Beige	J0050274
Pinky	J0050272
Lemon Peel	J0050270
Red Baron	J0050267
Sinbad Purple	J0050277
Cloud White	J0050278
Gray Hammer'tn	J0050276
Gecko Green	J0050280
Hot Pink	J0050281
Neon Yellow	J0050279

Bare Metal	J0043935
Black	J0040922
Texturized Black	J0043936
Southwest Blue	J0043939
Playboy Blue	J0043940
Neon Green	J0043942
Fluorescent Orange	J0043937
Locas Green	J0043944
Military Beige	J0043945
Pinky	J0043943
Lemon Peel	J0043941
Red Baron	J0043938
Sinbad Purple	J0043947
Cloud White	J0043948
Gray Hammer'tn	J0043946
Gecko Green	J0046537
Hot Pink	J0046538
Neon Yellow	J0046536

Upgrade your factory steering for off road use. Made in the USA from 1.50 OD x 0.25 DOM Tubing. 3/4" Chrome Moly Heim Joints. Grade 8 hardware included. Requires drilling the spindles and pitman arm to 3/4. Pitman Arm required if you have more than 4" lift.

Tailgate Plug Kit



3 pieces/kit **J0047357**



WARNING: Cancer and Reproductive Harm

Sway Bars and End Links

Bolt-on and Do-It-Yourself Kits

JK

Front Sway Bars



J0040928

← adjustable

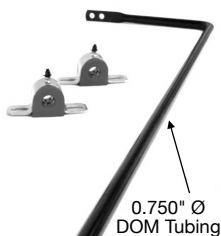

0.750" Ø
DOM Tubing

This undersized adjustable front sway bar helps improve stability at higher speeds, and gives you more flex when off-roading.

Sway Bar Hanger Kit



Hold your sway bar and end links out of the way when they are disconnected. Made the USA. 2 pcs in kit.



Black **J0043954**



Blue **J0043955**



Gray **J0043957**



Orange **J0043958**



Red **J0043956**

Quick Disconnect End Links

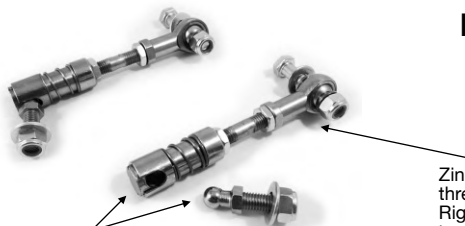

Metal-on-Metal Spring Loaded Ball Joint provides strength and ease of disconnecting.

Front

0.0 - 2.0" Lift Height **J0030554**

2.5 - 5.0" Lift Height **J0030555**

5.5 - 8.0" Lift Height **J0030556**

Zinc Plated steel Rod is threaded Left Hand and Right Hand to allow easy length adjustments.



Similar design to front links, except we've added a rubber boot to help protect the heims. Rod lengths based on rear geometry.

Rear

0.0 - 2.0" Lift Height **J0031035**

2.5 - 5.0" Lift Height **J0031036**

5.5 - 8.0" Lift Height **J0031037**

NON Disconnecting End Links

Front

0.0 - 2.0" **J0041011**

2.5 - 5.0" **J0041012**

5.5 - 8.0" **J0041013**

Rear

0.0 - 2.0" **J0030557**

2.5 - 5.0" **J0030558**

5.5 - 8.0" **J0030559**

Do It Yourself End Links

J0031207



Kit includes 1" OD x 0.095 DOM Tubes, studded chrome moly heims, thread bungs, boots and all hardware



Premium Front Track Bars

Fits stock to 6 inch lifts

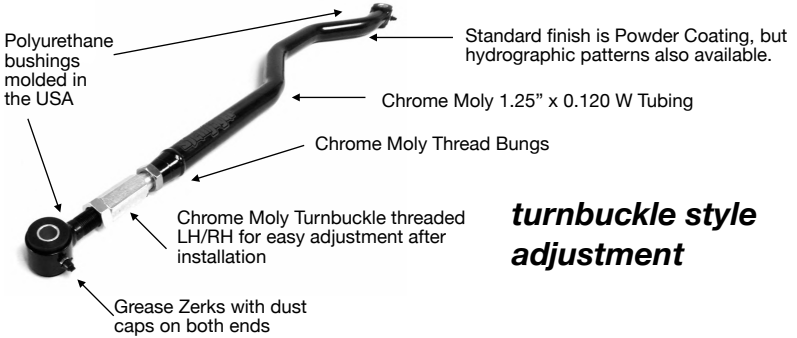

turnbuckle style adjustment

	<u>Left Hand Drive</u>	<u>Right Hand Drive</u>
	Bare Metal J0046168	J0047669
	Black J0044777	J0047670
	Texturized Black J0046178	J0047680
	Southwest Blue J0046171	J0047673
	Playboy Blue J0046172	J0047675
	Neon Green J0046174	J0047676
	Fluorescent Orange J0046169	J0047671
	Locas Green J0046176	J0047678
	Military Beige J0046177	J0047679
	Pinky J0046175	J0047677
	Lemon Peel J0046173	J0047675
	Red Baron J0046170	J0047672
	Sinbad Purple J0046180	J0047682
	Cloud White J0046181	J0047683
	Gray Hammer'tn J0046179	J0047681
	Gecko Green J0046588	J0047685
	Hot Pink J0046589	J0047686
	Neon Yellow J0046587	J0047684

Poly/Heim Style

J0044782



For stock to 6" Lifts

Rebuild Kit



J0045404



Fits Steinjäger Track Bars

Limiter Kit



J0045847



WARNING: Cancer and Reproductive Harm

Rear Panhard Bars

including Right Hand Drive Options

JK

Rear Panhard Bars



Fits stock to 6 inch lifts

turnbuckle style adjustment

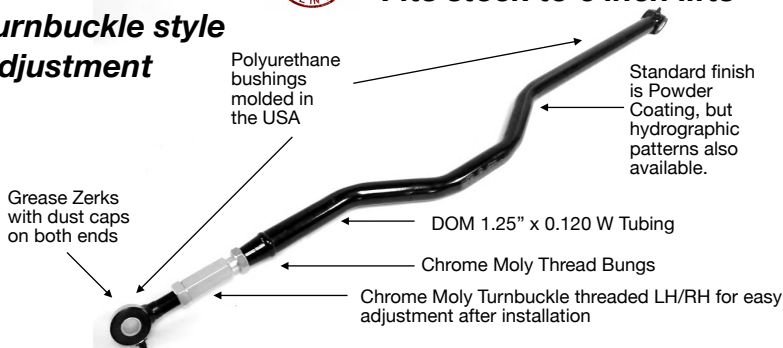

Poly/Heim Design

J0041428



For stock to 6" Lifts

Rebuild Kit



J0045405



Fits Steinjäger Panhard Bars

Left Hand Drive

Bare Metal	J0046813
Black	J0031389
Texturized Black	J0046611
Southwest Blue	J0046601
Playboy Blue	J0046602
Neon Green	J0046604
Fluorescent Orange	J0046599
Locas Green	J0046606
Military Beige	J0046607
Pinky	J0046605
Lemon Peel	J0046603
Red Baron	J0046600
Sinbad Purple	J0046609
Cloud White	J0046610
Gray Hammer'tn	J0046608
Gecko Green	J0046613
Hot Pink	J0046614
Neon Yellow	J0046612

Right Hand Drive

J0047704
J0047705
J0047715
J0047708
J0047709
J0047711
J0047706
J0047713
J0047714
J0047712
J0047710
J0047707
J0047717
J0047718
J0047716
J0047720
J0047721
J0047719

Chrome Moly designs available online



WARNING: Cancer and Reproductive Harm



Front Lower



Front Uppers



Made in the USA

Standard finish is Powder Coating, but hydrographic patterns also available.

Poly Bushings have grease zerks

Front Lower Control Arms

Front Upper Control Arms

Lift & Tube Size ->	0-2.5" Lift		2.5-4.0" Lift	
	1.750 x 0.12 Tube	DOM Steel	1.750 x 0.250 Tube	DOM Steel

Tube Material ->	0-2.5" Lift 1.750 x 0.12 Tube DOM Steel	2.5-4.0" Lift 1.750 x 0.250 Tube DOM Steel	0.0-4.0" Lift 1.50 x 0.120 Tube DOM Steel
Black	J0041277	J0041278	J0041275
Text Black	J0046751	J0047002	J0046768
SW Blue	J0046744	J0046995	J0046761
Playboy Blue	J0046745	J0046996	J0046762
Neon Green	J0046747	J0046998	J0046764
FL Orange	J0046742	J0046993	J0046759
Locas Green	J0046749	J0047000	J0046766
Military Beige	J0046750	J0047001	J0046767
Pinky	J0046748	J0046999	J0046765
Lemon Peel	J0046746	J0046997	J0046763
Red Baron	J0046743	J0046994	J0046760
Sinbad Purple	J0046753	J0047004	J0046770
Cloud White	J0046754	J0047005	J0046771
Gray Hammer	J0046752	J0047003	J0046769
Gecko Green	J0046756	J0047007	J0046773
Hot Pink	J0046757	J0047008	J0046774
Neon Yellow	J0046755	J0047006	J0046772



WARNING: Cancer and Reproductive Harm

Control Arms

Made in the USA

JK



Rear Lower



Rear Uppers



Made in the USA

Standard finish is Powder Coating, but hydrographic patterns also available.

Poly Bushings have grease zerks

Rear Lower Control Arms

Rear Upper Control Arms

Lift & Tube Size ->	0-2.5" Lift	2.5-4.0" Lift	0.0-4.0" Lift
Tube Material ->	1.750 x 0.12 Tube	1.750 x 0.250 Tube	1.50 x 0.120 Tube
	DOM Steel	DOM Steel	DOM Steel

	Black	J0041273	J0041274	J0041271
	Text Black	J0046833	J0046984	J0046785
	SW Blue	J0046826	J0046977	J0046778
	Playboy Blue	J0046827	J0046978	J0046779
	Neon Green	J0046829	J0046980	J0046781
	FL Orange	J0046824	J0046975	J0046776
	Locas Green	J0046831	J0046982	J0046783
	Military Beige	J0046832	J0046983	J0046784
	Pinky	J0046830	J0046981	J0046782
	Lemon Peel	J0046828	J0046979	J0046780
	Red Baron	J0046825	J0046976	J0046777
	Sinbad Purple	J0046835	J0046986	J0046787
	Cloud White	J0046836	J0046987	J0046788
	Gray Hammer	J0046834	J0046985	J0046786
	Gecko Green	J0046838	J0046989	J0046790
	Hot Pink	J0046839	J0046990	J0046791
	Neon Yellow	J0046837	J0046988	J0046789



WARNING: Cancer and Reproductive Harm

Suspension Coil Springs



Made in the USA

Each kit includes two Springs.

Springs are **single rate**.

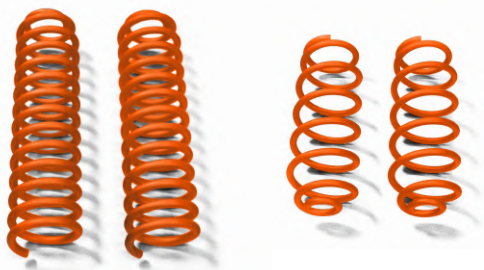

FRONT Coil Springs

REAR Coil Springs

Lift Height -> 0-2.5" Lift 4.0" Lift 0-2.5" Lift 4.0" Lift

J00# J00# J00# J00#

	Bare Metal	46644	46616	46645	46617
	Black	46646	46618	46663	46619
	SW Blue	46649	46622	46666	46634
	Playboy Blue	46650	46623	46667	46635
	Neon Green	46652	46625	46669	46637
	Flr Orange	46647	46620	46664	46632
	Locas Green	46654	46627	46671	46639
	Military Beige	46655	46628	46672	46640
	Pinky	46653	46626	46670	46638
	Lemon Peel	46651	46624	46668	46636
	Red Baron	46648	46621	46665	46633
	SB Purple	46658	46630	46675	46642
	Cloud White	46659	46631	46676	46643
	Gray Hammer	46657	46629	46674	46641
	Gecko Green	46661	46684	46678	46685
	Hot Pink	46662	46688	46679	46689
	Neon Yellow	46660	46680	46677	46681

PRICES INCLUDE DELIVERY



2.5" Lift Kits

Made in the USA

JK

Lift Kits, 2.5" for JK and JKU

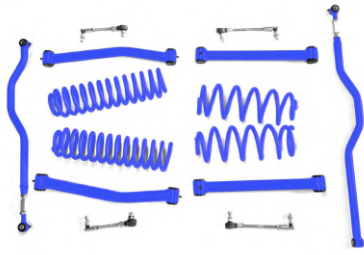

Bare Metal	J0046812
Black	J0046692
Texturized Black	J0046702
Southwest Blue	J0046695
Playboy Blue	J0046696
Neon Green	J0046698
Fl'orescent Orange	J0046693
Locas Green	J0046700
Military Beige	J0046701
Pinky	J0046699
Lemon Peel	J0046697
Red Baron	J0046694
Sinbad Purple	J0046704
Cloud White	J0046705
Gray Hammer'tn	J0046703
Gecko Green	J0046707
Hot Pink	J0046708
Neon Yellow	J0046706

Bare Metal	J0046899
Black	J0046882
Texturized Black	J0046892
Southwest Blue	J0046885
Playboy Blue	J0046886
Neon Green	J0046888
Fl'orescent Orange	J0046883
Locas Green	J0046890
Military Beige	J0046891
Pinky	J0046889
Lemon Peel	J0046887
Red Baron	J0046884
Sinbad Purple	J0046894
Cloud White	J0046895
Gray Hammer'tn	J0046893
Gecko Green	J0046897
Hot Pink	J0046898
Neon Yellow	J0046896

- Panhard Bar is 1.250" x 0.120" W DOM Tubing.
- Track Bar is 1.250" x 0.120 W Chrome Moly Tubing.
- Thread Bungs are Chrome Moly.
- Double Adjustable Panhard Bar and Track Bar.

- End Links come with rubber Dust Boots
- All Track Bars, Panhard Bars, Springs and Control Arms are Powder Coated.
- All Poly Bushings have a Grease Zerk & Cap.

Lifetime Warranty on track bar, panhard bar, control arms, and poly bushings. One year warranty on springs and end links. These kits are designed for moderate off-road use. Made in the USA.



WARNING: Cancer and Reproductive Harm



JK

2.5" Lift Kits Made in the USA

Lift Kits, 2.5" for JK and JKU

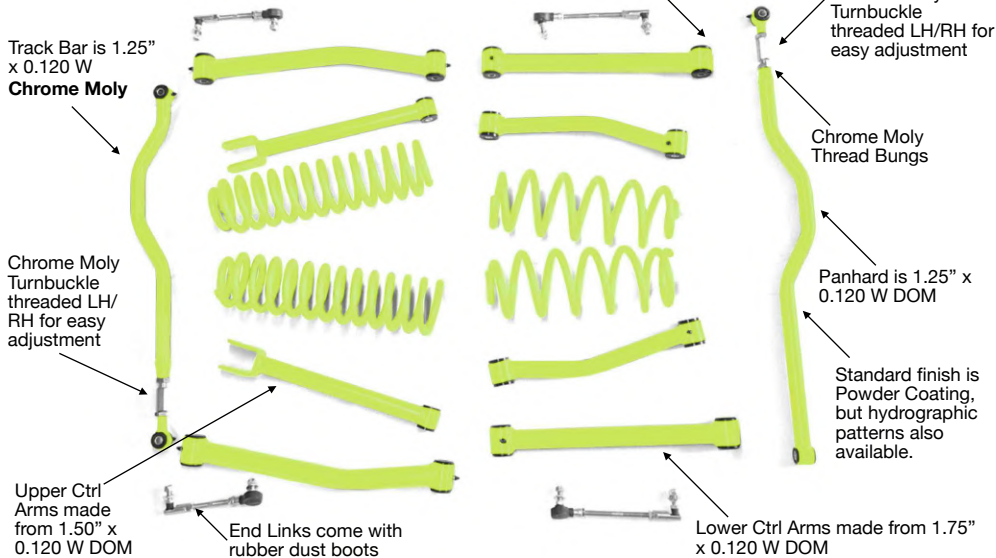

Lifetime Warranty on the control arms, track bar, and panhard bar, including the poly bushings. One year warranty on springs and end links. These kits are designed for moderate off-road use.

	Bare Metal	J0046967
	Black	J0046950
	Texturized Black	J0046960
	Southwest Blue	J0046953
	Playboy Blue	J0046954
	Neon Green	J0046956
	Fluorescent Orange	J0046951
	Locas Green	J0046958
	Military Beige	J0046959

	Pink	J0046957
	Lemon Peel	J0046955
	Red Baron	J0046952
	Sinbad Purple	J0046962
	Cloud White	J0046963
	Gray Hammer'tn	J0046961
	Gecko Green	J0046965
	Hot Pink	J0046966
	Neon Yellow	J0046964

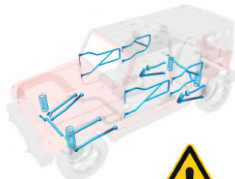

Use our free online 3D Configurator to design and color match your dream Jeep.

RHD ONLINE



WARNING: Cancer and Reproductive Harm

4.0" Lift Kits

Made in the USA

JK

Lift Kits, 4" for JK and JKU



All poly bushings come with grease zerks

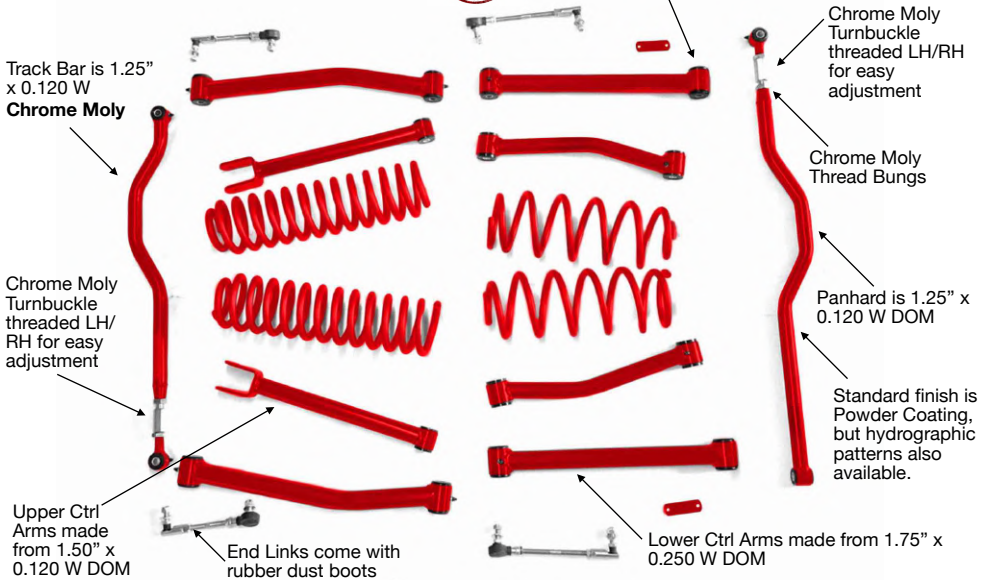

Lifetime Warranty on the control arms, track bar, and panhard bar, including the poly bushings. One year warranty on springs and end links. These kits are designed for moderate off-road use.

	Bare Metal	J0044941
	Black	J0041262
	Texturized Black	J0044937
	Southwest Blue	J0044930
	Playboy Blue	J0044931
	Neon Green	J0044933
	Fluorescent Orange	J0044928
	Locas Green	J0044935
	Military Beige	J0044936

	Pinky	J0044934
	Lemon Peel	J0044932
	Red Baron	J0044929
	Sinbad Purple	J0044939
	Cloud White	J0044940
	Gray Hammer'tn	J0044938
	Gecko Green	J0046561
	Hot Pink	J0046562
	Neon Yellow	J0046560



WARNING: Cancer and Reproductive Harm

RHD ONLINE





Tubular Trail Doors

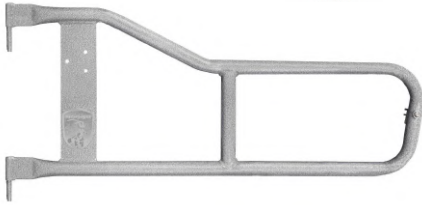

Our classic and original trail Tube Door design.

	Black	J0029673
	Texturized Black	J0041016
	Southwest Blue	J0040989
	Playboy Blue	J0040990
	Neon Green	J0040991
	Fluorescent Orange	J0040992
	Locas Green	J0040993
	Military Beige	J0040994
	Pinky	J0040995
	Lemon Peel	J0040996
	Red Baron	J0040997
	Sinbad Purple	J0042641
	Cloud White	J0042642
	Gray Hammer'tn	J0041338
	Gecko Green	J0046489
	Hot Pink	J0046490
	Neon Yellow	J0046488

Premium Flag Doors



Our premium Flag Doors come with upgraded latches and door limit straps. Doors have a formed integral arm rest. Made from 3/16" steel in the USA.

	Black	J0050149
	Texturized Black	J0050159
	Southwest Blue	J0050152
	Playboy Blue	J0050153
	Neon Green	J0050155
	Fluorescent Orange	J0050150
	Locas Green	J0050157
	Military Beige	J0050158
	Pinky	J0050156
	Lemon Peel	J0050154
	Red Baron	J0050151
	Sinbad Purple	J0050161
	Cloud White	J0050162
	Gray Hammer'tn	J0050160
	Gecko Green	J0050164
	Hot Pink	J0050165
	Neon Yellow	J0050163



Arm Rests - see Page 23



Latch Upgrades - see Page 7



Tube Door Straps
J0041621



Doors for Renegade BU



Front and Rear Doors available



WARNING: Cancer and Reproductive Harm

Door Hangers & Accessories

Arm Rests, Latches, Limiting Straps

TJ/LJ

Wall Mounted Door Hanger

Holds Two Doors



Mounts to wall studs and holds factory and tubular doors.

Factory Door Limiting Straps



For TJ stock doors.
2 Straps per kit.



Black	J0043901
Blue	J0043905
Gray	J0043904
Orange	J0043902
Red	J0043903

	Bare Metal	J0044946
	Black	J0030813
	Texturized Black	J0044956
	Southwest Blue	J0044949
	Playboy Blue	J0044950
	Neon Green	J0044952
	Fluorescent Orange	J0044947
	Locas Green	J0044954
	Military Beige	J0044955

	Pinky	J0044953
	Lemon Peel	J0044951
	Red Baron	J0044948
	Sinbad Purple	J0044958
	Cloud White	J0044959
	Gray Hammer'tn	J0044957
	Gecko Green	J0046410
	Hot Pink	J0046411
	Neon Yellow	J0046409

CB Mount



Mounts easily using the 2 upper dash bolts and tucks your CB cleanly out of the way. Made in the USA from 11 gauge steel. Two 1/4" slots are spaced 1.625" apart and are 3" long.



	Bare Metal	J0050202
	Black	J0050203
	Texturized Black	J0050213
	Southwest Blue	J0050206
	Playboy Blue	J0050207
	Neon Green	J0050209
	Fluorescent Orange	J0050204
	Locas Green	J0050201
	Military Beige	J0050212

	Pinky	J0050210
	Lemon Peel	J0050208
	Red Baron	J0050205
	Sinbad Purple	J0050215
	Cloud White	J0050216
	Gray Hammer'tn	J0050214
	Gecko Green	J0050218
	Hot Pink	J0050219
	Neon Yellow	J0050217



WARNING: Cancer and Reproductive Harm

Door Mesh & Net Inserts

Fits Steinjäger Tube Doors



Door Mesh Inserts



Made in the USA. Prices include bungees and two door covers. Fits Steinjäger **TJ**, **YJ**, **CJ-7** and **CJ-8** tube doors.



Black J0041190

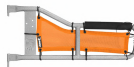

Orange J0041625



White J0041626

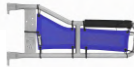

Royal Blue J0041627



Gray J0041628



Lemon Yellow J0041631



Red J0041632

Door Net Inserts

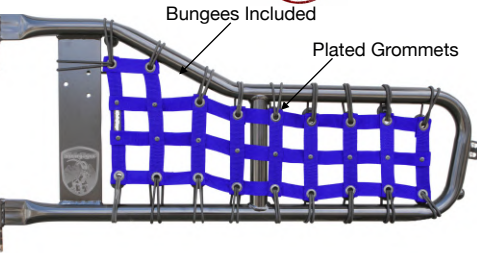

Made in the USA. Prices include bungees and two door nets. Fits Steinjäger **TJ** tube doors.



Black J0043570



Orange J0043689



Gray J0043690

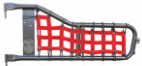

Red J0043691

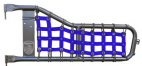

Blue J0043692

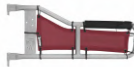

Burgundy J0043599

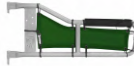

Green, Dark J0043600



Mauve J0043858



WARNING: Cancer and Reproductive Harm

Mirrors and Mirror Legs

fits the TJ, LJ, YJ, CJ-7 and CJ-8

TJ/LJ

Tube Door Mirror Legs



For Steinjäger Tube Doors on TJ, LJ, YJ, CJ-7, and CJ-8

Fits Steinjäger tube doors. Will also fit on factory doors.

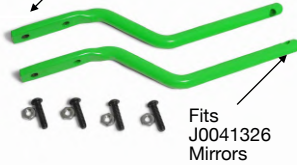

Fits J0041326 Mirrors

A Pillar Mirror Legs

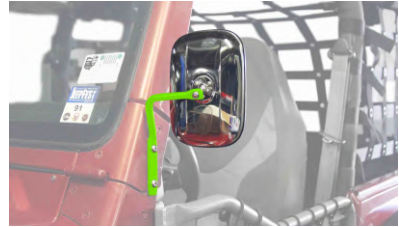

Includes 2 Mirrors, 2 Legs & Hardware

Black	J0046214
Texturized Black	J0046227
Southwest Blue	J0046226
Playboy Blue	J0046223
Neon Green	J0046221
Fluorescent Orange	J0046216
Locas Green	J0046219
Military Beige	J0046220
Pinky	J0046222
Lemon Peel	J0046218
Red Baron	J0046224
Sinbad Purple	J0046225
Cloud White	J0046215
Gray Hammer'tn	J0046217
Gecko Green	J0046597
Hot Pink	J0046598
Neon Yellow	J0046596

Black	J0047281
Texturized Black	J0047291
Southwest Blue	J0047284
Playboy Blue	J0047285
Neon Green	J0047287
Fluorescent Orange	J0047282
Locas Green	J0047289
Military Beige	J0047290
Pinky	J0047288
Lemon Peel	J0047286
Red Baron	J0047283
Sinbad Purple	J0047293
Cloud White	J0047294
Gray Hammer'tn	J0047292
Gecko Green	J0047296
Hot Pink	J0047297
Neon Yellow	J0047295

Mirrors

J0041326
2 Mirrors



Magnetic Hinge Legs

J0046183 2 Legs



Door Mirrors (Stock)

J0049394
2 Mirrors



WARNING: Cancer and Reproductive Harm

Stingers & Harness Bars

Made in the USA

Stinger



3/16" Plate Steel Bumper with 1.250" OD x 0.120" Wall Tubular Stinger with 3/16" Gussets. Includes D-Ring Mounts. Made in the USA.

D-Ring Mounts, Rear

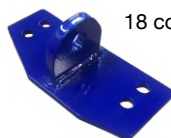

18 colors - see online



	Bare Metal	J0049284
	Black	J0049285
	Texturized Black	J0049295
	Southwest Blue	J0049288
	Playboy Blue	J0049289
	Neon Green	J0049291
	Fluorescent Orange	J0049286
	Locas Green	J0049293
	Military Beige	J0049294

	Pinky	J0049292
	Lemon Peel	J0049290
	Red Baron	J0049287
	Sinbad Purple	J0049297
	Cloud White	J0049298
	Gray Hammer'tn	J0049296
	Gecko Green	J0049300
	Hot Pink	J0049301
	Neon Yellow	J0049299

Harness Bar



	Bare Metal	J0048191
	Black	J0048192
	Texturized Black	J0048202
	Southwest Blue	J0048195
	Playboy Blue	J0048196
	Neon Green	J0048198
	Fluorescent Orange	J0048193
	Locas Green	J0048200
	Military Beige	J0048201

Lap Belt Mount

18 colors - see online



LED Lights

50" Bar - see online



	Pinky	J0048199
	Lemon Peel	J0048197
	Red Baron	J0048194
	Sinbad Purple	J0048204
	Cloud White	J0048205
	Gray Hammer'tn	J0048203
	Gecko Green	J0048207
	Hot Pink	J0048208
	Neon Yellow	J0048206



WARNING: Cancer and Reproductive Harm

Bumpers

Made in the USA

TJ/LJ

Front Bumpers (TJ/LJ)



3/16" Steel Plate with D-ring Mounts. Made in USA



	Bare Metal	J0048722
	Black	J0048723
	Texturized Black	J0048733
	Southwest Blue	J0048726
	Playboy Blue	J0048727
	Neon Green	J0048729
	Fluorescent Orange	J0048724
	Locas Green	J0048731
	Military Beige	J0048732

	Pinky	J0048730
	Lemon Peel	J0048728
	Red Baron	J0048725
	Sinbad Purple	J0048735
	Cloud White	J0048736
	Gray Hammer'tn	J0048734
	Gecko Green	J0048738
	Hot Pink	J0048739
	Neon Yellow	J0048737

Rear Bumpers (TJ/LJ)



Includes 7/8" D-ring Mounts. Made in USA



	Bare Metal	J0049302
	Black	J0049303
	Texturized Black	J0049313
	Southwest Blue	J0049306
	Playboy Blue	J0049307
	Neon Green	J0049309
	Fluorescent Orange	J0049304
	Locas Green	J0049311
	Military Beige	J0049312

	Pinky	J0049310
	Lemon Peel	J0049308
	Red Baron	J0049305
	Sinbad Purple	J0049315
	Cloud White	J0049316
	Gray Hammer'tn	J0049314
	Gecko Green	J0049318
	Hot Pink	J0049319
	Neon Yellow	J0049317

Brackets



J0049416



Rear Bumper Tie Ins

J0048481



Frame Repair Kit

J0048503



Rear Ctrl Arm Patch

J0049151



Frame Repair Kit



WARNING: Cancer and Reproductive Harm

Spare Tire Delete Plates and Hood Latch Kits

Spare Tire Delete Plates



WARNING: Cancer and Reproductive Harm

Made in the USA from 1/8" steel. Uses factory bolts. Available with custom laser images or private labeling.



	Bare Metal	J0046866
	Black	J0043675
	Texturized Black	J0043685
	Southwest Blue	J0043678
	Playboy Blue	J0043679
	Neon Green	J0043681
	Fluorescent Orange	J0043676
	Locas Green	J0043683
	Military Beige	J0043684

	Pinky	J0043682
	Lemon Peel	J0043680
	Red Baron	J0043677
	Sinbad Purple	J0043687
	Cloud White	J0043688
	Gray Hammer'tn	J0043686
	Gecko Green	J0046386
	Hot Pink	J0046387
	Neon Yellow	J0046385

Hood Latch Kits



J0023990

Plated Steel (dry climates only). Requires 33/64 drill bit and basic hand tools for installation



J0023987

Stainless Steel. Requires 33/64 drill bit and basic hand tools for installation



J0045424

Red Poly. Installation requires masking tape, 2 pairs of locking pliers and 2 phillips screw drivers. 2 per kit. Made in the USA.



J0045423

Black Poly. Installation requires masking tape, 2 pairs of locking pliers and 2 phillips screw drivers. 2 per kit. Made in the USA.



J0049911

Factory Replacement Hood Latch. One Latch - fits either side. Uses Factory Mounting Points. Does NOT include the hood bracket



J0049912

Pair of black locking hood catches.

Transfer Case Shifter Cable Grab Handles

TJ/LJ

Transfer Case Cable Shifter Kit



J0048041

for 231 Transfer Case
on Sport & Sahara

J0048480

for 241 Transfer Case
on Rubicon

The Steinjäger Transfer Case Shifter fixes problematic stock shifter linkage by replacing everything between the shifter and the transfer case.

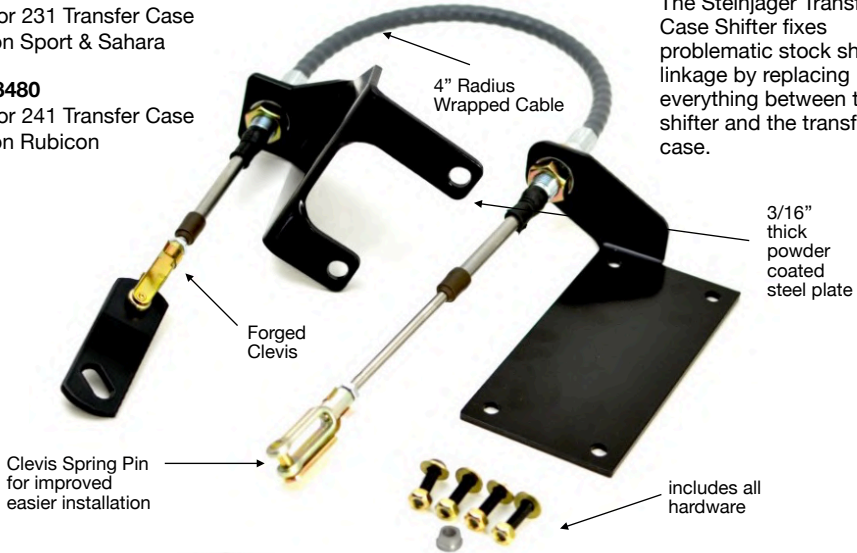

Grab Handles



Solid 3/4" Ø Bar & 1/4" Plate

Shifter Repair Kit



J0049398

Fits NP231 Transfer Case

Shifter Bezel



J0049413

For TJ models equipped with AX4, AX5, AX15 manual transmissions

	Bare Metal	J0048692
	Black	J0048693
	Texturized Black	J0048703
	Southwest Blue	J0048696
	Playboy Blue	J0048697
	Neon Green	J0048699
	Fluorescent Orange	J0048694
	Locas Green	J0048701
	Military Beige	J0048702

	Pinky	J0048700
	Lemon Peel	J0048698
	Red Baron	J0048695
	Sinbad Purple	J0048705
	Cloud White	J0048706
	Gray Hammer'tn	J0048704
	Gecko Green	J0048708
	Hot Pink	J0048709
	Neon Yellow	J0048707



WARNING: Cancer and Reproductive Harm

TJ/LJ

Foot Pegs

fits the TJ, LJ, YJ, CJ-7 and CJ-8



Wire Foot Pegs

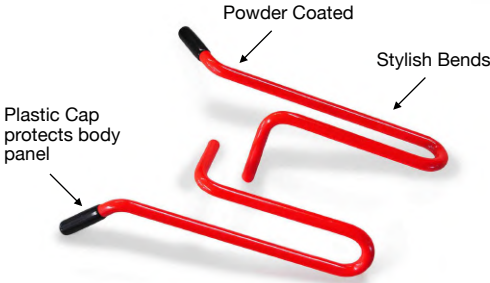

Also fits YJ, CJ-7, CJ-8

Premium Foot Pegs



	Bare Metal	J0045905
	Black	J0028970
	Texturized Black	J0045915
	Southwest Blue	J0045908
	Playboy Blue	J0045909
	Neon Green	J0045911
	Fl'rescent Orange	J0045906
	Locas Green	J0045913
	Military Beige	J0045914
	Pinky	J0045912
	Lemon Peel	J0045910
	Red Baron	J0045907
	Sinbad Purple	J0045917
	Cloud White	J0045918
	Gray Hammer'tn	J0045916
	Gecko Green	J0046576
	Hot Pink	J0046577
	Neon Yellow	J0046575

	Bare Metal	J0047013
	Black	J0043881
	Texturized Black	J0043891
	Southwest Blue	J0043884
	Playboy Blue	J0043885
	Neon Green	J0043887
	Fl'rescent Orange	J0043882
	Locas Green	J0043889
	Military Beige	J0043890
	Pinky	J0043888
	Lemon Peel	J0043886
	Red Baron	J0043883
	Sinbad Purple	J0043893
	Cloud White	J0043894
	Gray Hammer'tn	J0043892
	Gecko Green	J0046534
	Hot Pink	J0046535
	Neon Yellow	J0046533

Steinjäger's foot pegs are made in the USA. Both of our designs include a rubber or non-metallic component to prevent scratching. Do **NOT** operate your vehicle with any part of your body protruding beyond the vehicle. **Caution!**



WARNING: Cancer and Reproductive Harm

High Lift Mount Kits

Made in the USA

TJ/LJ

High Lift Hood Mount Kit



Easy-to-use bolt on kit. Kit includes powder coated bracket, plated nuts, and stainless steel studs. Made in the USA.



	Bare Metal	J0048286
	Black	J0048287
	Texturized Black	J0048297
	Southwest Blue	J0048290
	Playboy Blue	J0048291
	Neon Green	J0048293
	Fl'rescent Orange	J0048288
	Locas Green	J0048295
	Military Beige	J0048296

	Pinky	J0048294
	Lemon Peel	J0048292
	Red Baron	J0048289
	Sinbad Purple	J0048299
	Cloud White	J0048300
	Gray Hammer'tn	J0048298
	Gecko Green	J0048302
	Hot Pink	J0048303
	Neon Yellow	

High Lift Roll Bar Mount Kit



Clamps to Roll Bar

Stainless Steel Threaded Stems

Includes all hardware



	TJ Part#	LJ Part#	
	Bare Metal	J0047607	J0047625
	Black	J0047608	J0047626
	Texturized Black	J0047618	J0047636
	Southwest Blue	J0047611	J0047629
	Playboy Blue	J0047612	J0047630
	Neon Green	J0047614	J0047632
	Fl'rescent Orange	J0047609	J0047627
	Locas Green	J0047616	J0047634
	Military Beige	J0047617	J0047635
	Pinky	J0047615	J0047633
	Lemon Peel	J0047613	J0047631
	Red Baron	J0047610	J0047628
	Sinbad Purple	J0047620	J0047638
	Cloud White	J0047621	J0047639
	Gray Hammer'tn	J0047619	J0047637
	Gecko Green	J0047623	J0047641
	Hot Pink	J0047624	J0047642
	Neon Yellow	J0047622	J0047640

Molded Holder

J0046232



WARNING: Cancer and Reproductive Harm

TJ/LJ

Teddy® Cargo Nets

Made in the USA

Cargo Nets for the TJ



Our Teddy® Cargo Net covers the back half and sides of your TJ Wrangler. The open design allows for great visibility while keeping your cargo inside the vehicle. Made in the USA.

Double back straps allow adjustability and easy installation



Black grommets

2 inch wide webbing

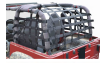

Black J0046110



Blue J0047018



Gray J0047019



Orange J0047020



Red J0047021



Made in Bushnell, IL USA

Cargo Nets for the LJ



Black J0047376



Blue J0047377



Gray J0047378



Orange J0047379



Red J0047380

Cargo Cover

J0041212 TJ



Hardtop Hardware Kit



J0045490

Stainless Steel components to replace your factory hardtop hardware. Fits TJ and YJ.

Soft Top Tailgate Bar

J0050282



Fits TJ
Soft Top Tailgate Bar
Replaces OE 55176736AB.



WARNING: Cancer and Reproductive Harm

Solar Screen Teddy® Tops

Made in the USA

TJ/LJ

Teddy® Top Solar Screens (Front Seat ONLY)



J0041460
Black



J0043710
Green



J0041461
Orange



J0043711
Yellow



J0043706
White



J0043712
Red



J0043707
Blue



J0043713
Burgundy



J0043708
Gray



J0043714
Dark Green



J0043709
Tan















J0043715
Mauve

For those who only want to cover the front seat, this Teddy® design has all the neat features of our other Teddy® Tops. made in the USA.

Teddy® Top Solar Screens (Front AND Back Seats)



Color	For TJ	For LJ	Color	For TJ	For LJ
 Black	J0045985	J0046868	 Burgundy	J0045994	J0046877
 Yellow	J0045992	J0046875	 Tan	J0045990	J0046873
 Blue	J0045988	J0046871	 Orange	J0045986	J0046869
 Dark Green	J0045995	J0046878	 Red	J0045993	J0046876
 Green	J0045991	J0046874	 Gray	J0045989	J0046872
 White	J0045987	J0046870	 Mauve	J0045996	J0046879



WARNING: Cancer and Reproductive Harm

Rear Sway Bar Kit



J0030153

Material: 1.050" inch OD x 0.109" Wall HREW
 Black Powder Coated
 Includes Poly Mounting Brackets

Sway Bar Hanger Kits

See Page 45



Sway Bar End Links



Application

Style

For TJ's
at Stock
Height

For TJ's
with 2"
Lift

For TJ's
with 4"
Lift

For TJ's
with 6"
Lift

Front Quick
Disconnect

Spring Loaded
Ball Joint

J0030837

J0030838

J0030839

J0030840



Rear Quick
Disconnect

Spring Loaded
Ball Joint

J0031038

J0031039

J0031040

J0031041



Front
Disconnect

Pin Style

J0028972

J0028974

J0028975

J0028976



Rear

Pin Style

J0030297

J0030298

J0030299

J0030300

Limb Riser Kit (TJ/LJ)



J0030944

Our Limb Risers are made in the USA of stainless wire rope with a non-metallic jacket, stainless quick disconnect ball joints, and powder coated steel mounting brackets. Some drilling required for installation. Installation video online.

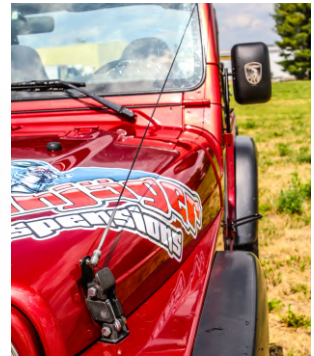

WARNING: Cancer and Reproductive Harm

Crossover Steering Kit

Steering Box Support Kit & Stabilizer

TJ

Crossover Steering Kits

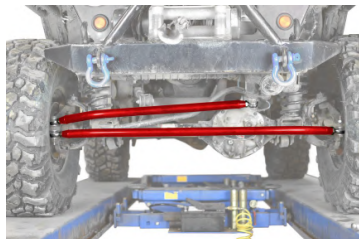

1.50 OD x 0.25 wall
DOM Tubing

Chrome Moly
Heim Joints

Made in the USA

Stabilizer Kit



J0048823



- fits 1.500 OD tubing
- made from 3/16" steel
- black powder coated
- includes stainless steel u-bolts, and zinc plated bolt, washer and lock nut

	Bare Metal	J0048524
	Black	J0048525
	Texturized Black	J0048535
	Southwest Blue	J0048528
	Playboy Blue	J0048529
	Neon Green	J0048531
	Fluorescent Orange	J0048526
	Locas Green	J0048533
	Military Beige	J0048534

	Pink	J0048532
	Lemon Peel	J0048530
	Red Baron	J0048527
	Sinbad Purple	J0048537
	Cloud White	J0048538
	Gray Hammer'tn	J0048536
	Gecko Green	J0048540
	Hot Pink	J0048541
	Neon Yellow	J0048539

Steering Box Skid

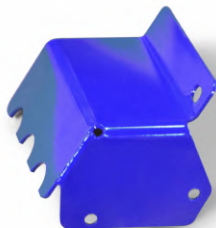

Made in the USA from
3/16" thick steel. Simple
installation.

	Bare Metal	J0049932
	Black	J0049913
	Texturized Black	J0049923
	Southwest Blue	J0049916
	Playboy Blue	J0049917
	Neon Green	J0049919
	Fluorescent Orange	J0049914
	Locas Green	J0049921
	Military Beige	J0049922

Rear View Mirror



J0049402

	Pink	J0049920
	Lemon Peel	J0049918
	Red Baron	J0049915
	Sinbad Purple	J0049925
	Cloud White	J0049926
	Gray Hammer'tn	J0049924
	Gecko Green	J0049928
	Hot Pink	J0049929
	Neon Yellow	J0049927



WARNING: Cancer and Reproductive Harm

TJ

Track Bars & Panhard Bars

Made in the USA

Front Track Bars

Fits TJ, LJ & XJ



Rear Panhard Bars

Fits TJ & LJ

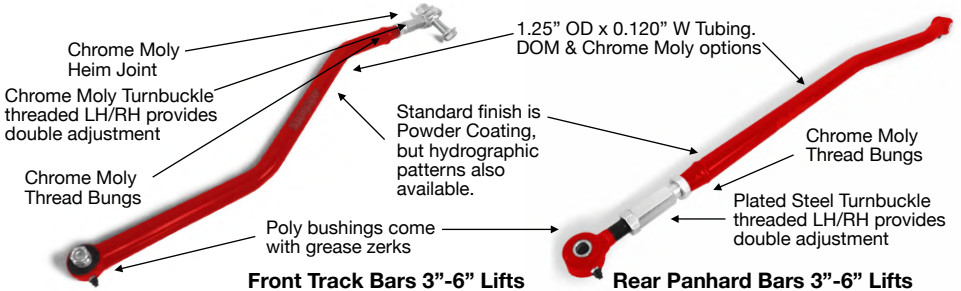

Front Track Bars 3"-6" Lifts

Rear Panhard Bars 3"-6" Lifts

	DOM Tubes	Chrome Moly	DOM Tubes	Chrome Moly
	J00#	J00#	J00#	J00#
Bare Metal	46140	46154	46094	46095
Black	30946	44779	30945	44780
Textured Blk	46150	46164	46077	46090
SW Blue	46143	46157	46070	46083
Playboy Blue	46144	46158	46071	46084
Neon Green	46146	46160	46073	46086
Flr Orange	46141	46155	46068	46081
Locas Green	46148	46162	46075	46088
Military Beige	46149	46163	46076	46089
Pinky	46147	46161	46074	46087
Lemon Peel	46145	46159	46072	46085
Red Baron	46142	46156	46069	46082
SB Purple	46152	46166	46079	46092
Cloud White	46153	46167	46080	46093
Gray Hammer	46151	46165	46078	46091
Gecko Green	46479	46482	46425	46428
Hot Pink	46480	46483	46426	46429
Neon Yellow	46478	46481	46424	46427



WARNING: Cancer and Reproductive Harm

Tie Rods & Control Arms

Made in the USA

TJ

Tie Rods (TJ, LJ & XJ)



Control Arms (TJ)

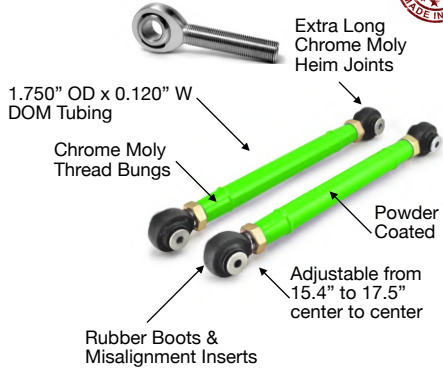
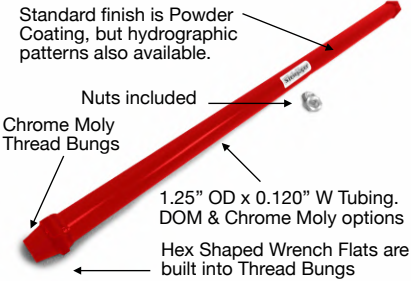

Tie Rods

Control Arms for 0" to 6" Lifts

	DOM Tubes	Chrome Moly	Front Lower	Rear Lower	
	<u>J00#</u>	<u>J00#</u>	<u>J00#</u>	<u>J00#</u>	
	Bare Metal	46112	46126	47315	47333
	Black	30947	31075	47316	47334
	Textured Blk	46122	46136	47326	47344
	SW Blue	46115	46129	47319	47337
	Playboy Blue	46116	46130	47320	47338
	Neon Green	46118	46132	47322	47340
	Flr Orange	46113	46127	47317	47335
	Locas Green	46120	46134	47324	47342
	Military Beige	46121	46135	47325	47343
	Pinky	46119	46133	47323	47341
	Lemon Peel	46117	46131	47321	47339
	Red Baron	46114	46128	47318	47336
	SB Purple	46124	46138	47328	47346
	Cloud White	46125	46139	47329	47347
	Gray Hammer	46123	46137	47327	47345
	Gecko Green	46470	46473	47331	47349
	Hot Pink	46471	46474	47332	47350
	Neon Yellow	46469	46472	47330	47348



WARNING: Cancer and Reproductive Harm

Rear Upper Control Arms

2" to 8" Lifts



J0041318 2 arms
• 1.500" x 0.120" W DOM

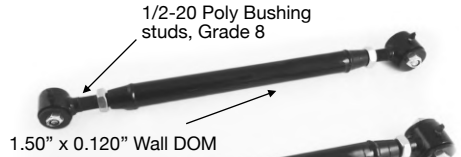

Front & Rear Lower Control Arms

2" to 8" Lifts



J0041314 2 arms
• fits Front or Rear
• 1.750" x 0.120" W DOM

1"-12 Poly Bushing studs, Grade 8

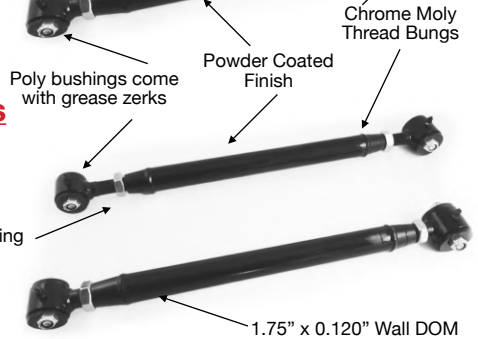

Front Upper Control Arms

2" to 8" Lifts



J0041319 2 arms
• 1.500" x 0.120" W DOM

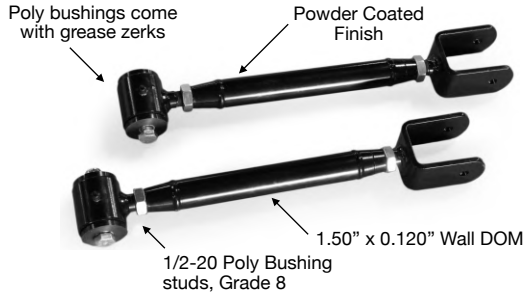

For 0" to 2" Lifts



Front Upper Control Arms



J0041316 2 arms
1.500" x 0.120" Wall DOM

Control Arm Clevis



J0043464
3/4-16 LH x 0.438 Bore



Rear Upper Control Arms



J0041317 2 arms
1.500" x 0.120" Wall DOM



WARNING: Cancer and Reproductive Harm

Long Arm Kits

Made in the USA

TJ

Long Arm Kits





















2" to 6" Lifts

- Install Time: 20 to 30 hours
- Requires welding
- Includes 8 double adjustable Control Arms
- Heim Joints are Chrome Moly
- Includes 2 Chassis Mounts
- Includes 1 Transmission Cross Member
- Includes all components shown in photo



Manual Transmission

Automatic Transmission

	DOM Tubes J00#	Chrome Moly Tubes J00#	DOM Tubes J00#	Chrome Moly Tubes J00#
 Bare Metal	46012	46040	46026	46054
 Black	30796	30795	31113	31112
 Textured Blk	46022	46050	46036	46064
 SW Blue	46015	46043	46029	46057
 Playboy Blue	46016	46044	46030	46058
 Neon Green	46018	46046	46032	46060
 Flr Orange	46013	46041	46027	46055
 Locas Green	46020	46048	46034	46062
 Military Beige	46021	46049	46035	46063
 Pinky	46019	46047	46033	46061
 Lemon Peel	46017	46045	46031	46059
 Red Baron	46014	46042	46028	46056
 SB Purple	46024	46052	46038	46066
 Cloud White	46025	46053	46039	46067
 Gray Hammer	46023	46051	46037	46065
 Gecko Green	46858	46860	46859	46861
 Hot Pink	46862	46864	46863	46865
 Neon Yellow	46854	46856	46855	46857



WARNING: Cancer and Reproductive Harm

YJ

Tube Doors Fits YJ, CJ-7 and CJ-8

TUBULAR DOORS FOR YJ, CJ-7, CJ-8

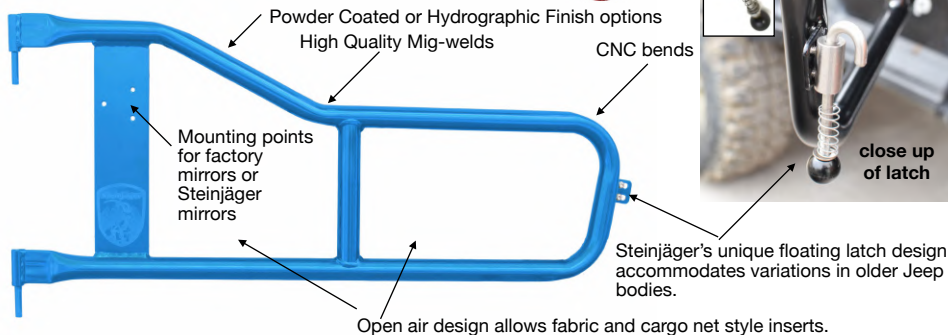

	Bare Metal	J0046712
	Black	J0043574
	Texturized Black	J0043584
	Southwest Blue	J0043577
	Playboy Blue	J0043578
	Neon Green	J0043580
	Fluorescent Orange	J0043575
	Locas Green	J0043582
	Military Beige	J0043583

	Pink	J0043581
	Lemon Peel	J0043579
	Red Baron	J0043576
	Sinbad Purple	J0043586
	Cloud White	J0043587
	Gray Hammer'tn	J0043585
	Gecko Green	J0046519
	Hot Pink	J0046520
	Neon Yellow	J0046518

Door Nets for Steinjäger YJ, CJ-7 & CJ-8 Tube Doors

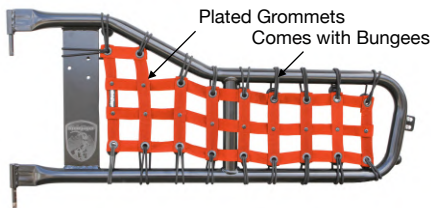

	Black	J0044923
	Blue	J0044927
	Gray	J0044926
	Orange	J0044924
	Red	J0044925

Lower Door Hinges



J0049875
Fits 76-06 CJ, YJ and TJ
Black Powder Coated



J0049394
Fits 87-02 TJ YJ factory half doors, 94-02 full doors



WARNING: Cancer and Reproductive Harm

Teddy® Top Solar Screens

Front Covers and Back Covers

YJ

Teddy® Top Solar Screens

Our Teddy® Top installs easily in minutes with the supplied bungee balls. Our tops will work with factory hard tops. Made in the USA.



Front & Back Covers Sold Separately

Front Cover

Front Cover

Rear Cover

Rear Cover

Covers rear seats only with the Family Style Roll Cage.

Does **NOT** work with the Sport Cage.

PRICES INCLUDE DELIVERY



Black
Front **J0045478**
Rear **J0045505**



Green
Front **J0045484**
Rear **J0045511**



Orange
Front **J0045479**
Rear **J0045506**

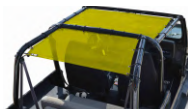

Yellow
Front **J0045485**
Rear **J0045512**



White
Front **J0045480**
Rear **J0045507**



Red
Front **J0045486**
Rear **J0045513**



Blue
Front **J0045481**
Rear **J0045508**



Burgundy
Front **J0045487**
Rear **J0045514**



Gray
Front **J0045482**
Rear **J0045509**



Dark Green
Front **J0045488**
Rear **J0045515**



Tan
Front **J0045483**
Rear **J0045510**



Mauve
Front **J0045489**
Rear **J0045516**

Hood Latch Kit - Stainless



J0049874
Fits YJ, CJ-5,
CJ-7, CJ-8

Half Door Window Inserts



J0049388
Fits 87-95 YJ,
97-06 TJ,
04-06 LJ

Teddy® Cargo Nets



Our Teddy® Cargo Net covers the back half and sides of your YJ. You must have the Family Style Roll Cage in your YJ in order for this to fit properly. Easy installation with double back straps. This will fit with your factory top, so there is no need to remove it once it's installed. Made in the USA.

2 inch wide webbing

Double back straps allow adjustability and easy installation

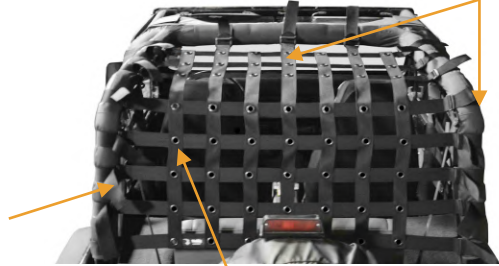

Black Grommets



Black
J0046615



Orange
J0047028



Blue
J0047026



Red
J0047029



Gray
J0047027



Hardtop Hardware Kit
See Page 64



Tube Door Limiting Straps
See Page 54



Door Hangers
See Page 55



Arm Rests
See Page 23



Fabric Door Inserts
See Page 56



Foot Pegs for YJ
See Page 62

Door Limiting Straps



For YJ stock doors.

2 Straps per kit.

- Black J0045473
- Blue J0045477
- Gray J0045476
- Orange J0045474
- Red J0045475

U-Joint Strap Kit



J0049389

Fits XJ, YJ, YJ, CJ-7, CJ-8, CJ-5, MJ.



WARNING: Cancer and Reproductive Harm

Drag Links & High Lift Mount Kits

Made in the USA

YJ

Drag Links



The Steinjäger Drag Link is a strong alternative to the original factory piece. It is made in the USA from 1.25" OD x 0.120 W DOM tubing. Comes with RH and LH jam nuts.

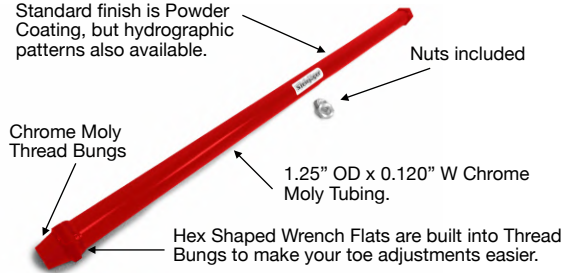

Bare Metal	J0045816
Black	J0045817
Texturized Black	J0045827
Southwest Blue	J0045820
Playboy Blue	J0045821
Neon Green	J0045823
Fl'orescent Orange	J0045818
Locas Green	J0045825
Military Beige	J0045826

Pinky	J0045824
Lemon Peel	J0045822
Red Baron	J0045819
Sinbad Purple	J0045829
Cloud White	J0045830
Gray Hammer'tn	J0045828
Gecko Green	J0046455
Hot Pink	J0046456
Neon Yellow	J0046454

High Lift Mount Kit



Bolt on kit to mount your High Lift Jack onto your Roll Bar. Made in the USA.



Bare Metal	J0048227
Black	J0048228
Texturized Black	J0048238
Southwest Blue	J0048231
Playboy Blue	J0048232
Neon Green	J0048234
Fl'orescent Orange	J0048229
Locas Green	J0048236
Military Beige	J0048237

Pinky	J0048235
Lemon Peel	J0048233
Red Baron	J0048230
Sinbad Purple	J0048240
Cloud White	J0048241
Gray Hammer'tn	J0048239
Gecko Green	J0048243
Hot Pink	J0048244
Neon Yellow	J0048242



WARNING: Cancer and Reproductive Harm

Quick Disconnect End Links



J0045815 2-4" Lift
J0047690 4-6" Lift

Grade 5 Hex Head Cap Screws

Powder Coated metal Drop Clevis

Chrome Moly Heim Joint

Chrome Plated Heim Spacer Cones

Look for the Steinjäger engraved trademarked Logo to ensure you have genuine Steinjäger End Links!

LH / RH Turnbuckle Jackscrew Adjuster makes adjustments after installation easier.

Metal-on-Metal Spring Loaded Ball Joint with 1/2-20 threads provides strength and ease of disconnecting.

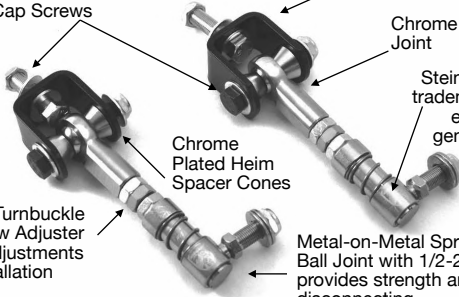

Track Bars & Tie Rods

Track Bars see Page 68

Tie Rods see Page 69



Rear View Mirror

J0049402



Front Tube Door DIY KIT (fits 4 Door XJ)

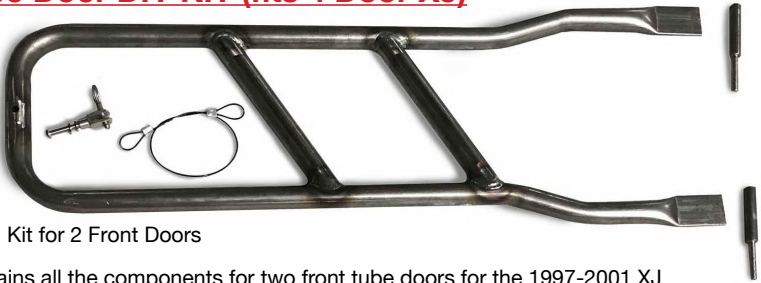

J0047644 Kit for 2 Front Doors

Our Kit contains all the components for two front tube doors for the 1997-2001 XJ Cherokee. **Requires Welding.** Bare Steel finish. 1.25" OD tubing. **Note:** these only fit the 4 Door XJ. Made in the USA.

Rear Tube Door DIY KIT



J0047855 Kit for 2 Rear Doors

Our Kit contains all the components for two rear tube doors for the 1997-2001 XJ Cherokee. **Requires Welding.** Bare Steel finish. 1.25" OD tubing. Made in the USA.



U-Joint Strap Kit

J0049391



Fits XJ, YJ, YJ, CJ-7, CJ-8, CJ-5, MJ.

Replacement Door Pin Kit



J0043671
for 2 pins

J0043669
for 8 pins

Shifter Repair Kit

J0049396



Fits NP231 and NP242 Transfer Case



WARNING: Cancer and Reproductive Harm

Accessories for the XJ

Crossover Steering, Box Brace, Shifter

XJ

Steering Box Support Kit



J0049471

Helps eliminate added stress to frame rails when you have larger tires or aftermarket lockers on the front end. Brace requires drilling three holes.

Black Powder Coated

Made in the USA

231 Transfer Case Shifter Kit



J0048615 Kit for XJ 231

Allows 4" radius without kinking or effecting movement of the inner core. Kit attaches to OEM handle. Brackets are black powder coated.

Fits ONLY the 4.0L automatic.

Does NOT work on the 242 transfer case

Does NOT work with the 'Part Time 4' option

Crossover Steering Kits

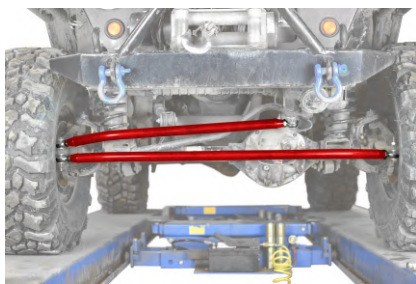

	Bare Metal	J0048824
	Black	J0048825
	Fluorescent Orange	J0048826
	Southwest Blue	J0048828
	Red Baron	J0048827
	Sinbad Purple	J0048837
	Cloud White	J0048838
	Gray Hammer	J0048836
	Neon Green	J0048831
	Lemon Peel	J0048830
	Gecko Green	J0048840

1.50 OD x 0.25 wall
DOM Tubing

Chrome Moly Heim Joints



WARNING: Cancer and Reproductive Harm

Builders Parts

Heim Joints, Bungs, Rebuildables

1.25"-1" Chrome Moly 4 Link Kits



Kit includes: **J0048450**

- (4) 1.25-12 x 1.00 RH Chrome Moly Rod Ends
- (4) 1.25-12 x 1.00 LH Chrome Moly Rod Ends
- (4) 1.25-12 RH Jam Nuts
- (4) 1.25-12 LH Jam Nuts
- (4) 1.25-12 RH Bungs for 1.500 ID Tubing
- (4) 1.25-12 LH Bungs for 1.500 ID Tubing
- (16) 1.00" to 3/4" High Misalignment Spacers.
2.625" Mounting Width

J0048452

same as above except spacers are as follows:

- (16) 1.00" to 9/16" High Misalignment Spacers.
2.625" Mounting Width

J0048451

same as above except spacers are as follows:

- (16) 1.00" to 5/8" High Misalignment Spacers.
2.625" Mounting Width

J0048585

same as above except NO spacers included

Rebuildable Rod Ends

Part#	Thrd	A	B	G	H	J	M	N
J0031304	3/4-16	12mm	0.843	4.500	2.750	2.5	1.5	2.625
J0031306	7/8-14	12mm	0.843	4.625	2.875	2.5	1.5	2.625
J0031310	1.25-12	12mm	0.843	4.875	3.125	2.5	1.5	2.625
J0031328	3/4-16	14mm	0.843	4.500	2.750	2.5	1.5	2.625
J0031330	7/8-14	14mm	0.843	4.625	2.875	2.5	1.5	2.625
J0031334	1.25-12	14mm	0.843	4.875	3.125	2.5	1.5	2.625
J0031340	3/4-16	9/16	0.843	4.500	2.750	2.5	1.5	2.625
J0031342	7/8-14	9/16	0.843	4.625	2.875	2.5	1.5	2.625
J0031346	1.25-12	9/16	0.843	4.875	3.125	2.5	1.5	2.625
J0031364	3/4-16	5/8	0.903	4.500	2.750	2.5	1.5	2.625
J0031366	7/8-14	5/8	0.903	4.625	2.875	2.5	1.5	2.625
J0031370	1.25-12	5/8	0.903	4.875	3.125	2.5	1.5	2.625
J0031685	3/4-16	3/4	0.875	4.500	2.750	2.5	1.5	2.625
J0031687	7/8-14	3/4	0.875	4.625	2.875	2.5	1.5	2.625
J0031691	1.25-12	3/4	0.875	4.875	3.125	2.5	1.5	2.625

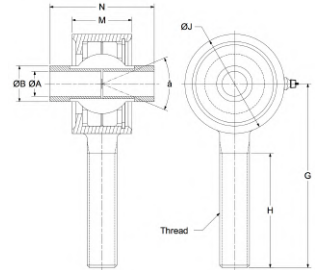

Chrome Moly Housing, Grade 8 Stud. **Rod End is designed to be used in a double shear application only!**



WARNING: Cancer and Reproductive Harm

Trademarks

Warnings, Warranties, Trademarks

WARNING

Steinjäger products are for **OFF ROAD USE ONLY**.

Buyer assumes all risk and liability whatsoever from the use of Steinjäger products and agrees to hold Steinjäger, Inc and its affiliates harmless from any claim, action or demand arising out of or incident to the buyer's installation or use of Steinjäger's products. All parts are aftermarket replacement parts and are NOT original equipment parts.

Steinjäger products are no substitute for safe driving. Never drink and drive. Don't drive faster than conditions permit. Avoid angles or speeds that increase the chance of rollover.

Trademarks ®

Trademarks of the Steinjäger brand include the slogan and words *When Baad is Good®*, *Steinjäger®*, and *Teddy®* (for cloth tops), as well as the mechanical ibex, the horizontal mountain logo, and the acorn shaped shield.

Jeep®, Wrangler®, CJ®, YJ®, JL®, TJ®, JK®, JKU®, XJ® and the Jeep® front grill designs used in this catalog are registered trademarks of Chrysler LLC. Steinjäger is not affiliated with Chrysler LLC.

