

Steinjäger

Suspensions & Accessories for Jeep® Wrangler®

NOV 2018 EDITION



CJ-7 >
1976-1986



CJ-8 >
1981-1986



YJ >
1987-1995



XJ >
1984-2001



TJ >
1997-2006



JK/JKU >
2007-2017



JL/JLU >
2018-Present

































We make most of our products in the USA. Look for the "Made in the USA" logo throughout our catalog.



Steinjäger

Suspensions & Accessories

	CJ-7	JK	JKU	JL	JLU	LJ	TJ	XJ	YJ
 Bumpers		38-39	38-39			60	60		
 Cargo Nets & Covers		30, 32	30,32			59	59		70
 D-Ring Shackles & Mounts	14	14	14	14, 28	14,28	14	14	14	14
 Dead Pedals & Stirrup Steps		22	22			22	22		
 Doors, Tube Trail	68	15	15	4	4	50	50	72	68
 Door Hangers and Holders	51	5	5	5	5	51	51		51
 Door Handle Inserts		27	27						
 Door Inserts for Tube Doors	52, 68	16-17	16-17	6-7	6-7	52	52		52, 68
 Flag Poles, Holders & Hitches	12-13	12-13	12-13	12-13	12-13	12-13	12-13	12-13	12-13
 Foot Pegs	55	9	9	9	9	55	55		55
 Grab Handles		19-21	19-21			54	54		
 Harness Bar			40						
 High Lift Jack Holders		23	23			57	57		71
 Hood Latches		26	26			58	58		
 LED Brackets		34-35	34-35			56	56		
 License Plate Relocate Kit	40	40	40	40	40	40	40	40	40
 Lift Kits & Springs & Ctrl Arms		44-49	44-49			65-67	65-67		71
 Limb Risers		26	26			60	60		
 Mirrors & Mirror Brackets	53	8, 18	8, 18	7-8	7-8	53-54	53-54		53
 Organizers		29	29			54	54		54
 Rear Storage Boxes		24							
 Rock Sliders		36	37						
 Spare Tire Delete Plates		28	28	9	9	58	58		
 Sway Bars & End Links		41	41			62-63	62-63	72	
 Teddy® Tops		31-33	31-33	11	11	61	60-61		69
 Tire Carrier		25							
 Track Bars & Panhard Bars		42-43	42-43			64	64	64-65	
 Transfer Case Shifter Cable							54		
 Trashy Teddy®	10	10	10	10	10	10	10	10	10
 Swag, T-shirts, Decals	73-75	73-75	73-75	73-75	73-75	73-75	73-75	73-75	73-75
 Winch Plate, Bolt On						56	56		

Why Steinjäger?

Made in the USA: Vertical Integration

Over 98% of Steinjäger's accessories for Jeeps are ALL made in the same factory in Bushnell, Illinois, USA, including our Grab Handles, Lift Kits, Tube Doors, Rock Sliders, Teddy® Tops and more. Our suspension bushings are even molded in the same building where we make our Teddy® Tops. Look for the 'Made in the USA' image to denote our American made products.



Customer Service & Focus

Whether you buy the product from us, from one of our retail/installer dealers, or from one of our online dealers, if you have any questions or service issues, we want you to contact us DIRECT. We enjoy servicing our customers and will do everything we can to help you enjoy your Steinjäger products. We take a sincere interest in our customers: what you've purchased, the type of Jeeps you own, how you accessorize your Jeep, what events you go to, your accent colors... these are all important to us and we will do our best to personalize your experience with us.



Great Value

We focus a lot on creating value for you. Before we start work on a project, we make sure that our finished design is going to give a better value than offshore and domestic alternatives. This 'Great Value' principle of Steinjäger stems from our belief that American companies that understand their manufacturing niche, can manufacture high quality, great value, and globally competitive products *in the USA*. We want you to know that when you buy a Steinjäger accessory for your Jeep, you are buying the best an American manufacturer has to offer.

Tubular Doors

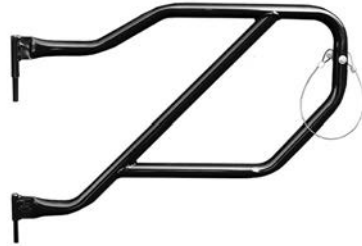
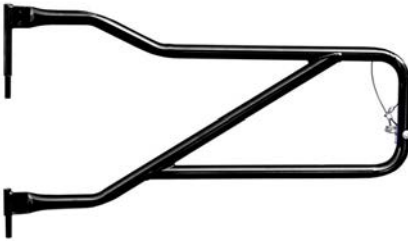

Front Doors

Rear Doors

	Bare Metal	J0048305
	Black	J0048306
	Texturized Black	J0048316
	Southwest Blue	J0048309
	Playboy Blue	J0048310
	Neon Green	J0048312
	Fl'rescent Orange	J0048307
	Locas Green	J0048314
	Military Beige	J0048315
	Pinky	J0048313
	Lemon Peel	J0048311
	Red Baron	J0048308
	Sinbad Purple	J0048318
	Cloud White	J0048319
	Gray Hammer'tn	J0048317
	Gecko Green	J0048321
	Hot Pink	J0048322
	Neon Yellow	J0048320

	J0048323
	J0048324
	J0048334
	J0048327
	J0048328
	J0048330
	J0048325
	J0048332
	J0048333
	J0048331
	J0048329
	J0048326
	J0048336
	J0048337
	J0048335
	J0048339
	J0048340
	J0048338

Steinjäger's Tube Doors come ready to install. First time assembly and installation takes less than 10 minutes. Check out our installation video on [YouTube](#) by searching for 'Steinjäger'. Installation may require a minor adjustment to the striker latch. Kits include all attaching hardware. Doors are made in the USA from 1.25" OD tubing.



Door Holders & Hangers

works for JL, JLU, JK and JKU

JL/JK

Four Door Holder Stand (fits JLU & JKU)

Holds Four Doors



This unique product can be used to store factory doors or tubular doors in the field, in the showroom, or in your hotel room. Knocks down quickly for travel, but rugged enough for dealer showrooms. Powder Coated. Made in the USA.

Wall Mounted Door Hanger (JL & JK)

Holds Two Doors Mounts to wall studs and holds factory and tubular doors.



Bare Metal	J0048006
Black	J0030814
Texturized Black	J0048016
Southwest Blue	J0048009
Playboy Blue	J0048010
Neon Green	J0048012
Fl'orescent Orange	J0048007
Locas Green	J0048014
Military Beige	J0048015
Pinky	J0048013
Lemon Peel	J0048011
Red Baron	J0048008
Sinbad Purple	J0048018
Cloud White	J0048019
Gray Hammer'tn	J0048017
Gecko Green	J0048021
Hot Pink	J0048022
Neon Yellow	J0048020

Steinjäger Latch Upgrade



These handy latch upgrades make our great tube doors even better!

Part#	# of Pins
J0043481	1
J0043482	2
J0043483	4

Door Covers



Made in the USA. Fits Steinjäger tube doors. Prices include bungees.

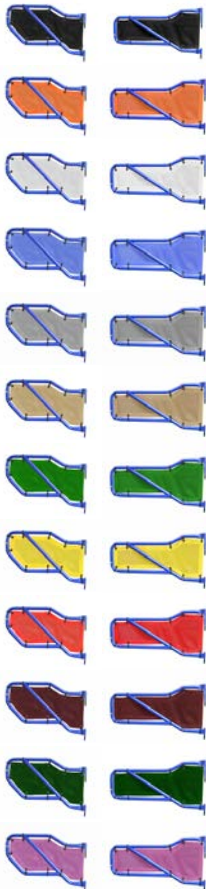

Color	MSRP	Front#
Black	J0048371	J0048359
Orange	J0048379	J0048367
White	J0048375	J0048363
Blue	J0048376	J0048364
Gray	J0048377	J0048365
Tan	J0048382	J0048370
Green	J0048378	J0048366
Lemon Yellow	J0048372	J0048360
Red	J0048374	J0048362
Burgundy	J0048380	J0048368
Dark Green	J0048373	J0048361
Mauve	J0048381	J0048369

Tube Door Net Inserts & Mirrors

Made in the USA

JL

Door Nets (JL)

Made in the USA. Fits Steinjäger tube doors. Prices include bungees.

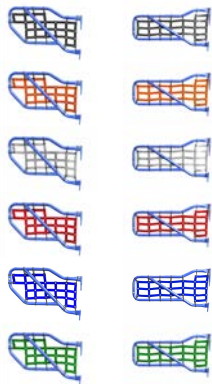
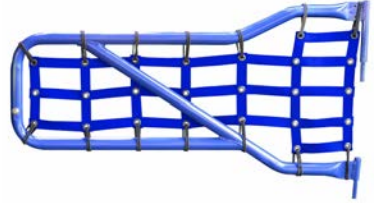
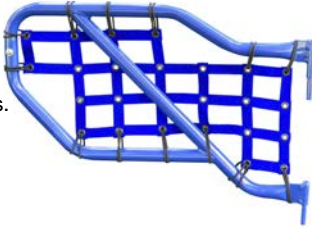

Color	Rear Set	Front Set
Black	J0048420	J0048414
Orange	J0048421	J0048415
Gray	J0048422	J0048416
Red	J0048423	J0048417
Blue	J0048424	J0048418
Green	J0048425	J0048419

Tube Door Mirrors (JL & JK)



Mirrors

2 Mirrors
J0041326

Fits
J0041326
Mirrors



Bare	J0048397	Pinky	J0048391
Black	J0048383	Lemon Peel	J0048387
Texturized Black	J0048396	Red Baron	J0048393
Southwest Blue	J0048395	Sinbad Purple	J0048394
Playboy Blue	J0048392	Cloud White	J0048384
Neon Green	J0048390	Gray Hammer'tn	J0048386
Fl'orescent Orange	J0048385	Gecko Green	J0048399
Locas Green	J0048388	Hot Pink	J0048400
Military Beige	J0048389	Neon Yellow	J0048398

Doorless Mirrors

fits JL, JLU, JK and JKU

Basic Mirror Legs



2 Legs per Kit

Fits J0046184 Mirrors

Powder Coated finish is standard



Premium Isolated Mirror Legs



2 Legs per Kit

US Patent# 9,475,432

Non-Metallic Surface Protects from Scratching

Locknut secures legs

Fits J0041326 Mirrors

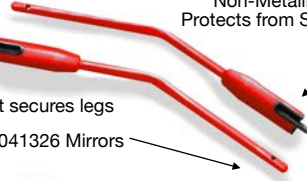

	Bare Metal	J0046296
	Black	J0046185
	Texturized Black	J0046199
	Southwest Blue	J0046198
	Playboy Blue	J0046195
	Neon Green	J0046193
	Fl'rescent Orange	J0046188
	Locas Green	J0046191
	Military Beige	J0046192
	Pinky	J0046194
	Lemon Peel	J0046190
	Red Baron	J0046196
	Sinbad Purple	J0046197
	Cloud White	J0046187
	Gray Hammertone	J0046189
	Gecko Green	J0046591
	Hot Pink	J0046592
	Neon Yellow	J0046590
	Black Hammertone	J0046186

	Bare Metal	J0045998
	Black	J0045997
	Texturized Black	J0046008
	Southwest Blue	J0046001
	Playboy Blue	J0046002
	Neon Green	J0046004
	Fl'rescent Orange	J0045999
	Locas Green	J0046006
	Military Beige	J0046007
	Pinky	J0046005
	Lemon Peel	J0046003
	Red Baron	J0046000
	Sinbad Purple	J0046010
	Cloud White	J0046011
	Gray Hammer'tn	J0046009
	Gecko Green	J0046585
	Hot Pink	J0046586
	Neon Yellow	J0046584

Mirrors

2 Mirrors J0046184



2 Mirrors J0041326



Foot Pegs & Delete Plates

American Made

JL/JK

Foot Pegs (fits JK, JKU, JL & JLU)

Steinjäger's patented Foot Pegs are made in the USA of powder coated metal and an internal nonmetallic molded insert that protects your hinge while giving a snug fit for the Peg. US Patent# 9,475,432.



	Black	J0048043
	Texturized Black	J0048054
	Southwest Blue	J0048044
	Playboy Blue	J0048045
	Neon Green	J0048046
	Fluorescent Orange	J0048047
	Locas Green	J0048048
	Military Beige	J0048049
	Pinky	J0048050









	Lemon Peel	J0048051
	Red Baron	J0048052
	Sinbad Purple	J0048055
	Cloud White	J0048056
	Gray Hammer'tn	J0048053
	Gecko Green	J0048058
	Hot Pink	J0048059
	Neon Yellow	J0048057

Spare Tire Delete Plates (JL)



If you have removed your back up camera, third brake light, and factory spare tire in preparing your Jeep for off road use, you can use this product to hide the unsightly openings in the factory tailgate. 1/8" steel plate. Made in the USA.



	Bare Metal	J0048209
	Black	J0048210
	Texturized Black	J0048220
	Southwest Blue	J0048213
	Playboy Blue	J0048214
	Neon Green	J0048216
	Fluorescent Orange	J0048211
	Locas Green	J0048218
	Military Beige	J0048219

	Pinky	J0048217
	Lemon Peel	J0048215
	Red Baron	J0048212
	Sinbad Purple	J0048222
	Cloud White	J0048223
	Gray Hammer'tn	J0048221
	Gecko Green	J0048225
	Hot Pink	J0048226
	Neon Yellow	J0048224

JK/JL

the Trashy Teddy®







fits JL, JLU, JK, JKU, TJ, LJ

Little Trashy



The Little Trashy Trash Bag has a single strap to hang from the head rest of your seat. Made in the USA.



-  Black J0048072
-  Orange J0048073
-  White J0048074
-  Blue J0048075
-  Gray J0048076
-  Tan J0048077





-  Green J0048078
-  Yellow J0048079
-  Red J0048080
-  Burgundy J0048081
-  Dark Green J0048082
-  Maive J0048083







Trashy Teddy®



Keep the trails, beach or wherever you go a little bit cleaner with the Trashy Teddy®. Constructed from mesh and easy to clean, the Trashy comes with built in handles. 48" carabiner bungee sold separately.



-  Black J0047812
-  Orange J0047813
-  White J0047814
-  Blue J0047815
-  Gray J0047816
-  Tan J0047817

-  Green J0047818
-  Yellow J0047819
-  Red J0047820
-  Burgundy J0047821
-  Dark Green J0047822
-  Maive J0047823

Carabiner - 48"

J0047853



Use a 48" Carabiner Bungee Cord to hold your Trashy Teddy® to your spare tire.

Fabric Teddy® Tops

Solar Covers - Made in the USA

JL

Front Seat Teddy@ (JL/JLU)



Our Teddy® Top Solar Screen Cover easily installs in minutes with the supplied bungee balls. Compatible with the JL's hard top and soft top, please note the center strap will need to be unclipped when installing the Freedom Panels.



Black J0048401



Green J0048408



Orange J0048409



Yellow J0048402



White J0048405



Red J0048404



Blue J0048406



Burgundy J0048410



Gray J0048407



Dark Green J0048403



Tan J0048412



Mauve J0048411

Teddy@ Tops (fits JLU)



Our Teddy® Top Solar Screen Cover easily installs in minutes with the supplied bungee balls. Compatible with the JL's hard top and soft top, please note that the front section will need folded back when the Freedom Panels are installed.



Black J0048106



Green J0048112



Orange J0048107



Yellow J0048113



White J0048108



Red J0048114

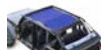

Blue J0048109



Burgundy J0048115



Gray J0048110

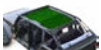

Dark Green J0048116



Tan J0048111



Mauve J0048117

Flag Poles

fits Steinjäger Holders

Flag Poles



Our Flag Poles are made in the USA from 1" OD x 0.120" wall tubing. Hitch Mounts sold separately.

Prices are for one flag pole

3.8' Long Pole

5.0' Long Pole

Bare Metal	J0045709		J0045723
Black	J0045710		J0045724
Southwest Blue	J0045713		J0045727
Playboy Blue	J0045714		J0045728
Neon Green	J0045716		J0045730
Fluorescent Orange	J0045711		J0045725
Locas Green	J0045718		J0045732
Military Beige	J0045719		J0045733
Pinky	J0045717		J0045731
Lemon Peel	J0045715		J0045729
Red Baron	J0045712		J0045726
Sinbad Purple	J0045721		J0045735
Cloud White	J0045722		J0045736
Gray Hammer'tn	J0045720		J0045734
Gecko Green	J0046449		J0046452
Hot Pink	J0046450		J0046453
Neon Yellow	J0046448		J0046451

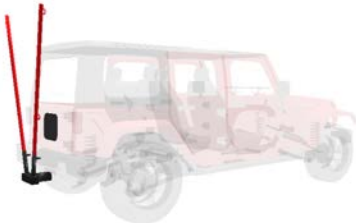
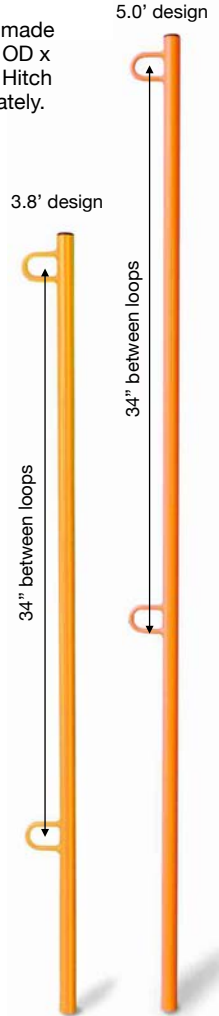

Doorless Can Holder

J0031196

Fits in door hinge.

Holds a 12 oz can.



Hitch Mount Accessories

Covers and Flag Holders

JK/JL

Hitch Covers



Our Hitch Cover makes an excellent accessory to cover up your unused hitch. Fits any standard 2" square hitch opening. Made in the USA.

Hitch Mounted Flag Holders



Our Flag Holder fits any class 3 vehicle hitch. 3 offset holes allow for plenty of adjustment. Accepts flag poles of 1" or less diameter. Made in the USA.



	Hitch Covers		Single Pole Holder		Double Pole Holder	
	Bare Metal	J0046842		J0047515		J0045890
	Black	J0045799		J0047516		J0045891
	Textured Blk	J0045813		J0047526		J0045901
	SW Blue	J0045800		J0047519		J0045894
	Playboy Blue	J0045801		J0047520		J0045895
	Neon Green	J0045803		J0047522		J0045897
	Fir Orange	J0045810		J0047517		J0045892
	Locas Green	J0045805		J0047524		J0045899
	Military Beige	J0045806		J0047525		J0045900
	Pinky	J0045804		J0047523		J0045898
	Lemon Peel	J0045802		J0047521		J0045896
	Red Baron	J0045811		J0047518		J0045893
	SB Purple	J0045808		J0047528		J0045903
	Cloud White	J0045809		J0047529		J0045904
	Gray Hammer	J0045807		J0047527		J0045902
	Gecko Green	J0046567		J0047531		J0046434
	Hot Pink	J0046568		J0047532		J0046435
	Neon Yellow	J0046566		J0047530		J0046433

Note: some hitch covers come with the Steinjäger logo, depending on how well the powder coat accepts laser etched images.

Private Labeling available on some of the hitch cover colors.



JK/JL

D-Ring Shackles

for JL, JK, JKU, TJ, LJ, YJ, CJ-7, etc

D-Ring Shackles



Our 3/4" D-Rings have a working load limit of 4.75 tons. Solid forged steel design. Imported forging, but powder coated in the USA.





Zinc Plated	J0045662
Black	J0045648
Texturized Black	J0045658
Southwest Blue	J0045651
Playboy Blue	J0045652
Neon Green	J0045654
Fluorescent Orange	J0045649
Locas Green	J0045656
Military Beige	J0045657

Pinky	J0045655
Lemon Peel	J0045653
Red Baron	J0045650
Sinbad Purple	J0045660
Cloud White	J0045661
Gray Hammer'tn	J0045659
Gecko Green	J0046440
Hot Pink	J0046441
Neon Yellow	J0046439

D-Ring Base Isolator



-  **J0045982** Black
-  **J0047692** Red

Molded in the USA, these isolators simply slide over the D-Ring, eliminating the metal on metal clanking noise. Easily removed when the D-Ring is needed for winching or pulling.



Steinjäger color matched powder coat paint powders are available online in 1 pound increments.

D-Ring Side Isolator

J0045984

2 pieces/kit



Molded in the USA, these isolators simply slide over the bolt of most standard 3/4" D-Rings. These will fit within mounts up to 3/4" wide.



Tube Doors for JK and JKU

Made in the USA - 18 Powder Coat Options

JKU

Tubular Doors



Front Doors



Rear Doors

	Bare Metal	J0041322
	Black	J0031026
	Texturized Black	J0041015
	Southwest Blue	J0040944
	Playboy Blue	J0040945
	Neon Green	J0040946
	Fl'orescent Orange	J0040947
	Locas Green	J0040948
	Military Beige	J0040949
	Pinky	J0040950
	Lemon Peel	J0040951
	Red Baron	J0040952
	Sinbad Purple	J0042643
	Cloud White	J0042646
	Gray Hammer'tn	J0041339
	Gecko Green	J0046380
	Hot Pink	J0046381
	Neon Yellow	J0046379
	Hydrographic	J0046814

	J0041323
	J0031027
	J0041259
	J0040954
	J0040955
	J0040956
	J0040957
	J0040958
	J0040959
	J0040960
	J0040961
	J0040962
	J0042644
	J0042647
	J0041340
	J0046383
	J0046384
	J0046382
	J0046815

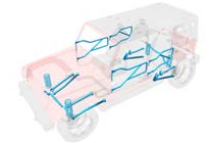

Steinjäger's Tube Doors come ready to install. First time assembly and installation takes less than 10 minutes. Check out our installation video on [YouTube](#) by searching for 'Steinjäger'. Installation may require a minor adjustment to the striker latch. Kits include all attaching hardware. Doors are made in the USA from 1.25" OD tubing.

Steinjäger Latch Upgrade



Part#	# of Pins
J0043481	1
J0043482	2
J0043483	4

These handy latch upgrades make our great tube doors even better!

Door Covers



Made in the USA. Fits Steinjäger tube doors. Prices include bungees.

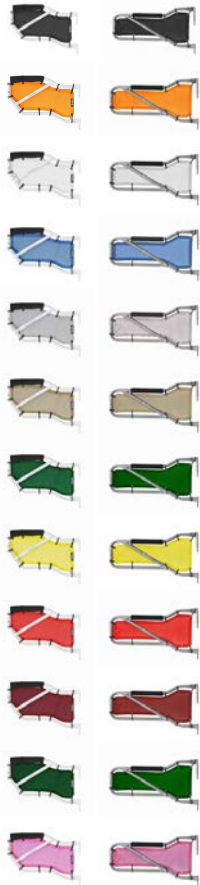

Color	Rear#	Front#
Black	J0041085	J0041050
Orange	J0041355	J0041366
White	J0041356	J0041367
Royal Blue	J0041357	J0041368
Gray	J0041358	J0041369
Tan	J0041359	J0041370
Green	J0041360	J0041371
Lemon Yellow	J0041361	J0041372
Red	J0041362	J0041373
Burgundy	J0043601	J0043603
Dark Green	J0043602	J0043604
Mauve	J0043855	J0043856

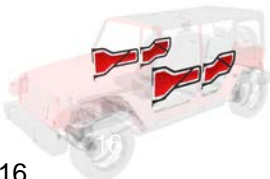

Tube Door Net Inserts

Made in the USA

JKU

DOOR NETS



Made in the USA. Fits Steinjäger tube doors. Prices include bungees.

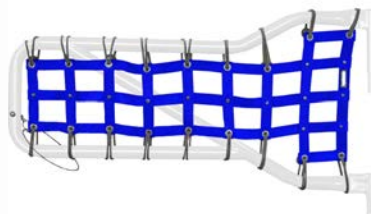
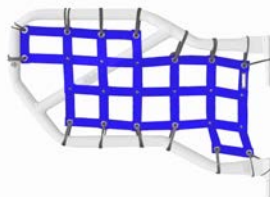

Color	Rear Set	Front Set
Black	J0043597	J0043596
Orange	J0043661	J0043657
Gray	J0043662	J0043658
Red	J0043663	J0043659
Blue	J0043664	J0043660

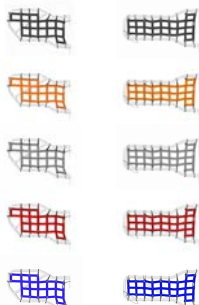

Arm Rests



Made in the USA. Fits Steinjäger tube doors.

2 per kit



Black	J0041031
Red	J0046098
Blue	J0046104

Door Limiting Straps



For Steinjäger Tube Doors

Front Doors J0041622

Rear Doors J0041623

Bungees, 6" Long



8 pack J0043458
10 pack J0041051



A-Pillar Mirror Legs

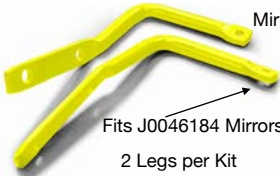

Mirrors sold Separately



Bare Metal	J0046715
Black	J0046716
Texturized Black	J0046726
Southwest Blue	J0046719
Playboy Blue	J0046720
Neon Green	J0046722
Fl'rescent Orange	J0046717
Locas Green	J0046724
Military Beige	J0046725
Pinky	J0046723
Lemon Peel	J0046721
Red Baron	J0046718
Sinbad Purple	J0046728
Cloud White	J0046729
Gray Hammer'tn	J0046727
Gecko Green	J0046731
Hot Pink	J0046732
Neon Yellow	J0046730

Tube Door Mirrors



Fits J0041326 Mirrors



Bare Metal	J0046295
Black	J0040967
Texturized Black	J0046213
Southwest Blue	J0046212
Playboy Blue	J0046209
Neon Green	J0046207
Fl'rescent Orange	J0046202
Locas Green	J0046205
Military Beige	J0046206
Pinky	J0046208
Lemon Peel	J0046204
Red Baron	J0046210
Sinbad Purple	J0046211
Cloud White	J0046201
Gray Hammer'tn	J0046203
Gecko Green	J0046594
Hot Pink	J0046595
Neon Yellow	J0046593

Mirrors

2 Mirrors J0046184



Magnetic Legs



Patented Design

2 Legs J0041001

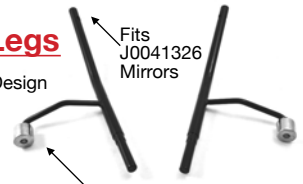

Vent Mirrors

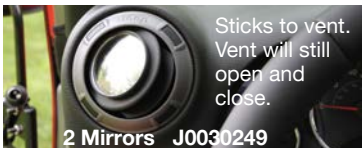

Mirrors

2 Mirrors J0041326



Grab Handles - JK and JKU

Made in the USA

JKU

Front Rigid Grab Handles



Steinjäger Front Rigid Grab Handles are made from steel and are powder coated a variety of colors. Our handles' original and unique design gives you a great grab handle without interference with the Jeep's visor. Made in the USA.

	Bare Metal	J0041455
	Black	J0041052
	Texturized Black	J0041248
	Southwest Blue	J0041241
	Playboy Blue	J0041242
	Neon Green	J0041244
	Fluorescent Orange	J0041239
	Locas Green	J0041246
	Military Beige	J0041247
	Pinky	J0041245
	Lemon Peel	J0041243
	Red Baron	J0041240
	Sinbad Purple	J0043589
	Cloud White	J0043592
	Gray Hammer'tn	J0041351
	Gecko Green	J0046504
	Hot Pink	J0046505
	Neon Yellow	J0046503
	Hydrographic	J0046900



Design your dream Jeep with our free online 3D Configurator

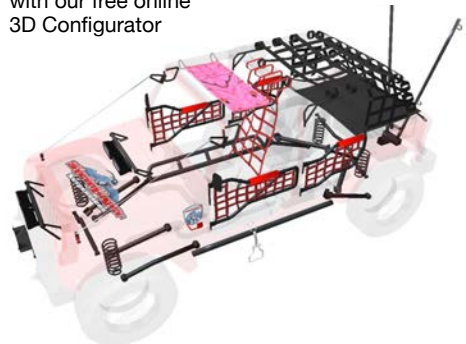



Rear Rigid Grab Handles

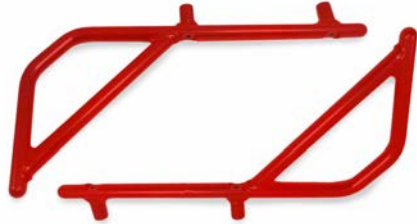

Made from steel and powder coated a variety of colors, our rear handles come in two different designs to allow for differences between the 2 door (JK) and 4 door (JKU) models. Made in the USA.

2 Door JK

	Bare Metal	J0043508
	Black	J0043494
	Texturized Black	J0043504
	Southwest Blue	J0043497
	Playboy Blue	J0043498
	Neon Green	J0043500
	Fluorescent Orange	J0043495
	Locas Green	J0043502
	Military Beige	J0043503
	Pinky	J0043501
	Lemon Peel	J0043499
	Red Baron	J0043496
	Sinbad Purple	J0043506
	Cloud White	J0043507
	Gray Hammer'tn	J0043505
	Gecko Green	J0046498
	Hot Pink	J0046499
	Neon Yellow	J0046497
	Hydrographic	J0046949

4 Door JKU

	J0041454
	J0040941
	J0041238
	J0041231
	J0041232
	J0041234
	J0041229
	J0041236
	J0041237
	J0041235
	J0041233
	J0041230
	J0043590
	J0043593
	J0041350
	J0046507
	J0046508
	J0046506
	J0046901

Accessories

Made in the USA

JKU



Roll Bar Grab Handles



We mold and sew these handles in the USA. Designed to fit over the factory roll bar, these handles come ready for installation.

Black: 2 Handles **J0031248**

Red: 2 Handles **J0043796**



Rear Middle Grab Handles



We mold and sew these handles in the USA. Designed to utilize the factory bolts in the sound bar.



1 Handle **J0040915**

Rear Grab Handles



We mold and sew these handles in the USA. Designed to utilize the factory bolts in the outside sound bar. These can also attach to the head rest posts.



2 Handles **J0040917**

Winch Hook Straps



Our Winch Hook Straps are designed for a non-slip grip to making pulling the winch cable easier.

J0043803 Black

J0043805 Blue

J0043807 Red

J0043809 Orange

J0043811 Gray



Vacuum Pump Relocator



J0041007

When installing an aftermarket bumper, it may be necessary to move your vacuum pump. This handy kit comes with all the needed hardware to complete this job. The vacuum pump is moved from behind the bumper to under the hood.

Adjustable Bungee Ties



J0047988

J0047989

J0047990



Stirrup Steps (fits TJ & JK)



Convenience for getting into your lifted Jeep. The Stirrup fits easily under the seat when not in use.



Bare Metal	J0045861
Black	J0045860
Texturized Black	J0045871
Southwest Blue	J0045864
Playboy Blue	J0045865
Neon Green	J0045867
Fl'rescent Orange	J0045862
Locas Green	J0045869
Military Beige	J0045870
Pinky	J0045868
Lemon Peel	J0045866
Red Baron	J0045863
Sinbad Purple	J0045873
Cloud White	J0045874
Gray Hammer'tn	J0045872
Gecko Green	J0046458
Hot Pink	J0046459
Neon Yellow	J0046457

Fits JK, JKU, TJ and LJ

Dead Pedals (JK & JKU)



Need a comfortable place to rest your foot while driving? Use the Steinjäger Dead Pedal.

Installation is simple and allows you to keep your door limit straps.



Bare Metal	J0046247
Black	J0046233
Texturized Black	J0046243
Southwest Blue	J0046236
Playboy Blue	J0046237
Neon Green	J0046239
Fl'rescent Orange	J0046234
Locas Green	J0046241
Military Beige	J0046242
Pinky	J0046240
Lemon Peel	J0046238
Red Baron	J0046235
Sinbad Purple	J0046245
Cloud White	J0046246
Gray Hammer'tn	J0046244
Gecko Green	J0046464
Hot Pink	J0046465
Neon Yellow	J0046463

Fits JK & JKU with automatic transmissions

High Light Accessories

Roll Bar Mount Kits & Holders

JKU

High Lift Roll Bar Mount Kit



Easy to bolt-on kit to attach your High Lift Jack to the factory Roll Bar. Made in the USA.

Powder Coated



	JK (2 Door)
Bare Metal	J0047589
Black	J0047590
Texturized Black	J0047600
Southwest Blue	J0047593
Playboy Blue	J0047594
Neon Green	J0047596
Fl'rescent Orange	J0047591
Locas Green	J0047598
Military Beige	J0047599
Pinky	J0047597
Lemon Peel	J0047595
Red Baron	J0047592
Sinbad Purple	J0047602
Cloud White	J0047603
Gray Hammer'tn	J0047601
Gecko Green	J0047605
Hot Pink	J0047606
Neon Yellow	J0047604

	JKU (4 Door)
J0047571	
J0047572	
J0047582	
J0047575	
J0047576	
J0047578	
J0047573	
J0047580	
J0047581	
J0047579	
J0047577	
J0047574	
J0047584	
J0047585	
J0047583	
J0047587	
J0047588	
J0047586	



Molded Handle Holder

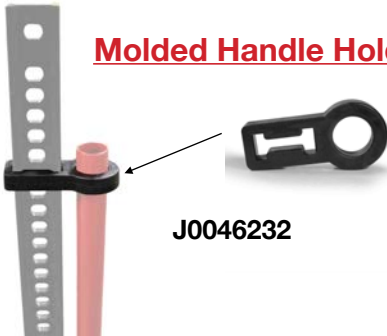

J0046232

Molded in the USA from high grade polyurethane, this Holder fits the Hi-Lift Jack Handle and is the perfect accessory for keeping your handle from rattling.

JK

Rear Storage Box fits 2 Door JK

Rear Storage Box for 2 Door JK Wrangler



The one piece construction of our Rear Storage Box helps keep your cargo secure while in transit or unattended. Fits to existing anchor points within your Jeep. Fits 2 door models only. Powder Coated 16 gage steel. Made in the USA.

	Bare Metal	J0045947
	Black	J0045948
	Texturized Black	J0045958
	Southwest Blue	J0045951
	Playboy Blue	J0045952
	Neon Green	J0045954
	Fluorescent Orange	J0045949
	Locas Green	J0045956
	Military Beige	J0045957
	Pinky	J0045955
	Lemon Peel	J0045953
	Red Baron	J0045950
	Sinbad Purple	J0045960
	Cloud White	J0045961
	Gray Hammer'tn	J0045959
	Gecko Green	J0046467
	Hot Pink	J0046468
	Neon Yellow	J0046466



Internal Tire Carrier

fits 2 Door JK









JK

Internal Tire Carrier for 2 Door JK Wrangler



Holds 35 inch tire inside while still leaving room for tools and a cooler. Mounts to factory roll bar. Angled design makes handling tire easier. Fits 2 door models only. Made in the USA.



	Bare Metal	J0045491
	Black	J0041055
	Texturized Black	J0045501
	Southwest Blue	J0045494
	Playboy Blue	J0045495
	Neon Green	J0045497
	Fl'rescent Orange	J0045492
	Locas Green	J0045499
	Military Beige	J0045500

	Pinky	J0045498
	Lemon Peel	J0045496
	Red Baron	J0045493
	Sinbad Purple	J0045503
	Cloud White	J0045504
	Gray Hammer'tn	J0045502
	Gecko Green	J0046573
	Hot Pink	J0046574
	Neon Yellow	J0046572

Metal Hood Latch Kits



J0041024

Steinjäger Hood Latch Kits eliminate Jeep hood flutter. Installation requires drilling with a 3/32 drill bit along with basic hand tools. Online video tutorial. Installation takes one hour.

Limb Riser



Non-Metallic Jacket
Protects from Scratching



J0040942

Our Limb Risers are made in the USA of stainless wire rope with a non-metallic jacket, stainless quick disconnect ball joints, and powder coated steel mounting brackets. Some drilling required for installation. Installation video links on our website.

A-Pillar Adaptor Kit



J0047534

Brackets and Cables to attach to our LED A-Pillar Brackets.



Poly Hood Latch Kits



Black **J0041036**

Red **J0043480**



Steinjäger's molded polyurethane hood latch kits are easy to install. Installation requires masking tape, locking pliers and phillips screw drivers - takes only 15 minutes. Online video available. Made in the USA.

Do it Yourself Limb Riser Cables

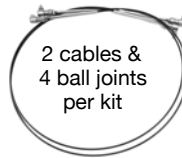

2 cables &
4 ball joints
per kit

We've had so many requests for our special non-metallic coated stainless wire cable and quick disconnect stainless ball joints for applications other than the Jeep Wranglers, that we now offer the cable and ball joint as a kit.

Lengths are ball joint stud to ball joint stud...

J0045634	48.5"	J0045641	55.5"
J0045635	49.5"	J0045642	56.5"
J0045636	50.5"	J0045643	57.5"
J0045637	51.5"	J0045644	58.5"
J0045638	52.5"	J0045645	59.5"
J0045639	53.5"	J0045656	61.5"
J0045640	54.5"	J0045647	63.5"

DIY Limb Risers Brackets



fits JK **J0045633**



Fits the JK Hood Latch.

Door Handle Accents

for the JK and JKU

JKU

Door Handle Accents



1 Pc Kit



3 Pc Kit
2 doors + tailgate



5 Pc Kit
4 doors + tailgate

Add a splash of color and style to your factory door handles with the addition of these easy to install Door Handle Accents. Simply mark the hole locations using the accent piece as your template and pre-drill a 3/32" pilot hole. Made in the USA.

1 Pc Kit

Bare Metal	J0045425
Black	J0045426
Textured Blk	J0045436
SW Blue	J0045429
Playboy Blue	J0045430
Neon Green	J0045432
Flr Orange	J0045427
Locas Green	J0045434
Military Beige	J0045435
Pinky	J0045433
Lemon Peel	J0045431
Red Baron	J0045428
SB Purple	J0045438
Cloud White	J0045439
Gray Hammer	J0045437
Gecko Green	J0046710
Hot Pink	J0046711
Neon Yellow	J0046709

3 Pc Kit

J0045402
J0044792
J0044802
J0044795
J0044796
J0044798
J0044793
J0044800
J0044801
J0044799
J0044797
J0044794
J0044804
J0044805
J0044803
J0046549
J0046550
J0046548

5 Pc Kit

J0045403
J0044806
J0044816
J0044809
J0044810
J0044812
J0044807
J0044814
J0044815
J0044813
J0044811
J0044808
J0044818
J0044819
J0044817
J0046552
J0046553
J0046551

Magnetic Can Holders



J0030968

Top Mount: Poly encased magnet holds a standard 12 oz can with a 2.75" OD.



J0031228

Poly encased magnet holds a standard 12 oz can with a 2.75" OD

Spare Tire Delete Plates



Made in the USA from 1/8" steel. Uses factory bolts. Available with custom laser images or private labeling.

Use our Delete Plate to clean up the look of your Jeep.

	Bare Metal	J0043935
	Black	J0040922
	Texturized Black	J0043936
	Southwest Blue	J0043939
	Playboy Blue	J0043940
	Neon Green	J0043942
	Fluorescent Orange	J0043937
	Locas Green	J0043944
	Military Beige	J0043945
	Pinky	J0043943
	Lemon Peel	J0043941
	Red Baron	J0043938
	Sinbad Purple	J0043947
	Cloud White	J0043948
	Gray Hammer'tn	J0043946
	Gecko Green	J0046537
	Hot Pink	J0046538
	Neon Yellow	J0046536
	Hydrographic	J0046922

D-Ring Mounts



Our D-Ring Mounts can be mounted to any bumper utilizing 1/2" bolt holes with a 5.1" x 2.5" bolt pattern. Kit includes 4 stainless steel allen head bolts with 1/2-13 threads.

	Bare Metal	J0045341
	Black	J0045327
	Texturized Black	J0045337
	Southwest Blue	J0045330
	Playboy Blue	J0045331
	Neon Green	J0045333
	Fluorescent Orange	J0045328
	Locas Green	J0045335
	Military Beige	J0045336
	Pinky	J0045334
	Lemon Peel	J0045332
	Red Baron	J0045329
	Sinbad Purple	J0045339
	Cloud White	J0045340
	Gray Hammer'tn	J0045338
	Gecko Green	J0046407
	Hot Pink	J0046408
	Neon Yellow	J0046406
	Hydrographic	J0046921

Tailgate Plug Kit



3 pieces/kit



J0047357

Yard Can Holder



32" high J0031197

48" high J0031198



Overhead Organizers and Pistol & Gun Holders, Coat Hooks

JKU

Pistol Holder



J0045472

This handy device is made from stainless steel rod in the USA and hangs below the steering column.

It is your responsibility to follow all local, state and federal laws relevant to gun transport and use.

Overhead Organizers



**STORE SMALL ITEMS IN
POCKETS OVERHEAD**



Our overhead organizer has 4 pockets. Fits any top - stock or aftermarket. Made in the USA. Fits JK, JKU and TJ.

Coat Hook Kit



This simple metal loop and strap attaches to the rear roll bar and gives you a place to hang your jacket. Fits JK, JKU, TJ, YJ, CJ-7, CJ-8.

2 Hooks **J0045737**



Gun Magnet



J0030792

Poly encased magnet sticks to metal, creating a handy place to lean your unloaded shotgun.

Zipper Pulls



Black J0041222



Orange J0041224



Blue J0041588



Red J0041591



J0043921
Camo

J0045849
Pink Snowfall

J0045850
Black

J0045851
Royal Blue

J0045852
Red

J0045853
Charcoal

JK- Premium Cargo Nets



- Black J0045964
- Blue J0047014
- Gray J0047015
- Orange J0047016
- Red J0047017

JKU - Premium Nets



- Black J0046253
- Blue J0047022
- Gray J0047023
- Orange J0047024
- Red J0047025

Our Teddy® Top Cargo Nets cover the back half and sides of your Jeep, and can remain on your Jeep long term as they are compatible with factory hard tops, soft tops, Steinjäger Teddy® Fabric Tops and Teddy® Cargo Nets. The open design allows for great visibility while keeping your cargo inside of the vehicle. Made in the USA. Installation can be done by one person in 15 minutes.

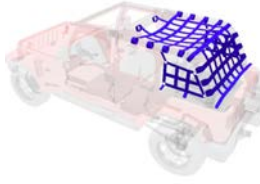
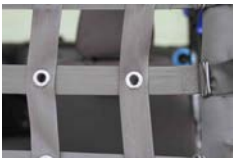

Fabric Teddy® Tops

Front Seat Solar Covers

JKU



Teddy® Top Solar Screens

Covers front seat only

Fits both JK (2 door) and JKU (4 door)



Our Teddy® Top Solar Screens reduce direct sunlight, keeping both you and your Jeep cooler. Our Teddy® Top Solar Screen can remain on your Jeep long term as it is compatible with factory hard tops, soft tops, Steinjäger Teddy® Cargo Covers and Teddy® Cargo Nets. Made in the USA. Covers front seats *only*. Installation can be done by one person in 15 minutes.

2007-2009 Model Years

2010-2018 Model Years



	<u>2007-2009 Model Years</u>	<u>2010-2018 Model Years</u>
Black	J0043976	J0043993
Blue	J0043979	J0043996
Burgundy	J0043985	J0044002
Gray	J0043980	J0043997
Green	J0043982	J0043999
Green, Dark	J0043986	J0044003
Mauve	J0043987	J0044004
Orange	J0043977	J0043994
Red	J0043984	J0044001
Tan	J0043981	J0043998
White	J0043978	J0043995
Yellow	J0043983	J0044000

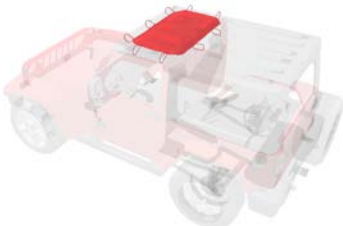

*Images from
Steinjäger's online
3D Configurator -
free and fun to use*

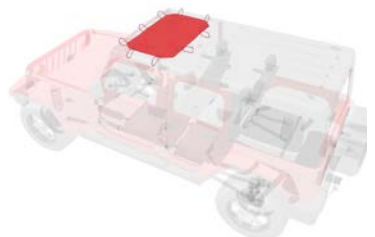

JK

Fabric Teddy® Tops Covers Front & Rear Seats of 2 Door JK

Teddy® Top Solar Screens for 2 Dr JK



Covers JK Front & Back Seats



Our Teddy® Top Solar Screens reduce direct sunlight, keeping both you and your Jeep cooler, and can remain on your Jeep long term as they are compatible with factory hard tops, soft tops, Steinjäger Teddy® Cargo Covers and Teddy® Cargo Nets. Made in the USA.



Black J0041662



Mauve J0043725



Blue J0043717



Orange J0041663



Burgundy J0043723



Red J0043722



Gray J0043718



Tan J0043719



Green J0043720



White J0043716



Green, Dark J0043724



Yellow J0043721

Cargo Covers for JK (2 Door)



Our Cargo Covers install in under 5 minutes and help keep your cargo inside your Jeep when you have your soft top down or your hard top off. Made in the USA.

For JKU (4 Door)



J0041214



J0041215

Fabric Teddy® Tops

Covers Front & Rear Seats of 4 Door JKU

JKU

Teddy® Top Solar Screens



Covers JKU Front & Back Seats



Our Teddy® Top Solar Screens reduce direct sunlight, keeping both you and your Jeep cooler. Our Teddy® Top Solar Screen can remain on your Jeep long term as it is compatible with factory hard tops, soft tops, Steinjäger Teddy® Cargo Covers and Teddy® Cargo Nets. Made in the USA. Installation can be done by one person in 15 minutes.

2007-2009 Model Years

2010-2018 Model Years



Black	J0041463	J0041320
Blue	J0043697	J0043731
Burgundy	J0043703	J0043693
Gray	J0043698	J0043732
Green	J0043700	J0043734
Green, Dark	J0043704	J0043694
Mauve	J0043705	J0043695
Orange	J0041464	J0041465
Red	J0043702	J0043736
Tan	J0043699	J0043733
White	J0043696	J0043730
Yellow	J0043701	J0043735

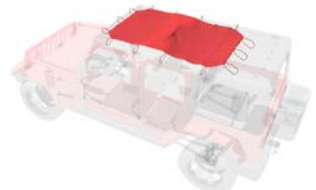



All of our LED brackets are made in the USA

Lower Windshield Hood Mounted



2 Brackets in this kit



A - Pillar



2 Brackets in this kit

Lower Windshield

Hood Mounted

A-Pillar Mounted

Bare Metal	J0041660
Black	J0040929
Textured Blk	J0041571
SW Blue	J0041564
Playboy Blue	J0041565
Neon Green	J0041567
Flr Orange	J0041562
Locas Green	J0041569
Military Beige	J0041570
Pinky	J0041568
Lemon Peel	J0041566
Red Baron	J0041563
SB Purple	J0043974
Cloud White	J0043975
Gray Hammer	J0041572
Gecko Green	J0046392
Hot Pink	J0046393
Neon Yellow	J0046391

J0041441
J0041042
J0041439
J0041432
J0041433
J0041435
J0041430
J0041437
J0041438
J0041436
J0041434
J0041431
J0043607
J0043609
J0041440
J0046510
J0046511
J0046509
J0046903

J0047358
J0047359
J0047369
J0047362
J0047363
J0047365
J0047360
J0047367
J0047368
J0047366
J0047364
J0047361
J0047371
J0047372
J0047370
J0047374
J0047375
J0047373



LED Lights available online

LED Brackets

Front Grill and Front Bumper Brackets

JKU

External Grill Bracket



LED Lights

Bumper Light Bar



LED Lights

	Bare Metal	J0041402
	Black	J0041388
	Texturized Black	J0041401
	Southwest Blue	J0041393
	Playboy Blue	J0041394
	Neon Green	J0041396
	Fl'rescent Orange	J0041391
	Locas Green	J0041398
	Military Beige	J0041399
	Pinky	J0041397
	Lemon Peel	J0041395
	Red Baron	J0041392
	Sinbad Purple	J0044773
	Cloud White	J0044774
	Gray Hammer'tn	J0041400
	Gecko Green	J0046395
	Hot Pink	J0046396
	Neon Yellow	J0046394

	Black	J0045688
	Texturized Black	J0045699
	Red Baron	J0045690

More colors available online

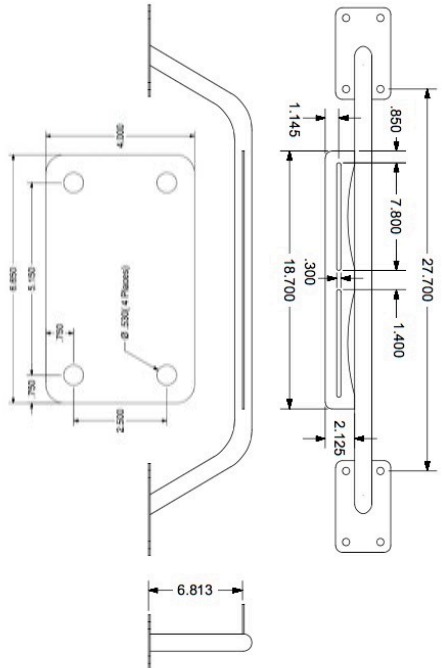

Compatible with winches, our Bracket has two slots that measure 0.300" high x 7.800" long onto which you can mount your LEDs. Made in the USA.

JK

Rock Sliders for the 2 Door JK

Rock Sliders



	Bare Metal	J0046840
	Black	J0044820
	Texturized Black	J0044830
	Southwest Blue	J0044823
	Playboy Blue	J0044824
	Neon Green	J0044826
	Fluorescent Orange	J0044821
	Locas Green	J0044828
	Military Beige	J0044829
	Pinky	J0044827
	Lemon Peel	J0044825
	Red Baron	J0044822
	Sinbad Purple	J0044832
	Cloud White	J0044833
	Gray Hammer'tn	J0044831
	Gecko Green	J0046398
	Hot Pink	J0046399
	Neon Yellow	J0046397



Phantom Style Available online



Made in the USA from 1.750" OD x 0.120" W tubing. Our simple, yet rugged design installs in minutes with the supplied hardware.

Rock Sliders

for the 4 Door JKU

JKU

Rock Sliders



These simple to install rock sliders utilize the three body mounts on each side. Simply remove the body bolts and install the rock sliders with the new hardware supplied.

Made in the USA from 1.75" OD ASTM 513 Type 1 Tubing.



	Bare Metal	J0046880
	Black	J0043899
	Texturized Black	J0043931
	Southwest Blue	J0043924
	Playboy Blue	J0043925
	Neon Green	J0043927
	Fluorescent Orange	J0043922
	Locas Green	J0043929
	Military Beige	J0043930
	Pinky	J0043928
	Lemon Peel	J0043926
	Red Baron	J0043923
	Sinbad Purple	J0043933
	Cloud White	J0043934
	Gray Hammer'tn	J0043932
	Gecko Green	J0046389
	Hot Pink	J0046390
	Neon Yellow	J0046388

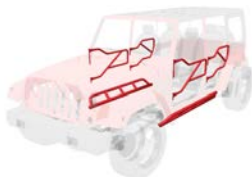

Front Tubular Bumper



Rear Tubular Bumper



	Bare Metal	J0048118
	Black	J0048119
	Texturized Black	J0048129
	Southwest Blue	J0048122
	Playboy Blue	J0048123
	Neon Green	J0048125
	Fluorescent Orange	J0048120
	Locas Green	J0048127
	Military Beige	J0048128
	Pinky	J0048126
	Lemon Peel	J0048124
	Red Baron	J0048121
	Sinbad Purple	J0048131
	Cloud White	J0048132
	Gray Hammer'tn	J0048130
	Gecko Green	J0048134
	Hot Pink	J0048135
	Neon Yellow	J0048133

	Bare Metal	J0048157
	Black	J0048158
	Texturized Black	J0048168
	Southwest Blue	J0048161
	Playboy Blue	J0048162
	Neon Green	J0048164
	Fluorescent Orange	J0048159
	Locas Green	J0048166
	Military Beige	J0048167
	Pinky	J0048165
	Lemon Peel	J0048163
	Red Baron	J0048160
	Sinbad Purple	J0048170
	Cloud White	J0048171
	Gray Hammer'tn	J0048169
	Gecko Green	J0048173
	Hot Pink	J0048174
	Neon Yellow	J0048172

The Steinjäger Tubular Bumper is made in the USA from 1.750" OD x 0.120" W Tubing, and comes with a standard 4x10 winch plate along with fairlead mounting points. Stainless Hardware is included. Note: some Jeeps will require a vacuum pump relocation kit.

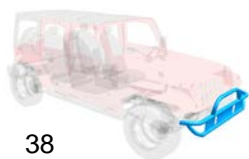

Rear Bumpers

Made in the USA

JKU

Rear Bumper



with D-Ring Mounts



	Bare Metal	J0047859
	Black	J0047860
	Texturized Black	J0047870
	Southwest Blue	J0047863
	Playboy Blue	J0047864
	Neon Green	J0047866
	Fluorescent Orange	J0047861
	Locas Green	J0047868
	Military Beige	J0047869
	Pinky	J0047867
	Lemon Peel	J0047865
	Red Baron	J0047862
	Sinbad Purple	J0047872
	Cloud White	J0047873
	Gray Hammer'tn	J0047871
	Gecko Green	J0047875
	Hot Pink	J0047876
	Neon Yellow	J0047874

	Bare Metal	J0048136
	Black	J0048137
	Texturized Black	J0048147
	Southwest Blue	J0048140
	Playboy Blue	J0048141
	Neon Green	J0048143
	Fluorescent Orange	J0048138
	Locas Green	J0048145
	Military Beige	J0048146
	Pinky	J0048144
	Lemon Peel	J0048142
	Red Baron	J0048139
	Sinbad Purple	J0048149
	Cloud White	J0048150
	Gray Hammer'tn	J0048148
	Gecko Green	J0048152
	Hot Pink	J0048153
	Neon Yellow	J0048151

The Steinjäger Rear Bumper will give your Jeep a fresh new look. The sleek design covers up and caps the unsightly frame rails and tucks tightly to the body. Made of 3/16" thick steel plate. Made in the USA.

Harness Bar Kit



License Plate Relocator



Bare Metal	J0047552
Black	J0047553
Texturized Black	J0047563
Southwest Blue	J0047556
Playboy Blue	J0047557
Neon Green	J0047559
Fl'rescent Orange	J0047554
Locas Green	J0047561
Military Beige	J0047562
Pinky	J0047560
Lemon Peel	J0047558
Red Baron	J0047555
Sinbad Purple	J0047565
Cloud White	J0047566
Gray Hammer'tn	J0047564
Gecko Green	J0047568
Hot Pink	J0047569
Neon Yellow	J0047567

Bare Metal	J0045831
Black	J0045832
Texturized Black	J0045842
Southwest Blue	J0045835
Playboy Blue	J0045836
Neon Green	J0045838
Fl'rescent Orange	J0045833
Locas Green	J0045840
Military Beige	J0045841
Pinky	J0045839
Lemon Peel	J0045837
Red Baron	J0045834
Sinbad Purple	J0045844
Cloud White	J0045845
Gray Hammer'tn	J0045843
Gecko Green	J0046446
Hot Pink	J0046447
Neon Yellow	J0046445

Our Harness Bar is designed to not only stiffen up the B-Pillars, but also to give you a solid place to attach your shoulder harness straps. Installation is simple, but requires a few hand tools and a drill. Made in the USA.

Fits JKU

When you need to remove your license plate in order to use your winch, simply remove the thumbscrews and place in a safe location. Loosen, not remove, the fairlead and slip the bracket behind. There is no need to remove your hook or safety thimble. Made in the USA.

Fits TJ, LJ, JK and JKU

Sway Bars & End Links

Bolt-On and Do-It-Yourself Kits

JKU

Front Sway Bars



J0040928



This undersized adjustable front sway bar helps improve stability at higher speeds, and gives you more flex when off-roading.

Quick Disconnect End Links



Front

- 0.0 - 2.0" Lift Height **J0030554**
- 2.5 - 5.0" Lift Height **J0030555**
- 5.5 - 8.0" Lift Height **J0030556**

Zinc Plated steel Rod is threaded Left Hand and Right Hand to allow easy length adjustments.



Rear

- 0.0 - 2.0" Lift Height **J0031035**
- 2.5 - 5.0" Lift Height **J0031036**
- 5.5 - 8.0" Lift Height **J0031037**

NON Disconnecting End Links

Front

- 0.0 - 2.0" **J0041011**
- 2.5 - 5.0" **J0041012**
- 5.5 - 8.0" **J0041013**

Rear

- 0.0 - 2.0" **J0030557**
- 2.5 - 5.0" **J0030558**
- 5.5 - 8.0" **J0030559**

Do It Yourself End Links

J0031207



Kit includes 1" OD x 0.095 DOM Tubes, studded chrome moly heims, thread bungs, boots and all hardware

Sway Bar Hanger Kit



Hold your sway bar and end links out of the way when they are disconnected. Made the USA.



Black **J0043954**



Blue **J0043955**



Gray **J0043957**



Orange **J0043958**



Red **J0043956**

Premium Front Track Bars

Fits stock to 6 inch lifts

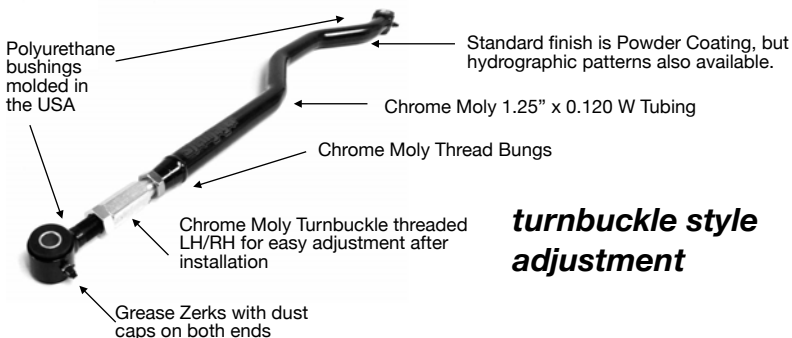

turnbuckle style adjustment

Right Hand Drive

	Bare Metal	J0046168	J0047669
	Black	J0044777	J0047670
	Texturized Black	J0046178	J0047680
	Southwest Blue	J0046171	J0047673
	Playboy Blue	J0046172	J0047675
	Neon Green	J0046174	J0047676
	Fluorescent Orange	J0046169	J0047671
	Locas Green	J0046176	J0047678
	Military Beige	J0046177	J0047679
	Pinky	J0046175	J0047677
	Lemon Peel	J0046173	J0047675
	Red Baron	J0046170	J0047672
	Sinbad Purple	J0046180	J0047682
	Cloud White	J0046181	J0047683
	Gray Hammer'tn	J0046179	J0047681
	Gecko Green	J0046588	J0047685
	Hot Pink	J0046589	J0047686
	Neon Yellow	J0046587	J0047684
	Hydrographics	J0046928	

Poly/Heim Style

J0044782



For stock to 6" Lifts

Rebuild Kit



J0045404



Fits Steinjäger Track Bars

Limiter Kit



J0045847

Rear Panhard Bars

including Right Hand Drive Options

JKU

Rear Panhard Bars



Fits stock to 6 inch lifts

turnbuckle style adjustment

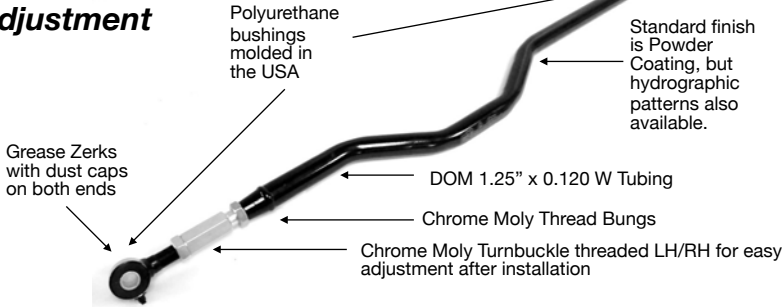

	<u>Left Hand Drive</u>
Bare Metal	J0046813
Black	J0031389
Texturized Black	J0046611
Southwest Blue	J0046601
Playboy Blue	J0046602
Neon Green	J0046604
Fl'orescent Orange	J0046599
Locas Green	J0046606
Military Beige	J0046607
Pinky	J0046605
Lemon Peel	J0046603
Red Baron	J0046600
Sinbad Purple	J0046609
Cloud White	J0046610
Gray Hammer'tn	J0046608
Gecko Green	J0046613
Hot Pink	J0046614
Neon Yellow	J0046612
Hydrographic	J0046931

	<u>Right Hand Drive</u>
	J0047704
	J0047705
	J0047715
	J0047708
	J0047709
	J0047711
	J0047706
	J0047713
	J0047714
	J0047712
	J0047710
	J0047707
	J0047717
	J0047718
	J0047716
	J0047720
	J0047721
	J0047719

Poly/Heim Design

J0041428



For stock to 6" Lifts

Rebuild Kit



J0045405



Fits Steinjäger Panhard Bars

Chrome Moly designs available online



Front Lower



Front Uppers



Made in the USA

Standard finish is Powder Coating, but hydrographic patterns also available.

Poly Bushings have grease zerks

Front Lower Control Arms

Front Upper Control Arms

Lift & Tube Size ->

0-2.5" Lift

2.5-4.0" Lift

0.0-4.0" Lift

1.750 x 0.12 Tube

1.750 x **0.250** Tube

1.50 x 0.120 Tube

Tube Material ->

DOM Steel

DOM Steel

DOM Steel

	Black	J0041277	J0041278	J0041275
	Text Black	J0046751	J0047002	J0046768
	SW Blue	J0046744	J0046995	J0046761
	Playboy Blue	J0046745	J0046996	J0046762
	Neon Green	J0046747	J0046998	J0046764
	FL Orange	J0046742	J0046993	J0046759
	Locas Green	J0046749	J0047000	J0046766
	Military Beige	J0046750	J0047001	J0046767
	Pinky	J0046748	J0046999	J0046765
	Lemon Peel	J0046746	J0046997	J0046763
	Red Baron	J0046743	J0046994	J0046760
	Sinbad Purple	J0046753	J0047004	J0046770
	Cloud White	J0046754	J0047005	J0046771
	Gray Hammer	J0046752	J0047003	J0046769
	Gecko Green	J0046756	J0047007	J0046773
	Hot Pink	J0046757	J0047008	J0046774
	Neon Yellow	J0046755	J0047006	J0046772
	Hydrodipped	J0046907	J0046911	J0046908



Control Arms

Made in the USA

JKU



Rear Lower



Rear Uppers



Made in the USA

Standard finish is Powder Coating, but hydrographic patterns also available.

Poly Bushings have grease zerks

Rear Lower Control Arms

Rear Upper Control Arms

Lift & Tube Size ->	0-2.5" Lift 1.750 x 0.12 Tube	2.5-4.0" Lift 1.750 x 0.250 Tube	0.0-4.0" Lift 1.50 x 0.120 Tube
Tube Material ->	DOM Steel	DOM Steel	DOM Steel

	Black	J0041273	J0041274	J0041271
	Text Black	J0046833	J0046984	J0046785
	SW Blue	J0046826	J0046977	J0046778
	Playboy Blue	J0046827	J0046978	J0046779
	Neon Green	J0046829	J0046980	J0046781
	FL Orange	J0046824	J0046975	J0046776
	Locas Green	J0046831	J0046982	J0046783
	Military Beige	J0046832	J0046983	J0046784
	Pinky	J0046830	J0046981	J0046782
	Lemon Peel	J0046828	J0046979	J0046780
	Red Baron	J0046825	J0046976	J0046777
	Sinbad Purple	J0046835	J0046986	J0046787
	Cloud White	J0046836	J0046987	J0046788
	Gray Hammer	J0046834	J0046985	J0046786
	Gecko Green	J0046838	J0046989	J0046790
	Hot Pink	J0046839	J0046990	J0046791
	Neon Yellow	J0046837	J0046988	J0046789
	Hydrodipped	J0046909	J0046913	J0046910

Suspension Coil Springs



Made in the USA

Each kit includes two Springs.

Springs are **single rate**.



FRONT Coil Springs

REAR Coil Springs

Lift Height ->	0-2.5" Lift	4.0" Lift	0-2.5" Lift	4.0" Lift
	J00#	J00#	J00#	J00#
Bare Metal	46644	46616	46645	46617
Black	46646	46618	46663	46619
SW Blue	46649	46622	46666	46634
Playboy Blue	46650	46623	46667	46635
Neon Green	46652	46625	46669	46637
Flr Orange	46647	46620	46664	46632
Locas Green	46654	46627	46671	46639
Military Beige	46655	46628	46672	46640
Pinky	46653	46626	46670	46638
Lemon Peel	46651	46624	46668	46636
Red Baron	46648	46621	46665	46633
SB Purple	46658	46630	46675	46642
Cloud White	46659	46631	46676	46643
Gray Hammer	46657	46629	46674	46641
Gecko Green	46661	46684	46678	46685
Hot Pink	46662	46688	46679	46689
Neon Yellow	46660	46680	46677	46681



2.5" Lift Kits for JK and JKU

JKU

Lift Kits, 2.5" for JK and JKU

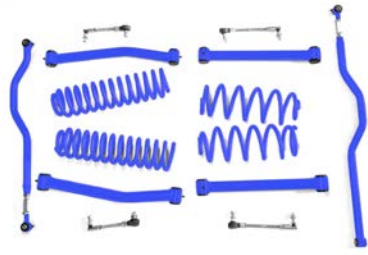

	Bare Metal	J0046812
	Black	J0046692
	Texturized Black	J0046702
	Southwest Blue	J0046695
	Playboy Blue	J0046696
	Neon Green	J0046698
	Fluorescent Orange	J0046693
	Locas Green	J0046700
	Military Beige	J0046701
	Pinky	J0046699
	Lemon Peel	J0046697
	Red Baron	J0046694
	Sinbad Purple	J0046704
	Cloud White	J0046705
	Gray Hammer'tn	J0046703
	Gecko Green	J0046707
	Hot Pink	J0046708
	Neon Yellow	J0046706

	Bare Metal	J0046899
	Black	J0046882
	Texturized Black	J0046892
	Southwest Blue	J0046885
	Playboy Blue	J0046886
	Neon Green	J0046888
	Fluorescent Orange	J0046883
	Locas Green	J0046890
	Military Beige	J0046891
	Pinky	J0046889
	Lemon Peel	J0046887
	Red Baron	J0046884
	Sinbad Purple	J0046894
	Cloud White	J0046895
	Gray Hammer'tn	J0046893
	Gecko Green	J0046897
	Hot Pink	J0046898
	Neon Yellow	J0046896

- Panhard Bar is 1.250" x 0.120" W DOM Tubing.
- Track Bar is 1.250" x 0.120 W Chrome Moly Tubing.
- Thread Bungs are Chrome Moly.
- Double Adjustable Panhard Bar and Track Bar.

- End Links come with rubber Dust Boots
- All Track Bars, Panhard Bars, Springs and Control Arms are Powder Coated.
- All Poly Bushings have a Grease Zerk & Cap.

RHD ONLINE



Lift Kits, 2.5" for JK and JKU

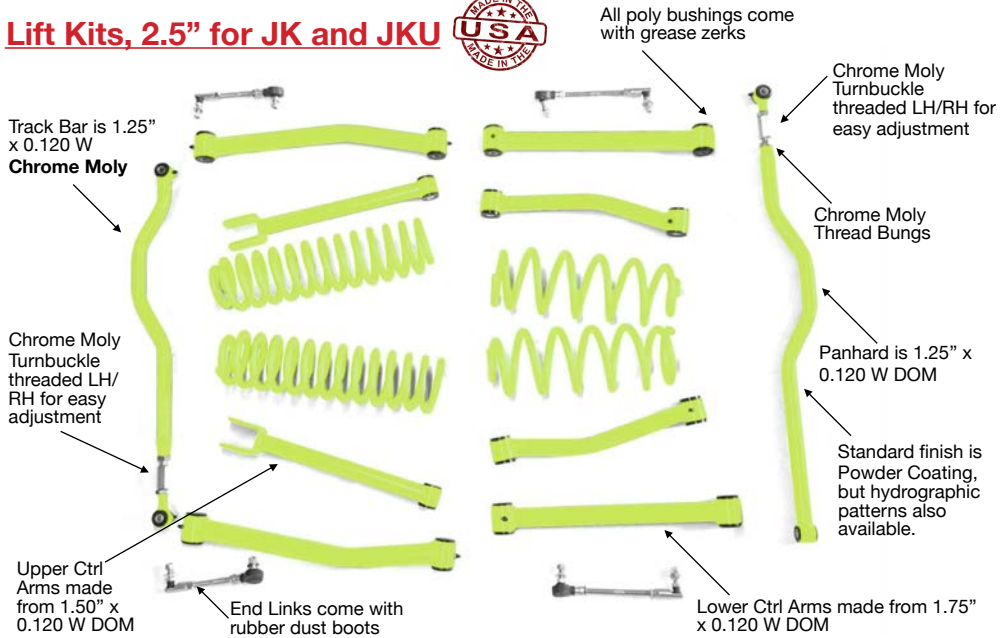

Lifetime Warranty on the control arms, track bar, and panhard bar, including the poly bushings. One year warranty on springs and end links. These kits are designed for moderate off-road use.

	Bare Metal	J0046967
	Black	J0046950
	Texturized Black	J0046960
	Southwest Blue	J0046953
	Playboy Blue	J0046954
	Neon Green	J0046956
	Fluorescent Orange	J0046951
	Locas Green	J0046958
	Military Beige	J0046959

	Pink	J0046957
	Lemon Peel	J0046955
	Red Baron	J0046952
	Sinbad Purple	J0046962
	Cloud White	J0046963
	Gray Hammer'tn	J0046961
	Gecko Green	J0046965
	Hot Pink	J0046966
	Neon Yellow	J0046964



Use our free online 3D Configurator to design and color match your dream Jeep.

RHD ONLINE



4.0" Lift Kits for JK and JKU

JKU

Lift Kits, 4" for JK and JKU



All poly bushings come with grease zerks

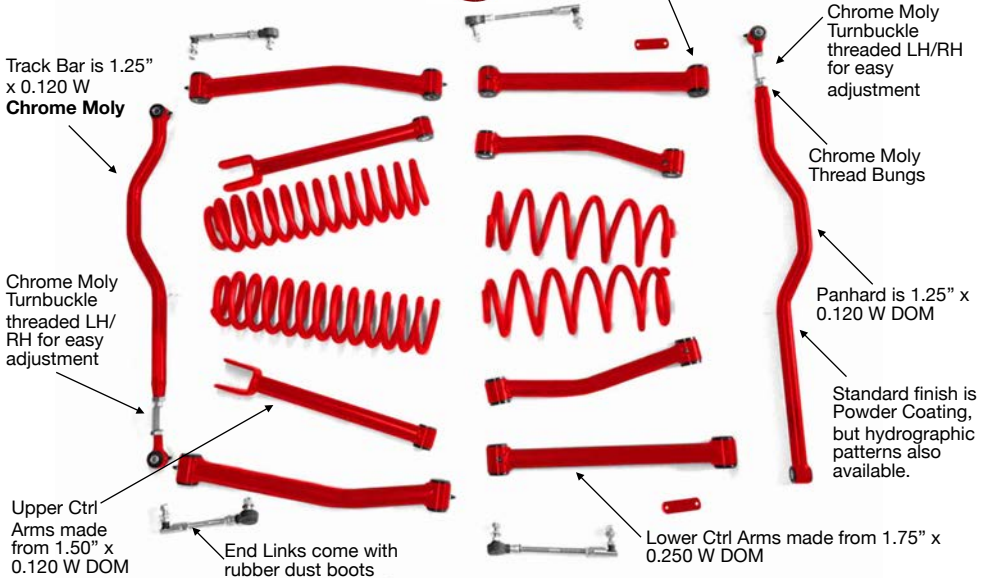

Lifetime Warranty on the control arms, track bar, and panhard bar, including the poly bushings. One year warranty on springs and end links. These kits are designed for moderate off-road use.

	Bare Metal	J0044941
	Black	J0041262
	Texturized Black	J0044937
	Southwest Blue	J0044930
	Playboy Blue	J0044931
	Neon Green	J0044933
	Fluorescent Orange	J0044928
	Locas Green	J0044935
	Military Beige	J0044936

	Pinky	J0044934
	Lemon Peel	J0044932
	Red Baron	J0044929
	Sinbad Purple	J0044939
	Cloud White	J0044940
	Gray Hammer'tn	J0044938
	Gecko Green	J0046561
	Hot Pink	J0046562
	Neon Yellow	J0046560







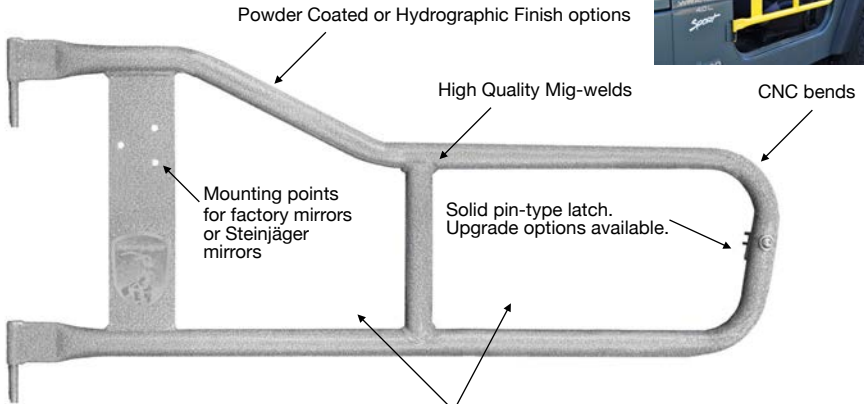









RHD ONLINE



TUBULAR DOORS FOR TJ & LJ



Open air design allows fabric and cargo net style inserts.

	Bare Metal	J0041331		Lemon Peel	J0040996
	Black	J0029673		Red Baron	J0040997
	Texturized Black	J0041016		Sinbad Purple	J0042641
	Southwest Blue	J0040989		Cloud White	J0042642
	Playboy Blue	J0040990		Gray Hammer'tn	J0041338
	Neon Green	J0040991		Gecko Green	J0046489
	Fl'rescent Orange	J0040992		Hot Pink	J0046490
	Locas Green	J0040993		Neon Yellow	J0046488
	Military Beige	J0040994		Hydrographic	J0046816
	Pinky	J0040995			

Check out our installation video on [YouTube](#) by searching for 'Steinjäger'. Installation may require a minor adjustment to the striker latch. Kits include all attaching hardware. Doors are made in the USA from 1.25" OD tubing.



Tube Door Limiting Straps



Fits Steinjäger Tube Doors on TJ, YJ, CJ-7 & CJ-8

J0041621

2 straps per kit

Door Hangers & Accessories

Arm Rests, Latches, Limiting Straps

TJ/LJ

WALL MOUNTED DOOR HANGER



Holds Two Doors Mounts to wall studs and holds factory and tubular doors.



	Bare Metal	J0044946
	Black	J0030813
	Texturized Black	J0044956
	Southwest Blue	J0044949
	Playboy Blue	J0044950
	Neon Green	J0044952
	Fluorescent Orange	J0044947
	Locas Green	J0044954
	Military Beige	J0044955
	Pinky	J0044953
	Lemon Peel	J0044951
	Red Baron	J0044948
	Sinbad Purple	J0044958
	Cloud White	J0044959
	Gray Hammer'tn	J0044957
	Gecko Green	J0046410
	Hot Pink	J0046411
	Neon Yellow	J0046409

Steinjäger Latch Upgrade



These handy latch upgrades make our great tube doors even better! Fits our JK & TJ tube doors.

Part#	# of Pins
J0043481	1
J0043482	2
J0043483	4

Arm Rests



Color Part#



Black J0041034



Red J0046100



Blue J0046106

Fits our JK, TJ, YJ, & CJ tube doors.

Door Limiting Straps



For TJ stock doors.
2 Straps per kit.

Black	J0043901
Blue	J0043905
Gray	J0043904
Orange	J0043902
Red	J0043903

Door Mesh & Net Inserts

Made in the USA for Steinjäger Tube Doors

Door Mesh Inserts



Made in the USA. Prices include bungees and two door covers. Fits Steinjäger **TJ**, **YJ**, **CJ-7** and **CJ-8** tube doors.

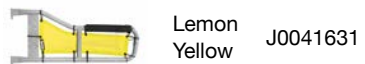
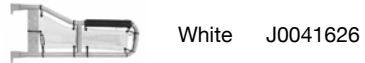

Door Net Inserts

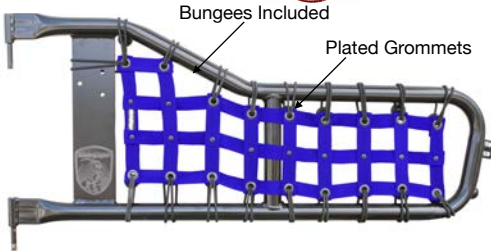

Made in the USA. Prices include bungees and two door nets. Fits Steinjäger **TJ** tube doors.

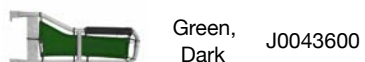
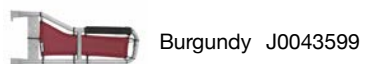

Mirrors and Mirror Legs

fits the TJ, LJ, YJ, CJ-7 and CJ-8

TJ/LJ

Tube Door Mirror Legs



For Steinjäger Tube Doors on TJ, LJ, YJ, CJ-7, and CJ-8

Fits Steinjäger tube doors. Will also fit on factory doors.

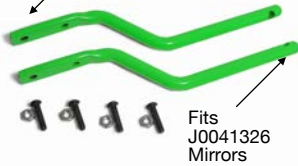

Fits J0041326 Mirrors

A Pillar Mirror Legs



Includes 2 Mirrors, 2 Legs & Hardware

Black	J0046214
Texturized Black	J0046227
Southwest Blue	J0046226
Playboy Blue	J0046223
Neon Green	J0046221
Fl'rescent Orange	J0046216
Locas Green	J0046219
Military Beige	J0046220
Pinky	J0046222
Lemon Peel	J0046218
Red Baron	J0046224
Sinbad Purple	J0046225
Cloud White	J0046215
Gray Hammer'tn	J0046217
Gecko Green	J0046597
Hot Pink	J0046598
Neon Yellow	J0046596

Black	J0047281
Texturized Black	J0047291
Southwest Blue	J0047284
Playboy Blue	J0047285
Neon Green	J0047287
Fl'rescent Orange	J0047282
Locas Green	J0047289
Military Beige	J0047290
Pinky	J0047288
Lemon Peel	J0047286
Red Baron	J0047283
Sinbad Purple	J0047293
Cloud White	J0047294
Gray Hammer'tn	J0047292
Gecko Green	J0047296
Hot Pink	J0047297
Neon Yellow	J0047295

Mirrors

2 Mirrors **J0041326**



Magnetic Legs for Mirrors



2 Legs **J0046183**

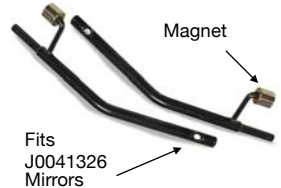

Fits J0041326 Mirrors

Transfer Case Cable Shifter Kit



J0048041 Cable Shifter Kit
for 231 Transfer Case

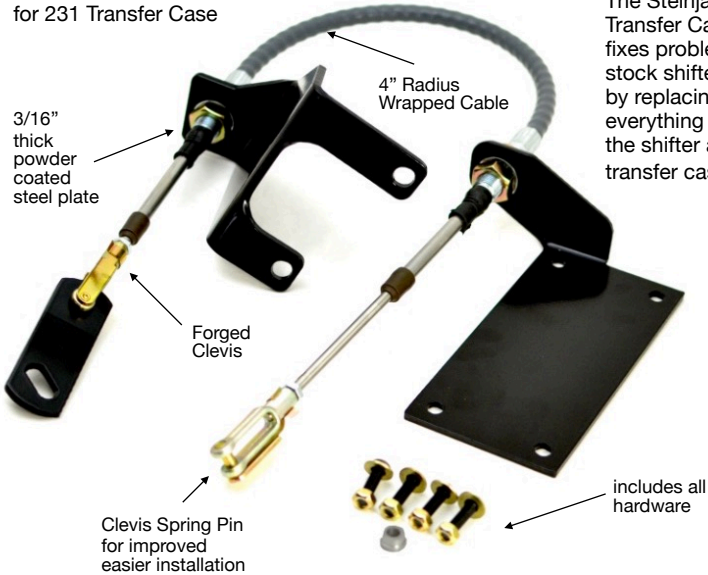

The Steinjäger Transfer Case Shifter fixes problematic stock shifter linkage by replacing everything between the shifter and the transfer case.

Hardtop Hardware Kit



J0045490



Stainless Steel components to replace your factory hardtop hardware. Fits **TJ** and **YJ**.

Roll Bar Grab Handles



Two Handles per Kit

Black Grips **J0043462**

Red Grips **J0043478**

We mold and sew these handles in the USA. Designed to fit over the factory roll bar, these handles come ready for installation.



Foot Pegs

fits the TJ, LJ, YJ, CJ-7 and CJ-8

TJ/LJ

Wire Foot Pegs

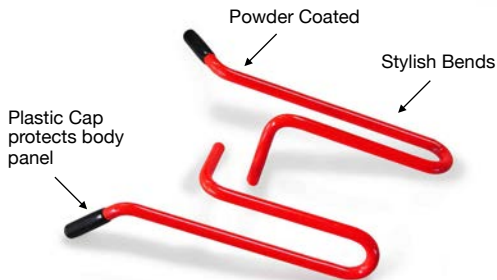

Also fits YJ, CJ-7, CJ-8

Premium Foot Pegs



	Bare Metal	J0045905
	Black	J0028970
	Texturized Black	J0045915
	Southwest Blue	J0045908
	Playboy Blue	J0045909
	Neon Green	J0045911
	Fluorescent Orange	J0045906
	Locas Green	J0045913
	Military Beige	J0045914
	Pinky	J0045912
	Lemon Peel	J0045910
	Red Baron	J0045907
	Sinbad Purple	J0045917
	Cloud White	J0045918
	Gray Hammer'tn	J0045916
	Gecko Green	J0046576
	Hot Pink	J0046577
	Neon Yellow	J0046575

	Bare Metal	J0047013
	Black	J0043881
	Texturized Black	J0043891
	Southwest Blue	J0043884
	Playboy Blue	J0043885
	Neon Green	J0043887
	Fluorescent Orange	J0043882
	Locas Green	J0043889
	Military Beige	J0043890
	Pinky	J0043888
	Lemon Peel	J0043886
	Red Baron	J0043883
	Sinbad Purple	J0043893
	Cloud White	J0043894
	Gray Hammer'tn	J0043892
	Gecko Green	J0046534
	Hot Pink	J0046535
	Neon Yellow	J0046533

Steinjäger's foot pegs are made in the USA. Both of our designs include a rubber or non-metallic component to prevent scratching. Do **NOT** operate your vehicle with any part of your body protruding beyond the vehicle. **Caution!**

Bolt on Winch Plate and Brackets for 50" LED Lights

Brackets for 50" LED's



Our 50" Light Bar Bracket utilizes the top of the windshield frame for a simple and sleek design. Includes mounting hardware and 2 brackets. LED lights also available online. Brackets are made in the USA.

Bolt On Winch Plate



Steinjäger's Bolt On Winch Plate is designed to work with your factory bumper and some aftermarket tube bumpers. It is mounted with the four top bumper bolts along with the front sway bar bolt. Made in the USA from 1/4" thick steel plate.

	Bare Metal	J0046794
	Black	J0046795
	Texturized Black	J0046805
	Southwest Blue	J0046798
	Playboy Blue	J0046799
	Neon Green	J0046801
	Fluorescent Orange	J0046796
	Locas Green	J0046803
	Military Beige	J0046804
	Pinky	J0046802
	Lemon Peel	J0046800
	Red Baron	J0046797
	Sinbad Purple	J0046807
	Cloud White	J0046808
	Gray Hammer'tn	J0046806
	Gecko Green	J0046810
	Hot Pink	J0046811
	Neon Yellow	J0046809
	Hydrographic	J0046906

	Bare Metal	J0046867
	Black	J0046278
	Texturized Black	J0046288
	Southwest Blue	J0046281
	Playboy Blue	J0046282
	Neon Green	J0046284
	Fluorescent Orange	J0046279
	Locas Green	J0046286
	Military Beige	J0046287
	Pinky	J0046285
	Lemon Peel	J0046283
	Red Baron	J0046280
	Sinbad Purple	J0046290
	Cloud White	J0046291
	Gray Hammer'tn	J0046289
	Gecko Green	J0046293
	Hot Pink	J0046294
	Neon Yellow	J0046292



See Page 40
Plate Relocator



High Lift Roll Bar Mount Kit for the TJ and the LJ

TJ/LJ

High Lift Mount Kit



Made in the USA. Mounts to roll Bar.

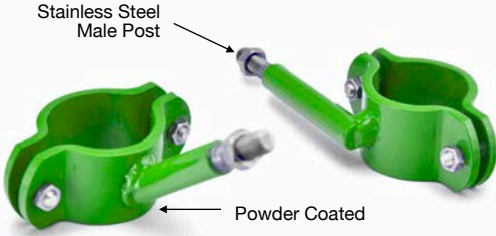

	TJ Part#	LJ Part#
Bare Metal	J0047607	J0047625
Black	J0047608	J0047626
Texturized Black	J0047618	J0047636
Southwest Blue	J0047611	J0047629
Playboy Blue	J0047612	J0047630
Neon Green	J0047614	J0047632
Fl'orescent Orange	J0047609	J0047627
Locas Green	J0047616	J0047634
Military Beige	J0047617	J0047635
Pinky	J0047615	J0047633
Lemon Peel	J0047613	J0047631
Red Baron	J0047610	J0047628
Sinbad Purple	J0047620	J0047638
Cloud White	J0047621	J0047639
Gray Hammer'tn	J0047619	J0047637
Gecko Green	J0047623	J0047641
Hot Pink	J0047624	J0047642
Neon Yellow	J0047622	J0047640

Spare Tire Delete Plates



Made in the USA from 1/8" steel. Uses factory bolts. Available with custom laser images or private labeling.

	Bare Metal	J0046866
	Black	J0043675
	Texturized Black	J0043685
	Southwest Blue	J0043678
	Playboy Blue	J0043679
	Neon Green	J0043681
	Fluorescent Orange	J0043676
	Locas Green	J0043683
	Military Beige	J0043684
	Pinky	J0043682
	Lemon Peel	J0043680
	Red Baron	J0043677
	Sinbad Purple	J0043687
	Cloud White	J0043688
	Gray Hammer'tn	J0043686
	Gecko Green	J0046386
	Hot Pink	J0046387
	Neon Yellow	J0046385
	Hydrographic	J0046923

Hood Latch Kits



Eliminate Jeep hood flutter with these easy to install adjustable hood latches. Installation takes 1 hour and requires a drill with a 3/32 bit, along with basic hand tools.

Plated Steel **J0023990**

Stainless Steel **J0023987**



2 per kit



Red Poly **J0045424**



Black Poly **J0045423**



Eliminate Jeep hood flutter with these easy to install adjustable hood latches. Installation takes 15 minutes and requires masking tape, 2 pairs of locking pliers, and 2 phillips screw drivers.



Teddy® Cargo Nets for the TJ and the LJ

TJ/LJ

Cargo Nets for the TJ



Our Teddy® Cargo Net covers the back half and sides of your TJ Wrangler. The open design allows for great visibility while keeping your cargo inside the vehicle. Made in the USA.

Double back straps allow adjustability and easy installation



2 inch wide webbing

Black grommets



- Black J0046110
- Blue J0047018
- Gray J0047019
- Orange J0047020
- Red J0047021

Cargo Nets for the LJ



- Black J0047376
- Blue J0047377
- Gray J0047378
- Orange J0047379
- Red J0047380

Cargo Cover to TJ



J0041212



Limb Riser Kit (TJ/LJ)



Our Limb Risers are made in the USA of stainless wire rope with a non-metallic jacket, stainless quick disconnect ball joints, and powder coated steel mounting brackets. Some drilling required for installation. Installation video online.



J0030944

Attachments



Cosmetic Stinger
J0029545



Cosmetic Stinger
With Light Bar
Lights NOT included
J0029544



Light Bar
Lights NOT included
J0029544

Teddy® Top Solar Screens



J0041460
Black



J0043710
Green



J0041461
Orange



J0043711
Yellow



J0043706
White



J0043712
Red



For those who only want to cover the front seat, this Teddy® design has all the neat features of our other Teddy® Tops. made in the USA.

J0043707
Blue



J0043713
Burgundy



J0043708
Gray



J0043714
Dark Green



J0043709
Tan



J0043715
Mauve



Covers front seat only



Solar Screen Teddy® Tops for the TJ and the LJ

TJ/LJ

Teddy® Top - TJ



Covers front and back seats

Our Teddy® Top installs easily in minutes with the supplied bungee balls. Our tops will work with factory hard and soft tops - no need to remove our Teddy® once installed! Made in the USA.



J0045985
Black



J0045991
Green



J0045986
Orange



J0045992
Yellow



J0045987
White



J0045993
Red

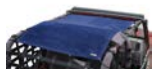

J0045988
Blue



J0045994
Burgundy



J0045989
Gray



J0045995
Dark Green



J0045990
Tan



J0045996
Mauve

Teddy® Top Solar Screens - LJ



- Black J0046868
- Green J0046874
- Orange J0046869
- Yellow J0046875
- White J0046870
- Red J0046876
- Blue J0046871
- Burgundy J0046877
- Gray J0046872
- Dark Green J0046878
- Tan J0046873
- Mauve J0046879



Sway Bars & End Links

Rear Sway Bars & End Links

Rear Sway Bar Kit



J0030153

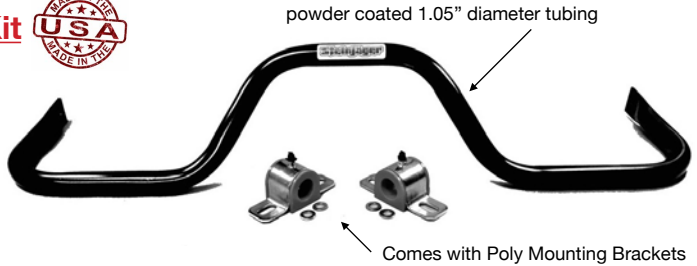

The Steinjäger Rear Sway Bar is constructed from heavy duty 1.050" inch OD x 0.109" Wall A513-Type 1 Tubing to help stiffen up the suspension of your Jeep. The Sway Bar is **powder coated** and includes the polyurethane mounting bushings. Our oversized rear sway bar design helps eliminate unwanted body roll. Disconnect the end links attached to this sway bar before serious rock crawling or off-roading. Otherwise, because of the large diameter, articulation will be reduced and hinder your off-road experience. Made in the USA.

Rear Quick Disconnect End Links

Heim Joint has a non-metallic bearing liner for wear resistance

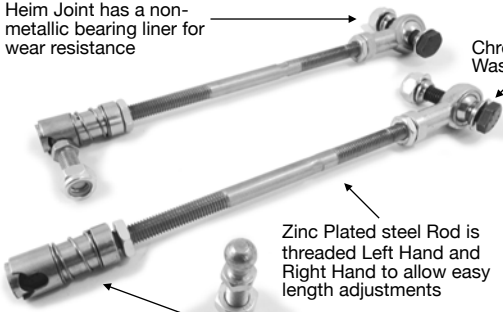

- for stock height TJ's **J0031038**
- for 2" lifted TJ's **J0031039**
- for 4" lifted TJ's **J0031040**
- for 6" lifted TJ's **J0031041**

Metal-on-Metal Spring Loaded Ball Joint with M10 x 1.50 threads provides strength and ease of disconnecting

Rear End Links



Chrome Moly Heim Joints with non-metallic bearing liner for wear resistance.

Powder Coated steel hex turnbuckle tubes threaded Left Hand / Right Hand

- for stock height TJ's **J0030297**
- for 2" lifted TJ's **J0030298**
- for 4" lifted TJ's **J0030299**
- for 6" lifted TJ's **J0030300**

Sway Bar End Links and Suspension Limiter Kit

TJ/LJ

Front Quick Disconnect End Links

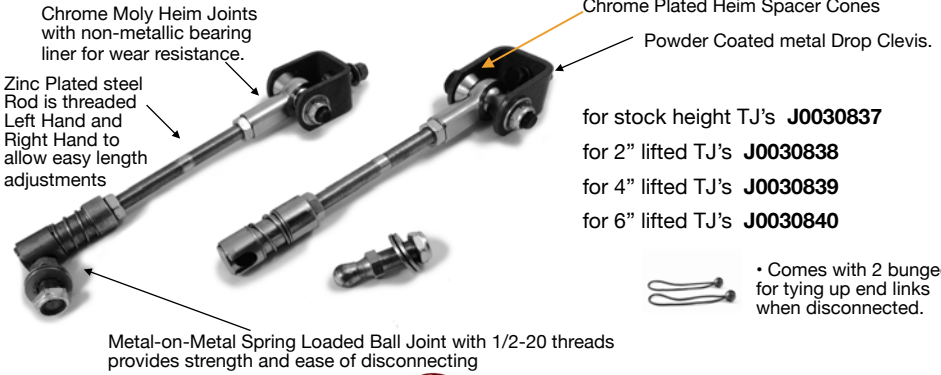

Front Pin Style End Links

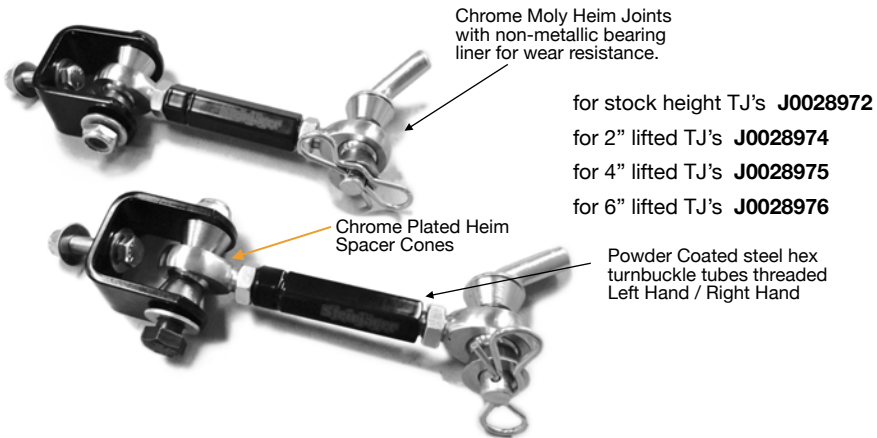

Sway Bar Hanger Kits

See Page 41



Front Track Bars

Fits TJ, LJ & XJ



Rear Panhard Bars

Fits TJ & LJ

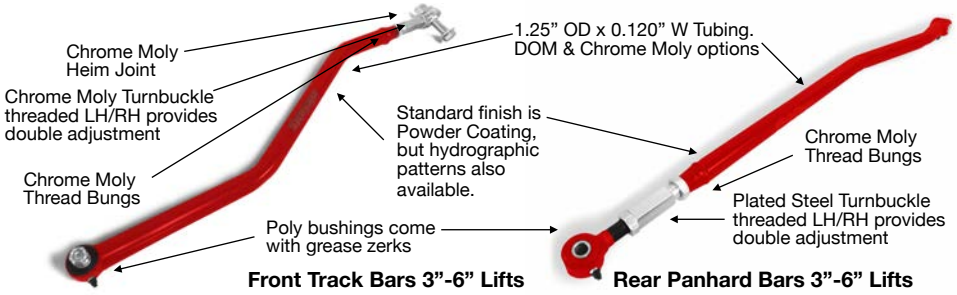

	DOM Tubes	Chrome Moly	DOM Tubes	Chrome Moly
	J00#	J00#	J00#	J00#
	Bare Metal 46140	46154	46094	46095
	Black 30946	44779	30945	44780
	Textured Blk 46150	46164	46077	46090
	SW Blue 46143	46157	46070	46083
	Playboy Blue 46144	46158	46071	46084
	Neon Green 46146	46160	46073	46086
	Flr Orange 46141	46155	46068	46081
	Locas Green 46148	46162	46075	46088
	Military Beige 46149	46163	46076	46089
	Pinky 46147	46161	46074	46087
	Lemon Peel 46145	46159	46072	46085
	Red Baron 46142	46156	46069	46082
	SB Purple 46152	46166	46079	46092
	Cloud White 46153	46167	46080	46093
	Gray Hammer 46151	46165	46078	46091
	Gecko Green 46479	46482	46425	46428
	Hot Pink 46480	46483	46426	46429
	Neon Yellow 46478	46481	46424	46427

Tie Rods & Control Arms

Made in the USA

TJ/LJ/XJ

Tie Rods (TJ, LJ & XJ)

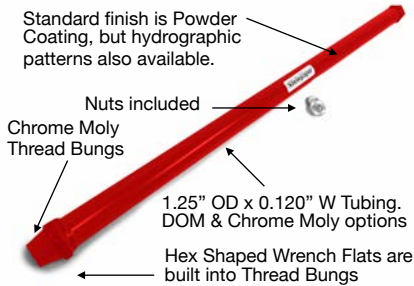

Control Arms (TJ)

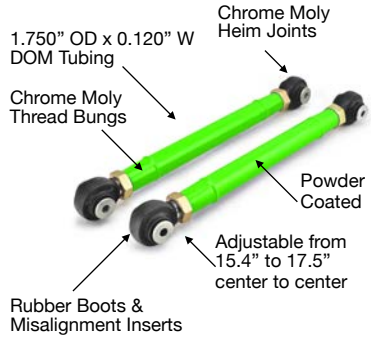

Tie Rods

Control Arms for 0" to 6" Lifts

	DOM Tubes	Chrome Moly	Front Lower	Rear Lower
	J00#	J00#	J00#	J00#
 Bare Metal	46112	46126	47315	47333
 Black	30947	31075	47316	47334
 Textured Blk	46122	46136	47326	47344
 SW Blue	46115	46129	47319	47337
 Playboy Blue	46116	46130	47320	47338
 Neon Green	46118	46132	47322	47340
 Flr Orange	46113	46127	47317	47335
 Locas Green	46120	46134	47324	47342
 Military Beige	46121	46135	47325	47343
 Pinky	46119	46133	47323	47341
 Lemon Peel	46117	46131	47321	47339
 Red Baron	46114	46128	47318	47336
 SB Purple	46124	46138	47328	47346
 Cloud White	46125	46139	47329	47347
 Gray Hammer	46123	46137	47327	47345
 Gecko Green	46470	46473	47331	47349
 Hot Pink	46471	46474	47332	47350
 Neon Yellow	46469	46472	47330	47348

Rear Upper Control Arms

2" to 8" Lifts



J0041318 2 arms
• 1.500" x 0.120" W DOM

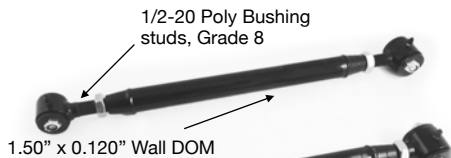

Front & Rear Lower Control Arms

2" to 8" Lifts



J0041314 2 arms
• fits Front or Rear
• 1.750" x 0.120" W DOM

1"-12 Poly Bushing studs, Grade 8

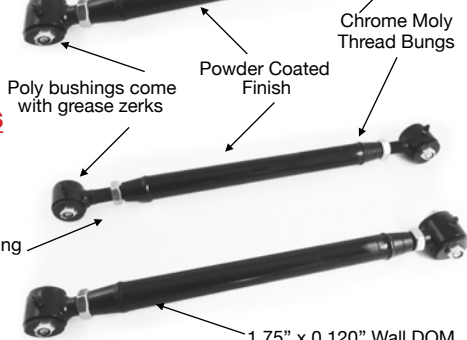

Front Upper Control Arms

2" to 8" Lifts



J0041319 2 arms
• 1.500" x 0.120" W DOM

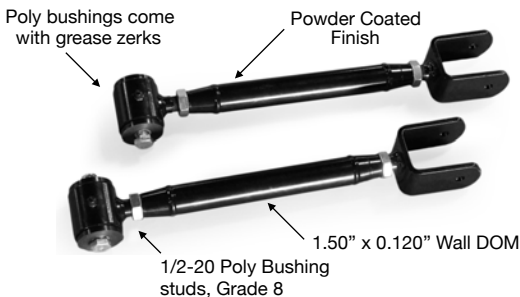

For 0" to 2" Lifts



Front Upper Control Arms

J0041316 2 arms
1.500" x 0.120" Wall DOM



Control Arm Clevis



J0043464
3/4-16 LH x 0.438 Bore



Rear Upper Control Arms

J0041317 2 arms
1.500" x 0.120" Wall DOM



Long Arm Kits

Made in the USA

TJ

Long Arm Kits





















2" to 6" Lifts

- Install Time: 20 to 30 hours
- Requires welding
- Includes 8 double adjustable Control Arms
- Heim Joints are Chrome Moly
- Includes 2 Chassis Mounts
- Includes 1 Transmission Cross Member
- Includes all components shown in photo



Manual Transmission

Automatic Transmission

	DOM Tubes	Chrome Moly Tubes	DOM Tubes	Chrome Moly Tubes
	J00#	J00#	J00#	J00#
	Bare Metal 46012	46040	46026	46054
	Black 30796	30795	31113	31112
	Textured Blk 46022	46050	46036	46064
	SW Blue 46015	46043	46029	46057
	Playboy Blue 46016	46044	46030	46058
	Neon Green 46018	46046	46032	46060
	Flr Orange 46013	46041	46027	46055
	Locas Green 46020	46048	46034	46062
	Military Beige 46021	46049	46035	46063
	Pinky 46019	46047	46033	46061
	Lemon Peel 46017	46045	46031	46059
	Red Baron 46014	46042	46028	46056
	SB Purple 46024	46052	46038	46066
	Cloud White 46025	46053	46039	46067
	Gray Hammer 46023	46051	46037	46065
	Gecko Green 46858	46860	46859	46861
	Hot Pink 46862	46864	46863	46865
	Neon Yellow 46854	46856	46855	46857

Tube Doors

fits YJ, CJ-7 and CJ-8

TUBULAR DOORS FOR YJ, CJ-7, CJ-8

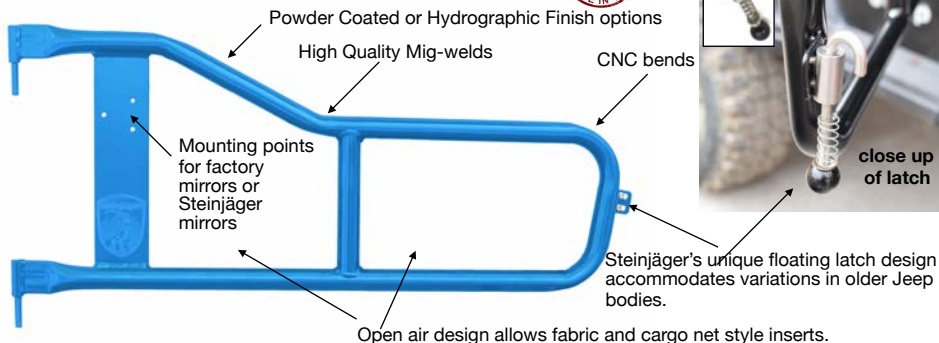

	Bare Metal	J0046712
	Black	J0043574
	Texturized Black	J0043584
	Southwest Blue	J0043577
	Playboy Blue	J0043578
	Neon Green	J0043580
	Fluorescent Orange	J0043575
	Locas Green	J0043582
	Military Beige	J0043583
	Pinky	J0043581

	Lemon Peel	J0043579
	Red Baron	J0043576
	Sinbad Purple	J0043586
	Cloud White	J0043587
	Gray Hammer'tn	J0043585
	Gecko Green	J0046519
	Hot Pink	J0046520
	Neon Yellow	J0046518
	Hydrographic	J0046817

Door Nets for Steinjäger YJ, CJ-7 & CJ-8 Tube Doors

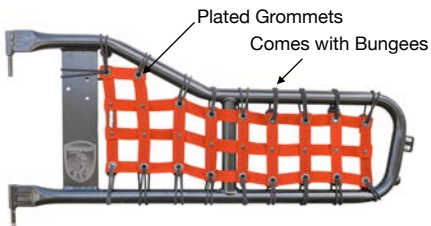

	Black	J0044923
	Blue	J0044927
	Orange	J0044926
	Orange	J0044924
	Red	J0044925



Door Mirror Kits
See Page 53

Teddy® Top Solar Screens

Front Covers and Back Covers

YJ



Teddy® Top Solar Screens

Our Teddy® Top installs easily in minutes with the supplied bungee balls. Our tops will work with factory hard tops. Made in the USA.

Front & Back Covers Sold Separately



Rear Cover

Covers rear seats only with the Family Style Roll Cage.

Does **NOT** work with the Sport Cage.



Black
Front **J0045478**
Rear **J0045505**



Green
Front **J0045484**
Rear **J0045511**



Orange
Front **J0045479**
Rear **J0045506**



Yellow
Front **J0045485**
Rear **J0045512**



White
Front **J0045480**
Rear **J0045507**

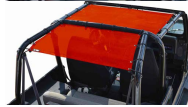

Red
Front **J0045486**
Rear **J0045513**



Blue
Front **J0045481**
Rear **J0045508**

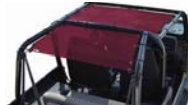

Burgundy
Front **J0045487**
Rear **J0045514**



Gray
Front **J0045482**
Rear **J0045509**



Dark Green
Front **J0045488**
Rear **J0045515**



Tan
Front **J0045483**
Rear **J0045510**



Mauve
Front **J0045489**
Rear **J0045516**

Teddy® Cargo Nets



Our Teddy® Cargo Net covers the back half and sides of your YJ. You must have the Family Style Roll Cage in your YJ in order for this to fit properly. Easy installation with double back straps. This will fit with your factory top, so there is no need to remove it once it's installed. Made in the USA.

2 inch wide webbing

Double back straps allow adjustability and easy installation

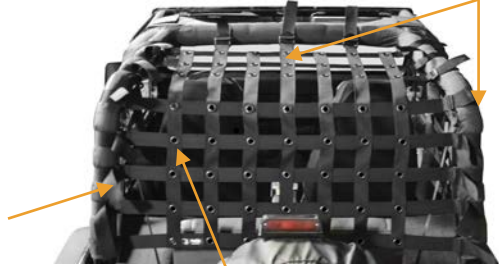

Black Grommets



Black
J0046615



Orange
J0047028



Blue
J0047026



Red
J0047029



Gray
J0047027



Hardtop Hardware Kit
See Page 54

Door Limiting Straps



For YJ **stock** doors.

2 Straps per kit.



Tube Door Limiting Straps
See Page 51

Door Hangers
See Page 51

Black **J0045473**
 Blue **J0045477**
 Gray **J0045476**
 Orange **J0045474**
 Red **J0045475**



Arm Rests
See Page 51



Fabric Door Inserts
See Page 52



Foot Pegs for YJ
See Page 55

Drag Links & High Lift Mount Kits

Made in the USA

YJ

Drag Links



The Steinjäger Drag Link is a strong alternative to the original factory piece. It is made in the USA from 1.25" OD x 0.120 W DOM tubing. Comes with RH and LH jam nuts.

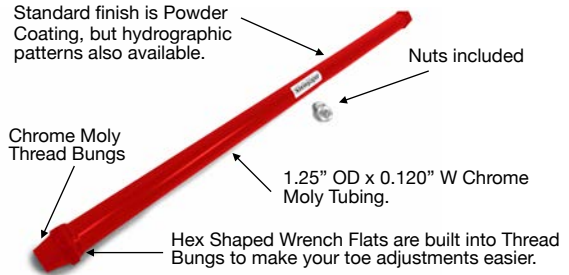

	Bare Metal	J0045816
	Black	J0045817
	Texturized Black	J0045827
	Southwest Blue	J0045820
	Playboy Blue	J0045821
	Neon Green	J0045823
	Fluorescent Orange	J0045818
	Locas Green	J0045825
	Military Beige	J0045826

	Pinky	J0045824
	Lemon Peel	J0045822
	Red Baron	J0045819
	Sinbad Purple	J0045829
	Cloud White	J0045830
	Gray Hammer'tn	J0045828
	Gecko Green	J0046455
	Hot Pink	J0046456
	Neon Yellow	J0046454

High Lift Mount Kit



Bolt on kit to mount your High Lift Jack onto your Roll Bar. Made in the USA.



	Bare Metal	J0048227
	Black	J0048228
	Texturized Black	J0048238
	Southwest Blue	J0048231
	Playboy Blue	J0048232
	Neon Green	J0048234
	Fluorescent Orange	J0048229
	Locas Green	J0048236
	Military Beige	J0048237

	Pinky	J0048235
	Lemon Peel	J0048233
	Red Baron	J0048230
	Sinbad Purple	J0048240
	Cloud White	J0048241
	Gray Hammer'tn	J0048239
	Gecko Green	J0048243
	Hot Pink	J0048244
	Neon Yellow	J0048242

Quick Disconnect End Links



J0045815 2-4" Lift
J0047690 4-6" Lift

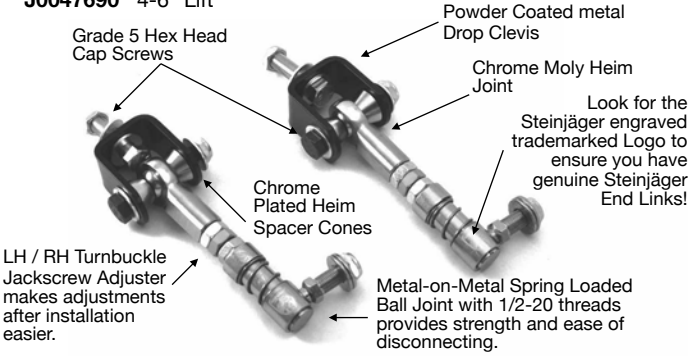

Track Bars

See Page 64



Tie Rods

See Page 65



Front Tube Door DIY KIT (fits 4 Door XJ)



J0047644 Kit for 2 Front Doors

Our Kit contains all the components for two front tube doors for the 1997-2001 XJ Cherokee. **Requires Welding.** Bare Steel finish. 1.25" OD tubing. **Note:** these only fit the 4 Door XJ. Made in the USA.

Rear Tube Door DIY KIT



J0047855 Kit for 2 Rear Doors

Our Kit contains all the components for two rear tube doors for the 1997-2001 XJ Cherokee. **Requires Welding.** Bare Steel finish. 1.25" OD tubing. Made in the USA.



Replacement Door Pin Kit

J0043671



Sportswear

Printed by us in the USA

Our shirts are 100% cotton. Machine Wash. Images printed by us in the USA.



J0029536 S
J0029537 M
J0029538 L



J0029539 XL
J0029540 XXL



J0045014 S
J0030885 M
J0030886 L



J0030887 XL
J0030888 XXL



J0041506 S
J0041507 M
J0041508 L



J0041509 XL
J0041510 XXL



J0041511 S
J0041512 M
J0041513 L



J0041514 XL
J0041515 XXL

Steinfäger
WHEN BAD IS GOOD.

J0046736 S
J0046737 M
J0046738 L

J0046739 XL
J0046740 XXL



Sportswear

Printed by Us in the USA

Our shirts are 100% cotton. Machine Wash. Images printed by us in the USA.



J0045009 S J0045012 XL
 J0045010 M J0045013 XXL
 J0045011 L



J0041496 S J0041499 XL
 J0041497 M J0041500 XXL
 J0041498 L



J0041471 S J0041474 XL
 J0041472 M J0041475 XXL
 J0041473 L



J0047211 S J0047214 XL
 J0047212 M J0047215 XXL
 J0047213 L



J0047207 J0047209 XL
 J0047208 J0047210 XXL

Sportswear

Hoodies, Decals, Hats

Hoodies

Our Hoodies are a 50/50 blend of cotton with spandex cuffs, a front pouch pocket, relaxed waistband, and fully cover seamed. Printed by us in the USA.



Gray

S	J0041545
M	J0041546
L	J0041547
XL	J0041548
XXL	J0041549



Orange

S	J0041535
M	J0041536
L	J0041537
XL	J0041538
XXL	J0041539



Blue

S	J0041530
M	J0041531
L	J0041532
XL	J0041533
XXL	J0041534



Black

S	J0041550
M	J0041551
L	J0041552
XL	J0041553
XXL	J0041554



Pink

S	J0041540
M	J0041541
L	J0041542
XL	J0041543
XXL	J0041544

Decals



J0023975	6" x 8"
J0045034	12" x 18"



J0030943	Hood/Door Decal	16" x 36"
J0028964	Window Decal	12" x 24"

Hats



J0041468	Black
J0041528	Gray



J0017852	Hood/Door Decal	2" x 5"
J0028963	Window Decal	12" x 14"