

PARTS LIST:

1	Bull Bar	8	12mm Lock Washers
1	Driver/Left Mounting Bracket	4	12mm Hex Nuts
1	Passenger/Right Mounting Bracket	2	10-1.5mm x 30mm Hex Bolts
1	Driver/Left Support Bracket	4	10mm x 30mm OD x 2.5mm Flat Washers
1	Passenger/Right Support Bracket	2	10mm Lock Washers
2	8mm x 25mm Bolt Plates	2	10mm Hex Nuts
4	12-1.25mm x 40mm Special Fine Thread Hex Bolts	2	8mm x 24mm OD x 2mm Flat Washers
4	12-1.75mm x 30mm Coarse Thread Hex Bolts	2	8mm Lock Washers
12	12mm x 32mm OD x 3mm Flat Washers	2	8mm Hex Nuts

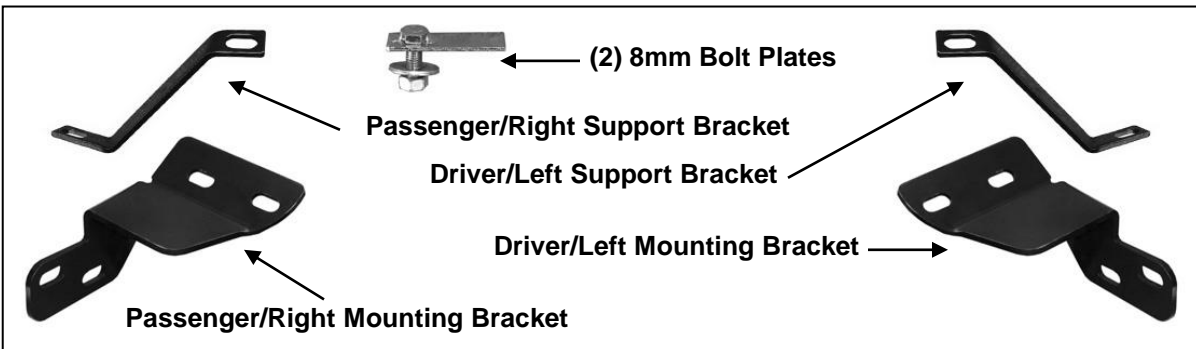

PROCEDURE:

REMOVE CONTENTS FROM BOX. VERIFY ALL PARTS ARE PRESENT. READ THE INSTRUCTIONS CAREFULLY. CUTTING AND DRILLING IS REQUIRED. It may be necessary to remove/relocate front license plate and license plate bracket. It is not required, but strongly recommended. If local/state law requires a license plate, a license plate relocation kit is available separately.

1. Start installation under the front bumper and carefully remove the large center plastic splash guard under the engine. **NOTE:** Depending on the model and year of vehicle, there may be several two-piece plastic push-in clips holding the splash guard up to the vehicle. Pry the center pin of the clip up with a small flat blade screwdriver and remove the entire clip. Pay close attention to the type and location of all factory hardware for reinstallation. Move the splash guard to a stable work area.
 - a. **Info for 2012-13 models only:** Also remove the plastic lower bumper air dam. It is not necessary to remove the plastic inner mounting plate for the air dam.
2. Locate and remove the two factory bolts securing the driver side frame support bracket to the front cross member, **(Figures 1A & 1B)**. Pull down on the support bracket just enough to slide the driver side Mounting Bracket between the frame bracket and the cross member, **(Figure 2)**. **VERY IMPORTANT:** Only install one Mounting Bracket at a time. Do not pull down too hard or you may bend the frame bracket. If more room is required to insert the Mounting Bracket, loosen but do not remove the large hex bolt at the end of the frame support bracket, **(Figure 2)**.
 - a. **Info for 2012-13 models only:** Slide the Bracket up in position as previously described to check fitment, **(Figure 2)**. Note that the plastic mounting plate attached directly to the body for the air dam will need to be trimmed slightly to clear the Brackets. Remove as little material as possible to install the Bracket. **IMPORTANT:** Do not cut off any of the mounting tabs for the air dam.
3. Line up the (2) holes in the Mounting Bracket with the holes in the factory support bracket. Replace the factory hex bolts with the included longer (2) 12-1.25mm x 40mm Special Fine Thread Hex Bolts, (2) 12mm Lock Washers and (2) 12mm Flat Washers, **(Figure 3)**. Snug but do not tighten all hardware at this time.
4. Repeat **Steps 2 - 3** for the passenger side Mounting Bracket installation.
 - a. **Info for 2012-13 models only:** Hold the lower air dam up in approximate position against the bottom of the (2) Mounting Brackets. Mark the location of the Brackets onto the underside of the air dam.

**BULL BAR
2009-13 HONDA PILOT**

- b. Cut slots wide enough for the Brackets to slide through the air dam, **(Figures 4 & 5)**. **VERY IMPORTANT:** Do not cut through the front or back edge of the air dam. Only remove enough plastic to clear the Brackets. Use small cuts and gradually increase the size of the slot for best fit. Do not cut off any of the mounting tabs on the back of the air dam.
 - c. Reinstall air dam with factory hardware.
5. With assistance, bolt the Bull Bar to the outside of the Mounting Brackets with the included (4) 12-1.75mm x 30mm Hex Bolts, (8) 12mm Flat Washers, (4) 12mm Lock Washers and (4) 12mm Hex Nuts, **(Figure 6)**. Once the Bull Bar is fully installed on the vehicle, level, adjust and tighten all hardware including the factory hex bolts from **Step 2**.
 6. Next, select the driver side Support Bracket, **(Figure 7)**. Bolt the Bracket to the bottom of the tab on the Bull Bar using (1) 10mm x 30mm Hex Bolt, (2) 10mm Flat Washers, (1) 10mm Lock Washer and (1) 10mm Hex nut. Move the top of the Support Bracket into position under the cross member behind the front bumper. Mark the bracket location, **(Figure 8)**. Repeat this Step to mark the passenger side Support Bracket location.
 7. Temporarily remove the Bull Bar and both Support Brackets. Drill two 3/8" holes through the cross member in the previously marked locations, **(Figure 9)**. **IMPORTANT:** Check to see if there is adequate clearance behind the cross member before drilling.
WARNING! Any cutting or drilling tool may break or shatter. Government regulations require safety glasses & equipment at all times when cutting or drilling.
 8. Insert (1) 8mm Bolt Plate down and through the drilled hole in the cross member, **(Figure 10)**. Attach the top of the driver side Support Bracket to the Bolt Plate with (1) 8mm Flat Washer, (1) 8mm Lock Washer and (1) 8mm Hex Nut, **(Figure 11)**. Leave hardware loose at this time.
 9. Repeat **Step 8** to install the passenger side Support Bracket.
 10. Reinstall the Bull Bar and attach the Support Brackets as previously described in **Step 6**. Level and adjust the Bull Bar and fully tighten all hardware, **(Figure 12)**.
 11. Hold the splash guard up to the original location and mark the area pictured in **Figures 13A & 13B** to cut for clearance. Once trimmed, reinstall the splash guard using the factory hardware.
 - a. **Info 2012-13 models only:** Pictures of splash guard are for example only. Actual area requiring trimming may differ.
 12. Do periodic inspections to the installation to make sure that all hardware is secure and tight.

To protect your investment, wax this product after installing. Regular waxing is recommended to add a protective layer over the finish. Do not use any type of polish or wax that may contain abrasives that could damage the finish.

For stainless steel: Aluminum polish may be used to polish small scratches and scuffs on the finish. Mild soap may be used also to clean the Bull Bar.

For gloss black finishes: Mild soap may be used to clean the Bull Bar.

Remove these (2) factory bolts

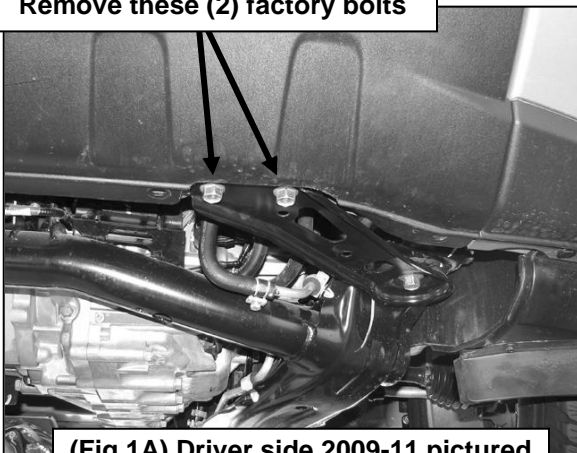

(Fig 1A) Driver side 2009-11 pictured

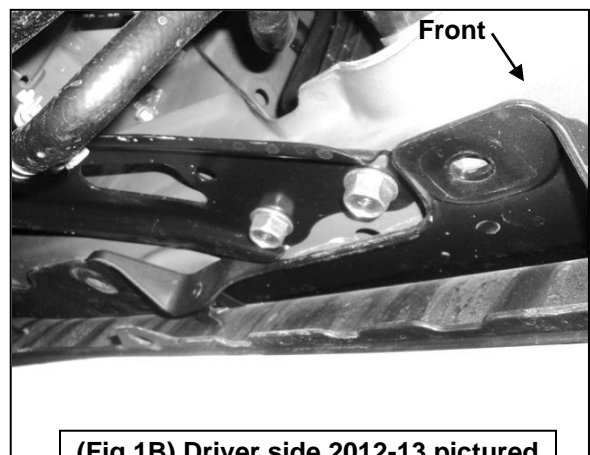

(Fig 1B) Driver side 2012-13 pictured

Insert Mounting Bracket between frame support and cross member (2012-13 passenger side pictured)

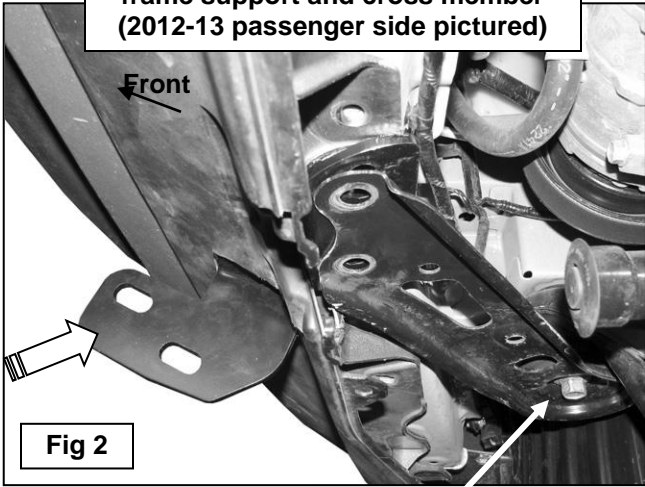
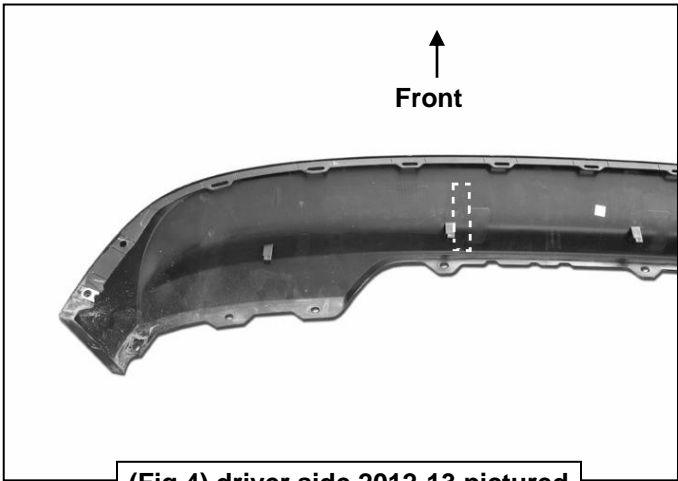

Fig 2

Loosen but **do not remove** this factory bolt if needed



(Fig 4) driver side 2012-13 pictured

Do not cut through the front or back edge of the air dam

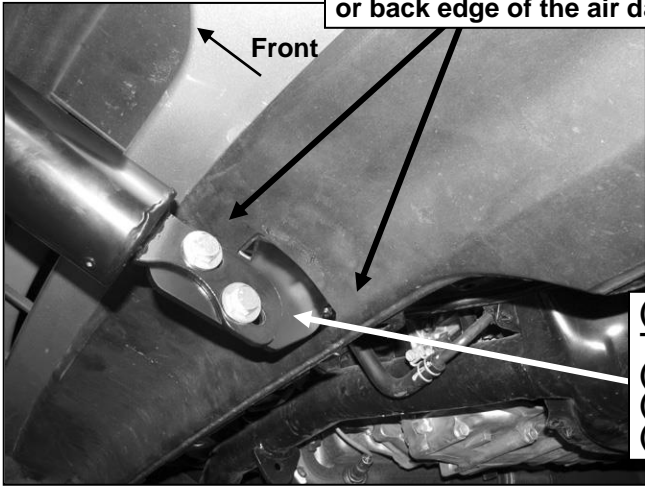

(Fig 6) driver side 2012-13 pictured

- (2) 12-1.75mm x 30mm Coarse Thread Hex Bolts
- (2) 12mm Lock Washers
- (4) 12mm Flat Washers
- (2) 12mm Hex Nuts

2012-13 installation pictured with air dam in place for instruction purposes only

2012-13 driver side pictured

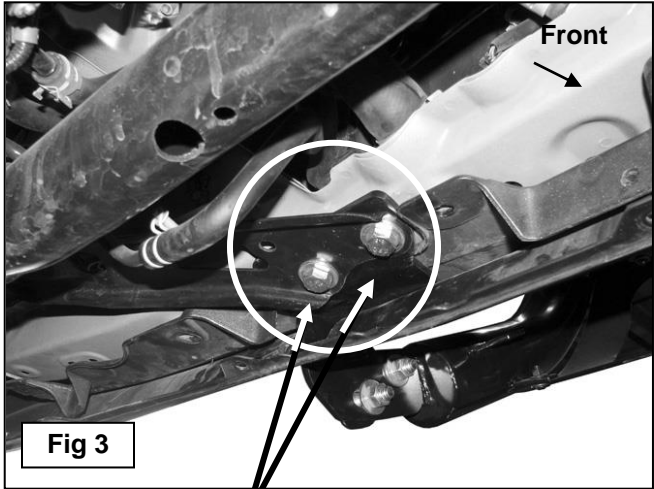
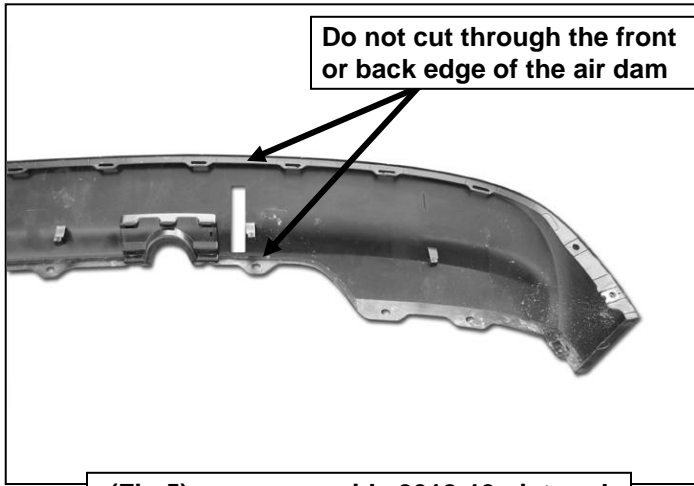

Fig 3

- (2) 12-1.25mm x 40mm Special Fine Thread Hex Bolts
- (2) 12mm Lock Washers
- (2) 12mm Flat Washers

Do not cut through the front or back edge of the air dam



(Fig 5) passenger side 2012-13 pictured

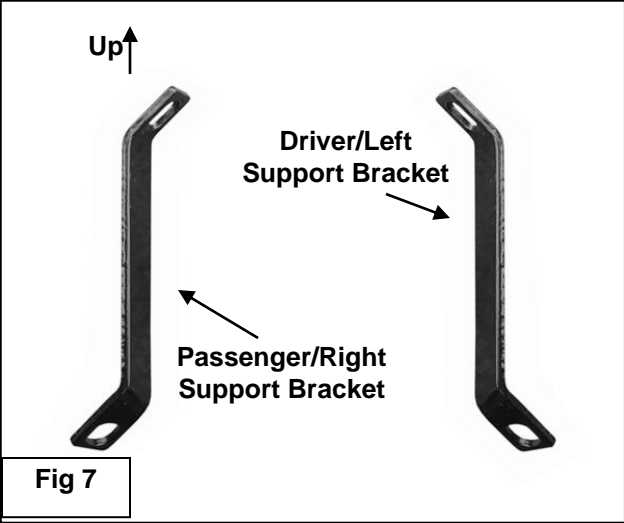

Fig 7

Mark the Bracket location onto the bottom of the crossmember. Temporarily remove the Bull Bar and Support Brackets. Check backside of crossmember for clearance before drilling. (driver side pictured from below)

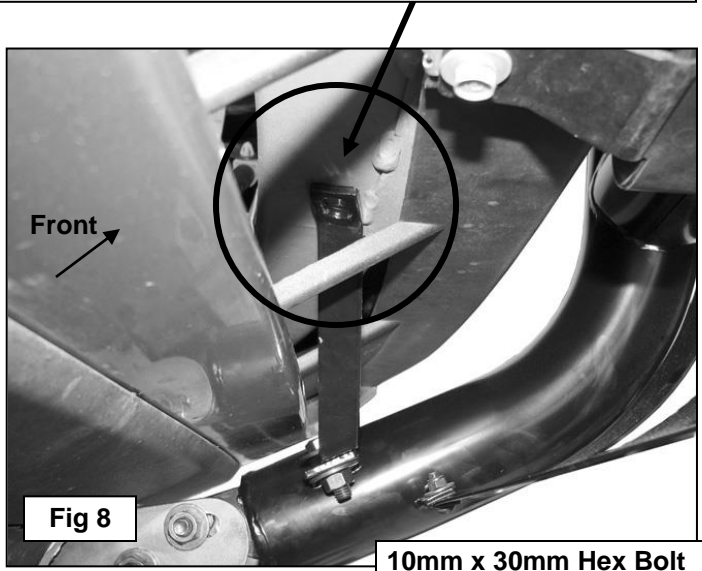

Fig 8

10mm x 30mm Hex Bolt
10mm Lock Washer
(2) 10mm Flat Washers
10mm Hex Nut

Drill a 3/8" hole through the cross member behind the front bumper. (driver side pictured from below)

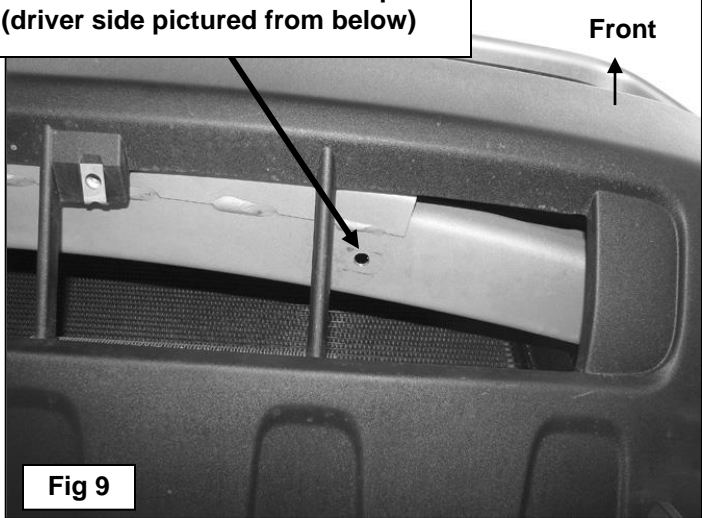
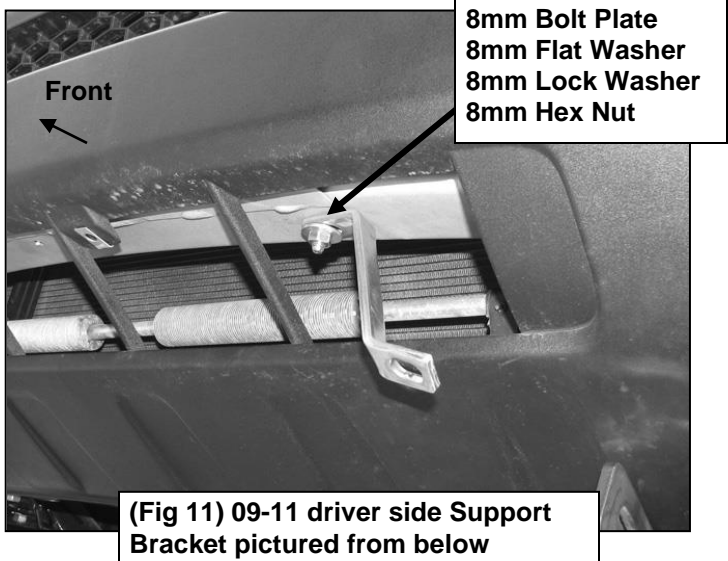
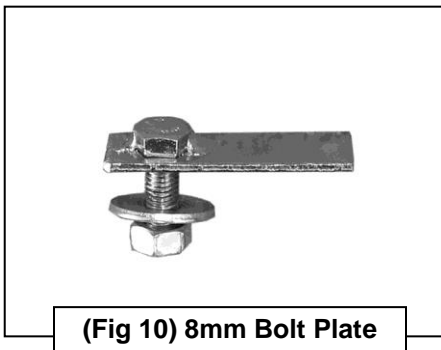

Fig 9



8mm Bolt Plate
8mm Flat Washer
8mm Lock Washer
8mm Hex Nut

(Fig 11) 09-11 driver side Support Bracket pictured from below



**BULL BAR
2009-13 HONDA PILOT**

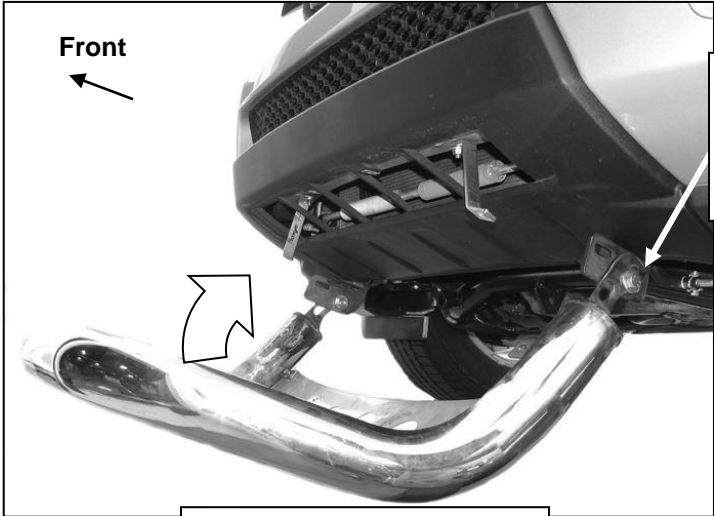

(Fig 12) 2009-11 pictured

Install and align the Bull Bar as per instructions, tighten all hardware before marking the area on the splash guard to cut for clearance. Cut along dotted line.

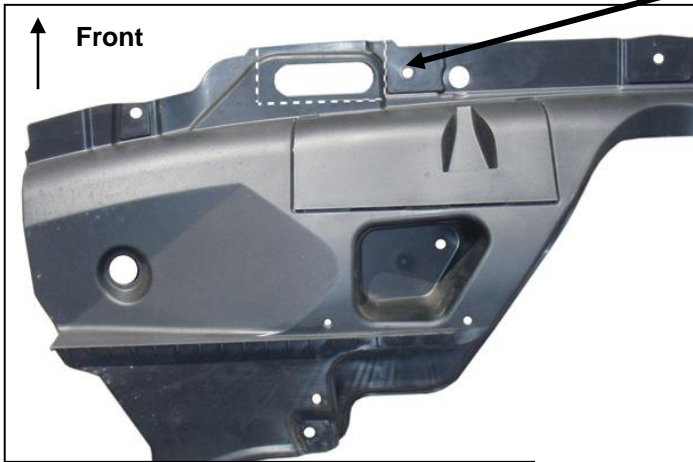

(Fig 13A) 09-11 Passenger side pictured

