

SPICER®



Driveline Components Catalog Tube Shafts

J300P-7

August 2015

Supersedes Section 7

Dated December 2012

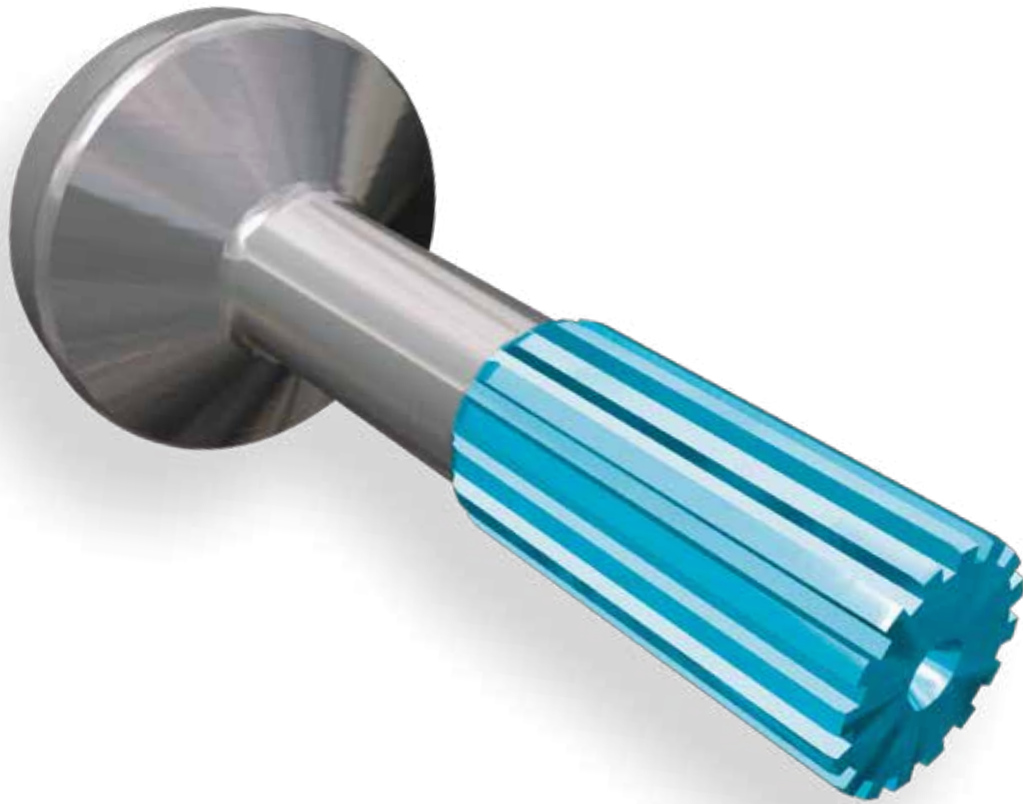

Determine which type of tube shaft you have

- Slip tube shaft (pages 4-7)
- Round tube shafts (page 8)
- Midship tube shaft, style used with a companion flange or end yoke (pages 8-11)
- Midship tube shaft, used with outboard slip yokes (pages 12-15)

To identify a Slip Tube Shaft:

1. Determine spline O.D. and number of teeth
2. Determine the size and wall thickness of the tube it fits
3. Determine weld to end of spline dimension
4. Check any other dimensions listed; Determine part number, check for footnotes

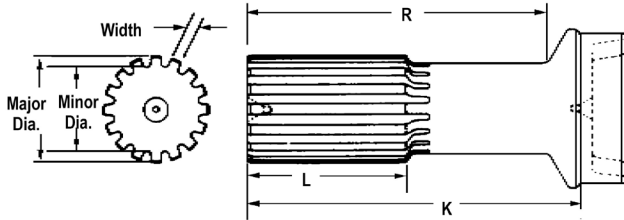

Note: Spline is Glidecote except where footnoted.

Fits Tube		K	L	R	Spicer Part Number
Diameter	Wall Thickness	End of Spline to Weld	Length of Spline	End of Spline to Radius	
1.250-16 Spline					
1.250	.120	6.125	1.906	5.375	2-40-1771
1.750	.065	4.469	2.000	3.938	2-40-971
1.750	.095	5.969	2.000	5.438	2-40-2241
2.000	.083	6.000	2.000	5.406	2-40-1741

To identify a Companion flange or End Yoke Style Midship Tube Shaft:

1. Determine spline O.D. and number of teeth
2. Determine bearing diameter
3. Determine the size and wall thickness of the tube it fits
4. Determine end of spline to bearing shoulder dimension
5. Determine weld to end of spline dimension
6. Make sure style of shaft matches part being identified
7. Make sure thread type and size match part being identified
8. Check any other dimensions listed; Determine part number, check for footnotes

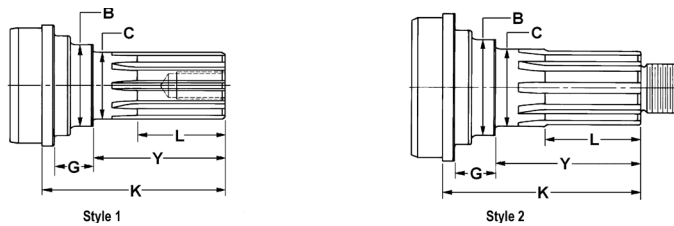

Fits Tube		Y	K	S t y l e	L	Thread Size	B	G	Midship Tube Shaft Part Number
Tube Dia.	Wall Thickness	End of Spline to Bearing Shoulder	End of Spline to Point of Weld		Length of Spline		Shoulder Diameter	Length of Shoulder	
1.125-26 Involute Spline									
1.181 Bearing Diameter (C)									
2.500	.065	1.906	3.406	2	1.375	.625-18	1.156	.438	2-53-1321
2.500	.065	2.031	3.406	2	1.375	.625-18	1.690	.781	2-53-1011
2.500	.065	2.340	3.407	2	1.730	.625-18	1.344	—	2-53-1561
2.500	.083	1.469	3.406	2	1.375	.625-18	1.469	.393	2-54-351X

Includes slinger



To identify an Outboard Slip Yoke Style Midship Tube Shaft:

1. Determine spline O.D. and number of teeth
2. Determine bearing diameter
3. Determine the size and wall thickness of the tube it fits
4. Determine end of spline to bearing shoulder dimension
5. Determine weld to end of spline dimension
6. Make sure style of shaft matches part being identified
7. Determine bearing shoulder diameter
8. Check any other dimensions listed; Determine part number, check for footnotes

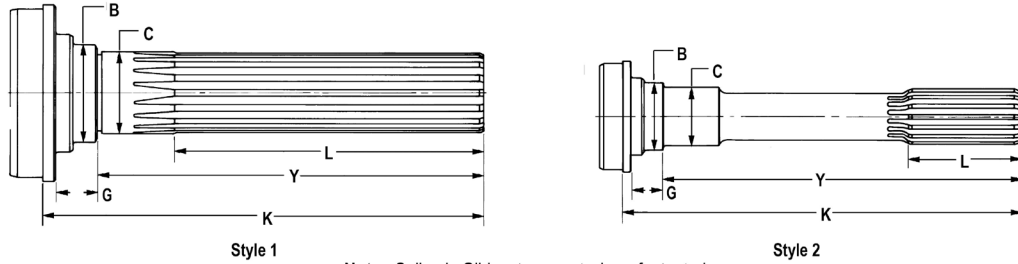

Note: Spline is Glidecote except where footnoted.

Fits Tube		Y	K	S t y l e	L	B	G	Midship Tube Shaft Part Number
Tube Diameter	Wall Thickness	End of Spline to Bearing Shoulder	End of Spline to Point of Weld		Length of Spline	Shoulder Diameter	Length of Shoulder	
1.3750-16 Spline								
1.378 Bearing Diameter (C)								
2.000	.083	5.969	7.281	1	4.438	1.688	.812	2-53-121
2.000	.083	6.938	8.250	1	5.406	1.688	.812	2-53-511
2.500	.065	6.938	8.000	1	5.406	1.688	.812	2-53-531
2.500	.083	5.969	7.031	1	4.438	1.688	.812	3-53-211•
2.500	.083	6.750	8.094	1	4.969	1.719	1.125	3-53-1351
2.500	.083	6.938	8.000	1	5.406	1.688	.812	2-53-471



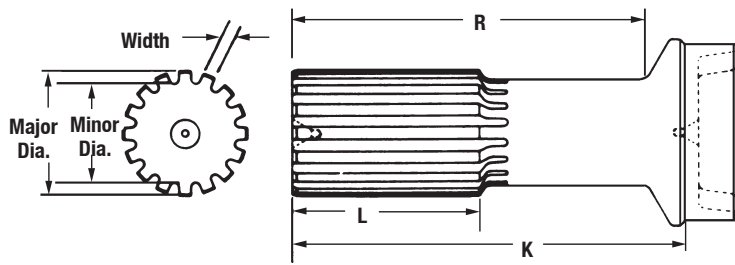

Note: Spline is Glidecote except where footnoted.

Fits Tube		K End of Spline to Weld	L Length of Spline	R End of Spline to Radius	Spicer Part Number
Diameter	Wall Thickness				
1.062-16 Spline					
1.250	.095	4.281	1.750	4.000	1-42-31
1.250	.095	5.344	2.000	4.938	1-42-101• <i>Spline not Glidecoated</i>
1.125-26 Involute Spline					
2.500	.065	7.320	1.583	6.665	27-40-31•
1.148-26 Involute Spline					
1.250	.095	4.438	2.000	4.188	10-40-11 <i>Spline not Glidecoated</i>
1.250-15 Based On 16 Spline					
1.750	.065	4.469	2.000	3.938	2-40-1071•
1.250-16 Spline					
1.250	.120	6.125	1.906	5.375	2-40-1771
1.750	.065	4.469	2.000	3.938	2-40-971
1.750	.095	5.969	2.000	5.438	2-40-2241
2.000	.083	6.000	2.000	5.406	2-40-1741
2.000	.120	6.000	2.000	5.406	2-40-2381
2.000	.120	7.625	2.500	7.031	2-40-2221•
2.500	.065	6.125	2.000	5.406	2-40-2211•
2.500	.065	6.125	3.625	5.406	2-40-2481•
2.500	.065	7.750	2.500	7.031	2-40-2301•
1.290-20 Involute Spline					
3.500	.065	7.880	3.500	6.880	2-40-02972
3.500	.065	7.880	3.500	6.880	5002972• <i>5002972 was replaced by 2-40-02972</i>
1.312-19 Based On 20 Involute Spline					
2.000	.120	6.913	3.500	6.338	2-40-01930
2.000	.120	6.913	3.500	6.338	5001930• <i>5001930 was replaced by 2-40-01930</i>
2.500	.083	7.530	3.500	6.840	2-40-2841
3.500	.065	7.880	3.500	6.880	2-40-01918
3.500	.065	7.880	3.500	6.880	5001918• <i>5001918 was replaced by 2-40-01918</i>
1.375-15 Based On 16 Spline					
2.500	.095	7.531	3.625	6.812	2-40-2791•
1.375-16 Spline					
1.250	.095	5.090	2.750	4.690	2-42-581
1.250	.188	8.125	3.625	7.640	2-40-2781•
1.750	.095	7.750	3.625	7.240	2-40-2681
2.000	.083	5.188	2.250	4.625	2-40-1031
2.000	.083	6.188	2.250	5.625	2-40-2451
2.000	.083	6.562	2.125	6.000	2-40-1841
2.000	.120	5.188	2.250	4.625	2-40-2021
2.000	.120	6.188	2.250	5.625	2-40-1701
2.000	.120	6.188	3.625	5.625	2-40-2441
2.000	.120	6.190	2.250	5.620	2-40-2851• <i>.310 x 30 degree chamfer on spline end</i>
2.000	.120	7.906	3.625	7.328	2-40-2661
2.500	.065	5.344	2.250	4.625	2-40-1041

• Part is discontinued ■ Part is available until supply is exhausted ▲ Not sold separately



Fits Tube		K	L	R	Spicer Part Number
Diameter	Wall Thickness	End of Spline to Weld	Length of Spline	End of Spline to Radius	
1.375-16 Spline (Continued)					
2.500	.065	6.344	2.250	5.625	2-40-1811
2.500	.065	6.844	2.250	6.125	2-40-1291
2.500	.065	8.000	3.625	7.312	2-40-2671
2.500	.083	10.000	3.000	9.375	2-40-2611•
2.500	.083	5.344	2.250	4.625	2-40-1131
2.500	.083	6.344	2.250	5.625	2-40-1711
2.500	.083	7.100	3.188	6.375	2-40-2801•
2.500	.083	7.375	3.000	6.656	2-40-2871•
2.500	.083	7.531	2.250	6.812	2-40-1851
2.500	.083	7.531	2.250	6.812	2-40-2631•
					<i>Special center in spline end</i>
2.500	.083	7.531	3.625	6.813	2-40-2461
2.500	.083	8.000	3.000	7.310	2-40-2941•
2.750	.083	7.390	3.000	6.540	2-40-2891•
3.000	.065	5.625	2.250	4.812	2-40-1211
3.000	.065	6.438	2.250	5.625	2-40-1221
3.000	.065	7.625	2.250	6.812	2-40-2051
3.000	.083	6.050	2.250	5.220	2-40-2811•
3.000	.083	6.438	2.250	5.625	2-40-1521
3.000	.083	7.625	2.250	6.812	2-40-2231
3.000	.083	7.625	3.620	6.812	2-40-2691
3.000	.083	8.641	6.781	7.828	2-40-1871•
3.500	.065	6.625	2.250	5.625	2-40-1671
3.500	.065	7.875	3.625	6.875	2-40-2761
3.500	.083	6.625	2.250	5.625	2-40-1531
3.500	.083	7.906	2.250	6.906	2-40-2041
3.500	.083	7.906	3.625	6.906	2-40-2531
3.500	.083	8.969	6.906	7.969	2-40-2091•
1.375-31 Based On 32 Involute Spline					
2.000	.120	6.312	3.000	5.750	2-40-2421•
2.000	.120	7.438	3.531	6.875	2-40-2361
					<i>Spline not Glidecoated</i>
2.500	.083	6.344	2.250	5.625	2-40-2501•
					<i>Spline not Glidecoated</i>
1.437-21 Based On 22 Involute Spline					
3.500	.083	7.375	3.500	6.489	5007289
					<i>Includes 232817 boot can</i>
3.500	.083	8.281	3.500	7.344	3-40-2241
1.500-15 Based On 16 Spline					
2.500	.156	7.812	2.500	7.094	3-42-451
1.500-16 Spline					
2.500	.083	5.625	2.500	4.969	3-40-1471
3.000	.083	5.938	2.500	5.125	3-40-1101
3.000	.083	6.281	3.000	5.469	3-40-1511
3.000	.083	7.250	2.500	6.438	3-40-1611
3.000	.083	7.406	3.000	6.594	3-40-1421
3.000	.083	8.250	3.000	7.406	3-40-1911
3.000	.095	6.437	2.500	5.610	3-40-1961•
3.500	.065	6.562	3.000	5.625	3-40-1521•
3.500	.065	7.344	2.500	6.406	3-40-481•
3.500	.083	10.260	4.000	9.320	3-40-2181
3.500	.083	5.375	2.000	4.438	3-40-2071
3.500	.083	6.562	3.000	5.625	3-40-1531
3.500	.083	6.844	2.500	5.828	3-40-1431
3.500	.083	7.344	2.500	6.406	3-40-1621

• Part is discontinued ■ Part is available until supply is exhausted ▲ Not sold separately



Important: See Safety Information in General Information Section (J300P-GI)

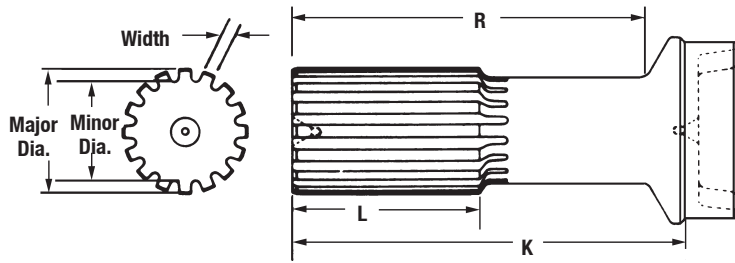

Note: Spline is Glidecote except where footnoted.

Fits Tube		K End of Spline to Weld	L Length of Spline	R End of Spline to Radius	Spicer Part Number
Diameter	Wall Thickness				
1.500-16 Spline (Continued)					
3.500	.083	7.531	3.000	6.594	3-40-1491
4.000	.083	7.875	3.000	6.688	3-40-1501
4.500	.095	7.688	2.500	6.438	3-40-1281•
1.562-16 Spline					
3.500	.083	10.750	3.000	9.810	3-40-1411
3.500	.083	6.750	3.000	5.810	3-40-1571
3.500	.083	8.750	3.000	7.810	3-40-1871
4.000	.083	6.940	3.000	5.810	3-40-1381
4.000	.083	8.940	3.000	7.810	3-40-1551
1.562-23 Based On 24 Involute Spline					
3.500	.083	8.000	3.000	7.060	3-40-2091•
					<i>3-40-2091 was replaced by 3-40-2171</i>
1.563-23 Based On 24 Involute Spline					
3.500	.083	7.402	3.500	5.781	55-40-61X•
3.500	.083	8.000	3.000	7.060	3-40-2171
3.500	.083	8.701	3.500	7.083	55-40-71•
					<i>55-40-71 was replaced by 55-40-81X</i>
3.500	.083	8.701	3.500	7.080	55-40-81X
4.000	.083	7.400	3.500	5.781	55-40-11
4.000	.083	7.400	3.500	5.781	55-40-21X•
4.000	.083	8.701	3.500	7.080	55-40-41X•
1.750-16 Spline					
3.000	.095	6.750	3.000	5.906	4-40-821•
3.500	.095	12.000	5.000	11.030	4-40-1031•
3.500	.095	14.219	3.000	13.360	4-40-981•
3.500	.095	15.469	3.000	14.610	4-40-1021•
3.500	.095	20.120	3.000	19.250	4-40-1011•
3.500	.095	20.750	3.000	19.870	4-40-1061
3.500	.095	6.781	3.000	5.812	4-40-761
3.500	.095	7.938	3.000	6.969	4-40-741•
3.500	.095	9.219	3.000	8.250	4-40-721
3.500	.156	6.781	3.000	5.812	4-40-951
4.000	.083	6.938	3.000	5.812	4-40-781
4.000	.134	6.938	3.000	5.812	4-40-991•
1.752-26 Based On 27 Involute Spline					
3.500	.095	8.752	3.500	7.140	70-40-71▲
3.500	.095	8.752	3.500	7.140	70-40-81X
4.000	.083	7.953	3.500	6.531	70-40-11•
4.000	.083	7.953	3.500	6.531	70-40-21X•
4.000	.083	8.751	3.500	7.330	70-40-41X•
1.812-28 Involute Spline					
3.500	.095	9.812	4.000	8.906	4-40-961•
1.937-29 Based On 30 Involute Spline					
4.000	.095	8.799	4.000	6.841	100-40-21X•
					<i>Refer to bulletin JOI-TEC-41 for important spline data</i>
4.000	.095	9.590	4.000	7.831	100-40-31•
					<i>100-40-31 was replaced by 100-40-41X; Refer to bulletin JOI-TEC-41 for important spline data</i>

• Part is discontinued ■ Part is available until supply is exhausted ▲ Not sold separately





Fits Tube		K	L	R	Spicer Part Number
Diameter	Wall Thickness	End of Spline to Weld	Length of Spline	End of Spline to Radius	
1.937-29 Based On 30 Involute Spline (Continued)					
4.000	.095	9.590	4.000	7.831	100-40-41X <i>Refer to bulletin JOI-TEC-41 for important spline data</i>
1.937-30 Involute Spline					
2.756	.159	7.185	2.953	6.161	6C-40-21X• <i>Includes 212114-1X tube and seal assembly</i>
4.000	.095	8.281	4.000	7.188	90-40-21•
4.000	.134	10.094	4.000	9.000	90-40-11
4.000	.134	8.281	4.000	7.190	90-40-41
2.000-15 Based On 16 Spline					
3.500	.095	8.562	3.500	7.656	5-40-491•
2.000-16 Spline					
3.500	.095	7.562	3.500	6.656	5-40-451
3.500	.095	8.562	3.500	7.625	5-40-471•
3.500	.095	9.562	3.500	8.656	5-40-501
3.500	.134	10.188	3.500	9.281	5-40-1041
3.500	.134	7.562	3.500	6.656	5-40-1191
3.500	.134	7.844	4.000	6.938	4-40-891
3.500	.134	8.562	3.500	7.656	5-40-1101• <i>5-40-1101 was replaced by 5-40-1151</i>
3.500	.134	8.562	3.500	7.656	5-40-1151
3.500	.134	9.688	3.500	8.781	5-40-1011
3.500	.156	8.562	3.500	7.656	5-40-1121•
3.500	.156	9.562	3.500	8.688	5-40-1031
3.550	.207	7.562	3.500	6.656	5-40-1241•
4.000	.134	9.844	3.500	8.781	5-40-1051
2.500-10 Spline					
3.500	.156	10.344	4.000	9.500	6-40-61
3.500	.156	8.344	4.000	7.500	6-40-51•
2.500-16 Spline					
3.500	.156	9.250	4.000	8.375	6-40-741
3.550	.207	10.344	4.000	9.500	6-40-701
4.000	.134	10.562	4.000	9.562	6-40-521
4.000	.134	13.500	4.000	12.500	6-40-821•
4.000	.134	8.438	4.000	7.438	6-40-711
4.000	.134	9.250	4.000	8.250	6-40-541
4.095	.180	9.440	5.000	8.620	6-40-851
4.500	.134	10.656	4.000	9.469	6-40-621
4.500	.134	9.500	4.000	8.312	6-40-631
2.500-9 Based On 10 Spline					
3.500	.156	10.344	4.000	9.500	6-40-111
2.672-18 Involute Spline					
3.500	.134	3.594	1.500	3.281	5-40-1181 <i>Spline not Glidecoated</i>
3.550	.207	3.594	2.000	3.281	5-40-1341• <i>Spline not Glidecoated</i>
3.000-16 Spline					
3.550	.207	10.812	4.500	10.000	6.5-40-141•
4.500	.134	11.250	4.500	10.031	6.5-40-191
4.500	.134	11.250	5.500	10.031	6.5-40-251
4.500	.134	9.469	4.500	8.406	6.5-40-201
4.500	.259	11.531	4.500	10.219	8-40-101
4.500	.259	9.906	4.500	8.594	8-40-91
3.250-18 Involute Spline					
3.500	.156	4.250	2.000	3.906	6-40-181 <i>Spline not Glidecoated</i>

• Part is discontinued ■ Part is available until supply is exhausted ▲ Not sold separately



Important: See Safety Information in General Information Section (J300P-GI)

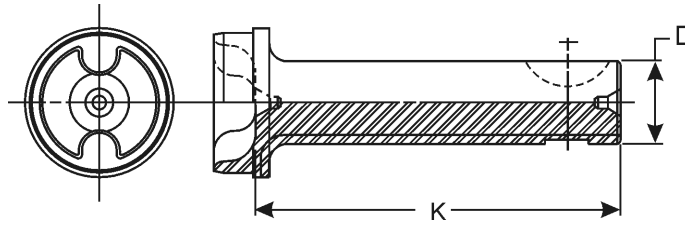

D	K	Fits Tube		Spicer® Assembly Number
Diameter	End of Shaft to Weld	Diameter	Wall Thickness	
.999	4.310	1.750	.065	10-53-18X* <i>Key Included</i>

SPLINED MIDSHIP TUBE SHAFTS Companion Flange or End Yoke Design

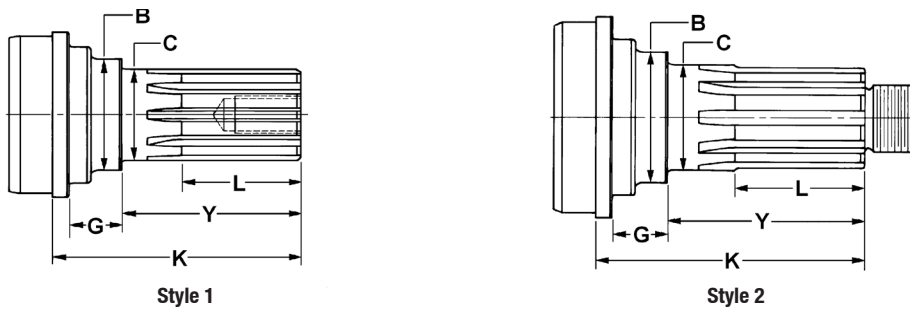

Fits Tube		Y	K	S t y l e	L Length of Spline	Thread Size	B	G	Midship Tube Shaft Part Number
Tube Dia.	Wall Thickness	End of Spline to Bearing Shoulder	End of Spline to Point of Weld				Shoulder Diameter	Length of Shoulder	

1.125-26 Involute Spline

1.181 Bearing Diameter (C)

2.500	.065	1.906	3.406	2	1.375	.625-18	1.156	.438	2-53-1321
2.500	.065	2.031	3.406	2	1.375	.625-18	1.690	.781	2-53-1011•
2.500	.065	2.340	3.407	2	1.730	.625-18	1.344	.852	2-53-1561
2.500	.083	1.469	3.406	2	1.375	.625-18	1.469	.393	2-54-351X• <i>Includes slinger</i>
2.500	.083	1.469	3.406	2	1.375	.625-18	1.469	.393	2-54-361•
2.500	.083	1.906	3.406	2	1.375	.625-18	1.181	.665	2-53-1351
2.500	.083	2.031	3.406	2	1.359	.625-18	1.500	.750	2-53-1051•
2.500	.083	2.031	3.406	2	1.344	.625-18	1.188	1.165	2-53-1331•
3.000	.065	2.125	3.410	2	1.344	.625-18	1.656	.703	2-53-1161•
3.000	.065	2.340	3.406	2	1.568	.625-18	1.344	.852	2-53-1571•
3.000	.065	2.438	4.300	2	1.875	.625-18	1.500	1.859	2-53-1311•
3.000	.083	2.031	3.406	2	1.344	.625-18	1.453	.400	2-53-1071•
3.000	.083	2.440	4.531	2	1.875	.625-18	1.496	1.859	2-53-01931
3.000	.083	2.440	4.531	2	1.875	.625-18	1.496	1.859	5001931• <i>5001931 was replaced by 2-53-01931</i>
3.000	.083	2.440	5.066	2	1.902	.625-18	1.500	2.394	5002332 <i>Hardened seal surface</i>
4.000	.065	2.440	4.688	2	1.790	.625-18	1.500	.630	3-53-06154• <i>Hardened seal surface</i>
4.000	.083	3.720	4.687	2	1.980	.625-18	1.500	—	2-53-1651

1.260 Bearing Diameter (C)

2.000	.083	2.280	3.297	2	1.469	.625-18	1.688	.703	2-53-901•
-------	------	-------	-------	---	-------	---------	-------	------	-----------

• Part is discontinued ■ Part is available until supply is exhausted ▲ Not sold separately



SPLINED MIDSHIP TUBE SHAFTS

Companion Flange or End Yoke Design

Fits Tube		Y	K	S t y l e	L	Thread Size	B	G	Midship Tube Shaft Part Number
Tube Dia.	Wall Thickness	End of Spline to Bearing Shoulder	End of Spline Spline to Point of Weld		Length of Spline		Shoulder Diameter	Length of Shoulder	
1.250-29 Involute Spline									
1.378 Bearing Diameter (C)									
3.000	.083	2.440	3.190	2	1.530	1.000-20	1.690	.500	2-53-1411•
1.574									
3.500	.083	2.149	3.268	2	1.527	1.000-20	1.811	.688	3-53-08000
3.500	.083	2.149	3.268	2	1.527	1.000-20	1.811	.688	5008000•
<i>5008000 was replaced by 3-53-08000</i>									
3.500	.083	2.340	3.460	2	1.530	1.000-20	1.810	.880	3-53-2541
1.375-10 Spline									
1.378 Bearing Diameter (C)									
2.500	.065	2.688	3.750	2	1.781	1.000-20	1.688	.812	2-53-1211•
2.500	.083	2.688	3.750	2	1.781	1.000-20	1.688	.812	2-53-1191
3.000	.083	2.291	3.969	1	2.000	.500-20	1.688	1.062	3-53-191•
3.000	.083	2.656	4.000	2	1.688	1.000-20	1.719	1.125	3-54-611
3.000	.083	2.688	3.750	2	1.781	1.000-20	1.688	.812	2-53-1151
1.500-10 Spline									
1.574 Bearing Diameter (C)									
3.000	.083	2.650	3.875	2	1.938	1.000-20	1.812	1.040	3-53-2371X▲
3.000	.083	2.750	3.875	2	1.940	1.000-20	1.810	.875	3-53-1781
3.000	.083	2.938	4.000	2	1.844	1.000-20	1.938	.812	3-53-1811
3.000	.083	3.590	4.650	2	1.940	1.000-20	1.940	.810	3-53-2321•
3.000	.095	2.750	3.875	2	1.938	1.000-20	1.812	.875	3-53-1891•
3.500	.065	2.750	3.875	2	1.938	1.000-20	1.812	.875	3-53-2061
3.500	.083	2.750	3.875	2	1.940	1.000-20	1.812	.880	3-53-2301■
3.500	.083	2.750	3.880	2	1.940	1.000-20	1.810	.890	3-53-1791
3.500	.083	2.969	4.031	2	2.000	1.000-20	1.938	.812	3-53-1821
3.500	.083	3.000	4.406	2	2.031	1.000-20	2.062	1.156	3-53-421•
3.500	.095	2.969	4.031	2	2.000	1.000-20	1.938	.812	4-53-361
4.000	.083	2.750	3.875	2	1.938	1.000-20	1.812	1.125	3-53-1801
4.000	.083	2.969	4.031	2	2.000	1.000-20	1.938	.812	3-53-1831
1.771 Bearing Diameter (C)									
3.500	.095	2.969	4.062	2	2.000	1.000-20	2.190	.810	4-53-401
4.000	.083	2.969	4.062	2	2.000	1.000-20	2.188	.810	4-53-271
2.000 Bearing Diameter (C)									
3.500	.095	5.375	5.875	2	1.938	1.000-20	2.500	.230	4-53-351•
<i>used with pillow block</i>									
1.543-36 Involute Spline									
1.574 Bearing Diameter (C)									
3.500	.083	2.740	3.538	2	1.875	1.000-20	1.803	.559	55-53-101
3.500	.083	2.748	3.667	2	1.875	1.000-20	1.812	.688	5016017
3.500	.083	2.748	3.677	2	1.940	1.000-20	1.811	.688	3-53-16017
1.750-10 Spline									
1.771 Bearing Diameter (C)									
3.500	.095	3.250	4.344	2	2.281	1.250-18	2.188	.812	5-53-111•
3.500	.134	3.188	4.281	2	2.000	1.250-18	2.188	.812	5-53-141
4.000	.134	3.250	4.344	2	2.281	1.250-18	2.188	.812	5-53-191

• Part is discontinued ■ Part is available until supply is exhausted ▲ Not sold separately



Important: See Safety Information in General Information Section (J300P-GI)

SPLINED MIDSHIP TUBE SHAFTS

Companion Flange or End Yoke Design

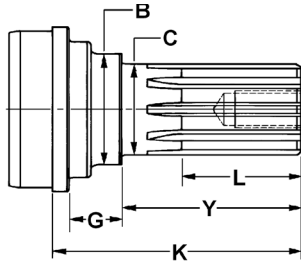

Style 1

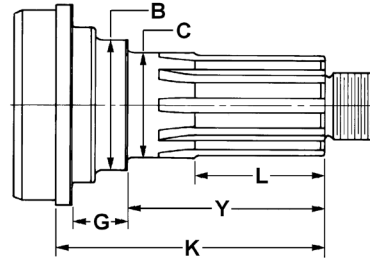

Style 2

Fits Tube		Y End of Spline to Bearing Shoulder	K End of Spline to Point of Weld	S t y l e	L Length of Spline	Thread Size	B Shoulder Diameter	G Length of Shoulder	Midship Tube Shaft Part Number
Tube Dia.	Wall Thickness								
1.750-34 Involute Spline									
1.771 Bearing Diameter (C)									
3.500	.095	3.188	5.050	2	2.060	1.250-18	2.153	.322	70-53-61
<i>Spline has helix on tooth. End yokes will be a tight fit.</i>									
3.500	.134	3.250	4.344	2	2.062	1.250-18	2.188	.812	5-53-261
<i>Spline has helix on tooth. End yokes will be a tight fit.</i>									
4.000	.095	3.189	4.327	2	2.059	1.250-18	2.154	—	100-53-31
<i>Spline has helix on tooth. End yokes will be a tight fit.</i>									
4.000	.095	3.250	4.344	2	2.125	1.250-18	2.188	.812	90-53-31
<i>Spline has helix on tooth. End yokes will be a tight fit.</i>									
4.000	.134	3.125	4.219	2	2.000	1.250-18	2.188	.812	90-53-11
<i>Spline has helix. Mates with 90-4-11-1 or 5-4-7171-1</i>									
4.000	.134	3.250	4.344	2	2.125	1.250-18	2.188	.812	5-53-271•
<i>5-53-271 was replaced by 90-53-11</i>									
2.000 Bearing Diameter (C)									
3.500	.134	5.625	7.125	2	2.062	1.250-18	2.500	.344	5-53-291
1.752-34 Involute Spline									
1.772 Bearing Diameter (C)									
4.000	.083	3.188	3.988	2	2.059	1.250-18	2.154	.559	70-53-31
1.950-38 Involute Spline									
1.968 Bearing Diameter (C)									
4.000	.134	4.060	5.150	2	2.840	1.250-18	2.440	.812	6-53-411
<i>Spline has helix on tooth. End yokes will be a tight fit.</i>									
4.330	.197	3.811	5.055	2	2.618	M30X2-6G	2.440	.811	140-53-11
4.562	.165	4.062	5.156	2	2.844	1.250-18	2.438	.812	6-53-421
<i>Spline has helix on tooth. End yokes will be a tight fit.</i>									
4.566	.157	3.346	4.591	2	2.125	M30X2-6G	2.441	.811	140-53-41•
4.567	.157	3.811	5.055	2	2.618	M30X2-6G	2.441	.811	140-53-31•
1.958-10 Spline									
1.967 Bearing Diameter (C)									
4.000	.134	3.000	4.438	2	1.938	1.250-18	2.625	1.062	6-53-211•
1.968									
3.500	.156	4.062	5.156	2	3.000	1.250-18	2.438	.812	6-53-151•
4.000	.134	4.062	5.156	2	2.875	1.250-18	2.438	.812	6-53-201
4.500	.134	4.062	5.156	2	2.875	1.250-18	2.438	.812	6-53-241
1.983-31 Involute Spline									
2.363 Bearing Diameter (C)									
3.500	.134	4.484	7.406	2	2.141	.500-20	2.774	1.281	4-53-331•
2.437 Bearing Diameter (C)									
3.500	.134	7.531	8.562	1	1.859	M12X1.750-6H	—	4.719	4-53-501•
<i>.268 key width in shoulder; Metric thread</i>									
2.000-10 Spline									
2.165 Bearing Diameter (C)									
4.000	.134	4.250	6.844	2	2.875	1.250-18	2.938	1.875	6-53-331
4.000	.134	4.562	7.875	2	2.625	1.250-18	2.562	2.938	6-53-261•

• Part is discontinued ■ Part is available until supply is exhausted ▲ Not sold separately



SPLINED MIDSHIP TUBE SHAFTS

Companion Flange or End Yoke Design

Fits Tube		Y	End of Spline	S t y l e	L	Thread Size	B	G	Midship Tube Shaft Part Number
Tube Dia.	Wall Thickness	End of Spline to Bearing Shoulder	Spline to Point of Weld		Length of Spline		Shoulder Diameter	Length of Shoulder	
2.350-16 Spline									
2.362 Bearing Diameter (C)									
3.500	.188	4.000	5.310	2	2.750	1.250-18	2.880	.810	6.5-53-21•
4.000	.134	4.000	5.312	2	2.625	1.250-18	2.875	.812	6-53-311
4.500	.134	4.000	5.312	2	2.750	1.250-18	2.875	1.312	6.5-53-91
4.500	.259	4.000	5.438	2	2.750	1.250-18	2.875	.812	6.5-53-51
2.350-46 Involute Spline									
2.362 Bearing Diameter (C)									
4.000	.134	4.000	5.312	2	2.625	1.250-18	2.875	.812	6.3-53-21 <i>Spline has helix on tooth. End yokes will be a tight fit.</i>
4.330	.197	4.000	5.311		2.618	M30X2-6G	2.886	.811	140-53-21 <i>Spline has helix on tooth. End yokes will be a tight fit.</i>
4.500	.134	4.000	5.312	2	2.625	1.250-18	2.875	.812	6.5-53-171 <i>Spline has helix on tooth. End yokes will be a tight fit.</i>
4.500	.259	4.000	5.312	2	2.625	1.250-18	2.875	.812	6.5-53-181 <i>Spline has helix on tooth. End yokes will be a tight fit.</i>
5.197	.236	3.980	5.291	2	2.618	M30X2-6G	2.886	.812	250-53-11 <i>Spline has helix on tooth. End yokes will be a tight fit.</i>
2.560 Bearing Diameter (C)									
3.500	.134	6.703	7.000	1	2.469	.500-20	3.125	1.234	4-53-301•
2.750 Bearing Diameter (C)									
4.500	.259	5.490	6.310	2	2.750	1.250-18	3.620	—	6.5-53-201•
2.360-16 Spline									
2.361 Bearing Diameter (C)									
4.000	.134	4.688	7.562	2	3.000	1.250-18	3.000	1.188	6-53-271
2.500-10 Spline									
2.559 Bearing Diameter (C)									
4.500	.134	6.281	7.000	2	2.938	1.500-18	3.500	1.500	6.5-53-111•
2.578-25 Involute Spline									
2.749 Bearing Diameter (C)									
4.095	.180	5.781	6.500	2	2.500	1.625-12	3.125	—	6-53-371
2.656-18 Involute Spline									
2.756 Bearing Diameter (C)									
4.500	.259	4.562	6.000	2	2.875	1.500-18	3.312	.812	8-53-61
2.707-68 Involute Spline									
2.756 Bearing Diameter (C)									
140.000	5.000	3.366	5.020	1	2.244	M38X1.5-6G	3.130	.216	350-53-23770
140.000	5.000	3.366	5.020	1	2.244	M38X1.5-6G	3.130	.216	5023770•
<i>5023770 was replaced by 350-53-23770</i>									

• Part is discontinued ■ Part is available until supply is exhausted ▲ Not sold separately



SPLINED MIDSHIP TUBE SHAFTS

Slip Yoke Design For Use with Outboard Slip Yokes

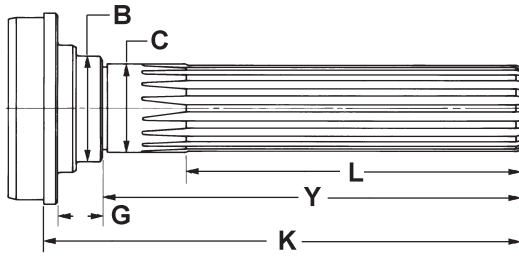

Style 1

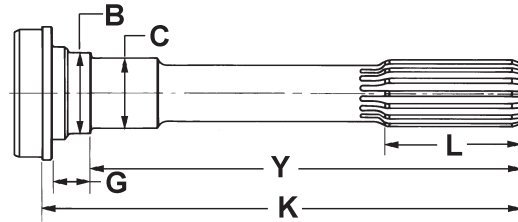

Style 2

Note: Spline is Glidecote except where footnoted.

Fits Tube		Y	K	S t y l e	L	B	G	Midship Tube Shaft Part Number
Tube Diameter	Wall Thickness	End of Spline to Bearing Shoulder	End of Spline to Point of Weld		Length of Spline	Shoulder Diameter	Length of Shoulder	
1.3120-19 Based On 20 Involute Spline								
1.575 Bearing Diameter (C)								
3.000	.065	6.851	7.466	2	3.500	1.800	.375	2-53-1441 <i>May use boot 212094X, order separate</i>
3.000	.083	6.850	7.598	2	3.500	1.690	.500	2-53-03448 <i>May use boot 212094X, order separate</i>
3.000	.083	6.850	7.598	2	3.500	1.690	.500	5003448• <i>5003448 was replaced by 2-53-03448 ; May use boot 212094X, order separate</i>
1.3750-15 Based On 16 Spline								
1.378 Bearing Diameter (C)								
2.500	.083	7.406	8.469	2	2.500	1.688	.812	2-53-921
2.500	.083	7.812	8.875	2	2.500	1.688	.812	2-53-681
3.000	.065	7.812	8.875	2	2.500	1.688	.812	2-53-691
3.000	.083	7.969	9.031	2	2.500	1.688	.812	2-53-711 <i>May use boot 211916X or dust cap 211121X, order separate</i>
3.000	.083	8.480	9.540	2	3.500	1.688	.810	2-53-1511 <i>May use boot 211932X, order separate</i>
1.3750-16 Spline								
1.378 Bearing Diameter (C)								
2.000	.083	5.969	7.281	1	4.438	1.688	.812	2-53-121
2.000	.083	6.938	8.250	1	5.406	1.688	.812	2-53-511
2.500	.065	6.938	8.000	1	5.406	1.688	.812	2-53-531•
2.500	.083	5.969	7.031	1	4.438	1.688	.812	3-53-211•
2.500	.083	6.750	8.094	1	4.969	1.719	1.125	3-53-1351
2.500	.083	6.938	8.000	1	5.406	1.688	.812	2-53-471
3.000	.065	6.938	8.000	1	5.406	1.688	.812	2-53-491•
3.000	.083	6.750	8.094	1	4.969	1.719	1.125	3-53-1361
3.000	.083	6.781	7.031	1	4.438	1.688	.812	3-53-1371
3.000	.083	6.938	8.000	1	5.406	1.688	.812	2-53-501
3.000	.083	7.848	8.908	2	2.500	1.688	.812	2-53-1131
3.500	.065	6.750	8.094	1	4.969	1.719	1.125	3-53-1381•
1.3750-31 Based On 32 Involute Spline								
1.378 Bearing Diameter (C)								
3.500	.083	7.469	8.812	2	3.344	1.719	1.125	3-53-1301• <i>Spline not Glidecoated</i>
1.3760-31 Based On 32 Involute Spline								
1.378 Bearing Diameter (C)								
2.750	.065	7.469	8.812	2	3.344	1.719	1.125	3-53-1991
3.000	.083	7.469	8.812	2	3.344	1.719	1.125	3-53-1181

• Part is discontinued ■ Part is available until supply is exhausted ▲ Not sold separately



SPLINED MIDSHIP TUBE SHAFTS

Slip Yoke Design For Use with Outboard Slip Yokes



Fits Tube		Y	K	S t y l e	L	B	G	Midship Tube Shaft Part Number
Tube Diameter	Wall Thickness	End of Spline to Bearing Shoulder	End of Spline to Point of Weld		Length of Spline	Shoulder Diameter	Length of Shoulder	
1.4370-21 Based On 22 Involute Spline								
1.575 Bearing Diameter (C)								
3.000	.065	7.460	8.080	2	3.500	1.800	.375	3-53-02255 <i>May use boot 212094X, order separate</i>
3.000	.065	7.460	8.080	2	3.500	1.800	.375	5002255• <i>5002255 was replaced by 3-53-02255 ; May use boot 212094X, order separate</i>
3.000	.083	9.500	10.618	2	3.500	1.810	.889	3-53-12525 <i>May use boot 212010X, order separate</i>
3.000	.083	9.500	10.618	2	3.500	1.810	.880	5012525• <i>5012525 was replaced by 3-53-12525 ; May use boot 212010X, order separate</i>
3.000	.083	9.500	10.620	2	3.500	1.810	.880	3-53-2451 <i>May use boot 211503X, order separate</i>
3.500	.065	7.385	8.000	2	3.500	1.812	.375	3-53-2381 <i>May use boot 212094X, order separate</i>
3.500	.065	7.492	8.240	2	3.500	1.690	.500	3-53-02410 <i>May use boot 212094X, order separate</i>
3.500	.065	7.492	8.240	2	3.500	1.690	.500	5002410• <i>5002410 was replaced by 3-53-02410 ; May use boot 212094X, order separate</i>
3.500	.083	7.683	8.083		3.500	1.810	.880	3-53-07287
3.500	.083	7.683	8.803		3.500	1.810	.880	5007287• <i>5007287 was replaced by 3-53-07287</i>
3.500	.083	7.715	8.080	2	3.500	1.800	.375	3-53-2441 <i>May use boot 212094X, order separate</i>
3.500	.083	8.838	9.618	2	3.500	1.809	.540	3-53-08002
3.500	.083	8.838	9.618	2	3.500	1.809	.540	5008002• <i>5008002 was replaced by 3-53-08002</i>
3.500	.083	9.510	10.630	2	3.500	1.810	.880	3-53-2591 <i>May use boot 212094X or 211010X, order separate</i>
1.5000-15 Based On 16 Spline								
1.575 Bearing Diameter (C)								
3.000	.083	8.240	9.375	2	3.000	1.812	.812	3-53-1551 <i>May use 211158X dust cap (or) 211600X or 212010X boot kit,</i>
3.000	.083	9.500	10.625	2	3.000	1.810	.875	3-53-1951 <i>May use boot 211503X, order separate</i>
3.000	.095	8.234	9.350	2	3.000	1.812	.875	3-53-2291 <i>May use boot 212010X, order separate</i>
3.500	.065	8.230	9.350	2	3.000	1.810	.875	3-53-2011
3.500	.083	9.625	10.719	2	3.000	1.810	.875	3-53-2281 <i>May use 211158X dust cap or 211916X boot, order separate</i>
4.000	.083	9.500	10.625	2	3.000	1.810	.875	3-53-2181• <i>May use boot 211503X, order separate</i>
4.095	.180	9.500	10.625	2	3.000	1.810	.875	3-53-1981•
1.5000-16 Spline								
1.575 Bearing Diameter (C)								
3.000	.083	5.940	7.062	1	4.438	1.810	.875	3-53-1031
3.000	.083	7.188	8.312	1	5.688	1.810	.875	3-53-1041•
3.000	.083	8.080	9.200	1	6.580	1.810	.875	3-53-1531
3.000	.083	9.040	10.160	1	7.540	1.810	.875	3-53-1481•
3.500	.083	5.940	7.062	1	4.440	1.810	.875	3-53-1121
4.000	.083	5.940	7.062	1	4.438	1.810	.875	3-53-1131

• Part is discontinued ■ Part is available until supply is exhausted ▲ Not sold separately



Important: See Safety Information in General Information Section (J300P-GI)

SPLINED MIDSHIP TUBE SHAFTS

Slip Yoke Design For Use with Outboard Slip Yokes

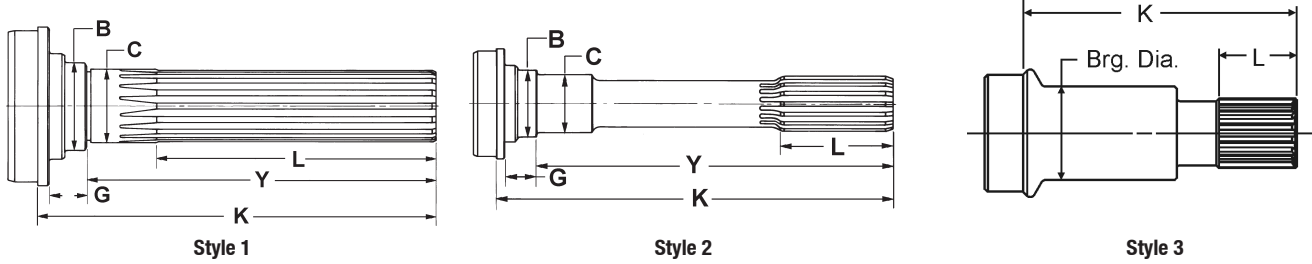

Note: Spline is Glidecote except where footnoted.

Fits Tube		Y	K	S t y l e	L	B	G	Midship Tube Shaft Part Number
Tube Diameter	Wall Thickness	End of Spline to Bearing Shoulder	End of Spline to Point of Weld		Length of Spline	Shoulder Diameter	Length of Shoulder	
1.5620-16 Spline								
1.575 Bearing Diameter (C)								
3.000	.083	7.470	8.531	1	5.940	1.940	.875	3-53-411•
3.500	.083	7.410	8.531	1	5.906	1.810	.875	3-53-1311
3.500	.083	7.470	8.531	2	5.938	1.940	.812	3-53-451•
<i>3-53-451 was replaced by 5007832</i>								
3.500	.083	7.470	8.578	2	3.000	1.940	.810	3-53-07832
3.500	.083	7.470	8.578	2	3.000	1.940	.810	5007832•
<i>5007832 was replaced by 3-53-07832</i>								
3.500	.083	7.880	9.290	1	5.938	2.060	1.156	3-53-441•
4.000	.083	7.470	8.531	1	5.938	1.940	.812	3-53-1191
1.772								
3.500	.095	7.480	8.570	1	5.940	2.190	.810	4-53-531•
1.5620-23 Based On 24 Involute Spline								
1.575 Bearing Diameter (C)								
3.500	.083	7.531	8.331	2	3.500	1.803	.555	55-53-11
<i>May use boot 212094X, order separate</i>								
3.500	.083	8.704	9.500	2	3.500	1.803	.555	55-53-51
<i>May use boot 212094X, order separate</i>								
3.500	.083	8.732	9.512	2	3.000	1.811	.540	3-53-08004
3.500	.083	8.732	9.512	2	3.000	1.811	.540	5008004•
<i>5008004 was replaced by 3-53-08004</i>								
3.500	.083	8.750	9.875	2	3.000	1.812	.880	3-53-2571
<i>Use boot 212007X, order separate</i>								
4.000	.083	7.531	8.331	2	3.500	1.803	.555	55-53-21•
<i>May use boot 212094X, order separate</i>								
4.000	.083	8.689	9.468	2	3.000	1.809	.540	3-53-08003
4.000	.083	8.689	9.468	2	3.000	1.809	.540	5008003•
<i>5008003 was replaced by 3-53-08003</i>								
4.000	.083	8.704	9.500	2	3.500	1.803	.555	55-53-31•
<i>May use boot 212094X, order separate</i>								
4.000	.083	8.750	9.875	2	3.000	1.810	.880	3-53-2561
<i>Use boot 212007X, order separate</i>								
1.7500-16 Spline								
1.772 Bearing Diameter (C)								
3.500	.095	7.469	8.562	1	5.938	2.188	.812	4-53-61
4.000	.083	7.469	8.562	1	5.938	2.188	.812	4-53-101

• Part is discontinued ■ Part is available until supply is exhausted ▲ Not sold separately



SPLINED MIDSHIP TUBE SHAFTS

Slip Yoke Design For Use with Outboard Slip Yokes



Fits Tube		Y	K	S t y l e	L	B	G	Midship Tube Shaft Part Number
Tube Diameter	Wall Thickness	End of Spline to Bearing Shoulder	End of Spline to Point of Weld		Length of Spline	Shoulder Diameter	Length of Shoulder	
1.7500-34 Spline								
2.185 Bearing Diameter (C)								
3.500	.134	—	7.000	3	2.031	—	—	5-53-331• <i>Has .625-18 thread at spline end</i>
1.7520-26 Based On 27 Involute Spline								
1.772 Bearing Diameter (C)								
3.500	.095	8.902	9.693	2	3.500	2.154	.554	70-53-51 <i>Use boot 212146X, order separate</i>
4.000	.083	8.102	8.902	2	3.500	2.154	.554	70-53-11 <i>Use boot 212146X, order separate</i>
4.000	.083	8.902	9.693	2	3.500	2.154	.554	70-53-21• <i>Use boot 212146X, order separate</i>
1.9370-29 Based On 30 Involute Spline								
1.968 Bearing Diameter (C)								
4.000	.095	8.720	9.862	2	4.000	2.441	—	100-53-11• <i>Use boot 212146X, order separate</i>
4.000	.095	9.520	10.661	2	4.000	2.441	—	100-53-21 <i>Use boot 212146X, order separate</i>
1.9370-30 Involute Spline								
1.968 Bearing Diameter (C)								
4.000	.095	8.906	10.000	2	4.000	2.438	.812	90-53-21 <i>Mates with 90-3-41X</i>
4.000	.134	8.906	10.000	2	4.000	2.438	.812	90-53-41
1.9830-31 Involute Spline								
2.436 Bearing Diameter (C)								
3.500	.134	—	9.540	3	2.810	2.400	—	70-53-81 <i>.268 Keyway. Metric Thrd. Used w/pillow block</i>

• Part is discontinued ■ Part is available until supply is exhausted ▲ Not sold separately



Important: See Safety Information in General Information Section (J300P-GI)

Exploded View

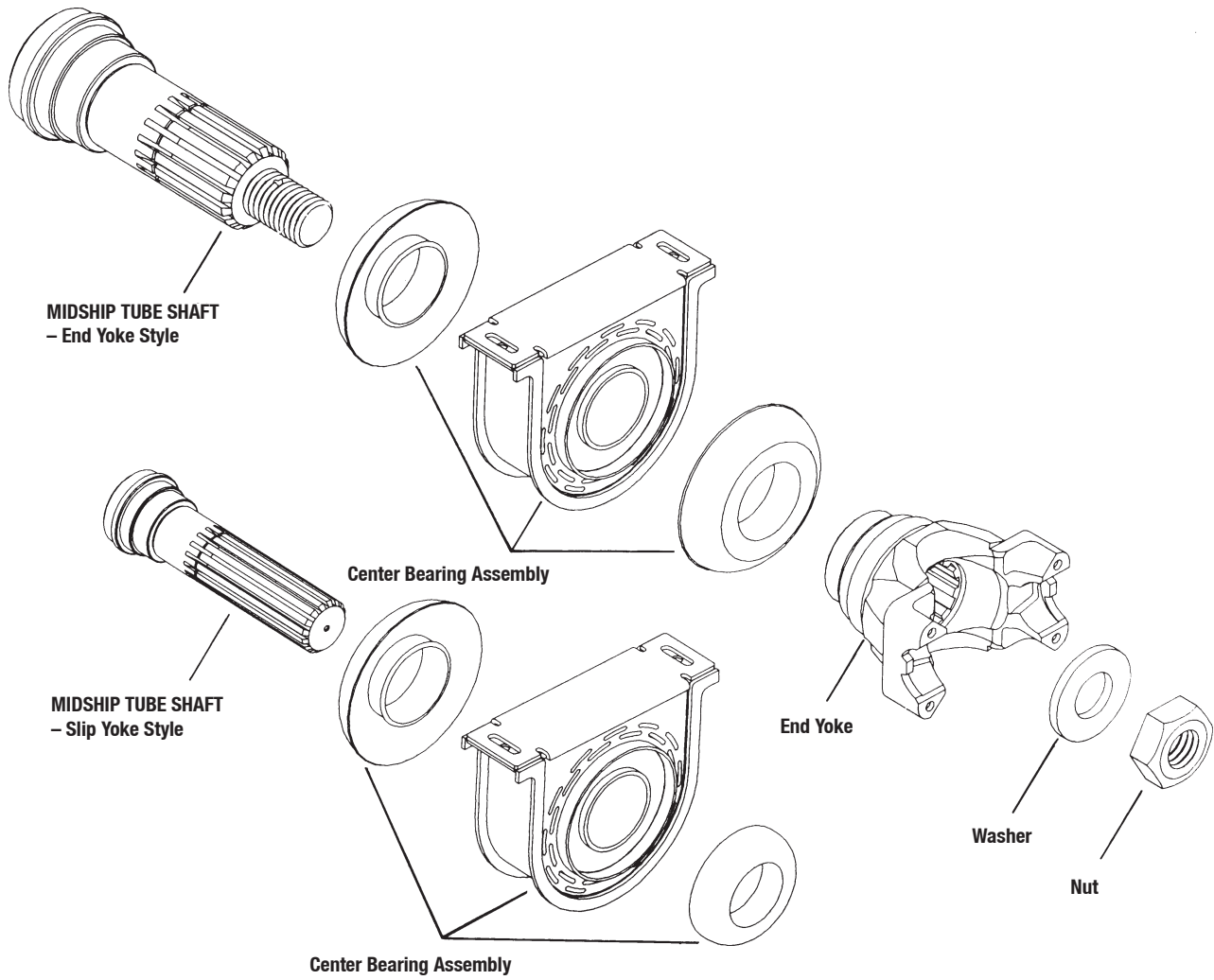

Tube Shaft Part Number	Center Bearing Number	End Yoke/ Flange Number	Series	Washer	Nut	Bolt	Cotter Pin
2-53-121	210088-1X	-	1310	-	-	-	-
2-53-121	211130X	-	1310	-	-	-	-
2-53-121	210088-1X	----	1310	----	----	----	----
2-53-121	211130X	----	1310	----	----	----	----
2-53-331	210090-1X	281638	1310	230123-11	-	500412-11	-
2-53-361	210090-1X	281638	1310	230123-11	-	500412-11	-
2-53-381X	211341X	2-4-6411-1X	1310	230123-12	231781	-	-
2-53-471	211175X	-	-	-	-	-	-
2-53-491	211175X	-	-	-	-	-	-
2-53-501	210088-1X	-	-	-	-	-	-
2-53-501	211175X	-	-	-	-	-	-
2-53-511	211175X	-	-	-	-	-	-
2-53-531	211175X	-	-	-	-	-	-
2-53-681	211175X	-	-	-	-	-	-
2-53-691	211175X	-	-	-	-	-	-
2-53-711	211130X	-	-	-	-	-	-
2-53-711	211131X	-	-	-	-	-	-
2-53-711	211175X	-	-	-	-	-	-
2-53-901	211431X	1567292	1210	230123-12	231781	-	-
2-53-901	211431X	2-4-6191-1	1210	230123-12	231781	-	-
2-53-901	211748-1X	2-4-6731-1X	1210	230123-12	231781	-	-
2-53-921	211415X	-	-	-	-	-	-
2-53-991	211478-1X	2-4-6731-1X	1210	230123-12	231781	-	-
2-53-1011	211590-1X	2-4-7021-1	1310	230123-12	231781	-	-
2-53-1021X	211590-1X	2-4-7021-1	1310	230123-12	231781	-	-
2-53-1051	211574-1X	2-4-7201-1X	1310	230123-12	231781	-	-
2-53-1051	211589-1X	2-4-7291-1X	1310	230123-12	231781	-	-
2-53-1051	211938-1X	2-4-7291-1X	1310	230123-12	231781	-	-
2-53-1061X	211574-1X	2-4-7291-1X	1310	230123-12	231781	-	-
2-53-1071	211502X	2-4-6411-1X	1210	230123-12	231781	-	-
2-53-1081X	211502X	2-4-6411-1X	1310	230123-12	231781	-	-
2-53-1121	211618X	2-4-7281-1X	1310	230123-12	231781	-	-
2-53-1131	211579-1X	-	-	-	-	-	-
2-53-1141X	211589-1X	2-4-7291-1X	1310	230123-12	231781	-	-
2-53-1141X	211938-1X	2-4-7291-1X	1310	230123-12	231781	-	-
2-53-1151	210090-1X	281638	1310	-	16-74-101	-	-
2-53-1151	210090-1X	2-4-2671-1	1310	-	16-74-101	-	-
2-53-1161	211406X	2-4-6181-1X	1310	230123-6	231781	-	-
2-53-1161	211406X	2-4-7501-1X	1310	230123-6	231781	-	-
2-53-1171X	211406X	2-4-7501-1X	1310	230123-12	231781	-	-
2-53-1191	210090-1X	281638	1310	-	16-74-101	-	-
2-53-1191	210090-1X	2-4-2671-1	1310	-	16-74-101	-	-
2-53-1191	211134X	281638	1310	-	16-74-101	-	-
2-53-1191	211134X	2-4-2671-1	1330	-	16-74-101	-	-
2-53-1191	211161X	792978	1310	-	16-74-101	-	-
2-53-1191	211173X	1377366	1330	-	16-74-101	-	-
2-53-1191	211569-1X	2-4-2671-1	1310	-	16-74-101	-	-
2-53-1211	210090-1X	281638	1310	-	16-74-101	-	-
2-53-1211	210090-1X	2-4-2671-1	1310	-	16-74-101	-	-
2-53-1211	211757-1X	281638	1310	-	16-74-101	-	-
2-53-1271X	211747-1X	2-4-7571-1X	1310	230123-12	231781	-	-
2-53-1311	211750-1X	2-4-7561X	1310	230123-14	10-74-101	-	-
2-53-1321	211872-1X	2-4-7021-1	1310	230123-12	231781	-	-
2-53-1331	211590-1X	2-4-7021-1	1310	230123-12	231781	-	-
2-53-1351	211872-1X	2122460	1310	230123-12	231781	-	-
2-53-1351	211872-1X	2-4-7021-1	1310	230123-12	231781	-	-
2-53-1371	211925-1X	-	-	-	-	-	-
2-53-1371	211986-1X	-	-	-	-	-	-
2-53-1411	211924X	3-4-5721-1	1350	-	16-74-101	-	-

Note: For detail information on Center Bearings, refer to J300P-9A.



Important: See Safety Information in General Information Section (J300P-GI)

Tube Shaft Part Number	Center Bearing Number	End Yoke/ Flange Number	Series	Washer	Nut	Bolt	Cotter Pin
2-53-1411	211985X	3-4-13611-1	1350	-	16-74-101	-	-
2-53-1411	211985X	3-4-14581-1	1350	-	16-74-101	-	-
2-53-1411	211985X	3-4-5721-1	1350	-	16-74-101	-	-
2-53-1411	212169X	3-4-13611-1	1350	-	16-74-101	-	-
2-53-1411	212169X	3-4-14581-1	1350	-	16-74-101	-	-
2-53-1411	212169X	3-4-5721-1	1350	-	16-74-101	-	-
2-53-1411	212273X	3-4-14581-1	1350	-	16-74-101	-	-
2-53-1411	212275X	3-4-14581-1	1350	-	16-74-101	-	-
2-53-1441	212028-1X	-	1330	-	-	-	-
2-53-1441	212030-1X	-	1330	-	-	-	-
2-53-1441	212032-1X	-	1330	-	-	-	-
2-53-1441	212030-1X	----	1330	----	----	----	----
2-53-1441	212028-1X	----	1330	----	----	----	----
2-53-1441	212032-1X	----	1330	----	----	----	----
2-53-1511	5001874	-	1330	-	-	-	-
2-53-1511	212088-1X	-	1330	-	-	-	-
2-53-1511	5001874	-	1330	-	-	-	-
2-53-1511	212088-1X	----	1330	----	----	----	----
2-53-1511	5001874	----	1330	----	----	----	----
2-53-1571	212165-1X	2-4-8541-1X	1310	230123-14	231781	-	-
2-53-1571	212166-1X	2-4-8541-1X	1310	230123-14	231781	-	-
2-53-1651	5002334	5002008	1330	230123-14	10-74-101	-	-
2-53-1651	211750-1X	2-4-8171X	1330	230123-14	10-74-101	-	-
2-53-1651	211750-1X	5002008	1330	230123-14	10-74-101	-	-
2-53-1651	211750-1X	5002008	1330	230123-14	10-74-101	----	----
2-53-1651	5002334	5002008	1330	230123-14	10-74-101	----	----
2-53-1651	211750-1X	2-4-8171X	1330	230123-14	10-74-101	----	----
2-53-01931	5002007	5002008	1330	230123-14	10-74-101	-	-
2-53-01931	5002334	5002008	1330	230123-14	10-74-101	-	-
2-53-01931	5014091	5002008	1330	230123-14	10-74-101	-	-
2-53-01931	5014092	5002008	1330	230123-14	10-74-101	-	-
2-53-01931	5016911	5002008	1330	230123-14	10-74-101	-	-
2-53-01931	5002007	5002008	1330	230123-14	10-74-101	----	----
2-53-01931	5002334	5002008	1330	230123-14	10-74-101	----	----
2-53-01931	5016911	5002008	1330	230123-14	10-74-101	----	----
2-53-01931	5014091	5002008	1330	230123-14	10-74-101	----	----
2-53-01931	5014092	5002008	1330	230123-14	10-74-101	----	----
2-53-01931	5002007	5002008	1330	230123-14	10-74-101	----	----
2-53-03448	5002103	-	1310	-	-	-	-
2-53-03448	5016003	-	1330	-	-	-	-
2-53-03448	5016101	-	1330	-	-	-	-
2-53-03448	5016124	-	1330	-	-	-	-
2-53-03448	5016101	----	1330	----	----	----	----
2-53-03448	5016003	----	1330	----	----	----	----
2-53-03448	5002103	----	1310	----	----	----	----
2-53-03448	5016124	----	1330	----	----	----	----
2-54-361	211406X	2-4-6181-1X	1310	230123-12	231781	-	-
2-54-361	211406X	2-4-7501-1X	1310	230123-12	231781	-	-
2-54-371	211502X	2-4-8211-1X	1310	230123-12	231781	-	-
2-54-351X	211406X	2-4-6181-1X	1310	230123-12	231781	-	-
2-54-351X	211406X	2-4-7501-1X	1310	230123-12	231781	-	-
2-54-381X	211505X	2-4-6411-1X	1310	230123-12	231781	-	-
3-53-181	210088-1X	-	-	-	-	-	-
3-53-191	NO DATA						
3-53-191	NO DATA						
3-53-211	211175X	-	-	-	-	-	-
3-53-411	210433-1X	-	-	-	-	-	-
3-53-421	210119-1X	3-4-3331X	1480	-	16-74-101	-	-
3-53-421	210119-1X	47942	1550	-	16-74-101	-	-

Note: For detail information on Center Bearings, refer to J300P-9A.



Tube Shaft Part Number	Center Bearing Number	End Yoke/ Flange Number	Series	Washer	Nut	Bolt	Cotter Pin
3-53-421	210144-1X	3-4-3331X	1480	-	16-74-101	-	-
3-53-441	210140-1X	-	-	-	-	-	-
3-53-451	210433-1X	-	-	-	-	-	-
3-53-1031	210866-1X	-	-	-	-	-	-
3-53-1041	210866-1X	-	-	-	-	-	-
3-53-1121	210866-1X	-	-	-	-	-	-
3-53-1131	210866-1X	-	-	-	-	-	-
3-53-1181	210370-1X	-	-	-	-	-	-
3-53-1191	210391-1X	-	-	-	-	-	-
3-53-1191	210433-1X	-	-	-	-	-	-
3-53-1211	210866-1X	-	-	-	-	-	-
3-53-1301	210370-1X	-	-	-	-	-	-
3-53-1311	210866-1X	-	-	-	-	-	-
3-53-1351	210370-1X	-	-	-	-	-	-
3-53-1361	210370-1X	-	-	-	-	-	-
3-53-1371	NO DATA						
3-53-1371	NO DATA						
3-53-1381	NO DATA						
3-53-1381	NO DATA						
3-53-1391	210088-1X	-	-	-	-	-	-
3-53-1391	211200X	-	-	-	-	-	-
3-53-1481	210866-1X	-	-	-	-	-	-
3-53-1531	210866-1X	-	-	-	-	-	-
3-53-1551	211359X	-	-	-	-	-	-
3-53-1551	211499-1X	-	-	-	-	-	-
3-53-1551	211793-1X	-	-	-	-	-	-
3-53-1561	210866-1X	-	-	-	-	-	-
3-53-1781	210873-1X	1702460	1410	-	16-74-101	-	-
3-53-1781	210873-1X	3-4-6901-1	1410	-	16-74-101	-	-
3-53-1781	210873-1X	3-4-6561-1	1410	-	16-74-101	-	-
3-53-1781	210873-1X	3-4-6631X	1410	-	16-74-101	-	-
3-53-1791	210873-1X	1702460	1410	-	16-74-101	-	-
3-53-1791	210873-1X	3-4-6901-1	1410	-	16-74-101	-	-
3-53-1791	210873-1X	1826642	1410	-	16-74-101	-	-
3-53-1791	210873-1X	3-4-6561-1	1410	-	16-74-101	-	-
3-53-1791	210873-1X	3-4-6631X	1410	-	16-74-101	-	-
3-53-1801	210873-1X	1702460	1410	-	16-74-101	-	-
3-53-1801	210873-1X	3-4-6561-1	1410	-	16-74-101	-	-
3-53-1801	210873-1X	3-4-6561-2	1410	-	16-74-101	-	-
3-53-1801	210873-1X	1826642	1480	-	16-74-101	-	-
3-53-1801	210873-1X	3-4-6901-1	1480	-	16-74-101	-	-
3-53-1811	210391-1X	380282	1410	-	16-74-101	-	-
3-53-1821	210391-1X	380282	1410	-	16-74-101	-	-
3-53-1821	210391-1X	3-4-2941-1	1410	-	16-74-101	-	-
3-53-1821	210391-1X	3-4-4421X	1480	-	16-74-101	-	-
3-53-1831	210391-1X	380282	1410	-	16-74-101	-	-
3-53-1831	210391-1X	3-4-4421X	1480	-	16-74-101	-	-
3-53-1831	210391-1X	931826	1550	-	16-74-101	-	-
3-53-1831	210391-1X	55247	1550	-	16-74-101	-	-
3-53-1881	210391-1X	997538	1410	-	16-74-101	-	-
3-53-1891	210873-1X	1702460	1410	-	16-74-101	-	-
3-53-1891	210873-1X	3-4-6561-1	1410	-	16-74-101	-	-
3-53-1891	210873-1X	3-4-6561-2	1410	-	16-74-101	-	-
3-53-1891	210873-1X	3-4-6631X	1410	-	16-74-101	-	-
3-53-1921	211453X	3-4-10551-1	1410	98-216	16-74-11	-	500024-11
3-53-1951	211359X	-	-	-	-	-	-
3-53-1951	211499X	-	-	-	-	-	-
3-53-1951	211793-1X	-	-	-	-	-	-
3-53-1951	211848-1X	-	-	-	-	-	-

Note: For detail information on Center Bearings, refer to J300P-9A.



Important: See Safety Information in General Information Section (J300P-GI)

Tube Shaft Part Number	Center Bearing Number	End Yoke/ Flange Number	Series	Washer	Nut	Bolt	Cotter Pin
3-53-1951	211963-1X	-	-	-	-	-	-
3-53-1981	211359X	-	-	-	-	-	-
3-53-1991	NO DATA	-	-	-	-	-	-
3-53-1991	NO DATA	-	-	-	-	-	-
3-53-2011	211793-1X	-	-	-	-	-	-
3-53-2061	210873-1X	1702460	-	-	16-74-101	-	-
3-53-2061	210873-1X	3-4-11451-1	-	-	16-74-101	-	-
3-53-2061	210873-1X	3-4-6561-1	-	-	16-74-101	-	-
3-53-2061	210873-1X	3-4-6561-2	-	-	16-74-101	-	-
3-53-2171	232429	3-4-12271-1M	1480	232430	-	232431	-
3-53-2181	211848-1X	-	-	-	-	-	-
3-53-2181	211963-1X	-	-	-	-	-	-
3-53-02255	212028-1X	-	1350	-	-	-	-
3-53-02255	212028-1X	----	1350	----	----	----	----
3-53-2281	211359X	-	-	-	-	-	-
3-53-2281	211499X	-	-	-	-	-	-
3-53-2281	211848-1X	-	-	-	-	-	-
3-53-2281	211963-1X	-	-	-	-	-	-
3-53-2281	212093-2X	-	-	-	-	-	-
3-53-2291	211793-2X	-	-	-	-	-	-
3-53-2301	211966-1X	3-4-7391-1X	1480	-	16-74-101	-	-
3-53-2301	212053-1X	3-4-13881-1	1350	-	16-74-101	-	-
3-53-2301	212053-1X	3-4-13871-1	1410	-	16-74-101	-	-
3-53-2301	212053-1X	3-4-13921-1	1480	-	16-74-101	-	-
3-53-2331	211359X	-	-	-	-	-	-
3-53-2331	211499X	-	-	-	-	-	-
3-53-2331	211793-1X	-	-	-	-	-	-
3-53-2351	210433-1X	-	-	-	-	-	-
3-53-2361	212004-1X	3-4-13721-1X	1410	-	16-74-101	-	-
3-53-2371X	212004-1X	3-4-13721-1X	1410	-	16-74-101	-	-
3-53-2371X	212004-1X	3-4-13721-1X	1410	----	16-74-101	----	----
3-53-2381	212028-1X	-	-	-	-	-	-
3-53-2381	212030-1X	-	-	-	-	-	-
3-53-2381	212031-1X	-	-	-	-	-	-
3-53-2381	212032-1X	-	-	-	-	-	-
3-53-2441	212030-1X	-	-	-	-	-	-
3-53-2441	212031-1X	-	-	-	-	-	-
3-53-2441	212177-1X	-	-	-	-	-	-
3-53-2451	211359X	-	-	-	-	-	-
3-53-2451	211499X	-	-	-	-	-	-
3-53-2451	212020-1X	-	-	-	-	-	-
3-53-2471	211359X	-	-	-	-	-	-
3-53-2541	211966-1X	3-4-14621-1	1350	-	16-74-101	-	-
3-53-2541	211966-1X	3-4-14591-1	1410	-	16-74-101	-	-
3-53-2541	212053-1X	3-4-14621-1	1350	-	16-74-101	-	-
3-53-2541	212053-1X	3-4-14591-1	1410	-	16-74-101	-	-
3-53-2561	5006144	-	1480	-	-	-	-
3-53-2561	5006145	-	1410	-	-	-	-
3-53-2561	5007091	-	1410	-	-	-	-
3-53-2561	5012699	-	1480	-	-	-	-
3-53-2561	5012702	-	1410	-	-	-	-
3-53-2561	5014409	-	1480	-	-	-	-
3-53-2561	5018034	-	1480	-	-	-	-
3-53-2561	210865-1X	-	1480	-	-	-	-
3-53-2561	211359X	-	1480	-	-	-	-
3-53-2561	211359X	-	1410	-	-	-	-
3-53-2561	211359X	----	1410	----	----	----	----
3-53-2561	210865-1X	----	1480	----	----	----	----
3-53-2561	5007091	----	1410	----	----	----	----

Note: For detail information on Center Bearings, refer to J300P-9A.



Tube Shaft Part Number	Center Bearing Number	End Yoke/ Flange Number	Series	Washer	Nut	Bolt	Cotter Pin
3-53-2561	5006144	----	1480	----	----	----	----
3-53-2561	5006145	----	1410	----	----	----	----
3-53-2561	5012702	----	1410	----	----	----	----
3-53-2561	5012699	----	1480	----	----	----	----
3-53-2561	5014409	----	1480	----	----	----	----
3-53-2561	5018034	----	1480	----	----	----	----
3-53-2561	211359X	----	1480	----	----	----	----
3-53-2571	211499X	-	-	-	-	-	-
3-53-2591	5003685	-	1410	-	-	-	-
3-53-2591	5005850	-	1410	-	-	-	-
3-53-2591	5006144	-	1410	-	-	-	-
3-53-2591	5006145	-	1410	-	-	-	-
3-53-2591	5007091	-	1410	-	-	-	-
3-53-2591	5009792	-	1410	-	-	-	-
3-53-2591	5012539	-	1410	-	-	-	-
3-53-2591	5012699	-	1410	-	-	-	-
3-53-2591	5012705	-	1410	-	-	-	-
3-53-2591	5017406	-	1410	-	-	-	-
3-53-2591	5017407	-	1410	-	-	-	-
3-53-2591	5017950	-	1410	-	-	-	-
3-53-2591	211359X	-	1350	-	-	-	-
3-53-2591	211499X	-	1350	-	-	-	-
3-53-2591	211359X	----	1350	----	----	----	----
3-53-2591	211499X	----	1350	----	----	----	----
3-53-2591	5003685	----	1410	----	----	----	----
3-53-2591	5006144	----	1410	----	----	----	----
3-53-2591	5006145	----	1410	----	----	----	----
3-53-2591	5005850	----	1410	----	----	----	----
3-53-2591	5007091	----	1410	----	----	----	----
3-53-2591	5009792	----	1410	----	----	----	----
3-53-2591	5012539	----	1410	----	----	----	----
3-53-2591	5012699	----	1410	----	----	----	----
3-53-2591	5012705	----	1410	----	----	----	----
3-53-2591	5017950	----	1410	----	----	----	----
3-53-2591	5017406	----	1410	----	----	----	----
3-53-2591	5017407	----	1410	----	----	----	----
3-53-02410	5016101	-	1410	-	-	-	-
3-53-02410	5016101	----	1410	----	----	----	----
3-53-02410	5016101	----	1410	----	----	----	----
3-53-06154	5002007	5006150	1350	230123-14	10-74-101	-	-
3-53-06154	211750-1X	5006148	1350	5007771	5007770	-	-
3-53-06154	5008306-1	5006150	1350	5007771	5007770	-	-
3-53-06154	5008306-2	5006148	1350	5007771	5007770	-	-
3-53-06154	5002007	5006150	1350	230123-14	10-74-101	----	----
3-53-06154	5008306-1	5006150	1350	5007771	5007770	----	----
3-53-06154	5008306-2	5006148	1350	5007771	5007770	----	----
3-53-06154	211750-1X	5006148	1350	5007771	5007770	----	----
3-53-07287	5007103	-	1410	-	-	-	-
3-53-07287	5007104	-	1410	-	-	-	-
3-53-07287	5009794	-	1410	-	-	-	-
3-53-07287	5012700	-	1410	-	-	-	-
3-53-07287	5012706	-	1410	-	-	-	-
3-53-07287	5014121	-	1410	-	-	-	-
3-53-07287	5014411	-	1410	-	-	-	-
3-53-07287	5014412	-	1410	-	-	-	-
3-53-07287	5017408	-	1410	-	-	-	-
3-53-07287	5017409	-	1410	-	-	-	-
3-53-07287	5017410	-	1410	-	-	-	-
3-53-07287	5007103	----	1410	----	----	----	----

Note: For detail information on Center Bearings, refer to J300P-9A.



Important: See Safety Information in General Information Section (J300P-GI)

Tube Shaft Part Number	Center Bearing Number	End Yoke/ Flange Number	Series	Washer	Nut	Bolt	Cotter Pin
3-53-07287	5007104	----	1410	----	----	----	----
3-53-07287	5009794	----	1410	----	----	----	----
3-53-07287	5012700	----	1410	----	----	----	----
3-53-07287	5012706	----	1410	----	----	----	----
3-53-07287	5014121	----	1410	----	----	----	----
3-53-07287	5014412	----	1410	----	----	----	----
3-53-07287	5014411	----	1410	----	----	----	----
3-53-07287	5017410	----	1410	----	----	----	----
3-53-07287	5017409	----	1410	----	----	----	----
3-53-07287	5017408	----	1410	----	----	----	----
3-53-07832	210433-1X	-	SPL55	-	-	-	-
3-53-07832	210433-1X	----	SPL55	----	----	----	----
3-53-08000	5008040	3-4-14591-1	1410	-	16-74-101	-	-
3-53-08000	5008040	3-4-14621-1	1410	-	16-74-101	-	-
3-53-08000	5008041	3-4-14591-1	1410	-	16-74-101	-	-
3-53-08000	5008042	3-4-14591-1	1410	-	16-74-101	-	-
3-53-08000	5017206	3-4-14591-1	1410	-	16-74-101	-	-
3-53-08000	5021048	3-4-14591-1	1410	-	16-74-101	-	-
3-53-08000	5008040	3-4-14591-1	1410	----	16-74-101	----	----
3-53-08000	5008041	3-4-14591-1	1410	----	16-74-101	----	----
3-53-08000	5008042	3-4-14591-1	1410	----	16-74-101	----	----
3-53-08000	5008040	3-4-14621-1	1410	----	16-74-101	----	----
3-53-08000	5017206	3-4-14591-1	1410	----	16-74-101	----	----
3-53-08000	5021048	3-4-14591-1	1410	----	16-74-101	----	----
3-53-08002	5006144	-	1410	-	-	-	-
3-53-08002	5006145	-	1410	-	-	-	-
3-53-08002	5007091	-	1410	-	-	-	-
3-53-08002	5008025	-	1410	-	-	-	-
3-53-08002	5008025	-	1410	-	-	-	-
3-53-08002	5008028	-	1410	-	-	-	-
3-53-08002	5017283	-	1410	-	-	-	-
3-53-08002	5017943	-	1410	-	-	-	-
3-53-08002	5008025	----	1410	----	----	----	----
3-53-08002	5008028	----	1410	----	----	----	----
3-53-08002	5007091	----	1410	----	----	----	----
3-53-08002	5006144	----	1410	----	----	----	----
3-53-08002	5006145	----	1410	----	----	----	----
3-53-08002	5008025	----	1410	----	----	----	----
3-53-08002	5017943	----	1410	----	----	----	----
3-53-08002	5017283	----	1410	----	----	----	----
3-53-08003	5007091	-	1410	-	-	-	-
3-53-08003	5008025	-	1410	-	-	-	-
3-53-08003	5008040	-	1480	-	-	-	-
3-53-08003	10015274	-	1480	-	-	-	-
3-53-08003	5008040	----	1480	----	----	----	----
3-53-08003	10015274	----	1480	----	----	----	----
3-53-08003	5008025	----	1410	----	----	----	----
3-53-08003	5007091	----	1410	----	----	----	----
3-53-08004	5007091	-	1480	-	-	-	-
3-53-08004	5008025	-	1480	-	-	-	-
3-53-08004	5017283	-	1480	-	-	-	-
3-53-08004	5008025	----	1480	----	----	----	----
3-53-08004	5007091	----	1480	----	----	----	----
3-53-08004	5017283	----	1480	----	----	----	----
3-53-12525	211359X	-	1410	-	-	-	-
3-53-12525	211499X	-	1350	-	-	-	-
3-53-12525	211359X	----	1410	----	----	----	----
3-53-12525	211499X	----	1350	----	----	----	----
3-53-16017	5008040	5018183	1480	230123-15	16-74-101	-	-

Note: For detail information on Center Bearings, refer to J300P-9A.



Tube Shaft Part Number	Center Bearing Number	End Yoke/ Flange Number	Series	Washer	Nut	Bolt	Cotter Pin
3-53-16017	5017206	5018183	1480	230123-15	16-74-101	-	-
3-53-16017	5017206	5021639	1480	230123-15	16-74-101	-	-
3-53-16017	5022921	5018183	1480	230123-15	16-74-101	-	-
3-53-16017	211966-1X	5018183	1480	230123-15	16-74-101	-	-
3-53-16017	212053-1X	5018183	1480	230123-15	16-74-101	-	-
3-53-16017	211966-1X	5018183	1480	230123-15	16-74-101	----	----
3-53-16017	5008040	5018183	1480	230123-15	16-74-101	----	----
3-53-16017	5017206	5018183	1480	230123-15	16-74-101	----	----
3-53-16017	5017206	5021639	1480	230123-15	16-74-101	----	----
3-53-16017	5022921	5018183	1480	230123-15	16-74-101	----	----
3-53-16017	212053-1X	5018183	1480	230123-15	16-74-101	----	----
3-54-611	210367-1X	3-4-178-1X	1350	-	16-74-101	-	-
3-54-611	210367-1X	3-4-2851X	1410	-	16-74-101	-	-
3-54-611	210367-2X	3-4-178-1X	1350	-	16-74-101	-	-
4-53-61	210084-2X	-	-	-	-	-	-
4-53-61	210207-1X	-	-	-	-	-	-
4-53-91	211118X	47942	1550	-	16-74-101	-	-
4-53-91	211118X	47942	1550	-	16-74-101	-	-
4-53-101	210084-2X	-	-	-	-	-	-
4-53-101	210207-1X	-	-	-	-	-	-
4-53-111	210209-1X	-	1550	-	-	-	-
4-53-131	NO DATA	-	-	-	-	-	-
4-53-261	210084-2X	844170	1550	-	16-74-101	-	-
4-53-261	210084-2X	4-4-4211-1	1550	-	16-74-101	-	-
4-53-271	210084-2X	844170	1550	-	16-74-101	-	-
4-53-271	210084-2X	4-4-4211-1	1550	-	16-74-101	-	-
4-53-301	-	1899721	1550	-	-	-	-
4-53-331	NO DATA	-	-	-	-	-	-
4-53-331	NO DATA	-	-	-	-	-	-
4-53-341	210084-2X	4-4-6031-1	1550	-	231502	-	-
4-53-341	210969-1X	-	1550	-	-	-	-
4-53-341	211064-1X	4-4-6031-1	1550	-	231502	-	-
4-53-341	211064-1X	4-4-6031-1	1550	-	20-74-91	-	-
4-53-341	211084-2X	1169233	1550	-	231502	-	-
4-53-341	211084-2X	1183843	1550	-	231502	-	-
4-53-341	211084-2X	1187495	1550	-	231502	-	-
4-53-341	211084-2X	1202105	1550	-	231502	-	-
4-53-341	211084-2X	1519867	1550	-	231502	-	-
4-53-341	211084-2X	1866846	1550	-	231502	-	-
4-53-341	211084-2X	1870499	1550	-	231502	-	-
4-53-341	211084-2X	1508912	1550	-	231502	-	-
4-53-341	211084-2X	4-4-6031-1	1550	-	231502	-	-
4-53-341	211084-2X	1497982	1550	-	231502	-	-
4-53-341	211423X	1519867	1550	-	231502	-	-
4-53-341	211551X	1150971	1550	-	231502	-	-
4-53-341	211581-1X	1183843	1550	-	231502	-	-
4-53-341	211603-1X	1187495	1550	-	231502	-	-
4-53-341	211603-1X	1202105	1550	-	231502	-	-
4-53-341	211886-1X	4-4-6031-1	1550	-	231502	-	-
4-53-341	211084-2X	4-1-6061	1550	----	231502	----	----
4-53-341	211084-2X	4-4-6031	1550	----	231502	----	----
4-53-341	211084-2X	5-1-6001	1550	----	231502	----	----
4-53-341	211084-2X	4-1-7011	1550	----	231502	----	----
4-53-341	211084-2X	4-1-7021	1550	----	231502	----	----
4-53-341	211423X	4-1-6061	1550	----	231502	----	----
4-53-341	211084-2X	4-4-6031-1	1550	----	231502	----	----
4-53-341	211551X	4-1-5051	1550	----	231502	----	----
4-53-341	211084-2X	4-1-5101	1550	----	231502	----	----
4-53-341	211581-1X	4-1-5141	1550	----	231502	----	----

Note: For detail information on Center Bearings, refer to J300P-9A.



Important: See Safety Information in General Information Section (J300P-GI)

Tube Shaft Part Number	Center Bearing Number	End Yoke/ Flange Number	Series	Washer	Nut	Bolt	Cotter Pin
4-53-341	211084-2X	4-1-5151	1550	----	231502	----	----
4-53-341	211064-1X	4-4-6031-1	1550	----	231502	----	----
4-53-341	211064-1X	4-4-6031-1	1550		20-74-91	----	----
4-53-341	211084-2X	4-1-5191	1550	----	231502	----	----
4-53-341	211603-1X	4-1-5151	1550	----	231502	----	----
4-53-341	211603-1X	4-1-5191	1550	----	231502	----	----
4-53-341	211886-1X	4-4-6031-1	1550	----	231502	----	----
4-53-341	211084-2X	4-1-5141	1550	----	231502	----	----
4-53-341	210969-1X	----	1550	----	----	----	----
4-53-361	210391-1X	55247	1550	-	16-74-101	-	-
4-53-361	210391-1X	4-4-2051-1	1550	-	16-74-101	-	-
4-53-401	210084-2X	844170	1550	-	16-74-101	-	-
4-53-401	210084-2X	4-4-4211-1	1550	-	16-74-101	-	-
4-53-401	210084-2X	4-4-4211-2	1550	-	16-74-101	-	-
4-53-461	4-4-2051-1	-	-	-	-	-	-
4-53-501	232373	4-4-7101-1M	1550	-	-	-	-
4-53-531	210207-1X	-	1480	-	-	-	-
5-53-111	210084-2X	1497982	1610	-	231502	-	-
5-53-111	210084-2X	5-4-1721	1610	-	231502	-	-
5-53-131	210084-2X	5-4-1721	1610	-	231502	-	-
5-53-141	210084-2X	1497982	1610	-	231502	-	-
5-53-141	210084-2X	5-4-1721	1610	-	231502	-	-
5-53-141	210084-2X	5-4-1721-1	1610	-	231502	-	-
5-53-141	210084-2X	77191	1650	-	231502	-	-
5-53-171	NO DATA	-	-	-	-	-	-
5-53-191	210084-2X	1497982	1610	-	231502	-	-
5-53-191	210084-2X	5-4-1721	1610	-	231502	-	-
5-53-191	210084-2X	5-4-1721-1	1610	-	231502	-	-
5-53-231	210121-1X	1030474	1610	-	231502	-	-
5-53-261	210084-2X	5-4-7171-1	1610	-	231502	-	-
5-53-271	210084-2X	5-4-7171-1	1610	-	231502	-	-
5-53-271	210084-2X	90-4-11-1	SPL90	-	231502	-	-
5-53-291	NO DATA						
5-53-291	NO DATA						
5-53-301	231995	4-4-6461-1	1550	-	-	-	-
5-53-301	231995	5-4-8071-1	1610	-	-	-	-
5-53-341	232634	6-4-9161-1M	1710	232374	-	232375	-
5-53-341	232634	6-4-9761-1M	1710	232374	-	232375	-
6-53-151	NO DATA						
6-53-151	NO DATA						
6-53-201	210121-1X	1001283	1710	230123-6	231502	-	-
6-53-201	210121-1X	29741	1710	230123-6	231502	-	-
6-53-201	210881-1X	1001283	1710	230123-6	231502	-	-
6-53-201	210881-1X	29741	1710	230123-6	231502	-	-
6-53-211	211594-1X	6-4-2391-1	1710	230123-6	231502	-	-
6-53-241	210121-1X	29741	1710	230123-6	231502	-	-
6-53-241	210881-1X	29741	1710	230123-6	231502	-	-
6-53-261	-	37046	1710	230123-6	231502	-	-
6-53-271	NO DATA						
6-53-271	NO DATA						
6-53-311	210661-1X	6-4-5071-1X	1710	230123-6	231502	-	-
6-53-311	210661-1X	6-4-5071X	1710	230123-6	231502	-	-
6-53-311	210661-1X	6.3-4-161	1760	230123-6	231502	-	-
6-53-311	210661-1X	6.3-4-161-1	1760	230123-6	231502	-	-
6-53-311	210661-1X	6.5-1-1811	1810	230123-6	231502	-	-
6-53-311	210661-1X	6.5-4-1891	1810	230123-6	231502	-	-
6-53-311	210875-1X	6-4-5071-1X	1710	230123-6	231502	-	-
6-53-311	210875-1X	6-4-5071X	1710	230123-6	231502	-	-
6-53-311	210875-1X	6.3-4-161	1760	230123-6	231502	-	-

Note: For detail information on Center Bearings, refer to J300P-9A.



Tube Shaft Part Number	Center Bearing Number	End Yoke/ Flange Number	Series	Washer	Nut	Bolt	Cotter Pin
6-53-311	210875-1X	6.3-4-161-1	1760	230123-6	231502	-	-
6-53-311	210875-1X	6.5-1-1811	1810	230123-6	231502	-	-
6-53-311	210875-1X	6.5-4-1891	1810	230123-6	231502	-	-
6-53-331	-	106442	1710	-	500898J	-	-
6-53-411	210121-1X	1914392	1710	230123-6	231502	-	-
6-53-411	210121-1X	6-4-7141-1	1710	230123-6	231502	-	-
6-53-421	210121-1X	1914392	1710	230123-6	231502	-	-
6-53-421	210121-1X	6-4-7141-1	1710	230123-6	231502	-	-
6-53-471	210121-1X	6-4-5071X	1710	230123-6	231502	-	-
6.3-53-21	210661-1X	6-4-7481-1	1710	-	231502	-	-
6.3-53-21	210661-1X	6.3-4-821-1	1760	-	231502	-	-
6.5-53-21	210661-1X	6.5-4-1891	1810	230123-6	231502	-	-
6.5-53-21	210661-1X	6.5-4-1891-1	1810	230123-6	231502	-	-
6.5-53-21	210875-1X	6.5-4-1891	1810	230123-6	231502	-	-
6.5-53-21	210875-1X	6.5-4-1891-1	1810	230123-6	231502	-	-
6.5-53-51	210661-1X	6.5-4-1891	1810	230123-6	231502	-	-
6.5-53-51	210661-1X	6.5-4-1891-1	1810	230123-6	231502	-	-
6.5-53-51	210661-1X	8-4-851 (WB)	1880	230123-6	231502	-	-
6.5-53-51	210875-1X	6.5-4-1891-1	1760	230123-6	231502	-	-
6.5-53-51	210875-1X	6.5-1-1811	1810	230123-6	231502	-	-
6.5-53-91	210661-1X	6-4-5071-1X	1710	230123-6	20-74-91	-	-
6.5-53-91	210661-1X	6-4-5071X	1710	230123-6	20-74-91	-	-
6.5-53-91	210661-1X	6.5-1-1811	1810	230123-6	20-74-91	-	-
6.5-53-91	210661-1X	6.5-4-1891	1810	230123-6	20-74-91	-	-
6.5-53-91	210661-1X	6.5-4-1891-1	1810	230123-6	20-74-91	-	-
6.5-53-91	210661-1X	8-4-851(WB)	1810	230123-6	20-74-91	-	-
6.5-53-91	210875-1X	6-4-5071-1X	1710	230123-6	20-74-91	-	-
6.5-53-91	210875-1X	6-4-5071X	1710	230123-6	20-74-91	-	-
6.5-53-91	210875-1X	6.3-4-161	1760	230123-6	231502	-	-
6.5-53-91	210875-1X	6.3-4-161-1	1760	230123-6	231502	-	-
6.5-53-91	210875-1X	6.5-1-1811	1810	230123-6	231502	-	-
6.5-53-91	210875-1X	6.5-4-1891	1810	230123-6	231502	-	-
6.5-53-91	210875-1X	6.5-4-1891-1	1810	230123-6	231502	-	-
6.5-53-91	210875-1X	8-4-851(WB)	1810	230123-6	231502	-	-
6.5-53-111	-	6.5-4-2151	1810	231296	231297	-	-
6.5-53-171	210661-1X	6.5-4-3591-1	1810	230123-6	231502	-	-
6.5-53-171	210875-1X	6.3-4-821-1	1760	230123-6	20-74-91	-	-
6.5-53-181	210661-1X	6.5-4-3591-1	1810	230123-6	231502	-	-
6.5-53-181	210875-1X	6.5-4-3591-1	1810	230123-6	20-74-91	-	-
6.5-53-191	210661-1X	6.3-1-25	1810	230123-6	20-74-91	-	-
6.5-53-201	212037-1X	6.5-4-4771-1	1810	230123-6	20-74-91	-	-
6.5-53-201	212037-1X	6.5-4-4771-1	1810	230123-6	20-74-91	----	----
8-53-41	211759-1X	6.5-4-2131	1810	230123-6	231502	-	-
8-53-61	210748-1X	8-4-351	1880	230123-7	24-74-21	-	500024-16
55-53-11	212028-1X	-	-	-	-	-	-
55-53-11	212031-1X	-	-	-	-	-	-
55-53-11	212032-1X	-	-	-	-	-	-
55-53-11	212144-1X	-	-	-	-	-	-
55-53-21	212031-1X	-	-	-	-	-	-
55-53-21	212144-1X	-	-	-	-	-	-
55-53-31	212031-1X	-	-	-	-	-	-
55-53-41	212031X	55-4-11-1	SPL55	230123-15	16-74-101	-	-
55-53-51	212031-1X	-	SPL55	-	-	-	-
70-53-11	211963-1X	-	-	-	-	-	-
70-53-11	212135-1X	-	-	-	-	-	-
70-53-11	212145-1X	-	-	-	-	-	-
70-53-21	212135-1X	-	-	-	-	-	-
70-53-31	212134-1X	70-4-11-1	SPL70	230123-6	20-74-91	-	-
70-53-31	212145X	70-4-11-1	SPL70	230123-6	20-74-91	-	-
70-53-51	212135-1X	-	-	-	-	-	-

Note: For detail information on Center Bearings, refer to J300P-9A.



Important: See Safety Information in General Information Section (J300P-GI)

Tube Shaft Part Number	Center Bearing Number	End Yoke/ Flange Number	Series	Washer	Nut	Bolt	Cotter Pin
70-53-61	212134-1X	70-4-11-1	SPL70	230123-6	20-74-91	-	-
70-53-61	212261-1X	70-4-11-1	SPL70	230123-6	20-74-91	-	-
70-53-81	232373	-	SPL70	-	-	-	-
70-53-81	232373	----	SPL70	----	----	----	----
90-53-11	210084-2X	90-4-11-1	SPL90	-	231502	-	-
90-53-21	211625-1X	-	-	-	-	-	-
90-53-31	210084-2X	90-4-11-1	SPL90	-	231502	-	-
90-53-41	211625-1X	-	-	-	-	-	-
100-53-11	212142-1X	-	-	-	-	-	-
100-53-21	212142-1X	-	-	-	-	-	-
100-53-21	212153-1X	-	-	-	-	-	-
100-53-31	5010885	5007266	SPL70	230123-6	20-74-91	-	-
100-53-31	5010885	5009493	SPL70	230123-6	20-74-91	-	-
100-53-31	212145X	100-4-931-1	SPL100	230123-6	20-74-91	-	-
100-53-31	212261-1X	100-4-931-1M	SPL100	230123-6	20-74-91	-	-
100-53-31	212261-1X	100-4-931-1	SPL100	230123-6	20-74-91	-	-
100-53-31	212261-1X	100-4-931-1	SPL100	230123-6	20-74-91	----	----
100-53-31	212145X	100-4-931-1	SPL100	230123-6	20-74-91	----	----
100-53-31	5010885	5007266	SPL70	230123-6	20-74-91	----	----
100-53-31	5010885	5009493	SPL70	230123-6	20-74-91	----	----
100-53-31	212261-1X	100-4-931-1M	SPL100	230123-6	20-74-91	----	----
140-53-11	210121-1X	140-4-11-1	SPL140	230123-6	250-74-11	-	-
140-53-11	210881-1X	140-4-11-1	SPL140	230123-6	250-74-11	-	-
140-53-11	212156-1X	140-4-11-1	SPL140	230123-6	250-74-11	-	-
140-53-21	210661-1X	140-4-1011-1	SPL140	230123-6	250-74-11	-	-
140-53-21	210875-1X	140-4-1011-1	SPL140	230123-6	250-74-11	-	-
140-53-31	210121-1X	140-4-11-1	SPL140	230123-6	250-74-11	-	-
140-53-41	210121-1X	140-1-15	SPL140	230123-6	250-74-11	-	-
140-53-41	210881-1X	140-1-15	SPL140	230123-6	250-74-11	-	-
140-53-41	210881-1X	140-1-25	SPL140	230123-6	250-74-11	-	-
250-53-11	210661-1X	170-4-1271-1	SPL170	230123-6	250-74-11	-	-
250-53-11	210661-1X	250-1-15	SPL250	230123-6	250-74-11	-	-
250-53-11	210661-1X	250-4-21-1	SPL250	230123-6	250-74-11	-	-
250-53-11	210875-1X	250-1-11	SPL250	230123-6	250-74-11	-	-
250-53-11	210875-1X	250-1-15	SPL250	230123-6	250-74-11	-	-
250-53-11	210875-1X	250-4-21-1	SPL250	230123-6	250-74-11	-	-
250-53-11	212066-1X	250-4-21-1	SPL250	230123-6	250-74-11	-	-
350-53-23770	350CB0001X	350-4-11-1	SPL350	-	5023806	-	-
350-53-23770	350CB0001X	350-4-11-1	SPL350	----	5023806	----	----
5002332	5002334	5002008	1330	230123-14	10-74-101	-	-
5002332	5006628	5006147	1350	230123-14	10-74-101	-	-
5002332	5013838	5006147	1350	230123-14	10-74-101	-	-
5002332	5013853	5006147	1350	230123-14	10-74-101	-	-
5002332	5013937	5006147	1350	230123-14	10-74-101	-	-
5002332	211750-1X	5002008	1330	230123-14	10-74-101	-	-
5002332	5002334	5002008	1330	230123-14	10-74-101	----	----
5002332	211750-1X	5002008	1330	230123-14	10-74-101	----	----
5002332	5006628	5006147	1350	230123-14	10-74-101	----	----
5002332	5013853	5006147	1350	230123-14	10-74-101	----	----
5002332	5013937	5006147	1350	230123-14	10-74-101	----	----
5002332	5013838	5006147	1350	230123-14	10-74-101	----	----
5002410	212258-1X	-	1350	-	-	-	-

Note: For detail information on Center Bearings, refer to J300P-9A.



1-42-101	4	2-40-2801	5	3-40-1501	6	3-53-1891	9
1-42-31	4	2-40-2811	5	3-40-1511	5	3-53-191	9
2-40-01918	4	2-40-2841	4	3-40-1521	5	3-53-1951	13
2-40-01930	4	2-40-2851	4	3-40-1531	5	3-53-1981	13
2-40-02972	4	2-40-2871	5	3-40-1551	6	3-53-1991	12
2-40-1031	4	2-40-2891	5	3-40-1571	6	3-53-2011	13
2-40-1041	4	2-40-2941	5	3-40-1611	5	3-53-2061	9
2-40-1071	4	2-40-971	4	3-40-1621	5	3-53-211	12
2-40-1131	5	2-42-581	4	3-40-1871	6	3-53-2181	13
2-40-1211	5	2-53-01931	8	3-40-1911	5	3-53-2281	13
2-40-1221	5	2-53-03448	12	3-40-1961	5	3-53-2291	13
2-40-1291	5	2-53-1011	8	3-40-2071	5	3-53-2301	9
2-40-1521	5	2-53-1051	8	3-40-2091	6	3-53-2321	9
2-40-1531	5	2-53-1071	8	3-40-2171	6	3-53-2371X	9
2-40-1671	5	2-53-1131	12	3-40-2181	5	3-53-2381	13
2-40-1701	4	2-53-1151	9	3-40-2241	5	3-53-2441	13
2-40-1711	5	2-53-1161	8	3-40-481	5	3-53-2451	13
2-40-1741	4	2-53-1191	9	3-42-451	5	3-53-2541	9
2-40-1771	4	2-53-121	12	3-53-02255	13	3-53-2561	14
2-40-1811	5	2-53-1211	9	3-53-02410	13	3-53-2571	14
2-40-1841	4	2-53-1311	8	3-53-06154	8	3-53-2591	13
2-40-1851	5	2-53-1321	8	3-53-07287	13	3-53-411	14
2-40-1871	5	2-53-1331	8	3-53-07832	14	3-53-421	9
2-40-2021	4	2-53-1351	8	3-53-08000	9	3-53-441	14
2-40-2041	5	2-53-1411	9	3-53-08002	13	3-53-451	14
2-40-2051	5	2-53-1441	12	3-53-08003	14	3-54-611	9
2-40-2091	5	2-53-1511	12	3-53-08004	14	4-40-1011	6
2-40-2211	4	2-53-1561	8	3-53-1031	13	4-40-1021	6
2-40-2221	4	2-53-1571	8	3-53-1041	13	4-40-1031	6
2-40-2231	5	2-53-1651	8	3-53-1121	13	4-40-1061	6
2-40-2241	4	2-53-471	12	3-53-1131	13	4-40-721	6
2-40-2301	4	2-53-491	12	3-53-1181	12	4-40-741	6
2-40-2361	5	2-53-501	12	3-53-1191	14	4-40-761	6
2-40-2381	4	2-53-511	12	3-53-12525	13	4-40-781	6
2-40-2421	5	2-53-531	12	3-53-1301	12	4-40-821	6
2-40-2441	4	2-53-681	12	3-53-1311	14	4-40-891	7
2-40-2451	4	2-53-691	12	3-53-1351	12	4-40-951	6
2-40-2461	5	2-53-711	12	3-53-1361	12	4-40-961	6
2-40-2481	4	2-53-901	8	3-53-1371	12	4-40-981	6
2-40-2501	5	2-53-921	12	3-53-1381	12	4-40-991	6
2-40-2531	5	2-54-351X	8	3-53-1481	13	4-53-101	14
2-40-2611	5	2-54-361	8	3-53-1531	13	4-53-271	9
2-40-2631	5	3-40-1101	5	3-53-1551	13	4-53-301	11
2-40-2661	4	3-40-1281	6	3-53-16017	9	4-53-331	10
2-40-2671	5	3-40-1381	6	3-53-1781	9	4-53-351	9
2-40-2681	4	3-40-1411	6	3-53-1791	9	4-53-361	9
2-40-2691	5	3-40-1421	5	3-53-1801	9	4-53-401	9
2-40-2761	5	3-40-1431	5	3-53-1811	9	4-53-501	10
2-40-2781	4	3-40-1471	5	3-53-1821	9	4-53-531	14
2-40-2791	4	3-40-1491	6	3-53-1831	9	4-53-61	14



5-40-10117	6.5-40-2017	140-53-1110
5-40-10317	6.5-40-2517	140-53-2111
5-40-10417	6.5-53-111.....11	140-53-3110
5-40-10517	6.5-53-17111	140-53-4110
5-40-11017	6.5-53-18111	250-53-1111
5-40-11217	6.5-53-20111	350-53-2377011
5-40-11517	6.5-53-2111	5001918.....4
5-40-11817	6.5-53-5111	5001930.....4
5-40-11917	6.5-53-9111	5001931.....8
5-40-12417	8-40-1017	5002255.....13
5-40-13417	8-40-917	5002332.....8
5-40-4517	8-53-6111	5002410.....13
5-40-4717	10-40-114	5002972.....4
5-40-4917	10-53-18X.....8	5003448.....12
5-40-5017	27-40-314	5007287.....13
5-53-111.....9	55-40-116	5007289.....5
5-53-1419	55-40-21X.....6	5007832.....14
5-53-1919	55-40-41X.....6	5008000.....9
5-53-26110	55-40-61X.....6	5008002.....13
5-53-27110	55-40-716	5008003.....14
5-53-29110	55-40-81X.....6	5008004.....14
5-53-33115	55-53-1019	5012525.....13
6-40-111.....7	55-53-1114	5016017.....9
6-40-1817	55-53-2114	5023770.....11
6-40-517	55-53-3114	
6-40-5217	55-53-5114	
6-40-5417	70-40-116	
6-40-617	70-40-21X.....6	
6-40-6217	70-40-41X.....6	
6-40-6317	70-40-716	
6-40-7017	70-40-81X.....6	
6-40-7117	70-53-1115	
6-40-7417	70-53-2115	
6-40-8217	70-53-3110	
6-40-8517	70-53-5115	
6-53-15110	70-53-6110	
6-53-20110	70-53-8115	
6-53-21110	90-40-117	
6-53-24110	90-40-217	
6-53-26110	90-40-417	
6-53-27111	90-53-1110	
6-53-31111	90-53-2115	
6-53-33110	90-53-3110	
6-53-37111	90-53-4115	
6-53-41110	100-40-21X.....6	
6-53-42110	100-40-316	
6C-40-21X.....7	100-40-41X7	
6.3-53-2111	100-53-1115	
6.5-40-1417	100-53-2115	
6.5-40-1917	100-53-3110	