

SPICER[®]
DRIVETRAIN PRODUCTS

SPICER[®] AXLE

MAINTENANCE MANUAL

MODEL

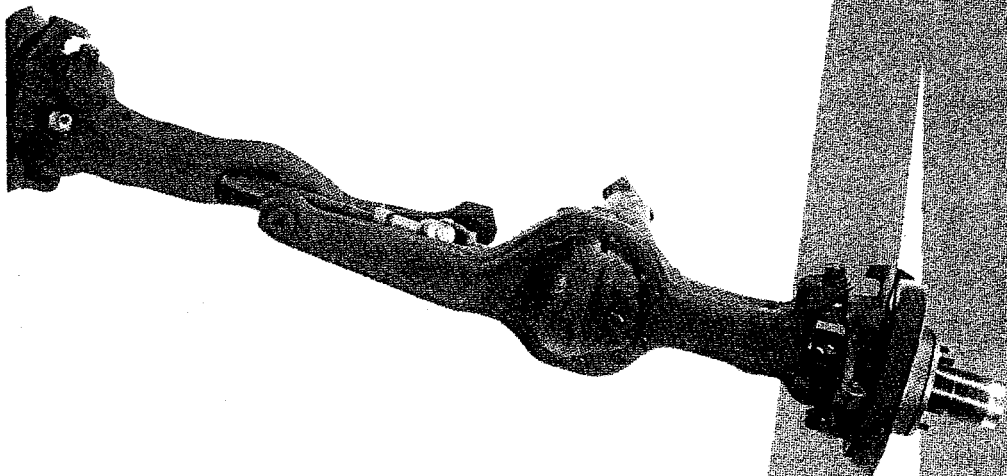

**INDEPENDENT
FRONT SUSPENSION**

INDEX

| | Page |
|--|------|
| LUBRICATION | 3 |
| IDENTIFICATION OF SERVICE TOOLS | 4 |
| IDENTIFICATION OF AXLE ASSEMBLY COMPONENTS | 5 |
| AXLE IDENTIFICATION | 6 |
| DISASSEMBLY OF WHEEL ENDS | 7 |
| SERVICING DIFFERENTIAL YOKE SHAFT BEARING | 13 |
| LUBRICATING UNIT BEARING | 15 |
| CARRIER SECTION | 19 |

IMPORTANT SAFETY NOTICE

Proper service and repair is important to the safe, reliable operation of all motor vehicles or driving axles whether they be front or rear. The service procedures recommended and described in this service manual are effective methods for performing service operations. Some of these service operations require the use of tools specially designed for the purpose. The special tool should be used when and as recommended.

It is impossible to know, evaluate, and advise the service trade of all conceivable ways in which service might be done or of the possible hazardous consequences of each way.

Accordingly, anyone who uses a service procedure or tool which is not recommended must first satisfy himself thoroughly that neither his safety nor vehicle safety will be jeopardized by the service methods he selects.

Should an axle assembly require component parts replacement, it is recommended that "Original Equipment" replacement parts be used. They may be obtained through your local service dealer or other original equipment manufacturer parts supplier. The use of non-original equipment replacement parts is not recommended as their use may cause unit failure and/or affect vehicle safety.

LUBRICATION

It is not our intent to recommend any particular brand or make of lubricant for the Spicer hypoid axles. However, a S.A.E. 90 weight multipurpose gear lubricant meeting Mil. Spec. L-2105-B, or 80W90 multipurpose gear lubricant meeting Mil. Spec. L-2105-C, and suitable for A.P.I. Service Classification GL-5 is suggested as a minimum requirement.

COLD WEATHER OPERATION

If the vehicle is operated below 0°F. (-18°C.), it is advisable to use S.A.E. 80 multipurpose gear lubricant meeting Mil. Spec. L-2105-B and suitable for A.P.I. Service Classification GL-5.

IMPORTANT

As special equipment, limited slip differentials are provided in many vehicles. The freedom from "chatter" is a function of the lubricant used and cannot be covered in the above specification. In some applications, a special limited slip differential lubricant may be required. If required, these special lubricants are normally available through equipment manufacturer.

WHEEL BEARING LUBRICATION

Wheel bearings are lubricated by packing the bearing with grease. It is recommended that a number 2 consistency, lithium base 12-hydroxy stearate grease containing an E.P. additive be used.

NOTE

We suggest that wheel bearing lubricants selected for use with disc brake applications, in addition to the E.P. properties expressed in this Manual, should be compatible with elevated temperatures, i.e., high temperature lubricant. For specified wheel bearing lubricant, refer to vehicle Service Manual.

SUBMERSION OR DEEP WATER FORDING

If the vehicle is exposed to water deep enough to cover the hubs of the front axle, it is recommended that the wheel ends be disassembled and inspected for water damage, and/or contamination daily.

Clean, examine, and if necessary, replace damaged parts, prior to relubricating and assembling the wheel end components. Pay particular attention to the bearings.

In the event the gear carrier housing should become submerged in water, particularly if over the breathers, it is recommended that the hypoid gear lubricant be drained daily and internal parts be inspected for water damage and/or contamination.

Clean, examine, and if necessary, replace damaged parts, prior to assembling and refilling with the specified hypoid lubricant.

NOTE

It is recommended that whenever bearings are removed they are to be replaced with new ones, regardless of mileage.

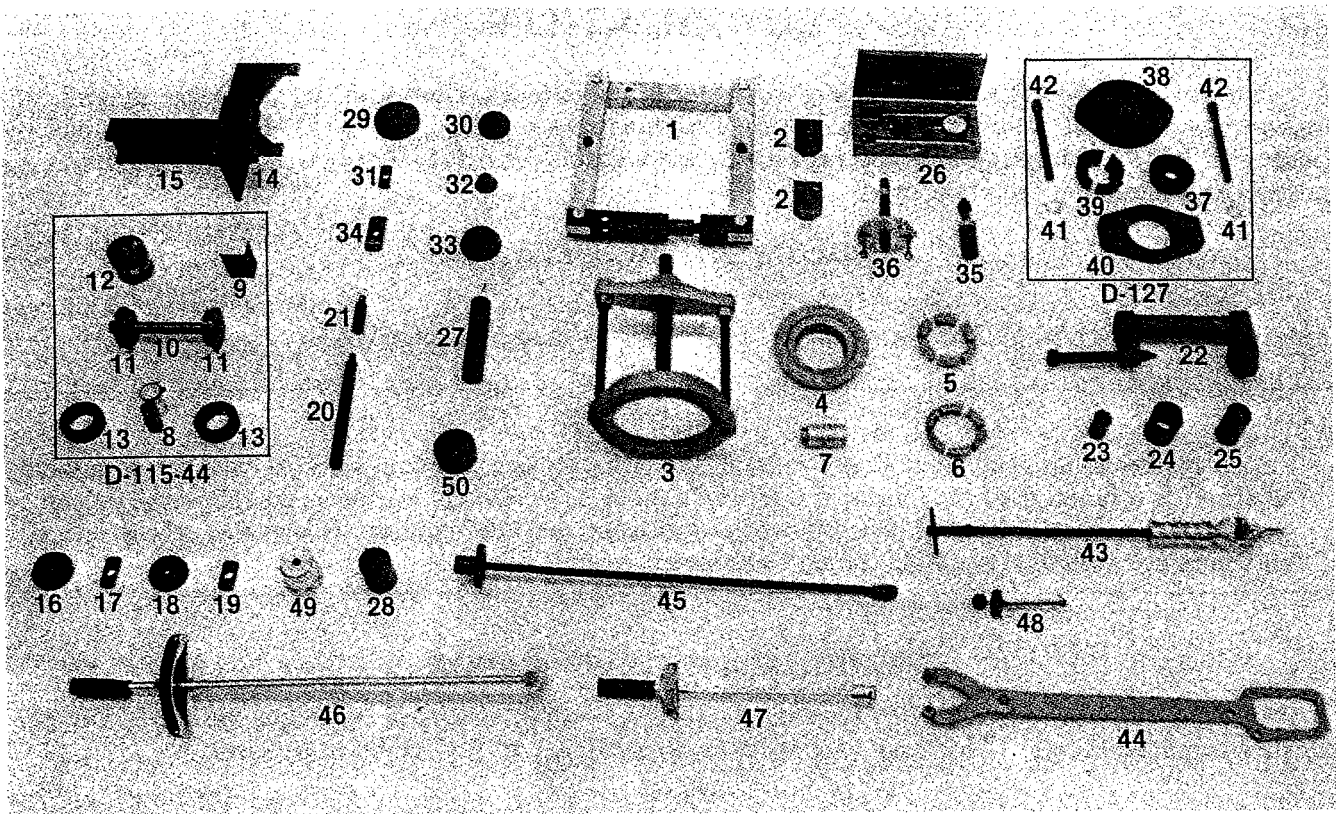

Figure 2

1020-2

The following is a detailed list of all special tools required to service the Spicer Model 44 Independent Front Suspension Axle Assembly.

| Item No. | Tool No. | Description | Item No. | Tool No. | Description |
|----------|----------|--|----------|----------|--|
| 1 | D-113 | Spreader | 14 | D-245 | Supporting Fixture |
| 2 | D-227 | Spreader Adapters | 15 | D-246 | Vise Adapter — Supporting Fixture |
| 3 | DD-914-P | Press | 16 | D-145 | Installer — Inner Pinion Bearing Cup |
| 4 | DD-914-9 | Adapter Ring | 17 | D-148 | Remover — Inner Pinion Bearing Cup |
| 5 | C-293-39 | Adapter Set — Rear Pinion Bearing Cone | 18 | D-144 | Installer — Outer Pinion Bearing Cup |
| 6 | C-293-18 | Adapter Set — Differential Bearing Cones | 19 | D-147 | Remover — Outer Pinion Bearing Cup |
| 7 | C-293-3 | Adapter Plug — Differential Hub | *8 | D-115 | Scooter Gauge (D-115-2 Scooter Block and D-106-5 Dial Indicator) |
| *9 | D-115-1 | Pinion Height Block | 20 | C-4171 | Handle — Universal |
| *10 | D-115-3 | Arbor | 21 | C-4291 | Extension — Universal |
| *11 | D-115-4 | Arbor Discs | **22 | D-150-1 | Remover & Installer — Front Axle Ball Joint |
| *12 | D-139 | Master Pinion Block | **23 | D-150-2 | Adapter — Ball Joint Removing |
| *13 | D-135 | Master Differential Bearing | **24 | D-150-3 | Sleeve — Ball Joint Removing |

| Item No. | Tool No. | Description | Item No. | Tool No. | Description |
|----------|----------|--|--|----------|---|
| **25 | D-150-4 | Sleeve — Ball Joint Installing | ***42 | SP-5026 | Screws |
| 26 | D-128 | Dial Indicator Set | 43 | D-131 | Puller — Slide Hammer |
| 27 | W-262 | Installer — Inner Pinion Bearing Cone | 44 | C-3281 | Wrench — Flange or Yoke |
| 28 | C-4170-A | Wrench — Wheel Bearing Adjusting Nut | 45 | D-249-A | Installer — Inner Axle Shaft Seal |
| 29 | D-155 | Installer — Front Brake Hub Grease Seal | 46 | C-4053 | Torque Wrench (300 Ft.Lb.) |
| 30 | D-140 | Installer — Front Brake Hub Outer Bearing Cup | 47 | C-3952-A | Torque Wrench (150 Ft.Lb.) |
| 31 | D-259 | Remover — Front Brake Hub Outer Bearing Cup | 48 | D-193 | Torque Wrench (50 In.Lb.) |
| 32 | D-122 | Installer — Front Spindle Needle Bearing | 49 | W-147-D | Installer — Pinion Oil Seal |
| 33 | D-154 | Installer — Front Brake Hub Inner Bearing Cup | 50 | D-156 | Installer — Differential Side Bearings |
| 34 | D-260 | Remover — Front Brake Hub Inner Bearing Cup | <p>*Pinion Setting Gauge and Master Differential Bearing Kit D-115-44</p> <p>**40 Degree Steer Front Ball Joint Removing and Installing Kit D-150</p> <p>***Axle Shaft Bearing Removing and Installing Kit D-127</p> | | |
| 35 | W-162-D | Installer — Flange or Yoke | | | |
| 36 | C-452 | Remover — Flange or Yoke | | | |
| ***37 | D-127-1 | Installing Ring — Bearing | | | |
| ***38 | D-127-2 | Flange Plate — Axle | | | |
| ***39 | D-127-3 | Adapters Removal | | | |
| ***40 | D-127-4 | Forcing Plate | | | |
| ***41 | SP-3020 | Washers | | | |

NOTE

Torque Wrenches C-4053, C-3952-A and D-193 are optional and can be purchased separately.

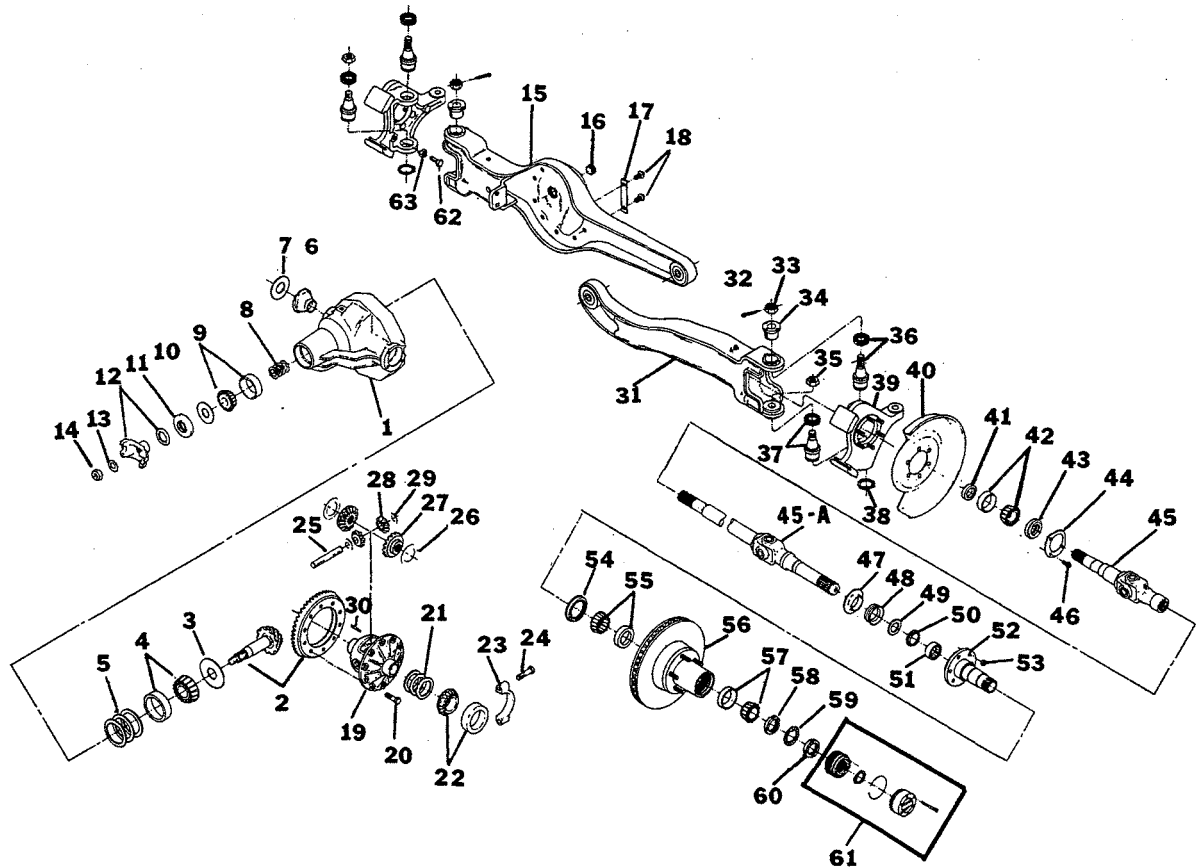

Figure 3

Arrangement of components

| ITEM | DESCRIPTION | ITEM | DESCRIPTION |
|------|---|------|---------------------------------------|
| 1 | Carrier | 33 | Slotted Nut |
| 2 | Drive Gear and Drive Pinion Assembly | 34 | Camber Adjuster |
| 3 | Slinger-Oil (Drive Pinion) | 35 | Locknut |
| 4 | Inner Pinion Bearing (Cup and Cone) | 36 | Upper Socket Assembly |
| 5 | Pinion Position Shims | 37 | Lower Socket Assembly |
| 6 | Oil Seal | 38 | Snap Ring |
| 7 | Dust Slinger | 39 | Steering Knuckle |
| 8 | Pinion Bearing Preload Shims | 40 | Brake Splash Shield |
| 9 | Outer Pinion Bearing (Cup and Cone) | 41 | Bearing Retaining Ring |
| 10 | Pinion Oil Seal Slinger (Outer) | 42 | Unit Bearing |
| 11 | Pinion Oil Seal | 43 | Oil Seal |
| 12 | End Yoke Assembly (End Yoke and Dust Shield) | 44 | Retainer Plate |
| 13 | Washer | 45 | Shaft Assembly and Slip Yoke Assembly |
| 14 | Pinion Nut | 45-A | Outer Shaft and Joint Assembly |
| 15 | Left Hand Support Arm | 46 | Retainer Plate Screws |
| 16 | Fill Plug | 47 | Dust Shield |
| 17 | Axle Identification Tag | 48 | Oil Seal |
| 18 | Cover Screws | 49 | Wheel Bearing Spindle Spacer |
| 19 | Differential Case | 50 | Grease Seal (Spindle) |
| 20 | Ring Gear Screws | 51 | Needle Bearing (Spindle) |
| 21 | Differential Bearing Preload and Backlash Shims | 52 | Spindle |
| 22 | Differential Bearing (Cup and Cone) | 53 | Nut (Spindle Retaining) |
| 23 | Differential Bearing Cap | 54 | Grease Seal (Hub) |
| 24 | Differential Bearing Cap Screw | 55 | Inner Wheel Bearing (Cone and Cup) |
| 25 | Differential Cross Shaft | 56 | Hub and Rotor |
| 26 | Differential Side Gear Thrust Washer | 57 | Outer Wheel Bearing (Cone and Cup) |
| 27 | Differential Side Gear | 58 | Wheel Bearing Adjusting Nut (Inner) |
| 28 | Differential Pinion Mate | 59 | Wheel Bearing Nut Lock Washer |
| 29 | Differential Pinion Mate Thrust Washer | 60 | Wheel Bearing Adjusting Nut (Outer) |
| 30 | Roll Pin | 61 | Hub Lok Assembly |
| 31 | Right Hand Support Arm | 62 | Stop Bolt (Steering) |
| 32 | Cotter Key | 63 | Nut (Stop Bolt) |

AXLE IDENTIFICATION

All Spicer Model 44 Independent Front Suspension axles are identified with a manufacturing date and complete part number, which are stamped on the left hand support arm in an area between the fill plug and wheel end.

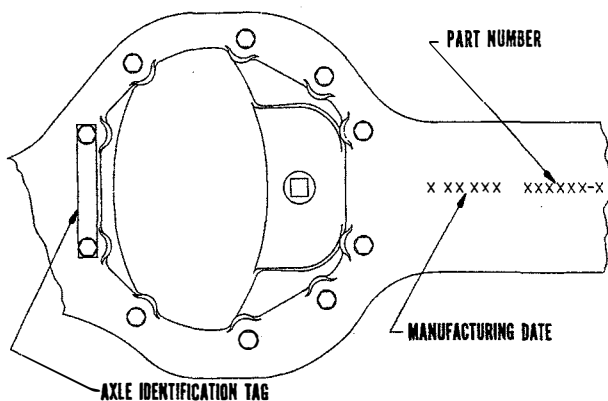

In this figure, the axle is identified with 1/8" (3.17mm) high stamped characters. For example: The manufacturing date or build date of the axle is interpreted as follows: The first number is the month, second number is the day of the month, the third number is year, the letter is the shift, and the last number is the line that built the axle. The next number is the part number. The digits reading from left to right is the basic number for identifying the particular axle assembly. The digit following the dash will identify ratio, differential, and end yoke options used in the assembly. The axle identification tag is required by the vehicle manufacturer, and provides their corresponding identification of the axle to the Dana Spicer part number. If the axle is equipped with limited slip differential, the axle identification tag will have the letters LS following the part number. Refer to the lubrication section of this manual for lubricant requirements involving limited slip differentials.

Figure 4

1020-4

NOTE

In the event there are two build dates, the latter will be the date in which the brake components were assembled. The number stamped next to the manufacturing date is the complete axle assembly part number.

It is recommended that when referring to the axle, obtain the complete part number, and build date. To do this, it may be necessary to wipe or scrape off the dirt, etc., from the support arm.

DISASSEMBLY OF WHEEL ENDS

Follow the Vehicle Manufacturer's recommendations for the removal of the tire and rim, brake caliper and hub-lock assembly.

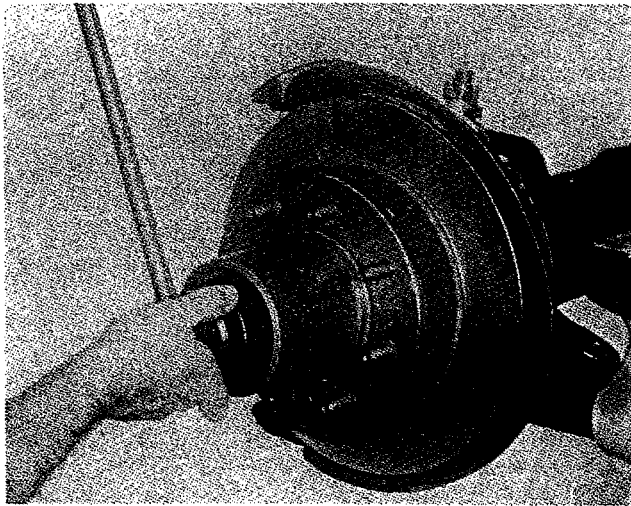

Figure 5

1020-5

Remove the outer lock nut, lock nut washer, and the inner wheel bearing adjusting nut.

Tool: C-4170-A Wheel Bearing Lock Nut Adjusting Wrench.

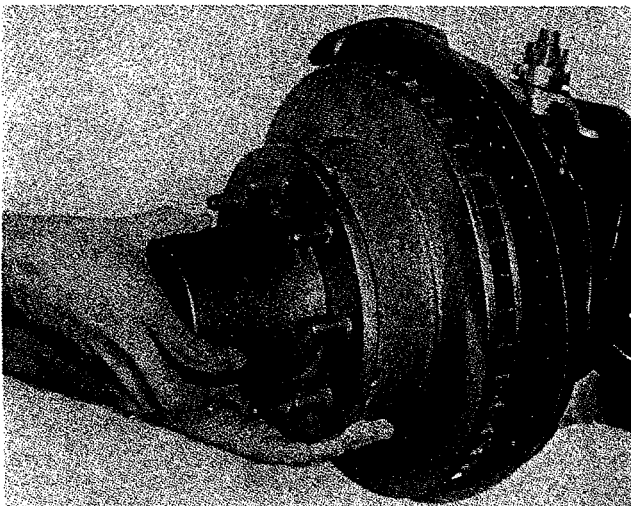

Figure 6

1020-6

Remove hub and rotor assembly. Outer wheel bearing cone will slide out as rotor is removed.

NOTE

If it is necessary to replace brake components, refer to vehicle service manual.

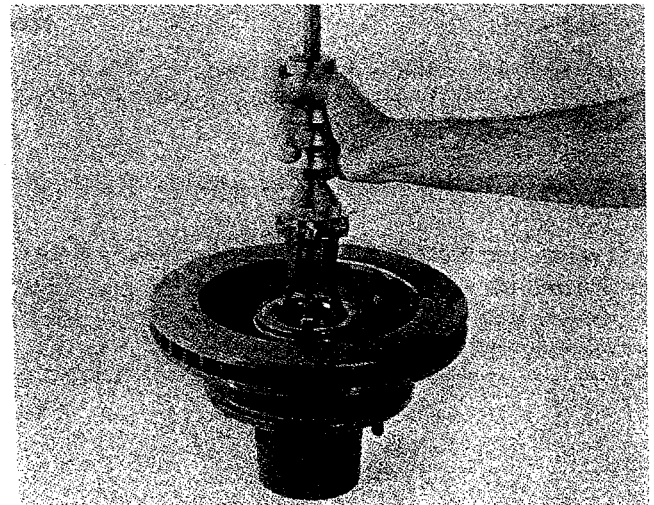

Figure 7

1020-7

Remove grease seal and inner bearing cone. Discard seal and replace with new one at time of assembly.

Tool: D-131 Slide Hammer

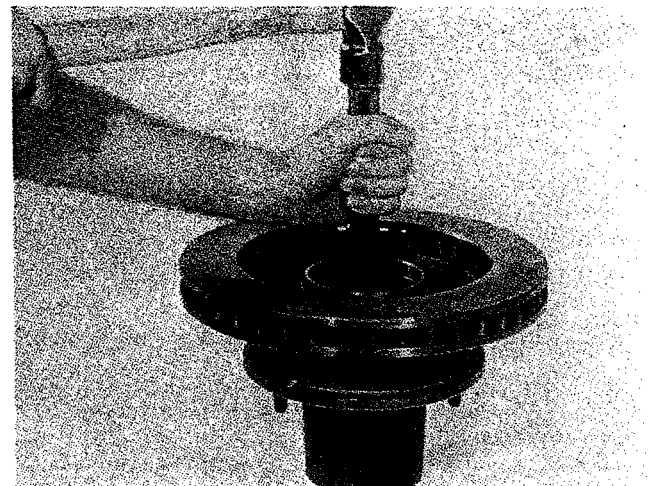

Figure 8

1020-8

Remove outer wheel bearing cup.

Tools: D-259 Bearing Cup Remover, C-4171 Handle.



Figure 9 1020-9

Remove inner wheel bearing cup.
Tools: D-260 Bearing Cup Remover, C-4171 Handle.

NOTE

The bearing bores must be free of nicks and burrs. Clean grease and dirt from hub and bearing bores with a standard metal cleaning solvent.



Figure 11 1020-11

Assemble inner wheel bearing cup.
Tools: D-154 Installer, C-4171 Handle.
Distribute a sufficient amount of grease inside the hub between the bearing cups. Pack inner bearing cone full with the specified grease. Wipe the excess grease around the rollers. Assemble inner wheel bearing cone into cup.

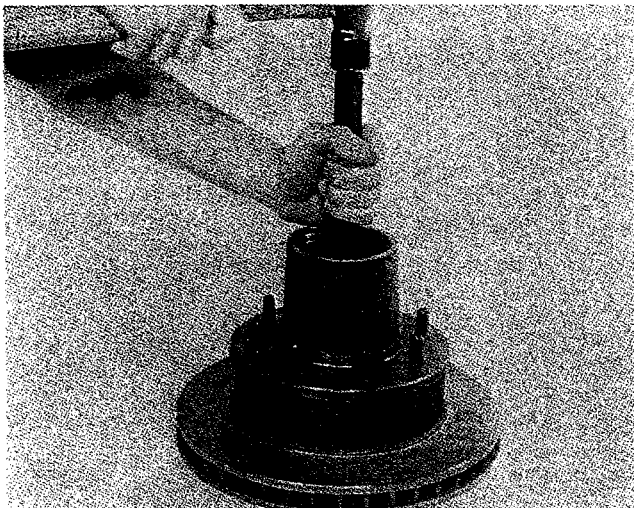

Figure 10 1020-10

Assemble outer wheel bearing cup.
Tools: D-140 Installer, C-4171 Handle.



Figure 12 1020-12

Assemble new grease seal. Apply a small amount of grease around lip of seal.
Tools: D-155 Seal Installer, C-4171 Handle.

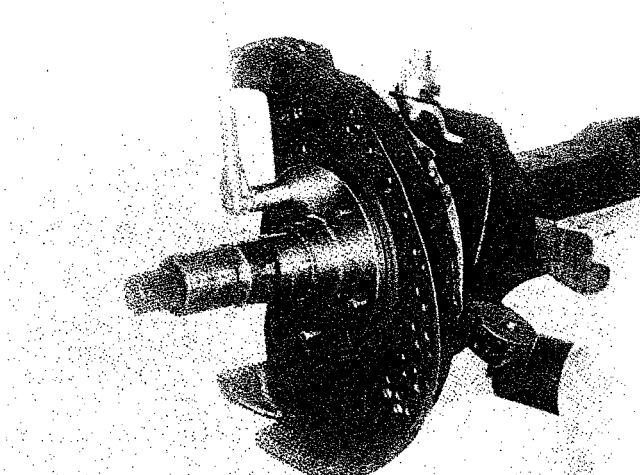

Figure 13

1020-13

Remove spindle nuts.

NOTE

If the nuts are of the torque prevailing design, they are to be replaced with new ones.

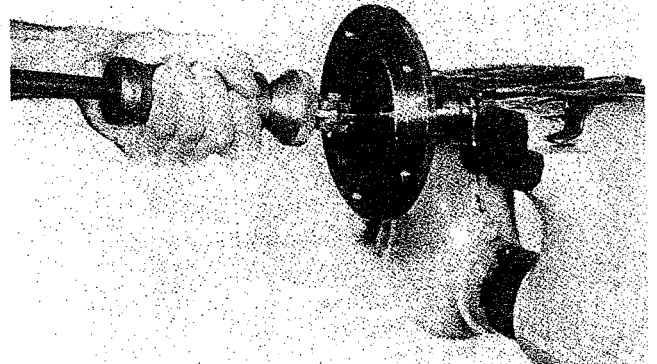

Figure 15

1020-15

Place spindle in a vise. Do not locate on bearing diameters or threads.

Remove the oil seal.

Remove the axle shaft needle bearing as shown in Figure 15.

Tool: D-131 Slide Hammer.

If the tie rod has not been removed, do so at this time following vehicle manufacturer's recommendations.

Remove shaft and joint assemblies. Plastic slinger will come out with left hand assembly. Right hand assembly will separate at the slip yoke.

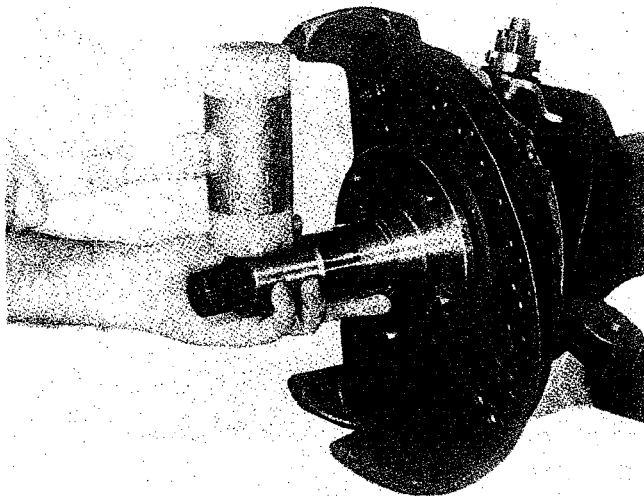

Figure 14

1020-14

Remove spindle. Tap lightly with a rawhide or heavy duty plastic hammer to break the spindle loose from the knuckle. Remove disc brake splash shield.

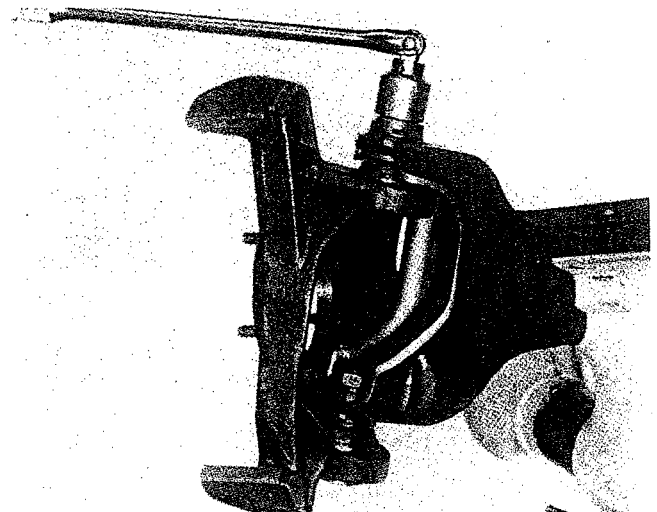

Figure 16

1020-16

Remove cotter key from top socket. Loosen both the top and bottom nuts. Remove the top nut.

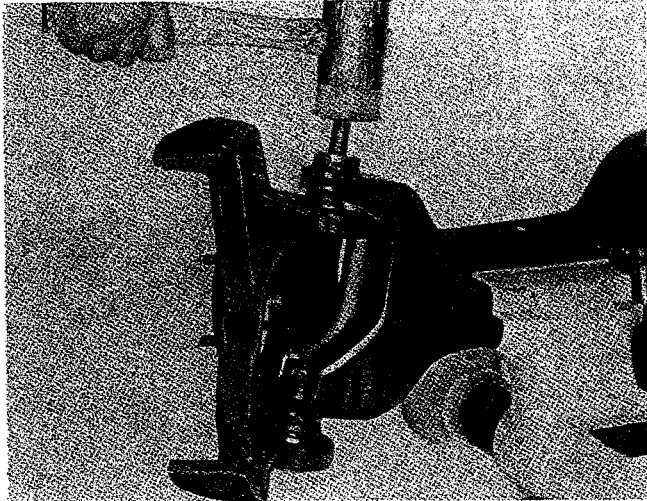

Figure 17

1020-17

Using a rawhide or heavy duty plastic hammer, hit sharply on the top stud to free the knuckle from the tube yoke. After knuckle is free from the yoke, remove the bottom nut.

NOTE

Discard bottom nut. The nut on the bottom socket is of the torque prevailing design, and is not to be reused.

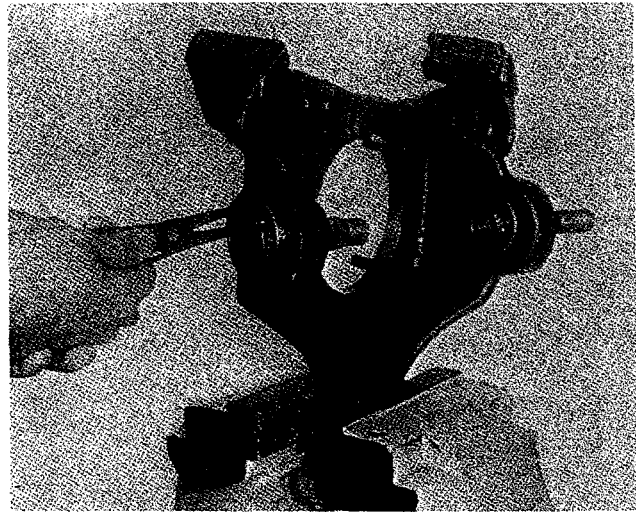

Figure 19

1020-19

Place knuckle in vise as shown. If bottom ball socket is equipped with a snap ring, remove as shown.

NOTE

Bottom ball socket must be removed first.



Figure 18

1020-18

Remove camber bushing as shown. If the camber bushing cannot be removed by hand, use a Pitman arm puller or similar tool.

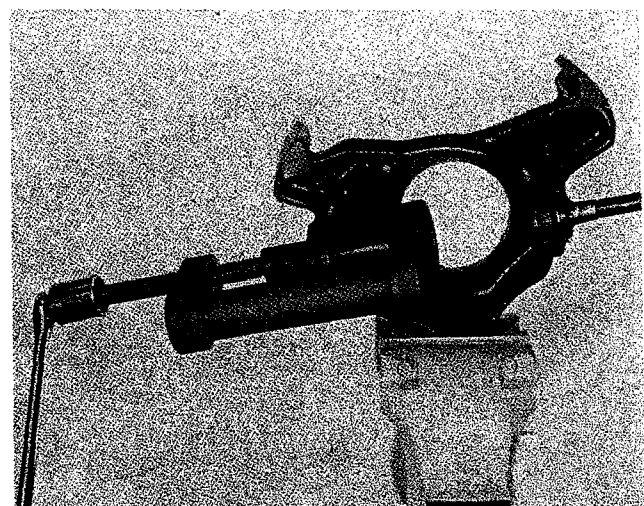

Figure 20

1020-20

Assemble ball socket tools as shown. Turn forcing screw and push out bottom socket.

Discard ball socket.

Tools: D-150-1 Ball Joint Remover & Installer,
D-150-2 Sleeve,
D-150-3 Sleeve — Ball Joint Removing.

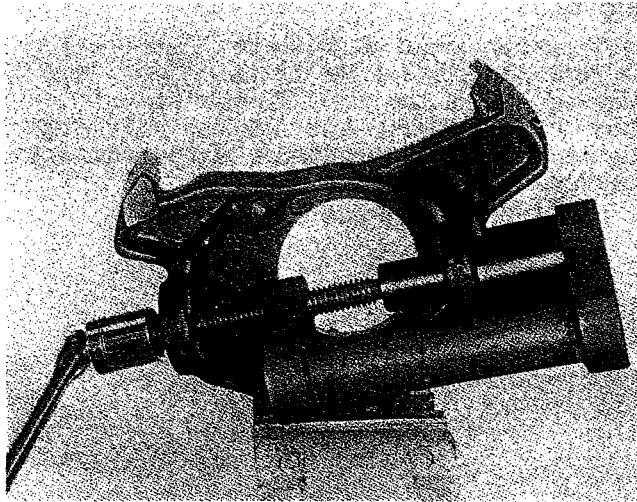

Figure 21

1020-21

Assemble ball socket tools as shown. Turn forcing screw and push out top socket.

Discard ball socket.

Tools: D-150-1 Ball Joint Remover & Installer,
D-150-2 Sleeve,
D-150-3 Sleeve — Ball Joint Removing.

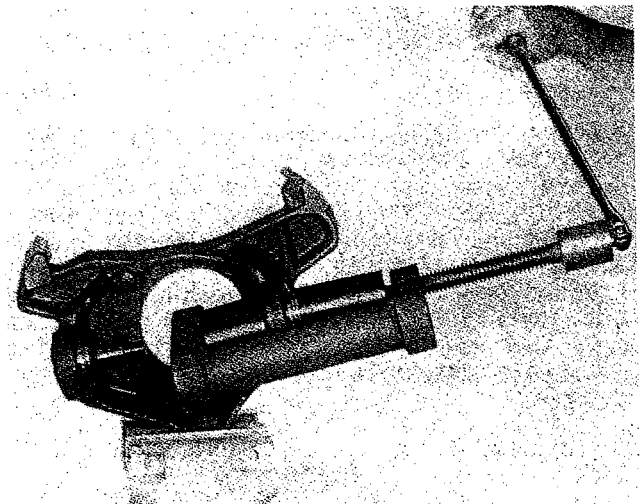

Figure 23

1020-23

Upper ball socket has a cotter key hole in the stud end. Assemble socket into knuckle. Make sure this area is free from dirt, etc., and that socket is straight. Assemble tools as shown. Turn forcing screw and push socket into knuckle as far as it will go.

Tools: D-150-1 Ball Joint Installer & Remover,
D-150-2 Sleeve,
D-150-4 Installing Sleeve.

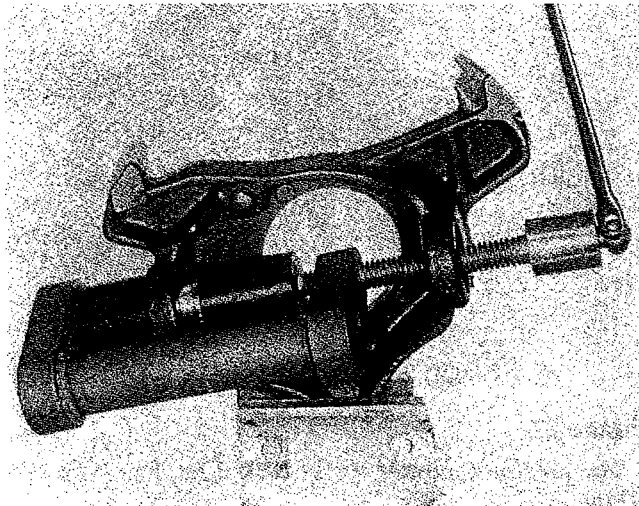

Figure 22

1020-22

Lower ball socket does not have a cotter key hole in the stud end. Assemble bottom socket into the knuckle. Make sure this area is free from dirt, etc., and that the socket is straight. Assemble tools as shown. Turn forcing screw and push socket into knuckle as far as it will go.

Tools: D-150-1 Ball Joint Remover & Installer,
D-150-2 Sleeve,
D-150-4 Installing Sleeve.

If required, assemble snap ring on bottom socket.

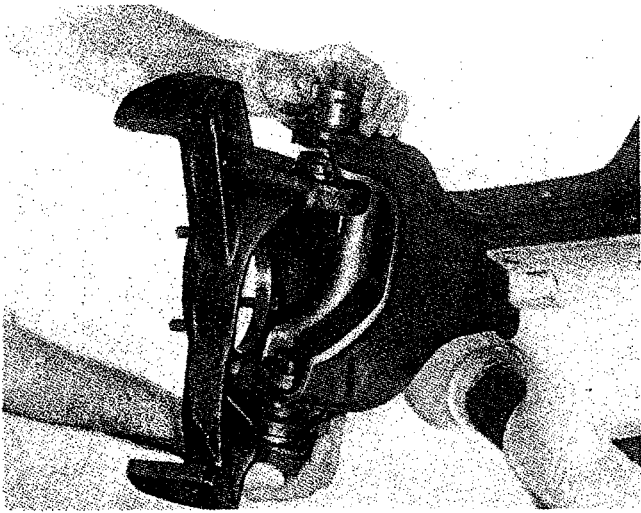

Figure 24 1020-24

Assemble knuckle and socket assembly to yoke as shown. Slide camber bushing into place on stud of top ball socket. Be sure lugs on yoke engage the slots in camber bushing. Assemble new torque prevailing nut on bottom socket and torque to 20-30 Lbs.-Ft. (27-41 N•m). Place a tool such as a socket or similar object on top of the bushing, and strike with a plastic or rawhide mallet to seat the bushing. Make sure the tool rests on the bushing and has enough height to prevent striking the ball joint stud.

NOTE

Install camber bushing on top ball joint stud with the arrow pointing outboard for "positive" camber. Install bushing with the arrow pointing inboard for "negative" camber. Zero camber bushings will not have arrows and may be rotated in either position as long as the lugs on yoke engage the slots in the bushing. For proper camber setting, refer to vehicle service manual.

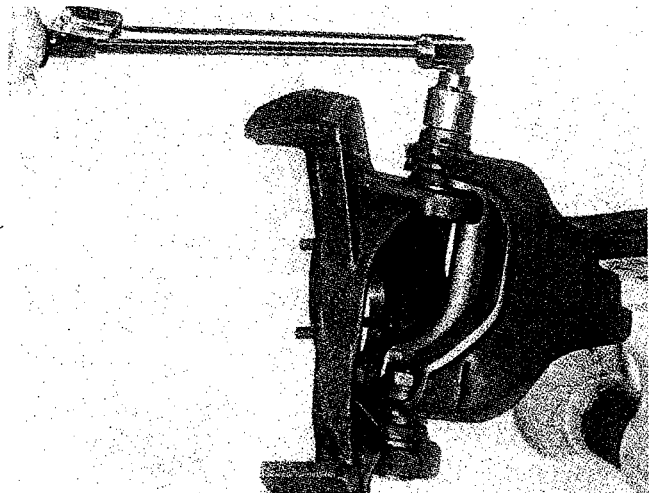

Figure 25 1020-25

Figure 25

Assemble top nut on top socket. Tighten nut until it pulls the stud of the bottom socket into the tapered hole of the yoke. Torque top nut to 100 Lbs.- Ft. (135 N•m). After nut has been torqued, tighten nut until castellation aligns with cotter key hole.

Tool: C-3952-A Torque Wrench.

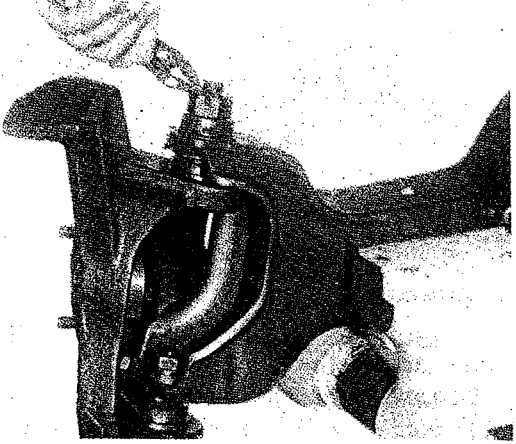

Figure 26 1020-26

Assemble cotter key.

NOTE

Do not loosen top nut to install cotter key.

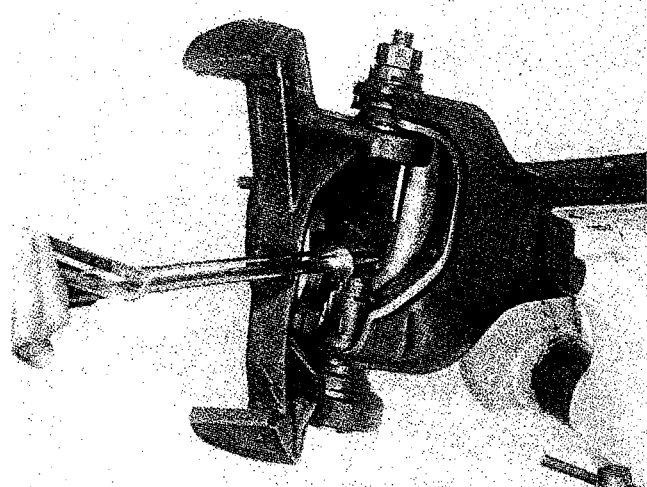

Figure 27 1020-27

Torque bottom nut to 90-110 Lbs.-Ft. (122-149 N•m).

Tool: C-3952-A Torque Wrench.

NOTE

In the event that knuckles are received with the sockets and snap ring assembled to the knuckle, along with new top and bottom nuts, and cotter key; follow procedures as illustrated in figures 24 through 27 for assembly. For steering angle setting, refer to vehicle service manual.

NOTE

It is recommended that all oil or grease seals be replaced with new ones whenever the axle is disassembled.

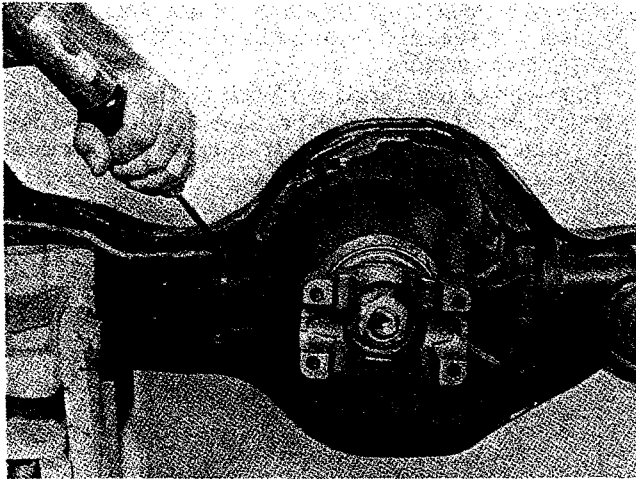

Figure 28

1020-28

Remove the inner axle shaft seal from the housing as shown. Pry seal out and discard.

CAUTION

When removing a seal, be careful so as to avoid nicking or gouging the housing.

Tools: Screwdriver or similar tool,
Plastic mallet.

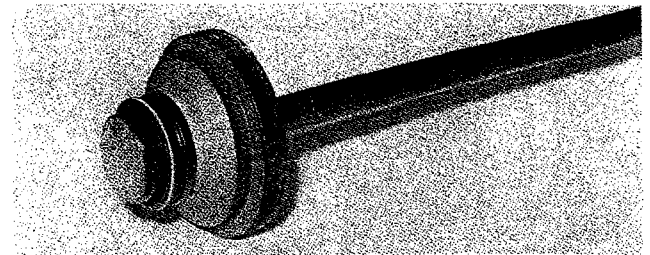

Figure 29

1020-29

Apply a light coat of hypoid lubricant or a good quality grease to the lip of the seal and position the seal on the Installer as shown.

Tool: D-249-A Installer — Inner Axle Shaft Seal.

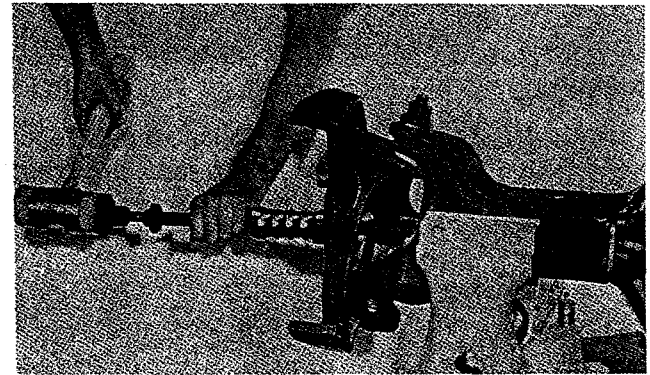

Figure 30

1020-30

Slide the seal into the carrier seal bore. Make sure the seal is centered and is straight with the seal bore. Use a rawhide or heavy duty plastic hammer as shown to completely seat the seal in the bore.

SERVICING DIFFERENTIAL YOKE SHAFT BEARING

NOTE

To remove axle shaft assemblies, follow procedures as illustrated in Figures 5 through 15.

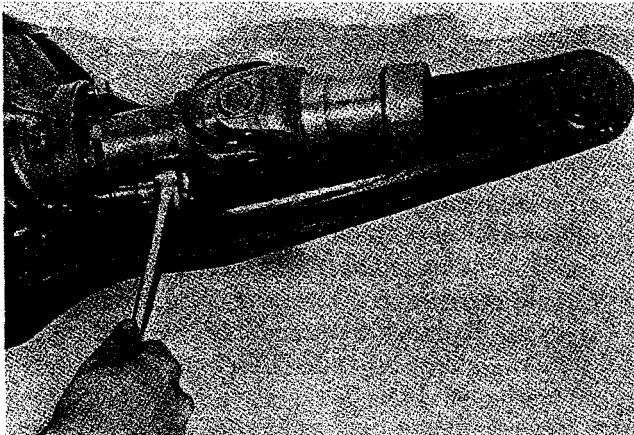

Figure 31

1020-31

Remove retainer plate, slip yoke, and stub shaft assembly. Remove slip yoke and journal cross from stub shaft.

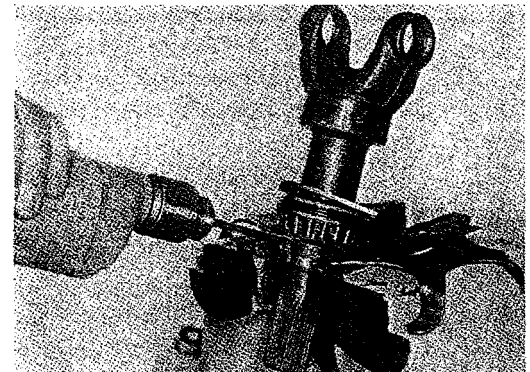

Figure 32

1020-32

Place the shaft in a vise. Drill a $\frac{1}{4}$ inch (6.4 mm) hole in the outside of the retainer ring to a depth approximately $\frac{3}{4}$ the thickness of the ring. Do not drill all the way through the ring. The drill could damage the axle shaft.

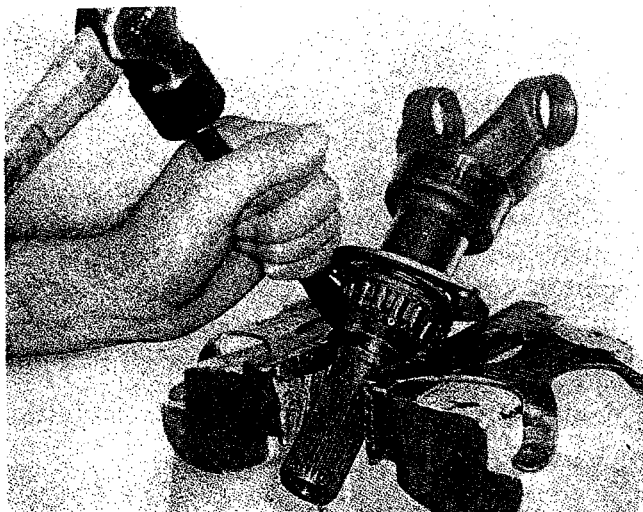

Figure 33

1020-33

After drilling the ring, use a chisel positioned across the hole and strike sharply to break the ring. Discard and replace with a new one at time of assembly.

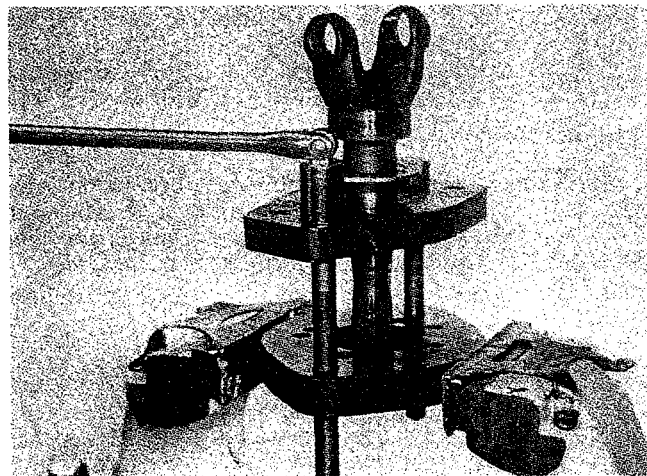

Figure 34

1020-34

Push retainer plate and seal towards the yoke end of the axle shaft. Install the flange plate in a vise. Position the yoke shaft through the forcing plate, and install the adapters between the forcing plate and the unit bearing.

Slide the screws through the washer and forcing plate, then start them into the flange plate. Gradually tighten the screws until they draw the adapters tight to the bearing.

Tools: D-127-2 Flange Plate,
D-127-3 Adapters,
D-127-4 Forcing Plate,
SP 3020 Washers,
WP 5026 Screws

Tighten the screws of the tool alternately and evenly until the bearing cone is removed from the yoke shaft. Be careful not to mar or nick the machined surfaces of the yoke shaft.

CAUTION

Do not heat or cut the bearing cone assembly with a torch. Damage to the yoke shaft will result.

Remove seal and retainer plate and discard. Replace the seal and retainer plate with new ones at the time of assembly.

Inspect the machined surfaces of the yoke shaft, particularly the seal and bearing diameters. Clean the yoke shaft and carefully remove all nicks or burrs.

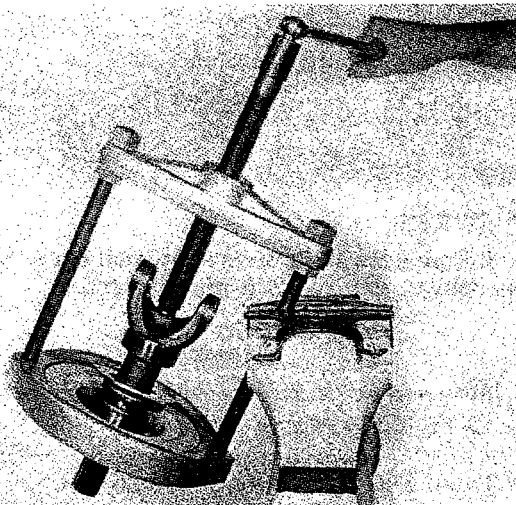

Figure 35

1020-35

Position the press in a vise. Assemble a new retainer plate, and a new oil seal onto the yoke shaft. The oil seal lip should be coated with the proper hypoid lubricant. Slide a new unit bearing onto the shaft. The proper direction to install the unit bearing is to have the large radius on the inner race towards the yoke end of the shaft.

NOTE

The unit bearing is a complete pre-assembled bearing assembly consisting of cup, cup rib ring, cone, rollers, and cage. The cup and rib ring are bonded together to facilitate handling and installation. When the bearing is serviced, the cup will usually separate from the rib ring. Should separation occur, care should be taken so as not to damage the cone, rollers, and cage. Should damage occur to these parts, the bearing assembly must be replaced with a new one.

Put the installing ring on the yoke shaft and place in the press as shown. Use a small flat washer between the forcing screw and the yoke shaft to protect each one from damage during the installation of the unit bearing.

Tighten the forcing screw until bearing is completely seated against the shoulder of the yoke shaft. To make sure the bearing is seated, use a .0015" (.038mm) feeler gage between the bearing seat and bearing. If the feeler gage will enter, then continue to force the bearing further onto the yoke shaft until the feeler gage does not enter.

Tools: DD-914-P Press
DD-914-9 Adapter Ring
D-127-1 Installing Ring — Bearing
& Small Flat Washer

CAUTION

Extra care must be taken during installation of the retainer ring onto the axle shaft. The press fit of the retainer ring is greater than the press fit of the bearing. Caution must be used to prevent crushing the bearing.

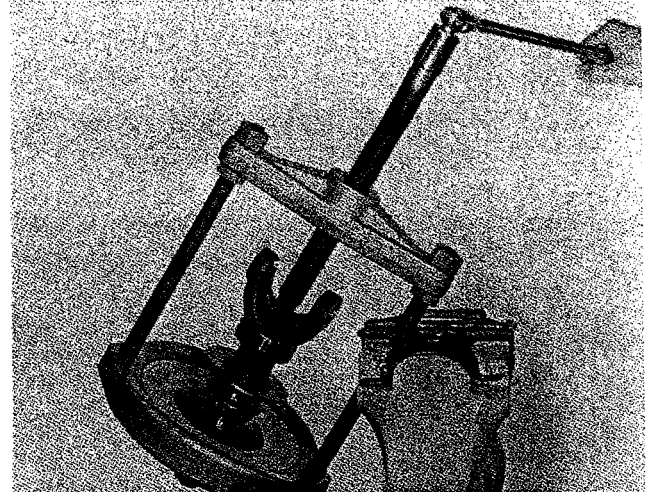

Figure 36

1020-36

To install the retainer ring on the yoke shaft follow the procedures as described in Figure 35. Use a .0015" (.038mm) feeler gage between the unit bearing and retainer ring to be sure that the retainer ring is seated. At least one point should exist where the feeler gage cannot enter between the bearing and the retainer ring. If the feeler gage can enter completely around the circumference, the retainer ring must be forced further onto the yoke shaft.

LUBRICATING THE UNIT BEARING WITH GREASE

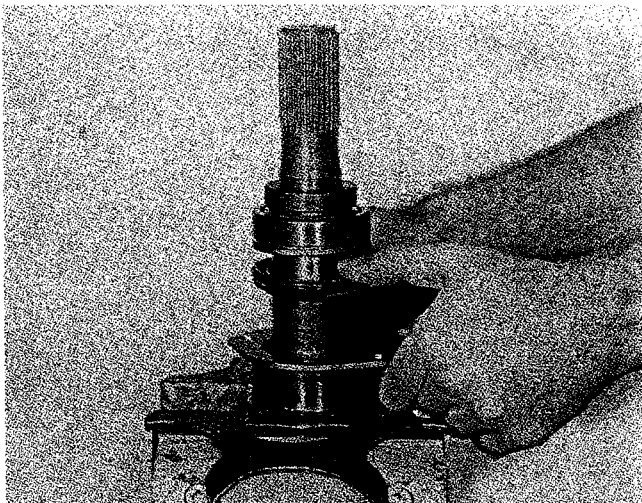

Figure 37

1020-37

Push seal and retainer plate away from the unit bearing to allow a cavity between the seal and bearing.

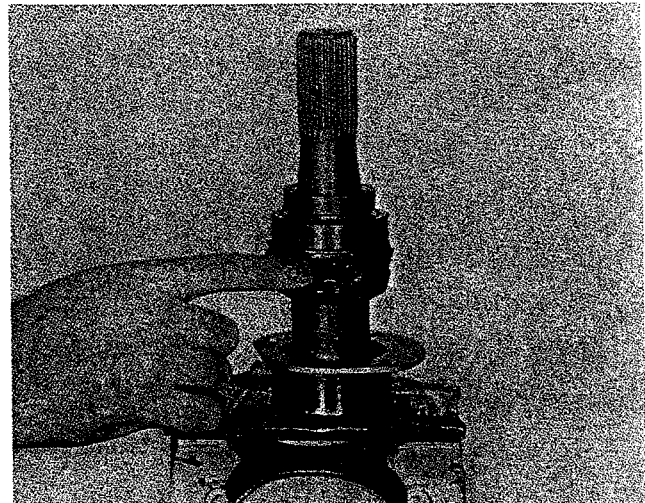

Figure 38

1020-38

Fill the cavity with a good quality number 2 E.P. (extreme pressure) lithium base wheel bearing grease.

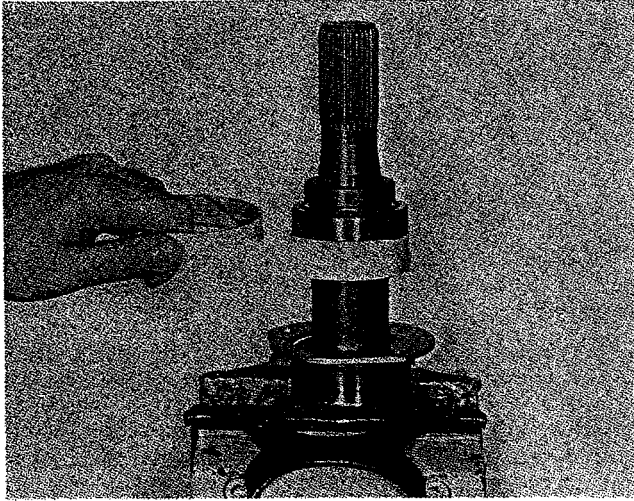

Figure 39

1020-39

After cavity is full of grease, wrap some tape completely around the rib ring and seal to enclose the cavity.

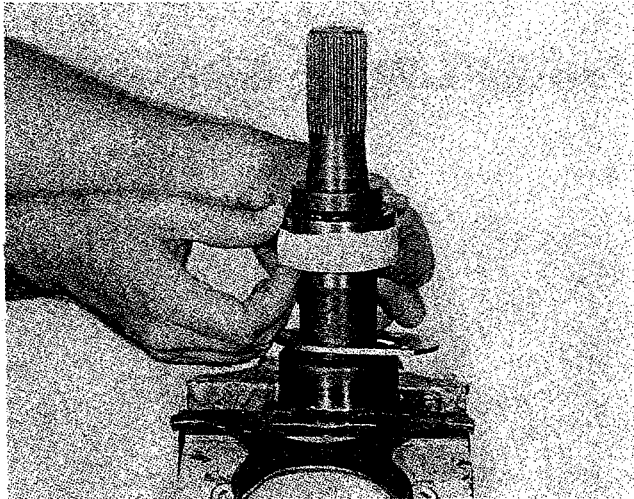

Figure 40

1020-40

Pull the seal towards the bearing until it contacts the rib ring. This will force the grease between the rollers and the cup.

NOTE

If the grease is not apparent on the small end of the rollers, repeat the same steps until the grease is evident between the small end of the roller and cup. Remove the tape.

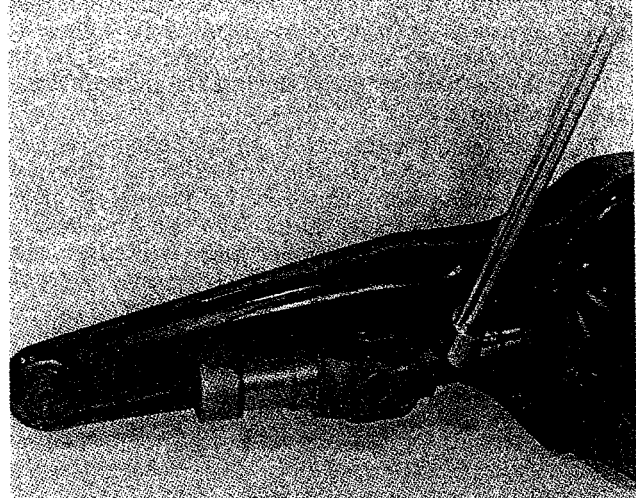

Figure 41

1020-41

Reassemble the slip yoke and journal cross to the stub shaft. Install the shaft assembly into the carrier. Torque the retainer plate screws to 30-40 Lbs.-Ft. (41-54 N•m). Install right hand shaft assembly into the slip yoke, giving special attention to the spline. If the slip yoke has a wide tooth space in the spline make sure that it is aligned with the wide tooth on the axle shaft spline.

Tool: C-3952-A Torque Wrench.

NOTE

Prior to installing the right hand shaft assembly into the slip yoke, lubricate the splines with a good extreme pressure grease satisfying N.L.G.I. grade 1 or 2 specifications. For lubrication after assembly, refer to vehicle service manual.

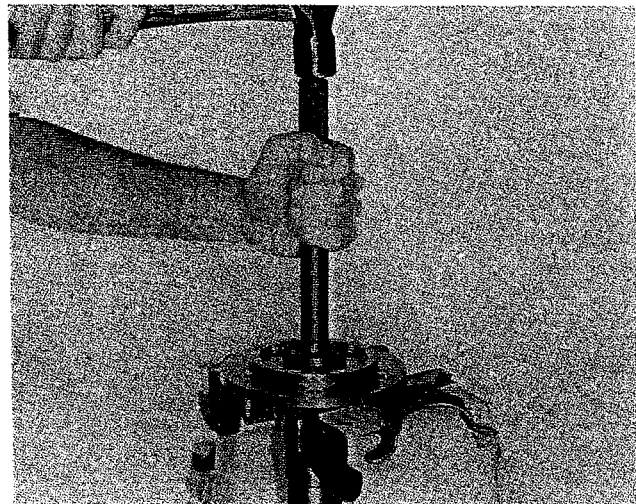

Figure 42

1020-42

Assemble new needle bearing into spindle.
Tools: D-122 Installer, C-4171 Handle.

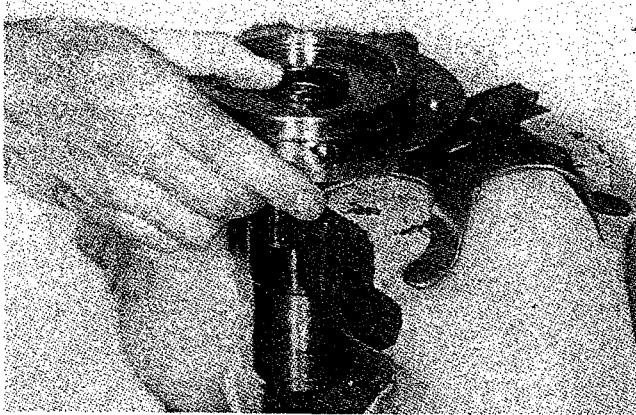

Figure 43

1020-43

Assemble grease seal into spindle. The lip of the seal is to be directed away from the spindle.

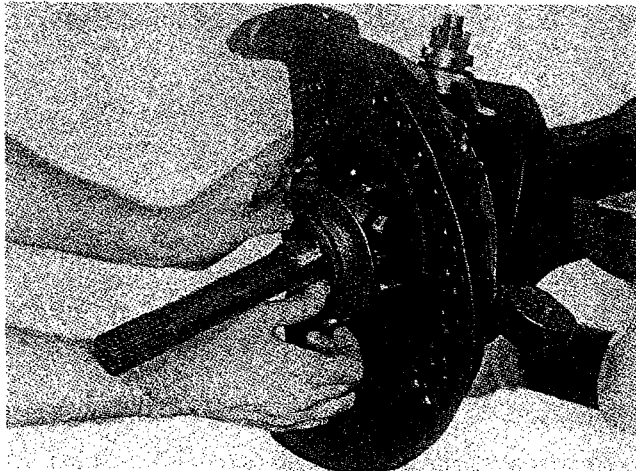

Figure 44

1020-44

Some front axles are equipped with a "V" seal which is assembled to the axle shaft stone shield as shown. If seal is worn, remove and replace with a new one.

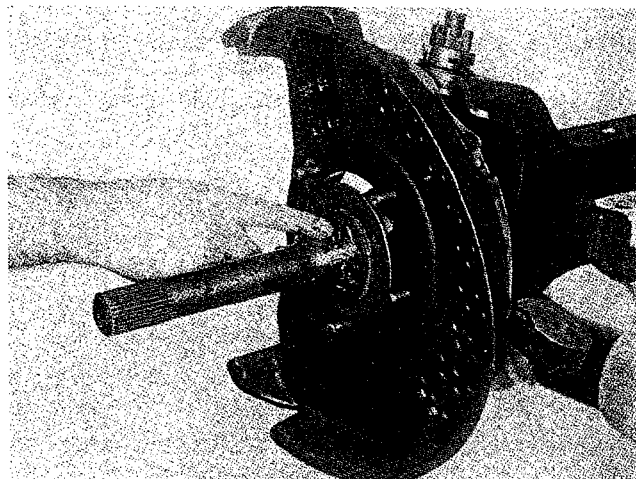

Figure 45

1020-45

Pack the thrust face area of the shaft and seal full of grease. Also, fill the seal area of the spindle with grease.

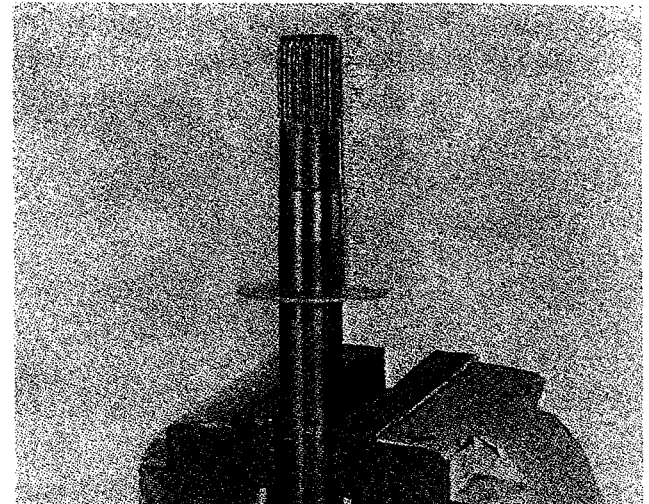

Figure 46

1020-46

Assemble the plastic slinger onto the left hand shaft and joint assembly 5.000" (127 mm) from the inboard spline end. This slinger protects the inner axle seal installed in Figures 29 and 30 from stones, etc. Place a mark on the shaft at the slinger position for checking purposes after shaft assembly has been installed.

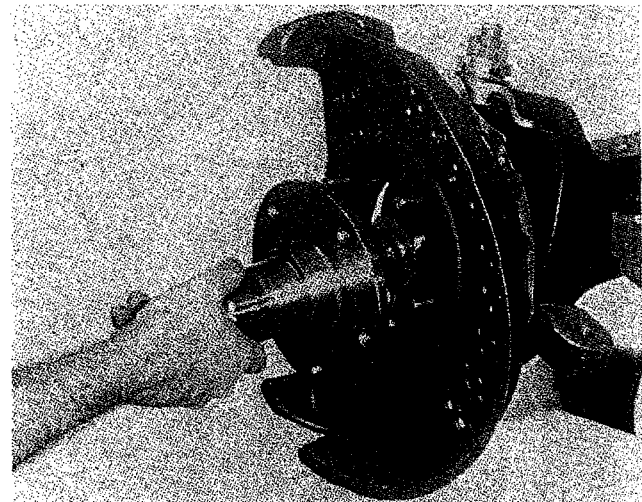

Figure 47

1020-47

Install the left hand shaft and joint assembly. Assemble new plastic spacer, disc brake, splash shield and "V" seal if required as shown in Figure 44. Assemble spindle assembly. Check the plastic slinger for proper position as described in Figure 46, and correct if necessary.

NOTE

Be sure the chamfer side of the thrust washer is toward the joint end of the axle shaft joint.

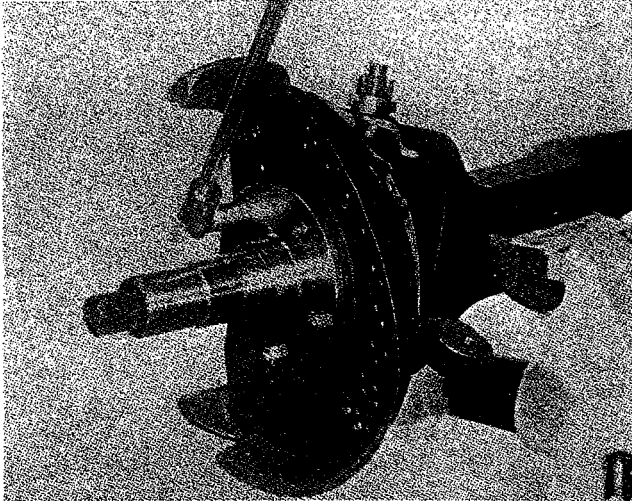

Figure 48

1020-48

Assemble new nuts. Torque nuts to 20-30 lbs. ft. (27-41 N•m).

Tool: C-3952-A Torque Wrench.

NOTE

To service hub and rotor assembly, refer to Figures 7 through 12.

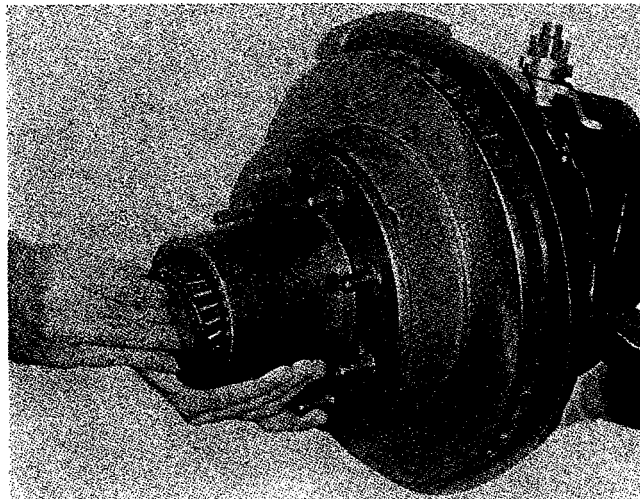

Figure 49

1020-49

Assemble hub and rotor onto spindle. Pack outer wheel bearing with specified grease, wipe excess grease around the rollers.

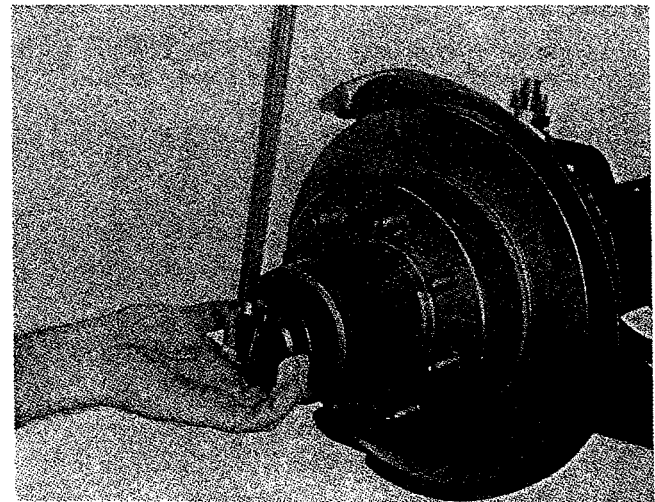

Figure 50

1020-50

To adjust wheel bearing end play, torque inner adjusting nut to 50 Lbs.-Ft.(68 N•m) to seat the bearings. Rotate the hub, then back off the inner adjusting nut one-fourth turn maximum. Assemble the lockwasher by turning inner locknut to nearest hole in lockwasher. Assemble outer locknut and torque to 150 Lbs.-Ft. (203 N•m) Min. Refer to vehicle manufacturer's specifications for wheel bearing end play.

Tools: C-4170 Wheel Bearing Wrench
C-3952-A Torque Wrench

To assemble the hub lock assemblies, refer to vehicle manufacturer's recommendations.

CARRIER SECTION

NOTE

If it becomes necessary to service any parts inside the carrier, it is suggested that the entire left hand unitized support arm and carrier assembly be removed from the vehicle and held in a large heavy duty vise or stand. Refer to appropriate section of the service manual for removal and installation of the wheel ends and shaft assemblies. Refer to the vehicle service manual for removal and installation of the unitized support arm.

Loosen the carrier screws holding the carrier assembly to the left hand unitized support arm and allow the lube to drain out. Carefully remove the carrier screws and remove the carrier from the unitized support arm. Drain all the lube from the carrier assembly.

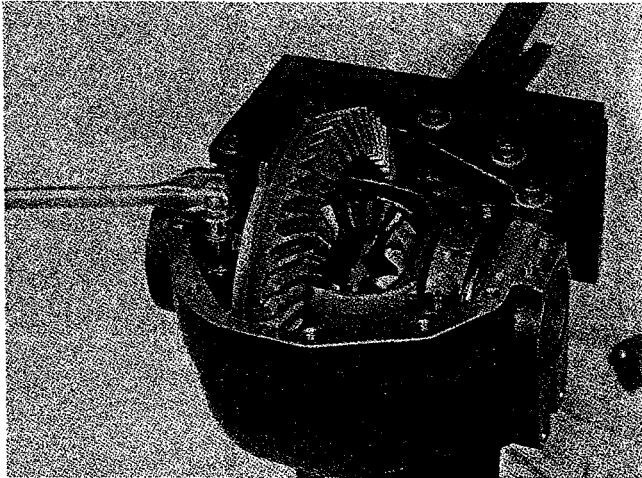

Figure 51

1020-51

Mount the carrier in a fixture as shown.

Note the matched numbers or letters stamped on the bearing caps and the carrier. When assembled the number or letter on the caps must agree in both the horizontal and vertical position with the number or letter stamped on the carrier. Remove the bearing caps.

Tools: D-245 Supporting Fixture,
D-246 Vise Adapter.

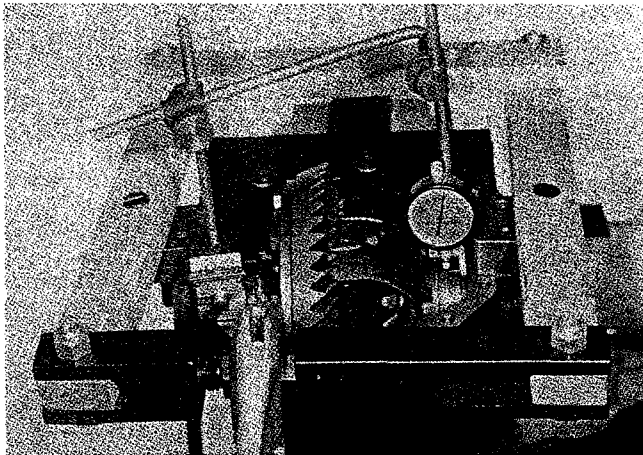

Figure 52

1020-52

Mount the spreader to the carrier. Use a dial indicator as shown. **DO NOT SPREAD THE CARRIER OVER .010" (.25 mm).** Remove the dial indicator set.

Tools: D-113 Spreader,
D-227 Spreader Adapters,
D-128 Indicator Set.

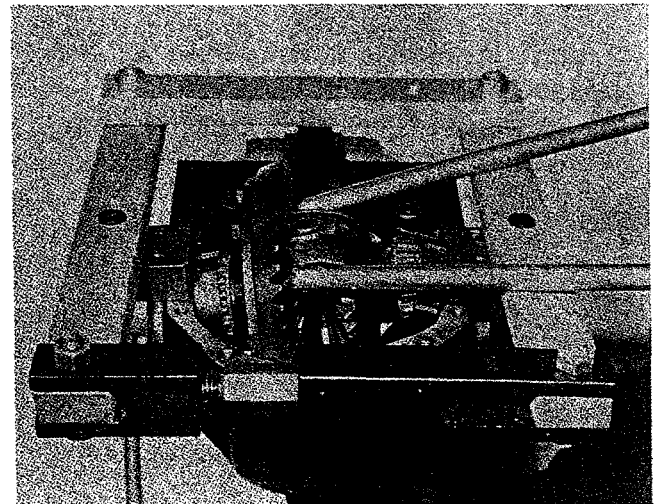

Figure 53

1020-53

Pry the differential case from the carrier with two pry bars. Use caution to avoid damage to any machined surfaces. Tag the bearing cups to indicate from which side they were removed. Remove spreader.

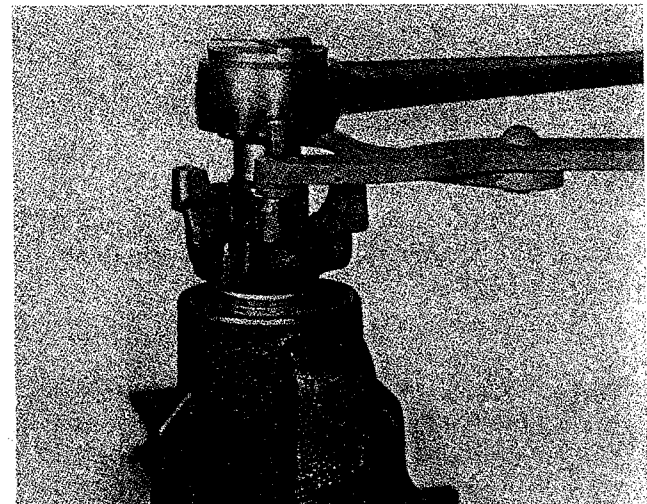

Figure 54

1020-54

Turn nose of carrier up. Hold end yoke or flange with a tool similar to the one shown and remove the pinion nut and washer.

Tool: C-3281 Holding Wrench.

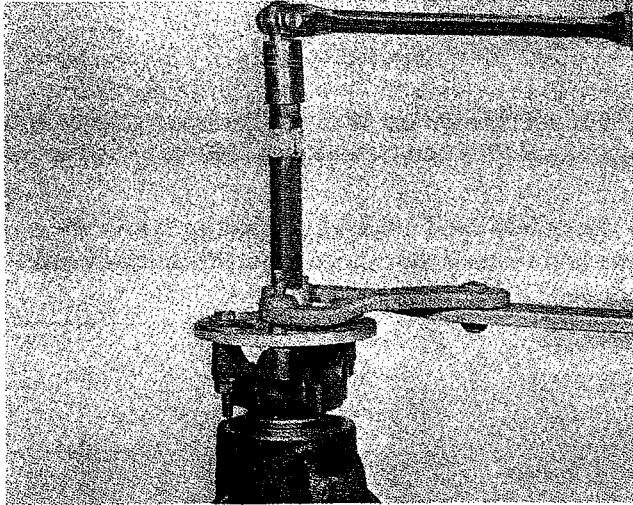

Figure 55

1020-55

Remove the end yoke or flange with the tools as shown. If the yoke or flange shows wear in the area of the seal contact, it should be replaced.

Tools: C-452 Yoke Remover,
C-3281 Holding Wrench.

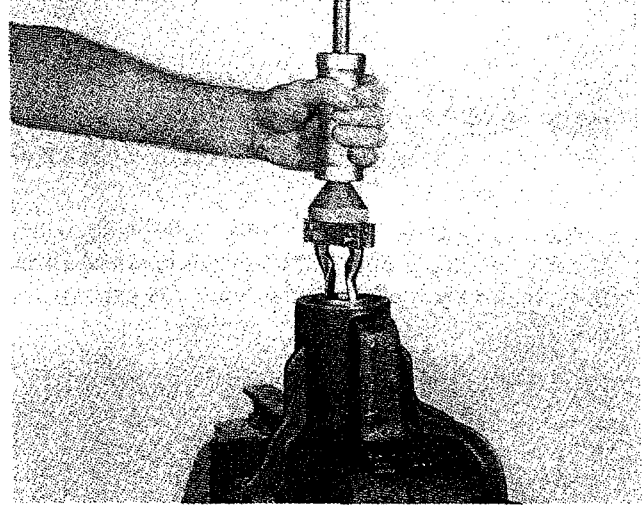

Figure 57

1020-57

Pull out the pinion oil seal with the puller as shown. Discard the seal and replace with a new seal at time of assembly. Remove the outer pinion bearing cone and outer pinion oil slinger.

Tool: D-131 Slide Hammer.

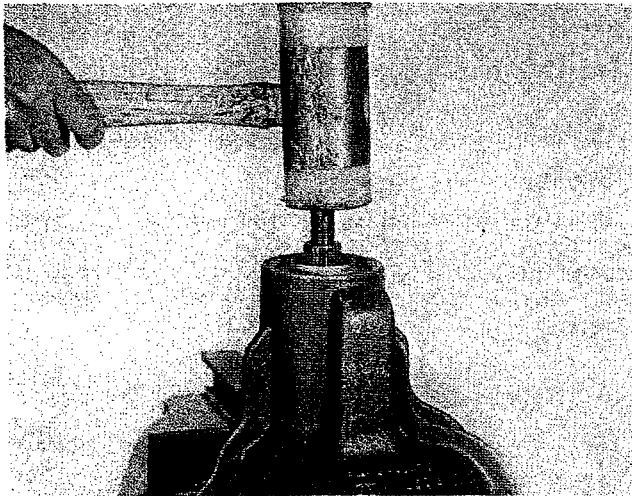

Figure 56

1020-56

Remove pinion by tapping with a rawhide or heavy duty plastic hammer. Catch the pinion with your hand to prevent it from falling to the floor and being damaged.

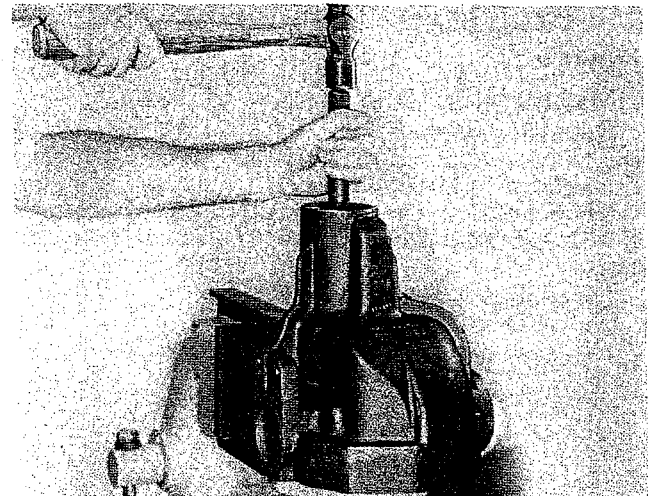

Figure 58

1020-58

Remove the inner pinion bearing cup with tools as shown.

Tools: D-148 Remover,
C-4171 Handle.

NOTE

On the spline end of the pinion, there are pinion bearing preload shims. These shims may stick to the outer bearing and then fall to the floor. Be sure to collect all these shims and keep them together since they will be used later in assembly. If shims are mutilated, replace with new ones. Shims are available in thicknesses of .003", .005", .010", and .030" (mm .08, .13, .25 and .76).

NOTE

Shims are located between the inner bearing cup and carrier bore, which may also include an oil baffle. If shims and baffle are bent or nicked, they should be replaced at time of assembly. Measure each shim individually and wire the shim stack together. If the stack has to be replaced, replace with the same thickness.

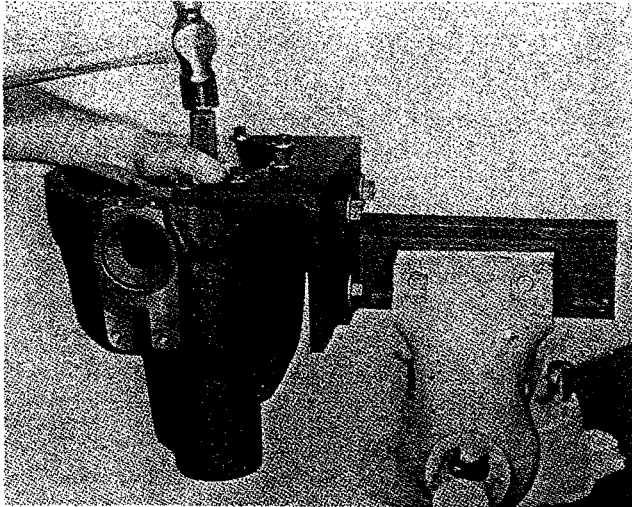

Figure 59

1020-59

Turn the nose of carrier down. Remove the outer pinion bearing cup as shown. Caution: Do not nick the carrier bore.

Tools: D-147 Remover,
C-4171 Handle,
C-4291 Extension.

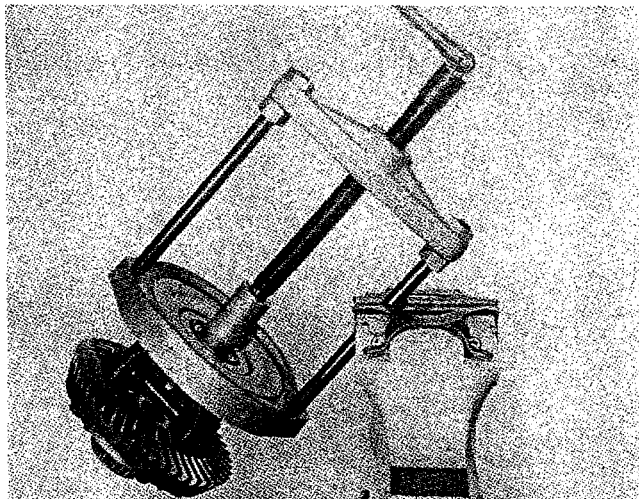

Figure 60

1020-60

Remove the differential bearings with a puller as shown. Wire the shims, bearing cup and cone together and identify from which side of the differential case they were removed (ring gear side or opposite side). If any of the shims are bent or mutilated they should be replaced with new ones at the time of assembly. New shims are available in thicknesses of .003", .005", .010" and .030" (mm .08, .13, .25, and .76).

Tools: DD-914-P Press,
DD-914-9 Adapter Ring,
C-293-18 Adapter Set,
C-293-3 Adapter Plug.

If the original shim stack, or equivalent replacement for each side is available, the shim stack may be used as a starting point to assemble the differential case. Assemble the shim stack and new bearings on the same side which they were taken from, and install the differential case into the carrier as described later in this manual. Follow the procedures

of measuring and adjusting backlash.

If the original shim stacks are lost or cannot be accurately determined, it is recommended that the shim stacks be found by using the procedures described in this manual.

NOTE

It is recommended that whenever bearings are removed, they are replaced with new ones, regardless of mileage.

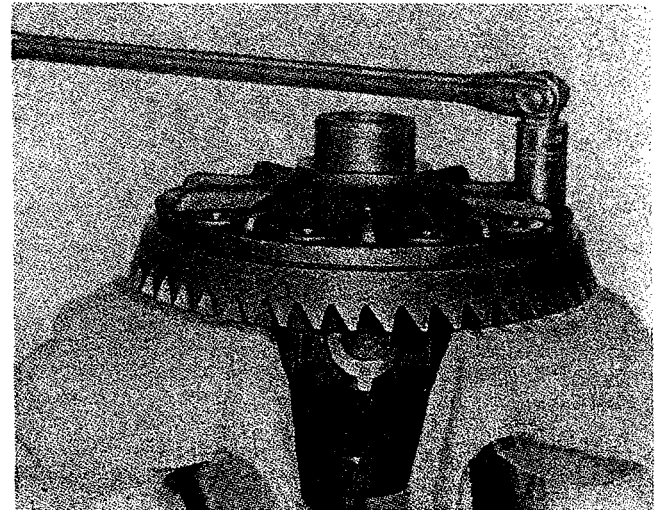

Figure 61

1020-61

Place a few shop towels over the vise to prevent the ring gear teeth from being nicked. Remove the ring gear screws.

NOTE

It is recommended that whenever the ring gear screws are removed, they are replaced with new ones, regardless of mileage.

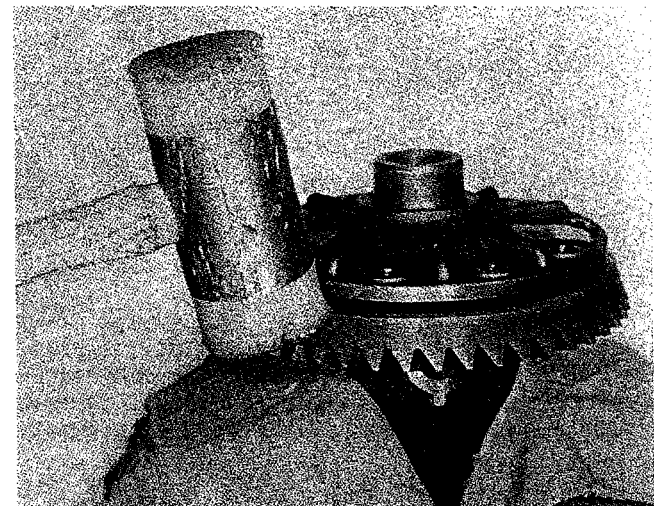

Figure 62

1020-62

Tap the ring gear with a rawhide or heavy duty plastic hammer to free it from the case. Remove the case and ring gear from the vise.

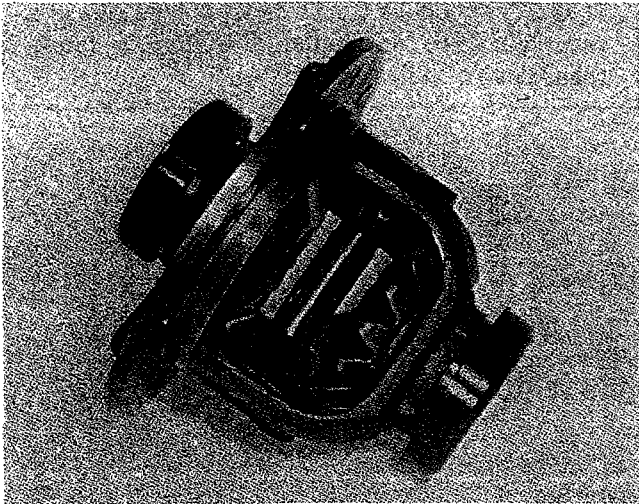

Figure 63

1020-63

Install the master differential bearings onto the case. Remove all nicks, burrs, dirt, etc. from hubs to allow the master bearings to rotate freely.

Tool: D-135 Master Bearings.

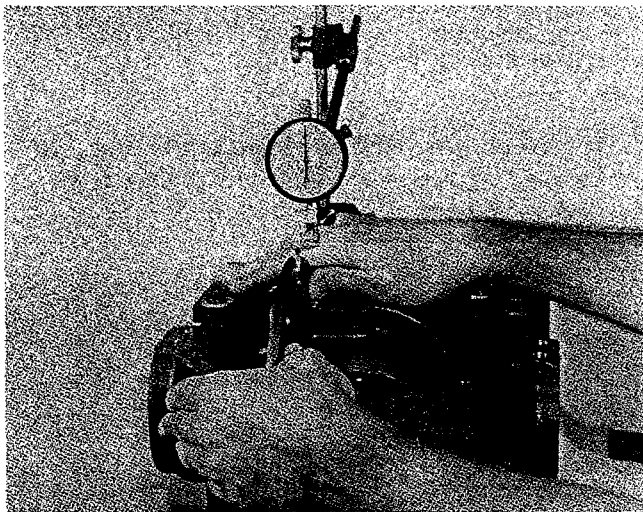

Figure 64

1020-64

Assemble differential case into carrier (less pinion). Mount a dial indicator with a magnetic base on the flange face as shown. Force the differential assembly as far as possible in the direction towards the indicator. With force still applied, set indicator at zero (0).

Tool: D-128 Indicator.

NOTE

Indicator D-128 should be adjusted to provide for a minimum of .200" (5.08 mm) travel.

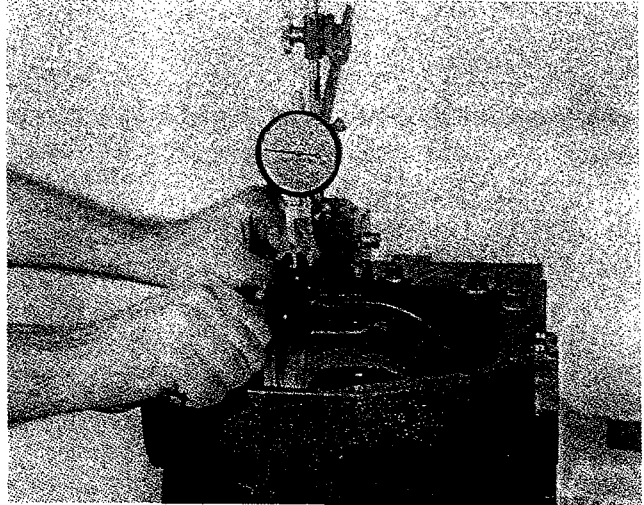

Figure 65

1020-65

Force the differential assembly as far as it will go in the opposite direction. Repeat these steps until the same reading is obtained.

Record the reading of the indicator. This amount, in shims, will be included in the final assembly shim stacks to establish differential bearing preload and ring gear backlash.

After making sure the readings are correct, remove the dial indicator and differential assembly from the carrier.

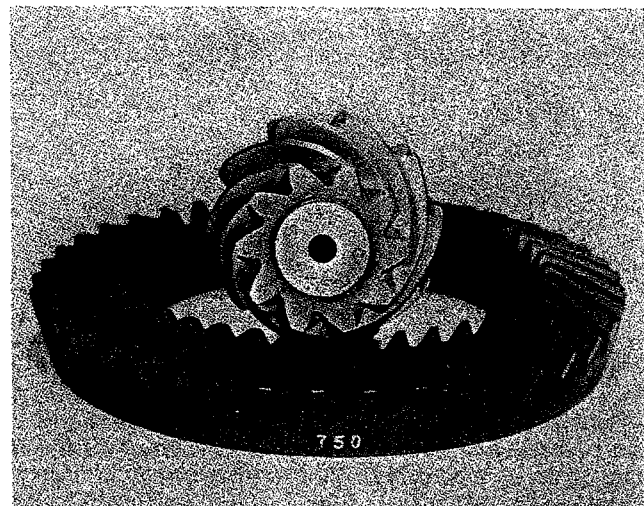

Figure 66

1020-66

View of ring and pinion etched with inch identification.

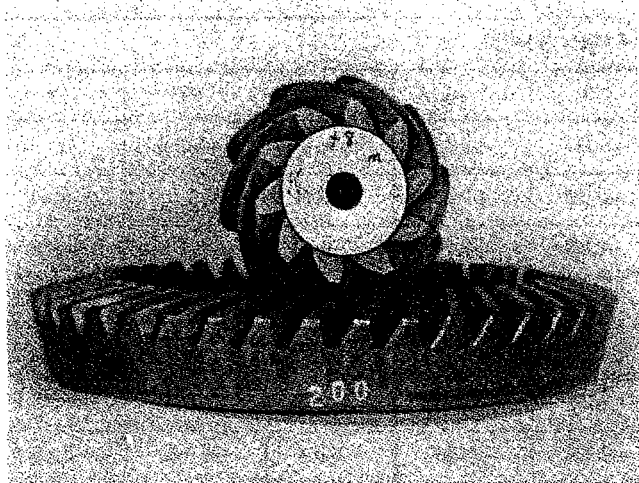

Figure 67 1020-67
View of ring and pinion etched with metric identification.

Ring gears and pinions are supplied in matched sets only. Matching numbers on both pinion and ring gear are etched for verification. If a new gear set is being used, verify the numbers on each pinion and ring gear before proceeding with assembly.

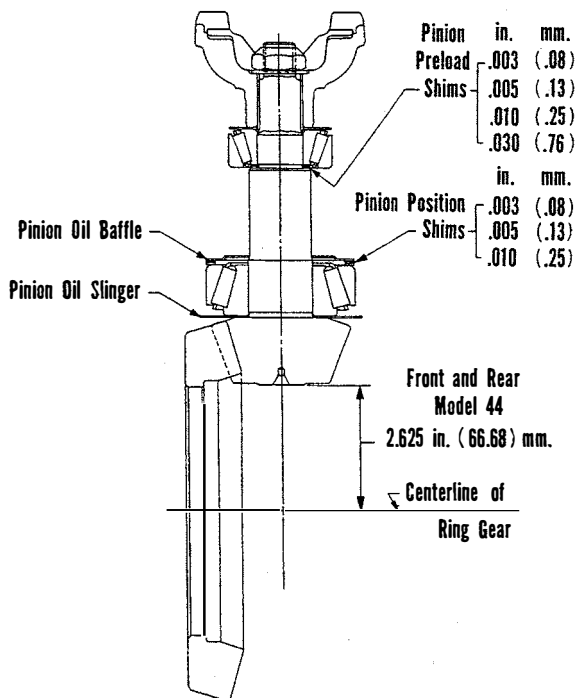

Figure 68

1020-68

Figure 68

The distance from the centerline of the ring gear to the button end of the pinion for the Model 44 axle is 2.625 inches (66.68 mm).

On the button end of each pinion, there is etched a plus (+) number, a minus (-) number, or a zero (0), which indicates the best running position for each particular gear set. The position of the pinion is controlled by the amount of shims between the inner pinion bearing cup and the carrier bearing bore.

For example — if a pinion is etched +3 (m+8), this pinion would require .003" (.08mm) less shims than a pinion etched "0". This means that by removing shims, the mounting distance of the pinion is increased to 2.628" (66.75mm), which is just what a +3 (m+8) indicates. Or if a pinion is etched -3 (m-8), we would want to add .003" (.08mm) more shims than would be required by a pinion that is etched "0". By adding .003" (.08mm) shims, the mounting distance of the pinion is decreased to 2.622" (66.60mm); which is just what a -3 (m-8) etching indicates.

If the old ring gear and pinion set is to be reused, measure the old shim stack and build a new shim stack to this same dimension. It is recommended that each shim be measured individually, and then added together to obtain the shim stack total. To change the pinion position, shims are available in thicknesses of .003", .005", and .010" (mm .08, .13, and .25).

If a new gear set is used, notice the plus (+), minus (-), or zero (0) etching on both the old and new pinion and adjust the thickness of the new shim pack to compensate for the difference between these two pinion etchings. The chart in Figures 68 and 69 is helpful for determining this change.

For example: If the old pinion is etched +2 (m+5) and the new pinion is etched -2 (m-5), then add .004" (.10mm) to the original shim stack thickness in order to install the new pinion at proper position.

| Old Pinion Marking | New Pinion Marking | | | | | | | | |
|--------------------|--------------------|--------|--------|--------|--------|--------|--------|--------|--------|
| | -4 | -3 | -2 | -1 | 0 | +1 | +2 | +3 | +4 |
| +4 | +0.008 | +0.007 | +0.006 | +0.005 | +0.004 | +0.003 | +0.002 | +0.001 | 0 |
| +3 | +0.007 | +0.006 | +0.005 | +0.004 | +0.003 | +0.002 | +0.001 | 0 | -0.001 |
| +2 | +0.006 | +0.005 | +0.004 | +0.003 | +0.002 | +0.001 | 0 | -0.001 | -0.002 |
| +1 | +0.005 | +0.004 | +0.003 | +0.002 | +0.001 | 0 | -0.001 | -0.002 | -0.003 |
| 0 | +0.004 | +0.003 | +0.002 | +0.001 | 0 | -0.001 | -0.002 | -0.003 | -0.004 |
| -1 | +0.003 | +0.002 | +0.001 | 0 | -0.001 | -0.002 | -0.003 | -0.004 | -0.005 |
| -2 | +0.002 | +0.001 | 0 | -0.001 | -0.002 | -0.003 | -0.004 | -0.005 | -0.006 |
| -3 | +0.001 | 0 | -0.001 | -0.002 | -0.003 | -0.004 | -0.005 | -0.006 | -0.007 |
| -4 | 0 | -0.001 | -0.002 | -0.003 | -0.004 | -0.005 | -0.006 | -0.007 | -0.008 |

Figure 69

1020-69

Pinion setting chart in thousandths of an inch.

| Old Pinion Marking | New Pinion Marking | | | | | | | | |
|--------------------|--------------------|-------|-------|-------|-------|-------|-------|-------|-------|
| | -10 | -8 | -5 | -3 | 0 | +3 | +5 | +8 | +10 |
| +10 | +0.20 | +0.18 | +0.15 | +0.13 | +0.10 | +0.08 | +0.05 | +0.03 | 0 |
| +8 | +0.18 | +0.15 | +0.13 | +0.10 | +0.08 | +0.05 | +0.03 | 0 | -0.03 |
| +5 | +0.15 | +0.13 | +0.10 | +0.08 | +0.05 | +0.03 | 0 | -0.03 | -0.05 |
| +3 | +0.13 | +0.10 | +0.08 | +0.05 | +0.03 | 0 | -0.03 | -0.05 | -0.08 |
| 0 | +0.10 | +0.08 | +0.05 | +0.03 | 0 | -0.03 | -0.05 | -0.08 | -0.10 |
| -3 | +0.08 | +0.05 | +0.03 | 0 | -0.03 | -0.05 | -0.08 | -0.10 | -0.13 |
| -5 | +0.05 | +0.03 | 0 | -0.03 | -0.05 | -0.08 | -0.10 | -0.13 | -0.15 |
| -8 | +0.03 | 0 | -0.03 | -0.05 | -0.08 | -0.10 | -0.13 | -0.15 | -0.18 |
| -10 | 0 | -0.03 | -0.05 | -0.08 | -0.10 | -0.13 | -0.15 | -0.18 | -0.20 |

Figure 70

1020-70

Pinion setting chart metric. Use these charts as a guideline to set pinion position.

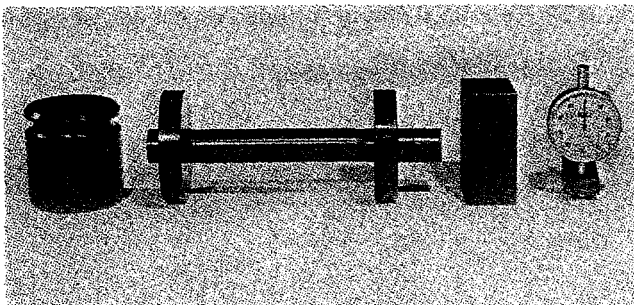

Figure 71

1020-71

Figure 71

View of master pinion block, pinion height block, scooter gage, cross arbor and arbor discs.

NOTE

Be sure that all carrier bores are free from all nicks, dirt or any other contamination.

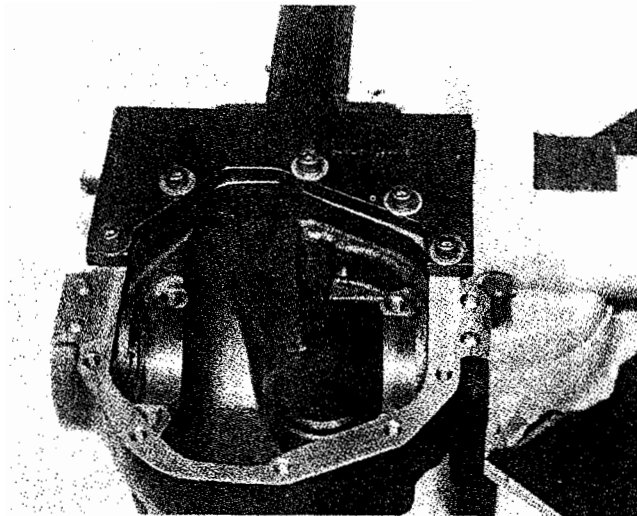

Figure 72 1020-72

Place the master pinion block into the inner pinion bearing bore of the carrier as shown.
 Tool: D-139 Master Pinion Block.

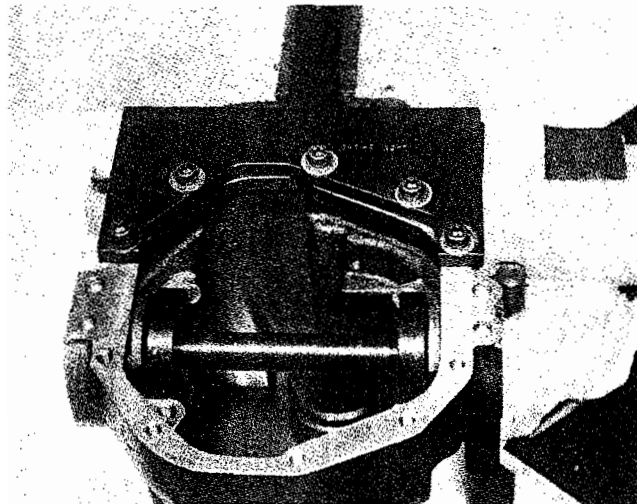

Figure 73 1020-73

Place arbor discs and arbor into the cross bores of the carrier as shown.

Tools: D-115-3 Arbor,
 D-115-4 Arbor Discs.

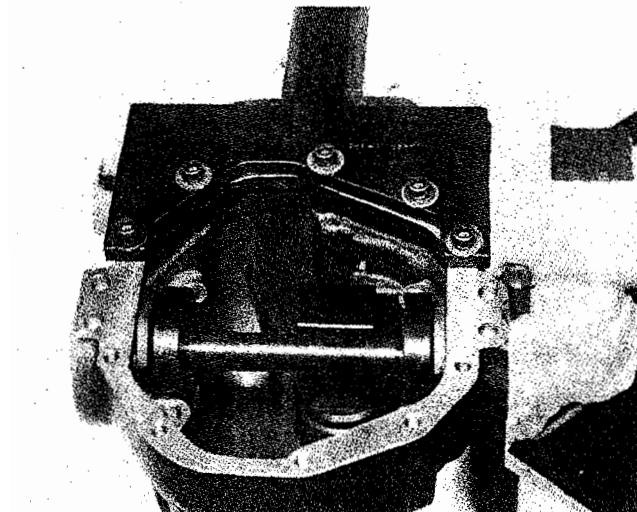

Figure 74 1020-74

Figure 74

Place pinion height block on top of master pinion block and against arbor as shown.

Tool: D-115-1 Pinion Height Block.

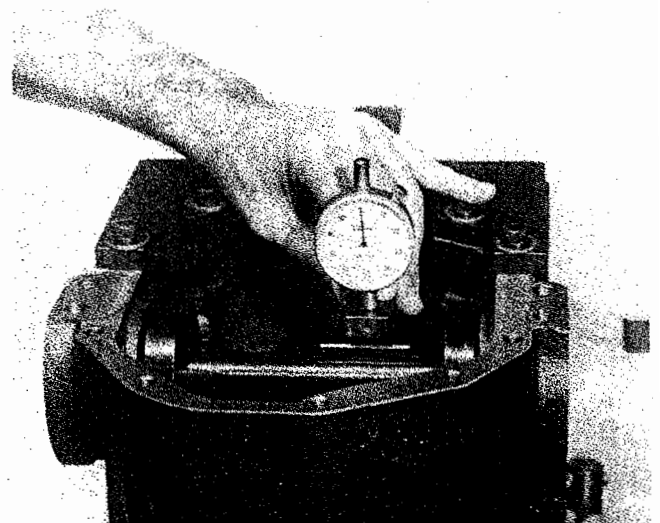

Figure 75 1020-75

Place scooter gage on pinion height block. Apply light pressure with fingers at the back side of the scooter gage. Make sure the scooter gage is flat on the pinion height block, then set the indicator at zero (0).

Tool: D-115 Scooter Gage.



Figure 76

Slide scooter gage towards the arbor. As the indicator moves over the top of the arbor, the dial will move in a clockwise direction across the face of the indicator. When the indicator is at the top center of the arbor, the dial will stop traveling in a clockwise direction. If the dial starts to move in a counter-clockwise direction, this means that you have passed the top center position on the arbor. Record only the reading when the indicator is at top center on the arbor and the dial has stopped moving clockwise on the indicator face. This reading indicates the thickness of the shim stack that is required to in-

stall a pinion that is etched with a zero (0) at a zero (0) position. If the pinion being installed has a plus (+) or a minus (-) etching, then an adjustment of this shim stack is required.

For example: If a pinion is etched +3 (m+8), then this pinion would require .003" (.08 mm) less shims than a pinion etched zero (0). If a pinion is etched -3 (m-8), we would want to add .003" (.08mm) more shims to the shim stack than would be required if the pinion were etched to zero (0).

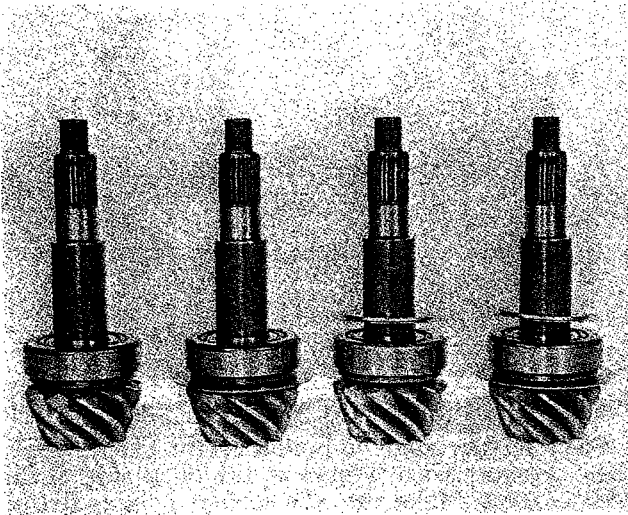

Figure 77

1020-77

Front and rear carrier sections may vary in the inner pinion bearing bore depth because of the need for either a pinion baffle or a pinion slinger or both. The application of an axle assembly in a particular vehicle determines whether these two items are required. If a baffle or slinger is removed, then they should be replaced with a new one during assembly. A baffle or slinger, when installed properly, help control the position of the pinion in relation to the centerline of the ring gear. Therefore, these items, if used, must be measured and used as a part of the inner pinion bearing shim stack.



Figure 78

1020-78

Figure 78

Measure each shim, baffle, and slinger separately with a micrometer and add together to get the total shim stack thickness.

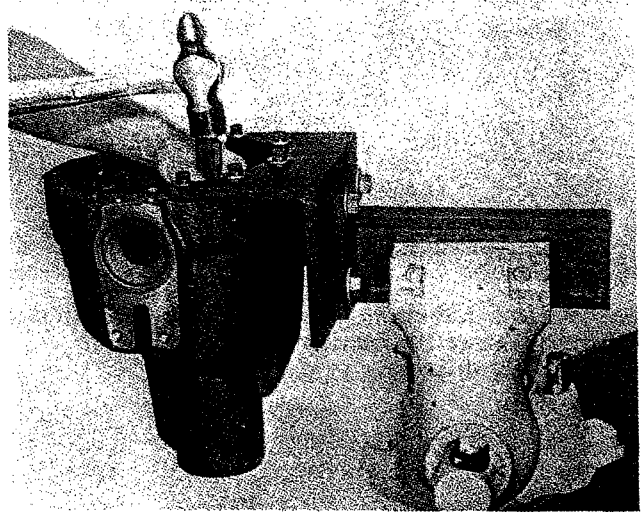

Figure 79

1020-79

Place the baffle and then the required amount of shims in the inner pinion bearing bore. Drive the inner pinion bearing cup into the carrier with tools as shown.

Tools: D-145 Installer,
C-4171 Handle.

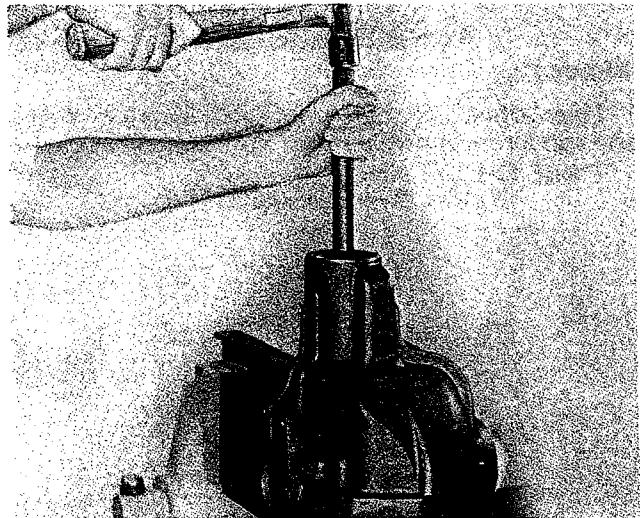

Figure 80

1020-80

Assemble the outer pinion bearing cup into carrier as shown.

Tools: D-144 Installer,
C-4171 Handle.

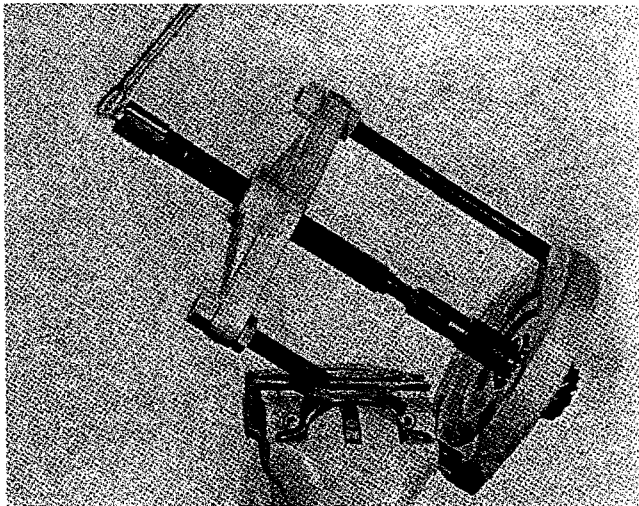

Figure 81

1020-81

Remove the inner pinion bearing cone as shown.

Tools: DD-914-P Press,
DD-914-9 Adapter Ring,
C-293-39 Adapter Set.

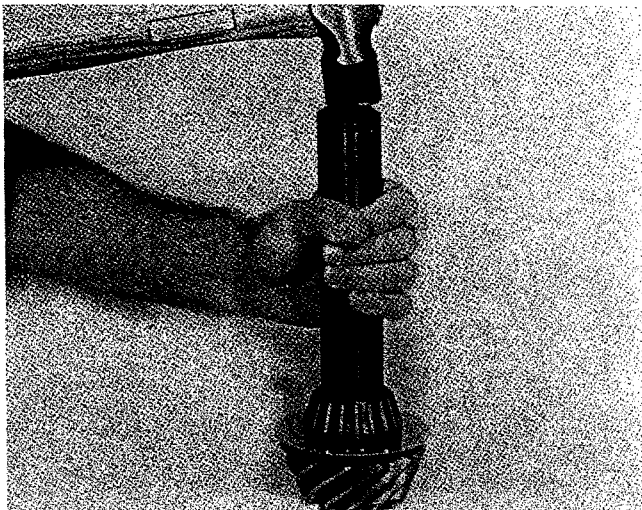

Figure 82

1020-82

If an inner pinion slinger is used, assemble the slinger and then the inner pinion bearing cone onto the pinion. Drive the bearing on the shaft until it is completely seated.

Tool: W-262 Installer.

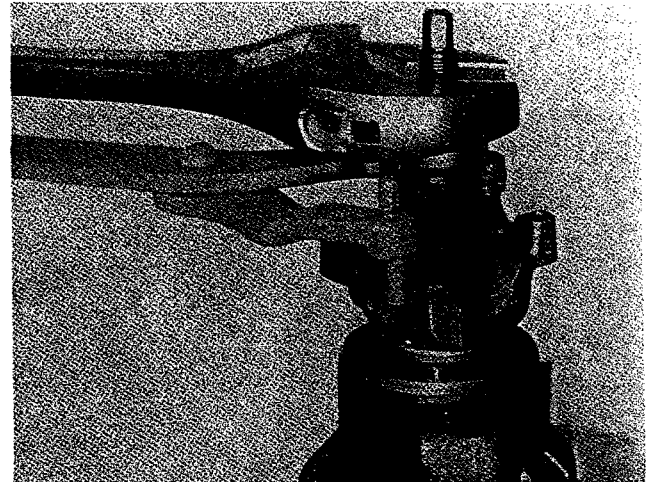

Figure 83

1020-83

Insert the pinion into the carrier.

Assemble the outer pinion bearing cone, slinger and end yoke onto the pinion spline. Do not assemble the oil seal and pinion bearing preload shims at this time.

Use the yoke installer (as shown) to draw the end yoke onto the pinion spline.

Tools: W-162 Installer,
C-3281 Holder.

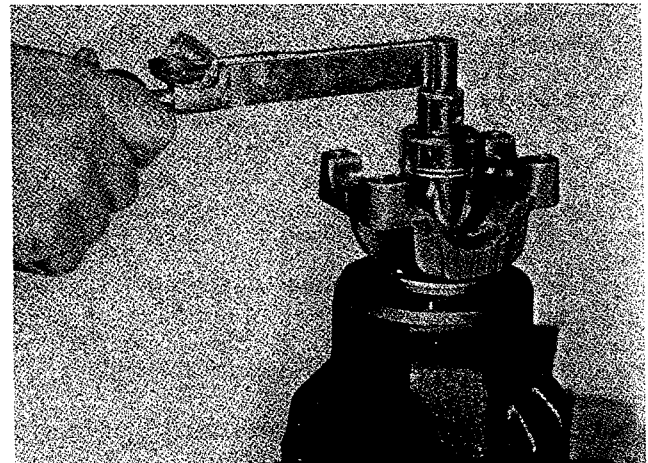

Figure 84

1020-84

Assemble the washer and pinion nut. Torque the nut until it requires 10 lbs. in. (1.1 N•m) to rotate the pinion. Rotate the pinion several revolutions before checking the pinion position. This is done to seat the bearings and assure a more accurate reading.

NOTE

The reason for not assembling the pinion oil seal and preload shims at this time is due to the possibility of having to adjust pinion bearing preload or pinion position. It would be necessary to again remove the oil seal; and as mentioned, whenever seals are removed, they are to be replaced with new ones.

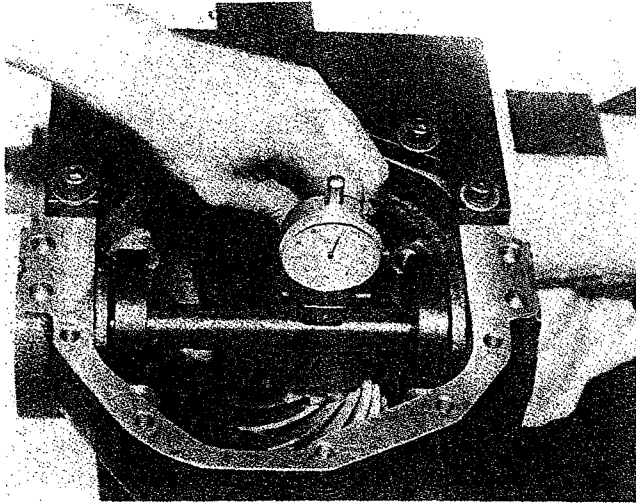

Figure 85

1020-85

Place the arbor discs and arbor into the cross bore of the carrier. Place the pinion height block on the button end of the pinion. Set the dial indicator of the scooter gage at zero (0). Slide the scooter gage towards the arbor. As discussed in Figure 76, the indicator will show the greatest clockwise reading when it is at the top center of arbor. This reading indicates the position of the pinion.

An indicator reading within .002" (.05mm) of the etching on the pinion is considered acceptable. If the pinion position is not within plus or minus (\pm).002" (\pm .05 mm) of the etching on the button of the pinion, refer to the pinion setting chart in Figures 69 or 70 as a guide to how much change in the shim stack is needed to position the pinion properly.

For example: If the etch on the button of the pinion is +2 ($m\pm 5$) and the indicator reading is -.003" (-.08 mm), the pinion is installed too close to the centerline of the differential crossbore. It is not within the acceptable tolerance of \pm .002" (\pm .005 mm) of the pinion etch. Referring to the chart in Figures 69 or 70, in order to move from a position of -3 (-8) to the correct position of +2 (+5), we need to remove .005" (.13mm) of shims from the shim stack.

Follow the recommended procedures for removing the shim stack and make the change. Reinstall the pinion according to Figure 83 to 84.

Tools: D-115-3 Arbor,
D-115-4 Arbor Discs,
D-115-1 Pinion Height Block,
D-115-2 Scooter Gage.

When the pinion position is within the acceptable tolerance of \pm .002" (\pm .05 mm) of the pinion etch, remove the pinion nut, washer, end yoke, slinger, outer pinion bearing cone and the pinion. Lubricate the inner and outer bearings by applying a small amount of the specified lube on the rollers of the bearing cone.

Model 44 axles which use a pinion oil baffle require the pinion be installed into the carrier before the preload shims are assembled onto the pinion. Insert the pinion into the carrier, and hold in place. Assemble the preload shims, which are equal in thickness to the stack height of the original preload shims removed during disassembly, onto the pinion.

Install the outer pinion bearing cone, outer slinger and end yoke onto the pinion. Use the yoke installer as shown in Figure 83. Assemble a washer and pinion nut and torque the pinion nut to 200-220 lbs.-ft. (271-298 N•m). Using an inch pound torque wrench, as shown in Figure 84, measure the preload on the pinion bearings. The rotating torque of the pinion should read 20-40 lbs.-in. (2.3-4.5 N•m) with new bearings. To increase preload, remove shims; to decrease preload, add shims. Remove the pinion nut, washer and end yoke as shown in Figures 54 and 55.

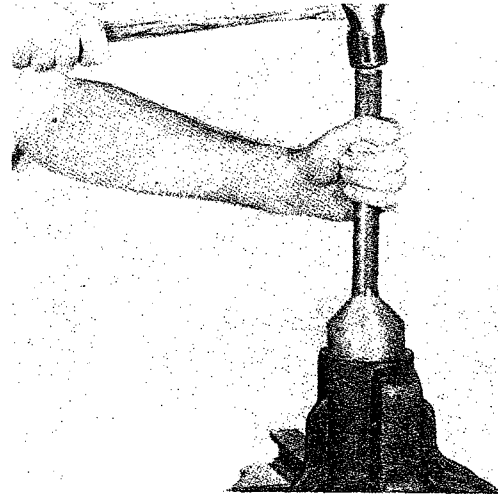

Figure 86

1020-86

Apply a light coat of hypoid lubricant to the lip of the pinion oil seal and assemble into the housing.

Tools: W-147-D Seal Installer,
C-4171 Handle.

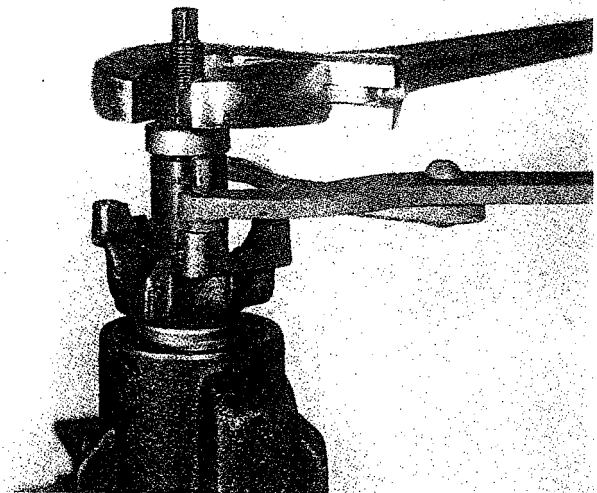

Figure 87

1020-87

Assemble the end yoke, washer and a new pinion nut.

Tools: W-162 Installer
C-3281 Holder

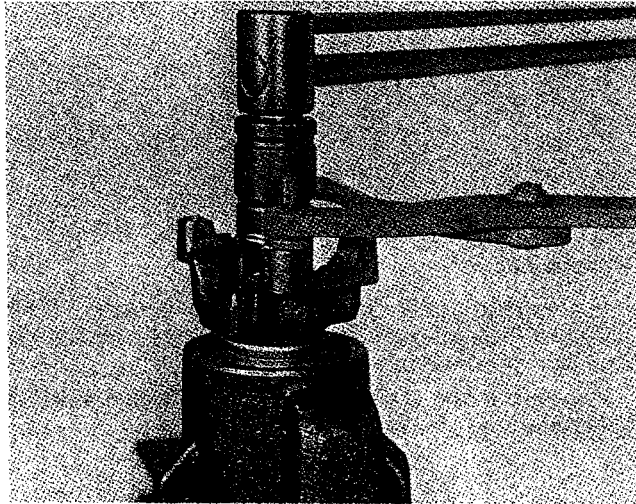

Figure 88 1020-88

Torque pinion nut to 200-220 lbs. ft. (271-298 N•m).

Tools: C-4053 Torque Wrench,
C-3281 Holder.

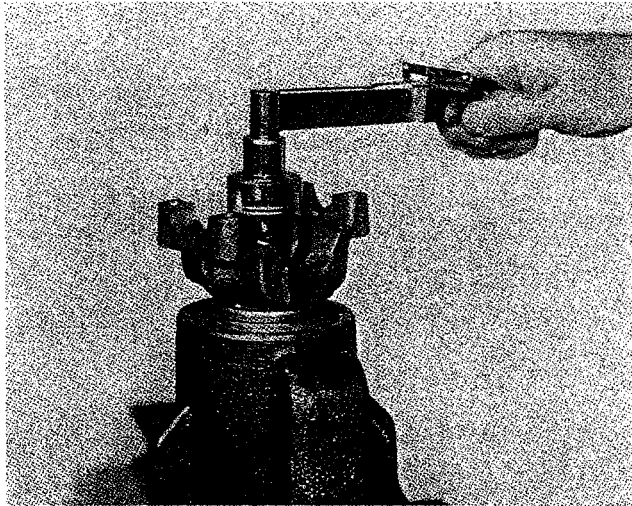

Figure 89 1020-89

Using an inch pound torque wrench as shown, rotating torque of pinion should read 20-40 lbs. in. (2.3-4.5 N•m) with new bearings. To increase preload, remove shims; to decrease preload, add shims.

Tool: D-193 Torque Wrench.

NOTE

If a limited slip differential is used, refer to the proper limited slip differential service manual.

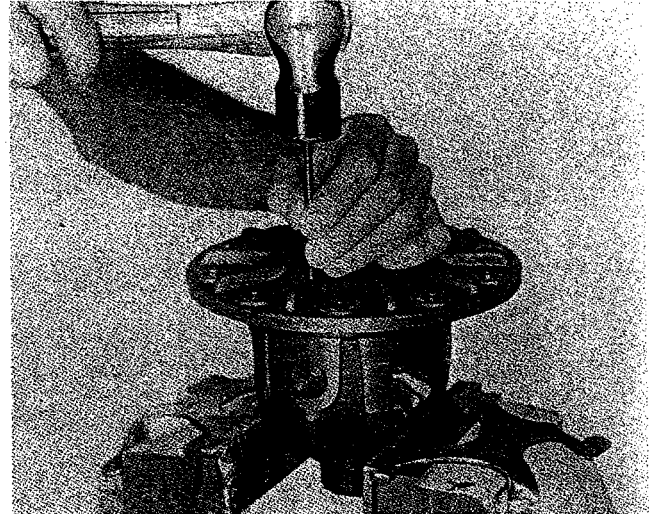

Figure 90 1020-90

Position the differential case in a vise and drive out the lock pin which secures the pinion mate shaft to the case. Use a small drift as shown.

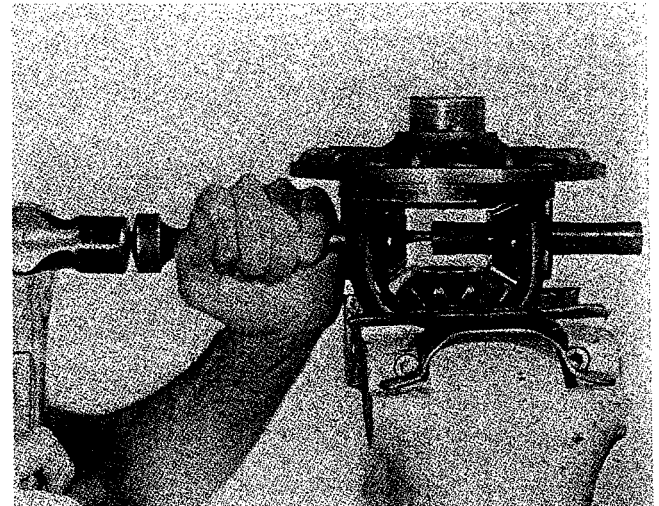

Figure 91 1020-91

Remove the pinion mate shaft with a drift as shown.

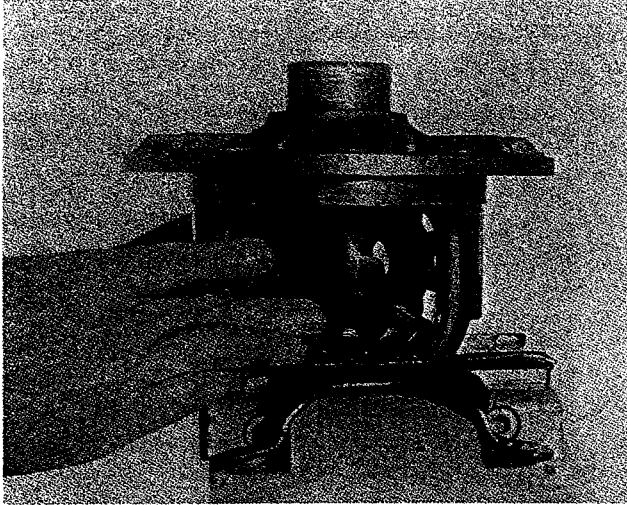

Figure 92

1020-92

Rotate the pinion mate gears and side gears until the pinion mates turn to the windows of the case. Remove the pinion mate gears and spherical washers. Lift the side gears and thrust washers out of the case. Inspect all the parts, including the machined surfaces of the case. If excessive wear is visible on all the parts, it is suggested that the complete differential assembly is replaced. If any one of the gears need replaced, then both gears are to be replaced as a set.

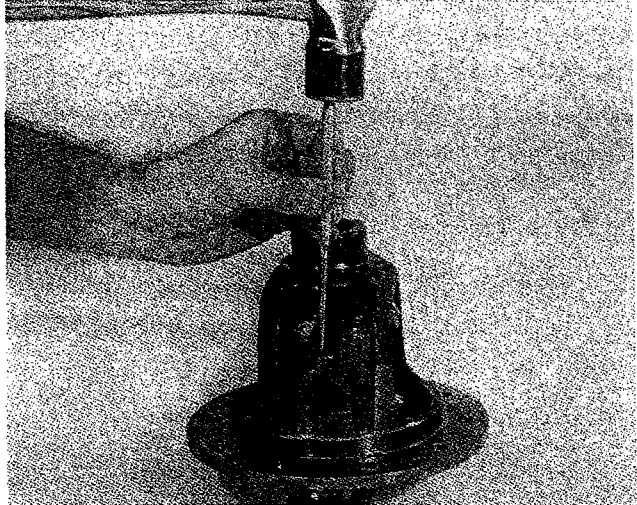

Figure 94

1020-94

Assemble the pinion mate shaft. Make sure the lock pin hole in the shaft lines exactly with the lock pin hole in the case.

Assemble the lock pin. Peen some metal of the case over the pin to lock it in place.

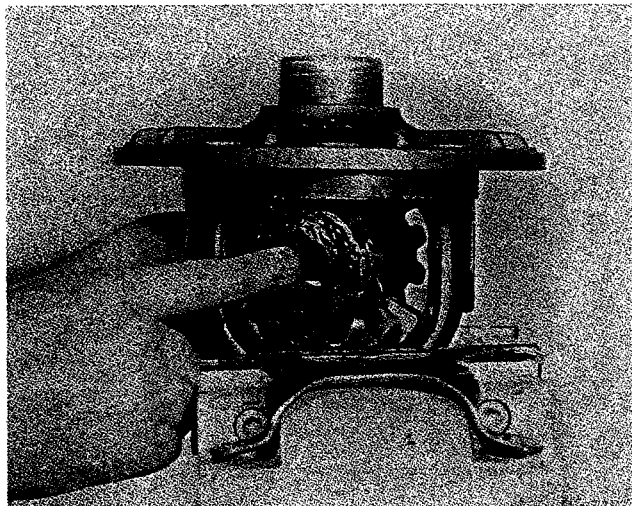

Figure 93

1020-93

Place the differential case in a vise. Apply a good quality grease to the new side gear thrust washers and to the hub and thrust face of the new side gears, and assemble into the case. Lubricate the new pinion mate gears and spherical washer. Hold the side gears in place with one hand, and assemble the pinion mate gears and spherical washers with the other hand. Rotate the side gears and pinion mate gears until the holes of the washers and pinion mate gears line up exactly with the holes in the case.

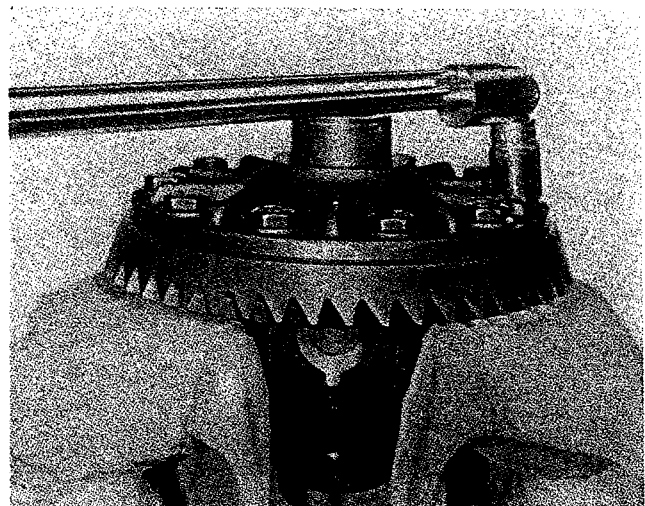

Figure 95

1020-95

Be sure flange face of the differential case is free of nicks or burrs. Assemble ring gear to differential case, using new ring gear screws. Draw up screws alternately and evenly.

Torque screws to 45-60 lbs. ft. (61-81 N•m).

Tool: C-3952-A Torque Wrench.

INSTALLATION OF DIFFERENTIAL

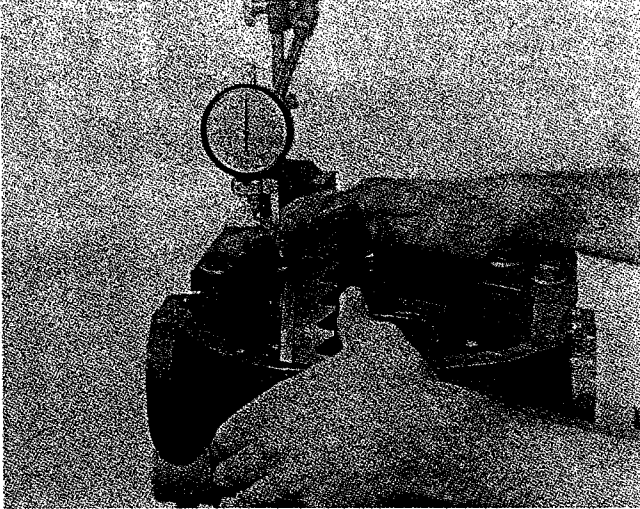

Figure 96

1020-96

Install master differential bearings onto case. Remove all nicks, burrs, dirt, etc., from hubs to allow master bearings to rotate freely.

Place differential assembly into the carrier.

Set up dial indicator as shown. Force the differential assembly away from the pinion gear until it is completely seated against the cross bore face of the carrier. With force still applied to the differential case, place tip of dial indicator on a flat machined surface of the differential case, if available, or on the head of a ring gear screw, and set the indicator at zero (0).

Tools: D-128 Dial Indicator,
D-135 Master Bearings.

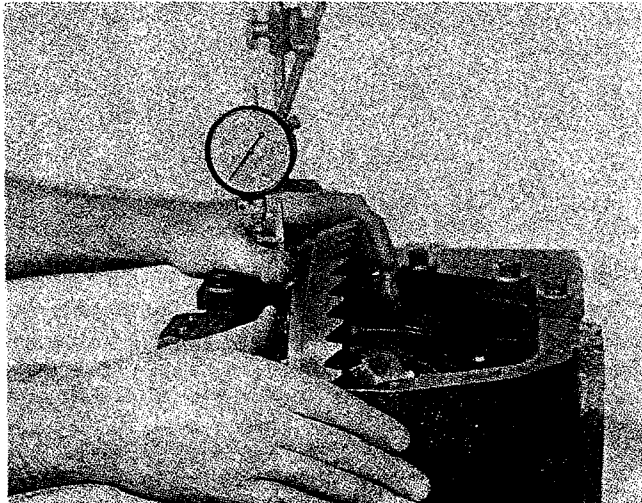

Figure 97

1020-97

Force ring gear to mesh with pinion gear. Rock ring gear slightly to make sure the gear teeth are meshed. Repeat this procedure several times until the same reading is obtained each time. Be sure the indicator reads zero (0) each time the ring gear is brought back against the cross bore face of the carrier. This reading will be the necessary amount of shims between the differential case and differential bearing on the ring gear side. Remove the dial indicator and the differential case from carrier. Remove master bearings from differential case.

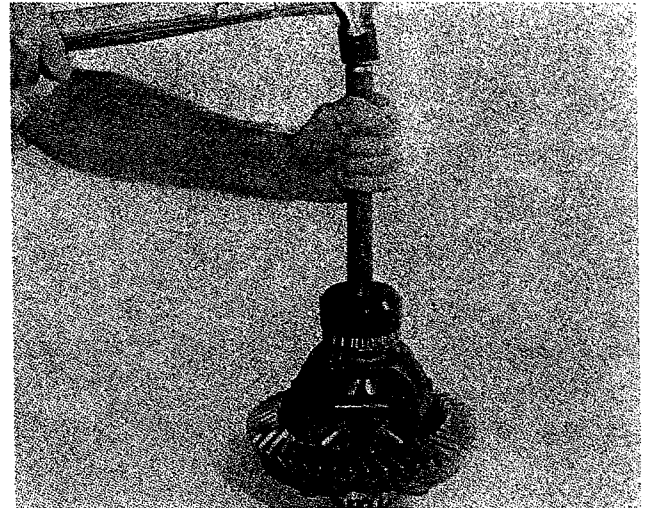

Figure 98

1020-98

Place the differential case onto step plate.

Assemble the required amount of shims to the ring gear side hub as determined in Figure 97. Place the bearing cone on the hub of the differential case. Use the bearing installer to seat the bearing cone.

The step plate is used to prevent possible damage to the hub and bearings while assembling bearing cones.

Tools: C-4487-1 Step Plate,
D-156 Installer,
C-4171 Handle.

Assemble the remaining shims of the total shim pack as determined in Figure 65. Add an additional .010" (.25 mm) to the remaining shims. Assemble the opposite side differential bearing cone as shown.

EXAMPLE: In Figure 65 a total of .077" (1.96 mm) was recorded. In Figure 97 a total of .059" (1.50 mm) was recorded.

This leaves a balance of .018" (.46 mm) for opposite side ring gear, and adds up to .077" (1.96 mm) which was obtained at the start.

To compensate for preload and backlash, add .010" (.25 mm) to the opposite side. The shim pack totals for this example are as follows:

Ring gear side: .059" (1.50 mm)

Opposite side: original balance of .018" (.46mm) plus .010" (.25 mm) gives .028" (.71 mm).

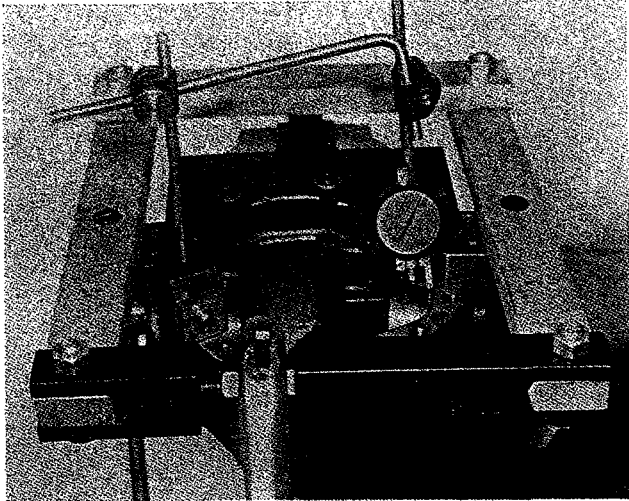

Figure 99

1020-99

Install spreader and indicator to carrier as shown. **DO NOT SPREAD CARRIER OVER .015" (.38mm).**

Tools: D-113 Spreader,
D-227 Spreader Adapters,
D-128 Dial Indicator Set.

Remove indicator.

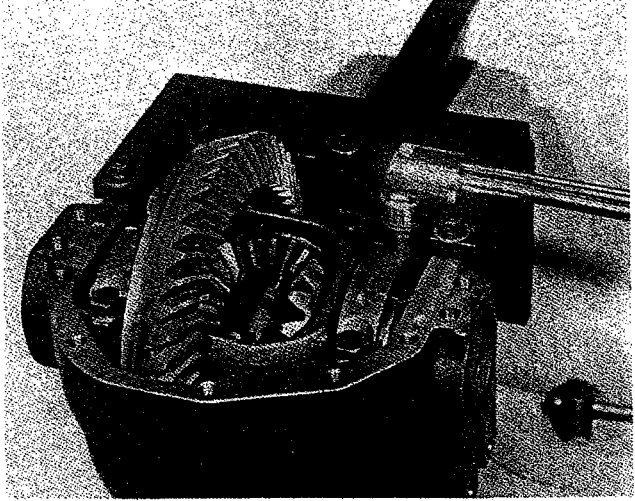

Figure 101

1020-101

Install the bearing caps and screws. Make sure the letters or numbers stamped on the caps correspond in both position and direction with the letters or numbers stamped into the carrier.

Torque the bearing cap screws to 80-90 Lbs. ft. (108-122 N•m).

Tool: C-3952-A Torque Wrench.

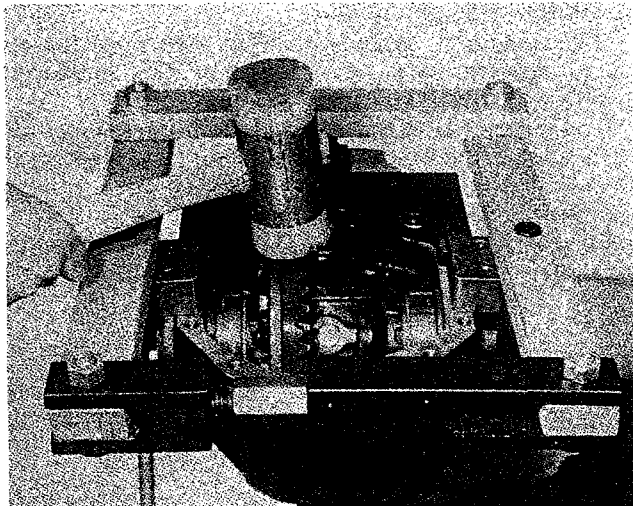

Figure 100

1020-100

Assemble differential bearing cups to differential bearing cones.

Install differential assembly into carrier.

Use a rawhide or heavy duty plastic hammer to seat differential assembly into cross bore of carrier. Care should be taken to avoid nicking the teeth of the ring gear or pinion during assembly.

Remove spreader.

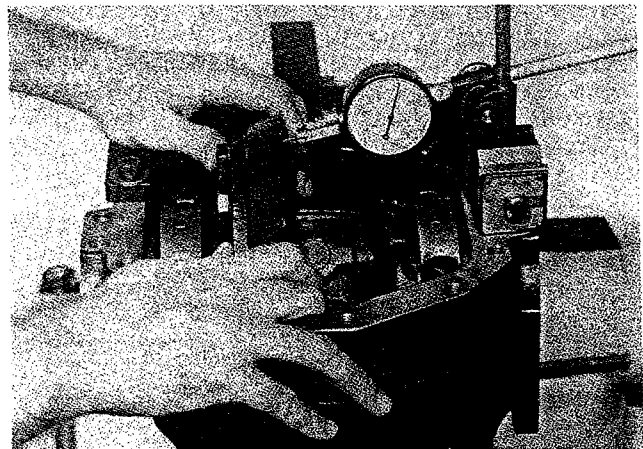

Figure 102

1020-102

Check ring gear and pinion backlash in three equally spaced points with a dial indicator as shown. Backlash tolerance is .005" (.13mm) to .009" (.23mm) and cannot vary more than .003" (.08mm) between points checked.

High backlash is corrected by moving shims from the opposite side of the differential case to the ring gear side; thus moving the ring gear closer to the pinion.

Low backlash is corrected by moving shims from the ring gear side of the differential case to the opposite side; thus moving the ring gear away from the pinion.

CAUTION

Before applying new silicone rubber sealer, make sure the carrier face and unitized support arm is clean and free of all foreign matter such as dirt, oil, and old silicone rubber sealant.

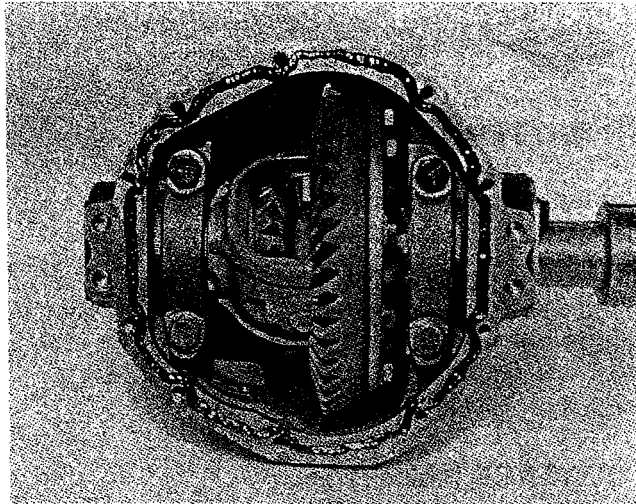

Figure 103

1020-103

The mating surfaces of the left hand unitized support arm and the carrier should be free of dirt, oil, etc. Apply the sealer to the carrier face as shown. The sealer bead is to be 1/8" (3.18mm) to 1/4" (6.35 mm) wide and should not pass through or outside of the holes.

Sealant material must meet specification of ASTM3, GE303, A19, B37, E16, E36, Z1, Z2, and Z3 sealant.

NOTE

Use of cleaning solvents may prevent the silicone rubber sealant from adhering to the carrier face and unitized support arm, resulting in leaks of axle lubricant.

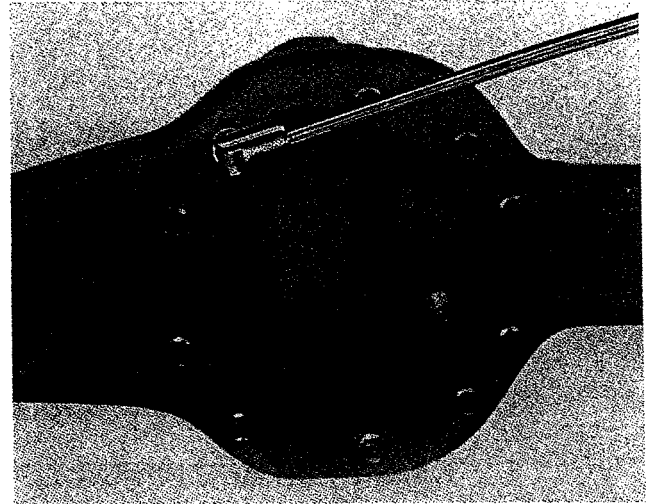

Figure 104

1020-104

Mount the carrier to the unitized support arm being careful not to smear the silicone rubber sealant material. Torque the cover screws to 30-40 lbs. ft. (41-54 N•m). Torque the (2) left hand support arm to carrier side tab screws. Early models used .375-16 screws while later models used .500-13 screws.

.375-16 screws—torque 30-40 Lbs.ft. (41-54 N•m).

.500-13 screws—torque 85-100 Lbs. ft. (115-136 N•m).

Allow one hour cure time before filling the unit with the proper hypoid lubricant.

When the carrier assembly is rebuilt to specifications, refer to the vehicle manufacturer's recommendations for the proper installation procedure into the vehicle.

Tool: C-3952-A Torque Wrench.

SPICER®



RING GEAR & PINION TOOTH PATTERN INTERPRETATION

When setting the pinion position, many of the service manuals required a final pinion position check by using gauges that verified the dimension from the center line of the differential carrier (center line of ring gear) to the face of the pinion (button).

This surface (button) is not used on all new gears for verifying the pinion position. The service tools will be used to establish the proper amount of shims required prior to installing the pinion gear. The final pinion position will be verified by using the GEAR CONTACT PATTERN METHOD, as described in this bulletin.

RING GEAR AND PINION TOOTH CONTACT PATTERN

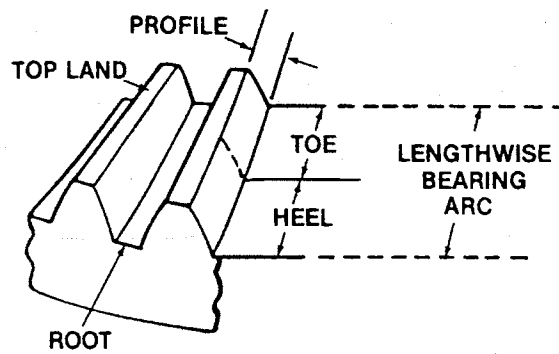

Figure 1 - RING GEAR TOOTH

The TOE of the gear tooth is the portion of the tooth surface at the end towards the center. The HEEL of the gear tooth is the portion of the tooth surface at the outer end. The TOP LAND of a gear tooth is the surface of the top of the tooth. Every gear has a characteristic pattern. The illustrations show typical patterns only, and explains how patterns shift as gear location is changed. When making pinion position changes, shims should be changed in the range of .002 inch (.05 mm) to .004 inch (.10 mm) until correct pattern has been obtained.

When a change in backlash is required, backlash shims should be changed in the range of 1-1/2 times the amount of backlash required to bring the gears into specification. For example, if the backlash needed to be changed by .004 inch (.10 mm), the shim pack should be changed by .006 inch (.15 mm) as a starting point. The actual amount of backlash change obtained will vary depending upon the ratio and gear size.

High backlash is corrected by moving the ring gear closer to the pinion. Low backlash is corrected by moving the ring gear away from the pinion. These corrections are made by switching shims from one side of the differential case to the other.

NOTE

When making changes, note that two variables are involved. Example: If you have the backlash set correctly to specifications and you change the pinion position shim, you may have to readjust the backlash to the correct specification before checking the pattern. Refer to pattern interpretation.



WARNING: Gear teeth may have sharp edges. When handling gears, use care to avoid personal injury.

STEPS

- (1) Paint ring gear teeth with a marking compound to both the drive and coast side.
- (2) Rotate ring gear one complete revolution in both directions while load is being applied with a large screwdriver or similar tool between the carrier casting and differential case flange.

PATTERN INTERPRETATION (RING GEAR)

DRIVE SIDE COAST SIDE
HEEL TOE TOE HEEL



Normal or desirable pattern. The drive pattern should be centered on the tooth. The coast pattern should be centered on the tooth, but may be slightly toward the toe. There should be some clearance between the pattern and the top of the tooth.



Backlash correct. Thinner pinion position shim required.



Backlash correct. Thicker pinion position shim required.



Pinion position shim correct. Decrease backlash.



Pinion position shim correct. Increase backlash.

PATTERN MOVEMENTS SUMMARIZED

- (1) Decreasing backlash moves the ring gear closer to the pinion.
Drive pattern (convex side of gear) moves slightly lower and toward the toe.
Coast pattern (concave side of gear) moves lower and toward the toe.
- (2) Increasing backlash moves the ring gear away from the pinion.
Drive pattern moves slightly higher and toward the heel.
Coast pattern moves higher and towards the heel.
- (3) Thicker pinion position shim with the backlash constant moves the pinion closer to the ring gear.
Drive pattern moves deeper on the tooth (flank contact) and slightly toward the toe.
Coast pattern moves deeper on the tooth and toward the heel.
- (4) Thinner pinion position shim with the backlash constant moves the pinion further from the ring gear.
Drive pattern moves toward the top of the tooth (face contact) and toward the heel.
Coast pattern moves toward the top of the tooth and slightly toward the toe.