

SPICER[®] AXLE

MAINTENANCE MANUAL

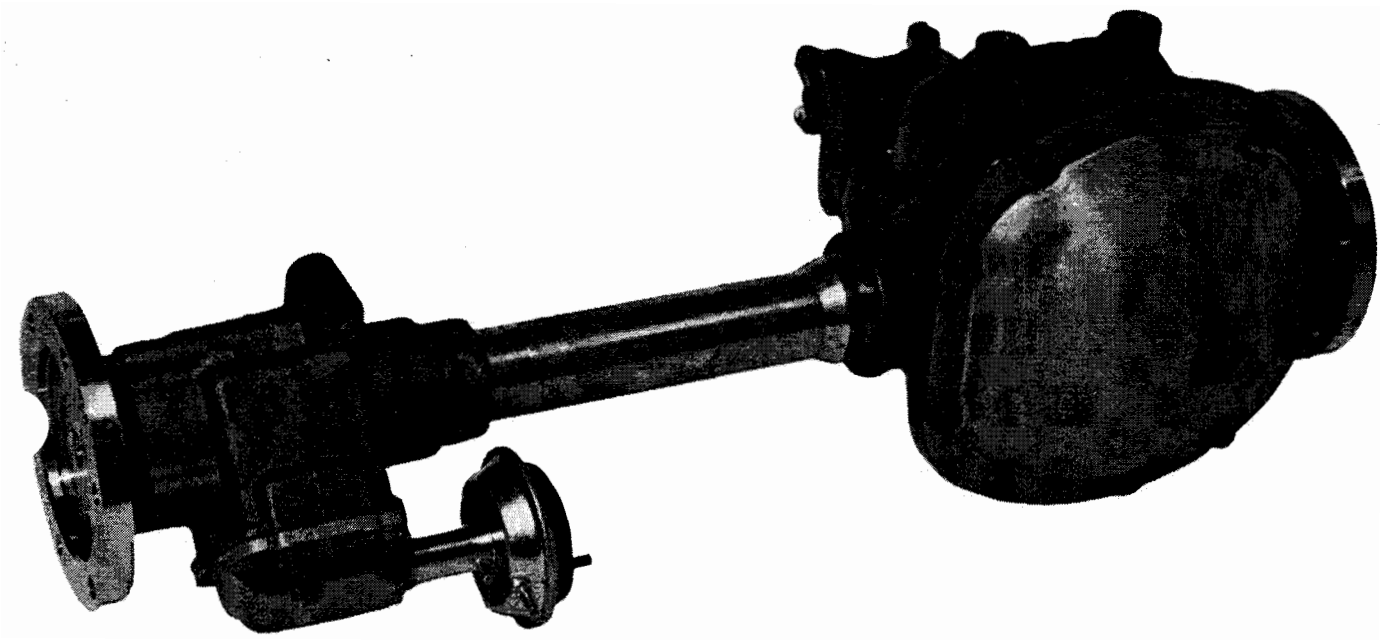

**MODEL 30 FRONT
DISCONNECT SUPPLEMENT**

FORWARD

This manual has been prepared as a supplement to the Spicer Axle Maintenance Manual, Model 30 Front, bulletin number 5325. This manual provides service procedures for servicing the disconnect unit of the axle assembly. For all other service procedures, refer to the Spicer Axle Maintenance Manual, Model 30, bulletin number 5325.

INDEX

	Page
LUBRICATION	3
SPECIAL SERVICE TOOLS	4
AXLE IDENTIFICATION	5
EXPLODED VIEW OF DISCONNECT COMPONENTS	5
SERVICE PROCEDURES	6
SERVICING SHIFT MOTOR ASSEMBLY	
Disassembly	6
Reassembly	8
SERVICING AXLE SHAFT, SEAL, UNIT BEARINGS AND	
OUTER DISCONNECT GEARS	8
SERVICING INTERMEDIATE SHAFT AND BEARING	
ASSEMBLY, AND CLUTCH COLLAR	12

IMPORTANT SAFETY NOTICE

Proper service and repair is important to the safe, reliable operation of all motor vehicles or driving axles whether they be front or rear. The service procedures recommended and described in this maintenance manual are effective methods for performing service operations. Some of these service operations require the use of tools specially designed for the purpose. The special tool should be used when and as recommended.

It is impossible to know, evaluate, and advise the service trade of all conceivable ways in which service might be done or of the possible hazardous consequences of each way.

Accordingly, anyone who uses a service procedure or tool which is not recommended, must first satisfy himself thoroughly that neither his safety nor vehicle safety will be jeopardized by the service methods he selects. The procedures described in this manual will consider the axle assembly removed from the vehicle. Consult the Original Equipment Manufacturers recommendations and procedures for proper axle removal and installation.

Should an axle assembly require component parts replacement, it is recommended that "original equipment" replacement parts be used. They may be obtained through your local service dealer or other original equipment manufacturer parts supplier. The use of non-original equipment replacement parts is not recommended as their use may cause unit failure and/or effect vehicle safety.

NOTE

Throughout this manual, reference is made to certain tool numbers whenever special tools are required. These numbers are numbers of Miller Special Tools, 32615 Park Lane, Garden City, Michigan 48135. They are used herein for customer convenience only. Dana makes no warranty or representation to these tools.

LUBRICATION

It is not our intent to recommend any particular brand or make of lubricant for the Spicer hypoid axles. However, a S.A.E. 90 weight multipurpose gear lubricant meeting Mil. Spec. L-2105-B, or 80 W 90 multipurpose gear lubricant meeting Mil. Spec. L-2105-C, and suitable for A.P.I. Service Classification GL-5 is suggested as a minimum requirement.

SHAFT BEARING LUBRICATION

Shaft bearings are lubricated with the hypoid gear lube in the housing. To eliminate any risk of damage prior to gear lube circulation reaching the shaft bearings, they must be packed with grease. For grease packing it is recommended that a number 2 consistency, lithium base, 12 Hydroxy Stearate Grease containing an E.P. additive be used.

COLD WEATHER OPERATION

If the vehicle is operated below 0°F (-18°C), it is advisable to use S.A.E. 80 Multi-Purpose Gear Lubricant meeting Mil. Spec. L-2105-B, and suitable for A.P.I. Service Classification GL-5.

SUBMERSION OR DEEP WATER FORDING

In the event the gear carrier housing should become submerged in water, particularly if over the breathers, it is recommended that the hypoid gear lubricant be drained daily and internal parts be inspected for water damage and/or contamination.

Clean, examine, and if necessary, replace damaged parts, prior to assembling and refilling with the specified hypoid lubricant.

NOTE

It is recommended that whenever bearings are removed they are to be replaced with new ones regardless of mileage.

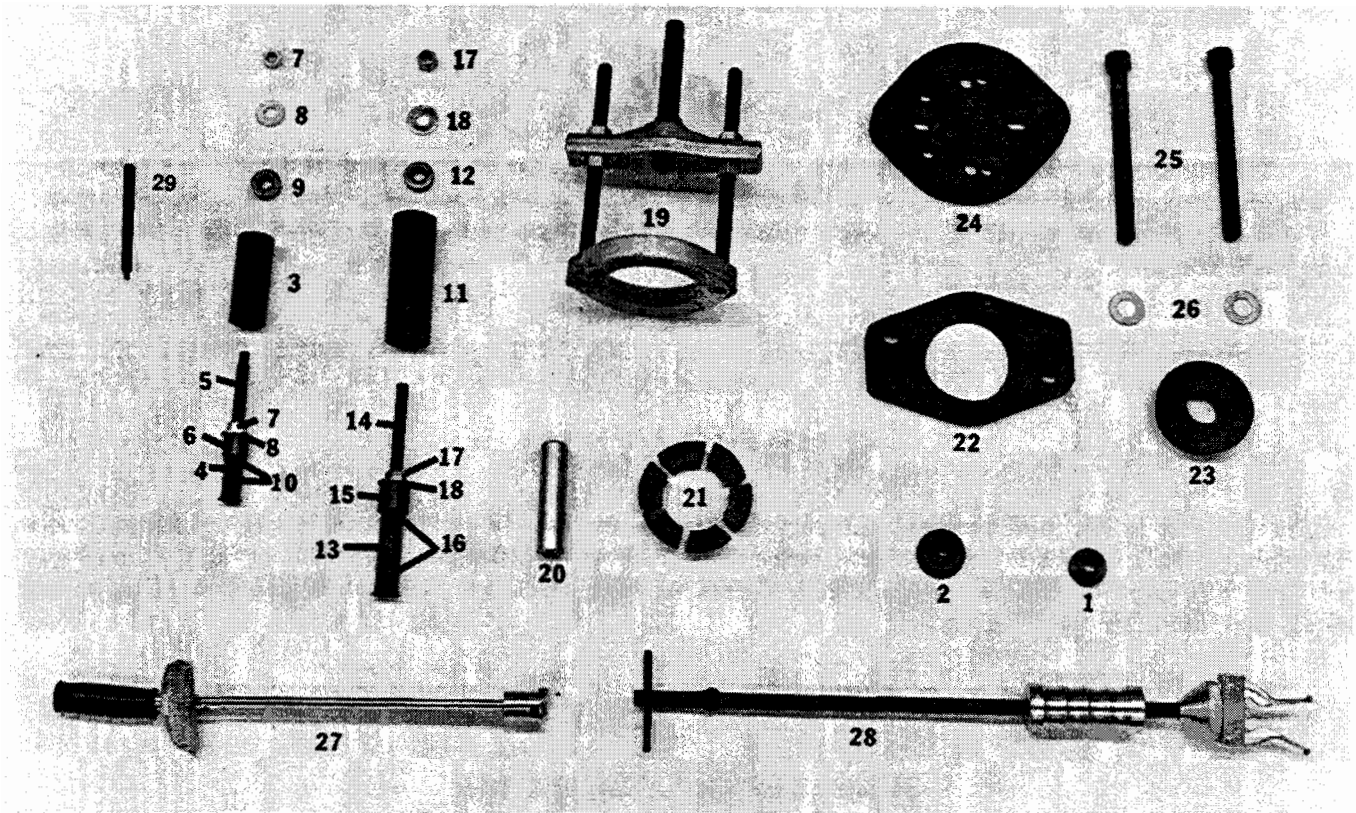

Figure 2

1021-2

SPECIAL SERVICE TOOLS

The following is a detailed list of all special tools required to service the Spicer Model 30 Disconnect Assembly.

Item No.	Tool No.	Description	Item No.	Tool No.	Description
	1	D-272	Installer - Needle bearing/ inner disconnect gear	** 16	L-4454-12 "O" Ring (2 required)
	2	D-274	Installer - Needle bearing disconnect housing	** 17	L-4454-13 Nut-Hex (2 required)
*	3	D-273-1	Receiver	** 18	L-4454-14 Washer (2 required)
*	4	D-273-2	Main body	19	C-293-PA Puller Press
*	5	D-273-3	Screw	20	DD-914-7 Extension
*	6	D-273-4	Cup-Main body	21	D-219 Adapters
*	7	D-273-5	Nut-Hex (2 required)	22	D-127-4 Forcing Plate
*	8	D-273-6	Washer (2 required)	23	D-127-1 Installer
*	9	D-273-7	Thrust bearing	24	D-127-2 Flange Platé
*	10	D-273-8	"O" Ring (2 required)	25	SP-5026 Screws (2 required)
**	11	D-275-1	Receiver	26	SP-3020 Washers (2 required)
**	12	L-4454-8	Thrust bearing	27	C-3952A Torque Wrench 150 lbs. ft.
**	13	L-4454-9	Main body	28	D-131 Slide Hammer
**	14	L-4454-10	Screw	29	C-4171 Handle
**	15	L-4454-11	Cup-Main body	*	D-273 Axle shaft bearing and seal remover tool set
				**	D-275 Disconnect housing bearing remover tool set

NOTE

Torque wrench C-3952A is optional and can be purchased separately. Torque wrenches are not included in the axle tool kits.

AXLE IDENTIFICATION

All Spicer axles are identified with a manufacturing date and the complete part number stamped in the right hand tube. Also, each axle contains a gear ratio tag.

Figure 3

In this figure the axle is identified with $\frac{1}{8}$ " (3.17mm) high numbers stamped in the tube. For Example: The manufacturing date or build date of the axle is interpreted as follows. The first number is the month, second number is the day of the month, the third number is the year, the letter is the shift, and the last number is the line that built the axle. The next number is the part number. The six digits reading from left to right is the basic number for identifying the particular axle assembly. The seventh digit following the dash will identify ratio, differential and end yoke options used in the assembly.

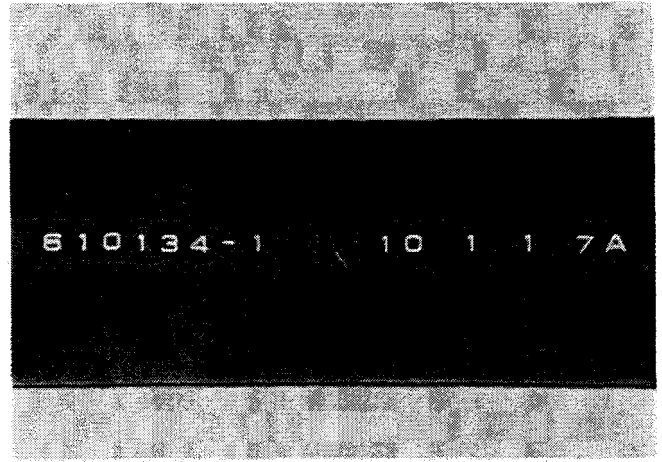

Figure 3

1021-3

NOTE

It is recommended that when referring to the axle, obtain the complete part number and build date. To do this, it may be necessary to wipe or scrape off the dirt etc. from the tube.

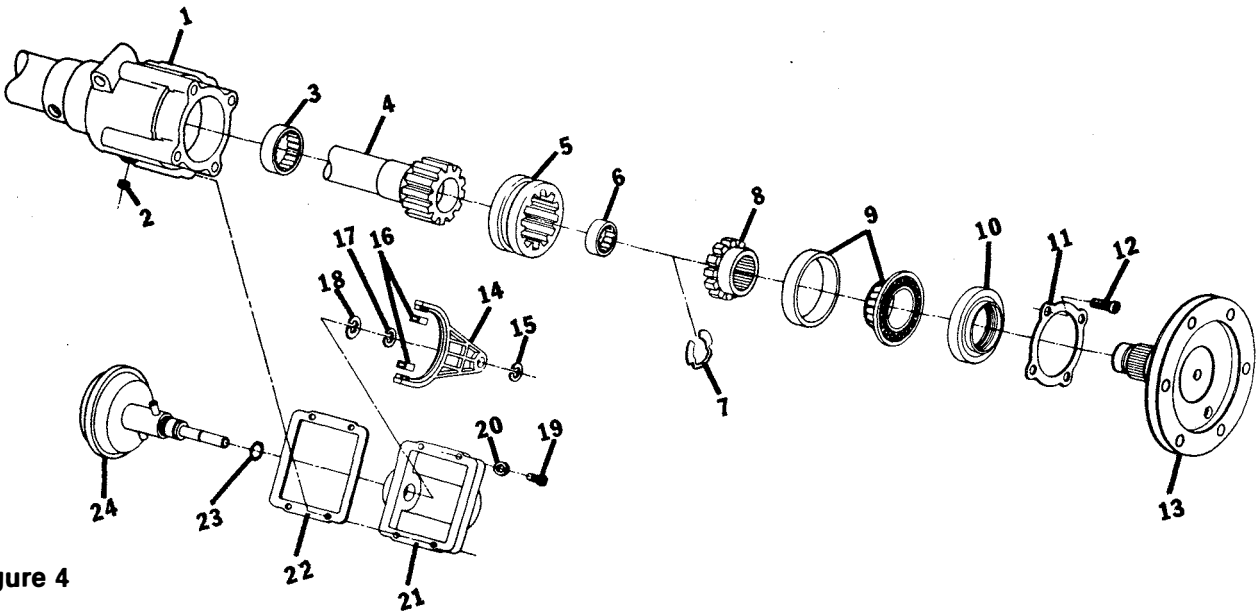

Figure 4

1021-4

ITEM	DESCRIPTION	ITEM	DESCRIPTION
1	Housing	13	Flanged Axle Shaft
2	Fill Plug	14	Shift Fork
3	Bearing Assembly	15	Snap Ring
4	Intermediate Shaft and Bearing Assy.	16	Shift Fork Clip
5	Clutch Collar	17	Snap Ring
6	Bearing Assembly	18	Snap Ring
7	Snap Ring	19	Cap Screw
8	Outer Disconnect Gear	20	Lock Washer
9	Bearing Assembly	21	Disconnect Housing Cover
10	Oil Seal	22	Disconnect Housing Gasket
11	Oil Seal Retainer	23	"O" Ring
12	Cap Screw	24	Motor Assembly (Vacuum)

SERVICE PROCEDURES

NOTE

Some of the service procedures will require the removal of the cover plate and axle shafts. Where vehicle installation restricts cover plate removal, refer to vehicle manufacturer's recommendations to remove entire axle housing and shaft assembly from the vehicle.

CAUTION

Do not apply vehicle weight to wheels without half-shaft assemblies in place and fasteners properly torqued. Refer to vehicle service manual for proper torque and service procedures.

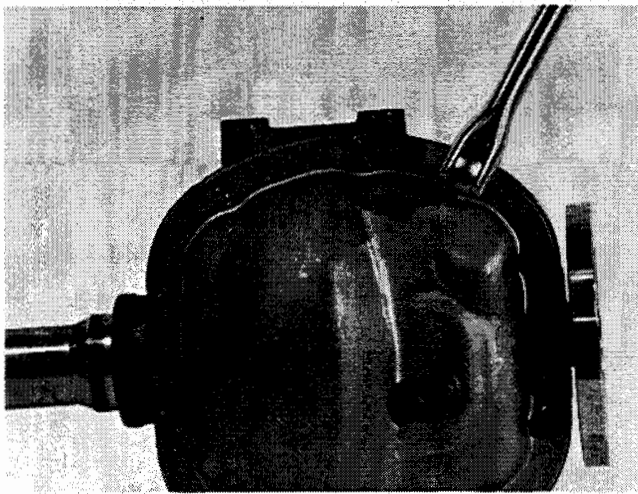

Figure 5

1021-5

Remove cover plate screws, cover plate, and gasket. Discard old gasket. Tip carrier to allow lube to drain completely.

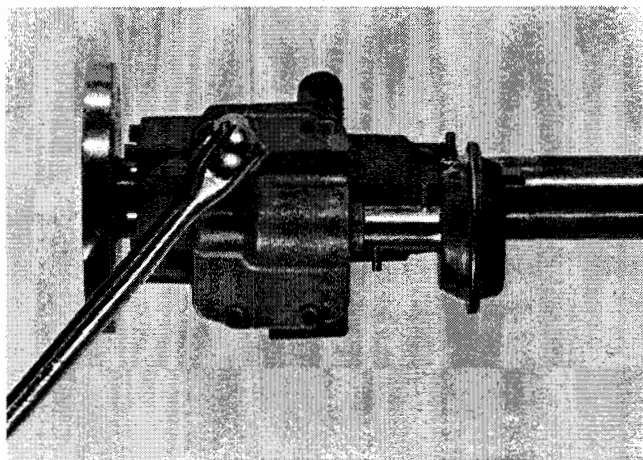

Figure 6

1021-6

Remove disconnect housing cover screws, housing cover and motor assembly and gasket. Discard old gasket. Tip carrier to allow lube to drain from disconnect housing.

SERVICING SHIFT MOTOR ASSEMBLY

DISASSEMBLY

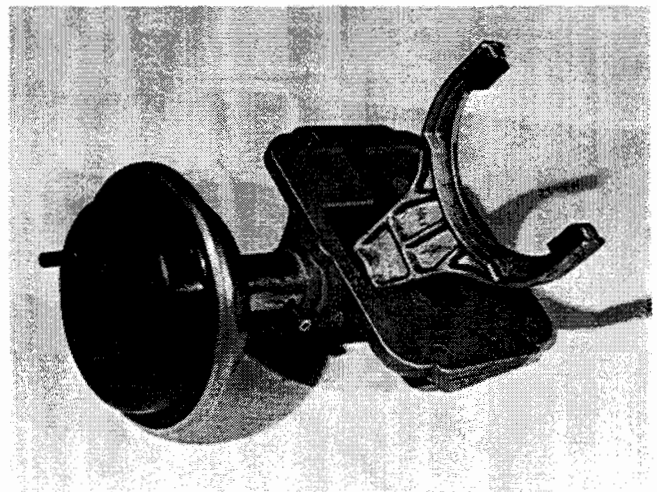

Figure 7

1021-7

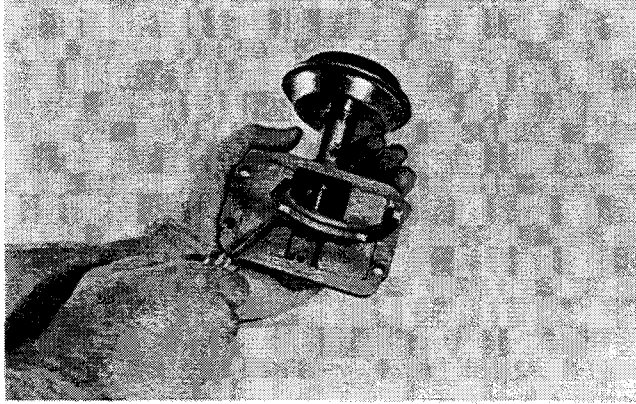

Figure 8 1021-8
Slide shift fork away from motor. Remove snap ring with screw driver or similar tool.

CAUTION
Eye protection should be worn when removing or installing the snap rings.

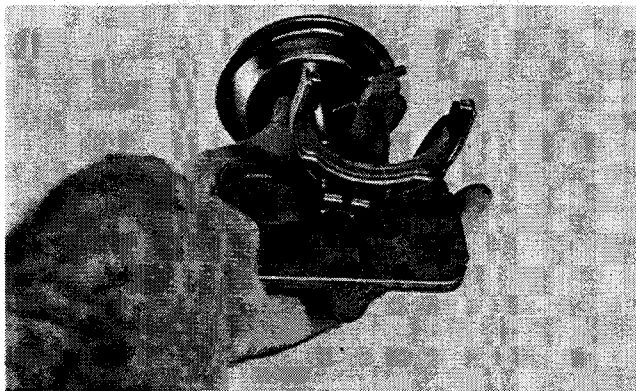

Figure 9 1021-9
Slide shift fork towards motor. Remove snap ring with screw driver or similar tool.

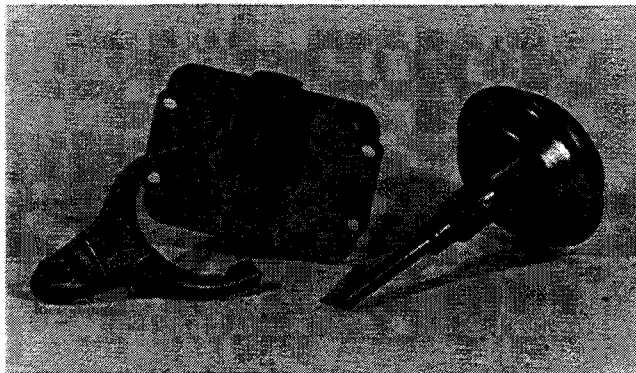

Figure 10 1021-10
Shift motor may now be pulled free from the shift fork and housing cover.

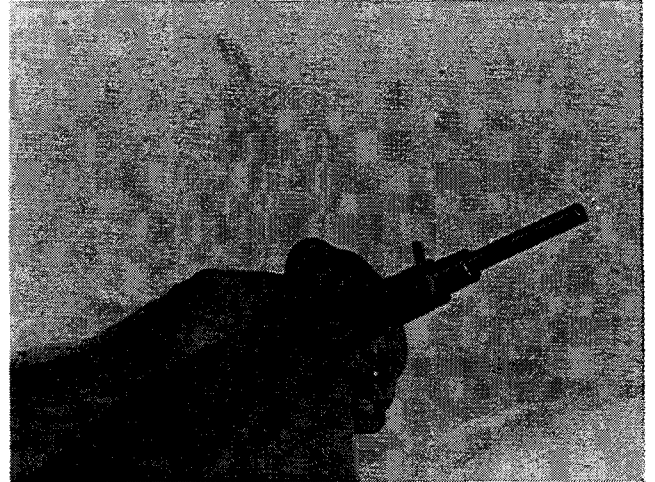

Figure 11 1021-11
Note "O" ring on motor shaft. "O" ring should be replaced with new one at time of reassembly.

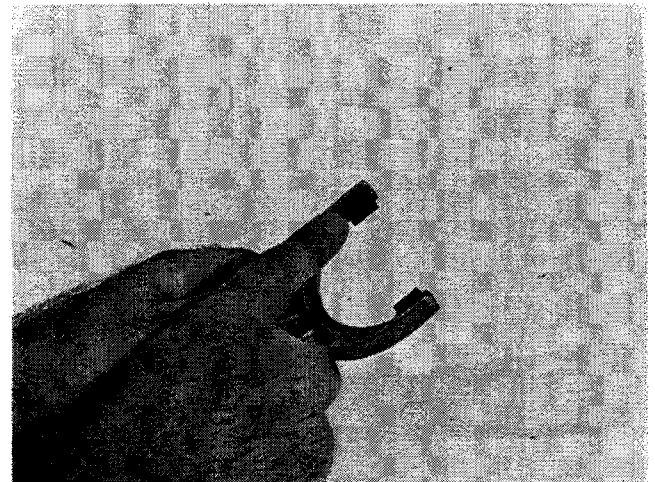

Figure 12 1021-12
Check pads on shift fork for wear. If excessive wear is evident, replace pads before reassembly.

NOTE
If shift motor is damaged or fails to operate, refer to the vehicle service manual.

REASSEMBLY

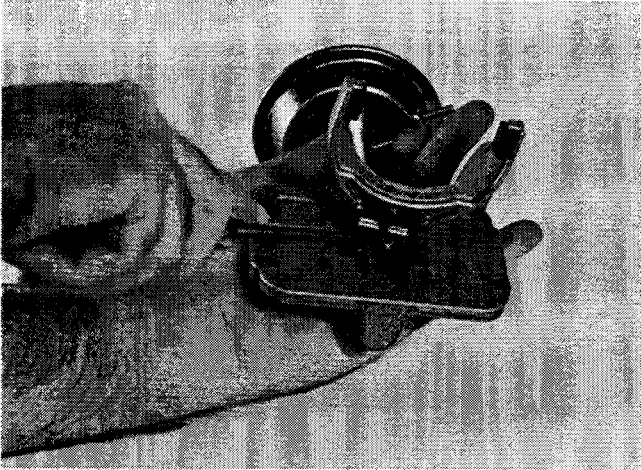

Figure 13

1021-13

After "O" ring has been replaced as shown in figure 11, and pads on shift fork as shown in figure 12, apply a small amount of Parker "O" ring lubricant to the "O" ring. Slide motor shaft into housing cover and hole in shift fork. Replace snap ring as shown.

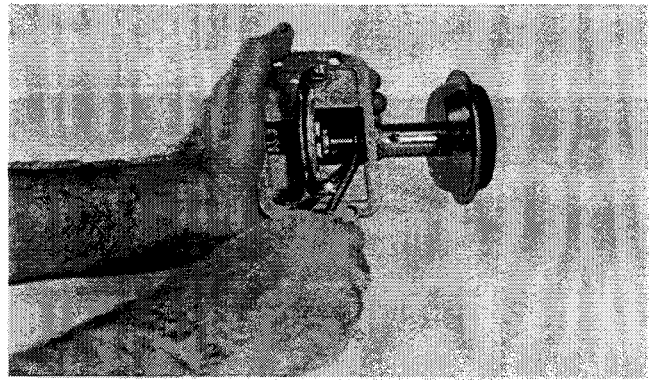

Figure 14

1021-14

Slide shift fork away from motor and replace snap ring as shown. Make sure snap rings seat into snap ring groove.

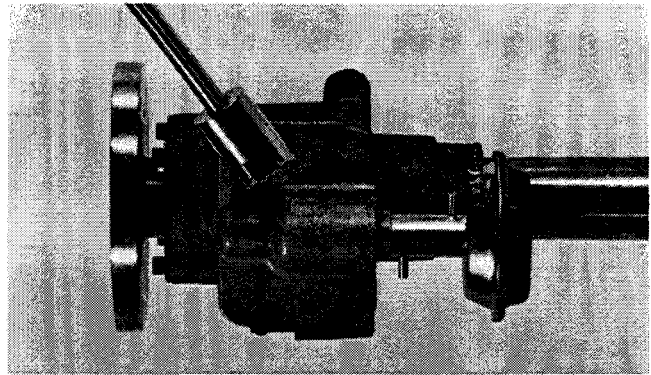

Figure 15

1021-15

Install housing cover and motor assembly. Install new housing cover gasket. Torque cover screws 84-108 lbs. in. (9.5-12.2 N·m).

SERVICING AXLE SHAFT, SEAL, UNIT BEARINGS AND OUTER DISCONNECT GEARS

Remove cover plate, disconnect housing cover, and motor assembly as described in figures 5 and 6.

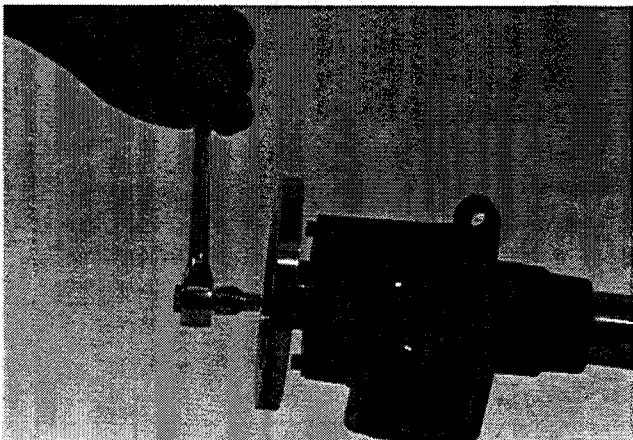

Figure 16

1021-16

Remove oil seal retainer plate cap screws.

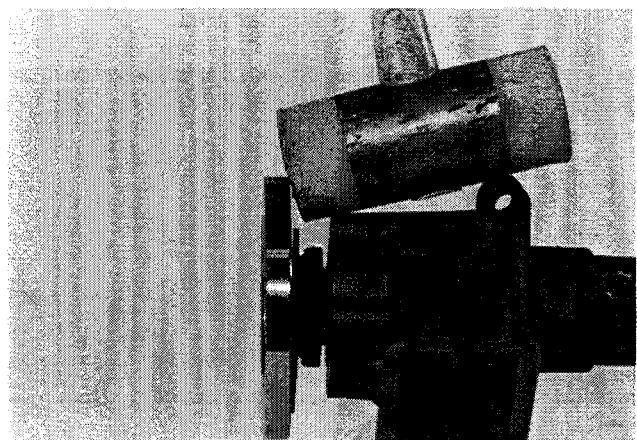

Figure 17

1021-17

Tap axle shaft flange with a plastic mallet, to loosen bearing assembly.

DISASSEMBLY OF UNIT BEARING, SEAL AND GEAR

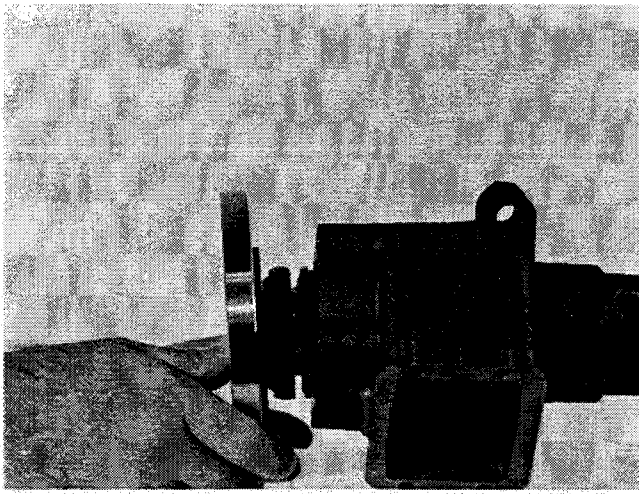

Figure 18

1021-18

Pull shaft and bearing assembly from housing.

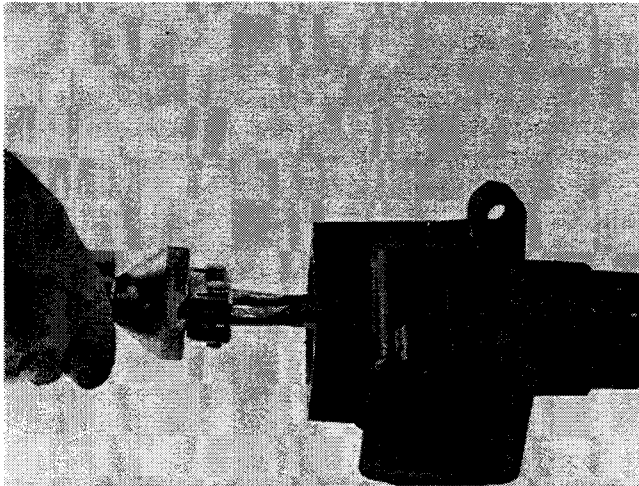

Figure 19

1021-19

Pull bearing cup from housing as shown.
Tool: D-131 Slide Hammer.

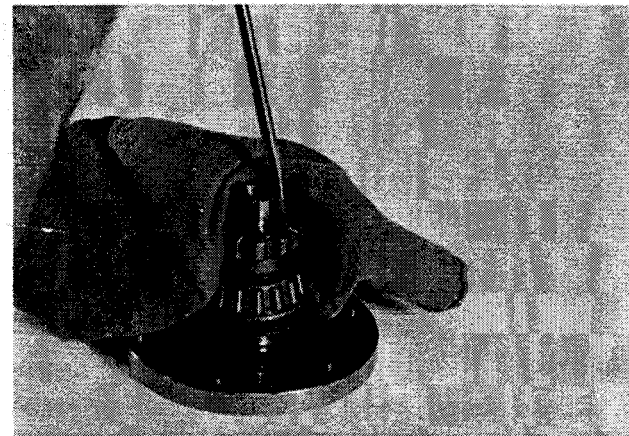

Figure 20

1021-20

Remove snap ring from flanged axle shaft. Place a shop towel around assembly to keep snap ring contained when being removed. Be careful not to mar or nick the machine surfaces of the axle shaft.

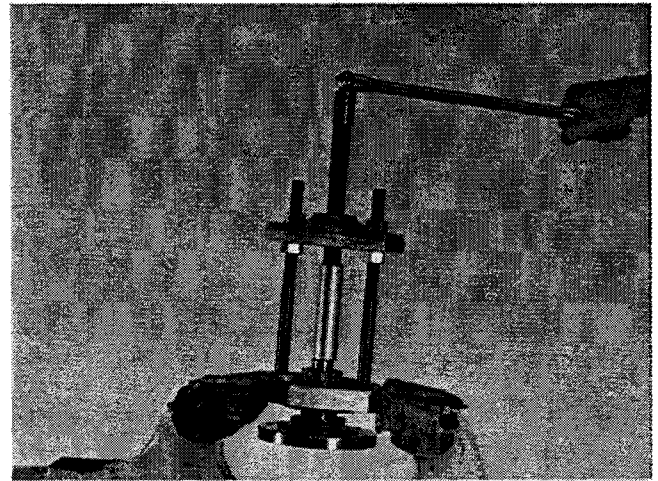

Figure 21

1021-21

Push retainer plate and seal towards the flange of the axle shaft. Position the axle shaft through the forcing plate, install the adapters between the forcing plate and the unit bearing. Tighten the forcing screw until the adapters draw tight to the bearing. Continue to tighten the forcing screw until the bearing cone and gear is removed from the axle shaft. Be careful not to mar or nick the machine surfaces of the axle shaft.

Tools: C-293-PA Puller Press
DD-914-7 Extension
D-219 Adapters

CAUTION

Do not heat or cut the bearing cone assembly with a torch. Damage to the axle shaft will result.

Remove seal and retainer plate and discard. Replace the seal and retainer plate with new ones at the time of assembly.

Inspect the machined surfaces of the axle shaft, particularly the seal and bearing diameters. Clean the axle shaft and carefully remove all nicks and burrs.

REASSEMBLY OF UNIT BEARING, SEAL AND GEAR

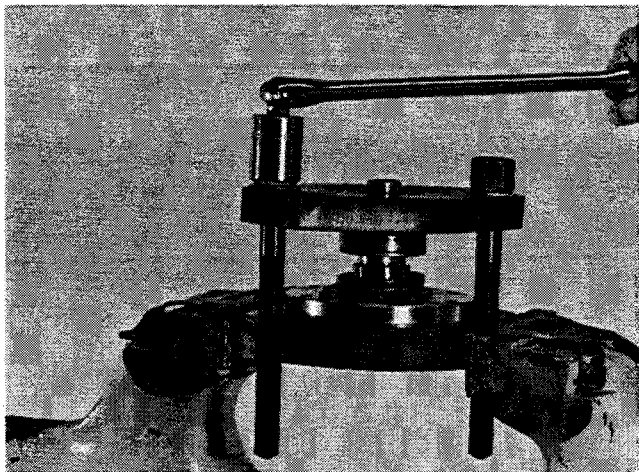

Figure 22

1021-22

Position the press in a vise. Assemble a new oil seal retainer plate, oil seal, and unit bearing assembly onto the axle shaft. The proper direction to install the unit bearing is to have the larger radius on the inner race towards the flange of the shaft. Make sure oil seal is reassembled the same direction as the one removed.

NOTE

The unit bearing is a complete pre-assembled bearing assembly consisting of cup, cup rib ring, cone, rollers, and cage. The cup and rib ring are bonded together to facilitate handling and installation. When the bearing is serviced, the cup will usually separate from the rib ring. Should separation occur, care should be taken so as not to damage the cone, rollers, and cage. Should damage occur to these parts, the bearing assembly must be replaced with a new one.

Install bolts and washer through the holes in the forcing plate and into the flange plate.

Tools: D-127-2 Flange Plate
D-127-4 Forcing Plate
D-127-1 Installer
SP-5026 Screws (2 required)
SP-3020 Washers (2 required)

Tighten bolts alternately and evenly, making sure bearing is not cocked on axle shaft. Continue until unit bearing is seated. To make sure bearing is seated, use a .0015 (.038mm) feeler gage between bearing seat and bearing. If gage enters, press bearing further on the axle shaft, until gage does not enter.

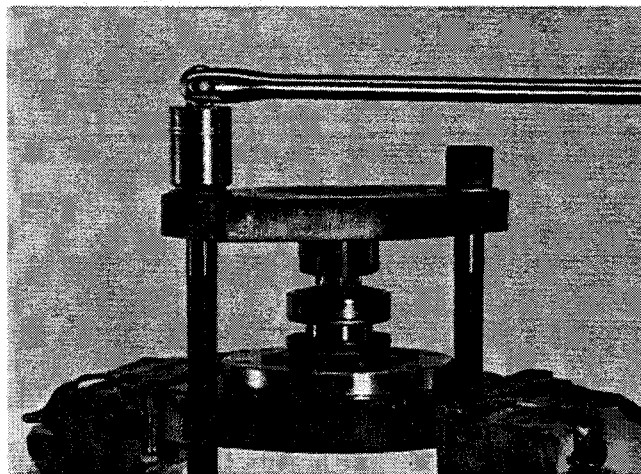

Figure 23

1021-23

After installing the unit bearing, loosen screws and back off so outer disconnect gear may be installed. Please note that some early designed models will have the gear as shown in figure 20. Later models will have the gear as shown in figure 23. This gear replaces and is interchangeable with the one shown in figure 20. Place gear on splined shaft with counterbore towards bearing. Tighten bolts alternately and evenly, forcing gear onto the splined shaft. Continue until the gear is seated against the bearing. To make sure gear is seated, use a .0015 (.038mm) feeler gage between the gear and the unit bearing. At least one point should exist where the gage will not enter between the gear and the bearing. If gage enters completely around the diameter, the gear must be pressed further onto the axle shaft.

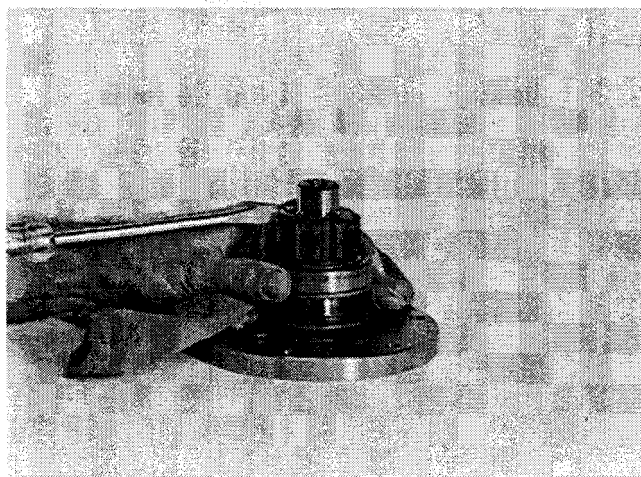

Figure 24

1021-24

Install snap ring in groove on flanged axle shaft as shown. Be careful not to mar or nick the machine surfaces of the axle shaft.

LUBRICATING NEW UNIT BEARING WITH GREASE

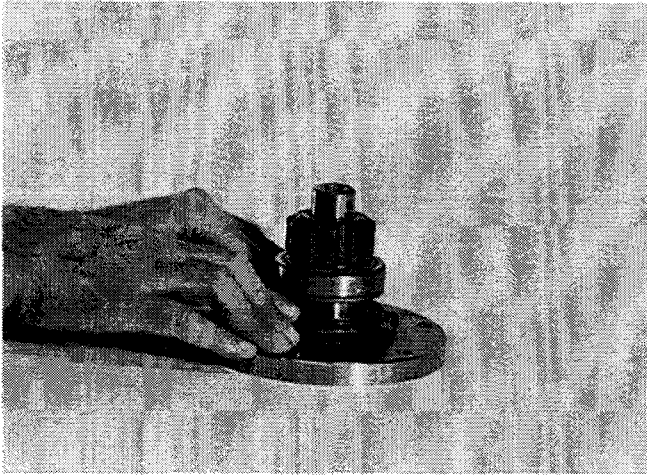

Figure 25

1021-25

Push seal and retainer away from bearing to allow a cavity between the seal and bearing.

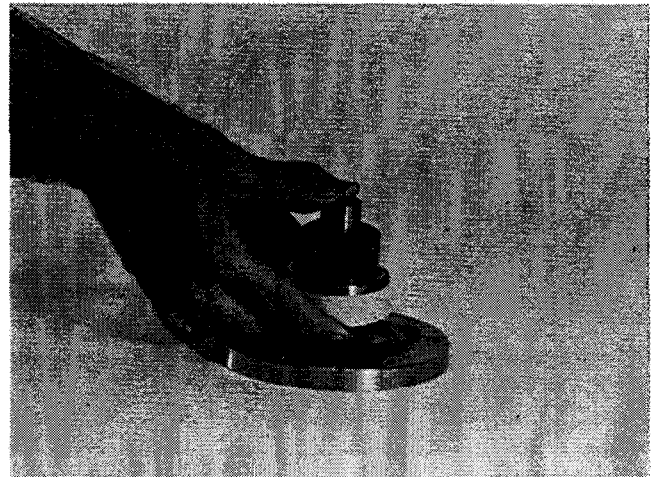

Figure 27

1021-27

After cavity is full of grease, wrap tape completely around rib ring and seal to enclose the cavity. Push seal towards the bearing until it contacts the rib ring. This will force the grease between the rollers and cup.

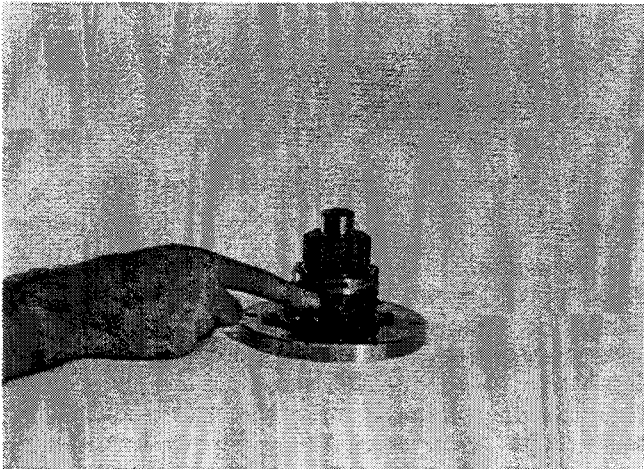

Figure 26

1021-26

Fill cavity with a good quality number 2 E.P. (extreme pressure), lithium soap wheel bearing grease.

NOTE

If grease is not apparent on the small ends of the rollers, repeat the same steps until grease is evident between the small end of the roller and cup. REMOVE TAPE.

SERVICING INTERMEDIATE SHAFT AND BEARING ASSEMBLY, AND CLUTCH COLLAR

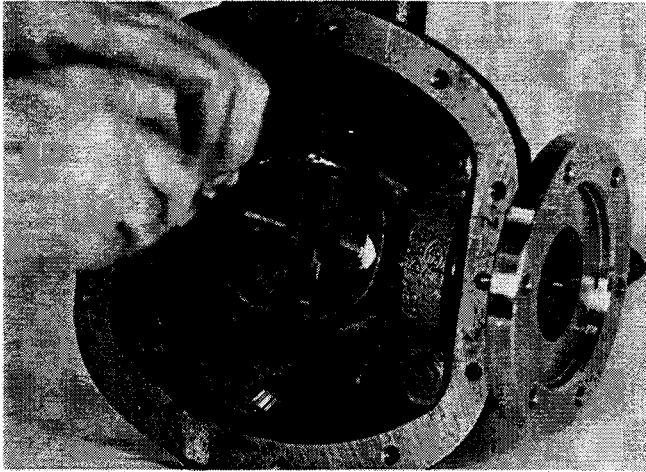

Figure 28

1021-28

Remove axle shaft snap ring by rotating the shaft so that the open side of the snap ring is exposed. Hold one side of the snap ring firmly with a screw driver, while pushing on the other side, as shown.

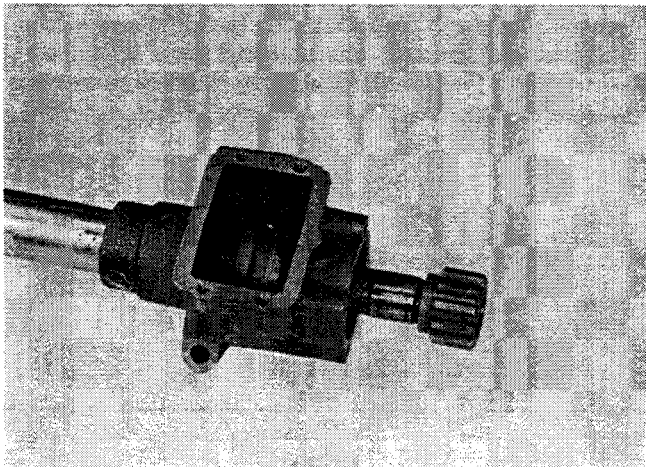

Figure 29

1021-29

Pull intermediate shaft from housing and clutch collar.

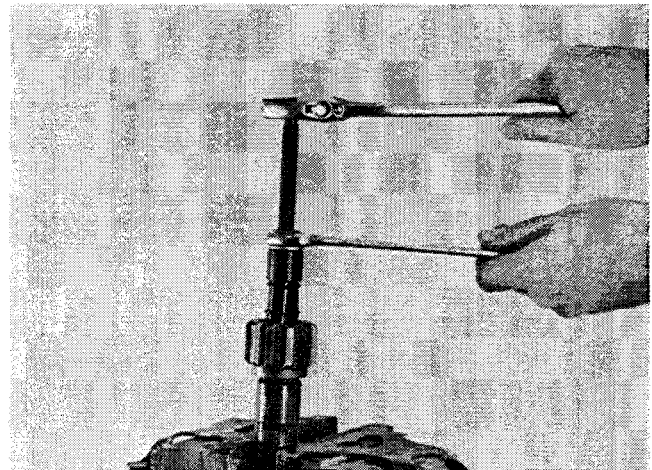

Figure 30

1021-30

Place shaft in vise as shown. Vise jaws should be equipped with soft brass protectors. Do not locate on bearing diameter. Insert the puller through the axle shaft bearing and position it to a depth that will allow the flange on the ends of the main body to expand into the relief behind the needle bearing. Expand the puller by holding the nut and turn the screw until the puller centers itself.

Tools: D-273-2 Main Body
D-273-3 Screw
D-273-4 Cup - Main Body
D-273-5 Nut-Hex
D-273-6 Washer
D-273-8 "O" Rings (2 required)

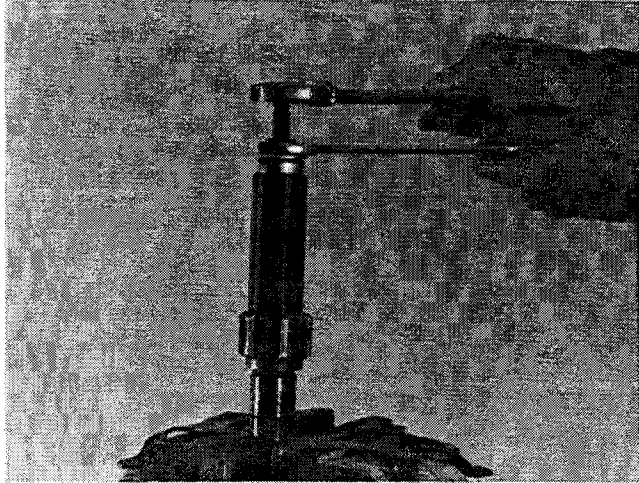

Figure 31

1021-31

Place the receiver over the puller and install the thrust bearing, washer and nut. Tighten nut, drawing the bearing from the shaft. Discard bearing and replace with a new one.

Tools: D-273-1 Receiver
 D-273-7 Thrust Bearing
 D-273-6 Washer
 D-273-5 Nut

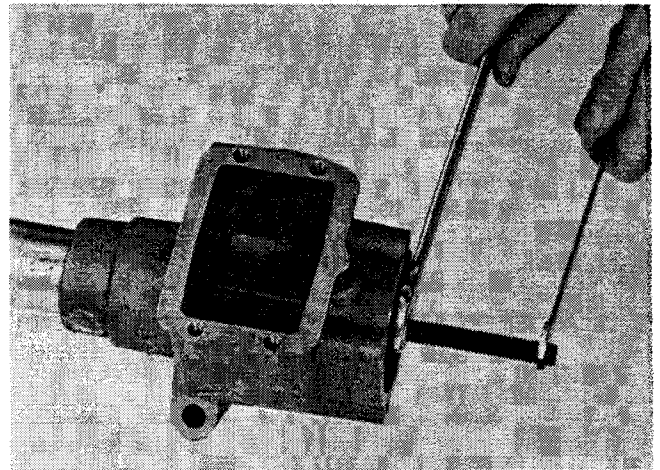

Figure 33

1021-33

To remove axle shaft bearing from housing, insert the puller through the axle shaft bearing and position it to a depth that will allow the flange on the ends of the main body to expand into the relief behind the bearing. Expand the puller by holding the nut and turn the screw until the puller centers itself.

Tools: L-4454-9 Main Body
 L-4454-10 Screw
 L-4454-11 Cup
 L-4454-12 "O" Ring
 L-4454-13 Hex-Nut
 L-4454-14 Washer

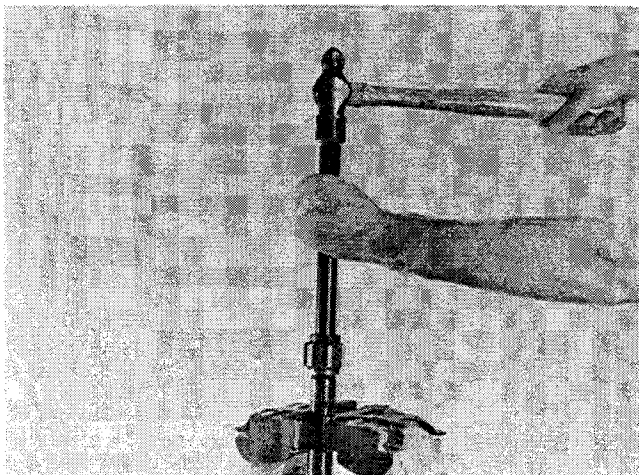

Figure 32

1021-32

Assemble new bearing as shown with the bearing number designation towards the tool shoulder. Tool controls bearing installation depth.

Tools: D-272 Installer
 C-4171 Handle

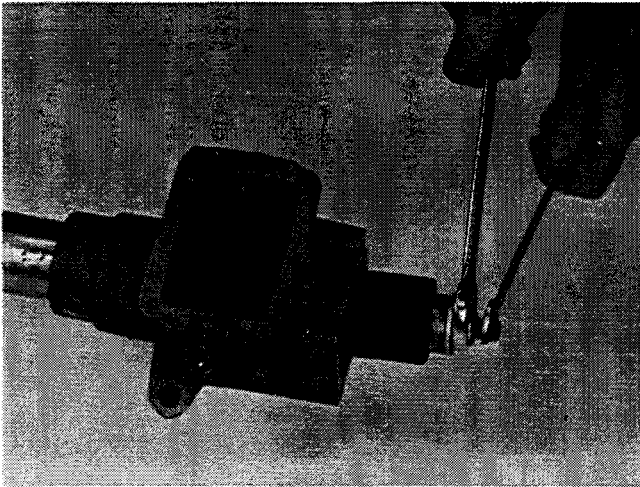

Figure 34

1021-34

Place the receiver over the puller and install the thrust bearing, washer, and nut. Draw the bearing from the housing.

Tools: D-275-1 Receiver
 L-4454-8 Thrust Bearing
 L-4454-14 Washer
 L-4454-13 Nut

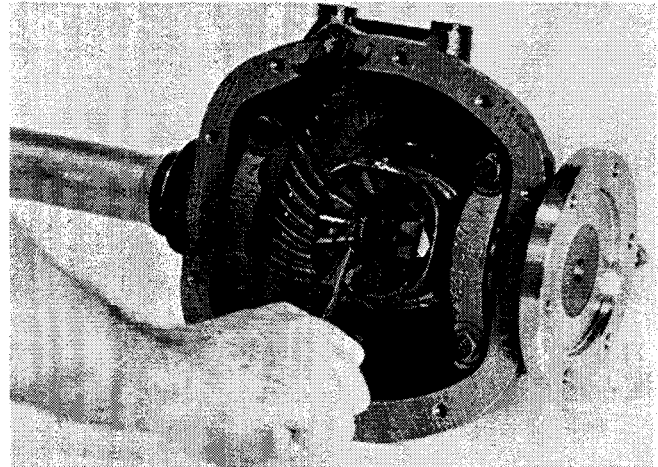

Figure 36

1021-36

Place the snap ring in the groove.

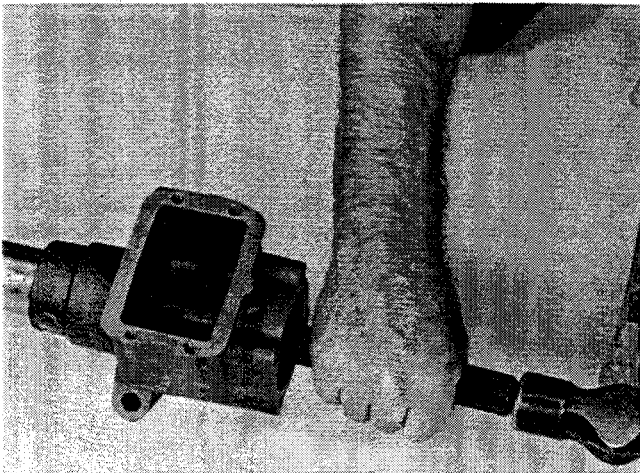

Figure 35

1021-35

Assemble new bearing into housing as shown with the bearing number designation towards the tool shoulder. Tool controls bearing installation depth.

Tools: D-274 Installer
 C-4171 Handle

Reassemble intermediate shaft and bearing assembly and the clutch collar into the housing as shown in Figure 29. Install the shaft through the side gear spline exposing the snap ring groove inside the differential.

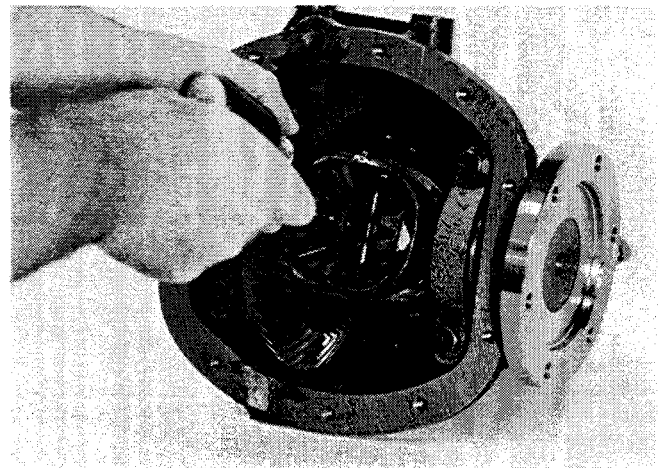

Figure 37

1021-37

Press the snap ring into place using two screw drivers or other suitable tools as shown.

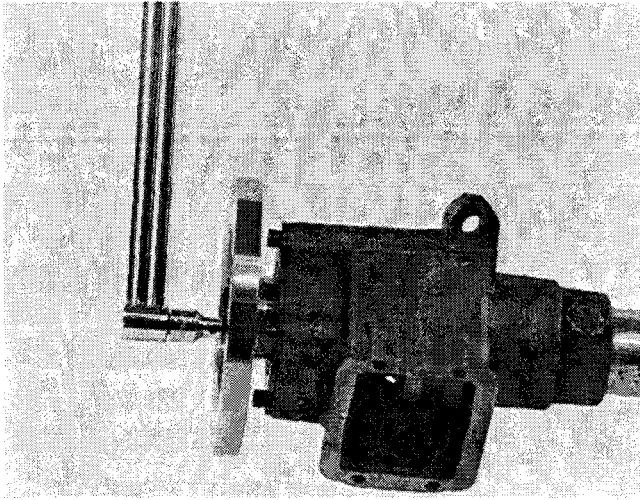

Figure 38

1021-38

Reassemble flange axle shaft bearing assembly. Torque screws alternately and evenly in a manner that assures that the seal and bearing assembly is drawn straight into the housing. Torque screws 120-144 lbs. in. (13.6-16.3 N·m).

Install housing cover and motor assembly as described in figure 15.

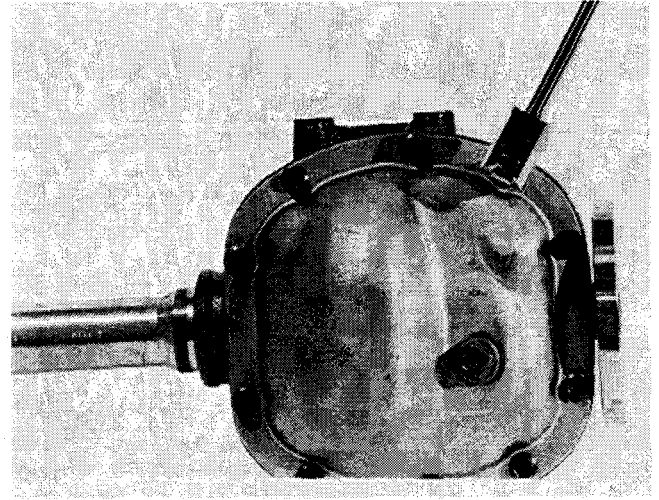

Figure 39

1021-39

Fill the two 1/2" diameter manufacturing holes with silicone type sealant material meeting ASTM3, GE303, A19, B37, E16, E36, Z1, Z2, and Z3 sealant. Install cover plate and new cover gasket. Torque screws to 30-40 lbs. ft. (40.7-54.2 N·m).