

# SCOSCHE®

## GM1583

### IN-DASH INSTALLATION KIT FOR SELECT 1992-UP GENERAL MOTORS/HUMMER/ ISUZU VEHICLES WITH OVERSIZE RADIO/M3000

#### ASSEMBLING THE KIT

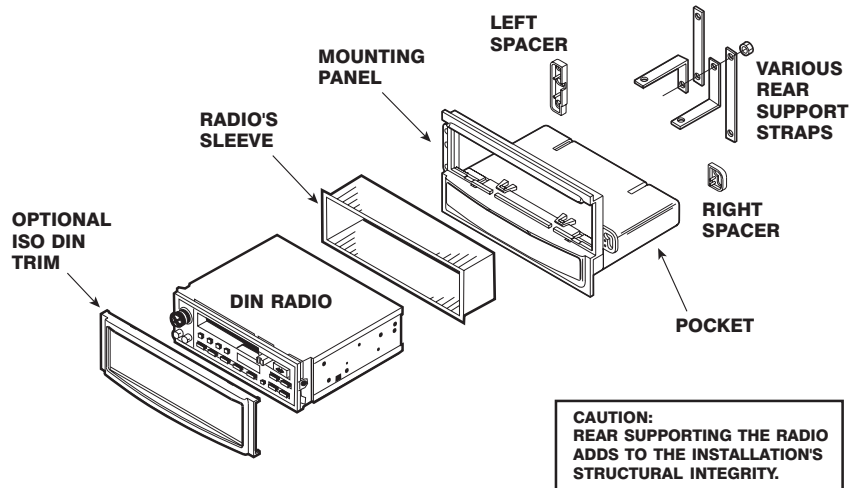

#### INTRODUCTION / PRELIMINARY

This premium installation kit is for 1992-UP General Motors vehicles with oversize radio/M3000. Included are all the parts you need to mount your car stereo, cassette or CD player into your vehicle's dash. Refer to the individual instruction in this manual to remove your vehicle's factory radio and assemble this kit.

#### CAUTION:

**DISCONNECT YOUR VEHICLE'S NEGATIVE BATTERY TERMINAL BEFORE THE INSTALLATION TO HELP PREVENT ELECTRICAL DAMAGE. WE RECOMMEND THE USE OF A VOLT/OHM METER OVER A TEST LIGHT TO CHECK WIRING. A TEST LIGHT OR GROUNDED WIRE PROBE CAN CAUSE DAMAGE TO THE VEHICLE'S COMPUTER AND/OR DIAGNOSTIC SYSTEMS. AVOID ALL FACTORY AIR BAG WIRING - AIR BAGS CAN ACCIDENTALLY DEPLOY CAUSING SERIOUS INJURY OR DEATH.**

#### NOTES:

- See your vehicle's instructions for any special tools your installation might require.
- Read all instructions accompanying your car stereo/cassette player for proper wiring and mounting instructions.

#### GM1583 POCKET PREPARATION

1. Cut along dotted line to remove middle screw mounting tab. (Illustration "A")

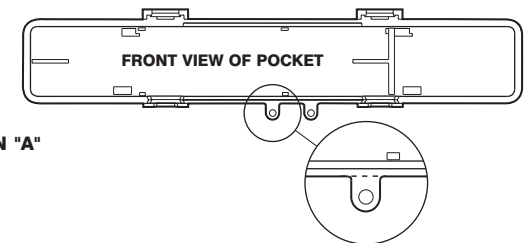

ILLUSTRATION "A"

2. Attach pocket to kit for added pocket strength, attach screw as shown in illustration (Illustration "B")

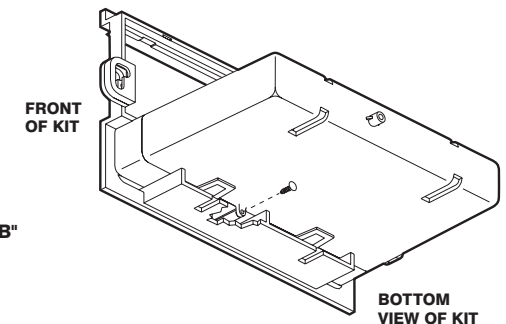
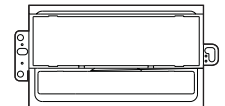

ILLUSTRATION "B"

#### 1997-UP Buick Century

##### RADIO REMOVAL:

1. Extract (1) screw from bottom lower dash panel at right of glove box.
2. Open glove box and pop out small lower dash panel along the right side.
3. Carefully pop out fuse box cover at right side of dash and extract (1) screw from the dash bezel at the right of the air vent.
4. Extract (2) screws at the bottom of the lower ashtray/lighter dash section pop out and remove.
5. Extract (1) screw from the right driver's side lower dash panel and one panel popper from the left side.
6. Carefully pop out the driver's side lower dash panel and remove.
7. Put the vehicle into first or low gear, and tilt the steering column adjustment all the way down and pull outward on the complete dash panel to unsnap, unplug, and remove panel.
8. Extract (3) 7 MM screws holding radio, unplug connector, antenna cable and remove radio.



## 2002-04 Oldsmobile Bravada

### RADIO REMOVAL:

1. Open arm rest and remove both rubber screw covers.
2. Remove (6) Phillips head screws.
3. Carefully pull up console and shift gear to first.
4. Locate and remove (2) Phillips head screws at bottom of center dash panel.
5. Carefully pull away center dash.
6. Remove (3) 9/32" screws.

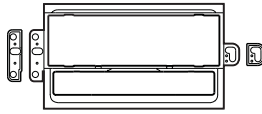

## 1994-99 Oldsmobile Eighty-Eight

### 1994-99 LSS

## 1994-96 Oldsmobile Ninety-Eight\Regency

### RADIO REMOVAL:

1. Open glove box, and remove (2) 9/32" Hex head screws at edge of Woodgrain panel.
2. Carefully pull out Woodgrain trim to release remaining snap clips and remove.
3. Extract (2) 9/32" Hex screws from bottom edge of center dash/radio bezel.
4. Carefully lift up and out on center dash/radio bezel, unsnap (3) clips from the top, and remove the bezel.
5. Extract (3) 9/32" Hex screws holding radio, unplug connector, antenna and remove radio.

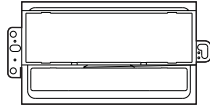

## 1998-02 Oldsmobile Intrigue

### RADIO REMOVAL:

1. Using panel removal tool, pry off radio bezel and remove.
2. Extract (3) 9/32" screws securing radio, disconnect and remove.

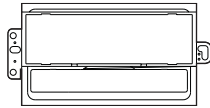

## 2000-UP Pontiac Bonneville

### RADIO REMOVAL:

**NOTE:** The factory stereo provision is for a Double DIN radio.

1. Remove (2) plastic fasteners from dash bezel above instrument cluster.
2. Pull bezel out and up, disconnect and remove. Pull radio out by depressing finger tabs, and remove.



## 2001-05 Pontiac Grand Am

### RADIO REMOVAL:

1. Use a panel removal tool to pry out radio dash bezel, unplug electrical connectors and remove bezel.
2. Extract (3) 7MM screws from radio.

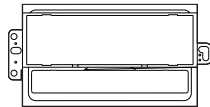

## 1995-99 Buick Le Sabre

## 1995-UP Buick Park Avenue

### RADIO REMOVAL:

1. Pop out small narrow trim panel around trunk/fuel door buttons and extract on screw at left.
2. Carefully pop out small narrow trim panel around a/c heater controls and bottom of passenger airbag. Extract (1) screw at far right and (1) screw above glove box.
3. Using a panel removal tool or small flat-blade screwdriver pop out all (4) dash vents and remove (1) screw behind each vent.
4. Make sure the parking brake is on, then insert the key and turn to the "on" position.
5. Put the vehicle into first or low gear, and tilt the steering column adjustment all the way down and pull outward on the complete dash panel.
6. Extract (3) 7 MM screws holding radio, unplug connector, antenna cable and remove radio.

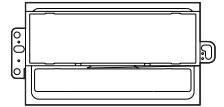

## 1997-04 Buick Regal

### RADIO REMOVAL:

1. Unsnap gear selector trim bezel, unplug and remove the bezel. Extract (2) 10 MM bolts from metal console bracket.
2. Open armrest storage, lift up rubber mat and extract (2) 10 MM bolts from underneath.
3. Extract (2) 10 MM bolts from the front sides of the console, which are concealed up under the dash.
4. Slide shifter back into low gear, push down on spring-loaded shifter trim and pull complete center console to rear of the vehicle, allowing the center lower dash section (attached) to unsnap from the dash.
5. Extract (1) screw from bottom lower dash panel at right of glove box.
6. Open glove box and pop out small lower dash panel along the right side.
7. Carefully pop out fuse box cover at right side of dash and extract (1) screw from the dash bezel at the right of the air vent.
8. Extract (1) screw from the lower right of driver's side lower dash panel and one panel popper from the left side.
9. Carefully pop out the driver's side lower dash panel and remove.
10. Extract (3) 7 MM screws holding radio, unplug connector, antenna cable and remove radio.

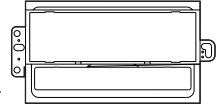

## 1995-96 Buick Regal

## 1995-97 Oldsmobile Cutlass Supreme

### RADIO REMOVAL:

1. Tilt steering column down to lowest position.
2. Unsnap dash bezel and remove.
3. Extract (3) 7MM screws securing radio, unplug connectors, antenna lead and remove radio.

**NOTE:** Back of dash cavity may need modification.



## 1996-98 Buick Riviera

### RADIO REMOVAL:

1. Gently pull outward on Left and Right windshield pillar panels to release (2) snap clips and extract each one.
2. Unsnap side dash panels and remove (1) 7 MM screw from behind each.
3. Extract (6) plastic push-pin fasteners from under front edge of upper dash pad. Pull outward to remove the bottom panel of the upper dash pad.
4. Extract (5) 7-MM screws securing upper dash pad, lift up and outward to remove pad.
5. Carefully pull outward on dash/instrument bezel to release clips, unplug and remove bezel.
6. Extract (3) 7-MM screws from climate control module, unplug and remove module.
7. Extract (4) 7-MM screws securing radio, unplug connectors, antenna lead, and remove radio.

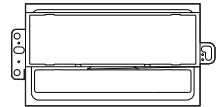

## 1995-96 Buick Roadmaster

### RADIO REMOVAL:

1. Remove side dash panels by carefully pulling outward on them to release fastening clips.
2. Carefully pull out on underdash panel below steering column to release fastening clips, and remove panel.
3. Carefully pull outward on lower panel at right of glove box to release fastening clips, and remove panel.
4. Extract (2) 7 MM screws above instrument cluster.
5. Make sure the parking brake is on, then insert the key and turn to the "on" position.
6. Put the vehicle into first or low gear, and tilt the steering column adjustment all the way down and pull outward on the complete instrument panel around gauges and along top of glovebox. Panel clips will release and dash panel can be removed.
7. Extract (3) 7 MM screws holding radio, unplug connector, antenna cable and remove radio.



**1996-98 Buick Skylark**  
**1996-98 Oldsmobile Achieva**

**RADIO REMOVAL:**

1. Twist and release fasteners holding drivers and passengers under dash covers, and remove.
2. Open glove box, push stopper tabs inward, open all the way down, and remove glove box.
3. Extract (6) 9/32" Hex screws from glove box area.
4. Extract (2) 9/32" Hex screws from plastic tube in glove box area and extract (2) from just below plastic tube.
5. Extract (2) 9/32" Hex screws from driver's side bottom dash.
6. Open and remove fuse panel access door.
7. Carefully grasp complete dash/radio bezel, pull out to release clips and remove.
8. Extract (3) screws holding radio in, unplug connector and remove.

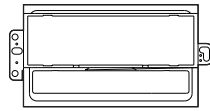

**1992-95 Cadillac Eldorado**  
**1992-95 Cadillac Seville**

**RADIO REMOVAL:**

1. Using a panel removal tool, carefully pry outward to release the trim ring around the radio and remove.
2. Carefully pry up on the ash tray/shifter bezel trim to release.

**CAUTION: WOOD TRIM BEZEL, USE EXTREME CARE.**

3. Extract (2) at the bottom edge of the radio, slide radio out, unplug and remove.

**NOTE:** Secure the mounting panel to the dash with the supplied Carriage Bolts and Hex Flange Nuts.

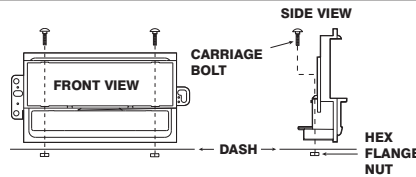

**2003-UP Cadillac Escalade**  
**2003-UP Cadillac Escalade ESV**  
**2003-UP Cadillac Escalade EXT**  
**2003-UP Chevrolet Avalanche**

**RADIO REMOVAL:**

1. Turn ignition on and shift vehicle into first gear.
2. Unsnap trim bezel by pulling firmly.
3. Using a 7mm socket, remove (3) bolts from radio, disconnect and remove.

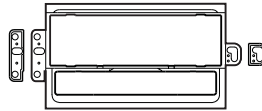

**2003-UP Chevrolet Silverado**  
**2003-UP Chevrolet Suburban**  
**2003-UP GMC Sierra**  
**2003-UP GMC Yukon**  
**2003-UP GMC Yukon XL**

**2000-05 Chevrolet Cavalier**  
**2000-UP Pontiac Sunfire**

**RADIO REMOVAL:**

1. Open glove box and remove (5) 9/32" screws.
2. Remove side panels from drivers side dash and passengers side dash, and extract (1) 9/32" screw from each side.
3. Remove 1 Phillips head screw at top center of air vent.
4. Extract (2) screws under vent panel, carefully remove top of dash.
5. Extract (3) screws from the top of the front dash panel, disconnect and remove.

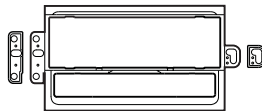

**2004-UP Chevrolet Colorado**  
**2004-UP GMC Canyon**

**RADIO REMOVAL:**

1. Unsnap dash bezel and lift away, disconnect and remove.
2. Unscrew (3) hex bolts securing radio, lift away, disconnect and remove.

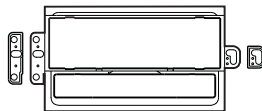

**2001-UP Chevrolet Express**  
**2001-UP GMC Savana**

**RADIO REMOVAL:**

1. Carefully pry out on dash bezel to release, unplug and remove.
2. Remove three (3) 7MM hex screws holding radio, unplug and remove.

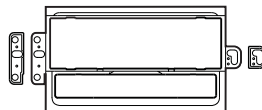

**2000-05 Chevrolet Impala**

**RADIO REMOVAL:**

1. Extract (2) 9/32" hex screws from above instrument panel.
2. Remove fuse panel cover and extract (1) 9/32" hex screw from behind.
3. Remove passenger side fuse cover and extract (1) 9/32" screw from behind.
4. Drop underdash covering using panel removal tool and extract (2) 9/32" screws from behind.
5. Remove (1) 9/32" screw from left side trim, tilt wheel down, and pull away dash bezel, disconnect and remove.
6. Remove (3) 9/32" screws securing the radio, disconnect and remove from dash.

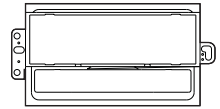

**2001-03 Chevrolet Malibu**  
**2004 Chevrolet Classic**

**RADIO REMOVAL:**

1. Use a small flat blade or pick to remove ignition switch collar.
2. Using panel removal tool, pry out dash bezel, disconnect and remove.
3. Remove three (3) 7MM screws securing radio, disconnect and remove.

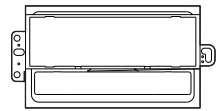

**2000-05 Chevrolet Monte Carlo**

**RADIO REMOVAL:**

1. Extract (1) Phillips head screw from glove box.
2. Remove cylinder cover from around ignition keyhole.
3. Extract (2) Phillips head screw from beneath steering column plate, and remove cover.
4. Remove fuse access cover and remove (1) Phillips head screw from behind.
5. Adjust steering wheel column down and remove dash trim bezel. Disconnect hazard switch and remove panel.

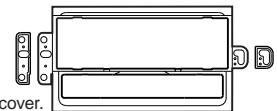

**2002-03 Chevrolet S-10 Pickup**

**RADIO REMOVAL:**

1. Turn ignition ON and shift vehicle into first if an automatic.
2. Extract (1) 9/32" screw from above gauge cluster.
3. Extract (5) 9/32" screws from underdash pane; and remove.
4. Extract (2) 9/32" screws from bottom of dash bezel, and carefully pry out bezel.

**CAUTION: WHEN YOU GO TO PULL BEZEL OVER HAZARD SWITCH BE VERY CAREFUL NOT TO BREAK SWITCH. DISCONNECT AND REMOVE BEZEL.**

5. Extract (3) 9/32" screws securing radio, disconnect, and remove.

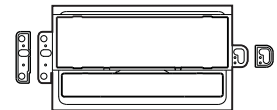

**2004-UP Chevrolet SSR**

**RADIO REMOVAL:**

1. Using a panel removal tool remove the aluminum trim that separates the dash.
2. Remove six (6) 7MM hex screws securing the dash panel.
3. Remove the dash by pulling towards you. Use caution when removing the dash around the passenger's air bag. Bend the sides of the passenger air bag cover to release the passenger side of the dash.
4. Remove three (3) 7MM hex screws securing radio to the dash. Disconnect and remove the radio.

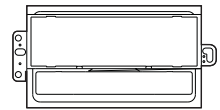

**2002-UP Chevrolet Trailblazer**

**RADIO REMOVAL:**

1. Extract (2) Phillips screws from above instrument panel.
2. Extract (1) Phillips screw from under AC controls.
3. Extract (2) Phillips screws from lower dash panel above brake panel.
4. Carefully pull dash bezel off, disconnect and pull away.
5. Extract (2) 9/32" hex screws, disconnect and remove radio.

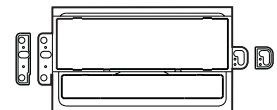

---

**2000-UP Chevrolet Venture**  
**2000-04 Oldsmobile Silhouette**  
**2000-UP Pontiac Montana**

**RADIO REMOVAL:**

1. Remove ashtray and extract (2) Phillips head screws from behind.
2. Unsnap perimeter of radio trim bezel, lift away and remove. Extract (3) Phillips head screws securing radio, lift away, disconnect and remove.

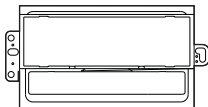

---

**2002-UP GMC Envoy**  
**2004-UP Buick Rainier**  
**2003-UP Isuzu Ascender**

**RADIO REMOVAL:**

1. Open center console lid and extract (2) Phillips screws from front of console, lift out rubber pads and extract (4) more Phillips screws from under. Remove console insert.
2. Extract (2) 9/32" screws from console cavity.
3. Remove rubber pad from front cup holder and extract (1) 9/32" screw from under.
4. Extract (4) Phillips screws from sides of carpeted panel directly under radio and climate controls, pull it down and out of the way.
5. Pull center console back and down to get to (2) Phillips screws on bottom of radio bezel. Pry bezel out from top to bottom, disconnect and remove.
6. Extract (3) 9/32" screws securing radio.

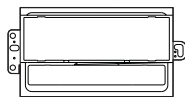

---

**2003-UP Hummer H1**

**RADIO REMOVAL:**

1. Remove (4) Screws securing radio/dash bezel & remove.
2. Remove (3) 7MM hex screws holding radio, unplug and remove.

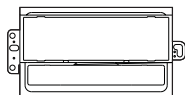

---

**2003-UP Hummer H2**

**RADIO REMOVAL:**

1. Open center console storage and extract 4 screws securing hinged lid.
2. Remove Torx lock nut holding Shift lever (Nut is facing forward) and Slide shift lever off.
3. Use a panel removal tool to carefully pop up cup holder/gear indicator plate.
4. Extract (2) 7mm hex screws at bottom of center dash bezel (revealed in previous step #3).
5. Extract (2) 7mm hex screws from center dash bezel (near each vent).
6. Carefully pry out on center dash bezel to unsnap, unplug and remove.
7. Extract (3) 7mm hex screws holding radio, unplug and remove.

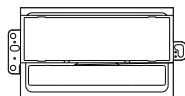

---

**1995-00 Oldsmobile Alero**

**RADIO REMOVAL:**

1. Unsnap shifter panel and leave it loose.
2. Using a panel removal tool remove radio trim bezel (there are a total of six snaps) unplug and remove.
3. Extract (3) 9/32" screws holding radio, unplug and remove.

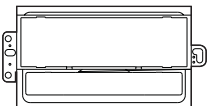

---

**1995-00 Oldsmobile Aurora**

**RADIO REMOVAL:**

1. Carefully unsnap dash bezel and remove.
2. Extract (3) 7MM screws securing radio, unplug connectors, antenna lead and remove radio.

