

RUSSELL®



AUTOMOTIVE PERFORMANCE CATALOG



2017 Automotive Performance Catalog





Table of Contents

INTRODUCTION	3
Facilities . Tech Tips	
HOSES	5
ProClassic . ProClassic II . ProFlex . Twist-Lok . Crimp-On System	
HOSE ENDS	8
Full Flow Swivel . Fittings . Accessories . Twist-Lok . SAE Quick Disconnect Hose Ends	
ADAPTER FITTINGS	15
Flare Bulkhead . Bulkhead Nut . Flare to Pipe . Pipe Adapter Fittings . Flare Reducer Flare Tee . B-Nut Reducer . B-Nut Flare Expander . NPT Pipe Reducers . Flare Cap Fuel Cell Bulkhead . Flare to Metric . Allen Sockets . Weld Bungs . Tube Sleeve Tube Nut . Flare Union . Flare Plug . Turbo Fittings . Swivel Coupler . Coupler Reducer O-Ring Boss Radius . Female AN . Carburetor . SAE Quick Disconnect . EFI . Fuel Line	
FUEL MANAGEMENT	27
Carbureted Fuel System Kits . Dual Inlet Carburetor Kits . Carbureted Fuel Pumps Fuel Pressure Regulators . EFI Fuel System Kits . EFI Fuel Pumps . EFI Pressure Regulators . ProFilter . Fuel Filters . Fuel System Accessories	
ACCESSORIES	41
Wrap it . Cushion Clamps . Sealing Washers	
TOOLS	43
Lube & Sealant . AN Wrenches . Wire Pliers . Safety Wire . Hose Assembly Tool Manual Crimper . Adjustable Wrench . Hose Separator . Line Clamp . Tube Straightener Tube Flare Tool . Aluminum Vise Jaws . Tube Bender	
TRANSMISSION	45
Heat Sink Coolers . ARB Stainless Hose Kits . Fittings	
POWER STEERING	46
PowerFlex Prepackaged Rolls . Power Steering Adapters . PowerFlex Hose Ends	
BRAKE HOSE KITS	47
Pre-Assembled, Direct Bolt-On Brake Hose Kits . -3 Universal Hose Assemblies PowerFlex Brake Hose . Brake Hose Ends . Brake Adapter Fittings . Banjo Bolts Flare to Pipe Fittings . Inverted Flare Adapter Fittings . Tube Nut . Residual Valves Brackets & Hardware . Brake Line Clamps . Speed Bleeder Assembly . Speed Bleeders	
NITROUS	63
Pre-Made Nitrous & Fuel Lines	
DEALER	64
Contingency Decals . Dealer Decal . Race Track Decal Sheet . Russell Banner	
BULK	65
Full Flow Swivel Ends . Crimp-On Swivel Ends . Tube Coupling Nut . Flare Cap . Tube Sleeves . Allen Socket Pipe Plug . O-Ring Boss Radius AN Port Adapter . Twist-Lok Hose Ends . Flare Union . Male Pipe Nipple . SAE Quick Disconnect Fittings . Flare to Pipe . PowerFlex Hose . PowerFlex Hose Ends . Power Steering Adapters	
TECH TIPS	67
Hose Installation Tips	



Performance Products

Quality & Reliability

Russell Performance Products has been the leader in advanced fluid transfer systems for more than 30 years. We manufacture a complete line of hoses and fittings for fuel, brake, water, oil and various other systems for automotive, motorcycle and marine applications. Our product line includes a variety of hoses, hose ends, adapter fittings, Street Legal brake hoses, Speed Bleeders, brake hose components, fuel management, specialty fittings and performance accessories. Russell has supplied innovative fluid transfer systems for everything from Sprint Cup to Top Fuel drag racing, Off-Road racing to high-performance street and marine. Most of Russell hoses are NHRA approved for competition.

Russell is an ISO 9001 certified manufacturer and supplier and has a 37,000 sq. ft. dedicated facility in Torrance, California. The Russell team has a dedicated engineering staff, as well as a state-of-the-art quality control department to ensure the best quality and consistency.

Performance Hose, Hose Ends & Fittings

For maximum protection and reliability, more professionals and enthusiasts choose Russell performance hoses and fittings. We offer a complete line of hoses and fittings to provide you the widest range of coverage for all your plumbing needs.



The 3 Basic Elements of Plumbing

In order to plumb your vehicle with a minimum amount of time, effort and money, you should know the basics about hose, hose ends and adapter fittings.

Male AN Adapter Identification Chart

The line drawings below depict actual sizes of the various common AN thread sizes by dash number. Lay your fitting over the appropriate drawing to determine what size fitting you have.

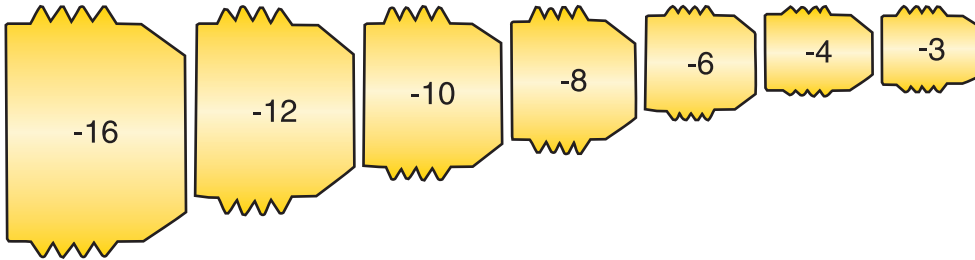

AN SIZE	OUTSIDE DIAMETER	THREAD SIZE
-3	3/16"	3/8" - 24
-4	1/4"	7/16" - 20
-5	5/16"	1/2" - 20
-6	3/8"	9/16" - 18
-8	1/2"	3/4" - 16
-10	5/8"	7/8" - 14
-12	3/4"	1-1/16" - 12
-16	1"	1-5/16" - 12
-20	1-1/4"	1-5/8" - 12

Tube Size Conversions

Tube diameters are assigned AN numbers. Using your automotive hose size, find the equivalent AN size from the chart on the right.

Another easy method to convert AN size to fractional is to remember that each AN number represents 1/16".

For example: -8 AN = 8/16" = 1/2".

STANDARD SIZE	AN EQUIVALENT
1/4"	-4
3/8"	-6
1/2"	-8
5/8"	-10
3/4"	-12
1"	-16
1-1/4"	-20
1-1/2"	-24

Pipe Thread Size Chart

Use the diagram to the right to find pipe thread size. Place fitting against base line; read fitting size where it intersects the vertical line.

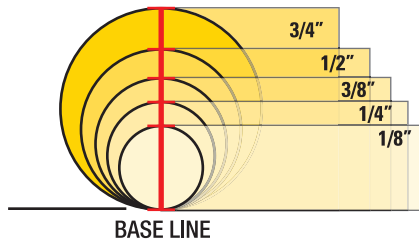

B-Nut Size Chart

The line drawings to the right depict actual sizes of the various common types of fittings, hose ends and adapters. The number in parenthesis is SAE wrench size equivalent.

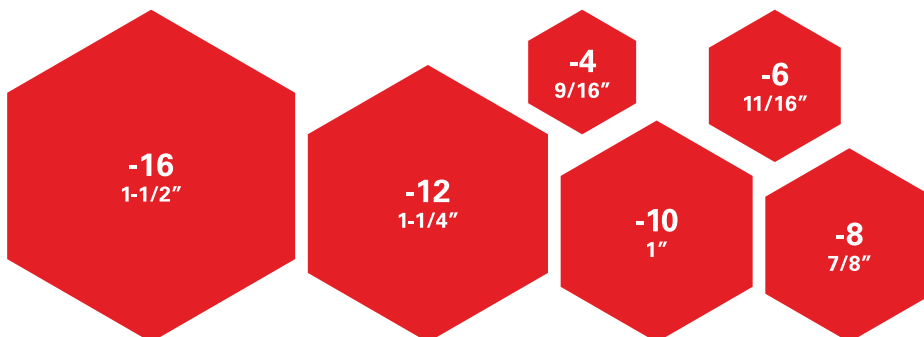

STEP 1 CHOOSE HOSE SIZE



**STEP 2
CHOOSE HOSE END STYLE**
Straight, 45°, 90°, 120°, 150°, 180°
in same AN size as hose



**STEP 3
CHOOSE ADAPTER**
Adapt AN to NPT
Example: -6 AN to 3/8" NPT



FINISHED PRODUCT





Performance Hoses

All the Performance with Less Weight

For maximum protection and reliability, more professionals and enthusiasts choose Russell Performance hoses. We offer a complete line of hoses and fittings to provide you the widest range of coverage for all your plumbing needs.

ProClassic Hose is constructed utilizing a synthetic rubber inner liner made from CPE and supported by a lightweight nylon fiber outer braid for a unique look. ProClassic Hose has a maximum pressure rating of 350 psi. It's easy to work with and will not scratch painted surfaces.

ProClassic II Hose is constructed utilizing a synthetic rubber inner liner made from CPE that's supported by multi-wire stainless steel braid to increase flexibility and a lightweight nylon fiber outer braid for a unique look. ProClassic II has a maximum pressure rating of 350 psi. It's easy to work with and will not scratch painted surfaces.

ProFlex Hose have the same great features as our ProClassic hose but utilizes a 308 stainless steel braided outer jacket. ProFlex hose is ideal for fuel, oil, water and transmission applications.

Twist-Lok Hose is constructed from all rubber with a CPE inner liner. It has excellent flexibility, abrasion resistance and is compatible with most fluids.



Performance Hoses



Made of extruded CPE synthetic rubber; inner liner is compatible with most fluids

High-quality nylon fiber braid cover for excellent flexibility and resistance to abrasion

ProClassic Hose

Russell ProClassic hose features a lightweight nylon fiber outer braid with a CPE inner liner, a maximum pressure rating of 350 psi and can withstand temperatures of -40°F to 350° F. Trouble free assembly without the need for special tools and capable of handling nearly every plumbing task on your car and is safe to use with fuel, oil, or antifreeze.

Please Note: Inner Coils may be used to prevent hose collapsing if the vacuum is over 27hg.

AN SIZE	3 FEET	6 FEET	10 FEET	20 FEET	50 FEET	100 FEET	300 FEET	500 FEET
-4	632003	632013	632023	632043	630253	630263	-	-
-6	632053	632063	632073	632093	630273	630283	-	630383
-8	632103	632113	632123	632143	630293	630303	630393	-
-10	632153	632163	632173	632193	630313	630323	-	-
-12	632203	632213	632223	632243	630333	630343	-	-
-16	632253	632263	632273	632293	630353	-	-	-



Chlorinated Polyethylene (CPE) Inner liner is supported by a multi-wire stainless braid



Made of extruded CPE synthetic rubber; inner liner is compatible with most fluids

High-quality nylon fiber braid cover for excellent flexibility and resistance to abrasion

ProClassic II Hose

ProClassic II hose features an all-black nylon fiber braided outer cover and a Chlorinated Polyethylene (CPE) synthetic rubber inner line. The CPE inner liner incorporates a bonded multi-braid stainless wire that improves bend radius with less possibility of collapsing when routing hoses in tight areas. ProClassic II hose has a maximum working pressure rate at 350 psi and can withstand temperatures of -40°F to 350° F. Safe to use with fuel, oil and antifreeze.

Please Note: Inner Coils may be used to prevent hose collapsing if the vacuum is over 27hg.

AN SIZE	3 FEET	6 FEET	10 FEET	20 FEET	50 FEET	100 FEET	300 FEET	500 FEET
-4	632005	632015	632025	632045	630255	630265	-	-
-6	632055	632065	632075	632095	630275	630285	-	630385
-8	632105	632115	632125	632145	630295	630305	630395	-
-10	632155	632165	632175	632195	630315	630325	-	-
-12	632205	632215	632225	632245	630335	630345	-	-
-16	632255	632265	632275	632295	630355	-	-	-

Inner Coils

These Inner Coils can be inserted into Russell hose for added support to prevent collapsing caused by vacuum and sharp turns.



651312 - Inner Coil

AN SIZE	LENGTH	ITEM
-12	4'	651312
-16	4'	651316



Hose Separator

AN SIZE	BLUE	RED	BLACK
-6	654302	654300	654303
-8	654312	654310	654313
-10	654322	654320	654323
-12	654332	654330	654333



Performance Hoses

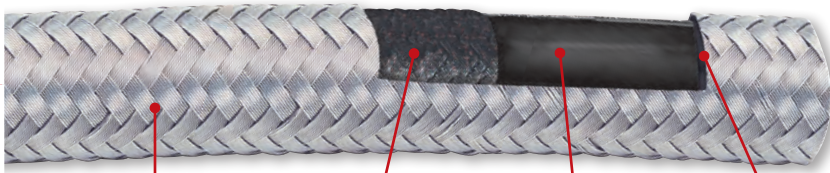

308 stainless wire braid outer provides durability and resists heat
 Secondary rubber jacket increases overall flexibility
 Inner liner made from Chlorinated Polyethylene (CPE)
 Superior bonding eliminates hose fraying when cut

ProFlex Specifications

AN SIZE	TYPICAL USE
-4	FUEL, OIL LINES / FUEL GAUGES / VACUUM LINES
-6	FUEL, OIL LINES / CARBURETOR
-8	FUEL, OIL, WATER LINES
-10	FUEL, OIL, WATER LINES / HEATER HOSES
-12	FUEL, OIL, WATER LINES / HEATER HOSES
-16	FUEL, OIL, WATER LINES / HEATER HOSES
-20	FUEL, OIL, WATER LINES

ProFlex Hose

Russell ProFlex performance hose is constructed with a stainless steel outer braid that resists abrasion and corrosion, ProFlex hose has a reinforced Chlorinated Polyethylene (CPE) synthetic rubber liner with a nylon inner braid that will not collapse under extreme heat, yet is extremely flexible.

Please Note: Inner Coils may be used to prevent hose collapsing if the vacuum is over 27hg.

AN SIZE	INSIDE DIAMETER		OUTSIDE DIAMETER	PSI	3 FEET	6 FEET	10 FEET	15 FEET	20 FEET	50 FEET	100 FEET
	ACTUAL	NOMINAL									
-4	7/32"	1/4"	1/2"	1000	632000	632010	632020	632030	632040	630250	630260
-6	11/32"	3/8"	9/16"	1000	632050	632060	632070	632080	632090	630270	630280
-8	7/16"	1/2"	5/8"	1000	632100	632110	632120	632130	632140	630290	630300
-10	9/16"	5/8"	25/32"	750	632150	632160	632170	632180	632190	630310	630320
-12	11/16"	3/4"	29/32"	750	632200	632210	632220	632230	632240	630330	630340
-16	7/8"	1"	1-1/8"	750	632250	632260	632270	632280	632290	630350	-
-20	1-1/8"	1-1/4"	1-7/16"	750	632300	632310	632320	632330	-	-	-



High-quality elastomer cover features excellent flexibility and resistance to abrasion
 Made of extruded, CPE compound compatible with most fluids
 Barb hose end technology allows quick, trouble-free assembly without special tools

Twist-Lok Specifications

AN SIZE	TYPICAL USE
-4	FUEL, OIL LINES / FUEL GAUGES / VACUUM LINES
-6	FUEL, OIL LINES / CARBURETOR
-8	FUEL, OIL, WATER LINES
-10	FUEL, OIL, WATER LINES / HEATER HOSES

Twist-Lok Hose

High-Quality Hose for the "Cost-Conscious" Racer

For the enthusiast looking for a quality performance hose while wanting to save assembly time and money, Russell Twist-Lok hose is the way to go. Flexible and lightweight, this hose is ideal for most automotive applications where a stainless steel braided line is not necessary. Check out our assorted Twist-Lok hose ends on page 12.

Please Note: Inner Coils may be used to prevent hose collapsing if the vacuum is over 27hg.

AN SIZE	INSIDE DIAMETER	OUTSIDE DIAMETER	PSI	3 FEET		6 FEET		10 FEET		15 FEET		25 FEET		100 FEET	
				BLUE	BLACK	BLUE	BLACK	BLUE	BLACK	BLUE	BLACK	BLUE	BLACK		
-4	1/4"	15/32"	250	634340	634343	634350	634353	634100	634103	634110	634113	634120	634123	634300	634303
-6	3/8"	5/8"	250	634360	634363	634370	634373	634140	634143	634150	634153	634160	634163	634310	634313
-8	1/2"	23/32"	250	634380	634383	634390	634393	634180	634183	634190	634193	634200	634203	634320	634323
-10	5/8"	13/16"	250	634400	634403	634410	634413	634220	634223	634230	634233	634240	634243	634330	634333



PERFORMANCE HOSE ENDS

Designed for ProFlex, ProClassic and ProClassic II Hose

Russell's performance hose ends have been the choice of racing professionals for more than 30 years. Featuring a unique tapered design for easy assembly and are mandrel bent for superior flow. They are also designed with a 37° angled sealing surface that guarantees a positive anti-leak seal and will not require the use of a sealing compound or PTFE tape. We've expanded our line of adapters to provide the widest range of coverage for whatever plumbing problem you need to solve.

Russell hose ends come in four basic styles; Full Flow Swivel, Twist-Lok, PowerFlex and ProClassic Crimp-On. Russell hose ends are easier to install than competitive ends due to their unique design.

360° Swivel Hose Ends Features:

Russell's Full Flow Swivel hose ends swivel 360° to maximize hose installation allowing for quick alignment of ends after hose assembly. These Full Flow Swivel hose ends are completely re-usable and feature a unique taper design for ease of installation.

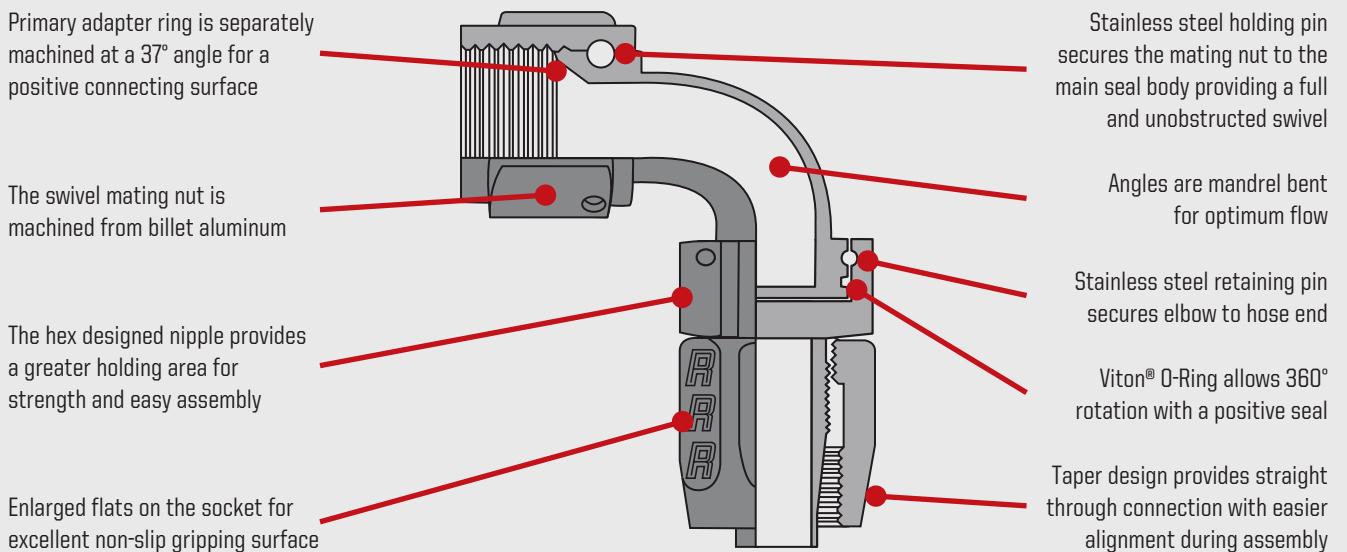

Multiple Finishes To Choose From...

Russell hose ends can be ordered in the following finishes to meet your needs and complement the look you want for your street rod, muscle car, daily driver or race vehicle.



Anodized Polished
Choice of purple, black, red, gray or orange

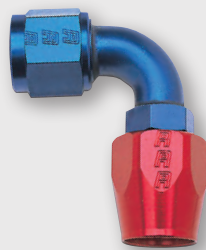

Red & Blue Anodized



Endura
Ultra-bright finish that simulates stainless steel



Black & Silver Anodized



Black Anodized



Full Flow Swivel Hose Ends

Standard Radius Full Flow Swivel Hose Ends

Russell's Standard Radius Full Flow Swivel hose ends are available in a variety of angles and finishes.



Straight Full Flow End

AN SIZE	RED / BLUE	ENDURA	BLACK / SILVER	BLACK
-4	610010	610011	610013	610015
-6	610020	610021	610023	610025
-8	610030	610031	610033	610035
-10	610040	610041	610043	610045
-12	610050	610051	610053	610055
-16	610060	610061	610063	610065
-20	610070	-	-	-

45° Swivel End

AN SIZE	RED / BLUE	ENDURA	BLACK / SILVER	BLACK
-4	610080	610081	610083	610085
-6	610090	610091	610093	610095
-8	610100	610101	610103	610105
-10	610110	610111	610113	610115
-12	610120	610121	610123	610125
-16	610130	610131	610133	610135
-20	610140	-	-	-

90° Swivel End

AN SIZE	RADIUS	RED / BLUE	ENDURA	BLACK / SILVER	BLACK
-4	1/2"	610150	610151	610153	610155
-6	1/2"	610160	610161	610163	610165
-8	1/2"	610170	610171	610173	610175
-10	5/8"	610180	610181	610183	610185
-12	7/8"	610190	610191	610193	610195
-16	1"	610200	610201	610203	610205
-20	1-1/4"	610210	-	-	-



Standard Radius Swivel Hose Ends

AN SIZE	RADIUS	120° RADIUS		150° RADIUS	180° RADIUS	
		RED / BLUE	ENDURA	RED / BLUE	RED / BLUE	ENDURA
-6	1"	613220	613221	613350	613260	613261
-8	1-1/4"	613230	613231	613360	613270	613271
-10	1-1/4"	613240	613241	613370	613280	613281
-12	1-1/2"	613250	613251	613380	613290	-

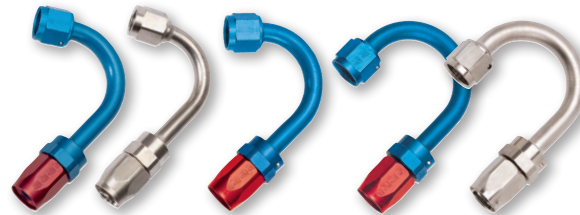

Tight Radius Full Flow Swivel Hose Ends

Russell's Tight Radius Full Flow Swivel hose ends have a shorter distance between fittings for use in tight spots.

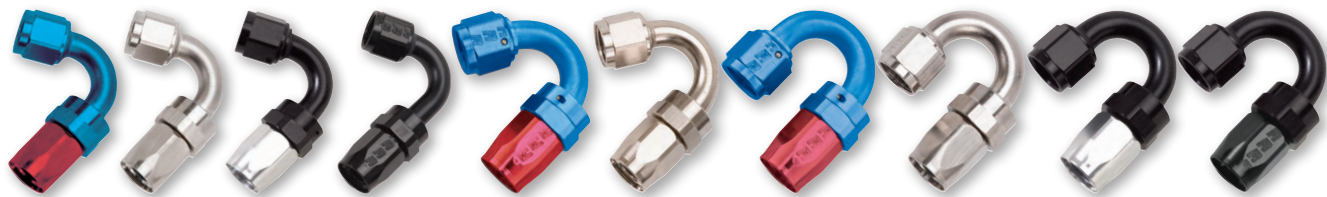

AN SIZE	RADIUS	RED / BLUE	120° RADIUS			150° RADIUS		180° RADIUS			
			ENDURA	BLACK / SILVER	BLACK	RED / BLUE	ENDURA	RED / BLUE	ENDURA	BLACK / SILVER	BLACK
-6	9/16"	613400	613401	613403	613405	613450	613451	613500	613501	613503	613505
-8	3/4"	613410	613411	613413	613415	613460	-	613510	613511	613513	613515
-10	15/16"	613420	613421	613423	613425	613470	-	613520	-	613523	613525
-12	1-1/8"	613430	613431	613433	613435	613480	-	613530	-	613533	613535
-16	1-1/2"	613440	613441	-	-	-	-	-	-	-	-



Full Flow Swivel Hose Ends

Pipe Thread Swivel Hose Ends

Perfect for connecting your oil and fuel lines without the need for a separate adapter. Attach hose end and thread directly into the fuel pump, fuel filter, Y-block or oil pump, eliminating the secondary AN adapter fitting.

AN SIZE	NPT SIZE	45° RADIUS	90° RADIUS
-6	1/8"	612150*	612170*
-6	1/4"	612000*	612090*
-6	3/8"	612160*	612180*
-8	3/8"	612010*	612100*
-8	1/2"	612020*	612110*
-10	3/8"	612080*	612190*
-10	1/2"	612030*	612120*
-12	1/2"	612040*	612130*
-12	3/4"	612050*	612140*

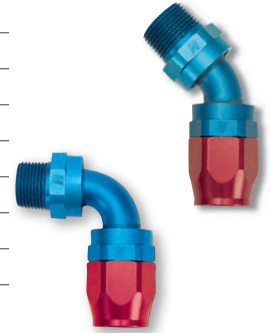

Radius Port Swivel Hose Ends

The Radius Thread Length is deigned to allow full engagement without blocking the port for unrestricted flow. The hose ends attach directly utilizing an o-ring for a positive seal eliminating the secondary adapter previously required to plumb regulators, fuel pumps and dry sump.



AN SIZE	INLET / OUTLET	THREAD	45° RADIUS		90° RADIUS	
			RED / BLUE	BLACK / SILVER	RED / BLUE	BLACK / SILVER
-6	-6	9/16" - 18	612440	612443	612460	612463
-8	-8	3/4" - 16	612450	612453	612470	612473
-8	-10	7/8" - 14	612420	612423	612430	612433
-10	-10	7/8" - 14	612200	-	612250	-
-10	-12	1-1/16" - 12	612210	-	612260	-
-10	-8	3/4" - 16	612240	-	612290	-
-12	-12	1-1/16" - 12	612220	-	612270	-
-12	-10	7/8" - 14	612230	-	612280	-

Forged Aluminum Swivel Hose Ends

Made of high-quality forged aluminum for superior strength and durability. The elbow design provides extra strength with 360° full swivel adjustment.

AN SIZE	90° ANGLE
-6	613640*
-8	613650*
-10	613660*
-12	613670



Anodized Polished Swivel Hose Ends

These sockets and hose ends provide a wide variety of color and hose end choices for the consumer with less inventory investment. Featuring black anodized and polished hose ends which can be paired with sockets.

Hose End Without Socket

AN SIZE	STRAIGHT	45° RADIUS	90° RADIUS
-6	615023	615093	615163
-8	615033	615103	615173
-10	615043	615113	615183

SOLD SINGLE



Hose End Socket

AN SIZE	RED	GRAY	PURPLE	BLACK	ORANGE
-6	615520	615521	615522	615523	615524
-8	615530	615531	615532	615533	615534
-10	615540	615541	615542	615543	615544

PACKAGE OF 2



*Available while supplies last



EFI SAE Female Quick-Disconnect Hose Ends

Russell's Quick-Disconnect Hose Ends allow you to transition from a SAE J2044 QD hard line directly to an AN hose, eliminating the need for an adapter. These unique fittings have a threaded collar that securely attaches the hose end to the hard line. Additionally two internal o-rings create a solid leak-free connection. Use with Russell ProFlex, ProClassic or ProClassic II hose series.



EFI SAE Female Quick-Disconnect Hose Ends

HOSE SIZE	SIZE	STRAIGHT		45° RADIUS		90° RADIUS		180° RADIUS	
		RED / BLUE	BLACK	RED / BLUE	BLACK	RED / BLUE	BLACK	RED / BLUE	BLACK
-6	5/16"	611250	611253	611260	611263	611270	611273	611280	611283
-6	3/8"	611200	611203	611210	611213	611220	611223	611230	611233

Russell's unique, threaded collar easily slips onto 5/16" or 3/8" OEM hard line ends. The threaded cap fastens to the collar resulting in a sturdy, leak free connection to -6 hose.

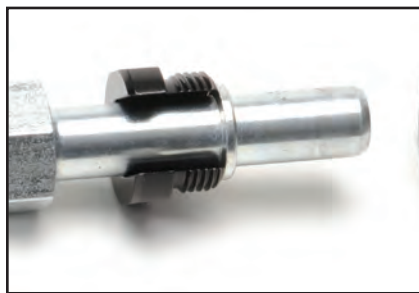

Position the threaded cap onto OEM hard line.

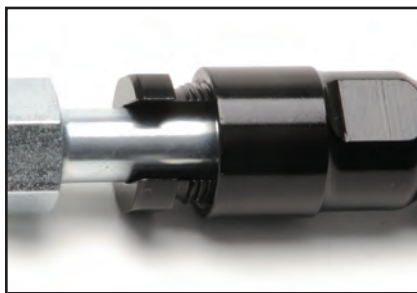

Screw the cap clockwise into the threaded collar.

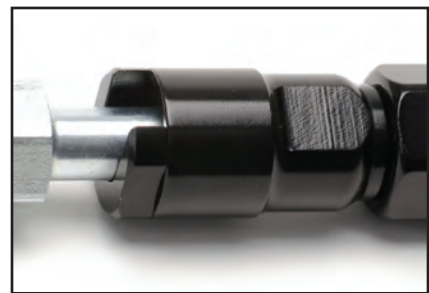

Tighten the cap until seated properly for a leak-proof seal.

Adjustable Wrench

Aluminum gray anodized.

DESCRIPTION	ITEM
ADJUSTABLE AN WRENCH	654400
ADJUSTABLE AN V-FLATS WRENCH	654410



654400 - Adjustable AN Wrench



654410 - Adjustable AN V-Flats Wrench



Twist-Lok Hose Ends

Russell Twist-Lok hose ends utilizes barbs for hose retention. These hose ends are constructed of lightweight aluminum and are 40% lighter than conventional hose ends. Twist-Lok hose ends work with any Russell AN adapter or conventional AN fittings. Russell Twist-Lok hose ends are available in blue or black anodized finish.



AN SIZE	STRAIGHT		45° RADIUS		90° RADIUS	
	BLUE	BLACK	BLUE	BLACK	BLUE	BLACK
-4	624000	624003	624070	624073	624150	624153
-6	624010	624013	624080	624083	624160	624163
-8	624020	624023	624090	624093	624170	624173
-10	624030	624033	624100	624103	624180	624183

Twist-Lok Hose Ends Standard & Tight Radius

Russell's Tight Radius Twist-Lok hose ends have a shorter distance between fittings for use in tight spots. The tight radius ends are available blue anodized in 120°, 150°, and 180°.

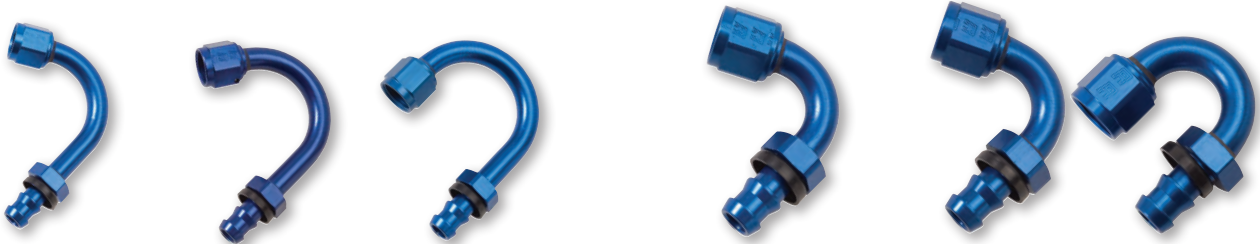

Standard Radius

AN SIZE	RADIUS	120° RADIUS	150° RADIUS	180° RADIUS
-6	1"	624260*	624300*	624340*
-8	1-1/4"	624270*	624310*	624350*
-10	1-1/4"	624280*	624320*	624360*

Tight Radius

AN SIZE	RADIUS	120° RADIUS	150° RADIUS	180° RADIUS
-6	9/16"	626000	626030	626060
-8	3/4"	626010	626040	626070
-10	15/16"	626020	626050	626080

Twist-Lok Adapter Fittings

Barb to Male NPT

PIPE SIZE	BARB SIZE	BLUE
3/8"	3/8"	670220
3/8"	1/2"	670230



Barb to Male AN

AN SIZE	BARB SIZE	BLUE	CLEAR
-6	3/8"	-	670300
-8	1/2"	670310	-
-10	5/8"	670320*	-
-12	3/4"	670330*	-

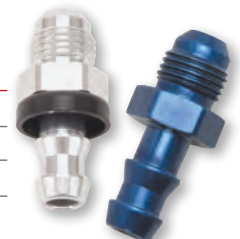

*Available while supplies last



ProClassic Crimp-On Hose Ends

Designed for shop or retail store use, the ProClassic Crimp-On program makes hose fabrication easy and profitable. Our simple push together barb technology makes pre-assembly a breeze. Simply cut the hose, push together the hose and fitting and crimp! Designed as a balanced hose assembly, our lightweight collar design is engineered by size for precise compression ensuring end attachment. The 360° Swivel hose ends allow for quick alignment after assembly. Available in sizes -4 through -12 and packaged complete with collar. The ProClassic Crimp-On hose ends work with ProClassic, ProClassic II and our ProFlex hoses. Crimp-On fittings are not interchangeable with other brands.



Crimp On Swivel Hose Ends

AN SIZE	STRAIGHT	45° RADIUS	90° RADIUS	120° RADIUS	150° RADIUS	180° RADIUS
-4	610403	610413	610423	-	-	-
-6	610463	610473	610483	610493	610503	610513
-8	610523	610533	610543	610553	610563	610573
-10	610583	610593	610603	610613	610623	610633
-12	610643	610653	610663	610673	610683	610693



Radius Port Hose End O-Ring Boss

HOSE	PORT	THREAD	45° RADIUS	90° RADIUS	180° RADIUS
-6	-6	9/16 -18"	610800	610810	610820
-8	-8	3/4 -16"	610830	610840	610850
-8	-10	7/8 -14"	610950	610960	-



Russell Manual Crimper

The ProClassic Manual Crimper is a hand operated vise-style crimper engineered for easy hose end attachment. Each hose size has a specific die engineered for consistent and repeatable crimping with no measurement or adjustment, ensuring proper attachment. An over-center operation design makes this crimper easy to use.



MANUAL CRIMPER | 652000

Replacement Crimp Collars

AN SIZE	ALUMINUM	STAINLESS STEEL
-4	610353	-
-6	610363	610362*
-8	610373	610372*
-10	610383	610382*
-12	610393	610392

PACKAGE OF 6



Crimper Dies

AN SIZE	OUTSIDE DIAMETER	ITEM
-4	0.450"	652001
-6	0.575"	652007
-8	0.675"	652008
-10	0.800"	652009
-12	0.950"	652005

EACH SOLD SEPARATELY



*Available while supplies last



Hose End Fittings & Accessories

INTRODUCTION
HOSES
HOSE ENDS
ADAPTER FITTINGS
FUEL MANAGEMENT
ACCESSORIES
TOOLS
TRANSMISSION
POWER STEERING
BRAKE HOSES
NITROUS
DEALER
BULK
INSTALL
INDEX

Anodized Aluminum & Chrome Tube Seal Hose Ends

Designed to add that finishing hose end appearance with the ease of installation of a hose clamp. Just screw the worm gear closed and insert inside the socket. Reopen the clamp, expanding the tube seal. Slip over the hose assembly, tighten onto the barb. Use with push-on tube adapters, not required for barb adapters.



AN SIZE	APPLICATION	RED	BLUE	CHROME	BLACK
-4	1/4" VACUUM HOSE	620250	623250	622250	-
-6	5/16" FUEL HOSE	620260	623260	622260	620263
-8	3/8" FUEL HOSE	620270	623270	622270	620273
-10	1/2" HEATER HOSE	620190	623190	622190	620193
-12	UNIVERSAL	620200	623200	622200	620203

Manifold Fittings

These Russell manifold fittings are required when adapting metric size hose to standard NPT inlets/outlets. They eliminate having to force the hose over an oversized barb or excessive overtightening of the worm gear clamp to achieve a positive seal. Ideal for use with Edelbrock Victor X manifolds.



APPLICATION	NPT SIZE	TUBE SIZE	ITEM
HOSE FITTING	1/8"	5MM (3/16")	697000
HOSE SINGLE BARB FITTING	1/8"	8MM (5/16")	697010*
HOSE SINGLE BARB FITTING	1/4"	8MM (5/16")	697020*
HOSE SINGLE BARB FITTING	1/4"	9MM (11/32")	697040
HOSE SINGLE BARB FITTING	1/4"	10MM (3/8)	697050



Straight Pipe to AN Tube*

AN SIZE	NPT SIZE	TUBE SIZE	STRAIGHT	45° ANGLE	90° ANGLE
-4	1/8"	1/4"	663000	663050*	663100*
-6	1/4"	3/8"	663010	663060*	663110*
-8	3/8"	1/2"	663020	663070*	663120*
-10	1/2"	5/8"	663030	663080*	663130*
-12	3/4"	3/4"	663040	663090*	663140*

*MUST USE HOSE CLAMP. WHILE SUPPLIES LAST.

Straight Pipe to Tube

These barb hose ends are designed to hold up to any plumbing task you have. They are made from high quality aluminum and are designed to be used with conventional rubber hose. They're available in clear or black anodized finish in a variety of sizes.



NPT SIZE	BARB	STRAIGHT		90° ANGLE	
		CLEAR	BLACK	CLEAR	BLACK
3/8"	3/8"	8118	8117	8168	8167
3/8"	1/2"	8115	8114	8164	8163
1/2"	3/8"	8186	8185	8177	8169
1/2"	5/8"	8160	8159	8179	8178
1/2"	1/2"	8121	8119	8182	8180
1/2"	3/4"	8184	8183	8166	8165
1/4"	3/8"	8199	8191	-	-
3/8"	5/8"	8188	8187	-	-

*Available while supplies last



Adapter Fittings

Russell's wide variety of lightweight aluminum adapter fittings allow for the connection of Russell hose ends to almost any component. Adapters are offered in standard thread, metric thread and pipe thread to fit most popular oil pumps, fuel pumps and fuel filters, plus a variety of other common components. To complement the looks of the hose installation, three finishes are available: Endura, blue/red or black.



- Precision Machined to Ensure Precise Thread Engagement
- Lightweight Aluminum Fittings are Designed to Match Up with All Russell Performance Hose and Hose Ends
- 37° Sealing Angle Guarantees a Positive Seal at Maximum Operating Pressures



Flare to Pipe

AN SIZE	NPT SIZE	BLUE	STRAIGHT ENDURA	BLACK	BLUE	45° ANGLE ENDURA	BLACK	BLUE	90° ANGLE ENDURA	BLACK
-3	1/8"	660410	660411	-	660930	660931*	-	660790	660791	-
-4	1/8"	660420	660421	660423	660940	660941	660943	660800	660801	660803
-4	1/4"	660430	660431	660433	660770	-	-	660810	660811	660813
-4	3/8"	660060	660061	660063	-	-	-	-	-	-
-6	1/8"	660450	660451	660453	660100	-	660103	660830	660831	660833
-6	1/4"	660440	660441	660443	660950	660951	660953	660820	660821	660823
-6	3/8"	660460	670461	660463	662390	662391	662393	660840	660841	660843
-6	1/2"	670150	670151	670153	-	-	-	-	-	-
-8	1/4"	660470	660471	660473	-	-	-	660850	660851	660853
-8	3/8"	660480	660481	660483	660960	660961	660963	660860	660861	660863
-8	1/2"	660490	660491	660493	662410	-	-	660870	660871*	660873
-10	3/8"	670030	670031	670033	662380	-	-	-	-	-
-10	1/2"	660500	660501	660503	660970	660971*	660973	660880	660881	660883
-10	3/4"	660080	-	-	-	-	-	-	-	-
-12	1/2"	660520	660521	660523	-	-	-	660900	660901	660903
-12	3/4"	660510	660511	660513	660980	-	660983	660890	-	660893
-16	3/4"	660540	-	660543	-	-	-	-	-	-
-16	1"	660530	-	660533	-	-	-	660910	-	660913

*Available while supplies last



Adapter Fittings

INTRODUCTION
HOSES
HOSE ENDS
ADAPTER FITTINGS
FUEL MANAGEMENT
ACCESSORIES
TOOLS
TRANSMISSION
POWER STEERING
BRAKE HOSES
NITROUS
DEALER
BULK
INSTALL
INDEX



Flare Bulkhead

AN SIZE	BLUE	STRAIGHT ENDURA	BLACK	45° ANGLE BLUE	BLUE	90° ANGLE ENDURA	BLACK	BLUE TEE	ENDURA
-3	661160	661161	-	-	661230	661231	-	661300	661301
-4	661170	661171	-	-	661240	661241	-	661310	661311
-6	661180	661181	661183	661390	661250	661251	661253	661320	661321
-8	661190	661191	661093	661400*	661260	661261	661263	661330	661331
-10	661200	661201	661203	-	661270	-	-	661340	661341
-12	661210*	661211	-	-	661280*	-	-	661350	661351



Flare To Pipe Tee on Run

Features one NPT port and one AN port "on run" (straight through portion of the tee) and one AN center port.

AN SIZE	NPT SIZE	BLUE
-3	1/8"	661100
-4	1/8"	661110
-6	1/4"	661120
-8	3/8"	661130
-10	1/2"	661140
-12	3/4"	661150

AN Flare To Pipe Tee

Features two AN ports "on run" (straight through portion of the tee) and one NPT center port.

AN SIZE	NPT SIZE	BLUE	ENDURA
-3	1/8"	661060	661061
-4	1/8"	661070	-
-6	1/4"	661080	-
-6	3/8"	660120	660121*
-8	3/8"	661090	-
-10	1/2"	660140*	-
-12	3/4"	660150	-

AN Flare Tee

Features three AN male flare ends.

AN SIZE	BLUE	ENDURA	BLACK
-3	660990	660991	-
-4	661000	661001	661003
-6	661020	661021	661023
-8	661030	661031	661033
-10	661040	-	661043
-12	661050	-	-

Bulkhead Nut

AN SIZE	THREAD	BLUE	ENDURA	BLACK
-3	3/8" - 24	661870	661871	-
-4	7/16" - 20	661880	661881	-
-6	9/16" - 18	661890	661891	661893
-8	3/4" - 16	661900	661901	661903
-10	7/8" - 14	661910	661911	661913
-12	1 1/16" - 12	661920	661921*	661923*
-16	1 5/16" - 12	661930*	-	-

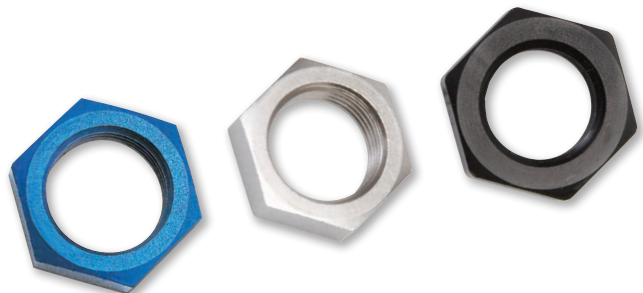

*Available while supplies last



Adapter Fittings

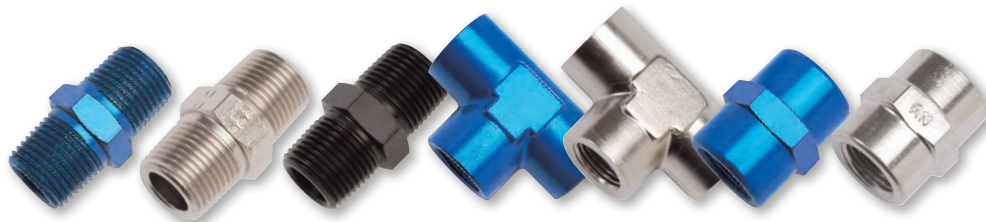

Pipe Adapter Fittings

NPT SIZE	MALE PIPE NIPPLE			FEMALE PIPE TEE		FEMALE PIPE COUPLER	
	BLUE	ENDURA	BLACK	BLUE	ENDURA	BLUE	ENDURA
1/8"	661500	661501	-	661710	661711	661440	661441
1/4"	661510	-	-	661720	-	661450	661451*
3/8"	661520	661521	661523	661730	-	661460	661461*
1/2"	661530*	-	-	661740	661741*	661470	-

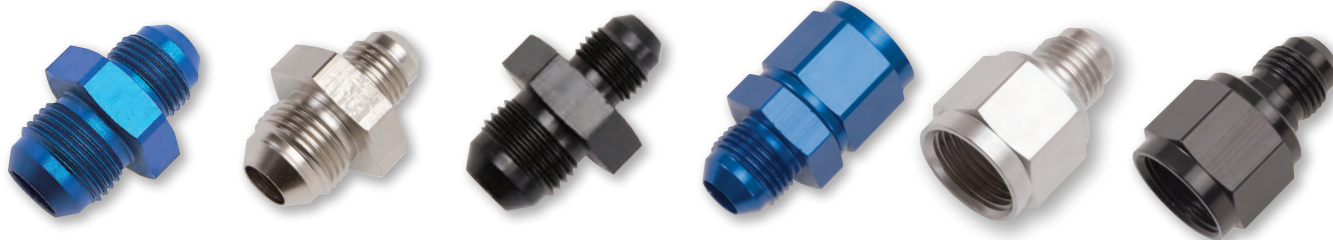

AN Flare Reducer

These male to male fittings reduce AN female connections.

MALE TO MALE	BLUE	ENDURA	BLACK
-3 TO -4	661750	661751	-
-4 TO -6	661760	661761	-
-6 TO -8	661770	661771	661773
-6 TO -10	661780	661781*	-
-8 TO -10	661790	661791	661793
-8 TO -12	661810	-	-
-10 TO -12	661820	-	-
-12 TO -16	661840	-	-

AN B-Nut Reducer

FEMALE TO MALE	BLUE	ENDURA	BLACK
-6 TO -4	660000	-	660003
-8 TO -4	660010	-	660013
-8 TO -6	660020	660021	660023
-10 TO -8	660030	660031	660033
-12 TO -10	660040	-	660043

AN B-Nut Flare Expander



FEMALE TO MALE	BLUE
-6 TO -4	659950
-8 TO -6	659960
-10 TO -8	659970
-12 TO -10	659980



NPT Pipe Bushing Reducer

Easily reduce a NPT female port to a smaller inside diameter with Russell pipe bushing reducers.

MALE TO FEMALE	RED	BLUE	ENDURA	BLACK
1/8" TO 1/4"	661690	-	-	-
1/4" TO 1/8"	-	661550	661551	-
3/8" TO 1/8"	-	661570	661571	661573
3/8" TO 1/4"	-	661560	661561	-
1/2" TO 1/8"	-	661600	661601	661603
1/2" TO 1/4"	-	661590	-	-
1/2" TO 3/8"	-	661580	661581	661583
3/4" TO 1/2"	-	661620	661621	-
1" TO 3/4"	661640	-	-	-



Sportsman racers like Marty Bernard use Russell Hose, Hose Ends and Adapter Fittings for race-winning performance and reliability

*Available while supplies last



Adapter Fittings



Flare Cap

AN SIZE	BLUE	ENDURA	BLACK
-4	661950	661951	661953
-6	661960	661961	661963
-8	661970	661971	661973
-10	661980	661981	661983
-12	661990	-	661993
-16	662000	-	-



Flare to Metric Adapter

AN SIZE	METRIC THREAD	BLUE	ENDURA	BLACK
-4	M8 X 1.0	670370	-	-
-4	M8 X 1.25	670380	-	-
-4	M10 X 1.0	670500	670501	-
-4	M10 X 1.25	670400	-	-
-4	M10 X 1.5	670410	-	-
-4	M12 X 1.0	670420	-	-
-4	M12 X 1.25	670430	-	-
-4	M12 X 1.5	670440	-	-
-4	M14 X 1.5	670450	-	-
-6	M10 X 1.0	670480	670481*	-
-6	M10 X 1.25	670460	-	-
-6	M10 X 1.5	670240*	-	-
-6	M12 X 1.5	670510	670511	670513
-6	M14 X 1.5	670520	670521	670523
-6	M16 X 1.5	670530	670531	670533
-6	M18 X 1.5	670540	-	-
-8	M12 X 1.5	670250	-	-
-8	M14 X 1.5	670490	670491	-
-8	M16 X 1.5	670550	670551	-
-8	M18 X 1.5	670560	670561	-
-10	M14 X 1.5	670260*	-	-
-10	M16 X 1.5	670270	-	-
-10	M18 X 1.5	670570*	-	-
-10	M20 X 1.5	670280*	-	-
-12	M20 X 1.5	670100	-	-

Fuel Cell Bulkheads

Radiused entry bulkheads provide unrestricted fuel flow out of the fuel cell and into the pump feed line. Fuel cell bulkheads come complete with PTFE sealing washer and jam nut. Sold one per package.



AN SIZE	BLACK
-6	670850
-8	670860
-10	670870
-12	670880

Aluminum Allen Socket Pipe Plugs



NPT SIZE	BLUE	ENDURA	BLACK
1/8"	662030	662031	662033
1/4"	662040	662041	662043
3/8"	662050	662051	662053
1/2"	662060	662061	662063
3/4"	662070	662071	-

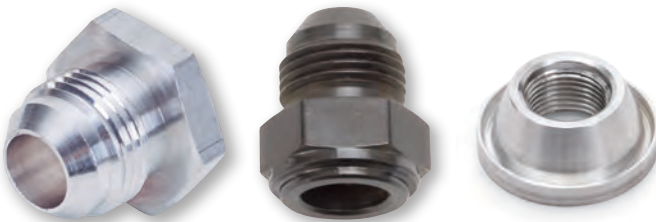

AN Aluminum Weld Bungs Male & Female

SIZE	THREAD	MALE		FEMALE
		ALUMINUM	STEEL	ALUMINUM
-6	9/16" - 18 SAE	670580	683700	640090*
-8	3/4" - 16 SAE	670590	683710	640100*
-10	7/8" - 14 SAE	670600	683720	640110*
-12	1-15/16" - 12 SAE	670610	-	-



NMCA Extreme Street Racer Jimmy Byrne relies on Russell adapters, lines and fittings.

NPT Weld Bungs Female



SIZE	THREAD	ITEM
1/8"	1/8" - 27 NPT	670740
1/4"	1/4" - 18 NPT	670750
3/8"	3/8" - 18 NPT	670760
1/2"	1/2" - 14 NPT	670770
3/4"	3/4" - 14 NPT	670780
1"	1" - 11/12 NPT	670790

*Available while supplies last



Adapter Fittings

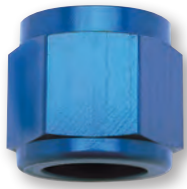

Tube Nut

AN SIZE	TUBE SIZE	QTY	BLUE	ENDURA	BLACK
-3	3/16"	6	660550	660551	-
-4	1/4"	6	660560	660561	660563
-6	3/8"	2	660570	660571	660575
-8	1/2"	2	660580	660581	660585
-10	5/8"	1	660590	660591	660593
-12	3/4"	1	660600*	-	-

Tube Sleeve

AN SIZE	TUBE SIZE	QTY	BLUE	ENDURA	BLACK
-3	3/16"	6	660630	660631	-
-4	1/4"	6	660640	660641	660643
-6	3/8"	2	660650	660651	660653
-8	1/2"	2	660660	660661	660663
-10	5/8"	1	660670	660671	660673
-12	3/4"	1	660680*	-	-



Flare Union

AN SIZE	BLUE	STRAIGHT ENDURA	BLACK	90° ANGLE BLUE
-3	660330	660331	-	-
-4	660340	660341	660343	-
-6	660350	660351	660353	-
-8	660360	660361	660363	640740
-10	660370	660371	660373	-
-12	660380	660381*	660383	-
-16	660390	-	-	-



Flare Plug

AN SIZE	BLUE
-3	660170*
-4	660180
-6	660190
-8	660200
-10	660210
-12	660220



Straight Thread Plug

AN SIZE	BLUE	ENDURA	BLACK
-3	660250	-	-
-4	660260	660261*	-
-6	660270	660271*	660273
-8	660280	660281*	660283
-10	660290	-	660293
-12	660300	660301*	-
-16	660310	660311*	-



697090 - Oil Pan Flange
1.125" CENTER TO CENTER



69700 - Twist-Lok Banjo



697070 - Oil Drain



697100 - Oil Inlet

Universal Turbo Fittings

Ideal for custom applications using Garrett T03, T25, T28 turbochargers. Engineered for maximum flow and a secure fit, these adapters allow easy plumbing for your turbo's oil and water hoses.

DESCRIPTION	ITEM
OIL PAN FLANGE, ADAPTS A MALE -10 AN TO ANY OIL PAN, BLACK ZINC PLATED STEEL, INCLUDES GASKET AND MOUNTING BOLTS	697090
WATER INLET/OUTLET 14MM BANJO TO -6 TWIST-LOK HOSE ADAPTER, ZINC PLATED STEEL, INCLUDES M14 X 1.5 BANJO BOLT AND CRUSH WASHERS	697080
OIL DRAIN TO MALE -10 AN ADAPTER BLUE ANODIZED ALUMINUM, INCLUDES VITON® O-RING	697070
OIL INLET (7/16"-24 INVERTED FLARE) TO -6 MALE AN, ZINC PLATED STEEL	697100



Adapter Fittings

INTRODUCTION
HOSES
HOSE ENDS
ADAPTER FITTINGS
FUEL MANAGEMENT
ACCESSORIES
TOOLS
TRANSMISSION
POWER STEERING
BRAKE HOSES
NITROUS
DEALER
BULK
INSTALL
INDEX



Swivel Coupler

These fittings allow you to make professional 37° AN union connections. All aluminum construction featuring precise thread engagement and available in straight, 45°, and 90° configurations, making it easier for customizing line routings. Features a high quality blue or black anodized finish or Russell's unique ultra-bright Endura finish that simulates the appearance of stainless steel.

AN SIZE	RED / BLUE	STRAIGHT			45° ANGLE		90° ANGLE		
		ENDURA	BLACK	RED / BLUE	ENDURA	RED / BLUE	ENDURA	BLACK	
-4	640140	640141*	640143	640150	640151	640250	-	-	
-6	640000	640001	640003	640040	640041	640160	640161	640163	
-8	640010	640011	640013	640050	-	640170	640171	640173	
-10	640020	640021	640023	640060	-	640180	640181	640183	
-12	640030	-	640033	640070	-	640190	-	-	

Coupler Reducer

These hose fittings allow you to make professional 37° AN reduction/expander union connections. All aluminum construction featuring precise thread engagement. Features a high quality Traditional or Russell's unique ultra-bright Endura finish that simulates the appearance of stainless steel.



FEMALE TO FEMALE	RED / BLUE	ENDURA
-6 TO -8	640550	640551
-8 TO -10	640560	640561*
-10 TO -12	640570	640571*

O-Ring Boss Radius AN Port Adapters

Russell Radius Port Adapter fittings are precision machined for positive thread engagement. They feature radius profiled angles at port inlet/outlet for optimum flow. These adapters are ideal when connecting regulators and fuel lines to pumps and tanks, and are also useful for dry sump applications. A black anodized finish is applied for appearance and durability. Each fitting is packaged complete with o-ring seal, except for -10 (P/N 670670) and -12 (P/N 670680), 1/2" NPT, which requires thread sealant.



PORT SIZE	-6 AN	-8 AN	-10 AN	-12 AN	-16 AN
-6	670840	670930	-	-	-
-8	670640	670700	670940	-	-
-10	670650	670660	670710	670720	-
1/2" NPT LONG	-	-	670670*	-	-
-12	-	-	-	670730	670690
1/2" NPT LONG (STEEL)	-	-	-	670680*	-

*Available while supplies last



Adapter Fittings



Female AN to Male NPT

AN SIZE	NPT SIZE	STRAIGHT		90° ANGLE BLUE
		BLUE	BLACK	
-3	1/8"	614203	-	-
-4	1/8"	614204	614202	-
-4	1/4"	614214	-	-
-6	1/8"	614216	614215	614016
-6	1/4"	614206	-	614006
-6	3/8"	614226	614225	614026
-8	1/4"	614208	-	614008
-8	3/8"	614218	614217	614018
-8	1/2"	614228	-	614028
-10	3/8"	614220	-	614020
-10	1/2"	614210	-	614010
-12	1/2"	614222	-	614022
-12	3/4"	-	-	614012

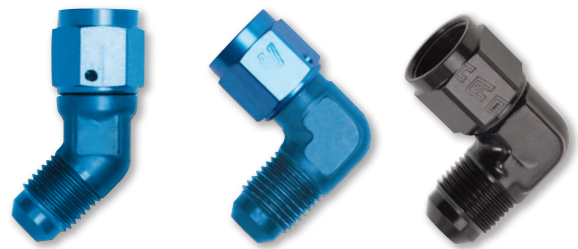

Female AN to Male AN

AN SIZE	45° ANGLE BLUE	90° ANGLE	
		BLUE	BLACK
-3	614703	614803	-
-4	614704	614804	-
-6	614706	614806	614805
-8	614708	614808	614807
-10	-	614810	-

AN Tee - Female AN on Side



AN SIZE	BLUE
-3	614303
-4	614304
-6	614306
-8	614308

Female AN to Female AN - Low Profile

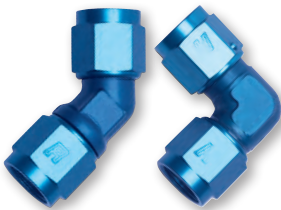

AN SIZE	45° ANGLE	90° ANGLE
-3	614603	614503
-4	614604	614504
-6	614606	614506
-8	-	614508

AN Tee - Female AN on Run



AN SIZE	BLUE	BLACK
-3	614403	-
-4	614404	-
-6	614406	614405
-8	614408	-
-10	614410	-



Customer's Report

"I will only use Russell fittings and hose in our racing applications. The quality and reliability of Russell is second to none. I race many different outlaw Mustangs that attain speeds up to and over 200 mph, and there is only one fitting we will use - Russell."

- John Urist

90° Male AN to Male Swivel NPT



AN SIZE	NPT SIZE	ITEM
-6	1/8"	614116
-6	1/4"	614106
-6	3/8"	614126
-8	1/4"	614108
-8	3/8"	614118
-8	1/2"	614128
-10	3/8"	614120
-10	1/2"	614110
-12	1/2"	614122
-12	3/4"	614112



Carburetor Adapter Fittings

INTRODUCTION
HOSES
HOSE ENDS
ADAPTER FITTINGS
FUEL MANAGEMENT
ACCESSORIES
TOOLS
TRANSMISSION
POWER STEERING
BRAKE HOSES
NITROUS
DEALER
BULK
INSTALL
INDEX

Carburetor Fuel Pump Adapter Fittings

Fits Ford, Chrysler, & early Chevy pumps with 1/2"-20 inverted flare thread.

AN SIZE	ZINC-PLATED STEEL	ENDURA
-6	640330	640331
-8	640390	-



Carburetor Fuel Pump Adapter Fittings

Fits Chevy fuel pumps inline filters with 5/8"-18 inverted flare thread.

AN SIZE	ZINC-PLATED STEEL	ENDURA
-6	640380	640381
-8	640400	-



O-Ring Adapter Female Fittings

Fits GM sending units/OEM hard lines.

DESCRIPTION	BLUE	BLACK
M14 X 1.5 TO -6 FLARE	640820	640823
M16 X 1.5 TO -6 FLARE	640830	640833



Inverted Flare Adapter Female Fittings

For use with OEM hardlines. 13/16" hex.

AN SIZE	ZINC-PLATED STEEL
-6 TO 1/2" -20	640600
-6 TO 5/8" -18	640610
-8 TO 1/2" -20	640620*
-8 TO 5/8" -20	640630



Carburetor Adapter Fittings

Fits Edelbrock Thunder Series, Performer Series and Carter AFB carbs with 5/8"-20 thread.

AN SIZE	BLUE	ENDURA	BLACK
-6	640240	640241	640243

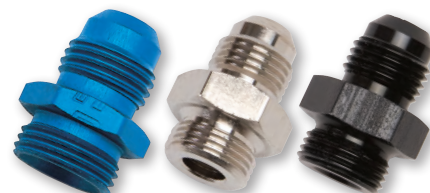

Carburetor Banjo Adapter Fittings

Fits Edelbrock Thunder Series, Performer Series and Carter AFB carbs with 5/8"-20 thread and Holly® Single Feed 600-660 Series and all two barrel series with 9/16" - 24 thread. Banjo fitting assembles directly to hose.

APPLICATION	AN SIZE	BLUE / RED	ENDURA	BLACK / SILVER
FOR EDELBROCK CARBURETORS	-6	640270	640271	640273
FOR HOLLY CARBURETORS	-6	640230	640231	640233



Quadrajets Carburetor Adapter Fittings

Fits Edelbrock Q-Jets for vehicles 1966-89 and stock factory Q-Jets for 1974-89.

DESCRIPTION	RED
1"-20 X 6 AN MALE FLARE ADAPTER	640340
1"-20 X 8 AN MALE FLARE ADAPTER	640350



*Available while supplies last



Carburetor Adapter Fittings

Carburetor Adapter Fittings

Fits Holley® Single Feed 600-660 Series, Holley Dual Feed 4010-4011 Series and Summit carbs, all Two Barrel Series and Demon® with 9/16" -24 thread.

AN SIZE	RED	ENDURA	BLACK
-6	640200	640201	640203

PACKAGE OF 2



Carburetor Adapter Fittings

Fits any Holley Dual Feed 750 through Dominator® 1350 Series, Quadrajet® up to 1974 with 7/8" -20 thread.

AN SIZE	RED	ENDURA	BLACK
-6	640220	640221	640223

PACKAGE OF 2

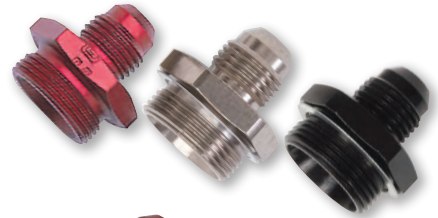

Carburetor Adapter Fittings

Fits any Holley Dual Feed 750 thru Dominator 1350 Series. Overall length is 2".

AN SIZE	RED	ENDURA	BLACK
-8	640210	640211*	640213

PACKAGE OF 2



Carburetor Inlet Fittings

Fits any Demon and BG carburetor with 9/16" -24 inlet thread. Overall length is 3-1/4".

AN SIZE	RED / BLUE	BLACK
-8	640770	640773

PACKAGE OF 2



Carburetor Inlet Fittings

Fits any Holley Dual Feed 750 through Dominator 1350 Series. Overall length is 3-1/4".

AN SIZE	RED / BLUE	ENDURA	BLACK
-8	640750	640751	640753

PACKAGE OF 2



GM TBI Adapter Fittings

SIZE	BLUE	BLACK
-6 TO 12MM X 1.25	640800	640803
-6 TO 14MM X 1.25	640810	640813



Extended Carburetor Adapter Fittings with Reduced Hex

Fits any Holley Dual Feed 750 thru Dominator 1350 Series. Overall length is 2".

SIZE	RED	ENDURA	BLACK
7/8" -20 X -6 AN MALE FLARE	640360	640361*	640363
7/8" -20 X -8 AN MALE FLARE	640370	-	640373

PACKAGE OF 2





SAE Quick-Disconnect Push-On Fittings

Russell OEM Style Push-On Fittings make connection to OEM hardlines simple and trouble free.

QUICK DISCONNECT FEMALE	AN MALE	BLUE	BLACK
3/8"	-6	640850	640853
5/16"	-6	640860	640863



SAE Quick-Disconnect Threaded Cap Fittings

Performance Series

Russell's innovative threaded end cap was engineered to insure positive retention in the hi-performance application where vibration and higher fuel pressures are common. Our unique dual O-ring system guarantees a leak proof seal.

QUICK DISCONNECT FEMALE	AN MALE	BLUE	BLACK
1/4"	-6	641300	641303
5/16"	-6	644110	644113
3/8"	-6	644120	644123
3/8"	-8	644130	644133



SAE Quick-Disconnect Specialty Adapters

Russell's SAE quick-disconnect adapters are the answer when connecting OEM stock lines to aftermarket fuel rails and components.

DESCRIPTION	ZINC PLATED
-6 AN MALE TO 5/16" SAE QUICK-DISCONNECT MALE	640930
-6 AN MALE TO 3/8" SAE QUICK-DISCONNECT MALE	640940
-6 AN MALE (ORB) SAE PORT TO 3/8" SAE QUICK-DISCONNECT MALE	644020
3/8" NPT MALE TO 3/8" SAE QUICK-DISCONNECT MALE	640690
3/8" SAE QUICK-DISCONNECT MALE TO 3/8" SAE QUICK-DISCONNECT FEMALE WITH 1/8" NPT FEMALE SIDE PORT/FUEL PRESSURE TAKE OFF	640730



SAE Quick-Disconnect Swivel End Adapter

These male to male adapters are the best way to add a SAE Quick-Disconnect to a carb port. Made with a black anodized finish.

QUICK DISCONNECT MALE	AN MALE	90° RADIUS	180° RADIUS
3/8"	-6 SAE (ORB)	644053	644013
3/8"	-8	644063	644043



Adapter Fittings

Billet Aluminum EFI Y-Blocks

Russell Billet Aluminum EFI Y-Blocks are designed to route separate fuel hoses to each individual fuel rail for a balanced system. The inlet port is designed for direct connection to 3/8" SAE quick-disconnect style hard lines. The "Threaded Cap" style EFI adapter fittings completely eliminate the plastic retaining clip and replace it with Russell's exclusive screw-in retaining cap for unsurpassed reliability. The dual O-ring seal insures a positive seal under high pressures. They are direct replacements for OEM fuel rail and return line fittings in late-model EFI pressure side application.



DESCRIPTION	ITEM
3/8" EFI SAE QUICK DISCONNECT FEMALE TO -6 AN MALE (DUAL)	644143
3/8" EFI SAE QUICK DISCONNECT FEMALE TO 3/8" EFI SAE Q.D. MALE (DUAL)	644163

Ford EFI Fittings

Adapts to the stock Ford EFI fuel rail fittings and allows either -6 AN or -8 AN fittings and hoses to be used. The spring lock and dual O-ring seal insures a positive seal under high pressures. They are direct replacements for OEM fuel rails and return line fittings in late-model EFI applications.



DESCRIPTION	BLUE	BLACK
FORD RETURN SIDE EFI X 6 AN	640870	640873
FORD PRESSURE SIDE EFI X 8 AN	640880	640883
FORD PRESSURE SIDE EFI X 6 AN	640900	640903

Banjo Fuel Fittings

Russell Banjo-style fuel fittings are precision machined for fit and finish. Ideal when connecting AN fuel lines your fuel system. All aluminum construction featuring precise thread engagement and a positive seal at maximum operating pressures. Features a high quality anodized finish.



DESCRIPTION	BLUE	BLACK
-6 AN MALE FLARE FOR CIVICS W/OUT FUEL PRESSURE DAMPER (12MM)	640910 [†]	640913 [†]
-6 AN MALE FLARE FOR CIVICS/INTEGRAS WITH FUEL PRESSURE DAMPER (12MM)	640920	640923

[†]ALSO FITS 1991-95 TOYOTA MR2

Ford EFI Fuel Pressure Fittings

This fitting plumbs into your Ford EFI fuel rail for easily routing AN hoses to your gauges or sender. Made of zinc plated steel.



DESCRIPTION	ITEM
-4 AN TO 1/16" NPT	640890



Fuel Line Adapter Fittings

Fuel Pressure Take Off Banjo Bolt

Features an 1/8" female NPT side port for gauge or pressure switch connection. Fits many Hondas and Toyotas. Use with P/N 640910, P/N 641110 & P/N 641120.

DESCRIPTION	ITEM
12MM TO 1.25	640700



Fuel Pressure Take Off

Features an 1/8" female NPT side port for gauge or pressure switch connection.

AN SIZE	RED / BLUE	BLACK
-4	670290	670293
-6	670340	670343
-8	670350	670353
-10	670360	670363



Flare 90° Fuel Pressure Adapter

Features an 1/8" female NPT side port for gauge or pressure switch connection.

AN SIZE	ITEM
-8	640790*



Flare Union Pressure Adapter

Features an 1/8" female NPT side port for gauge or pressure switch connection.

AN SIZE	BLUE	ENDURA	BLACK
-6	670000	670001	670010
-8	-	670011	670013



AN to Metric Adapter Fitting

All steel construction featuring precise thread engagement. Fits Edelbrock #3594, Walbro & other aftermarket fuel pumps.

DESCRIPTION	ITEM
-6 AN MALE TO M10 X 1.0" METRIC, STEEL WITH CRUSH WASHERS	670470



Flare to Pipe Pressure Adapter

Features an 1/8" female NPT side port for gauge or pressure switch connection.

AN SIZE	PIPE SIZE	BLUE	ENDURA	BLACK
-6	3/8"	670060	670061	670063
-8	3/8"	670080	-	670083



Edelbrock Fuel Pump Adapter Fittings

For Edelbrock billet fuel pumps with 5/8"-18 thread & copper sealing washer. Fits CV Products, fuel pumps.

AN SIZE	ITEM
-6	640950
-8	640960



*Available while supplies last



Carbureted Fuel System Kits

Complete fuel system kits include a state-of-the-art Edelbrock electric fuel pump offering maximum performance in a compact package.

Kits also include matching fuel pressure regulator (if required), a Russell ProFilter fuel filter, a dual-feed carb kit with fittings, a fuel pump relay and wiring assembly, 20 feet of our ProClassic or ProFlex hose, plus an assortment of hose ends, adapters and mounting brackets.



641520 - Fuel Hose Kit



641580 - Fuel Hose Kit



641523 - Fuel Hose Kit



641583 - Fuel Hose Kit



641510 - Fuel Hose Kit



641590 - Fuel Hose Kit

Carbureted - Fuel Cell to Carburetor Up to 160 GPH, 12 PSI

Includes fuel pump (P/N 1792) and regulator (P/N 1727).

DESCRIPTION	RED / BLUE	BLACK / SILVER
EDELBROCK DUAL-FEED THUNDER SERIES AVS CARB	641510	641513
HOLLEY/DEMON DUAL-FEED CARB	641520	641523

Carbureted - Fuel Cell to Carburetor Up to 120 GPH, 6.5 PSI

Includes fuel pump (P/N 1791). No regulator required.

DESCRIPTION	RED / BLUE	BLACK / SILVER
EDELBROCK DUAL-FEED THUNDER SERIES AVS CARB	641580	641583
HOLLEY/DEMON 4150 DUAL-FEED CARB	641590	641593



Carbureted Fuel Line Kits



8134 - Fuel Line Kit



8131 - Fuel Line Kit



81343 - Fuel Line Kit

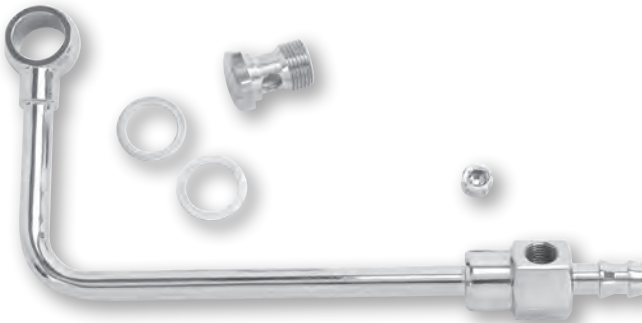

8126 - Fuel Line Kit



81263 - Fuel Line Kit



Edelbrock's unique design routes the line down the right side of the carb under the choke housing.

Single Feed Kit for Edelbrock Carburetors

Engineered for a clean and custom installation, Edelbrock's unique design routes the line down the right side of the carb under the choke housing. For use with push on barb for 3/8" rubber hose or with our competition aluminum filter with -6 male ends. To complete this install, use our fuel pump to filter kit on page 29.

DESCRIPTION	AN SIZE	RED / BLUE	CHROME	BLACK
SINGLE-FEED FUEL LINE WITH FILTER	-6 AN	8134	8131	81343
SINGLE-FEED FUEL LINE WITH BARB END, NO FILTER	3/8" BARB	-	8126	81263

Dual Inlet Hard Fuel Line for Thunder Series Carbs

Engineered for a clean and custom installation, Edelbrock's unique design routes the line down the right side of the carb under the choke housing. To complete this install, use our fuel pump to filter kit on page 29.

DESCRIPTION	AN SIZE	RED / BLUE	CHROME
DUAL-FEED FUEL LINE WITH FILTER	-6 AN	8133	8128
DUAL-FEED FUEL LINE, NO FILTER 3/8" BARB END	-6 AN	8132	-





Carbureted Fuel Hose Kits

Universal Carbureted Fuel Hose Kits

Connects mechanical fuel pumps with 1/2" NPT outlets to Edelbrock fuel pressure regulator kits (pg. 32). Made of the highest quality materials. Pre-assembled -8 ProFlex hose and hose ends.

DESCRIPTION	PROFLEX
22" BRAIDED FUEL HOSE KIT FOR SMALL BLOCK ENGINE	8122
27" BRAIDED FUEL HOSE KIT FOR BIG BLOCK ENGINE	8127



8122 - Fuel Hose Kit

Fuel Pump to Carburetor Hose Kits

Small Block Chevy with an Edelbrock Carburetor

Designed for direct bolt on fit with ease of installation these kits are engineered for use with Edelbrock Performer Series and Thunder Series AVS Carbs, when connecting to mechanical fuel pumps with 3/8" NPT outlet or OEM style mechanical pumps with 5/8" -18 outlets. Kit comes complete with necessary adapter fittings and sealing gaskets.

DESCRIPTION	PROCLASSIC
FUEL HOSE WITH STREET FILTER	8102
FUEL HOSE WITH COMPETITION FILTER	8103



8102 - Fuel Hose Kit



8103 - Fuel Hose Kit

Edelbrock Carburetor Single-Feed or Dual-Feed Fuel Inlet Kit

These high-quality fuel line kits offer a clean and precise fuel supply line when using an Edelbrock Single-Feed or Dual-Feed Fuel Inlet Kit (Edelbrock P/N 8128, 8133) to a mechanical fuel pump with a 3/8" NPT outlet. These hose kits are pre-assembled with hose ends. Carb fuel inlet and fuel filter not included.

APPLICATION	PROFLEX	PROCLASSIC
SMALL BLOCK CHEVY / SMALL BLOCK CHRYSLER / BIG BLOCK CHRYSLER	8123	81233
AMC / BIG BLOCK CHEVY / SMALL BLOCK FORD / 429/460 FORD / PONTIAC	8124	81243
SMALL BLOCK FORD	8125	-



8123 / 81233 - Fuel Hose Kit

OEM Carburetors

Designed to replace your original fuel line. These kits are pre-assembled and fit most GM applications. Includes big bore carb bowl fitting, fuel pump adapter, hose ends and a pre-cut length of -6 ProFlex or ProClassic hose. Fuel Filter not included.

DESCRIPTION	CARB TYPE	LENGTH	PROCLASSIC
1974 & LATER GM	QUADRAJET	2-1/2'	641020
INLET CARB KIT NO. 641090	HOLLEY 4150	2'	641030
PROFLEX KIT WITH CHROME SEAL ENDS	UNIVERSAL	3'	641050
PROCLASSIC KIT WITH CHROME SEAL ENDS	UNIVERSAL	3'	641053



640153 - Fuel Hose Kit



Dual Inlet Fuel Hose Kits

-6 Dual Inlet Carburetor Kits (Filter not included)

Designed to fit Holley and Demon carburetors. These kits are available in a multitude of hose choices and finishes. Factory assembled for precise fit and ease of installation.

Large 3/8" female NPT inlet adapts easily to mechanical or electric fuel pump. Optional 0-15 psi fuel pressure gauge.

Holley 4150 Series Carburetor Fuel Hose Kit

HOSE SIZE	INLET SIZE	FITTINGS	HOSE	WITH OUT GAUGE	WITH GAUGE
-6	3/8" FEMALE NPT	RED / BLUE	PROFLEX	641090	641100
-6	3/8" FEMALE NPT	ENDURA	PROFLEX	641091	641101
-6	3/8" FEMALE NPT	BLACK / SILVER	PROCLASSIC	641093	-
-6	3/8" FEMALE NPT	BLACK	PROCLASSIC II	641095	-

HOSE SIZE	INLET SIZE	FITTINGS	HOSE	WITH OUT FILTER	WITH FILTER
-6	-6 AN MALE	BLACK / SILVER	BLACK FABRIC PTFE	-	641243

Demon Carburetor Fuel Hose Kit

HOSE SIZE	INLET SIZE	FITTINGS	HOSE	WITH OUT GAUGE	WITH GAUGE
-6	3/8" FEMALE NPT	RED / BLUE	PROFLEX	641250	641260
-6	3/8" FEMALE NPT	ENDURA	PROFLEX	641251	641261
-6	3/8" FEMALE NPT	BLACK / SILVER	PROCLASSIC	641253	-

NOTE: FUEL FILTER AND FEED LINE SOLD SEPARATELY.

-8 Dual Inlet Carburetor Kits (Gauge not included)

Russell's -8 performance carb kits were designed for street and competition use where increased flow is required. These kits use large bore -8 carb adapters combined with billet fuel reservoirs for maximum flow. These kits are available in a wide range of -8 hoses in multiple finishes to complement any project. The rear reservoir features a 1/8" NPT pressure take off port for a fuel pressure gauge or line.

Holley 4150 Series Carburetor Fuel Hose Kit

HOSE SIZE	INLET SIZE	FITTINGS	HOSE	WITH OUT FILTER	WITH FILTER
-8	-8	RED / BLUE	TWIST-LOK	641160	-
-8	-8	BLACK	TWIST-LOK	641165	-
-8	-8	RED / BLUE	PROFLEX	641150	-
-8	-8	ENDURA	PROFLEX	641151	-
-8	-8	BLACK / SILVER	PROCLASSIC	641153	-
-8	-8	BLACK	PROCLASSIC II	641155	-
-8	-8 AN MALE	BLACK / SILVER	BLACK FABRIC PTFE	-	641273

Holley 4500 Series Carburetor Fuel Hose Kit

HOSE SIZE	INLET SIZE	FITTINGS	HOSE	WITH OUT FILTER	WITH FILTER
-8	-8	RED / BLUE	PROFLEX	641140	641350
-8	-8	ENDURA	PROFLEX	641141	641351

Demon Carburetor Fuel Hose Kit

HOSE SIZE	INLET SIZE	FITTINGS	HOSE	WITH OUT FILTER	WITH FILTER
-8	-8	RED / BLUE	PROFLEX	641180	641280
-8	-8	ENDURA	PROFLEX	641181	641281
-8	-8	BLACK / SILVER	PROCLASSIC	641183	-
-8	-8	BLACK	PROCLASSIC II	641185	-

King Demon Carburetor Fuel Hose Kit

HOSE SIZE	INLET SIZE	FITTINGS	HOSE	WITH OUT FILTER	WITH FILTER
-8	-8	RED / BLUE	PROFLEX	-	641360
-8	-8	ENDURA	PROFLEX	-	641361



641090
ProFlex hose with blue & red fittings



641095
ProClassic II hose with black fittings

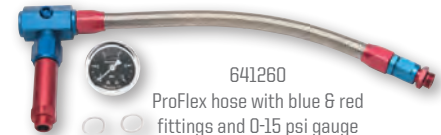

641260
ProFlex hose with blue & red fittings and 0-15 psi gauge



641253
ProClassic hose and fittings



641273
Black Fabric PTFE hose with black & silver fittings



641165
Twist-Lok hose with black fittings



641160
Twist-Lok hose with blue & red fittings

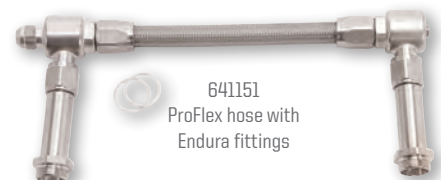

641151
ProFlex hose with Endura fittings



641153
ProClassic hose and fittings



Carbureted Electric Fuel Pumps

Universal Micro Electric Fuel Pumps

For Carbureted & Diesel Applications

Edelbrock Universal Micro Electronic Fuel Pumps deliver maximum performance in a compact package. They feature a durable simple design that reduces the chance of vapor lock and flooding. Easy to install and operate quietly so you won't know its there!

- Gravity fed in-line, self-priming and regulating design
- Easy to set up 2-wire design
- Can be used as a lift or transfer pump
- Use with automotive and industrial application

FREE FLOW RATE	FUEL TYPE	PSI RANGE	INLET	OUTLET	ITEM
30 GPH / 114 LPH	GAS & E85	2-3.5	5/16" NPT	5/16" BARB	17303
38 GPH / 144 LPH	GAS & E85	4-7	5/16" NPT	5/16" BARB	17301
38 GPH / 144 LPH	DIESEL	4-7	5/16" NPT	5/16" BARB	17302

INCLUDES: FUEL PUMP, FILTER, MOUNTING HARDWARE AND INSTRUCTIONS FOR A HASSLE FREE INSTALLATION

Replacement Filter Element

FOR FUEL PUMP	MICRON	ITEM
17301 / 17303	40	17311
17302	100	17312



17303 - Micro Electric Fuel Pump for Gas & E85 Engine



17302 - Micro Electric Fuel Pump for Diesel Engine

Electric Fuel Pumps

These state-of-the-art Electric Fuel Pumps are made with anodized aluminum housings and high-quality internals, they are both strong and durable. The carbon vanes and composite rotor give these pumps the added boost for maximum performance. P/N 1791 is factory preset to 6.5 psi and no regulator is required. With a replaceable screen type inlet filter and the free flow rate of 120 GPH it is sufficient to supply 480 hp. P/N 1792 has a free flow rate of 160 GPH, enough to feed a 1,000 hp engine. This pump is factory preset to 12 psi and requires an external regulator such as the Edelbrock regulator P/N 1727.

FREE FLOW RATE	SUPPORTS	CURRENT DRAW	INLET / OUTLET	PRESET PSI	ITEM
120 GPH / 454 LPH	384 HP @ 12.0 VDC	3.2 AMPS @ 12.0 VDC	3/8" NPT	6.5	1791
	480 HP @ 14.0 VDC	3.6 AMPS @ 14.0 VDC			
160 GPH / 605 LPH	864 HP @ 12.0 VDC	3.8 AMPS @ 12.0 VDC	1/2" NPT	12	1792
	1,000 HP @ 14.0 VDC	4.3 AMPS @ 14.0 VDC			

IMPORTANT NOTES: THESE PUMPS SHOULD BE MOUNTED AS CLOSE TO THE FUEL TANK AS POSSIBLE, AT OR BELOW THE FUEL LEVEL. FOR PROPER INSTALLATION AND VOLTAGE REQUIREMENTS, USE FUEL PUMP RELAY KIT #1795. ALL FUEL PUMPS ARE FOR GASOLINE ONLY.



1792 - Electric Fuel Pump

The body is machined from aluminum billet stock and anodized for protection from corrosion

Precision molded composite rotor reduce inertia loads for longer fuel pump life

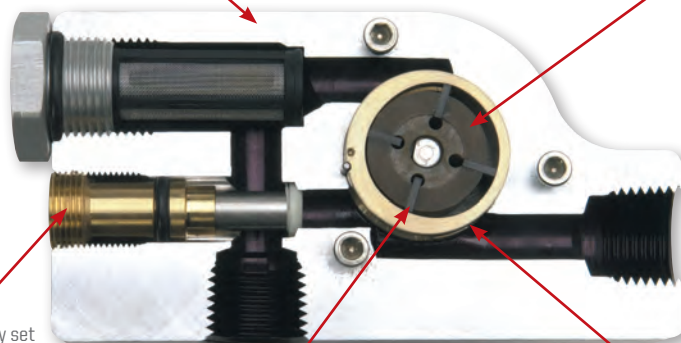

Accurately set to factory specs, and can be easily adjusted with this screw if needed

Lightweight carbon vanes reduce the centrifugal force for less friction and wear

Internal race is machined to minimize wear, improve performance, and reduce noise

Universal Fuel Pump Relay Kit

Strongly recommended when installing Electric Fuel Pumps P/N 1791 and P/N 1792. Can be used on competitor's pumps. Constructed with high quality wires and weather pack 30-amp Bosch relay.

DESCRIPTION	ITEM
FUEL PUMP RELAY KIT	1795





Fuel Pressure Regulators

Fuel Pump & Regulator Kits

Edelbrock Fuel Pump and Regulator kits take the guesswork out of selecting the right fuel pump and regulator combination for your application.

FLOW RATE	SUPPORTED HP	FUEL PUMP	REGULATOR	ITEM
160 GPH	1,000 HP	1792	1727	17923

Fuel Pressure Regulator Kits

These kits allow for the adjustment of fuel pressure from 4-1/2 to 9 psi. Includes fittings, mounting plate, fuel line and regulator.

DESCRIPTION	ITEM
SINGLE REGULATOR - DUAL OUTLET, STANDARD FLANGE	8192*
SINGLE REGULATOR - DUAL OUTLET, 4500 FLANGE	8193*
SINGLE REGULATOR PLATE ONLY - STANDARD FLANGE	8189*

NOTE: FUEL LINE FROM FUEL PUMP TO REGULATOR IS NOT INCLUDED; USE UNIVERSAL CARBURETED FUEL LINE KIT #8122 OR #8127 FOR PUMPS WITH 1/2" NPT OUTLET.

Fuel Pressure Regulators

Fuel Pressure Regulator (P/N 8190) is manufactured from billet aluminum and features a Nylon-reinforced nitrile diaphragm for excellent heat and leak resistance. Fuel Pressure Regulator (P/N 1789) is ideal for providing consistent pressure in Edelbrock 94 or other low pressure carburetor applications.

DESCRIPTION	PSI	OUTLET	PORTS INLET	GAUGE	CHROME	SATIN
FUEL PRESSURE REGULATOR	1 TO 4	3/8" NPT	3/8" NPT	NO	1789	-
BILLET FUEL PRESSURE REGULATOR	5 TO 12	3/8" NPT	3/8" NPT	1/8" NPT	-	8190

Adjustable Fuel Pressure Regulators

Compatible with all grades of gasoline & methanol. Made with fluorosilicone diaphragm material for extended life and high temperature protection. Select regulators available with a boost reference fitting for blow through or pressurized carb applications (even beyond 30 PSI of boost). Pressure regulation slope is 0.75 psi/gal of flow rate change.

Non-Bypass Style

FLOW RATE	PSI	INLET	OUTLET	PORTS RETURN	VACUUM	GAUGE	RED	BLUE	BLACK	SATIN
160 GPH	5-10	3/8" NPT	3/8" NPT	-	NO	1/8" NPT	174121	174122	174123	1727

Bypass Style

FLOW RATE	PSI	INLET	OUTLET	PORTS RETURN	VACUUM	GAUGE	RED	BLUE	BLACK	SATIN
160 GPH	5-10	3/8" NPT	3/8" NPT	3/8" NPT	NO	1/8" NPT	174131	174132	174133	1778
180 GPH	5-10	-10	-10	-6	YES	1/8" NPT	174051	174052	174053	-
180 GPH	5-10	-10	-6 (X2)	-8	YES	1/8" NPT	-	-	174103*	-

Carbureted Regulator Rebuild Kit

This Carbureted Regulator Rebuild Kit provides all the necessary hardware and diaphragm assembly. Use with P/N 174051, P/N 174052, P/N 174053, P/N 174081 & P/N 174103.

DESCRIPTION	ITEM
CARBURETED REGULATOR REBUILD KIT	178040



8192 - Regulator Kit



8192 - Regulator Kit

8193 - Regulator Kit



1789 Fuel Pressure Regulator



8189 - Regulator Plate



174131 Fuel Pressure Regulator



1727 Fuel Pressure Regulator



174052 Fuel Pressure Regulator



178040 - Regulator Service Parts

*Available while supplies last



EFI Fuel System Kits

Complete fuel system kits include a state-of-the-art Edelbrock electric fuel pump offering maximum performance in a compact package. Kits also include matching fuel pressure regulator (if required), a Russell ProFilter fuel filter, a fuel pump relay and wiring assembly, 20 feet of our ProClassic or ProFlex hose, plus an assortment of hose ends, adapters and mounting brackets.

Universal EFI Sump Fuel Kits

These Universal Sump Fuel Kits are designed to provide the necessary high fuel pressure required for EFI applications in vehicles equipped with an existing low pressure carbureted fuel system. They are a complete self-contained system that can be easily installed under the hood. The unique design of these systems allow them to deliver a constant fuel pressure with no fuel return line, fuel pressure regulator or fuel tank modifications. They are compatible with the existing factory fuel tank and pump. Ideal for use with various aftermarket EFI systems and with many popular engine swap applications that require constant fuel pressure.

Each complete kit includes a durable molded, lightweight plastic fuel sump tank with high pressure fuel pump installed, wiring harness, universal mounting brackets, hose, -6 port swivel to barb 90° black fittings and all of the necessary hardware for installation. These kits are the most affordable way to make your fuel system EFI ready. Both are great solutions when used with an E-Street, Pro-Flo 3 or other aftermarket EFI system and late-model engine swaps.

How does it work?

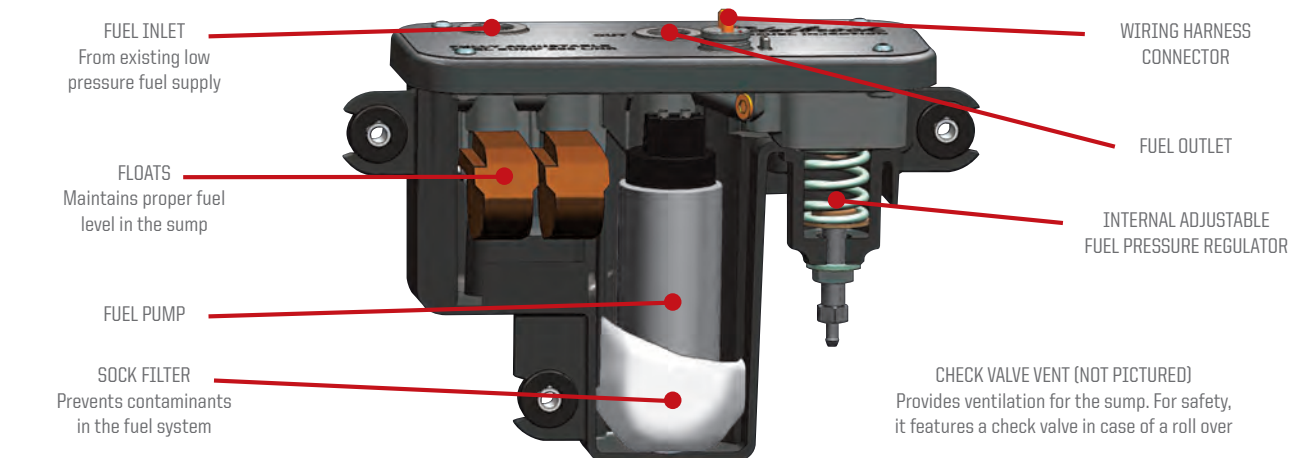
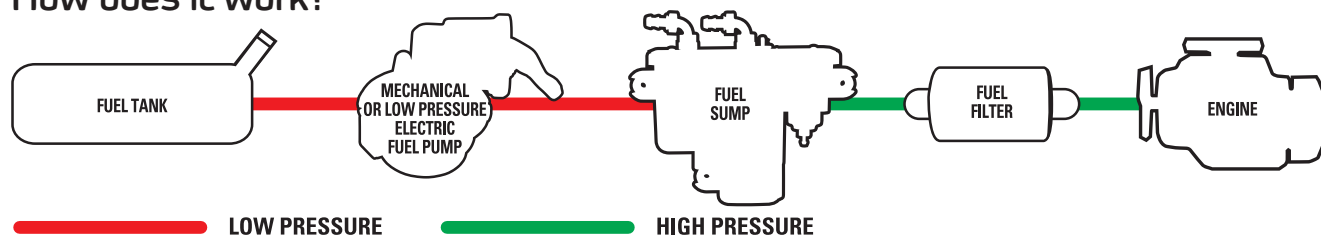

36031 - Universal EFI Sump Fuel Kit

DESCRIPTION	PSI	FLOW RATE	SUPPORTED HP	SIZE (H X W X D)	ITEM
PRESET UNIVERSAL EFI SUMP FUEL KIT	58	67 GPH	UP TO 600 HP	13" X 7.75" X 5"	3605
PRESET UNIVERSAL EFI SUMP FUEL KIT	49	67 GPH	UP TO 600 HP	13" X 7.75" X 5"	3607
REPLACEMENT PRESET FUEL TANK ONLY	58	67 GPH	-	13" X 7.75" X 5"	36052
ADJUSTABLE UNIVERSAL EFI SUMP FUEL KIT	35-90	67 GPH	UP TO 750 HP	9" X 10" X 3.75"	36031
ADJUSTABLE UNIVERSAL EFI SUMP FUEL KIT	35-90	105 GPH	UP TO 750 HP	9" X 10" X 3.75"	36033
REPLACEMENT ADJUSTABLE FUEL TANK ONLY	35-90	67 GPH	-	9" X 10" X 3.75"	36032
REPLACEMENT ADJUSTABLE FUEL TANK ONLY	35-90	105 GPH	-	9" X 10" X 3.75"	36034



EFI Fuel System Kits

Russell Fuel Plumbing Kits · Firewall to Manifold

Russell fuel plumbing kits include all of the necessary components to plumb your fuel system from the firewall to the manifold. Kits include an Edelbrock fuel pressure regulator, fuel rail kit, and ProClassic or ProFlex hose, plus an assortment of hose ends, adapters and mounting brackets.

APPLICATION	RED / BLUE	BLACK / SILVER
FORD 5.0L	641550	641553
HONDA B-SERIES ENGINES	641570	641573



641550 - Fuel Hose Kit

EFI - Fuel Tank/Fuel Cell to Manifold

80 GPH, 45 PSI

Includes a Fuel Pump (Domestic kits: P/N 1790 & Import kits: P/N 17937). All include Regulator (P/N 1728) and Fuel Rails.

APPLICATION	RED / BLUE	BLACK / SILVER
CHEVROLET LS*	641530*	641533
FORD 5.0L	641540*	641543
HONDA B-SERIES	641560*	641563

*ONLY WITH EDELBROCK VICTOR JR. MANIFOLD #29085.



641530 - Fuel Hose Kit

EFI Universal Complete Fuel Hose Kit

57 GPH, 45 PSI

These kits provides a complete fuel system for GM LS-Series and Chrysler HEMI engine swaps in muscle cars, street rods and off-road vehicles. When using with OEM fuel tank sending units, an additional adapter to -6 male AN is required.

APPLICATION	RED / BLUE	BLACK
CHEVY LS & CHRYSLER 5.7L HEMI	641600	641605



641543 - Fuel Hose Kit



641600 - Fuel Hose Kit

ProFlex EFI Fuel Line Kits

Engineered for direct replacement of OE lines, these kits are factory assembled for precise fit and ease of installation.



YEAR	MAKE	APPLICATION	PROFLEX
1987-93	FORD	5.0L MUSTANG	651104
2005-07	FORD	4.6L MUSTANG GT	651106
1996-00	HONDA	CIVIC DX, LX, EX	641110
1992-95	HONDA	CIVIC EX	641120
1999-00	HONDA	CIVIC SI	
1994-01	ACURA	INTEGRA	

OEM Style EFI Fuel Hose

Designed for direct replacement of your factory hose. Assembled with True Bore 3/8" inside diameter PowerFlex hose and OEM style crimp on end fittings, requires no secondary adapter for a compact installation delivering maximum flow.

YEAR	MAKE	APPLICATION	POWERFLEX
2004	PONTIAC	5.7L GTO FIREWALL TO RAIL	651120*
2005-06	PONTIAC	6.0L GTO	651121*



*Available while supplies last



EFI Fuel Pumps

EFI Fuel Pump & Regulator Kits

Edelbrock Fuel Pump and Regulator kits take the guesswork out of selecting the right fuel pump and regulator combination for your application.

DESCRIPTION	FLOW RATE	SUPPORTED HP	INCLUDES		ITEM
			FUEL PUMP	REGULATOR	
EFI IN-LINE KIT	57 GPH	600 HP	1794	1729	17943
EFI STREET/STRIP KIT	57 GPH	600 HP	3594	1728	35943



17943 - Electric Pump and Regulator Combo Kit

In-Line Electric Fuel Pumps - EFI & Carb Applications

These fuel pumps feature an anodized aluminum housing and high-quality internals, resulting in both a strong and durable design. The in-line design keeps the pump motor and components cool under harsh conditions. Each pump is factory-tested. Compatible with all grades of gasoline and methanol.

FLOW RATE	PSI	INLET	OUTLET	RED	BLUE	BLACK
80 GPH	45	-10 SAE	-10 SAE	182031	182032	1790
120 GPH	45	-12 SAE	-12 SAE	182071	182072	1794



182032
Fuel EFI Pump

Slim-Line Electric Fuel Pump - EFI & Carb Applications

Compact design for tight locations and can be mounted inside fuel cell or external. Flow-thru design keeps motor and pump components cool even under harsh conditions. Machined from aerospace quality components. Compatible with all 12-15 volt systems. Not for use with diesel fuel.

FLOW RATE	PSI	INLET	OUTLET	RED	BLUE	BLACK
67 GPH / 255 LPH	45	-8	-6	182081	182082	182083



182081
Fuel EFI Pump

In-Line Street/Strip Electric Fuel Pump For EFI Applications

Street/Strip fuel pumps can be utilized as an in line booster pump or as a stand-alone unit. These pumps are continuous duty rated and are ideal for EFI applications that require additional pumping capabilities from upgrade modifications such as high compression pistons, high flow intake manifold, big bore throttle bodies, cams, turbo kits, supercharger and nitrous applications up to 600 HP. For external use only.

FLOW RATE	PSI	BARB INLET	BARB OUTLET	ITEM
67 GPH / 255 LPH	45	3/8"	3/8"	3594

IMPORTANT NOTES: THESE PUMPS SHOULD BE MOUNTED AS CLOSE TO THE FUEL TANK AS POSSIBLE, AT OR BELOW THE FUEL LEVEL.



3594
Electric Fuel Pump

Fuel Pump Service Parts

FUEL PUMP REBUILD KIT FOR...	ITEM
1791 / 182051 / 182052	178050
1792 / 182061 / 182062	178060



178050 - Fuel Pump Service Parts

High Performance In-Tank Fuel Pumps

These OE in-tank upgrade pumps are ideal for supporting high performance improvements such as a intake manifold, cams, turbo, direct port nitrous systems, big-bore throttle body, etc. They replace your original pump exactly and include all necessary hardware for an easy installation.

YEAR	MAKE / MODEL	41 GPH / 155 LPH	50 GPH / 190 LPH	67 GPH / 255 LPH	HIGH PRESSURE 67 GPH / 255 LPH
1985-97	FORD MUSTANG EXCEPT 1996-97 COBRA	17930	17931	17932	-
1985-97	FORD MUSTANG TURBO OR NITROUS	-	-	-	17935
1985-92	GM VEHICLES FUEL-INJECTED NON-TBI	-	-	17933	-
1994-99	ACURA INTEGRA TURBO, SUPERCHARGER OR NITROUS	-	17938	17936	17937
1992-00	HONDA TURBO, SUPERCHARGER OR NITROUS	-	17938	17936	17937



17930 - In-Tank Fuel Pump



EFI Fuel Pressure Regulators

Rail Mounted Fuel Pressure Regulators

These fuel pressure regulators unique design allows it to be mounted directly to the fuel rail instead of trying to find a mounting place in the engine bay. It features a compact push-in style design with a swivel mounting bracket, so it can be clocked in various directions depending on your setup. They're used in Edelbrock Pro-Flo 3 EFI systems and can be used with any -6 AN aftermarket EFI system fuel rail.



FLOW RATE	PSI	INLET	OUTLET	ITEM
67 GPH / 255 LPH	43	-6	-6	17400
67 GPH / 255 LPH	58	-6	-6	17401



17400 - Fuel Pressure Regulator

Adjustable Fuel Pressure Regulators

These Fuel Pressure Regulators are compatible with all grades of gasoline/ methanol and machined from aircraft quality aluminum for those who demand the best. They have a diaphragm made of fluorosilicone for extended life and high temperature protection. These regulators will hold fuel system pressure for at least 20 minutes after pump shutdown. Mounting bracket and hardware are included. Each regulator features a vacuum/boost compensating port for a supercharger, turbo or intake manifold vacuum connection.

FLOW RATE	PSI	INLET	OUTLET	PORTS				RED	BLUE	BLACK	SATIN
				RETURN	VACUUM	GAUGE					
180 GPH	35-90	-6	-6	-6	YES	NO	174041	174042	174043	1728	
180 GPH	35-90	-10	-10	-6	YES	YES	174021	174022	174023	1729	
270 GPH	35-90	-10	-10	-8	YES	YES	-	-	174113*	-	



1729 - Fuel Pressure Regulator

174113 - Fuel Pressure Regulator



Regulator to Fuel Rail Adapter

These adapter fittings ease the installation and eliminate the need to stack fittings when connecting your EFI regulator to your fuel rail. Our unique swivel design allows 360° rotation after installation and uses our radius port O-Ring connection at the regulator for ultimate flow. For use with regulators with -10 ports and fuel rails with 3/8" NPT. Ideal for use with Edelbrock P/N 1729 regulator and fuel rail kits with 3/8" NPT Ports.

DESCRIPTION	ITEM
3/8" NPT SWIVEL TO -10 AN RADIUS INLET PORT	640543
-10 AN RADIUS PORT MALE X -8 RADIUS PORT MALE SWIVEL O.R.B.	644033

EFI Regulator Rebuild Kit

This complete EFI regulator rebuild kit provides all the necessary hardware and diaphragm assembly to rebuild the following part numbers: P/N 1728, P/N 1729, P/N 174021, P/N 174022, P/N 174023, P/N 174041, P/N 174042 & P/N 174043.

DESCRIPTION	ITEM
EFI REGULATOR REBUILD KIT	178010



178010 - EFI Regulator Rebuild Kit

*Available while supplies last



ProFilter

The Russell ProFilter series is engineered to provide the optimum in filtration with minimum restriction. Precision machined from 6061 T6 Aluminum for durability and appearance. There are 3 styles of elements to cover fuel requirements from gasoline to alcohol.

- Designed for Carbureted or EFI Systems
- Standard and Multiple End Configurations
- Available in Two Popular Finishes
- Nylon Element is E85 Compatible
- Flows Up to 140 Gallons Per Hour at 7 psi

8-1/4' ProFilter GAS & E85

Nylon element

INLET	OUTLET	RED / BLUE	BLACK / SILVER
-6	-6	649140	649143
-8	-8	649150	649153
-10	-6	649210*	649213
-10	-8	649190*	-
-10	-10	649160	-
-12	-10	649200*	-
-12	-12	649170	-



649150 - ProFilter

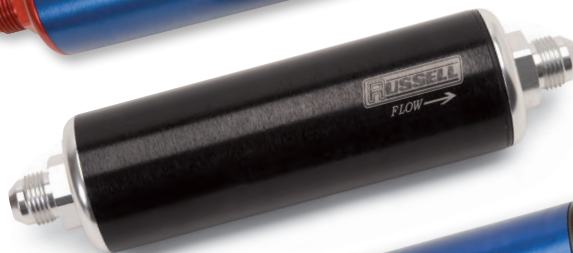

649153 - ProFilter

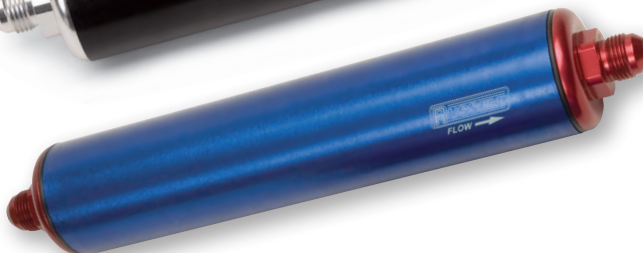

649000 - ProFilter

12' ProFilter GAS ONLY

Paper element

INLET	OUTLET	RED / BLUE
-8	-8	649000
-12	-12	649110

6' ProFilter for EFI GAS & E85

Russell's ProFilter for EFI systems utilizes an aircraft design that insures the maximum in filtration while delivering large volumes of fuel. The ports also incorporate an O-Ring Boss Sealing technology for positive seal.

Kit includes a cushion style mounting clamp.

FUEL TYPE	ELEMENT	INLET	OUTLET	MICRONS	BLUE	RED	BLACK
GAS ONLY	PAPER	-10	-10	10	649252	649251	649250
GAS & E85	STAINLESS STEEL	-10	-10	60	649262	649261	649260



649260 - ProFilter

Replacement Element, Seals and O-Ring

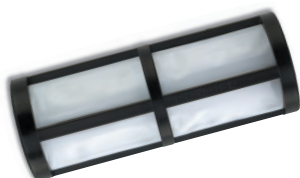

DESCRIPTION	FUEL TYPE	ELEMENT	MICRONS	ITEM
12" PROFILTER	GAS ONLY	PAPER	10	649060
8-1/4" PROFILTER	GAS & E85	NYLON	60	649180
6" EFI PROFILTER	GAS ONLY	PAPER	10	649255
6" EFI PROFILTER	GAS & E85	STAINLESS STEEL	60	649265



DESCRIPTION	ITEM
PROFILTER REPLACEMENT SEALS	648990
-10 REPLACEMENT O-RING (QTY 2)	648980



649053 - ProFilter Clamp

Russell ProFilter Clamp

USE WITH...	INSIDE DIAMETER	CLEAR ANODIZED
8-1/4" & 12" PROFILTER	2"	649053
6" PROFILTER	2.2"	649273



Aluminum Street Fuel Filters

Designed for carbureted engines making less than 300 hp, these aluminum fuel filters are made of billet aluminum for strength and shock resistance with a sintered-bronze 40 micron element can be cleaned or replaced.

Filters are bidirectional and available to fit 5/16" or 3/8" fuel hoses

INLET / OUTLET	LENGTH	DIAMETER	BLUE	RED	CHROME	BLACK
5/16"	3"	1-1/8"	645080	645070	645060	645090
3/8"	3"	1-1/8"	645140	645130	645120	645150



Aluminum Street Fuel Filters



DESCRIPTION	ITEM
REPLACEMENT ELEMENT	651660

Russell 1-1/4' Competition Fuel Filters

These inline fuel filters are designed for use on carbureted systems. Precision machined billet aluminum supports the 40 micron stainless steel disc element. Available in -6 or -8 as well as 3/8" NPT inlet that allows direct connection to fuel pumps, Y-blocks and regulators.

LENGTH	INLET / OUTLET	RED / BLUE	POLISHED	BLACK
3"	-6 MALE	650130	650140	650133
3-1/4"	-8 MALE	650100	650110	650103
3"	-6 X 3/8" MALE NPT	650190	650200*	650203
3-1/4"	-8 X 3/8" MALE NPT	650170	650180*	650183



Russell Competition Fuel Filters



DESCRIPTION	ITEM
REPLACEMENT ELEMENT 40 MICRONS	651670

Fuel and Oil Gauge Fitting Kit

This installation kit makes it a snap to connect remote mounted fuel or oil pressure gauges. Kit includes: 1/8" NPT block adapter, gauge adapter and one 6 foot -4 ProFlex hose assembly.



PRESSURE GAUGES ON NEXT PAGE

DESCRIPTION	AN SIZE	PROFLEX
FUEL AND OIL GAUGE FITTING KIT	-4	640720

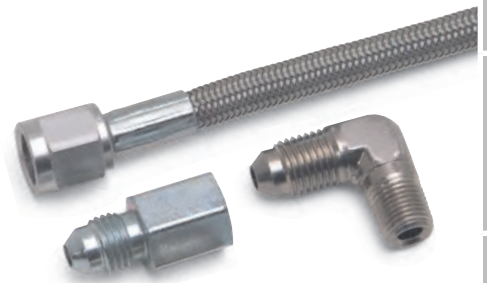

Check Valves

Engineered to allow flow in one direction and prevent flow back, Russell check valves feature a check piston that delivers optimum flow with minimal restriction and pressure loss. Low opening pressure (3 psi) makes these valves ideal for fuel systems.



DESCRIPTION	ITEM
-6 AN MALE TO -6 AN MALE	650603
-8 AN MALE TO -8 AN MALE	650613



650603 - Check Valve

*Available while supplies last



Fuel System Accessories

Billet Aluminum Fuel Y-Blocks

Designed for connecting dual fuel hoses to your carburetor, these Y-style fuel blocks are engineered for optimum flow for street applications. These blocks feature either a 3/8" NPT inlet and outlet ports or for maximum flow applications or a large 1/2" NPT inlets with either 3/8" NPT or 1/2" NPT outlet ports. All blocks feature a 1/8" NPT pressure gauge port and are anodized red for a great appearance.

INLET	OUTLET	ITEM
3/8"	3/8"	650370
1/2"	3/8"	650360*
1/2"	1/2"	650380

Billet Aluminum Y-blocks with AN Ports

These Russell billet Y-blocks are machined to accept AN straight thread adapters. Use Russell radius AN port adapters for the ultimate in flow capacity, (see page 20). O-rings are required.

INLET	OUTLET	GUAGE PORT	BLUE	POLISHED	BLACK
-6	-6	-	-	650401*	650400
-10	-8	1/8"	650410	-	650413
-10	-10	-	650420*	-	-

Flare to Flare "Y" Fittings

This flare to flare fitting features a true Y design for unrestricted flow, machined from billet with a male 37° connections, making it perfect for inline mounting. Also includes a 1/8" female pipe port for fuel pressure take off or gauge.

DESCRIPTION	INLET	OUTLET	SIDE PORT	BLACK
-6 AN MALE	-6 AN	-6 AN	-	650430
-8 AN MALE WITH FEMALE 1/8" NPT SIDE PORT	-8 AN	-8 AN	1/8" NPT	650440
-10 AN MALE WITH FEMALE 1/8" NPT SIDE PORT	-10 AN	-10 AN	1/8" NPT	650450

1-1/2 Fuel Pressure Gauges

Engineered for the serious street enthusiast, these gauges guarantee precise fuel pressure settings from 0 to 100 psi. Each comes with an easy to read face. These gauges have a 1/8" NPT male inlet. Available in both liquid-filled and non-liquid filled models. Designed to withstand severe vibration to extend service and performance for automotive and marine applications.

DESCRIPTION	LIQUID FILLED	PSI	ITEM
FUEL PRESSURE GAUGE	YES	0-15	650330
FUEL PRESSURE GAUGE	YES	0-100	650340
FUEL PRESSURE GAUGE	NO	0-15	650350
FUEL PRESSURE GAUGE WITH MACHINE FACE	YES	0-15	650390
FUEL PRESSURE GAUGE WITH BLACK FACE AND CASE	YES	0-15	650310
FUEL PRESSURE GAUGE WITH BLACK FACE AND CHROME CASE	YES	0-100	650320



650370
Fuel Y-Block



650411
Fuel Y-Block



650400
Fuel Y-Block
with AN ports



650410
Fuel Y-Block
with AN ports



650440
Flare to Flare
Y-Fitting



650330
Fuel Pressure Gauge



650390
Fuel Pressure Gauge

650310
Fuel Pressure Gauge



650320
Fuel Pressure Gauge

*Available while supplies last



Fuel System Accessories

Aluminum Fuel Line

Lightweight, inexpensive and easy to use, Russell's aluminum fuel line is available in two sizes and four finishes to fit virtually any fuel system. Used where a flexible fuel line is not required, it is easily contoured to route along frame rails and chassis tubes. Requires a 37° flare to connect fuel line adapters such as, Russell tube nuts and tube sleeves or our hard tube adapters. Rated up to 250 psi.



TUBE SIZE	THICKNESS	LENGTH	PSI	BLUE	BLACK	RED	NATURAL
3/8"	0.040"	25 FEET	UP TO 250	639250	639253	639260	639480
1/2"	0.034"	25 FEET	UP TO 250	639270	639273	639280	639490



Aluminum Fuel Line Adapters

Russell's Aluminum Fuel Line Adapters connects 3/8" or 1/2" aluminum tube to -6 or -8 adapters. The unique compression crimp design eliminates tube flaring.

AN SIZE	LINE SIZE	CONNECTION	BLUE / RED	BLACK / SILVER
-6	3/8"	FEMALE SWIVEL	639200	639203
-6	3/8"	MALE 37°	639210	639213
-8	1/2"	FEMALE SWIVEL	639220	639223
-8	1/2"	MALE 37°	639230	639233



Replacement Ferrules

AN SIZE	ITEM
-6	620155
-8	620165

PACKAGE OF 2

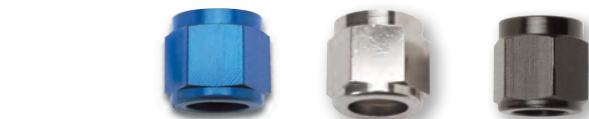

Tube Nut

TUBE SIZE	QTY	BLUE	ENDURA	BLACK
3/8"	2	660570	660571	660575
1/2"	2	660580	660581	660585

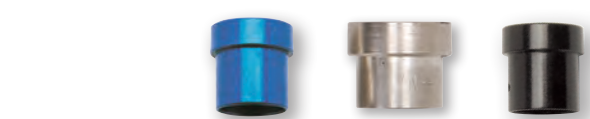

Tube Sleeve

TUBE SIZE	QTY	BLUE	ENDURA	BLACK
3/8"	2	660650	660651	660655
1/2"	2	660660	660661	660665



Accessories

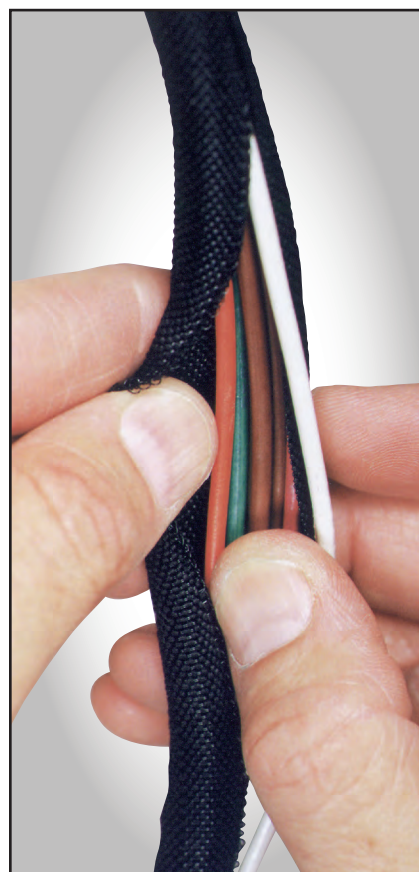

Wrap-It For Maximum Wire & Hose Protection

Cushion Clamps

Russell Cushion Clamps is the optimum method of securing hoses to frames or boat runners. Spring steel tab mount and rubber covered hose loop provides a rigid vibration absorbing mount.

AN SIZE	QTY	ITEM
-4	10	650970
-6	10	650980
-8	6	650990
-10	6	651000
-12	6	651010

Wrap-It For Maximum Wire & Hose Protection

Wrap-It is a lightweight oversleeve that reduces chafing, cutting and abrading of wires and hoses.

DIAMETER	3' LENGTH	10' LENGTH
3/16"	629050	629060
5/16"	629080	629090
1/2"	629110	629120
3/4"	629140	629150

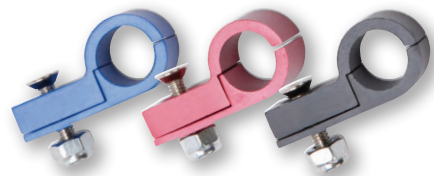

Tubing Clamps

SIZE	BLUE	RED	BLACK
3/8"	654252	654250	654253
1/2"	654262	654260	654263

Hose Separator

AN SIZE	BLUE	RED	BLACK
-6	654302	654300	654303
-8	654312	654310	654313
-10	654322	654320	654323
-12	654332	654330	654333

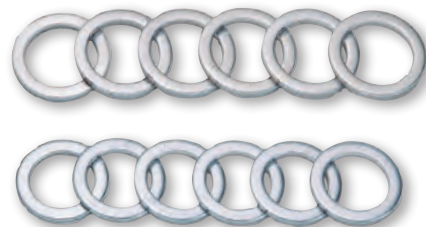

Copper Crush Washers

Use with Edelbrock Billet Fuel Pumps, Carter and CV Pumps.

SIZE	ITEM
5/8" - 18	640990 PACKAGE OF 2

Teflon Washers

Replacement washers for Russell Bulkhead Fittings.

AN SIZE	ITEM
-6	651206
-8	651208
-10	651210
-12	651212 PACKAGE OF 10

Brake Crush Washers

Replacement sealing washers used with brake hoses.

SIZE	ITEM
10MM - 3/8"	683980
12MM - 7/16"	683990 PACKAGE OF 10

Carburetor Fitting Sealing Washers

Replacement washers for servicing or rebuilding carburetors.

DESCRIPTION	SIZE	ITEM
HOLLEY & DEMON CARB FITTINGS	9/16" - 24	645210
HOLLEY & QUADRAJET CARB FITTINGS	7/8" - 20	645220
EDELBROCK & CARTER CARB FITTINGS	5/8" - 20	645230
QUADRAJET CARB FITTINGS	1" - 20	645240 PACKAGE OF 2

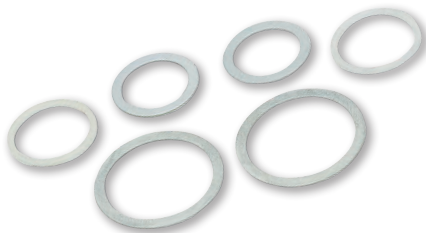



Viton® and Fluorosilicone O-Rings

Replacement O-rings for use with dry sump fittings, straight threaded AN plugs and flare unions. Viton O-rings are compatible with gasoline. Fluorosilicone O-rings offer superior sealing and are the best choice for use with ethylene glycol, motor oil and methanol.

SIZE	VITON	FLUOROSILICONE	SIZE	VITON	FLUOROSILICONE
-4	651030	651031	-10	651060	651061
-6	651040	651041	-12	651070	651071
-8	651050	651051	-16	651080	651081

PACKAGE OF 10

Stat-O-Seals

Russell Stat-O-Seals are manufactured with a Buna Rubber O-Ring mechanically bonded to the inside diameter of an aluminum washer. When tightened, the o-ring seal is compressed, forming a positive seal around the bolt shank.

AN SIZE	INSIDE DIMENSIONS	ITEM
-3	3/8"	683880
-4	7/16"	683890
-6	9/16"	683900
-8	3/4"	683910
-10	7/8"	683920

PACKAGE OF 2

Replacement Brass Ferrules for PowerFlex Hose & Hose Ends

Made for brake lines, clutch lines, mechanical gauges, power steering, and other applications that require high pressure. Steel hose ends feature a miniature brass ferrule, which holds the fitting inside the hose and must be used with PTFE Hose.

AN SIZE	QUANTITY	ITEM
-3	10	620135
-4	10	620145
-6	2	620405
-8	2	620475
-10	2	620505

Plastic AN Caps & Plugs

Use these convenient caps and plugs to prevent leaks after disassembly. For temporary use only, DO NOT use in pressurized applications.

DESCRIPTION	ITEM
-3 TO -12 CAP & PLUG ASSORTMENT	645560

PACKAGE OF 6

SIZE	PLASTIC CAP	PLASTIC PLUG
-3 AN	645500	645501
-4 AN	645510	645511
-6 AN	645520	645521
-8 AN	645530	645531
-10 AN	645540	645541
-12 AN	645550	645551

PACKAGE OF 10

Accessories

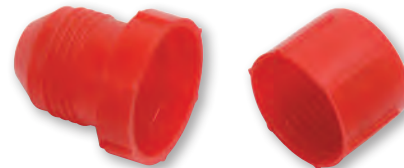



Tools



Russell Manual Crimper

The ProClassic manual crimper is a hand operated vise-style crimper engineered for easy hose end attachment. Each hose size has a specific die engineered for consistent and repeatable crimping with no measurement or adjustment, ensuring proper attachment. An over-center operation design makes this crimper easy to use.

DESCRIPTION	ITEM
MANUAL CRIMPER	652000



Crimper Dies

AN SIZE	OUTSIDE DIAMETER	ITEM
-4	0.450"	652001
-6	0.575"	652007
-8	0.675"	652008
-10	0.800"	652009
-12	0.950"	652005

Tube Bender

Makes installation of those tough-to-bend direct port nitrous lines a breeze. Get a professional looking installation every time. Can also be used on other 3/16" hard lines.

DESCRIPTION	ITEM
TUBE BENDING TOOL	76503



Tube Straightener

This tool is used to straighten coiled tubing of various materials and diameters. The allowable tubing size range is 3/16" to 1/2" outside diameter.

DESCRIPTION	ITEM
TUBE STRAIGHTENER	654440



Tube Flare Tool

This tool allows for tubing of various materials to be flared with a single 37° flare. The allowable tube sizes are 1/8" to 3/4"

DESCRIPTION	ITEM
TUBE FLARE TOOL	654430



Billet Aluminum Vise Jaws

These vice jaws are designed with integrated magnets to attach to vices with steel jaws. The jaws feature v-cuts to aid in gripping hex flats on the top and sides of the jaw. Recommended for holding delicate parts to prevent cosmetic damage during assembly.

DESCRIPTION	ITEM
ALUMINUM VISE JAWS	654420

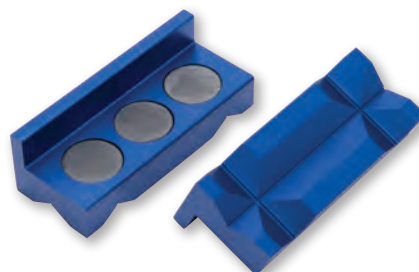



Russell AN Hose End Wrenches

AN hose end wrenches are precision machined to fit Russell hose ends without damaging the anodized finish. The satin, anodized finish features extended durability. Available individually or as a complete set.

DESCRIPTION	ITEM
-6 HOSE END WRENCH	651900
-8 HOSE END WRENCH	651910
-10 HOSE END WRENCH	651920
-12 HOSE END WRENCH	651930
-16 HOSE END WRENCH	651940
COMPLETE SET OF WRENCHES	651950



Adjustable Wrench

These aluminum wrenches are designed to prevent cosmetic damage to the finish on aluminum fittings and hose ends. The short handle also helps in preventing overtightening. Available in Straight or V-jaw style.

DESCRIPTION	ITEM
ADJUSTABLE AN WRENCH	654400
ADJUSTABLE AN V-FLATS WRENCH	654410



Russell Safety Wire Pliers

Russell safety wire pliers are great for wiring any parts subjected to loosening from vibration. This positive locking tool features automatic spin slide return.

DESCRIPTION	ITEM
SAFETY WIRE PLIERS	651960



Russell Safety Wire

Russell's Safety Wire is packaged in a convenient one-pound dispenser. The wire pulls and uncoils from the inside with no tangles. The wire is constructed of stainless steel.

DESCRIPTION	ITEM
0.32 O.D. STAINLESS STEEL WIRE, 1-LB. SPOOL	671580



Hose Assembly Tool for PowerFlex Hose & Hose Ends

This handy tool separates the steel braid from the teflon inner liner making insertion of the olive easier during hose assembly.

DESCRIPTION	ITEM
-3 AND -4	651970
-6 AND -8	651971



Hose & Fitting Assembly Lube and Sealant Kit

Precision Hose and Fitting Assembly Lube allows easy assembly and disassembly of hose ends. Our assembly lube will not damage the inner liner of the hose and prevents galling of hose ends during assembly. The anti-seize thread sealant provides an instant seal on pipe threads. This sealant has a temperature range from -60° to +600° F and can be used as a gasket and flange sealant.

DESCRIPTION	ITEM
ASSEMBLY LUBE/SEALANT KIT	671570





Transmission

1/4" Universal Mounting Holes

6061 Extruded Body

-8 O-Ring Port Connections



651480 - Heat Sink Transmission Cooler

Heat Sink Transmission Coolers

Utilizing the proven "heat sink" method of lowering temperature from your transmission and fluid, the Heat Sink Transmission Cooler does not rely on direct air flow for cooling efficiency. Russell heat sink transmission coolers have been engineered to reduce spikes in temperature, common with tube/fin style coolers. Our low profile design also allows for multiple mounting positions and locations, including frame rail mounting. They can also be used to help reduce temperature in power steering applications.



SIZE	LENGTH	WIDTH	HEIGHT	COOLING SURFACE	CAPACITY	ITEM
8"	10-3/8"	2-1/4"	3-1/8"	250 SQ-IN	8 oz	651470*
15"	17-1/2"	2-1/4"	3-1/8"	475 SQ-IN	16 oz	651480

Transmission Fittings

Transmission fittings are designed to replace OEM adapters in TH350, TH400, 700R4 and other applications that utilize 1/4" NPSM threads. Available in -6 and -8 complete with sealing washers.



DESCRIPTION	ITEM
-6 TO 1/4" NPSM	640520
-8 TO 1/4" NPSM	640530
-6 TO 1/4" 4L80	641390
-6 TO -8 4L80	641400

PACKAGE OF 2

ARB Stainless Hose Kits and Fittings

Russell's ARB Stainless Hose kits replaces OEM plastic lines for greater durability. The stainless steel hoses won't pinch in tight bends for better flow.



LENGTH	ITEM
5'	634510
12'	634520

DESCRIPTION	ITEM
FITTINGS KIT	634500

HOSES KITS INCLUDE FITTINGS



Power Steering Hose & Hose Ends

Stainless Braided Hose for High Pressure Power Steering Lines

For high pressure power steering lines, PowerFlex hose is the preferred choice. When used in conjunction with Russell's PowerFlex hose ends, the result is a durable and professional hose that resists leaks and provides years of service. A choice of power steering adapters is available to allow the connection to most pumps, feed, pressure and return lines.



- PTFE Inner Liner with 308 Stainless Steel Braid
- Corrosion Resistant Ultra Bright Endura Finish

PowerFlex Pre-Packaged Rolls

AN SIZE	ACTUAL INSIDE DIMENSIONS	NOMINAL INSIDE DIMENSIONS	OUTSIDE DIMENSIONS	MAX PSI	3'	6'	10'	15'	20'
-6	11/32"	3/8"	7/16"	2500	632600	632610	632620	632630	632640
-8	7/16"	1/2"	.565"	2500	632660	632670	632680	632740	-
-10	9/16"	5/8"	.656"	2500	632710	632720	632730	632770	-



Power Steering Adapters

Russell power steering adapters are designed to ensure the reliability required in a high pressure steering system.

PowerFlex Endura Hose Ends

PowerFlex hose ends is manufactured from high quality alloy steel providing the additional strength required to guarantee a quality high pressure hose assembly.

AN SIZE	STRAIGHT	45° RADIUS	90° RADIUS	REPLACEMENT FERRULES
-6	620401	620411	620421	620405
-8	620471	620481	620491	620475
-10	620501	620511	620521	620505

PACKAGED OF 2

AN SIZE	PORT / THREAD	INVERTED FLARE	O-RING SEAL
-6	1/2" -20	640330*	648010
-6	5/8" -18	640380*	648030
-6	11/16" -18	648050	648040
-6	16MM X 1.5	-	648060
-6	14MM X 1.5	-	648070
-6	18MM X 1.5	-	648080*
-6	9/16" -18	-	648020
-8	1/2" -20	640390*	-
-8	5/8" -18	640400*	-
-8	11/16" -18	640410*	-

*Available while supplies last



Pre-Assembled, Direct Bolt-On Brake Hose Kits

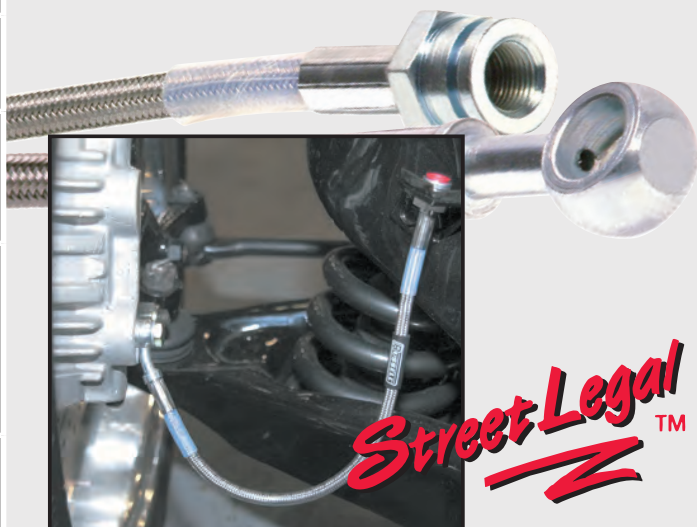

Direct bolt-on brake hoses bring the ultimate in braking performance. They improve your braking performance for competition or every-day driving. Replacing the OE rubber hoses with Russell brake hoses reduces brake hose expansion for more consistent braking. Featuring stainless steel braided hose with zinc-plated fittings, these brake hoses are factory assembled for convenient installation. They meet the guidelines of the U.S. Dept. of Transportation FMVSS-571.106 requirements. All Russell brake hoses kits are for stock applications unless noted otherwise.

DOMESTIC CARS

Buick

YEAR	MODEL	BRAKE DESCRIPTION			SPEED BLEEDERS		CLUTCH HOSE KIT	BRAKE HOSE KIT
		FRONT	REAR	QUANTITY	FRONT	REAR		
67-68	SKYLARK, GS, GSX (WITH 69-72 FRONT DISC SWAP)	DISC	DRUM	3	639590	639530	-	692330
97-04	REGAL FWD	DISC	DISC	4	639580	639580	-	692220
94-96	ROADMASTER	DISC	DISC	5	639580	639630	-	692120

Chevrolet

YEAR	MODEL	BRAKE DESCRIPTION			SPEED BLEEDERS		CLUTCH HOSE KIT	BRAKE HOSE KIT
		FRONT	REAR	QUANTITY	FRONT	REAR		
67-68	CAMARO	DRUM	DRUM	3	639530	639530	-	692070
67-68	CAMARO (WITH 69-72 FRONT DISC SWAP)	DISC	DRUM	3	-	-	-	692330
69-76	CAMARO (EXCEPT 1969 Z/28)	DISC	DRUM	3	639530	639530	-	692080
77-81	CAMARO	DISC	DRUM	3	639580	639530	-	692030
84-88	CAMARO (REAR DRUM)	DISC	DRUM	3	639580	-	-	692050
84-88	CAMARO (REAR DISC)	DISC	DISC	4	639580	-	-	692360
89-92	CAMARO	DISC	DRUM	3	639580	-	-	692050
89-92	CAMARO	DISC	DISC	5	639580	639560	-	692370
93-97	CAMARO (WITHOUT TRACTION CONTROL)	DISC	DISC	5	639580	639560	-	692260
98-02	CAMARO (WITHOUT TRACTION CONTROL)	DISC	DISC	5	639630	639630	-	692280
98-02	CAMARO (WITH TRACTION CONTROL)	DISC	DISC	6	639630	639630	-	692290
10-12	CAMARO SS (WITH BREMBO CALIPERS)	DISC	DISC	4	639560	639560	-	692380
94-96	CAPRICE	DISC	DISC	5	639580	639630	-	692120
95-04	CAVALIER	DISC	DRUM	4	639580	639520	-	692300
66-67	CHEVELLE, MALIBU, EL CAMINO	DRUM	DRUM	3	639590	639530	-	692070
67-68	CHEVELLE (WITH 69-72 FRONT DISC SWAP)	DISC	DRUM	3	639590	639530	-	692330
69-72	CHEVELLE	DISC	DRUM	3	639590	639530	-	692080
63-82	CORVETTE	DISC	DISC	4	639530	639530	-	692000
84-87	CORVETTE	DISC	DISC	4	639630	639630	-	692010
88-92	CORVETTE (INCLUDING 1990-92 ZR-1)	DISC	DISC	4	639630	639630	-	692020
94-96	CORVETTE (INCLUDING 1994-95 ZR-1)	DISC	DISC	4	639630	639630	-	692180
97-04	CORVETTE C5 (INCLUDING Z06)	DISC	DISC	4	639630	639630	-	692190



Brake Hose Kits

INTRODUCTION
HOSES
HOSE ENDS
ADAPTER FITTINGS
FUEL MANAGEMENT
ACCESSORIES
TOOLS
TRANSMISSION
POWER STEERING
BRAKE HOSES
NITROUS
DEALER
BULK
INSTALL
INDEX

Chevrolet (Continued)

YEAR	MODEL	BRAKE DESCRIPTION			SPEED BLEEDERS		CLUTCH HOSE KIT	BRAKE HOSE KIT
		FRONT	REAR	QUANTITY	FRONT	REAR		
05-12	CORVETTE C6	DISC	DISC	4	639560	639560	-	692350
06-12	CORVETTE Z06	DISC	DISC	4	639560	639560	-	692200
94-96	IMPALA SS	DISC	DISC	5	639580	639630	-	692120
00-05	IMPALA FWD	DISC	DISC	4	639580	639580	-	692220
70-72	MONTE CARLO	DISC	DRUM	3	639590	639530	-	692080
79-88	MONTE CARLO	DISC	DRUM	3	639580	639520	-	692100
00-05	MONTE CARLO FWD	DISC	DISC	4	639580	639580	-	692220
69-72	NOVA	DISC	DRUM	3	639590	639530	-	692080

Chrysler

YEAR	MODEL	BRAKE DESCRIPTION			SPEED BLEEDERS		CLUTCH HOSE KIT	BRAKE HOSE KIT
		FRONT	REAR	QUANTITY	FRONT	REAR		
06-10	CHARGER/RT 300C (DOESN'T FIT 300 OR 300C SRT-8)	DISC	DISC	4	639630	639560	-	694060

Dodge

YEAR	MODEL	BRAKE DESCRIPTION			SPEED BLEEDERS		CLUTCH HOSE KIT	BRAKE HOSE KIT
		FRONT	REAR	QUANTITY	FRONT	REAR		
06-10	CHARGER	DISC	DISC	4	-	-	-	694060
95-99	NEON (REAR DISC)	DISC	DISC	4	639540	639590	-	694330
03-05	NEON SRT-4	DISC	DISC	4	-	-	-	694310
91-95	STEALTH 2WD	DISC	DISC	4	639630	639630	-	686000

Eagle

YEAR	MODEL	BRAKE DESCRIPTION			SPEED BLEEDERS		CLUTCH HOSE KIT	BRAKE HOSE KIT
		FRONT	REAR	QUANTITY	FRONT	REAR		
90-94	TALON 2WD	DISC	DISC	4	639630	639560	-	686000

Ford

YEAR	MODEL	BRAKE DESCRIPTION			SPEED BLEEDERS		CLUTCH HOSE KIT	BRAKE HOSE KIT
		FRONT	REAR	QUANTITY	FRONT	REAR		
00-06	FOCUS	DISC	DRUM	4	639620	639560	-	693250
02-04	FOCUS SVT	DISC	DISC	6	639520	639570	-	693370
65-67	MUSTANG	DISC	DRUM	3	639540	639540	-	693050
68-70	MUSTANG (FRONTS ONLY)	DISC	N/A	2	639600	639540	-	693150
71-73	MUSTANG (FRONTS ONLY)	DISC	N/A	2	639600	639540	-	693160
71-73	MUSTANG	DISC	DRUM	3	639600	639590	-	693080
74-78	MUSTANG	DISC	DRUM	3	639590	639540	-	693090
79-86	MUSTANG	DISC	DRUM	3	639590	639540	-	693000
87-93	MUSTANG	DISC	DRUM	3	639590	639540	-	693010
94-95	MUSTANG COBRA - COMPLETE 5-LINE KIT	DISC	DISC	5	639630	639630	-	693350
94-95	MUSTANG GT - COMPLETE 5-LINE KIT	DISC	DISC	5	639590	639630	-	693040
96-98	MUSTANG COBRA	DISC	DISC	4	639560	639560	-	693400
96-98	MUSTANG COBRA (FRONTS ONLY)	DISC	DISC	2	639560	639560	-	693170
94-95	MUSTANG COBRA	DISC	DISC	3	639560	639560	-	693020
96-98	MUSTANG GT (FRONTS ONLY)	DISC	DISC	2	639590	639630	-	693180
96-98	MUSTANG GT	DISC	DISC	4	639590	639630	-	693190
99-04	MUSTANG WITH TRACTION CONTROL (EXCEPT COBRA)	DISC	DISC	4	639560	639630	-	693210
99-04	MUSTANG COBRA (WITH IRS)	DISC	DISC	4	639560	639630	-	693270
99-04	MUSTANG W/O TRACTION CONTROL	DISC	DISC	4	639560	639630	-	693290
05-12	MUSTANG (WITH ABS)	DISC	DISC	4	639560	639560	-	693380

Mercury

YEAR	MODEL	BRAKE DESCRIPTION			SPEED BLEEDERS		CLUTCH HOSE KIT	BRAKE HOSE KIT
		FRONT	REAR	QUANTITY	FRONT	REAR		
67	COUGAR	DRUM	DRUM	3	639540	639540	-	693060



Brake Hose Kits

Oldsmobile

YEAR	MODEL	BRAKE DESCRIPTION			SPEED BLEEDERS		CLUTCH HOSE KIT	BRAKE HOSE KIT
		FRONT	REAR	QUANTITY	FRONT	REAR		
67-68	CUTLASS, 442 (WITH 69-72 FRONT DISC SWAP)	DISC	DRUM	3	-	-	-	692330
98-02	INTRIGUE FWD	DISC	DISC	4	639580	639580	-	692220

Plymouth

YEAR	MODEL	BRAKE DESCRIPTION			SPEED BLEEDERS		CLUTCH HOSE KIT	BRAKE HOSE KIT
		FRONT	REAR	QUANTITY	FRONT	REAR		
90-94	LASER 2WD	DISC	DISC	4	639630	639560	-	686000
95-99	NEON (REAR DISC)	DISC	DISC	4	639540	639590	-	694330

Pontiac

YEAR	MODEL	BRAKE DESCRIPTION			SPEED BLEEDERS		CLUTCH HOSE KIT	BRAKE HOSE KIT
		FRONT	REAR	QUANTITY	FRONT	REAR		
67-68	FIREBIRD	DRUM	DRUM	3	639590	639530	-	692070
67-68	FIREBIRD (WITH 69-72 FRONT DISC SWAP)	DISC	DRUM	3	-	-	-	692330
69-76	FIREBIRD/TRANS AM	DISC	DRUM	3	639590	639530	-	692080
77-78	FIREBIRD/TRANS AM	DISC	DRUM	3	639590	639530	-	692030
79-81	FIREBIRD/TRANS AM	DISC	DRUM	3	639580	639520	-	692030
79-81	FIREBIRD/TRANS AM	DISC	DISC	3	639580	639580	-	692030
84-88	FIREBIRD/TRANS AM	DISC	DRUM	3	639580	639520	-	692050
84-88	FIREBIRD/TRANS AM	DISC	DISC	4	-	-	-	692360
89-92	FIREBIRD/TRANS AM	DISC	DRUM	3	639580	-	-	692050
89-92	FIREBIRD/TRANS AM	DISC	DISC	5	639580	639560	-	692370
93-97	FIREBIRD (WITHOUT TRACTION CONTROL)	DISC	DISC	5	639580	639580	-	692260
98-02	FIREBIRD (WITHOUT TRACTION CONTROL)	DISC	DISC	5	639630	639630	-	692280
98-02	FIREBIRD (WITH TRACTION CONTROL)	DISC	DISC	6	639630	639630	-	692290
79-81	GRAND AM	DISC	DRUM	3	-	-	-	692100
79-87	GRAND PRIX	DISC	DRUM	3	639580	639520	-	692100
97-03	GRAND PRIX FWD	DISC	DISC	4	639580	639580	-	692220
66-67	GTO, LEMANS, TEMPEST	DRUM	DRUM	3	639530	639530	-	692070
67-68	GTO (WITH 69-72 FRONT DISC SWAP)	DISC	DRUM	3	-	-	-	692330
69-72	GTO	DISC	DRUM	3	639590	639530	-	692080
2004	GTO	DISC	DRUM	6	639590	639530	-	692310
05-06	GTO	DISC	DISC	6	639560	639560	-	692320
08-09	G8 GT	DISC	DISC	4	639560	639560	-	692210
95-04	SUNFIRE FWD	DISC	DRUM	4	639580	639520	-	692300

IMPORT CARS

Acura

YEAR	MODEL	BRAKE DESCRIPTION			SPEED BLEEDERS		CLUTCH HOSE KIT	BRAKE HOSE KIT
		FRONT	REAR	QUANTITY	FRONT	REAR		
90-93	INTEGRA RS, LS, GS AND GSR	DISC	DISC	4	639610	639610	-	684800
94-97	INTEGRA LS AND GSR	DISC	DISC	4	639610	639520	684730	684850
98-01	INTEGRA LS AND GSR	DISC	DISC	4	639610	639510	684730	684850
97-01	INTEGRA TYPE R	DISC	DISC	4	639610	639520	684730	684860
99-06	TL/CL 3.2L (INCLUDING TYPE S)	DISC	DISC	4	639560	639610	-	684690
02-06	RSX COUPE TYPE S	DISC	DISC	4	639610	639610	-	684890

Honda

YEAR	MODEL	BRAKE DESCRIPTION			SPEED BLEEDERS		CLUTCH HOSE KIT	BRAKE HOSE KIT
		FRONT	REAR	QUANTITY	FRONT	REAR		
98-02	ACCORD	DISC	DISC	4	639560	639610	-	684690
88-91	CIVIC, CRX (REAR DISC)	DISC	DRUM	4	639560	-	-	684500
88-91	CIVIC EX, SI; CRX SI	DISC	DISC	4	639560	-	-	684550
92-95	CIVIC (ALL WITH REAR DISCS, NO ABS)	DISC	DISC	4	639610	-	-	684600



Brake Hose Kits

INTRODUCTION
HOSES
HOSE ENDS
ADAPTER FITTINGS
FUEL MANAGEMENT
ACCESSORIES
TOOLS
TRANSMISSION
POWER STEERING
BRAKE HOSES
NITROUS
DEALER
BULK
INSTALL
INDEX

Honda (Continued)

YEAR	MODEL	BRAKE DESCRIPTION			SPEED BLEEDERS		CLUTCH HOSE KIT	BRAKE HOSE KIT
		FRONT	REAR	QUANTITY	FRONT	REAR		
92-95	CIVIC (ALL WITH REAR DRUMS)	DISC	DRUM	4	639610	-	-	684480
96-00	CIVIC CX, DX, HX (WITH SMALL FRONT ROTOR)	DISC	DISC	4	639560	639610	684710	684610
96-00	CIVIC LX, EX (WITH LARGE FRONT ROTOR)	DISC	DISC	4	639560	639610	684710	684620
99-02	CIVIC COUPE SI	DISC	DISC	4	639560	639610	684720	684510
01-05	CIVIC EX, LX, DX (WITH REAR DRUMS)	DISC	DRUM	4	639560	639520	-	684630
03-05	CIVIC HATCHBACK SI	DISC	DISC	4	639610	639610	-	684890
06-11	CIVIC SI	DISC	DISC	4	639610	639610	684740	684470
00-06	S2000	DISC	DISC	4	639610	639610	-	684490

Infiniti

YEAR	MODEL	BRAKE DESCRIPTION			SPEED BLEEDERS		CLUTCH HOSE KIT	BRAKE HOSE KIT
		FRONT	REAR	QUANTITY	FRONT	REAR		
03-06	G35 COUPE & SEDAN (WITH STANDARD DISC BRAKES)	DISC	DISC	4	639560	639570	-	686910
03-06	G35 COUPE & SEDAN (WITH BREMBO BRAKES)	DISC	DISC	4	639630	639630	-	686920

Mazda

YEAR	MODEL	BRAKE DESCRIPTION			SPEED BLEEDERS		CLUTCH HOSE KIT	BRAKE HOSE KIT
		FRONT	REAR	QUANTITY	FRONT	REAR		
90-05	MIATA MX-5 (NON-SPORT SUSPENSION)	DISC	DISC	4	639550	-	-	685500
86-92	RX-7	DISC	DISC	4	639570	639570	-	685600
93-95	RX-7	DISC	DISC	4	639550	639570	-	685650
04-11	RX8	DISC	DISC	4	639550	639560	685680	685670

Mitsubishi

YEAR	MODEL	BRAKE DESCRIPTION			SPEED BLEEDERS		CLUTCH HOSE KIT	BRAKE HOSE KIT
		FRONT	REAR	QUANTITY	FRONT	REAR		
91-99	3000 GT 2WD	DISC	DISC	4	639630	639630	-	686000
90-94	ECLIPSE 2WD	DISC	DISC	4	639630	639630	-	686000
95-99	ECLIPSE 2WD & AWD	DISC	DISC	4	639570	639570	-	686150
03-07	LANCER EVOLUTION	DISC	DISC	4	-	-	686120	686110*

Nissan

YEAR	MODEL	BRAKE DESCRIPTION			SPEED BLEEDERS		CLUTCH HOSE KIT	BRAKE HOSE KIT
		FRONT	REAR	QUANTITY	FRONT	REAR		
89-94	240SX	DISC	DISC	4	639560	639560	-	686850
70-73	240Z	DISC	DRUM	4	639560	639570	-	686550
74	260Z	DISC	DRUM	4	639560	639570	-	686550
75-78	280Z	DISC	DRUM	4	639560	639570	-	686550
90-96	300ZX	DISC	DISC	4	639560	639560	-	686700
03-05	350Z (WITH STANDARD DISC)	DISC	DISC	4	639560	639570	-	686910
03-06	350Z (WITH BREMBO BRAKES)	DISC	DISC	4	639630	639630	-	686920

Subaru

YEAR	MODEL	BRAKE DESCRIPTION			SPEED BLEEDERS		CLUTCH HOSE KIT	BRAKE HOSE KIT
		FRONT	REAR	QUANTITY	FRONT	REAR		
02-05	IMPREZA 2.5 RS AND WRX	DISC	DISC	4	639570	639570	-	689700
2013-15	BRZ	DISC	DISC	4	639570	639570	-	688020

Toyota

YEAR	MODEL	BRAKE DESCRIPTION			SPEED BLEEDERS		CLUTCH HOSE KIT	BRAKE HOSE KIT
		FRONT	REAR	QUANTITY	FRONT	REAR		
93-97	SUPRA	DISC	DISC OR DRUM	4	639570	639570	-	688200

Scion

YEAR	MODEL	BRAKE DESCRIPTION			SPEED BLEEDERS		CLUTCH HOSE KIT	BRAKE HOSE KIT
		FRONT	REAR	QUANTITY	FRONT	REAR		
2013-15	FR-S	DISC	DISC	4	639570	639570	-	688020
05-10	TC	DISC	DISC	4	639570	639570	-	



Brake Hose Kits

TRUCKS & SUV'S

General Motors

YEAR	MODEL	BRAKE DESCRIPTION			SPEED BLEEDERS		CLUTCH HOSE KIT	BRAKE HOSE KIT
		FRONT	REAR	QUANTITY	FRONT	REAR		
85-99	ASTRO/SAFARI 2WD	DISC	DRUM	3	639580	639520	-	672320
82-91	S10/S15 BLAZER P/U 2WD	DISC	DRUM	3	639580	639520	-	672330
91-99	S10/S15 BLAZER P/U 2WD	DISC	DRUM	3	639580	639520	-	672360
81-82	S10/S15 (INCLUDING EARLY 91)	DISC	DRUM	3	639580	639520	-	672330
73-78	C-10/C-20 P/U, BLAZER, SUBURBAN 2WD	DISC	DRUM	3	639590	639530	-	672300
79-87	C-10/C-20 P/U 2WD	DISC	DRUM	3	639580	639520	-	672310
79-91	C-10/C-20 BLAZER, JIMMY, SUBURBAN 2WD	DISC	DRUM	3	639580	639520	-	672310
88-00	C1500/C2500 P/U 2WD	DISC	DRUM	3	639580	639520	-	672340
92-94	C1500 BLAZER/YUKON 2WD	DISC	DRUM	3	639580	639520	-	672400
95-99	C1500 TAHOE/YUKON 2WD	DISC	DRUM	3	639580	639520	-	672340
99-06	1500 TRUCK 2WD	DISC	DISC	5	639580	639560	-	672470
05-06	1500 TRUCK 2WD	DISC	DRUM	3	639580	TBD	-	672480
07-12	SUBURBAN, TAHOE, YUKON, YUKON XL 2WD/4WD	DISC	DISC	6	-	-	-	672500
79-87	K-10/K-20 P/U 4WD	DISC	DRUM	3	639580	639520	-	672420
79-91	K-10/K-20 BLAZER, JIMMY, SUBURBAN 4WD	DISC	DRUM	3	639580	639520	-	672420
88-00	K1500 P/U	DISC	DRUM	3	639580	639520	-	672370
88-96	K2500 P/U (7200GVW)	DISC	DRUM	3	639580	639520	-	672370
92-94	K1500 BLAZER/YUKON	DISC	DRUM	3	639580	639520	-	672400
95-99	K1500 TAHOE/YUKON (NON-DIESEL)	DISC	DRUM	3	639580	639520	-	672400
92-99	K1500 SUBURBAN (NON-DIESEL)	DISC	DRUM	3	639580	639520	-	672370
92-96	K2500 SUBURBAN (7200GVW)	DISC	DRUM	3	639580	639520	-	672370
99-05	SILVERADO/SIERRA 1500 TRUCK 4WD	DISC	DISC	5	639580	639560	-	672430
99-05	SILVERADO/SIERRA 1500 2WD	DISC	DISC	5	-	-	-	672470
04-05	SILVERADO 1500 SS	DISC	DISC	5	639580	639560	-	672430
99-06	SILVERADO/SIERRA 1500 2WD	DISC	DISC	5	639580	639560	-	672470
05-06	SILVERADO/SIERRA 1500 2WD	DISC	DRUM	3	639580	TBD	-	672480
05-06	SILVERADO/SIERRA 1500 4WD (INCLUDING 06 SS)	DISC	DRUM	3	639580	TBD	-	672490
07-08	GM SIERRA, SILVERADO WORK TRUCK	DISC	DRUM	3	-	-	-	695590
07-12	SUBURBAN 1500 2WD	DISC	DISC	6	-	-	-	672500
01-06	SILVERADO/SIERRA HD (ALL)	DISC	DISC	5	639580	639560	-	672440
91-99	S-10 P/U-BLAZER 4WD (LATE 91)	DISC	DRUM	3	639580	639520	-	672390
00-06	SUBURBAN, TAHOE, YUKON 1500 2WD/4WD (B)	DISC	DISC	5	639580	639560	-	672450

General Motors Lifted

YEAR	MODEL	BRAKE DESCRIPTION			SPEED BLEEDERS		CLUTCH HOSE KIT	BRAKE HOSE KIT
		FRONT	REAR	QUANTITY	FRONT	REAR		
73	K-10/K-20 P/U-BLAZER, SUBURBAN WITH 4" LIFT	DISC	DRUM	3	639590	639590	-	695730
74-77	K-10/K-20 P/U-BLAZER, SUBURBAN WITH 4" LIFT	DISC	DRUM	3	639590	639530	-	695730
78	K-10/K-20 P/U-BLAZER, SUBURBAN WITH 4" LIFT	DISC	DRUM	3	639580	639520	-	695730
79-87	K-10/K-20 P/U-BLAZER, SUBURBAN WITH 4" LIFT	DISC	DRUM	3	639580	639520	-	695710
79-91	K-10/K-20 P/U BLAZER, JIMMY SUBURBAN WITH 4" LIFT	DISC	DRUM	3	639580	639520	-	695710
88-00	K1500 P/U WITH 4" LIFT	DISC	DRUM	3	639580	639520	-	695700
88-96	K2500 P/U (7200GVW) WITH 4" LIFT	DISC	DRUM	3	639580	639520	-	695700
92-99	K1500 SUBURBAN (NON-DIESEL) WITH 4" LIFT	DISC	DRUM	3	639580	639520	-	695700
92-96	K2500 SUBURBAN (7200GVW) WITH 4" LIFT	DISC	DRUM	3	639580	639520	-	695700
99-06	SILVERADO/SIERRA 1500 2WD WITH 6"-7" LIFT 4WD W/ 4'-6"	DISC	DISC	5	639580	639560	-	695760
05-06	SILVERADO/SIERRA 1500 2WD WITH 6"-7" LIFT 4WD W/ 4'-6"	DISC	DRUM	3	639580	-	-	695780
01-06	SILVERADO/SIERRA HD (ALL) (ALSO FITS RANCHO)	DISC	DISC	5	639580	639560	-	695770
00-06	SUBURBAN, TAHOE, YUKON 1500 2WD/4WD WITH 6" LIFT (ALSO FITS RANCHO)	DISC	DISC	5	639580	639560	-	695560



Brake Hose Kits

INTRODUCTION
HOSES
HOSE ENDS
ADAPTER FITTINGS
FUEL MANAGEMENT
ACCESSORIES
TOOLS
TRANSMISSION
POWER STEERING
BRAKE HOSES
NITROUS
DEALER
BULK
INSTALL
INDEX

Dodge

YEAR	MODEL	BRAKE DESCRIPTION			SPEED BLEEDERS		CLUTCH HOSE KIT	BRAKE HOSE KIT
		FRONT	REAR	QUANTITY	FRONT	REAR		
85-02	ASTRO/SAFARI 2WD	DISC	DRUM	3	639580	639520	-	672320
94-99	RAM 1500, 2500 2WD	DISC	DRUM	3	639580	639520	-	694500
94-99	RAM 1500, 2500 4WD (WITH REAR ABS ONLY)	DISC	DRUM	3	639580	639520	-	694540
02-05	RAM 1500 4WD	DISC	DISC	3	639590	639590	-	694510
03-06	RAM 2500, 3500 2WD	DISC	DISC	3	639560	639560	-	694590
09-12	RAM 1500 4X4 (FRONT ONLY)	DISC	-	2	-	-	-	694600

Dodge Lifted

YEAR	MODEL	BRAKE DESCRIPTION			SPEED BLEEDERS		CLUTCH HOSE KIT	BRAKE HOSE KIT
		FRONT	REAR	QUANTITY	FRONT	REAR		
94-99	RAM 1500, 2500 4WD WITH 4"-6" LIFT	DISC	DRUM	3	639580	639520	-	694550
02-06	RAM 1500 4WD WITH 4"-6" LIFT	DISC	DISC	3	639590	639590	-	694580

Ford

YEAR	MODEL	BRAKE DESCRIPTION			SPEED BLEEDERS		CLUTCH HOSE KIT	BRAKE HOSE KIT
		FRONT	REAR	QUANTITY	FRONT	REAR		
92-96	F-150 2/4WD	DISC	DRUM	3	639510	639590	-	693220
97-03	F-150/F-250 2WD (EXCEPT SUPER DUTY)	DISC	DRUM	3	639590	639590	-	693310
99-03	LIGHTNING	DISC	DISC	3	639590	639590	-	693230
05-08	F-150 4X4 (A)	DISC	DISC OR DRUM	3	-	-	-	693390

Ford Lifted

YEAR	MODEL	BRAKE DESCRIPTION			SPEED BLEEDERS		CLUTCH HOSE KIT	BRAKE HOSE KIT
		FRONT	REAR	QUANTITY	FRONT	REAR		
90-96	BRONCO 4WD WITH 4" LIFT	DISC	DRUM	3	639510	639590	-	696140
90-96	F-150 4WD WITH 4" LIFT	DISC	DRUM	3	639510	639590	-	696140
99-06	EXCURSION 4WD WITH 4"-5.5" LIFT (B)	DISC	DISC	5	639560	639560	-	696490
99-06	EXCURSION 4WD WITH 6"-8" LIFT (B)	DISC	DISC	5	639560	639560	-	696500
80-89	F-100/150 WITH 4" LIFT	DISC	DRUM	3	639510	639590	-	696150
90-96	F-150 4WD WITH 4" LIFT	DISC	DRUM	3	639510	639590	-	696140
99-04	F-250/350 SUPER DUTY 4WD WITH 4-5.5" LIFT (B)	DISC	DISC	5	639560	639560	-	696490
99-04	F-250/350 SUPER DUTY 4WD WITH 6-8" LIFT (B)	DISC	DISC	5	639560	639560	-	696500
05-06	F-250/350 SUPER DUTY 4WD WITH 6" LIFT	DISC	DISC	5	639590	639590	-	696510

Jeep

YEAR	MODEL	BRAKE DESCRIPTION			SPEED BLEEDERS		CLUTCH HOSE KIT	BRAKE HOSE KIT
		FRONT	REAR	QUANTITY	FRONT	REAR		
84-01	CHEROKEE XJ STOCK HEIGHT TO 1" LIFT	DISC	DRUM	3	639590	639590	-	694850
07-12	JK W/ STOCK HEIGHT TO 1" LIFT	DISC	DISC	4	639590	639590	-	694860

Jeep Lifted

YEAR	MODEL	BRAKE DESCRIPTION			SPEED BLEEDERS		CLUTCH HOSE KIT	BRAKE HOSE KIT
		FRONT	REAR	QUANTITY	FRONT	REAR		
77-78	CJ5/CJ7 WITH 4" LIFT	DISC	DRUM	3	639590	639540	-	695910
79-81	CJ5/CJ7 WITH 4" LIFT	DISC	DRUM	3	639590	639590	-	695910
82-86	CJ5/CJ7/CJ8 WITH 4" LIFT	DISC	DRUM	3	639590	639590	-	695900
07-11	JK WITH 4" LIFT	DISC	DISC	4	639560	639560	-	695960
79-88	J10 & J20 PICKUP WITH 4" LIFT	DISC	DRUM	3	639590	639530	-	695920
79-83	WAGONEER & CHEROKEE (INCL. WIDE TRACK) WITH 4" LIFT	DISC	DRUM	3	639590	639530	-	695920
84-91	GRAND WAGONEER WITH 4" LIFT	DISC	DRUM	3	639590	639530	-	695920
87-95	WRANGLER YJ WITH 4" LIFT	DISC	DRUM	3	639590	639530	-	695940
97-06	WRANGLER TJ WITH 4" TO 6" LIFT NO ABS (INCLUDES UNLIMITED & RUBICON MODELS)	DISC	DISC OR DRUM	3	639590	639590	694870	695950

Toyota

YEAR	MODEL	BRAKE DESCRIPTION			SPEED BLEEDERS		CLUTCH HOSE KIT	BRAKE HOSE KIT
		FRONT	REAR	QUANTITY	FRONT	REAR		
00-06	TUNDRA	DISC	DRUM	3	639560	-	-	688480



-3 Universal Hose Assemblies

Universal hose assemblies are constructed from PowerFlex stainless steel braided hose and hose ends that are plated with Russell's ultra-bright Endura or black finish. The hose ends are factory precision crimped to eliminate leakage. Hose assemblies are street legal as they meet with the guidelines of D.O.T. FMVSS-571.106 requirements.

- PTFE Inner Liner and Stainless Steel Braid Eliminates Hose Expansion Common to Original Lines
- Better Braking Performance and a Firmer Pedal Feel
- Compatible with Virtually Any Hydraulic Brake or Clutch System



Endura Universal Hose

LENGTH	-3 TO -3		10MM BANJO (3/8") TO 3/16" HARDLINE	
	STRAIGHT	90° RADIUS	STRAIGHT -3	
9"	656012	655012	657012	657300
12"	656022	655022	657022	657310
13"	656302	655302	657302	657320
15"	656032	655032	657032	657330
16"	656242	655242	657242	657340
18"	656042	655042	657042	657350
20"	656222	655222	657222	657360
21"	656052	655052	657052	657370
24"	656062	655062	657062	657380
27"	656072	655072	657072	657390

Competition Brake Hoses For Professional Racing Applications

These Competition Brake Hoses have better braking performance and a firmer pedal feel. Made of stainless steel with zinc plated hose ends. They are pre-assembled and ready for adapter fittings. Choose from -3 or -4 brake hose from lengths of 9" up to 53". Non-D.O.T. hose for off-road use only

LENGTH	-3 TO STRAIGHT -3		10MM BANJO (3/8") TO STRAIGHT -3	-4 TO STRAIGHT -4 STRAIGHT
	STRAIGHT	90° RADIUS		
9"	656010	655010	657010	-
12"	656020	655020	657020	-
14"	-	-	-	659000
15"	656030	655030	657030	-
16"	-	-	-	659010
18"	656040	655040	657040	659020
20"	-	-	-	659030
21"	656050	655050	657050	-
22"	-	-	-	659040
24"	656060	655060	657060	659050
27"	656070	655070	657070	-
30"	656080	655080	657080	-
33"	656090	655090	657090	-
36"	656100	655100	657100	-
42"	656120	-	-	-
45"	656130	-	-	-
53"	656150	-	-	-



Black Universal Hose

LENGTH	-3 TO -3		10MM BANJO (3/8") TO STRAIGHT -3
	STRAIGHT	90° RADIUS	
9"	656013	655013	657013
12"	656023	655023	657023
15"	656033	655033	657033
16"	656243	655243	657243



PowerFlex Brake Hose Assemblies

High Pressure Hose, Hose Ends & Fittings for Brake Lines

PowerFlex stainless steel braided hose is specifically designed for high performance brake applications, features the combination of a PTFE inner liner with the corrosion and abrasion resistance of stainless steel braid for maximum pressure use.

- PTFE Inner Liner with a 308 Stainless Steel Braid
- Use with -3 and -4 Endura Adapter Fittings
- Available in a Variety of Pre-Cut Lengths



PowerFlex Pre-Packaged Rolls

AN SIZE	ACTUAL INSIDE DIMENSION	MAX PSI	3 FEET	6 FEET	10 FEET	15 FEET	20 FEET	50 FEET	100 FEET
-3	1/8"	2500	632490	632500	632510	632520	632530	633930	633940
-4	3/16"	2500	632540	632550	632560	632570	632580	633960	-

PowerFlex Endura Brake Hose Ends

Manufactured from high quality alloy steel for strength to guarantee a quality, high pressure hose assembly.

Standard Hose Ends

AN SIZE	STRAIGHT	45° ANGLE	90° ANGLE	10MM BANJO (3/8")
-3	620131	620431	620441	640641
-4	620141	620451	620461	-

Rebuildable Forged Hose Ends

AN SIZE	45° ANGLE	90° ANGLE
-3	620831	620391



620401

620411

620421



620641

620831

620391

-3 and -4 Endura Brake Adapter Fittings

Endura plated steel AN brake adapters from Russell are best suited for operating conditions where additional corrosion protection is needed. Choose from a wide selection of -3 and -4 fittings available in metric or SAE threads for most popular applications.

Inverted Flare Brake Adapter Fittings

AN SIZE	FEMALE	10MM X 1.0		10MM X 1.25	
		MALE	FEMALE TEE	MALE	FEMALE
-3	641411	641431	640510	641451	641471
-4	641421	-	-	-	641481

Bevel Brake Adapter Fittings

AN SIZE	10MM X 1.0		10MM X 1.25
	FEMALE	MALE	MALE
-3	640411	640431	640451
-4	640421	640441	640461



640411

641431

641451

641471

640421

640441

640461



Brake Adapter Fittings



Polished Residual Valves

These valves eliminate spongy-pedal feel by retaining pressure and keeping your brake pedal firm. Available in 2 psi for disc brakes and 10 psi for drum brakes.

DESCRIPTION	PSI	ITEM
POLISHED RESIDUAL VALVE	2	654010
POLISHED RESIDUAL VALVE	10	654040



Brake Proportioning Valve

Manufactured from billet aluminum and anti-corrosive brass internal components. They include 3/8" - 24 inverted flare hard line adapter. For use on aftermarket custom brake systems. Not an original equipment replacement.

DESCRIPTION	ITEM
BRAKE PROPORTIONING VALVE	654000



Universal Clutch Fitting Male

Features a 3/8" I.D. bore size. For use with Dodge/Jeep applications and GM vehicles with T56 transmissions.

AN SIZE	QTY	ENDURA
-3	2	640281
-4	2	641001

Speed Bleeder Assembly for Clutch Hose

When plumbed in a hydraulic clutch system, this assembly allows for one person clutch fluid bleeding.



AN SIZE	ITEM
-3	641370
-4	641380

*Available while supplies last



Brackets and Hardware

Keeps your factory or aftermarket brake lines secured in their proper location.

DESCRIPTION	QTY	ITEM
E-CLIP	10	683940
BRAKE LINE RETAINING CLIP	10	683941
BOLT-ON 90° MOUNTING BRACKET	2-PC	683942
WELD-ON BRAKE HOSE BRACKET	2-PC	683943

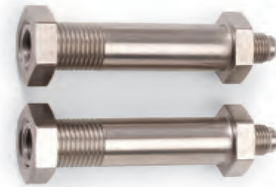

Russell Thru The Frame Fittings

These fittings route the brake hose through the frame for a neater and safer installation. Fittings are 2" long with -3 AN to 1/8" pipe. Package of 2.

DESCRIPTION	ITEM
FITTINGS	641490

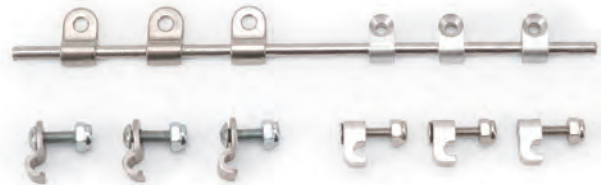

Russell Brake Line Clamps

These clamps are designed to work with 3/16" O.D. hard line for a secure method of attaching brake hard line. Package of 12.

DESCRIPTION	ITEM
STAINLESS STEEL BRAKE LINE CLAMPS	654030
BILLET ALUMINUM TUBING CLAMPS	654020*



Brake Adapter Fittings



SAE Brake Adapter Fittings

AN SIZE	1/8" NPT PIPE MALE		1/8" NPT PIPE MALE 45°		1/8" NPT PIPE MALE 90°		MALE TEE	BULKHEAD TEE
	ENDURA	BLACK	ENDURA	BLACK	ENDURA	BLACK	ENDURA	ENDURA
-3	642441	642443	642931	642933	642791	642793	642981	643301
-4	642451	-	-	-	-	-	-	-



SAE Brake Adapter Fittings

SIZE	ENDURA	BLACK
TEE 3/8" X 24 INVERTED FLARE - FEMALE	640500	640503
7/16" X 24 INVERTED FLARE - FEMALE	641331	-

Stainless Flare to Pipe (Zinc Plated)

AN SIZE	PIPE	STRAIGHT	45° FLARE 1/8" PIPE TO -3	90° ANGLE
-3	1/8"	660412	660932*	660792



Inverted Flare Brake Adapter Fittings

AN SIZE	3/8" X 24 - FEMALE		3/8" X 24 - MALE		7/16" X 20 - MALE		7/16" X 24 - MALE
	ENDURA	BLACK	ENDURA	BLACK	ENDURA	BLACK	ENDURA
-3	641291	641293	643961	643963	641321	641323	641311
-4	640291	-	640301	-	640321	-	640311

Mustang to -3 Fittings

AN SIZE	ENDURA
3/8" -24	640581
7/16" -24	640591

Banjo

AN SIZE	GM STYLE 7/16" TO -3 AN		STRAIGHT 10MM (3/8")		35° RADIUS 10MM (3/8")		90° RADIUS 10MM (3/8")
	ENDURA	BLACK	ENDURA	BLACK	ENDURA	BLACK	ENDURA
-3	640491	640493	640471	640473	640511	640513	640541
-4	-	-	640481	-	-	-	-

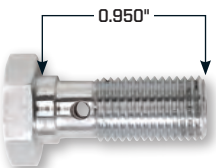

Banjo Bolts

SIZE	ZINC-PLATED
3/8" -24	640650
7/16" -20	640660
7/16" -24	640670
10MM X 1.5"	640680



Tube Nut

AN SIZE	QTY	ENDURA
-3	6	642941

WITH INTEGRATED TUBE SLEEVE



Bulkhead Nut

AN SIZE	ENDURA
-3	643871



-3 to -3 Brake Switch Junction

AN SIZE	PIPE	STAINLESS STEEL
-3	1/8"	660402



Brake Adapter Fittings



Polished Residual Valves

These valves eliminate spongy-pedal feel by retaining pressure and keeping your brake pedal firm. Available in 2 psi for disc brakes and 10 psi for drum brakes.

DESCRIPTION	PSI	ITEM
POLISHED RESIDUAL VALVE	2	654010
POLISHED RESIDUAL VALVE	10	654040



Brake Proportioning Valve

Manufactured from billet aluminum and anti-corrosive brass internal components. They include 3/8" - 24 inverted flare hard line adapter. For use on aftermarket custom brake systems. Not an original equipment replacement.

DESCRIPTION	ITEM
BRAKE PROPORTIONING VALVE	654000



Universal Clutch Fitting Male

Features a 3/8" I.D. bore size. For use with Dodge/Jeep applications and GM vehicles with T56 transmissions.

AN SIZE	QTY	ENDURA
-3	2	640281
-4	2	641001

Speed Bleeder Assembly for Clutch Hose

When plumbed in a hydraulic clutch system, this assembly allows for one person clutch fluid bleeding.



AN SIZE	ITEM
-3	641370
-4	641380

*Available while supplies last



Brackets and Hardware

Keeps your factory or aftermarket brake lines secured in their proper location.

DESCRIPTION	QTY	ITEM
E-CLIP	10	683940
BRAKE LINE RETAINING CLIP	10	683941
BOLT-ON 90° MOUNTING BRACKET	2-PC	683942
WELD-ON BRAKE HOSE BRACKET	2-PC	683943



Russell Thru The Frame Fittings

These fittings route the brake hose through the frame for a neater and safer installation. Fittings are 2" long with -3 AN to 1/8" pipe. Package of 2.

DESCRIPTION	ITEM
FITTINGS	641490

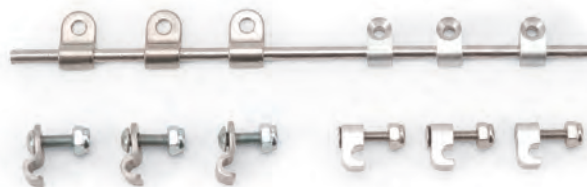

Russell Brake Line Clamps

These clamps are designed to work with 3/16" O.D. hard line for a secure method of attaching brake hard line. Package of 12.

DESCRIPTION	ITEM
STAINLESS STEEL BRAKE LINE CLAMPS	654030
BILLET ALUMINUM TUBING CLAMPS	654020*



Speed Bleeders

One Person System Takes The Work Out Of Brake Bleeding

Bleeding your brake or clutch line has never been easier or simpler! Revolutionary double-patented Speed Bleeder replaces the original bleeder valve in your caliper/wheel cylinder with a spring-loaded one-way ball and check valve design. This unique design opens to allow the old fluid and air out, then closes automatically between pumps to prevent the old fluid and air from re-entering the line. It's a real time saver!

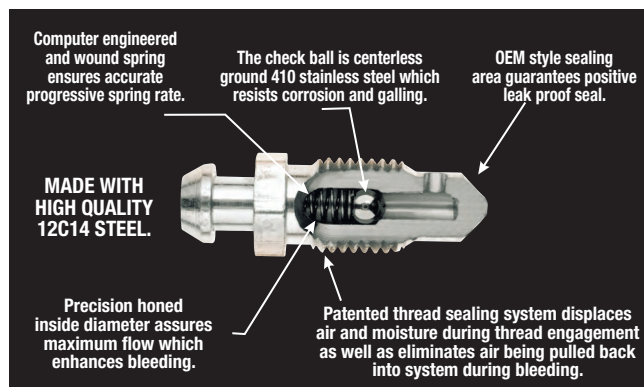

Speed Bleeder Reference Chart

THREAD	OVERALL LENGTH	ITEM
7/16 - 20	1.25"	639510
8MM X 1.25MM	24MM	639520
5/16 - 24	1"	639530
1/4 - 28	1"	639540
8MM X 1.0	34MM	639550

THREAD	OVERALL LENGTH	ITEM
10MM X 1.0	35MM	639560
7MM X 1.0	34MM	639570
10MM X 1.5	30MM	639580
3/8 - 24	1"	639590
3/8 - 24 LONG	1.50"	639600

THREAD	OVERALL LENGTH	ITEM
10MM X 1.25	33MM	639610
8MM X 1.25	39MM	639620
10MM X 1.0	33MM	639630

Speed Bleeder Bag

Environmentally friendly Speed Bleeder Bag catches your old brake fluid for a no-spill, no-mess operation. This EPA-approved, user-friendly item includes plastic tubing and a 7" x 7" plastic bag with handy plastic tube connection that holds approximately 12 ounces.



DESCRIPTION	ITEM
SPEED BLEEDER BAG	639500

Easy Installation

Position container to collect brake fluid. Remove your OEM bleeder screw and replace with the Speed Bleeder Screw.

- Makes Brake Bleeding A One Person Task
- Fits Virtually Any Hydraulic Brake or Clutch System
- Standard Dust Protection Cap
- Metric & Standard Sizes
- Replaces Stock Bleeder Screw
- Unique Double-Patent Design
- OEM Style Sealing Guarantees A Positive Leak-Proof Seal

Speed Bleeder Instructions



Step One: Open Russell Speed Bleeder screw 1/4 to 1/2 turn. Attach hose to Speed Bleeder bag or catch can to collect brake fluid.

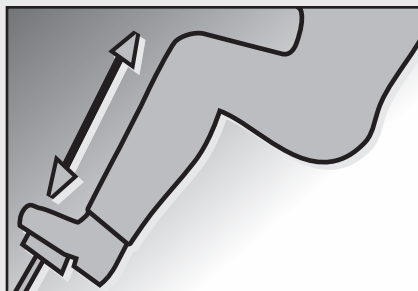

Step Two: Pump brakes until air is purged from wheel cylinder. No need to close the screw between pumps as with a stock brake bleeder screw.

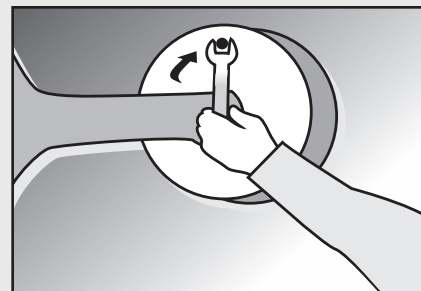

Step Three: Close valve. Repeat previous steps for other wheels, adding brake fluid to master cylinder as needed to maintain level.



DOMESTIC CARS

Buick

YEAR	MODEL	DISC		DRUM	
		FRONT	REAR	FRONT	REAR
73-78	REGAL	639590	-	-	639530
79-04	REGAL	639580	-	-	639520
94-96	ROADMASTER	639580	-	-	639630

Cadillac

YEAR	MODEL	DISC		DRUM	
		FRONT	REAR	FRONT	REAR
82-90	BROUGHAM	639580	-	-	639520
79-84	DEVILLE	639580	-	-	639520
02-07	ESCALADE	639560	639610	-	-
79-84	FLEETWOOD	639580	-	-	639520

Chevrolet

YEAR	MODEL	DISC		DRUM	
		FRONT	REAR	FRONT	REAR
90-97	APV	639580	-	-	639520
87-96	BERETTA	639580	-	-	639520
67-68	CAMARO	639530	-	639530	639530
69-76	CAMARO	639530	639530	639530	639530
77-81	CAMARO	639580	639590	-	639530
82-88	CAMARO	639580	639580	-	639520
89-92	CAMARO	639580	639560	-	639520
93-97	CAMARO (W/O TRACTION CONTROL)	639580	639560	-	639520
95-97	CAMARO (W/O TRACTION CONTROL)	639580	639580	-	-
98-02	CAMARO	639630	639630	-	-
2010	CAMARO	639560	639560	-	-
82-04	CAVALIER	639580	-	-	639520
82-90	CELEBRITY	639580	-	-	639520
65-72	CHEVELLE / MALIBU	639590	-	639530	639530
73-77	CHEVELLE / MALIBU	639590	-	-	639530
76-78	CHEVETTE	639520	-	-	639520
79-85	CHEVETTE	639580	-	-	639520
05-09	COBALT	639560	-	-	639520
87-96	CORSICA	639580	-	-	639520
56-65	CORVETTE (DRUM)	-	-	639590	639590
63-82	CORVETTE	639530	639530	-	-
84-04	CORVETTE	639630	639630	-	-
05-09	CORVETTE	639560	639560	-	-
69-76	IMPALA / CAPRICE	639590	-	-	639530
77-96	IMPALA / CAPRICE	639580	639630	-	639520
00-06	IMPALA	639580	639580	-	-
90-94	LUMINA	639580	639580	-	-
95-01	LUMINA	639580	639580	-	639520
78-83	MALIBU	639580	-	-	639520
70-77	MONTE CARLO	639590	-	-	639530
78-06	MONTE CARLO	639580	639580	-	639520
64-68	NOVA	-	-	639530	639530
69-79	NOVA	639590	-	639530	639530
85-88	NOVA	639570	-	-	639570

Chrysler

YEAR	MODEL	DISC		DRUM	
		FRONT	REAR	FRONT	REAR
83-84	E CLASS	639590	-	-	639530
65-93	FIFTH AVENUE	639590	-	-	639530
78-95	LASER	639590	-	-	639530
94-97	LEBARON	639590	-	-	639530
95-97	LHS	639590	639590	-	-
01-06	PT CRUISER	639630	639560	-	639560
05-08	300C	639630	639560	-	-
95-97	SEBRING	639560	639560	-	639560
89-91	MASERATI	639590	639590	-	-

Dodge

YEAR	MODEL	DISC		DRUM	
		FRONT	REAR	FRONT	REAR
78-90	24	639590	-	-	639530
83-88	600	639590	639530	-	-
68-69	CHALLENGER	639530	-	-	639530
70-72	CHALLENGER	639590	-	-	639530
73-83	CHALLENGER	639560	-	-	639570
66-69	CHARGER	639530	-	-	639530
70-77	CHARGER	639590	-	-	639530
78-90	CHARGER	639590	-	-	639530
71-84	COLT GTS	639560	-	-	639560
85-90	COLT GTS	639570	-	-	639560
91	COLT LC	639570	-	-	639570
91	COLT LA	639570	-	-	639560
92-97	COLT	639570	639570	-	639570
70-72	DART	639590	-	-	639530
84-94	DAYTONA	639590	639590	-	639530 639590
70	DEMON	639590	-	-	639530
77-89	DIPLOMAT	639590	-	-	639530
88-93	DYNASTY	639590	-	-	639530
93-04	INTREPID	639590	639590	-	639530
85-89	LANCER	639590	-	-	639530
78-79	MAGNUM XE	639590	-	-	639530
77-89	MIRADA	639590	-	-	639530
63-69	MONACO	639590	-	639530	639530
95-99	NEON	639590	639590	-	639530
00-05	NEON	639560	639560	-	639560
78-90	OMNI	639590	-	-	639530
63-69	POLARA	639590	-	639530	639530
63-69	ROYAL MONACO	639590	-	639530	639530
87-94	SHADOW	639590	-	-	639530
84-94	SHELBY Z	639590	639590	-	639530 639590
91-96	STEALTH	639630	639630	-	-
95-97	STRATUS	639590	639590	-	639530
70-84	ST. REGIS	639590	-	-	639530
90	ST. REGIS	639560	639560	-	639530
91-92	ST. REGIS	639590	639560	-	639590
65-69	SUPER BEE	639530	-	-	639530
69-76	SUPER BEE	639590	-	-	639530
70	SWINGER	639590	-	-	639530
84-94	TURBO Z	639590	-	-	639530
92-02	VIPER	639630	639630	-	-

Dodge Truck

YEAR	MODEL	DISC		DRUM	
		FRONT	REAR	FRONT	REAR
61-65	1/2-TON PICKUP	639590	-	639590	-
65-93	1/2-TON PICKUP	639590	-	-	639530
65-71	3/4-TON PICKUP	639590	-	-	639590
72	3/4-TON PICKUP	639590	-	-	639530
73-93	3/4-TON PICKUP	639590	-	-	639590
69-93	1-TON PICKUP	639590	-	-	639590
84-06	CARAVAN	639590	-	-	639530
79-94	D50 RAM PICKUP	639590	-	-	639570
86-97	DAKOTA	639590	-	-	639530
98-03	DURANGO	639590	-	-	639590
84-97	MINI RAM	639590	-	-	639530
94-01	RAM	639580	-	-	639520
02-05	RAM	639590	639590	-	-
06	RAM 1500	639560	639560	-	-
70-97	VAN 1/2-TON	639590	-	-	639530
71-97	VAN 3/4-TON	639590	-	-	639530
73-97	VAN 1-TON	639590	-	-	639590

*Available while supplies last

INTRODUCTION
HOSES
HOSE ENDS
ADAPTER FITTINGS
FUEL MANAGEMENT
ACCESSORIES
TOOLS
TRANSMISSION
POWER STEERING
BRAKE HOSES
NITROUS
DEALER
BULK
INSTALL
INDEX



Speed Bleeders

Eagle

YEAR	MODEL	DISC		DRUM	
		FRONT	REAR	FRONT	REAR
87-88	EAGLE	639590	-	-	639590
88-90	PREMIER	639560	639560	-	-
93-96	SUMMIT	639570	-	-	639560
90-94	TALON	639630	639560	-	-
93-94	VISION	639590	639590	-	639530

Ford

YEAR	MODEL	DISC		DRUM	
		FRONT	REAR	FRONT	REAR
94-97	ASPIRE	639550	-	-	639550
95-00	CONTOUR	639560	639560	-	639520
80-06	CROWN VICTORIA	639590	-	-	639590
81-90	ESCORT	639590	-	-	639590
91-92	ESCORT	639550	639550	-	639550
93-97	ESCORT	639550	-	-	639550
82-89	EXP	639590	-	-	639590
77-80	FIESTA	639630	-	-	639630
00-04	FOCUS	639620	-	-	639560
02-04	FOCUS SVT	639520	639570	-	-
65-69	GALAXIE	639590	-	-	639590
65-86	LTD	639590	-	-	639590
70-75	MAVERICK	639590	-	639540	639540
76-77	MAVERICK	639590	-	-	639590
65-67	MUSTANG	639540	-	639540	639540
68-70	MUSTANG	639600	-	639540	639540
71-73	MUSTANG	639600	-	639540	639590
74-93	MUSTANG	639590	639590	-	639540
94-98	MUSTANG	639590	639630	-	-
99-04	MUSTANG	639560	639630	-	-
05-10	MUSTANG (WITH ABS)	639560	639560	-	-
94-95	MUSTANG COBRA	639630	639630	-	-
96-98	MUSTANG COBRA	639560	639560	-	-
99-04	MUSTANG COBRA	639560	639630	-	-
71-80	PINTO	639590	-	-	639550
88-97	PROBE	639570	639570	-	639550
86-06	TAURUS	639630	639630	-	639630
84-97	TEMPO	639590	-	-	639590
65-88	THUNDERBIRD (EXCEPT TURBO)	639590	639590	639590	639590
87-88	THUNDERBIRD TURBO COUPE	639590	639560	-	-
89-91	THUNDERBIRD	639560	639560	-	639560
92-97	THUNDERBIRD	639590	639560	-	639560
02-05	THUNDERBIRD	639560	639560	-	-

Ford Truck

YEAR	MODEL	DISC		DRUM	
		FRONT	REAR	FRONT	REAR
86-89	AEROSTAR	639590	-	-	639530
93-96	AEROSTAR	639590	-	-	639590
67-79	BRONCO (FULL SIZE)	639590	-	639590	639590
80-96	BRONCO (FULL SIZE)	639510	-	-	639590
84-90	BRONCO II	639510	-	-	639590
77-82	COURIER	639570	-	-	-
64-79	ECONOLINE VAN 1/2-TON	639590	-	639590	639590
80-97	ECONOLINE VAN 1/2-TON	639510	-	-	639590
69-97	ECONOLINE VAN 3/4-TON	639590	-	-	639590
69-97	ECONOLINE VAN 1-TON	639590	-	-	639590
99-06	EXCURSION 4WD	639560	639560	-	-
91-97	EXPLORER	639590	-	-	639590
68-72	F-100 2WD	-	-	639590	639540
68-71	F-100 4WD	-	-	639590	639540
72	F-100 4WD	-	-	639530	639590

Ford Truck (continued)

YEAR	MODEL	DISC		DRUM	
		FRONT	REAR	FRONT	REAR
73-75	F-100 2WD/4WD	639590	-	639530	639540 639590
78-79	F-100	639590	-	-	639590
80-83	F-100 PU LT	639590	-	-	639540
84-96	F-150	639510	-	-	639590
97-03	F-150 2WD	639590	-	-	639590
04	F-150 4WD	639560	-	-	-
67-94	F-250	639510	-	-	639590
95-96	F-250	639590	-	-	639590
97-03	F-250 2WD (EXC. SUPER DUTY)	639590	-	-	639590
99-04	F-250 4WD SUPER DUTY	639560	639560	-	-
05-08	F-250 4WD SUPER DUTY	639590	639590	-	-
68-94	F-350	639510	-	-	639590
95-97	F-350	639590	-	-	639590
99-04	F-350 4WD SUPER DUTY	639560	639560	-	-
05-08	F-350 4WD SUPER DUTY	639590	639590	-	-
99-03	LIGHTNING	639590	639590	-	-
82-88	RANGER	639510	-	-	639540 639590
89-00	RANGER	639590	-	-	639540 639590
95-97	WINDSTAR	639560	639590	-	639590

Geo

YEAR	MODEL	DISC		DRUM	
		FRONT	REAR	FRONT	REAR
89-97	METRO	639560	-	-	639520
89-94	METRO TURBO	639560	-	-	639520
89-97	PRIZM	639570	639570	-	-
89-97	TRACKER	639560	-	-	639560

GM Truck

YEAR	MODEL	DISC		DRUM	
		FRONT	REAR	FRONT	REAR
85-98	ASTRO / SAFARI	639580	-	-	639520
71-72	BLAZER / JIMMY	639590	-	-	639590
73-78	BLAZER / JIMMY	639590	-	-	639530
79-91	BLAZER / JIMMY FULL-SIZE	639580	-	-	639520
92-94	BLAZER / YUKON FULL-SIZE	639580	-	-	639520
64-72	C-10 / 20 PICKUP	639590	-	-	639590
73-78	C-10 / 20 PICKUP	639590	-	-	639530
79-87	C-10 / 20 PICKUP	639580	-	-	639520
88-00	C1500 / 2500 PICKUP	639580	-	-	639520
99-06	C1500 PICKUP 2WD	639580	639560	-	-
04-06	COLORADO / CANYON 4WD	639580	-	-	639520
65-69	EL CAMINO	639530	-	-	639530
70-77	EL CAMINO	639590	-	-	639530
78-88	EL CAMINO	639580	-	-	639520
72-77	G-10 VAN	639590	-	-	639530
78-97	G-10 VAN	639580	-	-	639520
71-78	G-30 VAN	639590	-	-	639590
64-73	K-10 / 20 PICKUP	639590	-	-	639590
74-77	K-10 / 20 PICKUP	639590	-	-	639530
78-87	K-10 / 20 PICKUP	639580	-	-	639520
88-00	K1500 / 2500 / 3500 PU	639580	-	-	639520
82-99	S-SERIES PU / BLAZER	639580	-	-	639520
99-06	SILVERADO / SIERRA 1500	639580	639560	-	-
01-06	SILVERADO / SIERRA HD	639580	639560	-	-
73-78	SUBURBAN 2WD	639590	-	-	639530
79-99	SUBURBAN 2WD	639580	-	-	639520
73	SUBURBAN 4WD	639590	-	-	639590



GM Truck (continued)

YEAR	MODEL	DISC		DRUM	
		FRONT	REAR	FRONT	REAR
74-77	SUBURBAN 4WD	639590	-	-	639530
78-99	SUBURBAN 4WD	639580	-	-	639520
00-06	SUBURBAN 2 / 4WD	639580	639560	-	-
07-09	SUBURBAN 2 / 4WD	639580	639560	-	-
95-99	TAHOE / YUKON	639580	-	-	639520
00-06	TAHOE / YUKON	639580	639560	-	-
97-98	VENTURE	639580	-	-	639520

Hummer

YEAR	MODEL	DISC		DRUM	
		FRONT	REAR	FRONT	REAR
03-06	H2 (INCL. SUT)	639580	639580	-	-
06	H3	639560	639560	-	-

Jeep

YEAR	MODEL	DISC		DRUM	
		FRONT	REAR	FRONT	REAR
74-97	CHEROKEE 2WD / 4 WD	639590	639590	-	639530
84-97	GRAND CHEROKEE	639590	639590	-	639530
84-91	GRAND WAGONEER	639590	-	-	639530
65-73	J10 & J20 PICKUP	-	-	639590	639590
74-90	J10 & J20 PICKUP	639590	-	639590	639530
67-71	CJ (ALL)	-	-	639540	639540
72-86	CJ (ALL)	639590	-	639590	639590
81-86	CJ (ALL)	639590	-	-	639590
74-83	WAGONEER	639590	-	-	639530
87-95	WRANGLER YJ	639590	-	-	639530
97-06	WRANGLER TJ	639590	639590	-	639590
07-08	WRANGLER JK	639560	639560	-	-

Lincoln

YEAR	MODEL	DISC		DRUM	
		FRONT	REAR	FRONT	REAR
65-90	TOWN CAR	639590	639590	-	639590
91-94	TOWN CAR	639590	639560	-	-
95-97	TOWN CAR	639590	639590	-	-
65-90	LINCOLN	639590	639590	-	639590
65-87	CONTINENTAL	639590	639590	-	639590
88-99	CONTINENTAL	639560	639590	-	-
77-80	VARSAILLES	639590	639590	-	-
68-89	MARK III-VIII	639590	639590	-	639590
93-97	MARK III-VIII	639560	639590	-	-
90-92	MARK III-VIII	639590	639560	-	-

Mercury

YEAR	MODEL	DISC		DRUM	
		FRONT	REAR	FRONT	REAR
67-73	COUGAR	639590	-	639540	639540
74-88	COUGAR	639590	-	-	639590
89-91	COUGAR	639560	639560	-	639540
92-97	COUGAR	639590	639560	-	639560

Oldsmobile

YEAR	MODEL	DISC		DRUM	
		FRONT	REAR	FRONT	REAR
71-78	88	-	-	-	639530
79-85	88	639580	-	-	639520
65-69	98	639590	-	639590	639590
70	98	639590	-	639590	639530
79-84	98	639580	-	-	639520
79-90	CUSTOM CRUISER	639580	-	-	639520
68-77	CUTLASS	639590	-	-	639530
78-97	CUTLASS	639580	639580	-	639520
79-97	DELTA	639580	-	-	639520
98-02	INTRIGUE	639580	639580	-	-
90-04	SILHOUETTE	639580	-	-	639520

Plymouth

YEAR	MODEL	DISC		DRUM	
		FRONT	REAR	FRONT	REAR
67-68	BARRACUDA	-	-	639540	639530
69-74	BARRACUDA	639590	-	639530	639530
62-69	BELVEDERE	-	-	639530	639530
70-75	BELVEDERE	639590	-	639530	639530
96-97	BREEZE	639590	639590	-	639530
83-88	COLT / COLT TURBO	639560	-	-	639560
89-91	COLT	639570	-	-	639570
92-94	COLT	639570	639570	-	639570
69-76	DUSTER	639590	-	639530	639530
78-90	HORIZON	639590	-	-	639530
68-69	ROAD RUNNER	639530	-	639530	639530
70-75	ROAD RUNNER	639590	-	-	639530
69-76	SCAMP	639590	-	639530	639530
82-83	SCAMP	639590	-	-	639530
65-68	VALIANT	639590	-	639530	639530
69-76	VALIANT	639590	-	-	639530

Pontiac

YEAR	MODEL	DISC		DRUM	
		FRONT	REAR	FRONT	REAR
82-91	6000	639580	-	-	639520
69-78	BONNEVILLE	639590	-	-	639530
79-05	BONNEVILLE	639580	639580	-	639520
69-78	CATALINA	639580	-	-	639530
79-81	CATALINA	639580	-	-	639520
84-88	FIERO	639580	639580	-	-
67-68	FIREBIRD	639530	-	639530	639530
69-76	FIREBIRD/TRANSAM	639530	639530	639530	639530
77-81	FIREBIRD/TRANSAM	639580	639590	-	639530
82-88	FIREBIRD/TRANSAM	639580	639580	-	639520
89-92	FIREBIRD/TRANSAM	639580	639560	-	639520
93-97	FIREBIRD / TRANSAM (WITHOUT TRACTION CONTROL)	639580	639560	-	639520
95-97	FIREBIRD / TRANSAM (WITH TRACTION CONTROL)	639580	639580	-	-
98-02	FIREBIRD / TRANSAM	639630	639630	-	-
85-97	GRAND AM	639580	-	-	639520
69-77	GRAND PRIX	639590	-	-	639530
78-03	GRAND PRIX	639580	639580	-	639520
64-68	GTO	-	-	639530	639530
69-77	GTO	639590	-	639530	639530
04-06	GTO	639560	639560	-	-
08-09	GTO & G8	639560	639560	-	-
64-68	LEMANS	-	-	639530	639530
69-77	LEMANS	639590	-	-	639530
78-81	LEMANS	639580	-	-	639520
64-68	TEMPEST	-	-	639530	639530
69-77	TEMPEST	639590	-	639530	639530
78-81	TEMPEST	639580	-	-	639520
78-79	PHOENIX	639590	-	639530	639520
80-84	PHOENIX	639580	-	-	639520
69-78	SAFARI WAGON	639590	-	-	639530
79-89	SAFARI WAGON	639580	-	-	639520
76-80	SUNBIRD	639590	-	-	639590
82-94	SUNBIRD	639580	-	-	639520
95-04	SUNFIRE	639580	-	-	639520
90-00	TRANSPORT	639580	-	-	639520

Saturn

YEAR	MODEL	DISC		DRUM	
		FRONT	REAR	FRONT	REAR
91-01	ALL	639560	639560	-	639570



Speed Bleeders

IMPORT CARS

Acura

YEAR	MODEL	DISC		DRUM	
		FRONT	REAR	FRONT	REAR
99-06	CL	639560	639610	-	-
90-93	INTEGRA	639610	639610	-	-
94-97	INTEGRA	639610	639520	-	-
98-01	INTEGRA (EXC. TYPE R)	639610	639610	-	-
98-01	INTEGRA TYPE R	639610	639520	-	-
90-95	LEGEND (ALL)	639610	639610	-	-
91-00	NSX	639520	639620	-	-
02-06	RSX	639610	639610	-	-
96-97	SLX	639570	639570	-	-
03-06	TSX	639610	639610	-	-
99-06	TL	639560	639610	-	-

BMW

YEAR	MODEL	DISC		DRUM	
		FRONT	REAR	FRONT	REAR
75-98	ALL	639570	639570	-	-

Fiat

YEAR	MODEL	DISC		DRUM	
		FRONT	REAR	FRONT	REAR
-	ALL MODELS	639520	639520	-	639520

Honda

YEAR	MODEL	DISC		DRUM	
		FRONT	REAR	FRONT	REAR
76-85	ACCORD	639560	-	-	639520
88-89	ACCORD (DX)	639560	-	-	-
88-89	ACCORD (LXI)	639610	-	-	-
90-92	ACCORD 2DR	639610	-	-	639610
90-97	ACCORD 4DR & WAGON	639560	639610	-	639520
93-97	ACCORD 2DR	639560	639610	-	639520
98-02	ACCORD	639560	639610	-	-
76-91	CIVIC (EXCEPT 4WD WAGON)	639560	-	-	-
88-91	CIVIC WAGON 4WD	639610	-	-	-
92-93	CIVIC DX/LX 3DR / 4DR	639560	639610	-	-
92-93	CIVIC EX 4DR	639610	639610	-	-
93-95	CIVIC 2DR	639610	639610	-	-
94-95	CIVIC 3DR / 4DR	639610	639610	-	-
96-00	CIVIC	639560	639610	-	-
99-02	CIVIC SI	639560	639610	-	-
01-05	CIVIC (EXCEPT SI)	639560	-	-	639520
03-09	CIVIC SI	639610	639610	-	-
97-01	CRV	639610	-	-	-
88-91	CRX (INCLUDING SI)	639560	-	-	-
93-96	DEL SOL S & SI (WITHOUT ABS)	639560	639610	-	-
94-96	DEL SOL VTEC & SI (WITH ABS)	639610	639610	-	-
94-05	NXS	639620	639620	-	-
94-97	PASSPORT	639570	639570	-	-
79-82	PRELUDE	639560	-	-	639520
83-91	PRELUDE	639610	639610	-	639520
92-01	PRELUDE	639520	639620	-	-
00-06	S2000	639610	639610	-	-

Infiniti

YEAR	MODEL	DISC		DRUM	
		FRONT	REAR	FRONT	REAR
03-06	G35 (WITH STANDARD BRAKES)	639560	639570	-	-
03-06	G35 (WITH BREMBO BRAKES)	639630	639630	-	-
93-97	J30	639560	639560	-	-
90-92	M30 COUPE	639560	639560	-	-
90-97	Q45	639560	639560	-	-

Isuzu

YEAR	MODEL	DISC		DRUM	
		FRONT	REAR	FRONT	REAR
89-96	AMIGO	639570	639570	-	-
81-83	PICKUP	639570	-	-	639560
84-85	PICKUP	639570	-	-	639570
91-97	RODEO	639570	639570	-	-
86-97	TROOPER II	639570	639570	-	-

Lexus

YEAR	MODEL	DISC		DRUM	
		FRONT	REAR	FRONT	REAR
01-05	IS300	639570	639570	-	-

Mazda

YEAR	MODEL	DISC		DRUM	
		FRONT	REAR	FRONT	REAR
86-89	323	639570	-	-	-
90-94	323	639550	639570	-	639570
83-02	626 (MX6)	639570	639570	-	639570
88-91	929	639550	639570	-	-
92-97	929	639570	639570	-	-
95-96	B2300 PICKUP	639590	-	-	639540
95-96	B4000	639590	-	-	639540
95-96	B3000	639590	-	-	639540
90-02	MIATA (MX5)	639550	639570	-	-
95-02	MILLENNIA (MX8)	639570	639570	-	-
92-96	MPV	639550	-	-	639550
92-96	MX3	639550	639570	-	-
77-96	PICKUP 2, 4WD	639570	-	-	639570
90-01	PROTÉGÉ	639550	639570	-	639550
02-03	PROTÉGÉ MAZDASPEED	639570	639570	-	-
78-91	RX7 (EXC. HD SUSP. & TURBO)	639570	639570	-	639570
86-88	RX7 (WITH HD SUSPENSION)	639550	639570	-	-
89-91	RX7 TURBO	639550	639570	-	-
92-95	RX7	639550	639570	-	-
04-06	RX8	639550	639560	-	-

Mercur

YEAR	MODEL	DISC		DRUM	
		FRONT	REAR	FRONT	REAR
88-90	SCORPIO	639560	639560	-	-
85-89	XR4TI	639560	-	-	-

Mitsubishi

YEAR	MODEL	DISC		DRUM	
		FRONT	REAR	FRONT	REAR
1/91 - 5/93	3000GT VR4	639560	639570	-	-
91-93	3000GT 2WD	639630	639630	-	-
92-97	DIAMANTE	639560	639560	-	-
89-94	ECLIPSE	639630	639630	-	-
95-05	ECLIPSE	639570	639570	-	-
89-03	GALANT	639560	639560	-	-
84-96	MONTERO / MONTERO SPORT	639560	639570	-	-
87-97	PICKUP/VAN	639560	-	-	639560

Nissan / Datsun

YEAR	MODEL	DISC		DRUM	
		FRONT	REAR	FRONT	REAR
80-98	200SX	639560	639560	-	639560
89-98	240SX	639560	639560	-	-
69-78	240/260/280Z	639560	-	-	639570
79-83	280ZX	639630	639630	-	-
84-89	300ZX	639630	639630	-	-
90-96	300ZX	639560	639560	-	-



Speed Bleeders

INTRODUCTION
HOSES
HOSE ENDS
ADAPTER FITTINGS
FUEL MANAGEMENT
ACCESSORIES
TOOLS
TRANSMISSION
POWER STEERING
BRAKE HOSES
NITROUS
DEALER
BULK
INSTALL
INDEX

Nissan / Datsun (continued)

YEAR	MODEL	DISC		DRUM	
		FRONT	REAR	FRONT	REAR
03-05	350Z (WITH STANDARD BRAKES)	639560	639570	-	-
03-06	350Z (WITH BREMBO BRAKES)	639630	639630	-	-
93-06	ALTIMA	639560	639560	-	639570
84-06	MAXIMA	639560	639560	-	639570
83-06	SENTRA	639560	639560	-	639570
87-92	STANZA	639560	639560	-	-

Nissan / Datsun Trucks

YEAR	MODEL	DISC		DRUM	
		FRONT	REAR	FRONT	REAR
98-04	FRONTIER	639560	-	-	639570
86-97	PATHFINDER	639560	639560	-	-
77-96	PICKUP	639560	-	-	-
93-97	QUEST	639590	-	-	-
04-06	TITAN 4WD	639630	639630	-	-
00-04	XTERRA	639560	-	-	639570

Porsche

YEAR	MODEL	DISC		DRUM	
		FRONT	REAR	FRONT	REAR
69- EARLY 75	911	639570	639570	-	-
LATE 75-89	911	639520	639520	-	-
89-94	911 CARRERA 2,4	639630	639630	-	-
91-94	911 TURBO	639630	639630	-	-
70-76	914-4	639570	639570	-	-
76-82	924	639570	639570	-	-
82-1/86	928	639570	639570	-	-
2/86-94	928	639630	639570	-	-
89	944, 944S	639560	639570	-	-
86-91	944 TURBO, S2	639560	639560	-	-

SAAB

YEAR	MODEL	DISC		DRUM	
		FRONT	REAR	FRONT	REAR
68-80	99	639630	639630	-	-
79-87	900	639630	639630	-	-
88-97	900	639520	639570	-	-
86-89	9000	639630	639630	-	-
90-97	9000	639570	639570	-	-

Scion

YEAR	MODEL	DISC		DRUM	
		FRONT	REAR	FRONT	REAR
05-09	TC	639570	639570	-	-

Subaru

YEAR	MODEL	DISC		DRUM	
		FRONT	REAR	FRONT	REAR
93-01	IMPREZA	639560	639560	-	639560
02-05	IMPREZA (EXCEPT WRX)	639560	639570	-	-
02-05	IMPREZA WRX	639570	639570	-	-
87-88	JUSTY	639570	-	-	-
89-94	JUSTY	639560	-	-	639560
90-96	LEGACY (INCLUDING OUTBACK)	639560	639560	-	-
97-04	LEGACY (INCLUDING OUTBACK)	639570	639560	-	-
92-97	SVX	639560	639560	-	-

Suzuki

YEAR	MODEL	DISC		DRUM	
		FRONT	REAR	FRONT	REAR
86-95	SAMURAI	639560	-	-	-
89-01	SWIFT	639560	639560	-	-
89-96	SIDEKICK	639560	-	-	-

Toyota

YEAR	MODEL	DISC		DRUM	
		FRONT	REAR	FRONT	REAR
97-04	AVALON	639570	639570	-	-
83-06	CAMRY	639570	639570	-	-
71-81	CELICA	639630	639630	-	639570
82-05	CELICA (NON TURBO)	639570	639570	-	639570
93-96	CELICA (TURBO)	639560	639560	-	-
79-06	COROLLA	639570	639570	-	639570
84-94	MR2	639570	639570	-	-
92-95	PASEO	639570	-	-	639570
70-81	SUPRA	639560	639560	-	639570
82-98	SUPRA	639570	639570	-	639570

Toyota Trucks

YEAR	MODEL	DISC		DRUM	
		FRONT	REAR	FRONT	REAR
84-94	4RUNNER	639560	-	-	639570
95-03	4RUNNER	639560	-	-	639560
70	LANDCRUISER	-	-	639610	639610
74-97	LANDCRUISER	639560	639560	-	639560
2008	LANDCRUISER	639560	639560	-	-
83-95	PICKUP (2WD)	639570	-	-	639560
83-88	PICKUP (4WD)	639560	-	-	639560 639570
89-95	PICKUP (4WD)	639560	-	-	639560
91-97	PREVIA	639560	639560	-	-
93-96	T100 (2WD)	639570	-	-	639560
93-98	T100 (4WD)	639560	-	-	639560
93-97	T100 (1 TON)	639560	-	-	639560
95-04	TACOMA (2WD EXC. PRERUNNER)	639570	-	-	-
98-04	TACOMA 2WD PRERUNNER	639560	-	-	-
95-04	TACOMA (4WD)	639560	-	-	-
00-06	TUNDRA	639560	-	-	-

Volkswagen

YEAR	MODEL	DISC		DRUM	
		FRONT	REAR	FRONT	REAR
72-79	BEETLE	639570	-	-	639570
98-06	BEETLE (NEW)	639560	639560	-	-
85-96	CABRIOLET	639570	-	-	639570
89-95	CORRADO	639570	-	-	639570
85-95	GOLF	639570	639570	-	639570
96-99	GOLF VR6	639560	639560	-	-
85-95	GTI	639570	639570	-	-
81-84	JETTA	639570	-	-	639570
85-95	JETTA	639570	639570	-	639570
96-99	JETTA VR6	639560	639560	-	-
90-97	PASSAT	639570	639570	-	-
95-96	PASSAT VR6	639560	639560	-	-
75-84	RABBIT	639570	-	-	639570
75-84	SCIROCCO	639570	-	-	639570
85-90	SCIROCCO	639570	639570	-	639570
73-89	VAN	639570	-	-	-
92-95	VAN	639560	-	-	-

Aftermarket

YEAR	MODEL	DISC		DRUM	
		FRONT	REAR	FRONT	REAR
ALL	BAER ALCON SYSTEM (2 PER CALIPER)	639560	-	-	-
ALL	BAER PBR SYSTEM (1 PER CALIPER)	639590	-	-	-
ALL	OUTLAW RACING CALIPERS	639540	639540	-	-
ALL	STOPTECH ST-40 CALIPERS	639560	639560	-	-
ALL	WILWOOD CALIPERS	639540	639540	-	-



Pre-Made Nitrous & Fuel Hoses

Russell nitrous hose assemblies are manufactured at the Russell facility and assembled by dedicated Russell professionals. All nitrous hose assemblies are constructed using Russell PowerFlex stainless steel braided hose. The Russell hose ends feature precision crimp installation using a hydraulic crimping method that provides the ultimate leak free connection. Use blue hose ends for nitrous, and red for fuel lines.



INLET	OUTLET	HOSE	RED	BLUE
-3 AN	-3 AN	8-1/2"	658010	658000
-3 AN	1/8" NPT	8-1/2"	658030	658020
-3 AN	-3 AN	10"	658780	658770
-3 AN	-3 AN	12"	658070	658040
-3 AN	1/8" NPT	12"	658060	658050
-3 AN	-3 AN	15"	658090	658080
-3 AN	-3 AN	18"	658110	658100
-3 AN	-3 AN	2"	658150	658120
-3 AN	1/8" NPT	2"	658140	658130
-3 AN	-3 AN	3"	658170	658160
-3 AN	-3 AN	4"	-	658180
-3 AN 90° TO STRAIGHT		4"	658190	-
-4 AN	-4 AN	8-1/2"	658210	658200
-4 AN	-4 AN	1"	658230	658220
-4 AN 90° TO STRAIGHT		15"	658240	-
-4 AN	-4 AN	18"	658260	658250
-4 AN	-4 AN	2"	-	658270
-4 AN	1/8" NPT	2"	658290	658280
-4 AN	-4 AN	2"	658300	-
-4 AN	-4 AN	3"	658320	658310
-4 AN	-4 AN	4"	-	658330
-4 AN	-4 AN	6"	-	658340
-4 AN	-4 AN	8"	-	658350

INLET	OUTLET	HOSE	RED	BLUE
-4 AN	-4 AN	10"	-	658360
-4 AN	-4 AN	12"	-	658370
-4 AN	-4 AN	14"	-	658380
-4 AN	-4 AN	16"	-	658390
-4 AN	-4 AN	18"	-	658400
-4 AN	-4 AN	20"	-	658410
-4 AN	-3 AN	1"	658430	658420
-4 AN	-3 AN	18"	658450	658440
-4 AN	-6 AN	1"	-	658460
-4 AN	-6 AN	18"	658480	658470
-6 AN	-6 AN	1"	658500	658490
-6 AN	-6 AN	2"	658520	658510
-6 AN	-6 AN	4"	-	658530
-6 AN	-6 AN	6"	-	658540
-6 AN	-6 AN	8"	-	658550
-6 AN	-6 AN	10"	-	658560
-6 AN	-6 AN	12"	-	658570
-6 AN	-6 AN	14"	-	658580
-6 AN	-6 AN	16"	-	658590
-6 AN	-6 AN	20"	-	658600
-4 AN	-3 AN	15"	658800	658790
-4 AN	-3 AN	8"	658820	658810





9-inch Contingency Decals

Printed on adhesive backed white vinyl for durability, these 9" Russell contingency decals are the ideal size for race cars. Great for trailer and point of purchase use too.

DESCRIPTION	ITEM
RUSSELL DECAL	601900
RUSSELL PERFORMANCE PLUMBING DECAL	601903
RUSSELL PROCLASSIC DECAL	601904

Dealer Decal

The red, yellow and black decal lets your customers know that you sell Russell products.

DESCRIPTION	ITEM
DEALER DECAL (6-1/4" X 9-3/4")	601902

Race Track Decal Sheet

Raise your customers' awareness of the Russell name by handing out this Russell decal sheet at events. Each sheet contains 7 die cut logos: one 4-1/2" decal, two 2" decals and four 1-1/2" decals. Red, yellow and black printed on white vinyl.

DESCRIPTION	ITEM
RACE TRACK DECAL SHEET	601910

Reorder Cards

Let's you know when it's time to reorder stock for your Plan-O-Grams. Measures 2 1/4" x 2 1/4". Qty: 100.

DESCRIPTION	ITEM
RUSSELL REORDER CARDS	600299

Russell Banner

Brilliant Russell logo printed on reinforced all weather vinyl with brass grommets. Recognizable from over a half mile away, these banners let people know you carry the Russell brand of fittings, hose ends, brake lines and more. Great for promotional displays and events.

DESCRIPTION	ITEM
RUSSELL BANNER (99" X 28")	600290
RUSSELL BANNER (24" X 62")	600291





Buy In Bulk and Save!

Are you an installer or builder that is constantly buying individual plumbing components for each build? Then our bulk product offerings on the following pages are ideal for you. We offer our top selling applications and highly requested components in bulk to help you save money and to ensure that you will always have the product you need on hand to complete the install. All the fittings and hose ends are sold in packs of 25 and our ProFlex and PowerFlex hose is available in 300' and 500' rolls.



ProFlex Hose

AN SIZE	ACTUAL INSIDE DIAMETER	NOMINAL INSIDE DIAMETER	OUTSIDE DIAMETER	PSI	LENGTH	
					300 FEET	500 FEET
-6	11/32"	3/8"	9/16"	1000	-	630380
-8	7/16"	1/2"	5/8"	1000	630390	-

Crimp On Swivel Hose Ends

Bulk Packaged of 25

AN SIZE	STRAIGHT	45° RADIUS	90° RADIUS
-4	610408	610418	610428
-6	610468	610478	610488
-8	610528	610538	610548
-10	610588	610598	610608
-12	610648	610658	610668



Full Flow Hose Ends

Bulk Packaged of 25

AN SIZE	STRAIGHT		45° RADIUS		90° RADIUS		180° RADIUS
	RED / BLUE	BLACK	RED / BLUE	BLACK	RED / BLUE	BLACK	BLACK
-4	610018	-	-	-	610158	-	-
-6	610028	610027	610098	613097	610168	613167	613507
-8	610038	610037	610108	613107	610178	613177	613517
-10	610048	610047	610118	-	610188	-	-



Twist-Lok Hose Ends

Packaged of 25

AN SIZE	STRAIGHT	45° RADIUS	90° RADIUS
-4	624007	-	624157
-6	624017	624087	624167
-10	624037	624107	-



Allen Socket Pipe Plugs

Packaged of 25

SIZE	BLUE	BLACK
1/8"	662038	-
1/4"	662048	-
3/8"	662058	662057
1/2"	662068	662067



SAE Quick-Disconnect Fittings

STYLE	AN MALE	SAE FEMALE	BLUE	BLACK
PUSH-ON	-6	3/8"	640858	640857
THREADED CAP	-6	5/16"	644118	644117
THREADED CAP	-6	3/8"	644128	644127





Tube Coupling Nut

Bulk Packaged of 25

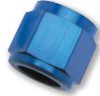

AN SIZE	BLUE	ENDURA
-3	660558	660559
-6	660578	-
-8	660588	-

Flare Cap

Bulk Packaged of 25



AN SIZE	BLUE	BLACK
-6	661968	-
-8	661978	661977

Tube Sleeve

Bulk Packaged of 25

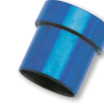

AN SIZE	BLUE	ENDURA
-3	660638	660639
-6	660658	-
-8	660668	-

Flare Union

Bulk Packaged of 25



AN SIZE	ITEM
-6	660358
-8	660368

Male Pipe Nipple

Bulk Packaged of 25



AN SIZE	NPT SIZE	ITEM
-3	1/8"	661509

O-Ring Boss Radius AN Port Adapter

Packaged of 25



PORT SIZE	AN SIZE	ITEM
-8	-6	670648

Flare to Pipe

Bulk Packaged of 25



AN SIZE	NPT SIZE	BLUE	STRAIGHT ENDURA	BLACK	45° RADIUS BLACK	BLUE	90° RADIUS ENDURA	BLACK	TEE ENDURA
-3	1/8"	660418	660419	-	-	660798	660799	-	661069
-4	1/8"	660428	660439	660427	-	660808	-	-	-
-6	1/8"	660458	-	-	-	-	-	-	-
-6	1/4"	660448	-	660447	-	660828	-	660827	-
-6	3/8"	660468	-	660467	-	660848	-	660847	-
-8	3/8"	660488	-	-	-	660868	-	660867	-
-8	1/2"	660498	-	-	-	660878	-	-	-
-10	1/2"	660508	-	660507	660977	-	-	-	-
-10	3/8"	670038	-	-	-	-	-	-	-

PowerFlex Hose Ends

Endura Finish. Bulk Packaged of 25



AN SIZE	STRAIGHT	90° RADIUS
-6	620409	620429
-10	620509	620529

Power Steering Adapters

Bulk Packaged of 25



AN SIZE	THREAD	INVERTED FLARE	O-RING SEAL
-6	1/2" - 20	640339	648019
-6	5/8" - 18	640389	648039
-6	11/16" - 18	648058	648049
-6	14MM x 1.5	-	648078
-6	16MM x 1.5	-	648069
-6	18MM x 1.5	-	648089
-6	9/16" - 18	-	648029



Hose Installation Tips

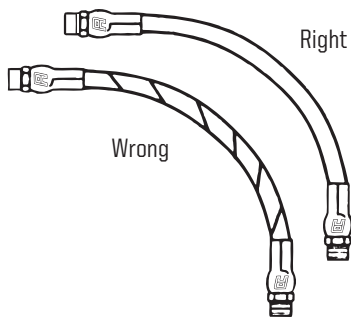

Avoid installing the hose in a twisted position.

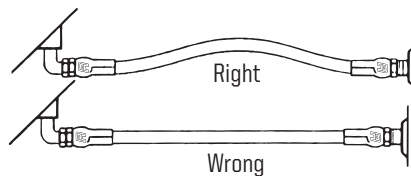

Allow slack in your hose assembly for changes in length that occur under pressure.

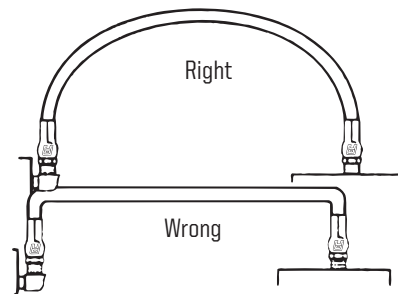

When routing the hose assembly, provide a smooth bend radius. Avoid sharp bends, which will collapse the hose I.D. and could restrict flow.

How To Assemble ProFlex & ProRace Hose with Full Flow Hose Ends



Step One: Wrap hose tightly with race or electrical tape at the point determined for cut. Clamp the hose loosely in a vise close to the tape. Use a hacksaw with two blades opposing one another or abrasive cut-off wheel. Remove the tape when you are finished cutting.



Step Two: Unscrew the red socket of the hose end from the nipple. Hold the socket in a vise using soft jaws and insert the hose into the socket by turning it counterclockwise. The hose will stop at the bottom step of the socket.



Step Three: Position the nipple assembly of the hose end in the vise using soft jaws. Apply assembly lube to the threads of the socket as well as to the nipple assembly.



Step Four: Start the socket over the nipple by hand and tighten as far as possible by hand. Using an AN wrench, tighten until it reaches the nipple hex or when there is no more than 1/16" gap between the nipple/socket assembly. Be sure to wash & pressure test the assembly before using.

How To Assemble ProClassic Hose with ProClassic Crimp Hose Ends



Step One: Cut hose to length, as straight and square as possible, with razor blade-type hose cutter or shears.



Step Two: Install the ProClassic Crimp Collar onto hose.



Step Three: Apply Russell Assembly Lube (or oil) onto barb assembly. Start barb assembly into hose; grasp hose behind collar & push hose onto barb assembly until it has fully bottomed out at collar's edge.



Step Four: Check collar/barb assembly to insure there is no gap (as shown by the arrow). If collar moves freely between hose and end fitting repeat step three.



Step Five: Make sure your die number is correct for hose you are crimping. Lift handle to top position opening dies. Place end assemble in dies. Align edge of the collar (at hose) with back face of dies, using over center action push down on handle until assembly releases from crimper. Inspect assembly, be sure to wash & pressure test prior to use.



Step Six: Completed hose assembly.

How To Assemble ProClassic Hose with Full Flow Hose Ends



Step One: Cut hose to length, as straight and square as possible, with razor blade-type hose cutter or shears.



Step Two: Unscrew socket from hose end. Push hose into socket, turning counter-clockwise, until hose is seated against step in socket. Make sure rubber part of hose does not protrude into socket threads.



Step Three: Apply Russell Assembly Lube to threads on nipple assembly and in socket. Insert nipple into socket/hose and start threads by hand (clockwise).



Step Four: Hold socket/hose in vise. Turn nipple with wrench until there is less than 1/16" between nipple hex and socket. Repeat Steps 1-3 for other end of hose. Then, flush hose assembly with solvent or soapy water and blow clean with compressed air or let air dry.

How To Assemble PowerFlex Hose & Hose Ends

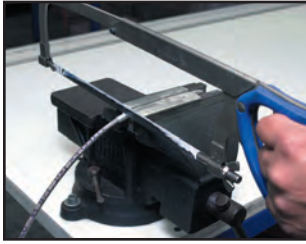

Step One: Wrap the hose tightly with electrical or racers tape. Hold the hose firmly in a vise without crushing and cut through the tape. Make sure you make a straight cut. Remove the tape slowly and deburr the PTFE edges. Install the socket on the hose and slide it back out of the way.



Step Two: Insert the nipple portion of the PowerFlex hose end in a vise. Slip the hose over the nipple using a twisting motion to size the inside diameter of the Teflon. Separate the wire braid from the outside diameter of the PTFE tube with a small screwdriver. Be careful not to crush the Teflon.



Step Three: Push the olive sleeve around the PTFE and between the braid. This can be done by pushing the olive sleeve against the side of your workbench or vise. Be sure the PTFE liner is square to the bottom of the olive. With the nipple in the vise, lube the threads and the nipple portion of the hose end sparingly. Insert the hose over the nipple making sure the olive does not pop off the PTFE tube.



Step Four: Start the socket onto the nipple by hand. Tighten with a wrench until the gap between the nipple and the socket is no more than 1/16". Clean the hose assembly and pressure test before using.

Hose Assembly Tool

SIZE	ITEM
-3 6-4	651970
-6 6-8	651971



How To Assemble Twist-Lok Hose & Hose Ends



Step One: Cut hose to length using a hand knife or shears.



Step Two: Liberally oil inside of hose & barbed end of hose end. Insert barbed end into hose using a twisting action. Put the swivel end at center hex in a vise. Use a twisting motion make bottom of hex even with hose edge, rubber insulator will cover end of hose.



Step Three: Completed hose assembly.



INTRODUCTION
 HOSES
 HOSE ENDS
 ADAPTER FITTINGS
 FUEL MANAGEMENT
 ACCESSORIES
 TOOLS
 TRANSMISSION
 POWER STEERING
 BRAKE HOSES
 NITROUS
 DEALER
 BULK
 INSTALL
 INDEX

1727.....32	610353-61040313	624010-62401312	632115.....6
1728-172936	610408.....65	624017.....65	632120.....7
1778-178932	610413.....13	624020-62403312	632123-6321256
1790.....35	610418.....65	624037.....65	632130-6321407
1791-179231	610423.....13	624070-62408312	632143-6321456
1794.....35	610428.....65	624087.....65	632150.....7
1795.....31	610463.....13	624090-62410312	632153-6321556
3594.....35	610468.....65	624107.....65	632160.....7
3605-360733	610473.....13	624150-62415312	632163-6321656
8102-810329	610478.....65	624157.....65	632170.....7
8114-812114	610483.....13	624160-62416312	632173-6321756
8122-812529	610488.....65	624167.....65	632180-6321907
8126.....28	610493-61052313	624170-62608012	632193-6321956
8127.....29	610528.....65	629050-62915041	632200.....7
8128-813428	610533.....13	630250.....7	632203-6322056
8159-818814	610538.....65	630253-6302556	632210.....7
8189-819032	610543.....13	630260.....7	632213-6322156
8191.....14	610548.....65	630263-6302656	632220.....7
8192-819332	610553-61058313	630270.....7	632223-6322256
8199.....14	610588.....65	630273-6302756	632230-6322407
17301-1731231	610593.....13	630280.....7	632243-6322456
17400-1740136	610598.....65	630283-6302856	632250.....7
17923.....32	610603.....13	630290.....7	632253-6322556
17930-3594335	610608.....65	630293-6302956	632260.....7
36031-3605233	610613-61064313	630300.....7	632263-6322656
49273.....37	610648.....65	630303-6303056	632270.....7
76503.....43	610653.....13	630310.....7	632273-6322756
81233-8124329	610658.....65	630313-6303156	632280-6322907
81263-8134328	610663.....13	630320.....7	632293-6322956
174021-17404336	610668.....65	630323-6303256	632300-6323307
174051-17410332	610673-61096013	630330.....7	632490-63258054
174113.....36	611200-61128311	630333-6303356	632600-63277046
174121-17413332	612000-61247310	630340.....7	633930-63396054
178010.....36	613167-61317765	630343-6303456	634100-6344137
178040.....32	613220-6135059	630350.....7	634500-63452045
178050-18208335	613507.....65	630353-6303556	639200-63949040
600290-60191064	613510-6135159	630380.....65	639500-63963057
610010-6100159	613517.....65	630383-6303856	640000-64007020
610018.....65	613520-6135359	630390.....65	640090-64011018
610020-6100259	613640-61367010	630393-6303956	640140-64019020
610027-61002865	614006-61481021	632000.....7	640200-64022323
610030-6100359	615023-61554410	632003-6320056	640230-64024322
610037-61003865	620131.....54	632010.....7	640250.....20
610040-6100459	620135.....42	632013-6320156	640270-64027322
610047-61004865	620141.....54	632020.....7	640281.....56
610050-6100959	620145.....42	632023-6320256	640291-64032155
610098.....65	620155-62016540	632030-6320407	640330-64033122
610100-6101059	620190-62027314	632043-6320456	640339.....66
610108.....65	620401-62040546	632050.....7	640340-64035022
610110-6101159	620409.....66	632053-6320556	640360-64037323
610118.....65	620411-62042146	632060.....7	640380-64038122
610120-6101559	620429.....66	632063-6320656	640389.....66
610158.....65	620431-62046154	632070.....7	640390-640400 22, 46
610160-6101659	620471-62050546	632073-6320756	640410.....46
610168.....65	620509.....66	632080-6320907	640411-64046154
610170-6101759	620511-62052146	632093-6320956	640471-64050355
610178.....65	620529.....66	632100.....7	640510.....54
610180-6101859	622190-62327014	632103-6321056	640511-64051355
610188.....65	624000-62400312	632110.....7	640520-64053045
610190-6102109	624007.....65	632113.....6	640541.....55



Index

640543.....36	648058.....66	660560-66056319	670060-67008326
640550-64057120	648060.....46	660570-660575 19, 40	670100.....18
640581-64059155	648069.....66	660578.....66	670150-67015315
640600-64063022	648070.....46	660580-660585 19, 40	670220-67023012
640641.....54	648078.....66	660588.....66	670240-67028018
640650-64068055	648080.....46	660590-66063119	670290-67029326
640690.....24	648089.....66	660638-66063966	670300-67033012
640700.....26	648980-64926537	660640-66064319	670340-67036326
640720.....38	650100-65020338	660650-660651 19, 40	670370-67046018
640730.....24	650310-65045039	660653.....19	670461.....15
640740.....19	650603-65061338	660655.....40	670470.....26
640750-64077323	650970-65101041	660658.....66	670480-67061018
640790.....26	651030-65108142	660660-660661 19, 40	670640.....20
640800-64081323	651104-65112134	660663.....19	670648.....66
640820-64083322	651206-65121241	660665.....40	670650-67073020
640850-64085324	651312-6513166	660668.....66	670740-67079018
640857-64085865	651470-65148045	660670-66068019	670840.....20
640860-64086324	651660-65167038	660770-66079115	670850-67088018
640870-64092325	651900-65196044	660792.....55	670930-67094020
640930-64094024	651970-651971 44, 68	660798-66079966	671570-67158044
640950-64096026	652000-652009 43, 13	660800-66080315	672310-67250051
640990.....41	654000-65404056	660808.....66	683700-68372018
641001.....56	654250-65426341	660810-66082315	683880-68392042
641020-64105329	654300-654333 6, 41	660827-66082866	683940-68394356
641090-64110130	654400-654410 11, 44	660830-66083315	683980-68399041
641110-64112034	654420-65444043	660847-66084866	684470-68449050
641140-64128130	655010-65739053	660850-66086315	684500.....49
641291-64129355	658000-65882063	660867-66086866	684510.....50
641300-64130324	659000-65905053	660870-66087315	684550-68460049
641311-64133155	659950-66004317	660878.....66	684610-68463050
641350-64136130	660060-66010315	660880-66093115	684690.....49
641370-64138056	660120-66015016	660932.....55	684710-68472050
641390-64140045	660170-66035319	660940-66097315	684730.....49
641411-64148154	660358.....66	660977.....66	684740.....50
641490.....56	660360-66036319	660980-66098315	684800-68486049
641510-64152327	660368.....66	660990-66106116	684890-68820050
641530-64157334	660370-66039019	661069.....66	688480.....52
641580-64159327	660402.....55	661070-66140016	689700.....50
641600-64160534	660410-66041115	661440-66150117	692000-69219047
642441-64396355	660412.....55	661509.....66	692200.....48
644003-64402024	660418-66041966	661510-66184017	692210-69237049
644033.....36	660420-66042315	661870-66193016	692380.....47
644043-64411324	660427-66042866	661950-66196318	693000-69321048
644117-64411865	660430-66043315	661968.....66	693220-69323052
644120-64412324	660439.....66	661970-66197318	693250-69329048
644127-64412865	660440-66044315	661977-66197866	693310.....52
644130.....24	660447-66044866	661980-66203318	693350-69338048
644143-64416325	660450-66045315	662038.....65	693390.....52
645060-64515038	660458.....66	662040-66204318	693400-69433048
645210-64524041	660460-66046315	662048.....65	694500-69487052
645500-64556042	660467-66046866	662050-66205318	695560-69578051
648010.....46	660470-66048315	662057-66205865	695900-69651052
648019.....66	660488.....66	662060-66206318	697000-69705014
648020.....46	660490-66049315	662067-66206865	697070-69710019
648029.....66	660498.....66	662070-66207118	
648030.....46	660500-66050315	662380-66284315	
648039.....66	660507-66050866	663000-67000026	
648040.....46	660510-66054315	670001-67001326	
648049.....66	660550-66055119	670030-67003315	
648050.....46	660558-66055966	670038.....66	

INTRODUCTION
HOSES
HOSE ENDS
ADAPTER FITTINGS
FUEL MANAGEMENT
ACCESSORIES
TOOLS
TRANSMISSION
POWER STEERING
BRAKE HOSES
NITROUS
DEALER
BULK
INSTALL
INDEX