

RUPPRIGGER® SERIES

RUPP

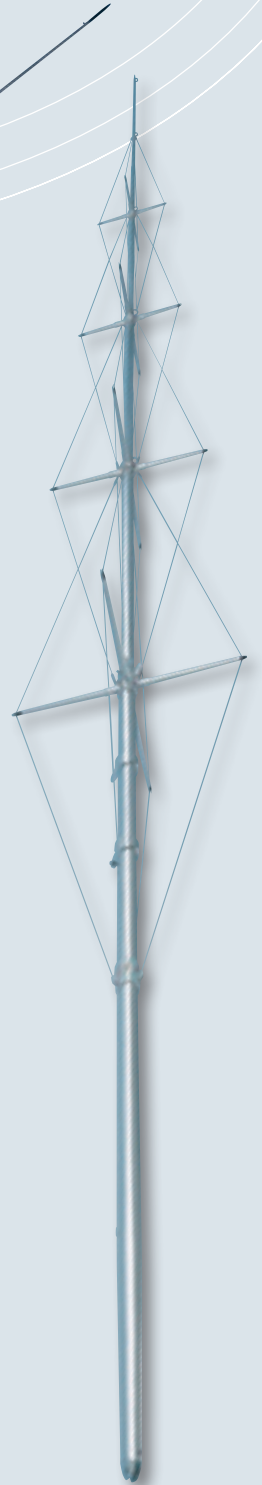

SERIOUS SPORTFISHING HARDWARE SINCE 1980



RUPP POWER RIGGERS™



With the push of a button, your Tournament or Big Rigg outriggers can be hydraulically actuated by adding a Rupp Power Rigger Package. Available in 110V AC and 24V DC.



Hydraulic Locking Mechanism
(Patent Number: 7,654,214)



Anodized Aluminum Cylinders



Stainless Steel Attachment Hardware

RUPP BIGG RIGGS™

This innovative product combines precision engineered design features with Rupp's highest quality materials to create a longer, stronger outrigger for today's larger, faster sportfishers. Big Riggs are the outrigger of choice for many custom and semi-custom manufacturers of sportfishing boats over 50 feet.

O.R. LENGTH	# SPREADERS	MODEL #
39'-41'	THREE	A3-0012-BR
42'-44'	THREE	A3-0014-BR
45'-47'	FOUR	A4-0012-BR
48'-50'	FOUR	A4-0014-BR



Rupp Big Riggs are the lightest and strongest (per foot) aluminum outrigger available on the market.

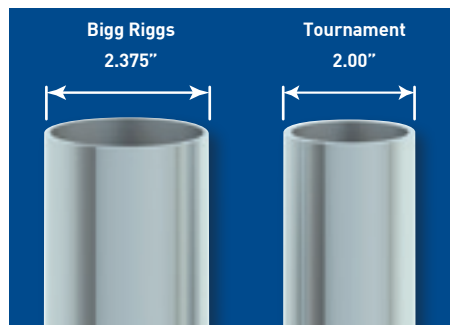

Big Riggs are made of larger diameter tubing for the latest Rupp riggers.

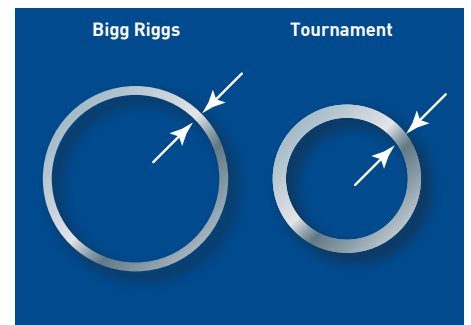

A thinner wall keeps the weight down, without sacrificing strength.

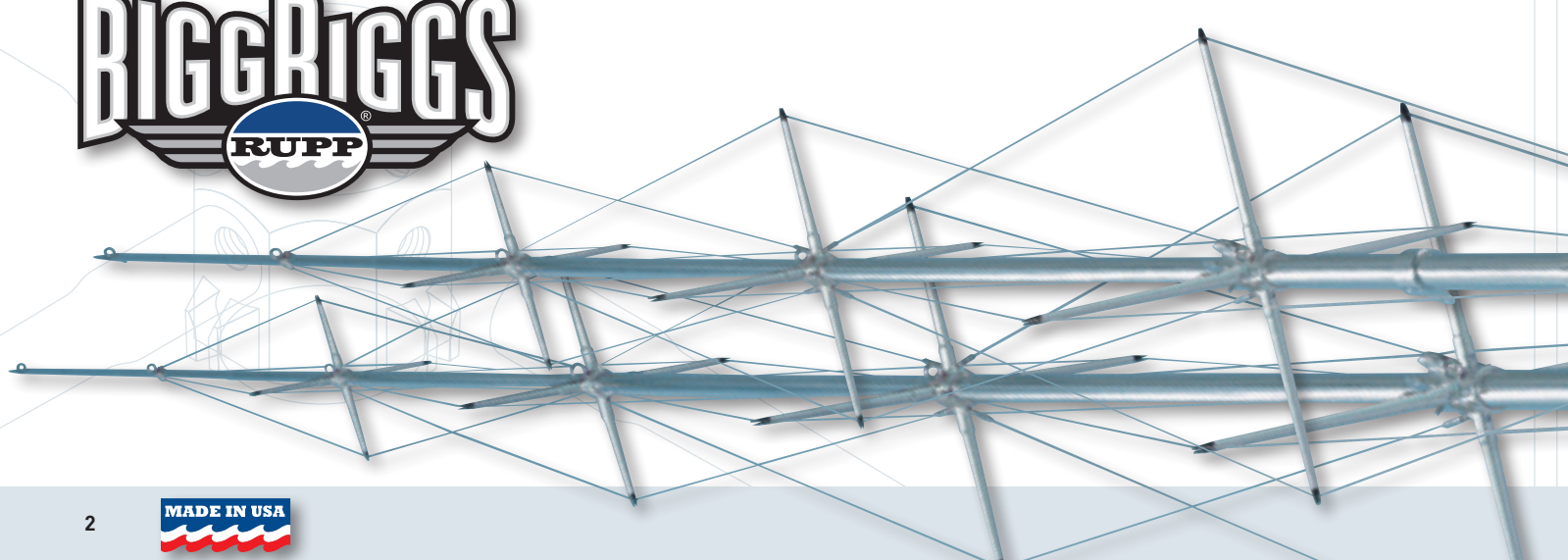

STANDARD POWER RIGGER PACKAGE

Includes two hydraulic cylinders (one port/one starboard) for laying out your outrigger. This package also includes Rupp's patented hydraulic locking mechanism allowing for push button release of outriggers for fishing and automatic locking upon return to the stowed position.

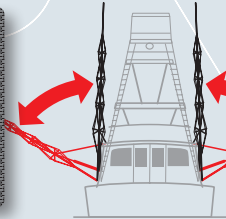

DELUXE POWER RIGGER PACKAGE

Four hydraulic cylinders (two port/two starboard). Two for laying out your outriggers for fishing, while additional two lay down your outriggers for bridges or other obstacles. This package also includes Rupp's patented hydraulic locking mechanism allowing for push button release of outriggers for fishing and automatic locking upon return to the stowed position.

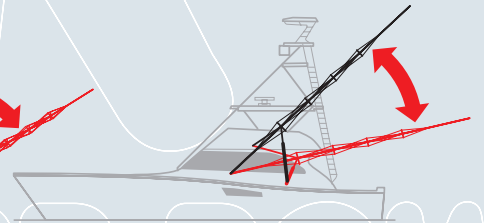
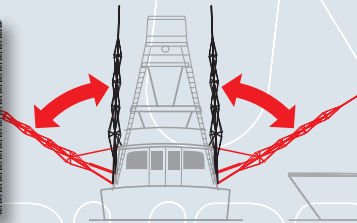
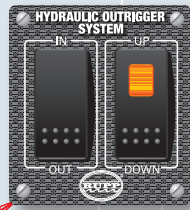

SYSTEM TYPE	POWER	MODEL #
STANDARD	24V DC	AO-HYDR-STD
DELUXE	24V DC	AO-HYDR-DLX
STANDARD	110V AC	AC-HYDR-STD
DELUXE	110V AC	AC-HYDR-DLX

Outriggers sold separately.

RUPPRIGGER H.D. OPTIONS

Unmatched durability for the hardcore fishing machine. By specifying one of these Heavy Duty packages you get all three optional components added to any Bigg Rigg outrigger order. The packages includes larger diameter layout arms, and Rupp's new larger diameter upper tip section. You can also upgrade your existing Bigg Riggs or Tournament RuppRiggers to HD by ordering components individually.

PACKAGES	MODEL #
HD PACKAGE/KNUCKLE-TIP	CA-0152-HDBB
HD PACKAGE/COLLAPSIBLE BACK BAR	CA-0152-HDCB

COMPONENTS	O.D.	TYPE	MODEL #
COLLAPSIBLE BACK BAR	1.75"/1.50"	BIGG RIGG H.D.	A0-BR00-CBB
HEAVY BACK BAR	1.75"	BIGG RIGG H.D.	CA-0065-BR
HEAVY LAYOUT ARM	1.375"	BIGG RIGG H.D.	A0-BR00-KN
HEAVY TIP SECTION	1.50"/1.10"	BIGG RIGG H.D.	CA-0151

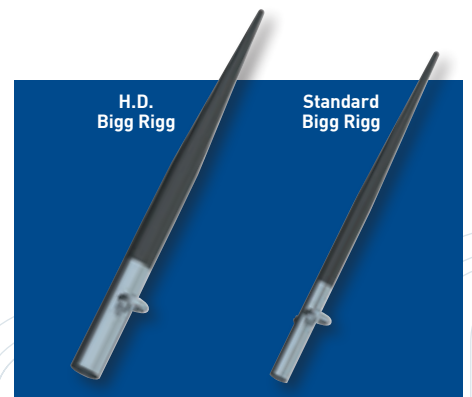

The larger H.D. Bigg Rigg tip section includes all new components above the upper spreader including a redesigned tip point.

TOURNAMENT RUPPRIGGERS™

Rupp Marine's flagship product, Tournament Ruppriggers, have been the industry standard for over 35 years. Engineered for consistent high performance, they combine patented designs with meticulous craftsmanship and top-grade materials to become the outrigger of choice for those who demand the very best. Cold-drawn from aircraft quality aluminum for maximum strength and minimum weight, Tournament Ruppriggers are built to last. Every piece is highly polished and protected by the toughest anodizing. Exclusive user-friendly designs provide effortless, one-man operation. You'll find them a fitting addition to the finest boats — from luxurious pleasure yachts to state-of-the-art sportfishing machines.

O.R. LENGTH	# SPREADERS	MODEL #
28' - 30'	ONE	A1-0010-SPL
28' - 30'	TWO	A2-0010-SPL
30' - 32'	ONE	A1-0010-STD
30' - 32'	TWO	A2-0010-STD
31' - 32'	ONE	A1-0012-SPL
31' - 32'	TWO	A2-0012-SPL
33' - 34'	ONE	A1-0012-STD
33' - 34'	TWO	A2-0012-STD
35' - 36'	THREE	A3-0010-SPL
37' - 38'	THREE	A3-0012-SPL
38' - 39'	THREE	A3-0010-STD
40' - 41'	THREE	A3-0012-STD

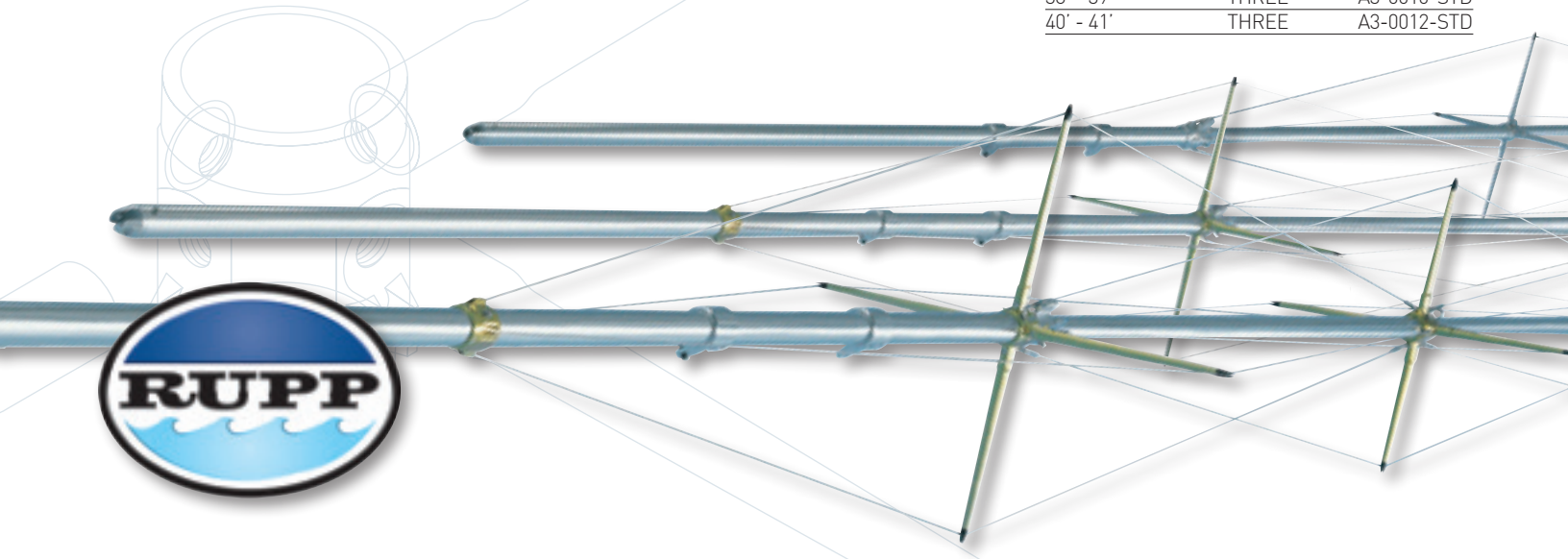

STANDARD LIFT-OUT BASES & POLES



STANDARD LIFT-OUT BASES

These bridge operated outriggers offer the versatility of lift-out poles, plus the same overall look of Rupp's Tournament Ruppriggers with a slightly smaller diameter. All aluminum, two piece construction allows poles to be removed for easy cleaning, storage and re-rigging. Bases are 5' or 8' long; available poles are 15', 18' or 20', with or without spreaders. Collapsible back bars are optional, see page 6.

- 5' STANDARD LIFT-OUT BASE A0-0005-MIN
- 8' STANDARD LIFT-OUT BASE A0-0008-MIN



TOWER MOUNT

Make any Rupp Tournament or Standard Lift-Out Base a Tower Mount with the addition of our Clamp-On Fittings. See chart below for proper sizing of clamps.

PIPE SIZE	I.D OF CLAMP	MODEL #
0.75"	1.050"	11-1178-23
1.00"	1.315"	11-1130-23
1.25"	1.660"	11-1131-23
1.50"	1.90"	11-1132-23
2.00"	2.40"	11-1449-23
1.00" TUBE	1.00"	11-1171-23

STANDARD LIFT-OUT POLES

The best combination of performance and style. Advanced patented designs and state-of-the-art components offer the ultimate in strength and durability. Made of cold-drawn aluminum, stepped and tapered for good looks and solid performance. Available with silver or gold spreaders and collars. Standard lift-out poles have a base diameter of 1.50" and are designed to work with Rupp Standard Lift-Out Bases.

POLE LENGTH	# SPREADERS	MODEL #
15'	BARE	A0-1500-MIN
15'	ONE	A1-1500-MIN
18'	BARE	A0-1800-MIN
18'	ONE	A1-1800-MIN
20'	BARE	A0-2000-MIN
20'	ONE	A1-2000-MIN



TOURNAMENT LIFT-OUT BASES & POLES

RUPPRIGGER H.D. OPTIONS

HEAVY DUTY UPGRADES	O.D.	MODEL #
COLLAPSIBLE BACK BAR	1.75"/1.50"	A0-BR00-CBB
TOURN. HEAVY BACK BAR	1.375"	CA-0065
BIGG RIGG HEAVY BACK BAR	1.75"	CA-0065-BR
HEAVY LAYOUT ARM	1.375"	A0-BR00-KN
HEAVY TIP SECTION	1.50"/1.10"	CA-0151

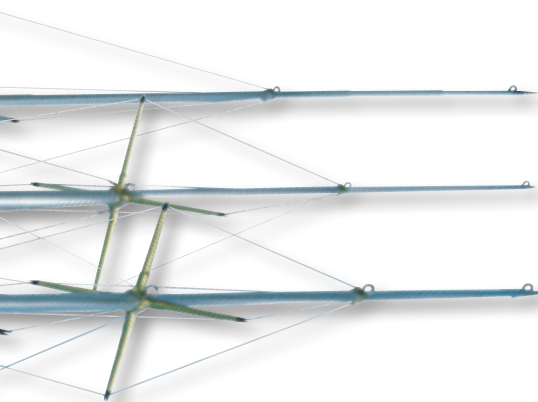

Shown with gold accent hardware.

TOURNAMENT LIFT-OUT BASES

These bridge operated outriggers offer the versatility of lift-out poles, plus the same overall look and diameter as Tournament Rupprippers. All aluminum, two-piece construction allows poles to be removed for easy cleaning, storage and re-rigging. Tournament Lift-Out Bases include collapsible back bars and 2.00" diameter base tubes. Base tube length is 8 feet; available poles are 21' single spreader or 26' double spreader. (For overall length, add 8' to pole size) Designed to accept 1.75" diameter outrigger poles.

MODEL # A0-0008-TLO



TOURNAMENT LIFT-OUT POLES

The best combination of performance and style. Advanced patented designs and state-of-the-art components offer the ultimate in strength and durability. Made of cold-drawn aluminum, stepped and tapered for good looks and solid performance. All the features of Tournament Rupprippers with the convenience of two-piece lift-out design. Pole base diameters are 1.75". Designed to work with Rupp Tournament Lift-Out Bases.

POLE LENGTH	# SPREADERS	MODEL #
21'	BARE	A0-2100-TLO
21'	ONE	A1-2100-TLO
26'	TWO	A2-2600-TLO



CENTER RIGGERS

Add that extra pole with these great center riggers from Rupp. Traditional high quality makes these mounts great additions to the finest line of outriggers in the world. I.D. of 1.50". The fixed mount (below left) is a top quality welded assembly highly polished to look great on any boat. Set at 21°. The adjustable mount (below right) allows the center rigger pole to be set at any angle that matches the lines of your outriggers or tower. Center rigger poles (left) are made of high strength, cold-drawn aluminum with silver or gold accent hardware. O.D. of poles 1.50".

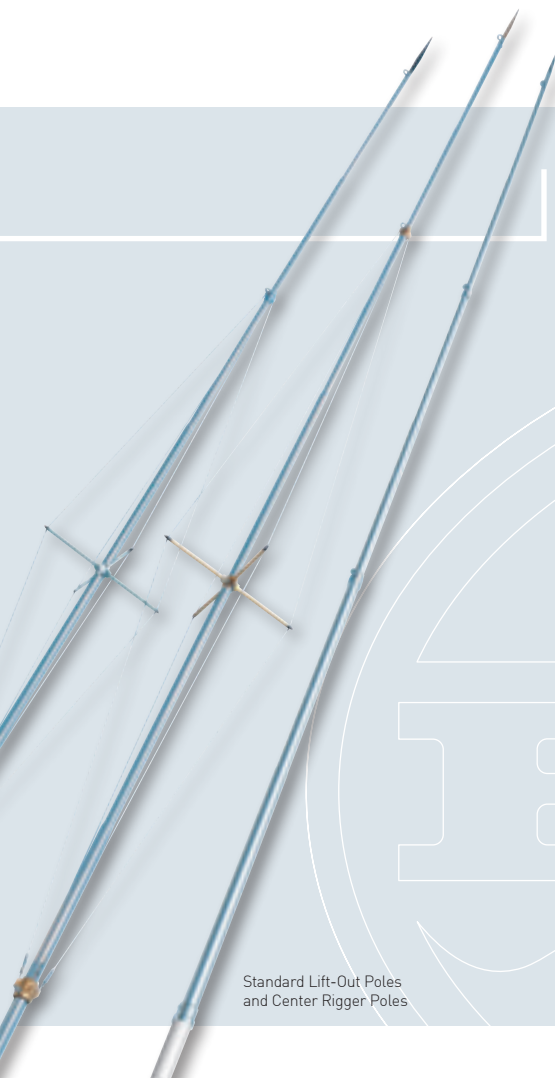

Standard Lift-Out Poles and Center Rigger Poles

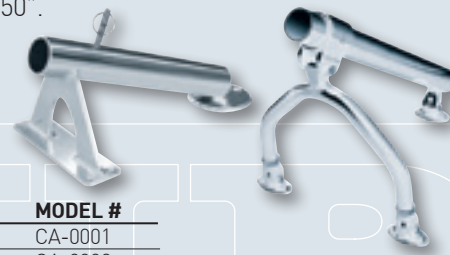

CENTER RIGGER MOUNTS

TYPE	MODEL #
ADJUSTABLE	CA-0001
FIXED	CA-0002

CENTER RIGGER POLES

POLE LENGTH	MATERIAL	# SPREADERS	MODEL #
15'	ALUMINUM	BARE	A0-1500-CRP
15'	CARBON FIBER	BARE	A0-1500-CRC
18'	CARBON FIBER	BARE	A0-1800-CRC
18'	ALUMINUM	ONE	A1-1800-CRP
20'	ALUMINUM	ONE	A1-2000-CRP

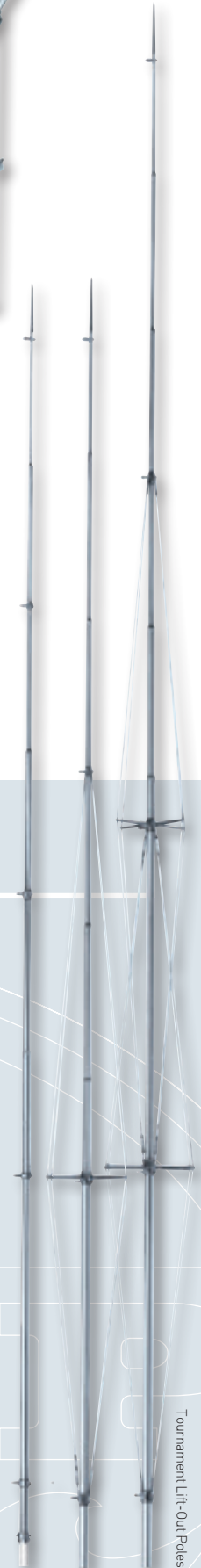

Tournament Lift-Out Poles

RUPPRIGGER OPTIONS

AUTO-LOK™ HOLD-IN ARMS

Auto-Lok Hold-In Arms are a custom and convenient addition to your outrigger system. Rupp Auto-Loks have become an industry standard, with a unique clamp-on collar providing a positive hands free lock-up. Your choice of fittings allow attachment to towers, railings and hardtops.

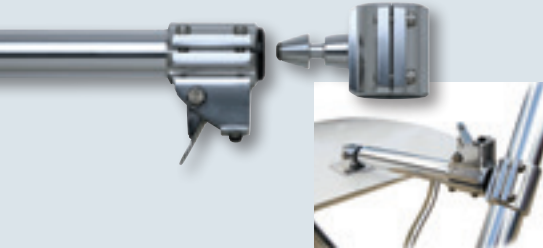

MOUNT TYPE	MODEL #
WELD-ON	CA-0129
BOLT-ON	CA-0129-WF
HARD-TOP	CA-0043

EXTRA HOLD-IN ARMS

Keep your riggers locked in place when lowered. Ideal for those ordering collapsible back bars. Sold as shown, complete with pads.

MODEL # CA-0037



COLLAPSIBLE BACK BAR

Easily lower your riggers to clear bridges and other obstacles. Rupp's innovative latch releases smoothly and returns to lock firmly in place. Collapsible back bars make re-rigging, cleaning and waxing your outriggers a snap! Available for Tournament and Bigg Rigg outriggers.

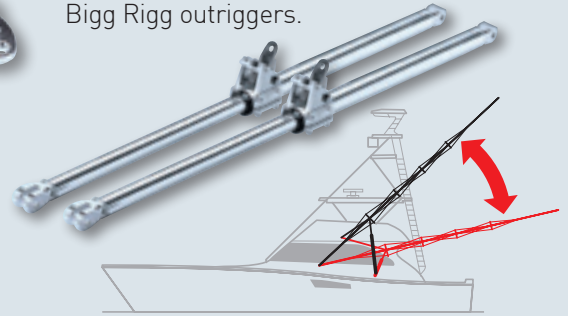

DESCRIPTION	MODEL #
TOURN. COLLAPSIBLE BACK BAR	A0-0000-CBB
BIGG RIGG COLLAPSIBLE BACK BAR	A0-BRXX-CBB

ACCESSORIES

PIPE MOUNT-TOGGLE BASE

Ideal for attaching a variety of outrigger and antenna fixtures to a rounded surface such as aluminum pipe, tubing or your hardtop edge. The product provides installers with additional options for mounting various Rupp hardware. (Shown with optional toggle PN 03-1013-23.)

MODEL # 03-1550-23

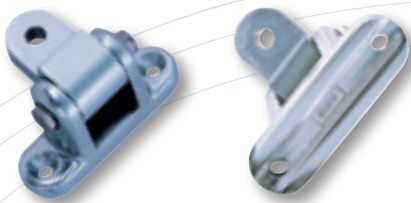

CLAMP-ON FITTINGS

Anodized aircraft grade aluminum collar that easily adapts outriggers to towers, tops and arches. Available in various sizes to fit standard pipe and tube diameters



PIPE SIZE	I.D OF CLAMP	MODEL #
0.75"	1.050"	11-1178-23
1.00"	1.315"	11-1130-23
1.25"	1.660"	11-1131-23
1.50"	1.90"	11-1132-23
2.00"	2.40"	11-1449-23
1.00" TUBE	1.00"	11-1171-23

CAMERA CLAMPS

Mount cameras to your outriggers or other aluminum structure with these anodized aluminum collars. Available in various sizes to fit standard pipe and tube diameters. Designs are available to fit GoPro® and other marine grade cameras.



HALYARD LINE TENSIONER - THRU GUNWALE

Stainless steel fairlead tube, mounting bracket and cleat all incorporated into an assembly designed to allow for easy installation in the gunwale. Fairlead tubes available in lengths of 2.875" or 3.875".

SIZE	MODEL #
3.875"	MI-0011-LG
2.875"	MI-0011-ST



SPACER BLOCKS

Ideal for spacing riggers away from cabin sides and to give more clearance around hardtops and tower structure. Available in the four sizes listed below.



SIZE	MODEL #
1" SPACERS	03-1278-23
1-1/2" SPACERS	03-1279-23
2" SPACERS	03-1280-23
2-1/2" SPACERS	03-1281-23

PULL ROPES

Set and retrieve your riggers with these first class pull ropes. Rupp pull ropes feature heavy duty stainless steel hooks and braided nylon rope. Sold individually.

MODEL # CA-0029



OUTRIGGER BACKING PLATE

Anodized aluminum backing plates for Rupp rigger oval bases. With a polished finish, these are ideal for applications where backing hardware is visible.

MODEL # 03-1057-23



ALL PURPOSE CLAMPS

Rupp's popular Clamp-on Fittings are available in a basic two-piece design, ready to be used for your special applications. Made of extruded aircraft alloy with a polished and anodized finish. These fittings are ideal to fabricate custom pieces for your towers and tops. Available in all popular sizes.

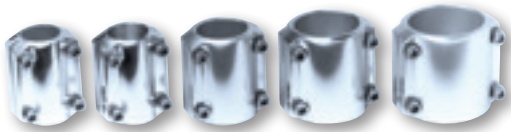

PIPE SIZE	I.D OF CLAMP	MODEL #
0.75"	1.050"	11-1447-23
1.00" TUBE	1.00"	11-1442-23
1.00"	1.315"	11-1443-23
1.25"	1.660"	11-1444-23
1.50"	1.90"	11-1445-23

BUSHING KIT

Replace lost and worn out sleeves and bushings. Kit contains enough Delrin pieces for a pair of Rupp outriggers.



DESCRIPTION	MODEL#
DELRIN BUSHINGS ONLY	CA-0032
BUSHINGS, NUTS & BOLTS	CA-0033

SPREADER TIP ASSEMBLY

Replacement spreader tips for Rupp outriggers. Black Delrin spreader tips complete with O-rings.

MODEL # 03-1033-AS

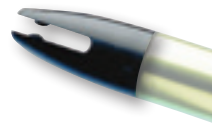

REPLACEMENT PARTS

Contact Rupp Marine for complete assortment of replacement parts. Reference serial number tag on outrigger base when ordering.

SUPER LUBE®

A patented, multi-purpose synthetic lubricant, containing SYNCOLON® (PTFE) particles held in suspension. Super Lube lasts longer and outperforms conventional petroleum-based greases and oils. Available as a 3 oz. tube in grease form.

MODEL # MI-0009



CONTROL KNOBS

Elegance at your fingertips with these beautiful knobs for Morse controls. Anodized aluminum available in two colors adds that special touch of class to any boat. Specify gold or silver when ordering.

MODEL # 03-1226-23



ACCESSORIES & RIGGING



RELEASE CLIPS

The ultimate high-performance outrigger release clips. Precision designs provide fisherman with outstanding trolling capabilities. Choose from Rupp's exclusive Nok-Outs®, Klickers® and Zip Clips®.



TYPE	QUANTITY	MODEL #
KLICKERS	PAIR	CA-0105
ZIP CLIPS	PAIR	CA-0106
NOK-OUTS*	PAIR	CA-0023

* Patent # 4,611,423

RIGGING KITS

Complete rigging package for both outriggers. Available in single, double and triple models. Kit includes Rupp pulley shock cords, mounting hardware, halyard lines and your choice of Rupp Release Clips.

RELEASE CLIPS	LINE TYPE	SINGLE MODEL #	DOUBLE MODEL #	TRIPLE MODEL #
KIT W/ZIP CLIPS	WHITE NYLON	CA-0109	CA-0107	CA-0158
KIT W/KLICKERS	WHITE NYLON	CA-0110	CA-0108	CA-0159
KIT W/NOK-OUTS	WHITE NYLON	CA-0025	CA-0026	CA-0160
KIT W/ZIP CLIPS	BLACK MONO	CA-0109-MO	CA-0107-MO	CA-0158-MO
KIT W/KLICKERS	BLACK MONO	CA-0110-MO	CA-0108-MO	CA-0159-MO
KIT W/NOK-OUTS	BLACK MONO	CA-0025-MO	CA-0026-MO	CA-0160-MO

LOK-UPSTM

Firmly locks your outrigger halyard lines in place while trolling. Includes a spring loaded trigger for positive locking and unlocking. Adaptable to various rigging setups and halyard line material. Includes replaceable, serviceable locking components available with military grade bungee cord.

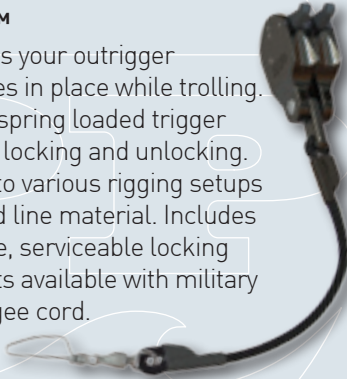

TYPE	MODEL #
SINGLE	CA-0157-1X
SINGLE W/BUNGEE	CA-0157-1
DOUBLE	CA-0157-2X
DOUBLE W/BUNGEE	CA-0157-2
TRIPLE	CA-0157-3X
TRIPLE W/BUNGEE	CA-0157-3
QUAD	CA-0157-4X
QUAD W/BUNGEE	CA-0157-4

Patent Pending

SHOCK CORD ASSEMBLIES

The ultimate rigging component. Durable 1/4" shock cord secures a stainless steel snap swivel with or without pulleys.

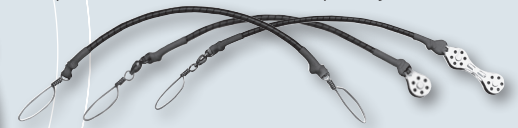

TYPE	MODEL #
SINGLE PULLEY SHOCK CORD	CA-0118
DOUBLE PULLEY SHOCK CORD	CA-0119
MULTI-PURPOSE SHOCK CORD	CA-0120

PULLEYS & PULLEY CLUSTERS

Original pulleys are high strength, polished stainless steel with Delrin® rollers, available as single or double pulleys for single or double rigging options. Rupp pulley clusters, eliminate eye-bolt and halyard line chafing by adding a roller pulley in place of each outrigger eye-bolt.

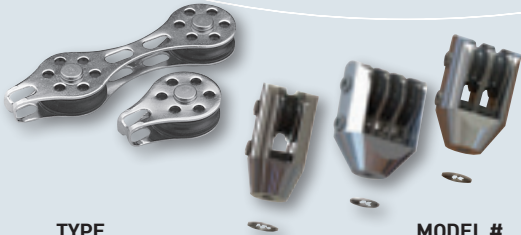

TYPE	MODEL #
SINGLE PULLEY	CA-0027
DOUBLE PULLEY	CA-0028
SINGLE PULLEY CLUSTER	CA-0144
DOUBLE PULLEY CLUSTER	CA-0145
TRIPLE PULLEY CLUSTER	CA-0146

TEASER CLAMPS

Clamp collar with stainless steel eye-bolt. Ideal for locating your teaser line almost anywhere on the outrigger. Available in five diameters, call Rupp if you don't see the size you need. Sold individually.



ALUMA GUARD®

Forms a protective coating on surfaces, prevents penetration of harmful substances and restores a lasting shine. Guards against pitting and corrosion caused by the harsh effects of marine use. Sold in 16 oz. bottle.

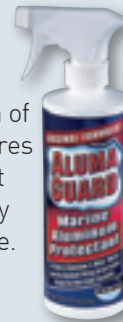

MODEL # CA-0087

TUBE O.D.	APPLICATION	MODEL #
1.625"	TR-ABOVE SPREADER 2	CA-0086-TS
1.75"	TR-ABOVE SPREADER 1	CA-0086-T
1.75"	BR-ABOVE SPREADER 2	CA-0086-T
2.00"	TR-BELOW SPREADER 1	03-1154-23T
2.175"	BR-ABOVE SPREADER 1	03-1528-23T
2.375"	BR-BELOW SPREADER 1	03-1531-23T

TR: TOURNAMENT OUTRIGGER
BR: BIGG RIGGS OUTRIGGER

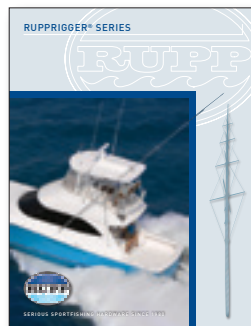

Rupp Marine provides the best in maintenance and winterization equipment.