

REMUS

Custom Exhaust



HARLEY-DAVIDSON® / BUELL

CUSTOM EXHAUST SLIP-ON (OPTIMIZED)

with changeable end caps (with EC homologation)



Geometry:

Cylindrical

Diameter:

Ø 84 mm

Sleeve length :

420 mm

Sleeve material:

Stainless steel

Surface treatment:

Chrome plated or black coated

Weight:

2,65 kg

Choose between 6
different end caps



EK80 / EK10 - SLASH CUT



EK81 / EK11 - STRAIGHT END



EK82 / EK12 - TAPERED

- Improved sound by third octave analysis
- Deeper sound at low frequencies
- Catalytic converter place in inlet unit
- Inlet unit equipped with heat shield
- Available for:
Harley-Davidson® Sportster, Dyna & Softail



CUSTOM EXHAUST

with changeable end caps (with EC homologation)



Geometry: _____

Cylindrical

Diameter: _____

Ø 84 mm

Sleeve length _____ :

~ 405 mm

Sleeve material: _____

Stainless steel

Surface treatment: _____

Chrome plated or black coated

Weight: _____

2,65 kg

Choose between 9
different end caps



EK76 - SNIPER



EK72 / EK02 - PERFORATED



EK73 / EK03 - TAPERED



EK71 / EK01 - SLASH CUT



EK75 / EK05 - ROLLED UP



Custom Exhaust Touring \varnothing 102 mm (4 inch)

with changeable end caps (with EC homologation)



Geometry: _____

Cylindrical

Diameter: _____

\varnothing 102 mm

Sleeve length: _____

~ 670 mm

Sleeve material: _____

Stainless steel

Surface treatment: _____

Chrome plated or black coated

Weight: _____

3,6 kg



Custom Exhaust Complete systems

(with EC homologation)



Complete system 2-1 with conical exhaust



Complete system 2-1 with PowerCone exhaust



Complete system 2-2 with cylindrical exhaust

REMUS SC15 / SC17

for Sportster, Dyna, Softail and Touring

The electronic sound control system from REMUS, called SC15, is a CAN-bus controlled valve system, with a muffler integrated valve. The control unit processes the CAN-bus signals and passes it via the actuator to the exhaust valve. This leads in dependence on engine parameters and ride conditions to an accurate triggering of the valve to optimize the sound under consideration of legal guidelines.

Total new electronics and the optimized hardware of the SC17 ensured that the CAN-bus-controlled valve system fulfills the stringent R41.01 requirements in regards to noise emissions.

At both systems the sound can be modulated via a handle bar mounted push button switch. In any situation the complex electronic ensures in dependency of rpm, speed and gear the compliance with the latest sound regulations.

In addition to this, high-quality coated catalysts ensure compliance with the emission limits of the currently valid Euro 4 exhaust gas standard.

FACT BOX

	SC15	SC17
CAN-bus controlled valve system	✓	✓
Sound modulation via push button switch	✓	✓
Selectable and changeable end caps	✓	✓
Compliance with EURO 4 emission limits		✓
Compliance with R 41.04 noise limits		✓
EC homologation	✓	✓
For Sportster, Dyna, Softail and Touring	✓	
For Sportster and Touring		✓

SC15 - for Touring



SC15 - for Touring



SC15 - for Sportster, Dyna & Softail



deactivating plug for serial valve
(RACING - no EG/ABE/EEC)

Taster / push button



LED loop OFF
valve closed



LED loop GREEN
valve 10% open



LED loop YELLOW
valve 40% open



LED loop RED
valve 100% open

SC17 - for Touring



Modell	Bj.	Nr.
XG1 Street 750	14-	007702 270214
XG1 Street 750	17-	
SPORTSTER, XR1		015682 239308
XR 1200	08-	115682 239308
XR 1200 X	09-	015782 239308BS
		115782 239308BS
SPORTSTER, XL2		
XL 883C Custom	07-13	007152 230507
XL 883L Sportster 883 Super Low		007752 230507
XL 883N Iron		
XL 883R Sportster 883 Roadster		EK01
XL 1200C Sportster 1200 Custom	07-13	EK71
XL 1200N Nightster		EK02
XL 1200V Sportster Seventy-Two	12-13	EK72
XL 1200X Forty-Eight	10-13	EK03
		EK73
		EK05
		EK75
		EK76
		007703 239010



Modell	Bj.	Nr.
SPORTSTER, XL2		
XL 883L Sportster 883 Super Low	14-	007152 210514
XL 883N Iron	14-	007752 210514
XL 883R Sportster 883 Roadster	14-15	007152 280514
XL 1200C Sportster 1200 Custom	14-	007752 280514
XL 1200C ANV 1200 Custom 110th Aniv. Edition	14-	KAT013
XL 1200CA 1200 Custom Limited	14-	
XL 1200CB 1200 Custom Limited	14-	
XL 1200V Sportster Seventy-Two	14-	EK10
XL 1200X Forty-Eight	14-	EK80
XL 1200T Super Low 1200	15-	EK11
		EK81
		EK12
		EK82
		DBMHD-02
		HBLHD1
		HBLHD8
		017702 280014
		KAT013
		017702 282014
		KAT013



REMUS Custom Exhaust / HARLEY-DAVIDSON®

Modell	Bj.	Nr.
SPORTSTER, XL2		
XL1200C Custom	17-	007152 210517
XL1200X Forty-Eight	17-	007752 210517
XL1200T Superlow	17-	007152 280517
XL1200CX Roadster	17-	007752 280517
XL1200CB Custom		0115 000517
Euro 4		0105 000517
		EK10
		EK80
		EK11
		EK81
		EK12
		EK82
		HBLHD1
		HBLHD8



REMUS Custom Exhaust / HARLEY-DAVIDSON®

Modell	Bj.	Nr.
DYNA, FD2		
FXDC Super Glide Custom	07-11	007152 210307
FXDB Street Bob		007752 210307
FXDBA Street Bob Limited		KAT013
FXDL Low Rider	05-08	
FXDWG Wide Glide	07-08	
		EK10
		EK80
		EK11
		EK81
		EK12
		EK82
		DBMHD-02
		HBLHD1
		HBLHD8
		HD001



Modell	Bj.	Nr.
DYNA, FD2		
FXDC Super Glide Custom	12-14	007152 210307
FXDB Street Bob	12-	007752 210307
FXDBA Street Bob Limited	12-	007152 280312
FXDBC Street Bob Limited	16-	007752 280312
		KAT013
		EK10
		EK80
		EK11
		EK81
		EK12
		EK82
		DBMHD-02
		HBLHD1
		HBLHD8
		HD001



Modell	Bj.	Nr.	
DYNA, FD2 FXDF Fat Bob FXDWG Wide Glide	08-11	007102 230408	
		09-11	
		EK01	
		EK71	
		EK02	
		EK72	
		EK03	
		EK73	
		EK05	
		EK75	
		EK76	
		HD001	
	DYNA, FD2 FXDF Fat Bob FXDWG Wide Glide	12-	
007702 230408			
007102 290412			
007702 290412			
		EK01	
		EK71	
		EK02	
		EK72	
		EK03	
		EK73	
		EK05	
		EK75	
		EK76	
	HD001		

Modell	Bj.	Nr.
DYNA, FD2 FLD Switchback FXDL Low Rider	11- 14-	007102 229011
		007702 229011
		007102 229211
		007702 229211
		007103 229011
		229011HBL
SOFTAIL, FS2 FLSTC Heritage Softail Classic FXSTB Night Train FXSTC Softail Custom FXCW Rocker FXCWC Rocker C	07-10	
		007152 210107
		007752 210107
		KAT013
		EK10
		EK80
		EK11
		EK81
		EK12
		EK82
		DBMHD-02
		HBLHD1
		HBLHD8
HD001		



Modell	Bj.	Nr.
SOFTAIL, FS2		
FLSTC Heritage Softail Classic	11	007152 210107
FXCWC Rocker C	11	007752 210107
FXSB Breakout	13-	007152 280111
FXSBSE Breakout CVO	14	007752 280111
FLSTNSE CVO Softail Deluxe	14-15	KAT013
		EK10
		EK80
		EK11
		EK81
		EK12
		EK82
		DBMHD-02
		HBLHD1
		HBLHD8
		HD001



Modell	Bj.	Nr.
SOFTAIL, FS2		
FLSTF Fat Boy	07-	007152 210007
FLSTFB Fat Boy Special	09-	007752 210007
Fat Boy S	16-	KAT013
		EK10
		EK80
		EK11
		EK81
		EK12
		EK82
		DBMHD-02
		HBLHD1
		HBLHD8
HD001		



Modell	Bj.	Nr.
SOFTAIL, FS2 FLSTN Softail Deluxe FLSTSB Cross Bones	07-10	007152 210211
		007752 210211
	08-10	KAT013
		EK10
		EK80
		EK11
		EK81
		EK12
		EK82
		DBMHD-02
		HBLHD1
		HBLHD8
		HD001



Modell	Bj.	Nr.
SOFTAIL, FS2		
FLSTN Softail Deluxe	11-	007152 210211
FLS Softail Slim	12-	007752 210211
FLSTSB Cross Bones	11	007152 280211
FXS Blackline	11-13	007752 280211
FLSS Softail Slim S	16-	KAT013
		EK10
		EK80
		EK11
		EK81
		EK12
		EK82
		DBMHD-02
		HBLHD1
		HBLHD8
		HD001



Modell	Bj.	Nr.	
SOFTAIL, FS2			
FLSTC Heritage Softail Classic	17-	007152 210117	
FXSB Breakout	17-	007752 210117	
Euro 4		0115 000517	
		0105 000517	
		EK10	
		EK80	
		EK11	
		EK81	
		EK12	
		EK82	
		HBLHD1	
		HBLHD8	
		117752 210117	



Modell	Bj.	Nr.
TOURING, FL2	09-13	
FLHR Road King		007102 272009LR
FLHRC Road King Classic		007702 272009LR
FLHT Electra Glide		
FLHTC Electra Glide Custom		EK20
FLHTCU Ultra Classic Electra Glide		EK90
FLHX Street Glide		EK21
FLTRX Road Glide Custom		EK91
FLHTK Electra Glide Ultra Limited		0101 270014
FLHP Road King Police		HD001
FLHTP Electra Glide Police		
FLTRU Road Glide Ultra		
FLHTCUSE CVO Ultra Classic Electra Glide		
FLHXSE CVO Street Glide		
FLTRUSE CVO Road Glide Ultra		
FLTRXSE CVO Road Glide		
FLHRSE CVO Road King		



Modell	Bj.	Nr.	
TOURING, FL3			
FLHTK Electra Glide Ultra Limited	14	007102 272009LR	
FLHTP Electra Glide Police	14	007702 272009LR	
FLHXS Street Glide Special	14	007102 292014LR	
FLHRC Road King Classic	14-	007702 292014LR	
FLHX Street Glide	14-		
FLHTCU TC Electra Glide Ultra Classic	14-	EK20	
FLTRXS Road Glide Special	14-	EK90	
FLHTKSE CVO Ultra Limited	14-	EK21	
FLHTSE CVO Road King	14-15	EK91	
FLTRUSE CVO Road Glide Ultra	15-	0101 270014	
FLHXSE CVO Street Glide	15-		
FLHTCUL TC Electra Glide Ultra Classic Low	15-	HD001	
FLHTKL Electra Glide Ultra Limited Low	15-		
Road King	16-		
Road Glide Ultra	16-		
TOURING, FL3 (Euro 4),			
Milwaukee Eight		007102 272017LR	
FLHR Road King	17-	007702 272017LR	
FLHRC Road King Classic	17-	007102 292017LR	
FLHXS Street Glide Special	17-	007702 292017LR	
FLTRXS Road Glide Special	17-		
FLTRU Road Glide Ultra	17-	EK22	
FLHTK Electra Glide Ultra Limited	17-	EK92	
FLHTKL Electra Glide Ultra Limited Low	17-	EK23	
		EK93	

Modell	Bj.	Nr.
VRSC, VR2		007102 239005
VRSCR Street Rod	05-07	007702 239005
VRSC, VR1		
VRSCD Night Rod	05-	
VRSCDX Night Rod Special	07-	
VRSC, VR1		007102 239005
VRSCD Night Rod	07-	007702 239005
VRSCDX Night Rod Special	12-	007702 279005
		EK20
		EK90BV
		EK21
		EK91BV
		117752 238012

CVO Ultra Limited
Slip on, Ø 102 mm Endkappe "Slash Cut"



Night-Rod Special



BUELL SPORTEXHAUST

(with EC homologation)



Geometry:

~ 190 x 130 mm

Sleeve length:

~ 800 mm

Sleeve material:

Stainless steel

Surface treatment:

shot blasted matt or black coated

Weight:

8,2 kg

Modell			Typ	Geometrie	Bestell-Nr.
XB-12R Firebolt	04-		EG/ABE	2x Ø94mm rund	092782 098004LR
XB-12S Lightning			EG/ABE	2x Ø94mm rund	092782 098004LRM
XB1, 74.6 kW	05-				
XB-12Ss Lightning					
XB2, 74.6 kW					
XB-9SX Lightning	08-		EG/ABE	2x Ø 90 mm rund	092782 098008LRB
XB1, 60 kW				Abdeckung/cover	098008B
XB-12S Lightning	08-				
XB-12Scg Lightning	08-				
XB-1, 70 kW					
XB-12XT					
XB-12X					
XB-12Ss Lightning	08-				
XB-12STT Lightning	08-				
XB2, 70 kW					

HARLEY-DAVIDSON® / VICTORY / BUELL

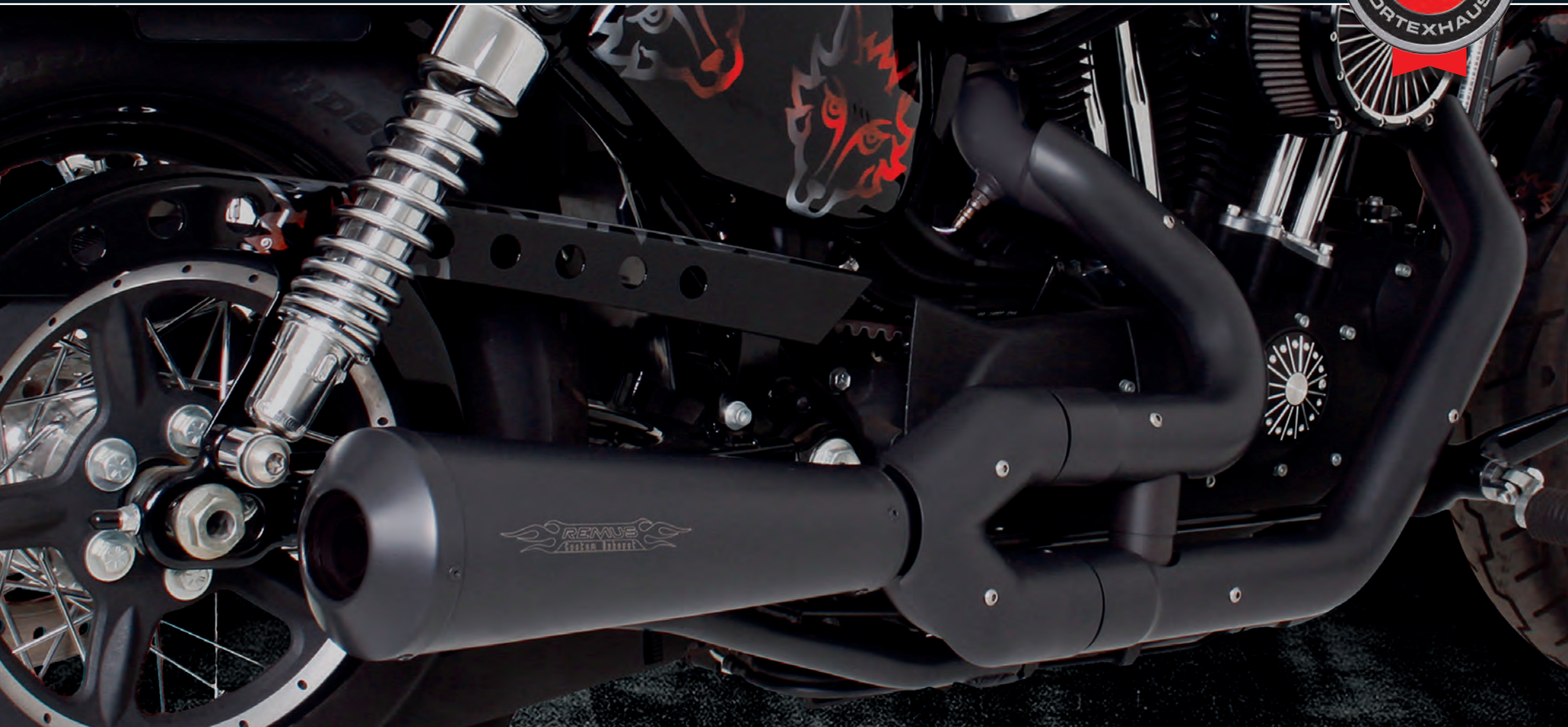

CUSTOM EXHAUST

with changeable end caps (with EEC homologation)



- Cylindrical geometry
- Diameter: Ø 84 mm
- Sleeve length ~ 405 mm
- Sleeve material: Stainless steel
- Surface treatment: chrome plated or black coated
- Weight: 2,65 kg



choose between
11 different
end caps



SNIPER



PERFORATED



STRAIGHT END



TAPERED



SLASH CUT



ROLLED UP

CUSTOM EXHAUST Touring Ø 102 mm (4inch)

with changeable end caps (with EEC homologation)

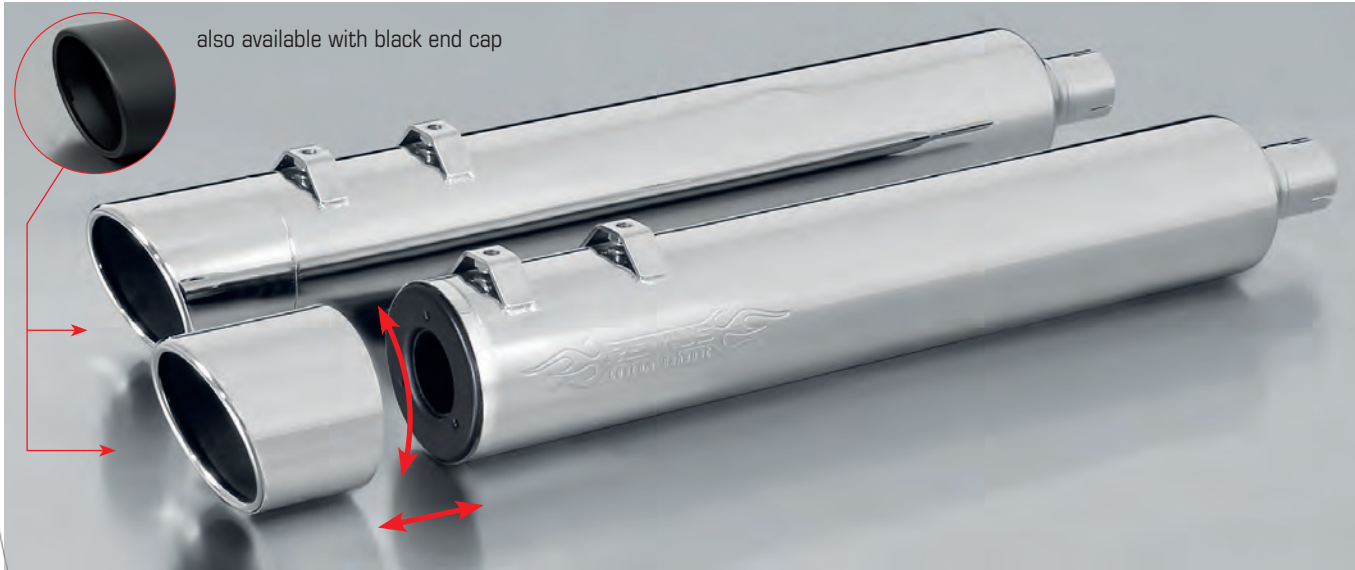

- Cylindrical shape
- Diameter: Ø102 mm
- Sleeve length ~ 670 mm
- Sleeve materials: Stainless steel
- Surface treatment: Chrome
- Weight: 3,6kg



CUSTOM EXHAUST Slash cut / Tapered / Straight end

(with EEC homologation)



- Cylindrical geometry
- Diameter: Ø 84 mm & Ø 90 mm
- Sleeve length ~ 500 mm
- Sleeve material: Stainless steel
- Surface treatment: black coated or chrome plated
- Weight: 2,65 kg

CUSTOM EXHAUST Complete systems

(with EEC homologation)



Complete system 2-1 with PowerCone exhaust

CUSTOM EXHAUST Complete systems

(with EEC homologation)



NEW



Complete system 2-1 with conical exhaust

CUSTOM EXHAUST Complete systems

(without EEC homologation)



Complete system 2-1 with CustomCone exhaust

REMUS SC15 - ELECTRONIC SOUND CONTROL

for Sportster, Dyna, Softail and Touring



- for Sportster, Dyna & Softail



NEW

LED loop OFF
valve closed

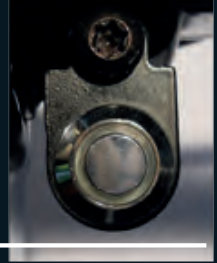

LED loop GREEN
valve 10% open

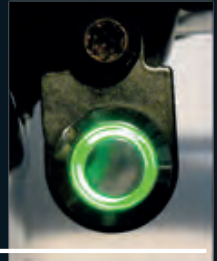

LED loop YELLOW
valve 40% open

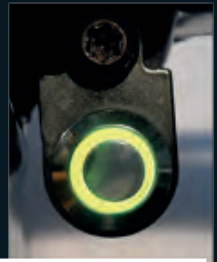

LED loop RED
valve 100% open



- CAN-bus controlled valve system
- Sound modulation via push button switch
- Hot sound
- Selectable and changeable end caps
- For Sportster, Dyna, Softail and Touring
- EEC homologation



deactivating plug for serial valve (RACING - no EG/ABE/EEC)

The newest electronic sound control system from REMUS, called SC15, is a CAN-bus controlled valve system, with a muffler-integrated flap. The control unit processes the CAN-bus signals and passes it via the actuator to the exhaust flap. This leads in dependence on engine parameters and drive conditions to an accurate triggering of the flap to optimize the sound under consideration of legal guidelines.

In addition to this the sound can be modulated via a handle bar mounted push button switch. In any situation the complex electronic ensures in dependency of rev, speed and gear the compliance with sound regulations stated in the EEC homologation.

- for Touring



- for Touring



REMUS MCS - MECHANICAL CONTROLLED SOUND

for Sportster, Dyna and Softail



- Perfect design
- Hot sound
- Selectable and changeable end caps
- For Sportster, Dyna and Softail
- EEC homologation*



* ATTENTION:
The activation of the mechanical valve (MCS) of the EEC homologated exhaust is not permitted according to homologation documents. The increase in sound once the valve is activated is too loud for public road usage and not permissible according to the road transport authority.

model	Bj. / year	description		Typ / type	sleeve version	Bestell Nr. / order no.		
SPORTSTER, XR1 XR 1200 XR 1200 X	08-	PowerCone complete system no cat. (header polished)		Sport (no EG/ABE/EEC)	stainless steel	015682 239308		
		PowerCone complete system incl. cat. (header polished)		EG/ABE/EEC	stainless steel	115682 239308		
	09-	PowerCone complete system no cat. (header black)		Sport (no EG/ABE/EEC)	stainless steel black	015782 239308BS		
		PowerCone complete system incl. cat. (header black)		EG/ABE/EEC	stainless steel black	115782 239308BS		
SPORTSTER, XL2		PowerCone complete system incl. cat. (header black)		EG/ABE/EEC	stainless steel black	115782 239907BS		
XL 883C Custom	07-13	CUSTOM exhaust and selectable end cap design only fits as a complete system						
XL 883L Sportster 883 Super Low	07-13	2 x CUSTOM exhaust incl cat., no end cap		EG/ABE/EEC	stainless steel chrome	007152 230507		
XL 883N Iron				EG/ABE/EEC	stainless steel black	007752 230507		
XL 883R Sportster 883 Roadster		2 x CUSTOM exhaust incl. cat., no end cap		EG/ABE/EEC	stainless steel chrome	007152 260507		
XL 1200C Sportster 1200 Custom		MCS - system**		EG/ABE/EEC	stainless steel black	007752 260507		
XL 1200N Nightster	Selectable end caps must be ordered separately							
XL 1200V Sportster Seventy-Two	12-13	description		sleeve version	order no.			
XL 1200X Forty-Eight	10-13	description		sleeve version	order no.			
		end cap slash-cut (2 pcs.)	stainless steel chrome	EK01		end cap straight end (2 pcs.)	stainless steel chrome	EK04
		end cap slash-cut (2 pcs.)	stainless steel black	EK71		end cap straight end (2 pcs.)	stainless steel black	EK74
		end cap perforated (2 pcs.)	stainless steel chrome	EK02		end cap rolled up (2 pcs.)	stainless steel chrome	EK05
		end cap perforated (2 pcs.)	stainless steel black	EK72		end cap rolled up (2 pcs.)	stainless steel black	EK75
		end cap tapered (2 pcs.)	stainless steel chrome	EK03		end cap sniper (2 pcs.)	stainless steel black	EK76
		end cap tapered (2 pcs.)	stainless steel black	EK73				
		2 x CUSTOM exhaust Straight-thru tapered (front/rear)		Race (no EG/ABE/EEC)	stainless steel chrome	007103 239907		
				Race (no EG/ABE/EEC)	stainless steel black	007703 239907		
		2 x CUSTOM exhaust Straight-thru slash-cut (front/rear)		Race (no EG/ABE/EEC)	stainless steel chrome	007103 239010		
				Race (no EG/ABE/EEC)	stainless steel black	007703 239010		
		tapered muffler front/rear incl. cat.		EG/ABE/EEC	stainless steel chrome	007102 239907		

XR 1200x
PowerCone complete system



XL Sportster 1200
PowerCone complete system



XL Sportster 72
slip on, end cap "slash cut"



Modell / model	year	description		type	sleeve version	order no.
SPORTSTER, XL2						
CUSTOM exhaust and selectable end cap design only fits as a complete system						
XL 883L Sportster 883 Super Low	14-	2 x CUSTOM exhaust incl. cat., no end cap		EG/ABE/EEC	stainless steel chrome	007152 230514
XL 883N Iron	14-			EG/ABE/EEC	stainless steel black	007752 230514
XL 883R Sportster 883 Roadster	14-15	2 x CUSTOM exhaust incl. cat., no end cap		EG/ABE/EEC	stainless steel chrome	007152 260514
XL 1200C Sportster 1200 Custom	14-	MCS - system**		EG/ABE/EEC	stainless steel black	007752 260514
XL 1200C ANV 1200 Custom 110th Aniv. Edition	14-	2 x CUSTOM exhaust incl. cat., no end cap		EG/ABE/EEC	stainless steel chrome	007152 290514
XL 1200CA 1200 Custom Limited	14-	*SC15 - (CAN-BUS actuated sound system)		EG/ABE/EEC	stainless steel black	007752 290514
XL 1200CB 1200 Custom Limited	14-					
XL 1200V Sportster Seventy-Two	14-					
XL 1200X Forty-Eight	14-					
XL 1200T Super Low 1200	15-					
		description	sleeve version	order no.		
		end cap slash-cut (2 pcs.)	stainless steel chrome	EK01		
		end cap slash-cut (2 pcs.)	stainless steel black	EK71		
		end cap perforated (2 pcs.)	stainless steel chrome	EK02		
		end cap perforated (2 pcs.)	stainless steel black	EK72		
		end cap tapered (2 pcs.)	stainless steel chrome	EK03		
		end cap tapered (2 pcs.)	stainless steel black	EK73		
		2 x CUSTOM exhaust Straight-thru slash-cut (front/rear)		Race (no EG/ABE/EEC)	stainless steel black	007703 239014
		complete system (2-2) incl. end caps SNIPER			stainless steel black	017702 280014
		*SC15 - (CAN-BUS actuated sound system)				
		plug-in catalytic converter set (2 pcs.)		EG/ABE/EEC		KAT013
		complete system (2-1) incl. conical CUSTOM exhaust			stainless steel black	017702 282014
		plug-in catalytic converter set (2 pcs.)		EG/ABE/EEC		KAT013
The exhaust system has an EEC approval, but is only authorised for road use in combination with the plug-in catalytic converter.						

Sportster 48 slip on, end cap "rolled up"



Sportster 48 complete system



Sportster 48 complete system, end cap "sniper"



Modell / model	year	description	type	sleeve version	order no.																																						
DYNA, FD2																																											
CUSTOM exhaust and selectable end cap design only fits as a complete system																																											
FXDC Super Glide Custom	07-11	2 x CUSTOM exhaust incl. cat., no end cap	EG/ABE/EEC	stainless steel chrome	007152 230307																																						
FXDB Street Bob			EG/ABE/EEC	stainless steel black	007752 230307																																						
FXDBA Street Bob Limited	05-08	2 x CUSTOM exhaust incl. cat., no end cap MCS - system**	EG/ABE/EEC	stainless steel chrome	007152 260307																																						
FXDL Low Rider			EG/ABE/EEC	stainless steel black	007752 260307																																						
FXDWG Wide Glide	07-08	Selectable end caps must be ordered separately																																									
		<table border="1"> <thead> <tr> <th>description</th> <th>sleeve version</th> <th>Bestell-Nr. / order no.</th> </tr> </thead> <tbody> <tr> <td>end cap slash-cut (2 pcs.)</td> <td>stainless steel chrome</td> <td>EK01</td> </tr> <tr> <td>end cap slash-cut (2 pcs.)</td> <td>stainless steel black</td> <td>EK71</td> </tr> <tr> <td>end cap perforated (2 pcs.)</td> <td>stainless steel chrome</td> <td>EK02</td> </tr> <tr> <td>end cap perforated (2 pcs.)</td> <td>stainless steel black</td> <td>EK72</td> </tr> <tr> <td>end cap tapered (2 pcs.)</td> <td>stainless steel chrome</td> <td>EK03</td> </tr> <tr> <td>end cap tapered (2 pcs.)</td> <td>stainless steel black</td> <td>EK73</td> </tr> </tbody> </table>	description	sleeve version	Bestell-Nr. / order no.	end cap slash-cut (2 pcs.)	stainless steel chrome	EK01	end cap slash-cut (2 pcs.)	stainless steel black	EK71	end cap perforated (2 pcs.)	stainless steel chrome	EK02	end cap perforated (2 pcs.)	stainless steel black	EK72	end cap tapered (2 pcs.)	stainless steel chrome	EK03	end cap tapered (2 pcs.)	stainless steel black	EK73	<table border="1"> <thead> <tr> <th>description</th> <th>sleeve version</th> <th>order no.</th> </tr> </thead> <tbody> <tr> <td>end cap straight end (2 pcs.)</td> <td>stainless steel chrome</td> <td>EK04</td> </tr> <tr> <td>end cap straight end (2 pcs.)</td> <td>stainless steel black</td> <td>EK74</td> </tr> <tr> <td>end cap rolled up (2 pcs.)</td> <td>stainless steel chrome</td> <td>EK05</td> </tr> <tr> <td>end cap rolled up (2 pcs.)</td> <td>stainless steel black</td> <td>EK75</td> </tr> <tr> <td>end cap sniper (2 pcs.)</td> <td>stainless steel black</td> <td>EK76</td> </tr> </tbody> </table>	description	sleeve version	order no.	end cap straight end (2 pcs.)	stainless steel chrome	EK04	end cap straight end (2 pcs.)	stainless steel black	EK74	end cap rolled up (2 pcs.)	stainless steel chrome	EK05	end cap rolled up (2 pcs.)	stainless steel black	EK75	end cap sniper (2 pcs.)	stainless steel black	EK76	
description	sleeve version	Bestell-Nr. / order no.																																									
end cap slash-cut (2 pcs.)	stainless steel chrome	EK01																																									
end cap slash-cut (2 pcs.)	stainless steel black	EK71																																									
end cap perforated (2 pcs.)	stainless steel chrome	EK02																																									
end cap perforated (2 pcs.)	stainless steel black	EK72																																									
end cap tapered (2 pcs.)	stainless steel chrome	EK03																																									
end cap tapered (2 pcs.)	stainless steel black	EK73																																									
description	sleeve version	order no.																																									
end cap straight end (2 pcs.)	stainless steel chrome	EK04																																									
end cap straight end (2 pcs.)	stainless steel black	EK74																																									
end cap rolled up (2 pcs.)	stainless steel chrome	EK05																																									
end cap rolled up (2 pcs.)	stainless steel black	EK75																																									
end cap sniper (2 pcs.)	stainless steel black	EK76																																									
		2 x CUSTOM exhaust Straight-thru slash-cut (top/bottom)	Race (no EG/ABE/EEC)	stainless steel chrome	007103 239107																																						
		FLAP-KILL (deactivating plug for serial valve)	Race (no EG/ABE/EEC)		HD001																																						

Street Bob
slip on, end cap "rolled up"



Street Bob
slip on, end cap "perforated"



Wide Glide
slip on, end cap "perforated"



Fat Bob
slip on, end cap "rolled up"



Modell / model	year	description	Typ / type	sleeve version	order no.																					
DYNA, FD2																										
CUSTOM exhaust and selectable end cap design only fits as a complete system																										
FXDC Super Glide Custom	12-14	2 x CUSTOM exhaust incl. cat., no end cap	EG/ABE/EEC	stainless steel chrome	007152 230307																					
FXDB Street Bob	12-		EG/ABE/EEC	stainless steel black	007752 230307																					
FXDBA Street Bob Limited	12-	2 x CUSTOM exhaust incl. cat., no end cap	EG/ABE/EEC	stainless steel chrome	007152 260307																					
		MCS - system**	EG/ABE/EEC	stainless steel black	007752 260307																					
		2 x CUSTOM exhaust incl. cat., no end cap	EG/ABE/EEC	stainless steel chrome	007152 290312																					
		*SC15 - (CAN-BUS actuated sound system)	EG/ABE/EEC	stainless steel black	007752 290312																					
Selectable end caps must be ordered separately																										
		<table border="1"> <thead> <tr> <th>description</th> <th>sleeve version</th> <th>order no.</th> </tr> </thead> <tbody> <tr> <td>end cap slash-cut (2 pcs.)</td> <td>stainless steel chrome</td> <td>EK01</td> </tr> <tr> <td>end cap slash-cut (2 pcs.)</td> <td>stainless steel black</td> <td>EK71</td> </tr> <tr> <td>end cap perforated (2 pcs.)</td> <td>stainless steel chrome</td> <td>EK02</td> </tr> <tr> <td>end cap perforated (2 pcs.)</td> <td>stainless steel black</td> <td>EK72</td> </tr> <tr> <td>end cap tapered (2 pcs.)</td> <td>stainless steel chrome</td> <td>EK03</td> </tr> <tr> <td>end cap tapered (2 pcs.)</td> <td>stainless steel black</td> <td>EK73</td> </tr> </tbody> </table>	description	sleeve version	order no.	end cap slash-cut (2 pcs.)	stainless steel chrome	EK01	end cap slash-cut (2 pcs.)	stainless steel black	EK71	end cap perforated (2 pcs.)	stainless steel chrome	EK02	end cap perforated (2 pcs.)	stainless steel black	EK72	end cap tapered (2 pcs.)	stainless steel chrome	EK03	end cap tapered (2 pcs.)	stainless steel black	EK73			
description	sleeve version	order no.																								
end cap slash-cut (2 pcs.)	stainless steel chrome	EK01																								
end cap slash-cut (2 pcs.)	stainless steel black	EK71																								
end cap perforated (2 pcs.)	stainless steel chrome	EK02																								
end cap perforated (2 pcs.)	stainless steel black	EK72																								
end cap tapered (2 pcs.)	stainless steel chrome	EK03																								
end cap tapered (2 pcs.)	stainless steel black	EK73																								
		<table border="1"> <thead> <tr> <th>description</th> <th>sleeve version</th> <th>order no.</th> </tr> </thead> <tbody> <tr> <td>end cap straight end (2 pcs.)</td> <td>stainless steel chrome</td> <td>EK04</td> </tr> <tr> <td>end cap straight end (2 pcs.)</td> <td>stainless steel black</td> <td>EK74</td> </tr> <tr> <td>end cap rolled up (2 pcs.)</td> <td>stainless steel chrome</td> <td>EK05</td> </tr> <tr> <td>end cap rolled up (2 pcs.)</td> <td>stainless steel black</td> <td>EK75</td> </tr> <tr> <td>end cap sniper (2 pcs.)</td> <td>stainless steel black</td> <td>EK76</td> </tr> </tbody> </table>	description	sleeve version	order no.	end cap straight end (2 pcs.)	stainless steel chrome	EK04	end cap straight end (2 pcs.)	stainless steel black	EK74	end cap rolled up (2 pcs.)	stainless steel chrome	EK05	end cap rolled up (2 pcs.)	stainless steel black	EK75	end cap sniper (2 pcs.)	stainless steel black	EK76						
description	sleeve version	order no.																								
end cap straight end (2 pcs.)	stainless steel chrome	EK04																								
end cap straight end (2 pcs.)	stainless steel black	EK74																								
end cap rolled up (2 pcs.)	stainless steel chrome	EK05																								
end cap rolled up (2 pcs.)	stainless steel black	EK75																								
end cap sniper (2 pcs.)	stainless steel black	EK76																								
		2 x CUSTOM exhaust Straight-thru slash-cut (top/bottom)	Race (no EG/ABE/EEC)	stainless steel chrome	007103 239107																					
		FLAP-KILL (deactivating plug for serial valve)	Race (no EG/ABE/EEC)		HD001																					
DYNA, FD2																										
FXDF Fat Bob	08-11	2 x CUSTOM exhaust, no cat., no end cap	EG/ABE/EEC	stainless steel chrome	007102 230408																					
			EG/ABE/EEC	stainless steel black	007702 230408																					
FXDWG Wide Glide	09-11	2 x CUSTOM exhaust no cat., no end cap	EG/ABE/EEC	stainless steel chrome	007102 260408																					
		MCS - system**	EG/ABE/EEC	stainless steel black	007702 260408																					
Selectable end caps must be ordered separately																										
		<table border="1"> <thead> <tr> <th>description</th> <th>sleeve version</th> <th>order no.</th> </tr> </thead> <tbody> <tr> <td>end cap slash-cut (2 pcs.)</td> <td>stainless steel chrome</td> <td>EK01</td> </tr> <tr> <td>end cap slash-cut (2 pcs.)</td> <td>stainless steel black</td> <td>EK71</td> </tr> <tr> <td>end cap perforated (2 pcs.)</td> <td>stainless steel chrome</td> <td>EK02</td> </tr> <tr> <td>end cap perforated (2 pcs.)</td> <td>stainless steel black</td> <td>EK72</td> </tr> <tr> <td>end cap tapered (2 pcs.)</td> <td>stainless steel chrome</td> <td>EK03</td> </tr> <tr> <td>end cap tapered (2 pcs.)</td> <td>stainless steel black</td> <td>EK73</td> </tr> </tbody> </table>	description	sleeve version	order no.	end cap slash-cut (2 pcs.)	stainless steel chrome	EK01	end cap slash-cut (2 pcs.)	stainless steel black	EK71	end cap perforated (2 pcs.)	stainless steel chrome	EK02	end cap perforated (2 pcs.)	stainless steel black	EK72	end cap tapered (2 pcs.)	stainless steel chrome	EK03	end cap tapered (2 pcs.)	stainless steel black	EK73			
description	sleeve version	order no.																								
end cap slash-cut (2 pcs.)	stainless steel chrome	EK01																								
end cap slash-cut (2 pcs.)	stainless steel black	EK71																								
end cap perforated (2 pcs.)	stainless steel chrome	EK02																								
end cap perforated (2 pcs.)	stainless steel black	EK72																								
end cap tapered (2 pcs.)	stainless steel chrome	EK03																								
end cap tapered (2 pcs.)	stainless steel black	EK73																								
		<table border="1"> <thead> <tr> <th>description</th> <th>sleeve version</th> <th>order no.</th> </tr> </thead> <tbody> <tr> <td>end cap straight end (2 pcs.)</td> <td>stainless steel chrome</td> <td>EK04</td> </tr> <tr> <td>end cap straight end (2 pcs.)</td> <td>stainless steel black</td> <td>EK74</td> </tr> <tr> <td>end cap rolled up (2 pcs.)</td> <td>stainless steel chrome</td> <td>EK05</td> </tr> <tr> <td>end cap rolled up (2 pcs.)</td> <td>stainless steel black</td> <td>EK75</td> </tr> <tr> <td>end cap sniper (2 pcs.)</td> <td>stainless steel black</td> <td>EK76</td> </tr> </tbody> </table>	description	sleeve version	order no.	end cap straight end (2 pcs.)	stainless steel chrome	EK04	end cap straight end (2 pcs.)	stainless steel black	EK74	end cap rolled up (2 pcs.)	stainless steel chrome	EK05	end cap rolled up (2 pcs.)	stainless steel black	EK75	end cap sniper (2 pcs.)	stainless steel black	EK76						
description	sleeve version	order no.																								
end cap straight end (2 pcs.)	stainless steel chrome	EK04																								
end cap straight end (2 pcs.)	stainless steel black	EK74																								
end cap rolled up (2 pcs.)	stainless steel chrome	EK05																								
end cap rolled up (2 pcs.)	stainless steel black	EK75																								
end cap sniper (2 pcs.)	stainless steel black	EK76																								
			Race (no EG/ABE/EEC)		HD001																					

model	year	description		Typ / type	sleeve version	order no.
DYNA, FD2						
CUSTOM exhaust and selectable end cap design only fits as a complete system						
FXDF Fat Bob FXDWG Wide Glide	12-	2 x CUSTOM exhaust, no cat., no end cap		EG/ABE/EEC	stainless steel chrome	007102 230408
				EG/ABE/EEC	stainless steel black	007702 230408
		2 x CUSTOM exhaust no cat., no end cap		EG/ABE/EEC	stainless steel chrome	007102 260408
		MCS - system**		EG/ABE/EEC	stainless steel black	007702 260408
		2 x CUSTOM exhaust no cat., no end cap		EG/ABE/EEC	stainless steel chrome	007102 290412
		*SC15 - (CAN-BUS actuated sound system)		EG/ABE/EEC	stainless steel black	007702 290412
Selectable end caps must be ordered separately						
		description		sleeve version		order no.
		end cap slash-cut (2 pcs.)		stainless steel chrome		EK01
		end cap slash-cut (2 pcs.)		stainless steel black		EK71
		end cap perforated (2 pcs.)		stainless steel chrome		EK02
		end cap perforated (2 pcs.)		stainless steel black		EK72
		end cap tapered (2 pcs.)		stainless steel chrome		EK03
		end cap tapered (2 pcs.)		stainless steel black		EK73
		FLAP-KILL (deactivating plug for serial valve)		Race (no EG/ABE/EEC)		HD001
DYNA, FD2						
FLD Switchback FXDL Low Rider	11-	1 x CUSTOM exhaust slash-cut (heat protection shield for Low Rider must be ordered separately)		EG/ABE/EEC	stainless steel chrome	007102 229011
				EG/ABE/EEC	stainless steel black	007702 229011
	14-	1 x CUSTOM exhaust straight end (heat protection shield for Low Rider must be ordered separately)		EG/ABE/EEC	stainless steel chrome	007102 229211
				EG/ABE/EEC	stainless steel black	007702 229211
		1 x CUSTOM exhaust Straight-thru slash-cut (heat protection shield for Low Rider must be ordered separately)		EG/ABE/EEC	stainless steel chrome	007103 229011
				EG/ABE/EEC	stainless steel black	007703 229011
		heat protection shield for FXDL Low Rider			stainless steel chrome	229011HBL

Low Rider
slip on, "slash cut"



Switchback
slip on, straight end



model	year	description		type	sleeve version	order no.			
SOFTAIL, FS2									
CUSTOM exhaust and selectable end cap design only fits as a complete system									
FLSTC Heritage Softail Classic	07-10	2 x CUSTOM exhaust incl. cat., no end cap		EG/ABE/EEC	stainless steel chrome	007152 230107			
FXSTB Night Train				EG/ABE/EEC	stainless steel black	007752 230107			
FXSTC Softail Custom		2 x CUSTOM exhaust incl. cat., no end cap		EG/ABE/EEC	stainless steel chrome	007152 260107			
FXCW Rocker				EG/ABE/EEC	stainless steel black	007752 260107			
FXCWC Rocker C	MCS - system**								
Selectable end caps must be ordered separately									
		description	sleeve version	order no.			description	sleeve version	order no.
		end cap slash-cut (2 pcs.)	stainless steel chrome	EK01			end cap straight end (2 pcs.)	stainless steel chrome	EK04
		end cap slash-cut (2 pcs.)	stainless steel black	EK71			end cap straight end (2 pcs.)	stainless steel black	EK74
		end cap perforated (2 pcs.)	stainless steel chrome	EK02			end cap rolled up (2 pcs.)	stainless steel chrome	EK05
		end cap perforated (2 pcs.)	stainless steel black	EK72			end cap rolled up (2 pcs.)	stainless steel black	EK75
		end cap tapered (2 pcs.)	stainless steel chrome	EK03			end cap sniper (2 pcs.)	stainless steel black	EK76
		end cap tapered (2 pcs.)	stainless steel black	EK73					
				FLAP-KILL (deactivating plug for serial valve)	Race (no EG/ABE/EEC)				HD001
				tapered muffler top/bottom incl. cat.	EG/ABE/EEC	stainless steel chrome			007102 239507

Fat Boy Special
slip on, end cap "tapered"



Fat Bob
slip on, end cap "slash cut"



model	year	description	Typ / type	version	order no.	
SOFTAIL, FS2 FLSTC Heritage Softail Classic FXCWC Rocker C FXSB Breakout FXSBSE Breakout CVO FLSTNSE CVO Softail Deluxe	11-	2 x CUSTOM exhaust incl. cat., no end cap	EG/ABE/EEC	stainless steel chrome	007152 230107	
			EG/ABE/EEC	stainless steel black	007752 230107	
	13-	2 x CUSTOM exhaust incl. cat., no end cap MCS - system**	EG/ABE/EEC	stainless steel chrome	007152 260107	
			EG/ABE/EEC	stainless steel black	007752 260107	
	14-15	2 x CUSTOM exhaust incl. cat., no end cap *SC15 - (CAN-BUS actuated sound system)	EG/ABE/EEC	stainless steel chrome	007152 290111	
			EG/ABE/EEC	stainless steel black	007752 290111	
	Selectable end caps must be ordered separately					
	description		sleeve version	order no.	description	
	end cap slash-cut (2 pcs.)		stainless steel chrome	EK01	end cap straight end (2 pcs.)	
	end cap slash-cut (2 pcs.)		stainless steel black	EK71	end cap straight end (2 pcs.)	
end cap perforated (2 pcs.)		stainless steel chrome	EK02	end cap rolled up (2 pcs.)		
end cap perforated (2 pcs.)		stainless steel black	EK72	end cap rolled up (2 pcs.)		
end cap tapered (2 pcs.)		stainless steel chrome	EK03	end cap sniper (2 pcs.)		
end cap tapered (2 pcs.)		stainless steel black	EK73			
FLAP-KILL (deactivating plug for serial valve) - not for CVO - models			Race (no EG/ABE/EEC)		HD001	
SOFTAIL, FS2 FLSTF Fat Boy FLSTFB Fat Boy Special Fat Boy S	CUSTOM exhaust and selectable end cap design only fits as a complete system					
	07-	2 x CUSTOM exhaust incl. cat., no end cap	EG/ABE/EEC	stainless steel chrome	007152 230007	
			EG/ABE/EEC	stainless steel black	007752 230007	
	09-		Selectable end caps must be ordered separately			
			description		sleeve version	order no.
	end cap slash-cut (2 pcs.)		stainless steel chrome	EK01	end cap straight end (2 pcs.)	
	end cap slash-cut (2 pcs.)		stainless steel black	EK71	end cap straight end (2 pcs.)	
	end cap perforated (2 pcs.)		stainless steel chrome	EK02	end cap rolled up (2 pcs.)	
	end cap perforated (2 pcs.)		stainless steel black	EK72	end cap rolled up (2 pcs.)	
	end cap tapered (2 pcs.)		stainless steel chrome	EK03	end cap sniper (2 pcs.)	
end cap tapered (2 pcs.)		stainless steel black	EK73			
2 x CUSTOM exhaust Straight-thru slash-cut (top/bottom)			Race (no EG/ABE/EEC)	stainless steel chrome	007103 239307	
FLAP-KILL (deactivating plug for serial valve)			Race (no EG/ABE/EEC)		HD001	
slash cut muffler top/bottom incl. cat.			EG/ABE/EEC	stainless steel chrome	007102 239307	
			EG/ABE/EEC	stainless steel black	007702 239307	

Modell / model	year	description	type	sleeve version	order no.
SOFTAIL, FS2					
CUSTOM exhaust and selectable end cap design only fits as a complete system					
FLSTN Softail Deluxe	07-10	2 x CUSTOM exhaust incl. cat., no end cap	EG/ABE/EEC	stainless steel chrome	007152 230211
FLTSB Cross Bones	08-10		EG/ABE/EEC	stainless steel black	007752 230211
		2 x CUSTOM exhaust incl. cat., no end cap MCS - system**	EG/ABE/EEC	stainless steel chrome	007152 260211
			EG/ABE/EEC	stainless steel black	007752 260211
Selectable end caps must be ordered separately					
		description	sleeve version	order no.	
		end cap slash-cut (2 pcs.)	stainless steel chrome	EK01	
		end cap slash-cut (2 pcs.)	stainless steel black	EK71	
		end cap perforated (2 pcs.)	stainless steel chrome	EK02	
		end cap perforated (2 pcs.)	stainless steel black	EK72	
		end cap tapered (2 pcs.)	stainless steel chrome	EK03	
		end cap tapered (2 pcs.)	stainless steel black	EK73	
		description	sleeve version	order no.	
		end cap straight end (2 pcs.)	stainless steel chrome	EK04	
		end cap straight end (2 pcs.)	stainless steel black	EK74	
		end cap rolled up (2 pcs.)	stainless steel chrome	EK05	
		end cap rolled up (2 pcs.)	stainless steel black	EK75	
		end cap sniper (2 pcs.)	stainless steel black	EK76	
FLAP-KILL (Deaktivierungsstecker für Serienklappe)		FLAP-KILL (deactivating plug for serial valve)	Race (no EG/ABE/EEC)		HD001

Heritage Softail
slip on, end cap "perforated"



Softail Deluxe
slip on, end cap "perforated"



model	year	description	type	sleeve version	order no.	
SOFTAIL, FS2						
CUSTOM exhaust and selectable end cap design only fits as a complete system						
FLSTN Softail Deluxe	11-	2 x CUSTOM exhaust incl. cat., no end cap	EG/ABE/EEC	stainless steel chrome	007152 230211	
FLS Softail Slim	12-		EG/ABE/EEC	stainless steel black	007752 230211	
FLSTSB Cross Bones	11	2 x CUSTOM exhaust incl. cat., no end cap MCS - system** - (not for FXS Blackline)	EG/ABE/EEC	stainless steel chrome	007152 260211	
FXS Blackline	11-13		EG/ABE/EEC	stainless steel black	007752 260211	
FLSS Softail Slim S	16-	2 x CUSTOM exhaust incl. cat., no end cap *SC15 - (CAN-BUS actuated sound system) - (not for FXS Blackline)	EG/ABE/EEC	stainless steel chrome	007152 290211	
			EG/ABE/EEC	stainless steel black	007752 290211	
Selectable end caps must be ordered separately						
		description	sleeve version	order no.		
		end cap slash-cut (2 pcs.)	stainless steel chrome	EK01		
		end cap slash-cut (2 pcs.)	stainless steel black	EK71		
		end cap perforated (2 pcs.)	stainless steel chrome	EK02		
		end cap perforated (2 pcs.)	stainless steel black	EK72		
		end cap tapered (2 pcs.)	stainless steel chrome	EK03		
		end cap tapered (2 pcs.)	stainless steel black	EK73		
				description	sleeve version	order no.
				end cap straight end (2 pcs.)	stainless steel chrome	EK04
				end cap straight end (2 pcs.)	stainless steel black	EK74
				end cap rolled up (2 pcs.)	stainless steel chrome	EK05
				end cap rolled up (2 pcs.)	stainless steel black	EK75
				end cap sniper (2 pcs.)	stainless steel black	EK76
			FLAP-KILL (deactivating plug for serial valve)	Race (no EG/ABE/EEC)	HD001	

Breakout
slip on, end cap "rolled up"

Softail Slim S
slip on, end cap "rolled up"

Softail Slim S
slip on, end cap "rolled up"



model	year	description		type	sleeve version	order no.	
TOURING, FL2	09-13	CUSTOM exhaust and selectable end cap design only fits as a complete system					
FLHR Road King		2 x CUSTOM exhaust no cat., no end cap		EG/ABE/EEC	stainless steel chrome	007102 272009LR	
FLHRC Road King Classic				EG/ABE/EEC	stainless steel black	007702 272009LR	
FLHT Electra Glide		Selectable end caps must be ordered separately					
FLHTC Electra Glide Custom							
FLHTCU Ultra Classic Electra Glide							
FLHX Street Glide							
FLTRX Road Glide Custom		CUSTOM exhaust slash cut left/right Ø 102 mm (4"), electronically controlled valve and remote control (ECS)		EG/ABE/EEC	stainless steel chrome	047102 271014LR	
FLHTK Electra Glide Ultra Limited		"CUSTOM exhaust straight end left/right Ø 102 mm (4")", electronically controlled valve and remote control (ECS)		EG/ABE/EEC	stainless steel chrome	047102 271114LR	
FLHP Road King Police		header (2-2) no cat. instead of OE header		Race (no EG/ABE/EEC)		0101 270014	
FLHTP Electra Glide Police		(not combinable with ECS)					
FLTRU Road Glide Ultra		FLAP-KILL (deactivating plug for serial valve) - not for CVO - models		Race (no EG/ABE/EEC)		HD001	
FLHTCUSE CVO Ultra Classic Electra Glide							
FLHXSE CVO Street Glide							
FLTRUSE CVO Road Glide Ultra							
FLTRXSE CVO Road Glide							
FLHRSE CVO Road King							

Electra Glide Ultra slip on, Ø 102 mm end cap "slash cut"



CVO Ultra Limited slip on, Ø 102 mm end cap "slash cut"

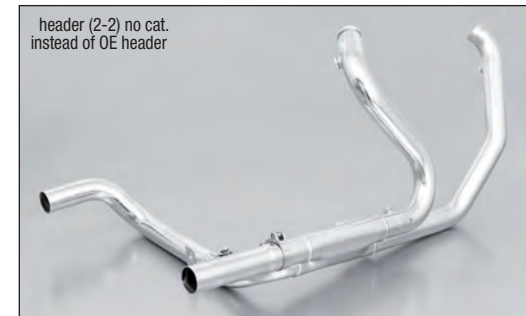

header (2-2) no cat. instead of OE header

model	year	description		type	sleeve version	order no.	
TOURING, FL3							
CUSTOM exhaust and selectable end cap design only fits as a complete system							
FLHTK Electra Glide Ultra Limited	14	2 x CUSTOM exhaust Ø 102 mm (4") no cat., no end cap		EG/ABE/EEC	stainless steel chrome	007102 272009LR	
FLHTP Electra Glide Police	14			EG/ABE/EEC	stainless steel black	007702 272009LR	
FLHXS Street Glide Special	14	2 x CUSTOM exhaust Ø 102 mm (4") no cat., no end cap		EG/ABE/EEC	stainless steel chrome	007102 292014LR	
FLHRC Road King Classic	14-	*SC15 - (CAN-BUS actuated sound system)		EG/ABE/EEC	stainless steel black	007702 292014LR	
FLHX Street Glide	14-	Selectable end caps must be ordered separately					
FLHTCU TC Electra Glide Ultra Classic	14-	description	sleeve version	order no.	description	sleeve version	order no.
FLTRXS Road Glide Special	14-	end cap slash-cut (2 pcs.)	stainless steel chrome	EK20	end cap straight end (2 pcs.)	stainless steel chrome	EK21
FLHTKSE CVO Ultra Limited	14-	end cap slash-cut (2 pcs.)	stainless steel black	EK90	end cap straight end (2 pcs.)	stainless steel black	EK91
FLHTSE CVO Road King	14-15	header (2-2) no cat. instead of OE header		Race (no EG/ABE/EEC)		0101 270014	
FLTRUSE CVO Road Glide Ultra	15-	FLAP-KILL (deactivating plug for serial valve) - not for CVO - models		Race (no EG/ABE/EEC)		HD001	
FLHXSE CVO Street Glide	15-						
FLHTCUL TC Electra Glide Ultra Classic Low	15-						
FLHTKL Electra Glide Ultra Limited Low	15-						
Road King	16-						
Road Glide Ultra	16-						

CVO Ultra Limited slip on, Ø 102 mm end cap "slash cut"



CVO Ultra Limited slip on, Ø 102 mm end cap "slash cut"



CVO Ultra Limited slip on, Ø 102 mm end cap "straight end"



Modell	year	description		type	version	order no.
VRSC, VR2 VRSCR Street Rod	05-07	2 x CUSTOM exhaust slash-cut (top/bottom)		EG/ABE/EEC	stainless steel chrome	007102 239005
				EG/ABE/EEC	stainless steel black	007702 239005
VRSC, VR1 VRSCD Night Rod VRSCDX Night Rod Special	05-07	2 x CUSTOM exhaust slash-cut (top/bottom)		EG/ABE/EEC	stainless steel chrome	007102 239005
				EG/ABE/EEC	stainless steel black	007702 239005
VRSC, VR1 VRSCD Night Rod VRSCDX Night Rod Special	07-12	2 x CUSTOM exhaust slash-cut (top/bottom)		EG/ABE/EEC	stainless steel chrome	007102 239005
		2 x CUSTOM exhaust Ø 102 mm (4"), no end cap		EG/ABE/EEC	stainless steel black	007702 279005
	Selectable end caps must be ordered separately					
	description		sleeve version	order no.	description	
end cap slash-cut (2 pcs.)		stainless steel chrome	EK20	end cap straight end (2 pcs.)		EK21
end cap slash-cut (2 pcs.)		stainless steel black	EK90	end cap straight end (2 pcs.)		EK91
complete system (2-2) incl. cat.				EG/ABE/EEC	stainless steel black	117752 238012
complete system (2-1) no cat with CUSTOMCONE silencer				RACE (no EG/ABE/EEC)	stainless steel black	0117783 238112
VRSC, VR1 VRSCF V-Rod Muscle	09-	2 x CUSTOM exhaust slash-cut (left/right)		EG/ABE/EEC	matt chrome	007102 229009LR
				EG/ABE/EEC	stainless steel black	007702 229009LR
		2 x CUSTOMCONE incl. Connection tube		Race (no EG/ABE/EEC)	stainless steel black	0517783 239012LR
XG1 Street 750	14-	1 x CUSTOM exhaust rolled up cut Ø 102 mm (4")		EG/ABE/EEC	stainless steel black	007702 270214

Night-Rod Special
slip on, Ø 102 mm end cap "rolled up"

Night-Rod Special
complete system

Street 750
slip on, rolled up

NEW



BUELL SPORTEXHAUSTS

with EEC homologation



- Width x height: ~ 190 x 130 mm
- Muffler length ~ 800 mm
- Sleeve material: Stainless steel
- Surface treatment:
shot blasted matt / black coated
- Weight: 8,2 kg

model	year	Ø mm	description	type		sleeve version	order no.
XB-12R Firebolt	04-		slip on left/right (muffler)	EG/ABE/EEC	2x Ø94 mm	stainless steel polished	092782 098004LR
XB-12S Lightning				EG/ABE/EEC	2x Ø94 mm	stainless steel matt	092782 098004LRM
XB1, 74.6 kW							
XB-12Ss Lightning	05-						
XB2, 74.6 kW							
XB-9SX Lightning	08-		slip on left/right (muffler)	EG/ABE/EEC	2x Ø 90 mm	stainless steel black	092782 098008LRB
XB1, 60 kW			Stainless steel belt cover for XB2 models		cover	stainless steel black	098008B
XB-12S Lightning	08-						
XB-12Scg Lightning	08-						
XB-1, 70 kW							
XB-12XT, XB-12X							
XB-12Ss Lightning	08-						
XB-12STT Lightning	08-						
XB2, 70 kW							
1125R / CR	08-	54	slip on (muffler with connecting tube and pre muffler) incl. cat.	EG/ABE/EEC	Ø 76 mm	stainless steel polished	151182 097508
XB3, 109 kW			slip on (muffler with connecting tube) no cat.	Race (no EG/ABE/EEC)	Ø 76 mm	stainless steel polished	051182 097508

CUSTOM EXHAUST VICTORY CRUISERS

with EEC homologation



model	year	description	type	sleeve version	order no.
CRUISERS		2 x CUSTOM exhaust slash-cut incl. Cat. (top/bottom)	EG/ABE/EEC	stain-less steel chrome	007152 509013
Vegas 8-Ball	09-		EG/ABE/EEC	stain-less steel black	007752 509013
Vegas Zach Ness	12				
Vegas Jackpot	09-12				
Highball	12-				
Hammer 8-Ball	10-				
Hammer S	09-				
Boardwalk	12-				
Judge	12-				
Jackpot	10-				

Victory Boardwalk
slip on, slash cut



Victory Cross Roads
slip on, slash cut Ø 102 mm (4 inch)



CUSTOM EXHAUST VICTORY TOURING / BAGGERS

with EEC homologation



Modell / model	year	description	type	sleeve version	order no.
TOURING		2 x CUSTOM exhaust slash-cut (left/right)	EG/ABE/EEC	less steel chrome	007152 509113LR
Cross Country Tour	12-	incl. Cat. Ø 102 mm (4 inches)	EG/ABE/EEC	less steel black	007752 509113LR
Cory Ness Cross Country Tour	12				
BAGGERS					
Cross Country	10-				
Zach Ness Cross Country	13				
Hard-Ball	12-				
Cross Roads	10-12				
Cross Roads Classic	12-				
Cross Roads Deluxe	12				
Magnum	15-				
Magnum X-1	15-				

Victory Cross Roads Deluxe slip on, slash cut black Ø 102 mm (4 inch)



REMUS MoTo 2017



REMUS BLACK HAWK

with EEC homologation & Racing

MOTORRAD
TESTsieger
Ausgabe 16/2016



- Hexagonal geometry
- Width x height:
~ 105 x 137 mm
- Sleeve length from 350 to 420 mm,
depends on motorcycle
- Sleeve materials: Stainless steel black painted
- Inlet cap: Stainless steel
- End cap: Carbon
- Weight: from 1,96 kg



Ducati Hypermotard 939 SP
REMUS Black Hawk slip-on, Stainless steel black



REMUS HEXACONE

with EEC homologation & Racing



- Hexagonal geometry
- Width x height:
~ 105 x 137 mm
- Sleeve length from 250 to 420 mm, depends on motorcycle
- Sleeve materials: Stainless steel, Carbon, Titanium
- Inlet cap: Carbon
- End cap: Carbon
- Weight: from 1,54 kg

BMW R 1200 GS
REMUS HexaCone slip-on, Titanium



KTM 1290 Super Adventure
REMUS HexaCone slip-on, Stainless steel



REMUS HYPERCONE

with EEC homologation & Racing



EMPFEHLUNG
Motorrad-
fahrer
Ausgabe 9/2016

- Conical geometry
- Diameter:
up to ~ Ø 75 mm
- Sleeve length from 250 to 400 mm,
depends on motorcycle
- Sleeve materials: Stainless steel,
Stainless steel black, Carbon, Titanium
- Inlet cap: Stainless steel
- End cap: Carbon
- Weight: ab / from 1,28 kg

Ducati Monster 1200 R
REMUS HyperCone slip-on, Stainless steel black



Yamaha MT-10
REMUS HyperCone slip-on, Stainless steel



REMUS OKAMI

with EEC homologation & Racing



- Hexagonal geometry
- Width x height: ~105 x 137 mm
- Sleeve length from 250 to 420 mm, depends on motorcycle
- Sleeve materials: Stainless steel, Stainless steel black, Carbon, Titanium
- Inlet cap: Stainless steel
- End cap: Plastic compound material
- Weight: from 1,54 kg

Suzuki SV 650
REMUS Okami slip-on, Titanium



Honda - CRF 1000 L Africa Twin
REMUS Okami Stainless steel complete system



REMUS

Custom Exhaust



IT'S TIME
TO RIDE



CAN-bus controlled valve system

11 different end cap designs

Slip-on and complete systems

EEC homologation

REMUS MoTo 2017



CUSTOM BIKES
SCOOTER
STREETBIKES

REMUS
SPORTEXHAUST

REMUS INNOVATION

competence in motorbike sport exhaust systems

Since more than 25 years, high quality sport exhaust systems for motorbikes are produced and manufactured at REMUS.

Furthermore, REMUS produces OE components and complete OE exhaust systems for well known vehicle manufactures.

The REMUS Research and Development center offers extensive possibilities in the development of exhaust systems. Beside the mechanical and thermal design and optimization, the creation of the well known sonorous REMUS sound is one of the most important development targets.

The combination of high quality raw materials, modern machining and special process technologies together with highly qualified employees results in first class products of perfect shape and fitting accuracy.

*STAY TUNED!
YOUR REMUS TEAM*



CUSTOM BIKES



IT'S TIME
TO RIDE



CUSTOM EXHAUST SLIP-ON (OPTIMIZED)

with changeable end caps (with EC homologation)

**NEW
PRODUCT**



- Improved sound by third octave analysis
- Deeper sound at low frequencies
- Catalytic converter place in inlet unit
- Inlet unit equipped with heat shield
- Available for Harley-Davidson® Sportster, Dyna und Softail

**Choose between 6
different end caps**



EK80 / EK10 - SLASH CUT



EK81 / EK11 - STRAIGHT END



EK82 / EK12 - TAPERED

- Cylindrical geometry
- Diameter: Ø 84 mm
- Sleeve length 420 mm
- Sleeve material: Stainless steel
- Surface treatment: chrome plated or black coated
- Weight: 2,65 kg



CUSTOM EXHAUST

with changeable end caps (with EC homologation)



Choose between 9 different end caps



EK76 - SNIPER



EK72 / EK02 - PERFORATED



EK73 / EK03 - TAPERED



EK71 / EK01 - SLASH CUT



EK75 / EK05 - ROLLED UP

- Cylindrical geometry
- Diameter: Ø 84 mm
- Sleeve length ~ 405 mm
- Sleeve material: Stainless steel
- Surface treatment: chrome plated or black coated
- Weight: 2,65 kg

CUSTOM EXHAUST Touring Ø 102 mm (4inch)

with changeable end caps (with EC homologation)



- Cylindrical shape
- Diameter: Ø102 mm
- Sleeve length ~ 670 mm
- Sleeve materials: Stainless steel
- Surface treatment: Chrome
- Weight: 3,6kg



CUSTOM EXHAUST Complete systems

(with EC homologation)



Complete system 2-1 with conical exhaust



Complete system 2-1 with PowerCone exhaust

REMUS SC15 - ELECTRONIC SOUND CONTROL

for Sportster, Dyna, Softail and Touring

The latest electronic sound control system from REMUS, called SC15, is a CAN-bus controlled valve system, with a muffler integrated flap.

The control unit processes the CAN-bus signals and passes it via the actuator to the exhaust flap. This leads in dependence on engine parameters and drive conditions to an accurate triggering of the flap to optimize the sound under consideration of legal guidelines.

In addition to this the sound can be modulated via a handle bar mounted push button switch. In any situation the complex electronic ensures in dependency of rev, speed and gear the compliance with sound regulations stated in the EC homologation.

- for Sportster, Dyna & Softail



deactivating plug for serial valve (RACING - no EG/ABE/EEC)

- for Touring



- for Touring



- for selected models only



LED loop OFF
valve closed

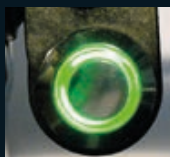

LED loop GREEN
valve 10% open



LED loop YELLOW
valve 40% open



LED loop RED
valve 100% open

- CAN-bus controlled valve system
- Sound modulation via push button switch
- Hot sound
- Selectable and changeable end caps
- EC homologation

REMUS CUSTOM EXHAUSTS

Model	Year	Description	Type	Sleeve	Order no.
HARLEY-DAVIDSON®					
XG1 Street 750	14-	1 x CUSTOM exhaust rolled up Ø 102 mm (4")	EG/ABE/EEC	stainless steel black	007702 270214
SPORTSTER, XR1		PowerCone complete system no cat. (header polished)	Sport (no EG/ABE/EEC)	stainless steel	015682 239308
XR 1200	08-	PowerCone complete system incl. cat. (header polished)	EG/ABE/EEC	stainless steel	115682 239308
XR 1200 X	09-	PowerCone complete system no cat. (header black)	Sport (no EG/ABE/EEC)	stainless steel black	015782 239308BS
		PowerCone complete system incl. cat. (header black)	EG/ABE/EEC	stainless steel black	115782 239308BS
SPORTSTER, XL2		PowerCone complete system incl. cat. (header black)	EG/ABE/EEC	stainless steel black	115782 239907BS
XL 883C Custom	07-13	CUSTOM exhaust and selectable end cap design only fits as a complete system			
XL 883L Sportster 883 Super Low		2 x CUSTOM exhaust incl cat., no end cap	EG/ABE/EEC	stainless steel chrome	007152 230507
XL 883N Iron			EG/ABE/EEC	stainless steel black	007752 230507
XL 883R Sportster 883 Roadster		Selectable end caps must be ordered separately			
XL 1200C Sportster 1200 Custom	07-13	end cap slash-cut (2 pcs.)		stainless steel chrome	EK01
XL 1200N Nightster		end cap slash-cut (2 pcs.)		stainless steel black	EK71
XL 1200V Sportster Seventy-Two	12-13	end cap perforated (2 pcs.)		stainless steel chrome	EK02
XL 1200X Forty-Eight	10-13	end cap perforated (2 pcs.)		stainless steel black	EK72
		end cap tapered (2 pcs.)		stainless steel chrome	EK03
		end cap tapered (2 pcs.)		stainless steel black	EK73
		end cap rolled up (2 pcs.)		stainless steel chrome	EK05
		end cap rolled up (2 pcs.)		stainless steel black	EK75
		end cap sniper (2 pcs.)		stainless steel black	EK76
		2 x CUSTOM exhaust Straight-thru slash-cut (front/rear)	Race (no EG/ABE/EEC)	stainless steel black	007703 239010
SPORTSTER, XL2		CUSTOM exhaust and selectable end cap design only fits as a complete system			
XL 883L Sportster 883 Super Low	14-	2 x CUSTOM exhaust, no cat., no end cap, inlet cap/catalyst heat protection shield in sleeve colour		stainless steel chrome	007152 210514
XL 883N Iron	14-			stainless steel black	007752 210514
XL 883R Sportster 883 Roadster	14-15	2 x CUSTOM exhaust, no cat., no end cap, inlet cap/catalyst heat protection shield in sleeve colour		stainless steel chrome	007152 280514
XL 1200C Sportster 1200 Custom	14-	*SC15 - (CAN-BUS actuated sound system)		stainless steel black	007752 280514
XL 1200C ANV 1200 Custom 110th Aniv. Edition	14-	EURO 3 catalytic converter set (2 pcs.)	EG/ABE/EEC		KAT013
XL 1200CA 1200 Custom Limited	14-	The exhaust system has an EEC approval, but is only authorised for road use in combination with the catalytic converter.			
XL 1200CB 1200 Custom Limited	14-	Selectable end caps must be ordered separately			
XL 1200V Sportster Seventy-Two	14-	end cap slash-cut (2 pcs.)		stainless steel chrome	EK10
XL 1200X Forty-Eight	14-	end cap slash-cut (2 pcs.)		stainless steel black	EK80
XL 1200T Super Low 1200	15-	end cap straight end (2 pcs.)		stainless steel chrome	EK11
		end cap straight end (2 pcs.)		stainless steel black	EK81
		end cap tapered (2 pcs.)		stainless steel chrome	EK12
		end cap tapered (2 pcs.)		stainless steel black	EK82
		Racing sound insert - set (2 pcs.) not for SC15!			DBMHD-02
		optional inlet cap/catalyst heat protection shield - set (2 pcs.)		stainless steel chrome	HBLHD1
				stainless steel black	HBLHD8
	"complete system (2-2) incl. end caps SNIPER			017702 280014	
	*SC15 - (CAN-BUS actuated sound system)"		stainless steel black	KAT013	
	catalytic converter set (2 pcs.)	EG/ABE/EEC			
				017702 282014	
	complete system (2-1) incl. conical CUSTOM exhaust		stainless steel black	KAT013	
	catalytic converter set (2 pcs.)	EG/ABE/EEC			

Street 750 slip on, rolled up



Sportster 48 complete system, end cap "sniper"



slip on



screw on



complete system

SPORT = Silencer with homologation number (sound level is within the tolerated limit), but without catalytic converter, therefore no EEC!

1) While stocks last! ***)** EC-approval only for vehicles with a registration date before 1st July 2004. Specifications in the registration document have to match the actual conditions, i.e. the omission of the catalyser has to be reported to the licensing authority! A warranty of 24 months is given on all systems with EC-approval. No warranty on racing products. No warranty is given for small colour changes of the carbon!

Technical changes and errors excepted!

Model	Year	Description	Type	Sleeve	Order no.
HARLEY-DAVIDSON®					
SPORTSTER, XL2 (Euro 4)					
CUSTOM exhaust and selectable end cap design only fits as a complete system					
XL1200C Custom	17-	2 x CUSTOM exhaust no cat., no end cap	EG/ABE/EEC	stainless steel chrome	007152 210517
XL1200X Forty-Eight	17-			stainless steel black	007752 210517
XL1200T Superlow	17-	2 x CUSTOM exhaust no cat., no end cap		stainless steel chrome	007152 280517
XL1200CX Roadster	17-	*SC15 - (CAN-BUS actuated sound system)		stainless steel black	007752 280517
		EURO 4 catalytic converter set (2 pcs.)			KAT020
The exhaust system has an EEC approval, but is only authorised for road use in combination with the catalytic converter.					
Selectable end caps must be ordered separately					
		end cap slash-cut (2 pcs.)		stainless steel chrome	EK10
		end cap slash-cut (2 pcs.)		stainless steel black	EK80
		end cap straight end (2 pcs.)		stainless steel chrome	EK11
		end cap straight end (2 pcs.)		stainless steel black	EK81
		end cap tapered (2 pcs.)		stainless steel chrome	EK12
		end cap tapered (2 pcs.)		stainless steel black	EK82
		Racing sound insert - set (2 pcs.) not for SC15!			DBMHD-02
		optional cat. cover - set (2 pcs.)			HBLHD1
					HBLHD8
DYNA, FD2					
CUSTOM exhaust and selectable end cap design only fits as a complete system					
FXDC Super Glide Custom	07-11	2 x CUSTOM exhaust no cat., no end cap, inlet cap/catalyst heat protection shield in sleeve colour	EG/ABE/EEC	stainless steel chrome	007152 210307
FXDB Street Bob				stainless steel black	007752 210307
FXDBA Street Bob Limited		EURO 3 catalytic converter set (2 pcs.)			KAT013
FXDL Low Rider	05-08	The exhaust system has an EEC approval, but is only authorised for road use in combination with the catalytic converter.			
FXDWG Wide Glide	07-08	Selectable end caps must be ordered separately			
		end cap slash-cut (2 pcs.)		stainless steel chrome	EK10
		end cap slash-cut (2 pcs.)		stainless steel black	EK80
		end cap straight end (2 pcs.)		stainless steel chrome	EK11
		end cap straight end (2 pcs.)		stainless steel black	EK81
		end cap tapered (2 pcs.)		stainless steel chrome	EK12
		end cap tapered (2 pcs.)		stainless steel black	EK82
		Racing sound insert - set (2 pcs.)			DBMHD-02
		optional inlet cap/catalyst heat protection shield - set (2 pcs.)		stainless steel chrome	HBLHD1
				stainless steel black	HBLHD8
		FLAP-KILL (deactivating plug for serial valve)	Race (no EG/ABE/EEC)		HD001

Sportster 48
2-1 complete system



Sportster 48
slip on, end cap "straight end"



Street Bob
slip on, end cap "rolled up"



SPORT = Silencer with homologation number (sound level is within the tolerated limit), but without catalytic converter, therefore no EEC!
 1) While stocks last! *1) EC-approval only for vehicles with a registration date before 1st July 2004. Specifications in the registration document have to match the actual conditions, i.e. the omission of the catalyser has to be reported to the licensing authority! A warranty of 24 months is given on all systems with EC-approval. No warranty on racing products. No warranty is given for small colour changes of the carbon!
Technical changes and errors excepted!



REMUS CUSTOM EXHAUSTS

Model	Year	Description	Type	Sleeve	Order no.
HARLEY-DAVIDSON®					
DYNA, FD2					
CUSTOM exhaust and selectable end cap design only fits as a complete system					
FXDC Super Glide Custom	12-14	2 x CUSTOM exhaust no cat., no end cap, inlet cap/catalyst heat protection shield in sleeve colour	EG/ABE/EEC	stainless steel chrome	007152 210307
FXDB Street Bob	12-			stainless steel black	007752 210307
FXDBA Street Bob Limited	12-	2 x CUSTOM exhaust no cat., no end cap, inlet cap/catalyst heat protection shield in sleeve colour		stainless steel chrome	007152 280312
FXDBC Street Bob Limited	16-	*SC15 - (CAN-BUS actuated sound system)		stainless steel black	007752 280312
		EURO 3 catalytic converter set (2 pcs.)			KAT013
The exhaust system has an EEC approval, but is only authorised for road use in combination with the catalytic converter.					
Selectable end caps must be ordered separately					
		end cap slash-cut (2 pcs.)		stainless steel chrome	EK10
		end cap slash-cut (2 pcs.)		stainless steel black	EK80
		end cap straight end (2 pcs.)		stainless steel chrome	EK11
		end cap straight end (2 pcs.)		stainless steel black	EK81
		end cap tapered (2 pcs.)		stainless steel chrome	EK12
		end cap tapered (2 pcs.)		stainless steel black	EK82
		Racing sound insert - set (2 pcs.) not for SC15!			DBMHD-02
		optional inlet cap/catalyst heat protection shield - set (2 pcs.)		stainless steel chrome	HBLHD1
				stainless steel black	HBLHD8
		FLAP-KILL (deactivating plug for serial valve)	Race (no EG/ABE/EEC)		HD001
DYNA, FD2					
CUSTOM exhaust and selectable end cap design only fits as a complete system					
FXDF Fat Bob	08-11	2 x CUSTOM exhaust, no cat., no end cap	EG/ABE/EEC	stainless steel chrome	007102 230408
FXDWG Wide Glide	09-11		EG/ABE/EEC	stainless steel black	007702 230408
Selectable end caps must be ordered separately					
		end cap slash-cut (2 pcs.)		stainless steel chrome	EK01
		end cap slash-cut (2 pcs.)		stainless steel black	EK71
		end cap perforated (2 pcs.)		stainless steel chrome	EK02
		end cap perforated (2 pcs.)		stainless steel black	EK72
		end cap tapered (2 pcs.)		stainless steel chrome	EK03
		end cap tapered (2 pcs.)		stainless steel black	EK73
		end cap rolled up (2 pcs.)		stainless steel chrome	EK05
		end cap rolled up (2 pcs.)		stainless steel black	EK75
		end cap sniper (2 pcs.)		stainless steel black	EK76
		FLAP-KILL (deactivating plug for serial valve)	Race (no EG/ABE/EEC)		HD001

Low Rider
slip on, "slash cut"



Fat Bob
slip on, end cap "tapered"



SPORT = Silencer with homologation number (sound level is within the tolerated limit), but without catalytic converter, therefore no EEC!

1) While stocks last! ***)** EC-approval only for vehicles with a registration date before 1st July 2004. Specifications in the registration document have to match the actual conditions, i.e. the omission of the catalyser has to be reported to the licensing authority! A warranty of 24 months is given on all systems with EC-approval. No warranty on racing products. No warranty is given for small colour changes of the carbon!

Technical changes and errors excepted!

Model	Year	Description	Type	Sleeve	Order no.	
HARLEY-DAVIDSON®						
DYNA, FD2		CUSTOM exhaust and selectable end cap design only fits as a complete system				
FXDF Fat Bob	12-	2 x CUSTOM exhaust, no cat., no end cap	EG/ABE/EEC	stainless steel chrome	007102 230408	
FXDWG Wide Glide			EG/ABE/EEC	stainless steel black	007702 230408	
		2 x CUSTOM exhaust, no cat., no end cap	EG/ABE/EEC	stainless steel chrome	007102 290412	
		*SC15 - (CAN-BUS actuated sound system)	EG/ABE/EEC	stainless steel black	007702 290412	
		Selectable end caps must be ordered separately				
		end cap slash-cut (2 pcs.)		stainless steel chrome	EK01	
		end cap slash-cut (2 pcs.)		stainless steel black	EK71	
		end cap perforated (2 pcs.)		stainless steel chrome	EK02	
		end cap perforated (2 pcs.)		stainless steel black	EK72	
		end cap tapered (2 pcs.)		stainless steel chrome	EK03	
		end cap tapered (2 pcs.)		stainless steel black	EK73	
		end cap rolled up (2 pcs.)		stainless steel chrome	EK05	
		end cap rolled up (2 pcs.)		stainless steel black	EK75	
		end cap sniper (2 pcs.)		stainless steel black	EK76	
	FLAP-KILL (deactivating plug for serial valve)	Race (no EG/ABE/EEC)		HD001		
DYNA, FD2		CUSTOM exhaust and selectable end cap design only fits as a complete system				
FLD Switchback	11-	1 x CUSTOM exhaust slash-cut (heat protection shield for Low Rider must be ordered separately)	EG/ABE/EEC	stainless steel chrome	007102 229011	
			EG/ABE/EEC	stainless steel black	007702 229011	
FXDL Low Rider	14-	1 x CUSTOM exhaust straight end (heat protection shield for Low Rider must be ordered separately)	EG/ABE/EEC	stainless steel chrome	007102 229211	
			EG/ABE/EEC	stainless steel black	007702 229211	
		1 x CUSTOM exhaust Straight-thru slash-cut (heat protection shield for Low Rider must be ordered separately)	Race (no EG/ABE/EEC)	stainless steel chrome	007103 229011	
		heat protection shield for FXDL Low Rider		stainless steel chrome	229011HBL	
SOFTAIL, FS2		CUSTOM exhaust and selectable end cap design only fits as a complete system				
FLSTC Heritage Softail Classic	07-10	2 x CUSTOM exhaust, no cat., no end cap, inlet cap/catalyst heat protection shield in sleeve colour		stainless steel chrome	007152 210107	
FXSTB Night Train				stainless steel black	007752 210107	
FXSTC Softail Custom		EURO 3 catalytic converter set (2 pcs.)	EG/ABE/EEC		KAT013	
FXCW Rocker		The exhaust system has an EEC approval, but is only authorised for road use in combination with the catalytic converter.				
FXCWC Rocker C		Selectable end caps must be ordered separately				
		end cap slash-cut (2 pcs.)		stainless steel chrome	EK10	
		end cap slash-cut (2 pcs.)		stainless steel black	EK80	
		end cap straight end (2 pcs.)		stainless steel chrome	EK11	
		end cap straight end (2 pcs.)		stainless steel black	EK81	
		end cap tapered (2 pcs.)		stainless steel chrome	EK12	
	end cap tapered (2 pcs.)		stainless steel black	EK82		
	Racing sound insert - set (2 pcs.)			DBMHD-02		
	optional inlet cap/catalyst heat protection shield - set (2 pcs.)		stainless steel chrome	HBLHD1		
			stainless steel black	HBLHD8		
	FLAP-KILL (deactivating plug for serial valve)	Race (no EG/ABE/EEC)		HD001		

Switchback
slip on, straight end



Softail Deluxe
slip on, end cap "perforated"



SPORT = Silencer with homologation number (sound level is within the tolerated limit), but without catalytic converter, therefore no EEC!
1) While stocks last! 2) EC-approval only for vehicles with a registration date before 1st July 2004. Specifications in the registration document have to match the actual conditions, i.e. the omission of the catalyser has to be reported to the licensing authority! A warranty of 24 months is given on all systems with EC-approval. No warranty on racing products. No warranty is given for small colour changes of the carbon!
Technical changes and errors excepted!



complete system



screw on



slip on

REMUS CUSTOM EXHAUSTS

Model	Year	Description	Type	Sleeve	Order no.
HARLEY-DAVIDSON®					
SOFTAIL, FS2					
CUSTOM exhaust and selectable end cap design only fits as a complete system					
FLSTC Heritage Softail Classic	11-	2 x CUSTOM exhaust, no cat., no end cap, inlet cap/catalyst heat protection shield in sleeve colour	EG/ABE/EEC	stainless steel chrome	007152 210107
FXCWC Rocker C	11			stainless steel black	007752 210107
FXSB Breakout	13-	2 x CUSTOM exhaust no cat., no end cap, inlet cap/catalyst heat protection shield in sleeve colour		stainless steel chrome	007152 280111
FXSBSE Breakout CVO	14	*SC15 - (CAN-BUS actuated sound system)		stainless steel black	007752 280111
FLSTNSE CVO Softail Deluxe	14-15	EURO 3 catalytic converter set (2 pcs.)			KAT013
The exhaust system has an EEC approval, but is only authorised for road use in combination with the catalytic converter.					
Selectable end caps must be ordered separately					
end cap slash-cut (2 pcs.)				stainless steel chrome	EK10
end cap slash-cut (2 pcs.)				stainless steel black	EK80
end cap straight end (2 pcs.)				stainless steel chrome	EK11
end cap straight end (2 pcs.)				stainless steel black	EK81
end cap tapered (2 pcs.)				stainless steel chrome	EK12
end cap tapered (2 pcs.)				stainless steel black	EK82
Racing sound insert - set (2 pcs.) not for SC15!					DBMHD-02
optional inlet cap/catalyst heat protection shield - set (2 pcs.)				stainless steel chrome	HBLHD1
				stainless steel black	HBLHD8
FLAP-KILL (deactivating plug for serial valve) - not for CVO - models			Race (no EG/ABE/EEC)		HD001
SOFTAIL, FS2					
CUSTOM exhaust and selectable end cap design only fits as a complete system					
FLSTF Fat Boy	07-	2 x CUSTOM exhaust, no cat., no end cap, inlet cap/catalyst heat protection shield in sleeve colour	EG/ABE/EEC	stainless steel chrome	007152 210007
FLSTFB Fat Boy Special	09-			stainless steel black	007752 210007
Fat Boy S	16-	EURO 3 catalytic converter set (2 pcs.)			
The exhaust system has an EEC approval, but is only authorised for road use in combination with the catalytic converter.					
Selectable end caps must be ordered separately					
end cap slash-cut (2 pcs.)				stainless steel chrome	EK10
end cap slash-cut (2 pcs.)				stainless steel black	EK80
end cap straight end (2 pcs.)				stainless steel chrome	EK11
end cap straight end (2 pcs.)				stainless steel black	EK81
end cap tapered (2 pcs.)				stainless steel chrome	EK12
end cap tapered (2 pcs.)				stainless steel black	EK82
Racing sound insert - set (2 pcs.) not for SC15!					DBMHD-02
optional inlet cap/catalyst heat protection shield - set (2 pcs.)				stainless steel chrome	HBLHD1
				stainless steel black	HBLHD8
FLAP-KILL (deactivating plug for serial valve)			Race (no EG/ABE/EEC)		HD001

Heritage Softail
slip on, end cap "perforated"



Breakout
slip on, end cap "slash cut"



slip on



screw on



complete system

SPORT = Silencer with homologation number (sound level is within the tolerated limit), but without catalytic converter, therefore no EEC!

1) While stocks last! ***)** EC-approval only for vehicles with a registration date before 1st July 2004. Specifications in the registration document have to match the actual conditions, i.e. the omission of the catalyser has to be reported to the licensing authority! A warranty of 24 months is given on all systems with EC-approval. No warranty on racing products. No warranty is given for small colour changes of the carbon!

Technical changes and errors excepted!

Model	Year	Description	Type	Sleeve	Order no.
HARLEY-DAVIDSON®					
SOFTAIL, FS2					
CUSTOM exhaust and selectable end cap design only fits as a complete system					
FLSTN Softail Deluxe	07-10	2 x CUSTOM exhaust, no cat., no end cap, inlet cap/catalyst heat protection shield in sleeve colour		stainless steel chrome	007152 210211
FLSTSB Cross Bones	08-10			stainless steel black	007752 210211
		EURO 3 catalytic converter set (2 pcs.)	EG/ABE/EEC		KAT013
The exhaust system has an EEC approval, but is only authorised for road use in combination with the catalytic converter.					
Selectable end caps must be ordered separately					
		end cap slash-cut (2 pcs.)		stainless steel chrome	EK10
		end cap slash-cut (2 pcs.)		stainless steel black	EK80
		end cap straight end (2 pcs.)		stainless steel chrome	EK11
		end cap straight end (2 pcs.)		stainless steel black	EK81
		end cap tapered (2 pcs.)		stainless steel chrome	EK12
		end cap tapered (2 pcs.)		stainless steel black	EK82
		Racing sound insert - set (2 pcs.) not for SC15!			DBMHD-02
		optional inlet cap/catalyst heat protection shield - set (2 pcs.)		stainless steel chrome	HBLHD1
				stainless steel black	HBLHD8
		FLAP-KILL (deactivating plug for serial valve)	Race (no EG/ABE/EEC)		HD001
SOFTAIL, FS2					
CUSTOM exhaust and selectable end cap design only fits as a complete system					
FLSTN Softail Deluxe	11-	2 x CUSTOM exhaust, no cat., no end cap, inlet cap/catalyst heat protection shield in sleeve colour		stainless steel chrome	007152 210211
FLS Softail Slim	12-			stainless steel black	007752 210211
FLSTSB Cross Bones	11	2 x CUSTOM exhaust, no cat., no end cap, inlet cap/catalyst heat protection shield in sleeve colour		stainless steel chrome	007152 280211
FXS Blackline	11-13	*SC15 - (CAN-BUS actuated sound system)		stainless steel black	007752 280211
FLSS Softail Slim S	16-	EURO 3 catalytic converter set (2 pcs.)	EG/ABE/EEC		KAT013
The exhaust system has an EEC approval, but is only authorised for road use in combination with the catalytic converter.					
Selectable end caps must be ordered separately					
		end cap slash-cut (2 pcs.)		stainless steel chrome	EK10
		end cap slash-cut (2 pcs.)		stainless steel black	EK80
		end cap straight end (2 pcs.)		stainless steel chrome	EK11
		end cap straight end (2 pcs.)		stainless steel black	EK81
		end cap tapered (2 pcs.)		stainless steel chrome	EK12
		end cap tapered (2 pcs.)		stainless steel black	EK82
		Racing sound insert - set (2 pcs.) not for SC15!			DBMHD-02
		optional inlet cap/catalyst heat protection shield - set (2 pcs.)		stainless steel chrome	HBLHD1
				stainless steel black	HBLHD8
		FLAP-KILL (deactivating plug for serial valve)	Race (no EG/ABE/EEC)		HD001

Softail Slim S
slip on, end cap "slash cut"



Softail Slim S
slip on, end cap "slash cut"



SPORT = Silencer with homologation number (sound level is within the tolerated limit), but without catalytic converter, therefore no EEC!
1) While stocks last! ***)** EC-approval only for vehicles with a registration date before 1st July 2004. Specifications in the registration document have to match the actual conditions, i.e. the omission of the catalyser has to be reported to the licensing authority! A warranty of 24 months is given on all systems with EC-approval. No warranty on racing products. No warranty is given for small colour changes of the carbon!
Technical changes and errors excepted!



REMUS CUSTOM EXHAUSTS

Model	Year	Description	Type	Sleeve	Order no.	
HARLEY-DAVIDSON®						
TOURING, FL2						
CUSTOM exhaust and selectable end cap design only fits as a complete system						
FLHR Road King	09-1	2 x CUSTOM exhaust Ø 102 mm (4") no cat., no end cap	EG/ABE/EEC	stainless steel chrome	007102 272009LR	
FLHRC Road King Classic				EG/ABE/EEC	stainless steel black	007702 272009LR
FLHT Electra Glide		Selectable end caps must be ordered separately				
FLHTC Electra Glide Custom		end cap slash-cut (2 pcs.)			stainless steel chrome	EK20
FLHTCU Ultra Classic Electra Glide		end cap slash-cut (2 pcs.)			stainless steel black	EK90
FLHX Street Glide		end cap straight end (2 pcs.)			stainless steel chrome	EK21
FLTRX Road Glide Custom		end cap straight end (2 pcs.)			stainless steel black	EK91
FLHTK Electra Glide Ultra Limited		header (2-2) no cat. instead of OE header		Race (no EG/ABE/EEC)		0101 270014
FLHP Road King Police		(not combinable with ECS)				
FLHTP Electra Glide Police		FLAP-KILL (deactivating plug for serial valve) - not for CVO - models		Race (no EG/ABE/EEC)		HD001
FLTRU Road Glide Ultra						
FLHTCUSE CVO Ultra Classic Electra Glide						
FLHXSE CVO Street Glide						
FLTRUSE CVO Road Glide Ultra						
FLTRXSE CVO Road Glide						
FLHRSE CVO Road King						
TOURING, FL3						
CUSTOM exhaust and selectable end cap design only fits as a complete system						
FLHTK Electra Glide Ultra Limited	14	2 x CUSTOM exhaust Ø 102 mm (4") no cat., no end cap	EG/ABE/EEC	stainless steel chrome	007102 272009LR	
FLHTP Electra Glide Police	14		EG/ABE/EEC	stainless steel black	007702 272009LR	
FLHXS Street Glide Special	14	2 x CUSTOM exhaust Ø 102 mm (4") no cat., no end cap	EG/ABE/EEC	stainless steel chrome	007102 292014LR	
FLHRC Road King Classic	14-	*SC15 - (CAN-BUS actuated sound system)	EG/ABE/EEC	stainless steel black	007702 292014LR	
FLHX Street Glide	14-	Selectable end caps must be ordered separately				
FLHTCU TC Electra Glide Ultra Classic	14-	end cap slash-cut (2 pcs.)		stainless steel chrome	EK20	
FLTRXS Road Glide Special	14-	end cap slash-cut (2 pcs.)		stainless steel black	EK90	
FLHTKSE CVO Ultra Limited	14-	end cap straight end (2 pcs.)		stainless steel chrome	EK21	
FLHTSE CVO Road King	14-15	end cap straight end (2 pcs.)		stainless steel black	EK91	
FLTRUSE CVO Road Glide Ultra	15-	header (2-2) no cat. instead of OE header	Race (no EG/ABE/EEC)		0101 270014	
FLHXSE CVO Street Glide	15-					
FLHTCUL TC Electra Glide Ultra Classic Low	15-	FLAP-KILL (deactivating plug for serial valve) - not for CVO - models	Race (no EG/ABE/EEC)		HD001	
FLHTKL Electra Glide Ultra Limited Low	15-					
Road King	16-					
Road Glide Ultra	16-					



Road Glide
slip on, Ø 102 mm end cap "straight end"



Krümmer (2-2) ohne Kat,
anstelle Serienkrümmer /
header (2-2) no cat.
instead of OE header



slip on



screw on

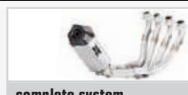

complete system

SPORT = Silencer with homologation number (sound level is within the tolerated limit), but without catalytic converter, therefore no EEC!

1) While stocks last! ***)** EC-approval only for vehicles with a registration date before 1st July 2004. Specifications in the registration document have to match the actual conditions, i.e. the omission of the catalyser has to be reported to the licensing authority! A warranty of 24 months is given on all systems with EC-approval. No warranty on racing products. No warranty is given for small colour changes of the carbon!

Technical changes and errors excepted!

Model	Year	Description	Type	Sleeve	Order no.
HARLEY-DAVIDSON®					
TOURING, FL3 (Euro 4),					
CUSTOM exhaust and selectable end cap design only fits as a complete system					
Milwaukee Eight		2 x CUSTOM exhaust Ø 102 mm (4") no cat., no end cap	EG/ABE/EEC	stainless steel chrome	007102 272017LR
FLHR Road King	17-			stainless steel black	007702 272017LR
FLHRC Road King Classic	17-	RACING Sound insert	Race (no EG/ABE/EEC)		DBMHD01
FLHXS Street Glide Special	17-	2 x CUSTOM exhaust Ø 102 mm (4") no cat., no end cap	EG/ABE/EEC	stainless steel chrome	007102 292017LR
FLTRXS Road Glide Special	17-	*SC15 - (CAN-BUS actuated sound system)		stainless steel black	007702 292017LR
FLTRU Road Glide Ultra	17-	Selectable end caps must be ordered separately			
FLHTK Electra Glide Ultra Limited	17-	end cap slash-cut (2 pcs.)		stainless steel chrome	EK22
FLHTKL Electra Glide Ultra Limited Low	17-	end cap slash-cut (2 pcs.)		stainless steel black	EK92
		end cap straight end (2 pcs.)		stainless steel chrome	EK23
		end cap straight end (2 pcs.)		stainless steel black	EK93
		header (2-2) no cat. instead of OE header (OE heat shields will be used)	Race (no EG/ABE/EEC)		0101 270017
		FLAP-KILL (deactivating plug for serial valve) - not for CVO - models	Race (no EG/ABE/EEC)		HD001
VRSC, VR2		2 x CUSTOM exhaust slash-cut (top/bottom)	EG/ABE/EEC	stainless steel chrome	007102 239005
VRSCR Street Rod	05-07	Attention: not for V-Rod VRSCA	EG/ABE/EEC	stainless steel black	007702 239005
VRSC, VR1					
VRSCD Night Rod	05-				
VRSCDX Night Rod Special	07-				
VRSC, VR1		2 x CUSTOM exhaust slash-cut (top/bottom)	EG/ABE/EEC	stainless steel chrome	007102 239005
VRSCD Night Rod	07-		EG/ABE/EEC	stainless steel black	007702 239005
VRSCDX Night Rod Special	12-	2 x CUSTOM exhaust Ø 102 mm (4"), no end cap	EG/ABE/EEC	stainless steel black	007702 279005
		Selectable end caps must be ordered separately			
		end cap slash-cut (2 pcs.)		stainless steel chrome	EK20
		end cap slash-cut (2 pcs.)		stainless steel black	EK90BV
		end cap straight end (2 pcs.)		stainless steel chrome	EK21
		end cap straight end (2 pcs.)		stainless steel black	EK91BV
		complete system (2-2) incl. cat.	EG/ABE/EEC	stainless steel black	117752 238012

CVO Ultra Limited slip on, Ø 102 mm end cap "slash cut"



Night-Rod Special 2-2 complete system



Night-Rod Special slip on, Ø 102 mm end cap "rolled up" short version



SPORT = Silencer with homologation number (sound level is within the tolerated limit), but without catalytic converter, therefore no EEC!
 1) While stocks last! *) EC-approval only for vehicles with a registration date before 1st July 2004. Specifications in the registration document have to match the actual conditions, i.e. the omission of the catalyser has to be reported to the licensing authority! A warranty of 24 months is given on all systems with EC-approval. No warranty on racing products. No warranty is given for small colour changes of the carbon!
Technical changes and errors excepted!



BUELL SPORTEXHAUSTS

with EC homologation



- Width x height: ~ 190 x 130 mm
- Muffler length ~ 800 mm
- Sleeve material: Stainless steel
- Surface treatment: shot blasted matt /black coated / electrolytic polished
- Weight: 8,2 kg

Modell	Bj.	Ø mm		Typ		Mantel	Bestell Nr.
Buell							
XB-12R Firebolt	04-		slip on left/right (muffler)	EG/ABE/EEC	2x Ø94mm rund	stainless steel polished	092782 098004LR
XB-12S Lightning				EG/ABE/EEC	2x Ø94mm rund	stainless steel matt	092782 098004LRM
XB1, 74.6 kW							
XB-12Ss Lightning	05-						
XB2, 74.6 kW							
XB-9SX Lightning	08-		slip on left/right (muffler) Stainless steel belt cover for XB2 models	EG/ABE/EEC	2x Ø 90 mm rund	stainless steel black	092782 098008LRB
XB1, 60 kW					Abdeckung/cover	stainless steel black	098008B
XB-12S Lightning	08-						
XB-12Scg Lightning	08-						
XB-1, 70 kW							
XB-12XT, XB-12X							
XB-12Ss Lightning	08-						
XB-12STT Lightning	08-						
XB2, 70 kW							

XB-12STT slip on



XB-12STT slip on



slip on



screw on



complete system

SPORT = Silencer with homologation number (sound level is within the tolerated limit), but without catalytic converter, therefore no EEC!

1) While stocks last! ***)** EC-approval only for vehicles with a registration date before 1st July 2004. Specifications in the registration document have to match the actual conditions, i.e. the omission of the catalyser has to be reported to the licensing authority! A warranty of 24 months is given on all systems with EC-approval. No warranty on racing products. No warranty is given for small colour changes of the carbon!

Technical changes and errors excepted!

CUSTOM EXHAUST CRUISERS / TOURING / BAGGERS

with EC homologation



Modell	Bj.		Typ	Mantel	Bestell-Nr.
VICTORY					
CRUISERS		2 x CUSTOM exhaust slash-cut incl. Cat. (top/bottom)	EG/ABE/EEC	stainless steel chrome	007152 509013
Vegas 8-Ball	09-		EG/ABE/EEC	stainless steel black	007752 509013
Vegas Zach Ness	12				
Vegas Jackpot	09-12				
Highball	12-				
Hammer 8-Ball	10-				
Hammer S	09-				
Boardwalk	12-				
Judge	12-				
Jackpot	10-				
TOURING		2 x CUSTOM exhaust slash-cut (left/right) incl. Cat. Ø 102 mm (4 inches)	EG/ABE/EEC	stainless steel chrome	007152 509113LR
Cross Country Tour	12-		EG/ABE/EEC	stainless steel black	007752 509113LR
Cory Ness Cross Country Tour	12				
BAGGERS					
Cross Country	10-				
Zach Ness Cross Country	13				
Hard-Ball	12-				
Cross Roads	10-12				
Cross Roads Classic	12-				
Cross Roads Deluxe	12				
Magnum	15-				
Magnum X-1	15-				

Victory Boardwalk
slip on, slash cut



Victory Cross Roads
slip on, slash cut Ø 102 mm (4 inch)



SPORT = Silencer with homologation number (sound level is within the tolerated limit), but without catalytic converter, therefore no EEC!
1) While stocks last! ***)** EC-approval only for vehicles with a registration date before 1st July 2004. Specifications in the registration document have to match the actual conditions, i.e. the omission of the catalyser has to be reported to the licensing authority! A warranty of 24 months is given on all systems with EC-approval. No warranty on racing products. No warranty is given for small colour changes of the carbon!
Technical changes and errors excepted!



SCOOTER



RSC DUAL FLOW SPORTEXHAUST

with EC homologation & Racing



- Double-Cylindrical shape
- Diameter: 2x Ø 84 mm
- Sleeve length: 220mm
- Sleeve materials: Stainless steel, Stainless steel black, Carbon
- Inlet cap: Stainless steel
- End cap: Plastic compound material
- Weight: ab / from 2,30 kg

Vespa GTS 300 ie Super
REMUS RSC dual flow Slip on



including EC homologation



EDIZIONE SPORTIVA

REMUS RSC dual flow & REMUS Performance air filter.



Package includes a REMUS RSC dual flow sport exhaust and a free REMUS Performance air filter.

SCOOTER SPORTEXHAUST

with EC homologation & Racing



- Hexagonal geometry
- Width x height:
~ 105 x 137 mm
- Sleeve length:
250 - 300 mm, (depends on motorcycle)
- Sleeve materials: Stainless steel, Stainless steel black, Carbon
- Inlet cap: Stainless steel
- End cap: Plastic compound material
- Weight: ab / from 2,82 kg



RSC SPORTEXHAUST

with EC homologation & Racing



- oval shape
- Width x height:
~ 100 x 134 mm
- Sleeve length: 250 - 300 mm,
(depends on motorcycle)
- Sleeve materials: Stainless steel and Carbon
- Inlet cap: Stainless steel highly polished
- End cap: Plastic compound material with REMUS Logo
- Weight: ab / from 1,70 kg



BRAKE LEVERS

Individually adjustable



suitable for:

GT 125: 03-07, GT 200: 03-06, GTS 125: 07, GTS 250: 05, GTS 300: 08, GTV 125: 07, GTV 250: 06, GTV 300: 08, LX 125: 05, LX 150: 05, LX 250: 05, LX 125: 11, LX 150: 11, Primavera 50 2T: 13, Primavera 50 4T: 13, Primavera 125 4T 3V: 13, Primavera 150 4T 3V: 13, Sprint 50 2T: 14, Sprint 50 4T: 14, Sprint 125 4T: 14



- Lever position adjustable in 20 positions
- CNC machined from high grade aluminium
- Stainless steel hardware
- Lever length continuously variable
- black or titanium anodized
- with EC homologation

REMUS SCOOTER

Model	Year	Ø mm	Description	Type	Muffler	Sleeve	Order no.
BMW							
C 600 Sport	12-15		slip on (muffler)	EG/ABE/EEC	HEXACONE	titanium	094882 084012
C 650 GT							
C650 Sport	16-16	54	slip on (muffler with connecting tube)	EG/ABE/EEC	HEXACONE	stainless steel	054682 084516
C650 GT				EG/ABE/EEC	HEXACONE	carbon	054482 084516
3C65 , 44kW				EG/ABE/EEC	HEXACONE	titanium	054882 084516
				EG/ABE/EEC	BLACK HAWK	stainless steel black	0564782 084516
HONDA							
Integra 700	12-	54	slip on (muffler with connecting tube)	EG/ABE/EEC	Sportexhaust	stainless steel	0524682 254512
38 kW				EG/ABE/EEC	Sportexhaust	carbon	0524482 254512
PIAGGIO							
Beverly 300ie	11-	55	"complete system incl. heat shield (only incl. catalytic converter street-legal)"	EG/ABE/EEC	Sportexhaust	stainless steel	0124682 751611
M69, 16.3 kW			The exhaust system has an EEC approval, but is only authorised for road use in combination with the catalytic converter.				
Beverly 350 ie	12-	55	slip on (muffler with connecting tube) no cat. incl. heat shield	Race (no EG/ABE/EEC)	Sportexhaust	stainless steel	0524683 751812
MP3 Sport 500 ie LT	14-	55	slip on (muffler with connecting tube) incl. heat protection shield	EG/ABE/EEC	Sportexhaust	stainless steel	0524682 753015
MP3 Business 500 ie LT			(only incl. catalytic converter street-legal)		Sportexhaust	stainless steel black	0524782 753015
29.5 kW			Sportexhaust		carbon	0524482 753015	
			catalytic converter		KAT010		
SUZUKI							
Burgman 200	10-	55	"slip on (muffler with connecting tube) incl. heat shield (only incl. catalytic converter street-legal)"		Sportexhaust	Edelstahl	0524682 851510
13.5 kW			Sportexhaust		stainless steel	KAT010	
The exhaust system has an EEC approval, but is only authorised for road use in combination with the catalytic converter.							

BMW C 650 Sport
Black Hawk



BMW C 650 GT
HexaCone



HONDA Integra 700
Scooter Sportexhaust



Piaggio Beverly 350 ie
Scooter Sportexhaust



Piaggio MP3 Sport 500 ie LT
Scooter Sportexhaust



SUZUKI Burgman 200
Scooter Sportexhaust



slip on



screw on

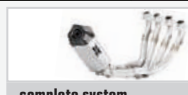

complete system

SPORT = Silencer with homologation number (sound level is within the tolerated limit), but without catalytic converter, therefore no EEC!

1) While stocks last! ***)** EC-approval only for vehicles with a registration date before 1st July 2004. Specifications in the registration document have to match the actual conditions, i.e. the omission of the catalyser has to be reported to the licensing authority! A warranty of 24 months is given on all systems with EC-approval. No warranty on racing products. No warranty is given for small colour changes of the carbon!

Technical changes and errors excepted!

Model	Year	Ø mm	Description	Type	Muffler	Sleeve	Order no.
VESPA							
LXV 125	09-	55	complete system - no cat. no heat shield	SPORT	Sportexhaust	stainless steel	0124682 751110
LX 125 ie 7.9 kW	11-						
SX 125 ie 7.9 kW	11-						
125 / GTS 125	09-	55	slip on (muffler with connecting tube) no cat. incl. heat shield	SPORT	Sportexhaust	stainless steel	0524682 751010
GT 200 14.6 kW	03-05	55	slip on (muffler with connecting tube) no cat. VESPA brake levers left and right lever position and length adjustable, engraved REMUS logo	SPORT	Sportexhaust	stainless steel black anodized red anodized titanium anodized	0524682 751405 750012S-LR 750012R-LR 750012T-LR
GTS 125 ie Super M45, 11 kW	09-	55	slip on (silencer incl. connecting tube) no heat shield (only incl. catalytic converter street-legal)		Scooter RSC	Stainless steel Carbon	0534682 752510 0534482 752510
GTS 250 ie M45, 15.7 kW	05-		slip on (muffler with connecting tube) incl. heat shield (only incl. catalytic converter street-legal)		Sportexhaust	stainless steel	0524682 751610
GTV 250 ie M45, 15.7 kW	06-				Sportexhaust	stainless steel black	0524782 751610
GTS 300 ie M45, 15.7 kW	08-		slip on (silencer incl. connecting tube) incl. heat shield (only incl. catalytic converter street-legal)		Scooter RSC	carbon	0524482 751610
GTS 300 ie Super M45, 15.8 kW					RSC Dual Flow	Stainless steel	0554682 751508
					RSC Dual Flow	stainless steel black	0554782 751508
					RSC Dual Flow	Carbon	0554482 751508
					RSC Dual Flow	Stainless steel	0554682 751508ES
					RSC Dual Flow	stainless steel black	0554782 751508ES
					RSC Dual Flow	Carbon	0554482 751508ES
			catalytic converter	EG/ABE/EEC			KAT010
			RACING sound insert for Sportexhaust	Race (no EG/ABE/EEC)			DBM201V
			RACING sound insert for Scooter RSC	Race (no EG/ABE/EEC)			DBM202V
			RACING sound insert for lower RCS Dual Flow	Race (no EG/ABE/EEC)			DBM219SV
			VESPA brake levers left and right lever position and length adjustable, engraved REMUS logo			black anodized red anodized titanium anodized	750012S-LR 750012R-LR 750012T-LR
The exhaust system has an EEC approval, but is only authorised for road use in combination with the catalytic converter.							
GTS 300 ie Super MA3C, 15,6 kW (Euro 4)	16-		in preparation				

Vespa GTS 125 ie
Scooter Sportexhaust

Vespa GTS 300 ie
Dual Flow

Vespa GTS 300 ie Super
Scooter Sportexhaust



SPORT = Silencer with homologation number (sound level is within the tolerated limit), but without catalytic converter, therefore no EEC!
 1) While stocks last! *) EC-approval only for vehicles with a registration date before 1st July 2004. Specifications in the registration document have to match the actual conditions, i.e. the omission of the catalyser has to be reported to the licensing authority! A warranty of 24 months is given on all systems with EC-approval. No warranty on racing products. No warranty is given for small colour changes of the carbon!
Technical changes and errors excepted!



REMUS SCOOTER

Model	Year	Ø mm	Description	Type	Muffler	Sleeve	Order no.	
VESPA								
946 8.5 kW	13-	55	complete system no cat. incl. carbon heat protecting shield	EG/ABE/EEC	Sportexhaust	stainless steel	0124682 751113	
			(only incl. catalytic converter street-legal)		Sportexhaust	stainless steel black	0124782 751113	
					Sportexhaust	carbon	0124482 751113	
			catalytic converter			KAT010		
The exhaust system has an EEC approval, but is only authorised for road use in combination with the catalytic converter.								
			RACING sound insert for Sportexhaust	Race (no EG/ABE/EEC)			DBM201V	
Vespa Primavera 125ie 3V Vespa Sprint 125ie 3V 7.9 kW LX 125 ie 3V LX 125 ie 3V Touring S 125 ie 3V (LXS 125 ie 3V) S 125 ie 3V Sport (LXS Sport 125 ie 3V) 8.5 kW	14-	55	complete system no heat shield	EG/ABE/EEC	Scooter RSC	stainless steel	0134682 752114	
	14-		(only incl. catalytic converter street-legal)		Scooter RSC	carbon	0134482 752114	
			catalytic converter				KAT010	
		12-		RACING sound insert for Scooter RSC	Race (no EG/ABE/EEC)		DBM202V	
		12-	65	complete system no cat. incl. heat shield	EG/ABE/EEC	Sportexhaust	stainless steel	0124682 751114
	(only incl. catalytic converter street-legal)			Sportexhaust		stainless steel black	0124782 751114	
				Sportexhaust		carbon	0124482 751114	
	catalytic converter					KAT010		
				RACING sound insert for Sportexhaust	Race (no EG/ABE/EEC)		DBM201V	
	The exhaust system has an EEC approval, but is only authorised for road use in combination with the catalytic converter.							
			VESPA brake levers left and right			black anodized	750014S-LR	
			lever position and length adjustable and engraved REMUS logo			titanium anodized	750014T-LR	
Vespa Primavera 125ie 3V Vespa Sprint 125ie 3V MA1A, 7.9 kW , (Euro 4)	16-	65	complete system no heat shield (only incl. catalytic converter street-legal)	EG/ABE/EEC	Scooter RSC	stainless steel	0134682 752116	
	16-				Scooter RSC	carbon	0134482 752116	
			catalytic converter (EURO 4)				KAT019	
			RACING sound insert for Scooter RSC	Race (no EG/ABE/EEC)			DBM202V	
		12-	65	complete system no cat. incl. heat shield (only incl. catalytic converter street-legal)	EG/ABE/EEC	Sportexhaust	stainless steel	0124682 751116
				Sportexhaust		stainless steel black	0124782 751116	
				Sportexhaust		carbon	0124482 751116	
				catalytic converter (EURO 4)			KAT019	
				RACING sound insert for Sportexhaust	Race (no EG/ABE/EEC)		DBM201V	
	The exhaust system has an EEC approval, but is only authorised for road use in combination with the catalytic converter.							
			VESPA brake levers left and right lever position and length adjustable and engraved REMUS logo			schwarz eloxiert	750014S-LR	
						black anodized	750014T-LR	

Vespa 946
Scooter Sportexhaust



Vespa Sprint 125ie 3V
Scooter RSC



Vespa Primavera 125ie 3V
Scooter RSC



slip on



screw on



complete system

SPORT = Silencer with homologation number (sound level is within the tolerated limit), but without catalytic converter, therefore no EEC!

1) While stocks last! ***)** EC-approval only for vehicles with a registration date before 1st July 2004. Specifications in the registration document have to match the actual conditions, i.e. the omission of the catalyser has to be reported to the licensing authority! A warranty of 24 months is given on all systems with EC-approval. No warranty on racing products. No warranty is given for small colour changes of the carbon!



STREETBIKES

REMUS 8

with EC homologation & Racing

**NEW
PRODUCT**



- Octagonal geometry
- L x B x H / L x W x H: 485 x 110 x 180 mm
- Sleeve materials: Stainless steel black or stainless steel
- Inlet cap: Stainless steel
- End cap: Carbon
- Weight: 3,20 kg

REMUS BLACK HAWK

with EC homologation & Racing



- Hexagonal geometry
- Width x height: ~ 105 x 137 mm
- Sleeve length from 350 to 420 mm, depends on motorcycle
- Sleeve materials: Stainless steel black
- Inlet cap: Stainless steel
- End cap: Carbon
- Weight: from 1,96 kg

REMUS HEXACONE

with EC homologation & Racing



- Hexagonal geometry
- Width x height:
~ 105 x 137 mm
- Sleeve length from 250 to 420 mm,
depends on motorcycle
- Sleeve materials: Stainless steel,
Carbon, Titanium
- Inlet cap: Carbon
- End cap: Carbon
- Weight: ab / from 1,54 kg



REMUS HYPERCONE

with EC homologation & Racing



- Conical geometry
- Diameter:
~ Ø 120 mm bis / up to ~ Ø 75 mm
- Sleeve length from 250 to 400 mm,
depends on motorcycle
- Sleeve materials: Stainless steel,
Stainless steel black, Carbon, Titanium
- Inlet cap: Stainless steel
- End cap: Carbon
- Weight: from 1,28 kg



REMUS OKAMI

with EC homologation & Racing



- Hexagonal geometry
- Width x height:
~105 x 137 mm
- Sleeve length from 250 to 420 mm, depends on motorcycle
- Sleeve materials: Stainless steel, Stainless steel black, Carbon, Titanium
- Inlet cap: Stainless steel
- End cap: Plastic compound material
- Weight: from 1,54 kg



REMUS POWERCONE

with EC homologation & Racing



- Conical geometry
- Diameter:
~ Ø 120 mm – ~ Ø 75 mm
- Sleeve length 250 – 400 mm, depends on motorcycle
- Sleeve materials: Stainless steel, Titanium
- Inlet cap: Stainless steel
- End cap: Stainless steel
- Weight: from 1,28 kg



REMUS STREETBIKES

Model	Year	Ø mm	Description	Type	Muffler	Sleeve	Order no.
BMW ENDURO							
G 650 GS	11-		slip on (muffler with connecting tube) incl. cat., with carbon clamp	EG/ABE/EEC	ROXX	titanium	1599882 084511L
G 650 GS Serato	11-		slip on (muffler with connecting tube) no cat., with carbon clamp	SPORT	ROXX	titanium	0599882 084511L
BMW STREETBIKES							
C 600 Sport	12-15		slip on (muffler)	EG/ABE/EEC	HEXACONE	titanium	094882 084012
C 650 GT							
C650 Sport	16-	54	slip on (muffler with connecting tube)	EG/ABE/EEC	HEXACONE	stainless steel	054682 084516
C650 GT	16-			EG/ABE/EEC	HEXACONE	carbon	054482 084516
3C65, 44kW				EG/ABE/EEC	HEXACONE	titanium	054882 084516
				EG/ABE/EEC	BLACK HAWK	stainless steel black	0564782 084516
F 650 GS	08-12		slip on (muffler)	EG/ABE/EEC	HEXACONE	titanium	094882 085208
E8GS, 52 kW				EG/ABE/EEC	BLACK HAWK	stainless steel black	0964782 085208
F 700 GS	12-		"stainless steel header (2-1) no cat. instead of original header	Race (no EG/ABE/EEC)		Edelstahl	0101 085208
E8GS, 55 kW							
F 800 GS	08-		(nicht für F 800 GS Adventure)"	Race (no EG/ABE/EEC)		stainless steel	
E8GS, 63 kW							
F 800 GS Triple Black	12-						
F 800 GS Adventure	13-						
F 800 S	06-	54					154682 085206
F 800 ST			slip on (muffler with connecting tube) incl. cat.	EG/ABE/EEC	HEXACONE	stainless steel	154882 085206
E8ST, 62.5 kW				EG/ABE/EEC	HEXACONE	titanium	054682 085206
			slip on (muffler with connecting tube) no cat.	Race (no EG/ABE/EEC)	HEXACONE	stainless steel	054882 085206
F 800 R	09-		slip on (muffler)	Race (no EG/ABE/EEC)	HEXACONE	titanium	094682 085209
E8ST, 63 kW				EG/ABE/EEC	HEXACONE	stainless steel	094882 085209
F 800 R	15-			EG/ABE/EEC	HEXACONE	titanium	0964782 085209
E8ST, 66 kW				EG/ABE/EEC	BLACK HAWK	stainless steel black	
F 800 GT	13-						
K 1 / K 100 RS 4-Vent.	83-	76	complete system incl. cat., travelcase version	EG/ABE/EEC	INNOVATION	aluminium	012102 087589
BMW 100, 74 kW							
K 1100 LT / RS 4-Vent.	91-						
BMW 100, 74 kW							
K 1200 RS	97-	76					018802 088097L
K 1200 GT	02-		complete system (with pre muffler) no cat.	EG/ABE/EEC*	REVOLUTION	titanium	
BMW 589, 72 / 96 kW							
K 1200 GT	06-	60					154482 088305
K12S, 112 kW			slip on (muffler with connecting tube) incl. cat.	EG/ABE/EEC	HEXACONE	carbon	154882 088305
				EG/ABE/EEC	HEXACONE	titanium	054482 088305
			slip on (muffler with connecting tube) no cat.	Race (no EG/ABE/EEC)	HEXACONE	carbon	054882 088305

BMW C 650 GT
Black Hawk



BMW C 650 Sport
Black Hawk



slip on



screw on

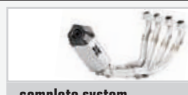

complete system

SPORT = Silencer with homologation number (sound level is within the tolerated limit), but without catalytic converter, therefore no EEC!

1) While stocks last! ***)** EC-approval only for vehicles with a registration date before 1st July 2004. Specifications in the registration document have to match the actual conditions, i.e. the omission of the catalyser has to be reported to the licensing authority! A warranty of 24 months is given on all systems with EC-approval. No warranty on racing products. No warranty is given for small colour changes of the carbon!

Technical changes and errors excepted!

Model	Year	Ø mm	Description	Type	Muffler	Sleeve	Order no.			
BMW STREETBIKES										
K 1200 S / R K12, 123 kW	05-	60	slip on (muffler with connecting tube) incl. cat.	EG/ABE/EEC	HEXACONE	carbon	154482 088305			
				EG/ABE/EEC	HEXACONE	titanium	154882 088305			
K 1200 R Sport K12R, 120 kW	07-		slip on (muffler with connecting tube) no cat.	Race (no EG/ABE/EEC)	HEXACONE	carbon	054482 088305			
				Race (no EG/ABE/EEC)	HEXACONE	titanium	054882 088305			
				TITANIUM HIGH PERFORMANCE RACING SYSTEM Titanium header (4-2-1) with conical tubes & complete GENESIS Ti. Racing muffler Not possible to fit in combination with a main stand			Race (no EG/ABE/EEC)	REVOLUTION	titanium	013803 088105
				HIGH PERFORMANCE RACING SYSTEM Stainless Steel header (4-2-1) with conical tubes & GENESIS Ti. Racing muffler Not possible to fit in combination with a main stand			Race (no EG/ABE/EEC)	REVOLUTION	titanium	013703 088105
K 1300 R	09-		slip on (muffler) incl. cat.	EG/ABE/EEC	HEXACONE	titanium	094852 088509			
K 1300 S 129 kW	09-		slip on (muffler) no cat.	Race (no EG/ABE/EEC)	HEXACONE	titanium	094883 088509			
			high performance complete system S/S header (4-2-1) conical tubes & full Ti. Race muffler (102 / 107dB(A))	Race (no EG/ABE/EEC)	HEXACONE	titanium	014883 088509			
K 1300 GT K12S, 118 kW	09-	60	slip on (muffler with connecting tube) incl. cat.	EG/ABE/EEC	HEXACONE	carbon	154482 088305			
				EG/ABE/EEC	HEXACONE	titanium	154882 088305			
			slip on (muffler with connecting tube) no cat.	Race (no EG/ABE/EEC)	HEXACONE	carbon	054482 088305			
				Race (no EG/ABE/EEC)	HEXACONE	titanium	054882 088305			
K 1600 GT K 1600 GTL 118 kW	11-	54	slip on left/right (muffler with connecting tube)	EG/ABE/EEC	HEXACONE	carbon	054482 089911LR			
				EG/ABE/EEC	HEXACONE	titanium	054882 089911LR			
				EG/ABE/EEC	BLACK HAWK	stainless steel black	0564782 089911LR			
			stainless steel header (6-2) no cat. instead of original header	Race (no EG/ABE/EEC)		stainless steel	0101 089911			
R 1100 R / GS / R 850 R 52 / 59 kW	95-	76	slip on (muffler with connecting tube, without pre muffler) no cat.	EG/ABE/EEC*	REVOLUTION	titanium	078802 087095			
R 1100 RS / RT R 850 RT 52 / 59 kW	95-	76	slip on (muffler with connecting tube, without pre muffler) no cat.	EG/ABE/EEC*	REVOLUTION	aluminium	078102 087595			
				EG/ABE/EEC*	REVOLUTION	titanium	078802 087595			
R 850 GS	99-		slip on (muffler)	EG/ABE/EEC	REVOLUTION	Aluminium	008102 087799			
R 1150 GS				EG/ABE/EEC	REVOLUTION	carbon	008402 087799			
R 1150 R				EG/ABE/EEC	REVOLUTION	titanium	008802 087799			
R 1150 R Rockster R21, 62 kW	03-		slip on (muffler with connecting tube, without pre muffler) no cat.	EG/ABE/EEC*	REVOLUTION	aluminium	078102 087799			
R 1200 GS	04-09	54	slip on (muffler with connecting tube)	EG/ABE/EEC	HEXACONE	stainless steel	054682 088104L			
R 1200 GS Adventure R12, 74 kW	06-09			EG/ABE/EEC	HEXACONE	carbon	054482 088104L			
				EG/ABE/EEC	HEXACONE	titanium	054882 088104L			
R 1200 GS	08-09			complete system no cat.	Race (no EG/ABE/EEC)	HEXACONE	stainless steel	014682 088104L		
R 1200 GS Adventure R12, 77 kW	08-09			Race (no EG/ABE/EEC)	HEXACONE	carbon	014482 088104L			
		Race (no EG/ABE/EEC)	HEXACONE	titanium	014882 088104L					

BMW F 800 GS
Black Hawk



BMW K 1600 GT
Black Hawk



SPORT = Silencer with homologation number (sound level is within the tolerated limit), but without catalytic converter, therefore no EEC!
 1) While stocks last! 2) EC-approval only for vehicles with a registration date before 1st July 2004. Specifications in the registration document have to match the actual conditions, i.e. the omission of the catalyser has to be reported to the licensing authority! A warranty of 24 months is given on all systems with EC-approval. No warranty on racing products. No warranty is given for small colour changes of the carbon!
Technical changes and errors excepted!



REMUS STREETBIKES

Model	Year	Ø mm	Description	Type	Muffler	Sleeve	Order no.	
BMW STREETBIKES								
R 1200 GS	10-12	60	slip on (muffler with connecting tube)	EG/ABE/EEC	HEXACONE	carbon	054482 088010L	
R 1200 GS Adventure				EG/ABE/EEC	HEXACONE	titanium	054882 088010L	
R12, 81 kW			complete system no cat.	Race (no EG/ABE/EEC)	HEXACONE	carbon	014482 088010L	
				Race (no EG/ABE/EEC)	HEXACONE	titanium	014882 088010L	
R 1200 GS	13-		slip on (muffler) incl. CARBON heat protecting shield	EG/ABE/EEC	HEXACONE	stainless steel	094682 088013	
92 kW				EG/ABE/EEC	HEXACONE	carbon	094482 088013	
R 1200 GS Adventure	14-		slip on (muffler) incl. CARBON heat protecting shield	EG/ABE/EEC	HEXACONE	titanium	094882 088013	
92 kW				EG/ABE/EEC	BLACK HAWK	stainless steel black	0964782 088013	
				stainless steel header (2-1) no cat. instead of original header	Race (no EG/ABE/EEC)		stainless steel	0101 088115
R 1200 GS	16-		slip on (muffler) incl. CARBON heat protecting shield	EG/ABE/EEC	HEXACONE	stainless steel	094682 088016	
92 kW, 1G12 (Euro 4)				EG/ABE/EEC	HEXACONE	carbon	094482 088016	
R 1200 GS Adventure	16-		slip on (muffler) incl. CARBON heat protecting shield	EG/ABE/EEC	HEXACONE	titanium	094882 088016	
92 kW, 1G12 (Euro 4)				EG/ABE/EEC	BLACK HAWK	stainless steel black	0964782 088016	
				EG/ABE/EEC	REMUS 8	stainless steel mat	0584682 088016	
				EG/ABE/EEC	REMUS 8	stainless steel black	0584782 088016	
stainless steel header (2-1) no cat. instead of original header	Race (no EG/ABE/EEC)	HYPERCONE	stainless steel	0101 088115				
R 1200 ST / RT	05-	54	slip on (muffler with connecting tube)	EG/ABE/EEC	HEXACONE	stainless steel	054682 088005L	
R1ST, 81 kW				EG/ABE/EEC	HEXACONE	carbon	054482 088005L	
				EG/ABE/EEC	HEXACONE	titanium	054882 088005L	
			complete system no cat.	Race (no EG/ABE/EEC)	HEXACONE	stainless steel	014682 088005L	
			Race (no EG/ABE/EEC)	HEXACONE	carbon	014482 088005L		
			Race (no EG/ABE/EEC)	HEXACONE	titanium	014882 088005L		
R 1200 R	06-	54	slip on (muffler with connecting tube)	EG/ABE/EEC	HEXACONE	stainless steel	054682 088206L	
R1ST, 80 kW				EG/ABE/EEC	HEXACONE	titanium	054882 088206L	
R 1200 R	11-	60	slip on (muffler with connecting tube)	EG/ABE/EEC	HEXACONE	stainless steel	054682 088011L	
80 kW				EG/ABE/EEC	HEXACONE	titanium	054882 088011L	
R 1200 RS	15-	66	slip on (muffler inkl. connecting tube) incl. CARBON heat protecting shield	EG/ABE/EEC	HEXACONE	stainless steel	054682 088115	
R 1200 R				EG/ABE/EEC	HEXACONE	carbon	054482 088115	
				92 kW	EG/ABE/EEC	HEXACONE	titanium	054882 088115
				EG/ABE/EEC	BLACK HAWK	stainless steel black	0564782 088115	
			stainless steel header (2-1) no cat. instead of original header	Race (no EG/ABE/EEC)		stainless steel	0101 088115	
R 1200 RT	10-13		slip on (muffler with connecting tube)	EG/ABE/EEC	HEXACONE	carbon	054482 088110L	
R12T, 81 kW				EG/ABE/EEC	HEXACONE	titanium	054882 088110L	
			complete system no cat.	Race (no EG/ABE/EEC)	HEXACONE	carbon	014482 088110L	
Race (no EG/ABE/EEC)				HEXACONE	titanium	014882 088110L		
R 1200 RT	14-	66	slip on (muffler inkl. connecting tube) incl. CARBON heat protecting shield	EG/ABE/EEC	HEXACONE	stainless steel	054682 088014	
				EG/ABE/EEC	HEXACONE	carbon	054482 088014	
				EG/ABE/EEC	HEXACONE	titanium	054882 088014	
				EG/ABE/EEC	BLACK HAWK	stainless steel black	0564782 088014	
			stainless steel header (2-1) no cat. instead of original header	Race (no EG/ABE/EEC)		stainless steel	0101 088115	

BMW R 1200 R
Black Hawk



BMW R 1200 RT
HexaCone



BMW R 1200 GS Adventure
Black Hawk



slip on



screw on

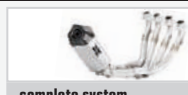

complete system

SPORT = Silencer with homologation number (sound level is within the tolerated limit), but without catalytic converter, therefore no EEC!

1) While stocks last! ***)** EC-approval only for vehicles with a registration date before 1st July 2004. Specifications in the registration document have to match the actual conditions, i.e. the omission of the catalyser has to be reported to the licensing authority! A warranty of 24 months is given on all systems with EC-approval. No warranty on racing products. No warranty is given for small colour changes of the carbon!

Technical changes and errors excepted!

Model	Year	Ø mm	Description	Type	Muffler	Sleeve	Order no.
BMW STREETBIKES							
S 1000 RR K46, 143 kW	09-		slip on (muffler) incl. heat protecting shield	EG/ABE/EEC	HYPERCONE	stainless steel	096602 087009
				EG/ABE/EEC	HYPERCONE	titanium	096802 087009
S 1000 R K10, 118 kW	14-		high performance complete system - full titanium optional muffler bracket black (rear footrest must be removed)	Race (no EG/ABE/EEC)	HEXACONE	titanium	014883 087009T HA087009
S 1000 RR K10, 146 kW	15-	60	slip on (muffler with connecting tube) optional muffler bracket black for slip on versions (rear footrest must be removed) high performance complete system - full titanium optional muffler bracket black for complete system (rear footrest must be removed)	EG/ABE/EEC	HYPERCONE	stainless steel	056602 087015
				EG/ABE/EEC	HYPERCONE	stainless steel black	056702 087015
				EG/ABE/EEC	HYPERCONE	titanium	056802 087015
							HA087015
				Race (no EG/ABE/EEC)	HEXACONE	titanium	014883 087015T HA087009
S 1000 XR K10, 110 kW	15-		slip on (muffler) with carbon heat protection shield	EG/ABE/EEC	HEXACONE	stainless steel	094682 087115
				EG/ABE/EEC	HEXACONE	carbon	094482 087115
				EG/ABE/EEC	HEXACONE	titanium	094882 087115
R nineT R1ST, 81 kW	14-	60	slip on (muffler with connecting tube)	EG/ABE/EEC	HYPERCONE	stainless steel	056602 087514L
				EG/ABE/EEC	HYPERCONE	stainless steel black	056702 087514L
				EG/ABE/EEC	HYPERCONE	titanium	056802 087514L
						0108 087514	
						087514HBL	
			SPORT (no EG/ABE/EEC)	HYPERCONE	stainless steel	0101 087514	
						087514KER	

BUELL							
XB-12R Firebolt XB1, 74.6 kW	04-		slip on left/right (muffler)	EG/ABE/EEC	2x Ø94mm rund	stainless steel polished	092782 098004LR
				EG/ABE/EEC	2x Ø94mm rund	stainless steel matt	092782 098004LRM
XB-12Ss Lightning XB2, 74.6 kW	05-						
XB-9SX Lightning XB1, 60 kW	08-		slip on left/right (muffler) Stainless steel belt cover for XB2 models	EG/ABE/EEC	2x Ø 90 mm rund	stainless steel black	092782 098008LRB
					Abdeckung/cover	stainless steel black	098008B
XB-12S Lightning	08-						
XB-12Scg Lightning	08-						
XB-1, 70 kW							
XB-12XT							
XB-12X							
XB-12Ss Lightning	08-						
XB-12STT Lightning	08-						
XB2, 70 kW							

BMW S1000RR
HyperCone



BMW R nine T
HyperCone



SPORT = Silencer with homologation number (sound level is within the tolerated limit), but without catalytic converter, therefore no EEC!
 1) While stocks last! 2) EC-approval only for vehicles with a registration date before 1st July 2004. Specifications in the registration document have to match the actual conditions, i.e. the omission of the catalyser has to be reported to the licensing authority! A warranty of 24 months is given on all systems with EC-approval. No warranty on racing products. No warranty is given for small colour changes of the carbon!
Technical changes and errors excepted!



REMUS STREETBIKES

Model	Year	Ø mm	Description	Type	Muffler	Sleeve	Order no.	
DUCATI								
Ducati Monster 821	15-	65	slip on (muffler with connecting tube)	EG/ABE/EEC	HYPERCONE	stainless steel	056682 155315	
Ducati Monster 821 Stripe	15-	(only incl. catalytic converter street-legal)	HYPERCONE		stainless steel black	056782 155315		
			HYPERCONE		titanium	056882 155315		
		catalytic converter				KAT016		
The exhaust system has an EEC approval, but is only authorised for road use in combination with the catalytic converter.								
Monster 1100 EVO 70 kW	11-	60	slip on (muffler with connecting tube) no cat.	SPORT	HYPERCONE	stainless steel	056682 157111	
				SPORT	HYPERCONE	stainless steel black	056782 157111	
				SPORT	HYPERCONE	titanium	056882 157111M	
Monster 1200 R (Euro 4)	16-	65	slip on (muffler with connecting tube) (only incl. catalytic converter street-legal)	EG/ABE/EEC	HYPERCONE	stainless steel	056682 158016	
					HYPERCONE	stainless steel black	056782 158016	
					HYPERCONE	titanium	056882 158016	
		catalytic converter (Euro 4)					KAT018	
The exhaust system has an EEC approval, but is only authorised for road use in combination with the catalytic converter.								
Monster 1200	14-	65	slip on (muffler with connecting tube)	EG/ABE/EEC	HYPERCONE	stainless steel	056682 158114	
Monster 1200 S	14-	(only incl. catalytic converter street-legal)	HYPERCONE		stainless steel black	056782 158114		
			HYPERCONE		titanium	056882 158114		
		catalytic converter				KAT016		
The exhaust system has an EEC approval, but is only authorised for road use in combination with the catalytic converter.								
Streetfighter 848	11-	65	slip on (muffler incl. connecting tube)	RACE	HEXACONE	titanium	054883 155512	
Streetfighter S	09-							
Hypermotard 939	16-	65	slip on (muffler with connecting tube) (only incl. catalytic converter street-legal)	EG/ABE/EEC	BLACK HAWK	stainless steel black	0564782 156516	
Hypermotard 939 SP (Euro 4)			catalytic converter (Euro 4)				KAT018	
			slip on (muffler with connecting tube)		Race (no EG/ABE/EEC)	HYPERCONE	stainless steel	056683 156516
					Race (no EG/ABE/EEC)	HYPERCONE	stainless steel black	056783 156516
			Race (no EG/ABE/EEC)	HYPERCONE	titanium	056883 156516		
Hypermotard 1100	07-		slip on left/right (muffler with connecting tube)	EG/ABE/EEC	HEXACONE	carbon	054482 157107LR	
Hypermotard 1100S B1, 62 kW	07-		complete system left/right no cat.	Race (no EG/ABE/EEC)	HEXACONE	carbon	014482 157107LR	
Hypermotard 1100 EVO SP B1, 69.9 kW	10-		not suitable for Hypermotard 796					
Hypermotard 796 B1, 59.6 kW	10-							
Hypermotard ABS	13-		slip on (muffler)	Race (no EG/ABE/EEC)	HYPERCONE	stainless steel	096683 155513	
Hypermotard SP ABS				Race (no EG/ABE/EEC)	HYPERCONE	stainless steel black	096783 155513	
Hyperstrada ABS								
B2, 81 kW								

Ducati Monster 1200R
HyperCone



Ducati Hypermotard 939
Black Hawk



slip on



screw on



complete system

SPORT = Silencer with homologation number (sound level is within the tolerated limit), but without catalytic converter, therefore no EEC!

1) While stocks last! ***)** EC-approval only for vehicles with a registration date before 1st July 2004. Specifications in the registration document have to match the actual conditions, i.e. the omission of the catalyser has to be reported to the licensing authority! A warranty of 24 months is given on all systems with EC-approval. No warranty on racing products. No warranty is given for small colour changes of the carbon!

Technical changes and errors excepted!

Model	Year	Ø mm	Description	Type	Muffler	Sleeve	Order no.
DUCATI							
Multistrada 1200	10-		slip on (muffler) with carbon heat protecting shield	EG/ABE/EEC	HYPERCONE	titanium	096802 158012
Multistrada 1200 S 110 kW	10-						
Multistrada 1200	15-	65	slip on (muffler) with carbon heat protecting shield	EG/ABE/EEC	HYPERCONE	stainless steel black	096702 158015
Multistrada 1200 Sport			slip on (muffler) with carbon heat protecting shield			titanium	096802 158015
Diavel 119 kW	11-	65	slip on (muffler with connecting tube)	EG/ABE/EEC	HYPERCONE	stainless steel	056682 158111
(only incl. catalytic converter street-legal)			stainless steel black			056782 158111	
incl. heat protecting shield black painted			titanium			056882 158111	
catalytic converter						KAT016	
The exhaust system has an EEC approval, but is only authorised for road use in combination with the catalytic converter.							
Ducati Scrambler Icon	15-		slip on (muffler with front silencer) (only incl. catalytic converter street-legal)	EG/ABE/EEC	HYPERCONE	stainless steel	406682 155215
Ducati Scrambler Full Throttle	15-		(only incl. catalytic converter street-legal)			stainless steel black	406782 155215
Ducati Scrambler Urban Enduro	15-					titanium	406882 155215
Ducati Scrambler Classic	15-		catalytic converter				KAT016
The exhaust system has an EEC approval, but is only authorised for road use in combination with the catalytic converter.							
			slip on (muffler with connecting tube)	Race (no EG/ABE/EEC)	HYPERCONE	stainless steel	036682 155215
				Race (no EG/ABE/EEC)	HYPERCONE	stainless steel black	036782 155215
				Race (no EG/ABE/EEC)	HYPERCONE	titanium	036882 155215
Scrambler Sixty2 (Euro 4)	16-	65	slip on (muffler with front silencer) (only incl. catalytic converter street-legal)	EG/ABE/EEC	HYPERCONE	stainless steel	406682 152016
(only incl. catalytic converter street-legal)			stainless steel black			406782 152016	
			titanium			406882 152016	
catalytic converter (Euro 4)						KAT018	
The exhaust system has an EEC approval, but is only authorised for road use in combination with the catalytic converter.							

Ducati Multistrada 1200
HyperCone



Ducati Diavel
HyperCone



Ducati Scrambler
HyperCone



Ducati Scrambler Sixty2
HyperCone



SPORT = Silencer with homologation number (sound level is within the tolerated limit), but without catalytic converter, therefore no EEC!
 1) While stocks last! *) EC-approval only for vehicles with a registration date before 1st July 2004. Specifications in the registration document have to match the actual conditions, i.e. the omission of the catalyser has to be reported to the licensing authority! A warranty of 24 months is given on all systems with EC-approval. No warranty on racing products. No warranty is given for small colour changes of the carbon!
Technical changes and errors excepted!



complete system



screw on



slip on

REMUS STREETBIKES

Model	Year	Ø mm	Description	Type	Muffler	Sleeve	Order no.
HONDA ENDURO							
CRF 250 R	10-	54	complete system	Race (no EG/ABE/EEC)	ROXX	titanium	0199883 251510
XL 650 V Transalp RD10 / RD11, 39 kW	01-04	54	slip on (muffler with connecting tube) not for sidecase version	EG/ABE/EEC	REVOLUTION GP	aluminium	253182 254501
XL 650 V Transalp RD11, 39 kW	05-						
XRV 750 Afrika Twin RD07-C, 35 / 37 kW	96-03-	54	slip on (muffler with connecting tube)	EG/ABE/EEC	REVOLUTION GP	aluminium	053182 255003
CRF1000L Africa Twin	16-		slip on (muffler)	EG/ABE/EEC	OKAMI	stainless steel	0914682 257016
				EG/ABE/EEC	OKAMI	Carbon	0914482 257016
				EG/ABE/EEC	OKAMI	titanium	0914882 257016
				EG/ABE/EEC	OKAMI	stainless steel black	0914782 257016
			sound insert with spark arrestor	Race (no EG/ABE/EEC)			DBM233RV
			header 2-1 incl. black heat shield, fits to REMUS or original muffler (only incl. catalytic converter street-legal)				stainless steel
catalytic converter			EG/ABE/EEC			KAT017	
HONDA STREETBIKES							
CB 1100 66 kW	13-		slip on (muffler with connecting tube)	EG/ABE/EEC	POWERCONE	stainless steel	055682 257513
				EG/ABE/EEC	POWERCONE	stainless steel black	055782 257513
				EG/ABE/EEC	POWERCONE	titanium	055882 257513
CBF 1000 F SC64, 72 / 79 kW	10-	54	slip on (muffler with connecting tube) no cat.	Race (no EG/ABE/EEC)	OKAMI	stainless steel	0514682 257010
			slip on (muffler with connecting tube) incl. cat.	EG/ABE/EEC	OKAMI	stainless steel	1514682 257010
CBR 250 R 19.4 kW	11-	54	complete system	Race (no EG/ABE/EEC)	OKAMI	titanium	0114883 251511
		54	slip on (muffler with connecting tube) no cat.	Race (no EG/ABE/EEC)	OKAMI	titanium	0314883 251511
CBR 600 F PC41, 75 kW	11-		slip on (muffler with connecting tube)	EG/ABE/EEC	HYPERCONE	stainless steel	056602 254011
CBR 600 RR PC40C, 88.1 kW	09-	60	slip on (muffler with connecting tube)	EG/ABE/EEC	REVOLUTION	aluminium	058102 254009
	CBR 600 RR C-ABS PC40, 88.1 kW						
CBR 600 RR 88 kW	13-		slip on (muffler with connection tube)	EG/ABE/EEC	OKAMI	stainless steel	0599682 254013
CBR 1100 XX SC35, 112 kW X-Eleven SC42, 100 kW	99-	54	slip on left/right (muffler with connecting tube) no cat.	EG/ABE/EEC*	REVOLUTION GP	aluminium	053182 257899LR

Honda CRF 250 R
RoxX



Honda CRF 1000L Africa Twin
Okami



slip on



screw on

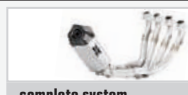

complete system

SPORT = Silencer with homologation number (sound level is within the tolerated limit), but without catalytic converter, therefore no EEC!

1) While stocks last! ***)** EC-approval only for vehicles with a registration date before 1st July 2004. Specifications in the registration document have to match the actual conditions, i.e. the omission of the catalyser has to be reported to the licensing authority! A warranty of 24 months is given on all systems with EC-approval. No warranty on racing products. No warranty is given for small colour changes of the carbon!

Technical changes and errors excepted!

Model	Year	Ø mm	Description	Type	Muffler	Sleeve	Order no.
HONDA STREETBIKES							
CBR 1000 RR SC59A, 131 kW	08-14	54	slip on (muffler with connecting tube incl. cat)	EG/ABE/EEC	HYPERCONE	stainless steel	156682 257108
				EG/ABE/EEC	HYPERCONE	stainless steel black	156782 257108
				EG/ABE/EEC	HYPERCONE	titanium	156882 257108
			slip on (muffler with connecting tube no cat)	Sport (no EG/ABE/EEC)	HYPERCONE	stainless steel	056682 257108
				Sport (no EG/ABE/EEC)	HYPERCONE	stainless steel black	056782 257108
				Sport (no EG/ABE/EEC)	HYPERCONE	titanium	056882 257108
„high performance complete system - full titanium When using the serial fairing you have to recut it! optional muffler bracket black (rear footrest must be removed)	Race (no EG/ABE/EEC)	HEXACONE	titanium	014883 257014T			
						HA087009	
NC 700 X/S NC 750 X/S	12-14	54	slip on (muffler with connecting tube)	EG/ABE/EEC	OKAMI	stainless steel	0514682 254512
				EG/ABE/EEC	OKAMI	carbon	0514482 254512
				EG/ABE/EEC	OKAMI	titanium	0514882 254512
VFR 800 XA Crossrunner	12-14	54	slip on (muffler with connecting tube)	EG/ABE/EEC	OKAMI	stainless steel	0514682 255212
				EG/ABE/EEC	OKAMI	carbon	0514482 255212
				EG/ABE/EEC	OKAMI	titanium	0514882 255212
VFR 800 F RC79, 78 kW	14-	54	slip on (muffler with connecting tube).	EG/ABE/EEC	OKAMI	stainless steel	0514682 255214
				EG/ABE/EEC	OKAMI	carbon	0514482 255214
				EG/ABE/EEC	OKAMI	titanium	0514882 255214
VFR 800 X Crossrunner	15-			EG/ABE/EEC	OKAMI	titanium	0514882 255214

Honda CRF 1000L Africa Twin
Okami + Krümmer/header



Honda - CBR 600 F
HyperCone



Honda - CBR 1000 RR
HyperCone



Honda VFR 800 XA Crossrunner
Okami



Honda VFR 800 F
Okami



SPORT = Silencer with homologation number (sound level is within the tolerated limit), but without catalytic converter, therefore no EEC!
1) While stocks last! ***)** EC-approval only for vehicles with a registration date before 1st July 2004. Specifications in the registration document have to match the actual conditions, i.e. the omission of the catalyser has to be reported to the licensing authority! A warranty of 24 months is given on all systems with EC-approval. No warranty on racing products. No warranty is given for small colour changes of the carbon!
Technical changes and errors excepted!



REMUS STREETBIKES

Model	Year	Ø mm	Description	Type	Muffler	Sleeve	Order no.
HUSQVARNA							
Nuda 900/900R 77 kW	12-		slip on (muffler) with heat protecting shield	EG/ABE/EEC	HYPERCONE	stainless steel	096682 326012
				EG/ABE/EEC	HYPERCONE	stainless steel black	096782 326012
701 Supermoto	16-		slip on (muffler with connecting tube)	RACE	HEXACONE	stainless steel	054683 325016
				RACE	HEXACONE	titanium	054883 325016

Husquarna Nuda 900
HyperCone



Husquarna 701 Supermoto
HyperCone



KAWASAKI STREETBIKES

ER-6N 53 kW	12		complete system no cat.	RACE	HYPERCONE	stainless steel black	016783 364512
				RACE	HYPERCONE	titanium	016883 364512
GTR 1400 ZGT40A, 114 kW	07- 10-	60	slip on (muffler with connecting tube)	EG/ABE/EEC	HEXACONE	carbon	054482 369007
				EG/ABE/EEC	HEXACONE	titanium	054882 369007
				EG/ABE/EEC	OKAMI	carbon	0514482 369007
Z 800 83 kW	13-	54	slip on (muffler with connecting tube) incl. control flap	EG/ABE/EEC	OKAMI	stainless steel	0514682 365312
				EG/ABE/EEC	OKAMI	Carbon	0514482 365312
				EG/ABE/EEC	OKAMI	titanium	0514882 365312
Z 800 e 70 kW (35 kW)	13-	54	slip on (muffler with connecting tube)	EG/ABE/EEC	OKAMI	stainless steel	0514682 365412
				EG/ABE/EEC	OKAMI	Carbon	0514482 365412
				EG/ABE/EEC	OKAMI	titanium	0514882 365412

Kawasaki ER-6N
HyperCone



Kawasaki Z 800
Okami



slip on



screw on



complete system

SPORT = Silencer with homologation number (sound level is within the tolerated limit), but without catalytic converter, therefore no EEC!

1) While stocks last! ***)** EC-approval only for vehicles with a registration date before 1st July 2004. Specifications in the registration document have to match the actual conditions, i.e. the omission of the catalyser has to be reported to the licensing authority! A warranty of 24 months is given on all systems with EC-approval. No warranty on racing products. No warranty is given for small colour changes of the carbon!

Technical changes and errors excepted!

Model	Year	Ø mm	Description	Type	Muffler	Sleeve	Order no.
KAWASAKI STREETBIKES							
Z 800 83 kW	13-	54	slip on (muffler with connecting tube)	RACE (no EG/ABE/EEC)	OKAMI	stainless steel	0514683 365212
				RACE (no EG/ABE/EEC)	OKAMI	Carbon	0514483 365212
				RACE (no EG/ABE/EEC)	OKAMI	titanium	0514883 365212
Z 1000 ZRT00, 92 kW	09-	54	slip on left/right (muffler with connecting tube) no cat.	Race (no EG/ABE/EEC)	HEXACONE	titanium	054882 367009LR
Z 1000 Z 1000 SX 104.5 kW	14-		slip on left/right (muffler)	EG/ABE/EEC	HYPERCONE	stainless steel	096682 367014LR
				EG/ABE/EEC	HYPERCONE	stainless steel black	096782 367014LR
				EG/ABE/EEC	HYPERCONE	titanium	096882 367014LR
Ninja 300 29 kW	12-		slip on (muffler with connecting tube) no cat.	Race (no EG/EEC)	OKAMI	carbon	0514483 361812
ZX-6R Ninja ZX600RR, 94.1 kW	09-	54	slip on (muffler with connecting tube) fits on serial pre muffler	EG/ABE/EEC	OKAMI	stainless steel	0514682 364009
ZX-10R ZXT00E, 138.3 kW	08-	54	high performance complete system stainless steel header (4-2-1) with conical tubes & full Titanium Race muffler, 107dB(A)	Race (no EG/ABE/EEC)	GRAND PRIX	titanium	013903 367008
ZX-10R 147.1 kW	11-	54	slip on (muffler with connecting tube)	EG/ABE/EEC	OKAMI	carbon	0514482 367011
				Race (no EG/ABE/EEC)	HYPERCONE	stainless steel	036682 367011
				Race (no EG/ABE/EEC)	HYPERCONE	stainless steel black	036782 367011
				Race (no EG/ABE/EEC)	HYPERCONE	titanium	036882 367011

Kawasaki Z 1000
HyperCone



KTM 125 Duke
RSC



KTM								
125 Duke 125 RC 11.3 kW	11- 14-	54	slip on (muffler with connecting tube) (only incl. catalytic converter street-legal) catalytic converter	EG/ABE/EEC	RSC	stainless steel	0544682 651514	
					RSC	carbon	0544482 651514	
							KAT014	
200 Duke 200 RC 19 kW	12- 14-	54	The exhaust system has an EEC approval, but is only authorised for road use in combination with the catalytic converter. mounting kit for RC - models stainless steel header only for KTM 125			stainless steel	0101 651211	
							MZ651514	
390 Duke 390 RC	13- 14-	54	slip on (muffler with front silencer) (only incl. catalytic converter street-legal) catalytic converter	EG/ABE/EEC	RSC	stainless steel	4044682 652014	
					RSC	carbon	4044482 652014	
							KAT015	
					The exhaust system has an EEC approval, but is only authorised for road use in combination with the catalytic converter.			
					Race (no EG/ABE/EEC)	RSC	stainless steel	0344682 652014
					Race (no EG/ABE/EEC)	RSC	carbon	0344482 652014
450 SXF	11-	54	complete system full titanium (muffler left/right with titanium header)	Race (no EG/ABE/EEC)	ROXX	titanium	0199883 652511LRT	
450 EXC	10-12	54	complete system full titanium (titanium muffler with titanium header)	Race (no EG/ABE/EEC)	ROXX	titanium	0199883 652810T	

SPORT = Silencer with homologation number (sound level is within the tolerated limit), but without catalytic converter, therefore no EEC!
 1) While stocks last! 2) EC-approval only for vehicles with a registration date before 1st July 2004. Specifications in the registration document have to match the actual conditions, i.e. the omission of the catalyser has to be reported to the licensing authority! A warranty of 24 months is given on all systems with EC-approval. No warranty on racing products. No warranty is given for small colour changes of the carbon!
Technical changes and errors excepted!



REMUS STREETBIKES

Model	Year	Ø mm	Description	Type	Muffler	Sleeve	Order no.	
KTM								
450 SX-F	07-		complete system	Race (no EG/ABE/EEC)	FREERIDE	titanium	219803 652607	
450 SMR	08-		incl. muffler with sound insert 94 or 100 db(A)					
			optional sound insert for 92 dB(A)	Race (no EG/ABE/EEC)			DBM068V	
625 LC4	96-		slip on (muffler)	EG/ABE/EEC*	FREERIDE	aluminium	299102 655003	
660 LC4 SMC Supermoto								
4T-SC								
LC4 620/625/640	96-							
LC4 640 Adventure								
LC4 625 SXC								
SMC 625 Supermoto								
4T-EGS								
690 SMC	08-	54	complete system incl. cat.	EG/ABE/EEC	HEXACONE	stainless steel	114682 655008	
690 Enduro	08-			EG/ABE/EEC	HEXACONE	titanium	114882 655008	
690 LC4, 46.3 kW			complete system no cat.	SPORT	HEXACONE	stainless steel	014682 655008	
690 SMC R	12-			SPORT	HEXACONE	titanium	014882 655008	
690 Enduro R	12-	54	slip on (muffler with connecting tube)	Race (no EG/ABE/EEC)	ROXX	stainless steel	0399683 655111L	
690 LC4, 49 kW				Race (no EG/ABE/EEC)	ROXX	titanium	0399883 655111L	
690 SMC R	14-							
690 Enduro R	14-							
690 LC4, 49 kW								
690 Duke 4	12-	54	slip on (muffler with connecting tube)	EG/ABE/EEC	BLACK HAWK	stainless steel black	0564782 655016	
50 kW			pre muffler fits to REMUS or original muffler (only incl. catalytic converter street-legal)			stainless steel	0101 655312	
690 Duke 4			catalytic converter	EG/ABE/EEC			KAT012	
51.5 kW			The exhaust system has an EEC approval, but is only authorised for road use in combination with the catalytic converter.					
			complete system (header with muffler)	RACE (no EG/ABE/EEC)	HYPERCONE	stainless steel	016683 654512	
				RACE (no EG/ABE/EEC)	HYPERCONE	stainless steel black	016783 654512	
				RACE (no EG/ABE/EEC)	HYPERCONE	titanium	016883 654512	

KTM 125 RC RSC



KTM 690 Enduro HexaCone



KTM 690 Duke 5 Black Hawk



KTM 690 Duke 5 Black Hawk - complete system



slip on



screw on

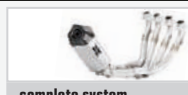

complete system

SPORT = Silencer with homologation number (sound level is within the tolerated limit), but without catalytic converter, therefore no EEC!

1) While stocks last! ***)** EC-approval only for vehicles with a registration date before 1st July 2004. Specifications in the registration document have to match the actual conditions, i.e. the omission of the catalyser has to be reported to the licensing authority! A warranty of 24 months is given on all systems with EC-approval. No warranty on racing products. No warranty is given for small colour changes of the carbon!

Technical changes and errors excepted!

Model	Year	Ø mm	Description	Type	Muffler	Sleeve	Order no.
KTM							
690 Duke 5 (Euro 4) 54 kW	16-	54	slip on (muffler with connecting tube)	EG/ABE/EEC	BLACK HAWK	stainless steel black	0564782 655016
			pre muffler fits to REMUS or original muffler	RACE (no EG/ABE/EEC)		stainless steel	0101 655312
690 Duke 5R (Euro 4) 55 kW			catalytic converter				KAT012
			complete system (header with muffler)	RACE (no EG/ABE/EEC)	HYPERCONE	stainless steel	016683 654512
				RACE (no EG/ABE/EEC)	HYPERCONE	stainless steel black	016783 654512
				RACE (no EG/ABE/EEC)	HYPERCONE	titanium	016883 654512
950 Adventure	03-05		slip on (muffler with connecting tube)	Race (no EG/ABE/EEC)	ROXX	titanium	0399883 657011
990 Adventure	06-						
990 Adventure S LC8, 72 kW							
990 Adventure LC8, 78 kW	09-						
990 Adventure R LC8, 84.5 kW	09-						
1190 Adventure	13-		slip on (muffler) incl. Carbon heat protecting shield	EG/ABE/EEC	HEXACONE	stainless steel	094682 658013
1190 Adventure R	13-			EG/ABE/EEC	HEXACONE	Carbon	094482 658013
1050 Adventure	15-			EG/ABE/EEC	HEXACONE	titanium	094882 658013
1290 Super Adventure	15-			EG/ABE/EEC	BLACK HAWK	stainless steel black	0964782 658013
			stainless steel header (2 - 1) no cat. instead of original header *not mountable with KTM Powerparts motor protection	RACE			0101 658013
1290 Super Duke R	14-		slip on (muffler)	EG/ABE/EEC	HYPERCONE	stainless steel	096682 658014
				EG/ABE/EEC	HYPERCONE	stainless steel black	096782 658014
				EG/ABE/EEC	HYPERCONE	titanium	096882 658014
			Racing connecting tube instead of original front silencer	Race (no EG/ABE/EEC)			0103 658014
1290 Super Duke GT (Euro 4)	16-		slip on (muffler)	EG/ABE/EEC	HYPERCONE	stainless steel	096682 658014
				EG/ABE/EEC	HYPERCONE	stainless steel black	096782 658014
				EG/ABE/EEC	HYPERCONE	titanium	096882 658014
			Racing connecting tube instead of original front silencer	RACE (no EG/ABE/EEC)			0103 658016

KTM - 1190 Adventure R
HexaCone



KTM - 1290 Super Duke R
HyperCone



KTM - 1290 Super Duke GT
HyperCone



KTM - 1290 Super Duke GT
HyperCone



SPORT = Silencer with homologation number (sound level is within the tolerated limit), but without catalytic converter, therefore no EEC!
 1) While stocks last! 2) EC-approval only for vehicles with a registration date before 1st July 2004. Specifications in the registration document have to match the actual conditions, i.e. the omission of the catalyser has to be reported to the licensing authority! A warranty of 24 months is given on all systems with EC-approval. No warranty on racing products. No warranty is given for small colour changes of the carbon!
Technical changes and errors excepted!



REMUS STREETBIKES

Model	Year	Ø mm	Description	Type	Muffler	Sleeve	Order no.
SUZUKI STREETBIKES							
DL 650 V-Strom 50.5 kW	12-	54	slip on (muffler with connecting tube) incl. cat.	EG/ABE/EEC	OKAMI	stainless steel	1514682 854512
				EG/ABE/EEC	OKAMI	carbon	1514482 854512
				EG/ABE/EEC	OKAMI	titanium	1514882 854512
		slip on (muffler with connecting tube) no cat.	SPORT (no EG/ABE/EEC)	OKAMI	stainless steel	0514682 854512	
			SPORT (no EG/ABE/EEC)	OKAMI	carbon	0514482 854512	
			SPORT (no EG/ABE/EEC)	OKAMI	titanium	0514882 854512	
DL 1000 V-Strom	14-	54	slip on (muffler with connecting tube)	EG/ABE/EEC	OKAMI	stainless steel	0514682 857014
				EG/ABE/EEC	OKAMI	carbon	0514482 857014
				EG/ABE/EEC	OKAMI	titanium	0514882 857014
GSF 1200 Bandit WVA9, 71 kW	04-05	54	slip on (muffler with connecting tube) no cat.	TG**/part EEC	REVOLUTION	carbon	058402 858001
GSR 750 78 kW	11-	54	slip on (muffler with connecting tube)	EG/ABE/EEC	OKAMI	stainless steel	0514682 855011
				EG/ABE/EEC	OKAMI	carbon	0514482 855011
				EG/ABE/EEC	OKAMI	titanium	0514882 855011
GSX-R 600 WVCV, 92 kW	08-	54	slip on (muffler with connecting tube)	EG/ABE/EEC	OKAMI	stainless steel	0514682 854108
GSX-R 750 WVCW, 110.3 kW	08-						
Suzuki GSX-S 1000	15-		slip on (muffler) incl. heat protecting shield	EG/ABE/EEC	HYPERCONE	stainless steel	096602 857015
Suzuki GSX-S 1000F			slip on (muffler) incl. heat protecting shield	EG/ABE/EEC	HYPERCONE	stainless steel black	096702 857015
			slip on (muffler) incl. heat protecting shield	EG/ABE/EEC	HYPERCONE	titanium	096802 857015
SV 650 (Euro 4)	16-	54	slip on (muffler with connecting tube)	EG/ABE/EEC	OKAMI	stainless steel	0514682 854516
				EG/ABE/EEC	OKAMI	Carbon	0514482 854516
				EG/ABE/EEC	OKAMI	titanium	0514882 854516
				EG/ABE/EEC	OKAMI	stainless steel black	0514782 084516

Suzuki DL 1000 V-Strom
Okami



Suzuki GSX-R 750
Okami



Suzuki GSX-S 1000
HyperCone



Suzuki SV 650
Okami



slip on



screw on



complete system

SPORT = Silencer with homologation number (sound level is within the tolerated limit), but without catalytic converter, therefore no EEC!

1) While stocks last! *1) EC-approval only for vehicles with a registration date before 1st July 2004. Specifications in the registration document have to match the actual conditions, i.e. the omission of the catalyser has to be reported to the licensing authority! A warranty of 24 months is given on all systems with EC-approval. No warranty on racing products. No warranty is given for small colour changes of the carbon!

Technical changes and errors excepted!

Model	Year	Ø mm	Description	Type	Muffler	Sleeve	Order no.
TRIUMPH CRUISER							
America	07-	45	slash-cut muffler left/right incl. cat.	EG/ABE/EEC	CUSTOM	chrome	007102 915508LR
986MK2, 45 kW				EG/ABE/EEC	CUSTOM	stainless steel black	007702 915508LR
America LT	14-						
986MK2, 45 kW							
Speedmaster	07-						
986ML2, 45 kW							
Thunderbird	09-		slash-cut muffler left/right	EG/ABE/EEC	CUSTOM	chrome	007102 919509LR
B16BA, 63.2 kW, 24.9 kW				EG/ABE/EEC	CUSTOM	stainless steel black	007702 919509LR
Thunderbird Storm	10-		Racing connecting tube instead of original front silencer	Race (no EG/ABE/EEC)			0103 919509
B17BA, 72.1 kW, 24.9 kW							
Bonneville	07-08		tapered muffler left/right incl. cat.	EG/ABE/EEC	CUSTOM	chrome	007102 915608LR
Bonneville T100	07-			EG/ABE/EEC	CUSTOM	stainless steel black	007702 915608LR
986MF, 48.6 kW, 24.3 kW							
Bonneville	09-		tapered muffler left/right incl. cat.	EG/ABE/EEC	CUSTOM	chrome	007102 916009LR
Bonneville SE				EG/ABE/EEC	CUSTOM	stainless steel black	007702 916009LR
986MF, 48.6 kW, 24.3 kW							
Bonneville T120 (Euro 4)	16-		Tapered muffler left/right Ø 84 mm	EG/ABE/EEC	CUSTOM	stainless steel chrome	007102 918016LR
Bonneville T120 black (Euro 4)				EG/ABE/EEC	CUSTOM	stainless steel black	007702 918016LR
Thruxton	07-		tapered muffler left/right incl. cat.	EG/ABE/EEC	CUSTOM	chrome	007102 915708LR
986ME, 50.1 kW, 24.6 kW							
Thruxton 1200	16-		Tapered muffler left/right Ø 90 mm	EG/ABE/EEC	CUSTOM	stainless steel matt	007502 918516LR
Thruxton 1200 R				EG/ABE/EEC	CUSTOM	Stainless steel chrome	007102 918516LR
(Euro 4)				EG/ABE/EEC	CUSTOM	stainless steel black	007702 918516LR
Rocket III Roadster	11-		slip on left/right incl. cat. (muffler) with aluminium end cap	EG/ABE/EEC		stainless steel black	007752 919511LR
Thunderbird LT	14-		CUSTOM exhaust slash cut left/right Ø 102 mm (4")	EG/ABE/EEC	CUSTOM	stainless steel chrome	007102 919514LR
B17, 69 kW				EG/ABE/EEC	CUSTOM	stainless steel black	007702 919514LR
Street Twin	16-		tapered muffler left/right Ø 76 mm	EG/ABE/EEC	CUSTOM	stainless steel mat	007102 916016LR
40.5 kW (Euro 4)				EG/ABE/EEC	CUSTOM	stainless steel black	007702 916016LR

Triumph Thunderbird LT Custom



Triumph Bonneville SE Custom



Triumph Rocket III Roadster Custom



Triumph Street Twin Custom black



SPORT = Silencer with homologation number (sound level is within the tolerated limit), but without catalytic converter, therefore no EEC!
 1) While stocks last! 2) EC-approval only for vehicles with a registration date before 1st July 2004. Specifications in the registration document have to match the actual conditions, i.e. the omission of the catalyser has to be reported to the licensing authority! A warranty of 24 months is given on all systems with EC-approval. No warranty on racing products. No warranty is given for small colour changes of the carbon!
Technical changes and errors excepted!



REMUS STREETBIKES

Model	Year	Ø mm	Description	Type	Muffler	Sleeve	Order no.
TRIUMPH STREETBIKES							
Daytona 675/R 94 kW	13-		slip on (muffler)	RACE (no EG/ABE/EEC)	HYPERCONE	stainless steel	096683 914613
				RACE (no EG/ABE/EEC)	HYPERCONE	stainless steel black	096783 914613
Speed Triple 1050 515NJ, 95.7 kW	05-06	54	slip on (muffler with connecting tube) no cat. **WARNING: indicators must be re-positioned!	Race (no EG/ABE/EEC)	POWERCONE	stainless steel black	055782 917505
Speed Triple 1050 Speed Triple 1050 S (Euro 4)	10-		slip on (muffler)	EG/ABE/EEC	HYPERCONE	stainless steel	096682 917716
	16-			EG/ABE/EEC	HYPERCONE	stainless steel black	096782 917716
					EG/ABE/EEC	HYPERCONE	titanium
Street Triple 675 Street Triple 675 R 78 kW	13-		slip on (muffler) right	EG/ABE/EEC	HYPERCONE	stainless steel	096682 914513
	13-			EG/ABE/EEC	HYPERCONE	stainless steel black	096782 914513
Tiger 800 Tiger 800 XC Tiger 800 XCx Tiger 800 XR Tiger 800 XRx	11-	54	slip on (muffler with connecting tube)	EG/ABE/EEC	HEXACONE	stainless steel	054682 915311
	11-			EG/ABE/EEC	HEXACONE	carbon	054482 915311
	15-			EG/ABE/EEC	HEXACONE	titanium	054882 915311
	15-						
	15-						
Tiger 1050 115NG, 84 kW	07-12	54	slip on (muffler with connecting tube)	EG/ABE/EEC	HEXACONE	stainless steel	054682 917007
				EG/ABE/EEC	HEXACONE	titanium	054882 917007
			complete system no cat.	Race (no EG/ABE/EEC)	HEXACONE	aluminium	014682 917007
				Race (no EG/ABE/EEC)	HEXACONE	titanium	014882 917007
			slip on (muffler with connecting tube) not suitable with centre stand	Race (no EG/ABE/EEC)	POWERCONE	stainless steel black	055783 917007
			complete system no cat.	Race (no EG/ABE/EEC)	POWERCONE	stainless steel black	015783 917007
Tiger 1050 Sport 92 kW	13-		slip on (muffler with connecting tube)	EG/ABE/EEC	HEXACONE	stainless steel	054682 916013
				EG/ABE/EEC	HEXACONE	Carbon	054482 916013
				EG/ABE/EEC	HEXACONE	titanium	054882 916013
			slip on (muffler) not in combination with travel cases	EG/ABE/EEC	HYPERCONE	stainless steel	096682 916113
				EG/ABE/EEC	HYPERCONE	stainless steel black	096782 916113
Tiger Explorer 1200 Tiger Explorer XC 101 kW	12-	54	slip on (muffler with connecting tube)	EG/ABE/EEC	HEXACONE	stainless steel	054682 918012
	13-			EG/ABE/EEC	HEXACONE	carbon	054482 918012
				EG/ABE/EEC	HEXACONE	titanium	054882 918012
Tiger Explorer XCA (Euro 4) Tiger Explorer XCX (Euro 4) Tiger Explorer XRX (Euro 4) Tiger Explorer XRT (Euro 4)	16-	54	slip on (muffler with connecting tube)	EG/ABE/EEC	HEXACONE	stainless steel	054682 918016
	16-			EG/ABE/EEC	HEXACONE	carbon	054482 918016
	16-			EG/ABE/EEC	HEXACONE	titanium	054882 918016
	16-			EG/ABE/EEC	BLACK HAWK	stainless steel black	0564782 918016

Triumph Street Twin
Custom black

Triumph Thruxton 1200 R
Stainless steel mat

Triumph Street Triple 675
HyperCone



slip on



screw on



complete system

SPORT = Silencer with homologation number (sound level is within the tolerated limit), but without catalytic converter, therefore no EEC!

1) While stocks last! ***)** EC-approval only for vehicles with a registration date before 1st July 2004. Specifications in the registration document have to match the actual conditions, i.e. the omission of the catalyser has to be reported to the licensing authority! A warranty of 24 months is given on all systems with EC-approval. No warranty on racing products. No warranty is given for small colour changes of the carbon!

Technical changes and errors excepted!

Model	Year	Ø mm	Description	Type	Muffler	Sleeve	Order no.
TRIUMPH STREETBIKES							
Trophy SE 99 kW	12-	54	slip on (muffler with connecting tube)	EG/ABE/EEC	HEXACONE	stainless steel	054682 918112
				EG/ABE/EEC	HEXACONE	carbon	054482 918112
				EG/ABE/EEC	HEXACONE	titanium	054882 918112
Sprint GT 1050 95.6 kW	10-		slip on (muffler with connecting tube) side case version	EG/ABE/EEC	HEXACONE	stainless steel	054682 918010
				EG/ABE/EEC	HEXACONE	carbon	054482 918010
				EG/ABE/EEC	HEXACONE	titanium	054882 918010

Triumph Speed Triple 1050S
HyperCone

EURO 4



Triumph Tiger 800 XCx
HexaCone



YAMAHA ENDURO							
XT 1200 Z Super Ténéré DP01, 80.9 kW	10-	54	slip on (muffler with connecting tube)	EG/ABE/EEC	HEXACONE	stainless steel	054682 998110
				EG/ABE/EEC	HEXACONE	titanium	054882 998110
YAMAHA STREETBIKES							
FZ8 RN25, 78.1 kW	10-	54	slip on (muffler with connecting tube)	EG/ABE/EEC	OKAMI	stainless steel	0514682 995210
				EG/ABE/EEC	OKAMI	carbon	0514482 995210
				EG/ABE/EEC	OKAMI	titanium	0514882 995210
YZF-R125 RE06, 11 kW	08-	45	complete system no cat.	Race (no EG/ABE/EEC)	POWERCONE	stainless steel	015682 991208
YZF-R6 RJ11, 93.4 kW	06-07	45	high performance complete system stainless steel header (4-2-1) with conical tubes & full Titanium Race muffler (107dB) *Only for FIM Supersport Reglement-107dB	Race (no EG/ABE/EEC)	GRAND PRIX	titanium	013903 994008
YZF-R6 RJ15, 94.9 kW	08-	45	high performance complete system stainless steel header (4-2-1) with conical shaped tubes & full Titanium Race muffler high performance complete system stainless steel header (4-2-1) with conical tubes & full Titanium Race muffler (107dB) *Only for FIM Supersport Reglement-107dB	Race (no EG/ABE/EEC)	HEXACONE	titanium	014883 994008
				Race (no EG/ABE/EEC)	GRAND PRIX	titanium	013903 994008

Yamaha - XT 1200 Z Super Ténéré
HexaCone



Yamaha - YZF-R125
PowerCone



SPORT = Silencer with homologation number (sound level is within the tolerated limit), but without catalytic converter, therefore no EEC!
 1) While stocks last! 2) EC-approval only for vehicles with a registration date before 1st July 2004. Specifications in the registration document have to match the actual conditions, i.e. the omission of the catalyser has to be reported to the licensing authority! A warranty of 24 months is given on all systems with EC-approval. No warranty on racing products. No warranty is given for small colour changes of the carbon!
Technical changes and errors excepted!



complete system



screw on



slip on

REMUS STREETBIKES

Model	Year	Ø mm	Description	Type	Muffler	Sleeve	Order no.	
YAMAHA STREETBIKES								
YZF-R1 RN22, 133.9 kW	09-		slip on (muffler) left/right	EG/ABE/EEC	HEXACONE	stainless steel	094682 997009LR	
			race connecting tube (replaces serial catalytic converter)	Race (no EG/ABE/EEC)	VBR / Conn.	stainless steel	0103 997009	
Yamaha YZF-R1M Yamaha YZF-R1 Yamaha YZF-R1	15-	60	high performance complete system - stainless steel stainless steel header (4-2-1) & full titanium race muffler incl. sound insert	Race (no EG/ABE/EEC)	HEXACONE	stainless steel	014883 997015	
XJR 1200 4PU, 4RB, 61 kW	95-	54	complete system (4-2-1) no cat., fits not on travelcase version	Race (no EG/ABE/EEC)	GRAND PRIX	aluminium	513103 997501	
XJR 1300 RP021, 78.1 kW	99-	54	complete system (4-2-1) no cat., fits not on travelcase version	Race (no EG/ABE/EEC)	GRAND PRIX	aluminium	513103 997501	
XJ 1300 72 kW								
XJR 1300 RP061, 72 kW	02-03							
XJR 1300 RP10, 78.1 kW	04-	54	slip on (muffler with connecting tube) left/right	EG/ABE/EEC	REVOLUTION GP	aluminium	053182 998504LR	
Yamaha MT-07 Yamaha MT-07 Moto Cage	14- 15-	65	complete system (header, front muffler and rear muffler) (only incl. catalytic converter street-legal)		HYPERCONE	stainless steel	406682 994515	
			catalytic converter	EG/ABE/EEC		stainless steel black	406782 994515	
						titanium	406882 994515	
			The exhaust system has an EEC approval, but is only authorised for road use in combination with the catalytic converter.					
			complete system (header, racing connecting tube and rear muffler)	Race (no EG/ABE/EEC)	HYPERCONE	stainless steel	036682 994515	
				Race (no EG/ABE/EEC)	HYPERCONE	stainless steel black	036782 994515	
				Race (no EG/ABE/EEC)	HYPERCONE	titanium	036882 994515	
XSR 700	16-		complete system (header, racing connecting tube and rear muffler)	Race (no EG/ABE/EEC)	HYPERCONE	stainless steel	036682 994515	
				Race (no EG/ABE/EEC)	HYPERCONE	stainless steel black	036782 994515	
				Race (no EG/ABE/EEC)	HYPERCONE	titanium	036882 994515	

Yamaha YZF-R6
Complete system



Yamaha YZF-R1M
High Performance Racing System



slip on



screw on

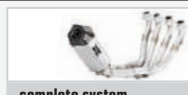

complete system

SPORT = Silencer with homologation number (sound level is within the tolerated limit), but without catalytic converter, therefore no EEC!

1) While stocks last! ***)** EC-approval only for vehicles with a registration date before 1st July 2004. Specifications in the registration document have to match the actual conditions, i.e. the omission of the catalyser has to be reported to the licensing authority! A warranty of 24 months is given on all systems with EC-approval. No warranty on racing products. No warranty is given for small colour changes of the carbon!

Technical changes and errors excepted!

Model	Year	Ø mm	Description	Type	Muffler	Sleeve	Order no.
YAMAHA STREETBIKES							
Yamaha MT-09	14-	65	complete system (header, front muffler and rear muffler)		HYPERCONE	stainless steel	406682 995515
Yamaha MT-09 Street Rally	14-		(only incl. catalytic converter street-legal)		HYPERCONE	stainless steel black	406782 995515
Yamaha MT-09 Sport Tracker	14-		*not suitable for models with centre stand		HYPERCONE	titanium	406882 995515
			catalytic converter	EG/ABE/EEC			KAT016
The exhaust system has an EEC approval, but is only authorised for road use in combination with the catalytic converter.							
			complete system (header, racing connecting tube and rear muffler)	Race (no EG/ABE/EEC)	HYPERCONE	stainless steel	036682 995515
			*not suitable for models with centre stand	Race (no EG/ABE/EEC)	HYPERCONE	stainless steel black	036782 995515
				Race (no EG/ABE/EEC)	HYPERCONE	titanium	036882 995515
			complete system (header, racing connecting tube and rear muffler)	Race (no EG/ABE/EEC)	HYPERCONE	stainless steel	036682 995515
			suitable for models with centre stand	Race (no EG/ABE/EEC)	HYPERCONE	stainless steel black	036782 995515
				Race (no EG/ABE/EEC)	HYPERCONE	titanium	036882 995515
Yamaha MT-09 Tracer	15-	65	complete system (header, racing connecting tube and rear muffler)	Race (no EG/ABE/EEC)	HYPERCONE	stainless steel	036682 995515
				Race (no EG/ABE/EEC)	HYPERCONE	stainless steel black	036782 995515
				Race (no EG/ABE/EEC)	HYPERCONE	titanium	036882 995515
MT-10 (Euro 4)	16-	65	slip on (muffler) incl. heat shield	EG/ABE/EEC	HYPERCONE	stainless steel	096682 997016
				EG/ABE/EEC	HYPERCONE	stainless steel black	096782 997016
			Racing connecting tube instead of original front silencer	RACE (no EG/ABE/EEC)			0103 997016
YAMAHA CRUISER							
XV 950	14-	55	slip on (muffler with connecting tube)		RETRO	stainless steel black	057702 996514
XV 950 R			catalytic converter	EG/ABE/EEC			KAT011
The exhaust system has an EEC approval, but is only authorised for road use in combination with the catalytic converter.							

Yamaha MT-10
HyperCone Full System



Yamaha XSR 700
HyperCone Full System



Yamaha MT-10
HyperCone

EURO 4



Yamaha XV 950
RETRO



SPORT = Silencer with homologation number (sound level is within the tolerated limit), but without catalytic converter, therefore no EEC!
 1) While stocks last! *) EC-approval only for vehicles with a registration date before 1st July 2004. Specifications in the registration document have to match the actual conditions, i.e. the omission of the catalyser has to be reported to the licensing authority! A warranty of 24 months is given on all systems with EC-approval. No warranty on racing products. No warranty is given for small colour changes of the carbon!
Technical changes and errors excepted!



REMUS RACING TECHNOLOGY

from the racetrack to the street

REMUS Racing Technology can be found on nearly every race track around the world. The technical expertise of racing is transferred straight to our street legal sport exhaust systems. Extensive racing usage provides the necessary feedback for the REMUS technicians to develop and produce REMUS sport exhaust systems and guarantee ongoing product innovation and highest quality.

- Since many years numerous Superbike and Supersport teams trust in the know-how of REMUS. Wins in different national and international racing series proved the performance of REMUS sport exhaust systems in an impressive manner.



REMUS RACING SYSTEMS

BMW S 1000 R / BMW S 1000 RR

HONDA CBR 1000 RR

SUZUKI GSX-R 600 / 750 / 1000

YAMAHA YZF-R6

YAMAHA YZF-R1M / Yamaha YZF-R1



Jochen Rotter - Austrian Supersport Championship



Yamaha YZF-R1M
High Performance Racing System



Honda - CBR 1000 RR
High Performance Racing System