

A silver SUV is shown from a side-rear perspective, driving on a dirt road that winds through a rugged, mountainous landscape. The sky is blue with scattered clouds, and the terrain is rocky with some green vegetation. The SUV's side mirror, door, and rear wheel are visible.

DRIVEN TO DELIVER

IRREESE BRANDS
PRODUCT CATALOG

A TRUSTED BRAND OF HORIZON GLOBAL



REESE®, a Horizon Global brand, is the market leader in automotive and recreational product solutions, engineered and designed to meet the demands of work and active lifestyles.

Since 1952, REESE has been a leader in the towing and trailering industry, with proven designs that exceed the industry standards. REESE is the “Brand of Choice” when performance is the expectation.

REESE provides quality solutions for a wide variety of industries, including automotive, agricultural, construction, industrial, marine, military, RV, trailer and utility applications.

The REESE family of sub-brands includes:



NUMBER ONE IN TOWING
A complete line of quality product solutions for light- to heavy-duty towing and trailering systems



FOR EVERY ADVENTURE
Durable cargo management solutions for active lifestyles, providing convenient and secure transportation of gear



PERFORMANCE DRIVEN
Innovative, solution driven products for securing, hauling and protecting all consumer and professional essentials



PERFORMANCE ON AND OFF THE ROAD
Providing enthusiasts with innovative products to match their passion for performance both on- and off-road



Horizon Global is the #1 designer, manufacturer and distributor of a wide variety of high-quality, custom engineered towing, trailering, cargo management and other related accessory products in North America, Australia and Europe.



REESE TOWPOWER
PAGES 4-163

RECEIVER HITCHES6-19

Custom-Fit Receiver Hitches 8-10
 Multi-Fit Receiver Hitches..... 10-15
 Receiver Adapters & Tubes 16-17
 Front-Mounted Hitch Receivers..... 18

HITCH ACCESSORIES22-47

REESE Tactical 22-27
 InterLock® Hitch Balls 28
 Standard Hitch Balls 29
 Interchangeable Hitch Ball Systems..... 30
 Carbon Forged Ball Mounts 32
 InterLock® Ball Mounts 33
 Standard Ball Mounts 34
 Class V Hitch Accessories 35
 3-in Hitch Accessories..... 36-37
 Forged Ball Mounts 38
 Adjustable Ball Mount..... 38
 Rotating Tri-Ball..... 39
 Multiple Ball Mount 40-41
 Carabiner Hooks 41
 Starter Kits and Security Kits 41-43
 Ball/Hook Mounts 44
 Pintle Hooks/Accessories 45
 Receiver Mount Pintles/Tow Hook/
 Tow Eye/Tow Ring, Clevis Mount..... 46-47

TOWING SECURITY48-63

REESE Towpower Professional Locks..... 50
 Easy Access Locks..... 51-52
 Barrel Style Locks..... 53
 Hitch Pin and Clips..... 54-55
 Anti-Theft Pin and Clip..... 56
 Ergoclips..... 56
 Bent Pin Locks..... 57
 Trailer Coupler Locks 58-59
 Cable Locks 60
 King Pin Lock..... 60
 Safety Chains 61
 Adjustable Tow Bars 62
 Spare Tire Carriers..... 62

COUPLERS, JACKS & WINCHES64-75

Couplers 66-67
 Jacks..... 68-72
 Winches 73
 Powered Jacks 74-75

TOWING ACCESSORIES.....76-89

Vehicle Recovery 78-79
 Chain Hoists..... 79
 Heavy-Duty Jacks..... 80
 Hitch Accessories 81
 Hitch Steps..... 82
 Wrenches..... 83
 Wheel Chocks 83
 POD Hazard 84-85
 Hitch Covers 86-87
 Bearing, Bushings 88
 Step Bumper Receiver..... 88
 Towing Mirrors 89
 Solohitch™..... 89

ELECTRICAL WIRING 90-121

T-Connectors 92-93
 Tail Light Converters..... 94-97
 Basic Connectors 97-111
 Mounting Brackets..... 111-112
 Wiring Accessories 113
 Adapters..... 114-90
 Back-Up Alarm, Power Adapter 121

BRAKE CONTROLLERS 122-133

How to Choose the Right Brake Controls..... 124
 Timed Brake Controls..... 125
 Proportional Brake Controls..... 1266
 Wireless Braking System 127
 Brake Control Harnesses 128-132
 Breakaway Systems..... 133

VEHICLE ILLUMINATION 134-163

Lighted Hitch Covers 136-137
 Lighted Vehicle Accessories 138-139
 Stop/Turn/Tail Lights..... 140-148
 Clearance/Marker Lights..... 149-155
 ID Light Bars 156
 Utility Specialty Lights 157-160
 Lighted Hitch Step 161
 Quick Mount Reflectors..... 162
 Conspicuity Strips..... 163

TECHNICAL268-277

Towing Made Easy268-271
 Selecting Ball Mount and Hitch Ball..... 272
 Important Information 273
 Federal Lighting Requirements..... 274 – 277

REESE SECURE

PAGES 164-227

TIE DOWNS 166-175

New T-Handle Ratchet 168
 Choosing the Proper Tie Down 169
 Light Duty Ratchets 170
 Standard Duty Ratchets 170-171
 Heavy Duty Ratchets 172
 Super Duty Ratchets 172-173
 Camo Ratchets 173
 Light Duty Cambuckles 174
 Standard Duty Cambuckles 174
 Heavy Duty Cambuckle 175
 Vehicle Tie Downs 175
 Lashing Strap 175

BUNGEE CORDS 176-183

Which Bungee Do You Need? 179
 Fat Strap Bungees 178
 Triple Strength Bungees 179
 Industrial Bungees 180
 Camo Bungees 180
 Standard Bungees 181
 Quick Wrap Bungees 182
 Corner Protect Bungees 182
 Mini Bungees 182
 Canopy Ties 183
 6-Arm Bungee 183

FASTENERS 184-187

EPDM Rubber Tarp Straps 186
 Tarp Clips 186
 Secure Wraps 187
 Carabiners 187
 Cable Ties 187
 Wrap-Tyte Ties 187

CARGO NETS & COVERS 188-191

Cargo Nets 190
 Deluxe Cargo Nets 191
 Motorcycle Cover 190

ANCHORING 192-197

Stake Pocket Anchors 194
 Heavy-Duty Bull Ring Stake Pocket Anchor Point 195
 Pop-Up Stake Pocket Anchor Point 195
 Recess Mount Ring Anchors 196
 Surface Mount Ring Anchors 196
 Movable Anchor 197
 Sure Step Self-Stick Rubber Mats 197

RECOVERY 198-203

Helpful Hints When Using Recovery Straps 201
 Hook-End Tow Straps 200
 Loop-End Tow Straps 200
 Tow Rope 201
 Shackles 202
 Tree Saver 202
 Axle Straps 203
 Winch Straps 203

CABLE PULLERS 204-207

Cable Pullers 206
 Webbing Puller 206
 Rope Hoist 207
 Cable Puller Storage Bag 207

E-TRACK SYSTEM 208-211

E-Track Sections 210
 E-Track Tie Downs 210
 E-Track D-Ring Strap 211
 E-Track O-Ring 211
 E-Track J-Hook 211

TRUCK RACKS 212-217

TransRACK Cargo Truck Rack System 214
 TransRACK Workmate Cargo Truck Rack System 214
 TransRACK Top Rail Kit 214
 TransRACK Load Stops 215
 TransRACK Conduit Carrier 215
 TransRACK Cross Bar Glides 215
 TransRACK Cargo Trimmer Rack 216
 TransRACK Tool Rack 216

ROPES 218-221

Nylon Ropes 220
 Polyester Rope 220
 Cotton Rope 220
 Polypropylene Ropes 221
 Jute Cord 221

WATER SPORT 222-227

Ceiling-Mount Kayak Pulley System 224
 Deluxe Wall-Mount Kayak Storage Rack 224
 Wall-Mount Kayak Storage Rack 225
 Wall-Mount Kayak Storage Straps 225
 J-Rac Kayak Carrier 226
 Kayak Tie Down Kit 226
 Tailgate Pads 226
 Cross Bar Pads 227
 Waterproof Dry Bags 227
 Bungee Kayak Deck Net 227

REESE POWERSPORTS

PAGES 228-239

Motorcycle Cargo Net	232	Marine Collection Winches.....	235
Lighted License Plate Frames.....	232	Marine Winches.....	235
Motorcycle Wheel Chock	232	Winch Straps	236
Tie Downs - ATV & Motorcycle	232	Spare Tire Carriers	236
Covers - ATV, UTV & Motorcycle.....	233	Marine Accessories	237
ATV Recovery Strap	233	Bow Tie Downs	238
ATV Cargo Net	233	Gunwale Tie Downs	238
ATV/UTV Jack	234	Transom Tie Downs.....	239
Jack Maintenance Kit.....	234	Retractable Transom Tie Downs	239
3-Way ATV Hitches.....	234	Dock Cleat.....	239

REESE EXPLORE

PAGES 240-267

RAMPS.....242-251

Aluminum Ramps.....	244
Zero-Turn Mower Ramps.....	244
Heavy-Duty Aluminum Ramps	245
Xtrusion Series Aluminum Ramps	245
Telescoping Aluminum Ramps	246
Connecting Ramps	246
Adjustable Top Plate Ramps.....	246
Steel Ramps	247
Threshold Ramps.....	247
Standard Ramp Kits	248
Adjustable Top Ramp Kits	249
Ramp Carry Handle	250
Ramp Carry Strap	250
Ramp Safety Strap	251
Ramp Bumper.....	251

CARGO CARRIERS.....252-259

Helpful Hints For Transporting Gear On Your Roof	255
Easily Load and Unload Your Gear with a Hitch Mount Cargo Carrier	256
J-Rac Kayak Carrier	254
Adjustable Cross Bars	254
Rooftop Baskets.....	254
Rooftop Cargo Bags	255

Folding Rooftop Carrier	256
Hitch Mount Cargo Trays.....	257
Cargo Tray Bags.....	257
Waterproof Dry Bags	258
Cross Bar Pads.....	258
Protective Cargo Mat.....	258
Full-Size Tailgate Pad.....	259
Protective Tailgate Pad	259

VEHICLE ORGANIZERS.....260-263

Universal Pet Barrier	262
Trunk Organizer	262
Storage Net.....	262
Cargo Bar.....	263
Internal Organization	263

BIKE CARRIERS.....264-267

What to Know When Selecting a Bike Carrier	266
Sportwing™ Hitch Mount Bike Carriers.....	266
Hitch Mount Tilt-Away 4-Bike Carrier	266
Aluminum Trunk Mount 2-Bike Carrier	267
Steel Trunk Mount 2-Bike Carrier	267
Axis 3™ Trunk Mount 3-Bike Carrier	267



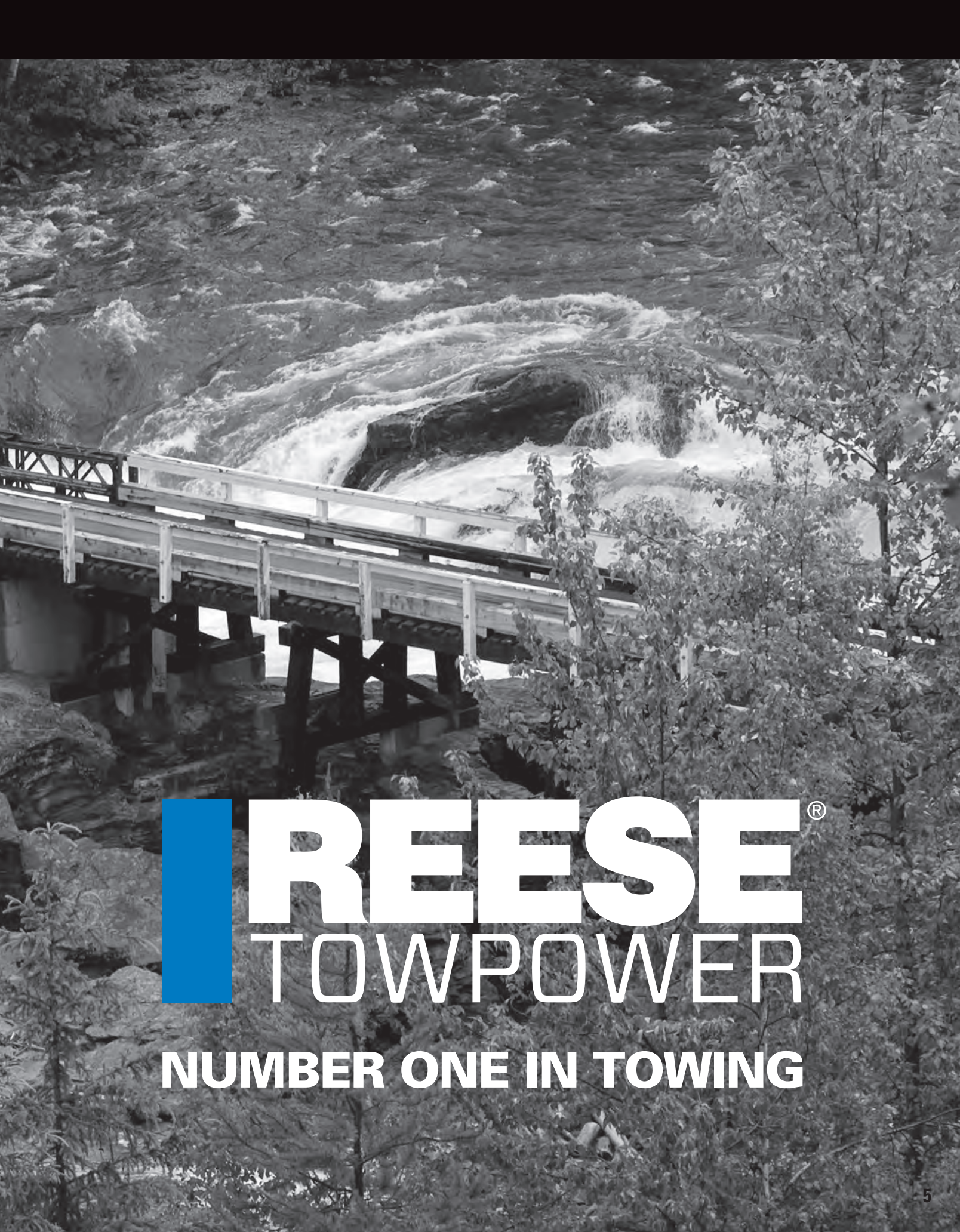

REESE[®]
TOWPOWER
NUMBER ONE IN TOWING

**PERFECT FIT
EVERY TIME**





Designed to look great and made to last. Solid, all-welded construction that's custom built to meet vehicle make and model specifications.

RECEIVER HITCHES

CUSTOM-FIT RECEIVER HITCHES 8-10
 Hitch Application Guide..... [CLICK HERE](#)

MULTI-FIT RECEIVER HITCHES 11-15

RECEIVER ADAPTERS & TUBES..... 16-17

FRONT-MOUNTED HITCH RECEIVERS..... 18



CLASS I/II CUSTOM-FIT HITCHES

CLASS I CUSTOM-FIT INSTA-HITCH



- 1-1/4-In square receiver tube opening
- Economical Class I receiver tube hitch
- Attaches to vehicle frame and/or bumper
- Resists rust and corrosion
- 2000 lb max gross trailer weight, 200 lb max tongue weight

[Click Here to Go to Our Application Guide](#)

Part Number	Receiver Type	Max. Gross Trailer Weight	Max. Tongue Weight	Install Time
77 Series	Square Tube	2000 lb	200 lb	15-35 min.
51 Series	Square Tube	2000 lb	200 lb	15-35 min.
97 Series	Square Tube	2000 lb	200 lb	15-35 min.



CLASS II CUSTOM-FIT INSTA-HITCH



- 1-1/4-in square receiver tube opening
- Economical Class II receiver tube hitch
- Attaches to vehicle frame and/or bumper
- Resists rust and corrosion
- 3500 lb maximum gross trailer weight
- 350 lb maximum tongue weight

Part Number	Receiver Type	Max. Gross Trailer Weight	Max. Tongue Weight	Install Time
06 Series	Square Tube	3500 lb	350 lb	15-35 min.
51 Series	Square Tube	3500 lb	350 lb	15-35 min.
97 Series	Square Tube	3500 lb	350 lb	15-35 min.



1 1/4 in RECEIVER OPENING
Class I & II
 Light to Medium Duty
 2,000 to 3,500 lb
 Gross Towing Capacity

2 in RECEIVER OPENING
Class III & IV
 Heavy Duty
 5,000 to 8,000 lb
 Gross Towing Capacity

2 in RECEIVER OPENING **2 1/2 in RECEIVER OPENING**
Class V
 Extra Heavy Duty
 Up to 18,000 lb
 Gross Towing Capacity

CLASS III/IV CUSTOM-FIT HITCH

2 in
RECEIVER
OPENING

- 2-in square receiver tube opening
- Round tubes available on some models
- Ball mount, pin and clip sold separately
- Attaches to vehicle frame and/or bumper
- Most include distinctive collar and plug

[Click Here to Go to Our Application Guide](#)

Part Number	Receiver Type	Max. Gross Trailer Weight	Max. Tongue Weight	Weight Dist.	Install Time
33 Series	Square Tube	8000 lb	800 lb	12000/1200	15-35 min.
35 Series	Square Tube	5000 lb	500 lb	10000/1000	15-35 min.
36 Series	Square Tube	5000 lb	500 lb	10000/1000	15-35 min.
37 Series	Square Tube	7500 lb	750 lb	12000/1200	15-35 min.
44 Series	Square Tube	8000 lb	800 lb	12000/1200	15-35 min.
84 Series	Square Tube	8000 lb	800 lb	12000/1200	15-35 min.
51 Series	Square Tube	6000 lb	600 lb	10500/1050	15-35 min.
97 Series	Square Tube	6000 lb	600 lb	10500/1050	15-35 min.



		COMPACT CARS	MID-SIZE CARS	FULL-SIZE CARS, MINI-VANS & TRUCKS	FULL-SIZE VANS, TRUCKS, SUVs
CLASS I	LIGHT DUTY WC GTW – Up to 2,000 lb WC TW – Up to 200 lb				
CLASS II	MEDIUM DUTY WC GTW – Up to 3,500 lb WC TW – Up to 350 lb	—			
CLASS III	HEAVY DUTY WC GTW – Up to 5,000 lb WC TW – Up to 500 lb	—	—		
CLASS IV	HEAVY DUTY WC GTW – Up to 8,000 lb WD GTW – Up to 12,000 lb WC TW – Up to 800 lb WD TW – Up to 1,200 lb	—	—		
CLASS V	EXTRA HEAVY DUTY WC GTW – Up to 15,000 lb WD GTW – Up to 18,000 lb WC TW – Up to 1,500 lb WD TW – Up to 1,600 lb	—	—		
	EXTRA HEAVY DUTY WC GTW – Up to 18,000 lb WD GTW – Up to 18,000 lb WC TW – Up to 2,000 lb WD TW – Up to 2,500 lb	—	—		

CLASS V CUSTOM-FIT HITCH

2 in
RECEIVER
OPENING

- 2-in & 2-1/2-in square receiver tube opening
- Designed for full-sized long wheelbase trucks, vans and utility vehicles with full frames and heavy-duty suspensions

2 1/2 in
RECEIVER
OPENING

- Ideal for high tongue-weight applications
- Strong, secure heavy-duty side bracket design
- All frame attachments, J-pin® ready
- Black powder coat finish over E-coat

[Click Here to Go to Our Application Guide](#)

Part Number	Receiver Type	Max. Gross Trailer Weight	Max. Tongue Weight	Weight Dist.	Install Time
96 Series	2-in Square Tube	15000 lb	1500 lb	16000/1600	60 min.
45 Series	2-1/2-in Square Tube	18000 lb	2000 lb	18000/2500	60 min.
457 Series	2-1/2-in Square Tube	18000 lb	2000 lb	18000/2500	60 min.

96 Series

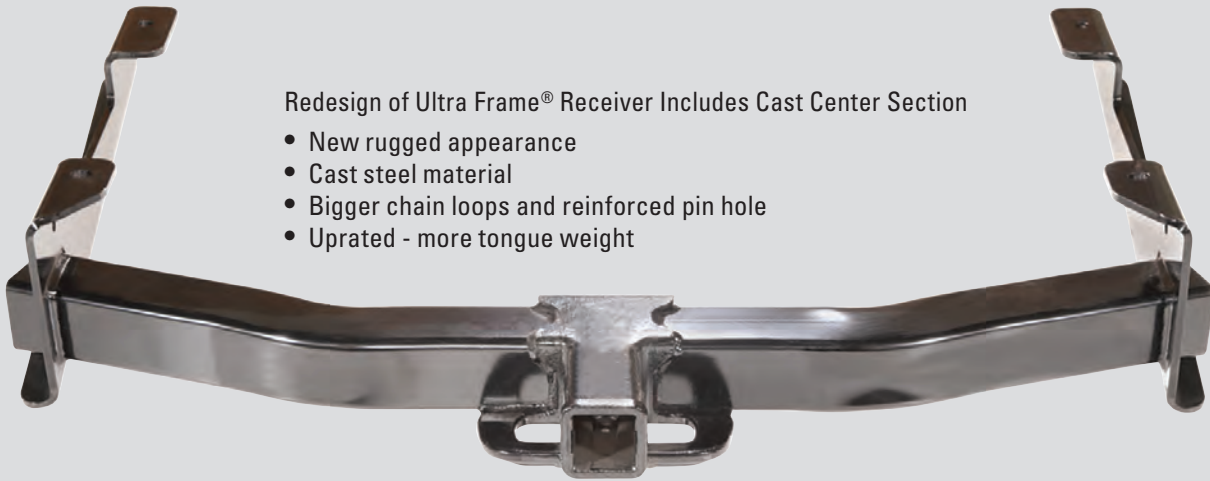

Redesign of Ultra Frame® Receiver Includes Cast Center Section

- New rugged appearance
- Cast steel material
- Bigger chain loops and reinforced pin hole
- Up-rated - more tongue weight

45 & 457 Series

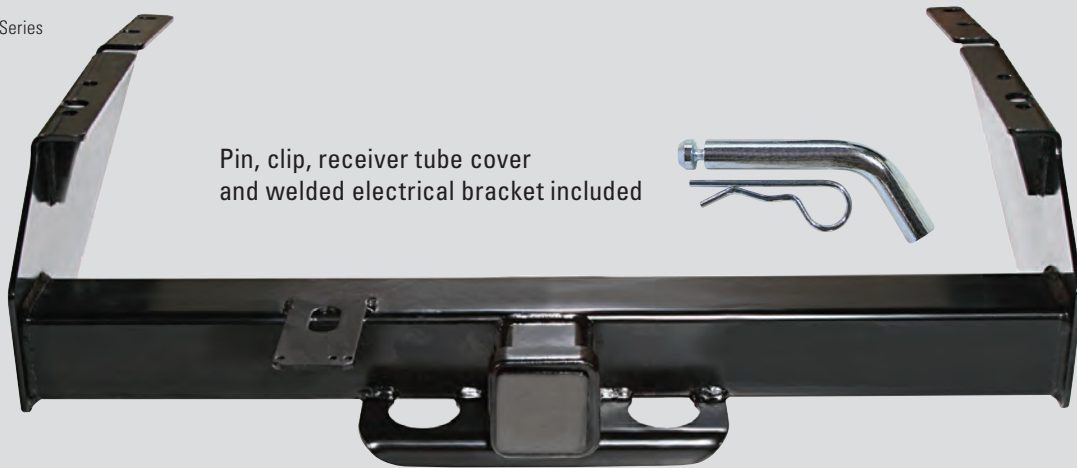

Pin, clip, receiver tube cover and welded electrical bracket included

37041 CLASS III/IV MULTI-FIT HITCH

2 in
RECEIVER
OPENING

- 2-in square receiver tube opening
- Passenger car, SUV, van & light truck applications
- 5000 lb maximum gross trailer weight
- 500 lb maximum tongue weight

METAL SHIELD®
RESISTS RUST & CORROSION

Year	Make	Model	Wiring
96-11	Chevrolet	Express Van	74659 (96-99), 85246 (00-02), 74051 (03-06)
95-05	Chevrolet	Blazer-Down Size (2 & 4 Dr.)	85217
99-01	Chevrolet	Trailer Blazer-Down Size	85219
92-94	Ford	Econoline	74664
95-03	Ford	Econoline Van Full Size, Including Super Wagon	
04-11	Ford	Econoline Van Full Size, Except E-28 , Super Wagon Cargo Van & 3-350 Models	
95-03	Ford	Clubwagon Van	74665
92-00	Ford	Explorer	74190 (92-94), 74724 (95-00)
01-03	Ford	Explorer 2 dr. Sport	
2001	Ford	Explorer 4 dr.	
96-08	GMC	Savana Van Full Size	74659 (96-99), 85246 (00-02), 74051 (03-06)
95-02	GMC	Jimmy-Down Size	74051
98-01	GMC	Envoy	74051
92-94	Mazda	Navajo	74190
97-01	Mercury	Mountaineer	74724
96-01	Oldsmobile	Bravada	74051

37041



MULTI-FIT HITCHES

37042 CLASS III/IV MULTI-FIT HITCH



- 2-in square receiver tube opening
- Passenger car, SUV, van & light truck applications
- 5000 lb maximum gross trailer weight
- 500 lb maximum tongue weight

METAL SHIELD®
RESISTS RUST & CORROSION

Year	Make	Model	Wiring
92-94	Chevrolet	Blazer Full Size	74180
96-12	Chevrolet	Express Van	74659 (96-99), 85246 (00-02), 78029 (03-11)
96-14	Chevrolet	Full Size Van	78058
82-07	Chevrolet	Pickup (F.S.) Long Bed Only (07 Classic Only)	74178 (85-87), 74178 (88-91 Old Style), 85741 (88-00), 74682 (99-07)
83-84	Chevrolet	S-10 w/Standard Box & Step Bumper	78058 (1983), 74427 (84-91)
83-04	Chevrolet	S-10 Pickup Long Bed 2 & 4WD	78058 (83), 74427 (84-91 2 Dr.), 74178 (85-97), 74216 (98-04)
85-97	Chevrolet	S-10 w/Standard Box & Step Bumper, Inc. ZR2 & Highlander Pkg.	74178 (85-97), 74216 (98-04)
98-04	Chevrolet	S-10 w/Standard Box & Step Bumper, Inc. ZR2 & Highlander Pkg & Crew Cab*	74051, 74216 (98-04)
98-04	Chevrolet	S-10 Pickup Short Bed 4 x 4 Only*	74216
01-04	Chevrolet	S-10 Pickup Crew Cab*	74216
92-99	Chevrolet	Suburban Old Body Style	74180 (92-99), 85262
00-06	Chevrolet	Suburban New Body Style w/Amber Turn Signals	74180 (92-99), 85262 (00-06 New Body Style)
95-00	Chevrolet	Tahoe Old Body Style	74180 (92-00)
00-06	Chevrolet	Tahoe New Body Style w/Amber Turn Signals, w/Factory 7-Way	78058 (00-11), 85262 (00-11 New Body Style)
99-04	Chevrolet	Tracker	74896
90-03	Chrysler	Town & Country	78058 (90-95), 74187 (91-95), 74658 (96-00), 85245 (01-03)
90-95	Chrysler	Town & Country Except Stow & Go Seats	78058 (84-90), 74187 (91-95)
84-95	Dodge	Caravan Except Stow & Go Seats	78058 (84-90), 74187 (91-95)
86-94	Dodge	Dakota Pickup Long Bed Only	74182
95-99	Dodge	Dakota Pickup Long Bed Only	74475
84-03	Dodge	Grand Caravan	78058 (84-95), 74187 (91-95), 74658 (96-00), 85245 (01-03)
94-95	Dodge	Caravan & Grand Caravan Except Sto & Go Seats, Inc. 4WD	78058 (04-95), 74187 (91-95), 74658 (96-00), 85245 (01-03), 78000 (04-07)
08-12	Dodge	Nitro	78017
82-01	Dodge	Pick-Up Full Size	74051 (82-95), 74182 (86-93), 74475 (95-01)
82-93	Dodge	Ramcharger	74182 (86-93), 78058 (82-93)
02	Dodge	2500/3500	74475
86-97	Ford	Aerostar Extended Only	78013 (86-96), 78051 (97), 78665 (97)
82-96	Ford	Bronco Full Size	74426 (80-86), 74669 (92-96)
84-90	Ford	Bronco II	78104, 78058 (87-91)
11-14	Ford	Edge Except Sports Models	85742
82-04	Ford	Pick-Up Full Size, 04 F250/350 & F150 Heritage Only, 2004 Heritage Only	74178 (85-87), 74178 (88-91)
82-97	Ford	Ranger	74179 (86-92), 74424 (93-99), 74665 (00-03), 78058 (88-97)
98-11	Ford	Ranger All, Except Flareside or w/Rear Fascia	74885 (98-99), 74424 (98-99), 74665 (00-03), 78058 (98-10)
96-14	GMC	Full Size Van	78058
92-94	GMC	Jimmy Full Size	74180
82-07	GMC	Pickup (F.S.) Long Bed Only (07 Classic Only)	74178 (85-87), 74178 (88-91 Old Style), 85741 (88-00), 74682 (99-07)
83-94	GMC	S-15, Sonoma w/Standard Box & Step Bumper	78058

Year	Make	Model	Wiring
95-97	GMC	S-15, Sonoma w/Standard Box & Step Bumper, Inc. ZR2 & Highlander Pkg.	74178
98-04	GMC	S-15 Short Bed 4 x 4 Only	74216
01-04	GMC	S-15 Pickup Crew Cab*, Short Bed 4 x 4	78058
98-04	GMC	Sonoma w/Standard Box & Step Bumper, Inc. ZR2 & Highlander Pkg.	74216
83-04	GMC	Sonoma Long Bed	74178 (85-97), 74216 (98-04)
90-05	GMC	Safari Extended Only	78058
96-12	GMC	Savana Van	74659 (96-99), 85246 (00-02), 78029 (03-10)
07-12	GMC	Sierra 1500	74682 (00-12), 78058 (00-12)
92-99	GMC	Suburban	74180
92-00	GMC	Yukon Old Body Style	78180
00-06	GMC	Yukon New Body Style w/Amber Turn Signals, w/Factory 7-Way	85262 or 74682
99-00	GMC	Yukon Denali Old Body Style	74180
01-02	GMC	Yukon Denali New Body Style w/Amber Turn Signals w/Factory 7-Way	85262 or 74682
00-06	GMC	Yukon XL w/Factory 7-Way	85262 or 74682
98-00	Isuzu	Hombre w/Step Bumper, Short Bed, 4x4 only	74216 (98-00)
84-01	Jeep	Cherokee Downsize, All models, will not fit Grand Cherokee,	74476 (91-96), 74206 (97-01), 78013 (84-01)
97-01	Jeep	Cherokee	74206
84-96	Jeep	Cherokee XJ (Without Fuel Tank Shield and Existing Hardware In Frame)	78013 (84-90), 74476 (91-96)
93-98	Jeep	Grand Cherokee	74667 (93), 74668 (94-98)
02-07	Jeep	Liberty	85750
09-12	Jeep	Liberty	78017 or 78104
90-09	Mazda	Pickup B-Series	78013 (90-08), 74424 (94-08)
86-97	Nissan	Pickup 56" Bed	74494 (86 1/2-97)
87-03	Nissan	Pickup & Frontier (W/56" Beds)	74494 (87-97), 78013 (98-03)
98-04	Nissan	Frontier 56" Bed	74219 (98-04), 78013
84-95	Plymouth	Voyager	78058 (84-90), 74187 (91-95)
99-05	Suzuki	Vitara & Grand Vitara	74896
01-06	Suzuki	XL7	74896

37042



MULTI-FIT HITCHES

37096 CLASS III/IV MULTI-FIT HITCH

2 in
RECEIVER
OPENING

- 2-in square receiver tube opening
- Passenger car, SUV, van & light truck applications
- 5000 lb maximum gross trailer weight
- 500 lb maximum tongue weight

METAL SHIELD®
RESISTS RUST & CORROSION

Year	Make	Model	Wiring
88-00	Chevrolet	Pickup C/K Series, w/6 ft. Bed 2 Dr. Reg. & Ext. Cabs Incl. Sportside Fenders	85741
88-00	Chevrolet	Pickup C/K Series, w/8 ft. Bed 2 Dr. Regular & Extended Cabs	85741
92-00	Chevrolet	Pickup C/K Series, w/8 ft. Bed 4 Dr. Crew Cab	85741
01-06	Chevrolet	Silverado 1500 HD, 2 & 4 WD	74682 7-Way, 85262 4-Flat
2007	Chevrolet	Silverado Classic 1500 HD, 2 & 4 WD	74682 7-Way, 85262 4-Flat
99-06	Chevrolet	Silverado 1500 LD, 2 & 4 WD	74682 7-Way, 85262 4-Flat
07-13	Chevrolet	Silverado 1500 LD	74682 7-Way, 85262 4-Flat
01-07	Chevrolet	Silverado 2500 HD, 2 & 4 WD	74682 7-Way, 85262 4-Flat
2007	Chevrolet	Silverado Classic 1500 HD/LD, 2500 HD, 2 & 4 WD	74682 7-Way, 85262 4-Flat
94-01	Dodge	1500 Full Size Pickup, Short Bed	74475
94-02	Dodge	2500, 3500 Full Size Pickup, Short Bed	74475
94-01	Dodge	1500 Full Size Pickup, Long Bed	74475
94-02	Dodge	2500, 3500 Full Size Pickup, Long Bed	74475
87-91	Ford	F-150 Styleside/Flareside, All Models Incl. SuperCab	74181
87-96	Ford	Full Size Pickup	74051
92-96	Ford	F-150 Styleside/Flareside, All Models Incl. SuperCab	74051
97-03	Ford	F-150 Light Duty Styleside/Flareside	74665
2004	Ford	F-150 Heritage Flareside/Styleside (Old Body Style)	74051
00-03	Ford	F-150 SuperCrew	74051
87-96	Ford	F-250 All Models Incl. SuperCab	74051
1997	Ford	F-250 Super Duty, All Models Incl. SuperCab	74051
1997	Ford	F-250 Heavy Duty	74051
99-04	Ford	F-250 & F-350 Super Duty Pickups Only, Will Not Fit Cab & Chassis	74051
05-14	Ford	F-250 Super Duty Pickups Only, Will Not Fit Cab & Chassis	78058
05-14	Ford	F-350 Super Duty Pickups Only, Will Not Fit Cab & Chassis	78058
1997	Ford	F-350 Heavy Duty	74051
88-00	GMC	Pickup, C/K Series w/6 ft. Bed 2 Dr., Regular & Extended Cabs Incl. Sportside Fenders	74682 7-Way, 85262 4-Flat
88-00	GMC	Pickup C/K Series w/8 ft. Bed 2 Dr., Regular & Extended Cabs	74682 7-Way, 85262 4-Flat
92-00	GMC	Pickup C/K Series w/8 ft. Bed 4 Dr. 74682 7-Way 85262 4-Flat Crew Cab	
01-06	GMC	Pickup Sierra 1500 HD, 2 & 4 WD	74682 7-Way, 85262 4-Flat
01-07	GMC	Pickup Sierra 2500 HD, 2 & 4 WD	74682 7-Way, 85262 4-Flat
2007	GMC	Pickup Sierra 2500 HD, Classic Only	74682 7-Way, 85262 4-Flat
07-13	GMC	Pickup Sierra Classic 1500 HD, 2 & 4 WD	74682 7-Way, 85262 4-Flat
99-07	GMC	Pickup Sierra 1500 LD, 2 & 4 WD	74682 7-Way, 85262 4-Flat



37096

37094 CLASS IV MULTI-FIT HITCH



- 2-in square receiver tube opening
- Passenger car, SUV, van & light truck applications
- 7000 lb maximum gross trailer weight
- 700 lb maximum tongue weight

METAL SHIELD®
RESISTS RUST & CORROSION

Year	Make	Model	Wiring
88-00	Chevrolet	Pickup C/K Series w/6 ft. Bed 2 Dr. Regular & Extended Cabs, Inc. Sportside Fenders	74180 (99-00 Classic Only)
1988-00	Chevrolet	Pickup C/K Series w/8 ft. Bed 2 Dr., Regular & Extended Cabs	74180 (99-00 Classic Only)
992-00	Chevrolet	Pickup C/K Series w/8 ft. Bed 4 Dr. Crew Cab	74180 (99-00 Classic Only)
2001-06	Chevrolet	Pickup Silverado 1500 HD, 2 & 4 WD	85217 (with Amber Bulbs)
1999-06	Chevrolet	Pickup Silverado 1500 LD, 2 & 4 WD	85217 (with Amber Bulbs)
99-04	Chevrolet	Pickup Silverado 2500 LD, 2 & 4 WD	85217 (with Amber Bulbs)
2007	Chevrolet	Pickup Silverado Classic 1500 HD, 2 & 4 WD	85217 (with Amber Bulbs)
2007	Chevrolet	Pickup Silverado Classic 1500 LD, 2 & 4 WD	85217 (with Amber Bulbs)
71-93	Dodge	Pickup D/W Series, Full Size	74051 (71-85), 74182 (87-93)
94-01	Dodge	Pickup Ram, Full Size	74182 (94), 74475 (95-01)
2002	Dodge	Pickup Ram, Full Size 2500/3500 Only	74475
73-79	Ford	F-100, F-150, F-250, F-350	74426 (80-86), 74181 (87-96)
80-86	Ford	F-100, F-150, F-250, F-350 All, Inc. SuperCab, Will Not Fit Custom Fascia	74426
87-91	Ford	F-100, F-150, F-250, F-350, Styleside/Flareside, All Models Inc. SuperCab	74181
92-96	Ford	F-150 Styleside/Flareside, All Models Inc. SuperCab	74181
97-03	Ford	F-150 & 250 Light Duty Styleside	74665
2004	Ford	F-150 Heritage Flareside (Old Body Style)	74665
2004	Ford	F-150 Heritage Styleside (Old Body Style)	74665
97-03	Ford	F-150 Light Duty Flareside	74665
00-03	Ford	F-150 SuperCrew	74665
92-96	Ford	F-250 & F-350 All Models Inc. SuperCab	74051(99-01) (7-Way Upgrade Kit)
1997	Ford	F-250 & F-350 Heavy Duty All Models Inc. SuperCab	74181
99-04	Ford	F-250 & F-350 Super Duty Pickups Only, Will Not Fit Cab & Chassis	74051(99-01) (7-Way Upgrade Kit)
88-00	GMC	Pickup C/K Series w/6 ft. Bed 2 Dr., Regular & Extended Cabs, Inc. Sportside Fenders	74180 (99-00 Classic Only)
88-00	GMC	Pickup C/K Series w/8 ft. Bed 2 Dr., Regular & Extended Cabs	74180 (99-00 Classic Only)
92-00	GMC	Pickup C/K Series w/8 ft. Bed 4 Dr. Crew Cab	74180 (99-00 Classic Only)
01-06	GMC	Pickup, Sierra 1500 HD, 2 & 4 WD	85217 (with Amber Bulbs)
99-06	GMC	Pickup, Sierra 1500 LD, 2 & 4 WD	85217 (with Amber Bulbs)
99-04	GMC	Pickup, Sierra 2500 LD, 2 & 4 WD	85217 (with Amber Bulbs)
2007	GMC	Pickup, Sierra Classic 1500 HD, 2 & 4 WD	85217 (with Amber Bulbs)
2007	GMC	Pickup, Sierra Classic 1500 LD, 2 & 4 WD	85217 (with Amber Bulbs)
00-06	Toyota	Tundra	74682 7-Way, 85262 4-Flat
07-13	GMC	Pickup Sierra Classic 1500 HD, 2 & 4 WD	74682 7-Way, 85262 4-Flat
99-07	GMC	Pickup Sierra 1500 LD, 2 & 4 WD	74682 7-Way, 85262 4-Flat



37094

RECEIVER ADAPTERS

- Enables one-size receivers to accept accessories designed for a different size receiver opening
- Metal Shield® resists rust & corrosion

Part Number	Adapts	Length	Usage
7020500	1-1/4-in to 2-in	6-in	Fits 2-in accessories such as bike and cargo carriers
7022900	1-1/4-in to 2-in	10-in	Fits 2-in accessories such as bike and cargo carriers
7052500	2-in to 1-1/4-in	7-in	Ideal for bike racks & cargo carriers
7028700	2-1/2-in to 2-in	6-in	Ideal for bike racks & cargo carriers
7088800 NEW	3-in to 2-1/2-in	5-in	Features 3/4 inch pin hole for HD Class V 4000 - 25k receivers
7088200 NEW	3-in to 2-1/2-in	10-in	Ideal for today's HD 3-in receivers
7090600 NEW	3-in to 2-in	4-in	Anti-rattle J Pin ready with welded collar

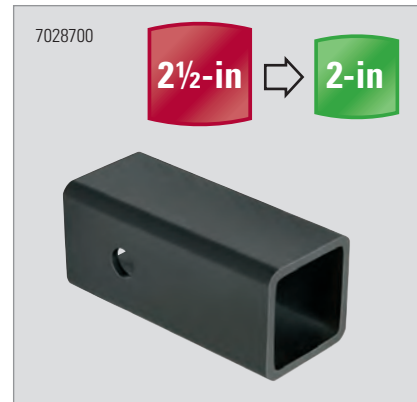
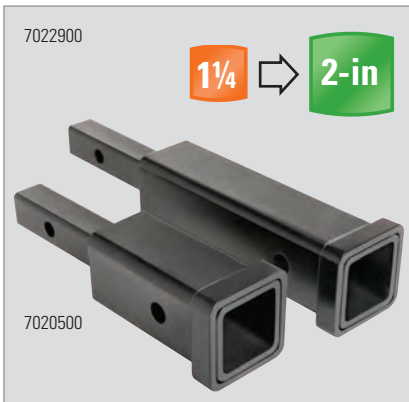

RECEIVER TUBES, SIZED WITH COLLARS

FITS
2 in
RECEIVERS

- 2-in square receiver tube opening

Part Number	Length
11021	12-in
11080	6-in



HITCH BOX EXTENSIONS - 2 x 2-in RECEIVER

FITS
2 in
RECEIVERS

- Weight Carrying Capacity - 400/4000 lb
- Weight Distribution Capacity - 650/6500 lb

Part Number	Length
11003	14-in
11004	18-in
11006	18-in, with step



FRONT-MOUNT RECEIVERS

FITS
2 in
RECEIVERS

- 2-In square receiver tube opening
- Up to 9000 lb line pull / 500 lb TW
- Front-mounted receivers offer a secure and useful attachment point
- All frame attachments, J-pin® ready

[Click Here to Go to Our Application Guide](#)

Part Number	Receiver Type	Max. Line Pull	Max. Tongue Weight	Install Time
65 Series	Square Tube	Up to 9000 lb	500 lb	20-50 min.

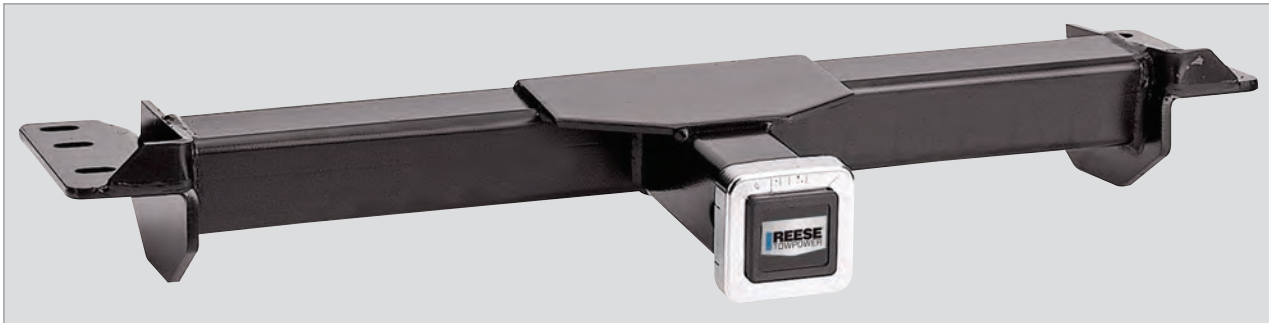

FRONT-MOUNT RECEIVER ACCESSORIES

Part Number	Description	Details
6495	Winch Mounting Plate	An easily removable platform for mounting your winch
6715	Spare Tire Carrier	Provides up front carriage of spare, universal bolt pattern
6758	Work Step	Provides easy access to engine, can be used on rear Class III/IV receivers
6771	Receiver Tub Skid Shield	Recommended for use with receivers mounted below the bumper
5443	License Plate Adapter	Solves the problem of the front hitch interfering with the license plate
49802	Fold Down License Plate Adapter	4 handy plate mounting holes

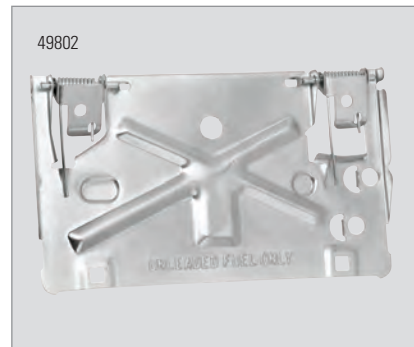
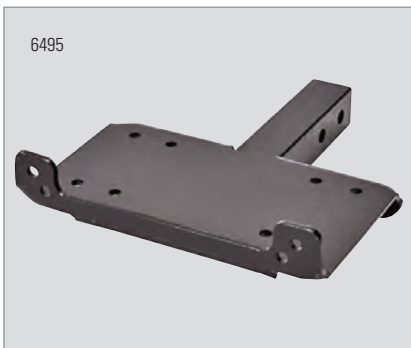

INNOVATION WITH 'MUSCLE'





Multi-axis fatigue tested for maximum strength and safety. Our patented, state-of-the-art InterLock® one-wrench tightening system and easy-load tapers provide a smooth assembly.

HITCH ACCESSORIES



REESE TACTICAL 22-27

HITCH BALLS

InterLock® Hitch Balls 28

Standard Hitch Balls 29

Interchangeable Hitch Ball Systems..... 30

BALL MOUNTS

Carbon Forged Ball Mounts 32

InterLock® Ball Mounts 33

Standard Ball Mounts 34

Class V Hitch Accessories 35

3-in Hitch Accessories..... 36-37

Forged Ball Mounts 38

Adjustable Ball Mounts 38

Rotating Tri-Balls..... 39

Utility Mounts 40-41

Carabiner Hooks 41

STARTER/SECURITY KITS..... 42-43

PINTLE HOOKS & ACCESSORIES

Ball/Hook Mounts 44

Pintle Hooks/Accessories..... 45

Receiver Mount Pintles/Tow Hook/
Tow Eye/Tow Ring, Clevis Mount..... 46-47



Strength, versatility, and style is the new standard.

With this mantra in mind, the REESE Tactical Collection has been engineered to provide towing enthusiasts with high-capacity, multi-purpose tools to tackle the demands of work and everyday life. With precise craftsmanship, rugged knurling aesthetics, and matte black and pewter finishes, this line stands apart from the rest.

Engineered to be different. Engineered to be better.



REESE[®]
TACTICAL[™]

HITCH ACCESSORIES



ENGINEERED TO BE DIFFERENT.



Adjustable Ball & Clevis Utility Mount

7089400

TOWING CAPACITY	7500 lb
MAXIMUM TONGUE WEIGHT	750 lb
PIN DIAMETER	5/8-in
RECEIVER OPENING	2-in



Clevis & Hitch Ball Utility Mount

7089200

TOWING CAPACITY	7500 lb
MAXIMUM TONGUE WEIGHT	750 lb
PIN DIAMETER	5/8-in
RECEIVER OPENING	2-in

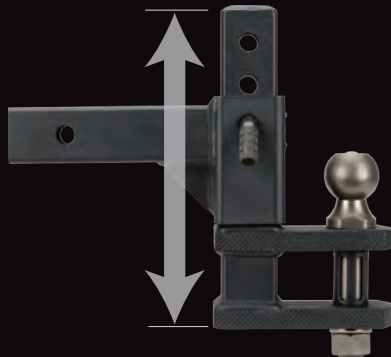

12-1/4-in Range of Travel
Boats, trailers, trucks, farm equipment – you name it.



2-in Hitch Ball
Deliberately engineered. Rugged craftsmanship.

Reinforced Recovery Sleeve
Use with tow straps for maximum security.



ENGINEERED TO BE BETTER.



**Bolt-Action
Rotating Tri-Ball**

7081900

TOWING CAPACITY	7500 lb
MAXIMUM TONGUE WEIGHT	750 lb
PIN DIAMETER	5/8-in
RECEIVER OPENING	2-in

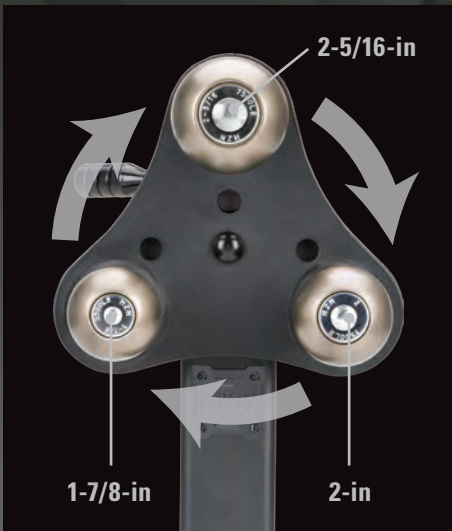

**Combination
Hook & Shackle**

7089300

CAPACITY	10000 lb
PIN DIAMETER	5/8-in
RECEIVER OPENING	2-in



**All-Terrain
Recovery
Hook**

Where bold
meets safe.

Security Shackle

10000 pounds of
reasoning to say,
"I can move that."



HITCH ACCESSORIES

HITCH ACCESSORIES



2-in
Hitch Ball
7090000

2-5/16-in
Hitch Ball
7090100

TOWING CAPACITY	7500 lb
MAXIMUM TONGUE WEIGHT	750 lb
DIAMETER	1-in
LENGTH	5-in

- 7500 lb of pure, raw tow strength
- Matte Pewter finish
- Use with tow straps for safe recovery



Pin & Clip
with Black
E-Coat Finish
7090200

Pin & Clip
with Matte
Pewter Finish
7090210

PIN DIAMETER	5/8-in.
RECEIVER OPENING	2-in & 2-1/2-in

- 5/8-in tough receiver pin and pull-pin style clip
- Rugged, knurled texture
- For use with Class III, IV and V towing accessories with 5/8-in hole
- Fits 2-in & 2-1/2-in receivers

Dogbone Receiver Lock
with Matte Pewter Finish
7092330

PIN DIAMETER	5/8-in
RECEIVER OPENING	2-1/2-in



HITCH ACCESSORIES

2-in. Starter Kit
709240

DROP	2 in.
RISE	3/4 in.
PIN DIAMETER	5/8 in.
TOWING CAPACITY	7500 lb
MAXIMUM TONGUE WEIGHT	750 lb
RECEIVER OPENING	2-in
HITCH BALL	2-in

3-1/4-in Starter Kit
7092500

DROP	3-1/4-in
RISE	2-in
PIN DIAMETER	5/8-in
TOWING CAPACITY	7,500 lb
MAXIMUM TONGUE WEIGHT	750 lb
RECEIVER OPENING	2-in
HITCH BALL	2-in



INTERLOCK® - ONE-WRENCH TIGHTENING SYSTEM

Quick and easy installation. The InterLock® feature allows the hitch ball to be seated into the hex location on the ball mount bar and tightened with a single wrench. You heard that right ... one wrench, one nut, and you're done.

HITCH ACCESSORIES

Part Number	Finish	Ball Diameter	Shank Diameter	Shank Length	Capacity
7008100	CHROME	1-7/8-in	3/4-in	1-1/2-in	2000 lb
7008400	CHROME	1-7/8-in	3/4-in	2-3/8-in	2000 lb
7008200	CHROME	2-in	3/4-in	1-1/2-in	3500 lb
7008500	CHROME	2-in	3/4-in	2-3/8-in	3500 lb
7008700	CHROME	1-7/8-in	1-in	2-in	2000 lb
7008300	CHROME	2-in	1-in	2-in	6000 lb
7008600	CHROME	2-5/16-in	1-in	2-in	6000 lb
7063400	CHROME	2-5/16-in	1-1/4-in	2-5/8-in	14000 lb
7011300	STAINLESS STEEL	2-in	1-in	2-in	6000 lb
7011400	STAINLESS STEEL	2-5/16-in	1-in	2-in	6000 lb
7060400	BLACK NICKEL	2-in	1-in	2-in	7500 lb
7071100	CHROME	1-7/8-in	3/4-in	1-1/2-in	3500 lb
7071200	CHROME	1-7/8-in	1-in	2-in	3500 lb
7061200	CHROME	2-in	1-in	2-in	7500 lb
7071000	CHROME	2-5/16-in	1-in	2-in	7500 lb
7071400	STAINLESS STEEL	2-in	1-in	2-in	7500 lb



Selecting The Right Hitch Ball

Always use the properly-rated hitch ball for your towing system.

- Your towing system's maximum weight rating is always equal to the lowest rated item in the system
- Your hitching system cannot be upgraded to a rating higher than the maximum rating of your hitch

For example, a 3500 lb ball on a 2000 lb max trailer weight-rated hitch does not increase your towing capacity to 3500 lb. Your hitching system is still rated at 2000 lb.

Conversely, a 2000 lb ball on a 3500 lb max trailer weight-rated hitch decreases your maximum towing capacity to 2000 lbs.

The hitch ball diameter (A) must be the same diameter as the trailer coupler (1-7/8-, 2- or 2-5/16-in). The shank diameter (B) of the hitch ball should be the same as the hole diameter in the ball mount. The shank length (C) should be long enough to allow at least two threads to be visible when the hitch ball is installed and the nut completely tightened.

STANDARD HITCH BALLS

Each meet SAE J684, the industry standard for strength testing of towing components. Our testing does not stop there. Each hitch ball must also pass an impact test at our corporate facilities -- a test that is still unique to REESE®.

Part Number	Finish	Ball Diameter	Shank Diameter	Shank Length	Capacity
74006	CHROME	1-7/8-in	3/4-in	1-1/2-in	2000 lb
74005	ZINC	1-7/8-in	3/4-in	1-1/2-in	2000 lb
7028900	CHROME	1-7/8-in	3/4-in	2-3/8-in	2000 lb
74023	CHROME	1-7/8-in	3/4-in	3-3/8-in	2000 lb
74008	CHROME	2-in	3/4-in	1-1/2-in	3500 lb
74007	ZINC	2-in	3/4-in	1-1/2-in	3500 lb
74020	CHROME	2-in	3/4-in	2-3/8-in	3500 lb
74025	CHROME	2-in	3/4-in	3-3/8-in	3500 lb
74022	CHROME	1-7/8-in	1-in	2-in	2000 lb
74024	CHROME	1-7/8-in	1-in	3-1/4-in	2000 lb
74010	CHROME	2-in	1-in	2-in	6000 lb
74009	ZINC	2-in	1-in	2-in	6000 lb
74026	CHROME	2-in	1-in	3-1/4-in	6000 lb
74021	CHROME	2-5/16-in	1-in	2-in	6000 lb
74011	ZINC	2-5/16-in	1-in	2-in	6000 lb
7080820 NEW	CHROME	2-in	1-in	3-3/8-in	7500 lb
7080920 NEW	CHROME	2-5/16-in	1-in	2-1/8-in	7500 lb
74294	CHROME	2-5/16-in	1-1/4-in	2-1/2-in	12000 lb
7028400	CHROME	2-5/16-in	1-1/4-in	2-3/4-in	12000 lb
7028500	CHROME	2-5/16-in	1-1/4-in	2-3/4-in	14000 lb
7028600	CHROME	2-5/16-in	1-1/4-in	2-3/4-in	17000 lb
7033900 NEW	CHROME	2-in	1-1/4-in	2-3/4-in	8000 lb
7036800-ATV/Tractor	CHROME	1-7/8-in	5/8-in	1-3/4-in	2000 lb



INTERCHANGEABLE HITCH BALLS

INTERCHANGEABLE HITCH BALL SYSTEMS

Designed to accommodate towing multiple trailers with ease, the Interchangeable Hitch Ball System allows you to change hitch ball sizes in seconds without any tools. Available in 2- and 3-ball sets, these kits feature a quick-release, positive-latch design. Available in 3/4-in and 1-in shank models.

- Innovative quick release changes balls in seconds
- Rated capacities up to 8,000 lbs.
- Durable heat-treated shank
- Positive latch design
- No special tools required

HITCH ACCESSORIES

Part Number	Finish	Shank Diameter	Ratings GTW	Hitch Ball Diameters
74307	CHROME	3/4-in	5000	1-7/8-in, 2-in
74308	CHROME	1-in	8000	1-7/8-in, 2-in
74309	CHROME	1-in	8000	1-7/8-in, 2-in, 2-5/16-in



ATTACH SHANK
Attach correct shank to drawbar or ball mount. Torque to required tightness.

ATTACH BALL
Select the correct ball size for your trailer. Place ball on shank.

TIGHTEN LOCKING HEAD
Innovative locking screw requires only 1/4 turn to secure.

YOU'RE READY TO TOW!

REPLACEMENT NUTS AND WASHERS

Part Number	Description
7027800	3/4-in Nut and Washer for Hitch Ball
7027900	1-in Nut and Washer for Hitch Ball
7028000	1-1/4-in Nut and Washer for Hitch Ball





O.E.M. BLACK

Applied over E-coat finish = two layers of superior protection.
 Increased corrosion resistance.
 Protects against UV rays, high humidity & extreme temperatures.
 Provides excellent abrasion-, scuff-, scratch- and impact-resistance.



CHROME PLATED

Chrome-plated steel with high-gloss finish.
 Resists rust and corrosion.
 Wear resistant.



BLACK NICKEL

Enhanced corrosion protection.
 Enhanced appearance.
 Unique look.

HITCH ACCESSORIES



BRIGHT ZINC

Provides extreme corrosion resistance.
 Maintenance-free finish.
 Increases durability.



METAL SHIELD®

RESISTS RUST & CORROSION
 A specialized OEM coating process for a superior look and finish.
 Products are dipped in a Zinc-Phosphate base, a rust-resistant coating that provides unmatched coverage in hard to fill-in areas.



STAINLESS STEEL

Completely resistant against rust and corrosion.
 Attractive polished stainless finish.
 A lifetime of protection from rust.



MATTE BLACK

Enhanced corrosion protection.
 Enhanced appearance.
 Unique look.



CARBON FORGED BALL MOUNTS

HITCH ACCESSORIES

Part Number	Finish	Drop	Rise	QtyBox Opening	Hitch Ball Hole Size	Capacity
7067900	O.E.M. BLACK	1-1/4-in	3/4-in	1-1/4-in	3/4-in	350/3500 lb
7068000	O.E.M. BLACK	2-in	1-1/2-in	1-1/4-in	3/4-in	350/3500 lb
7068300	O.E.M. BLACK	3-in	2-1/2-in	1-1/4-in	3/4-in	350/3500 lb
7060700	BLACK NICKEL	2-in	1/2-in	2-in	1-in	700/7000 lb
7060800	BLACK NICKEL	3-in	1-1/2-in	2-in	1-in	600/6000 lb
7060500	CHROME	2-in	1/2-in	2-in	1-in	700/7000 lb
7060600	CHROME	3-in	1-1/2-in	2-in	1-in	600/6000 lb
7062800	O.E.M. BLACK	2-in	1/2-in	2-in	1-in	700/7000 lb
7062900	O.E.M. BLACK	3-in	1-1/2-in	2-in	1-in	600/6000 lb
7065700	O.E.M. BLACK	4-in	2-1/2-in	2-in	1-in	500/5000 lb
7068100	O.E.M. BLACK	5-in	3-1/2-in	2-in	1-in	500/5000 lb



O.E.M BLACK



CHROME



BLACK NICKEL



CARBON FORGED

Innovation

REESE®, the market leader in towing, has fundamentally changed the approach to ball mounts with an innovative and patented line of products. Carbon Forged ball mounts offer users greater towing capacity through an innovative one-piece construction providing unequalled quality and performance in a unique weld-free design and quality finish.



INTERLOCK® BALL MOUNTS

Part Number	Finish	Drop	Rise	Box Opening	Hitch Ball Hole Size	Capacity
21901	METAL SHIELD®	1¼-in	¾-in	1¼-in	¾-in	3500 lb GTW, 300 lb TW
21900	METAL SHIELD®	2½-in	2-in	1¼-in	¾-in	3500 lb GTW, 300 lb TW
21792	METAL SHIELD®	2-in	¾-in	2-in	1-in	6000 lb GTW, 600 lb TW
21793	METAL SHIELD®	3¼-in	2-in	2-in	1-in	5000 lb GTW, 500 lb TW
21794	METAL SHIELD®	5¼-in	4-in	2-in	1-in	5000 lb GTW, 500 lb TW
7034300	CHROME	2-in	¾-in	2-in	1-in	6000 lb GTW, 600 lb TW
7034400	CHROME	3¼-in	2-in	2-in	1-in	5000 lb GTW, 500 lb TW
21790	STAINLESS STEEL	2-in	¾-in	2-in	1-in	6000 lb GTW, 600 lb TW
21791	STAINLESS STEEL	3¼-in	2-in	2-in	1-in	5000 lb GTW, 500 lb TW



METAL SHIELD



CHROME



STAINLESS STEEL

HITCH ACCESSORIES



STANDARD BALL MOUNTS

HITCH ACCESSORIES

Part Number	Finish	Drop	Rise	Box Opening	Length	Hitch Ball Hole Size	Class	Capacity
3594011	METAL SHIELD®	N/A	4-in	1-1/4-in	3/4-in	10-in	I	2000 lb GTW, 200 lb TW
3592011	METAL SHIELD®	2-3/4-in	2-1/8-in	1-1/4-in	9-3/4-in	3/4-in	I	2000 lb GTW, 200 lb TW
3593011	METAL SHIELD®	2-3/4-in	2-1/8-in	1-1/4-in	6-5/8-in	3/4-in	I	2000 lb GTW, 200 lb TW
3606111	METAL SHIELD®	N/A	3-1/8-in	1-1/4-in	3/4-in	9-3/4-in	II	3500 lb GTW, 300 lb TW
06280	BRIGHT ZINC	1-1/4-in	3/4-in	1-1/4-in	9	3/4-in	II	3500 lb GTW, 300 lb TW
06474	BRIGHT ZINC	2-1/2-in	2-in	1-1/4-in	7	3/4-in	II	3500 lb GTW, 300 lb TW
21287	CHROME	2-in	3/4-in	2-in	8	1-in	III	6000 lb GTW, 600 lb TW
21288	CHROME	3-1/4-in	2-in	2-in	8.5	1-in	III	5000 lb GTW, 500 lb TW
21289	CHROME	5-1/4-in	4-in	2-in	11.5	1-in	III	5000 lb GTW, 500 lb TW
21171	METAL SHIELD®	2-in	3/4-in	2-in	8	1-in	III	6000 lb GTW / 600 lb TW
21175	METAL SHIELD®	3-1/4-in	2-in	2-in	8.5	1-in	III	6000 lb GTW / 600 lb TW
21344	METAL SHIELD®	4-in	2-3/4-in	2-in	9	1-in	III	5000 lb GTW / 500 lb TW
21345	METAL SHIELD®	4-in	2-3/4-in	2-in	11	1-in	III	6000 lb GTW / 600 lb TW
21186	METAL SHIELD®	5-1/4-in	4-in	2-in	10	1-in	III	5000 lb GTW / 500 lb TW
21347	METAL SHIELD®	8-in	6-3/4-in	2-in	10	1-in	III	5000 lb GTW / 500 lb TW
21342 NEW	METAL SHIELD®	2-in	3/4-in	2-in	8.5	1-in	III / IV	7500 lb GTW / 750 lb TW
7081200 NEW	METAL SHIELD®	2-in	3/4-in	2-in	10.5	1-in	III	6000 lb GTW, 600 lb TW

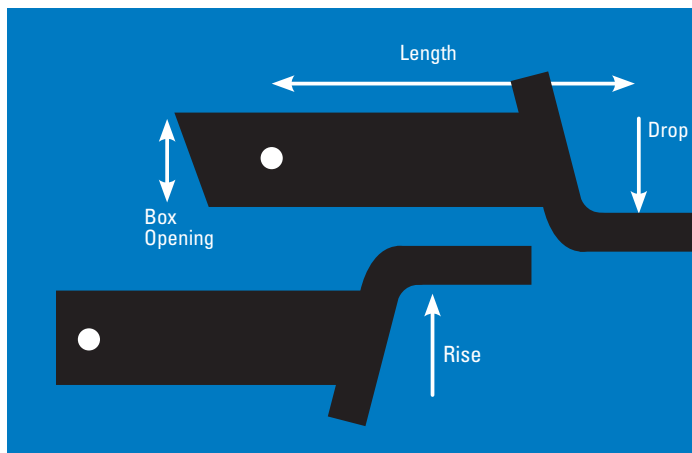

Selecting The Right Ball Mount



1. Measure from the ground to the top of the hitch.
2. Measure from the ground to the (inside) top of the trailer coupler (when level).

The difference in the two measurements is the amount of ball mount 'rise' or 'drop' required.

3. Subtract the height of the hitch ball (most are 2½ - 3-in high) from coupler measurement.

The difference in the two measurements is the amount of ball mount 'rise' or 'drop' required.

CLASS V - HEAVY DUTY BALL MOUNTS

Part Number	Finish	Drop	Rise	Box Opening	Hitch Ball Hole Size	Capacity
7028100	METAL SHIELD®	3-in	1-1/2-in	2-1/2-in	1-1/4-in	14000 lb GTW, 1400 lb TW
7028200	METAL SHIELD®	5-in	3-1/2-in	2-1/2-in	1-1/4-in	13000 lb GTW, 1300 lb TW
7089500 NEW	METAL SHIELD®	4-in	2-in	3-in	1-1/4-in	21000 lb GTW, 2100 lb TW
7089600 NEW	METAL SHIELD®	6-in	4-in	3-in	1-1/4-in	21000 lb GTW, 2100 lb TW
7089700 NEW	METAL SHIELD®	8-in	6-in	3-in	1-1/4-in	21000 lb GTW, 2100 lb TW
7089800 NEW	METAL SHIELD®	10-in	8-in	3-in	1-1/4-in	21000 lb GTW, 2100 lb TW
7063200 	METAL SHIELD®	3-in	1-1/2-in	2-1/2-in	1-1/4-in	14000 lb GTW, 1400 lb TW
7063300 	METAL SHIELD®	5-in	3-1/2-in	2-1/2-in	1-1/4-in	13000 lb GTW, 1400 lb TW

CLASS V HITCH BALLS

Part Number	Finish	Ball Diameter	Shank Diameter	Shank Length	Capacity
7028400	CHROME	2-5/16-in	1-1/4-in	2-3/4-in	12000 lb
7028500	CHROME	2-5/16-in	1-1/4-in	2-3/4-in	14000 lb
7028600	CHROME	2-5/16-in	1-1/4-in	2-3/4-in	17000 lb
7063400 	CHROME	2-5/16-in	1-1/4-in	2-5/8-in	14000 lb



HITCH ACCESSORIES

ADAPTERS

Part Number	Description
7088800	Adapts 3 to 2-1/2-in with 3/4 and 5/8 holes and collar
7090600	Receiver Adapter 3 to 2-in

REDUCER SLEEVES

Part Number	Description
7028700	Reducer Sleeve 2-1/2 to 2-in
7088200	Reducer Sleeve 3 to 2-1/2-in with 5/8 holes

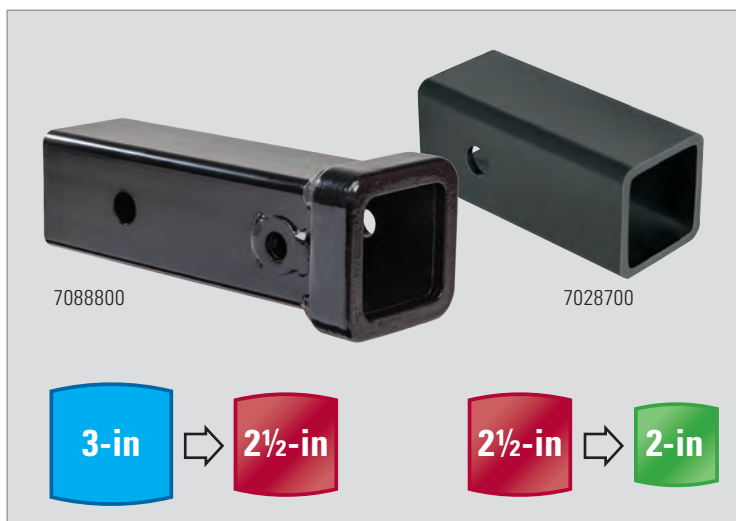

3-IN HITCH ACCESSORIES

REESE® Towpower introduces a complete line of 3-in receiver accessories that once again sets the bar in total capacity and quality. Designed to meet the heavy-duty demands of trucks with 21,000 lb of towing capacity, a forged construction provides not only the strongest, but the deepest drop ball mounts available in the marketplace.

3-in RECEIVER BALL MOUNTS

- Fits 3 inch square receiver tube opening
- Up rated 21,000 lb towing capacity (2100 TW)
- Sleek, black powder coat, solid forged steel

- 7089500 – 4 inch Drop
- 7089600 – 6 inch Drop
- 7089700 – 8 inch Drop
- 7089800 – 10 inch Drop

FITS
3 in
RECEIVERS



HITCH ACCESSORIES

3-in ADAPTERS

- Use 2.5 inch accessories in 3-in receiver openings
- Reinforced welded collar for greater capacity
- Ideal conversion for 3-in receivers on heavy-duty trucks

- 7088800 – 3-in to 2-1/2-in
- 7090600 – 3-in to 2-in



Features 3/4-in and 5/8-in holes for use with heavy-duty CLV 3000 and 4000 receiver hitches

Anti-rattle J pin ready with collar

3-in REDUCER SLEEVES

- Reduced sleeve adapter integrates with all Class V accessories
- Ideal conversion for 3-in receivers on heavy-duty trucks

- 7088200 – 3-in to 2-1/2-in
- 7028700 – 2-1/2-in to 2-in



FITS
3 in
RECEIVERS

3-in PINTLE HOOK MOUNTING PLATES

- Heavy duty for 3-in Receivers
- 25,000 lb towing capacity
- Quickly & easily mount pintle hooks, pintle & ball combo

7089900 – 5-in x 9-in Plate, 5 sets of mounting holes

7091300 – 5-in x 12-in Plate, 7 sets of mounting holes



7089900



7091300

HITCH ACCESSORIES

3-in SECURITY

- Designed to fit 3-in receiver openings

PROFESSIONAL LOCK

- Patented ball bearing design
- 5/8-in pin diameter, sleeved to 3/4-in

7081400 – 4-in span



7081400

Square key
pick proof design

DOG BONE LOCK

- 5/8-in pin diameter, sleeved to 3/4-in

7081500 – 4-in span



7081500

PIN & CLIP

- 5/8-in pin diameter, sleeved to 3/4-in

7081600 – Class III/IV/V



7081600

Features unique
Ergo clip

CLASS III/IV - FORGED STANDARD BALL MOUNTS - SOLID SHANK

Part Number	Finish	Drop	Rise	Box Opening	Hitch Ball Hole Size	Length	Capacity
21330	METAL SHIELD®	2-in	1-in	2-in	1-1/4-in	9-1/2-in	16000 lb GTW, 1600 lb TW
21331	METAL SHIELD®	4-in	2-in	2-in	1-1/4-in	10-in	16000 lb GTW, 1600 lb TW
21332	METAL SHIELD®	6-in	3-in	2-in	1-1/4-in	10-1/2-in	16000 lb GTW, 1600 lb TW



HITCH ACCESSORIES

CLASS III - ADJUSTABLE WEIGHT-CARRYING BALL MOUNT

Part Number	Finish	Drop Range	Rise Range	Box Opening	Hitch Ball Hole Size	Length	Drop Capacity	Rise Capacity
21141	METAL SHIELD®	3 to 7-1/2-in	3 to 6-1/4-in	2-in	1	13-1/2-in	5000 lb GTW, 500 lb TW	3500 lb GTW, 350 lb TW
7031300	METAL SHIELD®	3 to 7-1/2-in	3 to 6-1/4-in	2-in	1	13-1/2-in	5000 lb GTW, 500 lb TW	3500 lb GTW, 350 lb TW

ADJUSTABLE BALL & CLEVIS UTILITY MOUNT

Part Number	Finish	Drop Range	Rise Range	Box Opening	Hitch Ball Hole Size	Length	Towing Capacity
7089400 NEW	MATTE BLACK	4-1/4-in to 7-1/4-in	5-in	2-in	1	13-3/4-in	7500 lb GTW, 750 lb TW



ROTATING HEIGHT ADJUSTABLE TRI-BALL MOUNT

Part Number	Finish	Drop Max.	Rise Max.	Box Opening	Length	1-7/8-in Capacity	2-in Capacity	2-5/16-in Capacity
7068900	CHROME	4-3/4-in	5-11/16-in	2-in	10-in	2000 lb/200 lb	10000 lb/1000 lb	14000 lb/1400 lb
7021800	CHROME	7-in	7-in	2-in	10-in	2000 lb/200 lb	6000 lb/600 lb	16000 lb/600 lb

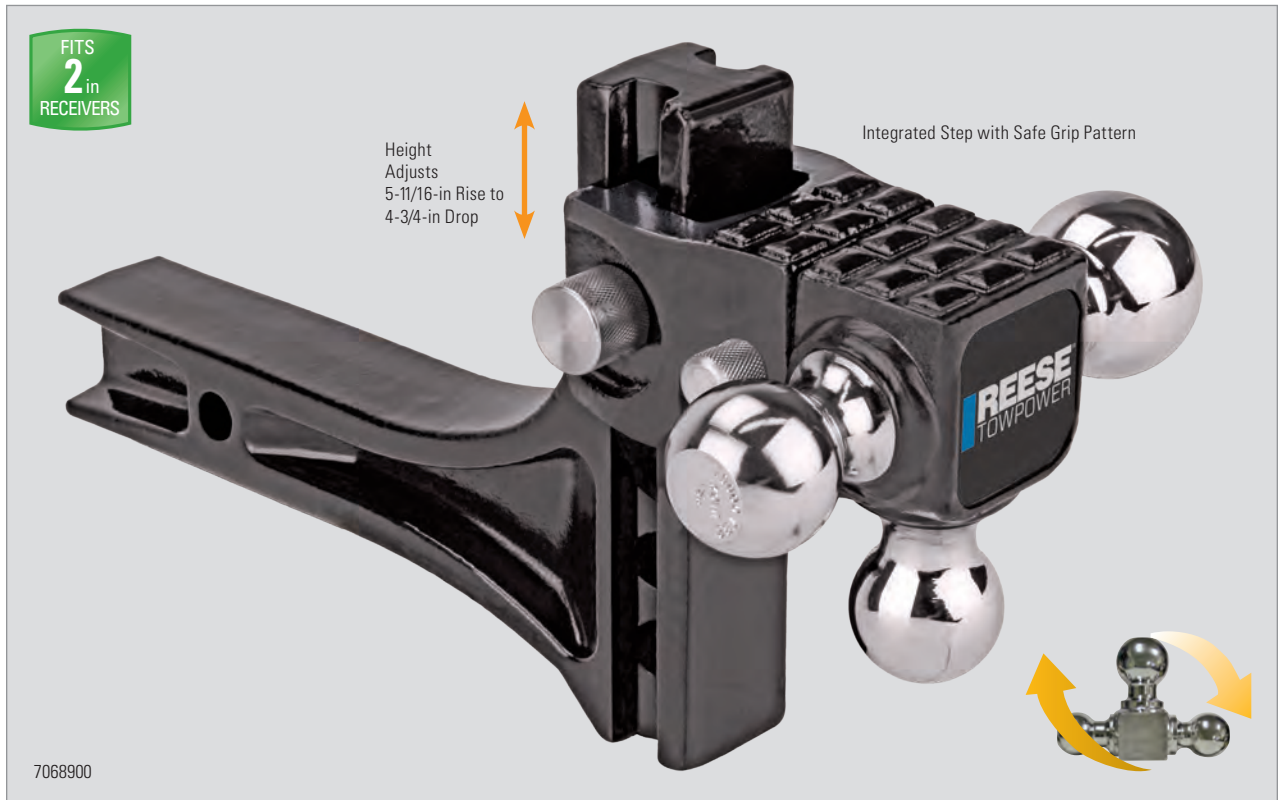

HITCH ACCESSORIES

FITS
2 in
RECEIVERS

DUAL AND TRI-BALL MOUNTS

HITCH ACCESSORIES

Part Number	Finish	Box Opening	Length	1-7/8-in Capacity	2-in Capacity	2-5/16-in Capacity
21511	METAL SHIELD®	2-in	10-in	2000 lb/200 lb	6000 lb/600 lb	N/A
21518	METAL SHIELD®	2-in	10-in	N/A	6000 lb/600 lb	6000 lb/600 lb
7086100 NEW	METAL SHIELD®	2-in	10-in	N/A	10000 lb/1000 lb	16000 lb/1600 lb
7039800	BLACK NICKEL	2-in	8-in	2000 lb/200 lb	6000 lb/600 lb	10000 lb/1000 lb
21514	CHROME	2-in	8-in	2000 lb/200 lb	6000 lb/600 lb	10000 lb/1000 lb
7022400	METAL SHIELD®	2-in	8-in	2000 lb/200 lb	6000 lb/600 lb	10000 lb/1000 lb
7081900 NEW	MATTE BLACK	2-in	13-1/2-in	3500 lb/350 lb	7500 lb/750 lb	7500 lb/750 lb



CLASS V TRI-BALL

- 2-1/2-in box opening
- 8-1/2-in length
- 1-7/8-in capacity: 2000 lb/200 lb
- 2-in capacity: 10000 lb/1000 lb
- 2-5/16-in capacity: 14000 lb/1400 lb

Part Number	Finish
7068800	METAL SHIELD®

CARABINER TOW HOOKS

- 20% greater capacity
- Spring-loaded safety latch
- Black powder-coat finish

Part Number	Finish	Box Opening	Length	Capacity
7074400	METAL SHIELD®	2-in	12-in	12000 lb
7090500 NEW	METAL SHIELD®	2-1/2-in	12.5-in	16000 lb



HITCH ACCESSORIES

TRI-BALL MOUNT WITH HOOK

Part Number	Finish	Box Opening	Length	1-7/8-in Capacity	2-in Capacity	2-5/16-in Capacity	Hook
7031400	METAL SHIELD®	2-in	8-in	2000 lb/200 lb	6000 lb/600 lb	10000 lb/1000 lb	10000 lb



InterLock® INTERLOCK® TOWING STARTER KITS

HITCH ACCESSORIES

Part Number	Finish	Drop	Rise	Ball	Box Opening	Pin and Clip	Length	Capacity
7043000	METAL SHIELD®	1-1/4-in	3/4-in	2-in	1-1/4-in	1/2-in	9-in	3500/300 lb
7043120	METAL SHIELD®	2-1/2-in	2-in	2-in	1-1/4-in	1/2-in	7-in	3500/300 lb
21542	METAL SHIELD®	2-in	3/4-in	2-in	2-in	5/8-in	8-1/5-in	6000/600 lb
21543	METAL SHIELD®	3-1/4-in	2-in	2-in	2-in	5/8-in	9-in	5000/500 lb
7092400 NEW	MATTE BLACK	2-in	3/4-in	2-in	2-in	5/8-in	10-1/4-in	7500/750 lb
7092500 NEW	MATTE BLACK	3-1/4-in	2-in	2-in	2-in	5/8-in	10-1/4-in	7500/750 lb
7090800 NEW	METAL SHIELD®	3-in	1-1/2-in	2-5/16-in	2-1/2-in	5/8-in	9-7/8-in	14000/1400 lb
7090900 NEW	METAL SHIELD®	5-in	3-1/2-in	2-5/16-in	2-1/2-in	5/8-in	10-1/4-in	13000/1300 lb



STANDARD TOWING STARTER KITS

- Ball mount has Metal Shield® finish
- Includes ball and pin and clip

Part Number	Drop	Rise	Ball	Box Opening	Pin and Clip	Capacity
21536	2-in	3/4-in	2-in	2-in	1/2-in	6000/600 lb
21556	3-1/4-in	2-in	2-in	2-in	1/2-in	5000/500 lb
7043200	2-in	3/4-in	1-7/8-in	2-in	5/8-in	2000/200 lb
7080500 NEW	2-in	3/4-in	2-in	2-in	5/8-in	7500/750 lb
7081000 NEW	4-in	2-3/4-in	2-in	2-in	5/8-in	7500/750 lb



INTERLOCK® TOWING SECURITY KITS

Part Number	Finish	Drop	Rise	Ball	Box Opening	Bent Pin Lock	Length	Capacity
7005100	METAL SHIELD®	2-in	3/4-in	2-in	2-in	5/8-in	8-1/5-in	6000/600 lb
7005200	METAL SHIELD®	3-1/4-in	2-in	2-in	2-in	5/8-in	9-in	5000/500 lb



HITCH ACCESSORIES



INTERLOCK® STARTER KIT

Part Number	Finish	Drop	Rise	Ball	Box Opening	Length	Capacity
7039200	BLACK NICKEL	2-in	3/4-in	2-in	2-in	5/8-in	6000/600 lb
7039300	BLACK NICKEL	3-1/4-in	2-in	2-in	2-in	5/8-in	5000/500 lb



8 TON PINTLE BALL AND HOOK COMBINATIONS

- Heavy-duty forged steel
- Secure, effortless towing over rough terrain
- Mounting hardware included

Part Number	Finish	Ball Size	Shank	Hook GTW	Maximum TW	Ball Rating
74115	METAL SHIELD®	1-7/8-in	1-1/8-in	16000 lb	3000 lb	6000 lb
74116	METAL SHIELD®	2-in	1-1/8-in	16000 lb	3000 lb	10000 lb
74117	METAL SHIELD®	2-5/16-in	1-1/8-in	16000 lb	3000 lb	14000 lb

HITCH ACCESSORIES

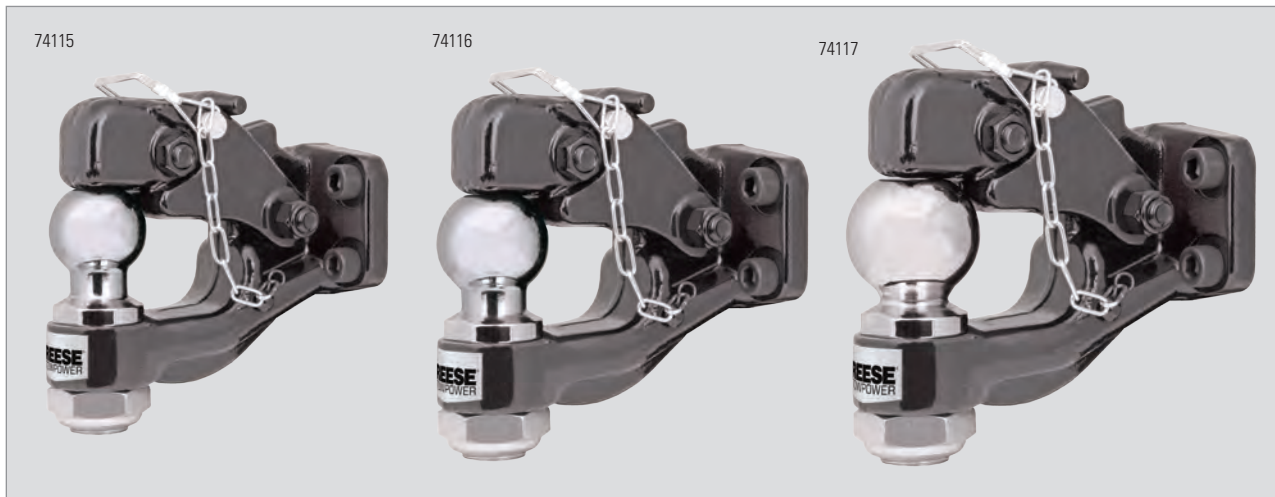

PINTLE REPLACEMENT BALLS

Part Number	Finish	Description	Shank	Length	Capacity
7021500	CHROME	1-7/8-in Replacement Ball	1-1/4-in	2-1/4-in	6000 lb
7021600	CHROME	2-in Replacement Ball	1-1/4-in	2-1/4-in	10000 lb
7021700	CHROME	2-5/16-in Replacement Ball	1-1/4-in	2-1/4-in	14000 lb
7093000 NEW	CHROME	1-7/8-in Replacement Ball	1-1/8-in	2-1/4-in	6000 lb
7093100 NEW	CHROME	2-in Replacement Ball	1-1/8-in	2-1/4-in	10000 lb
7093200 NEW	CHROME	2-5/16-in Replacement Ball	1-1/8-in	2-1/4-in	14000 lb



LUNETTE RINGS

- 2-1/2-in diameter, 4-in hole
- Mounting hardware sold separately

Part Number	Finish	Maximum GTW	Vehicle Load
7013700	METAL SHIELD®	42000 lb	4000 lb

PINTLE HOOK / REGULAR

- Mounting hardware included

Part Number	Description	Finish	Maximum GTW	Maximum TW
74118	10-ton Pintle Hook	METAL SHIELD	20000 lb	4000 lb
74119	15-ton Pintle Hook	METAL SHIELD	30000 lb	6000 lb

PINTLE HOOK MOUNTING PLATE

- Solid Shank

Part Number	Box Opening	Box Opening	Shank Length	Plate Size	Maximum GTW
74281	METAL SHIELD®	2-in	7-3/4-in	7-1/2 x 5-in	12000 lb



PINTLE PIN AND CHAIN

Part Number	Description
7044900	1/4-in diameter pin

LUNETTE EYE LOCK

Part Number	Description
4210	Fits 2-1/2-in and 3-in lunette eyes

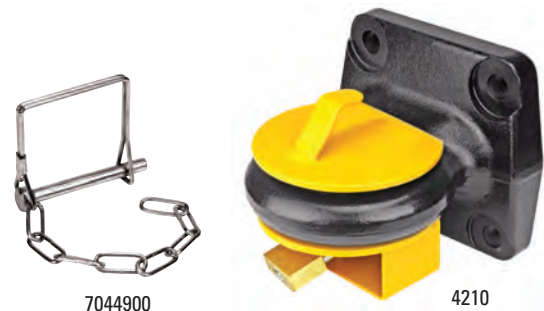

RECEIVER MOUNT PINTLE/BALL COMBO

- Solid Shank

Part Number	Finish	Ball Size	Box Opening	Max. GTW	Ball GTW	Max. VL
7024000	METAL SHIELD®	1-7/8-in	2-in	12000 lb	2000 lb	2400 lb
7024100	METAL SHIELD®	2-in	2-in	12000 lb	7000 lb	2400 lb
7024200	METAL SHIELD®	2-5/16-in	2-in	12000 lb	12000 lb	2400 lb

5 TON RECEIVER MOUNT PINTLE HOOK

- Solid Shank

Part Number	Finish	Box Opening	Max. GTW	Max. VL
7024300	METAL SHIELD®	2-in	10000 lb	2000 lb

FORGED RECEIVER MOUNT TOW HOOK

- Solid Shank

Part Number	Finish	Box Opening	Max. GTW	Length
7024400	METAL SHIELD®	2-in	10000 lb	7-3/8-in

FORGED RECEIVER MOUNT TOW EYE

- Solid Shank

Part Number	Finish	Box Opening	Max. GTW	Length
7024500	METAL SHIELD®	2-in	10000 lb	7-3/8-in

HITCH ACCESSORIES



RECEIVER MOUNT TOW RING

- Solid Shank

Part Number	Finish	Box Opening	Max. GTW	Length
7024600	METAL SHIELD®	2-in	800 lb	7-3/8-in

RECEIVER MOUNT CLEVIS

- 1-in diameter hole

Part Number	Finish	Box Opening	Max. GTW	Max. TW
8040900	METAL SHIELD	2-in	6000 lb	600 lb



HITCH ACCESSORIES

RECEIVER MOUNT CLEVIS PIN

- Heat-treated Grade 8 steel
- Comfortable soft-grip handle
- Includes cotter pin
- 4-3/4-in effective length

Part Number	Description
7031700	1-in Diameter Clevis Pin



2-IN BALL MOUNT STORAGE

- Mountable in horizontal or vertical position
- Safe storage for ball mounts
- Prevent damage from loose bar

Part Number	Description
7074000	2-in Ball Mount Storage



PROTECTING WHAT MATTERS





Deterring theft with a triple defense. Self-locking design, stronger break resistance, & patented locking design.

TOWING SECURITY

TOWING SECURITY



RECEIVER LOCKS

REESE Professional	50
Easy Access	51-52
Barrel Style Locks	53-54
Bent Pin Locks	53-54

PIN AND CLIPS

Hitch Pin and Clips	55-56
Anti-Theft Receiver Pins	57
Ergo Clips® Pin & Clips	57

COUPLER LOCKS

58-59

CABLE LOCKS

60

KING PIN LOCK

60

SAFETY CHAINS

61

ADJUSTABLE TOW BARS

62

SPARE TIRE CARRIERS

62

PROFESSIONAL CLASS III & IV LOCKS

- Heavy-duty steel design
- Security for ball mounts and hitch-mounted accessories
- Square key pick proof design

Part Number	Finish	Class	Pin Diameter	Receiver Opening	Span
7030200 - Receiver	STAINLESS STEEL	III/IV	5/8-in	2-in	3-1/2-in
7030300 - Receiver	CHROME	III/IV	5/8-in	2-in	3-1/2-in
7030400 - Receiver	CHROME	III/IV	5/8-in	2-in	3-1/2-in
7030600 - Receiver - Coupler	CHROME CHROME	III/IV N/A	5/8-in N/A	2-in N/A	3-1/2-in N/A
7070800 - Receiver	CHROME	III/IV	1/2-in & 5/8-in	2-in	3-1/2-in
7030500 - Coupler	CHROME	N/A	N/A	N/A	N/A



TOWING SECURITY

PROFESSIONAL CLASS V LOCK

Part Number	Finish	Class	Pin Diameter	Receiver Opening	Span
7070700	CHROME	V	5/8-in	2-in, 2-1/2-in	3-1/2-in
7081500 NEW	CHROME	V	5/8-in and 3/4-in	2-in, 2-1/2-in, 3-in	4-in



EASY ACCESS RECEIVER & COUPLER LOCKS

- Swivel head for convenient front access
- Durable black cover
- Easier access

Part Number	Style	Class	Finish	Pin Size	Receiver Opening	Length
7057030	Sleeved Receiver	III/IV	STAINLESS STEEL	1/2 & 5/8-in	1-1/4 & 2-in	2-7/8-in
7054630	Sleeved Receiver	III/IV	CHROME	1/2 & 5/8-in	1-1/4 & 2-in	2-7/8-in
7054430	Bent Pin Receiver	III/IV	CHROME	1/2 & 5/8-in	1-1/4 & 2-in	2 & 2-7/8-in
7054530	Bent Pin Receiver & Coupler	III/IV	CHROME STAINLESS STEEL	1/2 & 5/8-in	1-1/4 & 2-in	2 & 2-7/8-in
7057130	Class V Receiver	III/IV/V	STAINLESS STEEL	5/8-in	2-1/2-in	3-1/2-in
7057230	Class V Receiver	III/IV/V	CHROME	5/8-in	2-1/2-in	3-1/2-in
7057830	Class V Bent Pin	III/IV/V	CHROME	5/8-in	2-1/2-in	3-1/2-in
7057330	Adjustable Coupler	N/A	STAINLESS STEEL	3/16-in	N/A	3-in
7057430	Adjustable Coupler	N/A	CHROME	3/16-in	N/A	3-in



TOWING SECURITY

EASY ACCESS LOCKS

- 360° rotating head for easy lock access
- Integrated key slot cover helps protect lock from dirt
- Chrome plated

Part Number	Description	Class	Finish
7009300	1/2-in & 5/8-in Sleeved Easy Access Lock	I/II/III/IV	CHROME
7031500	Adjustable Coupler lock - 6 positions - 1 to 2-7/8-in		CHROME

7031500



7009300

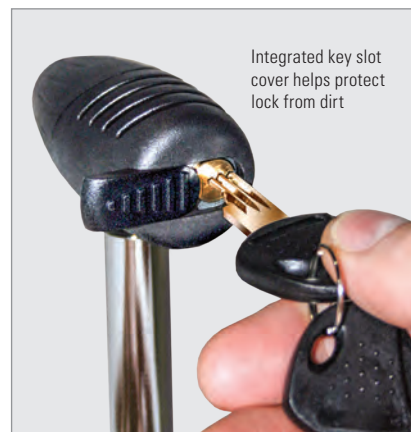

TOWING SECURITY



BARREL STYLE LOCKS

- Push-button lock mechanism, rubber cap keeps dirt out

Part Number	Style	Finish	Class	Pin Diameter	Receiver Opening	Span
7005600	Sleeved Dog Bone	CHROME	I/II/III/IV	1/2 and 5/8-in	1-1/4 & 2-in	3-in
7010100	Sleeved Dog Bone	STAINLESS STEEL	I/II/III/IV	1/2 and 5/8-in	1-1/4 & 2-in	3-in
7010200	Sleeved Dog Bone Coupler	CHROME	I/II/III/IV	1/2 and 5/8-in	1-1/4 & 2-in	3-in
7033300	Bent Pin	CHROME	V	5/8-in	2-1/2-in	3-1/2-in
7033200	Dog Bone	CHROME	V	5/8-in	2-1/2-in	3-1/2-in
7023900	Sleeved Dog Bone Set	CHROME	I/II/III/IV	1/2 and 5/8-in	1-1/4 & 2-in	3-in
7039000	Sleeved Dog Bone	BLACK NICKEL	I/II/III/IV	1/2 and 5/8-in	1-1/4 & 2-in	3-in
7039100	Sleeved Dog Bone	CHROME/SURE GRIP	I/II/III/IV	1/2 and 5/8-in	1-1/4 & 2-in	3-in
7081400 NEW	Sleeved Dog Bone	CHROME	III/IV/V	5/8 and 3/4-in	2, 2-1/2 & 3-in	4-in
7092330 NEW	Dog Bone	MATTE PEWTER	III/IV/V	5/8-in	2 & 2-1/2-in	3-1/2-in

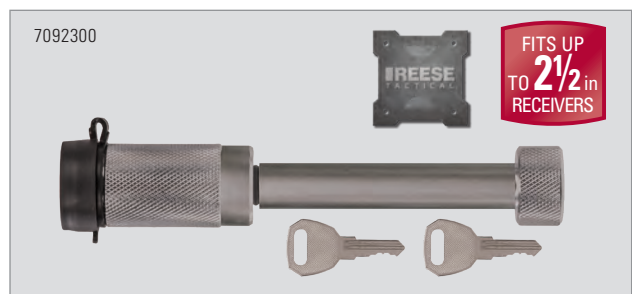
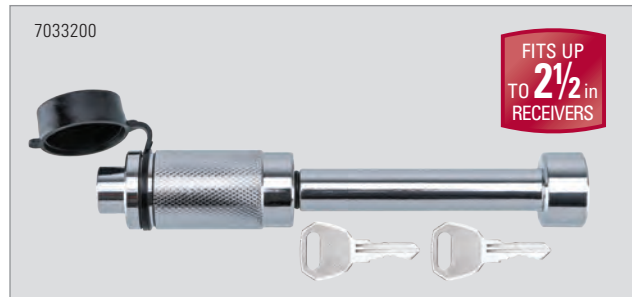
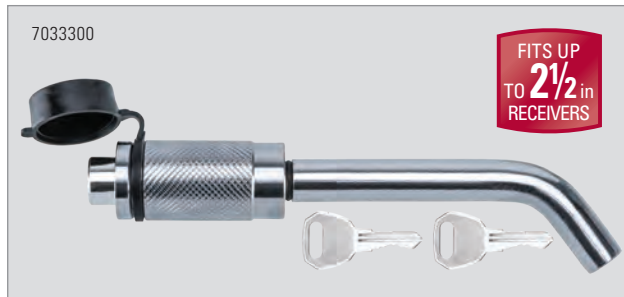
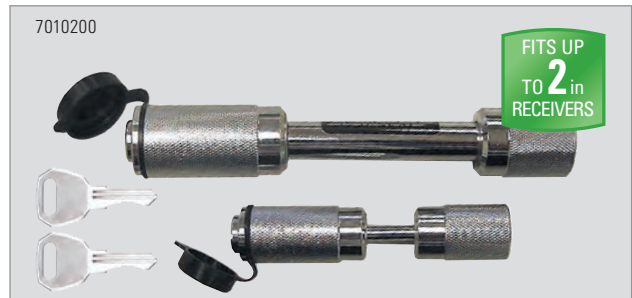

TOWING SECURITY

BALL MOUNT LOCKS

- Flat key design, keys can be copied by most retailers
- Includes 2 keys and vinyl lock cover

Part Number	Style	Finish	Class	Pin Diameter	Receiver Opening	Span
7006400	Bent Pin	CHROME	I/II	1/2-in	1-1/4-in	2-1/4-in
7006500	Bent Pin	CHROME	III/IV/V	5/8-in	2 & 2-1/2-in	3-1/2-in

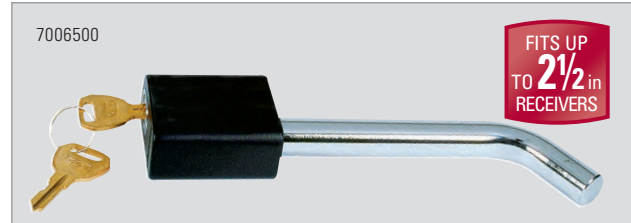
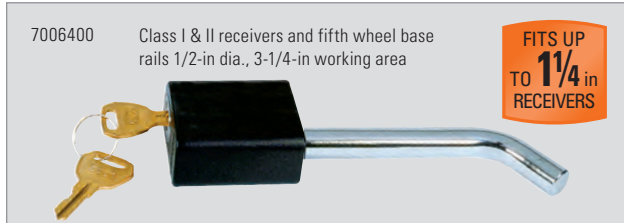

- Convenient push-button lock mechanism with flat key design
- Rubber cap keeps dirt out

Part Number	Style	Finish	Class	Pin Size	Receiver Opening	Span
7006000	Bent pin	CHROME	I/II/III/IV	1/2 and 5/8-in	1-1/4 & 2-in	3-in
7000400	Bent pin	STAINLESS STEEL	I/II/III/IV	1/2 and 5/8-in	1-1/4 & 2-in	3-in

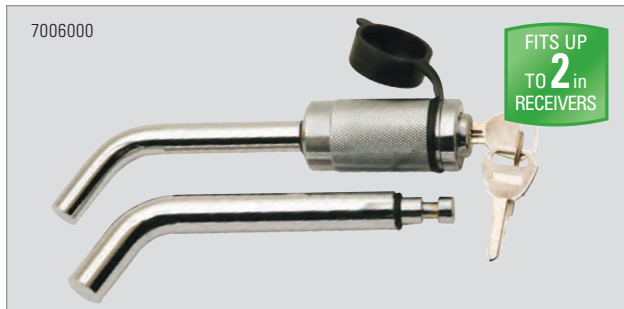

TOWING SECURITY

DUAL, BENT PIN STYLE RECEIVER/COUPLER LOCK COMBO PACK

- Push-button lock with flat key design, keyed alike
- Rubber cap keeps dirt out

Part Number	Style	Finish	Class	Pin Diameter	Receiver Opening	Span
7006100	Bent Pin	CHROME	I/II/III/IV	1/2 and 5/8-in	1-1/4 & 2-in	3-in

2-PACK SECURITY LOCK SET

- Use for adapters requiring both size hitch pins
- Keyed alike

Part Number	Style	Finish	Class	Pin Diameter	Receiver Opening	Span
7023900	Dog Bone	CHROME	I/II/III/IV	1/2 and 5/8-in	1-1/4 & 2-in	3-in



CLASS I & II HITCH PIN AND CLIPS

Part Number	Finish	Pin Diameter	Receiver Opening	Span	Special Feature
7006800	BRIGHT ZINC	1/2 and 5/8-in	1-1/4 & 2-in	3-in	Tethering eyelet
7009100	BRIGHT ZINC	1/2-in	1-1/4-in	2-1/4-in	Comfort grip
7010600	BRIGHT ZINC	1/2-in	1-1/4-in	2-1/4-in	Clip groove
7063830	BRIGHT ZINC	1/2-in	1-1/4-in	2-1/4-in	Rugged pin hole

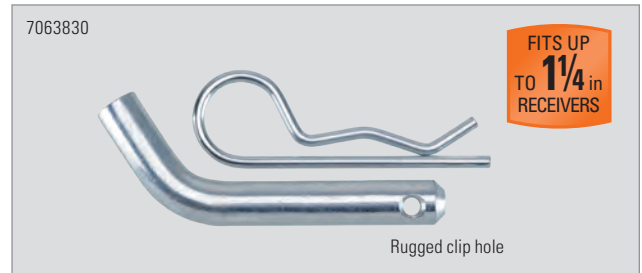
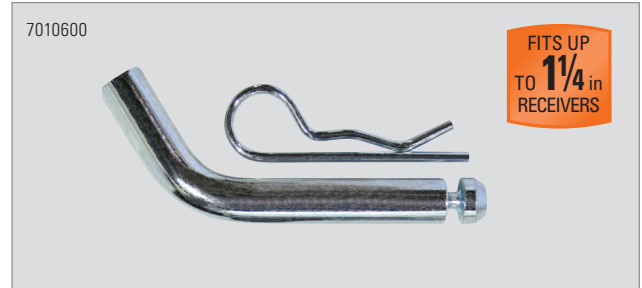

FITS UP TO 2 in RECEIVERS

CLASS III & IV HITCH PIN AND CLIPS

Part Number	Finish	Pin Diameter	Receiver Opening	Span	Special Feature
7006800	BRIGHT ZINC	1/2 and 5/8-in	1-1/4 & 2-in	3-in	Tethering eyelet
7009200	BRIGHT ZINC	5/8-in	2-in	3-in	Comfort grip
7010500	BRIGHT ZINC	5/8-in	2-in	3-in	Clip groove
7063930	BRIGHT ZINC	5/8-in	2-in	3-in	Rugged clip hole

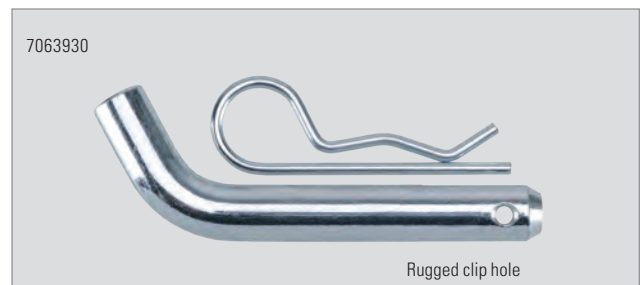

CLASS V HITCH PIN AND CLIPS

Part Number	Finish	Pin Diameter	Receiver Opening	Span	Special Feature
7033100	BRIGHT ZINC	5/8-in	2 & 2-1/2-in	3-1/2-in	Clip groove
7057700	BRIGHT ZINC	5/8-in	2 & 2-1/2-in	3-1/2-in	Rugged pin hole
7081600 NEW	BRIGHT ZINC	5/8-in	2, 2-1/2 & 3-in	4-in	Ergo clip
7090200 NEW	BLACK E-COAT	5/8-in	2 & 2-1/2-in	3-1/2-in	Pull-pin style clip
7092100 NEW	MATTE PEWTER	5/8-in	2 & 2-1/2-in	3-1/2-in	Pull-pin style clip

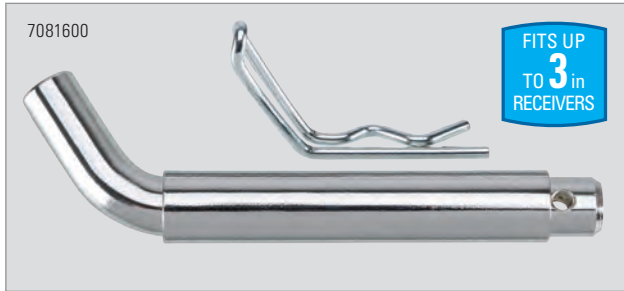
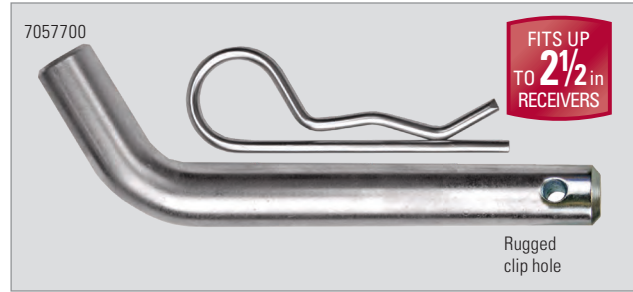

TOWING SECURITY



FITS UP TO **1 1/4** in RECEIVERS

FITS UP TO **2** in RECEIVERS

ANTI-THEFT RECEIVER PINS

- Swivel latch
- Bright finish

Part Number	Finish	Pin Diameter	Receiver Opening	Span	Lock
7014500	BRIGHT ZINC	5/8-in	2-in	3-in	Included
7021200	BRIGHT ZINC	1/2 and 5/8-in	1-1/4 & 2-in	3-in	Included
7006700	BRIGHT ZINC	5/8-in	2-in	3-in	Sold separately
7007100	BRIGHT ZINC	5/8-in	2-in	3-in	Sold separately
7007200	BRIGHT ZINC	1/2-in	1-1/4-in	3-in	Sold separately
7007300	STAINLESS STEEL	5/8-in	2-in	3-in	Sold separately



FITS UP TO **2** in RECEIVERS

ERGO CLIPS® PIN & CLIP

- Unique design, better clearance
- Ergonomic design for easier installation
- High-visibility comfort grips
- Clips are 0.148-in wire diameter

Part Number	Description
15058	5/8-In Diameter Pin with 0.148-in Wire Diameter Clip, With Rugged Hole and Clip
16210C	2-pack 0.148-in Wire Diameter Vinyl Dipped Clips

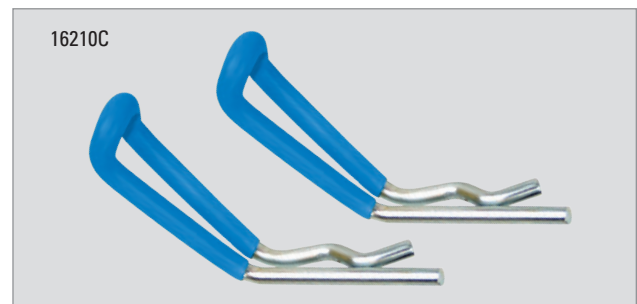

TOWING SECURITY

HEAVY-DUTY UNIVERSAL COUPLER LOCK

- 5/8-in hexagonal steel lock bar provides superior strength
- Guards against trailer towaway theft
- Virtually pick-proof square key design
- Works with all coupler styles

Part Number	Finish	Coupler Size
7088300 NEW	HEAVY-DUTY DIE CAST ALUMINUM	1-7/8-in, 2-in, 2-5/16-in

PROFESSIONAL UNIVERSAL COUPLER LOCK

- Heavy-duty die-cast aluminum design
- Ratchet design with 11 locking positions
- Square key virtually eliminates lock picking
- Provides security for trailer when in storage
- Works with all coupler styles

Part Number	Finish	Coupler Size
7066900	HEAVY-DUTY DIE-CAST ALUMINUM	1-7/8-in, 2-in, 2-5/16-in

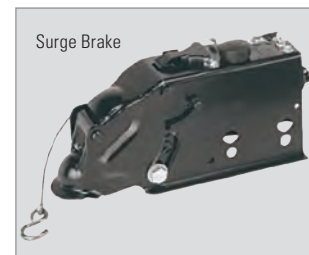

Both locks fit multiple coupler styles

TOWING SECURITY

TRAILER COUPLER LOCKS

- Fits most couplers
- Flat key design

Part Number	Finish	Adjustable
7006600	BRASS PLATING	No
7005300	BRASS PLATING	5/8-in to 1-in
7005800	STAINLESS STEEL	5/8-in to 1-in
7042100	BRUSHED SILVER	5/8-in to 3-in



UNIVERSAL COUPLER LOCK

- Ratchet design with 11 locking positions
- Provides security for trailer when in storage

Part Number	Finish	Coupler Size
72783	HEAVY-DUTY DIE CAST ALUMINIUM	1-7/8-in, 2-in, 2-5/16-in
55003 KEYED ALIKE	HEAVY-DUTY DIE CAST ALUMINIUM	1-7/8-in, 2-in, 2-5/16-in

TOW AND STORE ANTI-THEFT LOCK KIT

- Complete security when towing or storing includes:
Universal coupler lock (72783), Coupler lock (7005300), Dual bent pin lock (7006000)
- Keyed alike

Part Number	Description
7014700	Tow and Store Anti-theft Lock Kit



TOWING SECURITY

EASY ACCESS RECEIVER LOCK AND CABLE

- Sleeved receiver lock works with or without 3/8-in x 12-ft vinyl-coated steel cable
- 360° head for easy locking/unlocking

Part Number	Style	Finish	Class	Pin Size	Receiver Opening	Span
7031600	Sleeved Dog Bone	CHROME	I/II/III/IV	1/2 and 5/8-in	1-1/4 & 2-in	3-in

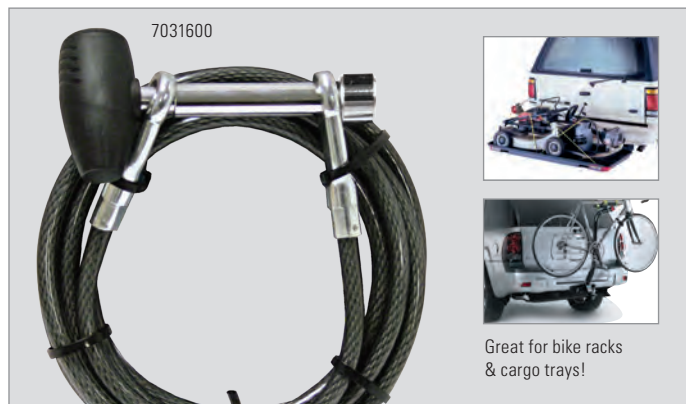

Great for bike racks & cargo trays!



HEAVY-DUTY SPARE TIRE SECURITY

- 5/16-in diameter x 4-ft vinyl-coated braided cable with looped ends
- Security for ladders, utilities, spare tires, tools

Part Number	Description	Finish	Cable Size
7033830	40 mm Laminated Steel Padlock	CHROME	5/16-in x 4-ft



KING PIN LOCK

- Maximum security for all king pins

Part Number	Description	Special Feature
63251	Fifth Wheel King Pin Lock	Extruded T6 tempered aluminum body



SAFETY CHAINS

- Safety chains are required by law in most states
- Bright zinc finish

Part Number	Capacity	Length	Attachment
7025700	2000 lb	72-in	2 Quick links
74059	5000 lb	72-in	2 Quick links
7007700	2000 lb	72-in	2 'S' hooks
7007800	5000 lb	72-in	2 Quick links
72786	5000 lb	36-in	1 Quick link and 1 U-Bolt
7007600	5000 lb	36-in	1 Quick link and 1 U-Bolt
7075300 NEW	7800 lb	24-in	2 carabiner safety hooks



QUICK LINKS

- For use with safety chains or as tie-downs
- Chrome finish

Part Number	Size	Capacity	Quantity	Class
7007900	5/16-in	5000 lb	2 links per pack	Class III
7008000	1/4-in	3500 lb	2 links per pack	Class II

2 TOWING SAFETY CABLES

Part Number	Size	Capacity	Hooks
7007500	40-in long with vinyl coating	5000 lb	Heavy-duty forged with spring-loaded safety latch

SURFACE MOUNT TOW HOOK

Part Number	Capacity
7007400	10000 lb



TOWING SECURITY

ADJUSTABLE TOW BARS & SPARE TIRE CARRIERS

ADJUSTABLE TOW BARS

- Includes 2-in coupler and one set of universal bumper brackets
- Limited lifetime warranty

Part Number	Capacity	Class
7014200 - Split rail	5000 lb	III
74344 - Solid rail	5000 lb	III



TOW BAR CHAINS Required by law in most states

- Kit Includes: 4 - 30-in, 5000 lb chains, 4 - 5/16-in quick links, 4 - U-bolts and locknuts

Part Number	Capacity
7024800	5000 lb



SPARE TIRE CARRIERS

- Mounts to most RV, marine and utility trailer frames
- Heavy-duty 1/2-in diameter construction

Part Number	Description	Finish	Rim Size
74247	Economy Spare Tire Carrier	CHROME	8, 9, 12, 13, 14 & 15-in, 4 or 5 lug
7019200	Marine Spare Tire Carrier with Locking Levers & Lock	CHROME	8, 9, 12, 13, 14 & 15-in, 4 or 5 lug

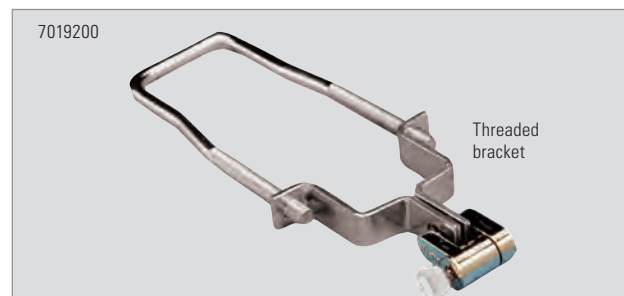

BUILT TO PERFORM





JACKS COUPLERS WINCHES

**Making light work of heavy loads.
Unmatched strength and reliability paired
with an ergonomic design deliver smooth
and efficient operation every time.**

COUPLERS	66-67
JACKS	68-72
WINCHES	73
POWERED JACKS	74-75



FAS-LOK® TRAILER COUPLERS

Part Number	Finish	Ball Size	Style	Channel Width	Trailer GVW
74338	ZINC	1-7/8-in	Fas-Lok	2-in	2000 lb
74040	ZINC	1-7/8-in	Fas-Lok	2-1/2-in	2000 lb
74783	ZINC	1-7/8-in	Fas-Lok	3-in	2000 lb
74042	ZINC	2-in	Fas-Lok	2-1/2-in	3500 lb
74280	ZINC	2-in	Fas-Lok	3-in	3500 lb

SECURITY DUAL-FIT COUPLERS

- KEY-LOK™ built-in security flat-key design with dust cover
- Welded protective lock housing
- Helps prevent trailer theft
- Includes dual-fit spacers

Part Number	Finish	Ball Size	Style	Channel Width	Trailer GVW
7005000	ZINC	1-7/8-in	Fas-Lok	2 & 2-1/2-in	2000 lb
7004900	ZINC	2-in	Fas-Lok	2-1/2 & 3-in	3500 lb

DUAL-FIT FAS-LOK® COUPLERS

- Dual-fit spacers ensure a proper fit for sizes of channels
- Tethered pin included for added safety

Part Number	Finish	Ball Size	Style	Channel Width	Trailer GVW
7004800	ZINC	1-7/8-in	Fas-Lok	2 & 2-1/2-in	2000 lb
7004700	ZINC	2-in	Fas-Lok	2-1/2 & 3-in	3500 lb

74338



74042



7004900



7004800

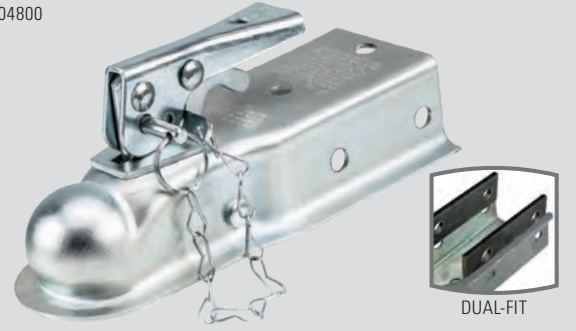

CLASS III & IV COUPLERS

Part Number	Finish	Ball Size	Style	Channel Width	Trailer GVW
33305 1360	PRIMER	2-in	Weld-on	A-frame	5000 lb
44305R1360	PRIMER	2-5/16-in	Weld-on	A-frame	10000 lb



COUPLER ACCESSORIES

Part Number	DESCRIPTION
7479636	1-7/8-in Ball Coupler Repair Kit
7479736	2-in Ball Coupler Repair Kit Coupler Pin and Chain
7050900	Coupler Pin and Chain



TRAILER JACKS

SWING AWAY TRAILER JACKS

Part Number	Description	Finish	Travel/Extension	Wheel	Trailer Tongue	Capacity
7042900	Sidewind Jack	ZINC	10-in/22.7-in	6-in dual wheel	3-in x 5-in	1000 lb
74412	Topwind Jack	ZINC	10-in Travel	6-in wheel	3-in x 5-in	600 lb
74413	Topwind Jack	ZINC	10-in Travel	Foot plate	3-in x 5-in	1000 lb
74410	Sidewind Jack	ZINC	10-in Travel	6-in wheel	3-in x 5-in	1000 lb



JACKS | COUPLERS | WINCHES



TOP-WIND TRAILER JACKS

Part Number	Finish	Travel/Extension	Foot Plate	Mounting	Capacity
74415	GRAY PAINT	10-in/22.7-in	3.8-in x 7.5-in	Weld-on tubular swivel mount	2000 lb
74414	BLACK PAINT	10-in Travel	3.8-in x 7.5-in	Weld-on retaining ring swivel	2000 lb
74407	BLACK PAINT	14-in Travel	Detachable 2.25 x 4.5-in	A-frame	2000 lb

CASTER WHEEL

- 6-in x 2-in reinforced poly wheel
- Provides easy roll and good ground support
- Zinc plated for corrosion resistance
- Easily removed with pin and clip included
- 1000 lb

Part Number	Finish	Wheel Dimensions	Capacity
74326	ZINC	6-in x 2-in	1000 lb



ROUND JACKS

BOLT-ON STANDARD ROUND JACKS - RETAINING RING SWIVEL

- Designed for use with recreational and utility trailers
- Black painted outer and clear zinc inner tubes
- Footplate included

Part Number	Lift Capacity	Handle Style	Travel	A Retracted	B Extended	C Clearance	Included
7076500 - Box 7076600 - Bulk	2000 lb	Topwind	10-in	11-in	21-in	4-in	Mating mount, mounting hardware & retaining ring included.

WELD-ON STANDARD ROUND JACKS - RETAINING RING SWIVEL WITH FOOTPLATE

Part Number	Lift Capacity	Handle Style	Travel	A Retracted	B Extended	C Clearance	Included
7078600 - Box 7078700 - Bulk	2000 lb	Topwind	10-in	11-in	21-in	4-in	Mating mount & retaining ring
7078000 - Box 7078100 - Bulk	2000 lb	Topwind	15-in	14.5-in	29.5-in	10-in	Mating mount, mounting hardware & retaining ring included
7077800 - Box 7077900 - Bulk	2000 lb	Sidewind	10-in	10-in	20-in	6.3-in	Mating mount & retaining ring

WELD-ON STANDARD ROUND JACKS - TUBULAR SWIVEL WITH FOOTPLATE

Part Number	Lift Capacity	Handle Style	Travel	A Retracted	B Extended	C Clearance	Included
7078200 - Box 7078300 - Bulk	2,000	Sidewind	10-in	11.2-in	21.2-in	5.5-in	Mating mount & pull pin
7078400 - Box 7078500 - Bulk	2,000	Sidewind	15-in	14.4-in	29.4-in	12.3-in	Mating mount & pull pin
7076000 - Box 7076100 - Bulk	2,000	Topwind	10-in	11-in	21-in	4-in	Mating mount & pull pin
7078800 - Box 7078900 - Bulk	2,000	Topwind	15-in	14.5-in	29.5-in	10-in	Mating mount & pull pin
7079100 - Box 7079000 - Bulk	5,000	Sidewind	10-in	10.5-in	20.5-in	6.3-in	Mating mount & pull pin
7079300 - Box 7079200 - Bulk	5,000	Sidewind	15-in	15.5-in	30.5-in	6.3-in	Mating mount & pull pin
7079400 - Box 7079500 - Bulk	5,000	Topwind	10-in	11.2-in	21.2-in	4-in	Mating mount & pull pin
7076400 - Box 7076300 - Bulk	5,000	Topwind	15-in	14.7-in	29.7-in	10-in	Mating mount & pull pin

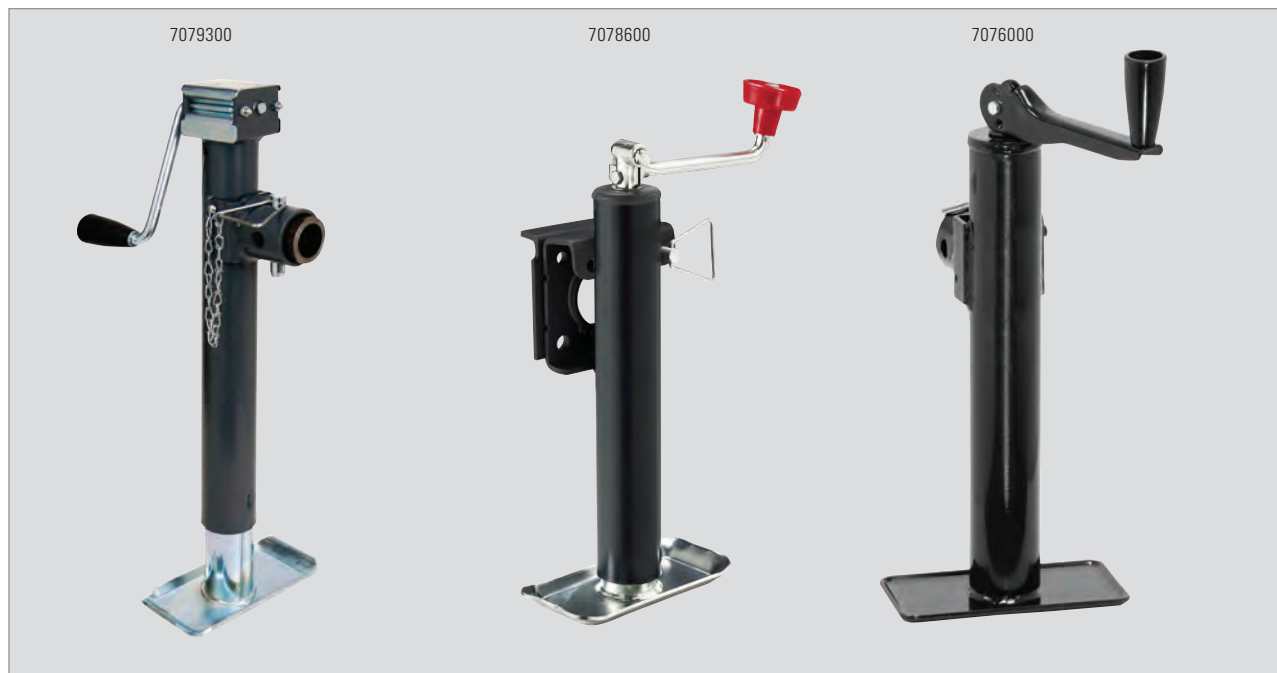

A-FRAME STANDARD ROUND JACKS - WITHOUT FOOTPLATE

- Designed for use with trailers with A-Frame couplers
- Weld-on or bolt-on mounting option
- A-frame models have black painted outer and inner tubes

Part Number	Lift Capacity	Handle Style	Travel	A Retracted	B Extended	C Clearance	Description
7080200 - Box 7080300 - Bulk	2,000	Sidewind	14-in	9-in	23-in	13-in	Front-facing handle
7080000 - Box 7080100 - Bulk	2,000	Topwind	14-in	8-in	22-in	11-in	
7076700 - Box 7076800 - Bulk	5,000	Topwind	15-in	10.8-in	25.8-in	14.6-in	

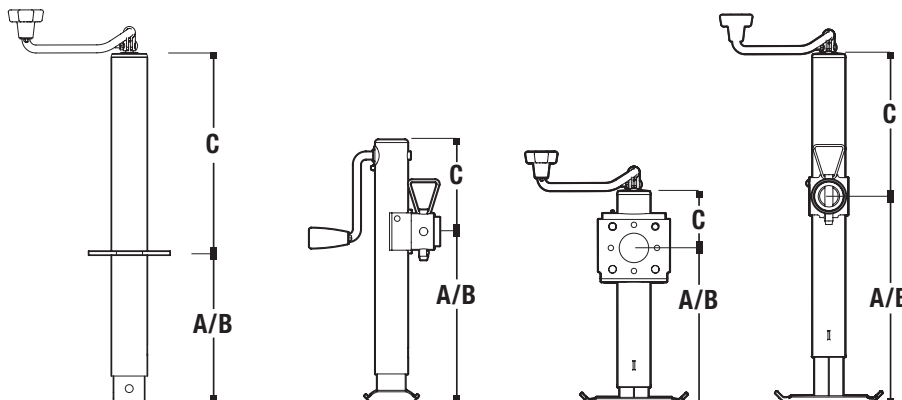

Travel and Clearance
 A = Retracted
 B = Extended
 C = Clearance Height

SQUARE JACKS

WELD-ON - SQUARE JACKS - TUBULAR SWIVEL

- Square jack dramatically improves side load strength
- Drop leg and fixed leg models available
- Tubular swivel models include mating mount and pull pin

Part Number	Lift Capacity	Handle Style	Travel	A Retracted	B Extended	C Clearance	Description
7079600 - Box 7079700 - Bulk	5,000	Topwind	10-in	17.2-in	27.2-in	5-in	Black painted outer tube, clear zinc inner tube. Fixed leg.
7079800 - Box 7079900 - Bulk	5,000	Sidewind	10-in	17.4-in	27.4-in	8-in	Black painted outer tube, clear zinc inner tube. Fixed leg.
7077400 - Box 7077300 - Bulk	8,000	Sidewind	10-in	17.2-in	27.2-in	7.3-in	Black painted outer tube, clear zinc inner tube. Fixed leg.

DIRECT WELD - SQUARE JACKS

Part Number	Lift Capacity	Handle Style	Travel	A Retracted	B Extended	C Clearance	Description
7077000 - Bulk	8,000	Topwind	15-in	22.9-in	51.50-in	N/A	All tubes painted black. Drop leg provides 28-in of travel.
7077200 - Bulk	8,000	Sidewind	15-in	25.2-in	53.80-in	N/A	All tubes painted black. Drop leg provides 28-in of travel.
7077600 - Bulk	12,000	Sidewind	12.5-in	27.3-in	53.3-in	N/A	Spring return drop leg jack offers 13.5-in of additional extension. Drop leg pin faces to the side. All tubes are painted black.
7077700 - Bulk	12,000	Sidewind	12.5-in	28.3-in	54.3-in	N/A	Non-spring return drop leg jack offers 13.5-in of additional extension. Drop leg pin faces to the side. All tubes are painted black.



Travel and Clearance
 A = Retracted
 B = Extended
 C = Clearance Height

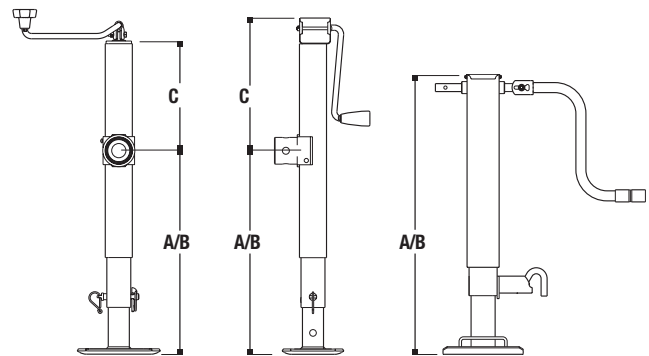

SINGLE-SPEED TRAILER WINCHES

- Includes comfort-grip handle for a positive hold while cranking
- Full-length drum bushing and oil-impregnated shaft bushing minimize maintenance
- High-carbon steel gears to resist wear and last longer

Part Number	Finish	Capacity	Gear Ratio	Ratchet Type	Rope	Strap	Strap Included
74337	ZINC-PLATED	600	3.1:1	One-way	36-ft x 1/4-in	15-ft x 2-in	NO
74418	ZINC-PLATED	1100	4.1:1	Two-way	36-ft x 1/4-in	15-ft x 2-in	NO
74419	ZINC-PLATED	1300	4.1:1	Two-way	30-ft x 5/16-in	20-ft x 2-in	NO
74329	ZINC-PLATED	1500	4.1:1	Two-way	20-ft x 5/16-in	20-ft x 2-in	YES



TWO-SPEED TRAILER WINCH

Part Number	Capacity	Gear Ratios	Ratchet Type	Drum Storage	Strap	Strap Included
74529	1800	4.1:1, 9.8:1	2-way with Neutral	20-ft x 7/16-in Rope		NO

SINGLE-SPEED PORTABLE ELECTRIC WINCH

Part Number	Pulling Capacity	Marine Capacity	Rolling Capacity
7033600	2000-lb	5000-lb	8000-lb

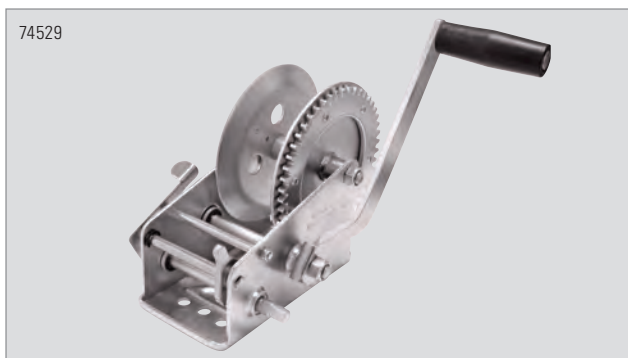

JACKS | COUPLERS | WINCHES

A-FRAME JACK WITH POWERED DRIVE

- Drop leg with spring-loaded pull pin
- Makes setting up easier with a handy built-in level right where you need it most
- Deploys and hooks up easily at night with onboard LED courtesy light
- Works in case of power loss with emergency manual override capability, easily accessible from the top
- Lasts for years with industry-leading REESE® performance, known worldwide for unmatched strength, durability, and side-load capacity
- Retains like-new appearance with corrosion-resistant surfaces
- 5 year limited warranty

Part Number	Finish	Travel/Extension	Description	Mounting	Capacity
500701 NEW	BLACK PAINT	14-in	Black cover, includes drop leg	A-frame	4000 lb
500702 NEW	BLACK PAINT	14-in	White cover, includes drop leg	A-frame	3500 lb



JACKS | COUPLERS | WINCHES

A-FRAME JACK WITH POWERED DRIVE

Part Number	Finish	Travel/Extension	Description	Mounting	Capacity
500703 NEW	BLACK PAINT	14-in	Black cover, includes drop leg	A-frame	3500 lb
500704 NEW	BLACK PAINT	14-in	White cover, includes drop leg	A-frame	3500 lb



POWERED A-FRAME JACK

Part Number	Finish	Travel/Extension	Foot Plate	Mounting	Capacity
7036400	BLACK PAINT	18-in	500244 sold separately	A-frame	2500 lb



JACKS | COUPLERS | WINCHES

SECURE AND RELIABLE





Getting the job done right.
Creating a complete towing
system with all the essentials
from recovery systems to
tow bar chains.

TOWING ACCESSORIES



VEHICLE RECOVERY	78-79
CHAIN HOISTS	79
HEAVY-DUTY JACKS	80
HITCH ACCESSORIES	81-82
WRENCHES	83
WHEEL CHOCKS	83
POD HAZARD	84-85
HITCH COVERS	86-87
BEARING, BUSHINGS	88
STEP BUMPER RECEIVER	88
TOWING MIRRORS	89
SOLOHITCH™	89

VEHICLE RECOVERY RINGS

- Use with tow straps to recover stranded vehicles
- Alloy steel
- Proven military design
- 360° rotation, 180° pivot

Part Number	Box opening	Hitch Pin Opening	Extended Length	Gross Capacity
7065400	1-1/4-in	1/2-in	9-in	2000 lb
7065500	2-in	5/8-in	13-in	10000 lb
7090300 NEW	2-1/2-in	5/8-in	13.6-in	16000 lb
7090400 NEW	3-in	5/8-in	13.6-in	21000 lb



VEHICLE RECOVERY SYSTEMS

- System Includes:**
- 1 - Vehicle recovery ring
 - 1 - 12-ft tow strap with loop ends
 - 1 - Reflective tow strap jacket
 - 1 - Threaded towing shackle
 - 1 - Heavy-duty carrying case

Part Number	Box opening	Hitch Pin Opening	Extended Length	System Capacity
7065600	2-in	5/8-in	13-in	5500 lb
7068200	1-1/4-in	1/2-in	9-in	1650 lb



CHAIN HOISTS

- Forged 360° swivel hooks
- Mechanical safety brake
- Protective steel housing
- Portable for indoor or outdoor use

Part Number	Lift	Pull Chain	Capacity
7067300	10-ft	8-1/2-ft	2000 lb
7067400	10-ft	8-1/2-ft	6000 lb



HEAVY-DUTY JACKS AND ACCESSORIES

HEAVY-DUTY JACKS

- Long removable handle for ease of use, clamp

Part Number	Height	Finish	Travel	Capacity	Features
7064200	36-in	BLACK	30-in	7000 lb	Includes 7061500 handle holder
7060900	54-in	BLACK	48-in	8000 lb	
7033400	48-in	RED/BLACK	42-in	7000 lb	

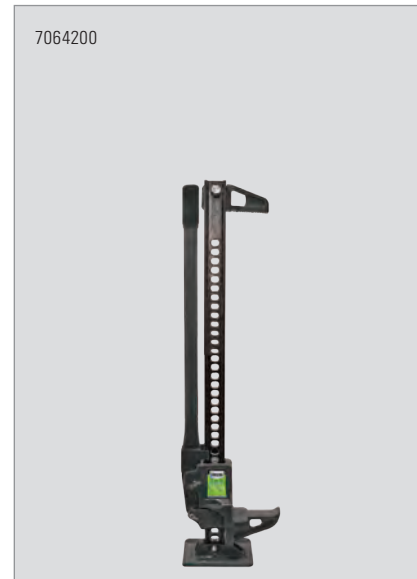
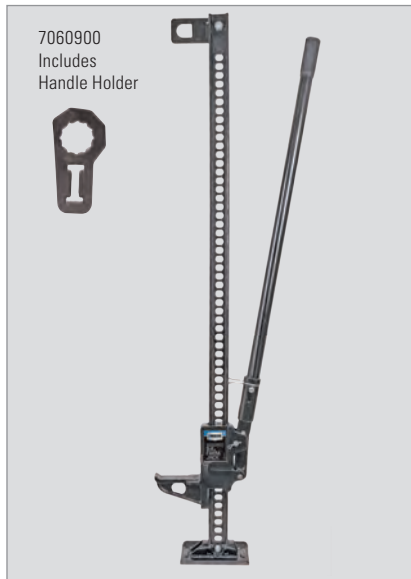

FARM JACK ACCESSORIES

Part Number	Description	Features
7071300	Universal ATV/UTV Jack Mounts,	REESE® Powersports – Mount jacks to bumpers, bull bars, roll cage, roof rack or cargo rack
7086500	Truck Box Mount	BULLDOG®
7048400	Farm Jack Foot Plate	10-in x 10-in, 7000 lb capacity – BULLDOG®
7061500	Handle Holder	Durable PVC, eliminates rattle
7088900	Carry Handle	BULLDOG® – Fits all farm jacks
7064100	Farm Jack Maintenance Kit	REESE® Powersports – 2 climbing pins and springs, 2 cross pins, 1 handle pin and clip

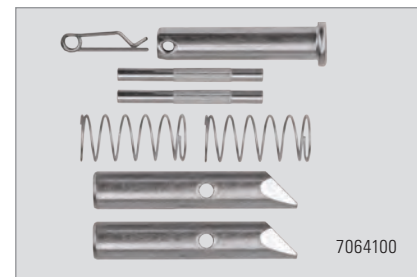
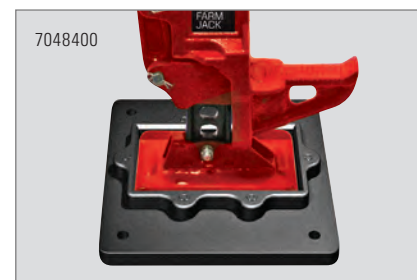
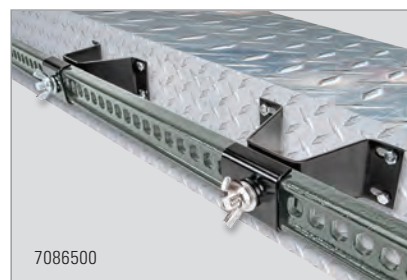

DUAL HITCH EXTENSION

- Carry your bikes or add a cargo tray while you tow
- Great for RV accessories
- Fits 2-in receiver opening

Part Number	Box opening	Gross Capacity	Tongue Capacity
7060100	2-in	4000 lb	400 lb

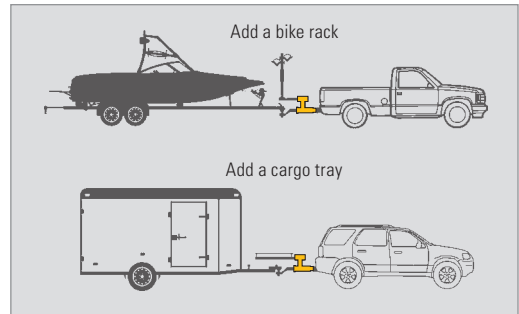
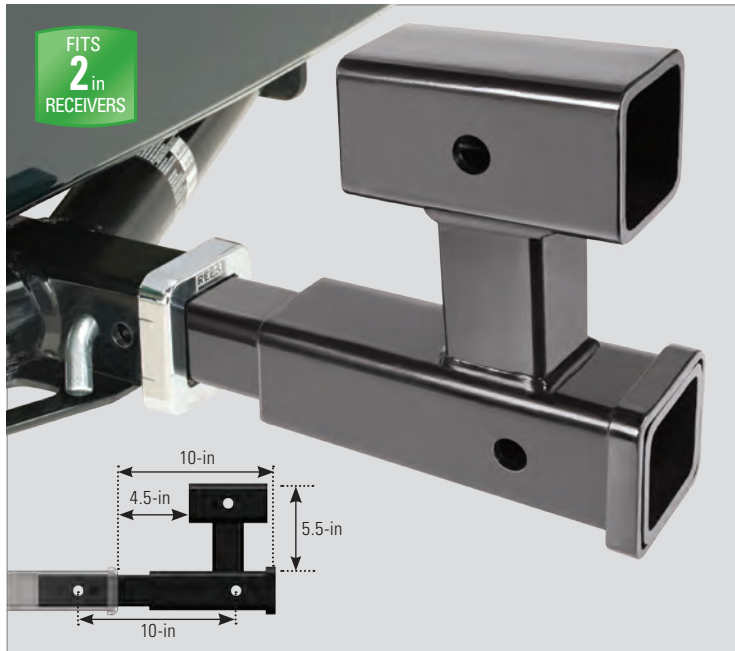

BALL MOUNT BOOT BRUSH

Part Number	Description	Ball Mount
7074100	Stainless Steel Mounting Hardware Included	2-in



Ideal for construction sites & landscaping fleets

- Remove sand, grass, dirt, mud
- Allows towing while installed
- Long-lasting heavy-duty fiber brush and high-strength aluminum alloy scraper mounted to a high-impact modular platform
- Mounts to Standard & InterLock® 2-in ball mounts
- Patented

HITCH STEPS

TOW & GO HITCH STEP

- Slip-resistant tread surface with raised edges, stays in place while you tow
- Durable high-grade aluminum alloy with black powder-coat finish for extended durability
- One-tool assembly; no drilling required, Patented

Part Number	Ball Mount	Features	Capacity
7060200	1-1/4-in, 2-in	Stainless steel mounting hardware and adapter included	500 lb



TOW & GO LIGHTED HITCH STEP

- Ultra-bright LED lights, great for added back-up light or connecting your vehicle to your trailer at night
- Heavy-duty aluminum, slip-resistant tread surface with raised edges, stays in place while you tow.
- No drilling required, Patented

Part Number	Ball Mount	Features	Capacity
7065300	2-in	Stainless steel mounting hardware included	500 lb



HITCH BALL WRENCHES

- Fits the most popular hitch ball nut sizes

Part Number	Finish	Wrench Ends	Length	Features
7073930 NEW	Drop forged, chrome-plated finish	1-1/2 and 1-7/8 in	11.5-in	1/2 the size and fits most 2 and 2-5/16-in hitch balls
74342	Drop forged, chrome-plated finish	1-1/8-in & 1-1/2-in	19-in	Fits most 1-7/8 and 2-in hitch balls



WHEEL CHOCKS

- Reduce risk of trailer roll

Part Number	Up to wheel size	Size	Construction	Features
7000100	17-in	8.25-in L x 5.75-in H x 6-in W	High-impact polymer	Set of 2, includes mounting holes
7074300	31-1/2-in	9.5-in L x 5.7-in H x 7.5-in W	Heavy-duty rubber	Includes handle
7000300	8-in	8 - in L x 1-1/2 - in x 8 in	High-impact polymer	Includes mounting holes



POD HAZARD MULTI-USE LED ROADSIDE WARNING DEVICE

Whether it's a flat tire, a warning light, or an overheated engine, vehicle trouble can occur at any time, and you'll want to do everything possible to keep yourself, and the ones you love as safe as possible.

Be prepared. Be seen. Be safe with POD Hazard.



HAZARD LIGHTING

Many hazard lights on today's vehicles can only be seen up to 1/10 of a mile away in daylight conditions. With the POD Hazard, motorists can see a vehicle on the side of the road from more than 1/4 of a mile away – that's more than double the time to react.

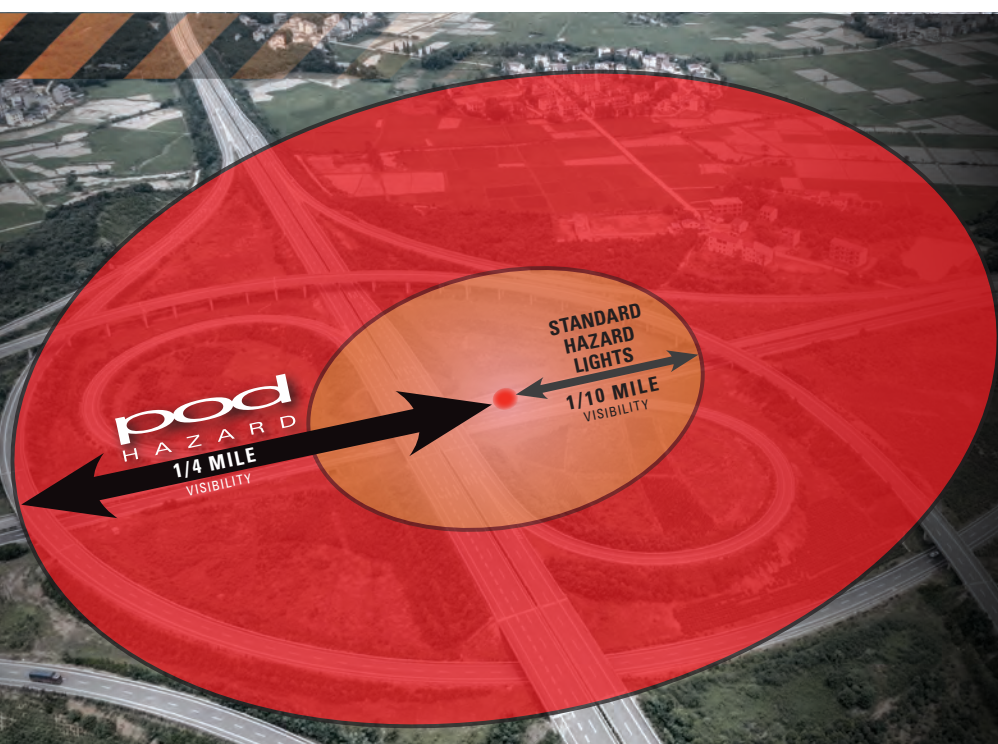

pod
HAZARD



Part Number	Description	Packaging
PD110200 NEW	POD HAZARD Multi-use LED Roadside Warning Device	2 pack, batteries sold separately
PD110700 NEW	POD HAZARD Countertop Display	Includes (3) PD110200, batteries sold separately
PD110101 NEW	POD HAZARD	1 pack clamshell, batteries sold separately
PD110302 NEW	POD HAZARD – Club	3 pack, 9 AAA batteries included, compact storage bag

LIGHT WHERE YOU NEED IT

When you need extra light around the vehicle, in the garage, at the camp site or simply at home, POD Hazard's ultra-bright utility light is ready when you are. Simply hang it, prop it up, or aim it, and it's ready to provide you with more than 350 lumens of light.



TOWING ACCESSORIES

RECEIVER TUBE COVERS

SPRING-LOADED HITCH COVER

- Fits most 2-in receiver openings
- Stays in place while you tow, anti-rattle design
- Spring-loaded cover keeps opening free from debris

Part Number	Receiver Size
7074630	2-in



3D SPORTS RECEIVER TUBE COVERS

- Anti-rattle patented design; Durable & weatherproof; No tools required

Part Number	Style	Receiver Size	Hitch Pin Opening
8654111	Football	2-in	5/8-in
8653711	Tennis	2-in	5/8-in
8653811	Soccer	2-in	5/8-in
8653911	Golf	2-in	5/8-in
8654011	Baseball	2-in	5/8-in
8653611	Basketball	2-in	5/8-in



LOOK FOR LIGHTED HITCH COVERS ON PAGE 136

RECEIVER TUBE COVERS

Part Number	Receiver Size	Class	Features
74099	2-In	IV	Black nylon
74514	2-In	IV	Tethered rubber hitch receiver cover with 4-way flat holder
74547	2-In	IV	Replacement plastic receiver plug
7000600	2-In	IV	Plastic receiver plug
7051500	1-1/4-in	III	Rubber receiver plug
7023100	2-In	IV	Distinctive chrome collar & rubber receiver plug
8654700 NEW	2-In	IV	Anti-rattle patented design; 2-minute installation, no tools required



HITCH BALL COVER

- Includes a 4-way flat wiring mounting pocket
- Prolong life of hitch ball
- Prevents accidental grease stains on hands and clothing

Part Number	Ball Size
7013100	1-7/8-in, 2-In

WHEEL BEARING PROTECTORS & KITS

- Permits easy lubrication for longer life
- Keeps water and dirt out; Easy to install

Part Number	Description
72790	Wheel Bearing Kit - 1-1/4-in - Single
72791	Wheel Bearing Kit - 1-in - Single
74176	Wheel Bearing Protector Set - 1.781-in dia. hub
74177	Wheel Bearing Protector Set - 1.980-in dia. hub
7036700	Wheel Bearing Protector Set - 2.328-in dia. hub

HITCH BALL BUSHINGS

- Allows smaller shank hitch balls to be used with ball mounts with larger shank holes

Part Number	Description
58109	Reduces from 1-in to 3/4-in
72800	Reduces from 1-in to 3/4-in for InterLock® Ball Mounts
58184	Reduces from 1-1/4-in to 1-in, Perfect for Class V Hitch Users

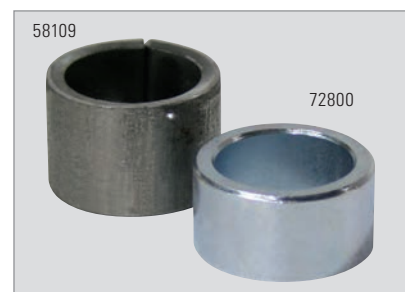

STEP BUMPER RECEIVER

Part Number	Tongue Weight	GTW Weight	Class
58109	350 lb	3500 lb	II (Not for use with weight-distributing equipment)



HITCH BALL LUBRICANT

- Water resistant, helps fight corrosion
- Reduces coupler and ball wear

Part Number	Description
7057900	0.14-oz Single Dose Pack
58117	4-oz jar



CLIP-ON TOWING MIRRORS

- Attaches to existing mirror in seconds
- Fully adjustable mirrors maximize vision

Part Number	Description	Features
7034200	Dual-view Clip-on Towing Mirror	Non-marring security straps, aerodynamic design adjusts to fit existing mirror
72787	Clip-on Towing Mirror	Extends view by up to 7 inches



ADHESIVE BACK WIDE-ANGLE MIRRORS

- Wide-angle convex mirrors with mounting tape
- Helps reduce dangerous blind spots

Part Number	Description
7043700	3-in Diameter, 2-pack, Adjustable, Easy Installation
7044000	2-in Diameter, 2-pack, Easy Installation



SOLOHITCH™ ALIGNMENT SYSTEM

- Convenient one-person hitch alignment system
- Magnetic base for fast, easy location
- Rods adjust up to 42-in
- Align trailer and hitch on first attempt

Part Number	Description
7012900	Solohitch Alignment System





A 'SMOOTH' CONNECTION

8536600
4-Flat to Dual 4-Flat Adapter
Page 115

Easily transition between vehicle and trailer wiring. Color-coded harnesses and compatible electrical components provide everything that's needed for safe, trouble-free towing.



ELECTRICAL WIRING



T-CONNECTORS	92-93
T-Connectors Application Guide	CLICK HERE
TAIL LIGHT CONVERTERS	94-96
CONNECTORS	97-110
MOUNTING BRACKETS	111-112
WIRING ACCESSORIES	113
ADAPTERS	114-120
BACK-UP ALARM, POWER ADAPTER	121



T-CONNECTORS

Simple Plug & Play!

If your vehicle does not have a trailer towing option installed, you'll need a T-connector; a simple plug-and-play option for your trailer's electrical connections.

- Factory appearance
- Quick-and-easy installation
- Solid construction, built with our Surface Mount Technology
- Weatherproof connection when needed
- No cutting, splicing or taping of vehicle wires
- Includes ModuLite® or converter where needed
- 16 gauge bonded wire with 4-Flat plug and integrated cap
- Just plug in and you're ready to tow
- See application guide for vehicle-specific applications



[Click Here to Go to Our Application Guide](#)

IT COULDN'T BE EASIER

With our simple do-it-yourself instructions in every package, just plug in the T-Connector and you're ready to tow!



1. Locate wiring position, see chart on next page.



2. Unplug the tail light harness.



3. Route T-connector to the tail light harness.



4. Plug the tail light into the T-connector.



5. Re-secure the tail light and you're ready to go!



NOTE: Some vehicles may require grounding and/or direct connection to the battery.

T-CONNECTOR WIRING POSITIONS

PASSENGER CARS (PC)

Passenger car wiring positions are referenced by the letters PC and a number. Use the illustration to identify the wiring location for all passenger cars.

- PC1 - Behind driver side tail light - externally
- PC2 - Behind passenger side tail light - externally
- PC3 - Inside trunk behind driver side tail light - internally
- PC4 - Inside trunk behind passenger side tail light - internally
- PC5 - Under vehicle, driver side
- PC6 - Under vehicle, center
- PC7 - Under vehicle, passenger side

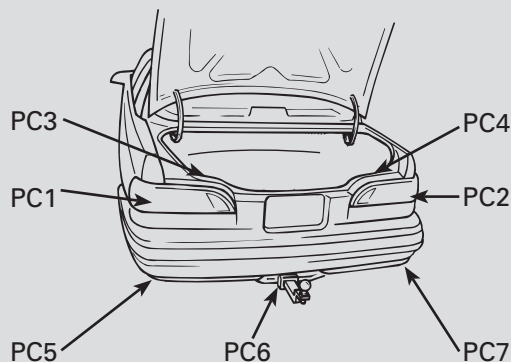

PICKUP TRUCKS, FULL & MID-SIZE (PU)

Pickup truck wiring positions are referenced by the letters PU and a number. Use the illustration to identify the wiring location for all trucks.

- PU1 - Behind driver side tail light
- PU2 - Behind passenger side tail light
- PU3 - Under vehicle, driver side
- PU4 - Under vehicle, passenger side
- PU5 - Under vehicle, center

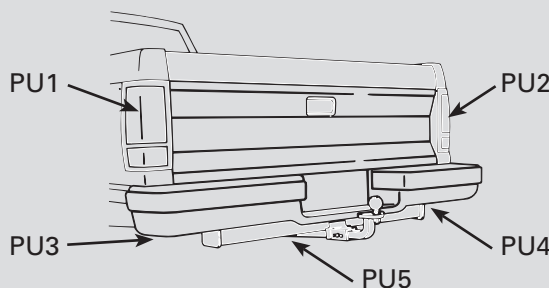

SPORT UTILITY, VANS & MINI-VAN (SUV)

Sport utility, vans & mini-van wiring positions are referenced by the letters SUV and a number. Use the illustration to identify the wiring location for all sport utility vehicles, vans and mini-vans.

- SUV1 - Behind driver side tail light
- SUV2 - Behind passenger side tail light
- SUV3 - Behind driver side trim panel
- SUV4 - Behind passenger side trim panel
- SUV5 - Under vehicle, driver side
- SUV6 - Under vehicle, center
- SUV7 - Under vehicle, passenger side
- SUV8 - Inside vehicle, center
- SUV9 - Inside vehicle, passenger side, behind panel near rear seat

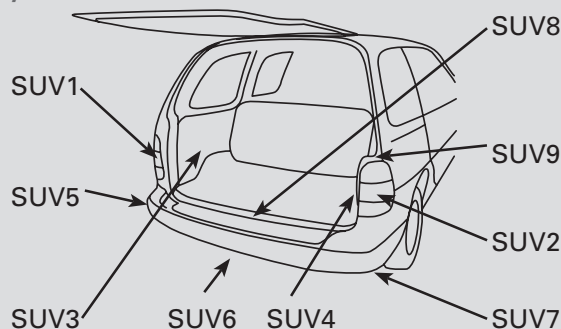

ELECTRICAL CODE GUIDE

***** = Do NOT cut wires to rear tail lights

1 = Upgrades from OEM 4-Flat to 6-Pin wiring.

2 = Upgrades from OEM 4-Flat to 7-Way wiring.

A = 2-wire system. No converter required, but a Powered Converter can be used.

AP = 2-wire system w/Pulse Width Modulation (PWM). Upgraded Powered Converter required.

B = 3-wire system. Requires Converter, but a Powered Converter can be used.

BTT = Shared Brake/Tail/Turn multiplexed wiring system. Powered Converter HD Plus or Ultra required.

BM = 3-wire system. Upgraded Powered Converter HD required. Multiplex Wiring System.

BN = Exterior-mounted plug on some or all models. May require an aftermarket electrical mounting box or bracket. (Sold separately.)

BT = Shared Brake/Tail multiplexed wiring system. Powered Converter HD Plus or Ultra required.

CE = T-Connector includes fuse(s) & relay(s), converter not required. Standard 2-wire system at factory tow plug.

CG = T-Connector incorporates circuit-protected tail light converter.

CH = T-Connector is equipped with circuit-protected Powered Converter.

E = Powered Converter required.

FV = 2003 Models w/build date after 11/1/02.

FW = 2003 Models w/build date before 11/1/02.

G = Low-side switching system.

H = 3-wire system with OEM standard 2-wire harness.

HG = T-Connector incorporates tail light converter.

HJ = Per Dodge owner's manual: If trailer is equipped with more than standard lighting (1 taillight per side), use of Powered Converter or dealer-supplied harness is required.

JM = Some early-production 1994 models may require # 74667

LD = Vehicle has LED tail lamps.

LS = T-Connector incorporates low-side switching taillight converter. Additional installation time required.

N = DO NOT cut or splice vehicle wiring. Only use approved T-Connector or see auto dealer for trailer tow wiring kit.

QP = Will NOT fit vehicles with backup sensors built into rear bumper.

RD = For vehicles equipped with factory tow package, may require additional components or may be used as a replacement harness.

RW = On some models, may be required an upgraded flasher or Powered Converter

TR = Trimming or modification of the vehicle connector may be required.

Z = May be equipped with Factory Tow Prep Plug. Determine at time of installation.

† = Available while supply lasts.

[CLICK HERE FOR T-CONNECTOR APPLICATION GUIDE](#)

POWERED TAIL LIGHT CONVERTERS ELIMINATE THE DRAIN ON YOUR VEHICLE'S ELECTRICAL SYSTEM

With a Power Module

the additional power required to supply the trailer lights (represented by the red line) is supplied directly from the battery. Only a small amount of power is required from the fuse panel, turn signal switch, tail light harness and lamp out sensor, to signal when to illuminate the trailer lights.

Without a Power Module all the additional power required to supply the trailer lights pass through the vehicle's electrical system.

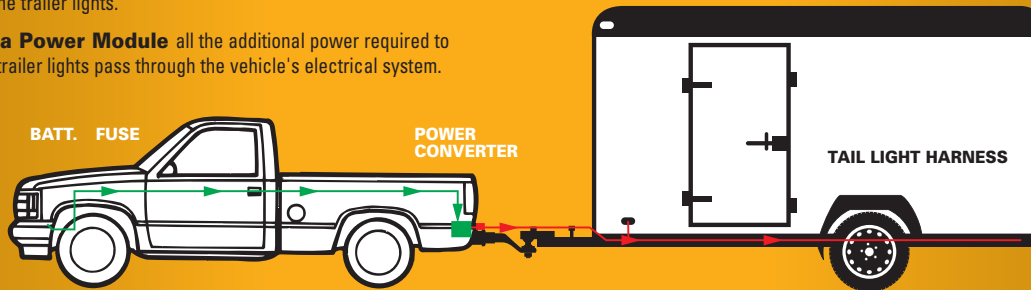

The converter you choose depends on the type of trailer you'll be towing and the car or truck you'll be towing it with (the electrical systems on some vehicles are designed to handle the power needs of the vehicle only).

Be sure to consult your vehicle owner's manual for recommendations.

Bulb Type	Candle Power	Rated Amps	Watts
57 / 1895	2	0.27	3.780
2057	32	2.10	26.880
	2	0.48	6.720
MR16	-	-	35
921	21	1.40	17.920
922	15	0.98	12.544
1141	21	1.44	18.432
93	15	1.04	13.312
105	12	1.07	13.696
1156	32	2.10	26.880
1157	32	2.10	26.880
	3	0.59	8.260
168	3	0.35	4.900
194	2	0.27	3.780

The tail, turn and stop light circuits of today's vehicles are manufactured with light gauge wire designed to carry only enough current to supply the lights of the vehicle. The additional load of trailer lights on these sensors can cause faulty operation and in some cases, may lead to failure.

Trailer light power modules provide power to the trailer lights directly from the tow vehicle's battery.

IDENTIFYING THE NEED FOR POWER MODULES

Power module products are required when towing with any of the following conditions:

- Any vehicle equipped with lamp-out sensors or other electronic devices that could be damaged by attaching trailer lights directly to the tow vehicle's electrical system.
- The trailer being towed is equipped with multiple clearance and running lights that may create an increased load on the tow vehicle's electrical system.
- If your vehicle manufacturer cautions against adding additional loads to electrical circuits (**always consult the vehicle owner's manual when installing trailer wiring**).

POWER MODULES

- Virtually eliminates draw on the vehicle's tail light circuit
- Maximum trailer light brightness
- Powers the trailer's stop, turn and tail/running lights directly from the tow vehicle's battery
- May be used on 2- or 3-wire systems
- No converter is required
- Eliminates the need for a heavy-duty flasher

LED AND INCANDESCENT

STANDARD

- Adapts import & domestic vehicles with separate turn and stop lights (3-wire system) to standard trailer tail light wiring (2-wire system)
- Rated for up to 2.1 amps for Turn/Stop circuits and 7.5 amps for the tail light circuit
- Will work with most LED and incandescent/standard bulbs (vehicle and trailer) & with most vehicle multiplex systems for lighting
- Prevents feedback from the trailer to the vehicle system
- Integrated protective cover

HEAVY-DUTY

- Draws power directly from vehicle's battery and uses less than 5 milliamps of the vehicle's circuit to sense the required functions and applies appropriate lighting to the trailer
- Works with most LED and incandescent/standard bulbs
- Rated for up to 2.1 amps for Turn/Stop circuits and 5.6 amps for the tail light circuit
- Tail Light circuit has been upgraded to work with vehicle's pulse width modulation (PWM), allowing the converter to turn on fully and give the trailer lights full brightness during activation
- This unit prevents feedback from the trailer to the vehicle system
- Can be used on a 2- or 3-wire system
- Integrated protective cover

ULTRA-POWERED

- Rated for up to 4.2 amps for Turn/Stop circuits and 16 amps for the tail light circuit
- Universal converter designed to be used on most vehicles
- Draws power directly from the vehicle battery and uses less than 5mA of the vehicle circuit.
- Works with LED or incandescent bulbs (vehicle & trailer)
- Integrated re-settable short circuit and overload protection
- Designed not to send feedback through the vehicle circuits
- Trailer brakes override hazard lamps.
- Advanced circuitry works in all standard applications as well as vehicles with ST and STT pulse width modulation (PWM) systems
- Interprets/decodes multiplex signal inputs (i.e. Audi, BMW, Mercedes and VW)
- Will not work with vehicles with low-side switch
- Use on a 2- or 3-wire system
- All solid-state components

Part Number	Description
8507900	Tail Light Converter with Circuit Protector
8551200	Tail Light Power Converter Kit with Circuit Protector
8508100	Tail Light Ultra Power Converter Kit with Circuit Protector



POWER CONVERTER KITS

HEAVY-DUTY

- Draws power directly from vehicle's battery and uses less than 5 milliamps of the vehicle's circuit to sense the required functions and appropriate lighting to the trailer
- Works with most LED and incandescent/standard bulbs
- Rated for up to 2.1 amps for Turn/Stop circuits and 7.5 amps for the tail light circuit
- Tail light circuit has been upgraded to work with vehicle's pulse width modulation (PWM), allowing the converter to turn on fully and give the trailer lights full brightness during activation
- Works with most vehicles that have multiplex systems for lighting
- Use on a 2- or 3-wire system
- Integrated protective cover

HEAVY-DUTY PLUS

- Draws power directly from vehicle's battery and uses less than 5 milliamps of the vehicle's circuit to sense the required functions and appropriate lighting to the trailer
- Works with most LED and incandescent/standard bulbs
- Rated for up to 4.2 amps for Turn/Stop circuits and 7.5 amps for the tail light circuit
- Works with most vehicles that have multiplex systems for lighting
- Can be used on a 2- or 3-wire system
- Includes integrated protective cover

WIRING KIT

- Includes: 20-ft of wire, fuse holder, fuse, terminals, cable ties



78103

Part Number	Description	Features
8551300	Tail Light Power Converter Kit	Heavy-Duty with Integrated Circuit Protector
8551400	Tail Light Power Converter Kit	Heavy-Duty Plus with Integrated Circuit Protector
78103	Tail Light Converter Wiring Kit	



8551300

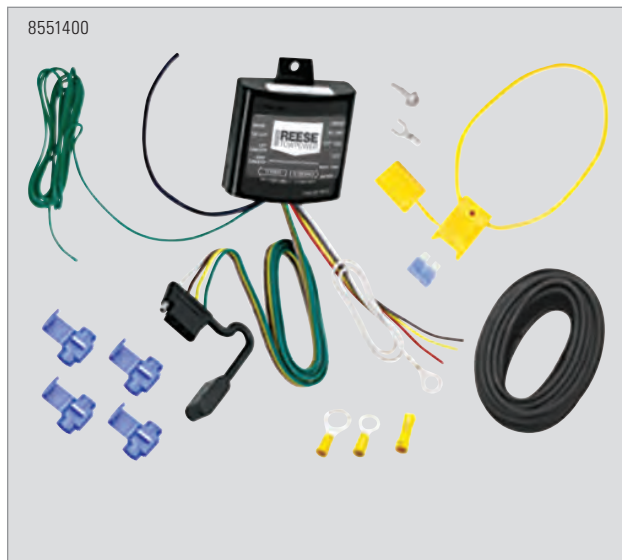

8551400



PROFESSIONAL CONNECTORS

Make it easy to connect your vehicle and trailering systems.



4-Flat
Turn, Stop, Tail, Ground



4-Pin Round
Turn, Stop, Tail, Ground



5-Flat
Turn, Stop, Tail,
Surge Brakes, Ground



6-Pin Round
Turn, Stop, Tail,
Electric Brakes,
Auxiliary, Ground



7-Way Blade
Turn, Stop, Tail,
Electric Brakes,
Auxiliary, 12V, Ground

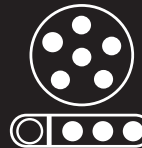

6-Pin/4-Flat



7-Way/4-Flat



7-Pin Round
Turn, Stop, Tail,
Auxiliary, Clearance,
Ground

HOW TO CHOOSE THE RIGHT REESE® TOWPOWER CONNECTOR

GENERAL CLASS	VEHICLE END	TRAILER END	BRACKET	PART NUMBER
All Purpose	7-Way Blade 5-Flat, 4-Flat		Included	551111
Camper/Landscaping		7-Way Blade	N/A	85478
Camper/Landscaping/Class A		7-Way Blade	N/A	8551511
Camper/Landscaping/Class A		7-Way Blade	Included	85475
Camper/Landscaping/Class A		7-Way Blade	85283	8550111
Camper/Landscaping/Class A	7-Way Blade		Included	8536511 - Kit Includes all items needed to install
Camper/Landscaping/Class A		7-Way Blade	N/A	8549100
Farm & Heavy-Duty	6-Pin Round		N/A	8549711
Farm & Heavy-Duty		6-Pin Round	N/A	8549411
Horse/Livestock	6-Pin Round		Included	85476
Horse/Livestock	6-Pin Round	N/A	85477	
Horse/Livestock	6-Pin Round	6-Pin Round	Included	85479 - Set - Includes Vehicle & Trailer Connectors
Horse/Livestock	6-Pin Round, 4-Flat		Included	85342
Horse/Livestock		6-Pin Round	N/A	74129
Horse/Livestock		6-Pin Round	N/A	74130
Horse/Livestock	6-Pin Round	6-Pin Round	Included	74608 - Kit Includes all items needed to install
Light-Duty/Marine	4-Flat		78096	78114
Light-Duty/Marine		4-Flat	78096	78115
Light-Duty/Marine	4-Flat	4-Flat	78096	78117
Light-Duty/Marine	4-Flat	4-Flat	78096	85353 - Set - Includes Vehicle & Trailer Connectors
Light-Duty/Marine		4-Flat	N/A	8550811
Light-Duty/Marine	4-Flat		N/A	8550511
Light-Duty/Marine	7-Way Blade, 4-Flat		Included	74682
Light-Duty/Marine Camper/ Landscaping/Class A	7-Way Blade, 4-Flat		Included	85343
Towed Vehicle Lt-Duty/Class A RV	4-Pin Round	4-Pin Round	74132	74131 - Set - Includes Vehicle & Trailer Connectors
Towed Vehicle Lt-Duty/Class A RV	4-Pin Round		74132	85206
Towed Vehicle Lt-Duty/Class A RV		4-Pin Round	N/A	74613
Towed Vehicle Lt-Duty/Class A RV	4-Pin Round	4-Pin Round	Included	74611 - Kit Includes all items needed to install



4-FLAT CONNECTOR



Trailer Plug

GREEN - Right Turn & Stop
YELLOW - Left Turn & Stop

Vehicle Plug

BROWN - Tail Lights
WHITE - Ground

4-FLAT PROFESSIONAL SERIES INSTA-PLUG CONNECTORS

- No slicing, no stripping, just close cover and screw down
- U.S. Patent # D617,284S

Part Number	Description
78114	Vehicle End with LED Circuit Tester and Dust Cover
78115	Trailer End with LED Circuit Tester and Dust Cover
85353	Kit Contain Both Connectors and Dust Cover, Vehicle End LED Circuit Tester

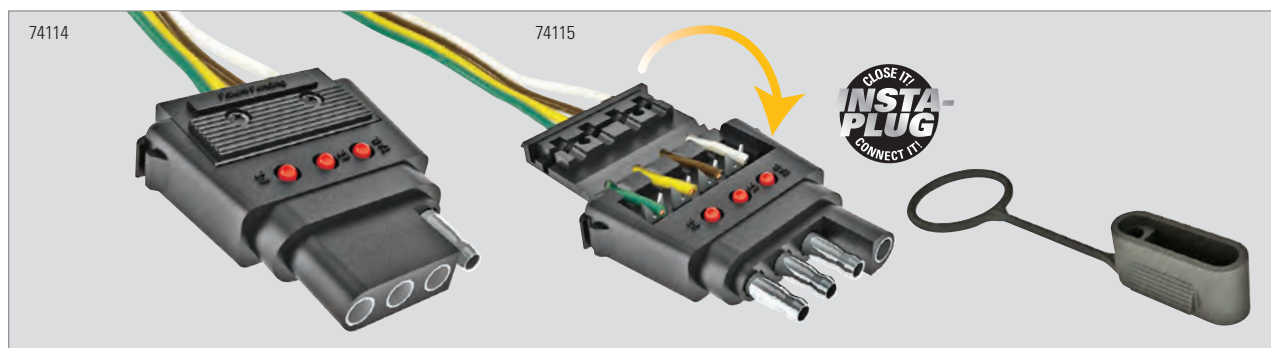

4-FLAT PROFESSIONAL SERIES

- Ergonomic weatherproof design with built-in "STRAIN RELIEF"
- Professional-grade jacketed cable over insulated 18 gauge wires

Part Number	Description	Cable Length
8550811	Y-wishbone Harness, Trailer End	20-ft
8551700	Trailer End	36-in
8550511	Vehicle End	48-in

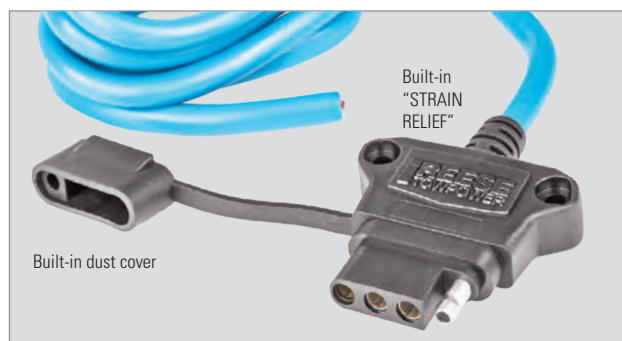

REESE® Towpower's basic 4-Flat Connectors allow for the electrical connection between the towing vehicle and the towed trailer. The simple 4-wire connection activates the trailer's stop, turn and tail lights.

4-FLAT CONNECTOR LOOP VEHICLE & TRAILER ENDS

- Features 18 gauge bonded wire
- Conforms to SAE spec. J1128

Part Number	Description
74687	12-in
8552600	12-in with LED Trailer Side
85307	18-in
74684	24-in
8552500	24-in with LED
78091	36-in with Eyelet
74689	48-in
8552200	48-in with 4 Slice Connectors
118044	48-in with Splices
74125	60-in
118045	60-in with Splices
74636	24-ft

4-FLAT WIRING KIT TRAILER END

- 7.5 Amps / circuit, 18 gauge bonded wire, ground wire runs full length of assembly
- Conforms to SAE spec. J1128

Part Number	Description
74124	12-in
118033	48-in
85275	21-ft, with 4 Splice Connectors

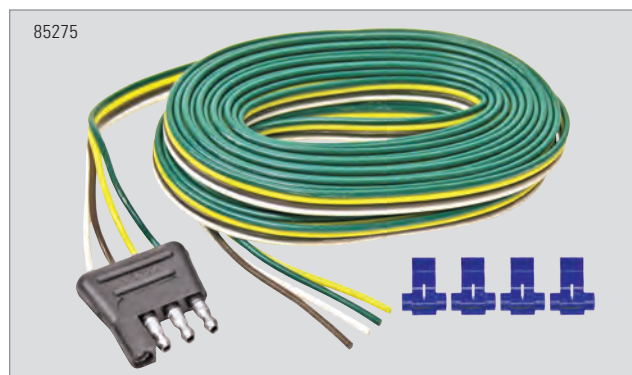
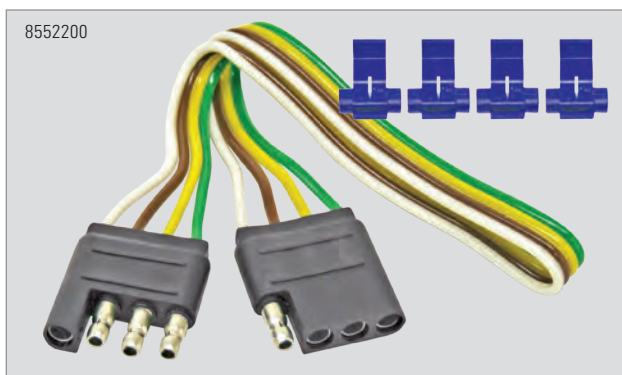
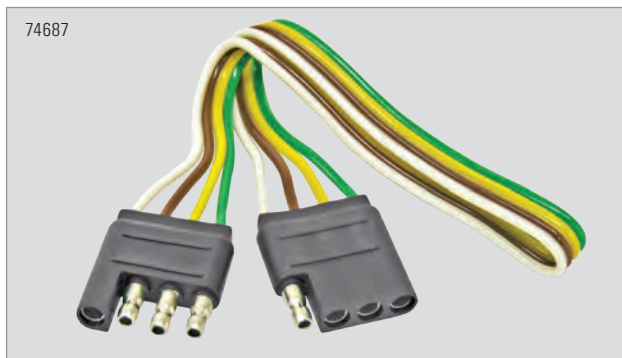

REESE® Towpower's basic 4-Flat Connectors allow for the electrical connection between the towing vehicle and the towed trailer. The simple 4-wire connection activates the trailer's stop, turn and tail lights. The heavy-duty versions offer thicker, more durable plugs and dust covers molded directly onto the connectors.

4-FLAT WIRING KITS VEHICLE END

REESE® Towpower's basic 4-Flat Connectors allow for the electrical connection between the towing vehicle and the towed trailer. The simple 4-wire connection activates the trailer's stop, turn and tail lights. The Heavy-duty versions offer thicker, more durable plugs and dust covers molded directly onto the connectors.

- Features 16 & 18 gauge bonded wire
- Conforms to SAE spec. J1128, 7.5 Amps / circuit

Part Number	Description
85217	12-in with Splice Connectors and Built-in Dust Cover
20250	144-in Heavy-duty with 4 insulated Butt Connectors and Built-in Dust Cover; 16 Gauge
78058	48-in with Splice Connectors with Eyelet
118001	48-in with Splice Connectors
78090	48-in with LED and Built-in Dust Cover
74123	60-in
74051	60-in with Splice Connectors and HD Flasher #552
118002	60-in with Splice Connectors, LED Tester and Built-in Dust Cover
20252	72-in Heavy-duty with Water-tight Shrink Splice Connectors & Circuit Tester; 16 Gauge
85277	4-Flat Loop 18-in with Splice Connectors

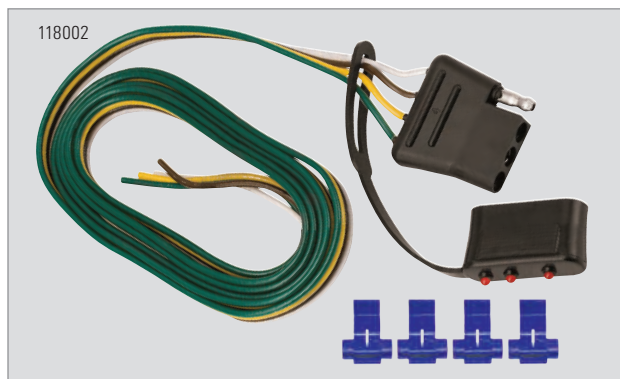

The REESE® Towpower wishbone connectors are designed for boat trailers or any trailers where wires running down both sides of the trailer are preferred. Each of the split wires are bonded together for a cleaner look and easier wiring.

4-FLAT CONNECTOR KIT "Y" WISHBONE TRAILER END

- 18 gauge split harness for running wires down each side of trailer
- Conforms to SAE spec. J1128

Part Number	Description
78082	20-ft with Splice Connectors
74676	25-ft with Splice Connectors
8550811	20-ft Y-wishbone Harness, Trailer End
118192	4-Flat Trailer End Connector, Dual Tail Light Wires, 25-ft Long

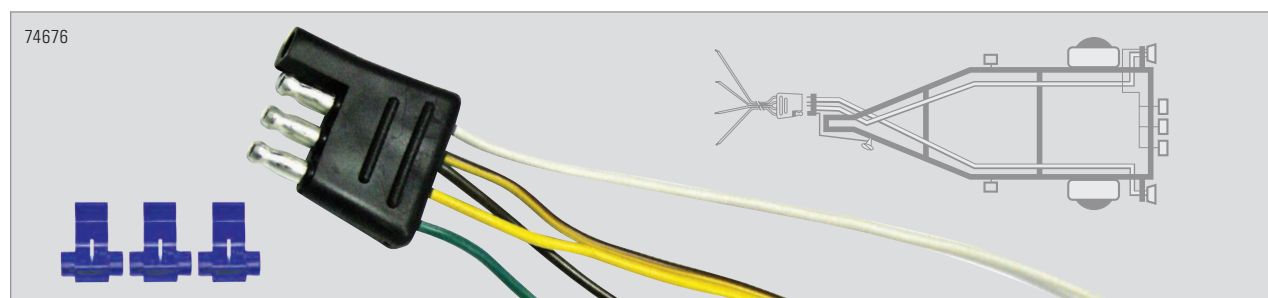

4-FLAT KNOCK-OUT WIRING KIT VEHICLE END

REESE® Towpower knock-out wiring connector is designed to push into a round hole found on some bumpers. This connector provides an easy access for most standard 4-Flat plugs on trailers.

- Mates with most standard 4-Way plugs
- 30-in leads, integrated dust cover

Part Number	Description
85211	4-Way Flat Knock Out Wiring Kit Vehicle End

4-FLAT TO 5-FLAT CONNECTOR KIT

Looking for a quick and fast way to connect your 5-Flat boat trailer to your standard 4-Flat vehicle connector? Try the 4- to 5-Flat connector kit.

Part Number	Description
20136	4-Way Flat to 5-Way Flat Connector Kit



4-PIN ROUND CONNECTORS



4-PIN ROUND CHROME CONNECTORS

REESE® Towpower 4-Pin round style connectors are used heavily on motorhomes when towing a towed vehicle. The rugged die-cast housing designed to withstand harsh treatment and still deliver the electrical connections when needed.

- 4-Pin round-style set
- Features non-corroding brass pins
- Chrome-plated finish, zinc die-cast construction for durability

Part Number	Description
85206	Vehicle End Connector
74613	Trailer End Connector
74131	Vehicle and Trailer End Connector Set



4-PIN ROUND KIT VEHICLE & TRAILER END

- Complete 4-Pin round-style kit
- Features non-corrosive chrome-plated connectors
- Includes 48-in of each wire & 3 wire splices for easy installation

Part Number	Description	Features
74611	4-Pin Round Kit, Vehicle and Trailer End	Simple do-it-yourself instructions in every package

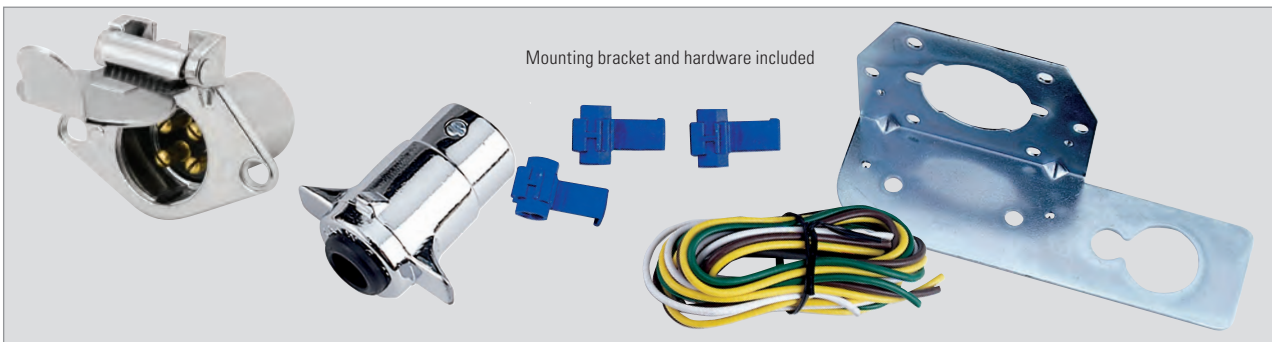

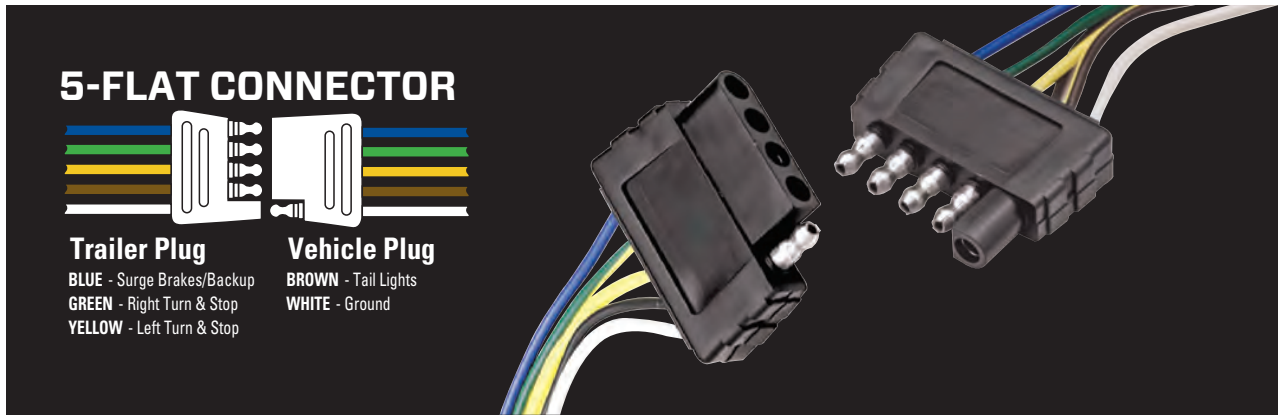

5-FLAT CONNECTOR



Trailer Plug

- BLUE - Surge Brakes/Backup
- GREEN - Right Turn & Stop
- YELLOW - Left Turn & Stop

Vehicle Plug

- BROWN - Tail Lights
- WHITE - Ground

REESE® Towpower Professional Series combination connector offers the most convenient way to wire your vehicle for both a 7-Way connector and a 5-Flat connector. The 5-Flat connector is designed to handle the needs of most boat trailers where the surge brake systems need to be deactivated when backing up the trailer. Most 4-Flat connectors can also be plugged into the 5-Flat connector giving greater flexibility to tow different trailers. The heavy-duty stainless steel spring on the gasket sealed 7-Way connector cap assists in keeping moisture and dust out of the electrical connections when not in use. Removing the snap-on wire protector allows full access to the tin plated terminals for easy wiring.

4-FLAT/5-FLAT/7-WAY BLADE

PROFESSIONAL SERIES MULTI-PORT CONNECTOR VEHICLE END

- Gasketed dust cap
- Glass fiber-reinforced nylon construction, stainless steel spring and pin
- Corrosion-resistant tin-plated terminals
- Wire-protecting strain relief

Part Number	Description
8551111	4-Flat/5-Flat/7-Way Blade Professional Series Multi-Port Connector Vehicle End

5-FLAT CONNECTORS

- Compatible with most standard 4-Flat plugs
- Includes fifth circuit for backup lights, surge brake lockouts or other low-amp 12V options, 7.5 Amps / circuit

Part Number	Description
85213	6-ft Vehicle End
85214	4-ft Trailer end
85215	60-in Loop

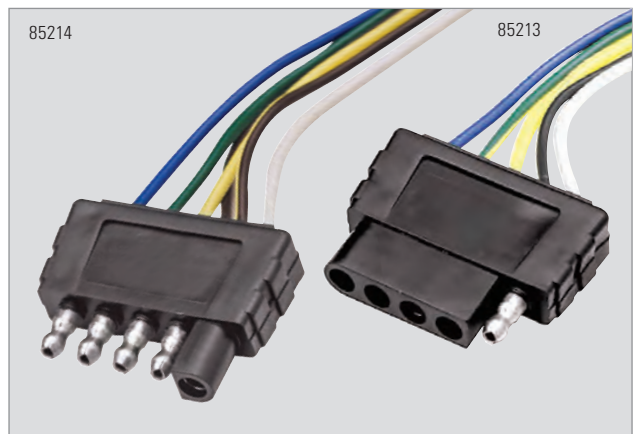

6-PIN CONNECTOR

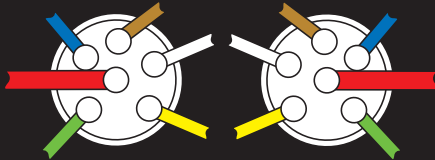

Vehicle Plug

BLUE - Electric Brakes*
GREEN - Right Turn & Stop
YELLOW - Left Turn & Stop

Trailer Plug

BROWN - Tail Lights
WHITE - Ground
RED - Auxiliary*



*** IMPORTANT: Brake and Auxiliary power have two different standards. Identify which way your vehicle/trailer is wired before wiring connectors.**

Get connected and stay connected. Trailers require electrical hook-ups that make towing safer for you and others on the road. Why not install a professional-grade connector and spend more time towing and less time rewiring your trailer in the future. REESE® Towpower offers a full line of professional-grade electrical components that install quickly and are constructed of materials designed to hold up. Every connector comes with simple do-it-yourself instructions.

PROFESSIONAL SERIES 6-PIN ROUND CONNECTORS

- Easy-wire a 6-Pole connector
- Corrosion-resistant tin-plated contacts
- Snap-on strain relief terminal cover allows instant access to terminals
- Durable glass-reinforced nylon construction

Part Number	Description	Position	
85476	6-Pin Round Connector	Vehicle End	Dust cover, mounting bracket and hardware
85477	6-Pin Round Connector	Trailer End	
85479	6-Pin Round Connector Set	Vehicle End Trailer End	LED Circuit Tester, dust cover, mounting bracket and hardware

85476



Mounting bracket and hardware included

85479



Mounting bracket and hardware included

85477



DUAL-PORT ROUND CONNECTOR 4-FLAT TO 4-FLAT 6-PIN ROUND _____

- Dual port connectors convert vehicle 4-Flat to 2-port flexibility (4-Flat & 6-Pin round)
- Provides versatility in going from 4-Flat to 6-Pin round
- Sealed connection increases protection against moisture & corrosion
- Low-profile design provides factory-installed appearance

Part Number	Description
85342	Dual-port Round Connector 4-Flat to 4-Flat 6-Pin Round

6-PIN METAL ROUND CONNECTOR VEHICLE END _____

- Provides versatility in going from 4-Flat to 6-Pin round plug
- Extra wires for adding brake controls, backup or hot wire

Part Number	Description
74183	6-Pin Round Connector Vehicle End

6-PIN METAL ROUND VEHICLE & TRAILER CONNECTORS _____

- Non-corrosive zinc die-cast construction & non-corroding brass pins
- Built-in strain relief keeps wire secured to terminals
- Designed for 12 volt systems when pulling agricultural & livestock trailers

Part Number	Description
74129	6-Pin Metal Round Connector Vehicle End, Requires mounting bracket #74132, (see page 111)
74130	6-Pin Metal Round Connector Trailer End

6-PIN METAL ROUND CONNECTOR KIT VEHICLE & TRAILER ENDS _____

- Complete 6-Pin round-style kit
- Features non-corrosive 6-Pin vehicle connector and Zinc die-cast 6-Pin trailer connector
- Includes 48-in of each wire, 5 wire splices, mounting bracket and hardware

Part Number	Description
74608	6-Pin Metal Round Connector Vehicle End





PROFESSIONAL SERIES 7-WAY BLADE TWIST-IN CONNECTOR VEHICLE END

- Direct replacement for GM twist-in connector
- Heavy-duty stainless steel pin and spring resist rusting
- Gasket-sealed cap to reduce moisture and corrosion
- Durable reinforced nylon construction

Part Number	Description
8551511	Professional Series 7-Way Blade Twist-in Connector, Vehicle End

PROFESSIONAL SERIES 7-WAY BLADE CONNECTOR TRAILER END

- Easy-wire 7-Way blade trailer connector
- Corrosion-resistant tin-plated contacts
- Strain relief protects wires from being pulled out
- Durable glass-reinforced nylon construction

Part Number	Description
85478	Professional Series 7-Way Blade Connector, Trailer End, Patented

PROFESSIONAL SERIES 7-WAY BLADE CONNECTOR FOR OEM-WIRED VEHICLE

- Easily plugs 7-Way connector into factory-equipped car end socket harness on Ford, GM and Nissan vehicles
- Allows remote trailer wiring in pickup beds or other hard-to-access areas
- Durable plastic shell; weathertight, mounting bracket

Part Number	Description
85219	Professional Series 7-Way Blade Connector, for OEM wired vehicle



PROFESSIONAL SERIES 7-WAY BLADE CONNECTOR KIT - VEHICLE END

- Easy-wire 7-Way blade vehicle connector
- Durable glass-reinforced nylon construction with corrosion-resistant tin-plated contacts
- Snap-on strain-relief cover for instant access to terminals

Part Number	Description
85475	Professional Series 7-Way Blade Connector Kit - Vehicle End

PROFESSIONAL SERIES 7-WAY BLADE WIRING KIT - VEHICLE END

- Easily upgrade your vehicle with a professional 7-Way Blade Connector
- Heavy-duty hinged dust cover with weather seal and corrosion-resistant terminals
- Plug directly into OEM socket with quick connect OEM-type pigtail socket

Part Number	Description
8550111	Professional Series 7-Way Blade Wiring Kit - Vehicle End
20147	Professional Series 7-Way Blade Pigtail OEM Replacement Kit with Butt Connectors - Vehicle End

PROFESSIONAL SERIES PRE-WIRED DUAL-PORT 7-WAY BLADE & 4-FLAT CONNECTOR KIT

- Easily plugs 7-Way connector into factory vehicles - Ford, Dodge, GM, Lexus, Nissan and Toyota
- Allows remote trailer wiring in pickup beds or other hard-to-access areas

Part Number	Description
74682	Professional Series Pre-wired Dual Port 7-Way Blade and 4-Way Flat Connector Kit

PROFESSIONAL SERIES 7-WAY BLADE WIRING KIT - VEHICLE END

- Heavy-duty hinged dust cover with weather seal with corrosion-resistant terminals
- Plug directly into OEM socket

Part Number	Description
8536511	Professional Series 7-Way Blade Wiring Kit - Vehicle End

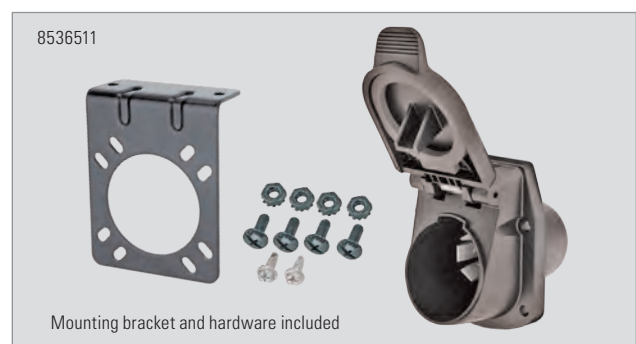
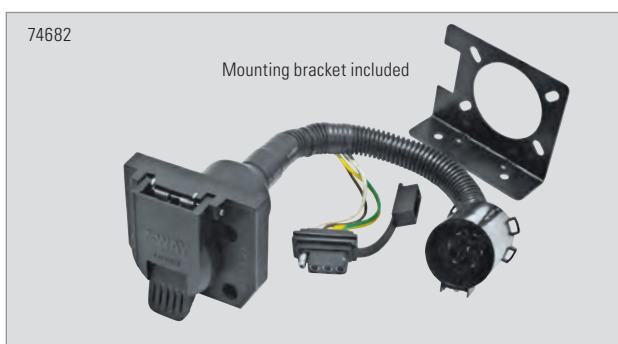
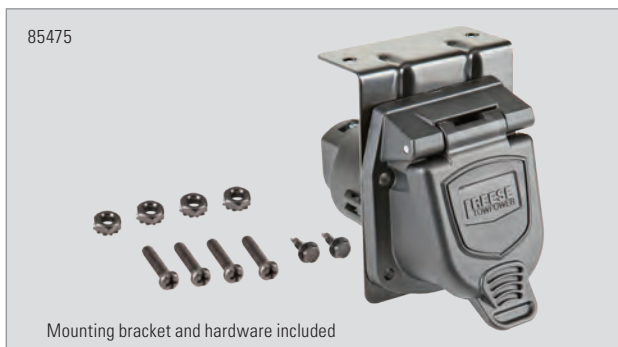

PROFESSIONAL SERIES 7-WAY BLADE RV MOLDED CABLE - TRAILER END

REESE® Towpower Professional Series 7-Way molded trailer connector with heavy-duty 7-Way insulated cable. Molded with encapsulated terminals and wires to form one weather-resistant, non-corrosive assembly. Heavy-duty construction and encapsulated molding.

- Insulated 6-ft cable protects wires from elements
- Easy OEM RV cable replacement

Part Number	Description
8549100	6-ft Cable



PROFESSIONAL SERIES PRE-WIRED OEM 7-WAY BLADE & 4-FLAT CONNECTOR KITS

- Easily plugs 7-Way connector onto factory vehicles (see listing below)
- For quick connection to 4-Flat or 7-Way trailer connectors
- Includes mounting bracket and hardware
- Easily adapts to existing vehicle 7-Way plug
- Ability to tow trailers with different style trailer connectors
- Durable plastic and weathertight seal

Part Number	Vehicle Application
8550900	Chrysler, Dodge, Freightliner, Jeep and Mitsubishi
8551000	Toyota and Lexus

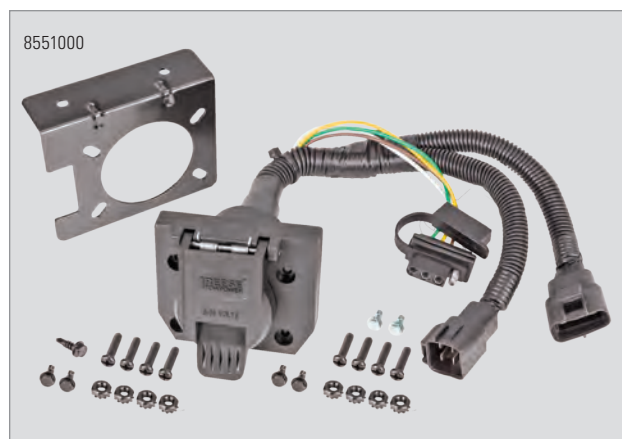
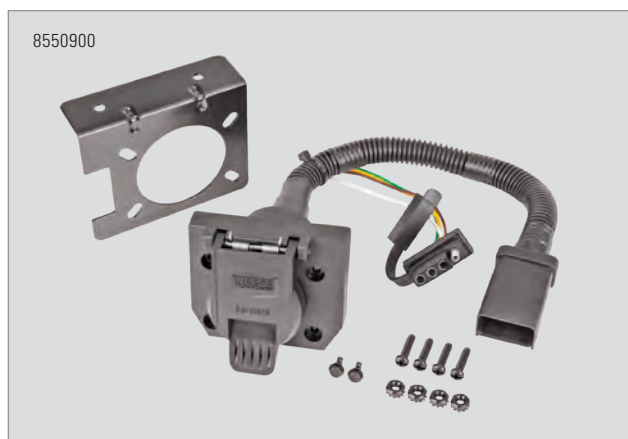

7-WAY BLADE CONNECTORS - VEHICLE & TRAILER END - RV

- Non-corrosive thermoplastic construction with non-corroding brass & tin-plated terminals
- Weatherproof rear grommet and strain relief

Part Number	Usage	Construction
74126	Vehicle end	Plastic
118030	Vehicle end	Metal
74127	Trailer end	Plastic
118031	Trailer end	Metal

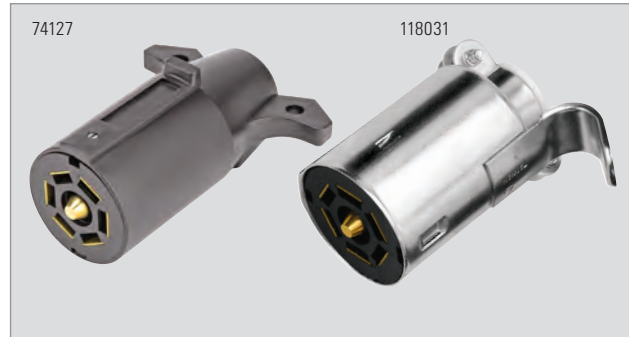

PRE-WIRED 7-WAY BLADE CONNECTOR - VEHICLE END

- Provide versatility in going from 4-Flat to 7-Way standard plug
- Extra wires for adding brake controls, back-up or hot wire

Part Number	Usage	Construction
74184	Vehicle end	Plastic

DUAL-PORT 7-WAY BLADE CONNECTOR & 4-FLAT TO 4-FLAT CONNECTOR

- Simple wiring converts vehicle 4-Flat to 2-port flexibility (4-Flat & 7-Way blade)
- Sealed connection increases protection against moisture and corrosion

Part Number	Description
85343	Dual Port 7-Way Blade Connector & 4-Flat to 4-Flat Connector

7-WAY BLADE CONNECTOR KIT VEHICLE & TRAILER ENDS - RV

- Kit includes: • 7-Way vehicle end and 7-Way trailer end
- Standard 7-Way bracket & wire included

Part Number	Description
85209	7-Way Blade Connector Kit, Vehicle and Trailer Ends - RV





PROFESSIONAL SERIES 7-PIN CONNECTORS WITH CABLE PROTECTOR

The Professional Series REESE® Towpower 7-Pin trailer connectors are the perfect choice for those heavy-duty applications that require a round pin connection such as agriculture, commercial or fleet vehicles. Its heavy-duty die-cast zinc housing protects from corrosive elements that cause corrosion.

- Weathertight design ideal for extreme conditions
- Corrosion-resistant tin-plated terminals
- Strain-relief spring protects cable
- Rated for 40 Amps continuous duty @ 6-28 VDCs
- Interchangeable with all competitive makes

Part Number	Usage	Construction
8549411	Trailer End	Rugged Heavy-duty Zinc Diecast
8549711	Vehicle End	Rugged Heavy-duty Zinc Diecast

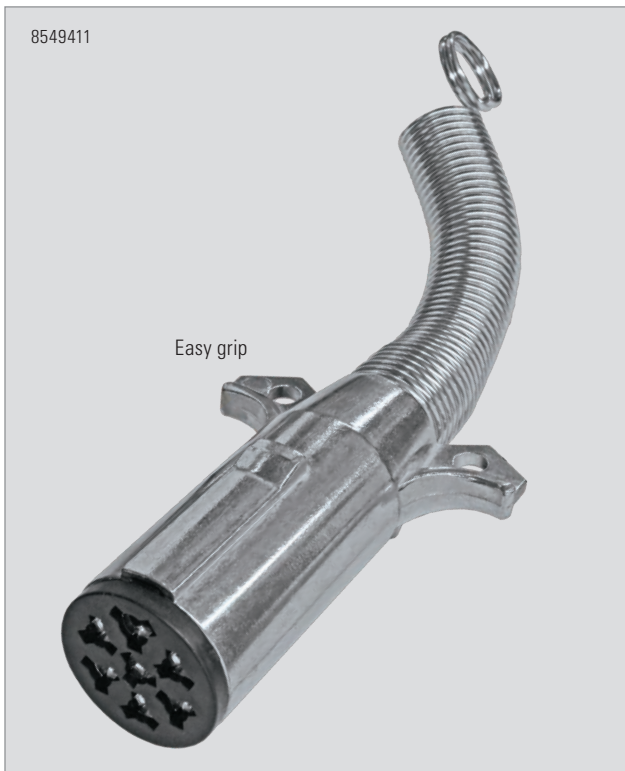

MOUNTING BRACKETS - VEHICLE END

- Mounts electrical connector to the attachment bracket or vehicle
- Easy installation

Part Number	Usage	Construction	Features
85281	4-, 5- and 6-Pin Round Connectors	Metal	Includes screws and nuts
85283	7-Way U.S. Car Connectors	Metal	Includes screws and nuts
74132	4-, 5- and 6-Pin Connectors	Metal, zinc-plated finish	Hitch ball attachment hole
74128	7-Way	Metal, zinc-plated finish	Vertical and horizontal mounting holes for connector
85282	7-Way	Black powder-coat finish	Includes screws and nuts

OPTIONAL "NO-DRILL" ATTACHMENTS

- Attaches to cross tube of hitch without damage to bumpers or fascia trim
- Includes clamp

Part Number	Usage	Construction	Features
118136	6-Pin and 7-Way Connector Brackets	Black powder-coat finish	No drill, 3-in x 3.75-in
118140	4-Flat, 5-Flat, 4-Pin, 5-way Round	Black powder-coat finish	No drill, 3-in x 6.50-in

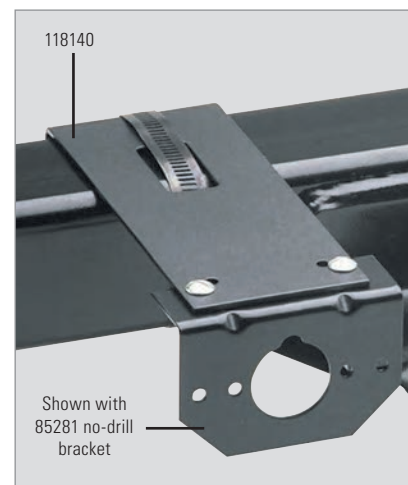
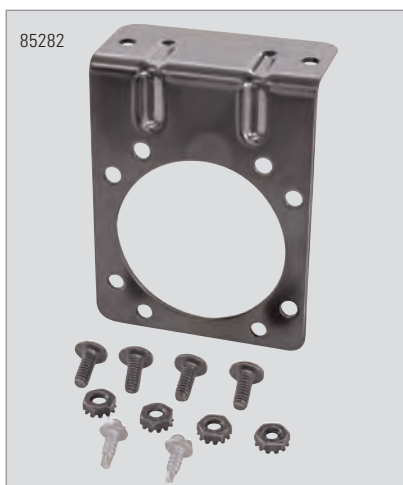

REESE® Towpower offers a wide variety of mounting brackets and kits designed to place connectors on your vehicle. Whether just a bracket or a complete mounting kit, we have the proper bracket to match your requirements.

UNIVERSAL 4-FLAT MOUNTING BRACKET

- Compact high-impact plastic design; corrosion free
- Designed to be attached to the receiver cross tube; does not require any drilling during installation or mounting
- Mounts with included plastic cable ties
- Fits most common 4-Flat connectors
- Can be used with 4-Flat dust cover (#85218), patented

Part Number	Description
78096	Universal 4-Way Flat Mounting Bracket

6-PIN & 7-WAY CONNECTOR MOUNTING BOX

- For hitches with 2-1/2-in square cross tubes
- Securely mounts all standard 6-Pin and 7-Way vehicle end connectors to hitch
- No drilling and no need to disconnect existing wiring
- Corrosion-free high-impact plastic

Part Number	Description
85285	6- And 7-Way Connector Mounting Box

CONNECTOR STORAGE BOX

- Neatly stores 4- and 5-Flat connectors
- Easily installs with cable ties or screws (included)
- Weatherproof plastic construction

Part Number	Description
74641	Connector Storage Box

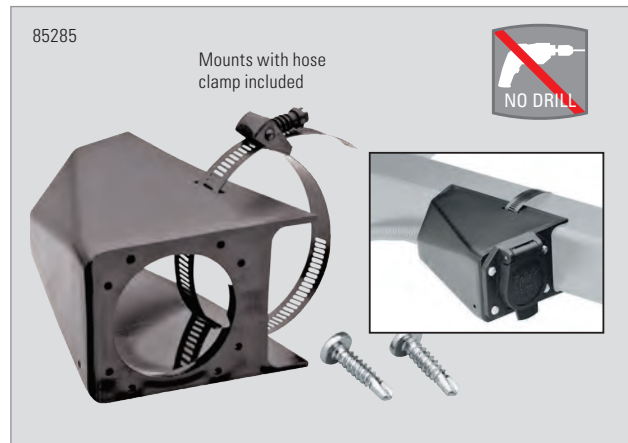
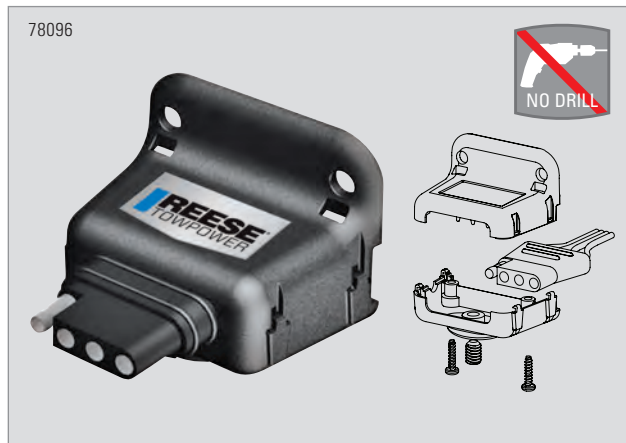

WIRING ACCESSORIES

REESE® Towpower electrical circuit testers are used to check the continuity of the lighting circuits on your vehicle. We offer a 4-Flat tester as well as the traditional alligator-clip style. Use REESE Towpower circuit testers whether installing for the first time or confirming that each circuit is functioning properly. When looking for wiring accessories, look to REESE Towpower for your wire, terminals, splice connectors, dust covers and testers.

Part Number	Description	Features
8692000	Electrical Kit	50 pieces, compact, reclosable case
74633	4-Flat Tester	To test for proper connections. LED indicator, key chain hook
85484	4-Flat Tester	To test for proper connections. LED indicator tethered
85355	Circuit Tester Kit	6 to 36 volt tester, LED indicator, alligator clip
85218	4-Flat Cover	Slips over any standard 4-Flat connector
85489	4 Wire Taps	Fits 16 to 18 gauge wire. No cutting required
85205	4-Flat Bonded Trailer Wire	25-ft 16/18-gauge
78089	4-Flat Bonded Trailer Wire	25-ft 14-gauge
85208	2-Flat Polarized Connector	Add 12V power to accessories and lights, 12-in loop with 2 ends

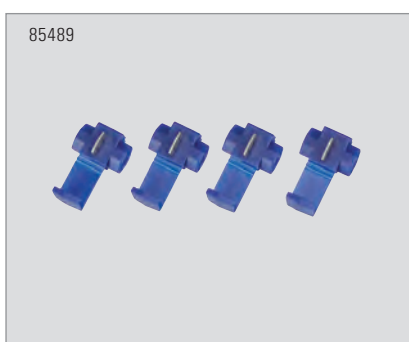
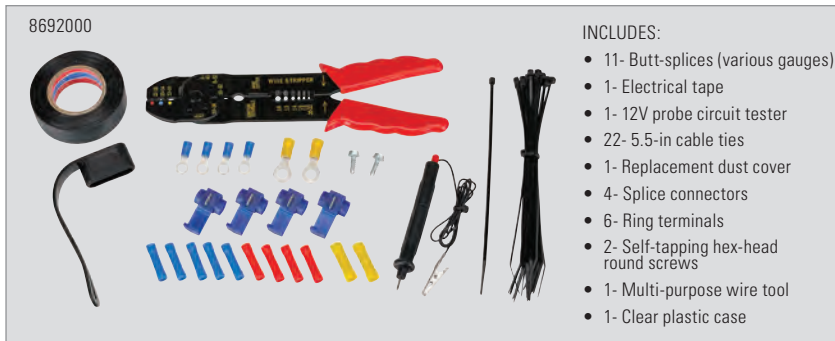



PROFESSIONAL ADAPTERS

Make it easy to adapt your vehicle to your trailer system.



6-Pin Round
Turn, Stop, Tail, Electric Brakes, Auxiliary, Ground



7-Pin Round
Turn, Stop, Tail, Electric Brakes, Auxiliary, Ground



7-Way Blade
Turn, Stop, Tail, Electric Brakes, Auxiliary, 12V, Ground

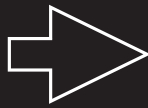

4-Flat
Turn, Stop, Tail, Ground



5-Flat
Turn, Stop, Tail, Surge Brakes, Ground



6-Pin Round
Turn, Stop, Tail, Electric Brakes, Auxiliary, Ground



7-Way Blade
Turn, Stop, Tail, Electric Brakes, Auxiliary, 12V, Ground

HOW TO CHOOSE THE RIGHT REESE® TOWPOWER ADAPTER

GENERAL CLASS	VEHICLE END	TRAILER END	LED TESTER	PART NUMBER
6-Pin to 4-Flat	6-Way Round	4-Way Flat	● ● ●	85357
6-Pin to 4-Flat - FLEX	6-Way Round	4-Way Flat	● ● ●	8536900
7-Way to 4-Flat - FLEX	7-Way Blade	4-Way Flat		8536700
7-Way to 4-Flat	7-Way Blade	4-Way Flat	● ● ●	78116
7-Way to 4-Flat	7-Way Blade	4-Way Flat	● ● ●	78117
7-Way to 4-Flat - FLEX	7-Way Blade	4-Way Flat	● ● ●	8536800
7-Way to 4-Flat - Coiled	7-Way Blade	4-Way Flat		74686
7-Way to 4-Flat - Retractable	7-Way Blade	4-Way Flat		78007
7-Way to 4/5-Flat	7-Way Blade	4-Way Flat 5-way Flat	● ● ●	78118
7-Way to 4/5-Flat - 12 Volt Outlet	7-Way Blade	4-Way Flat 5-way Flat 12 Volt	● ● ●	78119
7-Way to 4/5-Flat - Back-up Alarm	7-Way Blade	4-Way Flat 5-way Flat		74678
7-Way to 4/5-Flat - Coiled	7-Way Blade	4-Way Flat 5-way Flat		85360
7-Way to 6-Pin - Back-up Alarm	7-Way Blade	6-Way Round		74680
7-Way to 6-Pin & 4-Flat	7-Way Blade	6-Way Round 4-Way Flat	● ● ●	85350
7-Way to 7-Way - Back-up Alarm	7-Way Blade	7-Way Blade		74679
7-Way to - 12 Volt Outlet	7-Way Blade	12 Volt 12 Volt	●	74681

PROFESSIONAL SERIES 4-FLAT TO DUAL 4-FLAT ADAPTER

- Compact, solid encapsulated design
- Easy grip removal; tin plated contacts

Part Number	Function	Features
8536600 NEW	4-Flat to Dual 4-Flat Adapter	Great for adding a secondary 4-Flat outlet

PROFESSIONAL SERIES 6-PIN TO 4-FLAT ADAPTER

- Easily adapt 6-Pin connector to basic 4-Flat connector
- Built-in LED circuit tester instantly checks and displays connectivity

Part Number	Function	Features
85357	6-Pin to 4-Flat Adapter	Tethered dust cover

PROFESSIONAL SERIES 7-WAY BLADE TO 4-FLAT ADAPTER WITH LED CIRCUIT TESTER

- Easily adapt OEM 7-Way blade connector to basic 4-Flat connector, U.S. Patent# D620,453S
- Instantly checks electrical circuit for connectivity
- Displays connectivity using high-visibility LEDs

Part Number	Function	Features
78116	7-Way Blade to 4-Flat Adapter	Built-in snap-close dust cover included

PROFESSIONAL SERIES 7-WAY BLADE TO 4-FLAT ADAPTER W/TOW-GLO

- Easily adapt OEM 7-Way connector to basic 4-Flat connector, U.S. Patent# D620,452S
- Glows RED when tail light circuit is activated assisting on seeing connection at night time
- Attached dust cover included to keep terminals clean when not towing a trailer

Part Number	Function	Features
78117	7-Way Blade to 4-Flat Adapter	Tow-Glo



PROFESSIONAL SERIES 7-WAY BLADE TO 4/5-FLAT ADAPTER WITH LED CIRCUIT TESTER

- Easily adapt OEM 7-Way blade connector to either 4-Flat or a 5-Flat connector; U.S. Patent# D620,453S
- Instantly checks electrical circuit for connectivity
- Displays connectivity using high-visibility LEDs

Part Number	Function	Features
78118	7-Way To 4/5-Flat Adapter	Attached dust cover

PROFESSIONAL SERIES 7-WAY BLADE TO 6-PIN OR 4-FLAT WITH LED CIRCUIT TESTER

- Easily adapt OEM 7-Way connector to either 6-Pin or a 4-Flat connector, patent pending.
- 6-Pin round connector is switchable to meet desired wiring requirement
- Instantly checks basic trailer electrical circuit for connectivity & displays connectivity using high-visibility LEDs

Part Number	Function	Features
85350	7-Way Blade to 6-Pin or 4-Flat Adapter	Built-in snap close dust cover and 2 mode switch are included

PROFESSIONAL SERIES 7-WAY BLADE TO 4- OR 5-FLAT WITH 12V POWER OUTLET

- Easily adapt OEM 7-Way connector to 4-Flat or a 5-Flat connector, built-in 12V power outlet; patented
- Displays connectivity using high-visibility LEDs

Part Number	Function	Features
78119	7-Way Blade To 4- or 5-Flat Adapter	12V power outlet and built-in snap-close dust cover included



PROFESSIONAL SERIES COILED ADAPTERS

- Stretches with movement of vehicle
- Heavy-duty abrasion-resistant coiled cable
- Durable molded design
- Tin-plated terminals

Part Number	Function
74686	7-Way Blade to 4-Flat, 16 Gauge Wire, 6-ft full extension
85360	7-Way Blade to 5-Flat, 16 Gauge Wire, 5-ft full extension

PROFESSIONAL SERIES RETRACTABLE 7-WAY BLADE TO 4-WAY FLAT ADAPTER

- Converts 7-Way connector to standard 4-Flat connector
- Adjust length up to 42-in, no wires dragging on the ground
- Retractable 4-Flat car end plug connects with standard 4-Flat trailer end plug
- Protects and stores wire when not in use
- Patented

Part Number	Function
78007	7-Way Blade to 4-Flat, 42-in full extension



FLEX ADAPTERS

- Easily adapt OEM connector to basic connector
- Heavy-duty
- Tethered dust cover
- Corrosion-resistant terminals

Part Number	Function	Features
8536700	7-Way to 4-Flat Adapter	With flex cable
8536800	7-Way to 4-Flat Adapter	With LED tester
118710	7-Way to 4-Flat Adapter	European style, dust cover
8536900	6-Pin to 4-Flat Adapter	With LED tester
8536200	6-Pin to 7-Blade Adapter	Center-pin brake, flexible loom protects wires



EASY-GRIP ADAPTERS

- Easily adapt OEM connector to basic connector
- Corrosion-resistant terminals

Part Number	Function	Features
74607	7-Way to 4-Flat Adapter	
74685	7-Way to 4-Flat Adapter	With separate LED 4-Flat tester
20141	7-Way to 5-Flat Adapter	With LED lamp out by-pass
118601	4-Flat Knockout Adapter	With LED lamp out by-pass for European cars
85212	7-Way to 4/5-Flat Adapter	For boat and utility trailers with certain hydraulic surge brakes and/or back-up lights
85216	7-Way to 6-Pin Adapter	Center pin - AUXILIARY



EASY-GRIP ADAPTERS

- Easily adapt OEM connector to basic connector
- Compact
- Corrosion-resistant terminals

Part Number	Function	Features
74645	7-Way to 6-Pin Adapter	Center pin - BRAKE
85232	7-Pin to 4-Flat Adapter	Rated for 7.5 amps per circuit
74605	6-Pin to 4-Flat Adapter	Rated for 7.5 amps per circuit
74606	4-Pin to 4-Flat Adapter	Rated for 7.5 amps per circuit



PROFESSIONAL SERIES BACK-UP ALARM - 80dB

The REESE® Towpower 7-Way backup alarm adapter allows for an instant addition of a backup alarm and lets you still use the 7-Way connector to pull a trailer. Added safety is simple and quick with a REESE Towpower Back-up Alarm. Add one to your current 7-Way connection for an instant 80 decibel alarm.

- Pass-through design with built-in back-up alarm
- Warns when vehicle is in reverse
- Adapts trailer to vehicle
- Easy to store when not in use

Part Number	Description	Features
74679	7-Way to 7-Way Blade Adapter with Back-up Alarm	Built-in 80 dB backup alarm

DUAL PORT 12-VOLT POWER ADAPTER

- Instant dual 12-volt power
- Dual ports - use 2 accessories at the same time
- Quick installation

Part Number	Description	Features
74681	Dual Port 12 Volt Power Adapter	LED indicates when 12 volt power present

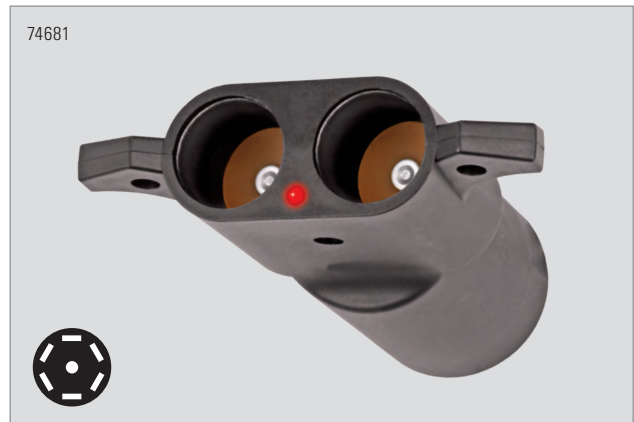

SAFETY COMES FIRST





Decreased stopping distance with a smooth response. Solid-state electronic systems with preassembled wiring harnesses provide a simple hook-up and disconnect.

BRAKE CONTROLS



HOW TO CHOOSE THE RIGHT BRAKE CONTROL 124

TIMED BRAKE CONTROLS 125

PROPORTIONAL BRAKE CONTROLS 126

WIRELESS BRAKING SYSTEM 127

BRAKE CONTROL HARNESSES 128-132

BREAKAWAY SYSTEMS 133

SAFETY FIRST!

REESE TOWPOWER® BRAKE CONTROLS are 100% "solid-state electronic." Models are designed for use with one- to four-axle systems and meet all National Highway Traffic Safety Administration and Department of Transportation (NHTSA/DOT) regulations regarding tow vehicle/trailer stoplight activation.

The perfect choice for today's towing vehicles.



How to Choose the Right REESE® Towpower Brake Control

	PROPORTIONAL			TIMED			
	CompactIQ™	BRAKE-EVN™	Voyager®	BRAKEMAN® IV	Pilot®	POD®	BRAKEMAN®
Part Number	8508700	8508211	78081	8507111	74378	7437711	74642
Braking Axles on Trailer	1-3	1-4	1-4	2-8	1-3	1-2	1-2
PROPORTIONAL Stopping-to-Vehicle Deceleration Rate	✓	✓	✓				
Plug & Play Installation	✓	✓	✓	✓	✓	✓	
Circuit & Grounding Protection	✓	✓	✓	✓	✓	✓	✓
Digital Display Indicator - Shows Power Output to Brake		✓		✓	✓		
"Boost" Feature Ability for Towing Both Light & Heavy Trailers	✓	✓					
Brake Failure Notification	✓	✓	✓	✓	✓	✓	
Diagnostics	✓	✓		✓	✓		
Reverse Battery Protection	✓	✓		✓			
Trailer Continuity Indicator	✓	✓	✓	✓	✓	✓	
Functions on Low Voltage Brake Signal (2013 - current RAM)	✓	✓		✓			
Flexible Behind-Dash Mounting	✓						
Peel-and-Stick Installation	✓						
Warranty Lifetime	Limited 3 Years	Limited 5 Years	Limited Lifetime	Limited Lifetime	Limited 3 Years	Limited Lifetime	Limited

BRAKEMAN™ TIMED COMPACT BRAKE CONTROL

- Red indicator light
- No moving parts; no leveling required
- Completely compatible with anti-lock braking systems

Part Number	Description	Axles	Warranty
74642	Brakeman™ Timed Compact Brake Control	1 to 2	3-year limited

POD® TIMED BRAKE CONTROL

- Power-on LED for a positive tow vehicle-to-trailer connection; solid-state electronics
- Rugged, easy-mount chassis
- Smooth and simple installation; mounting hardware included

Part Number	Description	Axles	Warranty
74377	POD® Timed Brake Control	1 to 2	5-year limited

PILOT® TIMED DIGITAL BRAKE CONTROL

Large easy-to-read dual digital display shows: Properly wired control - Voltage output to brakes - Connection to trailer

- Dark smoke lens ideal for direct light applications
- Protection against short circuit and loss of ground

Part Number	Description	Axles	Warranty
74378	Pilot® Timed Digital Brake Control	1 to 3	Limited lifetime

BRAKEMAN™ IV COMPACT BRAKE CONTROL

- 100% solid-state, small compact design
- Digital Display: "Output" setting "Sync" setting brake overload or short connection
- No leveling required; mounts in any direction

Part Number	Description	Axles	Warranty
8507111	Brakeman™ IV Compact Brake Control	2, 4, 6 & 8	Limited lifetime



BRAKE CONTROLS

PROPORTIONAL BRAKE CONTROLS

BRAKE-EVN™ PROPORTIONAL BRAKE CONTROL

- “Boost” feature gives you more initial trailer braking when towing heavier trailers
- Totally proportional - even in reverse
- Self-leveling - no adjustment needed
- Diagnostic LED display, digital readout for a secure electrical connection
- Snap-in dash mounting clip & hardware included

Part Number	Description	Axles	Warranty
85082	Brake-EVN™ Proportional Brake Control	up to 4	Limited lifetime

VOYAGER® PROPORTIONAL BRAKE CONTROL

- Broad control range makes setting quick & easy
- As braking power is applied, the LED changes color gradually from green (completed circuit) to red to indicate relative braking power
- Advanced electronics minimize false braking for smoother ride

Part Number	Description	Axles	Warranty
78081	Voyager® Proportional Brake Control	up to 4	5-year limited

COMPACT IQ™ PROPORTIONAL BRAKE CONTROL

- Unique remote “boost” feature for greater braking control on heavier trailers
- Flexible mounting options
- LED indicator shows status of braking system

Part Number	Description	Axles	Warranty
8508700	Compact IQ™ Proportional Brake Control	up to 4	3-year limited



Safety First! PROPORTIONAL CONTROLS offer a smooth braking response to almost any stop. A sensing device determines the tow vehicle's rate of deceleration and then applies the trailer brakes to match.



Decreased stopping distance!
Trailer & vehicle brake at the same rate!

ECHELON-RF PROPORTIONAL WIRELESS TRAILER-MOUNTED BRAKING SYSTEM

Wireless communication between the remote hand unit and trailer power module eliminates the need for under-dash wiring. No drilling, brackets or clips required!

- Easy-to-see LED display for trailer brake voltage, power output and diagnostics
- Diagnostic features include proper connection, shorted magnet condition
- Easy-to-read remote hand control; includes the “boost” system to allow for different levels of customized braking
- Unit provides continual diagnostic scanning with a visual warning in the hand display if a fault condition occurs
- Hand unit plugs into any standard 12-volt power accessory adapter. Diagnostic LED display, digital readout for a secure electrical connection
- Snap-in dash mounting clip & hardware included

Part Number	Description	Axles	Warranty
85065	Echelon-RF Proportional Wireless Trailer Mounted Braking System	up to 3	Limited lifetime

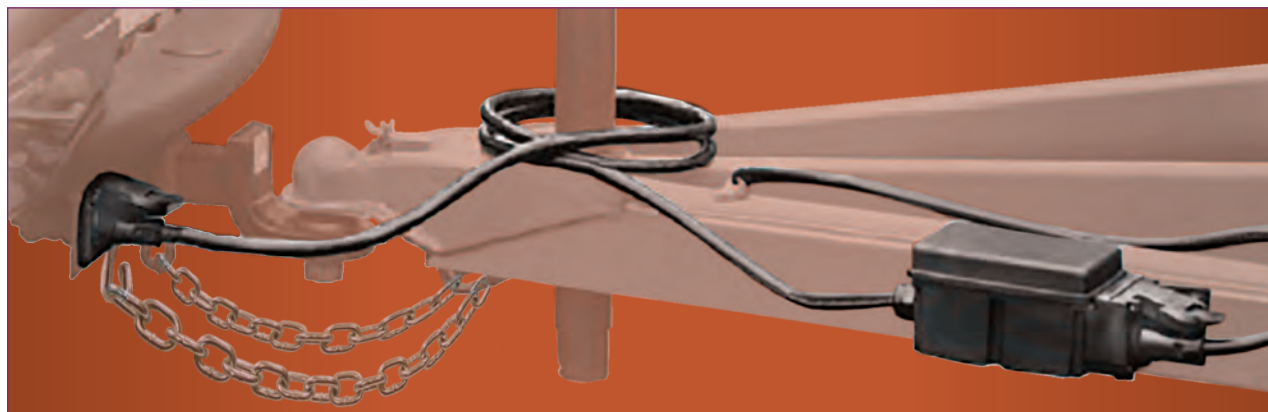

BRAKE CONTROLS

BRAKE CONTROL HARNESSES

Many of today's vehicles are pre-wired with a brake control connector. A standard brake control wiring harness is an easy way to install a brake controller into the factory's under-dash connector. REESE® Towpower brake control harnesses are designed to provide simple plug-in installation of your vehicle to the REESE Towpower brake control.

- Fit a wide range of vehicles
- Quick and easy plug-in style

Part Number	Applications
74437	Ford, Land Rover, Lincoln
74439	Chrysler, Dodge
74438	GM
85340	GM, Hummer
8506911	Universal, compatible with REESE® and TEKONSHA® brake controls

BRAKE CONTROLS

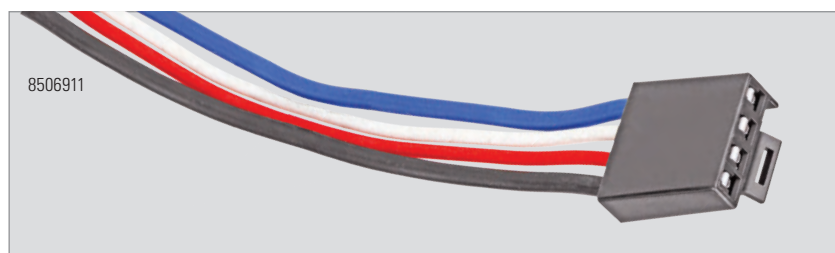
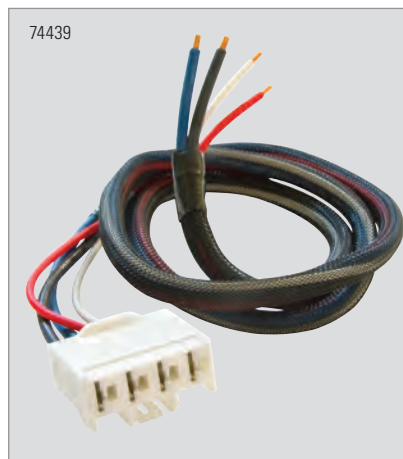

BRAKE CONTROL INSTALLATION KIT

Part Number	Description
85060	Brake Control Installation Kit

Kit Includes:

- 25-Ft 12 gauge blue wire
- 15-ft 12 gauge black wire
- 15-Ft 12 gauge white wire
- 3-ft 16 gauge red wire
- 20 6-in zip wire ties
- 3 Yellow butt splices
- 1 Blue butt splices
- 1 Splice connector, blue
- 1 Ring connector, yellow
- 1 20 Amp fuse
- 1 Fuse holder

BRAKE CONTROL O.E.M. WIRING HARNESS

Customized for an instant fit! O.E.M.-style wire harness for models equipped with trailer tow package. Quick and easy plug-in style connections reduce possible short circuits and cross wiring of brake controls.

Part Number	Applications
78050	GM/Hummer
78051	Chrysler/Dodge
78052	GM
78053	Buick/GM
78054	Ford/Land Rover
78055	Lexus/Toyota
78056	Infinity/Nissan
78057	Honda
78059	Ford Super Duty
78060	Ford
78124	Ford F-150

Part Number	Applications
85064	Kia
85066	Dodge/RAM
85067	Dodge & Jeep
850700	GM
8507400	JEEP
8507500	RAM
8507600	RAM
8507700	RAM
8507800	Toyota
85083	RAM Pickup
8508400	Toyota
8509000	Freightliner

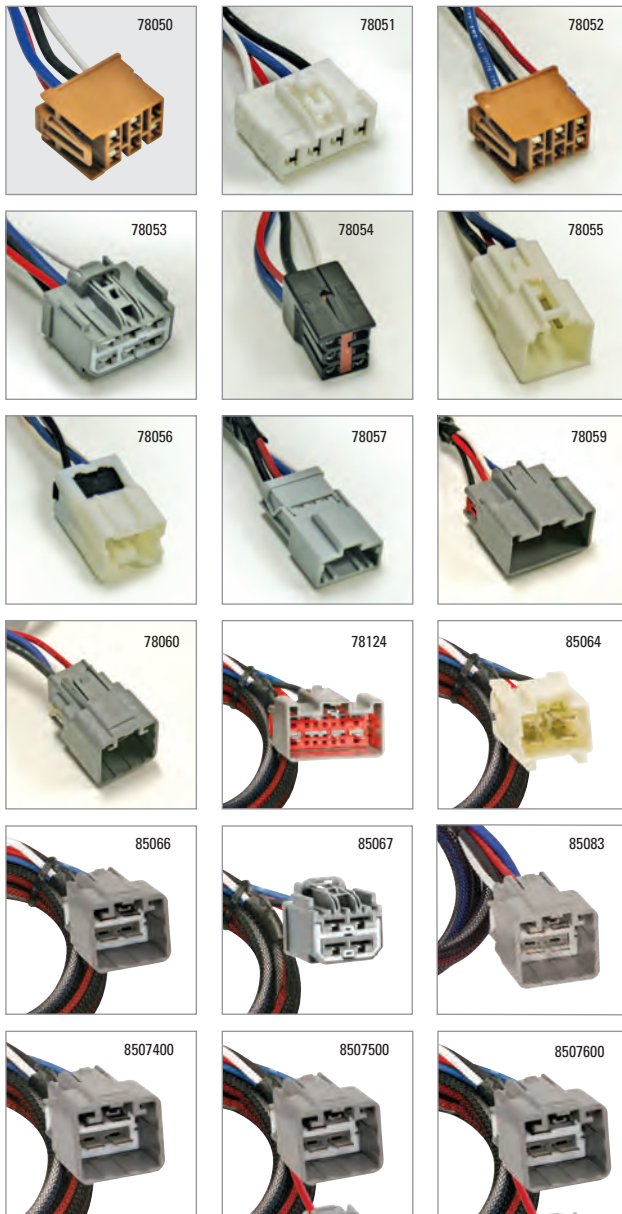

BRAKE CONTROLS

O.E.M. BRAKE CONTROL HARNESSES APPLICATION GUIDE

BUICK

Make/Model	Year	Position	1 Plug	2 Plug
Enclave w/Factory 7-way	08-17	BP1	-	78053

CADILLAC

Make/Model	Year	Position	1 Plug	2 Plug
Escalade	15-16	BP2	-	8507000
Escalade All, Inc. EXT & ESV	03-06	BP1	85340	78050
Escalade All, Inc. EXT	02	BP1	74438	78052

CHEVROLET

Make/Model	Year	Position	1 Plug	2 Plug
Avalanche 1500, 2500	03-06	BP1	85340	78050
Avalanche 1500, 2500	02	BP1	74438	78052
Pickup, Silverado 1500	15-18	BP1	-	8507000
Pickup, Silverado 2500 HD	15-18	BP1	-	8507000
Pickup, Silverado 3500 HD	15-18	BP1	-	8507000
Pickup, Silverado Except Classic	07-13	BP1	8506911	-
Pickup, Silverado All Styles, Classic Only	07	BP1	85340	78050
Pickup, Silverado	03-06	BP1	85340	78050
Pickup, Silverado	99-02	BP1	74438	78052
Suburban 1500, 2500	15-17	BP1	-	8507000
Suburban 1500, 2500	07-13	BP1	8506911	-
Suburban 1500, 2500	03-06	BP1	85340	78050
Suburban w/Amber Turn Signals, All Styles	00-02	BP1	74438	78052
Tahoe	15-16	BP1	-	8507000
Tahoe	03-06	BP1	85340	78050
Tahoe w/Amber Turn Signals	00-02	BP1	74438	78052
Traverse w/Factory 7-way	09-17	BP1	-	78053

CHRYSLER

Make/Model	Year	Position	1 Plug	2 Plug
Aspen w/Factory Tow Package	07-09	BP2	74439	78051

DODGE

Make/Model	Year	Position	1 Plug	2 Plug
Dakota Pickup w/Factory Tow Package	97-10	BP2	74439	78051
Durango w/Factory Tow Package	11-18	BP2	-	85067
Durango w/Factory Tow Package	98-09	BP2	74439	78051
Pickup, Ram, Full Size 1500 Only	10	BP1	-	85066
Pickup, Ram, Full Size 2500 HD Only	10	BP1	-	85066
Pickup, Ram, Full Size 3500 HD Only	10	BP1	-	85066
Pickup, Ram, Full Size 1500 Only	95-09	BP2	74439	78051
Pickup, Ram, Full Size 2500 Only	95-09	BP2	74439	78051
Pickup, Ram, Full Size 3500 Only	95-09	BP2	74439	78051

FORD

Make/Model	Year	Position	1 Plug	2 Plug
Bronco Full Size	94-96	BP3	74437	78054
E-150 Econoline Van Full Size	09-14	BP7	-	78059
E-150 Econoline Van Full Size	92-08	BP3	74437	78054
E-250 Econoline Van Full Size	09-14	BP7	-	78059

FORD continued

Make/Model	Year	Position	1 Plug	2 Plug
E-250 Econoline Van Full Size	92-08	BP3	74437	78054
E-350 Econoline Van Full Size	09-14	BP7	-	78059
E-350 Econoline Van RV Cutaway w/Factory Tow Prep Plug	09-11	BP7	-	78059
E-350 Econoline Van Full Size	92-08	BP3	74437	78054
E-350 Econoline Van RV Cutaway w/Factory Tow Prep Plug	92-08	BP3	74437	78054
E-450 Econoline Van RV Cutaway w/Factory Tow Prep Plug	09-11	BP7	-	78059
E-450 Econoline Super Duty, RV Cutaway w/Factory Tow Prep Plug	03-08	BP3	74437	78054
E-450 Econoline Van RV Cutaway w/Factory Tow Prep Plug	92-08	BP3	74437	78054
E-450 Econoline Super Duty Stripped RV Cutaway w/Factory Tow Prep Plug	00-02	BP3	74437	78054
Excursion	00-05	BP3	74437	78054
Expedition	13-14	BP5	-	78059
Expedition	15-17	BP3	-	78124
Expedition	97-12	BP3	74437	78054
Explorer Sport Trac w/Factory Tow Package	07-10	BP6	74437	78054
Explorer w/Factory Tow Package	02-16	BP6	74437	78054
F-150 Flareside New Body Style	09-18	BP3	-	78124
F-150 Styleside New Body Style	09-18	BP3	-	78124
F-150 SuperCrew New Body Style, w/5.5 & 6.5 ft. Beds	09-18	BP3	-	78124
F-150 Flareside New Body Style	04-08	BP3	74437	78054
F-150 Styleside New Body Style	04-08	BP3	74437	78054
F-150	94-08	BP3	74437	78054
F-150 SuperCrew New Body Style	04-08	BP3	74437	78054
F-150 Heritage	04	BP3	74437	78054
F-150 Light Duty Heritage Flareside Old Body Style	04	BP3	74437	78054
F-150 Light Duty Heritage Styleside Old Body Style	04	BP3	74437	78054
F-150 Light Duty Flareside	97-03	BP3	74437	78054
F-150 Light Duty Styleside	97-03	BP3	74437	78054
F-150 SuperCrew	97-03	BP3	74437	78054
F-250 Super Duty	08-16	BP3	-	78059
F-250 Super Duty	17-18	BP3	-	78124
F-250 Super Duty	05-07	BP5	-	78060
F-250 Super Duty	99-04	BP3	74437	78054
F-250 Light Duty Styleside	97-99	BP3	74437	78054
F-250 Heavy Duty	97	BP3	74437	78054
F-250	94-96	BP3	74437	78054
F-350 Super Duty	08-16	BP3	-	78059
F-350 Super Duty	17-18	BP3	-	78124
F-350 Super Duty Cab & Chassis	08-16	BP3	-	78059
F-350 Super Duty	05-07	BP5	-	78060
F-350 Super Duty Cab & Chassis	05-07	BP5	-	78060
F-350 Super Duty	99-04	BP3	74437	78054
F-350 Heavy Duty	97	BP3	74437	78054

FORD continued					
Make/Model	Year	Position	1 Plug	2 Plug	
F-350	94-96	BP3	74437	78054	
F-450 Super Duty	08-16	BP3	-	78059	
F-450 Super Duty	17-18	BP3	-	78124	
F-450 Super Duty Cab & Chassis	08-16	BP3	-	78059	
F-450 Super Duty Cab & Chassis	05-07	BP5	-	78060	
F-450 Super Duty Cab & Chassis	99-04	BP3	74437	78054	
F-550 Super Duty Cab & Chassis	08-16	BP3	-	78059	
F-550 Super Duty	17-18	BP3	-	78124	
F-550 Super Duty Cab & Chassis	05-07	BP5	-	78060	
F-550 Super Duty Cab & Chassis	99-04	BP3	74437	78054	
Flex w/Factory Tow Package	14-16		-	78059	
Flex w/Factory Tow Package	12-13	BP2	-	78124	
Flex w/Factory Tow Package	09-11	BP2	74437	78054	
Windstar w/Factory Tow Package	95-03	BP3	74437	78054	

FREIGHTLINER					
Make/Model	Year	Position	1 Plug	2 Plug	
SL & XC	04-16	BP2	-	8509000	

GMC					
Make/Model	Year	Position	1 Plug	2 Plug	
Acadia w/Factory 7-Way	07-17	BP1	-	78053	
Pickup, Sierra 1500	14-18	BP1	-	8507000	
Pickup, Sierra 2500 HD	15-18	BP1	-	8507000	
Pickup, Sierra 3500 HD	15-18	BP1	-	8507000	
Pickup, Sierra Except Classic	07-13	BP1	8506911	-	
Pickup, Sierra Classic Only	07	BP1	85340	78050	
Pickup, Sierra	03-06	BP1	85340	78050	
Pickup, Sierra	99-02	BP1	74438	78052	
Yukon	15-16	BP1	-	8507000	
Yukon	07-13	BP1	8506911	-	
Yukon	03-06	BP1	85340	78050	
Yukon XL 1500	03-06	BP1	85340	78050	
Yukon XL 1500, 2500 Denali	03-06	BP1	85340	78050	
Yukon Denali	03-06	BP1	85340	78050	
Yukon XL	00-02	BP1	74438	78052	
Yukon w/Amber Turn Signals	00-02	BP1	74438	78052	
Yukon XL Denali	01-02	BP1	74438	78052	
Yukon Denali w/Amber Turn Signals	01-02	BP1	74438	78052	

HONDA					
Make/Model	Year	Position	1 Plug	2 Plug	
Pilot w/Factory Tow Package	09-17	BP1	-	78057	
Ridgeline w/Factory Tow Package	06-14	BP1	-	78057	

HUMMER					
Make/Model	Year	Position	1 Plug	2 Plug	
H2	03-07	BP1	85340	78050	
H2 SUT	05-07	BP1	85340	78050	

JEEP					
Make/Model	Year	Position	1 Plug	2 Plug	
Jeep, Cherokee	14-16	BP1	-	8507400	
Jeep, Grand Cherokee w/Factory Tow Package	11-18	BP4	-	85067	

INFINITI					
Make/Model	Year	Position	1 Plug	2 Plug	
QX56	04-13	BP1	-	78056	

KIA					
Make/Model	Year	Position	1 Plug	2 Plug	
Borrego	09-11	BP4	-	85064	

LAND ROVER					
Make/Model	Year	Position	1 Plug	2 Plug	
Land Rover, LR3	05-09	BP3	74437	78054	
Land Rover, LR4	10-15	BP3	74437	78054	
Land Rover, Range Rover Evoque	12-16	BP3	74437	78054	
Land Rover, Range Rover	05-16	BP3	74437	78054	

LEXUS					
Make/Model	Year	Position	1 Plug	2 Plug	
GX 460	10-15	BP4	-	78055	
GX 470	03-09	BP3	-	78055	
LX 470	03-07	BP3	-	78055	
LX 570	08-11	BP3	-	78055	
LX 570	13-15	BP3	-	78055	

LINCOLN					
Make/Model	Year	Position	1 Plug	2 Plug	
Aviator w/Factory Tow Package	03-05	BP3	-	78054	
Lincoln MKT w/Factory Tow Package	10-11	BP1	74437	78054	
Lincoln, Mark LT	06-08	BP3	74437	78054	
MKT w/Factory Tow Package	12-15	BP1	-	78124	
Navigator	13-14	BP3	-	78059	
Navigator	15-17	BP3	-	78124	
Navigator	98-12	BP3	74437	78054	

MERCURY					
Make/Model	Year	Position	1 Plug	2 Plug	
Mercury, Mountaineer w/Factory Tow Package	02-10	BP6	74437	78054	

NISSAN					
Make/Model	Year	Position	1 Plug	2 Plug	
Armada	04-15	BP1	-	78056	
Frontier Pickup	05-15	BP3	-	78056	
Pathfinder	05-17	BP3	-	78056	
NV1500, NV2500, NV3500	13-15	BP1	-	78056	
Pathfinder Armada LE, SE	04	BP3	-	78056	
Xterra w/Factory Tow Package	05-15	BP3	-	78056	
Titan Pickup	04-16	BP1	-	78056	

O.E.M. BRAKE CONTROL HARNESSSES APPLICATION GUIDE

RAM					
Make/Model	Year	Position	1 Plug	2 Plug	
RAM, Pickup, 1500	15-17	BP1	-	85083	
RAM, Pickup, 2500	15-17	BP1	-	85083	
RAM, Pickup, 3500	15-17	BP1	-	85083	
RAM, Pickup, 1500 Standard Harness Only	13-14	BP1	-	8507500	
RAM, Pickup, 2500 Standard Harness Only	13-14	BP1	-	8507500	
RAM, Pickup, 3500 Standard Harness Only	13-14	BP1	-	8507500	
RAM, Pickup, 1500 California Converter & 7-Way Adapter Kit with Harness	13-14	BP1	-	8507600	
RAM, Pickup, 2500 California Converter & 7-Way Adapter Kit with Harness	13-14	BP1	-	8507600	
RAM, Pickup, 3500 California Converter & 7-Way Adapter Kit with Harness	13-14	BP1	-	8507600	
RAM, Pickup, 1500 All Styles (California Converter & 7-Way Adapter Kit ONLY)	13-16	BP1	-	8507700	
RAM, Pickup, 2500 California Converter & 7-Way Adapter Kit ONLY	13-16	BP1	-	8507700	
RAM, Pickup, 3500 California Converter & 7-Way Adapter Kit ONLY	13-16	BP1	-	8507700	
RAM, Dakota w/Factory Tow Package	11	BP2	74439	78051	
RAM, Pickup, 1500	11-12	BP1	-	85066	
RAM, Pickup, 2500	11-12	BP1	-	85066	
RAM, Pickup, 3500, All Styles	11-12	BP1	-	85066	

SATURN					
Make/Model	Year	Position	1 Plug	2 Plug	
Outlook w/Factory Tow Package	07-09	BP1	-	78053	

TOYOTA					
Make/Model	Year	Position	1 Plug	2 Plug	
4Runner	14-16	BP4	-	8508400	
4Runner	03-13	BP4	-	78055	
Land Cruisers	13-15	BP3	-	78055	
LandCruiser	03-11	BP3	-	78055	
Sequoia	03-15	BP4	-	78055	
Tacoma Pickup	16-17	BP7	-	8507800	
Tacoma Pickup	07-15	BP4	-	78055	
Tundra	15-16	BP4	-	8507800	
Tundra	03-14	BP4	-	78055	



Breakaway systems are designed to apply the brakes in the event that the trailer becomes disconnected from the tow vehicle's hitch while in motion. The different systems also offer a variety of charging systems and features. REESE® Towpower advanced units have integrated multi-stage chargers that provide a fast recharge up to 12.8 volts.

BREAKAWAY SWITCHES

- LED test light on 8507311- Indicates power to trailer brakes.
- Durable reinforced nylon case & weldable metal tab. Ergonomic corrosion-resistant design.
- Includes: switch, reinforced nylon pin, nylon-coated braided galvanized lanyard

Part Number	Description
8507311	Breakaway Switch with LED Test Light
8506311	Breakaway Switch

TRAILER BREAKAWAY EMERGENCY BRAKING SYSTEM

- Integrated multi-stage
- PUSH TO TEST: LED indicates fully charged, charging or recharge needed
- Integrated multi-stage charger provides a fast recharge to maximize voltage
- Weather/corrosion-resistant, heavy-duty polymer case to protect battery and charger

Part Number	Description
85062	Trailer Breakaway Emergency Braking System - 1 to 3 axles equipped with electric brakes
50-85-315	Trailer Breakaway Emergency Braking System - 1 to 3 axles equipped with electric brakes

TRAILER BREAKAWAY EMERGENCY BRAKING SYSTEM

- PUSH TO TEST: LED indicates fully charged, charging or recharge needed
- Frame or floor mounting option
- Built-in battery charger charges battery when plugged into the tow vehicle
- Weather/corrosion-resistant, heavy-duty polymer case to protect battery and charger

Part Number	Description
50-85-320	Trailer Breakaway Emergency Braking System - 1 to 3 Axles Equipped with Electric Brakes

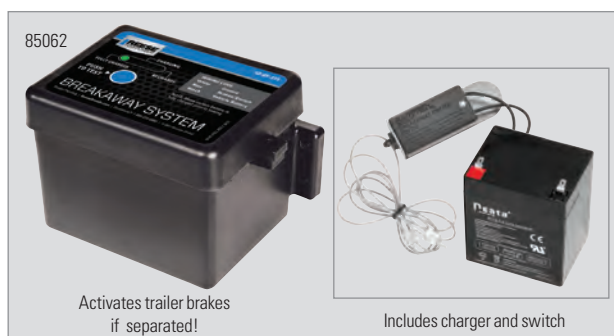
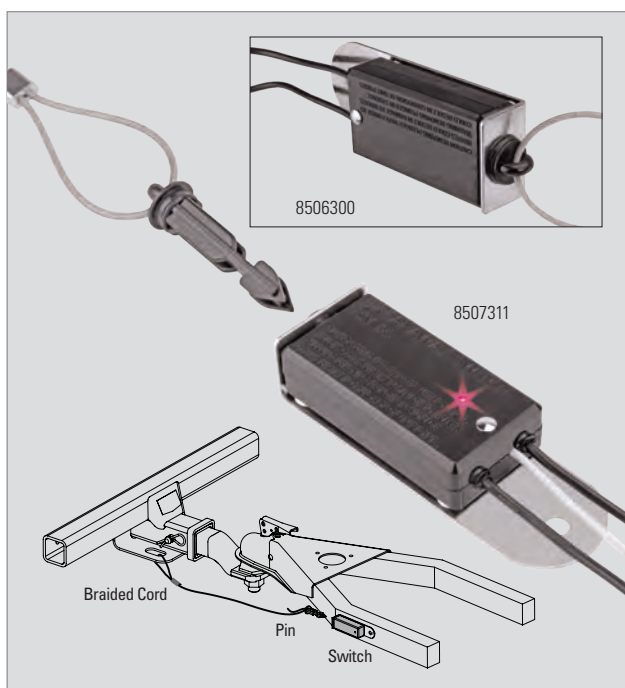

NOTES: Required by law in some states. For emergency use only: Not to be used for trailer parking brakes.

BRAKE CONTROLS

A BRIGHTER PATH

8612000
60-in LED Tailgate Light Bar
Page 139



Lighting the way for any lifestyle. Industry-approved options from stoplights to tailgate lights for agricultural, industrial, recreational and utility trailering.

VEHICLE ILLUMINATION

ILLUMINATION



LIGHTED HITCH COVERS	136-137
LIGHTED VEHICLE ACCESSORIES	138-139
STOP/TURN/TAIL LIGHTS	140-148
CLEARANCE/MARKER LIGHTS	149-155
ID LIGHT BARS	156
UTILITY SPECIALTY LIGHTS	157-160
LIGHTED HITCH STEP	161
REFLECTORS	162
CONSPICUITY STRIPS	163

LIGHTED HITCH COVERS

Unique one-of-a-kind lighted hitch covers display standard logos at daytime, then glow at nighttime.

- Fits 1-1/4-in & 2-in hitches
- Long life: LED light powered
- LOW illumination with tail lights, HIGH illumination with brakes
- Officially licensed and patented
- Simple 2-minute installation with a Phillips screwdriver

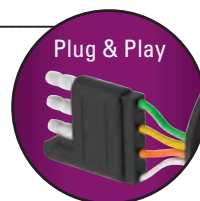

Part Number	Description	Finish
86061	GMC Lighted Hitch Cover	CHROME
86534	GMC Lighted Hitch Cover	BLACK
86062	Chevrolet Bow Tie Lighted Hitch Cover	CHROME
86530	Chevrolet Bow Tie Lighted Hitch Cover	BLACK
86065	Ford Lighted Hitch Cover	CHROME
86532	Ford Lighted Hitch Cover	BLACK
86066	RAM Lighted Hitch Cover	CHROME
86531	RAM Lighted Hitch Cover	BLACK
86523	Skull Lighted Hitch Cover	CHROME
86529	Skull Lighted Hitch Cover	BLACK

ILLUMINATION



REESE® Towpower offers a variety of LED-lighted hitch covers that provide low illumination with taillights on and high illumination when the brakes are applied. When not illuminated, the hitch cover is in the standard vehicle logo colors. This is a great way to customize your ride with a different look than the other vehicles on the road. Our logo hitch covers are fully licensed and ready to shine.

CHROME ARE STANDARD LOGOS IN THE DAY, THEN GLOW AT NIGHT



BLACK LOGOS DISAPPEAR IN THE DAY, AND GLOW BRIGHT AT NIGHT



ILLUMINATION

LIGHTED LOGO EMBLEMS

- Long life: LED-light powered, LOW illumination with tail lights, HIGH illumination with brake lights
- Officially licensed and patented
- Complete installation kit

Part Number	Description	Finish
8609144	GMC Lighted Logo Emblem	CHROME
8609244	Chevrolet Lighted Logo Emblem	CHROME
8661844	Chevrolet Lighted Logo Emblem	BLACK
8609344	RAM Lighted Logo Emblem	CHROME
8661944	RAM Lighted Logo Emblem	BLACK
8609444	Ford Lighted Logo Emblem	CHROME
8662044	Ford Lighted Logo Emblem	BLACK

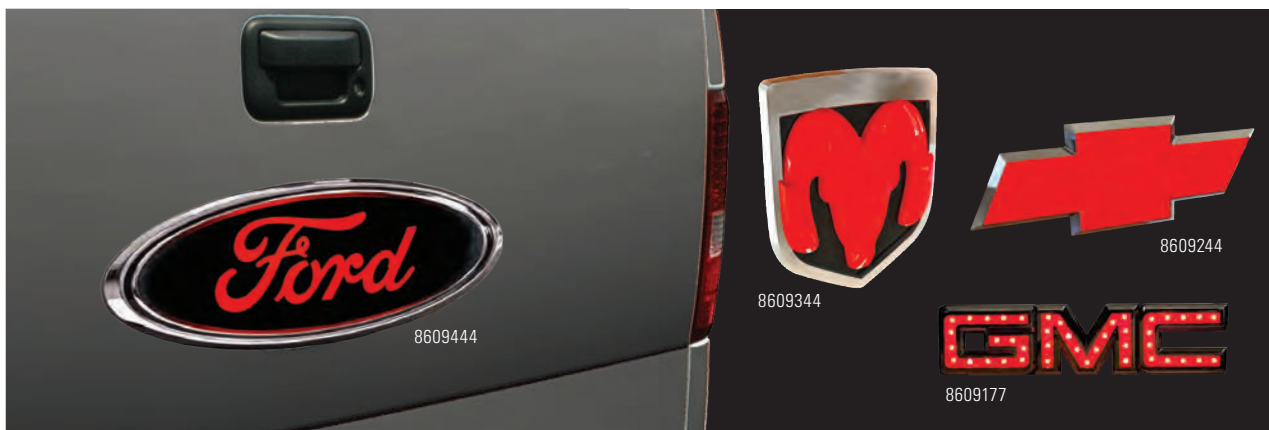

ILLUMINATION

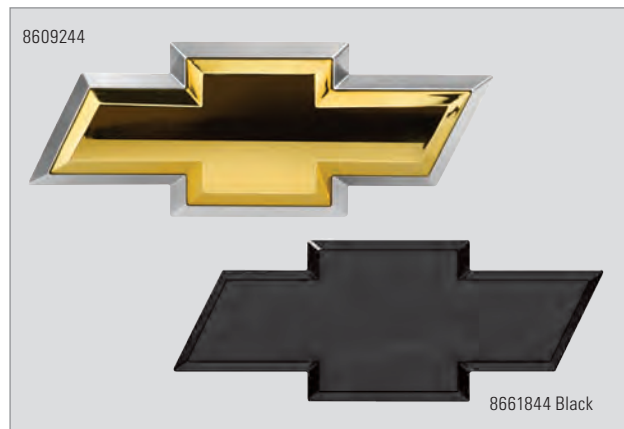

60-IN LED TAILGATE LIGHT BAR

The REESE® Towpower Multi-Function Tail Light Bar includes high-output LEDs that span the width of your vehicle. At 60-in long, you can illuminate the tail light, turn signals, brake lights, and backup lights in a new, aesthetically pleasing appearance. This creates a unique look for the back of your vehicle while adding additional lighting when backing up. Installation couldn't be easier.

- 4 functions – tail, turn, brake and backup
- Pre-wired 4-Flat connection, weather resistant
- Simple snap/click assembly, hardware included

Part Number	Description
8612000 NEW	60-in LED Tailgate Light Bar



ILLUMINATION



LED 6-IN CLEAR OVAL SEALED TURN & TAIL LAMPS _____

- Long life: 100,000+ hours
- Suitable for horizontal or vertical mounting
- Epoxy-encapsulated solid-state electronics, sonically sealed for water resistance

Part Number	Description
86078	Back-up Light Kit - White; with Clear Lens
86035	Turn Lamp Kit - Amber; with Clear Lens
86036	Stop/Tail Lamp Kit - Red; with Clear Lens



LED 6-IN OVAL SEALED STOP/TURN/TAIL LIGHTS _____

- Long life: 100,000+ hours
- Amperage draw is lower than incandescent
- Grommet mount, includes light, grommet and pigtail

Part Number	Description
73885	Red - 6-in Oval Stop/Turn/Tail
73884	Amber - 6-in Oval Turn
86056	Red, Replacement Light Only



LED 6-IN OVAL SEALED STOP/TURN & TAIL LIGHT _____

- Long life: 100,000+ hours
- Suitable for horizontal or vertical mounting
- Epoxy-encapsulated solid-state electronics, sonically sealed for water resistance

Part Number	Description
86046	Red - with Fixed Bezel
8610911	Red, With Fixed Bezel and Chrome Bezel



LED 4-IN ROUND SEALED STOP/TURN/TAIL LIGHTS _____

- Long life: 100,000+ hours

Part Number	Description
86014	Red - Round Kit



REESE® Towpower offers a wide range of incandescent and LED trailer tail lights to fit virtually any need. Some attach with easy-to-install stud mount bolts, while others recess into the trailer for a low-profile flush appearance. Whichever lighting kit you choose, be assured it will comply with Department of Transportation requirements.



LED SUBMERSIBLE LIGHTS

- Long life: 100,000+ hours
- Combination stop/turn/tail
- Built-in side marker reflectors meet D.O.T. requirements
- Submersible/waterproof
- Solid-state design
- Amperage draw is lower than incandescent
- Mounts on 2-in centers

Part Number	Functions	Trailer Width	Position
73854	7-Function, includes License Light	Under 80-in	Left/roadside
73853	6-Function	Under 80-in	Right/curbside
73856	8-Function, includes License Light	Over 80-in	Left/roadside
73855	7-Function	Over 80-in	Right/curbside



ILLUMINATION

LOOK FOR COMPLETE LED KITS ON PAGE 145

SEALED OVAL STOP, TURN & TAIL LIGHT KIT

- Sealed 6-in oval stop, turn and tail, red
- Can be used on roadside or curbside of vehicle or trailer
- Kit includes light, grommet, and wire plug
- Fits most competitive oval lights; popular on commercial market vehicles

Part Number	Description
73883	Sealed Oval Stop, Turn and Tail Light Kit - Red
73828	Sealed Oval Stop, Turn and Tail Light Kit - Red - Light Only

RECTANGULAR SURFACE-MOUNT LIGHT

- Multi-function stop/turn/tail light
- Hardware included

Part Number	Description
73831	Rectangular Surface-Mount Light - Red

PEDESTAL-MOUNT DUAL-FACE STOP, TURN & TAIL LIGHT

- Combination amber and red lenses
- Snap-on lens, mounting requires no rings or screws
- Reflector diameter: 4-in, total height: 5-in

Part Number	Description
73821	Pedestal-Mount Dual-Face Light - Amber/Red
73871	Pedestal-Mount Dual-Face Light - Red/Black, Single Face

3-PIECE REPLACEMENT LENS SET

- For use with under 80-in wide trailers (for 73824, 73825)

Part Number	Description
73849	3-Piece Replacement Lens Set

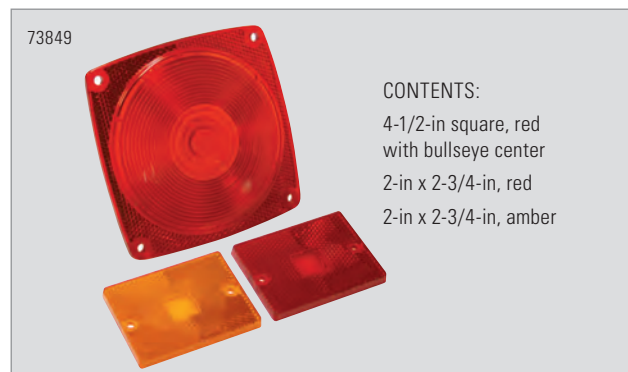

FLUSH-MOUNT STOP/TURN/TAIL LIGHT

- Designed for 12-volt systems
- Flange mount; 5-3/16-in diameter red lens mounts with tension ring

Part Number	Description
73822	Metal Flush-Mount Light- Red

SEALED UNIVERSAL GROMMET MOUNT STOP/TURN/TAIL LIGHT KIT

- Kit includes 4-in diameter red stop/turn/tail light, grommet and wire plug
- Replacement on trucks, trailers and other applications

Part Number	Description
73830	Grommet-Mount Light- Red

STOP/TURN/TAIL WITH LICENSE LIGHT

- 4-in diameter red screw-on lens with light for Stop/Turn/Tail use
- Stud-mount design

Part Number	Description
73823	Stop/Turn/Tail with License Light- Red

UNIVERSAL STOP/TURN/TAIL LIGHT WITH LICENSE LIGHT

Suitable for: tail light, stop light, turn signal, license light, back-up light, rear reflector

- Heavy-duty, flexible PVC tube with pre-installed wires
- Universal light, fits most trucks, 5-3/4-in x 6-3/4-in

Part Number	Description
73829	Universal Stop/Turn/Tail with License Light- Red



ILLUMINATION

STOP/TURN/TAIL LIGHTS

- Red screw-on lens
- 4-1/2-in square

Part Number	Functions	Trailer Width	Position
73825	7-Function: Stop/Turn/Tail, Reflector, Side Marker Light, Side Reflector and License Light	Under 80-in wide	Left/roadside
73824	6-Function: Stop/Turn/Tail Light, Reflector, Side Marker Light, Side Reflector	Under 80-in wide	Right/curbside
73827	8-Function: Stop/Turn/Tail Light, Rear Reflector, Side Marker Light, License Light Side Reflector, Clearance Marker Light	Over 80-in wide	Left/roadside
73826	7-Function: Stop/Turn/Tail Light, Rear Reflector, Side Marker Light, Side Reflector, Clearance Marker Light	Over 80-in wide	Right/curbside

73825

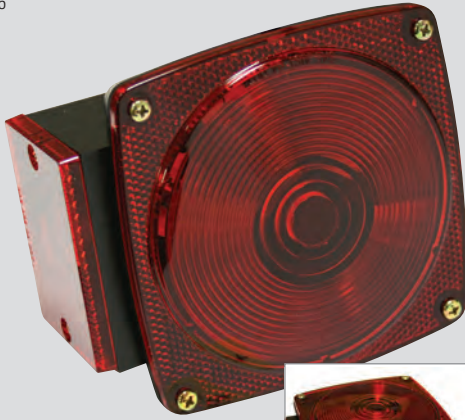

Includes
license
plate
light

73824

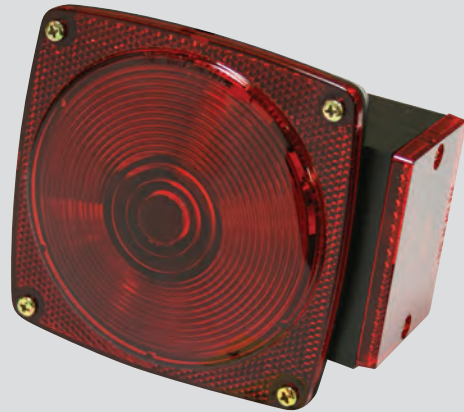

ILLUMINATION

73827



License
plate
light
built in

73826



LOOK FOR COMPLETE LED KITS ON PAGE 148



LED SUBMERSIBLE TRAILER LIGHT KITS

- Long life: 100,000 + hours
- Combination stop/turn/taill with built-in side marker reflectors
- Meets/exceeds all D.O.T. requirements for trailer over/under 80-in wide
- Submersible/waterproof design
- Amperage draw is lower than incandescent
- Mounts on 2-in centers

Part Number	Functions	Trailer Width	Position
86006	Kit contains two tail lights, one license plate bracket, one 25' wishbone trailer harness, one 48-in connector, mounting hardware and installation instructions.	Over 80-in wide Low profile	Left/roadside Right/curbside
86037	Kit contains one tail lights, mounting hardware and installation instructions.	Over 80-in wide Low profile	Right/curbside
86038	Kit contains one tail lights, mounting hardware and installation instructions.	Over 80-in wide Low profile	Left/roadside
73857	Kit contains two tail lights, one license plate bracket, one 25' wishbone trailer harness, one 48-in connector, mounting hardware and installation instructions.	Under 80-in wide	Left/roadside Right/curbside
73858	Kit contains two tail lights, one license plate bracket, one 25' wishbone trailer harness, one 48-in connector, mounting hardware and installation instructions.	Over or Under 80-in wide	Left/roadside Right/curbside

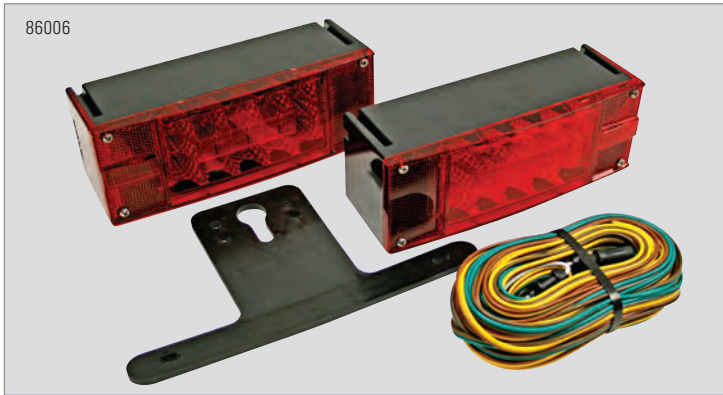

ILLUMINATION

MAGNETIC TOWING LIGHT KIT

The REESE® Towpower magnetic towing light kit is ideal for those situations where temporary lighting is needed. Can be used when towing a car or trailer and moved to different vehicles if necessary. Easy hook-up and removal; use with RVs, cars, boats, tow trucks and trailers

Part Number	Description
73864	Magnetic Towing Light Kit



Magnetic mount:

- Plugs into standard 4-wire vehicle connector
- 20-ft. 4-wire harness
- 4-wire trunk connector included
- Complete instructions included

Towing applications:

- RVs, cars, boats, tow trucks and trailers
- Agricultural & industrial equipment

Temporary tail lights:

- For legal highway operation

ILLUMINATION



LED AG LIGHT

REESE® Towpower offers light designed specifically for the rigors of the Agriculture Industry. Mounted on the tractor or your trailers, these lights are ready to safely move your equipment from farm to field.

- Waterproof, heavy-duty
- Vibration-resistant mounting stud
- Stainless steel hardware

Part Number	Features
8609900	Amber - Dual Face
8610000	Red

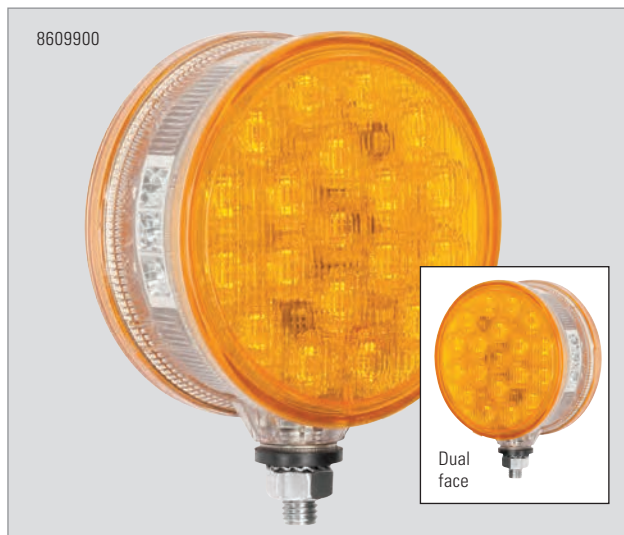

7-PIN DUAL AG LIGHT TRANSPORT TRAILER KIT HEAVY-DUTY MAGNET

- Dual AG trailer light kit, 7-way round pin connector tail light, side marker, turn & stop signal - 3 wire
- Features left- and right-side dual lamp units
- 46-ft round jacket wishbone cable
- 4 – Heavy-duty magnets with 90 lb pull force
- U.S. patent # D347,903/5,335,155
- Mounting hardware and installation instructions

Part Number	Features
86040	AG Light Transport Trailer Kit



ILLUMINATION



TRAILER LIGHT KITS

- Combination stop/turn/tail with built-in side marker reflectors
- Meets/exceeds all D.O.T. requirements for trailer over/under 80-in wide
- Mounts on 2-in centers, mounting hardware and instructions included

Part Number	Features	Trailer Width	Position
86006	Standard Tail Light Kit With 25-ft Harness, 48-in Connector and Marker Lights. For Wider Trailers, add Clearance Lights and ID Bars.	Under 80-in	Left/Roadside Right/Curbside
73832	Includes 25-ft Trailer and 48-in Vehicle Harness, License Bracket, Mounting Hardware and Installation Instructions. Front Side Marker/Clearance Lights, Reflectors and Rear Identification Lights Are Necessary To Meet All DOT Requirements.	Over or Under 80-in	Left/Roadside Right/Curbside
7383411	Contains 2 Multi-Function Stop, Turn & Tail Lights, 25-ft Wire Kit, Mounting Hardware, License Bracket and Installation Instructions.	Under 80-in	Left/Roadside Right/Curbside

UNIVERSAL LOW-PROFILE SUBMERSIBLE TRAILER LIGHT KIT

Part Number	Features	Trailer Width	Position
73867	Contains 2 Multi-Function Stop and Tail Lights, 25-ft Wire Harness, 48-in Vehicle Connector, License Bracket, Mounting Hardware, Instructions.	Over 80-In	Left/Roadside Right/Curbside
86054	Contains 1 Light	Over 80-In	Right/Curbside
86055	Contains 1 Light	Over 80-In	Left/Roadside



REESE® Towpower offers LED and traditional incandescent clearance lights, some with built-in reflex reflector, low-profile and stud mounting options. Look to REESE Towpower for finding the clearance light to meet your needs.

LED MICRO LIGHTS

- Environmentally sealed high-intensity light with grommet
- PC-rated for clearance and marker functions; easy to install

Part Number	Color
8610100	Amber
8610200	Red
8610300	Clear

LED STUD MOUNT LIGHTS

- Designed for 12-volt systems
- 1-1/8-in x 2-1/8-in, stainless steel

Part Number	Color
8608500	Amber
8608600	Red



LED MARKER/ CLEARANCE LIGHT WITH REFLECTOR

- Long life: 100,000+ hours, solid-state design
- Popular "59" Series rectangle styling clearance and side marker light with reflector

Part Number	Color
73862	Amber
73863	Red



LED MARKER/ CLEARANCE LIGHT

- Long life: 100,000+ hours, solid-state design
- 2-in x 4-in polycarbonate base and lens

Part Number	Color
73846	Amber
73845	Red



ILLUMINATION



LED SEALED CLEARANCE/ SIDE MARKER LIGHT

- Long life: 100,000+ hours
- Attractive chrome base; hardware included

Part Number	Color	Size
73841	Amber	1-1/4 x 2-1/2 x 7/8-in
73842	Red	1-1/4 x 2-1/2 x 7/8-in



LED SEALED CLEARANCE/ SIDE MARKER LIGHT

- Long life: 100,000+ hours
- Attractive chrome base

Part Number	Color	Size
73847	Red	3-7/8 x 1-1/4-in
73848	Amber	3-7/8 x 1-1/4-in



LED RECTANGULAR SIDE MARKER LIGHT W/REFLEX REFLECTOR

- Long life: 100,000+ hours
- Single-stud mounting; grounds through mounting stud

Part Number	Color	Size
8608711	Amber	2-3/4 x 2-1/8 x 1-3/4-in
86015	Amber, PC-rated	2-3/4 x 2-1/8 x 1-3/4-in



LED 2-IN "BEEHIVE" CLEARANCE/ MARKER LIGHT

- Long life: 100,000+ hours
- Vibration-resistant base

Part Number	Color	Size
73843	Red	Fits 2-3/4-in hole
73844	Amber	Fits 2-3/4-in hole

ILLUMINATION

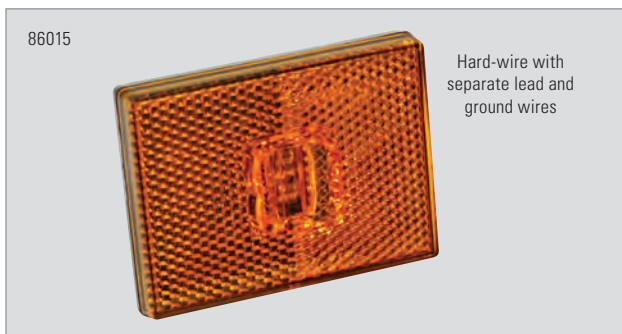
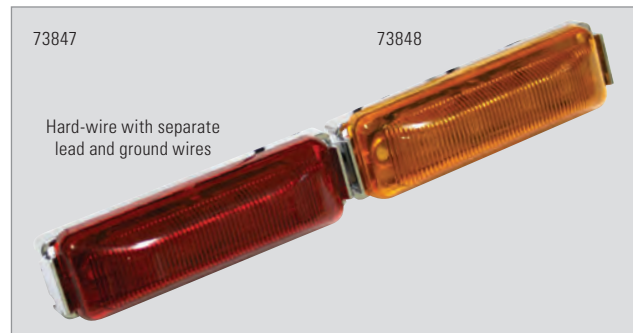



LED ROUND SEALED CLEARANCE LIGHTS

Long life: 100,000+ hours

- Solid-state design
- Amperage draw is lower than incandescent
- Grommet and plug

Part Number	Color	Size	Features
73892	Amber	Fits 2-5/16-in mounting hole	2-in round, with grommet and pigtail
73893	Red	Fits 2-5/16-in mounting hole	2-in round, with grommet and pigtail
73881	Amber	Fits 2-25/32-in mounting hole	2-1/2-in round. Accepts industry standard 2-prong plug. Functions as both clearance and side marker light when mounted on a 45° angle.
73882	Red	Fits 2-25/32-in mounting hole	2-1/2-in round. Accepts industry standard 2-prong plug. Functions as both clearance and side marker light when mounted on a 45° angle.
86050	Amber	Fits 2-5/16-in mounting hole	2-in round. Accepts industry standard 2-prong plug. Functions as clearance, side marker or identification light.
86051	Red	Fits 2-5/16-in mounting hole	2-in round. Accepts industry standard 2-prong plug. Functions as clearance, side marker or identification light.
86052	Amber	Fits 2-25/32-in mounting hole	2-1/2-in round. Accepts industry standard 2-prong plug. Functions as clearance, side marker or identification light.
86053	Red	Fits 2-25/32-in mounting hole	2-1/2-in round. Accepts industry standard 2-prong plug. Functions as clearance, side marker or identification light.



ILLUMINATION



2.5-IN ROUND SEALED LIGHT W/REFLECTOR

- Features reflector optic which eliminates need of separate vehicle reflector
- Accepts industry standard 2-prong plug

Part Number	Color	Size	Features
86042	Amber	Fits 2-25/32-in mounting hole	Functions as side marker or clearance light or as a combination
86043	Red	Fits 2-25/32-in mounting hole	Functions as side marker or clearance light or as a combination

2.75-IN ROUND CLEARANCE LAMP

- ABS housing, acrylic lens, 18 gauge wire
- Grounds through mounting screw with single lead wire

Part Number	Color	Features
73835	Red	Replaceable #194 bulb
73836	Amber	Replaceable #194 bulb



2-IN SEALED ROUND CLEARANCE/ SIDE MARKER LIGHT KIT

- Kit includes light, grommet and 2-wire plug
- Functions as side marker or clearance light or as combination when mounted at a 45° angle

Part Number	Color
73875	Amber
73876	Red

2.5-IN SEALED ROUND CLEARANCE/ SIDE MARKER LIGHT KIT

- Kit includes light, grommet and 2-wire plug
- Functions as side marker or clearance light or as combination when mounted at a 45° angle

Part Number	Color
73877	Amber
73878	Red

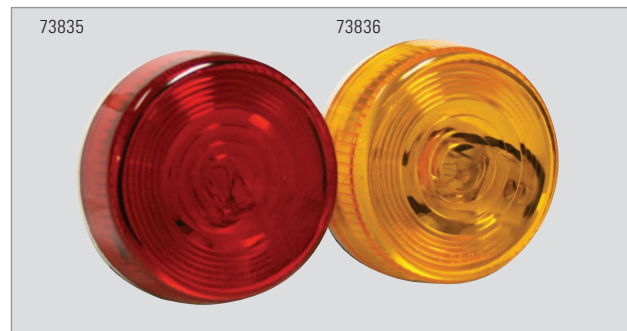
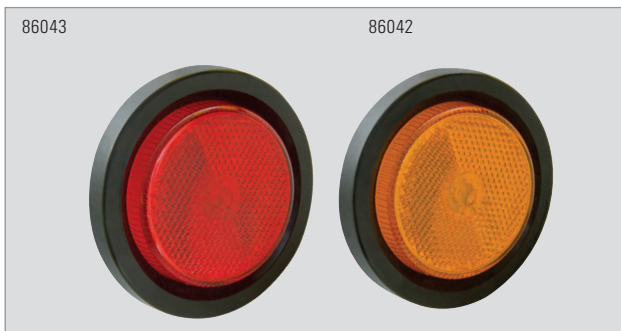

OBLONG SLIM LINE CLEARANCE SIDE MARKER LIGHT

- Snap-on lens, only 1-1/8-in high

Part Number	Color	Size	Features
73873	Amber	2-3/4-in center mounting hole	Replaceable #194 bulb
73874	Red	2-3/4-in center mounting hole	Replaceable #194 bulb

STUD-MOUNT LIGHT WITH REFLECTIVE LENS

- Designed for 12-volt systems; grounds through mounting stud when installed on metal surface

Part Number	Color	Size	Features
73812	Amber	2-7/8 x 2-1/2 x 7/8-in	Replaceable #194 bulb

4-IN OBLONG CLEARANCE LIGHT W/REFLEX LENS

- ABS base with acrylic snap-on reflex lens and built-in drain holes; designed for 12-volt systems

Part Number	Color	Size	Features
73801	Amber	4-in x 2 x 1-1/8-in	Replaceable #194 bulb
73802	Red	4-in x 2 x 1-1/8-in	Replaceable #194 bulb

2-IN X 4-IN DUAL BULB CLEARANCE LIGHT

- Dual bulb design with ABS base and acrylic snap-on lens
- Built-in drain holes
- Designed for 12-volt systems

Part Number	Color	Size	Features
73803	Red	2-in x 4-in	2 replaceable #194 bulbs
73804	Amber	2-in x 4-in	2 replaceable #194 bulbs

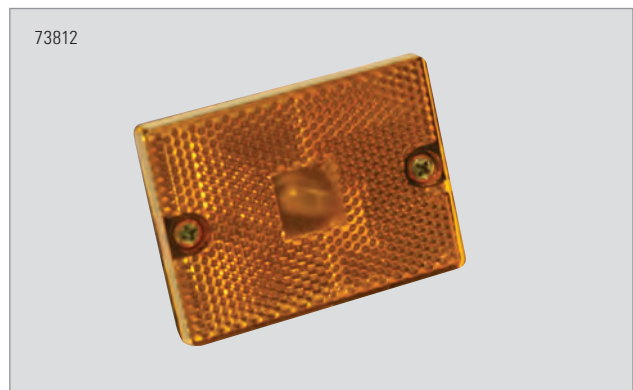

ILLUMINATION

STUD-MOUNT LIGHTS

- Designed for 12-volt systems

Part Number	Color	Size
8604900	Amber	1-1/8-in x 2-1/8-in
8608200	Red	1-1/8-in x 2-1/8-in

RECTANGULAR CLEARANCE SEALED LIGHT KIT

- Chrome base; hardware included

Part Number	Color	Size
73838	Red	1-1/4-in x 2-1/2-in
73839	Amber	1-1/4-in x 2-1/2-in

ARMORED LIGHT

- Protective weathertight base with single-wire design
- Designed for 12-volt systems
- Non-corrosive chrome plated

Part Number	Color	Features
73807	Amber	Replaceable #194 bulb
73808	Red	Replaceable #194 bulb

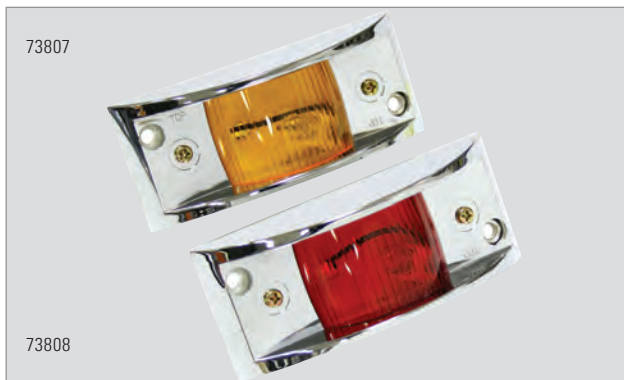

MINI CLEARANCE LIGHT

- Single-wire design with acrylic snap-on lens and built-in drain holes; designed for 12-volt systems

Part Number	Color	Size	Features
73805	Amber	3-1/8-in x 2-3/4 x 1-1/8-in	Replaceable #194 bulb
73806	Red	3-1/8-in x 2-3/4 x 1-1/8-in	Replaceable #194 bulb
73872	Blue	3-1/8-in x 2-3/4 x 1-1/8-in	Replaceable #194 bulb

CAB MARKER TEARDROP LIGHT

- Popular style
- Interchanges with competitive models
- Molded of corrosion/impact-resistant ABS
- Grounds through mounting hardware

Part Number	Color	Size	Features
86009	Amber	2-1/8-in x 5-1/2-in x 1-5/8-in	Replaceable #194 bulb

RUNNING LIGHT KIT

- 6 amber lights on white base
- Provide a custom appearance
- Install on running boards, front, side or back of the vehicle
- Great dress-up accessory; adds visibility

Part Number	Color	Size	Features
73859	Amber	3-1/8-in x 2-3/4-in x 1-1/8-in	Replaceable #194 bulb, hardware included

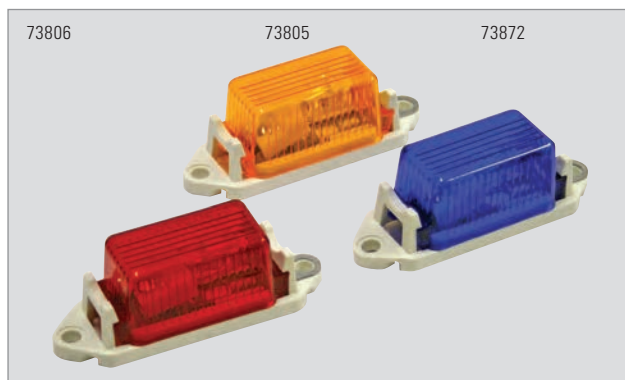

ILLUMINATION



ID LIGHT BARS

REESE® Towpower identification light bars are submersible and mini style. They are compliant for use to meet trailers over 80 inches wide rear clearance marking requirements. Lights are pre-mounted and pre-wired for easy installation.

- Submersible identification bar light for over 80-in wide applications

Part Number	Color	Size	Mounting	Features
73852	Red- LED	1-1/2 x 17 x 1-9/16-in	16-in center	Black polycarbonate bar is corrosion proof
8608900	Red- LED	1-1/8 x 14-1/4 x 1-in	8-1/2-in center	Stainless steel bar, 3 sealed lights, grounds through mounting hardware
86019	Red	1-1/8 x 14-1/4 x 1-in	8-1/2-in center	Stainless steel bar, 3 sealed lights, grounds through mounting hardware
86012	Red	1-1/2 x 17 x 1-9/16-in	16-in center	Black polycarbonate bar is corrosion proof, 3 sealed lights

73852



8608900



86012

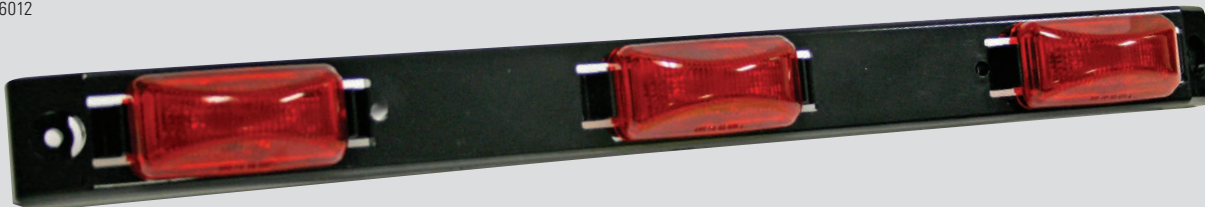

ILLUMINATION

MINI ID LIGHT BAR

- Economical identification bar light for over 80-in wide applications
- Mounts on 16-in centers

Part Number	Color	Size	Features
73851	Red	1 x 16-9/16 x 1-7/16-in	Acrylic lens, ABS base, painted steel bracket bar, 18 gauge wire light source: bulb #193

73851



REESE® Towpower offers interior dome lights ideal for locating inside truck caps or other areas where light is needed. A convenient push button switch is located on each unit for easy activation.

RECTANGULAR INTERIOR DOME LIGHT WITH SWITCH

- Convenient push-button ON/OFF switch, designed for 12-volt systems

Part Number	Size	Features
73894	2-1/2 x 4-1/2 x 1-5/8-in	Hardware included, #1141 Bulb

INTERIOR LIGHT WITH SWITCH

- Convenient push-button ON/OFF switch, designed for 12-volt systems

Part Number	Size	Features
73813	Mounts on 2-1/8-in center	Hardware included, #194 Bulb



LICENSE PLATE LIGHTS

- Chrome-plated finish
- Easy to install; grounds through mounting screws

Part Number	Description	Features
73815	Courtesy / Mini Utility / License Light	Hooded shield to prevent glare; mounting screws included; #193 bulb; 2-wire design
73837	Snap-In License Light	Can also be used for interior, courtesy, compartment or general illumination utility light. Snaps into 1-1/4-in diameter hole. 2 units required for legal license illumination, #67 bulb.
73890	Chrome License Plate Light	Interchangeable with most competitive models, #67 bulb; grounds through mounting screws
86013	Stud-Mount License Plate Light	Interchangeable with most competitive models, #194 bulb; grounds through mounting screws



ILLUMINATION

UTILITY SPECIALTY LIGHTS

A wide range of high-quality rugged specialty lighting products to meet your specific lighting necessities. Magnetic base, permanently mounted, warning, strobe or flood. All designed and built to handle the elements to get the job done.

ROTATING WARNING LIGHT

- Sealed lens enclosure
- Vibration- shock-, dust- and water-resistant
- Magnetic shock-mount base

Part Number	Description
73814	Rotating Warning Light; Sae J 845 Class 3 Certified; Amber; Spare Bulb Included (replacement: R10W)

ROUND UTILITY LIGHT

- Shock-resistant rubber housing
- Trapezoidal light beam pattern
- Ideal for farm implement use and other off-road applications
- Universal 12V par 36 sealed beam, features #4411 bulb

Part Number	Description
73840	Round Utility Light

MAGNETIC LED EMERGENCY LIGHT

- Bright; wireless LED warning light; 2 active settings: flash or constant illumination
- Strong magnetic mount or self standing
- Solid-state weathertight construction; operates on 4 AA batteries (sold separately)

Part Number	Description
86024	Magnetic LED Emergency Light - Amber
86025	Magnetic LED Emergency Light - Red

ILLUMINATION



PROFESSIONAL SERIES LED MAGNETIC BASE WORK LIGHTS

- Strong magnetic mount base
- Flood beam pattern, 800 lumens; operates on 9 to 36 Volts
- On/off switch, indicator plug
- Heavy-duty aluminum body; stainless steel hardware

Part Number	Description
8611100	Round - Professional Series LED Magnetic Work Light
8611200	Rectangle - Professional Series LED Magnetic Work Light

PROFESSIONAL SERIES LED CLEAR WORK LIGHTS

- 1000 Lumens, operates on 9 to 36 Volts
- Heavy-duty aluminum body, stainless steel hardware

Part Number	Description
8609700	Round - Professional Series LED Clear Work Light
8609800	Rectangle - Professional Series LED Clear Work Light

PROFESSIONAL SERIES LED STROBE LIGHTS

- Heavy-duty sealed aluminum body
- 7 optional flashing modes; flexible mounting options

Part Number	Description
8609000	Amber - Professional Series LED Strobe Light
8609600	Clear - Professional Series LED Strobe Work Light



ILLUMINATION

LED FLEXIBLE LIGHT STRIPS

- 36-in length with 3M adhesive
- Operates with 12V power supply, 100 lumens per foot

Part Number	Color
8610400	Red
8610500	Blue
8610600	Amber
8610700	White
8611300	Green

Cut to desired length

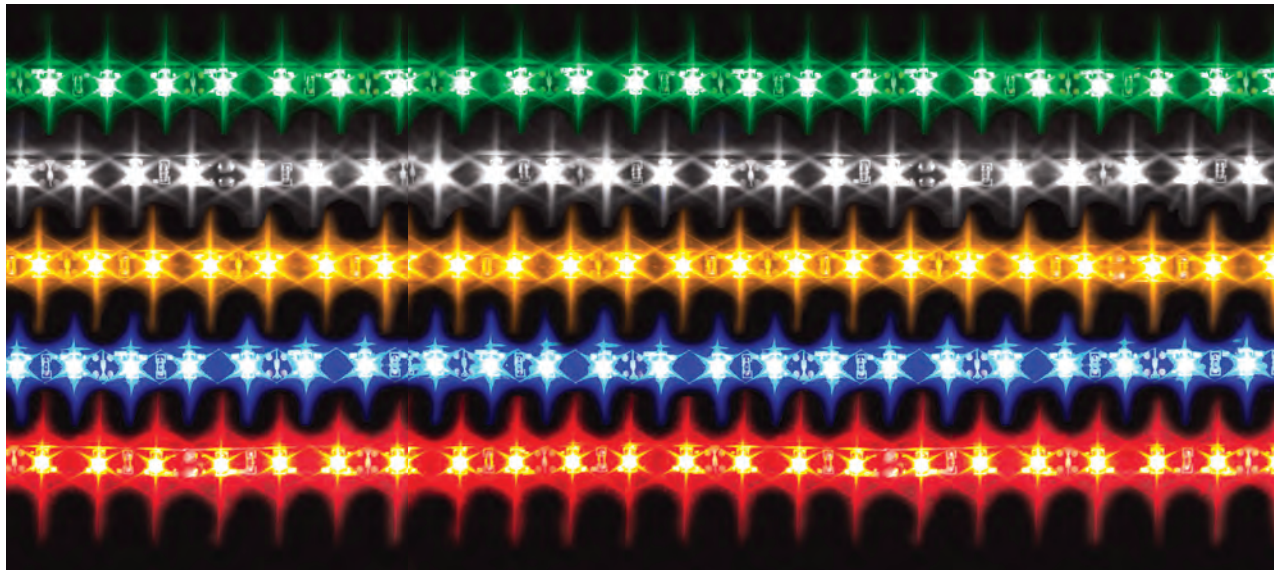

ILLUMINATION

POD HAZARD

- Multi-use LED roadside warning device
- Dual use: roadside emergency warning light, utility work light
- Magnetic base and built-in hanger and prop

Part Number	Description	Packaging
PD110200 NEW	POD HAZARD Multi-use LED Roadside Warning Device	2 pack, batteries sold separately
PD110700 NEW	POD HAZARD Countertop Display	Includes (3) PD110200, batteries sold separately
PD110101 NEW	POD HAZARD	1 pack clamshell, batteries sold separately
PD110302 NEW	POD HAZARD – Club Pack	3 pack, 9 AAA batteries included, compact storage bag



LIGHTED HITCH STEP

The REESE® Towpower Lighted Hitch Step is uniquely designed to provide an easy solution for loading and unloading of your cargo. The universal tow-and-go step makes it easy to load from hard-to-reach tow vehicles such as large trucks, vans, and SUVs. Just plug-in and you're ready to go.*

- Stays in place while you tow
- Ultra-bright LED lights; flood light pattern; up to 600 lumens
- Great for added back-up light or utility light with 3 modes switch: backup/off/work light
- Mounts to 2-in ball mount, some assembly required
- Step to reach high places

Part Number	Description
7065300	Lighted Hitch Step



ILLUMINATION



3 modes switch:
backup/off/work light

* Ready for easy plug-in on most vehicles with a factory 7-way tow package



QUICK-MOUNT REFLEX REFLECTORS

REESE® Towpower offers a wide variety of reflectors to meet any need, and all meet appropriate DOT requirements. Reflectors increase visibility on your vehicle and trailer and any area you wish to illuminate for increased safety.

- Highly reflective diamond pattern
- Stick-on reflectors will mount on any clean surface
- Conforms to FMVSS No. 108

Part Number	Color	Size	Packaging
73817	Amber	3-3/16-in - round	2 pack
73818	Red	3-3/16-in - round	2 pack
73819	Amber	4-3/8-in x 1-7/8-in - oblong	2 pack
73820	Red	4-3/8-in x 1-7/8-in - oblong	2 pack
73887	Amber	3-1/8-in x 1-3/8-in - rectangle	2 pack
73888	Red	3-1/8-in x 1-3/8-in - rectangle	2 pack

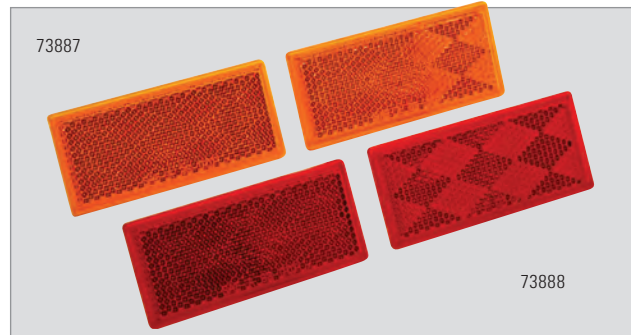
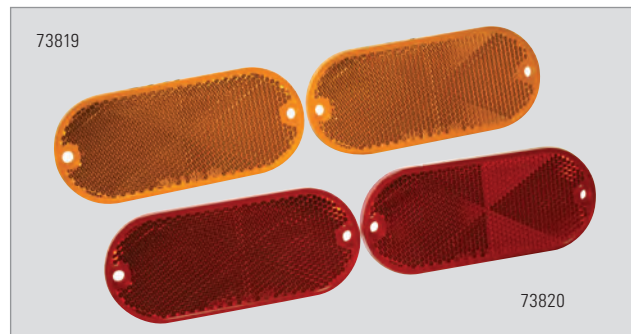
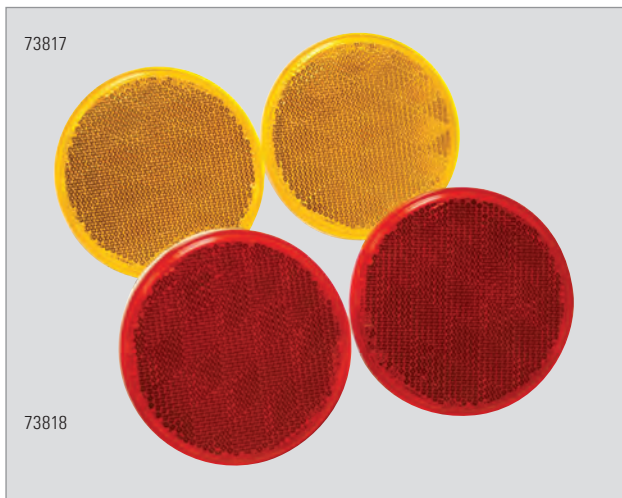

ILLUMINATION

ALUMINUM REFLEX REFLECTORS

- Low-profile oval housing constructed of rustproof aluminum
- Ideal for safety applications
- 3-in diameter acrylic lens

Part Number	Color	Size
86010	Amber	3-in diameter acrylic lens, 4-9/16-in - overall
86011	Red	3-in diameter acrylic lens, 4-9/16-in - overall



CONSPICUITY REFLECTIVE STRIPS

Designed to be detected and reflect light the longest sight distance possible. Very flexible for an easy, stick-on application. Great for wherever extra visibility is desired for safety or to just be noticed.

- Provides longer sight detection distance
- Withstands high-pressure washing and resists edge lift
- Complies to DOT requirements

Part Number	Size	Packaging
73886	2-in x 18-in	4 pack

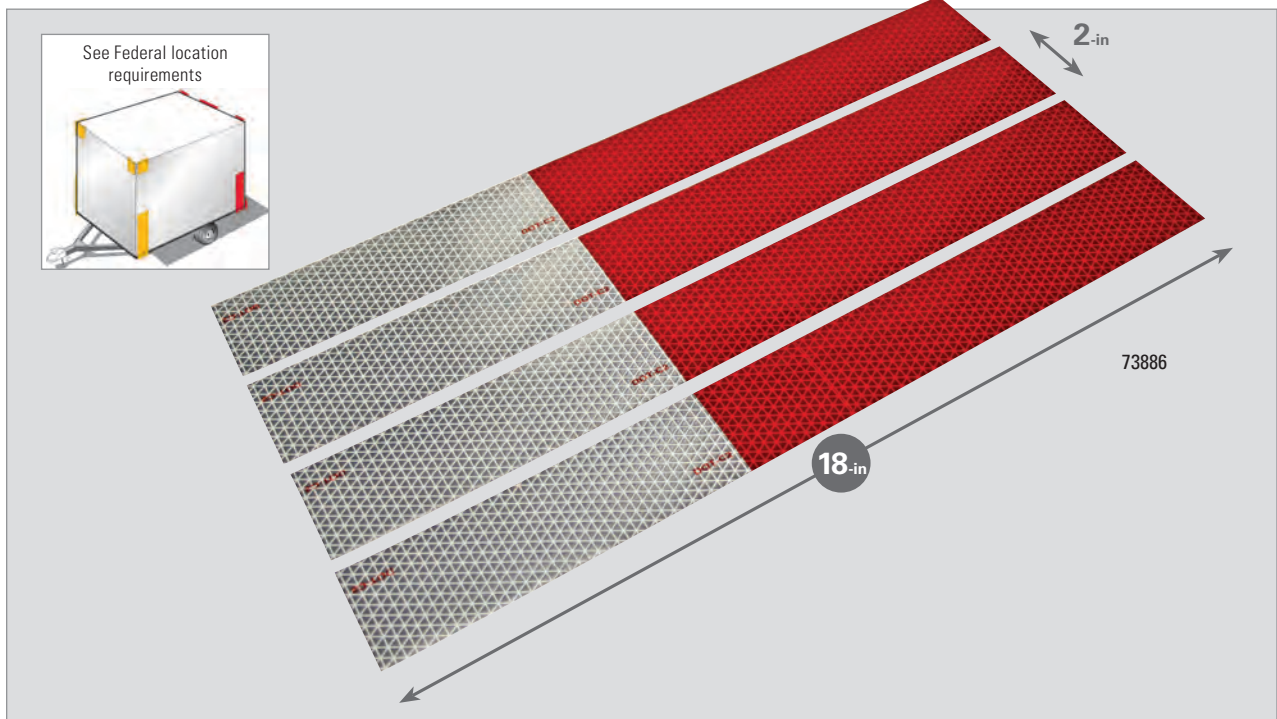

ILLUMINATION

CONSPICUITY REFLECTIVE TAPE ROLL

Part Number	Size
86063	2-in x 150-ft roll

CONSPICUITY REFLECTORS

- Adhesive will mount on any clean surface, DOT-C Rated

Part Number	Size	Packaging
86027	1-in x 12-in - Clear	2 pack
86028	1-in x 12-in - Red	2 pack

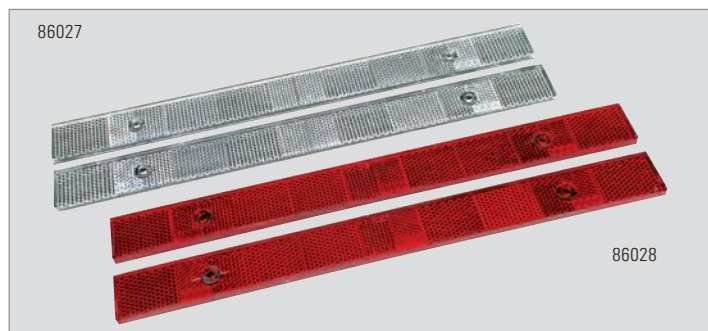
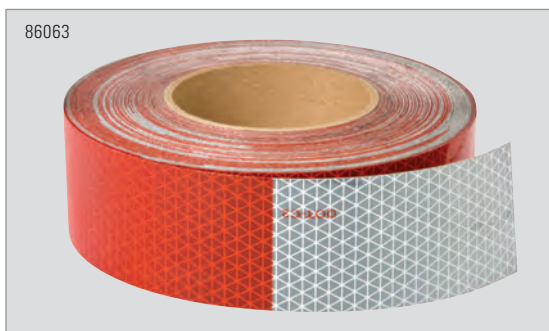



REESE[®]
SECURE

PERFORMANCE DRIVEN



**EMBRACE THE
STRENGTH**





When the job is demanding, REESE® Secure has the right tie down to put you in command of the situation.

TIE DOWNS



RATCHETS

- Light Duty 170
- Standard Duty 170-171
- Heavy Duty 172
- Super Duty 172-173
- Camo 173

CAMBUCKLES

- Light Duty 174
- Standard Duty 174
- Heavy Duty 175

VEHICLE TIE DOWNS 175

LASHING STRAP 175

NEW T-HANDLE RATCHET

Whether hauling for work or play, REESE® Secure REBEL T-Handles provide ultimate control with a rotating grip that allows for one- or two-handed ratcheting power. This new T-Handle performs just as well as it looks. REESE has combined the very best in functionality and corrosion protection to ensure our customers have the highest quality ratchet available.

Available in:



**REBEL
TD**



CHOOSING THE PROPER TIE DOWN

1. DETERMINE LOAD WEIGHT

LIGHT DUTY

SECURE LIGHT CARGO UP TO 330 LBS
Generator, Pressure Washer, Trimmer, Snow Thrower



STANDARD DUTY

SECURE MEDIUM-WEIGHT LOADS UP TO 660 LBS
Log Splitter, Motorcycle, Light Fishing Boat, Lawn Mower



HEAVY DUTY

SECURE HEAVY LOADS UP TO 1660 LBS
Power Tiller, Snowmobile, ATV, Lawn Tractor, Lawn Vacuum



SUPER DUTY

SECURE LARGE CARGO UP TO 3300 LBS
Large Loads, UTV, Heavy Equipment

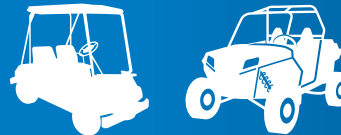

2. SELECT LENGTH & QUANTITY

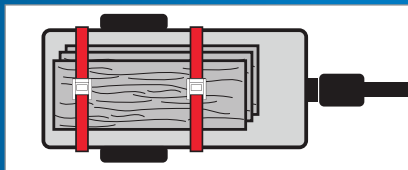

Measure distance between connection points and choose appropriate length.

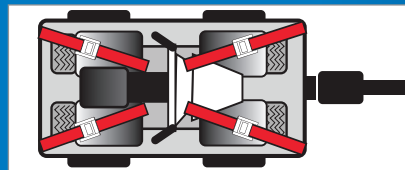

Use four or more straps for loads over 500 lb.

3. CHOOSING THE APPROPRIATE LEVER & HOLDING FORCE

CAMBUCKLE

Strap with a simple cam device to keep it tight. Quick and easy to use. Just press and tighten. Good for small, lightweight items and short trips.



SURELOK®

A locking cam buckle that combines the ease of use of a cam buckle with ratchet holding power. Can't be overtightened.



RATCHET

Strap exerts more downward force on your load due to mechanical action of ratcheting gears. Allows for precise tension adjustment to secure all loads.



LIGHT DUTY RATCHETS

**LIGHT
DUTY**

- Secure lightweight cargo up to 330 lbs
- Strong holding power with precise tension adjustment
- Tighten down with vise-like gripping power

Part Number	Description	Length	Capacity	Qty/Pkg	Package	Qty/Carton
9481500	1" Webbing with Metal Handle and S Hooks	10'	300/900 lb	1	Bulk	10
9481502 NEW	1" Webbing with Metal Handle and S Hooks	10'	300/900 lb	1	Bulk	4
9510800	1" Webbing with Metal Handle and S Hooks	10'	300/900 lb	4	Open	3
9510900	1" Webbing with Metal Handle and S Hooks	10'	300/900 lb	1	Box	3
9521000	1" Endless Webbing	12'	300/900 lb	1	Box	3
9513100 NEW	1" Webbing with Metal Handle and S Hooks	15'	300/900 lb	1	Bulk	6



STANDARD DUTY RATCHETS

**STANDARD
DUTY**

- Secure medium-weight cargo up to 660 lbs
- Ideal for securing motorcycles, ATVs, generators, and more
- Vinyl-coated steel hooks won't scratch or mar

Part Number	Description	Length	Capacity	Qty/Pkg	Package	Qty/Carton
9547300	1" Webbing Retractable Truck Bed Ratchet with S Hooks	9'	400/1200 lb	2	Box	2
9511100	1" Webbing with Padded Handle and S Hooks	10'	400/1200 lb	4	Open	3
9521700	1" Webbing Retractable with S Hooks	10'	400/1200 lb	2	Open	3
9547000	1" Webbing with Metal Handle and S Hooks	6'	500/1500 lb	2	Box	4
9425500	1" Webbing Retractable with S Hooks	6'	500/1500 lb	2	Open	3
9546700	1" Webbing Retractable with S Hooks	6'	500/1500 lb	1	Bulk	4
9482700	1" Webbing with Aluminum Grip Handle and S Hooks	10'	500/1500 lb	2	Open	4
9482800	1" Webbing with Aluminum Grip Handle and S Hooks	10'	500/1500 lb	4	Open	3
9485300	1" Webbing with Aluminum Grip Handle and S Hooks	10'	500/1500 lb	1	Bulk	4
9485600 NEW	1" Webbing with Aluminum Grip Handle and Slip Safe Hooks	10'	500/1500 lb	4	Open	3
9546300	1" Endless Webbing	12'	500/1500 lb	1	Bulk	8
9512900 NEW	1" Webbing with Padded Handle and S Hooks	15'	500/1500 lb	2	Open	4
9513000 NEW	1" Webbing with Padded Handle and S Hooks	15'	500/1500 lb	4	Open	3
9425900	1" Webbing with Aluminum TITAN Grip Handle and S Hooks	6'	600/1800 lb	2	Open	4
9510500	1" Webbing with Aluminum Full Grip Sport Handle and S Hooks	10'	600/1800 lb	2	Open	4
9510400	1" Webbing with Aluminum Full Grip Sport Handle and S Hooks	10'	600/1800 lb	4	Open	3
9522600 NEW	1" Webbing with Aluminum REBEL T-Handle and S Hooks	10'	600/1800 lb	2	Open	4
9522700 NEW	1" Webbing with Aluminum REBEL T-Handle and S Hooks	10'	600/1800 lb	4	Open	3

Part Number	Description	Length	Capacity	Qty/Pkg	Package	Qty/Carton
9425100	1" Webbing with Grip Handle and S Hooks	10'	600/1800 lb	4	Open	3
9426100	1" Webbing with Aluminum TITAN Grip Handle and S Hooks	10'	600/1800 lb	4	Open	3
9514100	NEW 1" Webbing with Padded Handle and S Hooks	14'	600/1800 lb	4	Open	3

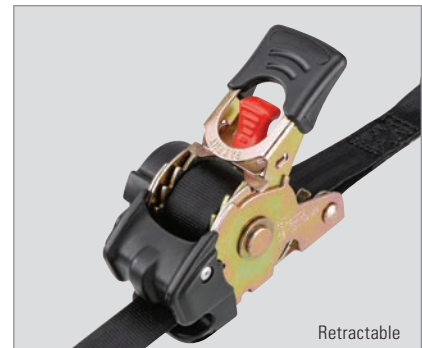
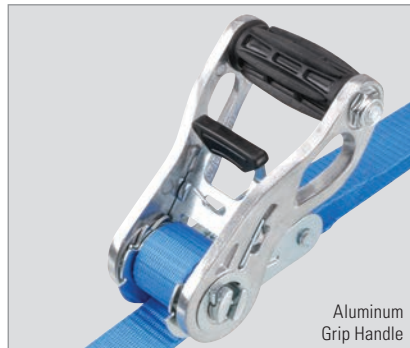

HEAVY DUTY RATCHETS

HEAVY DUTY

- Secure heavy loads up to 1660 lbs
- Ideal for lawn tractors, UTVs, golf carts, lumber, and more
- High-capacity, coated steel hooks

Part Number	Description	Length	Capacity	Qty/Pkg	Package	Qty/Carton
9521600 NEW	1" Webbing Lawn Tractor Tie Down Kit: - 4 Grip Handle Ratchets with Vinyl-Coated S Hooks - 4 Soft Axle Straps to Provide Secure Attachment Points	10'	1000/3000 lb	4 ea.	Box	3
9427300	2" Webbing Retractable with S Hooks	10'	1000/3000 lb	1	Bulk	4
9547200	1" Webbing with Grip Handle and S Hooks	12'	1000/3000 lb	1	Bulk	4
9425200	1" Webbing with Grip Handle and S Hooks	14'	1000/3000 lb	4	Open	3
9426001	1" Webbing with Aluminum MAX GRIP Open Handle and S Hooks	14'	1000/3000 lb	2	Open	4
9426200	1" Webbing with Aluminum MAX GRIP Open Handle and S Hooks	14'	1000/3000 lb	4	Open	3
9514200	1" Webbing with Aluminum MAX GRIP Open Handle and S Hooks	14'	1000/3000 lb	1	Bulk	4
9511600	1" Webbing with Metal Handle and Double J Hooks	15'	1000/3000 lb	1	Bulk	6
9511602 NEW	1" Webbing with Metal Handle and Double J Hooks	15'	1000/3000 lb	1	Bulk	4
9522800 NEW	1" Webbing with Aluminum REBEL T-Handle and S Hooks	15'	1000/3000 lb	2	Open	4
9522900 NEW	1" Webbing with Aluminum REBEL T-Handle and S Hooks	15'	1000/3000 lb	4	Open	3
9523200 NEW	1" Webbing with Aluminum REBEL T-Handle and S Hooks	15'	1000/3000 lb	1	Bulk	4
9546900	2" Webbing Retractable with S Hooks	6'	1100/3300 lb	1	Bulk	4
9546800	1.25" Webbing with Grip Handle and S Hooks	10'	1100/3300 lb	2	Open	3
9514800	1" Webbing with Open Handle and S Hooks	12'	1500/4500 lb	2	Open	4
9514900	1" Webbing with Open Handle and S Hooks	12'	1500/4500 lb	1	Bulk	4
9510200	1.25" Webbing with Grip Handle and S Hooks	12'	1500/4500 lb	2	Open	3
9510100	1.25" Webbing with Grip Handle and S Hooks	12'	1500/4500 lb	1	Bulk	4



SUPER DUTY RATCHETS

SUPER DUTY

- For the serious professional to secure heavy cargo up to 3300 lbs
- Ideal for heavy equipment, large loads, building materials, UTVs, and more
- Super strong steel hooks

Part Number	Description	Length	Capacity	Qty/Pkg	Package	Qty/Carton
9425300	1.5" Webbing with Grip Handle and Double J Hooks	14'	1830/5500 lb	1	Bulk	2
9482000	1.5" Webbing with Grip Handle and Double J Hooks	15'	1830/5500 lb	2	Open	3
9482002 NEW	1.5" Webbing with Grip Handle and Double J Hooks	15'	1830/5500 lb	1	Open	4
9429700	1.5" Webbing with Aluminum MAX GRIP Open Handle and Double S Hooks	15'	1830/5500 lb	1	Open	4

Part Number	Description	Length	Capacity	Qty/Pkg	Package	Qty/Carton
9511300	1.5" Webbing with Aluminum MAX GRIP Open Handle and Double S Hooks	15'	1830/5500 lb	1	Bulk	4
9512000	1.5" Webbing with Grip Handle and Flat Hooks	20'	1830/5500 lb	1	Bulk	4
9512002 NEW	1.5" Webbing with Grip Handle and Flat Hooks	20'	1830/5500 lb	1	Bulk	2
9482400	2" Webbing with Grip Handle and Double J Hooks	27'	3300/10,000 lb	1	Bulk	4
9482402	2" Webbing with Grip Handle and Double J Hooks	27'	3300/10,000 lb	1	Bulk	2
9523100 NEW	2" Webbing with T-Handle and Double J Hooks	27'	3300/10,000 lb	1	Bulk	2
9523300 NEW	2" Webbing with T-Handle and Double J Hooks	27'	3300/10,000 lb	1	Bulk	4
9534800 NEW	2" Webbing with Grip Handle and Flat Hooks	30'	3300/10,000 lb	1	Bulk	2
9546600	2" Webbing with Grip Handle and Flat Hooks Built in Webbing Keeper	30'	3300/10,000 lb	1	Bulk	6



CAMO RATCHETS



- Camouflage everything but the strength
- Proprietary camo-print webbing
- Realistic woodland pattern

Part Number	Description	Length	Capacity	Qty/Pkg	Package	Qty/Carton
9514500	LIGHT DUTY 1" Webbing with Metal Handle and S Hooks	6'	300/900 lb	4	Open	3
9514700	STANDARD DUTY 1" Webbing Retractable with S Hooks	6'	400/1200 lb	2	Open	3
9485500	STANDARD DUTY 1" Webbing with Metal Handle and S Hooks	8'	400/1200 lb	1	Bulk	10
9485502 NEW	STANDARD DUTY 1" Webbing with Metal Handle and S Hooks	8'	400/1200 lb	1	Bulk	4
9547700 NEW	Camo Value Pack: - STANDARD DUTY 1" Webbing with Metal Handle and S Hooks - Camo Bungee Straps	(2) 8' (4) 24" (4) 32"	400/1200 lb - -	10	Box	4
9511700	STANDARD DUTY 1" Webbing with Metal Handle and S Hooks	6'	500/1500 lb	2	Open	4
9485700 NEW	STANDARD DUTY 1" Webbing with Aluminum Grip Handle and S Hooks	10'	500/1500 lb	1	Bulk	4
9485900 NEW	STANDARD DUTY 1" Webbing with Aluminum Grip Handle and S Hooks	10'	500/1500 lb	4	Open	3
9485800 NEW	STANDARD DUTY 1" Webbing with Aluminum Grip Handle and S Hooks	10'	500/1500 lb	2	Open	4
9521400	STANDARD DUTY 1" Webbing with Aluminum Full Grip Sport Handle and S Hooks	10'	600/1800 lb	2	Open	4
9513400 NEW	HEAVY DUTY 1" Webbing with Grip Handle and S Hooks	12'	1000/3000 lb	2	Open	4
9511200	HEAVY DUTY 1.25" Webbing with Grip Handle and S Hooks	10'	1100/3300 lb	2	Open	3
9511800	SUPER DUTY 2" Webbing with Grip Handle and Double J Hooks	16'	3300/10,000 lb	1	Bulk	4
9511802 NEW	SUPER DUTY 2" Webbing with Grip Handle and Double J Hooks	16'	3300/10,000 lb	1	Bulk	2
9523000 NEW	SUPER DUTY 2" Webbing with T-Handle and Double J Hooks	16'	3300/10,000 lb	1	Bulk	2

LIGHT DUTY CAMBUCKLES

**LIGHT
DUTY**

- Secure light cargo up to 330 lbs
- Fast and easy to use
- Release instantly with thumb pressure

Part Number	Description	Length	Capacity	Qty/Pkg	Package	Qty/Carton
9481600	1" Webbing with Metal Handle and S Hooks	6'	300/900 lb	1	Bulk	10
9424700	1" Webbing with Metal Handle and S Hooks	6'	300/900 lb	4	Open	3
9482100	1" Webbing with Metal Handle and S Hooks	8'	300/900 lb	4	Open	3
9547600	1" Webbing with Metal Handle and S Hooks	10'	300/900 lb	1	Box	3
9521500	1" Webbing Push Mower Cambuckle with Flat Hooks	10'	300/900 lb	2	Open	3



STANDARD DUTY CAMBUCKLES

**STANDARD
DUTY**

- Secure medium-weight cargo up to 660 lbs
- Just press and tighten
- Coated steel hooks prevent scratches

Part Number	Description	Length	Capacity	Qty/Pkg	Package	Qty/Carton
9512800 NEW	1" Webbing with Surelok® and S Hooks	6'	400/1200 lb	2	Open	4
9520200	1" Webbing with Push Button and S Hooks	8'	400/1200 lb	2	Open	4
9520300	1" Webbing with Push Button and S Hooks	8'	400/1200 lb	1	Bulk	6
9520500	1" Webbing with Push Button and S Hooks - Camo	8'	400/1200 lb	1	Bulk	6
9520600	1" Webbing with Metal Handle and S Hooks	12'	400/1200 lb	1	Box	6
9429500	1" Webbing with Loop End and S Hooks	6'	430/1300 lb	2	Open	4
9520700	1" Webbing with Metal Handle and S Hooks	8'	430/1300 lb	2	Open	4

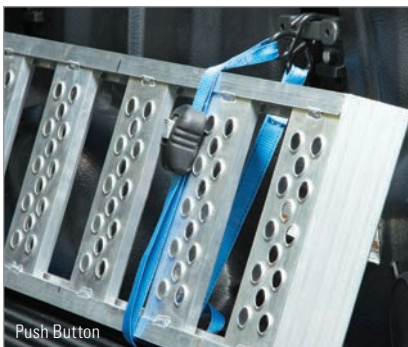

HEAVY DUTY CAMBUCKLE

HEAVY
DUTY

- Secure heavy loads up to 1660 lbs
- Made with heavy-duty webbing
- Release instantly with thumb pressure

Part Number	Description	Length	Capacity	Qty/Pkg	Package	Qty/Carton
9547800	2" Webbing with Metal Handle and S Hooks	12'	830/2500 lb	1	Bulk	6



VEHICLE TIE DOWNS

- Ideal for securing vehicles on trailers
- Snap hooks for sure attachment

Part Number	Description	Length	Capacity	Qty/Pkg	Package	Qty/Carton
9547100	2" Over Wheel Ratchet - For Up To 9" Width Wheels	9"	2000/6000 lb	1	Bulk	2
9514600	1.5" Vehicle Ratchet	7'	1667/5000 lb	1	Bulk	4

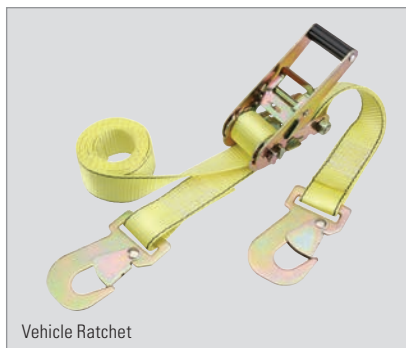

LASHING STRAP

- Quick and easy buckle

Part Number	Description	Length	Capacity	Qty/Pkg	Package	Qty/Carton
9520400	1" Lashing Strap	12'	100/300 lb	2	Box	3

STRENGTH MATTERS





There are hundreds of uses for a bungee cord. REESE® Secure offers a full variety to meet your need.

BUNGEE CORDS

HIGH STRENGTH	
Fat Strap Bungees	178
Triple Strength Bungees	179
Industrial Bungees	180
STANDARD	
Camo Bungees	180
Standard Bungees	181
SPECIALTY	
Quick Wrap Bungees	182
Corner Protect Bungees	182
Mini Bungees	182
Canopy Ties	183
6-Arm Bungee	183

FAT STRAP® BUNGEEES



- Extra-wide strap won't damage or dig into your cargo
- Strong, coated steel hooks
- Patented design

BUNGEE CORDS

Part Number	Description	Length	Color	Qty/Pkg	Package	Qty/Carton
9481000	Fat Strap	24"	Red	2	Bulk	8
9531900 NEW	Fat Strap	24"	Red	2	Bulk	6
9481100	Fat Strap	36"	Blue	2	Bulk	8
9532000 NEW	Fat Strap	36"	Blue	2	Bulk	6
9481200	Fat Strap	48"	Green	2	Bulk	8
9526600	Adjustable Fat Strap	10"- 48"	Orange	1	Wrap	6
9481300	Adjustable Fat Strap	10"- 48"	Orange	2	Bulk	8
9532100 NEW	Adjustable Fat Strap	10"- 48"	Orange	2	Bulk	6
9423000	Fat Strap Assortment	(2)30" (2)20" (2)15"	Assorted	6	Jar	6
9429100	Fat Strap Assortment	(2)35" (2)20" (2)15"	Assorted	6	Jar	4
9432700	Fat Strap Assortment	(1)45" (2)35" (3)20" (4)15"	Assorted	10	Jar	4



TRIPLE STRENGTH BUNGEEES



- Coated steel hooks
- Won't bend, break, scratch or mar
- Conveniently color-coded by length

Part Number	Description	Length	Color	Qty/Pkg	Package	Qty/Carton
9528600	Triple Strength	18"	Purple	2	Bulk	10
9480700	Triple Strength	24"	Red	2	Bulk	8
9480800	Triple Strength	36"	Blue	2	Bulk	8
9480900	Triple Strength	48"	Green	2	Bulk	6
9485400	Triple Strength	52"	Orange	2	Bulk	6
9548400	Triple Strength Assortment	(1)32" (2)24" (2)18"	Assorted	5	Polybag	6
9548500 NEW	Triple Strength Assortment	(1)32" (2)24" (2)18"	Assorted	5	Jar	6
9529500	Triple Strength Assortment	(2)40" (4)32" (4)24"	Assorted	10	Jar	3

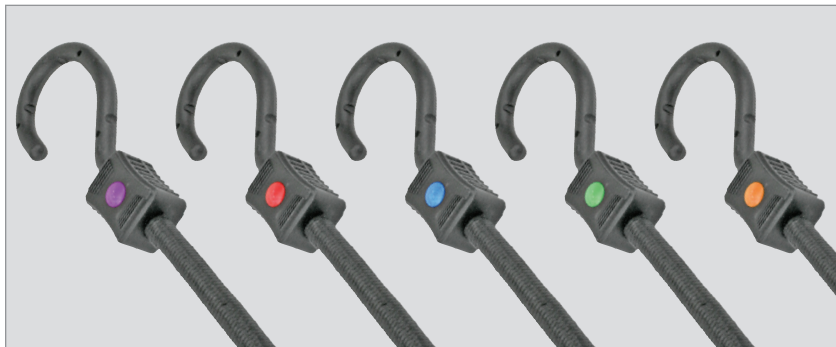

BUNGEE CORDS

WHICH BUNGEE DO YOU NEED?



STANDARD BUNGEE

- Extra-wide hook opening for improved fit and performance
- Stronger than conventional hooks
- Non-mar, no-rust coated steel hooks



TRIPLE STRENGTH BUNGEE

- High-strength steel hooks are 3 times stronger than conventional hooks
- Coated steel hooks won't bend, break, scratch or mar



FAT STRAP® BUNGEE

- Pressure is evenly distributed across wide band to protect cargo better
- Flat design prevents sliding and increases safety
- Coated steel hooks won't bend, break, scratch or mar

INDUSTRIAL BUNGEEES

- Thick cord for greater tension
- Rubber-tipped hooks prevent scratches
- Dichromate hooks provide corrosion resistance

Part Number	Description	Length	Color	Qty/Pkg	Package	Qty/Carton
9526500	Industrial Bungee	18"	Black	1	Bulk	20
9526200	Industrial Bungee	24"	Black	1	Bulk	25
9526300	Industrial Bungee	32"	Black	1	Bulk	20
9526400	Industrial Bungee	48"	Black	1	Bulk	20

BUNGEE CORDS



CAMO BUNGEEES

- Perfect for hunters and campers
- UV-resistant to withstand outdoor elements

Part Number	Description	Length	Color	Qty/Pkg	Package	Qty/Carton
9548700	Standard Bungee	24"	Camo	2	Polybag*	6
9526000	Bungee Assortment	(1)40" (1)32" (2)24" (3)18" (3)Mini (2)Canopy	Camo	12	Jar	4
9436100	Bungee Assortment	(2)32" (3)24" (2)18" (4)Mini (4)Canopy (1) O-Ring	Camo	16	Jar	3

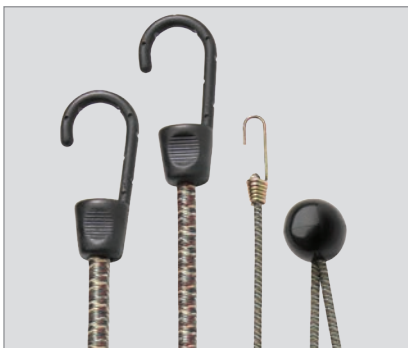

* Comes in New Polybag Design - See Page 182

STANDARD BUNGEEES

- Multi-strand, top-quality rubber cords for superior strength
- Coated steel hooks with extra-wide hook openings
- UV-resistant polypropylene jacket

Part Number	Description	Length	Color	Qty/Pkg	Package	Qty/Carton
9530500	Standard Bungee	12"	Black	2	Polybag	6
9528000	Standard Bungee	18"	Blue	2	Polybag	6
9528100	Standard Bungee	24"	Red	2	Polybag	6
9480400	Standard Bungee	24"	Red	2	Bulk	15
9531500 NEW	Standard Bungee	24"	Red	2	Bulk	6
9528200	Standard Bungee	32"	Green	2	Polybag	6
9480500	Standard Bungee	36"	Blue	2	Bulk	12
9531600	Standard Bungee	36"	Blue	2	Bulk	6
9528300	Standard Bungee	40"	Yellow	2	Polybag	6
9480600	Standard Bungee	48"	Green	2	Bulk	12
9531700	Standard Bungee	48"	Green	2	Bulk	6
9529400	Adjustable Bungee	6" - 40"	Yellow	1	Wrap	6
9532200 NEW	Adjustable Bungee	6" - 40"	Yellow	2	Bulk	6
9529100 NEW	Bungee Assortment	(1)32" (1)24" (2)18" (2)Mini	Assorted	6	Polybag	6
9428900	Bungee Assortment	(2)30" (2)20" (2)15" (2)Mini (2)Canopy	Assorted	10	Jar	4
9528800	Bungee Assortment	(1)40" (1)32" (2)24" (3)18" (3)Mini (2)Canopy	Assorted	12	Jar	8
9531400 NEW	Bungee Assortment	(2)32" (4)24" (4)18" (4)Mini	Assorted	14	Rack	4
9429000	Bungee Assortment	(2)40" (2)30" (4)20" (4)15" (6)Mini (2)Canopy	Assorted	20	Jar	4
9527300	Bungee Assortment	(2)40" (2)32" (4)24" (6)18" (6)Mini (4)Canopy	Assorted	24	Jar	6

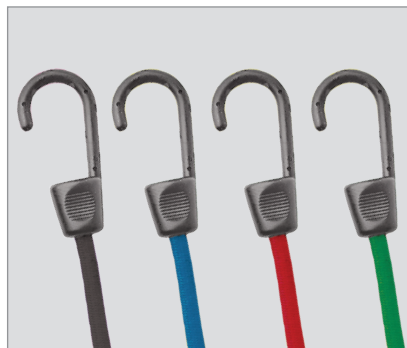

QUICK WRAP BUNGEEES

- One adjustable looped end creates soft anchor
- Wrapping and anchoring made easier

Part Number	Description	Length	Color	Qty/Pkg	Package	Qty/Carton
9529200	Quick Wrap Bungee	32"	Green	2	Wrap	4
9527100	Quick Wrap Bungee	32"	Green	2	Bulk	6
9529300	Quick Wrap Bungee	40"	Yellow	2	Wrap	4
9527200	Quick Wrap Bungee	40"	Yellow	2	Bulk	6

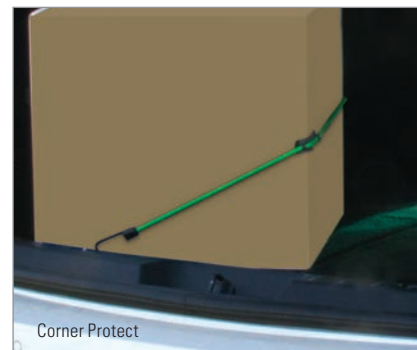
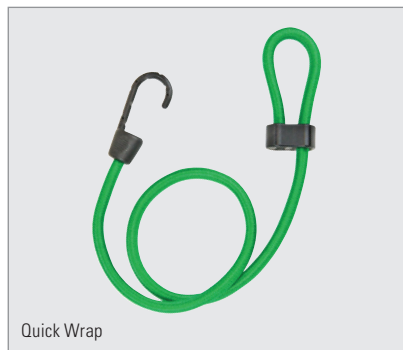

BUNGEE CORDS

CORNER PROTECT BUNGEEES

- Movable rubber pad protects fragile edges
- Withstand harshest weather conditions

Part Number	Description	Length	Color	Qty/Pkg	Package	Qty/Carton
9527500	Corner Protect Bungee	32"	Green	2	Bulk	8
9527600	Corner Protect Bungee	40"	Yellow	2	Bulk	6

MINI BUNGEEES

- Ideal for bundling small objects
- Hold stronger, last longer

Part Number	Description	Length	Color	Qty/Pkg	Package	Qty/Carton
9528500	Mini Bungee	10"	Assorted	4	Polybag*	12
9423200	Mini Bungee	10"	Assorted	20	Jar	6



CANOPY TIES

- Stretch tarps and canopies tight
- UV-resistant

Part Number	Description	Length	Color	Qty/Pkg	Package	Qty/Carton
9548300	Canopy Tie	8"	Black	4	Polybag	6
9427600	Canopy Tie	8"	Black	8	Jar	6
9533100 NEW	Canopy Tie	10"	Black	12	Jar	4
9527000	Adjustable Canopy Tie	12"	Black	8	Jar	4

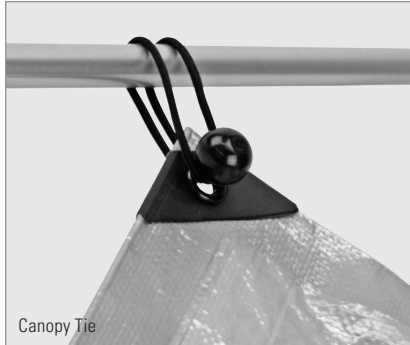

6-ARM BUNGEE

- Quick and easy to secure extra cargo
- Extra-wide hook openings

Part Number	Description	Length	Color	Qty/Pkg	Package	Qty/Carton
9530900	6-Arm Bungee	36"	Black	1	Polybag	6



BUNGEE CORDS

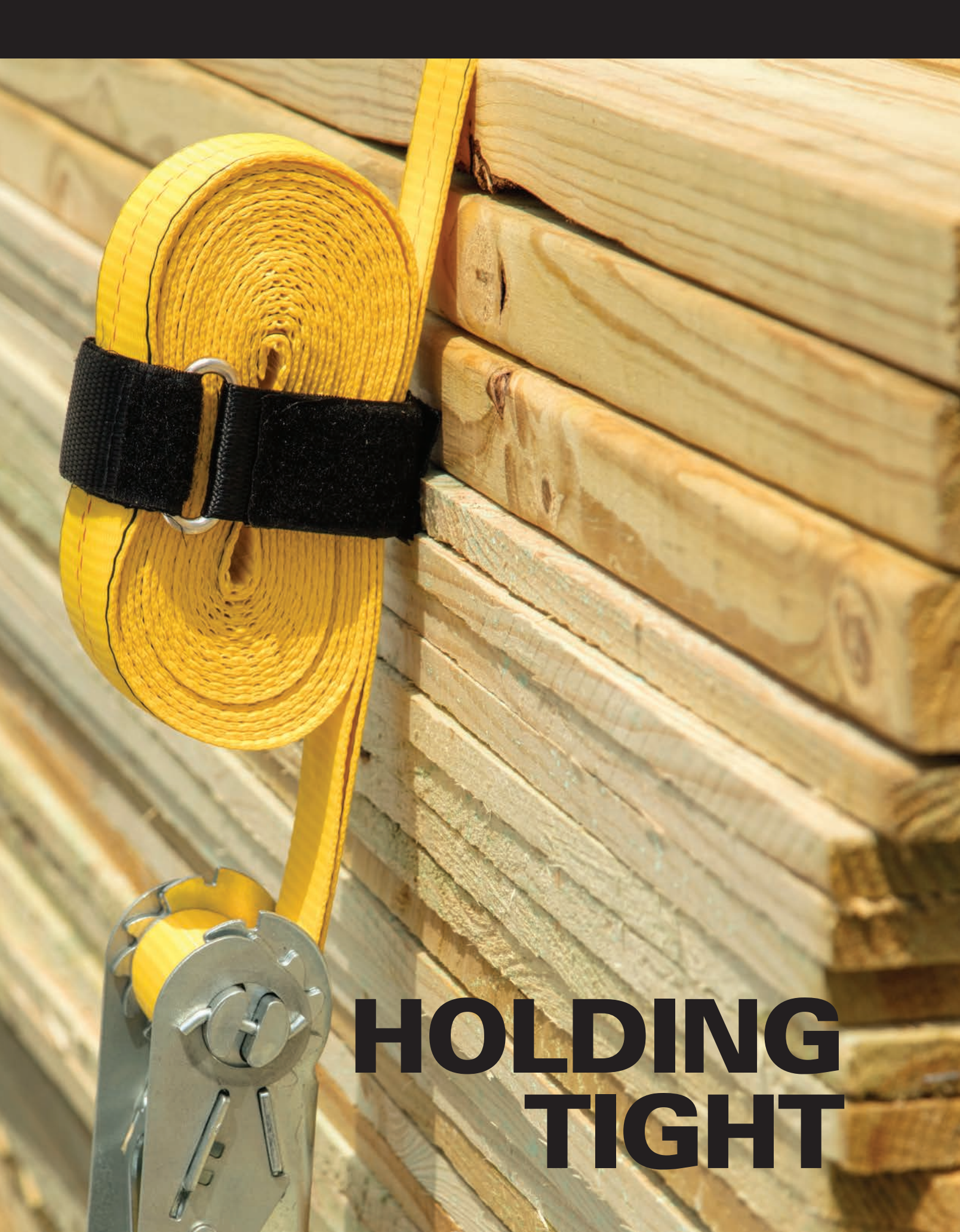

**HOLDING
TIGHT**



FASTENERS

Whether it's blowing tarps, tangled electrical cords, or extra strap webbing, REESE® Secure offers fasteners to help you hold it fast.

TARP FASTENERS

EPDM Tarp Straps	186
Tarp Clips	186

SPECIALTY

Secure Wraps	187
Carabiners	187
Cable Ties	187
Wrap-Tyte Ties	187



MULTI-PURPOSE EPDM RUBBER TARP STRAPS

- Constructed of UV- and ozone-resistant EPDM material
- Won't rot or lose stretchability when exposed to the elements

Part Number	Description	Length	Qty/Pkg	Package	Qty/Carton
9524000	Tarp Strap	15"	2	Polybag	6
9524400	Tarp Strap	15"	1	Bulk	10
9524600 NEW	Tarp Strap	15"	1	Bulk	6
9524100	Tarp Strap	21"	2	Polybag	6
9481700	Tarp Strap	21"	1	Bulk	10
9524700 NEW	Tarp Strap	21"	1	Bulk	6
9524200	Tarp Strap	31"	2	Polybag	6
9481800	Tarp Strap	31"	1	Bulk	10
9524800 NEW	Tarp Strap	31"	1	Bulk	6
9524300	Tarp Strap	41"	2	Polybag	6
9546000	Tarp Strap	41"	1	Bulk	15
9524900 NEW	Tarp Strap	41"	1	Bulk	6
9531000	Adjustable Tarp Strap	9"-41"	1	Wrap	8
9481900	Adjustable Tarp Strap	9"-41"	1	Bulk	8
9429300	Tarp Strap Assortment	(2)31" (2)21" (2)15"	6	Jar	4
9432800	Tarp Strap Assortment	(2)31" (4)21" (4)15"	10	Jar	4

FASTENERS

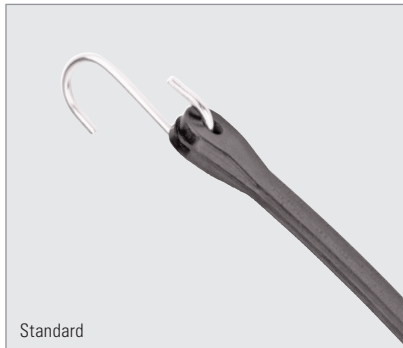

TARP CLIPS

- Secure tarps, canopies and covers
- Heavy-duty, crack-resistant

Part Number	Description	Color	Qty/Pkg	Package	Qty/Carton
9532900	Tarp Clip	Black	1	Bulk	50
9429400	Tarp Clip	Black	4	Jar	6

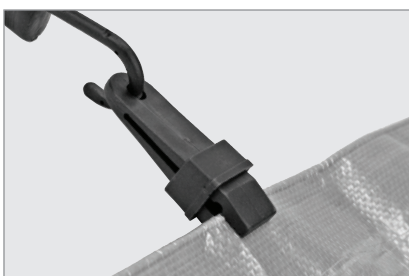

SECURE WRAPS

- Heavy-duty hook-and-loop with buckle
- Keeps excess webbing tightly secured
- Reusable for endless other storage uses

Part Number	Description	Length	Qty/Pkg	Package
9551000 NEW	1" Secure Wrap, Small	Adjust 1/4"-3"	1	Card
9551100 NEW	1.5" Secure Wrap, Large	Adjust 1/4"-4 1/2"	1	Card



CARABINERS

- Clip to tool belts
- Indoor and outdoor use
- Made of anodized aluminum

Part Number	Description	Color	Qty/Pkg	Package
9423700	Carabiner	Assorted	2	Card

CABLE TIES

- Assorted lengths and strengths
- Handy, reusable storage container
- 100% nylon construction

Part Number	Description	Color	Qty/Pkg	Package
9526900	Nylon Cable Ties	Assorted	650	Jar

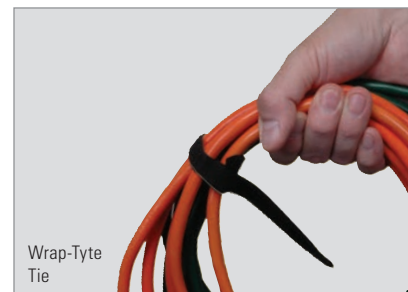
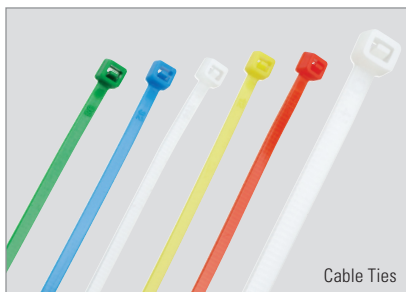

WRAP-TYTE TIES

- Reusable hook-and-loop ties
- Ideal for automotive, garage and home
- Indoor and outdoor use

Part Number	Description	Color	Dimensions	Qty/Pkg	Package
9423900	Wrap-Tyte Tie	Black	1/2" x 12"	8	Card

FASTENERS

ALL SECURE



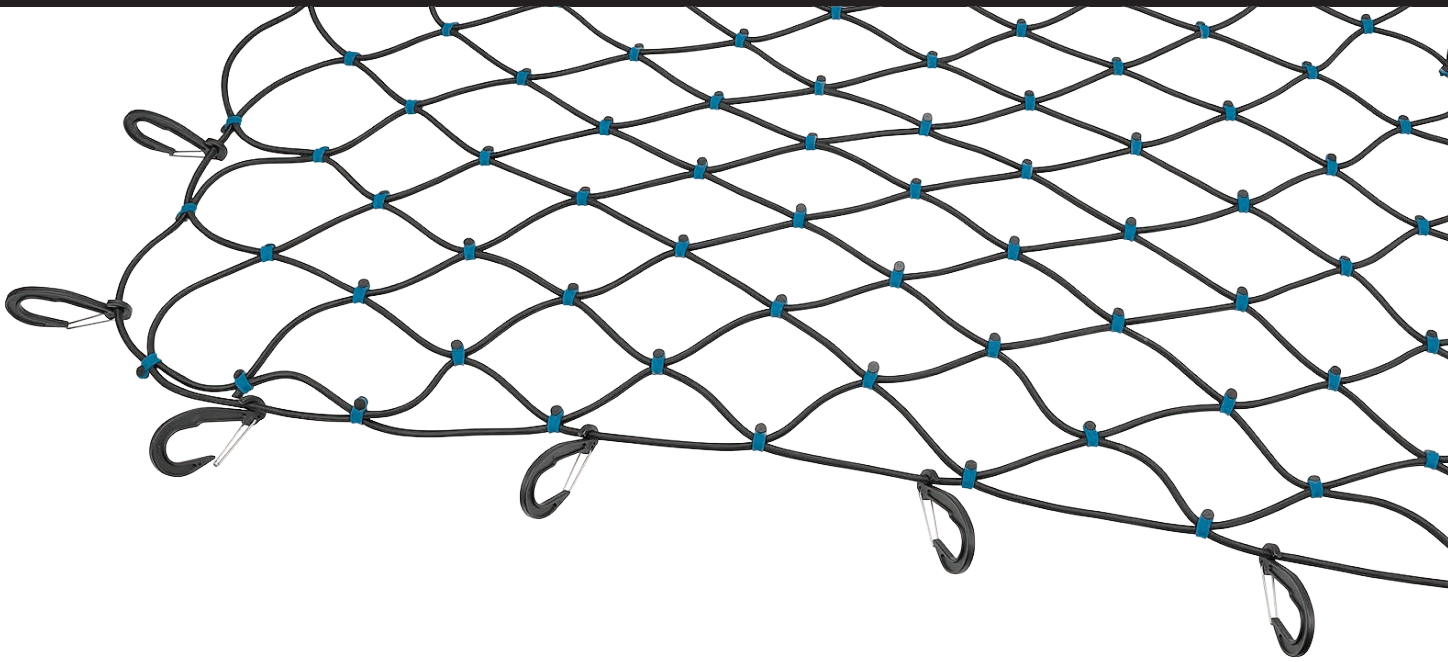

CARGO NETS & COVERS

Living an active lifestyle means having the ability to quickly load up and go. REESE® Secure provides the solution.

CARGO NETS

Cargo Nets	190
Deluxe Cargo Nets	191

STORAGE COVERS

Motorcycle Cover	190
------------------------	-----



CARGO NETS

- Secure loads quickly
- UV-resistant and weather-resistant
- Easy solution for light loads

Part Number	Description	Dimensions	Color	Qty/Pkg	Package
1393700	Cargo Net	36" x 48"	Black	1	Box
9424100	Bungee Truck Net	60" x 78"	Black	1	Box
9424200	Adjustable Truck Net	55" x 78"	Black	1	Box
9550700 NEW	Kayak Deck Net	12" x 12"	Black	1	Polybag*



MOTORCYCLE COVER

- Ideal for motorcycle storage
- Protects against dust, dirt and weather
- Elastic bottom creates a custom fit

Part Number	Description	Dimensions	Qty/Pkg	Package
9530100	Motorcycle Cover w/ Storage Bag	108" x 50"	1	Box



* Comes in New Polybag Design

DELUXE CARGO NETS

- Exclusive no-tangle, impact-resistant hook design
- Stretch to quickly secure complex loads
- Rubber gear protectors throughout to protect from scratches
- Heavy-duty storage bag included

Part Number	Description	Dimensions	Color	Qty/Pkg	Package
9427200 NEW	Bungee Cargo Net	36" x 48"	Black	1	Storage Bag
9427100 NEW	Bungee Truck Net	60" x 78"	Black	1	Storage Bag



Cargo Net



Anti-Tangle Hook



Truck Net



Storage Bag

ATV AND UTV COVERS AVAILABLE FROM
REESE POWERSPORTS

See page 233 for
 info and options.



THE PERFECT POINT





Combining strength and convenience, REESE® Secure has the perfect securing points to get your load there safely.

ANCHORING



TRUCK

- Stake Pocket Anchor Points 194
- Heavy-Duty Bull Ring Stake Pocket Anchor Point . . . 195
- Pop-up Stake Pocket Anchor Point 195

TRAILERING

- Recess-Mount Ring Anchors 196
- Surface-Mount Ring Anchors 196
- Movable Anchor 197
- Sure Step Self-Stick Rubber Mats 197

HIGH-QUALITY ANCHOR POINTS ENSURE SAFE AND SECURE TIE DOWN ATTACHMENT TO TRUCKS AND TRAILERS.



- Variety of mounting options available: movable, stake pocket, recessed, and surface-mounted anchor points
- Allow secure attachment points for ropes or tie downs
- Engineered in the USA to the highest standards
- Quality tested and approved

STAKE POCKET ANCHOR POINTS

- No-drill installation
- Fits all trucks with or without bed liners
- Safe and secure tie down attachment

Part Number	Description	Qty/Pkg	Package
9423800	Universal Chrome Anchor Point	2	Box
9420800	Universal Chrome Anchor Point	1	Bulk
9429800	Eyebolt Anchor Point	1	Bulk

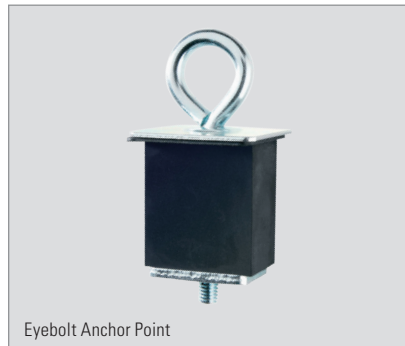
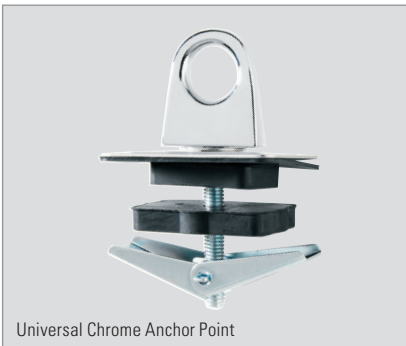

HEAVY-DUTY BULL RING STAKE POCKET ANCHOR POINT

- Retractable, universal fit
- Stainless steel eye
- No-drill installation

Part Number	Description	Capacity	Qty/Pkg	Package
9521200	Bull Ring Retractable Anchor Point	1000/3000 lb	2	Open



POP-UP STAKE POCKET ANCHOR POINT

- Remains flush when not in use
- Snaps up for use
- Universal fit

Part Number	Description	Qty/Pkg	Package
9549600	Pop-Up Anchor Point	2	Box



RECESS-MOUNT RING ANCHORS



- For use on trailers or truck beds
- Ring lays flush when not in use
- Mounting hardware included—grade 5 bolts

Part Number	Description	Capacity	Qty/Pkg	Package
9549300	Ring Anchor	400/1200 lb	1	Bulk
9549400	Ring Anchor	1600/4800 lb	1	Bulk



9549300



9549400

SURFACE-MOUNT RING ANCHORS



- Safely secure loads with floor- or wall-mounted tie down hardware
- Designed for trucks, trailers, or vans

Part Number	Description	Capacity	Qty/Pkg	Package
9549200	Ring Anchor	333/1000 lb	1	Bulk
9549100	Ring Anchor	400/1200 lb	1	Bulk
9549900 NEW	D-Ring Anchor Point	400/1200 lb	4	Card
9549000	Heavy-Duty Ring Anchor	1600/4800 lb	1	Bulk
9548900 NEW	D-Ring Anchor Point	1600/4800 lb	2	Card
9512700	Forged Ring Anchor	4000/12,000 lb	1	Bulk
9549700	Weld-On Flip Anchor	5000/15,000 lb	1	Bulk

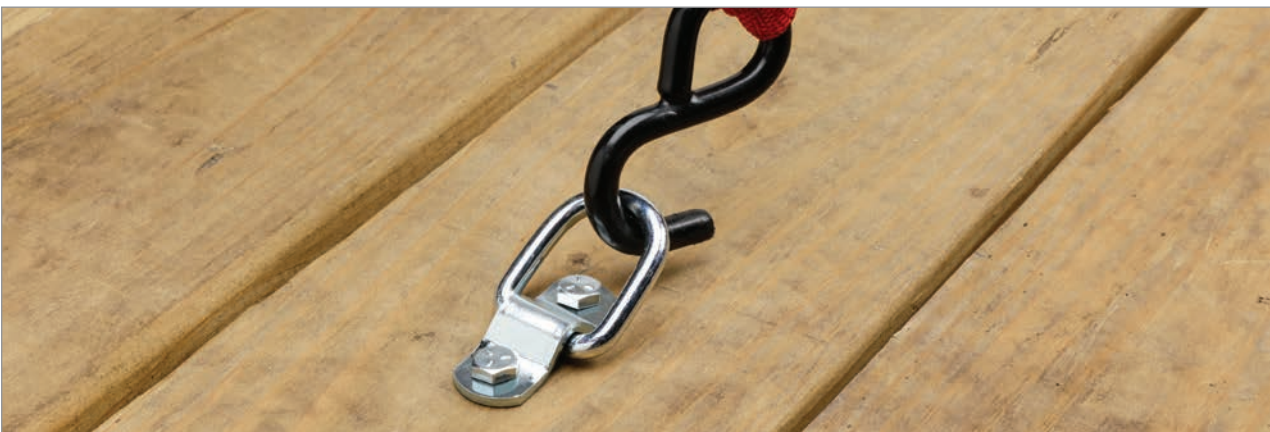

MOVABLE ANCHOR

- Use anywhere along entire side rail
- Easily transportable from truck to trailer
- Easy to install—no tools required

Part Number	Description	Capacity	Qty/Pkg	Package
9549500	Heavy-Duty Movable Anchor	1000/3000 lb	1	Bulk



SURE STEP SELF-STICK RUBBER MATS

- Self-stick, heavy-duty adhesive backing
- Adheres anywhere a non-skid surface is needed
- Weather-resistant material

Part Number	Description	Dimensions	Qty/Pkg	Package
1041200	Sure Step	4" x 15.5"	2	Bulk w/Sleeve
9547400	Sure Step	4" x 17.5"	2	Polybag





**TO THE
RESCUE**



Being prepared requires high-quality products ready to perform when needed. REESE® Secure has you covered in those unexpected situations.

RECOVERY



TOW STRAPS

Hook-End Tow Straps	200
Loop-End Tow Straps	200
Tow Rope	201
Shackles	202
Tree Saver	202

AXLE STRAPS	203
-------------------	-----

WINCH STRAPS	203
--------------------	-----

TOW STRAPS WITH HOOK ENDS



- Super-duty webbing
- Hook ends attach to recovery point locations
- Zinc-plated, forged hooks

Part Number	Description	Length	Capacity	Qty/Pkg	Package
9545200	2" Tow Strap with Hook Ends	15'	3300/10,000 lb	1	Bulk
9533700	2" Reflective Tow Strap with Hook Ends	15'	3300/10,000 lb	1	Bulk
9534000	2" Tow Strap with Hook Ends	20'	3300/10,000 lb	1	Bulk
9426300	2" Reflective Tow Strap with Hook Ends	20'	3300/10,000 lb	1	Bulk
9534100	2" Tow Strap with Hook Ends	30'	3300/10,000 lb	1	Bulk
9426500	2" Reflective Tow Strap with Hook Ends	30'	3300/10,000 lb	1	Bulk



TOW STRAPS WITH LOOP ENDS



- Super-duty webbing
- Loop ends attach around vehicle frame or shackle

Part Number	Description	Length	Capacity	Qty/Pkg	Package
9427500	2" ATV Tow Strap with Shackle	12'	1660/5000 lb	1	Box
9426400	2" Reflective Tow Strap with Loop Ends	20'	5660/17,000 lb	1	Bulk
9545100	3" Tow Strap with Loop Ends	30'	10,000/30,000 lb	1	Bulk
9545300	4" Tow Strap with Loop Ends	30'	11,600/35,000 lb	1	Bulk



HELPFUL HINTS WHEN USING RECOVERY STRAPS:

1. Never attach a recovery strap to vehicle's bumper, axles, suspension, steering rods, or trailer hitch ball.
2. Before using the strap, make sure it is in good condition (no cuts, frays, or broken stitching).
3. When freeing a stuck vehicle, drive very slowly. Sudden tugs may damage the vehicle or strap.
4. Choose reflective straps for improved safety in low-light emergency situations.

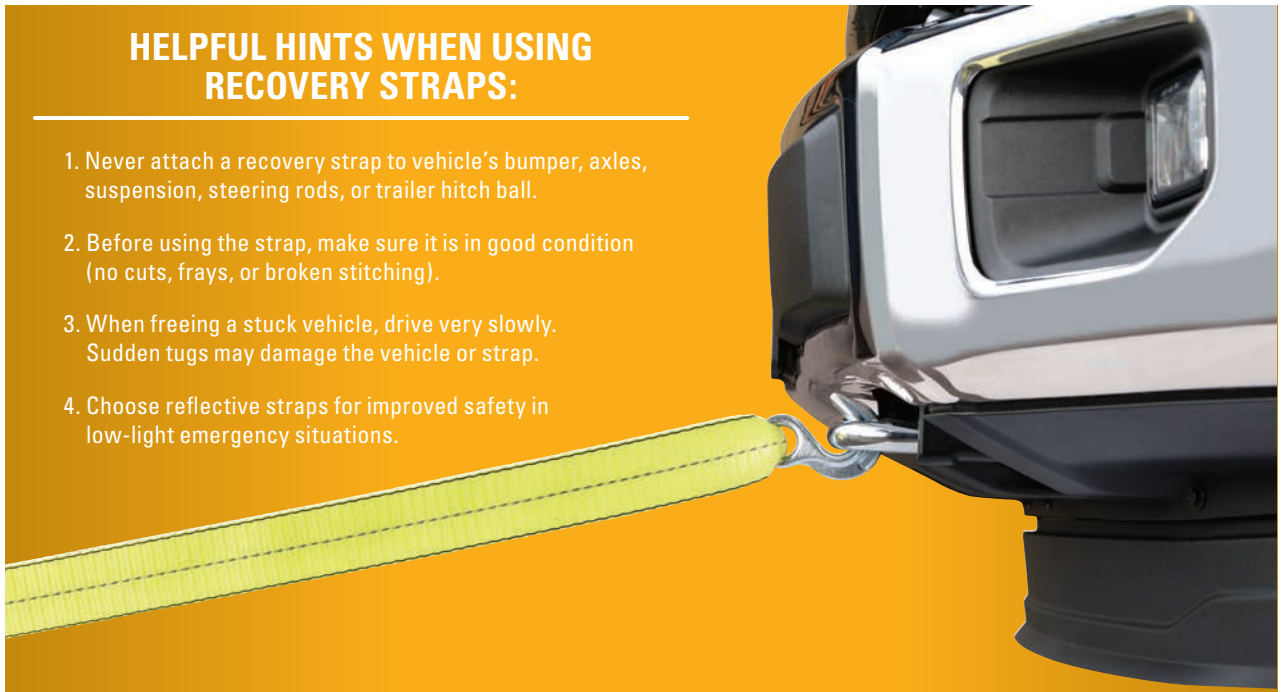

TOW ROPE



- Constructed of high-quality polypropylene braided rope
- Rust-resistant, zinc-plated hooks

Part Number	Description	Length	Capacity	Qty/Pkg	Package
9426600	5/8" Tow Rope	14'	2266/6800 lb	1	Bulk



SHACKLES

- Threaded pin assembly secures shackle in place
- High-quality steel
- Powder coated for corrosion resistance

Part Number	Description	Capacity	Qty/Pkg	Package
9523700	1/2" Anchor Shackle	4000/12,000 lb	1	Bulk
9523600	3/4" Anchor Shackle	9500/28,500 lb	1	Bulk
9523500	7/8" Anchor Shackle	13,000/39,000 lb	1	Bulk



Anchor Shackles



TREE SAVER

- Super-duty webbing
- Sleeve over loop end for added protection

Part Number	Description	Length	Capacity	Qty/Pkg	Package
9516700	3" Tree Saver Strap with Loop Ends	6'	10,000/30,000 lb	1	Bulk



AXLE STRAPS

- Super-duty webbing
- Protective sleeve for abrasion and wear resistance
- Stamped steel D-rings

Part Number	Description	Length	Capacity	Qty/Pkg	Package	Qty/Carton
9545000	2" Axle Strap	24"	3300/10,000 lb	1	Bulk	8
9544800	2" Axle Strap	24"	3300/10,000 lb	1	Bulk	4
9544900	2" Axle Strap	36"	3300/10,000 lb	1	Bulk	4



WINCH STRAPS

- Designed to work with flat deck winches
- Made with heavy-duty webbing
- Zinc-plated, forged hooks

Part Number	Description	Length	Capacity	Qty/Pkg	Package
9545400	2" Winch Strap	30'	3300/10,000 lb	1	Bulk
9545500	4" Winch Strap	30'	6000/18,000 lb	1	Bulk

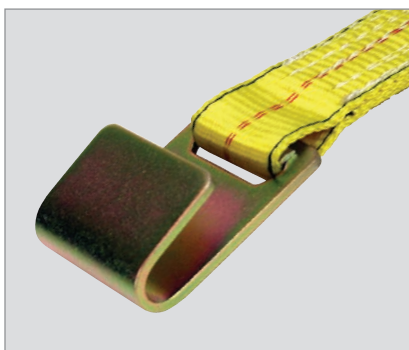



MORE POWER

To handle heavy jobs, REESE® Secure has the safe and secure way to give you that extra pulling power.

CABLE PULLERS

CABLE PULLERS 206

WEBBING PULLER 206

ACCESSORIES

Rope Hoist 207

Cable Puller Storage Bag 207

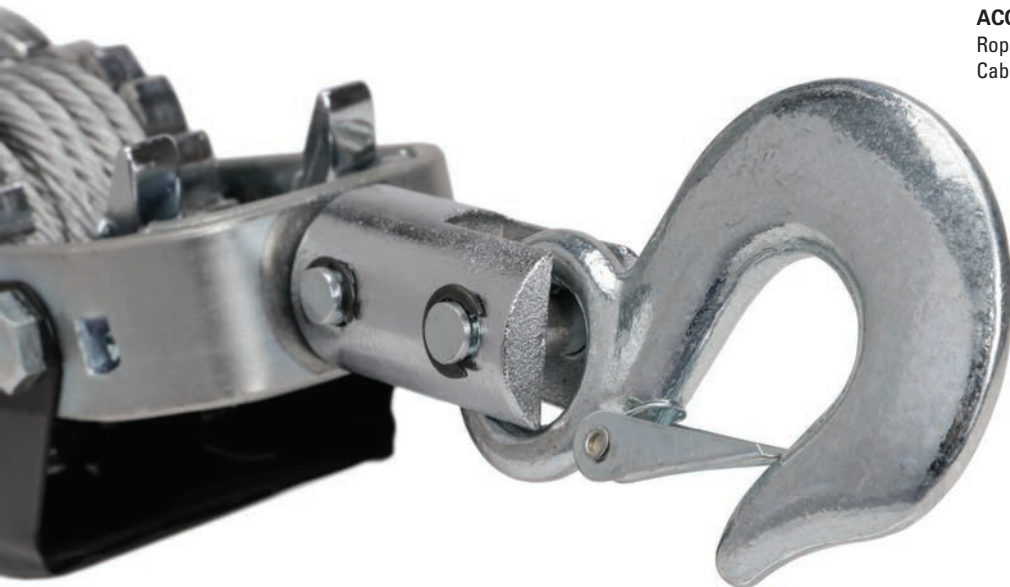

CABLE PULLERS

- Twin-drive gear and pawl
- Heavy-duty steel cable with swivel yoke
- Easy thumb-control lever release
- Non-slip rubber grip handle

Part Number	Description	Construction	Pull Length	Capacity	Qty/Pkg	Package
7066800 NEW	1-Ton Cable Puller - Single Line	Aluminum Gear and Pawl	8'	2000 lb	1	Box
7067600 NEW	2-Ton Cable Puller - Double Line	Aluminum Gear and Pawl	6'	4000 lb	1	Box
7067000	2.5-Ton Cable Puller - Double Line	Steel Gear and Pawl	6'	5000 lb	1	Box
7067700 NEW	3-Ton Cable Puller - Double Line	Aluminum Gear and Pawl	6'	6000 lb	1	Box
7067800 NEW	4-Ton Cable Puller - Single Line - Double Line	Aluminum Gear and Pawl	12' 6'	4000 lb 8000 lb	1	Box

CABLE PULLERS

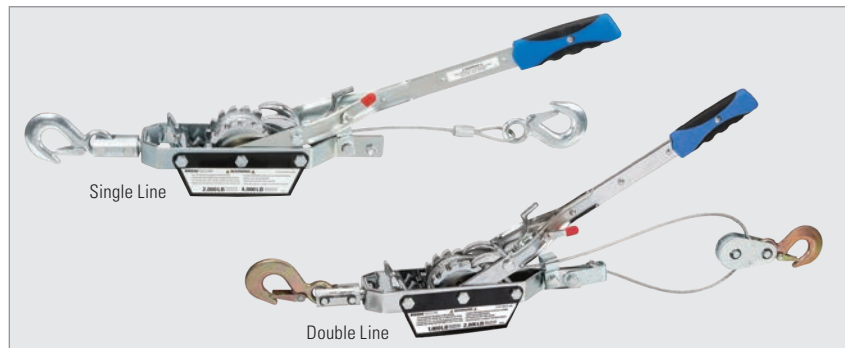

WEBBING PULLER

- Twin-drive gear and pawl
- Heavy-duty polyester webbing, plus swivel yoke
- Easy thumb-control lever release
- Non-slip rubber grip handle

Part Number	Description	Construction	Pull Length	Capacity	Qty/Pkg	Package
7067100 NEW	1-Ton Webbing Puller	Aluminum Gear and Pawl	8'	2000 lb	1	Box



ROPE HOIST

- Perfect for hunting, boating, farming, the shop, and so much more
- Strong, long-lasting, durable rope

Part Number	Description	Rope Length	Capacity	Qty/Pkg	Package
7067200 NEW	1/2-Ton Rope Hoist	50'	1000 lb	1	Box



CABLE PULLER STORAGE BAG

- Fits all REESE® Secure cable pullers, plus accessories
- Plastic reinforced bottom
- Heavy-duty stitching for durability

Part Number	Description	Size	Color	Qty/Pkg	Package
7066700 NEW	Cable Puller Storage Bag	30" x 6"	Black	1	Box



CABLE PULLERS



**LOCK IT
DOWN**



E-TRACK SYSTEM

E-TRACK

Making every hauling job effortless, REESE® Secure E-Track system safely secures cargo in trailers or trucks.

TRACK	
E-Track Sections.....	210
TIE DOWNS	210
ACCESSORIES	
D-Ring Strap	211
O-Ring	211
J-Hook.....	211



E-TRACK SECTIONS

- Rapid attach/detachment for quick and easy everyday use
- 12-Gauge steel construction with protective powder-coat finish
- Multi-point mounting locations for versatility

Part Number	Description	Length	Qty/Pkg	Package
9535000 NEW	E-Track	12"	1	Bulk
9535100 NEW	E-Track	24"	1	Bulk
9535200 NEW	E-Track	48"	1	Bulk

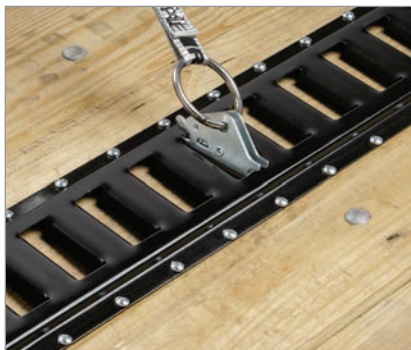

E-TRACK TIE DOWNS

- Includes E-Track fitting and coated S-hook for versatility
- Works with Ford® Boxlink system or standard E-Track systems

Part Number	Description	Length	Capacity	Qty/Pkg	Package
9535900 NEW	STANDARD DUTY E-Track Retractable Ratchet	10'	400/1200 lb	1	Open
9535800 NEW	STANDARD DUTY E-Track Cambuckle	8'	430/1300 lb	1	Open
9535600 NEW	STANDARD DUTY E-Track Ratchet with Grip Handle	8'	500/1500 lb	1	Open
9535700 NEW	HEAVY DUTY E-Track Ratchet with Open Handle	12'	1000/3000 lb	1	Open



Heavy Duty Ratchet



Standard Duty Ratchet



Retractable Ratchet



Cambuckle

WORKS WITH FORD® BOXLINK

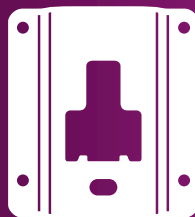

This REESE system is specifically designed to work with Ford Boxlink anchors; no track is needed. Simply lock in place and go.

(Standard since 2015 on F-Series)

Ford is a registered trademark of Ford Motors.

E-TRACK D-RING STRAP

- Works with Ford® Boxlink system or standard E-Track systems
- Heavy-duty webbing

Part Number	Description	Length	Capacity	Qty/Pkg	Package
9535400 NEW	E-Track D-Ring Strap	5"	1000/3000 lb	1	Card

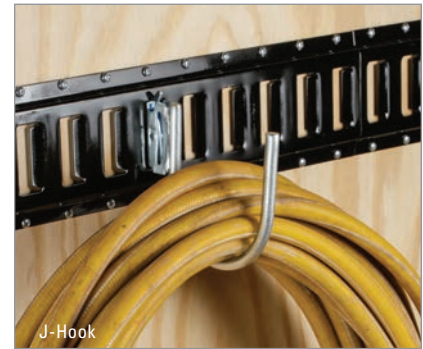

E-TRACK O-RING

- Works with Ford® Boxlink system or standard E-Track systems

Part Number	Description	Length	Capacity	Qty/Pkg	Package
9535300 NEW	E-Track O-Ring	-	1000/3000 lb	2	Card

E-TRACK J-HOOK

- Zinc plated for corrosion resistance
- Neatly store items such as ropes, cords, hoses and ladders

Part Number	Description	Size	Capacity	Qty/Pkg	Package
9535500 NEW	E-Track J-Hook	4.5"	400 lb	1	Card



E-TRACK



**ABOVE
THE BED**



Demanding jobs require products that are up to the challenge. REESE® Secure provides maximum versatility and carrying power in one convenient system.

TRUCK RACKS

TRUCK RACKS



TRUCK RACK SYSTEMS

- TransRACK Cargo Truck Rack System 214
- TransRACK Workmate Cargo Truck Rack System ... 214

TRUCK RACK ACCESSORIES

- TransRACK Top Rail Kit 214
- TransRACK Load Stops 215
- TransRACK Conduit Carrier..... 215
- TransRACK Cross Bar Glides 215
- TransRACK Trimmer Rack 216
- TransRACK Tool Rack..... 216

TRANSRACK CARGO TRUCK RACK SYSTEM

- Aluminum construction with stainless steel hardware resists rust and corrosion
- Includes 4 load stops
- No-drill installation and easy adjustability
- Vinyl-dipped feet and clamps protect truck bed
- One size fits long and short bed pickup trucks (not recommended for Nissan Titan, Toyota Tacoma, Toyota Tundra)

Part Number	Description	Capacity	Qty/Pkg	Package
7054700	TransRACK Cargo Truck Rack System	800 lb	1	Box



TRANSRACK WORKMATE CARGO TRUCK RACK SYSTEM

- No-drill installation
- Aluminum construction with steel hardware included
- One size fits long and short bed pickup trucks (not recommended for Nissan Titan, Toyota Tacoma, Toyota Tundra)

Part Number	Description	Capacity	Qty/Pkg	Package
7063500	TransRACK Workmate Cargo Truck Rack System	800 lb	1	Box

TRANSRACK TOP RAIL KIT

- Mounts to TransRACK crossbars
- 48 in. of additional support with included third crossbar
- High-grade aluminum alloy with stainless steel hardware
- Easy assembly, no drilling required

Part Number	Description	Capacity	Qty/Pkg	Package
7055200	TransRACK Top Rail Kit	800 lb	1	Box



TRANSRACK LOAD STOPS

- Help secure load to cross bar with 3 tie down points
- Easy left-to-right adjustment
- Ergonomic set screws
- Bottom loop is excellent for hooks

Part Number	Description	Capacity	Qty/Pkg	Package
7063000	TransRACK Load Stops	700 lb	4	Box



Load Stops

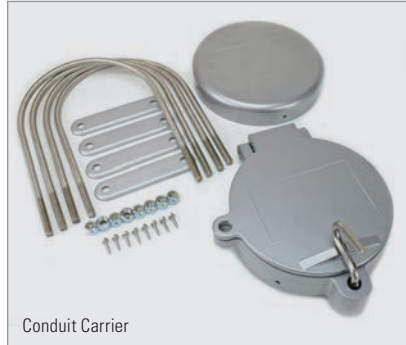

Conduit Carrier

TRANSRACK CONDUIT CARRIER

- Use with 6 in. PVC pipe (not included)
- Easily attaches to cross bars with provided hardware
- Lockable spring door
- Works with any truck rack system

Part Number	Description	Capacity	Qty/Pkg	Package
7054900	TransRACK Conduit Carrier	-	1	Box

TRANSRACK CROSS BAR GLIDES

- Protect ladders, lumber and other cargo from scratches
- Easy snap-fit, no tools required for installation
- Durable polypropylene

Part Number	Description	Capacity	Qty/Pkg	Package
7061700	TransRACK Cross Bar Glides	-	4	Box



Cross Bar Glides

TRANSRACK TRIMMER RACK

- Easily mounts to trailers or trucks
- Holds 2 trimmers or other equipment
- No drilling required

Part Number	Description	Capacity	Qty/Pkg	Package
7055000	TransRACK Trimmer Rack	-	1	Box



TRANSRACK TOOL RACK

- Holds 6 straight handle tools
- Easily mounts to trailers or trucks
- No drilling required

Part Number	Description	Capacity	Qty/Pkg	Package
7055100	TransRACK Tool Rack	-	1	Box



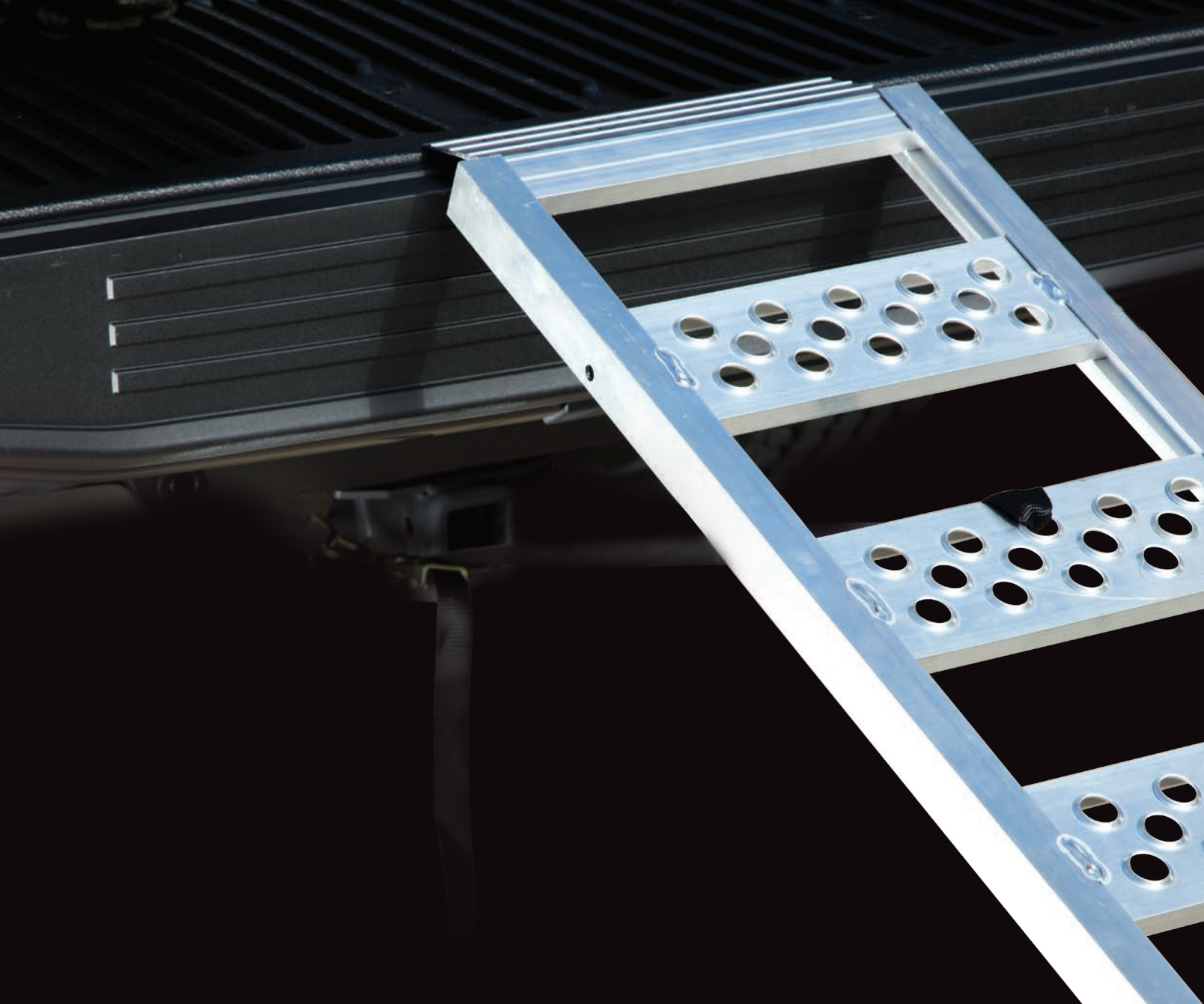

NEVER LEAVE ANYTHING BEHIND.

REESE® Explore makes sure you never have to leave anything behind. With a full line of straight, arched and hinged ramps for your truck or trailer we have what you need to carry your cargo to your destination. REESE ramps deliver durable cargo loading solutions for active lifestyles providing convenient and secure transport of your equipment, for work and for play.

See our full line of ramps on pages 242-251



ALL TIED UP





Whether tying down a tent or the trunk of a car, REESE® Secure has the rope for you.

ROPES



Nylon Ropes.....	220
Polyester Rope	220
Cotton Rope	220
Polypropylene Ropes	221
Jute Cord	221

NYLON ROPES

- Elasticity will absorb sudden tugs
- Resistant to abrasion
- Rot proof

Part Number	Description	Length	Capacity	Color	Package
9540900	1/16" Twisted Rope	300'	30 lb	Pink	Holder
9428700	1/8" Diamond Braid Rope	50'	90 lb	White	Holder
9540200	1/4" Twisted Rope	50'	124 lb	White	Holder



POLYESTER ROPE

- Abrasion resistant
- Retains strength when wet

Part Number	Description	Length	Capacity	Color	Package
9541100	3/16" Diamond Braid Rope	50'	70 lb	White	Holder



COTTON ROPE

- Soft and pliable; easy on the hands
- Great for household projects

Part Number	Description	Length	Color	Package
9428300	Twisted Line	500'	White	Holder

POLYPROPYLENE ROPES

- Lightweight and strong
- Floats; not affected by water, gasoline, or most chemicals

Part Number	Description	Length	Capacity	Color	Package
9428800	3/16" Clothesline	100'	22 lb	White	Holder
9541400 NEW	3/16" Diamond Braid Rope	100'	60 lb	White	Holder
9540600	3/16" Camo Rope	100'	70 lb	Camo	Holder
9540500	1/4" Camo Rope	50'	95 lb	Camo	Holder
9428400	1/4" Diamond Braid Rope	100'	95 lb	Red	Holder
9423600	3/8" Truck Rope	50'	220 lb	Orange/Black	Bulk

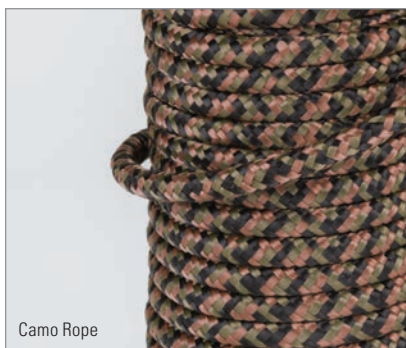

JUTE CORD

- Exceptional knot strength
- Great for arts and crafts, gardening and bundling

Part Number	Description	Length	Color	Package
9541000	1/16" Twisted Line	250'	Green	Holder

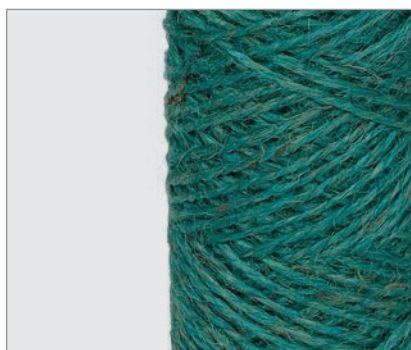



**RIDE THE
WAVE**



Passionate about the water? REESE® Brands works hard to help store and transport your gear safely and securely so you can enjoy the adventure.

WATER SPORT



STORAGE

Ceiling-Mount Kayak Pulley System	224
Deluxe Wall-Mount Kayak Storage Rack	224
Wall-Mount Kayak Storage Rack	225
Wall-Mount Kayak Storage Straps	225

TRAVEL

J-Rac Kayak Carrier	226
Kayak Tie Down Kit	226
Full-Size Tailgate Pad	226
Protective Tailgate Pad	226
Crossbar Pads	227

ACCESSORIES

Waterproof Dry Bags	227
Bungee Kayak Deck Net	227

CEILING-MOUNT KAYAK PULLEY SYSTEM



- Use to store kayak, bicycle, ladder, or rooftop box
- Easy to install, easy to use
- Pre-threaded pulleys for quick assembly

Part Number	Description	Capacity	Qty/Pkg	Package
9550300 NEW	Ceiling-Mount Kayak Pulley System	100 lb	1	Box



DELUXE WALL-MOUNT KAYAK STORAGE RACK



- Perfect for storing kayak or canoe, plus paddles
- Adjustable, padded aluminum arm rotates flat when not in use
- Safety straps provided for a secure hold

Part Number	Description	Capacity	Qty/Pkg	Package
9550200 NEW	Deluxe Wall-Mount Kayak Storage Rack	100 lb	1	Box



Deluxe Storage Rack



WALL-MOUNT KAYAK STORAGE RACK



- Perfect for storing kayak or canoe, plus paddles
- Sturdy aluminum frame rotates flat when not in use
- Safety straps provided for a secure hold

Part Number	Description	Capacity	Qty/Pkg	Package
9550100 NEW	Wall-Mount Kayak Storage Rack	100 lb	1	Box

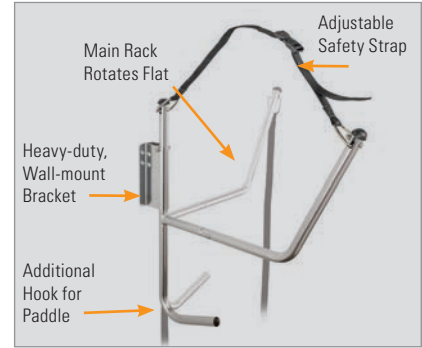

WALL-MOUNT KAYAK STORAGE STRAPS



- Quickly hang kayak or stand-up paddleboard
- Adjustable straps for a secure hold
- Easily holds paddles
- Hardware included

Part Number	Description	Capacity	Qty/Pkg	Package
9550000 NEW	Wall-Mount Kayak Storage Straps	70 lb	1	Box

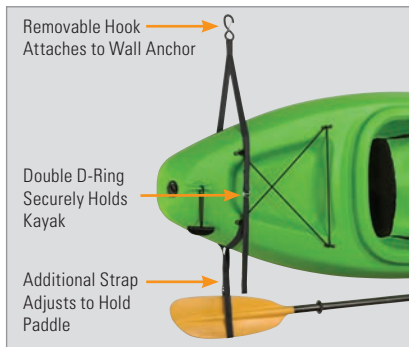

J-RAC KAYAK CARRIER

- Holds a single kayak in the upright position
- Padded to protect kayak
- Bow and stern tie down ropes and mounting hardware included
- Fits most cross bars

Part Number	Description	Capacity	Qty/Pkg	Package
1394900 NEW	J-Rac Kayak Carrier	165 lb	1	Box



KAYAK TIE DOWN KIT

- Hood and trunk tie down points make it easier than ever to secure kayaks
- Bow and stern tie down straps, plus hood and trunk anchor straps included
- Rubber protective boots on buckles safeguard against vehicle scratches

Part Number	Description	Capacity	Qty/Pkg	Package
9550400 NEW	Kayak Tie Down Kit	100 lb	1	Box

FULL-SIZE TAILGATE PAD

- Wrap-around pad protects tailgate and gear from scratches
- Top strap system secures bikes, ladders and other cargo
- Easy access to tailgate handle

Part Number	Description	Dimensions	Protection	Qty/Pkg	Package
1393600	Mid/Full-Size Tailgate Pad	54" x 30"	Rainproof	1	Box



PROTECTIVE TAILGATE PAD

- Protects cargo and top of tailgate
- Slips over tailgate and secures with 2 buckle straps (included)

Part Number	Description	Dimensions	Protection	Qty/Pkg	Package
1393900	Tailgate Pad	18"	Everyday	1	Box

CROSS BAR PADS

- Protect cargo and cross bars
- Pads secure with easy to use hook-and-loop closures
- Compatible with round and square cross bars

Part Number	Description	Dimensions	Details	Qty/Pkg	Package
1393800	Cross Bar Pads	18"	High Density Foam	2	Box
1397200 NEW	Cross Bar Pads	18"	High Density Foam	4	Box



WATERPROOF DRY BAGS

- For water sport and outdoor activities such as hunting, hiking and camping
- Provides protection against water, dirt and dust
- Keeps gear dry with waterproof, roll-top closure

Part Number	Description	Dimensions	Capacity	Qty/Pkg	Package
1396700 NEW	Waterproof Dry Bag	11" x 22"	12 L	1	Box
1396800 NEW	Waterproof Dry Bag	14" x 26"	20 L	1	Box



Bungee Kayak Deck Net

BUNGEE KAYAK DECK NET

- Works with kayaks and stand-up paddle boards
- Knotted construction to prevent scratches
- Quickly creates extra storage
- Includes 4 padeyes and clips

Part Number	Description	Qty/Pkg	Package
9550700 NEW	Bungee Kayak Deck Net	1	Polybag



REESE[®]
POWERSPORTS

**PERFORMANCE ON
AND OFF THE ROAD**





POWER ON

Extreme sports require products that are built to take the punishment.



POWERSPORTS

MOTORCYCLE
 Motorcycle Cargo Net 232
 Lighted Plate Frames 232
 Motorcycle Wheel Chock 232

TIE DOWNS
 Tie Downs - ATV & Motorcycle 232

COVERS
 Covers - ATV, UTV & Motorcycle..... 233

ATV
 ATV Recovery Strap 233
 ATV Cargo Net..... 233
 ATV/UTV Jack 234
 Jack Maintenance Kit 234
 3-Way ATV Hitches..... 234

MARINE
 Marine Collection Winches 235
 Marine Winches 235
 Winch Straps..... 236
 Spare Tire Carriers 236
 Marine Accessories..... 237

MARINE TIE DOWNS
 Bow Tie Downs 238
 Gunwale Tie Downs 238
 Transom Tie Downs 239
 Retractable Transom Tie Downs 239
 Dock Cleat 239



MOTORCYCLE CARGO NET

- Fastens bags, jackets, helmets, etc. to the rear seat
- 6 strong, secure molded hooks

Part Number	Description	Unstretched Size	Qty/Pkg	Package
1881000	Motorcycle Cargo Net	15" x 15"	1	Box



LIGHTED LICENSE PLATE FRAME

- Fits all standard motorcycle license plates
- 2 functions - tail light and brake light
- Increased visibility and safety
- Everything you need for easy hook-up

Part Number	Description	Color	Qty/Pkg	Package
8667200	Lighted Plate Frame	Black	1	Box
8667500	Lighted Plate Frame	Chrome	1	Box

MOTORCYCLE WHEEL CHOCK

- Load and secure motorcycle by yourself
- Pivoting bracket locks wheel into place
- Can be mounted to floor, truck bed or trailer

Part Number	Description	Construction	Qty/Pkg	Package
1881300	Wheel Chock	Aluminum	1	Bulk

TIE DOWNS - ATV & MOTORCYCLE

- Integrated soft ties and heavy-duty hooks

Part Number	Description	Capacity	Qty/Pkg	Package
1880400	8' Surelok® with Soft Ties	1000/3000 lb	2	Open
1880600	10' Grip Handle Ratchet with Soft Ties	500/1500 lb	4	Open



COVERS - ATV, UTV & MOTORCYCLE

- Protection from dirt and grime
- Fitted elastic bottom creates a tight fit
- Storage bag included

Part Number	Description	Color	Dimensions	Qty/Pkg	Package
1881200	Motorcycle Cover	Blue/Black	108" x 50"	1	Box
1882000	Large ATV Cover	Camo	75" x 45" x 34"	1	Box
1881800	Large ATV Cover	Gray	75" x 45" x 34"	1	Box
1882100	X-Large ATV Cover	Camo	85" x 48" x 40"	1	Box
1881900	X-Large ATV Cover	Gray	85" x 48" x 40"	1	Box
1882300	UTV Cover	Camo	130" x 65" x 76"	1	Box
1882200	UTV Cover	Gray	130" x 65" x 76"	1	Box



POWERSPORTS

ATV RECOVERY STRAP

- Zinc-plated steel anchor shackle included for easy attachment
- Mesh bag provided for storage

Part Number	Description	Capacity	Qty/Pkg	Package
1880900	12' Recovery Strap	1660/5000 lb	1	Box



ATV CARGO NET

- Secures lightweight equipment to your ATV racks
- 12 rugged securing hooks

Part Number	Description	Unstretched Size	Qty/Pkg	Package
1881100	ATV Cargo Net	30" x 15"	1	Box

ATV/UTV JACK

- Corrosion-resistant powder-coat finish
- 34 in. handle for superior leverage

Part Number	Description	Capacity	Dimensions	Qty/Pkg	Package
7064200	ATV/UTV Jack	7000 lb	36"	1	Box

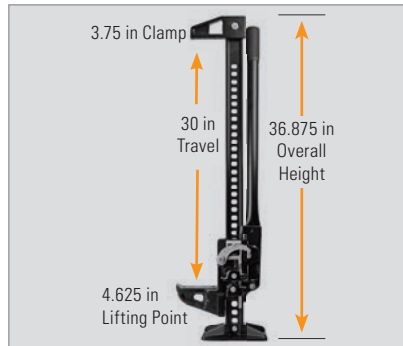

POWERSPORTS

JACK MAINTENANCE KIT

- Keeps jack operating trouble free

Part Number	Description	Qty/Pkg	Package
7064100	Maintenance Kit Includes: 2 climbing pins, 2 climbing pin springs, 2 cross pins, 1 handle pin and clip	1	Box

3-WAY ATV HITCHES

- Fits most ATVs
- Use a hitch ball, 5/8 in. clevis pin or tow hook
- 3/4 in. diameter ball shank hole
- Mounting hardware included

Part Number	Description	Gross Trailer Weight	Tongue Weight	Qty/Pkg	Package
7065000	3-Way ATV Hitch	2000 lb	200 lb	1	Box
7065100	3-Way ATV Hitch	2000 lb	200 lb	1	Box



MARINE COLLECTION WINCHES

- High-performance 4.1:1 gear ratio
- Corrosion-resistant powder-coat finish
- Precision-engineered 2-way ratchet
- Easy-grip non-skid handle
- All-weather strap with coated hook

Part Number	Description	Finish	Gear Ratio	Strap Length	Qty/Pkg	Package
7064600	1200 lb Marine Winch	Powder-Coat - Silver	4.1:1	15'	1	Box
7064700	1500 lb Marine Winch	Powder-Coat - Dark Gray	4.1:1	20'	1	Box
7064800	2000 lb Marine Winch	Powder-Coat - Black	5:1	20'	1	Box



POWERSPORTS

MARINE WINCHES

- Zinc-plated finish for superior corrosion resistance
- Easy-to-use 2-way ratchet with ergonomic handle
- High-performance gear system

Part Number	Description	Speeds	Strap Included	Qty/Pkg	Package
7019400	600 lb Marine Winch	One	15'	1	Box
74556	1100 lb Marine Winch	One	--	1	Box
74419	1300 lb Marine Winch	One	--	1	Box
7016800	1400 lb Marine Winch	One	20'	1	Box
7016900	1500 lb Marine Winch	One	20'	1	Box
7017000	2000 lb Marine Winch	Two	20'	1	Box



7019400



74556



74419

WINCH STRAPS

- Made with heavy-duty webbing

Part Number	Description	Capacity	Qty/Pkg	Package
7017100	2" x 15' Winch Strap	1833/5500 lb	1	Open
7017200	2" x 20' Winch Strap	1833/5500 lb	1	Open



POWERSPORTS

SPARE TIRE CARRIERS

- Easy to install
- Corrosion-resistant zinc-plated finish

Part Number	Description	Fits	Frame Sizes	Qty/Pkg	Package
7016200	Offset	Most 4-, 5- and 6-lug wheels	Up to 3" x 5"	1	Box
7016300	High Mount	Both 4- and 5-lug wheels	Up to 3" x 5"	1	Box
7016400	Economical	8"-15" wheels	Universal	1	Box
7019200	Locking	8"-15" wheels	Universal	1	Box

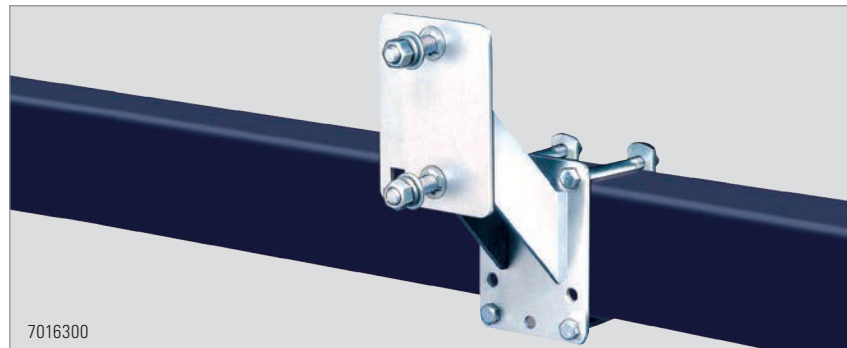

MARINE ACCESSORIES

Part Number	Description	Features	Qty/Pkg	Package
7015300	20" Upright Roller Guide	For frames up to 3" wide by 5" high	1	Box
7015400	44" Upright Boat Guide	Visual guide	1	Box
7015500	Adjustable Motor Support Bracket	Transfer weight from trailer to transom	1	Box
7015600	Motor Support Bracket	Transfer weight from trailer to transom	1	Box
7016000	Bunk Carpet	Reduces hull scratching	1	Wrap
7018100	Canoe Loader	Easy for 1 person to load	1	Box
74557	Side-Wind Swivel Jack	1000 lb capacity, 6" wheel, snap ring	1	Box

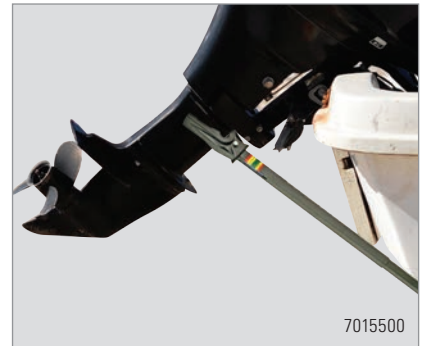

POWERSPORTS

BOW TIE DOWNS

- Coated steel hooks protect boat's finish
- Extra security, for use in combination with a gunwale or transom tie down
- Easy to tighten and release

Part Number	Description	Construction	Length	Capacity	Qty/Pkg	Package	Qty/Carton
2060100	1" Webbing with S Hooks	Stainless Steel	36"	300/900 lb	2	Clam	4
2060000	1" Webbing with S Hooks	Steel	36"	400/1200 lb	2	Clam	4

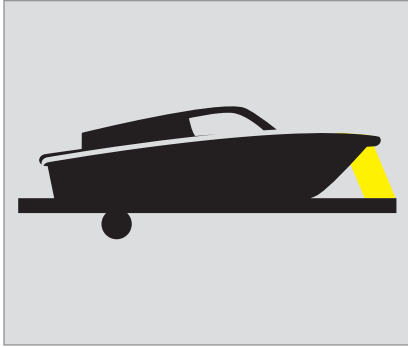

POWERSPORTS

GUNWALE TIE DOWNS

- Open handle fits any size hand comfortably
- Contoured release button provides a smooth release every time
- Coated steel hooks protect boat's finish

Part Number	Description	Construction	Length	Capacity	Qty/Pkg	Package	Qty/Carton
2060800	2" Webbing with S Hooks	Stainless Steel	10'	400/1200 lb	1	Open	3
2061200	2" Webbing with S Hooks	Steel	10'	833/2500 lb	1	Open	3
2060900	2" Webbing with S Hooks	Stainless Steel	13'	400/1200 lb	1	Open	3
2061300	2" Webbing with S Hooks	Steel	13'	833/2500 lb	1	Open	3
2061000	2" Webbing with S Hooks	Stainless Steel	16'	400/1200 lb	1	Open	3
2061400	2" Webbing with S Hooks	Steel	16'	833/2500 lb	1	Open	3
2061100	2" Webbing with S Hooks	Stainless Steel	20'	400/1200 lb	1	Open	3
2061500	2" Webbing with S Hooks	Steel	20'	833/2500 lb	1	Open	3

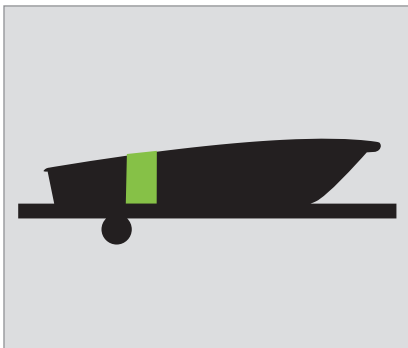

TRANSOM TIE DOWNS

- Lock in place to eliminate slippage
- Protective coating prevents scratches
- Can't be overtightened, preventing damage to your boat

Part Number	Description	Construction	Length	Capacity	Qty/Pkg	Package	Qty/Carton
2060500	2" Webbing with S Hooks	Stainless Steel	24"	333/1000 lb	2	Open	4
2060400	2" Webbing with S Hooks	Steel	24"	833/2500 lb	2	Open	4
2060600	2" Webbing with S Hooks	Stainless Steel	48"	333/1000 lb	2	Open	4
2060700	2" Webbing with S Hooks	Steel	48"	833/2500 lb	1	Bulk	6

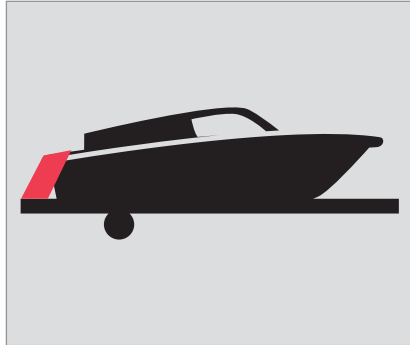

POWERSPORTS

RETRACTABLE TRANSOM TIE DOWNS

- Strap retracts for easy storage when not in use
- Easily bolt onto trailer with included hardware
- Coated steel hook protects boat's finish

Part Number	Description	Construction	Length	Capacity	Qty/Pkg	Package	Qty/Carton
2060200	2" Webbing Retractable with S Hook	Stainless Steel	43"	600/1800 lb	2	Open	3
2060300	2" Webbing Retractable with S Hook	Steel	43"	833/2500 lb	2	Open	3

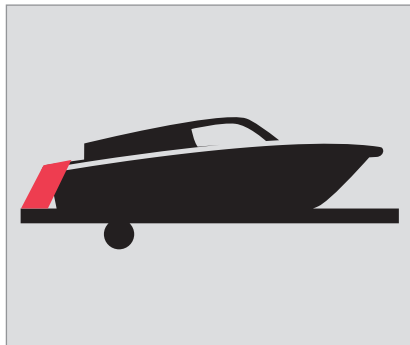

DOCK CLEAT

- For use when docking your watercraft
- Mounts easily with 4 screws

Part Number	Description	Key Feature	Qty/Pkg	Package	Qty/Carton
2061600	Dock Cleat	Mount to dock easily with 4 screws	1	Bulk	10



REESE[®]
EXPLORE

FOR EVERY ADVENTURE





**SMOOTH
LOADING**

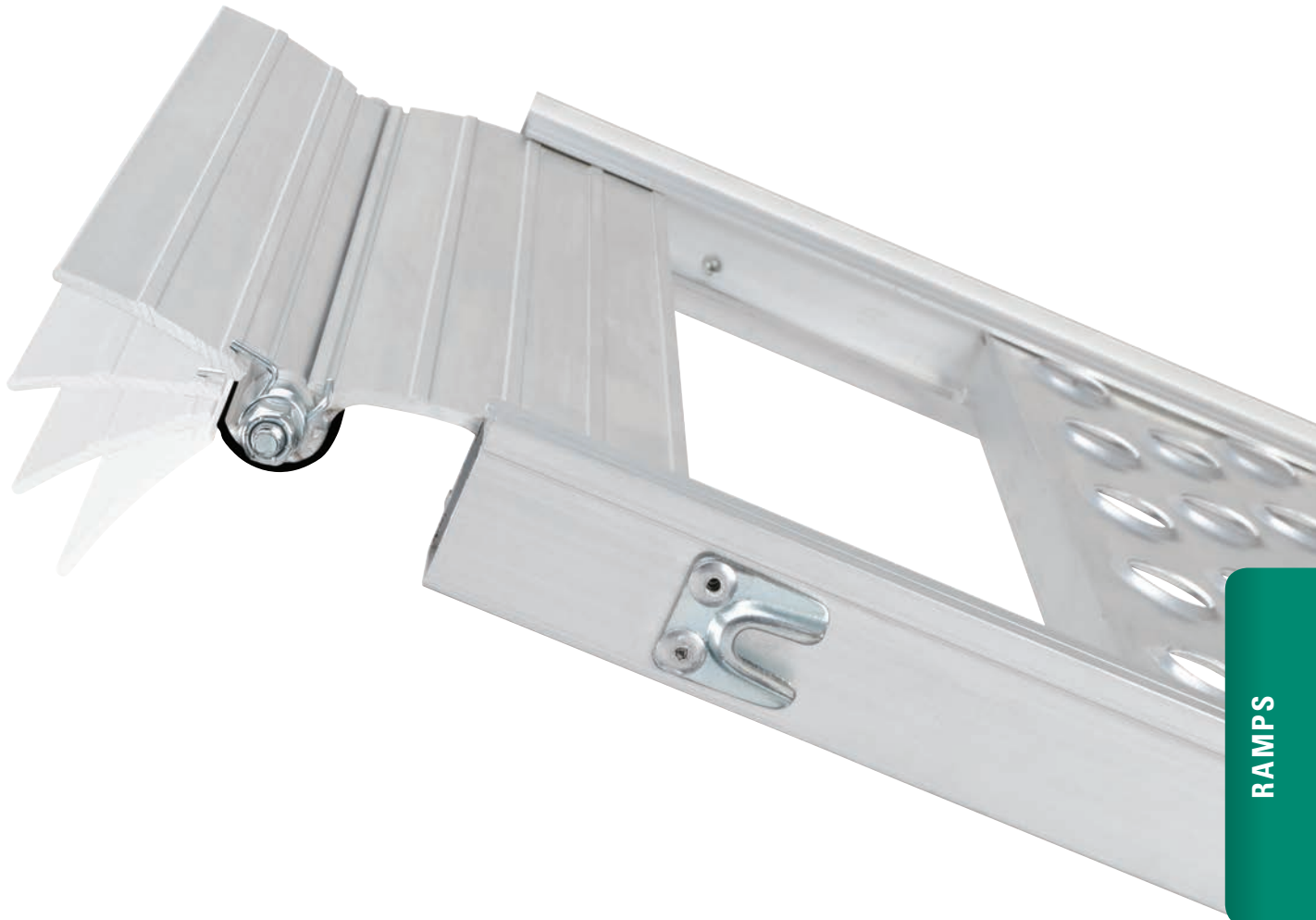

Active life means you are always on the move. REESE® Explore has the perfect solution to get your gear on the road safely.

RAMPS

ALUMINUM

Aluminum Ramps	244
Zero-Turn Mower Ramps	244
Heavy-Duty Aluminum Ramps	245
Xtrusion Series Aluminum Ramps	245
Telescoping Aluminum Ramp	246
Connecting Ramps	246
Adjustable Top Plate Ramps	246

STEEL

Steel Ramps	247
Threshold Ramp	247

KITS

Standard Ramp Kits	248
Adjustable Top Ramp Kits	249

ACCESSORIES

Ramp Carry Handle	250
Ramp Carry Strap	250
Ramp Safety Strap	251
Ramp Bumper	251

ALUMINUM RAMPS



- Smooth rolling rung design
- Adjustable attachment straps
- Welded aluminum construction
- Rust resistant and corrosion resistant

Part Number	Description	Size	Qty/Pkg	Capacity
7454300	Centerfold	12" x 85"	Single	700 lb
7452700	Arched	12" x 90"	Pair	1500 lb/pair
9515000	Arched Centerfold	12" x 90"	Pair	1500 lb/pair
7454700	Tri-Fold	45" x 69"	Single	1600 lb



RAMPS

SMOOTH ROLLING RUNG DESIGN

- Wide aluminum rungs provide a smooth transition into your truck or trailer
- Enhanced traction – 360° anti-slip ribs provide front-to-back and side-to-side traction
- Easier loading and unloading
- Close rung spacing supports wheels of all sizes

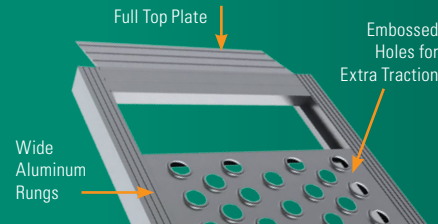

ALUMINUM RAMPS - FOR ZERO-TURN MOWERS

- Smooth rolling rung design
- Close rung spacing perfect for zero-turn mowers

Part Number	Description	Size	Qty/Pkg	Capacity
9515800 NEW	Arched	12" x 94"	Pair	1500 lb/pair
9516400 NEW	Arched - Ice Black	12" x 94"	Pair	1500 lb/pair
9515900 NEW	Arched Centerfold	12" x 92"	Pair	1500 lb/pair
9516300 NEW	Arched Centerfold - Ice Black	12" x 92"	Pair	1500 lb/pair



HEAVY DUTY ALUMINUM RAMPS



- Reinforced rungs for loading heavy equipment
- Full bottom transition plate for easier loading
- One-year limited warranty

Part Number	Description	Size	Qty/Pkg	Capacity
7454500	Heavy Duty Arched	12" x 90"	Pair	3000 lb/pair
9515500	Heavy Duty Straight	15" x 80"	Pair	4000 lb/pair



Straight

XTRUSION SERIES ALUMINUM RAMPS



- Smoothest rolling ramp
- Safe, solid aluminum, no-weld construction
- Superior traction with raised tread
- Patented design

Part Number	Description	Size	Qty/Pkg	Capacity
9515400 NEW	Straight	8" x 80"	Single	1000 lb
9515700 NEW	Angled Centerfold	11.5" x 86"	Single	1000 lb
9515600 NEW	Straight	11.5" x 80"	Pair	2000 lb/pair



Full Top Plate

Raised Pattern for Extra Traction



Straight



Straight Pair



Angled Centerfold

RAMPS

TELESCOPING ALUMINUM RAMP



- Adjusts to 3 lengths: 48 in., 71 in. and 82 in.
- Compact design for easy storage
- Designed for trailers, trucks, or thresholds

Part Number	Description	Size	Qty/Pkg	Capacity
9515300 NEW	Telescoping	13" x 82"	Single	700 lb



ALUMINUM RAMPS - WITH CONNECTORS

- Create wider ramps in seconds with built in connectors
- Full width top plate for improved loading

Part Number	Description	Size	Qty/Pkg	Capacity
7454600	Extra Wide	24" x 84"	Single	900 lb
7453700	Straight	13" x 77"	Pair	1250 lb/pair



ALUMINUM RAMP - WITH ADJUSTABLE TOP PLATE

- Patented self-adjusting, hinged top plate, creates smooth transitions on and off ramp
- Create wide ramps with built-in connectors

Part Number	Description	Size	Qty/Pkg	Capacity
9515100	Straight	13" x 77"	Pair	1250 lb/pair

ADJUSTABLE TOP PLATE

Hinged top plate creates smooth transitions on & off ramp

STEEL RAMPS

- Divide to form two ramps
- Built-in handles for easy carrying
- Adjustable attachment straps
- Galvanized steel for rust protection

Part Number	Description	Size	Qty/Pkg	Capacity
9515200	Centerfold	11" x 80"	Single	600 lb
7454000	Centerfold	11" x 80"	Single	800 lb

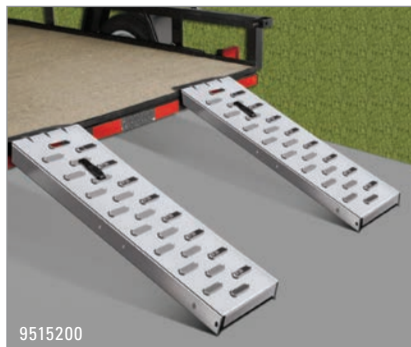

STEEL RAMP - FOR THRESHOLDS

- Creates smooth transition into sheds and barns
- Connect into one 80 in., 600 lb capacity loading ramp
- All hardware included

Part Number	Description	Size	Qty/Pkg	Capacity
9516000 NEW	Straight	11" x 40"	Pair	1200 lb/pair



RAMPS

STANDARD RAMP KITS

- Ramp kits turn ordinary wood planks into sturdy, rustproof, all-purpose ramps

Part Number	Description	Capacity	Ramp Tops	Ramp Bottoms	Safety Straps	Ramp Mats
0700900	Ramp Top Kit	700 lb	(2) 2" x 8"	-	-	-
9517100	Ramp Top Kit	700 lb	(2) 2" x 12"	-	-	-
9517300	Ramp Top Kit with Straps and Mats	700 lb	(2) 2" x 8"	-	2	12
9517600	Ramp Top Kit with Straps	700 lb	(2) 2" x 8"	-	2	-
7455000	Ramp Top and Bottom Kit	700 lb	(2) 2" x 8"	(2) 2" x 8"	-	-
7455100	Ramp Mat Kit	-	-	-	-	6



RAMP TOPS & BOTTOMS

- Super strong, top-quality extruded aluminum kits provide many years of service
- For use with 2" x 8" or 2" x 12" boards
- Protective pads included to protect tailgate
- Installation hardware included



SAFETY STRAPS

- Help to limit movement when loading and unloading
- Polyester strap with cambuckles secure ramps to loading vehicle
- D-ring included to attach safety strap to wood ramp



RAMP MATS

- Improve the traction of your ramps
- Lightweight . . . No sharp edges
- Fastening hardware included
- Use one set of six ramp mats per single ramp

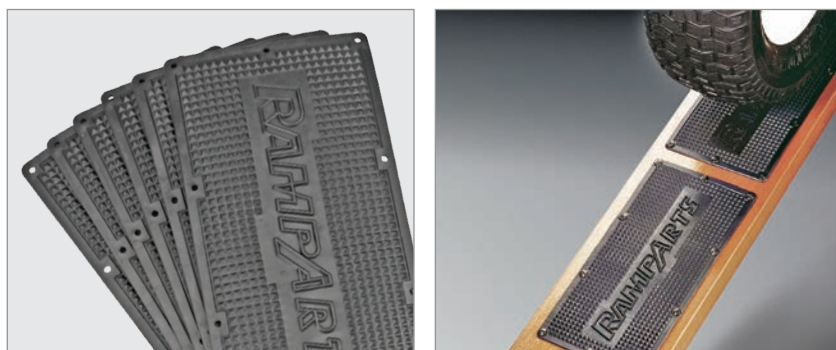

RAMPS

ADJUSTABLE TOP RAMP KITS

Part Number	Description	Capacity	Ramp Tops	Ramp Bottoms	Safety Straps	Ramp Mats
9517400	Adjustable Top Ramp Kit with Straps	700 lb	(2) 2" X 8"	-	2	-
9517500	Adjustable Top Ramp Kit	700 lb	(2) 2" X 8"	-	-	-
9517700	Adjustable Top Ramp Kit	700 lb	(2) 2" X 12"	-	-	-



RAMP CARRY HANDLE

- Safe and easy way to carry loading ramps
- Handle clamps to ramp side rail quickly and securely
- Leave handle on, or move it from ramp to ramp
- Works on straight, arched, or folded ramp styles

Part Number	Description	Material	Color	Qty/Pkg	Package
9518000	Carry Handle	Steel	Silver	1	Box



RAMP CARRY STRAP

- Bundle and carry multiple ramps
- Secure buckles provides custom fit

Part Number	Description	Material	Color	Qty/Pkg	Package
9518300	Carry Strap	Polyester	Black	1	Box



RAMP SAFETY STRAP

- Adjustable strap secures ramp to loading vehicle
- Strap limits movement of ramp while loading and unloading

Part Number	Description	Material	Color	Qty/Pkg	Package
9518200	Safety Strap	Polyester	Black	1	Box



RAMP BUMPER

- Protects tailgate or trailer from scratches
- Soft, protective pads and sturdy corner inserts attach to underside of ramp top
- Fits all REESE ramps with full top plate

Part Number	Description	Material	Color	Qty/Pkg	Package
9518100	Bumper Pads	Rubber	Black	1 Set	Box

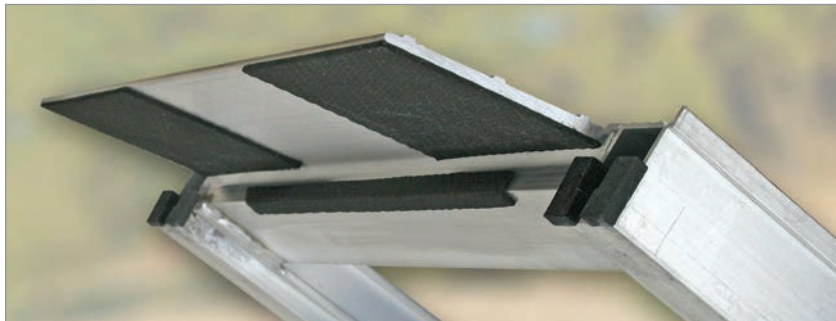



**TRAVEL
WISE**



CARGO CARRIERS

Wherever the adventure takes you, REESE® Explore has a convenient storage solution to help free up critical space in the vehicle.



ROOFTOP CARRIERS

J-Rac Kayak Carrier.....	254
Adjustable Cross Bars.....	254
Rooftop Baskets.....	254
Rooftop Cargo Bags.....	255
Folding Rooftop Carrier.....	256

HITCH MOUNT CARRIERS

Hitch Mount Cargo Trays.....	257
Cargo Tray Bags.....	257

ACCESSORIES

Waterproof Dry Bags.....	258
Cross Bar Pads.....	258
Protective Cargo Mat.....	258

TRUCK BED

Full-Size Tailgate Pad.....	259
Protective Tailgate Pad.....	259

ROOFTOP CARRIERS

J-RAC KAYAK CARRIER

- Holds a single kayak in the upright position
- Padded to protect kayak
- Bow and stern tie down straps, mounting hardware included
- Fits most cross bars

Part Number	Description	Capacity	Qty/Pkg	Package
1394900 NEW	J-Rac Kayak Carrier	165 lb	1 set	Box



ADJUSTABLE CROSS BARS

- Easily mount to raised side rails, no tools required
- Use with rooftop baskets, cargo bags and other accessories
- Tamper-resistant key for increased security
- Fits most cars and SUVs with raised side rails, and roof width 35 in. – 46 in.

Part Number	Description	Dimensions	Details	Capacity	Qty/Pkg	Package
1391400	Adjustable Cross Bars	48"	Steel	125 lb	1 set	Box

ROOFTOP BASKETS

- Provide extra cargo space
- Adjustable brackets fit most cross bar styles
- Rust-resistant finish

Part Number	Description	Dimensions	Details	Capacity	Qty/Pkg	Package
1391300	Rooftop Cargo Basket	44" x 35" x 4.25"	Steel	125 lb	1	Box
1040900	Rooftop Cargo Basket	44" x 33" x 4.25"	Steel	125 lb	1	Box
1394400	Low-Profile Rooftop Cargo Basket	37.25" x 26.5" x 3.75"	Steel	100 lb	1	Box

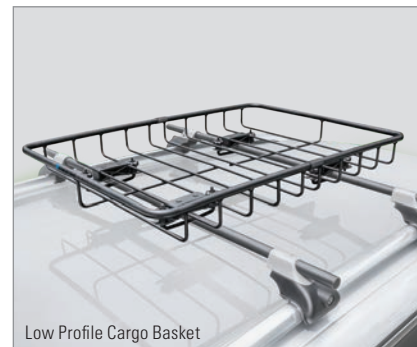

ROOFTOP CARGO BAGS

- Increase your storage area and free up space in your vehicle
- Easily attach to raised side rails, cross bars and/or rooftop baskets
- Available in a variety of sizes and styles

Part Number	Description	Dimensions	Capacity	Protection	Qty/Pkg	Package
1041000	Cargo Bag	37" x 30" x 15.5"	10 cu ft	Everyday	1	Box
1391100	Expandable Cargo Bag	37" x 32" x 19"-21"	10-15 cu ft	Everyday	1	Box
1041100	Cargo Bag	38" x 38" x 18"	15 cu ft	Rainproof	1	Wrap
1391800	Expandable Cargo Bag	40" x 38" x 13.5"-22.5"	12-16 cu ft	Rainproof	1	Box
1390100	Stormproof Shield Cargo Bag	40" x 38" x 23"	15 cu ft	Stormproof	1	Box



HELPFUL HINTS FOR TRANSPORTING GEAR ON YOUR ROOF

KNOW YOUR VEHICLE'S ROOF

- Cargo bags mount to raised side rails, cross bars or rooftop baskets
- Rooftop baskets require cross bars

CHOOSE THE PROPER CARGO BAG

- Everyday Protection – for wind, dust and sun
- Rainproof Protection – for rain, snow, wind, dust and sun
- Stormproof Protection – for heavy rain, snow, dust and sun

TRY YOUR BAG BEFORE YOU TRAVEL

- Adjust strap length and placement on raised side rails and/or cross bars
- Make sure contents fit into bag without overstuffing

HOW TO LOAD YOUR BAG

- Attach cargo bag to rooftop first—then load
- Keep all valuables in vehicle's interior
- Do not exceed your vehicle's rated roof capacity



*To protect the roof of your vehicle, we recommend using a rooftop mat
See page 258

FOLDING ROOFTOP CARRIER

- Folds flat and stays on vehicle when not in use for easy garage access
- Aerodynamic design
- Easy-to-assemble steel frame
- Mounts to most cross bars with provided hardware

Part Number	Description	Dimensions	Capacity	Protection	Qty/Pkg	Package
1393500	Folding Carrier	55" x 24" x 18"	13.5 cu ft	Rainproof	1	Box



EASILY LOAD AND UNLOAD YOUR GEAR WITH A HITCH MOUNT CARGO CARRIER

KNOW YOUR VEHICLE'S HITCH SIZE

- Cargo carriers are designed to fit 1-1/4" or 2" receivers

DETERMINE HOW TO BEST SECURE YOUR CARGO

- Cargo net
- Cargo tray bag
- Ratchet straps

KNOW THE WEIGHT OF THE CARGO YOU ARE CARRYING

- Cargo tray fitting a 1-1/4" receiver will hold up to 300 lbs
- Cargo tray fitting a 2" receiver will hold up to 500 lbs



HITCH MOUNT CARGO TRAYS

- Great for carrying sports gear, lawn and garden supplies, and camping equipment
- Easy to access, load and unload
- Heavy-duty construction

Part Number	Description	Details	Dimensions	Capacity	Qty/Pkg	Package
1041500	Steel Cargo Tray	Fits 1-1/4" and 2" Receivers	60" x 20" x 25"	300/500 lb	1	Box
1394500	Steel Cargo Tray	Fits 2" Receivers	60" x 20" x 25"	500 lb	Box	
1395800	Aluminum Cargo Tray	Fits 2" Receivers	60" x 20" x 25"	500 lb	1	Box



CARGO TRAY BAGS

- Perfect for hauling camping gear, sports equipment and tailgating supplies
- Rainproof storage for cargo trays
- Includes straps for secure attachment to most cargo trays

Part Number	Description	Details	Capacity	Protection	Qty/Pkg	Package
1043000	Rainproof Cargo Tray Bag	54" x 20" x 21"	13 cu ft	Rainproof	1	Box
63604	Rainproof Cargo Tray Bag	59" x 18.5" x 24"	15 cu ft	Rainproof	1	Box



CARGO CARRIERS

WATERPROOF DRY BAGS

- For water sport and outdoor activities such as hunting, hiking and camping
- Provides protection against water, dirt and dust
- Keeps gear dry with waterproof, welded seams

Part Number	Description	Dimensions	Capacity	Qty/Pkg	Package
1396700 NEW	Waterproof Dry Bag	11" x 22"	12 L	1	Box
1396800 NEW	Waterproof Dry Bag	14" x 26"	20 L	1	Box



CROSS BAR PADS

- Protect cargo and cross bars
- Pads secure with hook-and-loop closure
- Compatible with round and square cross bars

Part Number	Description	Dimensions	Details	Qty/Pkg	Package
1393800	Cross Bar Pads	18"	High Density Foam	2	Box
1397200 NEW	Cross Bar Pads	18"	High Density Foam	4	Box

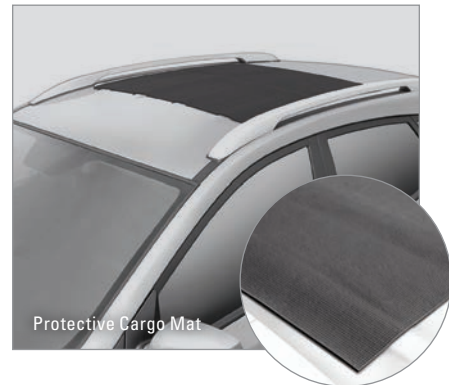

PROTECTIVE CARGO MAT

- Protects vehicle and cargo
- For use with rooftop cargo bag
- Prevents cargo bag from sliding and scratching vehicle finish

Part Number	Description	Dimensions	Color	Qty/Pkg	Package
1390200	Protective Cargo Mat	36" x 36"	Black	1	Box

FULL-SIZE TAILGATE PAD

- Wrap-around pad protects tailgate and gear
- Top strap system secures bikes, ladders and other cargo
- Easy access to tailgate handle

Part Number	Description	Dimensions	Protection	Qty/Pkg	Package
1393600	Mid/Full-Size Tailgate Pad	54" x 30"	Rainproof	1	Box



Full-Size Tailgate Pad



Protective Tailgate Pad

PROTECTIVE TAILGATE PAD

- Protects cargo and top of tailgate
- Slips over tailgate and secures with 2 buckle straps (included)

Part Number	Description	Dimensions	Protection	Qty/Pkg	Package
1393900	Tailgate Pad	18"	Everyday	1	Box



CARGO CARRIERS



**KEEP IT
CLEAN**

Simplify life with organization that balances performance and versatility. REESE® Explore equips you with the tools to keep your vehicle organized.

VEHICLE ORGANIZERS



PET BARRIER	262
TRUNK ORGANIZER	262
STORAGE NET	262
CARGO BAR	263
INTERNAL ORGANIZATION	263

UNIVERSAL PET BARRIER

- Gently keeps your pet in the cargo area of your car, minivan or SUV
- Installs in minutes
- Durable powder-coat finish

Part Number	Description	Dimensions	Color	Qty/Pkg	Package
1390800	Adjustable Universal Pet Barrier	31" x 39" - 45" x 65"	Black	1	Box



TRUNK ORGANIZER

- Two large interior compartments hold shopping bags, sports gear and tools
- Side pockets store smaller items
- Rigid inserts provide structure

Part Number	Description	Dimensions	Color	Qty/Pkg	Package
1392200	Collapsible Trunk Organizer	26" x 12" x 12"	Blue/Gray	1	Sleeve



STORAGE NET

- Organizes and secures cargo in your car, truck, SUV or van
- Installs easily with automotive tape or OEM-style screws (both included)

Part Number	Description	Dimensions	Color	Qty/Pkg	Package
9424000	Hammock Storage Net	21" x 48" - 64"	Black	1	Box

CARGO BAR

- Stops cargo from shifting in SUVs, trucks and vans
- Ratcheting mechanism allows for precise tension
- Rubber end pads hold securely without scratching

Part Number	Description	Dimensions	Qty/Pkg	Package
1390600	Ratcheting Cargo Bar	40" - 70"	1	Box



INTERNAL ORGANIZATION

- Organize your vehicle's interior
- Keep travel accessories in reach

Part Number	Description	Dimensions	Color	Qty/Pkg	Package
1933300	Sunglasses and Cellphone Visor Organizer	11" x 6.25"	Black	1	Sleeve
1930500	Litter Trap	5.5" x 12" x 2.5"	Black	1	Sleeve
1936100	Back Seat Organizer	13.5" x 16.5"	Black	1	Sleeve
1930300	Small Zipper Pouch	12" x 7.5"	Black	1	Sleeve
1930400	Large Zipper Pouch	18" x 9"	Black	1	Sleeve
1932600	Car Trash Keeper	11" x 12" x 3.5"	Black	1	Sleeve
1931100	Premium Glove Box Wallet	10" x 6.5"	Black	1	Sleeve





TIME TO RIDE



Providing efficient transporting solutions, REESE® Explore works hard to keep the adventure going.

BIKE CARRIERS



HITCH MOUNT

- Sportwing™ Hitch Mount Bike Carriers 266
- Hitch Mount Tilt-Away 4-Bike Carrier 266

TRUNK MOUNT

- Aluminum Trunk Mount 2-Bike Carrier 267
- Steel Trunk Mount 2-Bike Carrier 267
- Axis 3™ Trunk Mount 3-Bike Carrier 267

SPORTWING™ HITCH MOUNT BIKE CARRIERS



- Fit any style adult and children's bikes up to 44 in. wheel base
- Adjustable cradles support bikes by the wheels
- Quick and easy to load and unload
- Arms drop down providing access to rear of vehicle

Part Number	Description	Details	Capacity	Qty/Pkg	Package
1390000	SportWing™ 2-Bike Hitch Mount	Fits 1-1/4" and 2" Receivers	100 lb	1	Box
1390500	SportWing™ 4-Bike Hitch Mount	Fits 2" Receivers	160 lb	1	Box

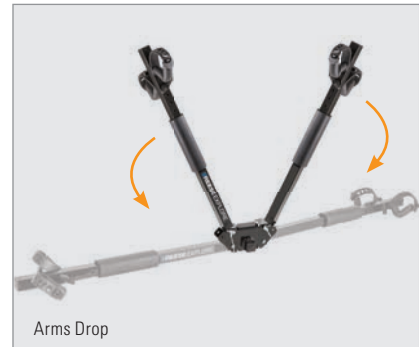

HITCH MOUNT TILT-AWAY 4-BIKE CARRIER



- Tilts away for easy trunk access
- Narrow arm design fits a variety of bike styles
- Supports bikes by the frame
- Arms fold down when not in use

Part Number	Description	Details	Capacity	Qty/Pkg	Package
1393100G	Tilt-Away 4-Bike Carrier	Fits 1-1/4" and 2" Receivers	120 lb	1	Box



WHAT TO KNOW WHEN SELECTING A BIKE CARRIER

Number of bikes to transport

2 BIKE

3 BIKE

4 BIKE

Hitch mount or trunk mount

HITCH MOUNT

TRUNK MOUNT

Vehicle's hitch size: 1-1/4" or 2"

1-1/4 INCH HITCH

2 INCH HITCH

Support bikes by wheel or frame

WHEEL HOLD

FRAME HOLD

ALUMINUM TRUNK MOUNT 2-BIKE CARRIER



- Lightweight, rustproof aluminum
- High-density foam pads for greater weight distribution
- Supports bikes by the frame
- Folds for compact storage

Part Number	Description	Capacity	Qty/Pkg	Package
1392900G	Aluminum 2-Bike Carrier	70 lb	1	Box



STEEL TRUNK MOUNT 2-BIKE CARRIER



- Powder-coated steel frame
- High-density foam pads for greater weight distribution
- Supports bikes by the frame
- Folds for compact storage

Part Number	Description	Capacity	Qty/Pkg	Package
1396600 NEW	Steel 2-Bike Carrier	70 lb	1	Box

AXIS 3™ TRUNK MOUNT 3-BIKE CARRIER













- Durable steel construction
- Supports bikes by the frame
- Adjustable design works with contours of most cars, minivans and SUVs
- Folds flat when not in use

Part Number	Description	Capacity	Qty/Pkg	Package
1390300	Axis 3-Bike Carrier	90 lb	1	Box



STEP 1: DETERMINE GROSS TRAILER WEIGHT

CHECK OWNERS MANUAL FOR WET & DRY WEIGHTS												
Tongue Weight	lbs	1000	2000	3000	4000	5000	6000	7000	8000	10,000	12,000	
Tongue weight should be about 10 to 15 percent of gross trailer weight.		Class I			Class II			Class III			Class III with Weight Distribution	
		Class IV with Weight Distribution										
	Vacation	14'	16'	18'	20'	22'	24'	26'	28'	30'	32'	
	lbs	2100	2400	2700	3000	3300	3600	3900	4200	4500	4800	
	Vacation	14'	16'	18'	20'	22'	24'	26'	28'	30'	32'	
lbs	2800	3200	3600	4000	4400	4800	5200	5600	6000	6400		
	Camper	11'	12'	13'	14'	15'	16'					
lbs	1100	1200	1300	1400	1500	1600						
	TRAILER WEIGHTS ONLY-ADD WEIGHT OF RECREATIONAL VEHICLE & CARGO											
	Boat	Aluminum										
		12 – 15 feet					Trailer Weight = 200 lbs					
		16 – 20 feet					Trailer Weight = 300 lbs					
	Boat	Fiberglass										
	Outboard	Up to – 17' Trailer Weight = 200 lbs					21' to 22' Trailer Weight = 570 lbs					
	Inboard	18' to 20' Trailer Weight = 527 lbs					22' to 24' Trailer Weight = 670 lbs					
	Rec. Vehicle	Motorcycle, Snowmobile, ATV, Personal Watercraft										
	1 Axle	Carries Two Vehicles – Trailer Weight = 250 lbs										
	Rec. Vehicle	Motorcycle, Snowmobile, ATV, Personal Watercraft										
	2 Axle	Carries Four Vehicles – Trailer Weight = 500 lbs										
	Open	4' x 6' Trailer Weight = 450 lbs										
		5' x 8' Trailer Weight = 645 lbs										
	Horse	1 Horse Vehicle Trailer Weight = 1000 lbs										
		2 Horse Vehicle Trailer Weight = 1800 lbs										
	Other	Car Transport Trailer Weight = 1800 lbs										
		Garden or Equipment Trailer Weight = 1800 lbs										
		Tow Dolly Trailer Weight = 500 lbs										

STEP 2: MATCH THE TOW VEHICLE & TRAILER WEIGHT

For safety, make sure the customer's tow vehicle is capable of towing the intended trailer. Neither the vehicle nor the trailer alone can determine the right hitch for the situation. They work together, and in no case should the trailer's GTW and TW exceed the vehicle's maximum towing capacity.

See below to determine passenger car/truck styles and truck bumper styles.

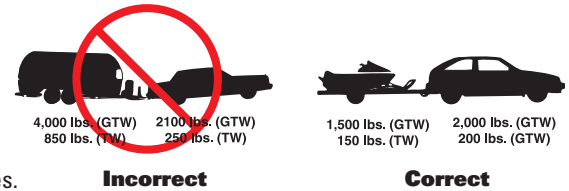

PASSENGER CAR & TRUCK STYLES

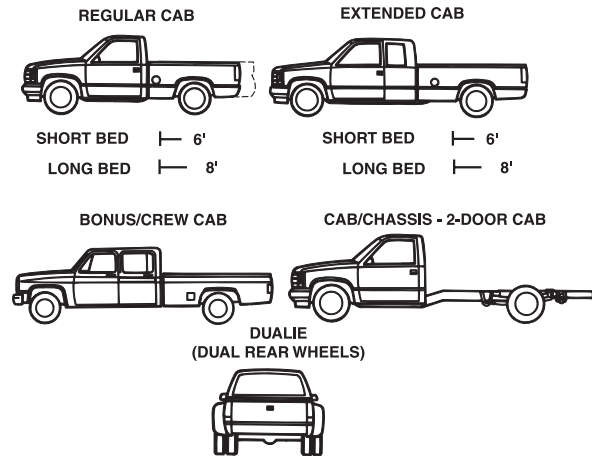
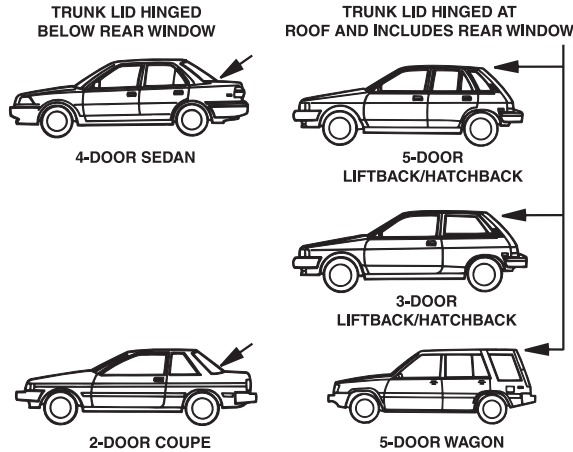

TRUCK BUMPER STYLES



IMPORTANT INSTALLATION TIPS

- Most states require a clear view of the license plate. The ball should be removed when not in use if it obstructs the view.
- REESE® Towpower will not be responsible for problems occurring as the result of unauthorized modifications to REESE® Towpower hitches, or the installation of hitches on vehicles other than those specified.
- If you have adjusted the bumper, exhaust system or any other vehicle components, make sure they have been retightened.
- Give the installation instructions to your customer, as they contain important consumer information.
This is required by law.
- REESE® Towpower hitches are designed to perform satisfactorily on towing vehicles in good condition. We will not be responsible for problems arising from damage, corrosion, or inadequate care of the towing vehicle.

WARNING

Do not modify. Install only on specified vehicle in good condition. Use only for trailer towing and/or attachment of REESE Towpower accessories. Do not extend the original structure. Do not tow one trailer behind another, which may cause loss of control. Failure to heed warnings and follow instructions may result in serious personal injury or death, vehicle crash, and/or property damage. Do not overload any part of your towing system.

STEP 3: DETERMINE HITCH TYPE

WEIGHT-CARRYING HITCHES

Weight-carrying hitches are generally used for lightweight trailers up to 3,500 lbs. GTW and 300 lbs. TW. Certain vehicles such as pickups, vans and utility vehicles with built-in extra cargo capacity can use weight-carrying hitches for higher loads. Weight-carrying hitches support the trailer tongue weight (TW), just as though it were luggage located at the hitch ball.

There are two basic styles of weight-carrying hitches:

- **Fixed Drawbar** — The ball platform is a permanent member welded to the hitch.
- **Removable Drawbar** — The ball platform is removable. In Classes I and II, it's called a drawbar, and in Class III, it's a utility ball mount.

WEIGHT-DISTRIBUTING HITCHES

Rather than merely supporting the trailer tongue weight (TW), weight-distributing hitches apply leverage between the towing vehicle and trailer causing the TW to be carried by all axles of the tow vehicle and trailer. When TW is distributed in this way, trailers with greater TWs can be towed, resulting in a more

level ride which reduces stress on the rear of the tow vehicle and provides greater steering and brake control. Weight-distributing hitches are selected on the basis of GTW and TW, and to some extent on the weight to be carried in the trunk of the towing vehicle. For example, a weight-distributing hitch rated for 7,500 lbs. GTW and 750 lbs. TW should be used for a 5,500 lbs. GTW trailer with 600 lbs. TW, where the towing vehicle will also be carrying 150 lbs. in the trunk. The excess tongue weight capacity of the hitch will help to carry the extra weight in the trunk.

A weight-distributing system includes a receiver attached to the tow vehicle, a removable hitch head and spring bar assembly that fits into the receiver opening and hook-up brackets that connect the spring bars to the trailer frame.

NOTE: AIR SPRINGS, AIR SHOCKS AND OVERLOAD SPRINGS These devices help the tow vehicle's rear suspension support trailer tongue weight as well as the weight of passengers and luggage. They are particularly useful on "soft-sprung" vehicles or those whose springs have settled. They are not substitutes for weight-distributing hitches, since they do not re-distribute load to other axles.

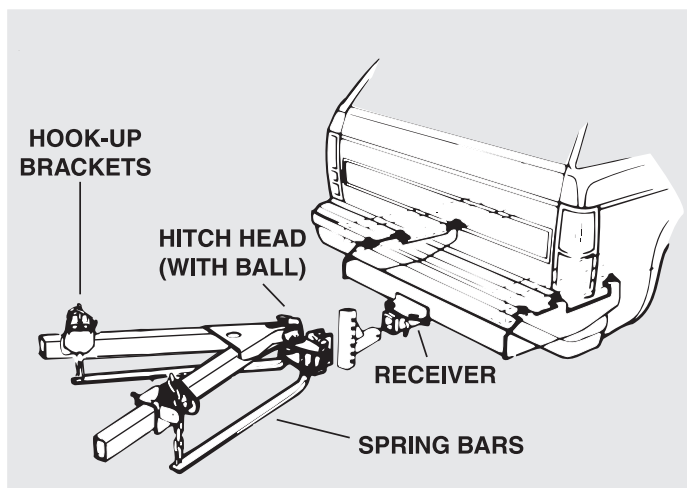
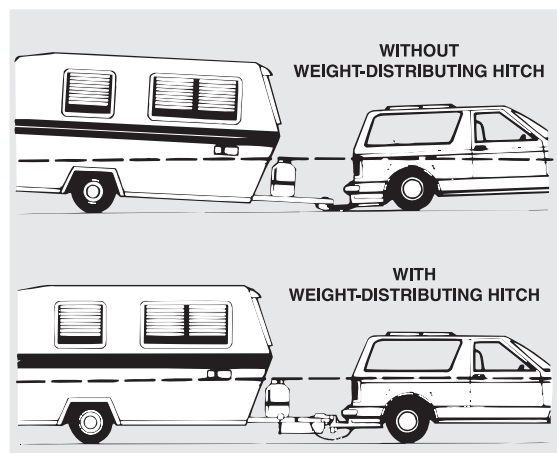
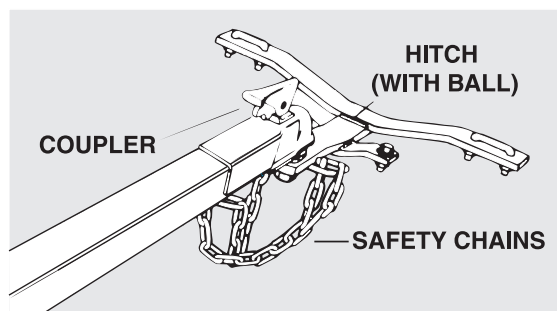

















STEP 3: DETERMINE HITCH TYPE (continued)

Using the information explained in Steps 1 through 3, the chart below makes it easier to find the right hitch type and class for your customer's tow vehicle-trailer combination.

HOW TO USE THE QUICK SELECTION CHART

Find the tow vehicle and size at left and the trailer size and GTW along the top. Where the boxes meet, you'll find the types of hitches that will work for that combination.

HITCH RATING SELECTION CHART				
	COMPACT CARS	MID-SIZE CARS	FULL-SIZE CARS, MINI-VANS & TRUCKS	FULL-SIZE VANS TRUCKS, SUVs
<p>CLASS I LT. DUTY</p> <p>WC GTW - Up to 2,000 lb WC TW - Up to 200 lb</p>				
<p>CLASS II MEDIUM DUTY</p> <p>WC GTW - Up to 3,500 lb WC TW - Up to 350 lb</p>				
<p>CLASS III HEAVY DUTY</p> <p>WC GTW - Up to 5,000 lb WC TW - Up to 500 lb</p>				
<p>CLASS IV HEAVY DUTY</p> <p>WC GTW - Up to 8,000 lb WC TW - Up to 800 lb WD GTW - Up to 12,000 lb WD TW - Up to 1,200 lb</p>				
<p>CLASS V 2-in SQUARE RECEIVER - EXTRA HEAVY DUTY</p> <p>WC GTW - Up to 15,000 lb WC TW - Up to 1,500 lb WD GTW - Up to 16,000 lb WD TW - Up to 1,600 lb</p>				
<p>CLASS V 2-1/2-in SQUARE RECEIVER - EXTRA HEAVY DUTY</p> <p>WC GTW - Up to 18,000 lb WC TW - Up to 2,000 lb WD GTW - Up to 18,000 lb WD TW - Up to 2,500 lb</p>				
				

NOTE: This chart is a general guide, and the specific weights and capacities of the actual trailer, tow vehicle and available hitch must be known in each case.

CAUTION: Class I hitches are not to be used for tandem axle trailers, horse trailers, or house-type travel trailers regardless of weight.

WARNING

DO NOT MODIFY. INSTALL ONLY ON SPECIFIED VEHICLE IN GOOD CONDITION. USE ONLY FOR TRAILER TOWING AND/OR ATTACHMENT OF REESE® BRANDS ACCESSORIES. DO NOT EXTEND THE ORIGINAL STRUCTURE. DO NOT TOW ONE TRAILER BEHIND ANOTHER, WHICH MAY CAUSE LOSS OF CONTROL. FAILURE TO HEED WARNINGS AND FOLLOW INSTRUCTIONS MAY RESULT IN SERIOUS PERSONAL INJURY OR DEATH, VEHICLE CRASH, AND/OR PROPERTY DAMAGE.

DO NOT OVERLOAD ANY PART OF YOUR TOWING SYSTEM

SELECTING THE RIGHT BALL MOUNT

LENGTH

Distance from the center of the ball hole to the center of the pin hole

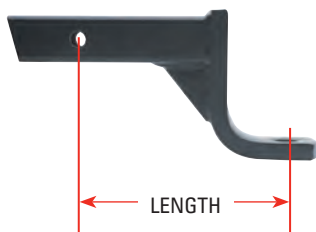

Tow vehicle and trailer level



For safe, comfortable towing, the trailer should always be set up to tow on a level plane.

Trailer not level



Sometimes a trailer's tongue is higher or lower than the ball mount on the vehicle, and a ball mount with a "rise" or a "drop" is required to level the trailer.

RISE

Distance from the top of the shank to the top of the ball platform



DROP

Distance from the top of the shank to the top of the ball platform

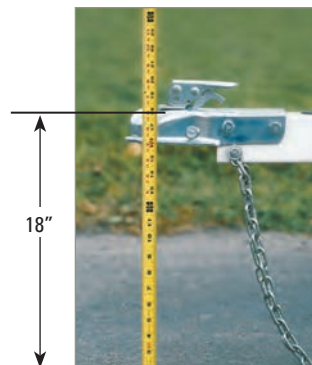
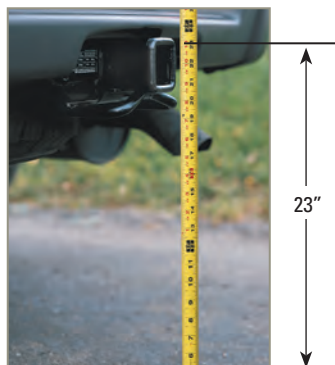

MEASURING FOR THE PROPER BALL MOUNT

1. Measure from the ground to the top of the hitch.
2. Measure from the ground to the (inside) top of the trailer coupler, when level.
3. Subtract the height of the hitch ball (most are 2-1/2-in - 3-in high) from coupler measurement.
4. An 8-in drop is needed to make the trailer level.

THE DIFFERENCE IN THE TWO MEASUREMENTS IS THE AMOUNT OF BALL MOUNT "RISE" OR "DROP" REQUIRED.

SELECTING THE RIGHT HITCH BALL



Selecting the right hitch ball is a must for trouble-free towing.

Always use the properly rated hitch ball for your towing system.

- Your towing system's maximum weight rating is always equal to the lowest rated item in the system
- Your hitching system cannot be upgraded to a rating higher than the maximum rating of your hitch

For example, a 3,500 lbs. ball on a 2,000 lbs. max trailer weight-rated hitch does not increase your towing capacity to 3,500 lbs. Your hitching system is still rated at 2,000 lbs.

Conversely, a 2,000 lbs. ball on a 3,500 lbs. max trailer weight-rated hitch decreases your maximum towing capacity to 2,000 lbs.

The hitch ball diameter (A) must be the same diameter as the trailer coupler (1-7/8", 2", or 2-5/16").

The shank diameter (B) of the hitch ball should be the same as the hole diameter in the (correct) ball mount you selected.

The shank length (C) should be long enough to allow at least two threads to be visible when the hitch ball is installed and the nut completely tightened.

TOWING EQUIPMENT OWNERS: Make sure all operators of your equipment read and understand this information before towing. Save for reference. This will help you properly select, use and maintain your towing equipment. Refer to owner's manuals for your tow vehicle, trailer, and other parts of your towing system. Learn the capabilities and limitations of each part. **GROSS TRAILER WEIGHT** and **TONGUE WEIGHT** are two of the most important items to consider. **THESE WEIGHTS MUST NEVER EXCEED THE LOWEST RATING OF ANY PART OF YOUR TOWING SYSTEM.** **GROSS TRAILER WEIGHT** is the weight of the trailer plus all cargo. Measure **GROSS TRAILER WEIGHT** by putting the fully loaded trailer on a vehicle scale. **TONGUE WEIGHT** is the downward force exerted on the ball by the trailer coupler. Measure **TONGUE WEIGHT** with the fully loaded trailer on a level surface. The coupler must be at its normal towing height. Use a commercial scale or a bathroom scale. Set up the bathroom scale as shown for heavy tongue weights.

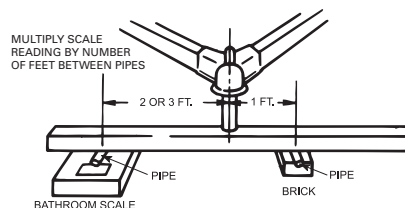
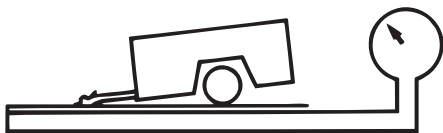

YOUR TOWING EQUIPMENT

TRAILER HITCHES, RECEIVERS, AND BALL MOUNTS.

Select these products by their gross trailer weight and tongue weight ratings. Match the products according to the anticipated use. Use only those products designed for your vehicle.

HITCH BALLS

Select by gross trailer weight rating, mounting platform thickness and hole size, and coupler socket size. Do not mix one class of hitch ball with another class of coupler. Platform must be at least 3/8 inch thick. Hole must not exceed threaded shank diameter by more than 1/16 inch. Use lock washer. Tighten per instructions. When tightened, shank must protrude beyond bottom of nut. Gross trailer weight rating and ball diameter are marked on hitch balls.

TRAILER COUPLERS

The coupler socket should be smooth, clean, and lightly lubricated. Tighten or adjust per coupler manufacturer's instructions. Use proper class type.

SAFETY CHAINS

Connect safety chains properly **EVERY TIME YOU TOW**. Cross chains under coupler. This is done to cradle the trailer tongue in the event the ball and coupler separate. Attach securely to the hitch or tow vehicle so they cannot bounce loose. Leave only enough slack to permit full turning. Too much slack may prevent chains from maintaining control if other connections separate. Don't let chains drag on the road to avoid chain degradation.

TRAILER LIGHTS, TURN SIGNALS, ELECTRIC BRAKES, AND BREAK-AWAY SWITCH CONNECTIONS

Make these safety-critical connections **EVERY TIME YOU TOW**, no matter how short the trip. Check operation, including electric brake manual control, before getting on the road.

SWAY CONTROLS

Sway controls can lessen the effects of sudden maneuvers, wind gusts, and buffeting caused by other vehicles. We recommend them for trailers with large surface areas, such as travel trailers. Adjustable friction models can help control trailers with low tongue weight. Recommended tongue weight is 10% of gross trailer weight.

OTHER USEFUL EQUIPMENT

AIR SPRINGS, AIR SHOCKS, or HELPER SPRINGS are useful for some hitch applications. A **TRANSMISSION COOLER** may be needed for heavy towing. Many states require **TOWING MIRRORS** on both sides.

TIRE INFLATION

Check often. Follow tow vehicle and trailer manufacturers' recommendations. Improper tire inflation can cause uncontrollable trailer sway.

DANGER

DO NOT MODIFY PRODUCT. TOWING VEHICLE MUST BE IN GOOD CONDITION. USE ONLY FOR TRAILER TOWING AND/OR ATTACHMENT OF REESE® BRAND. ACCESSORIES. DO NOT EXTEND ORIGINAL STRUCTURE. DO NOT TOW ONE TRAILER BEHIND ANOTHER, WHICH MAY CAUSE LOSS OF CONTROL. FAILURE TO HEED WARNINGS AND FOLLOW INSTRUCTIONS MAY RESULT IN SERIOUS PERSONAL INJURY OR DEATH, VEHICLE CRASH, AND/OR PROPERTY DAMAGE.

DO NOT OVERLOAD ANY PART OF YOUR TOWING SYSTEM

CHECK YOUR EQUIPMENT / REPLACE WORN PARTS

Check ball, coupler, chains, retaining pins and clips, and all other connectors **EVERY TIME YOU TOW**. Re-check at fuel and rest stops.

NO PASSENGERS IN TRAILERS!

Never allow people in trailers while towing, under any circumstances.

TRAILER LOADING

Proper loading helps prevent sway. Place heavy object on the floor ahead of the axle. Balance the load side-to-side. Secure it to prevent shifting. Tongue weight should be 10-15 percent of gross weight for most trailers. Too low a percentage of tongue weight can cause sway. **NEVER** load the trailer rear-heavy. **LOAD THE TRAILER HEAVIER IN FRONT.**

DRIVING

The additional weight of a trailer affects acceleration, braking and handling. Allow extra time for passing, stopping, and changing lanes. Severe bumps can damage your towing vehicle, hitch, and trailer. Drive slowly on rough roads. **STOP AND MAKE A THOROUGH INSPECTION IF ANY PART OF YOUR TOWING SYSTEM STRIKES THE ROAD. CORRECT ANY PROBLEMS AND REPLACE ANY DAMAGED PARTS BEFORE RESUMING TRAVEL CHECK FOR EXCESSIVE SWAY AND ELIMINATE IT.**

Excessive sway can lead to loss of control. Sway motion should settle out quickly. Sway tends to increase on a downgrade. Starting slowly, increase speed in gradual steps. If sway occurs, adjust your trailer load and equipment. Repeat until the trailer is stable at highway speed. Do this whenever your trailer loading changes.

IF TRAILER SUDDENLY STARTS TO SWAY

Turbulence from another vehicle, a wind gust, or a downgrade can cause sudden sway. So can a shift of the trailer's load or a trailer tire blowout. **IF THE TRAILER SWAYS, IT IS THE DRIVER'S RESPONSIBILITY TO ASSESS THE SITUATION AND TAKE APPROPRIATE ACTION.** Below are suggestions that may apply, depending on conditions:

DO

- Reduce your speed gradually
- Hold the steering wheel as steady as possible
- If your trailer has electric brakes, apply the trailer brakes alone without using the tow vehicle's brakes

DON'T

- Don't hit your brake pedal hard unless absolutely necessary. A "jackknife" can result.
- Don't try to steer out of the sway condition. Sudden or violent steering can make it worse.
- Don't speed up. Sway increases as you go faster.
- Don't continue towing a trailer that tends to sway. You may lose control during an emergency maneuver or if the conditions listed above occur.

TRAILERS: FEDERAL LIGHTING EQUIPMENT LOCATION REQUIREMENTS

IMPORTANT NOTE: Every lamp, reflex reflector, and conspicuity treatment must be permanently attached in the location specified below and must comply with all applicable requirements prescribed for it by FMVSS/CMVSS 108. The face of any device on the front/rear and sides should be, respectively perpendicular and parallel to the vehicle's centerline, unless it is photometrically

certified at installation angle. No part of the vehicle shall prevent any device from meeting its prescribed requirements unless an auxiliary device meeting all prescribed requirements is installed. In Canada: Manufacturers and importers of vehicles must have the proper certification test records demonstrating compliance of lighting components with all prescribed requirements.

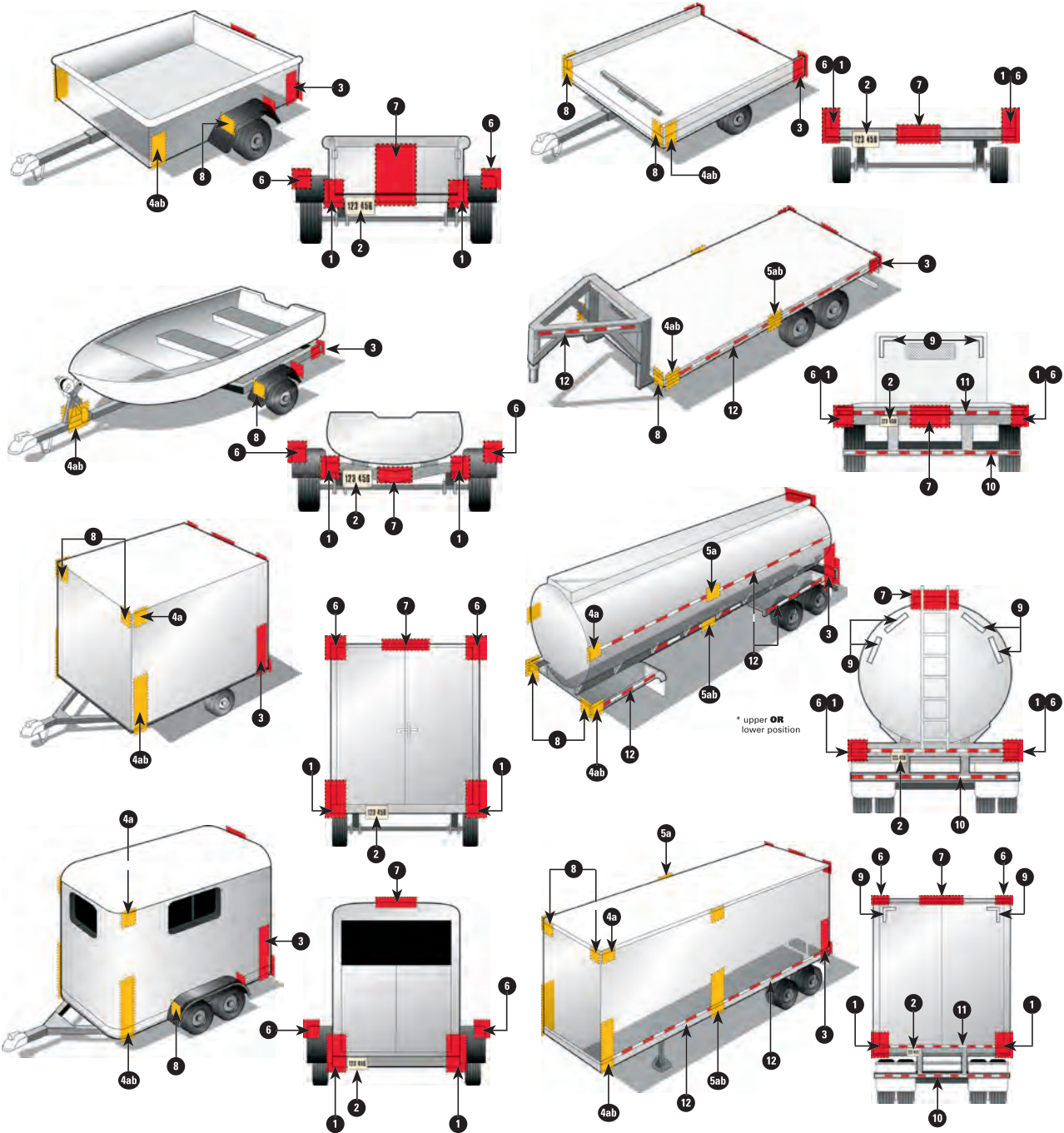

This table summarizes lighting equipment requirements contained in Federal/Canada Motor Vehicle Safety Standard 108. While Horizon Global believes this to be an accurate summary of the latest printed information, the actual standard should be consulted for design or other such purposes. For complete compliance requirements consult Title 49 - Code of Federal Regulations-Section 571.108 (USA) or Section 108 of the Motor Vehicle Safety Regulations (Canada). State or Provincial regulations, where they may apply, have not been included.

BASIC EQUIPMENT REQUIRED ON ALL TRAILERS

DESCRIPTION				MANDATORY REQUIREMENTS			
Area	Equipment	SAE Lens Coding	Functional Purpose	Quantity	Color	Location	Height mm (in.) from the ground
1	Tail Lamps	(T)	Indicate vehicle's presence and width	Minimum 2	Red	On the rear - symmetrical as far apart as practicable	380-1830 (15-72)
	Stop Lamps	(S)	Indicate braking	Minimum 2	Red	On the rear - symmetrical as far apart as practicable	380-1830 (15-72)
	Rear Turn Signal Lamps	(I)	Indicate direction of turn	Minimum 2	Red or Yellow	On the rear - symmetrical as far apart as practicable	380-2110 (15-83)
	Rear Reflex Reflectors	(A)	Indicate vehicle's presence and width	Minimum 2	Red	On the rear - symmetrical as far apart as practicable facing rearward	380-1530 (15-60)
2	License Plate Lamp(s)	(L)	Illuminates license plate	Minimum 1	White	On the rear - above or at the sides of license plate	No requirement
3	Rear Side Marker Lamps <small>*photometrically certified at installation angle</small>	(P2, PC* or P3, PC2*)	Front and rear side marker lamps / side reflex reflectors indicate vehicle's presence and length	Minimum 2	Red	Each side at rear as far back as practicable	380-1530 (15-60) no max. for veh. under 2032mm (80") wide
	Rear Side Reflex Reflectors	(A)		Minimum 2	Red	Each side at rear as far back as practicable facing sideward	380-1530 (15-60)
4	a Front Side Marker Lamps <small>*photometrically certified at installation angle</small>	(P2, PC* or P3, PC2*)		Minimum 2	Yellow	Each side at front as far forward as practicable	380 (15) minimum
	b Front Side Reflex Reflectors	(A)		Minimum 2	Yellow	Each side at front as far forward as practicable facing sideward	380-1530 (15-60)

ADDITIONAL EQUIPMENT FOR TRAILERS EXCEEDING THE FOLLOWING PARAMETERS

Length 9.1m (30 ft.) or longer

DESCRIPTION				MANDATORY REQUIREMENTS			
Area	Equipment	SAE Lens Coding	Functional Purpose	Quantity	Color	Location	Height mm (in.) from the ground
5	a Intermediate Side Marker Lamps	(P2 or P3)	Indicate presence of a long vehicle	Minimum 2	Yellow	Each side near center facing sideward	380 (15) minimum
	b Intermediate Side Reflex Reflectors	(A)	Indicate presence of a long vehicle	Minimum 2	Yellow	Each side near center facing sideward	380-1530 (15-60)

Width 2032mm (80 in.) or wider

DESCRIPTION			MANDATORY REQUIREMENTS				
Area	Equipment	SAE Lens Coding	Functional Purpose	Quantity	Color	Location	Height
6	Rear Clearance Lamps <small>*photometrically certified at installation angle</small>	(P2, PC* or P3, PC2*)	Show vehicle's width MAY NOT be combined with tail lamps	Minimum 2	Red	At widest point - symmetrical on the rear or near the rear facing rearward	As high as practicable may be lower only if ID lamps are at the top
7	Rear Identification (ID) Lamps	(P2 or P3)	Indicate presence of a wide vehicle	Exactly 3	Red	On the rear - center horizontally spaced 150mm (6 in.) to 300mm (12 in.) apart facing rearward	At the top - may be lower if door header narrower than 25mm
8	Front Clearance Lamps <small>*photometrically certified at installation angle</small>	(P2, PC* or P3, PC2*)	Show vehicle's width	Minimum 2	Yellow	At widest point - symmetrical on the front or near the front facing forward	As high as practicable

Width 2032mm (80 in.) or wider AND GVWR 4536 kg (10,000 lb.) or more

DESCRIPTION		MANDATORY REQUIREMENTS					
Area	Conspicuity Treatment	DOT Coding	Quantity	Color	Location	Height	Options
9	Rear Upper Body Markings		Exactly 2 pairs of 300mm long strips	White	On the rear upper corners facing rearward	At the top	Reflex reflectors may not be required if they are replaced in their required location with conspicuity treatment. Optional in Canada: Rear lower body and side conspicuity treatment may also be solid white, solid yellow, or white and yellow.
10	Bumper Bar Marking		Continuous	Red/White	On the rear bumper bar's horizontal element full width - facing rearward	No requirement	
11	Rear Lower Body Marking	DOT-C DOT-C2 DOT-C3 DOT-C4	Continuous	Red/White <i>(see options)</i>	On the rear full width of the vehicle facing rearward	As horizontal as practicable and as close as practicable to the range of 375 to 1525mm from the ground	
12	Side Marking		<i>(see location)</i>	Red/White <i>(see options)</i>	Each side - facing sideward continuous, or evenly spaced over minimum of 50% of length starts and ends as close to the front and rear of the vehicle as practicable	As horizontal as practicable and as close as practicable to the range of 375 to 1525mm from the ground	

NOTE: The edge of red conspicuity tape shall not be closer than 75 mm to the edge of any amber lamp and the edge of white conspicuity tape shall not be closer than 75 mm to the edge of any lamp

TRUCKS: FEDERAL LIGHTING EQUIPMENT LOCATION REQUIREMENTS

IMPORTANT NOTE: Every lamp, reflex reflector, and conspicuity treatment must be permanently attached in the location specified below and must comply with all applicable requirements prescribed for it by FMVSS/CMVSS 108. The face of any device on the front/rear and sides should be, respectively perpendicular and parallel to the vehicle's centerline, unless it is photometrically

certified at installation angle. No part of the vehicle shall prevent any device from meeting its prescribed requirements unless an auxiliary device meeting all prescribed requirements is installed. In Canada: Manufacturers and importers of vehicles must have the proper certification test records demonstrating compliance of lighting components with all prescribed requirements.

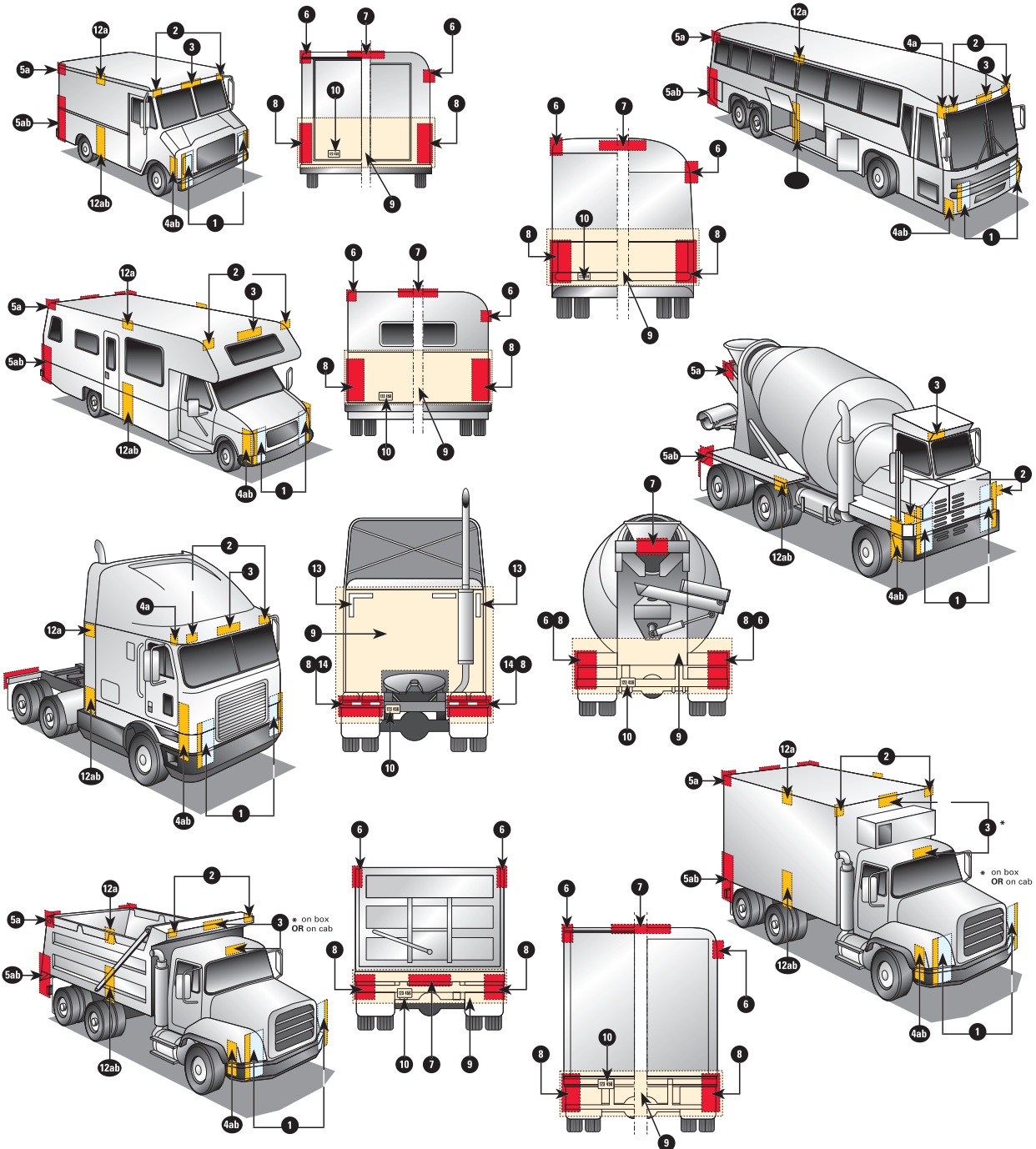

This table summarizes lighting equipment requirements contained in Federal/Canada Motor Vehicle Safety Standard 108. While HORIZON GLOBAL believes this to be an accurate summary of the latest printed information, the actual standard should be consulted for design or other such purposes. For complete compliance requirements consult Title 49 - Code of Federal Regulations-Section 571.108 (USA) or Section 108 of the Motor Vehicle Safety Regulations (Canada). State or Provincial regulations, where they may apply, have not been included.

For more information contact:

BASIC EQUIPMENT REQUIRED ON ALL TRUCKS, BUSES & MPVs

DESCRIPTION				MANDATORY REQUIREMENTS			
Area	Equipment	SAE Lens Coding	Functional Purpose	Quantity	Color	Location	Height mm(in.) from the ground
1	Headlamps - Lower Beam US requires "DOT" lettering on lens US&Canada - light source code required on lens	(H, HR)	Forward road illumination	Minimum 2	White	On the front - symmetrical as far apart as practicable If 4 lamp system - outboard or above upper beams	560-1370 (22-54)
	Headlamps - Upper Beam US requires "DOT" lettering on lens US&Canada - light source code required on lens	(H, HR)	Forward road illumination	Minimum 2	White	On the front - symmetrical If 4 lamp system - inboard or below lower beams	560-1370 (22-54)
	Parking Lamps Vehicles less than 2032mm wide	(P)	Indicate parked vehicle	Minimum 2	White or Yellow	On the front - symmetrical as far apart as practicable	380-1830 (15-72)
	Daytime Running Lamps (DRL) Canada - required / US - option US requires "DRL" lettering on lens if not headlamp	(Y2)	Indicate in use vehicle	Minimum 2	White or Yellow	On the front - symmetrical as far apart as practicable	380 (15) min. Max. depends on type of DRL
	Front Turn Signal/ Hazard Warning Lamps	(I)	Indicate direction of turn/ identify disabled vehicle	Minimum 2	Yellow	On the front - symmetrical as far apart as practicable	380-2110 (15-83)
2	Front Clearance Lamps Vehicles 2032mm wide or wider *photometrically certified at installation angle	(P2, PC* or P3, PC2*)	Show vehicle's width	Minimum 2	Yellow	At widest point - symmetrical on the front or near the front facing forward	As high as practicable
3	Front Identification Lamps (ID) Vehicles 2032mm wide or wider	(P2 or P3)	Indicate presence of a wide vehicle	Exactly 3	Yellow	On the front - center horizontally spaced 150 mm (6 in.) to 300 mm (12 in.) apart	As high as practicable or on top of the cab
4	a Front Side Marker Lamps *photometrically certified at installation angle	(P2, PC* P3, PC2*)	Front and rear side marker lamps / side reflex reflector indicate vehicle's presence and length	Minimum 2	Yellow	Each side at front as far forward as practicable	380 (15) minimum
	b Front Side Reflex Reflectors	(A)		Minimum 2	Yellow	Each side at front as far forward as practicable facing sideward	380-1530 (15-60)
5	a Rear Side Marker Lamps ** *photometrically certified at installation angle	(P2, PC* or P3, PC2*)		Minimum 2	Red	Each side at rear as far back as practicable	380 (15) minimum
	b Rear Side Reflex Reflectors ** **not required on Truck Tractors	(A)		Minimum 2	Red	Each side at rear as far back as practicable facing sideward	380-1530 (15-60)
6	Rear Clearance Lamps Vehicles 2032mm wide or wider Not required on Truck Tractors *photometrically certified at installation angle	(P2, PC* or P3, PC2*)	Show vehicle's width MAY NOT be combined with tail lamps	Minimum 2	Red	At widest point - symmetrical on the rear or near the rear facing rearward	As high as practicable may be lower only if rear ID lamps are at the top
7	Rear Identification (ID) Lamps Vehicles 2032mm wide or wider Not required on Truck Tractors	(P2 or P3)	Indicate presence of a wide vehicle	Exactly 3	Red	On the rear - center horizontally spaced 150mm (6 in.) to 300mm (12 in.) apart facing rearward	At the top may be lower if doo narrower than 25mm
8	Tail Lamps	(T)	Indicate vehicle's presence and width	Minimum 2	Red	On the rear - symmetrical as far apart as practicable	380-1830 (15-72)
	Stop Lamps	(S)	Indicate braking	Minimum 2	Red	On the rear - symmetrical as far apart as practicable	380-1830 (15-72)
	Rear Turn Signal/ Hazard Warning Lamps	(I)	Indicate direction of turn/ identify disabled vehicle	Minimum 2	Red or yellow	On the rear - symmetrical as far apart as practicable	380-2110 (15-83)
	Rear Reflex Reflectors	(A)	Show vehicle's presence and width	Minimum 2	Red	On the rear - symmetrical as far apart as practicable	380-1530 (15-60)
9	Backup Lamp	(R)	Illuminates ground behind the vehicle and alert road users	Minimum 1	White	Rear	No requirement
10	License Plate Lamp(s)	(L)	Illuminates license plate	Minimum 1	White	On the rear - above or at the sides of license plate	No requirement
11	Center High Mounted Stop Lamp Vehicles less than 2032mm wide and 4536kg	(U3)	Indicates braking	1	Red	On the rear - centerline of the vehicle	860 (34) minimum

ADDITIONAL EQUIPMENT FOR SPECIFIC VEHICLES VEHICLES 9.1m (30 ft.) LONG OR LONGER

DESCRIPTION				MANDATORY REQUIREMENTS			
Area	Equipment	SAE Lens Coding	Functional Purpose	Quantity	Color	Location	Height mm(in.) from the ground
12	a Intermediate Side Marker Lamps	(P2 or P3)	Indicate presence of a long vehicle	Minimum 2	Yellow	Each side near center	380 (15) minimum
	b Intermediate Side Reflex Reflectors	(A)	Indicate presence of a long vehicle	Minimum 2	Yellow	Each side near center facing sideward	380-1530 (15-60)

Truck Tractors

DESCRIPTION		MANDATORY REQUIREMENTS					
Area	Conspicuity Treatment	DOT Coding	Quantity	Color	Location	Height	Options
13	Rear Upper Body Markings	DOT-C DOT-C2	Exactly 2 pairs of 300mm long strips	White	Rear upper corners of cab facing rearward	As high as practicable excluding fairings	
14	Rear Marking	DOT-C3 DOT-C4	Exactly 2 sections of min. 600mm each	Red/ White	Rear - facing rearward - on fenders, on mud flap brackets, or within 300mm below the top of mud flaps	As horizontal as practicable and not higher than 1525mm from the ground	If mud flaps not used - on the cab or frame mounted brackets

NOTE: The edge of red conspicuity tape shall not be closer than 75 mm to the edge of any amber lamp and the edge of white conspicuity tape shall not be closer than 75 mm to the edge of any lamp

Part No.	Description	Page No.
06 Series	Custom-Fit Hitches	8
06280	Standard Ball Mount	34
06474	Standard Ball Mount	34
0700900	8" Standard Ramp Top Kit	248
1040900	Rooftop Cargo Basket	254
1041000	Rooftop Cargo Bag	255
1041100	Rooftop Rainproof Cargo Bag	255
1041200	Sure Step	197
1041500	Steel Hitch Mount Cargo Tray	257
1043000	Rainproof Cargo Tray Bag	257
11003	Hitch Box Extension	17
11004	Hitch Box Extension	17
11006	Hitch Box Extension	17
11021	Receiver Tube Sized with Collar	17
11080	Receiver Tube Sized with Collar	17
118001	4-Flat Wiring Kit	100
118002	4-Flat Wiring Kit	100
118030	7-Way Blade Connector	109
118031	7-Way Blade Connector	109
118033	4-Flat Connector	99
118044	4-Flat Connector	99
118045	4-Flat Connector	99
118136	Mounting Bracket Attachment	111
118140	Mounting Bracket Attachment	111
118192	4-Flat Connector Kit "Y" Wishbone	101
118601	4-Flat Knockout Adapter	119
118710	7-Way to 4-Flat Adapter	118
1390000	SportWing 2-Bike Hitch Mount	266
1390100	Rooftop Stormproof Shield Bag	255
1390200	Protective Cargo Mat	258
1390300	Axis 3 Trunk Mount 3-Bike Carrier	267
1390500	SportWing 4-Bike Hitch Mount	266
1390600	Ratcheting Cargo Bar	263
1390800	Adjustable Universal Pet Barrier	262
1391100	Rooftop Expandable Cargo Bag	255
1391300	Rooftop Cargo Basket	254
1391400	Adjustable Cross Bars	254
1391800	Rooftop Rainproof Expandable Cargo Bag	255
1392200	Collapsible Trunk Organizer	262
1392900G	Trunk Mount Aluminum 2-Bike Carrier	267
1393100G	Hitch Mount Tilt-Away 4-Bike Carrier	266
1393500	Rooftop Folding Carrier	256
1393600	Mid/Full-Size Tailgate Pad	226, 259
1393700	Cargo Net	190
1393800	Cross Bar Pads	227, 258
1393900	Tailgate Pad	226, 259
1394400	Low-Profile Rooftop Cargo Basket	254
1394500	Steel Hitch Mount Cargo Tray	257
1394900	J-Rac Kayak Carrier	226, 254
1395800	Aluminum Hitch Mount Cargo Tray	257
1396600	Steel Trunk Mount 2-Bike Carrier	267
1396700	12L Waterproof Dry Bag	227, 258
1396800	20L Waterproof Dry Bag	227, 258
1397200	Cross Bar Pads	227, 258
15058	Ergo Clips Pin & Clip	57
16210C	Ergo Clips, 2-pack	57
1880400	8' Surelok Tie Down with Soft Ties	232
1880600	10' Grip Handle Ratchet with Soft Ties	232
1880900	12' ATV Recovery Strap	233
1881000	Motorcycle Cargo Net	232
1881100	ATV Cargo Net	233
1881200	Motorcycle Cover	233
1881300	Motorcycle Wheel Chock	232
1881800	Large ATV Cover Gray	233
1881900	X-Large ATV Cover Gray	233
1882000	Large ATV Cover Camo	233
1882100	X-Large ATV Cover Camo	233
1882200	UTV Cover Gray	233
1882300	UTV Cover Camo	233
1930300	Small Zipper Pouch	263
1930400	Large Zipper Pouch	263
1930500	Litter Trap	263

Part No.	Description	Page No.
1931100	Premium Glove Box Wallet	263
1932600	Car Trash Keeper	263
1933300	Sunglasses and Cellphone Visor Organizer	263
1936100	Back Seat Organizer	263
20136	4-Way Flat to 5-Way Flat Connector Kit	101
20141	7-Way to 5-Flat Adapter	119
20147	7-Way Blade Connector Kit	107
20250	4-Flat Wiring Kit	100
20252	4-Flat Wiring Kit	100
2060000	36" Bow Tie Down	238
2060100	36" Stainless Steel Bow Tie Down	238
2060200	43" Stainless Steel Retractable Transom Tie Down	239
2060300	43" Retractable Transom Tie Down	239
2060400	24" Transom Tie Down	239
2060500	24" Stainless Steel Transom Tie Down	239
2060600	48" Stainless Steel Transom Tie Down	239
2060700	48" Transom Tie Down	239
2060800	10' Stainless Steel Gunwale Tie Down	238
2060900	13' Stainless Steel Gunwale Tie Down	238
2061000	16' Stainless Steel Gunwale Tie Down	238
2061100	20' Stainless Steel Gunwale Tie Down	238
2061200	10' Gunwale Tie Down	238
2061300	13' Gunwale Tie Down	238
2061400	16' Gunwale Tie Down	238
2061500	20' Gunwale Tie Down	238
2061600	Dock Cleat	239
21141	Adjustable Ball Mount	38
21171	Standard Ball Mount	34
21175	Standard Ball Mount	34
21186	Standard Ball Mount	34
21287	Standard Ball Mount	34
21288	Standard Ball Mount	34
21289	Standard Ball Mount	34
21330	Forged Ball Mount	38
21331	Forged Ball Mount	38
21332	Forged Ball Mount	38
21342	Standard Ball Mount	34
21344	Standard Ball Mount	34
21345	Standard Ball Mount	34
21347	Standard Ball Mount	34
21511	Dual Ball Mount	40
21514	Tri-Ball Mount	40
21518	Dual Ball Mount	40
21536	Standard Towing Starter Kit	42
21542	InterLock® Towing Starter Kit	42
21543	InterLock® Towing Starter Kit	42
21556	Standard Towing Starter Kit	42
21790	InterLock® Ball Mount	33
21791	InterLock® Ball Mount	33
21792	InterLock® Ball Mount	33
21793	InterLock® Ball Mount	33
21794	InterLock® Ball Mount	33
21900	InterLock® Ball Mount	33
21901	InterLock® Ball Mount	33
33 Series	Custom-Fit Hitches	9
33305 1360	Coupler	67
35 Series	Custom-Fit Hitches	9
3592011	Standard Ball Mount	34
3593011	Standard Ball Mount	34
3594011	Standard Ball Mount	34
36 Series	Custom-Fit Hitches	9
3606111	Standard Ball Mount	34
37 Series	Custom-Fit Hitches	9
37041	CLASS III/IV Multi-Fit Hitch	11
37042	CLASS III/IV Multi-Fit Hitch	12
37094	CLASS IV Multi-Fit Hitch	15
37096	CLASS III/IV Multi-Fit Hitch	14
4210	Lunette Eye Lock	45
44 Series	Custom-Fit Hitches	9
44305R1360	Coupler	67
45 Series	Custom-Fit Hitches	10
457 Series	Custom-Fit Hitches	10

Part No.	Description	Page No.
49802	Fold Down License Plate Adapter	18
50-85-315	Trailer Breakaway Emergency Braking System	133
50-85-320	Trailer Breakaway Emergency Braking System	133
500701	A-Frame Jack with Powered Drive	74
500702	A-Frame Jack with Powered Drive	74
500703	A-Frame Jack with Powered Drive	75
500704	A-Frame Jack with Powered Drive	75
51 Series	Custom-Fit Hitches	8, 9
55003	Universal Coupler Lock	59
58109	Hitch Ball Bushing	88
58109	Step Bumper Receiver	88
58117	Hitch Ball Lubricant	88
58184	Hitch Ball Bushing	88
63251	Fifth Wheel King Pin Lock	60
63604	Rainproof Cargo Tray Bag	257
6495	Winch Mounting Plate	18
65 Series	Front Mount Receivers	18
6715	Spare Tire Carrier	18
6758	Work Step	18
6771	License Plate Adapter	18
7000100	Wheel Chocks	83
7000300	Wheel Dock Chock	83
7000400	Ball Mount Lock	54
7000600	Receiver Tube Cover	87
7004700	Dual-Fit Fas-Lok® Coupler	66
7004800	Dual-Fit Fas-Lok® Coupler	66
7004900	Security Dual-Fit Coupler	66
7005000	Security Dual-Fit Coupler	66
7005100	InterLock® Towing Security Kit	43
7005200	InterLock® Towing Security Kit	43
7005300	Coupler Lock	59
7005600	Barrel Style Receiver Lock	53
7005800	Coupler Lock	59
7006000	Ball Mount Lock	54
7006100	Receiver and Coupler Locks	54
7006400	Ball Mount Lock	54
7006500	Ball Mount Lock	54
7006600	Coupler Lock	59
7006700	Anti-Theft Receiver Pin	57
7006800	Hitch Pin and Clip	55
7007100	Anti-Theft Receiver Pin	57
7007200	Anti-Theft Receiver Pin	57
7007300	Anti-Theft Receiver Pin	57
7007400	Surface Mount Tow Hook	61
7007500	Towing Safety Cables	61
7007600	Safety Chain	61
7007700	Safety Chain	61
7007800	Safety Chain	61
7007900	Quick Links	61
7008000	Quick Links	61
7008100	InterLock® Hitch Ball	28
7008200	InterLock® Hitch Ball	28
7008300	InterLock® Hitch Ball	28
7008400	InterLock® Hitch Ball	28
7008500	InterLock® Hitch Ball	28
7008600	InterLock® Hitch Ball	28
7008700	InterLock® Hitch Ball	28
7009100	Hitch Pin and Clip	55
7009200	Hitch Pin and Clip	55
7009300	Easy Access Receiver Lock	52
7010100	Barrel Style Receiver Lock	53
7010200	Barrel Style Receiver Lock	53
7010500	Hitch Pin and Clip	55
7010600	Hitch Pin and Clip	55
7011300	InterLock® Hitch Ball	28
7011400	InterLock® Hitch Ball	28
7012900	SoloHitch™ Alignment System	89
7013100	Hitch Ball Cover	87
7013700	Lunette Ring	45
7014200	Adjustable Tow Bar	62
7014500	Anti-Theft Receiver Pin	57
7014700	Tow and Store Anti-Theft Lock Kit	59

Part No.	Description	Page No.
7015300	20" Upright Roller Guide	237
7015400	44" Upright Boat Guide	237
7015500	Adjustable Motor Support Bracket	237
7015600	Motor Support Bracket	237
7016000	Bunk Carpet	237
7016200	Offset Spare Tire Carrier	236
7016300	High Mount Spare Tire Carrier	236
7016400	Economical Spare Tire Carrier	236
7016800	1400 lb Marine Winch	235
7016900	1500 lb Marine Winch	235
7017000	2000 lb Marine Winch	235
7017100	15' Marine Winch Strap	236
7017200	20' Marine Winch Strap	236
7018100	Canoe Loader	237
7019200	Locking Spare Tire Carrier	236
7019200	Spare Tire Carrier	62
7019400	600 lb Marine Winch	235
7020500	Receiver Adapter	16
7021200	Anti-Theft Receiver Pin	57
7021500	Pintle Ball	44
7021600	Pintle Ball	44
7021700	Pintle Ball	44
7021800	Rotating Tri-Ball Mount	39
7022400	Tri-Ball Mount	40
7022900	Receiver Adapter	16
7023100	Receiver Tube Cover	87
7023900	Barrel Style Receiver Lock	53
7023900	Security Lock Set - 2 pack	54
7024100	Receiver Mount Pintle/Ball Combo	46
7024200	Receiver Mount Pintle/Ball Combo	46
7024300	Receiver Mount Pintle Hook	46
7024400	Receiver Mount Tow Hook	46
7024500	Receiver Mount Tow Eye	46
7024600	Receiver Mount Tow Ring	47
7024800	Tow Bar Chain Kit	62
7025700	Safety Chain	61
7027800	3/4-in Nut and Washer	30
7027900	1-in Nut and Washer	30
7028000	1-1/4-in Nut and Washer	30
7028100	HD Standard Ball Mount	35
7028200	HD Standard Ball Mount	35
7028400	Class V Hitch Ball	35
7028400	Standard Hitch Ball	29
7028500	Class V Hitch Ball	35
7028500	Standard Hitch Ball	29
7028600	Class V Hitch Ball	35
7028600	Standard Hitch Ball	29
7028700	Receiver Adapter	16
7028700	Reducer Sleeve	35
7028900	Standard Hitch Ball	29
7030200	Professional Receiver Lock	50
7030300	Professional Receiver Lock	50
7030400	Professional Receiver Lock	50
7030500	Professional Coupler Lock	50
7030600	Professional Receiver and Coupler Locks	50
7031300	Adjustable Ball Mount	38
7031400	Tri-Ball with Hook	41
7031500	Easy Access Coupler Lock	52
7031600	Easy Access Receiver Lock and Cable	60
7031700	Receiver Mount Clevis Pin	47
7033100	Hitch Pin and Clip	56
7033200	Barrel Style Receiver Lock	53
7033300	Barrel Style Receiver Lock	53
7033400	Heavy-Duty Jack	80
7033600	Single-Speed Electric Winch	73
7033830	Cable Lock	60
7033900	Standard Hitch Ball	29
7034200	Towing Mirror	89
7034300	InterLock® Ball Mount	33
7034400	InterLock® Ball Mount	33
7036400	Powered A-Frame Jack	75
7036700	Wheel Bearing Protector Set	88

Part No.	Description	Page No.
7036800	Standard Hitch Ball	29
7039000	Barrel Style Receiver Lock	53
7039100	Barrel Style Receiver Lock	53
7039200	InterLock® Towing Security Kit	43
7039300	InterLock® Towing Security Kit	43
7039800	Tri-Ball Mount	40
7042100	Coupler Lock	59
7042900	Swing Away Trailer Jack	68
7043000	InterLock® Towing Starter Kit	42
7043120	InterLock® Towing Starter Kit	42
7043200	Standard Towing Starter Kit	42
7043700	Wide-Angle Mirror	89
7044000	Wide-Angle Mirrors	89
7044900	Pintle Pin and Clip	45
7048400	Farm Jack Foot Plate	80
7050900	Coupler Pin and Chain	67
7051500	Receiver Tube Cover	87
7052500	Receiver Adapter	16
7054430	Easy Access Receiver Lock	51
7054530	Easy Access Receiver and Coupler Locks	51
7054630	Easy Access Receiver Lock	51
7054700	TransRACK Cargo Truck System	214
7054900	TransRACK Conduit Carrier	215
7055000	TransRACK Trimmer Rack	216
7055100	TransRACK Tool Rack	216
7055200	TransRACK Top Rail Kit	214
7057030	Easy Access Receiver Lock	51
7057130	Easy Access Receiver Lock	51
7057230	Easy Access Receiver Lock	51
7057330	Coupler Lock	51
7057430	Coupler Lock	51
7057700	Hitch Pin and Clip	56
7057830	Easy Access Receiver Lock	51
7057900	Hitch Ball Lubricant	88
7060100	Dual Hitch Extension	81
7060200	Tow & Go Hitch Step	82
7060400	InterLock® Hitch Ball	28
7060500	Carbon Forged Ball Mount	32
7060600	Carbon Forged Ball Mount	32
7060700	Carbon Forged Ball Mount	32
7060800	Carbon Forged Ball Mount	32
7060900	Heavy-Duty Jack	80
7061200	InterLock® Hitch Ball	28
7061500	Jack Handle Holder	80
7061700	TransRACK Cross Bar Glides	215
7062800	Carbon Forged Ball Mount	32
7062900	Carbon Forged Ball Mount	32
7063000	TransRACK Load Stops	215
7063200	HD InterLock® Ball Mount	35
7063300	HD InterLock® Ball Mount	35
7063400	Class V Hitch Ball	35
7063400	InterLock® Hitch Ball	28
7063500	TransRACK Workmate Cargo Truck System	214
7063830	Hitch Pin and Clip	55
7063930	Hitch Pin and Clip	55
7064100	ATV/UTV Jack Maintenance Kit	234
7064100	Farm Jack Maintenance Kit	80
7064200	ATV/UTV Jack	234
7064200	Heavy-Duty Jack	80
7064600	1200 lb Marine Winch	235
7064700	1500 lb Marine Winch	235
7064800	2000 lb Marine Winch	235
7065000	3-Way ATV Hitch	234
7065100	3-Way ATV Hitch	234
7065300	Lighted Hitch Step	161
7065300	Tow & Go Lighted Hitch Step	82
7065400	Vehicle Recovery Ring	78
7065500	Vehicle Recovery Ring	78
7065600	Vehicle Recovery System	79
7065700	Carbon Forged Ball Mount	32
7066700	Cable Puller Storage Bag	207
7066800	1-Ton Cable Puller	206

Part No.	Description	Page No.
7066900	Professional Universal Coupler Lock	58
7067000	2.5-Ton Cable Puller	206
7067100	1-Ton Webbing Puller	206
7067200	1/2-Ton Rope Hoist	207
7067300	Chain Hoist	79
7067400	Chain Hoist	79
7067600	2-Ton Cable Puller	206
7067700	3-Ton Cable Puller	206
7067800	4-Ton Cable Puller	206
7067900	Carbon Forged Ball Mount	32
7068000	Carbon Forged Ball Mount	32
7068100	Carbon Forged Ball Mount	32
7068200	Vehicle Recovery System	79
7068300	Carbon Forged Ball Mount	32
7068800	Tri-Ball Mount	40
7068900	Rotating Tri-Ball Mount	39
7070700	Professional Receiver Lock	50
7070800	Professional Receiver Lock	50
7071000	InterLock® Hitch Ball	28
7071100	InterLock® Hitch Ball	28
7071200	InterLock® Hitch Ball	28
7071300	Universal ATV/UTV Jack Mounts	80
7071400	InterLock® Hitch Ball	28
7073930	Hitch Ball Wrench	83
7074000	Ball Mount Storage	47
7074100	Ball Mount Boot Brush	81
7074300	Wheel Chock	83
7074400	Carabiner Tow Hook	41
7074630	Spring-Loaded Hitch Cover	86
7075300	Safety Chain	61
7076000	Weld-On Standard Round Jack	70
7076100	Weld-On Standard Round Jack	70
7076300	Weld-On Standard Round Jack	70
7076400	Weld-On Standard Round Jack	70
7076500	Bolt-On Standard Round Jack	70
7076600	Bolt-On Standard Round Jack	70
7076700	A-Frame Standard Round Jack	71
7076800	A-Frame Standard Round Jack	71
7077000	Direct Weld Square Jack	72
7077200	Direct Weld Square Jack	72
7077300	Weld-On Square Jack	72
7077400	Weld-On Square Jack	72
7077600	Direct Weld Square Jack	72
7077700	Direct Weld Square Jack	72
7077800	Weld-On Standard Round Jack	70
7077900	Weld-On Standard Round Jack	70
7078000	Weld-On Standard Round Jack	70
7078100	Weld-On Standard Round Jack	70
7078200	Weld-On Standard Round Jack	70
7078300	Weld-On Standard Round Jack	70
7078400	Weld-On Standard Round Jack	70
7078500	Weld-On Standard Round Jack	70
7078600	Weld-On Standard Round Jack	70
7078700	Weld-On Standard Round Jack	70
7078800	Weld-On Standard Round Jack	70
7078900	Weld-On Standard Round Jack	70
7079000	Weld-On Standard Round Jack	70
7079100	Weld-On Standard Round Jack	70
7079200	Weld-On Standard Round Jack	70
7079300	Weld-On Standard Round Jack	70
7079400	Weld-On Standard Round Jack	70
7079500	Weld-On Standard Round Jack	70
7079600	Weld-On Square Jack	72
7079700	Weld-On Square Jack	72
7079800	Weld-On Square Jack	72
7079900	Weld-On Square Jack	72
7080000	A-Frame Standard Round Jack	71
7080100	A-Frame Standard Round Jack	71
7080200	A-Frame Standard Round Jack	71
7080300	A-Frame Standard Round Jack	71
7080500	Standard Towing Starter Kit	42
7080820	Standard Hitch Ball	29

Part No.	Description	Page No.
7080920	Standard Hitch Ball	29
7081000	Standard Towing Starter Kit	42
7081200	Standard Ball Mount	34
7081400	Barrel Style Receiver Lock	53
7081400	Professional Receiver Lock	37
7081500	Dogbone Lock	37
7081500	Professional Receiver Lock	50
7081600	Hitch Pin and Clip	56
7081600	Pin and Clip	37
7081900	Bolt-Action Rotating Tri-Ball	25
7086100	Dual Ball Mount	40
7086500	Truck Box Jack Mount	80
7088200	3-in Receiver Adapter	36
7088200	Receiver Adapter	16
7088200	Reducer Sleeve	35
7088300	Heavy-Duty Universal Coupler Lock	58
7088800	Adapter	35, 36
7088800	Receiver Adapter	16
7088900	Jack Carry Handle	80
7089200	Clevis & Hitch Ball	24
7089300	Combination Hook & Shackle	25
7089400	Adjustable Ball & Clevis Mount	24
7089400	Adjustable Ball & Clevis Utility Mount	24
7089500	3-in Receiver Ball Mount	36
7089500	HD Standard Ball Mount	35
7089600	3-in Receiver Ball Mount	36
7089600	HD Standard Ball Mount	35
7089700	3-in Receiver Ball Mount	36
7089700	HD Standard Ball Mount	35
7089800	3-in Receiver Ball Mount	36
7089800	HD Standard Ball Mount	35
7089900	Pintle Hook Mounting Plate	37
7090000	Hitch Ball	26
7090100	Hitch Ball	26
7090200	Hitch Pin and Clip	56
7090200	Pin & Clip	26
7090210	Pin & Clip	26
7090300	Vehicle Recovery Ring	78
7090400	Vehicle Recovery Ring	78
7090500	Carabiner Tow Hook	41
7090600	3-in Receiver Adapter	35, 36
7090600	Receiver Adapter	16
7090800	InterLock® Towing Starter Kit	42
7090900	InterLock® Towing Starter Kit	42
7091300	Pintle Hook Mounting Plate	37
7092100	Hitch Pin and Clip	56
7092330	Barrel Style Receiver Lock	53
7092330	Dogbone Receiver Lock	27
7092400	InterLock® Towing Starter Kit	42
7092400	Starter Kit	27
7092500	InterLock® Towing Starter Kit	42
7092500	Starter Kit	27
7093000	Pintle Ball	44
7093100	Pintle Ball	44
7093200	Pintle Ball	44
72783	Universal Coupler Lock	59
72786	Safety Chain	61
72787	Towing Mirror	89
72790	Wheel Bearing Kit	88
72791	Wheel Bearing Kit	88
72800	Hitch Ball Bushing	88
73801	4-in Oblong Clearance Light	153
73802	4-in Oblong Clearance Light	153
73803	2-in x 4-in Dual Bulb Clearance Light	153
73804	2-in x 4-in Dual Bulb Clearance Light	153
73805	Mini Clearance Light	155
73806	Mini Clearance Light	155
73807	Armored Light	154
73808	Armored Light	154
73812	Stud-Mount Light	153
73813	Interior Light	157
73814	Rotating Warning Light	158

Part No.	Description	Page No.
73815	License Plate Light	157
73817	Quick-Mount Reflex Reflector	162
73818	Quick-Mount Reflex Reflector	162
73819	Quick-Mount Reflex Reflector	162
73820	Quick-Mount Reflex Reflector	162
73821	Pedestal-Mount Dual-Face Light	142
73822	Metal Flush-mount Light	143
73823	Stop/Turn/Tail with License Light	143
73824	Stop/Turn/Tail Light	144
73825	Stop/Turn/Tail Light	144
73826	Stop/Turn/Tail Light	144
73827	Stop/Turn/Tail Light	144
73828	Oval Stop, Turn and Tail Light	142
73829	Universal Stop/Turn/Tail with License Light	143
73830	Grommet-Mount Light	143
73831	Surface-Mount Light	142
73832	Trailer Light Kit	148
7383411	Trailer Light Kit	148
73835	2.75-in Round Clearance Lamp	152
73836	2.75-in Round Clearance Lamp	152
73837	License Plate Light	157
73838	Rectangular Clearance Sealed Light Kit	154
73839	Rectangular Clearance Sealed Light	154
73840	Round Utility Light	158
73841	LED Sealed Clearance/Side Marker Light	150
73842	LED Sealed Clearance/Side Marker Light	150
73843	LED 2-in "Beehive" Clearance/Marker Light	150
73844	LED 2-in "Beehive" Clearance/Marker Light	150
73845	LED Marker/Clearance Light	149
73846	LED Marker/Clearance Light	149
73847	LED Sealed Clearance/Side Marker Light	150
73848	LED Sealed Clearance/Side Marker Light	150
73849	3-Piece Replacement Lens Set	142
73851	Mini ID Light Bar	156
73852	ID Light Bar	156
73853	LED Submersible Light	141
73854	LED Submersible Light	141
73855	LED Submersible Light	141
73856	LED Submersible Light	141
73857	Trailer Light Kit	145
73858	Trailer Light Kit	145
73859	Running Light Kit	155
73862	LED Marker/Clearance Light	149
73863	LED Marker/Clearance Light	149
73864	Magnetic Towing Light Kit	146
73867	Universal Low-Profile Trailer Light Kit	148
73871	Pedestal-Mount Dual-Face Light	142
73872	Mini Clearance Light	155
73873	Oblong Slim Line Clearance Side Marker Light	153
73874	Oblong Slim Line Clearance Side Marker Light	153
73875	2-in Sealed Round Light Kit	152
73876	2-in Sealed Round Light Kit	152
73877	2.5-in Sealed Round Light Kit	152
73878	2.5-in Sealed Round Light Kit	152
73881	LED Round Sealed Clearance Light	151
73882	LED Round Sealed Clearance Light	151
73883	Oval Stop, Turn and Tail Light Kit	142
73884	6-in Oval Turn Light	140
73885	6-in Oval Stop/Turn/Tail Light	140
73886	Conspicuity Reflective Strips	163
73887	Quick-Mount Reflex Reflector	162
73888	Quick-Mount Reflex Reflector	162
73890	License Plate Light	157
73892	LED Round Sealed Clearance Light	151
73893	LED Round Sealed Clearance Light	151
73894	Interior Dome Light	157
74005	Standard Hitch Ball	29
74006	Standard Hitch Ball	29
74007	Standard Hitch Ball	29
74008	Standard Hitch Ball	29
74009	Standard Hitch Ball	29
74010	Standard Hitch Ball	29

Part No.	Description	Page No.
74011	Standard Hitch Ball	29
74020	Standard Hitch Ball	29
74021	Standard Hitch Ball	29
74022	Standard Hitch Ball	29
74023	Standard Hitch Ball	29
74024	Standard Hitch Ball	29
74025	Standard Hitch Ball	29
74026	Standard Hitch Ball	29
74040	Fas-Lok® Trailer Coupler	66
74042	Fas-Lok® Trailer Coupler	66
74051	4-Flat Wiring Kit	100
74059	Safety Chain	61
74099	Receiver Tube Cover	87
74115	Pintle Ball and Hook	44
74116	Pintle Ball and Hook	44
74117	Pintle Ball and Hook	44
74118	Pintle Hook	45
74119	Pintle Hook	45
74123	4-Flat Wiring Kit	100
74124	4-Flat Connector	99
74125	4-Flat Connector	99
74126	7-Way Blade Connector	109
74127	7-Way Blade Connector	109
74128	Mounting Bracket	111
74129	6-Pin Round Connector	105
74130	6-Pin Round Connector	105
74131	4-Pin Round Connector	102
74132	Mounting Bracket	111
74176	Wheel Bearing Protector Set	88
74177	Wheel Bearing Protector Set	88
74183	6-Pin Round Connector	105
74184	7-Way Blade Connector	109
74247	Spare Tire Carrier	62
74280	Fas-Lok® Trailer Coupler	66
74281	Pintle Hook Mounting Plate	45
74294	Standard Hitch Ball	29
74307	Interchangeable Hitch Ball System	30
74308	Interchangeable Hitch Ball System	30
74309	Interchangeable Hitch Ball System	30
74326	Jack Caster Wheel	69
74329	Single-Speed Trailer Winch	73
74337	Single-Speed Trailer Winch	73
74338	Fas-Lok® Trailer Coupler	66
74342	Hitch Ball Wrench	83
74344	Adjustable Tow Bar	62
74377	POD Timed Brake Control	125
74378	Pilot Timed Digital Brake Control	125
74407	Top-Wind Trailer Jack	69
74410	Swing Away Trailer Jack	68
74412	Swing Away Trailer Jack	68
74413	Swing Away Trailer Jack	68
74414	Top-Wind Trailer Jack	69
74415	Top-Wind Trailer Jack	69
74418	Single-Speed Trailer Winch	73
74419	1300 lb Marine Winch	235
74419	Single-Speed Trailer Winch	73
74437	Brake Control Harness	128
74438	Brake Control Harness	128
74439	Brake Control Harness	128
74514	Receiver Tube Cover	87
7452700	Arched Aluminum Ramp	244
74529	Two-Speed Trailer Winch	73
7453700	Straight Aluminum Ramp with Connectors	246
7454000	Centerfold Steel Ramp	247
7454300	Centerfold Aluminum Ramp	244
7454500	Heavy Duty Arched Aluminum Ramp	245
7454600	Extra Wide Aluminum Ramp with Connectors	246
74547	Receiver Tube Cover	87
7454700	Tri-Fold Aluminum Ramp	244
7455000	8" Standard Ramp Top and Bottom Kit	248
7455100	Ramp Mat Kit	248
74556	1100 lb Marine Winch	235

Part No.	Description	Page No.
74557	Side-Wind Swivel Jack	237
74605	6-Pin to 4-Flat Adapter	120
74606	6-Pin to 4-Flat Adapter	120
74607	7-Way to 4-Flat Adapter	119
74608	6-Pin Round Connector	105
74611	4-Pin Round Connector Kit	102
74613	4-Pin Round Connector	102
74633	4-Flat Tester	113
74636	4-Flat Connector	99
74641	Connector Storage Box	112
74642	Brakeman Timed Compact Brake Control	125
74645	7-Way to 6-Pin Adapter	120
74676	4-Flat Connector Kit "Y" Wishbone	101
74679	Adapter with Back-Up Alarm	121
74681	Dual Port 12 Volt Power Adapter	121
74682	7-Way Blade Connector Kit	107
74684	4-Flat Connector	99
74685	7-Way to 4-Flat Adapter	119
74686	7-Way Blade to 4-Flat Coiled Adapter	117
74687	4-Flat Connector	99
74689	4-Flat Connector	99
74783	Fas-Lok® Trailer Coupler	66
7479636	Coupler Repair Kit	67
7479736	Coupler Repair Kit	67
77 Series	Custom-Fit Hitches	8
78007	Retractable 7-Way Blade to 4-Flat Adapter	117
78050	Brake Control O.E.M. Harness	129
78051	Brake Control O.E.M. Harness	129
78052	Brake Control O.E.M. Harness	129
78053	Brake Control O.E.M. Harness	129
78054	Brake Control O.E.M. Harness	129
78055	Brake Control O.E.M. Harness	129
78056	Brake Control O.E.M. Harness	129
78057	Brake Control O.E.M. Harness	129
78058	4-Flat Wiring Kit	100
78059	Brake Control O.E.M. Harness	129
78060	Brake Control O.E.M. Harness	129
78081	Voyager® Proportional Brake Control	126
78082	4-Flat Connector Kit "Y" Wishbone	101
78089	4-Flat Bonded Trailer Wire	113
78090	4-Flat Wiring Kit	100
78091	4-Flat Connector	99
78096	Mounting Bracket	112
78103	Tail Light Converter Wiring Kit	96
78114	Insta-Plug Connector	98
78115	Insta-Plug Connector	98
78116	7-Way Blade to 4-Flat Adapter	115
78117	7-Way Blade to 4-Flat Adapter	115
78118	7-Way To 4/5-Flat Adapter	116
78119	7-Way Blade To 4/5-Flat Adapter	116
78124	Brake Control O.E.M. Harness	129
8040900	Receiver Mount Clevis	47
84 Series	Custom-Fit Hitches	9
85060	Brake Control Installation Kit	128
85062	Trailer Breakaway Emergency Braking System	133
8506311	Breakaway Switch	133
85064	Brake Control O.E.M. Harness	129
85065	Echelon Wireless Braking System	127
85066	Brake Control O.E.M. Harness	129
85067	Brake Control O.E.M. Harness	129
8506911	Brake Control Harness	128
850700	Brake Control O.E.M. Harness	129
8507111	Brakeman IV Compact Brake Control	125
8507311	Breakaway Switch	133
8507400	Brake Control O.E.M. Harness	129
8507500	Brake Control O.E.M. Harness	129
8507600	Brake Control O.E.M. Harness	129
8507700	Brake Control O.E.M. Harness	129
8507800	Brake Control O.E.M. Harness	129
8507900	Tail Light Converter	95
8508100	Tail Light Ultra Power Converter	95
85082	Brake-EVN™ Proportional Brake Control	126

Part No.	Description	Page No.
85083	Brake Control O.E.M. Harness	129
8508400	Brake Control O.E.M. Harness	129
8508700	Compact IQ™ Proportional Brake Control	126
8509000	Brake Control O.E.M. Harness	129
85205	4-Flat Bonded Trailer Wire	113
85206	4-Pin Round Connector	102
85208	2-Flat Polarized Connector	113
85209	7-Way Blade Connector Kit	109
85211	4-Way Flat Knock Out Wiring Kit	101
85212	7-Way to 4/5-Flat Adapter	119
85213	5-Flat Connector	103
85214	5-Flat Connector	103
85215	5-Flat Connector	103
85216	7-Way to 6-Pin Adapter	119
85217	4-Flat Wiring Kit	100
85218	4-Flat Cover	113
85219	7-Way Blade Connector	106
85232	7-Pin to 4-Flat Adapter	120
85275	4-Flat Connector	99
85277	4-Flat Wiring Kit	100
85281	Mounting Bracket	111
85282	Mounting Bracket	111
85283	Mounting Bracket	111
85285	Mounting Box	112
85307	4-Flat Connector	99
85340	Brake Control Harness	128
85342	6-Pin Round Connector	105
85343	7-Way Blade Connector	109
85350	7-Way Blade to 6-Pin or 4-Flat Adapter	116
85353	Insta-Plug Connector	98
85355	Circuit Tester Kit	113
85357	6-Pin to 4-Flat Adapter	115
85360	7-Way Blade to 4-Flat Coiled Adapter	117
8536200	6-Pin to 7-Blade Adapter	118
8536511	7-Way Blade Connector Kit	107
8536700	7-Way to 4-Flat Adapter	118
8536800	7-Way to 4-Flat Adapter	118
8536900	6-Pin to 4-Flat Adapter	118
85475	7-Way Blade Connector Kit	107
85476	6-Pin Round Connector	104
85477	6-Pin Round Connector	104
85478	7-Way Blade Connector	106
85479	6-Pin Round Connector Set	104
85484	4-Flat Tester	113
85489	4 Wire Taps	113
8549100	7-Way Blade RV Molded Cable	108
8549411	7-Pin Connector	110
8549711	7-Pin Connector	110
8550111	7-Way Blade Connector Kit	107
8550511	4-Flat Connector	98
8550811	4-Flat Connector	98
8550811	4-Flat Connector Kit "Y" Wishbone	101
8550900	7-Way Blade & 4-Flat Connector Kit	108
8551000	7-Way Blade & 4-Flat Connector Kit	108
8551111	Multi-Port Connector	103
8551200	Tail Light Power Converter	95
8551300	Tail Light Power Converter Kit	96
8551400	Tail Light Power Converter Kit	96
8551511	7-Way Blade Connector	106
8551700	4-Flat Connector	98
8552200	4-Flat Connector	99
8552500	4-Flat Connector	99
8552600	4-Flat Connector	99
86006	Trailer Light Kit	145, 148
86009	Cab Marker Teardrop Light	155
86010	Aluminum Reflex Reflector	162
86011	Aluminum Reflex Reflector	162
86012	ID Light Bar	156
86013	License Plate Light	157
86014	4-in Oval Light	140
86015	LED Rectangular Side Marker Light	150
86019	ID Light Bar	156

Part No.	Description	Page No.
86024	Magnetic LED Emergency Light	158
86025	Magnetic LED Emergency Light	158
86027	Conspicuity Reflector	163
86028	Conspicuity Reflector	163
86035	Turn Lamp Kit	140
86036	Stop/Tail Lamp Kit	140
86037	Trailer Light Kit	145
86038	Trailer Light Kit	145
86040	AG Light Transport Trailer Kit	147
86042	2.5-in Round Sealed Light	152
86043	2.5-in Round Sealed Light	152
86046	6-in Oval Light	140
8604900	Stud-Mount Light	154
86050	LED Round Sealed Clearance Light	151
86051	LED Round Sealed Clearance Light	151
86052	LED Round Sealed Clearance Light	151
86053	LED Round Sealed Clearance Light	151
86054	Universal Low-Profile Trailer Light	148
86055	Universal Low-Profile Trailer Light	148
86056	Replacement Light	140
86061	GMC Lighted Hitch Cover	136
86062	Chevrolet Bow Tie Lighted Hitch Cover	136
86063	Conspicuity Reflective Tape Roll	163
86065	Ford Lighted Hitch Cover	136
86066	RAM Lighted Hitch Cover	136
86078	Back-Up Light Kit	140
8608200	Stud-Mount Light	154
8608500	LED Stud-Mount Light	149
8608600	LED Stud Mount Light	149
8608711	LED Rectangular Side Marker Light	150
8608900	ID Light Bar	156
8609000	LED Strobe Light	159
8609144	GMC Lighted Logo Emblem	138
8609244	Chevrolet Lighted Logo Emblem	138
8609344	RAM Lighted Logo Emblem	138
8609444	Ford Lighted Logo Emblem	138
8609600	LED Strobe Work Light	159
8609700	LED Clear Work Light	159
8609800	LED Clear Work Light	159
8609900	LED AG Light	146
8610000	LED AG Light	146
8610100	LED Micro Light	149
8610200	LED Micro Light	149
8610300	LED Micro Light	149
8610400	LED Flexible Light Strip	160
8610500	LED Flexible Light Strip	160
8610600	LED Flexible Light Strip	160
8610700	LED Flexible Light Strip	160
8610911	6-in Oval Light	140
8611100	LED Magnetic Work Light	159
8611200	LED Magnetic Work Light	159
8611300	LED Flexible Light Strip	160
8612000	60-in LED Tailgate Light Bar	139
86523	Skull Lighted Hitch Cover	136
86529	Skull Lighted Hitch Cover	136
86530	Chevrolet Bow Tie Lighted Hitch Cover	136
86531	RAM Lighted Hitch Cover	136
86532	Ford Lighted Hitch Cover	136
86534	GMC Lighted Hitch Cover	136
8653611	3D Sports Receiver Tube Cover	86
8653711	3D Sports Receiver Tube Cover	86
8653811	3D Sports Receiver Tube Cover	86
8653911	3D Sports Receiver Tube Cover	86
8654011	3D Sports Receiver Tube Cover	86
8654111	3D Sports Receiver Tube Cover	86
8654700	Anti-Rattle Hitch Cover	87
8661844	Chevrolet Lighted Logo Emblem	138
8661944	RAM Lighted Logo Emblem	138
8662044	Ford Lighted Logo Emblem	138
8667200	Lighted Plate Frame Black	232
8667500	Lighted Plate Frame Chrome	232
8692000	Electrical Kit	113

Part No.	Description	Page No.
9420800	Universal Chrome Anchor Point	194
9423000	Fat Strap Bungee Assortment	178
9423200	10" Mini Bungee	182
9423600	3/8" Truck Polypropylene Rope	221
9423700	Carabiners	187
9423800	Universal Chrome Anchor Point	194
9423900	Wrap-Tyte Ties	187
9424000	Hammock Storage Net	262
9424100	Bungee Truck Net	190
9424200	Adjustable Truck Net	190
9424700	6' Light Duty Metal Handle Cambuckle	174
9425100	10' Standard Duty Grip Handle Ratchet	171
9425200	14' Heavy Duty Grip Handle Ratchet	172
9425300	14' Super Duty Grip Handle Ratchet	172
9425500	6' Standard Duty Retractable Ratchet	170
9425900	6' Standard Duty TITAN Grip Handle Ratchet	170
9426001	14' Heavy Duty MAX GRIP Open Handle Ratchet	172
9426100	10' Standard Duty TITAN Grip Handle Ratchet	171
9426200	14' Heavy Duty MAX GRIP Open Handle Ratchet	172
9426300	20' Reflective Tow Strap with Hook Ends	200
9426400	20' Reflective Tow Strap with Loop Ends	200
9426500	30' Reflective Tow Strap with Hook Ends	200
9426600	14' Tow Rope	201
9427100	Bungee Truck Net	191
9427200	Bungee Cargo Net	191
9427300	10' Heavy Duty Retractable Ratchet	172
9427500	12' ATV Tow Strap with Shackle	200
9427600	8" Canopy Tie	183
9428300	Twisted Line Cotton Rope	220
9428400	1/4" Diamond Braid Polypropylene Rope	221
9428700	1/8" Diamond Braid Nylon Rope	220
9428800	3/16" Clothesline Polypropylene Rope	221
9428900	Standard Bungee Assortment	181
9429000	Standard Bungee Assortment	181
9429100	Fat Strap Bungee Assortment	178
9429300	Tarp Strap Assortment	186
9429400	Tarp Clip	186
9429500	6' Standard Duty Loop End Cambuckle	174
9429700	15' Super Duty MAX GRIP Open Handle Ratchet	172
9429800	Eyebolt Anchor Point	194
9432700	Fat Strap Bungee Assortment	178
9432800	Tarp Strap Assortment	186
9436100	Camo Standard Bungee Assortment	180
9480400	24" Standard Bungee	181
9480500	36" Standard Bungee	181
9480600	48" Standard Bungee	181
9480700	24" Triple Strength Bungee	179
9480800	36" Triple Strength Bungee	179
9480900	48" Triple Strength Bungee	179
9481000	24" Fat Strap Bungee	178
9481100	36" Fat Strap Bungee	178
9481200	48" Fat Strap Bungee	178
9481300	10" - 48" Adjustable Fat Strap Bungee	178
9481500	10' Light Duty Metal Handle Ratchet	170
9481502	10' Light Duty Metal Handle Ratchet	170
9481600	6' Light Duty Metal Handle Cambuckle	174
9481700	21" Tarp Strap	186
9481800	31" Tarp Strap	186
9481900	9" - 41" Adjustable Tarp Strap	186
9482000	15' Super Duty Grip Handle Ratchet	172
9482002	15' Super Duty Grip Handle Ratchet	172
9482100	8' Light Duty Metal Handle Cambuckle	174
9482400	27' Super Duty Grip Handle Ratchet	173
9482402	27' Super Duty Grip Handle Ratchet	173
9482700	10' Standard Duty Grip Handle Ratchet	170
9482800	10' Standard Duty Grip Handle Ratchet	170
9485300	10' Standard Duty Grip Handle Ratchet	170
9485400	52" Triple Strength Bungee	179
9485500	8' Camo Standard Duty Metal Handle Ratchet	173
9485502	8' Camo Standard Duty Metal Handle Ratchet	173
9485600	10' Standard Duty Grip Handle Ratchet	170
9485700	10' Camo Standard Duty Grip Handle Ratchet	173

Part No.	Description	Page No.
9485800	10' Camo Standard Duty Grip Handle Ratchet	173
9485900	10' Camo Standard Duty Grip Handle Ratchet	173
9510100	12' Heavy Duty Grip Handle Ratchet	172
9510200	12' Heavy Duty Grip Handle Ratchet	172
9510400	10' Standard Duty Full Grip Sport Handle Ratchet	170
9510500	10' Standard Duty Full Grip Sport Handle Ratchet	170
9510800	10' Light Duty Metal Handle Ratchet	170
9510900	10' Light Duty Metal Handle Ratchet	170
9511100	10' Standard Duty Padded Handle Ratchet	170
9511200	10' Camo Heavy Duty Grip Handle Ratchet	173
9511300	15' Super Duty MAX GRIP Open Handle Ratchet	173
9511600	15' Heavy Duty Metal Handle Ratchet	172
9511602	15' Heavy Duty Metal Handle Ratchet	172
9511700	6' Camo Standard Duty Metal Handle Ratchet	173
9511800	16' Camo Super Duty Grip Handle Ratchet	173
9511802	16' Camo Super Duty Grip Handle Ratchet	173
9512000	20' Super Duty Grip Handle Ratchet	173
9512002	20' Super Duty Grip Handle Ratchet	173
9512700	Forged Ring Anchor	196
9512800	6' Standard Duty Surelok Cambuckle	174
9512900	15' Standard Duty Padded Handle Ratchet	170
9513000	15' Standard Duty Padded Handle Ratchet	170
9513100	15' Light Duty Metal Handle Ratchet	170
9513400	12' Camo Heavy Duty Grip Handle Ratchet	173
9514100	14' Standard Duty Padded Handle Ratchet	171
9514200	14' Heavy Duty MAX GRIP Open Handle Ratchet	172
9514500	6' Camo Light Duty Metal Handle Ratchet	173
9514600	7' Vehicle Ratchet	175
9514700	6' Camo Standard Duty Retractable Ratchet	173
9514800	12' Heavy Duty Open Handle Ratchet	172
9514900	12' Heavy Duty Open Handle Ratchet	172
9515000	Arched Centerfold Aluminum Ramp	244
9515100	Adjustable Top Plate Straight Aluminum Ramp	246
9515200	Centerfold Steel Ramp	247
9515300	Telescoping Aluminum Ramp	246
9515400	Xtrusion Series Straight Aluminum Ramp	245
9515500	Heavy Duty Straight Aluminum Ramp	245
9515600	Xtrusion Series Straight Aluminum Ramp	245
9515700	Xtrusion Series Angled Centerfold Ramp	245
9515800	Zero-Turn Arched Aluminum Ramp	244
9515900	Zero-Turn Arched Centerfold Aluminum Ramp	244
9516000	Threshold Straight Steel Ramp	247
9516300	Zero-Turn Arched Centerfold Ramp - Ice Black	244
9516400	Zero-Turn Arched Aluminum Ramp - Ice Black	244
9516700	6' Tree Saver Strap with Loop Ends	202
9517100	12" Standard Ramp Top Kit	248
9517300	8" Standard Ramp Top Kit with Straps & Mats	248
9517400	8" Adjustable Top Ramp Kit with Straps	249
9517500	8" Adjustable Top Ramp Kit	249
9517600	8" Standard Ramp Top Kit with Straps	248
9517700	12" Adjustable Top Ramp Kit	249
9518000	Ramp Carry Handle	250
9518100	Ramp Bumper Pads	251
9518200	Ramp Safety Strap	251
9518300	Ramp Carry Strap	250
9520200	8' Standard Duty Push Button Cambuckle	174
9520300	8' Standard Duty Push Button Cambuckle	174
9520400	12' Lashing Strap	175
9520500	8' Camo Standard Duty Push Button Cambuckle	174
9520600	12' Standard Duty Metal Handle Cambuckle	174
9520700	8' Standard Duty Metal Handle Cambuckle	174
9521000	12' Light Duty Endless Ratchet	170
9521200	Bull Ring Retractable Anchor Point	195
9521400	10' Camo Standard Duty Full Grip Sport Handle Ratchet	173
9521500	10' Light Duty Push Mower Cambuckle	174
9521600	10' Heavy Duty Lawn Tractor Tie Down Kit	172
9521700	10' Standard Duty Retractable Ratchet	170
9522600	10' Standard Duty REBEL T-Handle Ratchet	170
9522700	10' Standard Duty REBEL T-Handle Ratchet	170
9522800	15' Heavy Duty REBEL T-Handle Ratchet	172
9522900	15' Heavy Duty REBEL T-Handle Ratchet	172
9523000	16' Camo Super Duty T-Handle Ratchet	173

Part No.	Description	Page No.
9523100	27' Super Duty T-Handle Ratchet	173
9523200	15' Heavy Duty REBEL T-Handle Ratchet	172
9523300	27' Super Duty T-Handle Ratchet	173
9523500	7/8" Anchor Shackles	202
9523600	3/4" Anchor Shackles	202
9523700	1/2" Anchor Shackles	202
9524000	15" Tarp Strap	186
9524100	21" Tarp Strap	186
9524200	31" Tarp Strap	186
9524300	41" Tarp Strap	186
9524400	15" Tarp Strap	186
9524600	15" Tarp Strap	186
9524700	21" Tarp Strap	186
9524800	31" Tarp Strap	186
9524900	41" Tarp Strap	186
9526000	Camo Standard Bungee Assortment	180
9526200	24" Industrial Bungee	180
9526300	32" Industrial Bungee	180
9526400	48" Industrial Bungee	180
9526500	18" Industrial Bungee	180
9526600	10" - 48" Adjustable Fat Strap Bungee	178
9526900	Nylon Cable Ties	187
9527000	Adjustable Canopy Tie	183
9527100	32" Quick Wrap Bungee	182
9527200	40" Quick Wrap Bungee	182
9527300	Standard Bungee Assortment	181
9527500	32" Corner Protect Bungee	182
9527600	40" Corner Protect Bungee	182
9528000	18" Standard Bungee	181
9528100	24" Standard Bungee	181
9528200	32" Standard Bungee	181
9528300	40" Standard Bungee	181
9528500	10" Mini Bungee	182
9528600	18" Triple Strength Bungee	179
9528800	Standard Bungee Assortment	181
9529100	Standard Bungee Assortment	181
9529200	32" Quick Wrap Bungee	182
9529300	40" Quick Wrap Bungee	182
9529400	6" - 40" Adjustable Bungee	181
9529500	Triple Strength Bungee Assortment	179
9530100	Motorcycle Cover	190
9530500	12" Standard Bungee	181
9530900	36" 6-Arm Bungee	183
9531000	9" - 41" Adjustable Tarp Strap	186
9531400	Standard Bungee Assortment	181
9531500	24" Standard Bungee	181
9531600	36" Standard Bungee	181
9531700	48" Standard Bungee	181
9531900	24" Fat Strap Bungee	178
9532000	36" Fat Strap Bungee	178
9532100	10" - 48" Adjustable Fat Strap Bungee	178
9532200	6" - 40" Adjustable Bungee	181
9532900	Tarp Clip	186
9533100	10" Canopy Tie	183
9533700	15' Reflective Tow Strap with Hook Ends	200
9534000	20' Tow Strap with Hook Ends	200
9534100	30' Tow Strap with Hook Ends	200
9534800	30' Super Duty Grip Handle Ratchet	173
9535000	12" E-Track Section	210
9535100	24" E-Track Section	210
9535200	48" E-Track Section	210
9535300	E-Track O-Ring	211
9535400	5" E-Track D-Ring Strap	211
9535500	E-Track J-Hook	211
9535600	8' Standard Duty E-Track Ratchet	210
9535700	12' Heavy Duty E-Track Ratchet	210
9535800	8' Standard Duty E-Track Cambuckle	210
9535900	10' Standard Duty E-Track Retractable Ratchet	210
9540200	1/4" Twisted Nylon Rope	220
9540500	1/4" Camo Polypropylene Rope	221
9540600	3/16" Camo Polypropylene Rope	221
9540900	1/16" Twisted Nylon Rope	220

Part No.	Description	Page No.
9541000	1/16" Twisted Line Jute Cord	221
9541100	3/16" Diamond Braid Polyester Rope	220
9541400	3/16" Diamond Braid Polypropylene Rope	221
9544800	24" Axle Strap	203
9544900	36" Axle Strap	203
9545000	24" Axle Strap	203
9545100	30' Tow Strap with Loop Ends	200
9545200	15' Tow Strap with Hook Ends	200
9545300	30' Tow Strap with Loop Ends	200
9545400	30' Winch Strap	203
9545500	30' Winch Strap	203
9546000	41" Tarp Strap	186
9546300	12' Standard Duty Endless Ratchet	170
9546600	30' Super Duty Grip Handle Ratchet w/ Webbing Keeper	173
9546700	6' Standard Duty Retractable Ratchet	170
9546800	10' Heavy Duty Grip Handle Ratchet	172
9546900	6' Heavy Duty Retractable Ratchet	172
9547000	6' Standard Duty Metal Handle Ratchet	170
9547100	9" Over Wheel Ratchet	175
9547200	12' Heavy Duty Grip Handle Ratchet	172
9547300	9' Standard Duty Retractable Truck Bed Ratchet	170
9547400	Sure Step	197
9547600	10' Light Duty Metal Handle Cambuckle	174
9547700	Camo Value Pack: Standard Duty Ratchets & Bungees	173
9547800	12' Heavy Duty Metal Handle Cambuckle	175
9548300	8" Canopy Tie	183
9548400	Triple Strength Bungee Assortment	179
9548500	Triple Strength Bungee Assortment	179
9548700	24" Camo Standard Bungee	180
9548900	D-Ring Anchor Point	196
9549000	Heavy-Duty Ring Anchor	196
9549100	Surface-Mount Ring Anchor	196
9549200	Surface-Mount Ring Anchor	196
9549300	Recess-Mount Ring Anchor	196
9549400	Recess-Mount Ring Anchor	196
9549500	Heavy-Duty Movable Anchor	197
9549600	Pop-Up Anchor Point	195
9549700	Weld-On Flip Anchor	196
9549900	D-Ring Anchor Point	196
9550000	Wall-Mount Kayak Storage Straps	225
9550100	Wall-Mount Kayak Storage Rack	225
9550200	Deluxe Wall-Mount Kayak Storage Rack	224
9550300	Ceiling-Mount Kayak Pulley System	224
9550400	Kayak Tie Down Kit	226
9550700	Bungee Kayak Deck Net	227
9550700	Kayak Deck Net	190
9551000	1/4" - 3" Secure Wrap, Small	187
9551100	1/4" - 4-1/2" Secure Wrap, Large	187
96 Series	Custom-Fit Hitches	10
97 Series	Custom-Fit Hitches	8, 9
PD110101	POD Hazard	85, 160
PD110200	POD Hazard - 2 Pack	85, 160
PD110302	POD Hazard - Club Pack	85, 160
PD110700	POD Hazard Countertop Display	85, 160