

MODEL: THUNDER DRIFT



THUNDER DRIFT



RC CARS & TRUCKS

FEATURES & SPECIFICATIONS

- Powerful Brushed Electric Motor
- Brushed ESC Waterproof
- Forward & Reverse
- 4 Wheel Drive
- Belt Drive System
- Aluminum Body Oil Filled Shocks
- RC Drift Tires
- 7.2v 2100mAh NiMH Battery Pack
- NiMH Battery Charger
- 2.4GHz Radio System

- Scale: 1/10
- Length: 360mm
- Width: 200mm
- Height: 112mm
- Wheelbase: 260mm
- Ground Clearance: 4.5mm

Vehicle Battery Capabilities

Minimum: 7.2V 2100mAh NiMH

Maximum: 7.2V 5800mAh NiMH

Warning: Exceeding the maximum battery voltage may cause damage to the motor and electronic components of this vehicle and will void the vehicle warranty.

VEHICLE OVERVIEW

- A: Oil Filled Shocks
- B: Steering Servo
- C: Steering Mechanism
- D: On/Off Switch
- E: ESC
- F: 2.4GHz Receiver
- G: Electric Motor
- H: Steering Linkage
- I: Upper Suspension Link
- J: Battery
- K: Battery Retainer
- L: Spur Gear

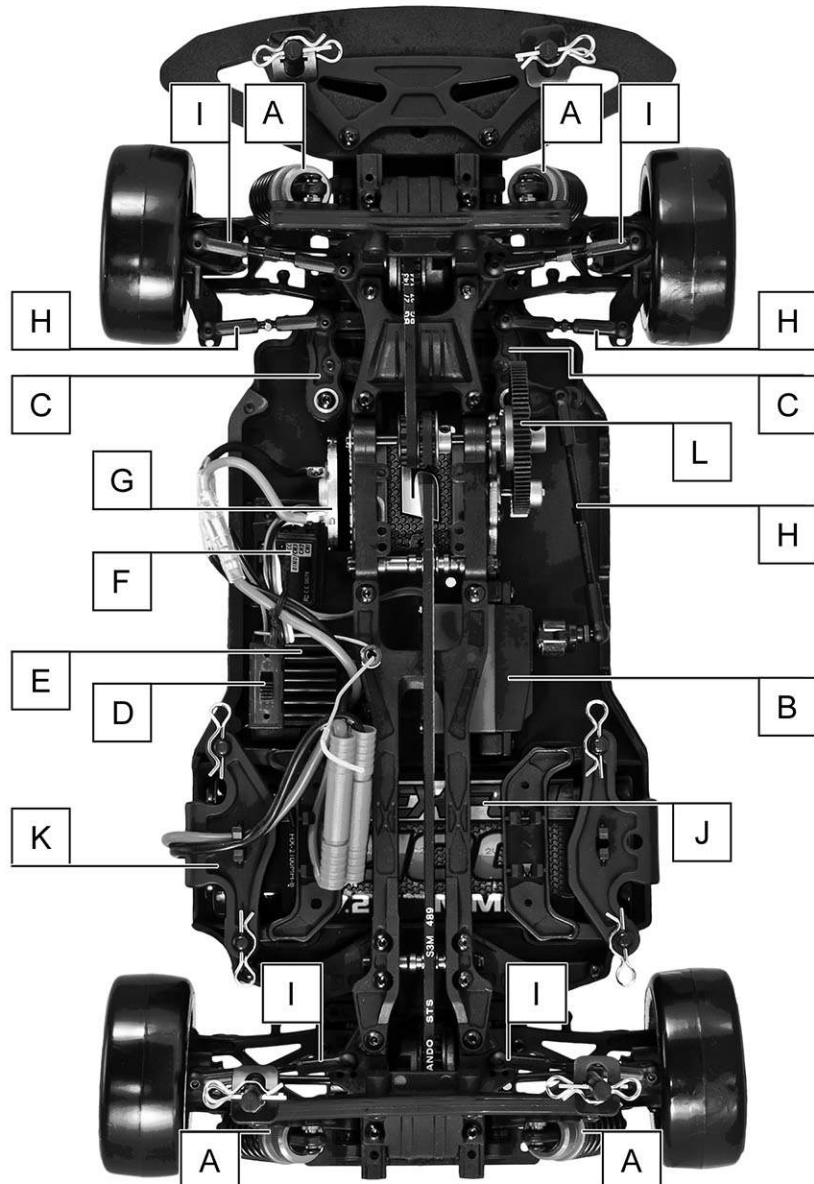

RADIO GUIDE

RCR-2C
 2.4 GHZ RADIO

CONTROL PANEL

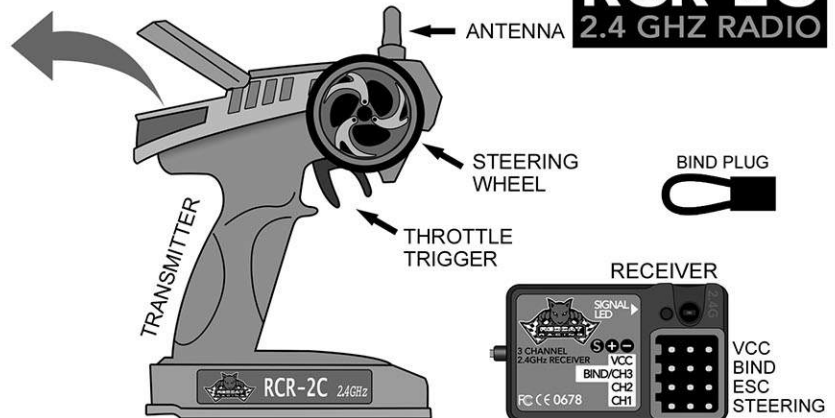

Steering Reverse Switch: Top left switch. Used to change steering orientation. If the car turns right when you steer left, flip this switch.

Throttle Reverse Switch: Top right switch. Used to change throttle trigger orientation. If the car goes in reverse while you pull the throttle trigger, flip this switch.

Power LED: Left LED light. Lights up when the transmitter is turned on.

Battery Level LED: Right LED light. Lights up green when transmitter batteries are full. Flashes when transmitter batteries are low and need replacing.

Bind Button: Used to bind the transmitter to the receiver. See binding instructions.

Steering Trim: Left knob. Used to set the steering neutral point. If the vehicle veers in one direction while the steering wheel is centered, turn this knob in the opposite direction until the car drives straight.

Throttle Trim: Middle knob. Used to set the throttle neutral point. If the vehicle moves forward or reverse while the throttle trigger is centered, turn this knob until the vehicle remains still. For maximum setting, turn slowly until the vehicle creeps forward, then turn the knob the opposite direction until the car stops.

Steering Dual Rate: Right knob. Used to limit the amount of steering. 0= little/no steering & 6= maximum steering. Set the knob to the amount of steering you feel comfortable with. If the vehicle has a tendency to spin out, lower the steering rate.

On/Off Switch: Bottom switch. Turns transmitter On and Off.

VCC: Not used.

Bind/Ch3: Used when binding to transmitter. Used for 3rd channel when needed.

Ch2: Used for Electronic Speed Controller.

Ch1: Used for steering servo.

Binding:

1. Insert the BIND PLUG into the receiver BIND port.
2. Make sure your ESC is plugged into CH2, and insert the bind plug into BIND/CH3. Now, power the vehicle on and the receiver light should begin to blink red.
3. Press the BIND button in the center of the transmitter's Control Panel and turn on radio.
4. Release the bind button when you see the green light on the radio flashing. At this point, your receiver's LED should now be solid red. Turn off the power to your vehicle, as well as the radio.
5. Remove the BIND PLUG from the receiver. Make sure the servos and ESC are attached as described above.
6. First turn your radio on, then your vehicle as normal. Your radio and receiver should be bound together and communicating with each other.

CHARGERS

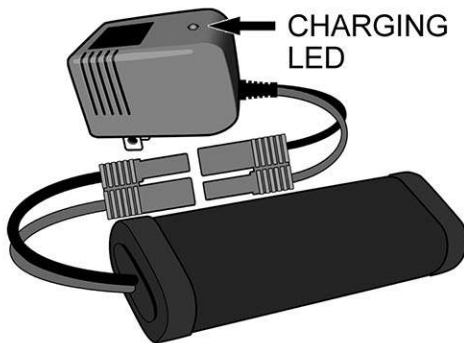

ATTENTION

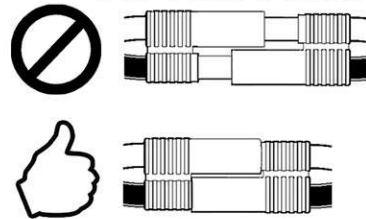

BATTERY CONNECTION INSTRUCTIONS:
Make sure battery connectors are fully pushed in when charging and connecting to the vehicle.

ATTENTION

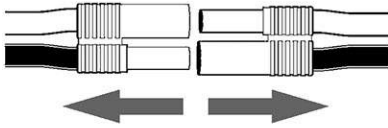

Before attempting to charge your NiMH battery, be sure to remove it from the vehicle and place it on a nonflammable surface away from hazards, such as curtains, couches, or clothing.

Warning! Batteries can potentially catch fire if over charged or charged incorrectly.

ATTENTION

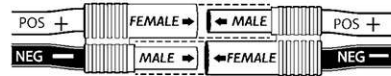

Be sure the wires are correctly orientated when plugging the battery into the vehicle.

When plugging the battery into the vehicle, Ensure the red (POS+) wire on the battery is connected to the red (POS+) wire of the ESC. Also ensure the black (NEG-) wire on the battery is connected to the black (NEG-) wire of the ESC.

Improper connection may damage electronics.

NIMH Charging:

Charging NiMH battery packs with the included charger is simple.

1. Unplug and remove the battery from the RC vehicle.
2. Plug the charger into a 110v wall receptacle.
3. Plug the battery pack into the charger.

When plugging the battery into the charger, ensure the red (POS+) wire on the battery is connected to the red (POS+) wire of the charger. Also ensure the black (NEG-) wire on the battery is connected to the black (NEG-) wire of the charger.

4. The LED light on the charger indicates the battery is charging. When the LED light turns off the battery is fully charged.
5. Battery takes approximately 3.5 hrs to charge completely.



WARNING



UNPLUG THE BATTERY PACK FROM THE VEHICLE!

BEFORE CHARGING YOUR BATTERY PACK, YOU MUST FIRST UNPLUG IT FROM THE ESC. FAILURE TO UNPLUG THE BATTERY FROM THE VEHICLE'S ESC BEFORE CHARGING MAY PERMANENTLY DAMAGE SOME OR ALL ELECTRONICS IN THE VEHICLE.

NEVER LEAVE BATTERY PACKS UNATTENDED WHILE CHARGING! Leaving a battery unattended while charging may result in fire and damage / injury.

NEVER ALLOW A BATTERY PACK TO GET HOT! It's normal for the battery pack to get warm, but it should never get hot! Monitor batteries during charging and unplug to let cool if the battery gets hot.

WHEN CHARGING LIPOs, A LIPO SAFE CHARGING BAG SHOULD BE USED TO HELP PREVENT FIRES.

PARTS IDENTIFICATION

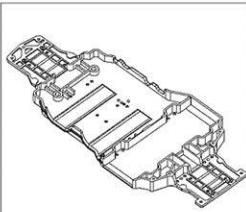

BS205-001 Chassis

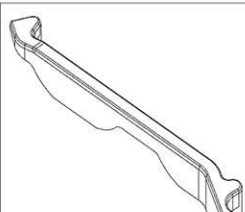

BS205-002 Side Guard Plate

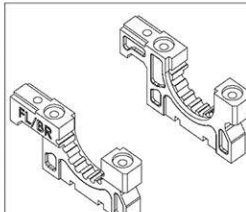

BS205-003 Diff. Box Holder L/F

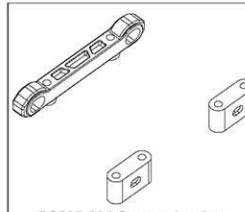

BS205-004 Suspension Arm Mount Block Set

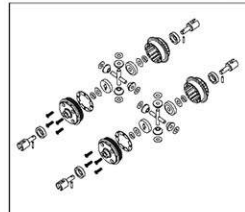

BS205-005 Diff. Gearbox Unit 2pcs

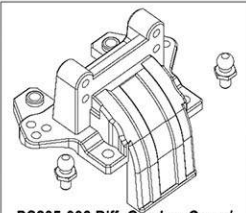

BS205-006 Diff. Gearbox Cover/Screws

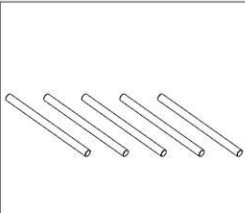

BS205-007 Pin(Ø3*45) 5pcs

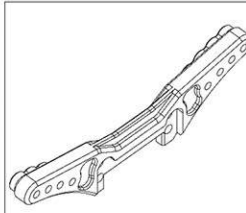

BS205-008 Front Brace

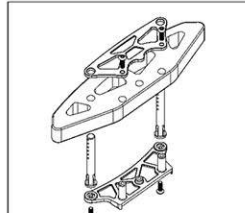

BS205-009 Front Bumper Assembly

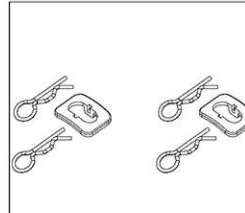

BS205-010 Body Pin Set 2pcs



BS204-001 Drift Tire Unit

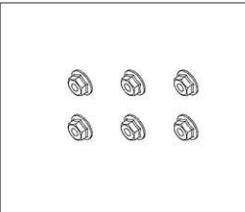

BS205-012 M4 Flange Nut 5pcs

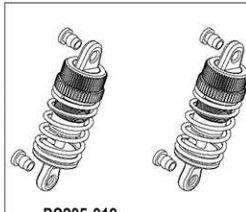

BS205-013 Shock Absorber Unit 2pcs

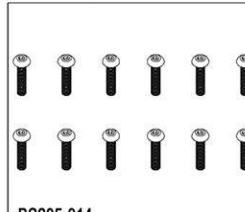

BS205-014 HM3*15 B-Head Hex Screw 12pcs

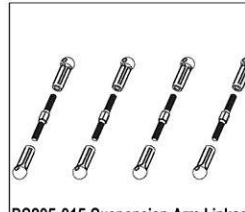

BS205-015 Suspension Arm Linkage M3*28mm 4pcs



BS205-016 Knuckle Arm Set (L)



BS205-017 Steering Linkage Set M3*16mm 2pcs

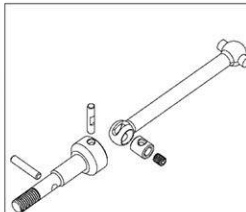

BS205-018 Front Axle W/Pin

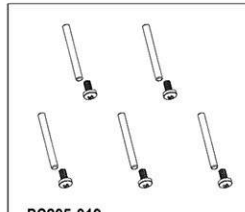

BS205-019 Suspension Arm Pin-Short 5pcs

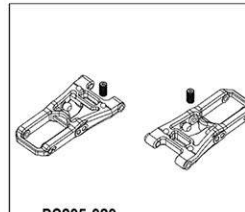

BS205-020 Front Suspension Unit 2pcs

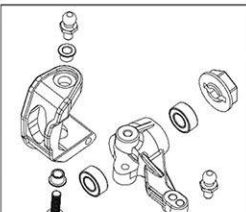

BS205-021 Knuckle Arm Set (R)

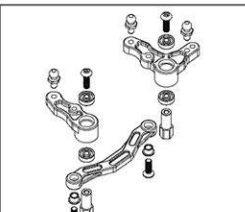

BS205-022 Steering System

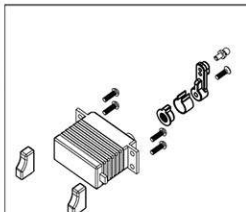

BS203-001 Servo Assembly

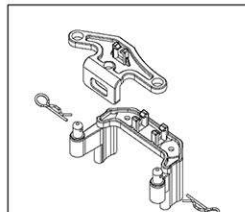

BS205-024 Battery Cover W/Pin



BS205-025 Front Drive Belt Adjusting Unit

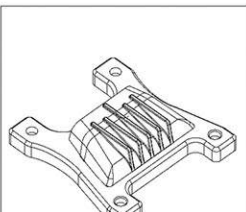

BS204-004 Front Upper Deck



BS204-002 Front Drive Belt S3M216

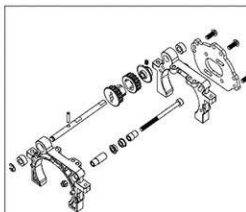

BS205-028 Motor Bracket Assembly

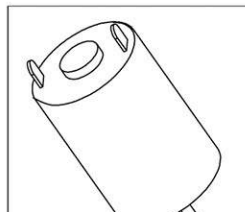

BS203-002 Brushed Motor 540

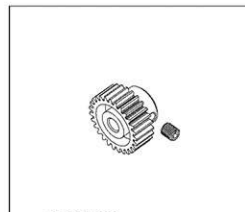

BS205-030 Motor Gear 27T/M3 Screw

PARTS IDENTIFICATION



BS205-031 88T Spur Gear Set



BS204-005 Rear Upper Deck

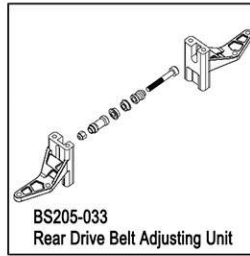

BS205-033
Rear Drive Belt Adjusting Unit



BS204-003 Rear Drive Belt S3M489

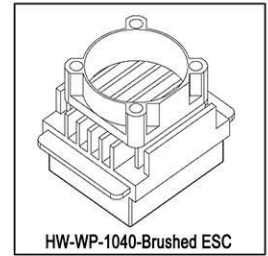

HW-WP-1040-Brushed ESC



BS205-036 Rear Axle W/Pin 2pcs

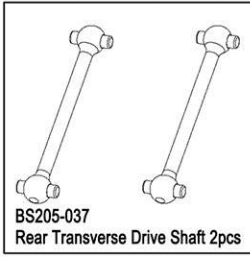

BS205-037
Rear Transverse Drive Shaft 2pcs

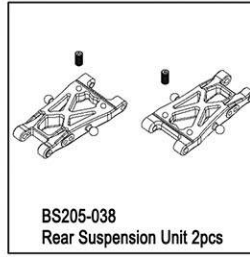

BS205-038
Rear Suspension Unit 2pcs

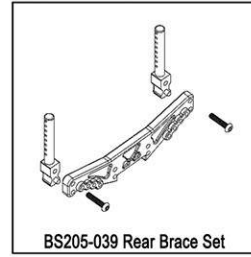

BS205-039 Rear Brace Set



BS204-006 Steering Servo Linkage

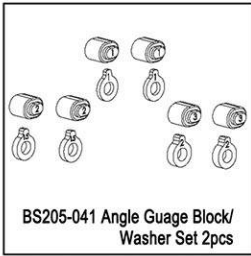

BS205-041 Angle Gauge Block/
Washer Set 2pcs



BS205-042
Flange Bearing (3*6*2.5) 2pcs

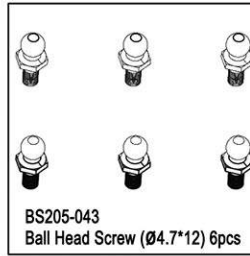

BS205-043
Ball Head Screw (Ø4.7*12) 6pcs

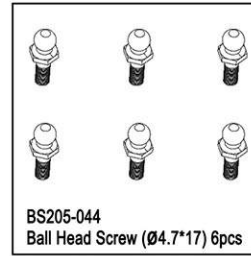

BS205-044
Ball Head Screw (Ø4.7*17) 6pcs

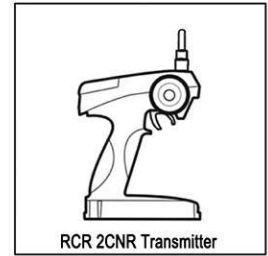

RCR 2CNR Transmitter

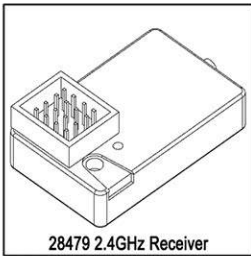

28479 2.4GHz Receiver

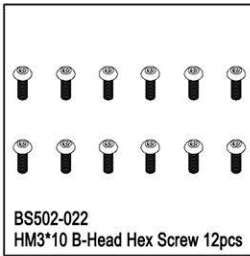

BS502-022
HM3*10 B-Head Hex Screw 12pcs

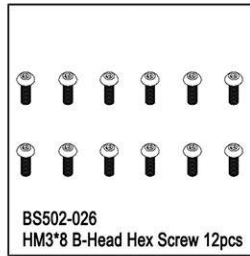

BS502-026
HM3*8 B-Head Hex Screw 12pcs

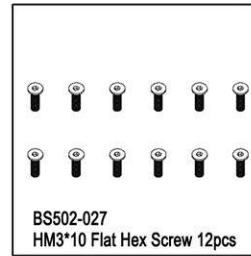

BS502-027
HM3*10 Flat Hex Screw 12pcs

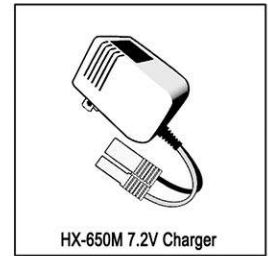

HX-650M 7.2V Charger

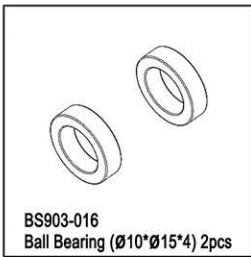

BS903-016
Ball Bearing (Ø10*Ø15*4) 2pcs

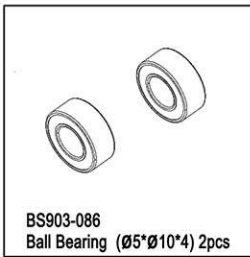

BS903-086
Ball Bearing (Ø5*Ø10*4) 2pcs

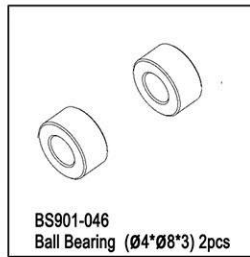

BS901-046
Ball Bearing (Ø4*Ø8*3) 2pcs

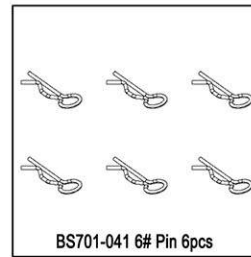

BS701-041 6# Pin 6pcs

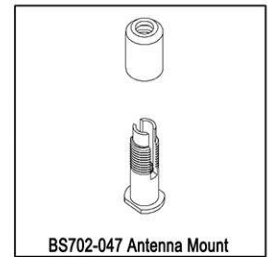

BS702-047 Antenna Mount



HX-2200MH-B
7.2V 2200mAh NiMH Battery



BS205-040B Blue Body
BS205-040G Green Body

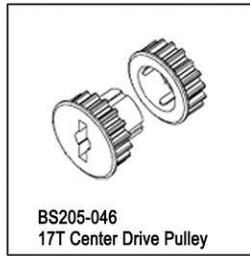

BS205-046
17T Center Drive Pulley

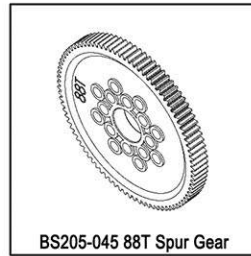

BS205-045 88T Spur Gear



BS502-023 HM3*12mm B-Head
Hex Screw 12pcs

PARTS IDENTIFICATION

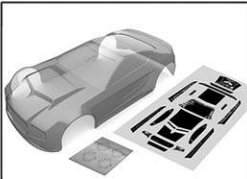

BS204-008C
Clear body w/sticker



BS204-008T
Gunmetal body w/sticker and all plastic parts:(wing w/wing mount, mirrors w/chrome stickers (2), wipers (2), mounting hardware)



BS204-008O
Orange body w/sticker and all plastic parts:(wing w/wing mount, mirrors w/chrome stickers (2), wipers (2), mounting hardware)



BS205-049
Plastic Parts:(wing w/wing mount, mirrors w/chrome stickers (2), wipers (2), mounting hardware)

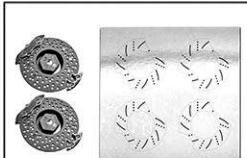

BS210-020R
Disc Brake w/ Red Chrome
QTY 2



BS204-009
Black Glossy Rim QTY 2



BS204-010
Wheel (black chrome rim w/ tire)
QTY 2

PARTS LIST

Item No.	Description	Item No.	Description
BS205-001	Chassis 1pcs	BS502-022	B-Head Hex Screws HM3*10 12pcs
BS205-002	Side Guard Plate L/R 1pcs	BS502-023	B-Head Hex Screw HM3*12mm 12pcs
BS205-003	Diff. Box Holder L/F 1pcs	BS502-027	T-Head Hex Screws HM3*10 12pcs
BS205-004	Suspension Arm Mount Block Set 1pcs	BS502-026	B-Head Hex Screws HM3*8 12pcs
BS205-005	Diff. Gearbox Unit 2pcs	BS901-066	M3 Self-lock Nut
BS205-006	Diff. gearbox Cover Assembly 1pcs	BS701-041	6# Pin 6pcs
BS205-007	Pin(3*45) 5pcs	BS903-086	Ball Bearing(5*10*4) 2pcs
BS205-008	Front Brace 1pcs	BS901-046	BallBearing(4*8*3) 2pcs
BS205-009	Front Bumper Assembly	BS903-016	Ball Bearing(10*15*4) 2pcs
BS205-010	Body Pin Set 4pcs	BS204-006	Steering Servo Linkage
BS204-001	Drift Tire Unit	BS702-047	Antenna Mount
BS205-012	M4 Flange Nut M4 6pcs	BS701-035b	7.2V NiMH Charger
BS205-013	Shock Absorber Unit	HX-2200MH-B	7.2V 2200mAh NiMH Battery
BS205-014	B-Head Cross Screw(BM3*15) 12pcs	HW-WP-1040-Brushed	Brushed ESC
BS205-015	Suspension Arm Linkage Set	BS204-008C	Clear body w/sticker
BS205-016	Knuckle Arm Set(L) 1pcs	BS204-008T	Gunmetal body (sticker & plastic parts)
BS205-017	Steering Linkage Set 2pcs	BS204-008O	Orange body (sticker & plastic parts)
BS205-018	Front Axle W/Pin	BS205-049	Plastic Parts:(wing w/mount, mirrors w/chrome stickers (2), wipers (2), hardware)
BS205-019	Suspension Arm Pin-Short	BS210-020R	Disc Brake w/ Red Chrome QTY 2
BS205-020	Front Suspension Unit	BS204-009	Black Glossy Rim QTY 2
BS205-021	Knuckle Arm Set(R)	BS204-010	Wheel (black chrome rim w/ tire) QTY 2
BS205-022	Steering System		
BS203-001	Servo Assembly		
BS205-024	Battery Cover w/Pin		
BS205-025	Front Drive Belt Adjusting Unit		
BS204-004	Front Upper Deck		
BS204-002	Front Drive Belt S3M216		
BS205-028	Motor Bracket Assembly		
BS203-002	Brushed Motor 540 1pcs		
BS205-030	Motor Gear 27T /M3 Screw		
BS205-031	88T Spur Gear Set		
BS204-005	Rear Upper Deck		
BS205-033	Rear Drive Belt Adjusting Unit		
BS204-003	Rear Drive Belt S3M489		
BS205-036	Rear Axle w/Pin		
BS205-037	Rear Transverse Drive Shaft Set 2pcs		
BS205-038	Rear Suspension Unit		
BS205-039	Rear Brace Set		
BS205-040	Body 1pcs		
BS205-041	Angle Gauge Block/ Washer Set		
BS205-042	Flange Bearing(3*6*2.5) 2pcs		
BS205-043	Ball Head Screw(4.7*12) 6pcs		
BS205-044	Ball Head Screw(4.7*17) 6pcs		
BS205-045	88T Spur Gear		
BS205-046	17T Center Pulley		
RCR-2CNR	Transmitter 2.4GHz 1pcs		
28479	Receiver 2.4GHz 1pcs		