



RC CARS & TRUCKS

INSTRUCTION MANUAL

1/24 RADIO CONTROLLED ELECTRIC VEHICLES

SCALE 1/24TH



READY TO RUN
2.4GHz RADIO SYSTEM

BUGGY



TRUGGY



SAND TRUCK



TRUCK



FEATURES AND SPECIFICATIONS

- Shaft-Drive 4WD
- 2.4GHz Radio System
- 4-Wheel Independent Wishbone Suspension
- Spring Coil Shocks
- High Grip Performance Wheels
- Powered By Four AA Batteries (not included)
- Driven By RC 131 Motor

- Length: 167mm(buggy/truggy), 160mm(truck/Sand Truck)
- Width: 121mm(buggy), 128mm(truggy), 130mm (Truck/Sand Truck)
- Height: 75mm(buggy/truggy), 72mm(truck/Sand Truck)
- Wheel Base: 102mm
- Tyre Diameter: 48mm
- Gear Ratio: 17:1 (8T motor pinion used), 13.6:1 (10T motor pinion used), 11.3:1 (12T motor pinion used)

- This product is not a toy. It is not intended for persons under 14 years of age, unless closely supervised by an adult.
- This manual is subject to change without prior notice.

TOOLS AND BATTERIES (NOT INCLUDED)

You will need to purchase additional tools and batteries for both the radio controller and the car.

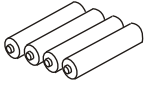

Batteries
(For car)

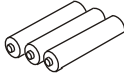

Batteries
(For radio controller)

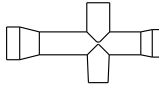

Small Cross Wrench

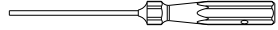

Screwdriver

- Ni-MH rechargeable battery is strongly recommended for best performance.
- Alkaline batteries are acceptable for the remote control.

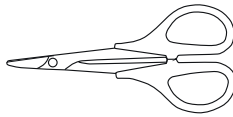

Body Cutter

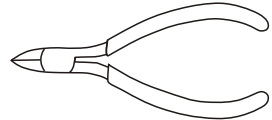

Wire Scissors

GETTING FAMILIAR WITH YOUR CAR

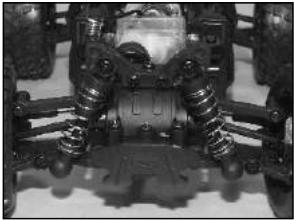

- Shaft-Drive 4WD
- Spring Coil Shocks
- Wishbone Suspension



- Mini Servo (9g)
- Motor RC 131
- AA size battery powered



- Solid Drive Shaft
- Skilled Steering Hub
- Stylish Off Road Tyre Tread



- Mini Upper Deck
- Compact Shock Tower
- Solid Front Bumper

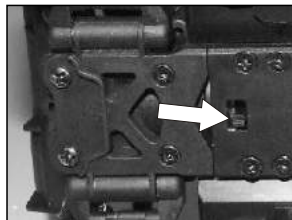

- The receiver on the main PCB plate inside the car.
- The receiver switch is located on the bottom.

GENERAL INFORMATION

- This user's manual is designed for use with your vehicles and contains the instructions you will need to assemble, operate and maintain your vehicles.
- We know you are anxious to start driving, but it is very important that you take time to read the manual even if you are an experienced R/C driver.
- Carefully read and follow all instructions in the manual. Failure to follow the instructions will be considered abuse and/or neglect and may void the warranty.
- Your vehicle is designed to run on uneven or rough terrain. However dust, sand, water and carpet fibres can lodge in the working parts of your cars and can damage your vehicle if not removed promptly. We do not warranty your vehicle from damage due to outside elements including sand, dirt or water. The users are responsible for the maintenance and safe operation of this vehicle.
- This product is not a toy. It is not suitable for users under 14 years old unless they are supervised by adults.
- Never attempt to re-assemble the motor , ESC, and receiver. These have been carefully calibrated at the factory.
- Only use manufactured parts to upgrade your car. If you perform a drive train upgrade, replace the entire system (Such as motor, ESC, receiver and the like) so that all components are properly matched. Any malfunction incurred by custom modification will void your warranty.
- Before driving your vehicle, please read this manual completely and examine your vehicle and radio control for any defects.
- For better performance, some adjustment may be necessary.
- This vehicle requires four AA batteries (not included). Make sure the vehicle's batteries have a sufficient charge before driving or possible loss of control may result.
- To avoid battery leakage, always remove batteries from the vehicle and remote when not in use.
- Please operate your vehicle in a spacious area. Never operate your vehicle in crowded street.
- This product is fully assembled at factory. We do not take any responsibility for damage and/or accidents that occur as the result of custom modifications and/or incorrect operation.

SAFETY INFORMATION

We want users to enjoy our RC vehicles and to operate them with care. Failure to operate your vehicle in a safe and responsible manner may result in injury to yourself, others or damage to property around you.

- Read and understand all instructions carefully before use and assembly/disassembly.
- Do not run your vehicle on public roads or any area where you may encounter pedestrian or vehicle traffic.
- Do not operate in a congested area or in crowds.
- Do not operate your vehicle with obstructed line of sight, at night, or near water.
- Your vehicle is radio controlled. Radio waves are subject to interference. Radio interference can cause loss of control of your vehicle.
- Take care not to cut yourself while using tools to adjust or upgrade your vehicle.
- Since the model contains many small parts, keep out of reach of children while assembling and/or disassembling.
- When turning off your model, always turn off the receiver first, before turning off the remote control. Always remove the batteries from your vehicle and the remote control when not in use.
- If your vehicle becomes stuck, release the throttle, then retrieve it by hand.
- Do not continue to apply the throttle or you may damage the motor and/or the ESC.
- Turn off your vehicle and discontinue use if it runs erratically. Not do you run it again until the issue has been found and resolved.

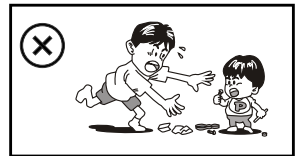
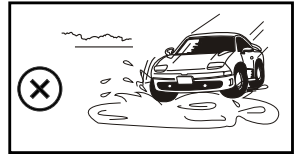
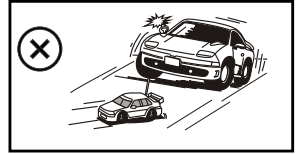

GETTING FAMILIARIZED WITH YOUR 2.4GHz RADIO SYSTEM

Your car is equipped with the new 2.4GHz radio system .Please read and understand all instructions below before operating.

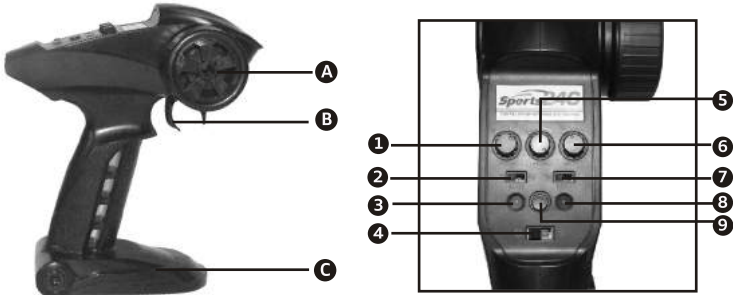

A: Steering Wheel	1: Steering Trim	4: Power Switch	7: Throttle Reverse
B: Trigger	2: Steering Reverse	5: Steering Dual Rate	8: Green Indicator
C: Battery Case	3: Red Indicator	6: Throttle Trim	9: Bind(Pair) Key

Steering Wheel: It proportionally operates the model's right and left steering control.

Battery Case: It requires 3pcs of AA size batteries.

Power Switch: It is used to turn the radio controller ON/OFF

Steering Dual Rate Dial: It allows you to change the amount of steering servo travel compared to the amount of physical movement of the steering wheel.

Throttle/Steering Trims: They are used to adjust the center trim of the throttle/steering channel.

Steering Reverse: It allows you to electronically switch the direction of steering servo travel. For example, if you move the steering wheel to the right and the steering servo moves to the left, flip the Steering Reverse Switch to make the steering servo move to the left.

Throttle Reverse : It allows you to electronically switch the direction that the motor operates in relation to the throttle trigger. For example, if you pull the throttle trigger to accelerate forward, but the model goes in reverse, flip the Throttle Reverse Switch to make the model accelerate forward.

Trigger: It controls the speed and braking ability of your car. Pull it to accelerate, release it to decelerate, and push it to brake. Pushing it a second time activates the reverse feature.

Indicators: It shows battery power level.

Bind(Pair) Key: It is used to bind your 2.4GHz radio system.

BATTERY INSTALLATION

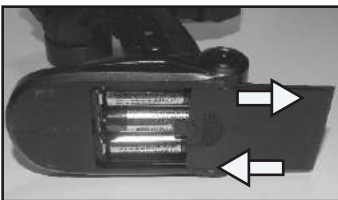

- 1) Slide the battery cover as shown, and according to the illustrations of polarities, install 3pcs of AA size batteries.
- 2) Replace the battery cover after batteries are installed.

NOTES:

- Use batteries of same type.
- Remove batteries from the case if not in use.
- Always check the battery power.
- Dispose of exhausted batteries properly.

TO BIND THE RECEIVER TO THE RADIO CONTROLLER

Perform the binding procedure ,following the instructions below .

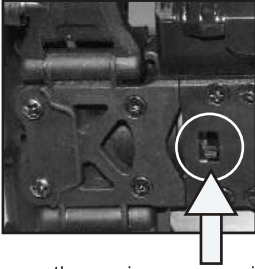

- 1) Turn on the receiver power switch , which is located on the bottom of the car.

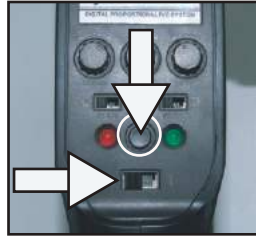

- 2) Hold the Bind (Pair) key, switching on the radio power. This operation should be performed within 5 seconds after your receiver is turned on.

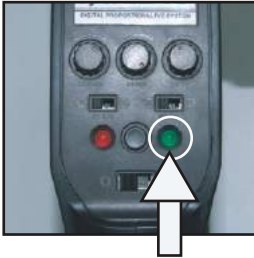

- 3) Green indicator goes flashing, meaning that the binding process is being performed in system.

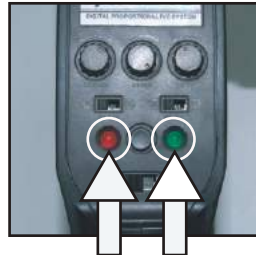

- 4) Red and green indicators being steady on means that your receiver is bound to your radio controller. Binding process is completed.

INSTALLING BATTERY COMPARTMENT AND PCB TO YOUR VEHICLE

This is for **ADVANCED USERS ONLY**. Do not attempt this upgrade unless you have experience with electronic soldering!

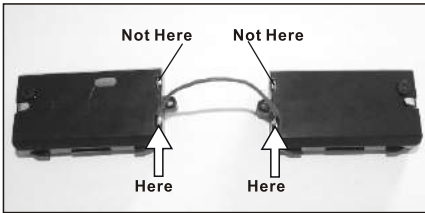

1. Connect the contacts of the battery compartments together with wires and solder. (See the soldering points as shown.)

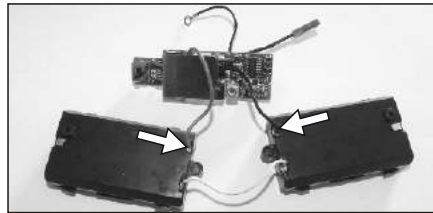

2. Connect the PCB to the battery compartments with wires and solder. (See the soldering points as shown.)

Note: Never re-assemble the PCB itself.

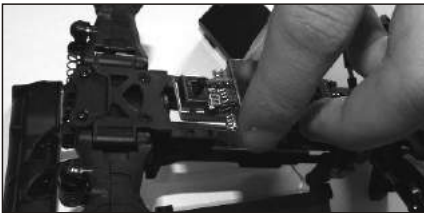

3. Install the PCB to the bottom of the vehicle.

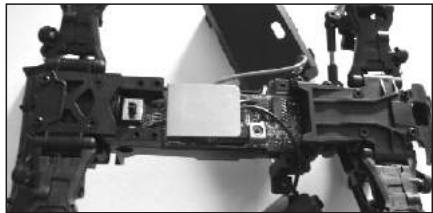

4. Fasten the PCB in place. (Make sure not to wrap the wires)

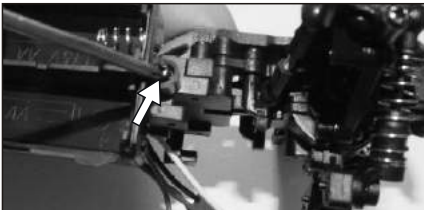

5. Secure the battery compartment on one side with a screw. (Screw No.: 24101, see part list)

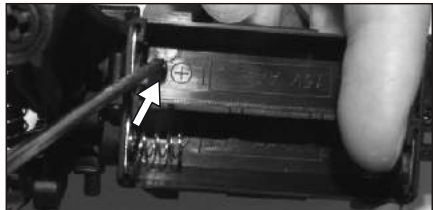

6. Secure the battery compartment on the another side. (Screw No.: 24101, see part list)



7. Cover the PCB mount after both battery mounts are installed.

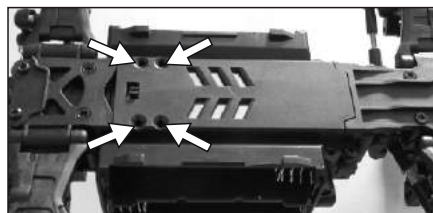

8. Secure the PCB mount with the screws as shown. (Screw No.: 24109, see part list)

INSTALLING THE SERVO TO YOUR VEHICLE

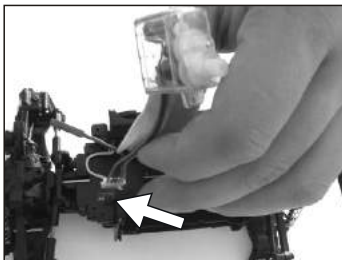

1. Insert the servo connector into the slot provided on the vehicle. (The slot on the top front of the vehicle)

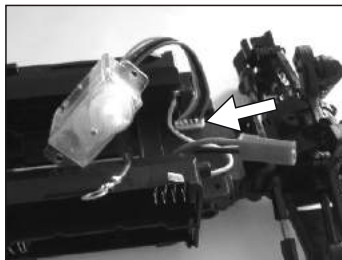

2. Make sure the servo is correctly installed on the vehicle. Inspect all of the wires to ensure they are undamaged.



3. The parts (servo saver and the pin) are from Part Pack 24008 and Part Pack 24016. (See part list)

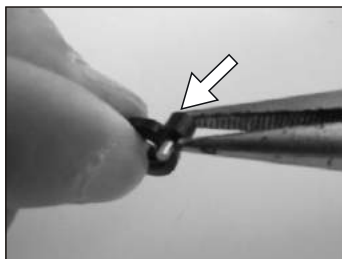

4. Use a needle nose pliers to fasten the pin onto the servo saver.

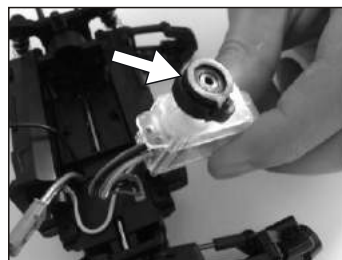
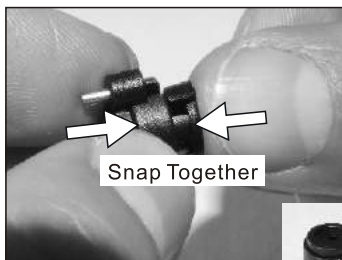
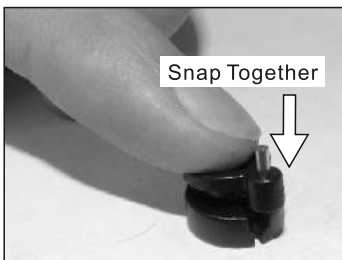

5. Press the servo saver onto the servo as shown.

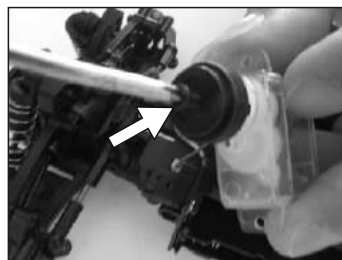

6. Secure it with a screw. (Screw No.: 24112, see part list)

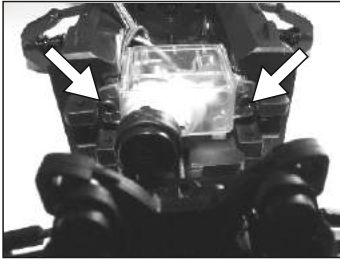

7. Install the servo in place as shown. (Make sure wiring configuration is correct.) Secure the servo with screws. (Screw No.: 24100, see part list)

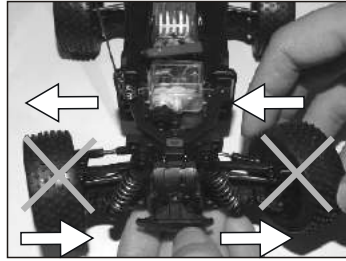

8. The gears inside the servo are very small and precisely built with tight tolerances. Never force the steering on the front wheels by hand. Doing this can severely damage the servo.

BATTERY INSTALLATION OF YOUR VEHICLE

Your vehicle is powered by four AA size batteries (not included).

Insert two AA size batteries into each of the two battery compartments. Be careful to insert them with correctly and match the polarity (marked + and -).

Replace each battery cover by pushing it gently until it snaps into place.



WARNINGS:

1. Always switch off the power before remove the body and batteries.
2. Do not use damaged batteries.
3. Never attempt to charge non-rechargeable batteries.
4. Rechargeable batteries should only be charged under adult supervision.
5. Do not mix fresh and old batteries together.
6. Do not use batteries of different kinds.
7. Batteries must be inserted properly with the correct polarity. (shown as + and - on the battery compartment).
8. Exhausted or leaking batteries should be removed from your vehicle immediately and disposed of properly.

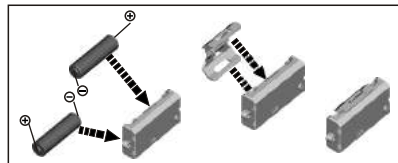
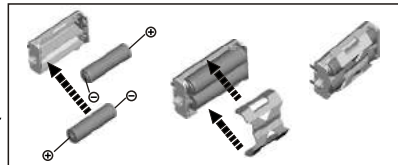

RUNNING YOUR CAR

1 TURN ON THE TRANSMITTER

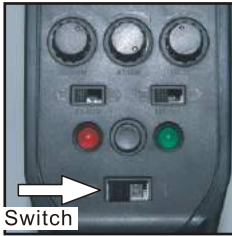

1) Slide the power switch of the radio controller to ON, which is located on the top of the radio controller.

2 TURN ON THE RECEIVER ON YOUR CAR

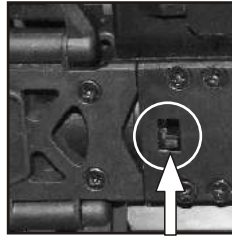

2) Slide the power switch of the receiver to ON, which is located on the bottom of the car.



CAUTION

- Before using your car, make sure the radio controller is of enough battery power. Low battery power will lead to the loss of control of your car.
- Always turn on the remote controller firstly, and then the receiver.

3 CHECK STEERING PERFORMANCE

- Ensure good steering performance.



1) To keep the car run straight in line, do not move the control wheel. (Keep it at centre)



2) Turn it left to allow your vehicle turn to left.



3) Turn it right to allow your vehicle turn to right.

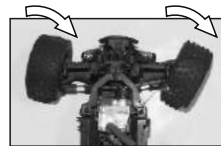
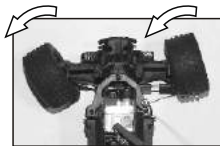
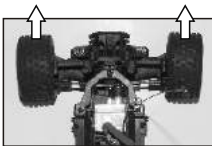

4 CHECK TRIGGER RESPONSE

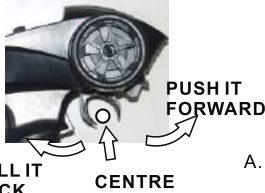

- A. Pull the trigger back to accelerate, release it to decelerate and push it to brake.
- B. To stop running your car, release the trigger to Neutral.
- C. Pushing the trigger a second time activates the reverse feature.

5 TO TUNE THE STEERING TRIM

STEERING TRIM

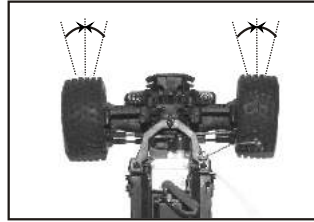

Gently pull the trigger to allow your car to run slowly. Meantime, tune the steering trim to allow the front wheels to be aligned.

6 TO TUNE THE STEERING DUAL RATE CONTROL DIAL



STEERING D/R

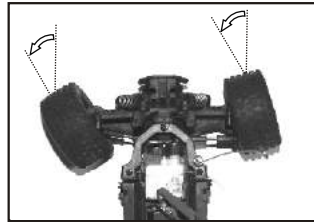

This dial adjusts the overall travel of the steering servo. Push the dial forward for maximum steering. Pull the dial back to reduce the steering level.

- Set the Steering Dual Rate Control Dial to Minimum first. To set the desired steering level increase it again whilst decelerating your vehicle.

STOPPING YOUR CAR

1 TURN OFF THE RECEIVER ON YOUR CAR

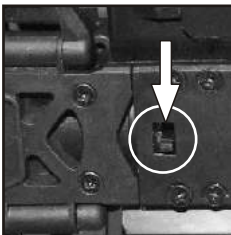

2 TURN OFF THE TRANSMITTER

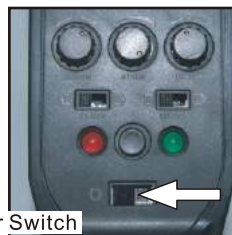

Power Switch



CAUTION

- Always switch off the receiver then the radio control.

3 REMOVE BATTERIES

- Do not forget to remove batteries from your car and transmitter when not in use.

MAINTAINING YOUR CAR

After running your car, the following procedures should be performed regularly and will help to maintain your car's performance.

- Inspect your car for any obvious damage.
- Check the gears for wear, debris or broken/slipping teeth.
- Check the wheels and tighten the wheel screws properly.
- Check for loose screws in the chassis.
- Check the wiring for frayed or damaged wires or connectors.
- Check the steering servo which will wear out over time and require replacement.
- Check all batteries.
- Keep the chassis clean and free of sand, dust and moisture.
- Remove and clean the motor if necessary. (Never attempt to re-assemble the motor, you will damage it and void the warranty).
- Clean the car body with a soft lint-free cloth.
- Remove all batteries from the car when not in use.



TROUBLESHOOTING

A. The vehicle does not work at all.

1. Check to see if transmitter and car are on.
2. Check to see if TX/RX are properly bound.
3. Adjust throttle trim on transmitter
4. Replace batteries.

B. The vehicle runs slow.

1. Change battery (AA size NiMH batteries are recommended.)
2. Make sure the vehicle is geared properly and the pinion and spur gear are over tightened.
3. Clean all bushings or ball bearings.
4. Check for stripped or dirty gears.

C. The throttle works, but it can not steer.

1. Check if the servo feels jammed, try centering it by hand.
2. Check the whole steering system.









D. It steers, but throttle is uncontrollable.

1. Adjust steering rim.
2. Replace the batteries.

E. The vehicle runs noisily.

1. Check gear mesh between spur gear and pinion.
2. Check for stripped and/or dirty gears.
3. Clean and oil bushings or ball bearings.

SPARE PARTS-1

<p>PART NO.: 24001</p>  <p>Main Drive Shaft (Length: approx. 95.2mm)</p>	<p>PART NO.: 24002</p>  <p style="text-align: right;">8P</p> <p>Suspension Arm Hinge Pin (Length: approx. 18.1mm)</p>	<p>PART NO.: 24003</p>  <p style="text-align: right;">8P</p> <p>Steering Linkage Screwbolt (Length: Approx. 18mm)</p>
<p>PART NO.: 24004</p>  <p style="text-align: right;">8P</p> <p>Shock Ball Bolt (Φ 4.7mm, length: approx. 17mm)</p>	<p>PART NO.: 24005</p>  <p style="text-align: right;">8P</p> <p>Steering Ball Bolt (Φ 3.8mm, length: approx. 7.6mm)</p>	<p>PART NO.: 24006</p>  <p style="text-align: right;">12P</p> <p>Steering Bushing Pin (Φ 1.5*8.8mm)</p>
<p>PART NO.: 24007</p>  <p style="text-align: right;">12P</p> <p>Drive Ball Pin (Φ 1.5*6.8mm)</p>	<p>PART NO.: 24008</p>  <p style="text-align: right;">12P</p> <p>Servo Saver Pin (Φ 1.5*6.8mm)</p>	<p>PART NO.: 24009</p>  <p style="text-align: right;">4P</p> <p>Shock Spring</p>
<p>PART NO.: 24011</p>  <p>Battery Contacts</p>	<p>PART NO.: 24012</p>  <p style="text-align: right;">20P</p> <p>Diff. Shims (4.8*9.5*0.15mm)</p>	<p>PART NO.: 24013</p>  <p>Bumpers+ Gear Box+ Gear Box Plate</p>

The images may vary from the actual parts.

SPARE PARTS-2

PART NO.: 24014



Main Body+ Servo Retainer

PART NO.: 24015



Battery Compartment Assembly+
PCB plate+Upper Deck+PCB
Mount

PART NO.: 24016



Drive Shaft Assembly+ Diff.
Outdrive+Servo Saver Assembly

PART NO.: 24017



Diff Large/Small Bevel Gears /
Mount+Diff Housings + Spur
Gear+Drive Pinion Gear +
Bushes(Plastic)

PART NO.: 24018



Front Uprights+ Rear Uprights
Front Steering Hubs+Fasteners

PART NO.: 24019



Wing + Wing Stay+ Body posts+
Front/rear Shock Tower

PART NO.: 24020



Diff. Complete (Front and rear
are same)- RTR plastic bushes
/Outdrives

PART NO.: 24021

4P



Shocks Complete

PART NO.: 24022



Suspension Arms+ Shock
Assembly +Front Gear Box Mount

PART NO.: 24023

4P



Buggy Rims (Dart)

PART NO.: 24024

4P



Buggy Tires (Pin)

PART NO.: 24025

4P



Buggy Wheels Complete

The images may vary from the actual parts.

SPARE PARTS-3

PART NO.: 24026

4P



Truggy Rims (8 Spoke)

PART NO.: 24027

4P



Truggy Tires (V-tread)

PART NO.: 24028

4P



Truggy Wheels Complete

PART NO.: 24029

4P



Truck Rims (Dial)

PART NO.: 24030

4P



Truck/Sand Truck Tires (Knobby)

PART NO.: 24031

4P



Truck /Sand Truck Wheels Complete

PART NO.: 24620



3-in-1 PCB Unit(2.4GHz System)

PART NO.: 24621



Steering Servo (3 plugs)

PART NO.: 24033C



RC 131 Motor(30000 rpm)

PART NO.: H021











12P



Body Clip A/B- Small

The images may vary from the actual parts.

Screws Required

<p>PART NO.: 24100 20P</p>  <p>Washer Head Self Tapping Screw 2*5mm</p>	<p>PART NO.: 24101 20P</p>  <p>Washer Head Self Tapping Screw 2*6mm</p>	<p>PART NO.: 24102 20P</p>  <p>Washer Head Self Tapping Screw 2*8mm</p>
<p>PART NO.: 24103 20P</p>  <p>Washer Head Self Tapping Screw 2*10mm</p>	<p>PART NO.: 24104 20P</p>  <p>Washer Head Partial Thread Screw 2*8mm</p>	<p>PART NO.: 24105 20P</p>  <p>Washer Head Partial Thread Screw 2*9.5mm</p>
<p>PART NO.: 24106 20P</p>  <p>Washer Head Partial Thread Screw 2*17.5mm</p>	<p>PART NO.: 24107 20P</p>  <p>Countersunk Self Tapping Screw 2*6mm</p>	<p>PART NO.: 24108 20P</p>  <p>Countersunk Self Tapping Screw 2*9mm</p>
<p>PART NO.: 24109 20P</p>  <p>Countersunk Self Tapping Screw 2*12mm</p>	<p>PART NO.: 24110 20P</p>  <p>Countersunk Screw 1.5*5mm</p>	<p>PART NO.: 24111 20P</p>  <p>Flat Head Screw 2*3mm</p>
<p>PART NO.: 24112 20P</p>  <p>Flange Self Tapping Screw 2*6mm</p>	<p>PART NO.: 24113 20P</p>  <p>Flange Self Tapping Screw 2.6*10 mm</p>	<p>PART NO.: P100 12P</p>  <p>Body Post Pad</p>

The images may vary from the actual parts.

More Information About The Parts In Big Packages

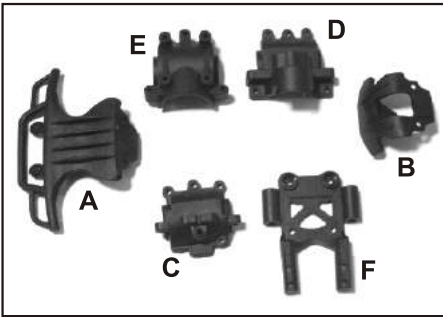

PART NO.:24013

- A: Front Bumper (Truck/Sand Truck Only)
- B: Front Bumper (Buggy/Truggy Only)
- C: Front Gear Box (Upper)
- D: Rear Gear Box (Upper)
- E: Rear Gear Box (Bottom)
- F: Rear Gear Box Plate

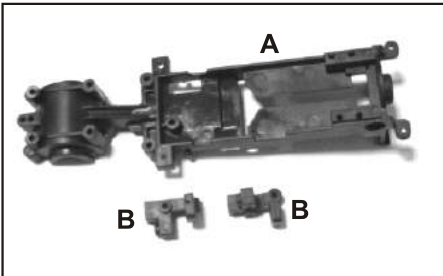

PART NO.:24014

- A: Main Body
- B: Servo Retainer

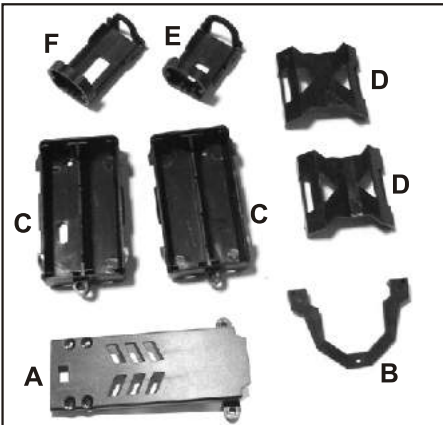

PART NO.:24015

- A: PCB Mount
- B: Upper Deck
- C: Battery Compartment
- D: Battery Retainer
- E: Motor Mount (RC 131 motor)
- F: Motor Mount (RC180 motor)

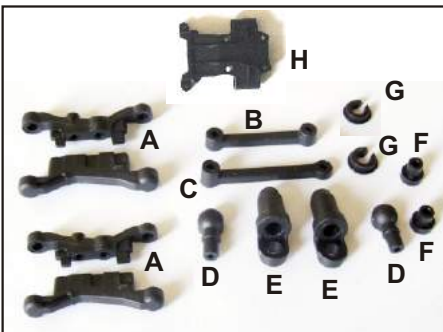

PART NO.:24022

- A: Front/rear Lower Suspension Arm
- B: Front Upper Suspension Arm
- C: Rear Upper Suspension Arm
- D: Shock Lower Mount
- E: Shock Body
- F: Shock Bush
- G: Shock Spring Holder
- H: Front Gear Box Mount

The images may vary from the actual parts.

More Information About The Parts In Big Packages

PART NO.:24017

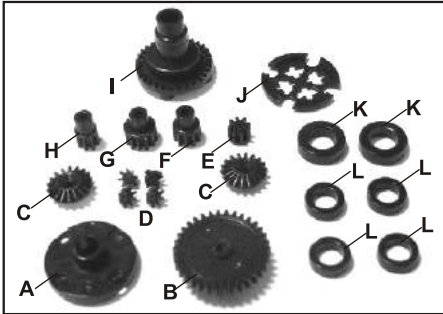

- A: Diff. Housing A
- B: Spur Gear (34T)
- C: Diff. Large Bevel Gear (18T)
- D: Diff. Small Bevel Gear(8T)
- E: Drive Pinion Gear (8T)
- F: Motor Pinion(10T)
- G: Motor Pinion(12T)
- H: Motor Pinion (8T)
- I: Diff. Housing B
- J: Diff. Small Bevel Gear Mount
- K: Diff. Bush (6*10*3mm)
- L: Wheel Shaft Bush (5*8*3mm)

PART NO.:24018

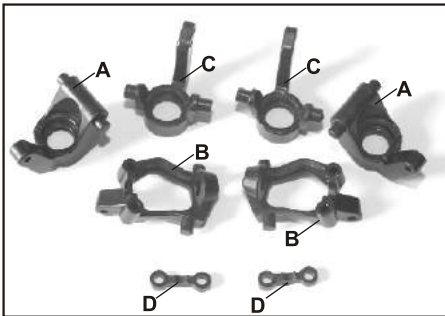

- A: Rear Uprights (Left/Right)
- B: Front Uprights (Left/Right)
- C: Front Steering Hubs (Left/Right)
- D: Front Steering Hub Fasteners

PART NO.:24016

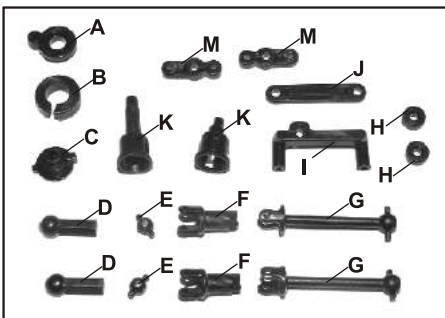

- A: Servo Saver Set 1
- B: Servo Saver Set 2
- C: Servo Saver Set 3
- D: Steering Linkage Set End
- E: Drive Joint Ball
- F: Wheel Shaft
- G: Drive Shaft
- H: Main Drive Bush (2*6*2.5mm)
- I: Steering Bushing Unit
- J: Steering Ackerman Plate
- K: Diff. Outdrive (Long+short)
- M: Steering Turning Arm

PART NO.:24019

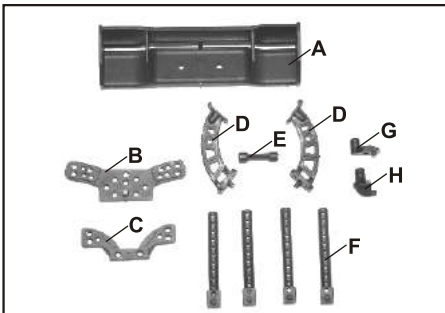

- A: Off Road Wing (Buggy/Truggy Only)
- B: Rear Shock Tower
- C: Front Shock Tower
- D: Wing Stay (Buggy/Truggy Only)
- E: Wing Post (Buggy/Truggy Only)
- F: Body Posts (Truggy/Truck /Sand Truck Only)
- G: Front Body Post (Buggy Only)
- H: Rear Body Post (Buggy Only)

The images may vary from the actual parts.

OPTIONAL PARTS (TO UPGRADE YOUR CAR)

<p>PART NO.: 24600</p> <p style="text-align: right;">4P</p>  <p>Aluminum Shocks</p>	<p>PART NO.: 24601C</p>  <p>RC 180 Motor with Rc180 Motor Mount Installed</p>	<p>PART NO.: 24602</p>  <p>Main Drive Ball Bearings (2*6*2.5mm) * 2PCS Wheel Shaft Ball Bearings(5*8*3mm) * 8PCS Diff. Ball Bearings (6*10*3mm) * 4PCS</p>
<p>PART NO.: 24603</p> <p style="text-align: right;">2P</p>  <p>Aluminum Front Shock Tower+ Aluminum Rear Shock Tower</p>	<p>PART NO.: 24604</p> <p style="text-align: right;">2P</p>  <p>Aluminum Front/Rear Lower Arms</p>	<p>PART NO.: 24605</p>  <p>Aluminum Motor Heat Sink (For RC 131/180 motor)</p>
<p>PART NO.: 24606A</p> <p style="text-align: right;">2P</p>  <p>Aluminum Front Upper Adjustable Linkage Set</p>	<p>PART NO.: 24606B</p> <p style="text-align: right;">2P</p>  <p>Aluminum Rear Upper Adjustable Linkage Set</p>	<p>PART NO.: 24607</p> <p style="text-align: right;">2 Pairs</p>  <p>Metal Diff. Outdrive (Two pairs) A long and a short outdrive are a pair.</p>
<p>PART NO.: 24608</p> <p style="text-align: right;">2P</p>  <p>Round head</p> <p>Front Universal shafts(L=Approx.48.4mm) + Pins (1.5*6.8mm) +Nuts M2.5</p>	<p>PART NO.: 24609</p> <p style="text-align: right;">2P</p>  <p>Flat head</p> <p>Rear Universal shafts(L=Approx.48.5mm) + Pins (1.5*6.8mm) +Nuts M2.5</p>	<p>PART NO.: 24610</p>  <p>Diff. Complete (Front and rear are same)- Metal Outdrives/Ball Bearings</p>

The images may vary from the actual parts.

OPTIONAL PARTS (TO UPGRADE YOUR CAR)

PART NO.: 24611



Rechargeable SC Ni-MH battery
(1.2V, 1600mAH)

PART NO.: 24612



Battery Charger (Europe Standard)

PART NO.: 24613



Battery Charger (U.S. Standard)

PART NO.: 24614



Battery Charger (Australia Standard)

PART NO.: 24615



Battery Charger (U.K. Standard)

PART NO.: 24616



Aluminum Steering Hubs (left/right)
Aluminum Front Uprights (left/right)

PART NO.: 24617



Aluminum Rear Uprights (left/right)

The images may vary from the actual parts.

INSTALLATION OF OPTIONAL PARTS(A)

Part Number 24600

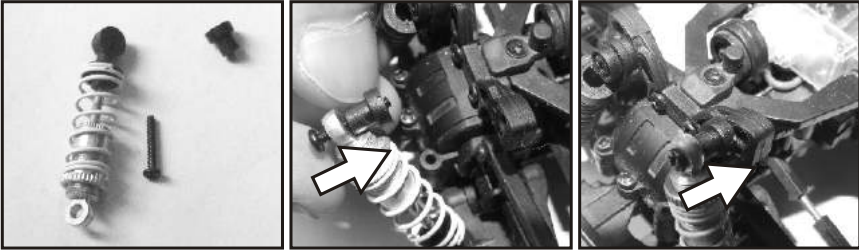

*This package includes: A) 4 Aluminum shocks , and B) 4 Washer head self tapping screws (2*12mm)*

The package does not include shock bushings. Be sure to save the stock shock bushings when you remove the standard shocks.

Note:

If the aluminum shock towers (part number 24603) are installed, do not install the aluminum shock with round head self tapping screws included in this package.

*Please use the non-self tapping washer head screws (2*12mm) that were included in the aluminum shock tower package.*

Part Number 24603

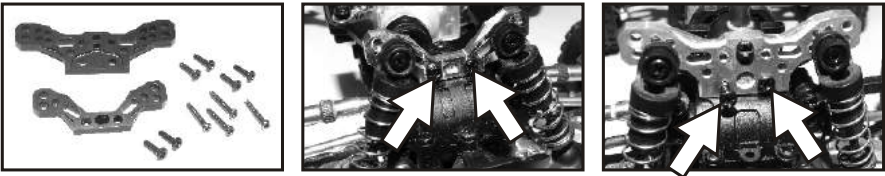

*This package includes: A) Aluminum shock towers(Front+Rear) , B) 4 Non-self tapping washer head screws (2*12mm) , and C) 4 Non-self tapping washer head screws (2*8mm) , D) 2 Non-self tapping washer head screws (2*6mm)*

Screws B) are used for installing aluminum shocks (24601).

Screws C) are used for installing standard shocks.

Screws D) are used for installing wing stay. (if your car is buggy or truggy which contains the wing)

Part Number 24604

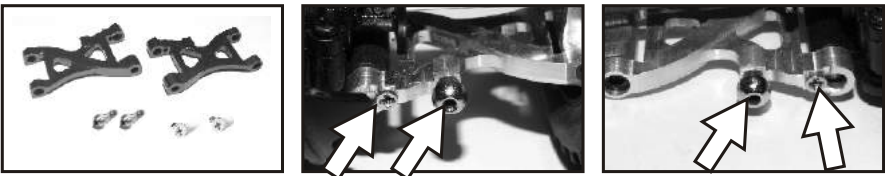

This package includes: A) One Pair of Aluminum Front/rear Lower Arms (front and rear are same).

*B) 2 Shock Ball Stud. (Dia. 4.7mm) and C) 2 Flat Head Screw (2*3mm)*

INSTALLATION OF OPTIONAL PARTS(B)

Part Number 24606A

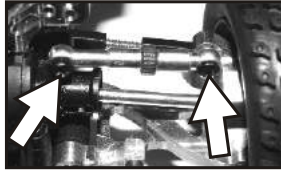

This package includes:
A) One Pair of Aluminum Front Upper Adjustable Link
The package does not include screws. Be sure to save the screws when you remove them from the car.

Part Number 24606B

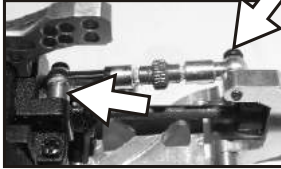
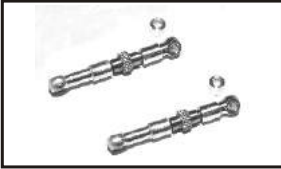

This package includes:
A) One Pair of Aluminum Rear Upper Adjustable Link
B) Pad Mount 2pcs
The package does not include screws. Be sure to save the screws when you remove them from the car.

Part Number 24616

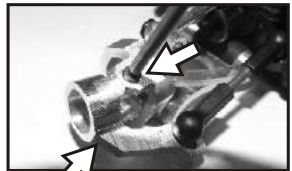

This package includes: A) One pair of aluminum steering hubs and front uprights.
B) 8 Hex. Screw (2*3mm) and C) 2 Non-self tapping Washer Head Screws (2*8mm)
Screw B) is to install aluminum steering hubs and front uprights.
Screw C) is to install the aluminum front upper adjustable link.

Part Number 24617

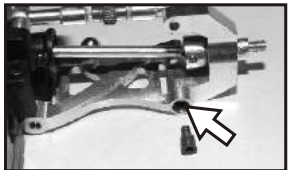
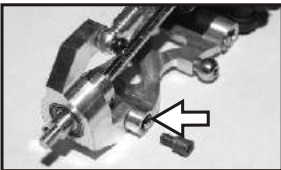

This package includes: A) One pair of aluminum Rear Uprights.
B) 4 Hex. Screw (2*3mm) and C) 2 Non-self tapping Washer Head Screws (2*8mm)
Screw B) is to install the aluminum rear uprights.
Screw C) is to install the aluminum rear upper adjustable link.

ASSEMBLY VIEWS

Shock Assembly

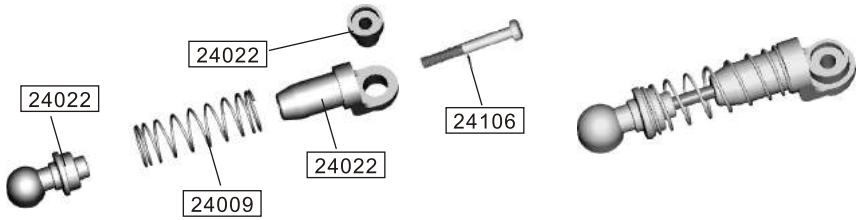

Steering Assembly

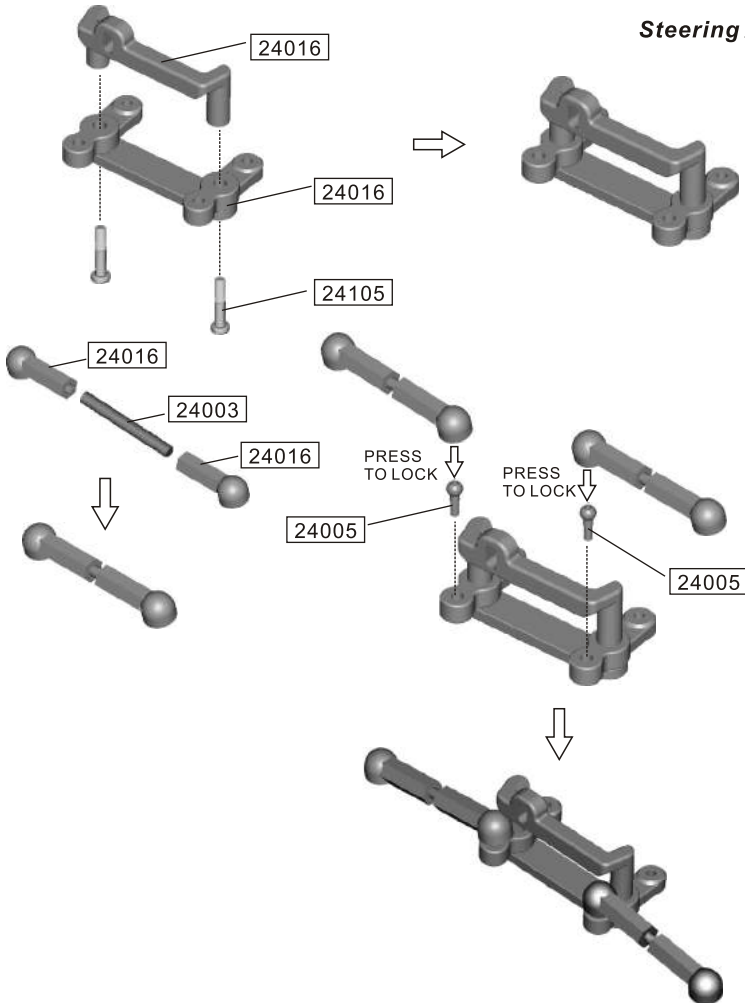

ASSEMBLY VIEWS

Installing front/rear body posts (TRUCK & BAJA TRUCK & TRUGGY ONLY)

FRONT

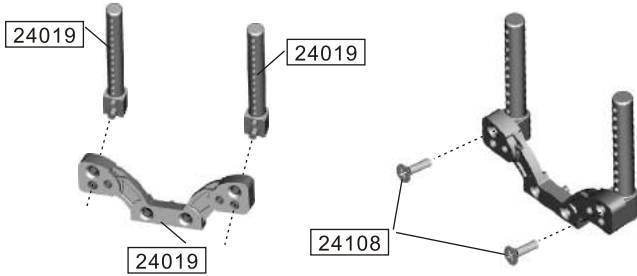

REAR

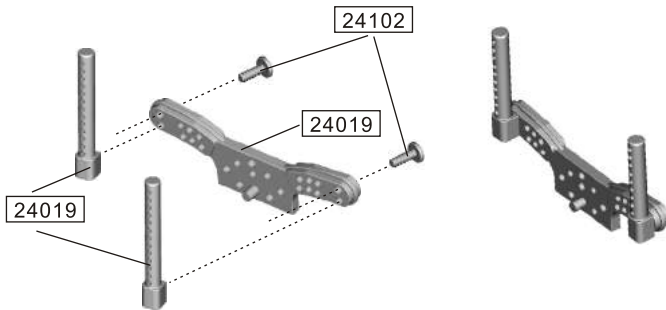

Installing front/rear body posts (BUGGY)

FRONT

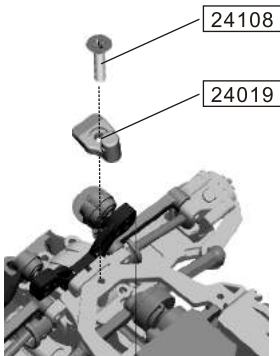

REAR

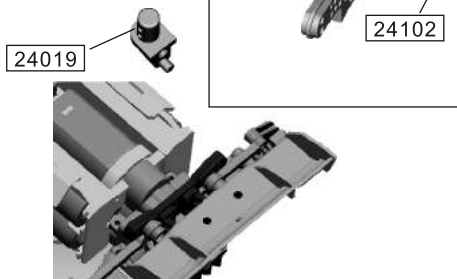

ASSEMBLY VIEWS

Front/Rear Diff. Assembly

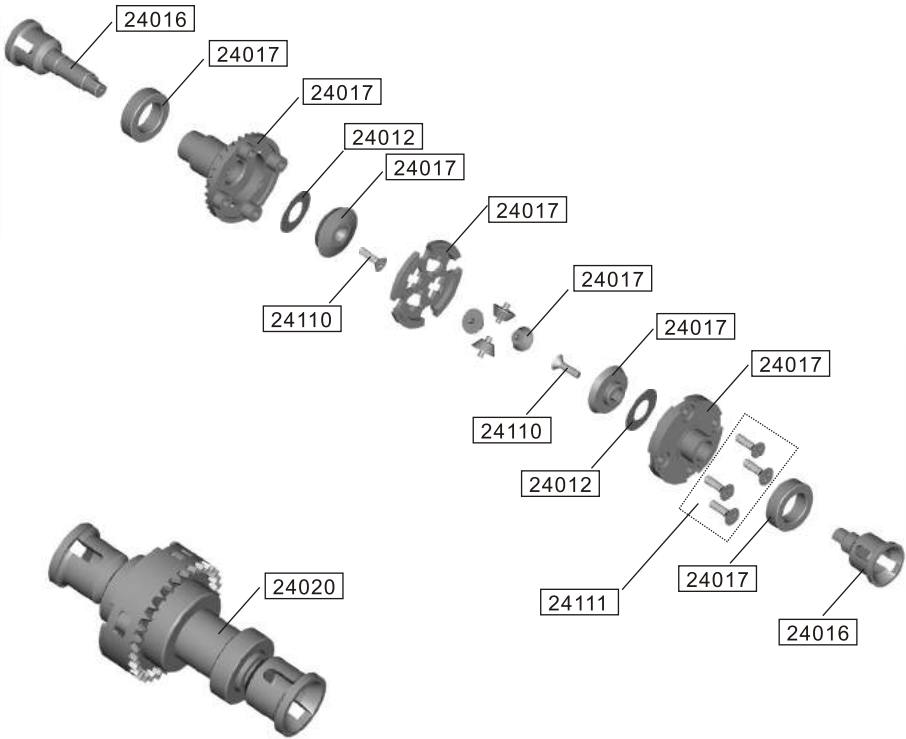

Installing Motor to the motor mount

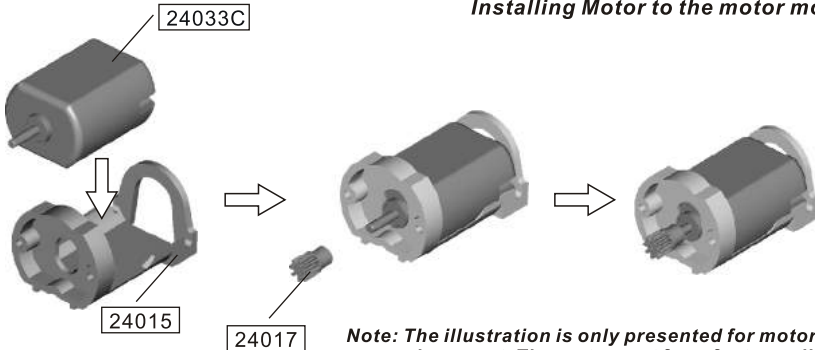

Note: The illustration is only presented for motor placement. The motor part from factory will be welded with motor wire and solder.

There are some optional motor pinions in Pack 24017.

Re-adjust the gear mesh between the spur gear and motor pinion when installing.

ASSEMBLY VIEWS

Servo Assembly

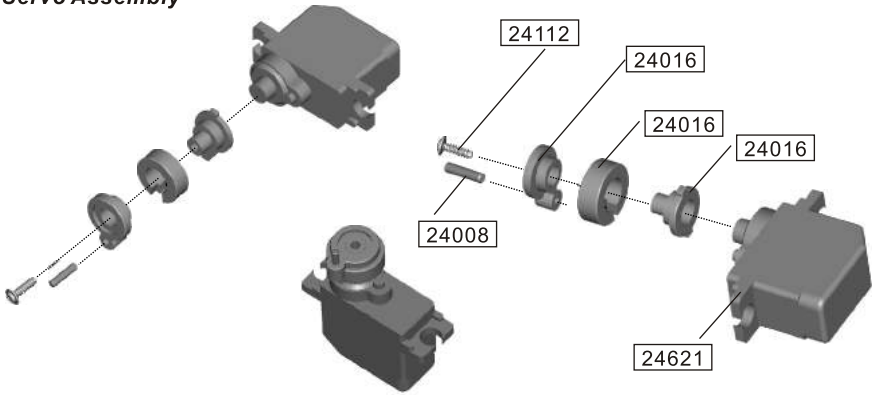

Rear Unit Assembly

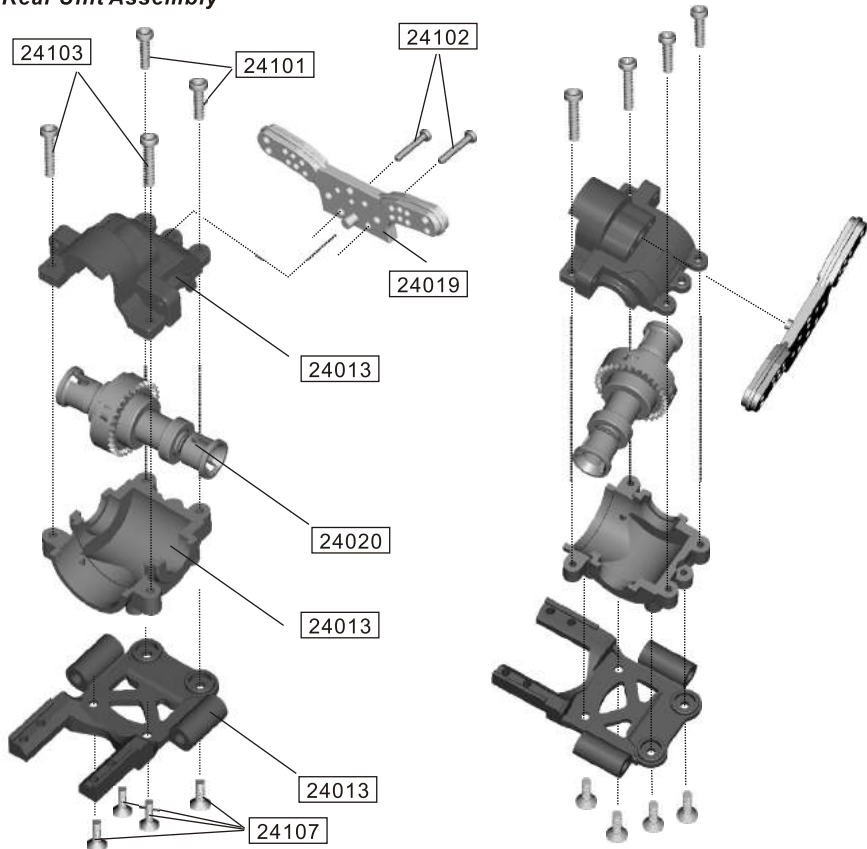

ASSEMBLY VIEWS

Installing wing to your cars (TRUGGY & BUGGY ONLY)

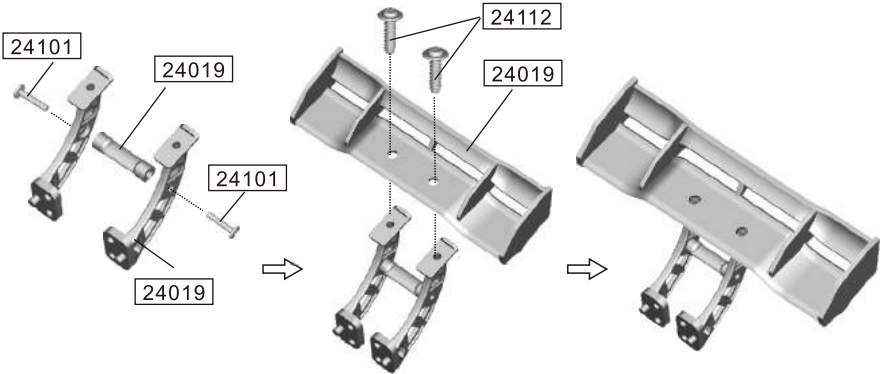

Installing battery case (batteries not included)

Insert the battery contacts into the battery compartment as shown

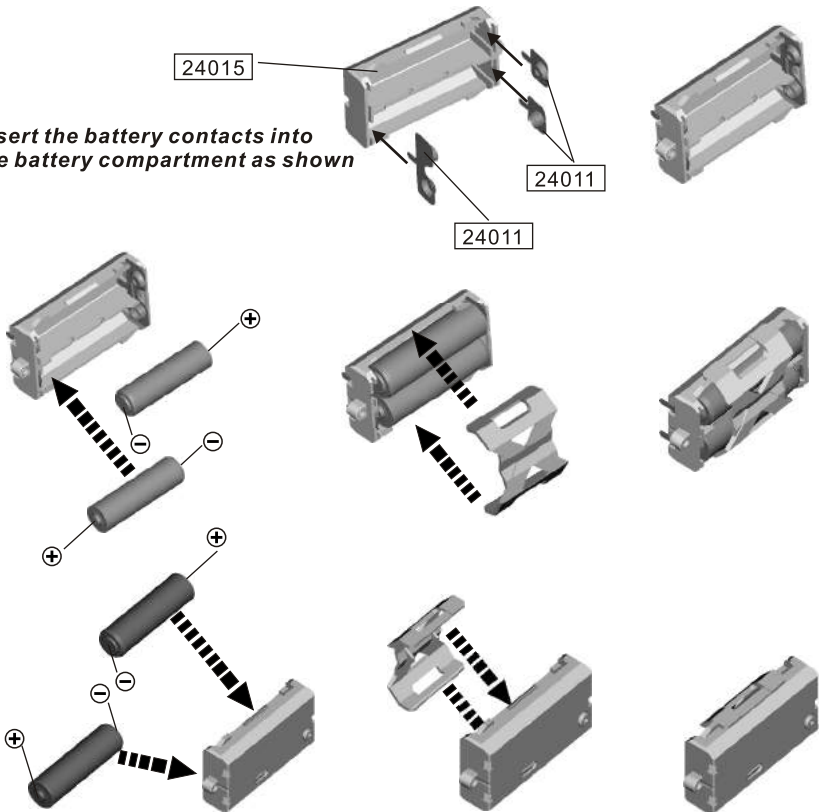

Please refer the part numbers to the part lists in the manual.

EXPLODED VIEW 1/24TH SCALE OFFROAD BUGGY

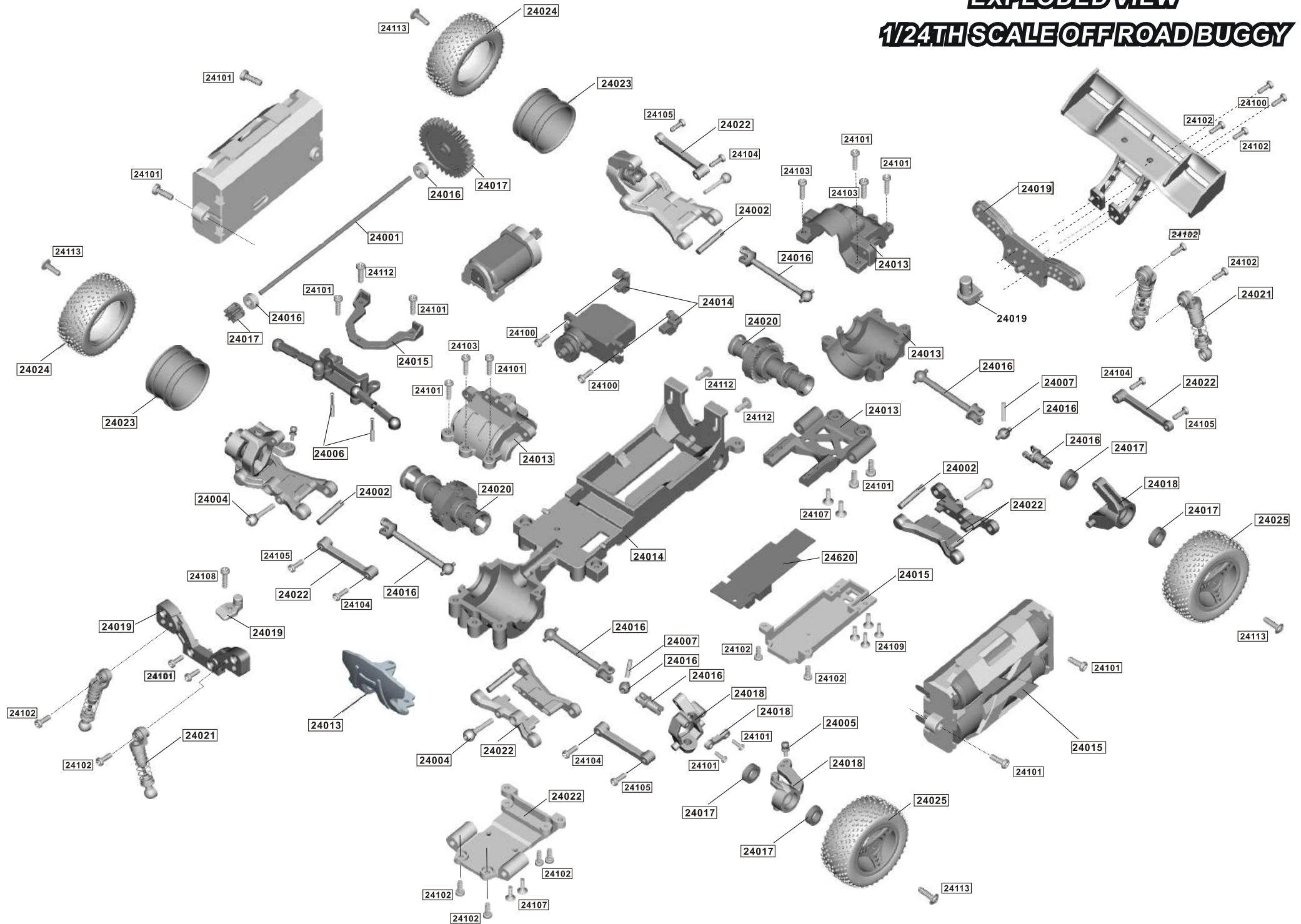

The images may vary from the actual parts.

Please refer the part numbers to the part lists in the manual.

EXPLODED VIEW

1/24TH SCALE OFF ROAD TRUCK

1/24TH SCALE OFF ROAD SAND TRUCK

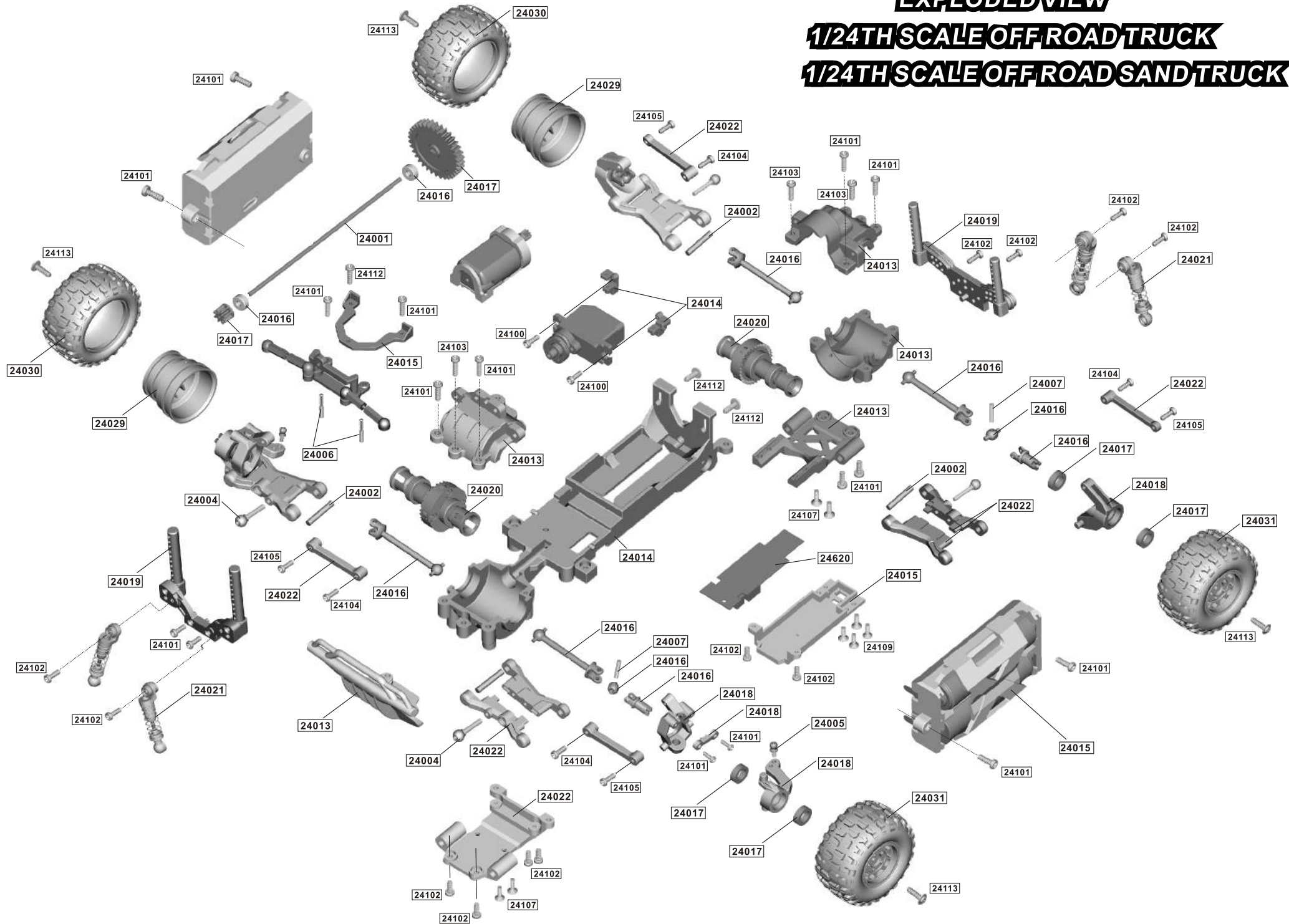

The images may vary from the actual parts.