



California Longboard Scooters



OWNER'S MANUAL

Read and understand this entire manual before allowing child to use this product!

**NOTE: Manual illustrations are for demonstration purposes only.
Illustrations may not reflect exact appearance of actual product.
Specifications subject to change without notice.**

SAFETY WARNINGS

! AN IMPORTANT MESSAGE TO PARENTS: This manual contains important information. For your child's safety, initial setup and steering tube installation require adult assistance for young riders. It is your responsibility to review this information with your child and make sure that your child understands all warnings, cautions, instructions and safety topics. Razor USA recommends that you periodically review and reinforce the information in this manual with younger riders and you are required to inspect and maintain your child's scooter to insure their safety.

! GENERAL WARNING: Scooter riding can be a hazardous activity. Scooters can and are intended to move, and it is therefore possible to get into dangerous situations and/or lose control and/or fall. If such things occur you can be seriously injured or die. LIKE ANY OTHER MOVING PRODUCT, USING A SCOOTER CAN BE A DANGEROUS ACTIVITY AND MAY RESULT IN INJURY OR DEATH EVEN WHEN USED WITH PROPER SAFETY PRECAUTIONS. USE AT YOUR OWN RISK AND USE COMMON SENSE.

- Always wear safety equipment, such as helmet, knee pads and elbow pads. Always wear a helmet when riding your scooter and keep the chinstrap securely buckled.
- Always wear closed toe shoes.
- Ride on smooth, paved surfaces away from motor vehicles.
- Avoid sharp bumps, drainage grates, and sudden surface changes. Scooter may suddenly stop.
- Avoid streets and surfaces with water, sand, gravel, dirt, leaves, and other debris. Wet weather impairs traction, braking, and visibility.
- Do not ride at night.
- Brake will get hot from continuous use. Do not touch after braking.
- Avoid excessive speed associated with downhill rides.
- Obey all local traffic and scootering laws and regulations.
- Watch out for pedestrians.
- Do not exceed 220 lb (100 kg) total weight on the California Longboard scooter.
- Do not allow children under age eight (8) to use the California Longboard scooter. Longboard scooters are for children ages eight (8) and above. All children and preteens should ride with adult guidance at all times.
- Rider weight does not necessarily mean a child's size is appropriate to fit or maintain control of the scooter.
- A parent's decision to allow his or her child to ride this product should be based on the child's maturity, skill and ability to follow rules.

ACCEPTABLE RIDING PRACTICES AND CONDITIONS

Direct parental supervision is required. Scooters are meant to be used only in controlled environments free of potential traffic hazards and not on public streets. Do not allow your child to ride a scooter in any areas where vehicle traffic is present. Child must maintain a hold on the handlebars at all times. Never allow more than one child at a time to ride a scooter. Never use near steps, sloped driveways, hills, roadways, alleys or swimming pool areas.

Do not ride a scooter in wet weather. Scooters are intended for use on solid, flat, clean and dry surfaces, such as pavement or level ground, without loose debris, such as rocks or gravel. Wet, slick or uneven and rough surfaces may impair traction and contribute to possible accidents. Do not ride a scooter in mud, ice, puddles or water. Avoid excessive speeds that can be associated with downhill rides. Never risk damaging surfaces, such as carpet or flooring, by use of a scooter indoors. Do not ride at night or when visibility is impaired.

PROPER RIDING ATTIRE

Always ensure child is wearing proper protective equipment, such as an approved safety helmet. A helmet may be legally required by local law or regulation in your area. A child should always wear shoes and keep shoelaces tied and out of the way of the wheels. Never ride barefooted or in sandals. Knee pads and elbow pads are recommended.

FAILURE TO USE COMMON SENSE AND HEED THE ABOVE WARNINGS FURTHER INCREASES RISK OF SERIOUS INJURY. USE AT YOUR OWN RISK AND WITH APPROPRIATE AND SERIOUS ATTENTION TO SAFE OPERATION. USE CAUTION.

! WARNING: ALWAYS INSPECT SCOOTER PRIOR TO RIDING. Properly inspecting and maintaining your scooter can reduce the risk of injury. Always inspect your scooter before riding and regularly maintain it.

! WARNING: CHECK LOCAL LAWS REGARDING SCOOTER USE. Check local laws and regulations to see where and how you may use your Razor scooter legally. In many states and local areas scooter riders are required BY LAW to wear a helmet. Check local laws and regulations regarding laws governing helmet use and scooter operation in your area.

BEFORE YOU BEGIN

Remove contents from box. Inspect the contents of the box for scratches in the paint and/or dents that may have occurred during shipping. Because your scooter was partially assembled and packed at the factory, there should not be any problems, even if the box has a few scars or dents.

⚠ WARNING: DO NOT USE NON-RAZOR PRODUCTS WITH YOUR SCOOTER.

Razor scooters have been built to certain Razor design specifications. The original equipment supplied at the time of sale was selected on the basis of its compatibility with the frame, fork and all other parts. Certain aftermarket products may not be compatible and will void the warranty.

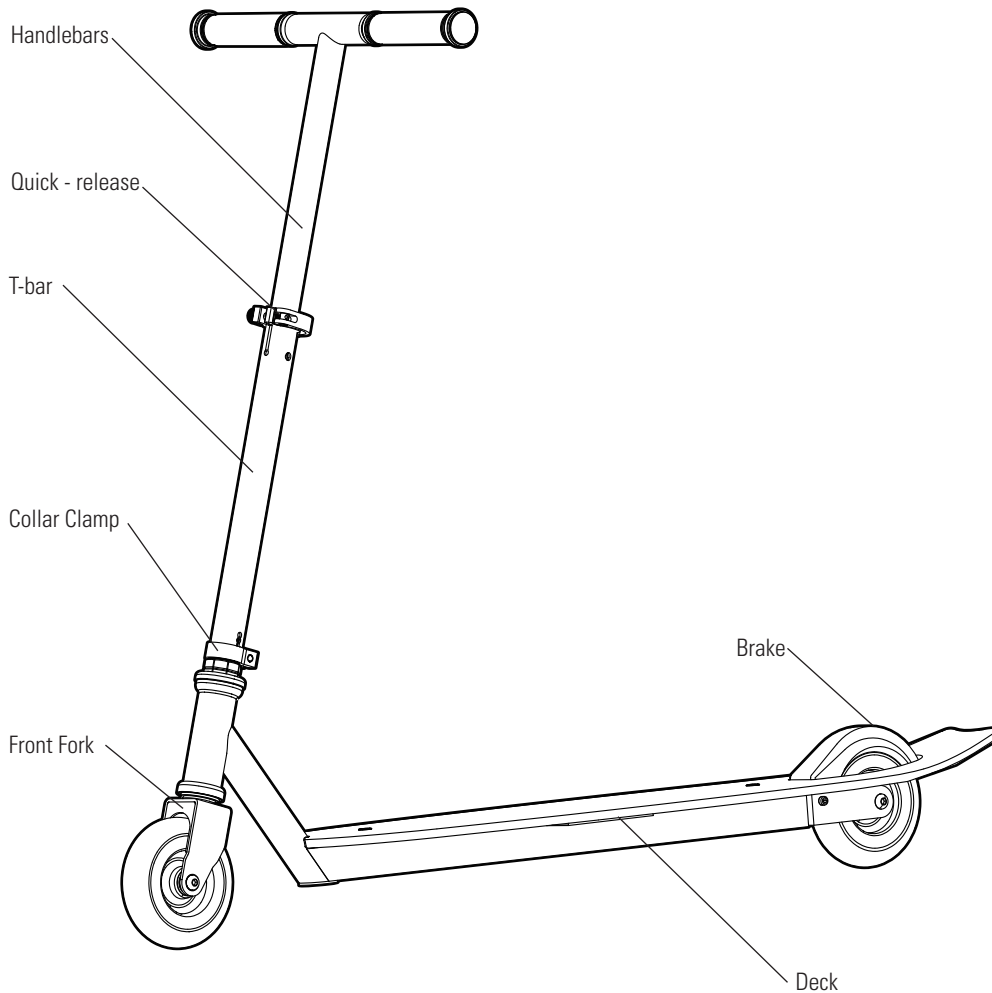

PRODUCT I.D. CODE

1. Underneath Deck
2. UPC Side of Box (not shown)

□ Required Tools

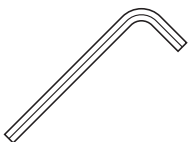

5 mm
Allen wrench
(Included)

ASSEMBLY INSTRUCTIONS

□ Handlebar

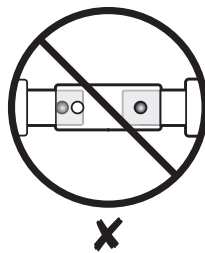
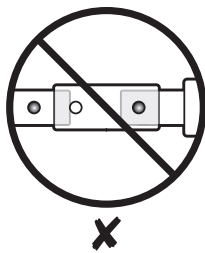
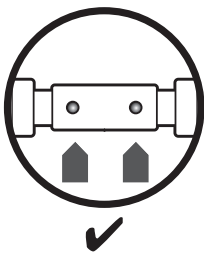
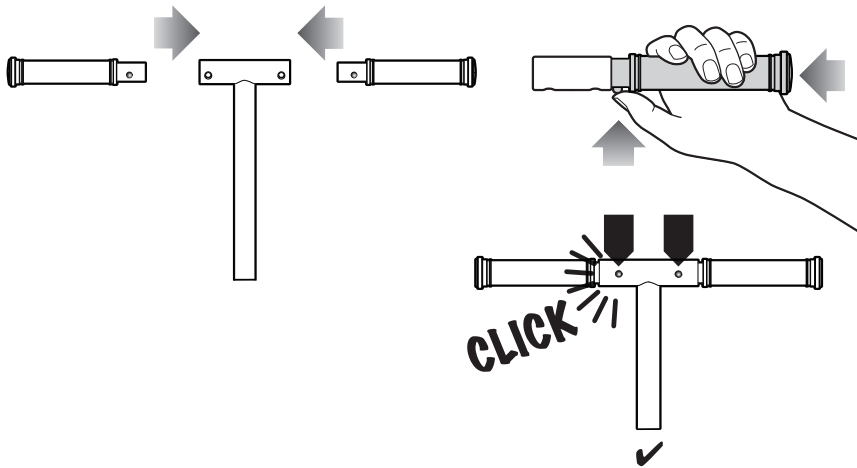

□ T-bar

1

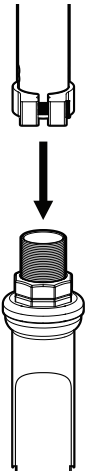

2

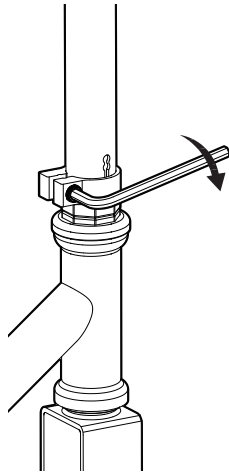

3 Check to ensure wheel and handlebars are aligned.

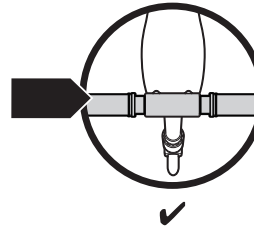
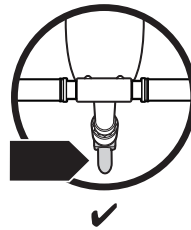

4

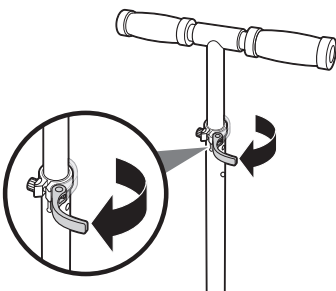

5

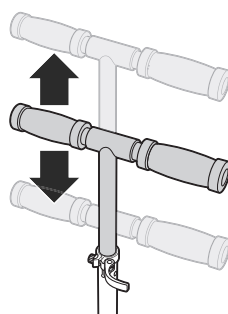

6

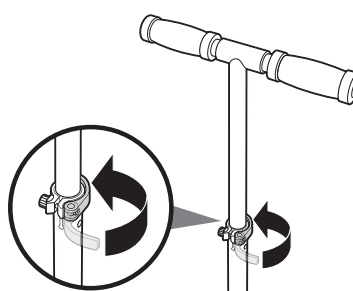

⚠ WARNING: Failure to properly engage the spring-loaded buttons may cause the handlebars to dislodge while riding and may cause you to lose control and fall. When correctly engaged, the handlebars will not rotate nor will they move sideways. Note that when properly engaged, the spring-loaded buttons are clearly visible in the holes on the T-bar.

⚠ WARNING: Failure to properly install and tighten the collar clamp may cause the rider to lose control and fall. If you do not understand these instructions, please contact Razor customer care for assistance.

CHECK BEFORE RIDING

❑ Collar Clamp

Using a 5 mm Allen wrench, check that the collar clamp bolts are tightened securely

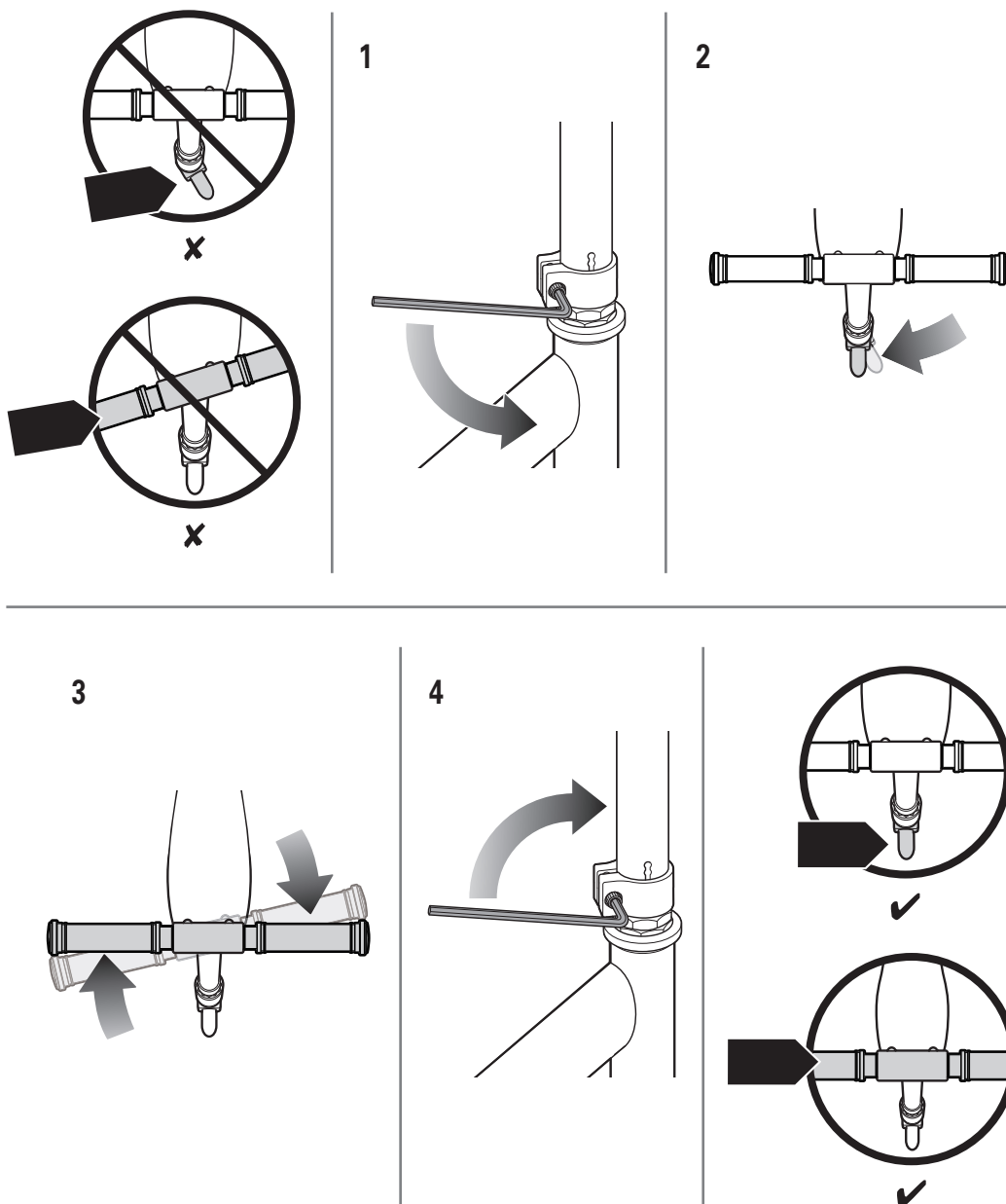

⚠ WARNING: Wheelies and other stunt-type riding reduces your ability to maneuver and control your scooter. Take the necessary precautions, such as wearing appropriate protective gear, and practice in an area safe for stunt riding and free from obstructions.

❑ Wheels and Bearings

Under normal circumstances and conditions, Razor wheels and wheel bearings are maintenance free. Nonetheless, it is the responsibility of the owner or guardian to periodically inspect the wheels for wear and tear, the axle for proper tightness, bearings for side-to-side play, and loose parts. When a wheel or wheel bearing develops play, this is an indication of excess wear and replacement is necessary. Replace immediately with only genuine Razor wheels. Worn wheels/bearings are considered normal wear-and-tear and are not covered by the Razor Warranty. Wheels other than genuine Razor wheels may not be compatible with your Razor scooter. The use of anything other than genuine Razor replacement parts may affect your safety and will void your warranty.

CHECK BEFORE RIDING

❑ **Cleaning Your Scooter**

Wipe with a damp cloth to remove dirt and dust.

Do not use industrial cleaners or solvents, as they may damage the surfaces. Do not use alcohol, alcohol-based or ammonia-based cleaners, as they may damage or dissolve the plastic components or soften the decals or decal adhesive.

❑ **How to Ride**

Place one foot on the baseboard, push forward with the other foot. Steer with both hands on the handlebars. For enhanced cornering, lean slightly into the direction of the turn. For controlled stops, apply the brake by stepping on the rear fender/brake. Razor recommends that you practice applying the brake at various speeds and in an open area free from obstructions before riding your Razor scooter around others.

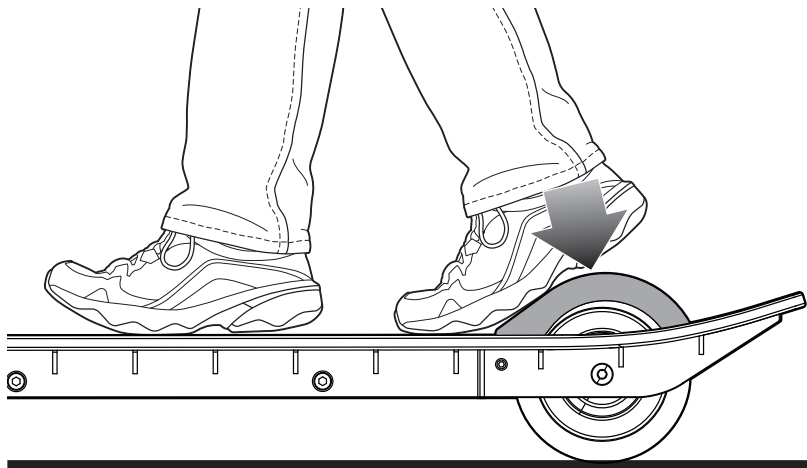

LONGBOARD SCOOTER PARTS

PLASTIC DECK

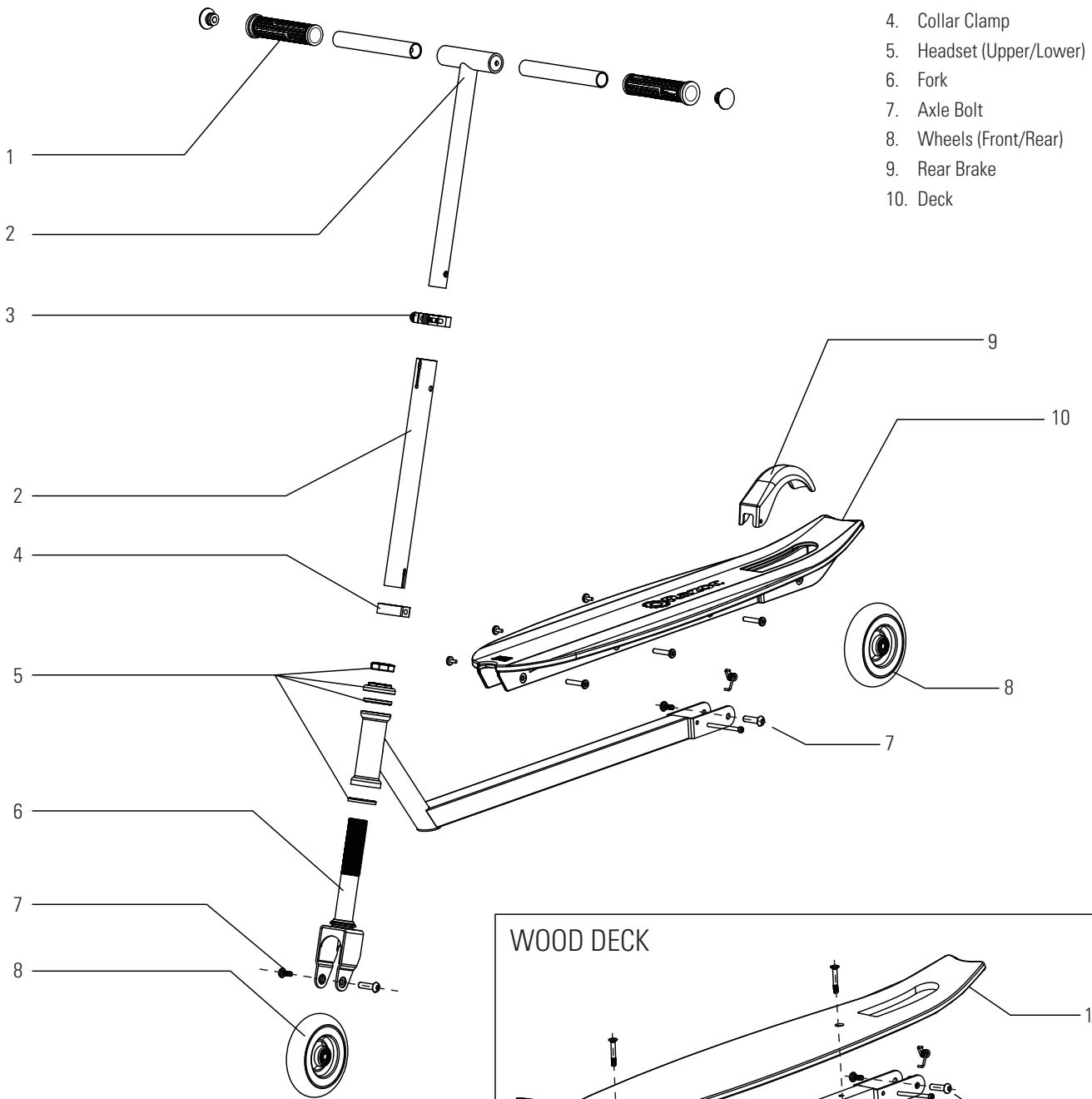

1. Handlebar Grips
2. T-bar/Extension Tube
3. Quick Release
4. Collar Clamp
5. Headset (Upper/Lower)
6. Fork
7. Axle Bolt
8. Wheels (Front/Rear)
9. Rear Brake
10. Deck

WOOD DECK

