

USER'S MANUAL



Planet Audio[®]

PNV9680

**BUILT-IN NAVIGATION
BLUETOOTH[®]-ENABLED**

**IN-DASH DOUBLE-DIN DVD/MP3/CD/AM/FM RECEIVER WITH 6.2" (157mm)
Widescreen Touchscreen TFT Digital Monitor
USB and SD Memory Card Ports and Front Panel AUX Input**

Safety Precautions

Thank you for purchasing this product. Please read through these operating instructions so you will know how to operate your model properly. After you've finished reading the instructions, keep this manual in a safe place for future reference.

Only connect the unit to a 12-volt power supply with negative grounding.

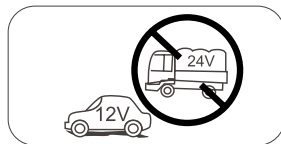

Never install this unit where the operation & condition for safe driving is impaired.

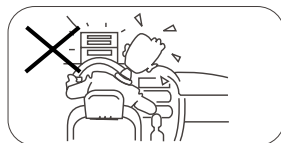

Never use the video display function in the front when driving to prevent the violation of laws & regulations and also to reduce the risk of traffic accident except for using rear view video camera.



Never expose this unit, amplifier, and speakers to moisture or water to prevent electric sparks or fire.

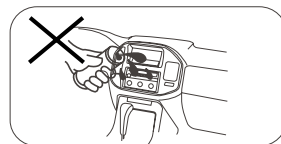

Please don't change the fuse on the power cord without professional guidance, using improper fuse may cause damage to this unit or even cause fire.

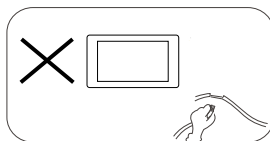

Please contact your nearest dealer if one of the following symptoms is experienced:

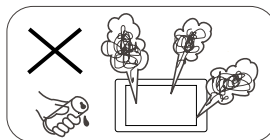

- (a). Water or other objects enters the unit.
 - (b). There is smoke.
 - (c). Peculiar smell.
-

To ensure safe driving, please adjust the volume to a safe and comfortable level in case of emergency situations.

Safety Precautions

1. Never disassemble or adjust the unit without any professional guidance.
For details, please consult any professional car shop / dealer for inquiry.
2. If the front panel or TFT monitor is dirty, please use a clean silicone cloth and neutral detergent to wipe off the spot. Using a rough cloth and non-neutral detergent such as alcohol for cleaning may result in scratching or decoloration to the monitor.
3. If any abnormal behavior of the unit is found, please refer to trouble shooting guide of this manual. If no relevant information is found, please press the [RESET] key on the front panel to resume factory default.
4. If you have parked the car in hot or cold weather for a long time, please wait until the temperature in the car becomes normal before operating the unit.
5. Using the car heater in low temperature environment may result in moisture inside the unit, DO NOT use the unit in this situation. Eject the disc and wipe off the moisture on the disc. If the unit still doesn't work after a few hours, please contact the service center.
6. Do not impact the LCD monitor which could cause damage.
7. To prevent damage to the screen, avoid touching it with sharp objects.
8. To provide a clear demonstration and an alternative for easy understanding to the operation of this unit, graphic illustrations are used.
However, some illustrations are different from the actual images displayed on the screen.
9. Operate the unit correctly according to this manual to prevent unnecessary problem. The guarantee won't be valid if the problem is caused by inappropriate operation.

Expanding Systems

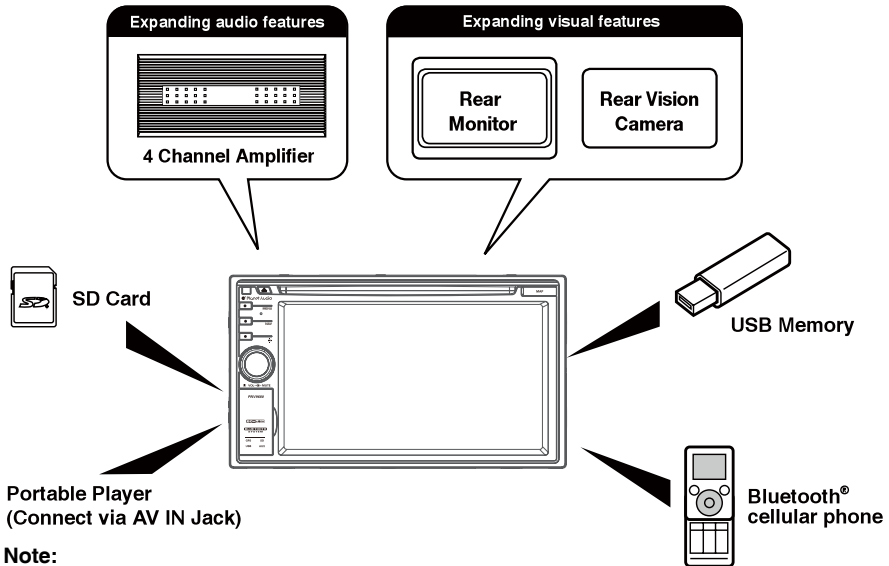

Note:

The items listed outside of the frame are the commercial products generally sold.

Before Using

Front Panel

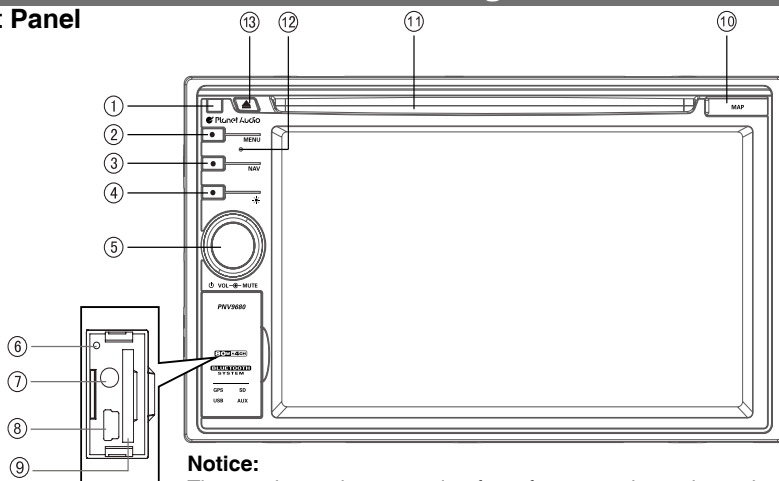

Notice:

The graphic in this manual is for reference only, and may be different from the actual unit. Reference to actual unit is suggested.

1. Remote sensor

2. **[MENU] Button:** Press to switch between the main menu and current source.

3. **[NAV] Button:** Press to switch to navigation mode.

4. **[☀] Button:** Press ☀ repeatedly to adjust screen brightness;
Press and hold ☀ to turn off the display.

5. [⏻ / VOL / MUTE] Knob

Rotate to adjust the volume.

Press momentarily to activate the MUTE function. Press again to resume normal listening.

Press to turn the unit ON. Press and hold to turn the unit OFF.

6. Reset Button

Press to reset system settings to factory default (except password and parental lock settings).

7. A/V Input

Accepts a 3.5mm jack through which signals from various audio/video devices can be applied to the unit.

8. USB Connector

Connect a USB device for playback of music/video/picture files.

9. SD Interface Connector

Insert an SD card for playback of music/video files.

10. Map Slot

The Mini SD card is used for the Navigation Map only, not for music or other files. This may be used for firmware updates if required.

11. Disc slot

12. Internal Microphone

Internal microphone for Bluetooth calls.

13. **[⏏] Button:** Press to eject a disc.

Before Using

Remote Control

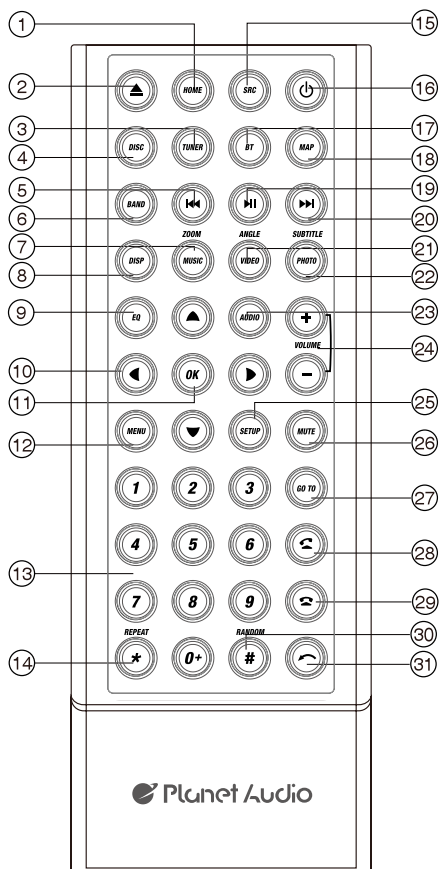

1. Return to the home menu
2. Eject the disc
3. Access to tuner source
4. Access to disc source
5. - Search an available radio station by decreasing tuning frequency
- Select the previous chapter/track for playback
6. Select radio band
7. - Zoom in (Video menu of DVD/VCD)
- Access to music list (Audio menu of music playing)
8. Adjust screen settings
9. Open EQ menu
10. Menu cursor
11. Enter
12. - Open route menu (DVD)
- Turns on/off PBC (VCD)
13. Digit area
14. Repeat playback
15. Change to next source
16. Power on/off
17. Access to Bluetooth source
18. Access to navigation source
19. Pause playback/Start playback
20. - Search an available radio station by increasing tuning frequency
- Select the next chapter/track for playback
21. - Playback disc in different angle for a scene (DVD)
- Rotate (photo playing)
- Access to video list
22. - Language selection for subtitle (DVD)
- Access to photo list
23. Change the audio language for disc playback (DVD)
24. Increase/Decrease volume
25. Access to settings source
26. Toggle on/off audio output
27. Activate direct access mode
28. Dial/Receive a call
29. Hang up
30. Play all chapter/tracks in random order
31. - Press to clear the number one by one
- Hold to clear all the numbers

Before Using

Notes on Remote Control Usage

1. Aim the remote control at the remote sensor on the unit.
2. Replace the battery from the remote control or insert a battery insulator if the battery has not been used for a month or longer.
3. DO NOT store the remote control in direct sunlight or in high temperature environment, or it may not function properly.
4. The battery can work for 6 months under normal condition. If the remote control won't work, please change the battery.
5. Use "button shaped" lithium battery "CR2025"(3V) only.
6. DO NOT recharge, disassemble, heat or expose the battery in fire.
7. Insert the battery in proper direction according to the (+) and (-) poles.
8. Store the battery in a place where children cannot reach to avoid the risk of accident.

Uninstall Battery

Slide out the battery compartment tray at the bottom on the back of the remote control.

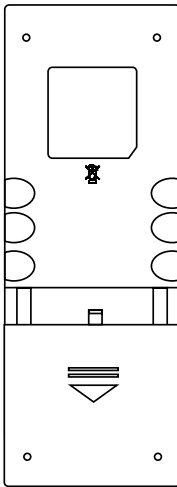

 PULL OUT

Install Battery

Use button-shaped lithium battery "CR2025 (3V)" only. Insert the battery to the battery tray with proper direction according to the (+) and (-) poles.

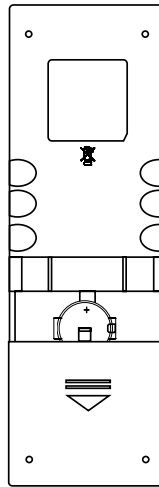



PUSH IN 

Basic Operations



Parking Brake

- When the “BRAKE” cable is connected to the brake switch, the display on the TFT monitor will display video only when the vehicle is applied.
- Parking brake function is overridden when the video source is set to REVERSE.
- When the parking brake inhibit is active, the front monitor displays warning information, preventing the driver from watching content while driving. Rear video screens are not affected.

Mute

Press [ / VOL / MUTE] knob to mute the volume from the unit. Press again to restore the volume. [] is displayed on the LCD. Adjusting the volume or using any of the audio setup features cancels the mute function.

Power On / Off

Press the [ / VOL / MUTE] knob on the unit to turn the unit on. The buttons on the front of the unit light up for a moment and the current mode status appears in the LCD. Press and hold the [ / VOL / MUTE] knob to power off the unit.

Audible Beep Confirmation

An audible beep tone confirms each function selection. The Beep tone can be disabled through the Setup menu.

Playing Source Selection

Press the [MENU] button on the front panel to change between available playing sources. The playing mode is displayed on the screen.

1. <<< or >>>: Touch this page button to view the first or second page of on-screen buttons
2. Function icons
3. Clock
4. Touch for quick access to Audio level settings



Volume Adjustment

To increase or decrease the volume level, turn the [ / VOL / MUTE] knob on the front panel. The volume ranges from “0” to “50”. The LCD or TFT screen displays the volume level for 3 seconds.



Audio Menu

The Audio Control feature allows you to easily adjust your audio system to meet the acoustical characteristics of your vehicle, which vary depending on the type of vehicle and its measurements. Proper setting of the Fader and Balance boosts the effects of the cabin equalizer.

Basic Operations

Select Preset Audio

1. Enter the Audio setup mode
Touch the [EQ] icon in the user interface and the Audio setup interface will display on the screen.
2. Select Audio mode
Touch the desired Audio selection: [Optional] / [Classic] / [Rock] / [Jazz] / [E.D.M] / [Pop], and the Audio mode will change.

Adjust Audio Parameters

To adjust Audio parameters, touch and drag the parameters adjustment bar.

- [User]: Set the desired audio effect.
- [Flat]: Select the original audio effect.
- [Reset]: Cancel the audio function settings.
- [Loud: On/Off]: When listening to music at low volumes, this feature will selectively boost certain bass and treble frequencies.



Adjust FAD BAL

You can adjust front/back/left/right balance of the speaker and the subwoofer volume to get balanced listening effect according to the surroundings and your interest.

1. Enter the Audio setup mode
Touch the [EQ] icon in the user interface and the Audio setup interface will display on the screen.
2. Adjust subwoofer volume
Touch [▲] / [▼] or drag [Sub] to adjust subwoofer volume from -12 to +12.
3. Adjust fader / balance value
Touch [▲] / [▼] / [◀] / [▶] to adjust fader / balance value.
 - [▲]: Front speaker
 - [▼]: Rear speaker
 - [◀]: Left speaker
 - [▶]: Right speaker

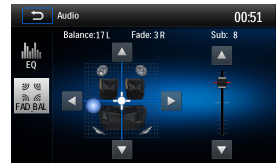

Notes:

1. The parameters of the Audio modes has been preset and you can not change them besides 'User'.
2. The Audio mode will change to 'User' automatically when you adjust the frequency value under the modes besides 'User'.
3. The value of Sub is independent of Audio mode and can be adjusted separately.

Basic Operations

Set Date /Time

1. Touch [Settings].
2. Touch [Time].
The date/time setup menu is displayed.



Set Date

1. Touch [Date].
2. Touch the date information on the screen .
A submenu is displayed.
3. Touch [▲] or [▼] to set year, month and day.

Set Clock Mode

1. Touch [Clock mode].
2. Touch [12Hr] or [24Hr] to switch clock mode.

Set Time

1. Touch [Time].
2. Touch the time on the screen, a submenu is displayed.
3. Touch [▲] or [▼] to set hour and minute.

Tip:

When date/time is set, touch [Save] to confirm or [Cancel] to exit.

Radio Mode

Radio Display

1. Touch to view the SOURCE MENU and select a new playback source
2. Strong Local signal broadcasting indicator
3. Stereo broadcasting indicator
4. Current radio band indicator
5. Broadcaster information stored at the preset
6. Touch to view more on-screen buttons
7. Touch to seek backward
8. Search stations automatically
9. Touch to seek forward
10. Touch to change between AM/FM bands
11. Clock
12. Current preset radio station
13. Current radio information
14. AF: Alternative Frequency indicator
15. TA: Traffic Announcement indicator
16. RDS setting options
17. Save the desired radio station
18. Touch to change between Local and Distance
19. Enter frequency directly
20. Touch for quick access to Audio level settings



Select Radio as Playing Source

Open the Source Menu and then touch [Radio].

Select One Radio Band

Touch the [📶] icon on the user interface to select one radio band among FM1, FM2, FM3, AM1 and AM2.

Tune

Auto Tuning

Touch and hold [⏮] / [⏭] icon on the user interface more than 1 second to seek a higher / lower station.

To stop searching, repeat the operation above or press other keys having radio functions.

Note:

When a station is received, searching stops and the station is played.

Manual Tuning

Method 1:

During manual tuning, the frequency will be changed in steps.

Touch the [⏮] / [⏭] icon on the user interface to tune in a higher / lower station.

Method 2:

1. Touch the numeric keypad icon [🔢]. Numeric keyboard is displayed, touch number to input frequency.
2. Touch [✖] to delete the input number step by step.
3. Touch [OK] to enter.



Radio Mode

Preset Station

The unit has 5 bands, such as FM1, FM2, FM3, AM1, AM2, and each band can store 6 stations; hence the unit can store 30 stations in total.

Search Stations Automatically

Touch [🔍] to search station and store 6 strongest stations in current band automatically.

Manual Store

1. Tune to a station.
2. Touch [📁].
3. Touch one of the channels P1 to P6 to save the select band.

Tune to a Preset Station

1. Touch [Radio].
2. Select a band (if needed).
3. Touch one of the preset channels (P1 to P6) on the screen.



Local Seeking

Touch the [📶] icon and choose the Radio Local or Distance.

When the [📶] icon turns bright, only stations with a strong signal strength will be detected. Default is "Distance".

Audio Selection

Press the [🔊] icon and enter the Audio setup.

Radio Mode

RDS Basics

RDS transmits data to the radio which displays information such as station identification, song artist, and song title.



RDS service availability varies with areas. Please understand if RDS service is not available in your area, the following service is not available.

Adjust RDS Settings

1. In Radio menu, touch [].

The option menu is displayed.

2. Touch on the selected option to change the setting.

- [RDS]: To turn on or off “RDS” function.
- [CT]: To turn on or off “Clock Time” synchronization function.
- [EON]: To turn on or off “EON” function.
- [TA]: To turn on or off “TA” function.
- [PTY]: To show PTY list.
- [VOL]: Touch [] / [] to adjust TA volume.



RDS (Radio Data System)

The unit provides basic functions of RDS.

RDS service availability varies with areas. Please understand if RDS service is not available in your area, the following service is not available.

AF Function

Alternative Frequencies Lists are used for the same program service and used in conjunction with the PI code (Program Identification code) to assist automatic tuning.

Using this information, a radio can automatically search out another station that is playing the same material. This is useful when the station you are listening to is fading out.

Note:

- During auto switching radio frequency, some interference may be heard.
- Turning off AF function can settle this problem.

EON (Enhanced Other Networks)

When EON data is received, the EON indicator lights and the TA and AF functions are enhanced.

TA: Traffic information can be received from the current station or stations in other network.

AF: The frequency list of preset RDS stations is updated by EON data. EON enables the radio to make fuller use of RDS information. It constantly updates the AF list of preset stations, including the one that currently tuned into. If you preset a station around the area at your home, you will later be able to receive the same station at an alternative frequency, or any other station serving the same program, EON also keeps track of locally available TP stations for quick reception.

TA Function

The TA (Traffic Announcement flag) function lets the unit receive traffic announcements automatically no matter what media source is playing back. The TA function can be activated by a TP (Traffic Program) station broadcasting traffic information.

When TA is activated and a traffic announcement is received, the current playing source will be overridden by the traffic announcement if the current radio band is FM, indicating that the unit is

Radio Mode

waiting for traffic announcements.

The unit returns to the original source after the traffic announcement has been received.

CT (Clock Time)

Some stations broadcast the time and date within the encoded RDS signal. The clock time is automatically adjusted when 'CT' is set to 'ON'.

PTY Function

PTY is the abbreviation for Program Type which is a code defining the type of program being broadcast (e.g. News or Rock).

Then PTY options will display on the screen. To view more PTY options, touch the scroll bar and arrows on the screen.

When one PTY option is touched (e.g. News), auto search for next available PTY by increasing tuning frequency until the PTY of the next station matches the current. If no matched PTY has been found, the unit will return to the original radio frequency.

Playback Mode

Load/eject

You can play video, audio or images stored on the following discs:

- DVD Video, DVD-R, DVD-RW
- VCD
- Audio CD, CD-R, CD-RW

Note:

Ensure that the disc contains playable content.

Eject a Disc

Press the [Δ] key on the front panel to eject the disc. When the disc is ejected, the unit switches to the previous source.

Touchscreen Controls

The touch key areas for DVD playback are outlined below:

- A: Return to the main menu
- B: Play the video and display playback information
- C: Display onscreen control menu
- D: Time display

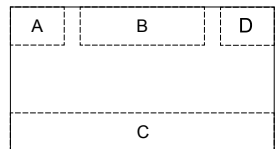

Controlling Playback

To access the on-screen controls, touch the screen except upper left corner, and touch again to cancel display. Touch [$\bullet\bullet\bullet\bullet$] to view all function icons.



Connect a USB Device

1. Open the USB door.
2. Insert the small end of the USB cable to the 3.5 jack and USB socket, then connect the other end of the cable to your USB device.

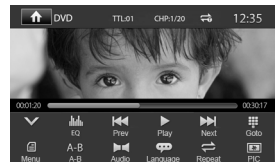

Remove a USB Device

1. Select other source on the main menu.
2. Remove the USB device.

Insert/Remove a SD Card

- Insert
 1. Open SD card cover.
 2. Insert the SD card into the SD card slot.
Play starts automatically.
- Remove
 1. Select other source on the main menu.
 2. Press the card unit you hear a click sound.
 3. Remove the SD card.

Play/Pause

1. Once a disc, USB or SD card is inserted, play starts automatically.
For DVD movie, if a menu appears, press [\blacktriangleright] to start play.

Playback Mode

- To pause, touch [⏸].
To resume play, touch [▶].
- Skip to previous / next track / chapter, press [⏮] / [⏭] key.

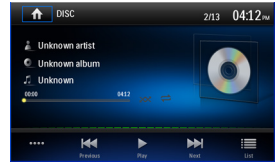

Previous/Next

Touch [⏮] / [⏭] key on the screen to skip to previous / next track / chapter.

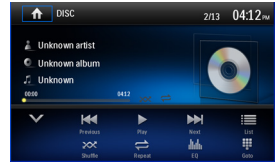

Search for a Folder

For Video Files

- Touch [📁] to display all available video folders.
- Touch a folder, then touch the desired file.
- Touch the file again to start play.

For Audio Files

- Touch [🎵] to display all available audio folders.
- Touch a folder, then touch the desired file.
- Touch the file again to start play.

For Picture Files

- Touch [🖼️] to display all available picture folders.
- Touch a folder, then touch the desired file.
- Touch the file again to start play.



For Folder Control

- Touch [📁] to display all available folders.
- Touch a folder, then touch the desired file.
- Touch the file again to start play.

Repeat

For DVD/VCD movie disc:

- Touch bottom half of the screen to display menu on the screen, if necessary.
- Touch [⋮] to display the 2nd menu.
- Touch [↺] repeatedly to select:

DVD

- [↺] Repeat chapter: Play the current chapter repeatedly.
- [↺] Repeat title: Play all chapters in the title repeatedly.
- [↺] Repeat all: Play all in the disc repeatedly.
- [↺] Repeat off: Cancel repeat play.

VCD

- [↺] Repeat single: Play the current single repeatedly.
- [↺] Repeat all: Play all in the disc repeatedly.
- [↺] Repeat off: cancel repeat play.

Playback Mode

For CD/MP3 files:

1. Touch anywhere except the upper left corner to display menu on the screen, if necessary.
2. Touch [↺] repeatedly:
 - [↺] Repeat single: Play the current single repeatedly.
 - [↺] Repeat all: Play all the tracks repeatedly.
 - [↺] Repeat off: Cancel repeat play.

Repeat A-B

You can repeat a specific of video file (repeat A-B).

1. Touch the screen to display control menu, if necessary.
2. Touch [••••] to display the 2nd menu, if necessary.
3. Touch [A-B] repeatedly to mark:
 - Repeat A-: the start of the section to repeat.
 - Repeat A-B: the end of the section to repeat.The selected section plays repeatedly.
4. To exit A-B repeat mode, touch A-B repeatedly, [Repeat A-B off] is displayed.

Shuffle (Random) Play

You can play audio tracks/files in random order.

1. Touch the screen to display control menu, if necessary.
2. Touch [••••] to display the 2nd menu, if necessary.
3. Touch [↻] on the screen repeatedly to turn random play on or off.

Select Audio Mode

When you play VCDs, you can select an audio mode (R/L/Stereo).

1. During play, touch bottom half of the screen to display menu on the screen, if necessary.
2. Touch [••••] to display the 2nd menu.
 - Touch [▶◀] repeatedly until the audio mode is selected.

Select Subtitle Language

For DVD or Divx discs that contain two or more subtitle languages.

1. During play, touch the screen to display menu on the screen, if necessary.
2. Touch [••••] to display the 2nd menu.
3. Touch [☺☺] repeatedly to select a language.
 - The selected language is displayed.

Video Setup

Touch [⊛] to access video setup mode, touch [⊕] or [⊖] to set the desired effect.

You may set the brightness, contrast, saturation, and hue of the video output from 1 to 20.



Playback Mode

Playback Information

Touch the screen when playing back DVD and VCD discs and the playback information will be displayed on the top area of the TFT.

For DVD

1. Disc type.
2. DVD Title information. "01/08" indicates that this DVD has 8 titles and the title playing back now is the first title.
3. DVD Chapter information. "005/012" indicates that current title has 12 chapters and the chapter playing back now is the fifth chapter.

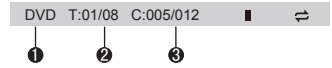

For VCD

1. Disc type.
2. VCD Track information. "01/08" indicates that this VCD has 8 tracks and the track playing back now is the first track.

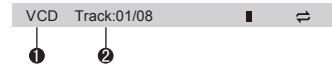

Elapsed Time

1. Elapsed time of the current track.
2. Total time of the current track.



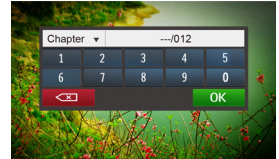

Direct Track Entry

To select a track directly, touch the [] icon on screen control to display the direct entry menu. Enter the desired track using the on-screen number pad. Press [OK] to the selected track.





Rotate Pictures

1. When you view pictures, touch the screen to display menu on the screen, if necessary.
2. Touch [] to display the 2nd menu.
3. Touch [] repeatedly to rotate the picture.

Zoom

You can zoom in pictures for a close view.

1. When you view pictures, touch the screen to display menu on the screen, if necessary.
2. Touch [] to display the 2nd menu.
3. Touch [] repeatedly to zoom in the picture.

Bluetooth Mode

You can make or receive phone calls with Bluetooth-enabled phones through the unit. You can also listen to music from a Bluetooth-enabled device.

Pair a Bluetooth Device

To connect your Bluetooth device to the unit, you need to pair the device to the unit. Pairing needs only to be done once. You can pair up to five devices. You also can search for Bluetooth devices by mobile phone.

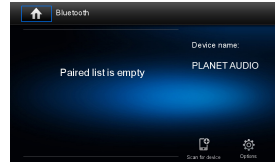

1. Turn on the Bluetooth function on the device.
2. Touch [] to search for Bluetooth device with the device.
3. Select the Bluetooth device ID in the pairing list.
4. Enter default password "0000".

Tip:

- The operational range between this unit and a Bluetooth device is approximately 16 ft (5m) .
- Before you connect a Bluetooth device to this unit, familiarize yourself with the Bluetooth capabilities of the device.
- Compatibility with all Bluetooth device is not guaranteed.
- Any obstacle between this unit and a Bluetooth device can reduce the operational range.
- Keep this unit away from any other electronic device that may cause interference.

Disconnect Bluetooth Device

To disconnect one device, touch [] .

Tip

- The device will also be disconnected when the device is moved beyond the operational range.
- If you want to reconnect the device to the unit, place it within the operational range.
- If you do not want to reconnect the device to the unit automatically, touch [], then set [Auto connect] to [Off] .
For details, see the "Adjust Bluetooth Settings" section.



Make a Call

1. Select Bluetooth function in the home menu.
2. Pair the phone with the unit.
3. Search for phone number from the following list:
 - [Phone Book]
 - [Call Log]
 - [Missed calls]
 - [Received calls]
 - [Dialed calls]

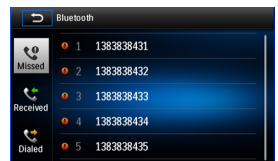

Or touch the number pad directly, then touch [] to dial.

Bluetooth Mode

Receive a Call

By default, all incoming calls are received automatically.

1. If there is an incoming call, the screen will appear "Incoming".
2. You may touch the screen to select [Hang up] or [Answer].
Speak into the Bluetooth microphone.

Tip

- You can select to receive calls manually by set [Auto answer] to [Off] status.

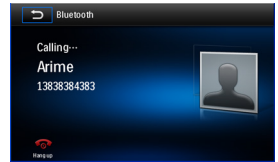
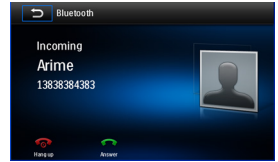

Adjust Bluetooth Settings

1. In Bluetooth menu, touch [].
The option menu is displayed.
2. Touch on the selected option to change the setting.
 - [Bluetooth]: To turn on or off "Bluetooth" function.
 - [Auto connect]: To turn on or off "Auto connect" function.
 - [Auto answer]: To turn on or off "Auto answer" function.
 - [Pairing code]: To set pairing code.
 - [Phone book sync]: To synchronize phone book, touch [OK] on the sub-menu popped out.

Phonebook sync may take several minutes to load on initial setup.

Tip

- You can also adjust Bluetooth settings in the "Settings" menu.

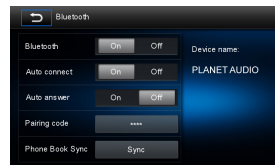

Music Mode

A2DP

A2DP is short for Advanced Audio Distribution Profile. The mobile phones supporting this function can transmit stereo audio, whereas the ones not supporting this function can transmit mono audio only.

AVRCP

AVRCP is short for Audio/Video Remote Control Profile. The mobile phones supporting this function can control the playback of a Bluetooth audio player.

In the mode of the music player working, if you want to make a phone call, you can press the number keys on the mobile phone. At the same time the music player will stop. The TFT screen will display "Calling", after the call received, the voice will be transferred to the unit. When the call ends, the screen will display music playing menu.

If there is an incoming phone call, the music player will stop, and the screen will display "Incoming". When the call ends, the screen will display music playing menu.

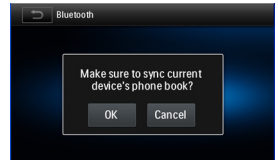

Settings

Display System

1. Touch the upper left corner to display main menu.
2. Touch [Settings].
The settings menu is displayed.

Adjust General Settings

1. Touch [General], if necessary.
2. Touch to highlight a setting.
3. Touch on the option to display/select an option.
4. Touch blank area of the screen to exit.

General settings	Options	Description
Radio region	USA	Select one that matches your location.
	China	
	Japan	
	Europe	
	Europe (LW)	
	OIRT	
Radio range	Local	
	Distance	
Blackout	Off/10s/20s	
Dimmer mode	Night/Dark/Normal/Brightness	Adjust the display brightness.
Beep	On	Turn on the beep sound. Each time you press a button, the unit beeps.
	Off	Turn off the beep sound.
Calibration	Start	Calibrate the touch screen.

Calibration

When the touch operation is not sensitive or valid, you should calibrate the touch screen through calibration setting function. Adjust the response positions of the touch panel as followings:

1. Press the [Calibration] option on the setup menu to enter.
2. Touch [Start] to enter.
3. Press and hold the center of [+] for 2 seconds, the [+] will move automatically.
4. Aim at center of [+], follow the path as shown of the figure, after steps from 1 to 5, the system will exit calibrating automatically.

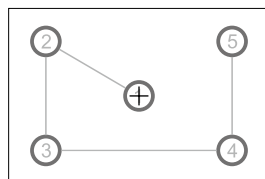

Adjust Video Settings

1. Touch [Video].
2. Touch an option repeatedly to select:
3. Touch blank area of the screen to exit.

Video settings	Options	Description
Parking	On	Enable video
	Off	Disable video

When in Park “On” mode, the screen will display “WARNING” [if you play the video disc]. The above warning screen will prevent the driver watching images.

Settings

Adjust SUB settings

1. Touch [SUB].
2. Touch an option repeatedly to select:
3. Touch blank area of the screen to exit.

Sound settings	Options	Description
Subwoofer	On	Turn on the subwoofer.
	Off	Turn off the subwoofer
Subwoofer filter	80Hz	Select subwoofer filter criteria.
	120Hz	
	160Hz	

Adjust Time Settings

1. Touch [Time].
2. Touch an option repeatedly to select:
3. Touch blank area of the screen to exit.

Time settings	Options	Description
Date	Y/M/D	Touch [▲] or [▼] to set year, month and day.
Clock mode	12Hr/24Hr	Touch [12Hr] or [24Hr] to switch clock mode.
Time	H / S / A M / PM	Touch [▲] or [▼] to set hour and minute.
		Touch [▲] or [▼] to set AM/PM (only for 12Hr).

Adjust Language Settings

1. Touch [Language].
2. Touch an option repeatedly to select.
3. Touch blank area of the screen to exit.

Language settings	Description
OSD	Select on-screen display language.
DVD audio	Select DVD audio language. Options available depend on DVD disc.
DVD subtitle	Select DVD subtitle language. Options available depend on DVD disc.
Disc menu	Select DVD menu language. Options available depend on DVD disc.

Adjust Bluetooth Settings

1. Touch [Bluetooth].
2. Touch an option repeatedly to select.
3. Touch blank area of the screen to exit.

Bluetooth settings	Options	Description
Bluetooth	On	Turn on the Bluetooth function.
	Off	Turn off the Bluetooth function.
Auto connect	On	If the pre-paired device is within the effective range, the unit re-connects to pre-paired device automatically.
	Off	Need to re-connect manually.
Auto answer	On	Answer paired phone call automatically.
	Off	Answer phone call manually.
Pairing code		Set the password for pairing the unit with other Bluetooth device.

Settings

Adjust Disc Rating

1. Touch [Disc].
2. Touch an option repeatedly to select.
3. Touch blank area of the screen to exit.

DVD rating	Options	Description
Set password	Set password to restrict the play of discs. The default password is 0000.	
Rating level	Kid safe	Acceptable for children.
	G	Acceptable for general viewers.
	PG	Parental guidance suggested.
	PG-13	Unsuitable for children under age 13.
	PG-R	Recommend parents to restrict children under 17 to view.
	R	Restricted recommend parents to guide children under 17 to view.
	NC-17	Unsuitable for children under age 17.
Adult	Acceptable for adults only.	
DRC	On/Off	Dynamic range compression on or off.
Load factory	Restore to default settings.	

Adjust Volume Settings

You can set different volume for different modes.

1. Touch [Volume].
The volume setting sub-menu is displayed.
2. Touch on a source.
[Disc] [Bluetooth]
[USB] [A/V Front]
[SD] [A/V Rear]
[Radio] [Navigation]
3. Touch [▲] or [▼] to assign value: 0 to 12.
When switching to the source, the volume increases automatically.
4. Touch blank area of the screen to exit.

Other Modes

Listen to Other Devices

You can connect an external audio/video device to the unit.

1. Connect the external device with the supplied AV cable.
2. Touch the upper left corner to display the main menu.
3. Touch [A/V Front] or [A/V Rear] to access external device.

Reset

When the unit hangs up, you can reset it.

Press [RESET] with a ball-point pen or similar tool.

Tip

When the unit has been reset, all the settings will return to default settings.

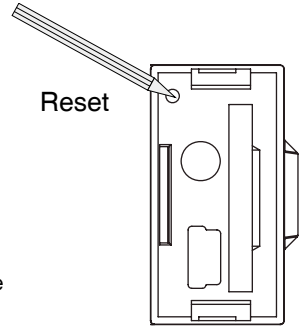

Replace a Fuse

If there is no power, the fuse may be damaged and need to be replaced.

1. Take out the unit from dashpboard.
2. Check all electrical connections.
3. Buy a fuse that matches the amperage of the damaged fuse.
4. Replace the fuse while the units power is disconnected.

GPS

1. Touch the upper left corner to display home menu.
2. Touch [NAVI], the navigation menu will display.
3. Refer to the map manual to operate the navigation tool.

Steering Wheel Control Programming

1. Touch the upper left corner to display home menu.
2. Touch [SWC], the SWC menu will display.
3. Adjust each key with a individual function.
3. Touch [Pair] to program.
4. Press each individual steering wheel control button for each corresponding function.
5. Once the final steering wheel control button is programmed, the functions are saved and the programming will end.
6. Touch [Reset] to reset the programming.

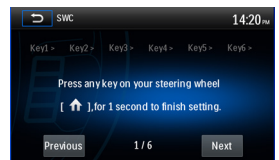
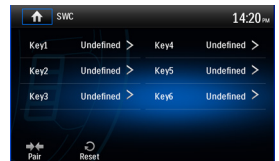

Specifications

General

Reference Supply Voltage.....	12V(DC)
Operating Voltage Range.....	10.5 - 15.8V(DC)
Max Operating Current.....	15A
Grounding System.....	Negative
Dimensions(WXHXD).....	7.0X4.0X6.5inch
Weight(main unit).....	1.9kg

FM

Signal Noise Ratio.....	≥55dB
Residual Noise Sensitivity (S/N=30dB).....	18dBμV
Frequency Response (±3dB).....	20Hz~12.5KHz
Station Seeking Level.....	20~28dBμV
Distortion.....	≤1.0%
Stereo Separation (1KHz).....	≥25dB
Antenna Impedance.....	75Ω

AM

Residual Noise Sensitivity (S/N=20dB).....	30dBμV
Selectivity (±9KHz).....	≥50dB

Screen

Screen size.....	6.2 inches(16:9)
Display resolution.....	800X480

DVD Player

S/N Ratio.....	80dB
THD+N.....	≤0.1%
Frequency Response (±3dB).....	20Hz~20KHz
Maximum Output Power.....	4x80W
Load Impedance.....	4Ω

AUX IN

Distortion.....	≤0.5%
Frequency Response (±3dB).....	20Hz~20KHz
Audio Input Level.....	0.5Vrms

Preout

Output Impedance.....	100Ω
Output Level.....	2V

Video

Normal Video Input Level (CVBS).....	1.0±0.2V
Video Input Impedance.....	75Ω
Video Output Impedance.....	75Ω
Video Output Level.....	1.0±0.2V

Environment

Operating Temperature.....	14°F ~ 140°F(-10°C ~ +60°C)
Storing Temperature.....	4°F ~ 158°F(-20°C ~ +70°C)
Operating Humidity.....	45%~80%RH
Storing Humidity.....	30%~90%RH

Notice:

When the unit is operated to extremes, such as with maximum power output for a long time, or the temperature is over 158°F, it will enter heat protection mode, the volume will be reduced automatically. This is normal.

Specifications

Supported Formats:

- USB or memory file format: FAT32
- MP3 bit rate(date rate): 32-320 Kbps and VBR (Variable Bit Rate)
- Directory nesting up to a maximum of 8 levels
- Number of albums/folders: 99 (Max)
- Number of tracks/titles: 999 (Max)
- ID3 tag v2.0 or later
- File name in Unicode UTF8(maximum length:128 bytes)

Unsupported Formats:

- Empty albums:an empty album is an album that does not contain MP3 files,and is not be shown in the display.
- Unsupported file formats are skipped.For example,Word documents(.doc) or Mp3 files with extension.dlf are ignored and not played.
- AAC,WMV,PCM audio files

Supported MP3 Disc Format:

- ISO9660,Joliet
- Maximum title number: 512(depending on file name length)
- Maximum album number: 255
- Supported sampling frequencies: 32kHz,44.1kHz,48kHz
- Supported Bit-rates: 32-320Kbps and variable bit rate

Supported Video Formats:

- DVD
- MP4
- Xvid (optional)

Region Code

According to DVD sale region, the whole world is divided into six regions. A DVD disc can be played back only when its region code is compatible with that of the player in use.

Region 1: USA, Canada, East Pacific Ocean Islands;

Region 2: Japan, West Europe, North Europe, Egypt, South Africa, Middle East;

Region 3: Taiwan of China, Hong Kong of China, South Korea, Thailand, Indonesia, South East Asia;

Region 4: Australia, New Zealand, Mid & south America, South Pacific Ocean Islands/Oceania;

Region 5: Russia, Mongolia, India, Middle Asia, East Europe, North Korea, North Africa, North West Asia;

Region 6: China, Mainland

Disc Cautions

1) DO NOT use irregular shaped disc.

2) Disc Cleaning

Use a dry, soft cloth to wipe the disc from center to edge, only neutral detergent can be used.

3) When playing a new disc

New disc may have some rough spots around the inner and outer edges. If such a disc is used, remove these rough spots with a pencil or ball-point pen, etc.

Troubleshooting

What appears to be trouble is not always serious. Please check the following points before calling a service center.

Problem	Cause	Corrective action
General		
Unit can not power on	Unit fuse blown.	Install new fuse with correct rating.
	Car battery fuse blown.	Install new fuse with correct rating.
	Illegal operation	Reset the unit.
No/low audio output	Improper audio output connection.	Check wiring and correct.
	Volume set too low.	Increase volume level.
	Speakers damaged.	Replace speakers.
	Heavily biased volume balance.	Adjust the channel balance to center position.
	Speaker wiring is in contact with metal part of car.	Insulate all speaker wiring connections.
Poor sound quality or distortion	Pirated disc is in use.	Use original disc.
	Speaker power rating does not match unit.	Replace speakers.
	Wrong connections.	Check wiring and correct.
	Speaker is shorted.	Check wiring and correct.
Unit resets itself when engine is off	Incorrect connection between ACC and BATT.	Check wiring and correct.
TFT monitor		
Warning information is shown at all times	Parking break wiring is not correct.	Check wiring and correct.
Flashing image or interference appears on screen	The color system of DVD disc does not match the monitor.	Adjust the color system of the DVD disc playing back or the monitor in use.
	Pirated disc is in use.	Use original disc.
	Video cable damaged.	Replace cables.
	Improper video signal connections.	Check wiring and correct.
Disc playback		
Cannot insert disc	A disc is already inside the unit.	Eject current disc and insert new one.
Disc does not play back	Disc is warped or scratched.	Use disc in good condition.
	Disc is dirty or wet.	Clean disc with soft cloth.
	Incompatible disc is used.	Use compatible disc.
	Disc is inserted upside down.	Insert disc with label side up.
	Disc region code is not compatible with unit.	Use disc with proper region code.
PBC cannot be used during VCD playback	PBC is not available on the disc.	Use disc with PBC available.
Repeat or search function is invalid during VCD playback	PBC is on.	Turn PBC off.
Error messages		
No disc	Disc is dirty.	Clean disc with soft cloth.
	Disc is upside down.	Insert disc with label side up.
	No disc inside.	Insert disc.
Bad disc	Disc is dirty.	Clean disc with soft cloth.
	Disc is upside down.	Insert disc with label side up.
Unknown disc	Disc format is not compatible with this unit.	Use disc with compatible format.
Region Error	DVD region code is not compatible with this unit.	Use disc with compatible region code.

Wire Connections

