



Pit Pal Products

OUTFITTING GARAGES, SHOPS & TRAILERS FOR OVER 30 YEARS
 UNIVERSAL ALUMINUM PRODUCTS TO ORGANIZE ANY SPACE
 WE MAKE A PLACE FOR EVERYTHING!

About Us

Back in the late 70's, two high school friends would rather spend late nights in the garage working on their race cars than going to the local disco. This desire, this passion for racing drove them to fabricate their own race cars (S&D Race Cars) and travel across the country racing competitively. Dealing with the common inconveniences of daily racing life, this dynamic duo started creating solutions. The products they developed became popular with fellow racers and enthusiasts alike. Pit Pal™ Products was born.

Slowly, the focus shifted away from race car building as demand exploded for the Pit Pal™ Product line. Disco died, but hard work, desire and innovative ideas helped to launch a very successful business that fulfilled the common need for racers and enthusiasts to get organized. Fast-forward 37 years and Pit Pal™ Products manufactures over 500 products, has a worldwide distribution network, and is still pushing the envelope to develop, design and produce the best products for you, our customers.

Whether you have a trailer, garage, shop, office, or home, it is essential to have a functionally organized environment. Since our introduction, we have manufactured top-of-the-line aluminum products, untouched by our competitors. Enthusiasts in the industry have come to know our products and ask for us by name. We manufacture products for everyone including race teams, trailer manufacturers, fabrication and speed shops, home builders and distributors, right here in the USA.



ACCESS DOORS	24
BRACKETS & HANGERS	7-8
CABINETS	2-3
CHOCKS	14
CIRCLE TRACK PRODUCTS	20
DISPLAY STANDS & HERO CARDS	24
ENGINE & TRANSMISSION	19
FUEL STORAGE	13
HARDWARE & ACCESSORIES	24
HELMET SHELVES	4
HOLDERS	9-10
JACK STORAGE	14
JUNIOR DRAGSTER PRODUCTS	23
KARTING PRODUCTS	21
LIGHTING	17
RACEDECK FLOORING	26
RAMPS	16
RATCHET STRAPS	25
REELCRAFT HOSE REELS	26
SHELVES	5-6
SINKS & WASHING STATIONS	23
SNOWMOBILING PRODUCTS	22
STEPS	17
TABLES	11
TIRE STORAGE	15
TOW STRAPS	25
TRAYS & CADDIES	12
VINYL STRIP DOORS	18

GET ORGANIZED



ORGANIZATION PRODUCTS FOR YOUR GARAGE, SHOP AND TRAILER

Home of the *Original Door Cabinet*

Trailer Door or Garage Wall Cabinets

Original DOOR/WALL CABINET
Part# 320



- Store aerosol cans & oil quarts
- Fold down tray with locking pin
- Tray has 40LB weight capacity
- Dual paper towel holder

OUR FIRST PRODUCT IN 1982!

DELUXE DOOR/WALL CABINET
Part# 320A



- Deeper storage shelves
- Fold down tray with locking pin
- Tray has 40LB weight capacity
- Dual paper towel holder
- Slim profile with tray upright

BEST SELLER

MEDIUM DOOR/WALL CABINET
Part# 323



GREAT FOR NARROW SPACES

- Store aerosol cans & oil quarts
- Paper towel holder
- Fold down tray with locking pin
- Tray has 40LB weight capacity

DELUXE MEDIUM DOOR/WALL CABINET
Part# 323D



- Store aerosol cans & oil quarts
- Deeper storage shelves
- Fold down tray with locking pin
- Tray has 40LB weight capacity
- Paper towel holder
- Slim profile with tray upright

SHORT STACK DOOR/WALL CABINET
Part# 320SS



- Store aerosol cans & oil quarts
- Fold down tray with locking pin
- Tray has 40LB weight capacity
- Dual paper towel holder

JUNIOR DOOR/WALL CABINET
Part# 321



- Storage shelves
- Paper towel holder
- Fold down tray with locking pin
- Tray has 40LB weight capacity

DELUXE JUNIOR DOOR/WALL CABINET
Part# 321D



- Deeper lower shelf
- Fold down tray with locking pin
- Tray has 40LB weight capacity
- Paper towel holder
- Slim profile with tray upright

OIL STORAGE CABINET
Part# 310



STORE YOUR OIL PRODUCTS IN ONE SPOT

- Stores 8 aerosol cans
- Stores 24 quarts of oil

NARROW OIL STORAGE CABINET
Part# 310N



NEW

OIL CABINET FOR NARROW SPACES

- Stores 6 aerosol cans
- Stores 6 quarts of oil each on lower shelves
- Bottom shelf fits gallon containers

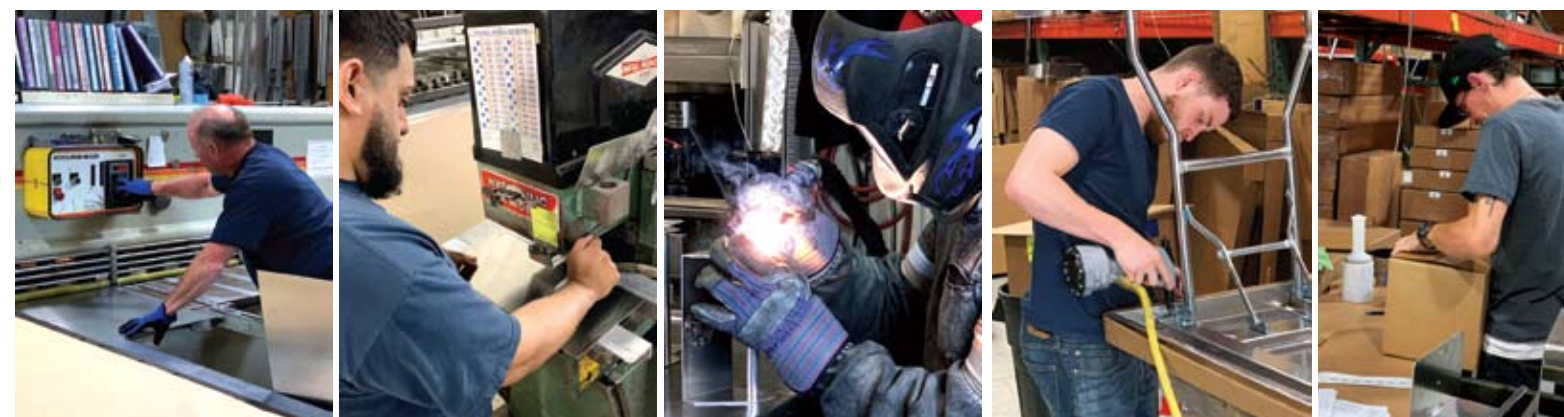

ALL PIT PAL PRODUCTS ARE HAND WELDED AND FABRICATED IN ZION, ILLINOIS. HUNDREDS OF HIGH QUALITY ALUMINUM STORAGE AND ORGANIZATION SOLUTIONS TO OUTFIT ANY SPACE. OUR PRODUCT LINE IS VERSATILE, IT'S NOT JUST FOR TRAILERS AND RACING. FROM HOME ORGANIZATION TO BUSINESS AND WAREHOUSE STORAGE, WE MAKE A PLACE FOR EVERYTHING. LIGHTWEIGHT AND DURABLE OUR PRODUCTS WILL LAST A LIFETIME. GET ORGANIZED!



CUSTOM PRODUCTS



BUILD A NEW CUSTOM PRODUCT FROM AN IDEA OR A SKETCH OR MODIFY AN EXISTING PRODUCT.
CALL & TALK TO OUR CUSTOM FABRICATORS TODAY!

- ADD OR SUBTRACT WIDTH, HEIGHT OR DEPTH
- ADD MORE OR LESS SHELVES



Trailex Fuel Jug Rack with Locking Bar

Gear Case Rack

ON THE ROAD



Look for us on the road all year! Our trailer will be loaded with quality products to get your trailer or garage looking its best. Talk to our professional sales staff for suggestions on how to organize your shop, trailer or garage the way you imagine it. Save on shipping charges. Purchase your Pit Pal Products at an event. Pre-paid orders are easy too, give us a call to place your order and make pickup arrangements at an event we are attending near you.

FREE FLOW SELF DRAINING TILES
Part# IFF-4
 Ideal choice for wet, muddy, and snowy climates. Allows for maximum air-flow and drainage.



Also available in 18" x 18"

DIAMOND TILE
Part# RD-1
 The original diamond tread garage flooring system. Available with TuffShield® - Super strong high gloss finish.





TUFFSHIELD HIGH GLOSS FINISH
Part# TS-1

Also available in 18" x 18"

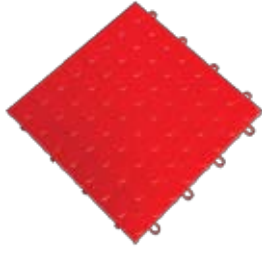
CIRCLETRAC
Part# CT-1
 Coin-top tread delivers not only a great-looking floor, but also added slip resistance.



- Modular flooring for garages, race teams, vendor booths
- Durable interlocking flooring
- 12" x 12" snap-fit tiles .5" Thick
- Easy installation; no glue or tools
- Not affected by chemicals, grease, brake fluid, antifreeze or sunlight
- Protective barrier between you and the elements
- Portable and lightweight for convenient transporting
- Made in the USA



MALE 3" BEVELED CORNER
Part# E3MC



MALE 3" BEVELED EDGE
Part# EDG-3M



FEMALE 3" BEVELED CORNER
Part# E3FC



FEMALE 3" BEVELED EDGE
Part# EDG-3F

Male Corner Female Edge



COMBO STORAGE CABINET
Part# 325



ULTIMATE STORAGE UNIT FOR GARAGES & TRAILERS

- Stores 8 aerosol cans
- Stores 8 quarts of oil or cleaners
- Bottom shelf fits gallon containers, hand cleaners, anti-freeze, windshield solvents

22"W x 36"H x 8.5"D

3 SHELF AEROSOL CABINET
Part# 335



• Stores up to 24 aerosol cans
 22"W x 32"H x 4.25"D

LUBRICANTS, PAINTS, CLEANERS & MORE!

NARROW 3 SHELF AEROSOL CABINET
Part# 335N



• Stores up to 18 aerosol cans
 16.5"W x 32"H x 4.25"D

ALUMINUM CHANNEL KIT
With 16 Rivets Part# 319
With 20 Screws Part# 319S

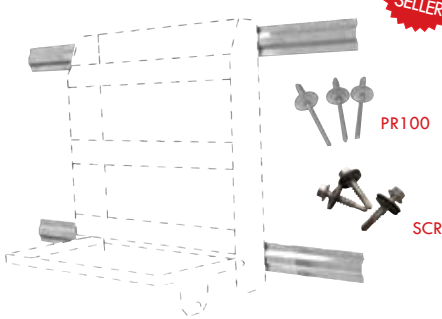

16 Rivets Part# PR100
20 Screws Part# SCR

Trailer doors do not have studs for mounting. Install our channel kit to the outer door frame with support rivets or screws. Once in place, products mount to channels creating no added stress to your doors surface.

48"W x 3.25"H 2 Pieces

24 QUART OIL CABINET
Part# 329



- Stores up to 24 oil quarts
- Fits spray bottle cleaners
- Ideal storage for any garage or trailer supplies

31"W x 18"H x 6"D

AEROSOL & OIL CABINET
Part# 1112



- Stores up to 11 aerosol cans on top shelf
- Stores up to 12 oil quarts on the bottom shelf

31"W x 16"H x 6"D

DETAILER'S CABINET
Part# 395



STORAGE CABINET FOR ALL YOUR DETAILING PRODUCTS

- A cabinet to store your aerosol cans, cleaners and tubs.

16.5"W x 36"H x 6.25"D

REELCRAFT HOSE REELS

REELCRAFT REELTEK HYBRID WHEEL
Part# RT650-OLP



Spring driven hose reel with a 3/8" diameter 50 ft. hose and 300 PSI capacity. Hybrid reel is lightweight, corrosion resistant, heavy duty and easy to maintain.

BEST SELLER

REELCRAFT SPRING RETRACTABLE HOSE REEL
Part# 4425-OLP



All Handle up to 300 PSI. 1/4" ID Hose 25' hose / 20lb Reel

3/8" ID 50 FEET
Part# 5650-OLP

REELCRAFT ELECTRIC CORD REEL
Part# L4050-163-3



Helps to eliminate tangled electrical cords. Automatic spring retraction quickly rewinds cords, keeps it out of the way when not in use. Each component is coated with a durable baked on powder coat finish. 50 feet.

REELCRAFT LED HAND LAMP
Part# L4035-163-10



Two ultra high intensity 4-watt LEDs; single 3-watt end spot light. Polycarbonate shatter resistant light tube. In-line tool tap, NEMA 5-15R configuration maximum 12 Amp draw. 50 feet.

REELCRAFT GARDEN HOSE REEL
Part# 7850-OLP-SW57



Retracts for hands free hose reeling. This professional grade steel construction hose reel is ideal for water applications that require maximum performance. Reel include 1/2" x 50 feet of highly visible hose. Male garden hose fitting on hose end, inlet is 3/4" NPT female.

- Air, water & electric reels
- Long lasting, durable
- Widely used in automotive service, construction, manufacturing shops, fire departments, etc.
- Made in the USA
- Many models to choose from
- Ships from manufacturer. Allow 2-3 weeks



JUNIOR COMBO CABINET
Part# 625



- Top shelf stores aerosol cans or bottles
- Bottom shelf stores gallon containers, hand cleaners, anti-freeze, windshield solvents

18"W x 24"H x 8.5"D

JUNIOR OIL CABINET
Part# 313



- For smaller spaces
- Stores up to 12 quarts of oil

16"W x 18"H x 5.5"D

JUNIOR OIL & AEROSOL CABINET
Part# 425



- Top shelf stores 6 aerosol cans
- Bottom shelf stores 6 quarts of oil

16.25"W x 16"H x 5.5"D

DON'T FORGET SCREWS & RIVETS FOR MOUNTING IN YOUR TRAILER! RIVETS #PR100 SCREWS #SCR

1 BAY HELMET SHELF

Part# 330



- Safe place for your helmet & gear
 - Hang your race wear, protective clothing or jackets on built-in underside garment hanger
- 14.25"W x 12"H x 15"D

1 BAY HELMET SHELF DELUXE

Part# 330D



- Safe place for your helmet
 - Extra storage shelf for gloves, shoes & race gear
 - Hang your race wear, protective clothing or jackets on built-in underside garment hanger
 - Removable tube on the front for hanging additional items
- 14.25"W x 12"H x 15"D

2 BAY HELMET SHELF

Part# 331

BEST SELLER



- Safe place for two helmets & gear
 - Hang your race wear, protective clothing or jackets on built-in underside garment hanger
- 28.5"W x 12"H x 15"D

2 BAY HELMET SHELF DELUXE

Part# 331D

BEST SELLER



- Safe place for your helmets
 - Extra storage shelf for gloves, shoes & race gear
 - Hang your race wear, protective clothing or jackets on built-in underside garment hanger
 - Removable tube on the front for hanging additional items
- 28.5"W x 12"H x 15"D

3 BAY HELMET SHELF

Part# 332



- Safe place for three helmets & gear
 - Hang your race wear, protective clothing or jackets on two built-in underside garment hangers
- 42.75"W x 12"H x 15"D

3 BAY HELMET SHELF DELUXE

Part# 332D



- Safe place for three helmets & gear
 - Extra storage shelf for gloves, shoes & race gear
 - Hang your race wear, protective clothing or jackets on two built-in underside garment hangers
 - Removable tube on the front for hanging additional items
- 42.75"W x 12"H x 15"D

HELMET HOOK

Part# HH338



- Heavy duty unique construction provides for a sturdy mount and an effective way to store helmets
- 2.5"W x 3.25"H x 5.75"D

GARMENT HANGER HOLDS 7

Part# 636



- Easily mounts to the wall of your trailer, garage or shop
 - Holds up to 7 garments
- 8.75"L x 6"H

ZINC PLATED E TRACK - 5' LENGTH

Part# ETH1

Horizontal E-Track makes a great adjustable hook-up point on floors, walls or ceilings. Made of 12 gauge steel, clear zinc plated.



DOUBLE END E TRACK STRAP 10' LENGTH

Part# 74116

Strap used with E or A track to adapt tie downs. Working Load Limit - 1,666LBS Breaking Strength - 5,000LBS



HOOK WITH E TRACK STRAP 10' LENGTH

Part# 74121

Strap used with E or A track to adapt tie downs. Working Load Limit - 1,666LBS Breaking Strength - 5,000LBS



RATCHET TIE DOWN W/ FIXED END HOOK - 2" STRAP X 10'L

Part# 51HK1064BL

Fixed hook attached to ratchet. This eliminates the 12" webbing on our #500C10 for an overall shorter length. Easier to access the ratchet.



NEW

TRACK STRAP - 6" LENGTH

Part# 74118

Strap used with E or A track to adapt tie downs. Working Load Limit - 1,000LBS Breaking Strength - 3,000LBS



TIRE BONNET

Part# 30RTMS - 6" LENGTH

A fast, easy way to secure your car for storage and/or transport. Heavy duty harness fits snug over the tire and clamps securely to the floor for stable transport.



E TRACK HEAVY DUTY SERIES E OR A FITTING WITH 2" O RING

Part# 10096HD

Use with E-Track or A-Track, this O-ring attaches in a snap. Use for heavy weight duty tie-downs. Work load limit 2,000LBS. Breaking strength 6,000LBS.



HD RECESSED D RING

Part# 10064

An industry standard for your trailer. 5,000LBS capacity D-ring lifts from the recess for easy use. Zinc plated for corrosion resistance.



ALUMINUM L TRACK - 50" LENGTH

Part# 74154

This sturdy aircraft quality aluminum extrusion offers versatility and durability. Mount to floor or walls, to secure straps to stud fittings. Fittings are spring loaded and snap securely into place yet can be moved to different positions quickly. Rated at 6,000LBS.



L TRACK DOUBLE STUD FITTING

Part# 74145

O-ring fitting for L-track tie down rail. The double stud mechanism locks into two holes on the track for a secure fit. Lift the end clip and insert into the track's slots. Slide until it's halfway between two slots, then release the clip to engage the lock. Working Load Limit Rated to 1,666LBS.



L TRACK SINGLE STUD FITTING WITH RING

Part# 74143

The L track single stud fitting with round ring is one of the strongest fittings available for securing into L track. This fitting can be quickly snapped into the track to provide you the anchor point you need to connect your tie down straps. Double stud fitting also available for increased strength. Load Limit Rated to 1,333LBS.



RATCHET TIE DOWN 2" X 10' LONG

Part# 500C10

Rated at 10,000LBS. H-tech fiber in superweb makes it stronger and cut-resistant. PVB coating is weather resistant.



AXLE STRAP 21" LENGTH

Part# 30AS21

Rated at 10,000LBS. A 21" strap with thick, protective sleeve. Ideal for various attachments using hook-type ends.



26" LIGHTWEIGHT STRAP TRACK

Part# LST26

26" LIGHTWEIGHT STRAP TRACK PAIR

Part# LST262

36" LIGHTWEIGHT STRAP TRACK

Part# LST38

36" LIGHTWEIGHT STRAP TRACK PAIR

Part# LST382

60" LIGHTWEIGHT STRAP TRACK

Part# LST60

60" LIGHTWEIGHT STRAP TRACK PAIR

Part# LST602



TOW STRAPS

16' SELF-RETRACTING DOUBLE HOOK TOW STRAP

Part# JBRC5060



16' SELF-RETRACTING DOUBLE HOOK TOW STRAP & TOW HOOK KIT

Part# JBRC5060TP 3/8" PIN



16' SELF-RETRACTING TOW HOOK & HOOK TOW STRAP

Part# JBRC5060T



NEW

CLIP-ON HERO CARD HOLDER

Part# 498



SINGLE TELESCOPING/COLLAPSIBLE HERO CARD HOLDER & STAND

Part# 499



FLOOR CATALOG OR MAGAZINE DISPLAY STAND

Part# 495F

50.5"H x 12"W x 13.5"D
Powder coated black.

Display your company catalog or literatures at races or trade shows. Our display stands features a header with a Lexan front to display your catalogs in. The front is open top to bottom which still allows full views of your catalog cover.



TABLE TOP CATALOG OR MAGAZINE DISPLAY STAND

Part# 495T

Natural aluminum. Display your company catalog or literatures at races or trade shows. Our display stands features a header with a Lexan front to display your catalogs in. The front is open top to bottom which still allows full views of your catalog cover.



ACCESS DOORS

SQUARE GAS FILL FLANGE

Part# 3003



ROUND GAS FILL FLANGE

Part# 3002



Bright polished flange with square or rounded corners. Gas fill hole 2.25" Diameter. Dimensions: 7.125"L x 3"D (Total Depth)

ACCESS DOOR 7.5" X 8.5"

Part# 3000



ACCESS DOOR 10" X 10"

Part# 3013



ACCESS DOOR W/ GAS FILL FLANGE 8.5"W X 7.25"H

Part# FG04



Eliminate running hoses & cords through trailer door. Easy access to cords, hoses, etc. Spring loaded hinges, key locking cylinder, outside flange, bright polished aluminum. All hardware is concealed. Lock & key assemblies included. **MADE IN THE USA**

GRAB HANDLE

Part# GB07



STREAK MASTER ULTRA GUARD TRAILER CLEANER

Part# SMUG



Leader in black streak removal and exterior stain cleaners.

HOLD BACK DOOR BRACKET

Part# HB2



SNAP PIN FOR CABINET TRAYS

Part# PIN



Replacement for missing/broken snap pins.

UTILITY HANDLE & TOOL HOLDER



KLEAR TO LAND WINDSHIELD CLEANER

Part# 8500

Removes filmy residue, road grime, bug juice, fingerprints and more.



KEY PUNCH BRACKETS

Set of 2 Part# 240
Set of 4 Part# 241



ROUND MAGNETIC PARTS TRAY

Part# 232



RECTANGLE MAGNETIC PARTS TRAY

Part# 233



POP RIVETS - 16CT

Part# PR100



SELF TAPPING SCREWS - 20CT

Part# SCR



- 6 QUART OIL SHELF 15"W x 4.375"ID Part# 309
- 12 QUART OIL SHELF 30"W x 4.375"ID Part# 311
- 24 QUART OIL SHELF 60"W x 4.375"ID Part# 312



- 3 GALLON SHELF 14"W Part# 316
- 4 GALLON SHELF 18.5"W Part# 317
- ALL SIZES 7.25"ID



- GREASE CARTRIDGE SHELF Part# 103
- 14.5"W x 2.25"D
- Holds 6 tubes.



- GEAR LUBE SHELF Part# 105
- 21.25"W x 3.5"ID
- Holds 6 bottles.



- HAND CLEANING CABINET Part# 210



- 4 ALL PURPOSE SHELF 10"W x 4.875"ID Part# 110
- 6 ALL PURPOSE SHELF 14.5"W x 4.875"ID Part# 111
- 10 ALL PURPOSE SHELF 24"W x 4.875"ID Part# 112



- STORAGE SHELF 30"W x 7.125"D Part# 504



- MEGA STORAGE SHELF 48"W x 8.5"D Part# 104



- DISPENSER SHELF 8"W x 6.125"D Part# 211
- TOWEL SHELF 7.875"W x 6.75"D Part# 212



- GOJO DISPENSER SHELF Part# 782
- 10.5"W x 7" OD
- 9.5"W x 6" ID
- Fits 1 gallon container.



- GOJO DISPENSER W/ ROLL TOWEL Part# 786
- 11.5"W x 11"H x 7.25"D (Shelf Depth 6.25")
- Great for a cleaning station in your shop, garage or trailer!



- UNIVERSAL 1 SHELF WITH ROLL TOWEL Part# 362
- 10.5"H x 11.5"W x 5.75"D
- Stores spray bottles in one spot with paper towels for easy clean-ups.



HARDWARE & ACCESSORIES

- UNIVERSAL 2 SHELF WITH ROLL TOWEL Part# 363
- 17"H x 11.5"W x 6.5"D
- Store one roll of paper towel, a shelf for all purpose bottles and one box of latex gloves.



- JUNIOR UNIVERSAL SHELF Part# 463
- 22"H x 11.5"W x 6.5"D
- Store your aerosol cans, spray bottles or quarts of oil. Also holds one roll of paper towel.



- UNIVERSAL 3 SHELF Part# 364
- 30"H x 11.5"W x 6.5"D
- Stores 4 aerosol cans, a roll of paper towels, spray bottles and latex gloves. Great product for your garage, shop or trailer!



- UNIVERSAL 3 SHELF WITH TOWEL BAR Part# 365
- 33"H x 11.5"W x 6.5"D
- Stores 4 aerosol cans, a roll of paper towels, spray bottles and latex gloves. Also includes a towel bar at the bottom. Great product for your garage, shop or trailer!



DON'T FORGET SCREWS & RIVETS FOR MOUNTING IN YOUR TRAILER!

VERTICAL AEROSOL RACKS

- 6 CAN Part# V98** 32"H x 4"W
- 12 CAN Part# V99** 32"H x 7.75"W
- 18 CAN Part# V101** 32"H x 11"W
- 24 CAN Part# V100** 32"H x 14.5"W

Vertical storage rack designed to keep aerosol cans organized. Store your spray paints, cleaners, etc.

- Wall mounted
- Ideal for use in garage, shop or trailer
- Also perfect for holding cold beverages
- Useful in food truck applications for sauces and containers



TOOL BOX TRAY WITH SHELF
Part# 127

28"W x 18"H x 13.5"D



REPAIR MANUAL/BOOKSHELF
Part# 3315

Keep shop manuals, books and data sheets off the work bench and organized. Slotted sliding bookend keeps books upright.



24"W x 13.5"D x 12"H
Top Shelf ID 11.5"D
Bottom Shelf ID 12.5"D

12 CAN HORIZONTAL TABLE RACK
Part# 108

TABLE TOP

22"L x 8"H x 9"D



MAGAZINE/LOG BOOK HOLDER
Part# 308

11.125"W x 2.5"D x 12"H



Holds your favorite racing magazines or your log books/clipboards. **NEW Deeper back pocket.**

SPRAY BOTTLE HOLDER HORIZONTAL

- 2 BOTTLE Part# H20**
- 3 BOTTLE Part# H30**

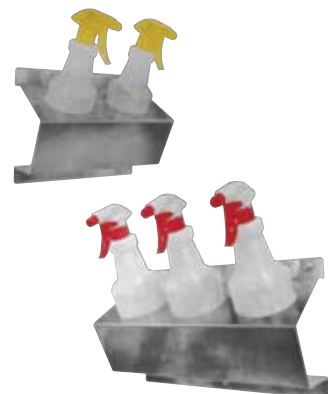

VERTICAL SPRAY BOTTLE HOLDER

- 1 BOTTLE Part# V10** 10"H
 - 2 BOTTLE Part# V20** 17.25"H
 - 3 BOTTLE Part# V30** 24.5"H
- 5.5"W x 6"D



ALL PURPOSE TOOL SHELF

Part# 102
30"W x 4"H x 6"D



This shelf works great above your work bench. Large enough to store an assortment of oil quarts, pump sprays, aerosol cans, cleaners and more. Hole punches fit various wrenches and screw drivers.

CAN OR CUP HOLDER
2 CAN/CUP Part# 337



Keep drinks handy and safe from spills in this can or cup holder. Made to fit cans or large drink cups. **8.5"W x 3.25"H x 4.5"D**

CUP DISPENSER
Part# 339

Mount next to your water cooler shelf for a convenient drink station.

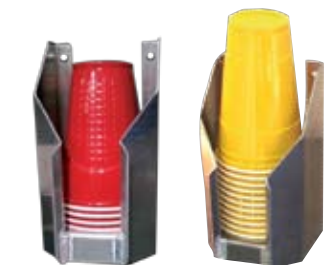

2 GALLON COOLER SHELF SHELF ONLY Part# 341

WITH COOLER Part# 340
9.75"W x 11.75"H x 9.25"D



5 GALLON COOLER SHELF SHELF ONLY Part# 343

WITH COOLER Part# 342
14.5"W x 17.25"H x 13.25"D
Also stores 5 gallon buckets!



JUNIOR DRAGSTER SLICK MOUNT

Part# 296
36"H x 7.5"W x 6"D

Holds a 3 or 5 lug rim and adjusts to hold any size rim and tire Jr. Dragster slick combination.



JUNIOR DRAGSTER UTILITY HOOKS PAIR A FRAME OR WARM-UP STAND

Part# 538P

With two of our Utility Hooks, you can mount them to hold your A-Frame on the wall or your warm-up stand. Inexpensive solution to save some space in your trailer or garage.



JUNIOR DRAGSTER SUPER TOOL TRAY

Part# 123
27"W x 14"H x 21"D

Designed exclusively for Junior Dragsters! Holds all of the tools necessary to service Junior Dragster cars. Fits over wide roll cages for easy access to tools, towels, spark plugs, etc.

Tools and magnets not included. Hardware not included. Ships in 2 boxes.



SINKS & WASHING STATIONS

CLIP-ON SINK

Part# 367

Quick & easy with our lightweight Clip-on Sink. Easy clip-on/off design makes it a must for all trailers. Simply quick-couples to a garden hose from existing water supply. Drains to a five gallon bucket. Completely powder coated with stainless steel sink. Small, compact design makes storage hassle free.

Dimensions: 19"H x 16"W x 20"D



CLIP-ON SINK WITH SOAP, TOWELTRAY & TRASH BRACKET

Part# 368

Our Clip-on Sink with accessories. Includes a trash bracket & soap/towel tray. Easy clip-on/off design. Simply quick-couples to a garden hose from existing water supply. Drains to a five gallon bucket. Powder coated with stainless steel sink. Compact design makes storage hassle free.

Dimensions: 19"H x 16"W x 20"D plus width of add-ons



COLLAPSIBLE PARTS WASHER

Part# 361

Designed to fit over 55 gallon drum for easy trackside cleanup. Collapses flat for storage.

Dimensions: 31.5"H x 42.5"W x 24.75"D



SNOWMOBILE WALL CABINET
Part# 420

- Great when your mounting location has height limitations
- Bottom shelf is 4.5"D to fit gallon size containers
- At 24" high it allows you to mount more storage solutions above or below this cabinet on the same trailer wall or shop wall.
- Two shelves for storage of aerosol cans, oil bottles, pump sprays, cleaners etc.
- Features a 25"W x 14"D locking work tray
- Spring loaded design holds two paper towel rolls on the bottom
- Tray has a 40LB Weight Capacity

25.5"W x 24"H x 6.75"D



SPARE TIRE MOUNT - SMALL TIRES
Part# 293

- Mount the bracket vertical to a stud and bolt the tire on through the wheel stud holes until secure.
- Bolt is attached to a slider plate to adjust the position to your needs.

26"L x 4"W x 1.5"D with 5.5" Bolt



ELECTRIC CORD BRACKET
Part# 220
5" Wide



AIR HOSE BRACKET
Part# 221
8" Wide



AIR HOSE DELUXE
Part# 223
8" Wide



Holds your air hose and includes a small shelf that's great for storing air chuck, air gauge, small tools, etc.

AIR STATION
Part# 114
11.25"H x 9"W x 5.5"D



Stores your air hose, holds your air tools and includes an upper tray for extra storage.

SNOWMOBILE WALL CABINET - NO TOWEL HOLDER
Part# 421

- Great when your mounting location has height limitations
- Bottom shelf is 4.5"D to fit gallon size containers
- At 24" high it allows you to mount more storage solutions above or below this cabinet on the same trailer wall or shop wall.
- Two shelves for storage of aerosol cans, oil bottles, pump sprays, cleaners etc.
- Features a 25"W x 14"D locking work tray
- Spring loaded design holds two paper towel rolls on the bottom
- Tray has a 40LB Weight Capacity

25.5"W x 20"H x 6.75"D



4 GALLON OIL CABINET
Part# 431
15.625"W x 18"H x 6"D

Neatly stores four gallon containers. Shelf depths: 4.5"D

Use as an all purpose storage cabinet too! Also fits oil quart bottles.



GARDEN HOSE BRACKET
Part# 225
10" Wide



DELUXE WITH SHELF 10" Wide
Part# 225D

HOUSE BROOM HOLDER
Part# 650
4.5" Wide



PUSH BROOM HOLDER
Part# 651
8" Wide

Store your cordless drills, dead blow hammers and fits a variety of yard tools.



UTILITY HOOK
Part# 538
7"H x 1.25"W

Great hook to hang just about anything on!



FOLD DOWN TABLES
Part# 458
26"W x 18"D

Part# 158
44"W x 18"D

Folds Down & Out of the Way

- Quickly folds down out of the way when you're through working!
- Folded, it protrudes only 4.5" from the wall
- Solid, heavy duty .125" aluminum fold down work surface
- Mounts on 32" centers
- 100LB Weight Capacity

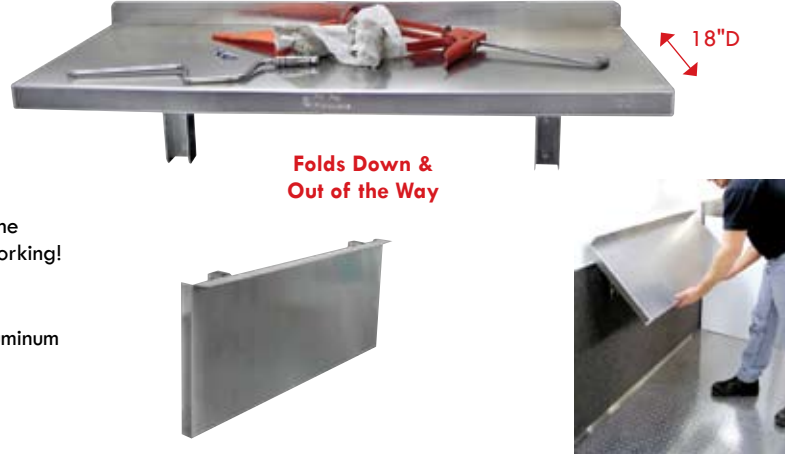

2 GALLON OIL & AEROSOL CABINET
Part# 428
15.625"W x 18"H x 6"D

Neatly stores two 1 gallon containers on the bottom and six aerosol cans up top or for use as an all purpose storage cabinet. Shelf depths: Top 2.75"D Bottom 4.5"D



8"W SINGLE TIE DOWN HANGER
Part# 217

PAIR OF 8"W TIE DOWN HANGERS
Part# 222

BEST SELLER



13"W TIE DOWN HANGER WITH SIDE HOOKS
Part# 217UH

Side hooks to hang drive belt, e-track strap, axle straps, jacket, etc.



18"W SINGLE STRAP HANGER
Part# 218

PAIR OF 18"W STRAP HANGERS
Part# 219



23"W STRAP HANGER WITH SIDE HOOKS
Part# 218UH

Side hooks to hang drive belt, e-track strap, axle straps, jacket, etc.



6 GALLON OIL CABINET
Part# 422
26"W x 18"H x 6"D

Designed for snowmobile trailers. Stores 6 gallon oil containers neatly. Can also be used as an all purpose storage cabinet for aerosols, spray bottles and supplies. Shelf Depth 4.5"D



WHITE OUT TECHNOLOGIES SKI TIE DOWN HOLDER
Part# 950
Part# 950P



Designed to secure your tie down bar and crank along the wall of your trailer allowing greater ease while loading or unloading your sled.

36"W MEGA TIE DOWN HANGER
Part# 918



5.75"W MINI STRAP HANGERS
Part# 818



MR. HOOK
Part# 213
18"W x 4"H

Hang all types of straps, cords, etc.



UNIVERSAL HANGER
Part# 170
3.5"W x 4"H

Weight capacity 5lbs.



DON'T FORGET SCREWS & RIVETS FOR MOUNTING IN YOUR TRAILER!

3 HOOK COAT/HAT RACK 24"W

Part# 336

5 HOOK COAT/HAT RACK 36"W

Part# 536

7 HOOK COAT/HAT RACK 48"W

Part# 736

Great place for jackets, aprons, hats, safety shields, helmets and more!



TAPE BRACKET 3.5"W

Part# 370

DOUBLE TAPE BRACKET 10.25"W

Part# 371



Great hanger for anything! Designed to store racers tape but works great for snowmobile belts or kart pushers.

VERTICAL TAPE BRACKETS 2

Part# 572 11"H x 4"W 3

Part# 573 17"H x 4"W

A vertical option to store your racers tape if you have space limitations that do not fit our horizontal brackets.



MULTI PURPOSE BRACKET

Part# 207

2.25"W x 6.5"H



TAPE GUN HOLDER SHIPPING/PACKAGING

Part# 409

Store your tape gun dispensers in a location convenient for use. Know where they are at whenever one is needed. Great product for warehouses and shipping departments!



STORAGE SOLUTIONS FOR KART RACING EQUIPMENT & TRAILER ORGANIZATION

2 TIER TELESCOPING KART TIRE RACK

Part# 388 RACK

28"H x 13"D ADJUSTS 32-48"W

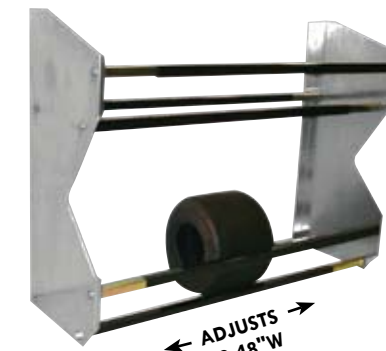

← ADJUSTS 32-48"W →

Holds 11" diameter kart tires securely during travel.

3 TIER TELESCOPING KART TIRE RACK

Part# 389 RACK

48"H x 13"D ADJUSTS 32-48"W



← ADJUSTS 32-48"W →

TELESCOPING KART TIRE RACK

Part# 288

9.5"H x 12.75"D ADJUSTS 60" - 112"W TO FIT ON CENTER STUD LOCATION

Holds 11" diameter kart tires. Floating center divider included to mount for added support. Tire capacity depends on tire widths and section widths. Ships in 2 boxes.



← FULLY ADJUSTABLE →
Up to 112"W to stud centers



CANOPY & POP UP SHELTER STORAGE BRACKETS

Part# 195

17"W x 5.75"H x 4.25"D

Store your pop up tent secure to your wall with our fully adjustable storage system. Also great for storing your golf clubs in the garage. Brackets are designed to fit 10' x 10' or 10' x 20' tents. System comes with 2 base brackets, 4 L-brackets, 1.5" wide heavy duty nylon safety belts and mounting hardware. 2 piece set. **Canopy/Pop Up not included.**



SMALL TRASH BIN 5 GALLON

Part# 590

11.5"W x 16"H x 6.75"D

LARGE TRASH BIN 12.5 GALLON

Part# 595

14.5"W x 24"H x 8.5"D

Clip on/off brackets make emptying easy without using bags. Fully welded seams and a custom radius shape make this can look good anywhere.



Hanging bracket included

JUNIOR TRASH BAG BRACKET

Part# 291

14.75"W x 10"D

LARGE TRASH BAG BRACKET

Part# 290

19.75"W x 12.25"D

Keep pit area clean with this portable trash bracket. Easy on and off design with aluminum construction and a built-in cloth bungee. Bags clip on in seconds.

Junior bracket fits kitchen bags.

Large bracket fits lawn/leaf bags.



KARTING AXLE RACK

Part# 166

18"W x 24"H x 3.5"D

Store up to 6 karting axles up to 50mm in diameter.



KARTING AXLE RACK

Part# 167

18.75"W x 24"H x 7"D

Store up to 12 karting axles up to 50mm in diameter.



VERTICAL KARTING SPLIT GEAR RACK

Part# 149V

7"W x 20"H x 2"D

Store karting split gears on wall. Holds 15 gears. Center channel so gears will not slide out.



VERTICAL KARTING FULL GEAR RACK

Part# 249V

10"W x 20"H x 2"D

Store karting full gears on wall. Holds sprocket sizes 66 up to 96. Sprocket size 6.5" to 9.5" diameter. Holds 15 gears.



KART SPLIT GEAR STORAGE RACK

Part# 149

12"W x 8"H x 6"D

Store eight 10" diameter karting split gears.



ADJUSTABLE KART ENGINE STORAGE BRACKETS

20" Wide 1.25" Tube Part# 173

34" Wide 1.25" Tube Part# 172

Solid way to store karting engines. Adjustable width tube spacing for different chassis designs.

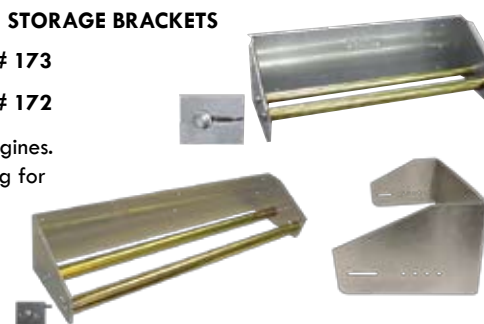

48" KARTING TIRE TROUGH

Part# 286

9"H x 48"W x 11"D

Store small spare tires up to 11" diameter. Perfect for karting or midget tires.



KART WORK TRAY

Part# 165

36"L x 11.5"W

Fits on top of kart seat. Front angle rests on steering wheel. Includes seat stop to adjust for different seat positions. Keep seat clean of dirt and grease while you work. Includes top tool tower. Tools not included.



AIR TOOL HOLDER 18"W

Part# 115

Made to hold 8 of your most common air tools. It works great above any workbench.



MINI 6"W

Holds 6 air tools.

Part# 115M

RACE RADIO BRACKETS

Part# 372

3.25"W x 8.5"H x 1.75"ID

Part# 376

3.25"W x 9"H x 2.5"ID

Keeps radio and headset together. Hang on trailer, golf cart, tool box or any vertical surface.



TAPE MEASURE HOLDER

Part# 627LG 4"W x 2"D

Fits most size tape measures.



ASSEMBLED KART AXLE RACK

Part# 168

33"W x 6"H x 10"D

Store a completely assembled rear axle on this rack. Will adjust to fit any axle housing width and accept up to a 50mm axle.

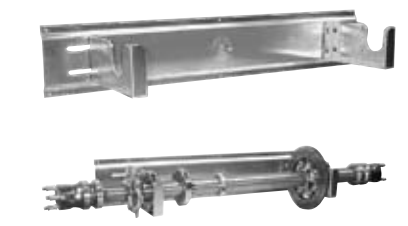

SHOCK RACKS ALL 33" WIDE
 6 Unit Part# 1038
 8 Unit Part# 136
 12 Unit Part# 1037

Store your spare race shocks. Completely powder-coated, with pins. Not intended to fit bulb shocks but may fit some styles. Please measure from pin center to fold to ensure shock clearance. 2 piece set.



8 UNIT - 3" SPRING
12 UNIT - NO SPRING

FOR SHOCKS WITH 5" SPRING

DOUBLE GEAR RACK
 Part# 139
 17.5"W x 22"H x 4.25"D

Stores 24 gears (12 Sets)

Great way to store your quick change gears.



GEAR CASE RACK - HOLDS 12 CASES
 Part# 143
 20.5"W x 22"H x 7"D

Hold 12 gear cases flat and easily accessible.



2LB EXTINGUISHER HOLDER - 3.25" BOTTLE
 Part# 353

5LB EXTINGUISHER HOLDER - 4.5" BOTTLE
 Part# 352

10LB EXTINGUISHER HOLDER - 5" BOTTLE
 Part# 452

BEST SELLER



2LB 5LB 10LB

PROPANE/FIRE EXTINGUISHER HOLDER
 Part# 326

6"H x 7.75"W x 4.5"D

Store propane and FireAde bottles securely and within easy reach. Propane and FireAde not included.

FIREADE 16OZ
 Part# 2055



GENESIS SHOCK RACKS
 Part# 1040 5.5"H
 25"W x 3"H (FACE) x 3.75"D

Part# 1041 9"H
 25"W x 7"H (FACE) x 3.75"D

For Genesis shocks or similar styles. Stores 8 shocks with 2" diameter holes. Fits bulb shocks.



GEAR CHANGE TRAY
 Part# 1285
 13.25"W x 2.5"H x 11"D

Organizes, stores and allows for quick and easy gear changes. Slotted tray provides gear change. Funnel holder on side helps to make clean up neater.



VERTICAL GEAR CASE RACK HOLDS 12 CASES
 Part# 144
 24"W x 9.75"H x 7"D

Compact in design, this unit will hold up to 12 gear cases standing vertically.



D CELL FLASHLIGHT HOLDER
 Part# 216
 2.75"W x 6.5"H x 3"D

Mount to trailer or garage walls or to your tool box.

Part# E216



RUBBER/LATEX GLOVE HOLDER
 Part# 202
 10.5"W x 4.5"H x 3.5"D



ECONO RUBBER/LATEX GLOVE HOLDER
 Part# 5202
 10"W x 5"H x 3.75"D

All corners are folded. Great for light duty use.

BEST SELLER



VERTICAL GLOVE HOLDER
 Part# 502
 5.25"W x 8"H x 3.75"D



TORSION BAR RACKS 33.37"W x 3.12"D
 16"H Part# 137
 24"H Part# 134

The best way to store bars while in transit! Has 2" diameter holes for bars with grommets in top and bottom holes to protect against damage. Designed to line up with trailer wall studs. All sizes hold 12 torsion bars.

1.5" ID GROMMETS



SPRINT CAR ENGINE SLING
 Part# 200
 22.25"W
 Two 20" Straps

Our engine sling makes engine changing a breeze. Simply hook it to your engine puller and attach the 2 straps to your engine using your header studs or exhaust bolt holes and pull. Plated for long lasting finish.

NEW



GEAR CASE
 Part# 142

Sturdy plastic. Keeps gears clean, secure and organized. Each case holds one set of gears. Each sold separately.



FIRST AID KIT WITH HOLDER
 Part# SP5
 10.25"W x 3.5"D x 6"H

First Aid Kit is included.



PAPER TOWEL & GLOVEDISPENSER
 Part# 226LG
 9.75"H x 13.75"W x 4.5"D



PAPER TOWEL HOLDER
 Part# 226
 4.375"H x 13.5"W x 4.125"D



POP UP TOWEL HOLDER
 200 Ct Part# 208 9.5" SQ
 300 Ct Part# 209 11.5" SQ



TORSION BAR TOOL TRAY
 Part# 133
 3.375"H x 12.5"W x 11"D

Designed for the sprint car racer to mount on the rear push car bumper. No more torsion bars rolling in the dirt! Holds bars while being changed. Tray holds grease, tools, etc.



TIRE GROOVER STATION
 Part# 480

Secure storage spot for your tire groover.



22" TIRE ROLLOUT CHECKER
 Part# 1001
 4"H x 22"W x 18.25"D

Easy and hassle free way to measure tire circumference rollout. No more back-aches!



BOX TOWEL HOLDER
 Part# 790
 11"W x 4.75"ID



C-FOLD TOWEL HOLDER
 Part# 206
 10.125"W x 10"H x 3.75"D

Dispenser provides a safe, solid storage for c-fold paper towels. Holder mounted on wall keeps paper towels within reach.



WET WIPE HOLDER
 Part# 562
 5.25"W x 5.25"D x 7.5"H

Our wet wipe holder is designed to store a round container of cleaning wipes for cleaning tough grease, dirt, grime and other messes in your garage or shop. Also, neatly holds a roll of shop towels.

NEW



DUAL TOWEL BAR
 Part# 405
 17.25"W x 5"H

Heavy duty tubes.



CAR DUSTER POUCH
 Part# 306
 6.375"W x 12"H x 3"D

CAR DUSTER & POUCH
 Part# 307

Our pouch makes a great storage solution for your Original California Car Duster®! Paraffin wax baked into 100% cotton strands to assure dust is lifted and removed, not just pushed around.



SHOP TOWEL HOLDER
 Part# 791
 16"W x 8.25"H x 9.5"D

Our Shop Towel Holder stores your reusable cotton terry cloth shop towels neatly in their own spot. Towels not included.

NEW



COLLAPSIBLE CHAIR HOLDER

Part# 303
22.5"W x 3.75"H x 6.75"D

Great solution for storing collapsible chairs. Stores up to 3 chairs. Can mount the upper piece to a height of your liking. Store baseball bats, hockey sticks, umbrellas, yard tools, construction supplies (ex. PVC), etc. Great product for storing anything upright! Two piece set with 7" square pockets. Fully welded bottom.



BEST SELLER

CABLE TIE HOLDER

Part# RT2
6.5"W x 14"H

Keep zip ties organized. Save work space and hassle of messy piles in drawers. Holds several different sizes.



TIRE GAUGE HOLDERS

Small 3.125"W Part# 227
Large 4.25"W Part# 228
Monster 5.25"W Part# 328



Store tire gauge on wall or other vertical surface for easy access.

SPARK PLUG HOLDERS

16 Single Boxes Part# 529
4"W x 16.5"H x 1.25"D
16 Boxes - Qty 4 Per Box Part# 829
4.75"W x 20"H x 4"D

Keep your new spark plugs organized and packed readily available.



INTERCOMP GAUGE HOLDER

Part# 622
3.625"W x 4"H x 2.25"D

Store your rectangular Intercomp digital tire pressure gauge.



LARGE UMBRELLA HOLDER

Part# 373
27"H x 3"W x 2.5"D

Protect your umbrella from getting bent, ripped or lost. Our holder mounts easily on door or wall for easy access when ready to use.



POLISHER OR GRINDER HOLDER

Part# 407
8"H x 12.25"D
9.75"W x 2.75"D ID

Easy and convenient way to store your buffer or grinder. Your buffer sits vertical and rests on the axle to prevent debris from collecting on the face that could scratch surfaces.



DRAGSTER NOSE CONE HOLDER

Part# 318
16.125"H x 10"W x 1.75"D

A fully adjustable wall-mount unit that fits nearly all dragster nose cones. Cushioned trim protects expensive paint jobs and delicate fiberglass edges.



ENGINE LIFT SLING

Part# 201
28"W x 27.5" Belt Length

Our engine sling makes engine changing a breeze. Simply hook it to your engine puller and attach the 4 straps to your engine using your header studs or exhaust bolt holes and pull. Plated for long lasting finish. Each royal blue polyester strap is 22" long. Great for cars with blowers or tunnel ram intakes.

Our engine slings are certified for a lifetime weight capacity of 1,000LBS.



BEST SELLER

PRO ENGINE CRADLE

Part# 162
28"W x 7.5"H x 27.25"D (Collapsed)
28"W x 17.5"H x 27.25"D (Extended)

When your engine repair requires it to be removed from the vehicle, our Engine Cradle is a secure support for easy access to all sides of the engine. Tubular rear uprights with large plates can be modified to fit other motor applications if necessary. Stands are recommended to fit Big Block and Small Block Chevy motors with motor plates. Heavy duty construction with dual wheel casters. Designed to fit motors with front motor plates and all accessories, such as oiling systems, air pumps, dry sump, tanks, etc. Unique front tubes accommodate any height or angle. Two large 1/2" spring loaded locking pins help secure stand during transportation.

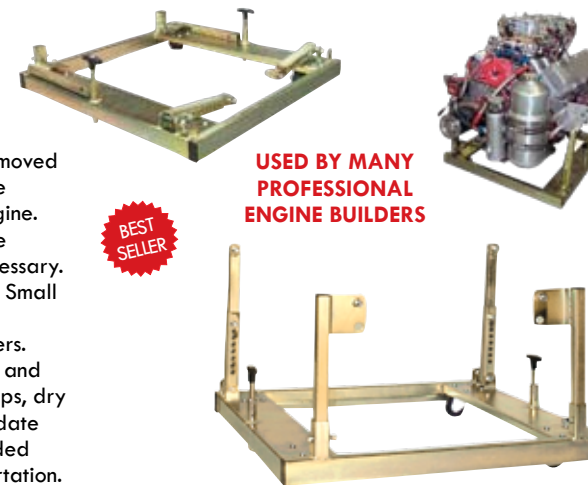

BEST SELLER

USED BY MANY PROFESSIONAL ENGINE BUILDERS

FORD ENGINE STAND

Part# 161
17.5"D x 22"W x 13"H

Strong, 1" x 1" steel tubing stand is a perfect fit for 289/302/351 motors. Great for engine storage or safe transport.



Fully fixture welded & guaranteed to fit.

CHEVY ENGINE STAND

BIG BLOCK/SMALL BLOCK Part# 160
17.5"D x 22"W x 14"H

Strong, 1" x 1" steel tubing stand fits Small Block and Big Block. Use for storage or safe transport.



Fully fixture welded & guaranteed to fit.

PEN/CALCULATOR HOLDER

Part# 304
5"W x 6"H x 3.5"D

Great desk organizer.



PEN/CALCULATOR HOLDER DELUXE

Part# 304D
Great for writing notes, holding time slips, or storing loose papers. A great gadget for your trailer, garage or office. Holds a calculator, small notepads, paper clips, etc. Six round tubes fit pens, pencils, highlighters or markers.

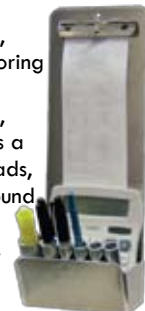

CLIPBOARD W/ PEN HOLDER

Part# 404
9"W x 12.5"H



CELL PHONE HOLDER

Part# 555
4.5"W x 6.75"H x 1.375"D

NEW Deeper Design



DRUM PUMP HOLDER

Part# 784
5.5"W x 5"H x 3.5"D
SIPHON DRUM PUMP Part# NP3051

Store your siphon drum pump upright and features a storage opening for the pump hose.



DRIP FREE FUNNEL HOLDER

Part# 224
20.125"H x 1.675" DIA

Eliminate messy spills on trailer and shop floors from funnel drips. Great for long extension funnels.



TRAILER PLUG HOLDER & HARNESS BRACKET

Part# 525
2"W x 2"D x 7"H WITH 1 7/8" TUBING

Prevents plugs from getting dirty.



GREASE GUN HOLDER

Part# 324
3"W x 12"H x 3"D

Best way to store your grease gun vertically in your trailer or workstation.



TORQUE CONVERTER DISASSEMBLY TRAY

Part# 386
14.25"W x 14.5"D x 4"H

Ideal for converters that disassemble. Holds the converter in place during disassembly and re-assembly. Indexes the flywheel bolts and input shaft. Features 2 carrying handles and a drain plug. Holds 2+ gallons of fluid.



LENCO TRANSMISSION REPAIR TRAY

Part# 116
18.25"W x 3.25"H x 14.25"D WITH 4" DIAMETER HOLDER

Holds 8+ quarts of fluid.



Rebuild your Lenco transmission with the same tray Lenco uses. Crafted of heavy aluminum - it will be with you for years of service. Includes drain plug. The pump housing fits in the center hole to allow the transmission to stand on end for easier servicing. The ATF reservoir keeps your work area clean, with an easy to empty drain plug to make disposal mess free. The side tray for screws and small parts assures you will not lose any important pieces.

DIRT BIKE STAND

Part# 177
BASE 15.75" SQUARE x 16"H

The top platform of this heavy duty bike stand is 10" x 10" and has a 4" x 4" hole which allows for easy oil drainage. The built-in work tray beneath works great for tools or your drain oil container. It has a 1/2" tough anti-slip riveted rubber top mat.



LENCO DRIVE DISASSEMBLY TRAY

Part# 716
21"W x 13"D x 7"H WITH A 6.5" DIAMETER HOLE

Holds 18+ quarts of fluid.

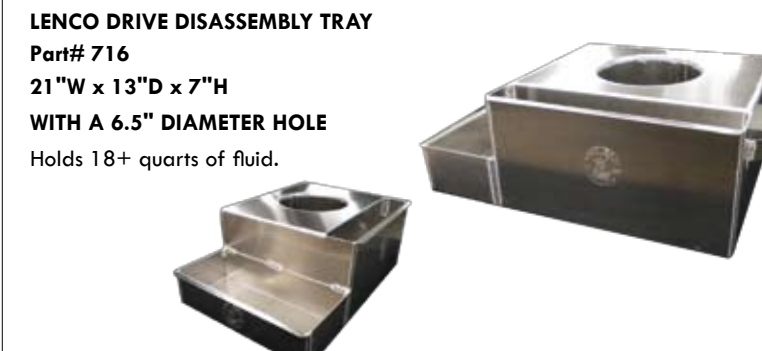

FULLY ASSEMBLED & READY TO INSTALL □ BEST IN THE INDUSTRY



- | | |
|--|--|
| <p>CLEAR</p> <p>3'W x 7'L
Part# VS3X7</p> <p>4'W x 7'L
Part# VS4X7</p> <p>5'W x 7'L
Part# VS5X7</p> <p>8'W x 7'L
Part# VS8X7</p> <p>8'W x 8'L
Part# VS8X8</p> | <p>DARK AMBER</p> <p>3'W x 7'L
Part# TVS3X7</p> <p>4'W x 7'L
Part# TVS4X7</p> <p>5'W x 7'L
Part# TVS5X7</p> <p>8'W x 7'L
Part# TVS8X7</p> <p>8'W x 8'L
Part# TVS8X8</p> |
|--|--|

BEST SELLER

BEST SELLER

More Sizes Available | Please Call For Details

Fully assembled and ready to install, our Vinyl Strip Doors are a great way to let people and vehicles in while keeping dust, dirt, noise, hot air and the sun out! Whether it's in a trailer or in a shop, this is a perfect way to maintain temperature control while keeping the traffic flowing.

Made of .080 thick PVC vinyl. Clear or tinted amber. Includes full width mounting bracket for door installation. (2.5"H)

Additional Storage Brackets are available when not in use. Mount in a second location in your trailer or garage when the curtain is not in use. (SEE BELOW)
Part# 242 (2 Piece)
Part# 243 (4 Piece)

If your door opening is in between sizes, order the next longer length. Vinyl can be easily cut down with a straight edge and box cutter to meet your length needs.

Need a custom width? Call us for a quote.

Vinyl Replacement Strips - Sold by the foot
#VS100
#TVS100

Note: Vinyl Doors are made for Wall installation (vertically), a ceiling style mount is possible using materials from your local hardware store. (Ex. Aluminum Angle)

Mounting Hardware Included



2PC. Vinyl Door Storage Brackets Recommended for 3' & 4' vinyl doors. Part# 242

4PC. Vinyl Door Storage Brackets Recommended for 5' to 8' vinyl doors. Part# 243

Additional Storage Brackets for vinyl doors when not in use. Store on a trailer or garage wall.



- ALUMINUM WORK TABLES**
- Small Table 42"W x 25"D x 31"H Part# 156
- Medium Table 64"W x 25"D x 31"H Part# 154
- Large Table 72"W x 31"D x 31"H Part# 155

BEST SELLER

Save cost when purchasing two or more large tables by shipping truck freight to commercial address. Call for details.

- All tables made of .125 aluminum
- 1,000LB Weight Capacity
- All have tubular steel locking legs that fold flat for storage
- Aluminum hat channel bracing



STRONGEST IN THE INDUSTRY!
GREAT FOR THE TRACK, GARAGE, TRADESMEN OR EVEN COOKOUTS!

31" x 31" SQUARE TABLE
Part# 456
31"W x 31"D x 31"H
No Lower Deck Shelf Available



FOLD DOWN TABLES
44"W x 18"D Part# 158
26"W x 18"D Part# 458



READY TO INSTALL NO ASSEMBLY REQUIRED



- Quickly folds down flat to wall when you're through working!
- Folded, it protrudes only 4.5" from the wall
- Solid, heavy duty 1/8" aluminum fold down work surface
- Mounts on 32" centers
- 100LB Weight Capacity

TABLE STORAGE BRACKETS
Part# ZB157
14"H x 3"D WITH 1 3/8" FOLD TO SECURE TABLE



Secure tables to trailer wall during transport or for storage in your garage. Set of 2 Z-Brackets fits one table.

ENGINE REPAIR PIT TABLE
Part# 153
30"W x 16"D Tray

This Engine Repair Pit Table easily slips under frame rails and over the radiator when your car is on jacks to bring work station closer to motor. A convenient mobile work station with adjustable heights that collapses for ease of storage in the trailer. Great for use in the dyno cell and machine shop to hold piston rods, measuring tools, etc. Table has 3 adjustable heights from 35.25" to 41"H.



GREAT PORTABLE WORK STATION FOR CREW CHIEFS

ADJUSTS TO 3 HEIGHTS COLLAPSES FLAT FOR STORAGE

DON'T FORGET SCREWS & RIVETS FOR MOUNTING IN YOUR TRAILER!

CLIP-ON/OFF TRAILER TRAY
Part# 150
38"W x 17"D

Protective bumpers, support brackets and key punch brackets for removal are included. 40LB weight capacity.



This clip-on tray has an easy on and off design that provides ample table space for portable outside pit use. Large enough for all pit needs, yet stores easily inside trailer.



JUNIOR FLIP DOWN TRAY
Part# 151
13.5"W x 7"D



Folds flat to wall when not in use.

FLIP DOWN TRAY
Part# 152
30"W x 16"D

This tray provides a fold down work surface when you need some extra counter space. Flip up for quick storage, flip down for a handy table when needed.



40LB Weight Capacity.
 Fold flat to wall when not in use.

SUPER TOOL TRAY
Part# 121
31.5"W x 16.5"H x 33.5"D

For both dragsters and funny cars. Fits over roll cage for easy access to tools, towels, spark plugs, etc. Large tray holds everything needed. Built in shelf stores aerosol and oil containers. Holds plenty of spark plugs. A-shaped tower features small hardware shelf on top, sides have option to add magnetic bars for extra storage capabilities.

31.5"W x 16.5"H x 33.5"D Ships in 2 boxes.



Tools and magnets not included.

31" REMOVABLE TRAILER STEP FOR 36" DOOR OPENING 12.75"H x 31"W x 16.5"D
Part# 492

42" REMOVABLE TRAILER STEP FOR 48" DOOR OPENING 12.75"H x 42"W x 16.5"D
Part# 490

54" REMOVABLE TRAILER STEP FOR 60" DOOR OPENING 12.75"H x 54"W x 16.5"D
Part# 494

Built from heavy wall aluminum 2x2 tubing. Wrapped with 1/8" bright tread plate. Side gussets and nylon rub bars. Made to conveniently flip up and out of the way, or remove with removable hinge pins. Measurements are for tread width.



Custom widths available upon request.

THE STRONGEST IN THE INDUSTRY.

PROVIDES SAFETY & EASE WHEN LOADING YOUR TRAILER.

BEST SELLER

READY TO INSTALL COMPLETE WITH HINGES & HARDWARE

3 SIZES

10.5"H



STANDARD TOOL TRAY
Part# 120
17"W x 8"H x 17"D

Choose from carburetor rings available in box below.



WITH STANDARD RING
Part# 120S

WITH DOM RING
Part# 120D

JUNIOR TOOL TRAY
Part# 129
16"W x 13.25"D

Choose from carburetor rings available in box below.



WITH STANDARD RING
Part# 129S

WITH DOM RING
Part# 129D

UTILITY TOOL TRAY
Part# 159
16"W x 5"H x 7"D

Similar to our Jr. Tool Tray, but with a narrower profile. Does not have spark plug holes. Ideal for clutch servicing. Great for carrying miscellaneous tools.



20"W PORTABLE ALUMINUM STEP 20"W x 12"D
Part# 596 30"W

PORTABLE ALUM INUM STEP 30"W x 16"D
496

Use as a free standing step for your trailer, or at home to access out of reach items. Great for reaching the top of trailers or tow vehicles when washing and detailing. Helpful when servicing autos on jack stands. Rubber bumpers on all corners prevent sliding or damage. Handles punched in both sides for carrying. Heavy duty construction.



STEPWELL STEP
Part# 485
47.25"W x 6"H x 11"D

A step that stores in the step well of your trailer! An 11" tread depth makes it easy to get in or out of the trailer and the aluminum construction makes it lightweight to maneuver. Rubber bumpers on all corners allow the step to be used on smooth floor surfaces without sliding or damage. Heavy duty construction.



STANDARD RING
Part# 118 5.25"W x 2.5"H



DOMINATOR RING
Part# 119 7.5"W x 2.5"H



Mount carburetor ring to our tool trays to cover your carburetor while you work and keep your tools and parts close while you work. Perfect for dual carb setups.

CLECO TOOL TRAY
Part# 262
16"W x 5"H x 7"D

Hold all three sizes of Cleco fasteners along with two pliers in one easy to carry tray. This tray is divided into three sections and will easily hold 100 fasteners in each section.



HARDWARE TRAY
Part# 239
9.5"W x 6"D



Keeps disassembly hardware organized and separated. Tray has six compartments.

SPARK PLUG CADDIES

Mini - Holds 8 **Part# 229**

Junior - Holds 48 **Part# 230**

Pro - Holds 64 **Part# 231**



CARBURETOR FUEL BOWL DRAIN TUBE
Part# 147
9.5"H x 1.5"L x 1.5"D

Change jets and repair carburetor without spilling fuel! Capacity allows you to drain both bowls when removing carb bowl screws. Round tube is also anodized for durability and appearance. Tube has tapered end to capture fuel without spilling.



LIGHTING

RECESSED LIGHT BUCKET WITH 500 WATT LIGHT
12"W x 11.75"H x 9.125"D
Part# 130LB

RECESSED LIGHT BUCKET ONLY
12"W x 11.75"H x 9.125"D
Part# 131LB



CLIP-ON TRAILER LIGHT
Part# 130

PAIR OF CLIP-ON LIGHTS
Part# 131

Make outdoor lighting safe with our state-of-the-art clip on design. For both outdoor and indoor use. Uses 500 watt quartz halogen lights with aluminum anodized poles and water-tight electrical joints. Lights swivel up and down. Brackets supplied for outside mounting and inside storage - quantity 2.



MOUNTED ARM SWING LIGHT - 500 WATT
Part# L41

Shine light on loading, unloading or work areas. Heavy duty light fixture provides great outdoor lighting for your trailer or shop. 500 Watt halogen light with professional grade construction. Adjustable arm extends from wall 40". Features a weatherproof on and off switch. Has a 10-Foot 18/3 grounded power cord.



LET



DON'T FORGET SCREWS & RIVETS FOR MOUNTING IN YOUR TRAILER! RIVETS #PR100 SCREWS #SCR

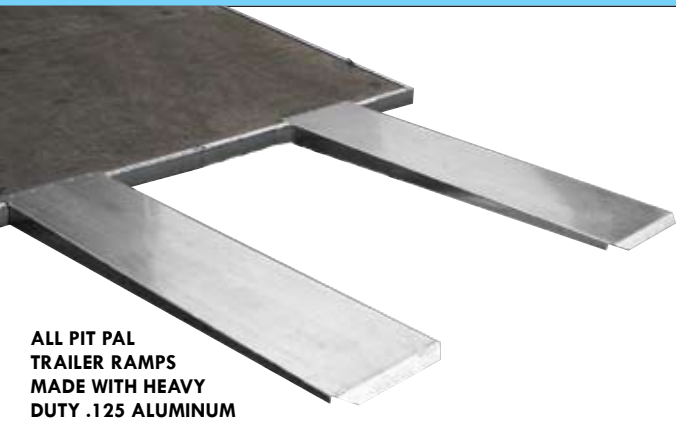

DUAL TRAILER RAMPS
 36"L x 14"W Part# 699
 60"L x 14"W Part# 701
 72"L x 14"W Part# 702

HINGES & HARDWARE INCLUDED FOR ALL RAMPS **SOLD AS PAIR**

- Easily flip up for transportation
- Fabricated height approximately 4"H
- Tig-welded A-shaped channel
- Heavy duty hinges that are zinc-yellow plated and rivets
- Unique non-slip embossed treads assist with loading & unloading
- Our ramp risers and trailer bumpers may be necessary for raising Pit Pal ramps to achieve your ideal approach angles and reduce sagging



ALL PIT PAL TRAILER RAMPS MADE WITH HEAVY DUTY .125 ALUMINUM

FULL EXTENSION TRAILER RAMPS

72"W x 60"L Part# 700
 72"W x 72"L Part# 720

FULL LENGTH HINGES & HARDWARE INCLUDED
 Fabricated height approximately 4"H

TRUCK FREIGHT

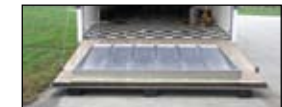

HEAVY DUTY HINGE ALLOWS RAMP TO EASILY FOLD OVER FOR TRANSPORT



ULTRA TRACK FOR DUAL RAMPS - 2 PIECE SET

Ultra Track System 34"L Each Part# 706
 Ultra Track w/ 36" Ramps Part# 699U
 Ultra Track w/ 60" Ramps Part# 701U
 Ultra Track w/ 72" Ramps Part# 702U

- Recessed mounting holes & adjustable end stops
- Load vehicles with different track widths with ease
- Each channel slides 31" side-to-side

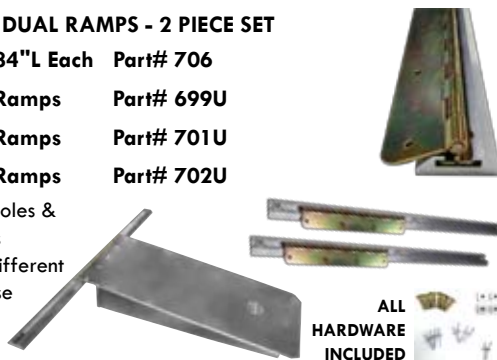

ALL HARDWARE INCLUDED

RAMP RISERS FOR APPROACH ANGLES 14"W

2"H Part# 710
 3"H Part# 711
 4"H Part# 712
SOLD AS PAIR

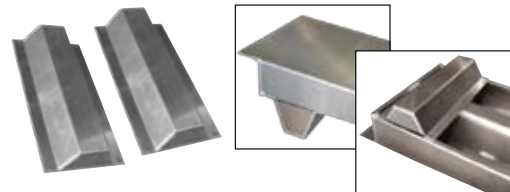

ASSIST RAMPS

Part# 281
 26"L x 9.125"W x 3.75"H
SOLD AS PAIR

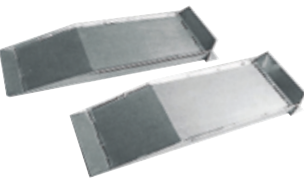

Raises car 2" for easy access to trailer or allows enough room for floor jacks. Allows you to park your vehicle in the same location inside your trailer.

PIT RAMPS

Part# 280
 24"W x 2.75"H x 8"D
SOLD AS PAIR



Allows jack to slide under chassis. Keeps front tires secure while raising rear of car 2.25". Helps maintain oil pressure by keeping car level while rear is elevated when warming motor and drive line. Great when pitted in grass or uneven ground at the track. Convenient handle allows for easy removal and storage.

STORAGE POUCH
 Part# 279

1.5" LOW RISE PIT RAMPS
 Part# 580

RUBBER TRAILER DOOR BUMPERS

3.25"H x 6"W Part# 704
 2"H x 7.75"W Part# 703



RUBBER D-SHAPED HOLLOW BUMPERS

Medium 6"L x 2"H Part# DR200
 Large 12"L x 3"H Part# DR300



ROUND RUBBER BUMPERS

Small 1.75" OD Part# DR26
 Large 2.5" OD Part# DR25



ADJUSTABLE TRAILER DOOR BUMPER

Part# 795
 Useful when pitted on uneven ground like dirt, grass or gravel. Keeps trailer door from being warped or twisted. Constructed of 2" heavy wall aluminum square tubing. Nine telescoping heights up to 11". 1" thick rubber bumper. Heavy duty locking pin.



E-Z FILL THRESHOLD BRIDGE

Part# 705
 20"W x 8"D x 2.5"H **SOLD AS PAIR**

Traverses the path from ramp to trailer, eliminating gaps and bumps that usually cause problems loading or unloading equipment, hand carts, cars or goods. Hanging storage brackets included.



HINGED TRAILER GAP COVERS **SOLD AS PAIR**

Part# 709
 36" x 9" 7" Leg

One piece components that cover the trailer gap to make loading carts, toolboxes, dollies, low front ends, etc. trouble free. Mounts to the inside of your trailer and flips up/down when you open/close your trailer door. Built with a formed angle to assist with easy loading. No welded pieces.



FUEL JUG RACKS

1 Bay 12.125"W x 12"D Part# 180
 2 Bay 23"W x 12"D Part# 181
 3 Bay 34.5"W x 12"D Part# 182
 4 Bay 46"W x 12"D Part# 183

Safely store your fuel in your trailer. Holds round or square 5 gallon fuel jugs. Also stores jack stands and air bottles. Open bottom and back. Mount easily on your trailer floor. **Bottoms can be installed. Call for pricing.**



STACKED 4 BAY FUEL JUG RACK
 Part# 481

23"W x 43"H x 11.375"ID

Are you limited on trailer space? Our Stacked Fuel Jug Racks takes up less floor space but hold more jugs! Mount on floor of trailer and secure to wall. Full back and bottom for fuel jugs. Fits round & square 5 gallon plastic fuel jugs only.



STACKED 2 BAY FUEL JUG RACK
 Part# 482

12.25"W x 41"H x 11.375"ID

14" Large Fuel Funnel Part# 188
 Large Fuel Funnel Holder Part# 187H
 17"L x 11"D
 Funnel & Holder Part# 187K
 Replacement Fuel Filter Part# 189
 Fuel Funnel with Filter Part# 187



5 Gallon Fuel Jugs Part# 185
 Replacement Cap Part#3042
 Screw-In Cap Tube Part# 186



3 COLORS

STACKED 4 BAY FUEL CAN RACK
 Part# 486

24.25"W x 41"H x 11.75"ID

The depth of these fuel racks allow for steel cans.



STACKED 2 BAY FUEL CAN RACK
 Part# 484
 13.25"W x 41"H x 11.75"ID

NITROGEN BOTTLE BRACKETS

7" Dia Part# 357
 9 1/4" Dia Part# 257
 17"W x 10"D x 1.5"H

Store nitrogen bottles in your trailer standing up. Bolt brackets to the studs (16" centers) on your trailer walls and strap your bottles in safe and secure. Sold in pairs.



2 BOTTLE CO2 WALL MOUNT
 Part# 255

Fits 2" 10oz Cylinders
 Provides extra cabinet or tool box storage space. Designed as a wall mount storage pouch that will keep bottles safe during transport.



10LB OR 15LB NITROUS BOTTLE RACKS

2 Bay Part# 249 14.75"W 3 Bay Part# 250 22.25"W 4 Bay Part# 251 29.5"W 5 Bay Part# 252 37.125"W 6 Bay Part# 253 44.5"W

These racks keep nitrous bottles vertical and prevent rolling around your trailer. They easily mount to the floor or wall. Also great storage for other trailer supplies. Will hold a 15lb bottle.



JACK IN THE POUCH
Part# 194
17.5"W x 24.25"H x 5.5"D

A fully enclosed back and bottom wall mounted pouch for racing floor jacks. Keeps jack contained while in transit.



BEST SELLER



E-Z LIFT POUCH W/ BACK
Part# 196
OVERALL 31.125"W x 24"H x 9"D
FRONT 25"W x 15"H x 2.75"D
BACK 29"W x 17.5"H x 3.75"D



FLOOR JACK MOUNTS
Part# 190
2.5"H x 17"W x 2.125"D

Drop your steel floor jack between rails and position front wheels in the saddles.



PRO-JACK HYDRAULIC UNIT STORAGE POUCH
Part# 117
5.375"W x 8.75"D ID

Our Pro Jack Hydraulic Unit Pouch allows convenient storage for your pump.



CHASSIS STABILIZER STORAGE POUCH
Part# 902
20"W x 8"D x 2.5"H

Mount to your trailer or shop wall. Perfect pouch to store the inflatable Chassis Stabilizer. DOES NOT INCLUDE STABILIZER.



ADJUSTABLE TIRE RACKS
48" Tire Rack Part# 294
48" Extension Kit Part# 294E
64" Tire Rack Part# 295
64" Extension Kit Part# 295E

48" - 64"W x 28"H x 18"D (OD)
Adjustable Depth 18" - 26"

Designed to save space. Rack can adjust in or out for different tire diameters. Tire bumper tube across the back of the unit to prevent wall damage. Unfolds from wall quickly and easily to full width. Locking pins for easy storage when folded flat to the wall. Crafted from heavy gauge steel tubing.

Note: 48"-64" Tire Racks and Add-On Kits can be interchangeable. For example, our 64" Tire Rack can be used with the 48" Add-On Kit. Built to mount on 16" on center wall studs.

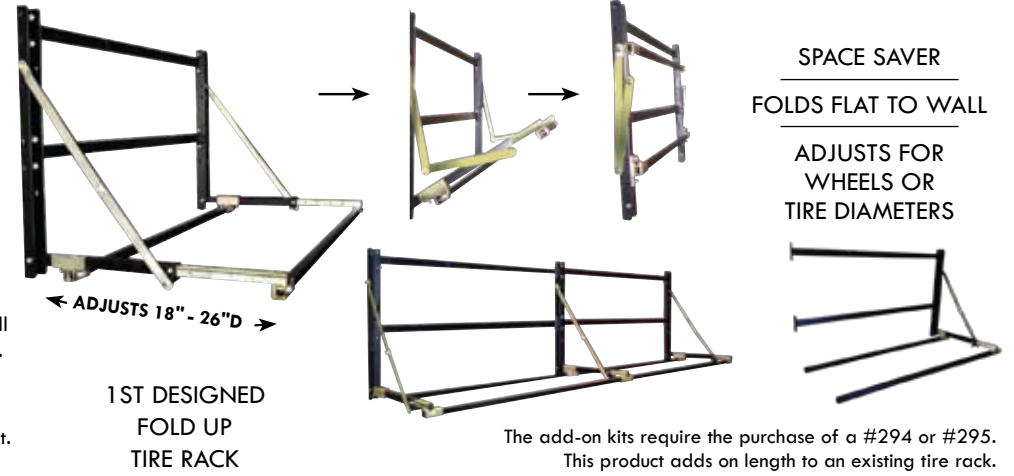

PRO-JACK POUCH W/ BACK
Part# 199
OVERALL 27.5"W x 24"H x 7.5"D
FRONT 25.5"W x 14.5"H x 3.5"D
BACK 25.5"W x 17.5"H x 3"D



BEST SELLER

STOCK CAR JACK MOUNT
Part# 193
7.25"W (Inside) x 15.25"L x 2"H



RACE CAR DOOR STAND
Part# 610
39"H x 36"W x 42"D

Store your race car doors safely when removed for repairs in the pits. Hassle free. Just fold it out & your ready to go. Features locking side bars for added stability. Lightweight and portable. Holds 2 doors.



HIGH DENSITY KNEELING PAD
Part# 539
23"L x 14"W x 1" THICK

Made of 4LB density cross linked polyethylene foam. Contoured hole makes it easy to carry. Crack proof, non-absorbent, waterproof and lightweight.



SLICK MOUNTS
Part# 282
SOLD AS PAIR

Unique telescoping design fits wheels with up to 11.5" backspacing and 5.5" backspacing with slight modification. Heavy duty construction in 14 gauge 1.5" square by 48" long steel tubing with .125 steel round clamping plates to hold wheels secure. Black powder coated finish. Mounting screws not included.

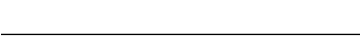

SPIN-ON SPARE TIRE HOLDER
Part# 292
13.75"H x 9"D x 4.75"W

Spin-on spare tire holder features a 1" diameter acme quick thread for increased clamping torque. Nylon cone shape centering hub will hold virtually secure any tire and wheel combination. Will not damage the wheel surface.



WHEEL CHOCKS

PIT BIKE CHOCK
Part# 270

Holds up to 15" diameter and 4.875"W tire. Front tire drops into cradle. Easy to mount. Holds bike secure for traveling.

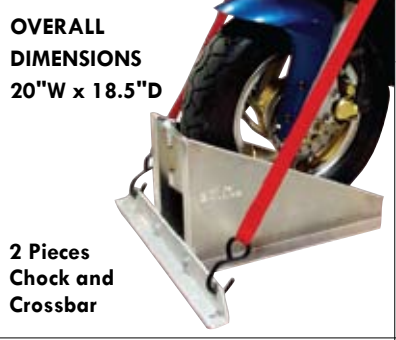

TRAILER AID STORAGE POUCH
Part# 602
8"H x 7"D x 6.25"W ID

Does Not Include Trailer Aid



MULTI-PURPOSE CHOCKS WITHOUT PINS
Part# 274
PAIR

MULTI-PURPOSE CHOCKS WITH PINS
Part# 275
PAIR

Part# 276
PAIR

Part# 277

Keeps tires secure in trailer.



HIGHWAY CHOCKS
Medium Part# DR500
5"W Large Part# DR800
8"W BOTH SIZES 7" D x 4"H



TONGUE JACK WHEEL CHOCK
Part# 400

Prevents runaway trailers, unlevel setups and sinking into the ground.



WHEEL CHOCK WITH HANDLE
Part# 565
12"W CHOCK

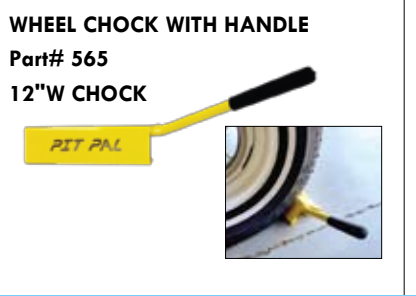

GOLF CART CHOCK
Part# 267
9"H x 14.5"W x 12.5"D

Unit is 12"W ID.



ALUMINUM DIAMOND PLATE RUNNER
Part# 750
1/8" Thick 48"L x 16"W



TELESCOPING KART TIRE RACK
Part# 288
9.5"H x 12.75"D

Designed for karting, this tire rack holds 11" diameter kart tires secure for travel. Tubing telescopes to 112" or 9' 4" on center stud location.



ATV TIRE RACK
Part# 298
22"H x 23.75"D

Holds up to 22" OD tires.



TIERED TELESCOPING KART TIRE RACKS
2 Tier Part# 388
28"H x 13"D

3 Tier Part# 389
48"H x 13"D

SPARE TIRE HOLDER
34" Tire Part# 287
34.5"W x 11.5"H x 11.5"D

HOLDS A TIRE LARGER THAN 205/R15 UP TO 107" CIRCUMFERENCE

SECURE TIRE STORAGE

MOUNT TO FLOOR OR WALL

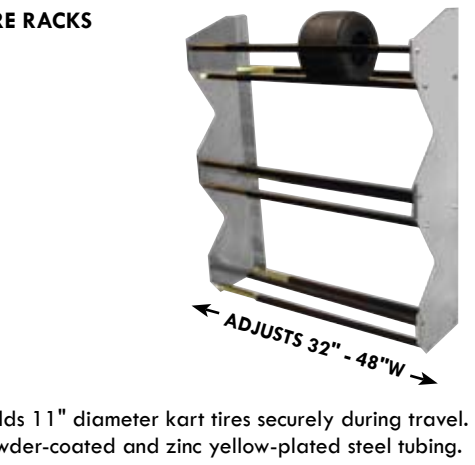
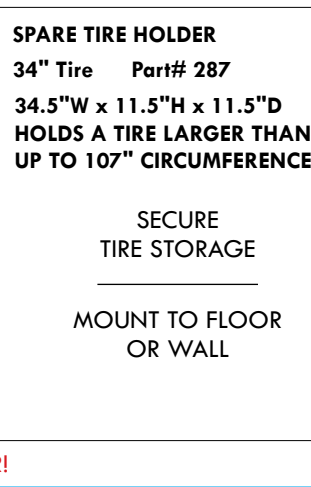
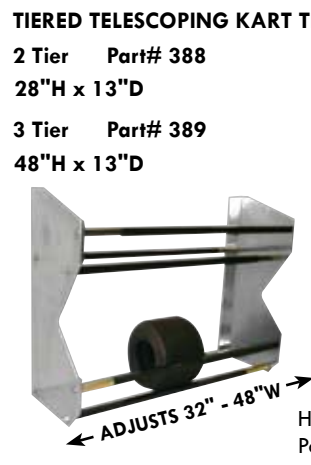

DON'T FORGET SCREWS & RIVETS FOR MOUNTING IN YOUR TRAILER!