

CD RDS RECEIVER

DEH-X6900BT
DEH-X6910BT

Pioneer

PANDORA®



Owner's Manual

 **Important (Serial number)**

The serial number is located on the bottom of this unit. For your own security and convenience, be sure to record this number on the enclosed warranty card.

Table of Contents

Before You Start.....	2
Getting Started	3
Radio.....	6
CD/USB/iPod/AUX.....	7
Bluetooth	8
App Mode	11
Pandora®	12
Spotify®	12
Using Pioneer ARC APP.....	13
Audio adjustments	14
Settings	15
FUNCTION settings	15
AUDIO settings.....	16
SYSTEM settings	17
ILLUMINATION settings	18
MIXTRAX settings	18
Connections/Installation	19
Additional Information	22

About this manual:

- In the following instructions, a USB memory or USB audio player are referred to as “USB device”.
- In this manual, iPod and iPhone are referred to as “iPod”.

Before You Start

Thank you for purchasing this PIONEER product

To ensure proper use, please read through this manual before using this product. It is especially important that you read and observe **WARNINGS** and **CAUTIONS** in this manual. Please keep the manual in a safe and accessible place for future reference.

FCC ID: AJDK071

MODEL NO.: DEH-X6900BT/DEH-X6910BT

IC: 775E-K071

This device complies with Part 15 of FCC Rules and Industry Canada licence-exempt RSS standard(s). Operation is subject to the following two conditions: (1) this device may not cause interference, and (2) this device must accept any interference, including interference that may cause undesired operation of this device.

This transmitter must not be co-located or operated in conjunction with any other antenna or transmitter.

The Bluetooth antenna cannot be removed (or replaced) by user.

This equipment complies with FCC/IC radiation exposure limits set forth for an uncontrolled environment and meets the FCC radio frequency (RF) Exposure Guidelines and RSS-102 of the IC radio frequency (RF) Exposure rules. This equipment has very low levels of RF energy that it deemed to comply without maximum permissive exposure evaluation (MPE). But it is desirable that it should be installed and operated keeping the radiator at least 20cm or more away from person's body (excluding extremities: hands, wrists, feet and ankles).

Alteration or modifications carried out without appropriate authorization may invalidate the user's right to operate the equipment.

Note

This equipment has been tested and found to comply with the limits for a Class B digital device, pursuant to Part 15 of the FCC Rules. These limits are designed to provide reasonable protection against harmful interference in a residential installation. This equipment generates, uses and can radiate radio frequency energy and, if not installed and used in accordance with the instructions, may cause harmful interference to radio communications. However, there is no guarantee that interference will not occur in a particular installation. If this equipment does cause harmful interference to radio or television reception, which can be determined by turning the equipment off and on, the user is encouraged to try to correct the interference by one or more of the following measures:

- Reorient or relocate the receiving antenna.
- Increase the separation between the equipment and receiver.
- Connect the equipment into an outlet on a circuit different from that to which the receiver is connected.
- Consult the dealer or an experienced radio/TV technician for help.

The Safety of Your Ears is in Your Hands

Get the most out of your equipment by playing it at a safe level—a level that lets the sound come through clearly without annoying blaring or distortion and, most importantly, without affecting your sensitive hearing. Sound can be deceiving.

Over time, your hearing “comfort level” adapts to higher volumes of sound, so what sounds “normal” can actually be loud and harmful to your hearing. Guard against this by setting your equipment at a safe level BEFORE your hearing adapts.

ESTABLISH A SAFE LEVEL:

- Set your volume control at a low setting.
- Slowly increase the sound until you can hear it comfortably and clearly, without distortion.
- Once you have established a comfortable sound level, set the dial and leave it there.

BE SURE TO OBSERVE THE FOLLOWING GUIDELINES:

- Do not turn up the volume so high that you can't hear what's around you.
- Use caution or temporarily discontinue use in potentially hazardous situations.
- Do not use headphones while operating a motorized vehicle; the use of headphones may create a traffic hazard and is illegal in many areas.

⚠ WARNING

- **Do not attempt to install or service this product by yourself. Installation or servicing of this product by persons without training and experience in electronic equipment and automotive accessories may be dangerous and could expose you to the risk of electric shock, injury or other hazards.**
- Do not attempt to operate the unit while driving. Make sure to pull off the road and park your vehicle in a safe location before attempting to use the controls on the device.

CAUTION:
USE OF CONTROL OR ADJUSTMENT OR PERFORMANCE OF PROCEDURES OTHER THAN THOSE SPECIFIED HEREIN MAY RESULT IN HAZARDOUS RADIATION EXPOSURE.

CAUTION:
THE USE OF OPTICAL INSTRUMENTS WITH THIS PRODUCT WILL INCREASE EYE HAZARD.

⚠ CAUTION

- Do not allow this unit to come into contact with moisture and/or liquids. Electrical shock could result. Also, damage to this unit, smoke, and overheating could result from contact with liquids.
- Always keep the volume low enough to hear outside sounds.
- This product is evaluated in moderate and tropical climate condition under the Audio, video and similar electronic apparatus - Safety requirements, IEC 60065.

CAUTION

This product is a class 1 laser product classified under the Safety of laser products, IEC 60825-1:2007.

CLASS 1 LASER PRODUCT

After-sales service for Pioneer products

Please contact the dealer, distributor from where you purchased this unit or the authorized PIONEER Service Station for after-sales service or any other information. In case the necessary information is not available, please contact the companies listed below:

Please do not ship your unit to the companies at the addresses listed below for repair without contacting them in advance.

Getting Started

Basic operation

DEH-X6900BT/X6910BT

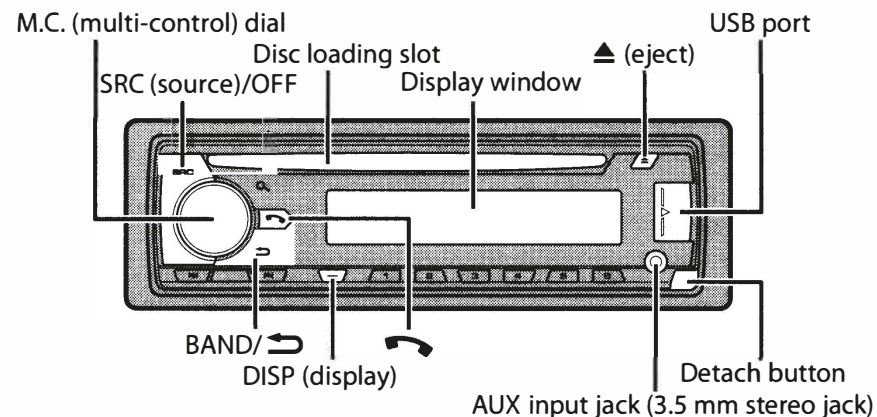

Remote Control

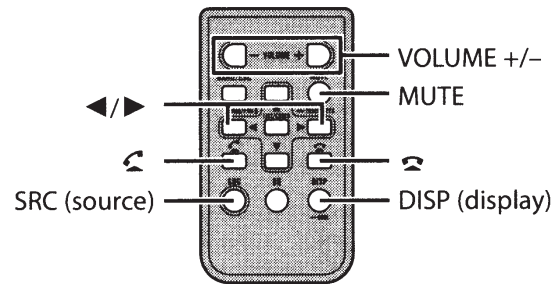

Frequently used operations

The available buttons vary depending on the unit.

Purpose	Operation	
	Head Unit	Remote Control
Turn on the power*	Press SRC/OFF to turn on the power. Press and hold SRC/OFF to turn off the power.	Press SRC to turn on the power. Press and hold SRC to turn off the power.
Adjust the volume	Turn the M.C. dial.	Press VOLUME + or - . Press MUTE to mute the unit. Press again to unmute.
Select a source	Press SRC/OFF repeatedly.	Press SRC repeatedly.
Change the display information	Press DISP repeatedly.	Press DISP repeatedly.
Return to the previous display/list	Press BAND/↶ .	Press ◀/▶ to select the next/previous folder.
Return to the normal display from the menu	Press and hold BAND/↶ .	-
Answering a call	Press ☎ .	Press ☎ .
Ending a call	Press ☎ .	Press ☎ .

* When this unit's blue/white lead is connected to the vehicle's auto-antenna relay control terminal, the vehicle's antenna extends when this unit's source is turned on. To retract the antenna, turn the source off.

Display indication

Indication	Description
	Appears when a lower tier of the menu or folder exists.
	Appears when a Bluetooth telephone is connected to this unit by HFP (Hands Free Profile) (page 8) and flashes while the telephone is on hold.
	Appears when a Bluetooth audio player is connected to this unit by A2DP (Advanced Audio Distribution Profile) (page 8).
	Appears when the button is pressed.
	Appears when the sound retriever function is set (page 15).
	Appears when random/shuffle play is set (except when BT AUDIO is selected as the source).
	Appears when repeat play is set (except when BT AUDIO is selected as the source).
	Appears when the iPod control function is set (page 8).
	Appears when a Bluetooth connection is made (page 8).

Detaching the front panel

Detach the front panel to prevent theft. Remove any cables and devices attached to the front panel and turn off the unit before detaching it.

Detach

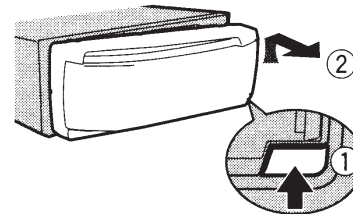

Attach

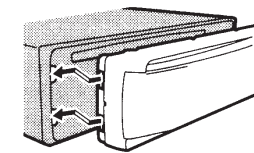

Important

- Avoid subjecting the front panel to excessive shock.
- Keep the front panel out of direct sunlight and high temperatures.
- Always store the detached front panel in a protective case or bag.

Resetting the microprocessor

The microprocessor must be reset in the following situations:

- Before using this unit for the first time after installation

- If the unit fails to operate properly
- When strange or incorrect messages appear on the display

- 1 Remove the front panel (page 4).
- 2 Press the RESET button with a pointed instrument longer than 8 mm.

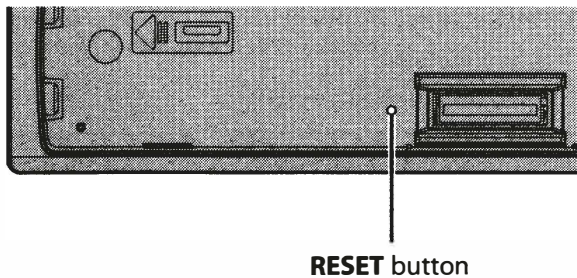

Preparing the remote control

Remove the insulation sheet before use.

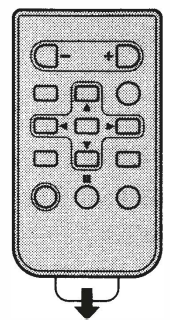

How to replace the battery

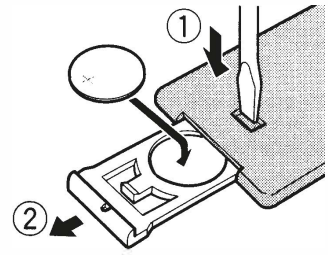

Insert the CR2025 (3 V) battery with the plus (+) and minus (-) poles orientated properly.

WARNING

- Do not ingest the battery, Chemical Burn Hazard (The remote control supplied with) This product contains a coin/button cell battery. If the coin/button cell battery is swallowed, it can cause severe internal burns in just 2 hours and can lead to death. Keep new and used batteries away from children. If the battery compartment does not close securely, stop using the product and keep it away from children. If you think batteries might have been swallowed or placed inside any part of the body, seek immediate medical attention.
- Do not expose the battery or remote control to excessive heat such as direct sunlight or fire.

CAUTION

- There is a potential danger of explosion if the battery is incorrectly replaced. When replacing the battery, replace it with the same type.
- Do not handle or store the battery with metallic tools or objects.
- If the battery leaks, remove the battery and wipe the remote control completely clean. Then install a new battery.
- When disposing of used batteries, please comply with governmental regulations or environmental public institutions' rules that apply in your country/area.
- "Perchlorate Material - special handling may apply."

Important

- Do not store the remote control in high temperatures or direct sunlight.
- Do not let the remote control fall onto the floor, where it may become jammed under the brake or accelerator pedal.

Setup menu

When you turn the ignition switch to ON after installation, the setup menu appears in the display.

WARNING

Do not use the unit in standard mode when a speaker system for network mode is connected to the unit. Do not use the unit in network mode when a speaker system for standard mode is connected to the unit. This may cause damage to the speakers.

- 1 Turn the M.C. dial to select the options, then press to confirm. To proceed to the next menu option, you need to confirm your selection.

Menu Item	Description
CLOCK SET	Set the clock. <ol style="list-style-type: none"> 1 Turn the M.C. dial to adjust the hour, then press to confirm. The indicator moves to the minute setting automatically. 2 Turn the M.C. dial to adjust the minute, then press to confirm.
SPEAKER MODE [STANDARD], [NETWORK]	Switch between two operation modes: the 2-way network mode (NETWORK) and the standard mode (STANDARD) according to the connections you have established. For details on operation modes, see page 14. After selecting the appropriate mode, turn the M.C. dial to select [YES], then press to confirm. <ul style="list-style-type: none"> • You cannot complete the setup menu without setting the [SPEAKER MODE]. • Once the speaker mode is set, this setting cannot be changed unless the default settings of this product are restored. Restore the default settings to change the speaker mode setting (refer to SYSTEM RESET on page 6).

2 [QUIT :YES] appears when all the settings have been made.
To return to the first item of the setup menu, turn the **M.C.** dial to select [QUIT :NO], then press to confirm.

3 Press the **M.C.** dial to confirm the settings.

NOTE

[CLOCK SET] can be made at any time. See page 17 for more details.

Canceling the demonstration display (DEMO OFF)

- 1** Press the **M.C.** dial to display the main menu.
- 2** Turn the **M.C.** dial to select [SYSTEM], then press to confirm.
- 3** Turn the **M.C.** dial to select [DEMO OFF], then press to confirm.
- 4** Turn the **M.C.** dial to select [YES], then press to confirm.

INITIAL settings

- 1** Press and hold **SRC/OFF** until the unit turns off.
- 2** Press the **M.C.** dial to display the main menu.
- 3** Turn the **M.C.** dial to select [INITIAL], then press to confirm.
- 4** Turn the **M.C.** dial to select an option, then press to confirm.

NOTE

The options vary depending on the unit.

Menu Item	Description
REAR-SP [FUL] [SW]	Select when there is a full-range speaker connected to the rear speaker output leads. Select when there is a subwoofer connected directly to the rear speaker output leads without any auxiliary amplifier.
SYSTEM UPDATE [SYSTEM INFO], [S/W UPDATE]	Select [SYSTEM INFO] to confirm the latest system information on the unit. Select [S/W UPDATE] to update the unit to the latest software and initialize the unit settings. For details on the latest software and updating, visit our website.

Menu Item	Description
SYSTEM RESET [YES], [CANCEL]	Select [YES] to initialize the unit settings. The unit will be restarted automatically. (Some of the settings may be retained even after resetting the unit.)

Radio

The tuner frequencies on this unit are allocated for use in North America. Use in other areas may result in poor reception.

Receiving preset stations

- 1** Press **SRC/OFF** to select [RADIO].
- 2** Press **BAND/↶** to select the band from [FM1], [FM2], [FM3] or [AM].
- 3** Press a number button (1/∧ to 6/↷).

NOTE

You can select a preset channel by pressing **Q** and turning the **M.C.** dial.

TIP

The **◀▶** buttons can be also used to select a preset station when [SEEK] is set to [PCH] in the **FUNCTION** settings (page 15).

Best stations memory (BSM)

The six strongest stations are stored on the number buttons (1/∧ to 6/↷).

- 1** After selecting the band, press the **M.C.** dial to display the main menu.
- 2** Turn the **M.C.** dial to select [FUNCTION], then press to confirm.
- 3** Turn the **M.C.** dial to select [BSM], then press to confirm.

To seek a station manually

- 1** After selecting the band, press **◀▶** to select a station.
Press and hold **◀▶** then release to seek an available station. Scanning stops when the unit receives a station. To cancel seek tuning, press **◀▶**.

NOTE

[SEEK] needs to be set to [MAN] in the **FUNCTION** settings (page 15).

To store stations manually

- 1 While receiving the station you want to store, press and hold one of the number buttons (1/▲ to 6/↶) until it stops flashing.

NOTE

You can select a preset channel by pressing **Q** and turning the **M.C.** dial. After selecting a channel, press and hold the **M.C.** dial to store a station.

CD/USB/iPod/AUX

Playing back

Disconnect headphones from the device before connecting it to the unit.

CD

- 1 Insert a disc into the disc loading slot with the label side up.

To eject a disc, stop playback first then press ▲.

USB devices (including Android™)/iPod

- 1 Open the USB port cover.
- 2 Plug in the USB device/iPod using an appropriate cable.

NOTE

To automatically switch to [USB] source when a USB device/iPod is connected to the unit, set [USB AUTO] to [ON] in the SYSTEM settings (page 18).

CAUTION

Use an optional Pioneer USB cable (CD-U50E) to connect the USB device as any device connected directly to the unit will protrude out from the unit, which could be dangerous.

Before removing the device, stop playback.

AOA connections

For details on AOA connection, see page 13.

MTP connection

A device installed with Android OS 4.0 or later can be connected to the unit via MTP, using the cable supplied with the device. However, depending on the connected device and the numbers of the files in the device, audio files/songs may not be able to be played back via MTP. Note that MTP connection is not compatible with WAV file formats and FLAC file formats, and cannot be used with the MIXTRAX function.

NOTE

If you use an MTP connection, [ANDROID WIRED] needs to be set to [MEMORY] in the SYSTEM settings (page 17).

AUX

- 1 Insert the stereo mini plug into the AUX input jack.
- 2 Press **SRC/OFF** to select [AUX] as the source.

NOTE





If [AUX] is set to [OFF] in the SYSTEM settings, [AUX] cannot be selected as a source (page 17).

Operations

You can make various adjustments in the FUNCTION settings (page 15).

Note that the following operations do not work for an AUX device. To operate an AUX device, use the device itself.

Purpose	Operation
Select a folder/album*1	Press 1/▲ or 2/▼.
Select a track/song (chapter)	Press ◀◀ or ▶▶.
Fast forward or reverse*2	Press and hold ◀◀ or ▶▶.
Search for a file from a list	<ol style="list-style-type: none"> 1 Press Q to display the list. 2 Turn the M.C. dial to select the desired file (folder) name or category, then press to confirm. 3 Turn the M.C. dial to select the desired file, then press to confirm. Playback starts.
View a list of the files in the selected folder/category*1	Press the M.C. dial when a folder/category is selected.
Play a song in the selected folder/category*1	Press and hold the M.C. dial when a folder/category is selected.
Alphabetical search (iPod only)	<ol style="list-style-type: none"> 1 Press Q to display the list. 2 Turn the M.C. dial to select the desired category list, then press Q to enter the alphabetical search mode. (Turning the M.C. dial twice also enters the alphabetical search mode.) 3 Turn the M.C. dial to select a letter, then press to display the alphabetical list. <p>To cancel alphabetical search, press BAND/↶.</p>

Purpose	Operation
Repeat play	Press 6 /  .
Random/shuffle play	Press 5 /  .
Shuffle all play (iPod only)	Press and hold 5 /  .
Pause/resume playback	Press 4 / PAUSE .
Return to root folder (CD/USB only)*1	Press and hold  .
Switch between compressed audio and CD-DA (CD only)	Press BAND /  .

*1 Compressed audio files only

*2 When you use the fast forward or reverse function while playing a VBR file, the playback time may be not correct.

Useful functions for iPod

Link play mode

You can access songs based on the artist, album, or genre currently playing.

- 1 While listening to a song, press and hold  to enter the link play mode.
- 2 Turn the M.C. dial to select the mode ([ARTIST], [ALBUM], [GENRE]), then press to confirm.

The selected song/album will be played after the currently playing song.

NOTE

The selected song/album may be canceled if you use functions other than those from the link play mode (e.g. fast forward and reverse).

iPod control

You can control the unit via a connected iPod.

The following iPod models are not compatible with this function.

- iPod nano 1st generation, iPod with video

- 1 Press **BAND**/ during playback, then select the control mode.

[CONTROL iPod]: The unit's iPod function can be operated from the connected iPod.

[CONTROL AUDIO]: The unit's iPod function can only be operated by the buttons on the unit or supplied remote control. In this mode, the connected iPod cannot be turned on or off.

NOTES

- Switching the control mode to [CONTROL iPod] pauses song playback. Use the connected iPod to resume playback.
- The following operations are still accessible from the unit, even if the control mode is set to [CONTROL iPod].

- Pause, fast forward/reverse, song/chapter selection
- The volume can only be adjusted from the unit.

About MIXTRAX (USB/iPod only)

The MIXTRAX function creates a non-stop mix of your music library, accompanied by illumination effects. For details on MIXTRAX settings, see page 18.

NOTES

- This function is not compatible with an Android device connected via MTP.
- Depending on the file/song, sound effects may not be available.
- Turn the MIXTRAX function off if the illumination effects it produces interfere with driving.

- 1 Press **3**/MIX to turn MIXTRAX on/off.

Bluetooth

Bluetooth connection

Important

If three or more Bluetooth devices (e.g. a phone and separate audio player) are connected, they may not work properly.

- 1 Turn on the Bluetooth function of the device.
- 2 Press  to display the phone menu.
- 3 Turn the M.C. dial to select [BT SETTING], then press to confirm.
- 4 Turn the M.C. dial to select [ADD DEVICE], then press to confirm.
The unit starts to search for available devices, then displays them in the device list.
 - To cancel searching, press the M.C. dial.
 - If the desired device is not in the list, select [RE-SEARCH].
 - If there is no device available, [NOT FOUND] appears in the display.
- 5 Turn the M.C. dial to select a device from the device list, then press to confirm.
Press and hold the M.C. dial to switch the displayed device information between the Bluetooth device address and device name.
- 6 Select [Pioneer BT Unit] shown in the device display.
- 7 Make sure the same 6-digit number appears on this unit and the device, then select "Yes" on the device.

NOTES

- [DEVICE FULL] appears if the unit has already been paired with three other devices. In this case, delete one of the paired devices. See [DEL DEVICE] or [GUEST MODE] in the Bluetooth settings (page 9).
- Depending on the device, the PIN code is required in step 7. In this case, input [0000].

TIP

The Bluetooth connection can be also made by detecting the unit from the Bluetooth device. To do so, [VISIBLE] in the Bluetooth settings needs to be set to [ON]. For details on a Bluetooth device operations, refer to the operating instructions supplied with the Bluetooth device.

Bluetooth settings

Menu Item	Description
DEVICELIST	Display the list of paired Bluetooth devices. "*" appears on the device name when the Bluetooth connection is established.
DEL DEVICE [DELETE YES], [DELETE NO]	Delete the device information.
ADD DEVICE	Register a new device.
A.CONN [ON], [OFF]	Select [ON] to connect to a Bluetooth device automatically.
VISIBLE [ON], [OFF]	Select [ON] so that a Bluetooth device can detect the unit when the unit is connected via Bluetooth to another device.
PIN CODE	Change the PIN code. <ol style="list-style-type: none"> 1 Press the M.C. dial to display the setting mode. 2 Turn the M.C. dial to select a number. 3 Press the M.C. dial to move the cursor to the next position. 4 After inputting the PIN code, press and hold the M.C. dial. After inputting the PIN code, pressing the M.C. dial returns you to the PIN code input display, and you can change the PIN code.
DEV. INFO	Switch the device information on the display between the device name and Bluetooth device address.
GUEST MODE [ON], [OFF]	Select [ON] to move to the [DEL DEVICE] screen automatically when the unit has already been paired with three devices.
A.PAIRING [ON], [OFF]	Select [ON] to pair the unit and iPhone automatically when an iPhone is connected to the unit via USB. (This function may not be available depending on the version of iOS you are using.)



Bluetooth telephone

First, make a Bluetooth connection with the Bluetooth telephone (page 8). Up to two Bluetooth telephones can be connected simultaneously.

Important

- Leaving the unit on standby to connect to your phone via Bluetooth while the engine is not running can drain the vehicle's battery.
- Be sure to park your vehicle in a safe place and apply the parking brake before operation.

To make a phone call

- 1 Press  to display the phone menu.
When two phones are connected, a phone name appears first then a phone menu will display. To switch to another phone, press  again.
- 2 Turn the **M.C.** dial to select [RECENTS] or [PHONE BOOK], then press to confirm.
If you select [PHONE BOOK], proceed to step 4.
- 3 Turn the **M.C.** dial to select [MISSED], [DIALED] or [RECEIVED], then press to confirm.
- 4 Turn the **M.C.** dial to select a name or phone number, then press to confirm.
The phone call starts.



To answer an incoming call

- 1 Press  when a call is received.

TIP



When two phones are connected to the unit via Bluetooth and there is an incoming call while one phone is being used for a call, a message will appear in the display. To answer that incoming call, you need to end the existing call.



Basic operations

Purpose	Operation
End a call	Press  .
Reject an incoming call	Press and hold  when a call is received.
Switch between the current caller and a caller on hold	Press the M.C. dial.
Cancel a caller on hold	Press and hold  .
Adjust the volume of the caller's voice (When private mode is on, this function is not available.)	Turn the M.C. dial during the call.

Purpose	Operation
Turn the private mode on or off	Press BAND/  during the call.

To preset phone numbers

- 1 Select a phone number from a phone book or call history.
- 2 Press and hold one of the number buttons (1/  to 6/ ).
The contact is stored in the selected preset number.

To make a call using a preset number, press one of the number buttons (1/  to 6/ ), then press the **M.C.** dial.

Voice recognition (Only for iPhone)

This function is only available when an iPhone equipped with voice recognition is connected to the unit via Bluetooth.



- 1 Press and hold  to activate the voice recognition mode.
- 2 Press the **M.C.** dial and then talk into the microphone to input voice commands.

To exit the voice recognition mode, press **BAND/** .

NOTE

For details on the voice recognition features, refer to the manual supplied with your iPhone.

Phone menu

Menu Item	Description
RECENTS	Display the missed call history.
[MISSED]	
[DIALED]	Display the dialed call history.
[RECEIVED]	Display the received call history.
PHONE BOOK*1	Display the contacts which have been transferred from your phone. Set [VISIBLE] in the Bluetooth settings to [ON] to browse the contacts via this unit.
PRESET 1-6	Recall the preset phone numbers. You can also recall the preset phone numbers by pressing one of the number buttons (1/  to 6/  .
A.ANSR*2	Select [ON] to answer an incoming call automatically.
[ON], [OFF]	

Menu Item	Description
R.TONE	Select [ON] if the ring tone does not come out from the car speakers. Depending on the connected phone, this function may not work.
[ON], [OFF]	
PB INVT	Invert the order of names in the phone book (name view).
PB A.SYNC	Select whether or not to transfer the contacts from your phone automatically when your phone is connected to the unit.
[ON], [OFF]	<ul style="list-style-type: none"> • When connected for the first time, the contacts from your phone are transferred automatically, regardless of the [PB A.SYNC] setting. • If you switch from [ON] to [OFF], the auto synchronization will not be performed on the next connection. • If you switch from [OFF] to [ON], the auto synchronization will be performed when your phone is connected to the unit. • During the auto synchronization, you cannot cancel the synchronization, even if you select [OFF].
BT SETTING	You can adjust various settings for Bluetooth connections. For details on Bluetooth settings, see page 9.

*1 The contacts on your phone will normally be transferred automatically when the phone is connected. If they are not, use your phone to transfer the contacts.

*2 If two phones are connected, this function does not work on incoming calls that are received while one of the phones is being used for a call.

Bluetooth audio

Important

- Depending on the Bluetooth audio player connected to this unit, the available operations will be limited to the following two levels:
 - A2DP (Advanced Audio Distribution Profile) can only play back songs on your audio player.
 - AVRCP (Audio/Video Remote Control Profile) can perform functions such as playback, pause, select song, etc.
- The sound of the Bluetooth audio player will be muted when the phone is in use.
- When the Bluetooth audio player is in use, you cannot connect to a Bluetooth telephone automatically.
- Depending on the type of Bluetooth audio player you have connected to this unit, operation and information displayed may vary based on availability and functionality.

- 1 Make a Bluetooth connection with the Bluetooth audio player.
- 2 Press **SRC/OFF** to select [BT AUDIO] as the source.
- 3 Press **BAND/**  to start playback.

Basic operations

You can make various adjustments in the FUNCTION settings (page 15).

Purpose	Operation
Fast forward or reverse	Press and hold ⏮ or ⏭ .
Select a track	Press ⏮ or ⏭ .
Repeat play*	Press 6 / ↺ .
Random play*	Press 5 / ⌘ .
Pause/resume playback	Press 4 / PAUSE .
Search for a file from a list	<ol style="list-style-type: none"> 1 Press Q to display a list. 2 Turn the M.C. dial to select the desired folder name, then press to confirm. 3 Turn the M.C. dial to select the desired file, then press to confirm. Playback starts.

* Depending on the connected device, these operations may not be available.

App Mode

You can enjoy listening to an application on an iPhone/Android device via the unit. In some cases, you can control an application by using the unit.

For details on compatible devices, visit our website.

Important

Use of third party apps may involve or require the provision of personally identifiable information, whether through the creation of a user account or otherwise, and for certain applications, the provision of geolocation data.

ALL THIRD PARTY APPS ARE THE SOLE RESPONSIBILITY OF THE PROVIDERS, INCLUDING WITHOUT LIMITATION COLLECTION AND SECURITY OF USER DATA AND PRIVACY PRACTICES. BY ACCESSING THIRD PARTY APPS, YOU AGREE TO REVIEW THE TERMS OF SERVICE AND PRIVACY POLICIES OF THE PROVIDERS. IF YOU DO NOT AGREE WITH THE TERMS OR POLICIES OF ANY PROVIDER OR DO NOT CONSENT TO THE USE OF GEOLOCATION DATA WHERE APPLICABLE, DO NOT USE THAT THIRD PARTY APP.

For iPhone users

This function is compatible with iPhones and iPod touches installed with iOS 5.0 or later.

For Android device users

This function is compatible with devices that have Android OS 2.3 or later installed.

NOTE

PIONEER IS NOT LIABLE FOR ANY THIRD PARTY APPS OR CONTENT, INCLUDING WITHOUT LIMITATION THEIR ACCURACY OR COMPLETENESS. THE CONTENT AND FUNCTIONALITY OF SUCH APPS ARE THE SOLE RESPONSIBILITY OF THE APP PROVIDER.

Playback of an application via the unit

- 1 **Connect this unit with the mobile device.**
 - iPhone via USB (page 7)
 - iPhone/Android device via Bluetooth (page 8)
 - 2 **Press the M.C. dial to display the main menu.**
 - 3 **Turn the M.C. dial to select [SYSTEM], then press to confirm.**
 - 4 **Turn the M.C. dial to select [PHONE CONNECT], then press to confirm.**
 - 5 **Turn the M.C. dial to select one of the below, then press to confirm.**
 - Select [IPHONE/IPOD] for iPhone.
 - Select [ANDROID] for Android device.
 - 6 **Turn the M.C. dial to select one of the below.**
 - Select [WIRED] for the USB connection.
 - Select [BLUETOOTH] for the Bluetooth connection.
- NOTE**
When the connection setting is changed, a message that lets you know that the connection setting had been changed will appear in the display. Press the **M.C.** dial and turn the **M.C.** dial to select [SRC OFF :YES], then press to confirm. The unit turns off automatically and the setting is executed.
- 7 **Press SRC/OFF to select [APP].**
 - 8 **Operate the mobile device to start up the application.**

Basic operations

You can make various adjustments in the FUNCTION settings (page 15).

Purpose	Operation
Select a track	Press ⏮ or ⏭ .
Fast forward or reverse	Press and hold ⏮ or ⏭ .
Pause/resume playback	Press BAND / ↺ .

Pandora®

Listening to Pandora

Update the firmware of the Pandora application to the latest version before use.

- 1 Connect this unit with the mobile device.**
 - iPhone via USB (page 7)
 - iPhone/Android device via Bluetooth (page 8)

If you choose a USB connection, proceed to step 6.
 - 2 Press SRC/OFF to select [PANDORA].**
 - 3 Press and hold BAND/↶ to display [PHONE CONNECT].**
 - 4 Turn the M.C. dial to select one of the below, then press to confirm.**
 - Select [IPHONE/IPOD] for iPhone.
 - Select [ANDROID] for Android device.
 - 5 Turn the M.C. dial to select [BLUETOOTH] for iPhone/Android device via Bluetooth.**
- NOTE**
When the connection setting is changed, a message that lets you know that the connection setting had been changed will appear in the display. Press the **M.C.** dial and turn the **M.C.** dial to select [SRC OFF :YES], then press to confirm. The unit turns off automatically and the setting is executed.
- 6 Press SRC/OFF to select [PANDORA].**
 - 7 Launch the Pandora application on the mobile device and start playback.**

Basic operations

You can make various adjustments in the FUNCTION settings (page 15).

Purpose	Operation
Skip a track	Press ►►.
Switch between Shuffle and the station	Press 🔍 (list), then turn the M.C. dial to select the Shuffle or the desired station.

Purpose	Operation
Change the sort order	Press 🔍 (list), then select one of the following. [ABC]: Sort the items in the list alphabetically. [DATE]: Sort the items in the list in order of the dates on which the items were created.
Play	When Shuffle or the station is selected, press the M.C. dial.
Delete a station	1 When the station is selected, press and hold the M.C. dial. [DELETE YES] appears. 2 Press the M.C. dial. To cancel, press BAND/↶ in step 1.
Pause/resume playback	Press 4/PAUSE .
Thumbs Up	Press 1/∧ .
Thumbs Down	Press 2/∨ .
Create a new station based on the track currently being played	Press and hold 5/🔀 .
Create a new station based on the artist currently being played	Press and hold 6/↻ .

NOTE

Some functions of Pandora may not be operated from the unit.

Spotify®

To enjoy Spotify as you drive, first download the Spotify app to your iPhone or Android device. You can download it on the iTunes App Store or Google Play™. Choose a free account or a paid Premium account, either in the app or at [spotify.com](https://www.spotify.com). A Premium account gives you more features, like offline listening.

Listening to Spotify

Update the firmware of the Spotify application to the latest version before use.

1 Connect this unit with the mobile device.

- iPhone via USB (page 7)
 - iPhone/Android device via Bluetooth (page 8)
- If you choose a USB connection, proceed to step 6.

2 Press SRC/OFF to select [SPOTIFY].

3 Press and hold BAND/↶ to display [PHONE CONNECT].

4 Turn the M.C. dial to select one of the below, then press to confirm.

- Select [IPHONE/IPOD] for iPhone.
- Select [ANDROID] for Android device.

5 Turn the M.C. dial to select [BLUETOOTH] for iPhone/Android device via Bluetooth.

NOTE

When the connection setting is changed, a message that lets you know that the connection setting had been changed will appear in the display. Press the **M.C.** dial and turn the **M.C.** dial to select [SRC OFF :YES], then press to confirm. The unit turns off automatically and the setting is executed.

6 Press SRC/OFF to select [SPOTIFY].

7 Launch the Spotify application on the mobile device and start playback.

Basic operations

You can make various adjustments in the FUNCTION settings (page 15).

NOTE

The available operations may vary according to the type of contents (track/album/artist/playlist/radio) you want to play.

Purpose	Operation
Skip a track	Press ⏮ or ⏭ .
Search for a track from a list	<ol style="list-style-type: none"> 1 Press 🔍 (list) to display the list. 2 Turn the M.C. dial to select the desired category, then press to confirm. 3 Turn the M.C. dial to select the desired file, then press to confirm. Playback starts.
Pause/resume playback	Press 4/PAUSE .

Purpose	Operation
Thumbs Up (Only for radio)	Press 1/▲ .
Thumbs Down (Only for radio)	Press 2/▼ .
Random play (Only for track/album/artist/playlist)	Press 5/🎲 .
Repeat play (Only for track/album/artist/playlist)	Press 6/↺ .
Start a radio channel based on the song currently being played.	<ol style="list-style-type: none"> 1 Press and hold 🔍 (list) to start a radio. 2 Press the M.C. dial. <ul style="list-style-type: none"> • This function may not be available depending on the selected song.

NOTE

Some functions of Spotify may not be operated from the unit.

Using Pioneer ARC APP

You can operate the unit from Pioneer ARC APP installed on an iPhone/Android device. In some cases, you can control aspects of the application, such as source selection, pause, etc., by using the unit.

For details on what operations are available on the application, see the application's help section.

⚠ WARNING

Do not attempt to operate the application while driving. Make sure to pull off the road and park your vehicle in a safe location before attempting to use the controls on the application.

For iPhone users

This function is compatible with iPhones (iPhone 5 or later) and iPod touches (5th and 6th generation) installed with iOS 8.0 or later.

You can download Pioneer ARC APP on iTunes App Store.

For Android device users

This function is compatible with devices that have Android OS 4.1 or later installed and also support AOA (Android Open Accessory) 2.0.

You can download Pioneer ARC APP on Google Play.

NOTE

Some Android devices connected via AOA 2.0 may not work properly or emit sounds due to their own software design, regardless of the OS version.

Making a connection with Pioneer ARC APP

- 1 Connect this unit with the mobile device.
 - iPhone/Android device via USB (page 7)
 - iPhone/Android device via Bluetooth (page 8)
 - 2 Press the **M.C.** dial to display the main menu.
 - 3 Turn the **M.C.** dial to select [SYSTEM], then press to confirm.
 - 4 Turn the **M.C.** dial to select [PHONE CONNECT], then press to confirm.
 - 5 Turn the **M.C.** dial to select one of the below, then press to confirm.
 - Select [IPHONE/IPOD] for iPhone.
 - Select [ANDROID] for Android device.
 - 6 Turn the **M.C.** dial to select one of the below.
 - Select [WIRED] for the USB connection.
 - Select [BLUETOOTH] for the Bluetooth connection.Proceed to step 10 if you select the USB connection for iPhone or the Bluetooth connection.
- NOTE**
When the connection setting is changed, a message that lets you know that the connection setting had been changed will appear in the display. Press the **M.C.** dial and turn the **M.C.** dial to select [SRC OFF :YES], then press to confirm. The unit turns off automatically and the setting is executed.
- 7 Repeat steps 2 to 3.
 - 8 Turn the **M.C.** dial to select [ANDROID WIRED], then press to confirm.
 - 9 Turn the **M.C.** dial to select [APP CONTROL] for an Android device connected via USB.

If [ON] is selected in [P.APP AUTO ON] (page 17), Pioneer ARC APP on the Android device starts automatically, and all the steps are finished.
- NOTE**
If Pioneer ARC APP has not been installed on your Android device yet, a message that prompts you to install the application will appear on your Android device. Select [OFF] in [P.APP AUTO ON] to clear the message (page 17).
- 10 Press **SRC/OFF** to select any source.
 - 11 Launch Pioneer ARC APP on the mobile device.
- NOTE**
You can also launch the application by pressing and holding the **M.C.** dial if you select the USB connection for iPhone or the Bluetooth connection.

Listening to music on Android

- 1 Press **SRC/OFF** to select [ANDROID].

Basic operations

Purpose	Operation
Select a track	Press ◀◀ or ▶▶.
Fast forward or reverse	Press and hold ◀◀ or ▶▶.
Pause/resume playback	Press 4/PAUSE.

Audio adjustments

You can also make various adjustments in the AUDIO settings (page 16).

Operation modes

This unit features two operation modes: network mode and standard mode. You can switch between modes as desired (page 5).

Network mode

You can create a 2-way + SW multi-amp and multi-speaker system with high range speaker, middle range speaker and subwoofer for reproduction of high, middle and low frequencies (bands).

Standard mode

You can create a 4-speaker system with front and rear speakers or front speakers and subwoofers, or a 6-speaker system with front and rear speakers and subwoofers.

Adjusting the cut-off frequency value and the slope value

You can adjust the cut-off frequency value and the slope value of each speaker. The following speakers can be adjusted.

Network mode:

[HIGH] (high-range speaker HPF), [MID HPF] (middle-range speaker HPF), [MID LPF] (middle-range speaker LPF), [SUBWOOFER]

Standard mode:

[FRONT], [REAR], [SUBWOOFER]

NOTE

[SUBWOOFER] can only be selected when [ON] is selected in [SUBWOOFER] (page 16).

- 1** Press the **M.C.** dial to display the main menu.
- 2** Turn the **M.C.** dial to select [AUDIO], then press to confirm.
- 3** Turn the **M.C.** dial to select [CROSSOVER], then press to confirm.
- 4** Turn the **M.C.** dial to select the speaker unit (filter) to be adjusted, then press to confirm.
- 5** Turn the **M.C.** dial to select [HPF] or [LPF] according to the speaker unit (filter), then press to confirm.
- 6** Turn the **M.C.** dial to select an appropriate cut-off frequency for the speaker unit (filter) selected in step 4, then press to confirm.

Network mode:
[1.25K] to [12.5K] (if you choose [HIGH] or [MID LPF])
[25] to [250] (if you choose [MID HPF] or [SUBWOOFER])

Standard mode:
[50HZ] to [200HZ]
- 7** Turn the **M.C.** dial to select an appropriate slope for the speaker unit (filter) selected in step 4.

Network mode:
[-6] to [-24] (if you choose [HIGH], [MID HPF] or [MID LPF])
[-12] to [-36] (if you choose [SUBWOOFER])

Standard mode:
[-6] to [-24]

Settings

You can adjust various settings in the main menu.

- 1** Press the **M.C.** dial to display the main menu.
- 2** Turn the **M.C.** dial to select one of the categories below, then press to confirm.
 - FUNCTION settings (page 15)
 - AUDIO settings (page 16)
 - SYSTEM settings (page 17)

- ILLUMINATION settings (page 18)
- MIXTRAX settings (page 18)

- 3** Turn the **M.C.** dial to select the options, then press to confirm.

FUNCTION settings

The menu items vary according to the source.

Menu Item	Description
BSM <input type="button" value="RADIO"/>	Store the six strongest stations on the number buttons (1/▲ to 6/↻) automatically.
LOCAL <input type="button" value="RADIO"/> FM: [OFF], [LV1], [LV2], [LV3], [LV4] AM: [OFF], [LV1], [LV2]	Restrict the tuning station according to the signal strength.
SEEK <input type="button" value="RADIO"/> [MAN], [PCH]	Assign ◀◀ or ▶▶ buttons to seek the stations one by one (manual tuning) or select a station from the preset channels.
SAVE <input type="button" value="SPOTIFY"/>	Store the information about the song currently being played to your music list on Spotify.
UNSAVE <input type="button" value="SPOTIFY"/>	Remove the song information stored in [SAVE].
SEL DEVICE <input type="button" value="iPod"/> <input type="button" value="PANDORA"/> <input type="button" value="APP"/> <input type="button" value="BT AUDIO"/> <input type="button" value="SPOTIFY"/>	Connect a Bluetooth device in the list.
S.RTRV <input type="button" value="CD"/> <input type="button" value="USB"/> <input type="button" value="iPod"/> <input type="button" value="PANDORA"/> <input type="button" value="APP"/> <input type="button" value="BT AUDIO"/> <input type="button" value="ANDROID"/> <input type="button" value="SPOTIFY"/> <input type="button" value="AUX"/> [1] (effective for low compression rates), [2] (effective for high compression rates), [OFF]	Enhance compressed audio and restore rich sound.
AUDIO BOOK <input type="button" value="iPod"/> [FASTER], [NORMAL], [SLOWER]	Change the playback speed. (Not available when [CONTROL iPod] is selected in the control mode.)

Menu Item	Description
BOOKMARK PANDORA	Store the track information currently being played in your Pandora account.
NEW STATION PANDORA [FROM TRACK], [FROM ARTIST]	Create a new station based on the track or artist currently being played.
PAUSE APP	Pause or resume playback.
PLAY BT AUDIO	Start playback.
STOP BT AUDIO	Stop playback.

AUDIO settings

Menu Item	Description
EQ SETTING [SUPER BASS], [POWERFUL], [NATURAL], [VOCAL], [CUSTOM1], [CUSTOM2], [FLAT] Select an equalizer band and level for further customizing. Equalizer band: [50HZ] to [12.5kHz] Equalizer level: [-6] to [+6]	Select or customize the equalizer curve. • When you select a setting other than [CUSTOM1] and [CUSTOM2], you can also customize the equalizer curve by pressing and holding the M.C. dial, then store the customized equalizer curve in [CUSTOM1].
FADER*1 (Only for standard mode)	Adjust the front and rear speaker balance.
BALANCE	Adjust the left and right speaker balance.
SUBWOOFER [ON], [OFF]	Set to [ON] when using a subwoofer speaker.
SUBWOOFER*2 [NOR], [REV]	Select the subwoofer phase.

Menu Item	Description
SPEAKER LEVEL Network mode: [HIGH L], [HIGH R], [MID L], [MID R], [SUBWOOFER] Standard mode: [FRONT L], [FRONT R], [REAR L], [REAR R], [SUBWOOFER] Output level: [-24] to [10]	Select a speaker unit (filter) and adjust the output level. • Each value you have adjusted changes when you change the [POSITION] setting (page 16).
CROSSOVER	Select a speaker unit (filter) to adjust the HPF or LPF cut-off frequency and the slope for each speaker unit. For details on the [CROSSOVER] setting, see page 14.
POSITION [OFF], [FRONT LEFT] (front seat left), [FRONT RIGHT] (front seat right), [FRONT] (front seats), [ALL]* * Only for standard mode	Select a listening position to adjust the speakers' output levels automatically and add a delay time that corresponds to the number and locations of occupied seats.
TIME ALGNMNT [INITIAL], [OFF], [CUSTOM]	Select or customize the time alignment settings to reflect the distance between the listener's position and each speaker. • Select [INITIAL] to initialize the setting value. • Select [OFF] to reset all setting values to 0. • The [CUSTOM] setting is available when [FRONT LEFT] or [FRONT RIGHT] is selected in [POSITION] (page 16). • The [CUSTOM] setting is not available when [OFF] is selected in [SUBWOOFER] (page 16).
SAVE SETTINGS [YES], [CANCEL]	Save to later recall the following sound settings at their current values: [CROSSOVER], [SPEAKER LEVEL], [EQ SETTING], [POSITION], [TIME ALGNMNT], [BASS BOOST], [SUBWOOFER].
LOAD SETTINGS	Load the sound settings, when you have already performed [SAVE SETTINGS].

Menu Item	Description
BASS BOOST [0] to [+6]	Select the bass boost level.
LOUDNESS [OFF], [LOW], [MID], [HI]	Compensate for clear sound at low volume.
AUTO LV CTRL [OFF], [MODE1], [MODE2]	Adjust the difference in volume levels among sources or audio files automatically.
SLA [+4] to [-4]	Adjust the volume level for each source except FM. Each of the below combinations are set to the same setting automatically. <ul style="list-style-type: none"> • When making a USB connection, set USB, iPod, PANDORA, ANDROID, SPOTIFY, and APP. • When making a Bluetooth connection, set BT AUDIO, iPod, PANDORA, ANDROID, SPOTIFY, and APP.

*1 Not available when [SW] is selected in [REAR-SP] in the INITIAL settings (page 6).

*2 Not available when [FUL] is selected in [REAR-SP] in the INITIAL settings (page 6).

SYSTEM settings

You can also access to these menus when the unit is turned off.

Menu Item	Description
CLOCK SET	Set the clock (page 5).
12H/24H [12H], [24H]	Select the time notation.
BEEP TONE [ON], [OFF]	A beep can be heard when any button is pushed. Select [OFF] to disable this function.
INFO DISPLAY [SOURCE/BTINFO], [SOURCE/SPEANA], [CLOCK/BTINFO], [CLOCK/SPEANA], [LEVEL METER], [SPEANA], [OFF]	Display the item on the sub information display. <ul style="list-style-type: none"> • When [SOURCE/SPEANA] or [CLOCK/SPEANA] is selected, display the antenna instead of the speana on the radio source.

Menu Item	Description
DOT DISPLAY [SPEANA], [ICON]	Select [SPEANA] or [ICON] to appear on the left side of the display.
AUX [ON], [OFF]	Set to [ON] when using an auxiliary device connected to the unit.
BT AUDIO [ON], [OFF]	Set the Bluetooth signal on/off.
SPOTIFY [ON], [OFF]	Set to [ON] when using the Spotify function.
BT MEM CLEAR [YES], [CANCEL]	Clear the Bluetooth device data (device list, PIN code, call history, phone book, preset phone numbers) stored in the unit. [CLEARED] appears when data is successfully deleted.
PHONE CONNECT [IPHONE/IPOD], [ANDROID]	Select the type of device ([IPHONE/IPOD] or [ANDROID]) and the appropriate connection method ([WIRED] or [BLUETOOTH]) according to your device. <ul style="list-style-type: none"> • When [BLUETOOTH] is selected, USB connections cannot be made regardless of the current Bluetooth connection to the unit. • Select [ANDROID] when you connect the mobile device other than iPhone or Android. • When the setting is changed, [USB AUTO] (page 18) is automatically performed if [USB AUTO] is set to [ON].
ANDROID WIRED [MEMORY], [APP CONTROL]	Select the appropriate connection method for an Android device. <ul style="list-style-type: none"> • This setting is not available when [BLUETOOTH] is selected in [PHONE CONNECT].
P.APP AUTO ON [ON], [OFF]	Select [ON] to automatically launch Pioneer ARC APP when an Android device is connected to the unit via AOA. (Not available when [MEMORY] is selected in [ANDROID WIRED].)

Menu Item	Description
USB AUTO	
[ON], [OFF]	Select [ON] to automatically switch to [USB] source when a USB device/iPod is connected to the unit. Select [OFF] when a USB device/iPod is being connected to the unit just for charging.

ILLUMINATION settings

Menu Item	Description
COLOR	
[KEY COLOR], [DISP COLOR], [BOTH COLOR]	Select color for the keys/display of the unit from 12 preset colors, [SCAN] or [CUSTOM]*. • [SCAN]: Cycle through a variety of colors automatically. • [CUSTOM]*: 1 Press and hold the M.C. dial until the color setting display appears. 2 Set the primary color (R (red)/G (green)/B (blue)) and brightness level ([0] to [60]). You cannot select a level below 10 for all three of R (red), G (green), B (blue) at the same time. You can also customize the preset colors. Select one of the preset colors, then press and hold the M.C. dial until the color setting display appears. * The CUSTOM setting is only available for [KEY COLOR] and [DISP COLOR].
DIM SETTING	
[SYNC ILLUMI], [SYNC CLOCK], [ON], [OFF]	Change the display brightness.
BRIGHTNESS	
[1] to [10]	Change the display brightness. The available setting ranges differ depending on [DIM SETTING].
PHONE COLOR	
[FLASHING]	Select the key color when a call is received. Applies the color set by [KEY COLOR].
[FLASH FX1] to [FLASH FX6]	Cycle through a variety of colors automatically.
[OFF]	No change in key color made.

Menu Item	Description
ILLUMI FX	
[ON], [OFF]	The illumination effect can be seen when: – there is an incoming call – you are on a phone call – a CD is inserted/ejected The illumination effect will activate when the ACC power is turned on/off regardless of this setting.

MIXTRAX settings

Menu Item	Description
SHORT PLAYBCK	
[1.0 MIN], [1.5 MIN], [2.0 MIN], [2.5 MIN], [3.0 MIN], [OFF]	Select the length of the playback time.
FLASH AREA	
[KEY/DISPLAY], [KEY], [OFF]	Select the area for the illumination effect. When [OFF] is selected, the color set under the ILLUMINATION settings (page 18) is used as the display color.
FLASH PATTERN	
[SOUND LEVEL 1] to [SOUND LEVEL 6]	Change the illumination effect according to the sound and bass level. The flash pattern changes according to the sound level.
[LOW PASS 1] to [LOW PASS 6]	The flash pattern changes according to the bass level.
[RANDOM1]	The flash pattern changes randomly according to the sound level mode and low pass mode.
[RANDOM2]	The flash pattern changes randomly according to the sound level mode.
[RANDOM3]	The flash pattern changes randomly according to the low pass mode.
DISPLAY FX	
[ON], [OFF]	Set the MIXTRAX special effects on/off.
CUT IN FX	
[ON], [OFF]	Turn the MIXTRAX sound effects on/off while manually changing the tracks.

Connections/Installation

Connections

In the following, "NW" represents network mode and "STD" represents standard mode. According to the connections you have established, change the speaker mode to standard mode (STD) or network mode (NW) (page 5).

⚠ WARNING

- When speaker output is used by 4 channels, use speakers over 50 W (maximum input power) and between 4 Ω to 8 Ω (impedance value). Do not use 1 Ω to 3 Ω speakers for this unit.
- When rear speaker output is used by 2 Ω of subwoofer, use speakers over 70 W (maximum input power).
* Please refer to connections for a connection method.
- The black cable is ground. When installing this unit or power amp (sold separately), make sure to connect the ground wire first. Ensure that the ground wire is properly connected to metal parts of the car's body. The ground wire of the power amp and the one of this unit or any other device must be connected to the car separately with different screws. If the screw for the ground wire loosens or falls out, it could result in fire, generation of smoke or malfunction.

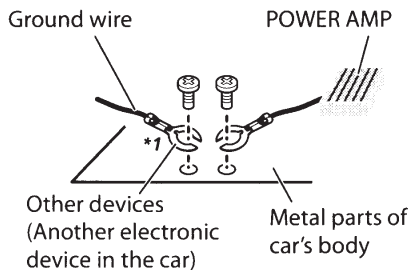

*1 Not supplied for this unit

🔄 Important

- When installing this unit in a vehicle without an ACC (accessory) position on the ignition switch, failure to connect the red cable to the terminal that detects operation of the ignition key may result in battery drain.



ACC position



No ACC position

- Use this unit with a 12-volt battery and negative grounding only. Failure to do so may result in a fire or malfunction.
- To prevent a short-circuit, overheating or malfunction, be sure to follow the directions below.
 - Disconnect the negative terminal of the battery before installation.
 - Secure the wiring with cable clamps or adhesive tape. Wrap adhesive tape around wiring that comes into contact with metal parts to protect the wiring.
 - Place all cables away from moving parts, such as the shift lever and seat rails.
 - Place all cables away from hot places, such as near the heater outlet.

- Do not connect the yellow cable to the battery by passing it through the hole to the engine compartment.
- Cover any disconnected cable connectors with insulating tape.
- Do not shorten any cables.
- Never cut the insulation of the power cable of this unit in order to share the power with other devices. The current capacity of the cable is limited.
- Use a fuse of the rating prescribed.
- Never wire the negative speaker cable directly to ground.
- Never band together negative cables of multiple speakers.

- When this unit is on, control signals are sent through the blue/white cable. Connect this cable to the system remote control of an external power amp or the vehicle's auto-antenna relay control terminal (max. 300mA 12 V DC). If the vehicle is equipped with a glass antenna, connect it to the antenna booster power supply terminal.
- Never connect the blue/white cable to the power terminal of an external power amp. Also, never connect it to the power terminal of the auto antenna. Doing so may result in battery drain or a malfunction.
- The graphical symbol  placed on the product means direct current.

This unit

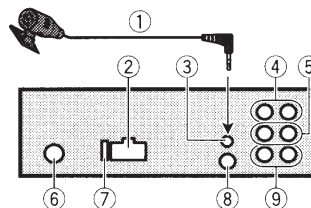

- ① Microphone 3 m (9 ft. 10-1/8 in.)
- ② Power cord input
- ③ Microphone input

- ④ Rear output (STD) or middle range output (NW)
- ⑤ Front output (STD) or high range output (NW)
- ⑥ Antenna input
- ⑦ Fuse (10 A)
- ⑧ Wired remote input
Hard-wired remote control adapter can be connected (sold separately).
- ⑨ Subwoofer output

Power cord

Perform these connections when not connecting a rear speaker or middle range speaker lead to a subwoofer.

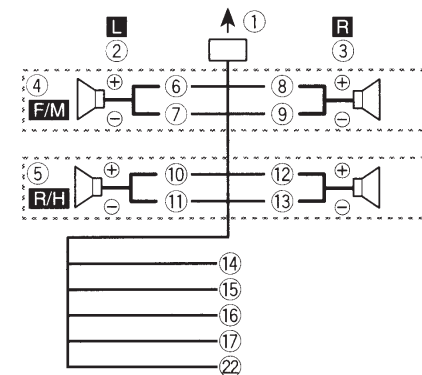

Perform these connections when using a subwoofer without the optional amplifier.

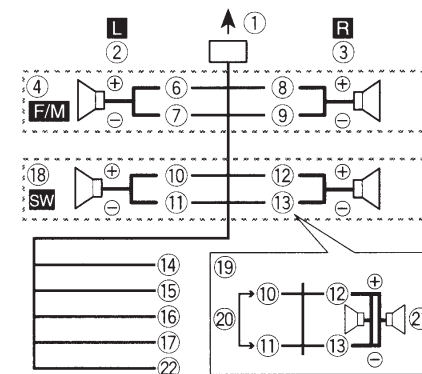

Important

In the case of 19 above, two 4 Ω subwoofers wired in parallel will represent a 2 Ω load.

- ① To power cord input
- ② Left
- ③ Right
- ④ Front speaker (STD) or high range speaker (NW)
- ⑤ Rear speaker (STD) or middle range speaker (NW)
- ⑥ White
- ⑦ White/black
- ⑧ Gray
- ⑨ Gray/black
- ⑩ Green
- ⑪ Green/black
- ⑫ Violet
- ⑬ Violet/black
- ⑭ Black (chassis ground)
Connect to a clean, paint-free metal location.
- ⑮ Yellow
Connect to the constant 12 V supply terminal.
- ⑯ Red
Connect to terminal controlled by the ignition switch (12 V DC).
- ⑰ Blue/white
Connect to the system control terminal of the power amp or auto-antenna relay control terminal (max. 300 mA 12 V DC).
- ⑱ Subwoofer (4 Ω)
- ⑲ When using a subwoofer of 2 Ω, be sure to connect the subwoofer to the violet and violet/black leads of this unit. Do not connect anything to the green and green/black leads.
- ⑳ Not used.
- ㉑ Subwoofer (4 Ω) × 2
- ㉒ Orange/white
Connect to a car's illumination signal.

Power amp (sold separately)

Perform these connections when using the optional amplifier.

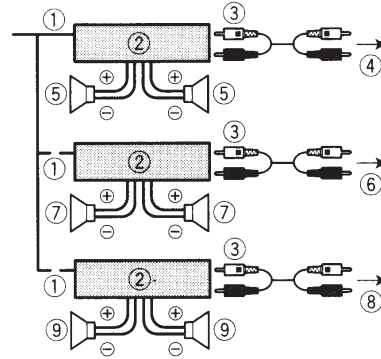

- ① System remote control
Connect to blue/white cable.
- ② Power amp (sold separately)
- ③ Connect with RCA cables (sold separately)
- ④ To rear output (STD) or middle range output (NW)
- ⑤ Rear speaker (STD) or middle range speaker (NW)
- ⑥ To front output (STD) or high range output (NW)
- ⑦ Front speaker (STD) or high range speaker (NW)
- ⑧ To subwoofer output
- ⑨ Subwoofer

Installation

Important

- Check all connections and systems before final installation.
- Do not use unauthorized parts as this may cause malfunctions.
- Consult your dealer if installation requires drilling of holes or other modifications to the vehicle.
- Do not install this unit where:

- it may interfere with operation of the vehicle.
- it may cause injury to a passenger as a result of a sudden stop.
- The semiconductor laser will be damaged if it overheats. Install this unit away from hot places such as near the heater outlet.
- Optimum performance is obtained when the unit is installed at an angle of less than 60°.
- When installing, to ensure proper heat dispersal when using this unit, make sure you leave ample space behind the rear panel and wrap any loose cables so they are not blocking the vents.

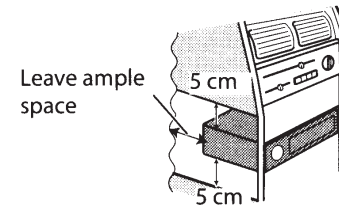
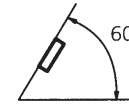

DIN mount installation

- 1 Insert the supplied mounting sleeve into the dashboard.
- 2 Secure the mounting sleeve by using a screwdriver to bend the metal tabs (90°) into place.

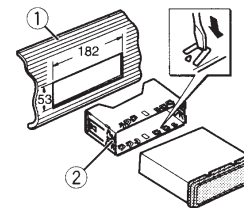

- ① Dashboard
- ② Mounting sleeve
- Make sure that the unit is installed securely in place. An unstable installation may cause skipping or other malfunctions.

When not using the supplied mounting sleeve

- 1 Determine the appropriate position where the holes on the bracket and the side of the unit match.

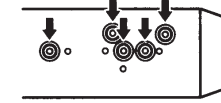

- 2 Tighten two screws on each side.

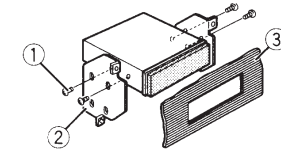

- ① Screw
- ② Mounting bracket
- ③ Dashboard or console
- Use either truss (5 mm × 9 mm) or flush surface (5 mm × 9 mm) screws, depending on the bracket screw holes.

Removing the unit (installed with the supplied mounting sleeve)

- 1 Remove the trim ring.

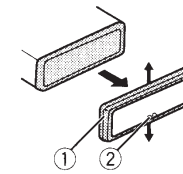

- ① Trim ring
- ② Notched tab
- Releasing the front panel allows easier access to the trim ring.
- When reattaching the trim ring, point the side with the notched tab down.
- 2 Insert the supplied extraction keys into both sides of the unit until they click into place.
- 3 Pull the unit out of the dashboard.

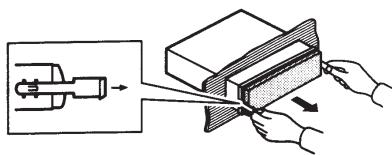

To secure the front panel

The front panel can be secured with the supplied screw.

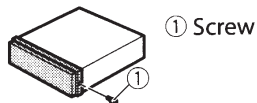

① Screw

Installing the microphone

The microphone should be placed directly in front of the driver at a suitable distance to pick up their voice clearly.

⚠ CAUTION

It is extremely dangerous to allow the microphone lead to become wound around the steering column or shift lever. Be sure to install the microphone in such a way that it will not obstruct driving. It is recommended to use the clamps (sold separately) to arrange the lead.

NOTE

Depending on the vehicle model, the microphone cable length may be too short when you mount the microphone on the sun visor. In such cases, install the microphone on the steering column.

To install on the sun visor

- 1 Fit the microphone lead into the groove.

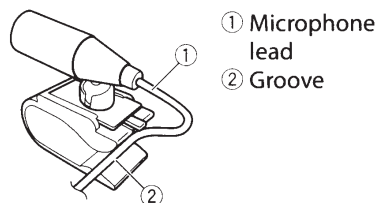

① Microphone lead
② Groove

- 2 Install the microphone clip on the sun visor.

Lowering the sun visor reduces the voice recognition rate.

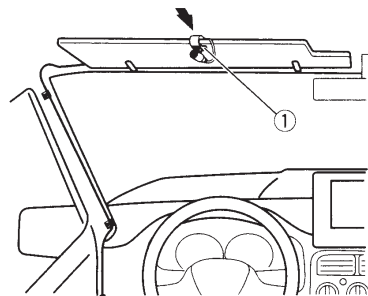

① Microphone clip

To install on the steering column

- 1 Slide the microphone base to detach it from the microphone clip.

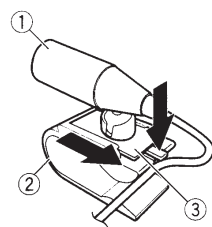

① Microphone
② Microphone clip
③ Microphone base

- 2 Install the microphone on the rear side of the steering column.

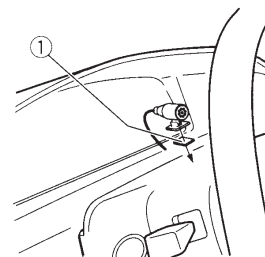

① Double-sided tape

Additional Information

Troubleshooting

The display automatically returns to the normal display.

- No operations have been made for about 30 seconds.
 - Perform an operation.

The repeat play range changes unexpectedly.

- Depending on the repeat play range, the selected range may change when another folder or track is being selected or during fast forwarding/reversing.
 - Select the repeat play range again.

A subfolder is not played back.

- Subfolders cannot be played when [FLD] (folder repeat) is selected.
 - Select another repeat play range.

The sound is intermittent.

- You are using a device, such as a cellular phone, that may cause audible interference.
 - Move electrical devices that may be causing the interference away from the unit.

The sound from the Bluetooth audio source is not played back.

- There is a call in progress on a Bluetooth-connected cellular phone.
 - The sound will be played back when the call is terminated.
- A Bluetooth-connected cellular phone is currently being operated.
 - Stop using the cellular phone.
- The connection between the unit and the cellular phone is not established correctly after a call made by a Bluetooth-connected cellular phone.

- Make a Bluetooth connection between the unit and the cellular phone again.

Error messages

Common

AMP ERROR

- This unit fails to operate or the speaker connection is incorrect.
- The protective circuit is activated.
 - Check the speaker connection.
 - Turn the ignition switch OFF and back to ON again. If the message remains, contact your dealer or an authorized Pioneer Service Station for assistance.

NO XXXX (NO TITLE, for example)

- There is no embedded text information.
 - Switch the display or play another track/file.

CD player

ERROR-07, 11, 12, 17, 30

- The disc is dirty.
 - Clean the disc.
- The disc is scratched.
 - Replace the disc.

ERROR-07, 10, 11, 12, 15, 17, 30, A0

- There is an electrical or mechanical error.
 - Turn the ignition switch OFF and back to ON, then back to the CD player.

ERROR-15

- The inserted disc is blank.
 - Replace the disc.

ERROR-23

- Unsupported CD format.
 - Replace the disc.

FORMAT READ

- Sometimes there is a delay between the start of playback and when you start to hear any sound.
 - Wait until the message disappears and you hear sound.

NO AUDIO

- The inserted disc does not contain any playable files.
 - Replace the disc.

SKIPPED

- The inserted disc contains DRM protected files.
 - The protected files are skipped.

PROTECT

- All the files on the inserted disc are embedded with DRM.
 - Replace the disc.

USB device/iPod

FORMAT READ

- Sometimes there is a delay between the start of playback and when you start to hear any sound.
 - Wait until the message disappears and you hear sound.

NO AUDIO

- There are no songs.
 - Transfer the audio files to the USB device and connect.
- The connected USB device has security enabled.
 - Follow the USB device instructions to disable the security.

SKIPPED

- The connected USB device contains DRM protected files.
 - The protected files are skipped.

PROTECT

- All the files on the connected USB device are embedded with DRM.

- Replace the USB device.

N/A USB

- The connected USB device is not supported by this unit.
 - Disconnect your device and replace it with a compatible USB device.

HUB ERROR

- The USB device connected via a USB hub is not supported by this unit.
 - Connect the USB device directly to this unit using a USB cable.

CHECK USB

- The USB connector or USB cable has short-circuited.
 - Check that the USB connector or USB cable is not caught in something or damaged.
- The connected USB device consumes more than maximum allowable current.
 - Disconnect the USB device and do not use it. Turn the ignition switch OFF and back to ACC or ON. Connect only compliant USB devices.
- The iPod operates correctly but does not charge.
 - Make sure the connection cable for the iPod has not shorted out (e.g., not caught in metal objects). After checking, turn the ignition switch OFF and back to ON, or disconnect the iPod and reconnect.

ERROR-19

- Communication failed.
 - Perform one of the following operations, then return to the USB source.
 - Turn the ignition switch OFF and back to ON.
 - Disconnect the USB device.
 - Change to a different source.
- iPod failure.
 - Disconnect the cable from the iPod. Once the iPod's main menu is

displayed, reconnect the iPod and reset it.

ERROR-23

- USB device was not formatted properly.
 - Format the USB device with FAT12, FAT16 or FAT32.

ERROR-16

- The iPod firmware version is old.
 - Update the iPod version.
- iPod failure.
 - Disconnect the cable from the iPod. Once the iPod's main menu is displayed, reconnect the iPod and reset it.

STOP

- There are no songs in the current list.
 - Select a list that contains songs.

NOT FOUND

- No related songs.
 - Transfer songs to the iPod.

NO BT DEVICE GO TO BT MENU TO REGISTER

- No Bluetooth device found.
 - Connect the unit and iPod via Bluetooth (page 8).

CONN. FAILED PRESS BAND KEY TO RETRY

- Bluetooth connection with iPod failed.
 - Press **BAND/**  to make a connection again.

DISCONNECTED PRESS BAND KEY TO RETRY

- Bluetooth connection with iPod failed.
 - Press **BAND/**  to make a connection again.

Bluetooth device

ERROR-10

- The power failed for the Bluetooth module of the unit.

- Turn the ignition switch OFF and back to ACC or ON.

Pandora

ERROR-19

- Communication failed.
 - Disconnect the cable from the device. Once the device's main menu is displayed, reconnect the device and reset it.

START UP APP

- The Pandora application has not started running yet.
 - Start up the Pandora application.

RATING ERROR

- The thumb rating operation was disabled.
 - Run the same command for another track.

CAN'T SKIP

- The skip operation was disabled.
 - Run the same command for another track.

TRY LATER

- Unable to save thumb rating.
- Unable to save BookMark.
- Unable to add station.
 - Try again later.

MAINTENANCE

- Pandora system is undergoing maintenance.
 - Try again later.

SKIP LIMIT

- Due to music licensing restrictions, Pandora limits the total number of skips per hour.
 - Wait until Pandora allows you to skip again.

UPDATE APP

- This version of the Pandora application is not supported.
 - Connect a device that has a compatible version of the Pandora application installed.

LOGIN ERROR

- Your Pandora account is not logged in.
 - Disconnect the cable from the device, and log in to your Pandora account. Then reconnect the device.

CHECK DEVICE

- Device error message displayed in the Pandora application.
 - Check the connected device.

PLEASE CREATE A STATION ON THE PHONE

- No station found.
 - Create a station in the Pandora application on your connected device.

SELECT STN

- No station selected.
 - Select a station.

NO BT DEVICE GO TO BT MENU TO REGISTER

- No Bluetooth device found.
 - Connect the unit and the device via Bluetooth (page 8).

CONN. FAILED PRESS BAND KEY TO RETRY

- Bluetooth connection failed.
 - Press **BAND/**  to make a connection again.

CHECK APP PRESS BAND KEY TO RETRY

- Connection to the Pandora application failed.
 - Press **BAND/**  to make a connection again.

DISCONNECTED PRESS BAND KEY TO RETRY

- Bluetooth connection lost.
 - Press **BAND/**  to make a connection again.

STATION FULL

- A new station cannot be added.
 - Delete an old station to open a spot for a new one.

CAN'T DELETE

- The station could not be deleted.
 - Run the same command for another station.

NO NETWORK

- The connected device is out of area.
 - Connect the device to a network.

NO SERVICE IN THIS COUNTRY

- The connected device is out of area.
 - Connect the device to a network.

STN DELETED

- The operation was disabled.
 - Run the same command for another station.

Apps

NO BT DEVICE GO TO BT MENU TO REGISTER

- No Bluetooth device found.
 - Connect the unit and the device via Bluetooth (page 8).

CONN. FAILED PRESS BAND KEY TO RETRY

- Bluetooth connection failed.
 - Press **BAND/**  to make a connection again.

DISCONNECTED PRESS BAND KEY TO RETRY

- Bluetooth connection failed.
 - Press **BAND/**  to make a connection again.

CHECK APP

- Connection to the application failed.
 - Follow the instructions that appear on the screen.

START UP APP

- The application has not started running yet.
 - Operate the mobile device to start up the application.

Spotify

NO BT DEVICE GO TO BT MENU TO REGISTER

- No Bluetooth device found.
 - Connect the unit and the device via Bluetooth (page 8).

CONN. FAILED PRESS BAND KEY TO RETRY

- Bluetooth connection failed.
 - Press **BAND/**  to make a connection again.

CHECK APP PRESS BAND KEY TO RETRY

- Connection to the Spotify application failed.
 - Press **BAND/**  to make a connection again.

DISCONNECTED PRESS BAND KEY TO RETRY

- Bluetooth connection lost.
 - Press **BAND/**  to make a connection again.

CHECK APP

- Connection to the Spotify application failed.
 - Follow the instructions that appear on the screen.

Handling guidelines

Discs and player

- Use only discs that feature either of the following two logos.



- Use 12-cm discs.
- Use only conventional, fully circular discs.
- The following types of discs cannot be used with this unit:
 - DualDiscs
 - 8-cm discs: Attempts to use such discs with an adaptor may cause the unit to malfunction.
 - Oddly shaped discs
 - Discs other than CDs
 - Damaged discs, including discs that are cracked, chipped or warped
 - CD-R/RW discs that have not been finalized
- Do not write on or apply chemicals to the surface of the discs.
- To clean a CD, wipe the disc with a soft cloth outward from the center.
- Condensation may temporarily impair the player's performance. Let it rest for about one hour to adjust to a warmer temperature. Also, wipe any damp discs off with a soft cloth.
- When using discs that can be printed on label surfaces, check the instructions and the warnings of the discs. Depending on the discs, inserting and ejecting may not be possible. Using such discs may result in damage to this equipment.
- Do not attach commercially available labels or other materials to the discs.
 - The discs may warp making the disc unplayable.
 - The labels may come off during playback and prevent ejection of the

discs, which may result in damage to the equipment.

USB storage device

- Connections via USB hubs are not supported.
- Firmly secure the USB storage device before driving. Do not let the USB storage device fall onto the floor, where it may become jammed under the brake or accelerator pedal.
- Depending on the USB storage device, the following problems may occur.
 - Operations may vary.
 - The storage device may not be recognized.
 - Files may not be played back properly.
 - The device may cause audible interference when you are listening to the radio.

iPod

- Do not leave the iPod in places with high temperatures.
- Firmly secure the iPod when driving. Do not let the iPod fall onto the floor, where it may become jammed under the brake or accelerator pedal.
- The settings of the iPod such as the equalizer and repeat play are changed automatically when the iPod is connected to the unit. Once the iPod is disconnected, those settings will return to the original settings.
- Incompatible text saved on the iPod will not be displayed by the unit.

Compressed audio compatibility

- Only the first 32 characters can be displayed as a file name (including the file extension) or a folder name.

- The unit may not work properly depending on the application used to encode WMA files.
- There may be a slight delay at the start of the playback of audio files embedded with image data, or audio files stored on a USB device with numerous folder hierarchies.

CAUTION

- Pioneer cannot guarantee compatibility with all USB mass storage devices, and assumes no responsibility for any loss of data on media players, smartphones, or other devices while using this product.
- Do not leave discs or a USB storage device in any place that is subject to high temperatures.

WMA files

File extension	.wma
Bit rate	48 kbps to 320 kbps (CBR), 48 kbps to 384 kbps (VBR)
Sampling frequency	32 kHz, 44.1 kHz, 48 kHz
Windows Media™ Audio Professional, Lossless, Voice/DRM Stream/Stream with video	Not compatible

MP3 files

File extension	.mp3
Bit rate	8 kbps to 320 kbps (CBR), VBR
Sampling frequency	8 kHz to 48 kHz (32 kHz, 44.1 kHz, 48 kHz for emphasis)
Compatible ID3 tag version	1.0, 1.1, 2.2, 2.3, 2.4 (ID3 tag Version 2.x is given priority over Version 1.x.)
M3u playlist	Not compatible

MP3i (MP3 interactive), mp3 PRO	Not compatible
---------------------------------	----------------

WAV files

- WAV file formats cannot be connected via MTP.

File extension	.wav
Quantization bits	8 and 16 (LPCM), 4 (MSADPCM)
Sampling frequency	16 kHz to 48 kHz (LPCM), 22.05 kHz and 44.1 kHz (MSADPCM)

AAC files

Compatible format	AAC encoded by iTunes
File extension	.m4a
Sampling frequency	11.025 kHz to 48 kHz
Transmission rate	16 kbps to 320 kbps, VBR
Apple Lossless	Not compatible
AAC file bought from the iTunes Store (.m4p file extension)	Not compatible

FLAC files

- FLAC file formats cannot be connected via MTP.
- FLAC files may not be playable, depending on the encoder.

File extension	.flac
Sampling frequency	8/11.025/12/16/22.05/24/32/44.1/48/96 kHz
Quantization bit rate	16/24 bit
Channel mode	1/2 ch

Disc

- Regardless of the length of the blank section between the songs from the original recording, compressed audio discs play with a short pause between songs.

Playable folder hierarchy	Up to eight tiers (A practical hierarchy is less than two tiers.)
Playable folders	Up to 99
Playable files	Up to 999
File system	ISO 9660 Level 1 and 2, Romeo, Joliet
Multi-session playback	Compatible
Packet write data transfer	Not compatible

USB device

- There may be a slight delay when starting playback of audio files on a USB storage device with numerous folder hierarchies.

Playable folder hierarchy	Up to eight tiers (A practical hierarchy is less than two tiers.)
Playable folders	Up to 1 500
Playable files	Up to 15 000
Playback of copyright-protected files	Not compatible
Partitioned USB device	Only the first partition can be played.

iPod compatibility

This unit supports only the following iPod models. Supported iPod software versions are shown below. Older versions may not be supported.

Made for

- iPod touch (1st through 6th generation)
- iPod classic
- iPod with video
- iPod nano (1st through 7th generation)
- iPhone 6s
- iPhone 6s Plus
- iPhone 6
- iPhone 6 Plus
- iPhone 5s
- iPhone 5c
- iPhone 5

- iPhone 4s
- iPhone 4
- iPhone 3GS
- iPhone 3G
- iPhone

- Operations may vary depending on the generation and/or software version of the iPod.
- Users of iPod with the Lightning Connector should use the Lightning to USB Cable (supplied with iPod).
- Users of iPod with the Dock Connector should use the CD-IU51. For details, consult your dealer.
- Refer to the iPod manuals for information about the file/format compatibility.
- Audiobook, Podcast: Compatible

CAUTION

Pioneer accepts no responsibility for data lost on the iPod, even if that data is lost while this unit is used.

Sequence of audio files

The user cannot assign folder numbers and specify playback sequences with this unit. Sequence of audio file depends on the connected device.

Note that the hidden files in a USB device cannot be played back.

Example of a hierarchy

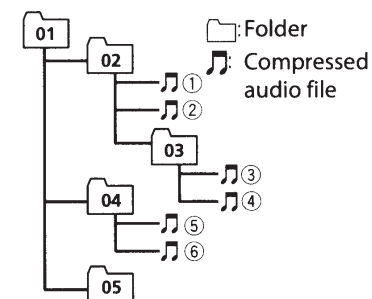

Level 1 Level 2 Level 3 Level 4

01 to 05: Folder number

① to ⑥: Playback sequence

Copyright and trademark

Bluetooth

The *Bluetooth*® word mark and logos are registered trademarks owned by Bluetooth SIG, Inc. and any use of such marks by PIONEER CORPORATION is under license. Other trademarks and trade names are those of their respective owners.

iTunes

Apple and iTunes are trademarks of Apple Inc., registered in the U.S. and other countries.

WMA

Windows Media is either a registered trademark or trademark of Microsoft Corporation in the United States and/or other countries.

This product includes technology owned by Microsoft Corporation and cannot be used or distributed without a license from Microsoft Licensing, Inc.

FLAC

Copyright © 2000-2009 Josh Coalson
Copyright © 2011-2014 Xiph.Org
Foundation

Redistribution and use in source and binary forms, with or without modification,

are permitted provided that the following conditions are met:

- Redistributions of source code must retain the above copyright notice, this list of conditions and the following disclaimer.
- Redistributions in binary form must reproduce the above copyright notice, this list of conditions and the following disclaimer in the documentation and/or other materials provided with the distribution.
- Neither the name of the Xiph.org Foundation nor the names of its contributors may be used to endorse or promote products derived from this software without specific prior written permission.

THIS SOFTWARE IS PROVIDED BY THE COPYRIGHT HOLDERS AND CONTRIBUTORS "AS IS" AND ANY EXPRESS OR IMPLIED WARRANTIES, INCLUDING, BUT NOT LIMITED TO, THE IMPLIED WARRANTIES OF MERCHANTABILITY AND FITNESS FOR A PARTICULAR PURPOSE ARE DISCLAIMED. IN NO EVENT SHALL THE FOUNDATION OR CONTRIBUTORS BE LIABLE FOR ANY DIRECT, INDIRECT, INCIDENTAL, SPECIAL, EXEMPLARY, OR CONSEQUENTIAL DAMAGES (INCLUDING, BUT NOT LIMITED TO, PROCUREMENT OF SUBSTITUTE GOODS OR SERVICES; LOSS OF USE, DATA, OR PROFITS; OR BUSINESS INTERRUPTION) HOWEVER CAUSED AND ON ANY THEORY OF LIABILITY, WHETHER IN CONTRACT, STRICT LIABILITY, OR TORT (INCLUDING NEGLIGENCE OR OTHERWISE) ARISING IN ANY WAY OUT OF THE USE OF THIS SOFTWARE, EVEN IF ADVISED OF THE POSSIBILITY OF SUCH DAMAGE.

iPod & iPhone

iPhone, iPod, iPod classic, iPod nano, and iPod touch are trademarks of Apple Inc., registered in the U.S. and other countries. Lightning is a trademark of Apple Inc.

"Made for iPod" and "Made for iPhone" mean that an electronic accessory has been designed to connect specifically to iPod or iPhone, respectively, and has been certified by the developer to meet Apple performance standards. Apple is not responsible for the operation of this device or its compliance with safety and regulatory standards. Please note that the use of this accessory with iPod or iPhone may affect wireless performance.

Android & Google Play

Android, Google Play, and the Google Play logo are trademarks of Google Inc.

Pandora® internet radio

PANDORA, the PANDORA logo, and the Pandora trade dress are trademarks or registered trademarks of Pandora Media, Inc. Used with permission. Pandora is only available in certain countries.

MIXTRAX

MIXTRAX is a trademark of the PIONEER CORPORATION.

Spotify®

SPOTIFY and the Spotify logo are among the registered trademarks of Spotify AB.

T-Kernel 2.0

This product uses the source code of T-Kernel 2.0 under T-License 2.0 granted by T-Engine Forum

MP3

Copyright (C) 1998-2009 PacketVideo

Licensed under the Apache License, Version 2.0 (the "License"); you may not use this file except in compliance with the License.

You may obtain a copy of the License at

Unless required by applicable law or agreed to in writing, software distributed under the License is distributed on an "AS IS" BASIS, WITHOUT WARRANTIES OR CONDITIONS OF ANY KIND, either express or implied.

See the License for the specific language governing permissions and limitations under the License.

Specifications

General

Power source: 14.4 V DC (10.8 V to 15.1 V allowable)

Grounding system: Negative type

Maximum current consumption: 10.0 A

Dimensions (W × H × D):

DIN

Chassis: 178 mm × 50 mm × 165 mm (7 in. × 2 in. × 6-1/2 in.)

Nose: 188 mm × 58 mm × 16 mm (7-3/8 in. × 2-1/4 in. × 5/8 in.)

D

Chassis: 178 mm × 50 mm × 165 mm (7 in. × 2 in. × 6-1/2 in.)

Nose: 170 mm × 46 mm × 16 mm (6-3/4 in. × 1-3/4 in. × 5/8 in.)

Weight: 1 kg (2.2 lbs)

Audio

Maximum power output:

- 50 W × 4 ch/4 Ω (for no subwoofer)
- 50 W × 2 ch/4 Ω + 70 W × 1 ch/2 Ω (for subwoofer)

Continuous power output:

22 W × 4 (50 Hz to 15 000 Hz, 5 % THD, 4 Ω load, both channels driven)

Load impedance: 4 Ω (4 Ω to 8 Ω (2 Ω for 1 ch) allowable)

Preout maximum output level: 2.0 V

Equalizer (13-Band Graphic Equalizer):

Frequency: 50 Hz/80 Hz/125 Hz/200 Hz/315 Hz/500 Hz/800 Hz/1.25 kHz/2 kHz/3.15 kHz/5 kHz/8 kHz/12.5 kHz
Gain: ±12 dB (2 dB step)

High pass filter (Standard mode):

Frequency: 50 Hz/63 Hz/80 Hz/100 Hz/125 Hz/160 Hz/200 Hz
Slope: -6 dB/oct, -12 dB/oct, -18 dB/oct, -24 dB/oct, OFF

Subwoofer/Low pass filter (Standard mode):

Frequency: 50 Hz/63 Hz/80 Hz/100 Hz/125 Hz/160 Hz/200 Hz
Slope: -6 dB/oct, -12 dB/oct, -18 dB/oct, -24 dB/oct, OFF
Gain: +10 dB to -24 dB (1 dB step)
Phase: Normal/Reverse

Speaker level (Standard mode):

+10 dB to -24 dB (1 dB step)

Time alignment (Standard mode):

0 Inch to 140 Inch (1 inch/Step)

Bass boost (Standard mode):

Gain: +12 dB to 0 dB

High pass filter (HIGH) (Network mode):

Frequency: 1.25 kHz/1.6 kHz/2 kHz/2.5 kHz/3.15 kHz/4 kHz/5 kHz/6.3 kHz/8 kHz/10 kHz/12.5 kHz
Slope: -6 dB/oct, -12 dB/oct, -18 dB/oct, -24 dB/oct

High pass filter (MID) (Network mode):

Frequency: 25 Hz/31.5 Hz/40 Hz/50 Hz/63 Hz/80 Hz/100 Hz/125 Hz/160 Hz/200 Hz/250 Hz
Slope: -6 dB/oct, -12 dB/oct, -18 dB/oct, -24 dB/oct, OFF

Low pass filter (MID) (Network mode):

Frequency: 1.25 kHz/1.6 kHz/2 kHz/2.5 kHz/3.15 kHz/4 kHz/5 kHz/6.3 kHz/8 kHz/10 kHz/12.5 kHz
Slope: -6 dB/oct, -12 dB/oct, -18 dB/oct, -24 dB/oct, OFF

Subwoofer (Network mode):

Frequency: 25 Hz/31.5 Hz/40 Hz/50 Hz/63 Hz/80 Hz/100 Hz/125 Hz/160 Hz/200 Hz/250 Hz

Slope: -12 dB/oct, -18 dB/oct, -24 dB/oct, -30 dB/oct, -36 dB/oct, OFF
 Gain: +10 dB to -24 dB (1 dB step)
 Phase: Normal/Reverse

Speaker level (Network mode):
 +10 dB to -24 dB (1 dB step)
 Time alignment (Network mode):
 0 Inch to 140 Inch (1 inch/Step)
 Bass boost (Network mode):
 Gain: +12 dB to 0 dB

CD player

System: Compact disc audio system
 Usable discs: Compact disc
 Signal-to-noise ratio: 94 dB (1 kHz) (IEC-A network)
 Number of channels: 2 (stereo)
 MP3 decoding format: MPEG-1 & 2 Audio Layer 3
 WMA decoding format: Ver. 7, 7.1, 8, 9, 10, 11 (2 ch audio) (Windows Media Player)
 AAC decoding format: MPEG-4 AAC (iTunes encoded only) (Ver. 10.6 and earlier)
 WAV signal format: Linear PCM & MS ADPCM (Non-compressed)

USB

USB standard specification: USB 2.0 full speed
 Maximum current supply: 1 A
 USB Protocol:
 MSC (Mass Storage Class)
 MTP (Media Transfer Protocol)
 AOA (Android Open Accessory) 2.0
 File system: FAT12, FAT16, FAT32
 MP3 decoding format: MPEG-1 & 2 Audio Layer 3
 WMA decoding format: Ver. 7, 7.1, 8, 9, 10, 11 (2 ch audio) (Windows Media Player)
 AAC decoding format: MPEG-4 AAC (iTunes encoded only) (Ver. 10.6 and earlier)
 FLAC decoding format: v1.3.0 (Free Lossless Audio Codec)

WAV signal format: Linear PCM & MS ADPCM (Non-compressed)

FM tuner

Frequency range: 87.9 MHz to 107.9 MHz
 Usable sensitivity: 11 dBf (1.0 μ V/75 Ω , mono, S/N: 30 dB)
 Signal-to-noise ratio: 72 dB (analog broadcasting) (IHF-A network)

AM tuner

Frequency range: 530 kHz to 1 710 kHz
 Usable sensitivity: 25 μ V (S/N: 20 dB)
 Signal-to-noise ratio: 62 dB (analog broadcasting) (IHF-A network)

Bluetooth

Version: Bluetooth 3.0 certified
 Output power: +4 dBm Maximum (Power class 2)
 Frequency band(s): 2 400 MHz to 2 483.5 MHz
 Bluetooth profiles:
 GAP (Generic Access Profile)
 SDAP (Service Discovery Application Profile)
 HFP (Hands Free Profile) 1.6
 PBAP (Phone Book Access Profile)
 A2DP (Advanced Audio Distribution Profile)
 AVRCP (Audio/Video Remote Control Profile) 1.5
 SPP (Serial Port Profile) 1.1

CEA2006 Specifications



Power output: 14 W RMS \times 4 Channels (4 Ω and \leq 1 % THD+N)
 S/N ratio: 91 dBA (reference: 1 W into 4 Ω)

NOTE

Specifications and the design are subject to modifications without notice.