



**ADVENTURE
MODE IS**



TECHNICAL FEATURES



X.D1
dual sport





User Options

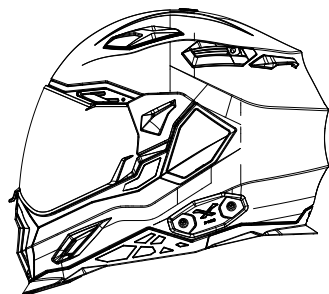

STREET

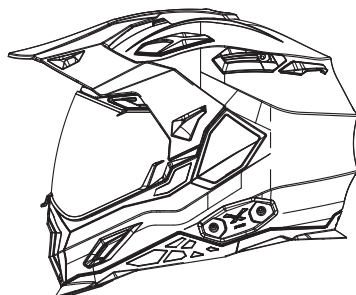

ENDURO

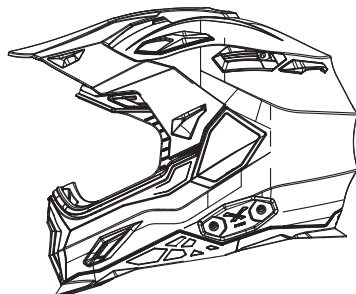

OFF-ROAD



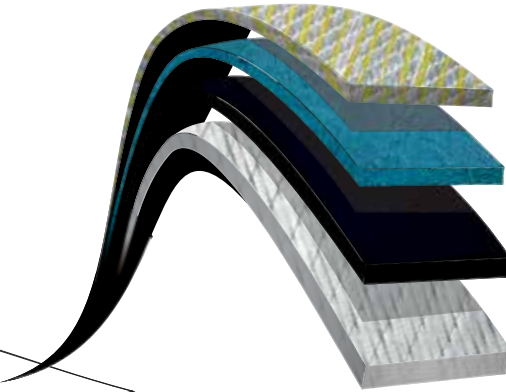

SPECIAL ARAMID
MULTIAXIALS FIBER

3D ORGANIC FIBER

CARBON
REINFORCEMENT

MULTIAXIAL
FIBERGLASS

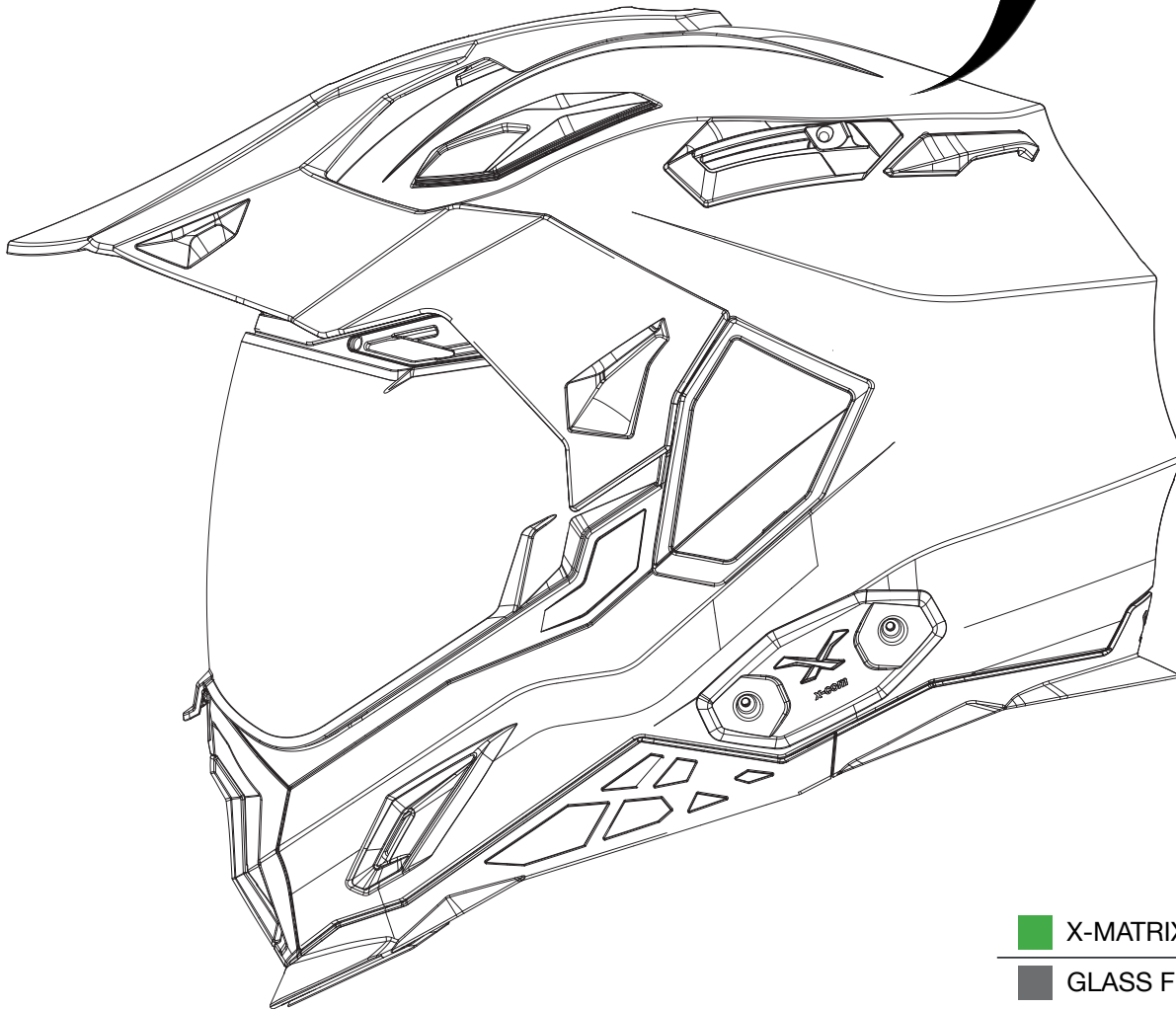

RESISTANCE AGAINST
ENVIRONMENTAL
INFLUENCES

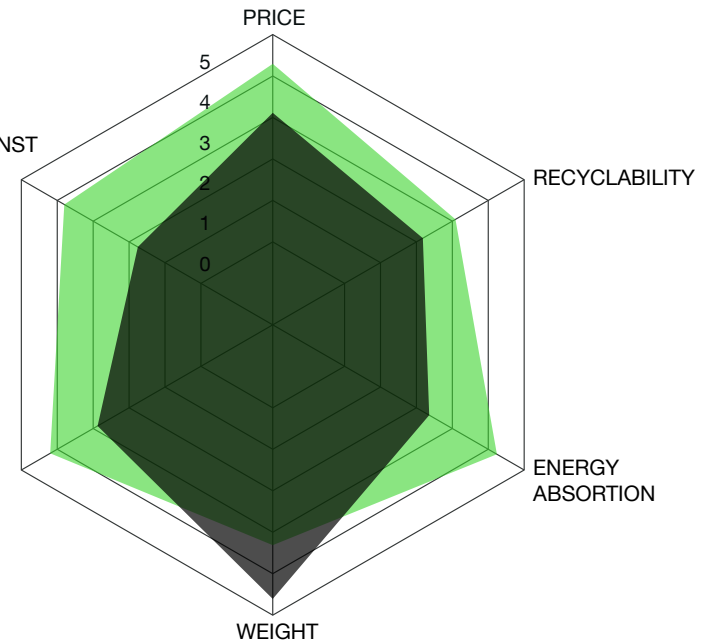

■ X-MATRIX FIBER

■ GLASS FIBER

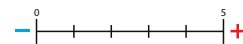

Peak Screw, No Tools Required

Peak Extensor

Sunvisor with Ergonomic Button Mechanism

Aerodynamic Rim Designed to Control Air Stream, Reducing Lift and Turbulence at High Speeds

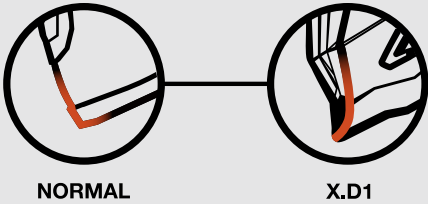
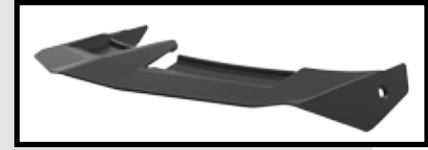

Special Chin Shape to reduce breast injury risk from frontal impacts

Textured Rubber Grip "Anti-Slip"

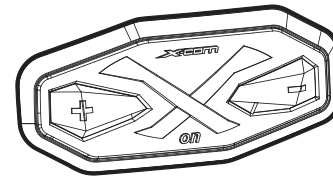

X-COM X.D1 is by Default Equipped to Accomodate the NEXX Helmets X-COM Communication System



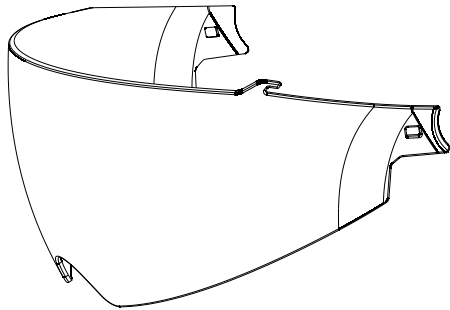

Big Inner Sunvisor



FASTSHOT
quick release system



FastShot with Safety Lock

**Visor With
Super Lock and
Anti-Fog Position**

Huge Eye Port

**Visor with Recessed
Cavity for Pinlock**



PINLOCK
ORIGINAL

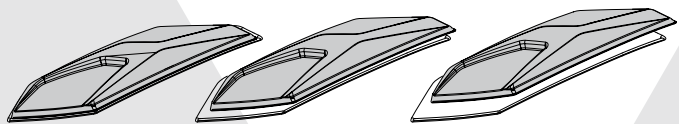

Close

Half Open

Full Open

Top Ventilation

Exhaust Vents

Standard

Off Road

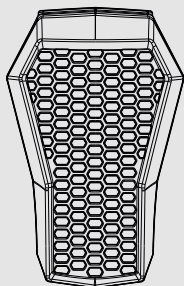
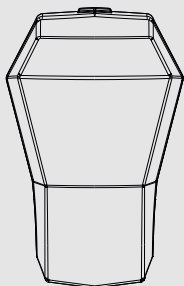

Optional Ventilation for "Off Road"

Exhaust Vents

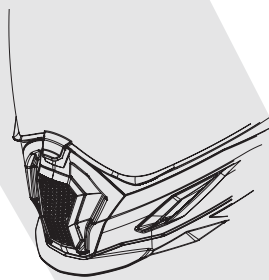
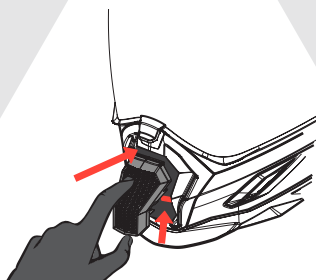
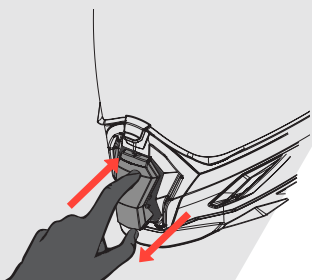

**Removable Action
Camera Supports (Top and Sides)**

Top

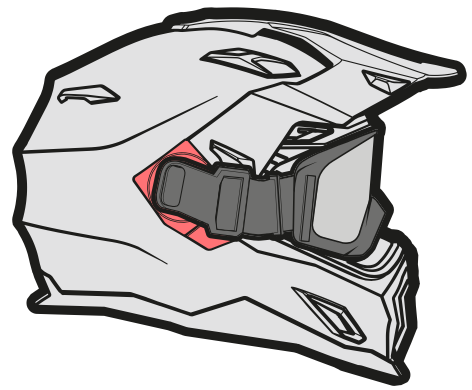
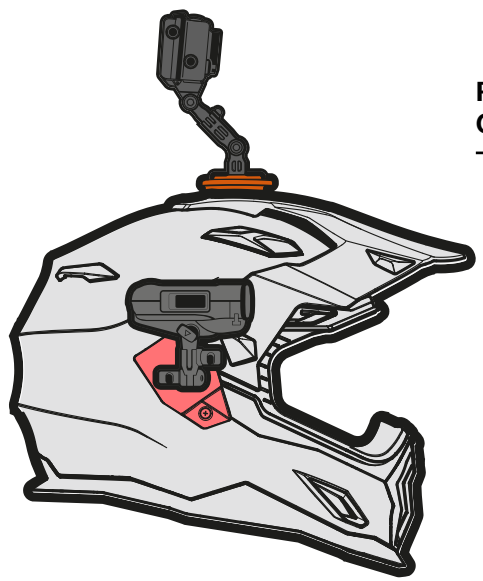
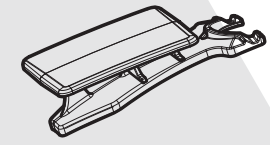

Sides

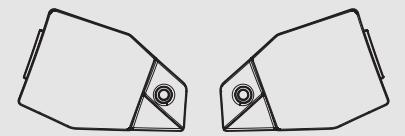

**Optional Support
for Quick Strap**

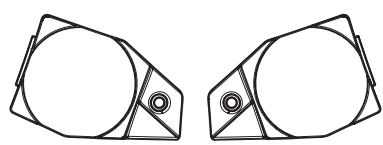



Technical Features

- X-MATRIX Shell (multiaxial fiberglass, 3D organic fibers, special aramid fibers and carbon reinforcement)
- ECE/22-05, DOT and NBR-7471:2001
- Pinlock ready
- X-MART DRY Fabrics
- Double D-Ring buckle
- Panoramic Eye Port
- 3D Lining and Cheek pads
- Prepared for X-COM – NEXX Intercom system
- Removable Breath Guard
- 80% Tint Inner Sun visor
- PC Lexan Shield Clear with Anti-Fog position and Super Lock
- FastShot Quick Release System
- Visor with recessed cavity for pinlock
- Chin Wind stopper
- Night vision - reflectors
- Chin Ventilation
- Air Dynamic System - 2 inlets and 4 outlets air-vents
- Aerodynamic Shell & Rim
- Shell available in 2 different sizes - XS to M / L a XXL
- Ergo Padding System
- Peak Extensor
- Action Camera Support top and sides
- Optional Support for Quick Strap
- Special Chin Shape to reduce breast injury risk from frontal impacts
- Weight: 1400gr Street Version and 1500gr Dual Version

