

MOROSO®

PERFORMANCE PRODUCTS



DIGITAL
CATALOG

2020

WELCOME	1
PRODUCT INDEX	2-7
NEW PRODUCTS FOR 2020	8-22
OIL PANS & ACCESSORIES	23-113
OIL PUMPS	114-137
OILING SYSTEMS	138-156
VACUUM PUMPS & ACCESSORIES	157-164
MOUNTING BRACKETS	165-169
OIL PUMP & VACUUM PUMP DRIVE KITS & PULLEYS	170-179
AIR-OIL SEPARATORS	180-184
TANKS & COVERS	185-206
TRANSMISSION PANS & ACCESSORIES	207-211
CHEMICALS	212-213
FASTENERS	214-226
BRAKE & WHEEL EQUIPMENT	227-230
TRICK SPRINGS	231-232
TOOLS	233-247
MOTOR & TRANSMISSION MOUNTS	248-251
COOLING SYSTEM	252-264
FUEL SYSTEM EQUIPMENT	265-279
AIR CLEANERS & ACCESSORIES	280-284
EXHAUST SYSTEM	285-286
VALVETRAIN EQUIPMENT	287
VALVE COVERS	288-318
IGNITION WIRE	319-341
IGNITION SYSTEMS	342-356
ELETRICAL SYSTEMS	357-369
REAR AXLE EQUIPMENT	370-371
SHEETMETAL & BODY	372
STEERING	373
TIRES	374-376
APPAREL	377-378
COMPETITION ENGINEERING	379-453
REPLACEMENT PARTS	454
NUMERICAL PRODUCT INDEX	455-464



Table of contents for Competition Engineering can be found on the reverse side of the tabbed section divider.

Thank you to the loyal Moroso and Competition Engineering customers that have been using our products for years, to the newcomers that are just picking up our catalog for the first time and are reading this. Rest assured that Dick Moroso's spirit lives on today in every product that we produce and we wouldn't have it any other way.

Rick Moroso
President & Owner

Rick Moroso

NEW PRODUCT CATEGORIES

Oil Pans	Pages 8-10
Oil Pump Pickups	Page 11
External Dry Sump Oil Pumps	Pages 12-15
Mounts and Fittings	Pages 16-17
Tanks and Covers	Pages 17-18
Hardware, Misc.	Pages 18-19
Water Pump Gaskets	Page 20
Thermostat Spacer, Gasket	Page 21
Fuel Pump Gaskets	Page 21
Valve Covers	Page 22
Ultra 40 Wire	Page 22
Crank Trigger	Page 22



NEW PRODUCTS

NEW PRODUCTS SECTION	8-22
A	
A & B EPOXY	212
ABS PUMP COVER	195
ACCESS DOOR	372
ACCUMULATORS	143-144
ACCUMULATOR ADAPTERS, MOUNTS AND VALVES	138-146
ADAPTER KITS, WATER PUMP	253-254
ADAPTER, LEAK TESTER	236
ADAPTER REAR SEAL	109
ADAPTER, GM LS VALVE COVERS	315
ADVANCE CURVE KITS	344
AIR BLEED VALVE	257
AIR CLEANERS AND ACCESSORIES	280-284
AIR CLEANER BASE GASKET	283
AIR PAN KITS, CARBURETOR	284
AIR OIL SEPARATORS	180-184, 190
AIR OIL SEPARATOR REPLACEMENT PARTS	180-184
ALL WEATHER SEAL	213
ALLEN HEAD PLUG KITS	214
ALTERNATOR DRIVE KITS, ALTERNATOR AND WATER PUMP, MOUNTING KITS	165-169
ALTERNATOR MOUNTING BRACKETS	165-169
ALTERNATOR AND VACUUM PUMP MOUNTING BRACKETS	165-169
ALTERNATOR PULLEYS	174, 176
ALTERNATOR SHUTDOWN RELAY KIT	362
AN FITTINGS	155-156
ALUMINUM FUEL LINE	275
ANTI-ROLL KITS	227
APPAREL	377-378
ASSEMBLY LUBE	212
AUTO TRANSMISSION EXPANSION TANKS	191
AUTO TRANSMISSION OIL COOLERS	211
B	
BAFFLES, LIFTER VALLEY	152
BAFFLES, MAIN CAP	110
BALANCER BOLT KITS	220
BALANCER INSTALLATION TOOLS	233
BALL VALVE	180, 182, 187-195
BALLAST RESISTOR	347
BAND CLAMP TIGHTENING TOOL	286
BATTERY BOX	357
BATTERY CHARGERS	357
BATTERY EQUIPMENT	357-364
BATTERY QUICK DISCONNECT	358-364
BELLHOUSING DOWEL PINS	215
BELLHOUSING PIN/SLEEVE KITS	215
BELT GUIDES	173
BELTS GILMER	179
BELTS RADIUS	179
BILLET OIL PUMPS	114-115
BLOCK FILLER, ENGINE	213
BLOCK OFF PLATE, OIL PUMP	138

B (CON'T)

BLUEPRINTED OIL PUMPS	120
BLUE MAX IGNITION WIRE	325-333
BOLT, BALANCER	220
BOLT WASHERS, CYLINDER HEAD	214
BOLTS, FLYWHEEL & FLEXPLATE	220
BOLTS, HEADER	219
BOLTS, INTAKE MANIFOLD	219
BOLTS, OIL PAN	217-220
BOLTS, TIMING COVER	219
BOOT SLEEVES, HIGH TEMPERATURE	338
BRACKETS, MOUNTING	165-169
BRACKETS, TANK	186-191
BRACKETS, VACUUM PUMP	164
BRAKE RESERVIOR COVERS	195-202
BRAKE/WHEEL EQUIPMENT	227-230
BREATHER KITS	314-318
BREATHER TANKS	17, 187-190
BREATHERS, POSITIVE LOCKING	313
BREATHERS, VALVE COVERS	295, 314-318
BULLET NOSE OIL PAN STUD KIT	218
BUNGS, WELD-ON	156
BUNGS, OXYGEN SENSOR	285
BUSHING, CARBURETOR LINKAGE	268
C	
CALCULATOR, POWER SPEED	241
CAM STOP BUTTONS	226
CAMSHAFT RETAINER & BOLTS	226
CAP COVERS, RADIATOR & INTERCOOLER	198
CAPS, RADIATOR	258
CARBURETOR 1:1 SLIP LINK	272
CARBURETOR ADAPTERS	269-270
CARBURETOR AIR PAN KITS	284
CARBURETOR CAPS	240
CARBURETOR DRAIN CUP	240
CARBURETOR FUEL BOWL SCREWS	272
CARBURETOR GASKETS	279
CARBURETOR JET EXTENSION KIT	271
CARBURETOR JET TOOL	240
CARBURETOR LINKAGE BUSHING SET	268
CARBURETOR NEEDLE & SEATS	274
CARBURETOR POWER VALVES	274
CARBURETOR SAFETY PLATE	268
CARBURETOR SIGHT PLUGS	271
CARBURETOR SPACERS	269-270
CARBURETOR STUD KITS	216
CARBURETOR TOP TOOL TRAYS	240
CARBURETOR WASHER KIT	271
CARBURETOR WEDGE PLATE	271
CARBURETOR WORK STANDS	239
CATCH/OVERFLOW RECOVERY TANK	192-195
CERAMIC ENGINE SEAL	213
CHECK VALVE, ACCUMULATOR	146
CHARGER, BATTERY	357
CHEMICALS	212-213
CHROME HOOD PINS	221
CHROME OIL FILTERS	147-149
CHROME PIPE PLUGS	214
CLEANING BRUSHES, ENGINE	235

C (CON'T)

CLEVIS ENDS	227
CLIMBING GEAR LUBE	212
COIL MOUNT BRACKET KIT	294, 348
COIL SHIELD COVER	202
COIL SPRINGS	231-232
COIL WIRE KITS	324, 335
COIL-OVER SHOCK ADJUSTING TOOL	243
COILS	349-353
COOLANT, SENSOR	196
COOLING SYSTEM EQUIPMENT	20-21, 252-264
COOLING SYSTEM EXPANSION TANKS	193-201
COVERS, FUSE BOX & BRAKE RESERVOIR	198-206
CRANK TRIGGER KITS & COMPONENTS	22, 354-355
CRANKCASE EVACUATION SYSTEM	151
CRANKSHAFT PULLEYS	173-178
CRANKSHAFT PULLEY SHIM KIT	173
CRANKSHAFT PULLEY WRENCH, HONDA/ACURA	234
CRANKSHAFT SOCKET TOOLS	234
CRANKSHAFT WIPERS	109
CUSTOM OIL PAN/ORDER FORM	105
CYLINDER HEAD DOWELS, OFFSET	214
CYLINDER HEAD WORK STAND	236
CYLINDER LEAK DOWN TESTER	236
CYLINDER LEAKAGE TESTERS	236

D

DANA 60 PARTS	370
DECK PLUG KIT	214
DEGREE WHEELS	234
DIAL INDICATOR STANDS	236
DIFFERENTIALS & REAR AXLE ACCESSORIES	370-371
DIPSTICK KIT, TRANSMISSION	210
DIPSTICK KITS, UNIVERSAL	106-107
DISCONNECT POWER SWITCHES	361-364
DISTRIBUTOR EQUIPMENT	342-347
DISTRIBUTORS	342-343
DISTRIBUTORS, ROTOR	345
DOWEL PINS, BELLHOUSING	215
DRAG RACE FRONT TIRES	374
DRAIN PLUGS	107-108
DRIVE KIT, SPACER RING	171, 356
DRIVE KIT, WATER PUMP	255
DRIVE KITS, ALTERNATOR	167
DRIVE KITS, DRY SUMP/EXTERNAL PUMP	170-172
DRIVE KITS, VACUUM PUMP/EXTERNAL OIL PUMP	170-172
DRIVE MANDREL SPACER KITS	172-173, 356
DRIVE MANDRELS, OIL PUMPS & VACUUM PUMPS	17, 171-173
DRIVESHAFT LOOPS	250
DRY SUMP BELTS	179
DRY SUMP DRIVE KITS	170-172
DRY SUMP PRIMER	136
DRY SUMP PULLEYS	170-179
DRY SUMP PUMP FITTINGS	132-136
DRY SUMP PUMPS	12-15, 126-136
DRY SUMP TANKS & ACCESSORIES	12-15, 185-187
DRY SUMP TANK MOUNTS	16, 186-187
DS2 DRAG TIRES	374
DUROMETER, DIGITAL WITH CASE	244
DUST SHIELD	49

E

EFI FUEL RETURN LINE KIT	277
ELECTRIC WATER PUMPS/DRIVE KITS	255
ELECTRICAL SYSTEM EQUIPMENT	357-369
ENGINE BLOCK FILLER	213
ENGINE CLEANING BRUSHES	235
ENGINE LIFT PLATES	237
ENGINE MAGNET KIT	151
ENGINE MOUNTS	248-251
ENGINE SAVER FILTER	150
ENGINE SEALERS	213
ENGINE STORAGE BAGS	235
ENGINE STORAGE PLATES	237
ENGINE TOOLS	233-241
EPOXY	212
EQUALIZING PLATES	163
EXHAUST SYSTEM EQUIPMENT	285-286
EXPANSION TANKS, COOLING SYSTEM	193-206
EXPANSION TANKS, TRANSMISSION	191
EXTERNAL OIL PUMPS	12-15, 127-129
EXTERNAL OIL PUMP ADAPTERS	138-139

F

FASTENERS	18, 214-226
FENDER COVER	239
FILLER CAP KITS	317, 371
FILLER NECKS	259-260
FILTERS, AIR CLEANER & ACCESSORIES	280-284
FILTERS, OIL	147-149
FILTERED FITTINGS	150, 156
FILTERS, FUEL	276
FIREWALL GROMMETS	220
FITTING, NON-WELD	316
FITTING KITS, -12AN, GM LS O.E.M. VALVE COVERS	316
FITTINGS, -AN	16, 155-156
FITTINGS, -AN PORT PLUGS	154
FITTINGS, -AN SPECIAL	155
FITTINGS, 1/2" NPT MALE TO 5/8" BARBED HOSE	17, 188
FITTINGS, -16AN, VACUUM	155, 162
FITTINGS, DRY SUMP OILING SYSTEM	154-156
FITTINGS, FILTERED	150-156
FITTINGS, FUEL LINE & FUEL GAUGE	275-275
FITTINGS, OXYGEN SENSOR	285
FITTING, POSITIVE SEAL 1/8" NPT	162
FITTINGS, POSITIVE SEAL VENTED -12AN, -16AN	16, 162
FITTINGS, TEMPERATURE GAUGE	257
FITTINGS, WELD-ON -AN BUNGS	156
FITTINGS, WELD-ON NPT BUNGS	156
FLAT BOTTOM AIR CLEANERS	281
FLOOR PAN BRACE	372
FLYWHEEL/FLEX PLATE BOLTS	220
FRONT TIRES	374
FUEL BLOCK KITS	276
FUEL FILTERS	276
FUEL INLET FITTINGS	275
FUEL HOSE FITTINGS	275
FUEL LINE	275
FUEL LINE FITTINGS	276
FUEL LOG	276



F (CON'T)

FUEL PRESSURE GAUGE	276
FUEL PRESSURE GAUGE/FITTINGS	275-277
FUEL PUMP BLOCK-OFF PLATES	278
FUEL PUMP PUSH RODS	279
FUEL PUMP SPRING	279
FUEL RETURN LINE KIT	277
FUEL SYSTEM EQUIPMENT	20-21, 265-279
FUSE BOX COVERS	202-206

G

GASKET, AIR CLEANER BASE	283
GASKETS, CARBURETOR	279
GASKETS, FUEL PUMP	21, 278
GASKETS FOR HOLLEY® CARBURETOR	274, 279
GASKETS, OIL PAN	106
GASKETS, SBC & BBC THERMOSTAT/WATERNECK	21, 263
GASKET, TRANSMISSION PAN	209
GASKETS, VALVE COVER	307
GASKETS, WATER PUMPS	20, 256-257
GAUGE, FUEL PRESSURE	277
GAUGE, OIL PRESSURE	151, 160, 277
GAUGE, TEMPERATURE FITTING	257
GAUGE, VACUUM	160, 277
GAUGES, TIRE	245-246, 375
GEAR LUBE, CLIMBING	212
GILMER DRIVE BELTS	179
GM LS, OIL PUMP FLANGE REINFORCEMENT	49
GROMMETS, FIREWALL	220
GROMMETS PCV /BAFFLES	311

H

HARMONIC BALANCER TOOLS	233
HEADER BOLTS	219
HEADER FLANGE KIT	286
HEADER WRAP	286
HEAT BARRIER BLANKET	286
HEAT SHIELD STARTER	366
HEATING PAD, OIL PREHEATERS	154
HEI IGNITION KIT	343
HEI MODULE REPLACEMENT	342, 344
HIGH-PRESSURE OIL PUMP RELIEF SPRING	111, 153
HOLLEY® ACCELERATOR PUMP EQUIPMENT	272-273
HOLLEY® NEEDLE AND SEATS	274
HOLLEY® POWER VALVES	274
HOLLEY® TUNING & SERVICE PARTS	271-274
HOLLEY® VACUUM SECONDARY KITS	273
HOOD PINS	221-222
HOOD SCOOP PLUG	372
HOSE ADAPTERS, ELECTRIC WATER PUMPS	253
HOW A MOROSO OIL PAN IS MANUFACTURED	23
HOW MOROSO IGNITION WIRE IS MANUFACTURED	319-320
HOW MOROSO ACCUMULATORS WORK	143-144

I

IGNITION COILS	347-353
IGNITION KIT, SUPER HEI	343
IGNITION MODULE	344

I (CON'T)

IGNITION SYSTEM EQUIPMENT	342-356
IGNITION WIRE	22, 319-341
IGNITION WIRE ACCESSORIES	336-341
IGNITION WIRE BLUE MAX	325-333
IGNITION WIRE BOOT SLEEVE	338
IGNITION WIRE HONDA	333
IGNITION WIRE SEPARATORS	339-341
IGNITION WIRE SLEEVE	338
IGNITION WIRE, SOLID CORE	334-335
IGNITION WIRE, SPIRAL CORE	325-333
IGNITION WIRE STRIPING TOOL	242, 337
IGNITION WIRE TOOLS	242, 337
IGNITION WIRE, ULTRA 40	22, 321-324
IN-LINE FUEL FILTERS	276
IN-LINE SCREENED OIL FILTER	150
INSULATING HEADER WRAP	286
INTAKE MANIFOLD BOLT KITS	219
INTAKE SPACERS	279
INTERCOOLER TANKS	203-206

J

JET EXTENSIONS, HOLLEY®	271
JET INSTALLATION TOOL FOR HOLLEY®	240
JET TOOL	240

L

LEAK TESTER, ADAPTER	236
LEAKDOWN TESTERS	236
LIFTER VALLEY VENTS	152
LIFTER VALLEY OIL BAFFLES	152
LIFTER VALLEY PLATE, GM LS	152
LIGHTED TIRE PRESSURE GAUGES	245, 375
LINE KIT, VACUUM PUMP	163
LINE LOCKS	227
LOUVERED WINDAGE TRAYS	15, 110-113
LOW OIL PRESSURE WARNING LIGHT	151
LOW-PROFILE AIR CLEANERS	280
LS GM COIL MOUNTS	294, 348
LUG NUTS	228-229

M

MAGNETIC KIT, ENGINE	151
MAIN CAP BAFFLES	110
MAIN CAP GIRDLE	112
MANIFOLD FILLER NECK KIT	260-261
MOLY PASTE™	212
MOMENTARY SWITCH	365-366
MOTOR & TRANSMISSION MOUNTS	248-251
MOUNTING BRACKETS	165-169
MOUNTING BRACKET REMOTE THERMOSTAT HOUSING	264
MOUNTING BRACKETS, ALTERNATOR	165-169
MOUNTING BRACKET, DRY SUMP TANKS	186-187
MOUNTING BRACKETS, POWER STEERING	192
MOUNTING BRACKETS, UNIVERSAL TANK	191
MOUNTING BRACKETS, VACUUM PUMP	167
MUFFLERS, RACING	285

O

OFFSET AIR CLEANERS	281
OFFSET CYLINDER HEAD DOWELS	214
OFFSET VACUUM PUMP PULLEY	178
OIL/AIR SEPARATOR TANKS	180-184
OIL ACCUMULATORS	143-145
OIL ACCUMULATORS ADAPTERS, MOUNTS AND VALVES	141-146
OIL BAFFLES, LIFTER VALLEY	152
OIL BYPASS ELIMINATOR, CHEVY	138
OIL CONTROL KITS	110
OIL COOLERS, AUTOMATIC TRANSMISSION	211
OIL CHECK VALVE, ONE WAY	146
OIL DEFLECTOR KIT	153, 287
OIL FILL KIT, VALVE COVER	317
OIL FILLER CAP	317
OIL FILTER ADAPTERS	138-140
OIL FILTER BYPASSES & BLOCK-OFFS	138-139
OIL FILTER MOUNTS, REMOTE	141-142
OIL FILTERS, IN-LINE	150
OIL FILTERS, SPIN-ON	147-149
OIL PAN ACCESSORIES	106-113
OIL PAN ACCESS PLUG	108
OIL PAN BAFFLE KITS	110-113
OIL PAN DRAIN PLUG	107-108
OIL PAN GASKETS	106-113
OIL PAN INSPECTION PLUG	108
OIL PAN STUD & BOLT KITS	217-219
OIL PAN T-HANDLE WRENCHES	235
OIL PANS	8-10, 23-104
OIL PANS, CHEVY BIG BLOCK	52-65
OIL PANS, DONOVAN, DRC2, MERLIN	9, 65-66
OIL PANS, CHEVY SMALL BLOCK	8, 25-36
OIL PANS, SBC DART/ROCKET	37-38
OIL PANS, GM LS NEXT	50
OIL PANS, GM LS SERIES	8-9, 39-49
OIL PANS, GM LT SERIES	51
OIL PANS, CHRYSLER/JEEP	10, 67-72
OIL PANS, CUSTOM	104-105
OIL PANS, FORD 4.6, 5.0, 5.4	82-83
OIL PANS, FORD 5.0 "COYOTE"	10, 84-86
OIL PANS, FORD SMALL BLOCK	73-83
OIL PANS, FORD BIG BLOCK	87-91
OIL PANS, FORD POWERSTROKE	91
OIL PANS, GEN V/GEN VI	62-65
OIL PANS, HONDA/ACURA	9, 94-96
OIL PANS, INTERNATIONAL	92
OIL PANS, LOTUS	103
OIL PANS, MAZDA	97
OIL PANS, MITSUBISHI	98
OIL PANS, NISSAN	99
OIL PANS, OLDSMOBILE	92
OIL PANS, PONTIAC	93
OIL PANS, SUBARU	100
OIL PANS, TOYOTA	101-103
OIL PREHEATERS	154
OIL PRESSURE GAUGE	151, 160, 277
OIL PRESSURE WARNING LIGHT	151
OIL PRIMER TOOL	237
OIL PUMP BLOCK-OFF PLATE	138
OIL PUMP DRIVE KITS	170-172

O (CON'T)

OIL PUMP DRIVE SHAFTS	125
OIL PUMP PICKUPS	11, 116-124
OIL PUMP PICKUPS, GM LS FRONT SUMP	45-46
OIL PUMP & PICKUP PACKAGE	114-117
OIL PUMP & VACUUM PUMP DRIVE KITS & PULLEYS	170-179
OIL PUMP PRIMERS	136, 237
OIL PUMP RELIEF SPRING	111
OIL PUMP SHAFTS	125
OIL PUMP STUD KITS	215
OIL PUMPS	114-137
OIL PUMPS, BILLET WET SUMP	114-115
OIL PUMPS, STEEL	119-120
OIL PUMPS, DRY SUMP	12-15, 127-136
OIL PUMPS, EXTERNAL	12-15, 127-134
OIL PUMPS, EXTERNAL P/U KITS	124
OIL RESTRICTOR KITS	153
OIL RETURN SCREEN KITS	150
OIL SCREEN PRE-FILTER	150
OIL SEPARATOR/BREATHERS	312-314
OILING SYSTEM EQUIPMENT	16, 138-156
OVERFLOW TANK, RADIATOR	192-206
OXYGEN SENSOR FITTINGS	285
OXYGEN SENSOR FITTING PLUG	285

P

PANEL SWITCH	367-369
PCV GROMMETS/BAFFLES	311-312
PILOT BEARING, ROLLER	210
PINION WRENCHES	243
PIPE PLUGS, ALUMINUM	214
PIPE PLUGS, CHROME PLATED	214
PISTON INSTALLATION TOOLS	235
PIT SOCKET	230, 244
PLUG, O2 SENSOR	285
PLUG KITS, ALLEN HEAD	214
PLUG, 22MM	108
POWER CHARGER, BATTERY	357
POWER STEERING PULLEY	175
POWER STEERING PUMP MOUNTING BRACKETS	169
POWER STEERING TANKS	192, 204
POWER-SPEED CALCULATOR	241
POWER VALVE TESTER	239
PRESSURE REGULATING FUEL LOG	276
PROCOILS	347-353
PULLEY WRENCH, HONDA/ACURA CRANKSHAFT	234
PULLEYS	173-178
PULLEYS, ALTERNATOR ROUND TOOTH	179
PULLEYS, DRY SUMP	170-178
PULLEY SHIM KITS	173
PULLEYS, VACUUM PUMP & DRIVE	173-179
PULLEYS, WATER PUMP & CRANKSHAFT	170-179

Q

QUICK DISCONNECT, BATTERY	360-364
QUICK FASTENERS/ACCESSORIES	222-224
QUICK FASTENER SINKING TOOL	243
QUICK FASTENER TRANSFER STUD PUNCH KITS	225
QUICK FASTENER WRENCHES	225



Q (CON'T)

QUICK RELEASE PINS 226

R

RACE WRITE 213
 RACING OIL FILTERS 147-149
 RADIATOR CAP COVERS 198
 RADIATOR CAPS 258
 RADIATOR HOSE DRAIN/FILLERS 258
 RADIATOR OVERFLOW TANKS 192-206
 RADIATOR RECOVERY TANKS 192-206
 RADIUS TOOTH BELTS 179
 RADIUS TOOTH, DRY SUMP & DRIVE PULLEYS 178
 REAR AXLE EQUIPMENT 370-371
 REAR END & WATER FILL CAP KITS 317
 REAR END COVERS 370
 REAR SEAL ADAPTERS 109
 REMOTE COIL MOUNTING BRACKET 294, 348
 REMOTE FILTER MOUNTS 141-143
 REMOTE OIL FILTER ADAPTERS & MOUNTS 141-143
 REMOTE THERMOSTAT HOUSING 264
 REMOVABLE COIL MOUNTING BRACKET 294, 348
 REPLACEMENT PARTS 454
 RIM SCREWS 230
 ROCKER SWITCH PANELS 368-369
 ROLL BAR PADDING 247
 ROLLER PILOT BEARING 210
 ROTORS, IGNITION 342-345

S

SAFETY WIRE 247
 SCREEN KIT, FILTER 150
 SCREEN KIT, OIL RETURN GALLEY 150
 SCREEN WINDAGE TRAYS 110-113
 SEALED BATTERY BOX 357
 SEALERS 212-213
 SELF-EJECTING FASTENERS 223
 SENSOR, COOLANT 196
 SEPARATORS, AIR-OIL 180-184, 190
 SHOCK ADJUSTING TOOL 243
 SHEETMETAL & BODY 372
 SHIM KIT PULLEY 173
 SIGHT PLUG FOR HOLLEY® 271
 SLEEVES, BOOT 338
 SLIP LINK, 1:1 272
 SOLENOID PRESSURE VALVE, ACCUMULATOR 146
 SPACER PLATES, INTAKE MANIFOLD 279
 SPARK PLUG HOLE AIR HOSE KIT 241
 SPARK PLUG INDEXER 241
 SPARK PLUG INDEXING WASHERS 345
 SPARK PLUG INSULATORS 324
 SPARK PLUG MARKERS 336
 SPARK PLUG RACK 265
 SPARK PLUG WIRE BOOT KITS 324, 336
 SPARK PLUG WIRE, IMPORT SETS 333
 SPARK PLUG WIRE INSULATED SLEEVE 338
 SPARK PLUG WIRE LOOM & SEPARATOR KITS 339-341
 SPARK PLUG WIRE SHRINK SLEEVES 338
 SPARK PLUG WIRE, SOLID CORE 334-335

S (CON'T)

SPARK PLUG WIRE, SPIRAL CORE 324-333
 SPARK PLUG WIRE, ULTRA 40 22, 321-324
 SPIN-ON, OIL FILTERS 147-149
 SPIRAL FLOW RACING MUFFLER 285
 SPOILER, UNIVERSAL REAR 372
 SPRING OILER 293
 SPRINGS, FASTENER 222-223
 SPRINGS, FRONT 231
 SPRINGS, REAR 232
 SPRINT CAR FRONT DRIVE 137
 SQUIRTER SCREW, HOLLEY® HIGH FLOW 272
 STARTER HEAT SHIELD 366
 STARTER QUICK DISCONNECT 364
 STEERING EQUIPMENT 373
 STEERING U-JOINTS 373
 STEERING WHEEL HUB, QUICK RELEASE 373
 STUD GIRDLES AND ACCESSORIES, VALVETRAIN 287
 STUD KITS, OIL PANS 216-217
 SUPER HEI IGNITION KIT 343
 SUPERCHARGER TANKS 197-201
 SWITCH COVERS 366
 SWITCH PANELS 367-369
 SWITCH, THERMOSTATIC 258
 SWITCHES 367-369

T

T-HANDLE WRENCHES, OIL PAN 235
 T-PINS 226
 TANK MOUNTING BRACKETS 186-187, 191
 TANKS 21, 185-206
 TANKS, AIR/OIL SEPARATORS 180-184
 TANKS, BREATHERS 187-191
 TANKS, COOLANT 18, 191-206
 TANKS, COOLANT EXPANSION 18, 194-205
 TANKS, DRY SUMP 185-187
 TANKS, POWER STEERING 192, 199, 204
 TAPE, SELF-VULCANIZING, BLACK 336
 TEMPERATURE GAUGE FITTING 257
 THERMOSTAT HOUSING BRACKET 264
 THERMOSTATIC SWITCH 258
 THROTTLE CABLE MOUNTING KITS 265-266
 THROTTLE RETURN SPRINGS & KITS 268
 THROTTLE STOPS 268
 TIE DOWNS 247
 TIMING COVER BOLTS 219
 TIMING COVERS 137
 TIMING POINTERS 356
 TIRE COVERS 376
 TIRE PRESSURE GAUGES & REPL. HOSE 246, 375
 TIRES 374-376
 TOGGLE PANELS & SWITCHES 366-369
 TOGGLE SWITCH COVER 366
 TOOLS 19, 233-247
 TORQUE CONVERTER BOLTS 211, 219
 TRANSMISSION COOLERS 211
 TRANSMISSION DIPSTICKS 210
 TRANSMISSION EXPANSION TANKS 191
 TRANSMISSION GASKETS 209
 TRANSMISSION PANS & ACCESSORIES 207-211

T (CON'T)

TRANSMISSION MOUNTS, SOLID	248-251
TRANSMISSION TAIL SHAFT PLUGS	211
TRICK SPRINGS	231-232

U

U-JOINT GIRDLES	371
ULTRA 40 RACE WIRE	22, 321-324
ULTRA 40 SPARK PLUG BOOT & TERMINAL KITS	324
UNIVERSAL DIPSTICK KITS	106-107
UNIVERSAL SPOILER	372
UNIVERSAL TRANSMISSION DIPSTICKS	210
UNIVERSAL WINDAGE TRAYS	110-113

V

VACUUM ADVANCE KITS	344
VACUUM GAUGE	160
VACUUM LINE CAP KIT	163
VACUUM PUMPS & ACCESSORIES	157-164
VACUUM PUMP BRACKETS	164-169
VACUUM PUMP DRIVE MANDRELS	171-173
VACUUM PUMP DRIVE KITS	170-172
VACUUM PUMP, LINE KIT	163
VACUUM PUMP, PULLEYS	170-178
VACUUM PUMP, REGULATORS	161
VACUUM PUMP, REPLACEMENT LINE	158
VACUUM PUMP TECH TIPS	157
VACUUM PUMPS	157-164
VACUUM RELIEF VALVES	161
VACUUM RELIEF VALVE BREATHER	161
VALLEY PLATES	152
VALVE, BALL	180-184
VALVE COVER ACCESSORIES	309-318
VALVE COVER ACORN NUTS	309
VALVE COVER BAFFLES, GROMMETS	311-312
VALVE COVER BREATHERS	295, 312-318
VALVE COVERS FITTINGS	316-317
VALVE COVER GASKETS	307
VALVE COVER HOLD DOWN TABS	308-310
VALVE COVER LOCK NUTS	215
VALVE COVER OIL FILL KIT	317
VALVE COVER WING NUTS	309
VALVE COVERS	22, 288-318
VALVE SEAT PRESSURE TESTER	238-239
VALVE SPRING COMPRESSORS & TESTER	238-239
VALVE SPRINGS, CHECKING	238-239
VALVE, AIR BLEED	257
VALVE, OIL CHECK, ONE WAY	146
VALVETRAIN EQUIPMENT	287
VALVETRAIN OIL DEFLECTOR	153, 287
VENT, LIFTER VALLEY	152

W

WARNING LIGHT KIT, LOW OIL PRESSURE	151
WASHERS, DRAIN PLUG	108
WASHERS, HEAD BOLT	215
WASHERS, QUICK FASTENER	225
WATER FILLER NECKS	259-264

W (CON'T)

WATER NECK BLOCK-OFF PLATE	262
WATER OUTLET FITTING	257-259
WATER OUTLET RESTRICTOR KIT	257
WATER PUMP ADAPTER KITS	253-254
WATER PUMP BRACKET KIT	165-169
WATER PUMP DRIVE KITS	255
WATER PUMP HOSE ADAPTERS	253
WATER PUMP PULLEY SHIMS	173
WATER PUMP, ELECTRIC	252-256
WATER PUMPS, MECHANICAL, ALUMINUM	256
WATER PUMP SPACER KITS	256
WATER PUMP SWITCHES	257-258
WELD-IN BUNGS, ALUMINUM	156
WET SUMP VS. DRY SUMP OILING INFORMATION	24
WHEEL RIM SCREWS	230
WHEEL STUDS AND NUTS	19, 228-229
WINDAGE TRAYS & ACCESSORIES	15, 110-113
WINDAGE TRY MOUNTING, FORD	111-112
WINDOW MARKER, RACE WRITE	213
WING NUTS, AIR CLEANER	284
WIRE SEPARATORS	339-340
WIRE STRIPPING/CRIMPING TOOLS	242, 337
WIRE, SOLID CORE	334-335
WIRE, SPIRAL CORE	325-333
WIRE, ULTRA 40	22, 321-324
WRENCHES, PINION	243
WRENCHES, QUICK FASTENER	225





CHEVROLET SMALL BLOCK, DRAG RACE, OIL PAN

Steel, Wet Sump, 7 Quart Capacity, 8-1/4" Deep

Engine Application: Pre-1980 engine blocks with driver-side dipstick and Dart Little M engine blocks with 4 bolt non-radiused front main caps

- Accepts 4" strokes with steel rods
- Core based oil pan utilizing stock pan rail bolt pattern
- Passenger-side kick-out for increased horsepower
- Solid louvered tray with main cap partitions for maximum power and oil control
- For use with 168 and 153-tooth flywheel combinations
- Dipstick provision in sump

PART # DESCRIPTION

21015 Oil Pan, Steel, Clear Zinc

PART # RECOMMENDED PICKUPS

24170 Fits: Moroso SBC Race Pump

Nos. 22099, 22101 or M55 style pump

24181 Fits: Moroso SBC, 3/4" Inlet,

M10552/M10555 style pumps

24350 Fits: Moroso SBC HV Race Pump

Nos. 22109, 22111 or M55HV style pump

24320 Fits: Moroso BBC Race Pump

No. 22150 or M77HV style pump

24360 Fits: M155HV/M10551 style pump,

with slight tray modifications



No. 21015

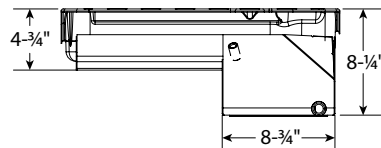
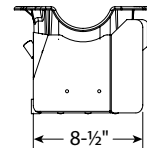

GM LS, CAST ALUMINUM, SWAP, OIL PAN KIT WITH SPIN-ON OIL FILTER PROVISION

Aluminum, Wet Sump, 6 Quart Capacity, 5-3/4" Deep

Engine Application: GM LS Series

Fits: LS Engine Conversions such as '55-'87 GM Cars & Trucks (except G-Body) that require a Rear Sump Oil Pan with a Spin-On Filter provision (Check Measurements)

- Based on customer inquires, this product is for the individual who prefers the O.E.M. look of a cast aluminum oil pan
- The oil pan is cast, then machined from aluminum
- Clears 4.25" stroke with most steel rods
- Includes a removable, heavy duty stainless steel anti-slosh baffle
- Features a heavy duty, high flow oil pump pickup
- Integral Spin-On oil filter provision with a O.E.M. oil cooler port that accepts a 22mm-1.5 thread Moroso Part No. 22463 or O.E.M. Spin-On oil filter
- Includes oil pan gasket and mounting hardware
- Use stock dipstick

PART # DESCRIPTION

20105 Oil Pan, Cast Aluminum, GM LS, Rear Sump Swap Kit, Spin-On Oil Filter

PART # AVAILABLE OPTIONS

22120 Oil Pump, GM LS, High Volume

24890 Oil Pump Flange Reinforcement



No. 20105

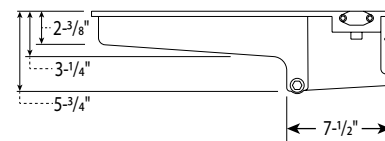
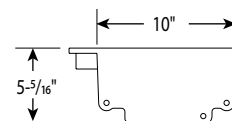
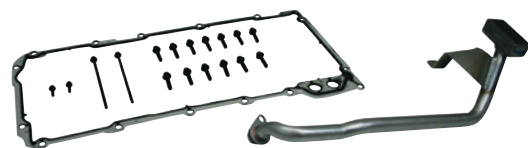

WARNING Prop. 65
This product contains a chemical known to the state of California to cause cancer, birth defects, or reproductive harm.

CAMARO/FIREBIRD '98-'02 GM LS SERIES, DRAG RACE, OIL PAN

Aluminum, Wet Sump, 7 Quart Capacity, 6" Deep
 Fits: Camaro and Firebird '98-02 with GM LS Engines,
 Camaro and Firebird '93-'02 with LS Swap

- Features a drag race proven trap door assembly and anti-slosh baffle that keeps oil contained in oil pump pickup area
- Oil pan has a thick CNC machined aluminum rail
- Clears 4.25" stroke with most steel rods
- The 7 Quart Capacity moves the oil away from the rotating assembly for oil control and horsepower saving
- Features a billet aluminum adapter that allows a 22mm thread Moroso No. 22463 or O.E.M. oil filter to be mounted in the stock location, no need to run a remote oil filter
- Included billet aluminum oil filter adapter has a 1/4" NPT sensor port
- Uses stock dipstick

PART # DESCRIPTION
21149 Oil Pan, Aluminum, Drag Race Baffled, Camaro/Firebird '98-'02

PART # RECOMMENDED PICKUP
24050 Stock Oil Pumps or Moroso LS Series High Volume Race Pump No. 22120

PART # AVAILABLE OPTIONS
93152 Oil Pan Gasket, GM LS Series (Except LS7 & LS9)
38541 Oil Pan Stud Kit



No. 21149

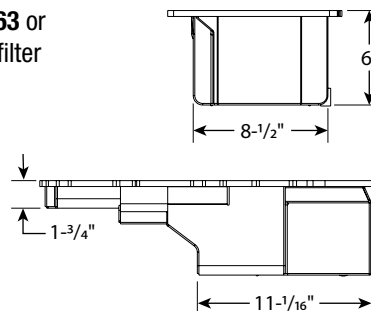

DONOVAN, DRC2, MERLIN, DRAG RACE, OIL PAN

Aluminum, Dry Sump
 Engine Application: Donovan 700, DRC2, Donovan Style blocks with 10" and 10-3/8" wide pan rails and 2-piece rear main seal

- Fully fabricated, aluminum
- Removable bottom with o-ring billet flange
- (4) -12AN female billet aluminum pickups
- Power kick-out design for maximum horsepower, removable crank scraper
- Internal uni-directional screen
- For use with 168-tooth flywheel combination
- Billet end seals ensure consistent sealing surface to billet front covers and rear main caps
- Accepts 5.30" stroke with aluminum rods

PART # DESCRIPTION
21598 Oil Pan, Aluminum, Donovan, DRC2, Merlin Big Block, Two Piece, 4 Pickups, Drag Race, Dry Sump

No. 21598

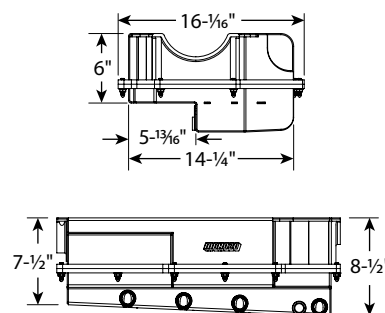

HONDA H-SERIES, OIL PAN

Steel, Wet Sump, 4 Quart Capacity, 5-1/4" Deep
 Engine Application: Honda H Series 2.2L/2.3L

- Sump baffle that fully surrounds the oil pump pickup
- 1/2" NPT fitting for turbo or supercharger drain back
- Features a magnetic drain plug and a 1/2" NPT fitting for a temperature sender
- Works with OEM exhaust manifold and most aftermarket exhaust/header combinations

PART # DESCRIPTION
20916 Oil Pan, Steel, Clear Zinc, Stock Configuration



No. 20916

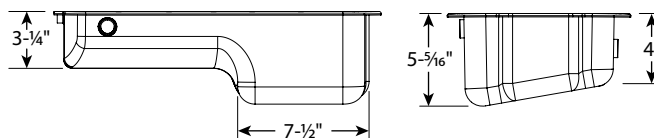

CHRYSLER HELLCAT, DRAG RACE, OIL PAN

Aluminum, Wet Sump, 7-1/2" Deep, 10 Quart Capacity
 Engine Application: Chrysler 6.2 & Gen. 3 Hemi with the Hellcat front timing cover

Fits: Chrysler Hellcat with Drag Pack or modified cross member, also can be used in other rear sump applications, check measurements for fit

- Robust billet aluminum oil pan rail with billet front seal area and a fabricated aluminum straight sided sump
- Features factory "Drag Pack Race Proven" internals
- To be used with Moroso Part No. 71161, Stainless Steel Dust Shield

PART # DESCRIPTION
21166 Oil Pan, Aluminum, Chrysler Hellcat, Rear Sump

PART # RECOMMENDED PICKUP
24166 Pickup, Oil Pump, Hellcat Rear Sump
 Fits: Chrysler Part Nos. 68195993AC, 5038398AE Oil Pumps



No. 21166

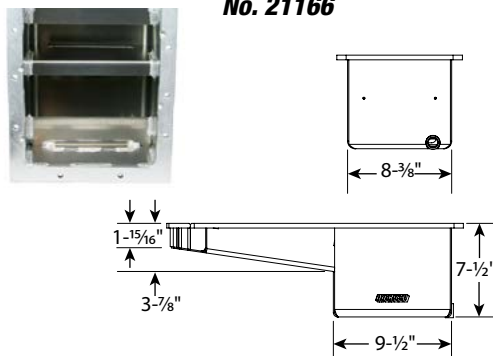

FORD 5.0 COYOTE / 5.2 VOODOO MUSTANG FOX BODY SWAP, OIL PANS

Steel/Aluminum, Wet Sump, 7.5 Quart Capacity, 6-5/8" Deep
 Engine Application: Ford 5.0 Coyote/5.2 Voodoo

Fits: Mustang '79-'93 and other Fox body chassis with a 5.0 Coyote/5.2 Voodoo swap using BBK or American Racing Headers

- Pans have a thick steel or billet aluminum rail, steel oil pan has clear zinc finish
- Designed to be used with the 5.0 "Coyote"/5.2 "Voodoo" factory windage tray/gasket
- Features a race proven trap door assembly and anti-slosh baffle that keeps oil contained in the oil pump pickup area during road racing and street/strip usage
- 1/2" NPT fitting for supercharger drain back
- 1/2" NPT fitting for oil temperature sender
- 20 mm fitting for the factory oil level sensor*

PART # DESCRIPTION
20575 Oil Pan, Steel, Clear Zinc, Fully Fabricated, Ford 5.0 Coyote/5.2 Voodoo swaps in '79-'93 Mustang, Road Race Baffled

20576 Oil Pan, Aluminum, Fully Fabricated, Ford 5.0 Coyote/5.2 Voodoo swaps in '79-'93 Mustang, Road Race Baffled

20577 Oil Pan, Aluminum, Fully Fabricated, Ford 5.0 Coyote/5.2 Voodoo swaps in '79-'93 Mustang, Drag Race Baffled

PART # AVAILABLE OPTIONS
22738 Factory Low Oil Warning Sensor Plug, 20mm
22936 Windage Tray, Oil Pan Gasket **NEW!**
 (See on page 15!)



No. 20575



No. 20576



No. 20577

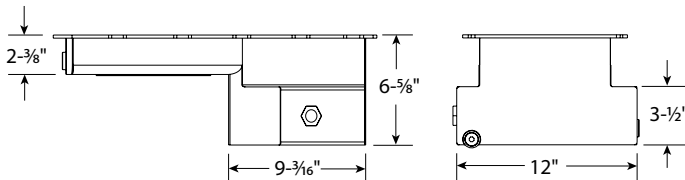

*If the factory low oil warning sensor is not going to be used, Part #22738, 20mm Plug with copper washer is available

RECOMMENDED PICKUPS - 5.0 COYOTE & 5.2 VOODOO

MOROSO OIL PAN PART #	GEN I & II OIL PUMP PICKUP	GEN III OIL PUMP PICKUP
20575	STOCK	24578
20576	STOCK	24578
20577	24574	24579

OIL PUMP PICKUP, GM LS REAR SUMP, MOROSO PART NO. 21153 OIL PAN

Fits: Moroso Part No. 22120 and other GM LS oil pumps

- To be used when a Moroso Part **No. 22120** or other GM LS oil pump is being used with a Moroso Part **No. 21153** rear sump oil pan
- Pickup has a double bolt hole mounting flange, pickup can be secured to the oil pump with 2 fasteners instead of one
- Pickup clears dipstick and windage tray even when the windage tray is spaced down for stroker engines
- O-Ring and mounting hardware are included
- Will only fit with 2020 COPO windage tray GM Part # 19202609 and main cap mounting hardware

PART #	DESCRIPTION
24154	Oil Pump Pickup, GM LS, Fits Moroso Part No. 21153 Oil Pan

FEATURES



DOUBLE BOLT HOLE MOUNTING FLANGE



No. 24154

OIL PUMP PICKUP KITS, FORD COYOTE GEN 3, GT 350 ENGINES WITH GEN 3 OIL PUMPS

- Pickup's machined steel bung inserts into a Gen. 3 oil pump, is retained by the bung's machined steps, o-ring and it's integral bracket
- Pickup has a large 1-1/4" diameter tube so that there is no restriction of flow during continuous high rpm track events
- Must use with Moroso Part **No. 22936** or Ford Part No. BR3Z-6710-A windage tray/gasket
- Kit includes pickup tube, o-ring, main cap bolt, standoff and 8mm flange head screw

PART #	DESCRIPTION
24576	Oil Pump Pickup Kit, Ford Coyote Gen 3, GT 350 Engines <i>Fits: Moroso Part No. 20573 Oil Pan</i>
24577	Oil Pump Pickup Kit, Ford Coyote Gen 3, GT 350 Engines <i>Fits: Moroso Part Nos. 20569 and 20570 Oil Pans</i>
24578	Oil Pump Pickup Kit, Ford Coyote Gen 3, GT 350 Engines <i>Fits: Moroso Part Nos. 20571, 20572, 20575 and 20576 Mustang rear sump oil pans</i>
24579	Oil Pump Pickup Kit, Ford Coyote Gen 3, GT 350 Engines <i>Fits: Moroso Part Nos. 20574 and 20577 Oil Pans</i>

FEATURES



MACHINED STEEL BUNG



No. 24576



No. 24577



No. 24578



No. 24579



EXTERNAL OIL PUMPS, SINGLE STAGE, V-BAND MOUNTING FLANGE

Fits: Alston Front Accessory Drives

- Two different gear sets are available, 1.200 or 1.800
- External pumps eliminate the camshaft loads that come with an internal pump
- V-Band mounting flange to mount External Oil Pump to Alston front drives
- Light weight and efficient
- Includes all replacement fittings, -16AN inlet, -12AN outlet
- External oil pumps run cooler than internal pumps and features an external bypass for ease of adjustment

PART #	DESCRIPTION
22411	External Oil Pump, with V-Band Mounting Flange for Alston Front Drives, 1.200 Pressure
22413	External Oil Pump, with V-Band Mounting Flange for Alston Front Drives, 1.800 Pressure

No. 22413



EXTERNAL OIL PUMPS, SINGLE STAGE, V-BAND MOUNTING FLANGE

Fits: ProCharger Front Accessory Drives

- Two different gear sets are available, 1.200 or 1.800
- External pumps eliminate the camshaft loads that come with an internal pump
- V-Band mounting flange to mount External Oil Pump to ProCharger and other supercharger front drives
- Light weight and efficient
- Includes all necessary fittings
- External oil pumps run cooler than internal pumps and features an external bypass for ease of adjustment
- ProCharger Part No. 3PCCD-032 is required for installation

PART #	DESCRIPTION
22311	External Oil Pump, Mounts to ProCharger Front Drives, V-Band Mounting Flange, 1.200 Pressure
22313	External Oil Pump, Mounts to ProCharger Front Drives, V-Band Mounting Flange, 1.800 Pressure

No. 22311

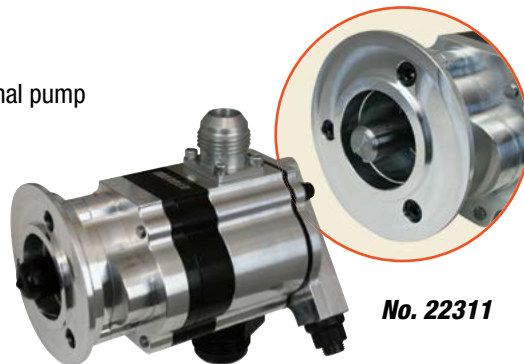

EXTERNAL OIL PUMP, SINGLE STAGE, REVERSE ROTATION V-BAND MOUNTING FLANGE

Fits: Alston Front Accessory Drives, Pump Mounted Towards Front of Car

- V-Band mounting flange to mount External Oil Pump to Alston front drives
- Spur gear 1.200 pressure section
- External pumps eliminate the camshaft loads that come with an internal pump
- Light weight and efficient
- Includes all necessary fittings
- External oil pumps run cooler than internal pumps and features an external bypass for ease of adjustment

PART #	DESCRIPTION
22412	External Oil Pump, Reverse Rotation, Alston Front Drives, V-Band Mounting Flange for 1.200 Pressure

No. 22412



EXTERNAL OIL PUMP, SINGLE STAGE, REVERSE ROTATION, V-BAND MOUNTING FLANGE

Fits: ProCharger Front Accessory Drives, Pump Mounted Towards Front of Car

- V-Band mounting flange to mount External Oil Pump to ProCharger supercharger front drives
- Spur gear 1.200 pressure section
- External pumps eliminate the camshaft loads that come with an internal pump
- Light weight and efficient
- Includes all necessary fittings
- External oil pumps run cooler than internal pumps and features an external bypass for ease of adjustment
- ProCharger Part No. 3PCCD-032 is required for installation

PART #	DESCRIPTION
22312	External Oil Pump, Reverse Rotation, ProCharger Front Drives, V-Band Mounting Flange, 1.200 Pressure

No. 22312



DRY SUMP PUMPS, TRI-LOBE, FIVE STAGE, V-BAND MOUNTING FLANGE

Available for Alston and ProCharger Front Accessory Drives

- V-Band mounting flange to mount Dry Sump Pump to front drives
- Tri-lobe aluminum scavenge sections featuring individual timing gears to ensure proper clearance at the highest of RPM's
- Spur gear pressure section based off Moroso's billet wet sump pump design
- Variable spring rates optimize your oil pressure for smooth, reliable oil pressure readings
- Saves weight and make big crankcase vacuum
- Includes replaceable fittings: Pressure Section -12AN Inlet, -12AN Outlet, Scavenge inlets -12AN Return -16AN
- Pumps weigh almost half of gerotor pumps, and takes up to 40% less power to drive
- Includes all necessary fittings
- On ProCharger applications, ProCharger Part No. 3PCCD-032 is required for installation



No. 22515

PART # DESCRIPTION

22515	Dry Sump Pump Five Stage, V-Band Mounting Flange, Alston Front Drives, 1.200 Pressure/1.700 Scavenge
22315	Dry Sump Pump Five Stage, V-Band Mounting Flange, ProCharger Front Drives, 1.200 Pressure/1.700 Scavenge

DRY SUMP PUMPS, TRI-LOBE, V-BAND MOUNTING FLANGE, REVERSE ROTATION

Available for Alston and ProCharger Front Accessory Drives, Pump Mounted Towards Front of Car

- V-Band mounting flange to mount Reverse Rotation Dry Sump Pump to Alston front drives
- Tri-lobe aluminum scavenge sections featuring individual timing gears to ensure proper clearance at the highest of RPM's
- Spur gear pressure section based off Moroso's billet wet sump pump design
- Variable spring rates optimize your oil pressure for smooth, reliable oil pressure readings
- Saves weight and make big crankcase vacuum
- Includes replaceable fittings: Pressure Section -12AN Inlet, -12AN Outlet, Scavenge inlets -12AN Return -16AN
- Pumps weigh almost half of gerotor pumps, and takes up to 40% less power to drive
- Includes all necessary fittings
- On ProCharger applications, ProCharger Part No. 3PCCD-032 is required for installation



No. 22517

PART # DESCRIPTION

22517	Dry Sump Pump Five Stage, V-Band Mounting Flange, Reverse Rotation, Alston Front Drives, 1.200 Pressure/1.700 Scavenge
22518	Dry Sump Pump Five Stage, V-Band Mounting Flange, Reverse Rotation, ProCharger Front Drives, 1.200 Pressure/1.700 Scavenge

EXTERNAL OIL PUMP, TWO STAGE, FUEL PUMP DRIVE

Driver's/Left Side Door Car Style Bracket

An expansion to our popular line of external oil pumps. This pump gives you the option of scavenging oil from the oil pan with one stage and using the second stage to scavenge oil from turbos, superchargers or areas that require oil to be scavenged.

- Rear 3/8" hex fuel pump drive with 1:1 ratio that accepts the popular 1.450 ID, 3 bolt, fuel pump swivel clamps
- Spur gear 1.800 pressure section
- External pumps eliminate the camshaft loads that occur with an internal pump
- Light weight and efficient
- Includes all necessary fittings
- External oil pumps run cooler than internal pumps and features an external bypass for ease of adjustment



No. 22342

PART # DESCRIPTION

22342	External Oil Pump, Two Stage, Fuel Pump Drive, Left Side Bracket, 1.800 Pressure
--------------	--





DRY SUMP PUMPS, TRI-LOBE, DUAL MOUNTS

Heavy Duty Dual Mount Bracket

- Features two of our driver's side/left side door car mounting brackets for circle track, marine and road racing applications where the extra weight of the second bracket isn't an issue
- Tri-lobe aluminum scavenge sections featuring individual timing gears to ensure proper clearance at the highest of RPM's
- Spur gear pressure section based off Moroso's billet wet sump pump design
- Variable spring rates optimize oil pressure for smooth, reliable oil pressure readings
- Saves weight and make big crankcase vacuum
- Includes replaceable fittings; Pressure Section -12AN Inlet, -12AN Outlet, Scavenge Inlets -12AN, Return -16AN
- Pumps weigh almost half of gerotor pumps, and takes up to 40% less power to drive
- Includes all necessary fittings

PART # DESCRIPTION

- | | |
|--------------|---|
| 22414 | Dry Sump Pump Four Stage, dual mount double driver's/left side door car mounting brackets 1.200 Pressure/1.700 Scavenge |
| 22415 | Dry Sump Pump Five Stage, dual mount double driver's/left side door car mounting brackets 1.200 Pressure/1.700 Scavenge |



No. 22414

DRY SUMP PUMP, TRI-LOBE, FIVE STAGE

Brinn/Bert Bellhousing Bracket

- Designed to mount Dry Sump Pump to Bert or Brinn Bellhousings
- Tri-lobe aluminum scavenge sections featuring individual timing gear to ensure proper clearance at the highest of RPM's
- Spur gear pressure section based off Moroso's billet wet sump pump design
- Variable spring rates optimize your oil pressure for smooth, reliable oil pressure readings
- This design saves weight and makes more crankcase vacuum than previous designs
- This Tri-Lobe Pump weighs almost half of gerotor pumps, and takes up to 40% less power to drive
- Includes replaceable fittings; Pressure Section -12AN Inlet, -12AN Outlet, Scavenge Inlets -12AN, Return -16AN

PART # DESCRIPTION

- | | |
|--------------|--|
| 22405 | Dry Sump Pump Five Stage, Bert or Brinn Bellhousing Mount, 1.200 Pressure/1.700 Scavenge |
|--------------|--|



No. 22405

DRY SUMP PUMP, TRI-LOBE, FIVE STAGE FUEL PUMP DRIVE

Brinn/Bert Bellhousing Bracket

- Rear 3/8" hex fuel pump drive with 1:1 ratio that accepts the popular 1.450 ID, 3 bolt, fuel pump swivel clamps
- Tri-lobe aluminum scavenge sections featuring individual timing gears to ensure proper clearance at the highest of RPM's
- Spur gear pressure section based off Moroso's billet wet sump pump design
- Variable spring rates optimize your oil pressure for smooth, reliable oil pressure readings
- Saves weight and makes big crankcase vacuum
- Includes replaceable fittings: Pressure Section -12AN Inlet, -12AN Outlet, Scavenge Inlets -12AN Return -16AN
- Pump weighs almost half of gerotor pumps, and takes up to 40% less power to drive
- Includes all necessary fittings

PART # DESCRIPTION

- | | |
|--------------|--|
| 22367 | Dry Sump Pump Five Stage, Fuel Pump Drive, 1.200 Pressure/1.700 Scavenge |
|--------------|--|



No. 22367

EXTERNAL SINGLE STAGE OIL PUMP/VACUUM PUMP KIT

SBC, Driver's/Left Bracket

- This kit includes a Moroso Tri-lobe Single Stage Oil Pump with a Moroso Enhanced Design 4-Vane Vacuum Pump driven off the back
- By driving the V-band clamp attached vacuum pump off the back of the oil pump this creates a compact weight saving design with one belt only being utilized
- Single stage external Tri-lobe oil pump is included that has a spur gear 1.200 pressure section, eliminates the camshaft loads that occur with an internal pump. Has replaceable fittings, -16AN inlet, -12AN outlet
- Enhanced Design 4-Vane Vacuum Pump is included that pulls more vacuum and is designed with maintenance-free precision sealed roller bearings. Has replaceable -12AN Inlet and Outlet fittings
- V-band clamp is included

PART #	DESCRIPTION
22652	External Oil Pump, Single Stage, Tri-Lobe, Vacuum Pump, SBC Left Side Bracket

No. 22652



EXTERNAL SINGLE STAGE OIL PUMP/VACUUM PUMP KIT

BBC, Driver's/Left Bracket

- This kit includes a Moroso Tri-lobe Single Stage Oil Pump with a Moroso Enhanced Design 4-Vane Vacuum Pump driven off the back of it
- By driving the V-band clamp attached vacuum pump off the back of the oil pump this creates a compact weight saving design
- Single stage external Tri-lobe oil pump is included that has a spur gear 1.200 pressure section, eliminates the camshaft loads that occur with an internal pump. Has replaceable fittings, -16AN inlet, -12AN outlet
- Enhanced Design 4-Vane Vacuum Pump is included that pulls more vacuum and is designed with maintenance-free precision sealed roller bearings. Has replaceable -12AN Inlet and Outlet fittings
- V-band clamp is included

PART #	DESCRIPTION
22654	External Oil Pump, Single Stage, Tri-Lobe, Vacuum Pump, BBC Left Side Bracket

No. 22654



WINDAGE TRAY AND OIL PAN GASKET

Fits: Ford 5.0 Coyote, 5.2 Voodoo

- Required when installing a Moroso oil pan and oil pump pickup on a Gen. 3 engine or is a replacement windage tray/oil pan gasket on a Gen. 1 or Gen. 2 engine
- Goes between the engine block and oil pan

PART #	DESCRIPTION
22936	Windage Tray & Oil Pan Gasket, Ford 5.0 Coyote, 5.2 Voodoo

No. 22936



DRY SUMP TANK MOUNTS

Now available in single packs

- Billet aluminum base for strength
- Includes stainless steel band clamp with interlocking rubber for cushioning
- Available in two sizes

PART #	DESCRIPTION
22701	Dry Sump Tank Mount, 6" diameter
22739	Dry Sump Tank Mount, 7" diameter

 **WARNING Prop. 65**
This product contains a chemical known to the state of California to cause cancer, birth defects, or reproductive harm.



No. 22701

DRY SUMP TANK REMOVABLE MOUNTING KITS, FOR 7" DIAMETER TANKS

- Mounting kit helps in the installation of 7" diameter dry sump tanks
- The kits contains a steel "I" shaped piece that allows the dry sump tank to be quickly removed and reinstalled in the vehicle
- Also this "I" shaped piece allows the installer to set what distance they would like their tank to be from the mounting surface
- Outer tube is drilled, inner tube needs to be drilled by customer
- Included in the mounting kit is the tank mount itself which has a billet aluminum base for strength
- A stainless steel band clamp with interlocking rubber for cushioning

PART #	DESCRIPTION
22697	Dry Sump Tank Removable Mounting Kit, Aluminum
22698	Dry Sump Tank Removable Mounting Kit, Steel

 **WARNING Prop. 65**
This product contains a chemical known to the state of California to cause cancer, birth defects, or reproductive harm.



No. 22697



No. 22698

OIL COOLER SANDWICH ADAPTER

Fits: Big Block Chevy Gen. 5, Gen. 6

- Mounts in the spin-on oil filter pocket, between the oil filter and the engine block to eliminate the need for a remote filter mount
- Machined out of billet aluminum with a black anodized finish for durability and long-lasting looks
- Eliminates the need for an oil-bypass eliminator, so unfiltered oil does not go back into the engine
- Features -10 AN female ports, Marked with "IN" and "Out"
- Includes mounting hardware and O-rings

PART #	DESCRIPTION
23705	Oil Cooler & Filter Adapter, Big Block Chevy Gen 5, Gen. 6



No. 23705

AN FITTING WITH O-RING, -8AN MALE TO -8AN STRAIGHT O-RING SIDE

- Radiused on inlet to reduce restriction for greater flow
- Black anodized billet aluminum
- Includes O-ring seal

PART #	DESCRIPTION
22604	Fitting, -8AN Male to -8AN Straight O-ring Side

 **WARNING Prop. 65**
This product contains a chemical known to the state of California to cause cancer, birth defects, or reproductive harm.



No. 22604

POSITIVE SEAL VENTED -8AN & -10AN FITTINGS, NON-WELD

Fits: 3/4" Holes

- Designed to greatly simplify the plumbing of a vacuum pump
- Screws into side of valve cover
- Provides leak free O-ring seal on any flat cover surface
- No welding required
- Anodized to prevent corrosion

PART #	DESCRIPTION
22624	Fitting, -10AN Male, Positive Seal, Non-Weld
22627	Fitting, -8AN Male, Positive Seal, Non-Weld

 **WARNING Prop. 65**
This product contains a chemical known to the state of California to cause cancer, birth defects, or reproductive harm.



No. 22624



No. 22627

FITTINGS, 1/2" NPT MALE TO 5/8" BARBED HOSE

- A valve cover breather assembly can be created easily by using these fittings with a Moroso Part No. 85455 Breather Tank, the following breathers; Part Nos. 68780, 68785 or 68788, plumbed together with 5/8" lines
- Brass construction
- One per package

PART #	DESCRIPTION
22735	Fitting, 1/2" NPT Male to 5/8" Barbed Hose, Straight
22736	Fitting, 1/2" NPT Male to 5/8" Barbed Hose, 90 Deg.

WARNING Prop. 65
 This product contains a chemical known to the state of California to cause cancer, birth defects, or reproductive harm.



LOWER BLOWER DRIVE MANDREL KIT, CHRYSLER GEN. 2 HEMI CRANK SNOOT

Fits: Chrysler Gen. 2 and most aftermarket Hemis

- Drive kit designed for all Chrysler and RCD based crankshaft pulley snouts
- Steel mandrel bolts to aluminum spacer for maximum strength for two-step and high torque applications
- 3/8" Bolt on a 2.782" bolt pattern and clears a 2.000" crankshaft hub register
- Will clear a 1.00" tall crankshaft bolt head
- Includes Top Fuel spec. blower pulley bolts with full shoulder and radius head for complete and correct installation the first time
- Drive pulleys not included

PART #	DESCRIPTION
63887	Drive Mandrel Kit, Chrysler Gen. 2 Hemi with Blower

WARNING Prop. 65
 This product contains a chemical known to the state of California to cause cancer, birth defects, or reproductive harm.



BREATHER TANK, TWO 1/2" FEMALE FITTINGS

- Use as a remote multi-inlet oil catch/breather for Crankcase Ventilation, Vacuum Pumps, Dry Sump Tanks or Rear Ends
- Can be used to collect from 2 sources
- Features Two 1/2" NPT Female Fittings that are 180 Degrees apart for ease of plumbing
- Aluminum, lightweight tank features internal baffling with mesh media for separation of air and oil
- Includes non-hooded, clamp-on filtered breather, Heavy Duty T-Clamp and a bottom petcock drain
- Dimensions: 3-1/8" diameter (without mount), 6-1/2" tank height (without filter or drain), 11-1/2" overall height

PART #	DESCRIPTION
85455	Breather Tank, Two 1/2" NPT Fittings

PART #	AVAILABLE OPTIONS
22735	Fitting, 1/2" NPT Male to 5/8" Barbed Hose, Straight
22736	Fitting, 1/2" NPT Male to 5/8" Barbed Hose, 90 Deg.

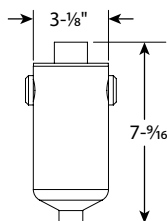

WARNING Prop. 65
 This product contains a chemical known to the state of California to cause cancer, birth defects, or reproductive harm.



VACUUM PUMP BREATHING TANK, TWO BREATHERS

- Bigger than your typical breather tank for capturing large amounts of vapor expelled by big cube, high boosted, big shot of nitrous, loose tolerances, high stressed types of engines
- Aluminum, lightweight tank features internal baffling with mesh media for separation of air and oil
- Includes two non-hooded, clamp-on filtered breathers, built-in mounting bracket and a easy to drain ball valve drain
- Dimensions: 7" wide (without mount), 4" deep, 11" tank height (without filter or drain), 15" overall height

PART #	DESCRIPTION
85390	Breather Tank, Vacuum Pump, Two Breathers, -16AN Inlet

WARNING Prop. 65
 This product contains a chemical known to the state of California to cause cancer, birth defects, or reproductive harm.

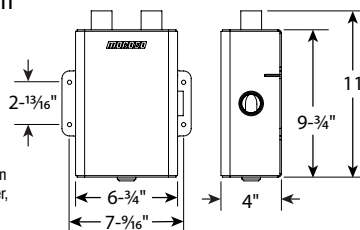

No. 85390



COOLANT EXPANSION TANK, FORD F-150 '15-'19 & RAPTOR '17-'19

Fits: F-150 (2.7, 3.5, 5.0) '15-'19 & Raptor '17-'19

- Direct bolt-in replacement to stock multi-piece plastic tank
- Fabricated aluminum for strength, factory tanks fail after repeated high heat situations
- This aluminum tank can be polished, chromed, painted, powder coated or left as is for a race look
- Features a billet aluminum radiator neck that accepts the factory cap



No. 63852

PART # DESCRIPTION

63852 Coolant Expansion Tank, Ford F-150 '15-'19 & Raptor '17-'19

COOLANT TANK, SUBARU IMPREZA, WRX/STI '08-'19

- Direct bolt-in replacement for stock cracked or mis-colored tanks
- Fabricated aluminum for strength, factory tanks fail after repeated high heat situations
- This aluminum tank can be polished, chromed, painted, powder coated or left as is for a race look
- Has a provision for the factory siphon hose
- Includes a billet aluminum cap



No. 63871

PART # DESCRIPTION

63871 Coolant Tank, Subaru Impreza WRX/STI '08-'19

VALVE COVER HARDWARE KIT FOR MOROSO GM LT BILLET VALVE COVERS

Fits: GM LT with Moroso GM LT Billet Valve Covers

- Kit includes (20) Clear Zinced Socket Head Cap Screws and (20) Washers

PART # DESCRIPTION

68832 Valve Cover Hardware Kit, Moroso GM LT Billet Valve Covers



No. 68832



WHEEL STUDS, 14MM X 1.5, 3" LONG, 5 PER PACK FOR MUSTANG S550, 2015-UP

- Manufactured from high grade SAE 8740 steel, 190,000 psi tensile strength (which exceeds Grade 8 specifications)
- These Moroso Press-in wheel studs have a .625" knurl and feature a "quick start dog end" for easier starting of lugnuts
- Black Oxide finish
- Made in the U.S.A.
- Five per package

PART #	DESCRIPTION
46247	Wheel Studs, 14mm x 1.5 x 3" long, press in with a .625" knurl, for Mustang S550 '15-Up

**No. 46247****EXHAUST BLOCK OFF STORAGE PLATES**

Fits: BBC Mark IV with conventional cylinder heads

- A convenient way to keep engines sealed up from foreign objects during storage or when an engine is getting painted
- Durable aluminum construction, come as pairs

PART #	DESCRIPTION
25160	Exhaust Block Off, Storage Plates, BBC Mark IV

**No. 25160****TOOL CASE, PLASTIC WITH FOAM INSERT**

- Rugged polyethylene plastic tool case is lined with a medium-density, open-cell foam insert to keep tools protected during transportation and storage
- Case's slide clasps have tabs for small padlocks
- Can also be used as replacement case for Moroso Part **Nos. 89552 and 89562** Pro Series Tire Pressure Gauges

PART #	DESCRIPTION
97481	Tool Case, Plastic with Foam Insert

**No. 97481**



WATER PUMP GASKETS, HEAVY DUTY, CHEVROLET

- An excellent way to seal a Moroso electric water pump or a conventional water pump to an engine block
- Race quality water pump gaskets are constructed out of a cellulose composition that conforms to it's mating surface
- Precision die cut design

PART #	DESCRIPTION
93230	Water Pump Gasket, SBC, 2 pack
93231	Water Pump Gasket, SBC, 10 pack
93232	Water Pump Gasket, BBC, 2 pack
93233	Water Pump Gasket, BBC, 10 pack



Nos. 93230,
93231



Nos. 93232,
93233

WATER PUMP GASKETS, HEAVY DUTY, CHRYSLER

- An excellent way to seal a Moroso electric water pump or a conventional water pump to an engine block
- Race quality water pump gaskets are constructed out of a cellulose composition that conforms to it's mating surface
- Precision die cut design

PART #	DESCRIPTION
93234	Water Pump Gasket, Chrysler 273-360, single pack
93235	Water Pump Gasket, Chrysler 273-360, 10 pack
93236	Water Pump Gasket, Chrysler 383-440, single pack
93237	Water Pump Gasket, Chrysler 383-440, 10 pack



Nos. 93234,
93235



Nos. 93236,
93237

WATER PUMP GASKETS, HEAVY DUTY, FORD

- An excellent way to seal a Moroso electric water pump or a conventional water pump to an engine block
- Race quality water pump gaskets are constructed out of a cellulose composition that conforms to it's mating surface
- Precision die cut design

PART #	DESCRIPTION
93238	Water Pump Gasket, Ford 289, Standard Rotation 302 & 351W, single pack
93239	Water Pump Gasket, Ford 289, Standard Rotation 302 & 351W, 10 pack
93240	Water Pump Gasket, Ford 429-460, single pack
93241	Water Pump Gasket, Ford 429-460, 10 pack



Nos. 93238,
93239

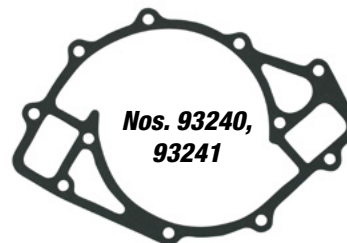

Nos. 93240,
93241

SUPER COOL CAN

For Carbureted and Fuel Injected Applications up to 125 PSI working pressure

- Polyethylene shell has a much higher insulating value than cork, allowing ice to last longer and cooling fuel more efficiently for a denser air-fuel mixture
- The higher insulating value of the shell combined with an advanced heat sink design reduces fuel temperature 20% over other cool cans
- The inlet and outlet are -8AN
- Lid is held on by a wing nut with a closed-cell foam seal between the lid and can
- NHRA approved mounting includes two stainless steel straps with T-bolt clamps and lightweight aluminum mounting bracket
- Spacing of steel straps aligns perfectly with mounting bosses molded into the Super Cool Can housing for strong attachment
- Holds ½ quart of fuel, approximate dimensions: 7-3/4" x 7-3/4" x 8" tall



No. 65127

PART #	DESCRIPTION
65127	Super Cool Can, -8AN female fittings

PART #	REPLACEMENT PART
97817	Super Cool Can Mounting Kit

PART #	AVAILABLE OPTION
22604	Fitting, -8AN Male to -8AN Straight O-ring Side

WARNING Prop. 65
This product contains a chemical known to the state of California to cause cancer, birth defects, or reproductive harm.

THERMOSTAT SPACER, BRODIX HV SERIES INTAKES INCLUDING SBC & BBC APPLICATIONS

- Spacer solves the issue of trying to use a thermostat on a Brodix HV Series Intake, can also be used on SBC and BBC applications to add water lines and/or raise thermostat to eliminate potential fitment issues
- Manufactured from billet aluminum with a machined O-ring groove on the intake side and thermostat register on top
- 1" thick spacer has two 3/8" NPT female ports for plumbing water lines to cylinder heads, includes O-ring

No. 63433



PART #	DESCRIPTION	PART #	AVAILABLE OPTION
63433	Thermostat Spacer, Brodix HV Series Intakes	63000	Gasket, Thermostat/Water Neck, SBC & BBC

SBC & BBC THERMOSTAT/WATERNECK GASKETS

- Same gasket that comes with Moroso non-o-ring filler/water neck kits
- Fiber construction
- Use as a replacement for Moroso non-o-ring filler/water neck kits or as a high quality replacement gasket for SBC & BBC thermostat housings
- Available as a single pack or 10 pack

No. 63000



PART #	DESCRIPTION
63000	Gasket, Thermostat/Water Neck, SBC & BBC
63001	Gasket, Thermostat/Water Neck, SBC & BBC, 10 Pack

SBC MECHANICAL FUEL PUMP GASKETS

- Same gaskets that comes with Moroso fuel pump block off plates
- Fiber construction
- Use as a replacement for Moroso fuel pump block off plates or as a high quality gasket for SBC mechanical fuel pumps
- Available as a single pack or 10 pack

No. 93320



PART #	DESCRIPTION
93320	Gasket, Mechanical Fuel Pump, SBC
93321	Gasket, Mechanical Fuel Pump, SBC, 10 Pack

MECHANICAL FUEL PUMP GASKETS

Fits: BBC, Chrysler 273-440, Ford 302, 351W, FE, 429-460

- Same gaskets that comes with Moroso fuel pump block off plates
- Fiber construction
- Use as a replacement for Moroso fuel pump block off plates or as a high quality gasket for BBC mechanical fuel pumps
- Available as a single pack or 10 pack

No. 93322



PART #	DESCRIPTION
93322	Gasket, Mechanical Fuel Pump, BBC, Chrysler 273-440, Ford 302, 351W, FE, 429-460
93323	Gasket, Mechanical Fuel Pump, BBC, Chrysler 273-440, Ford 302, 351W, FE, 429-460, 10 Pack

SUPERCHARGER CAP KIT, FUEL CAP STYLE

- Contains all of the parts necessary to replace broken or missing fuel cap style caps in Moroso or other tanks with this style of cap and neck
- Can also be used when an individual is producing a custom tank
- Cap is black so the kit can be used to change out red caps
- Kit contains; black fuel cap, neck, gasket, hardware and bonded sealing washers

No. 97092



WARNING Prop. 65
This product contains a chemical known to the state of California to cause cancer, birth defects, or reproductive harm.

PART #	DESCRIPTION
97092	Supercharger Cap Kit, Fuel Cap Style



SBC VALVE COVERS WITH OILERS, MULTIPLE OIL SUPPLY PORTS

*Fits: SBC 13 To 23 Deg. Cylinder Heads with the valves in the conventional location, 3.25" Tall
Please Note: Fits best with T&D Rockers, will not fit with All Pro 270-7 cylinder heads*

- Fabricated from superior quality aluminum welded to a one-piece billet rail that is machined to ensure a precision flat surface for superior sealing
- Tall enough to clear all popular rocker combinations
- Air-tight sealing allows the engine to pull greater vacuum for improved ring seal and power
- The spring oilers have removable/replaceable .025" jets
- Each spring oiler has multiple oil supply ports that the supplied -4 AN male fittings or plugs can be screwed into
- Having multiple oil supply ports makes plumbing routing easier in Sprint Cars, Dirt Late Models and other applications



No. 68332

WARNING Prop. 65
This product contains a chemical known to the state of California to cause cancer, birth defects, or reproductive harm.

PART # DESCRIPTION

68332* Valve Cover with Oilers, Fabricated Aluminum, Pair, SBC

MOROSO ULTRA 40 IGNITION WIRE SET FOR MOROSO GM LT SERIES, BILLET ALUMINUM VALVE COVERS

You have the Moroso all billet aluminum GM LT valve covers, why use any other spark plug wire than the Moroso Ultra 40 Sleeved sets that were designed to be used with these valve covers?

- All wires are 9.25" long
- Designed to be used with Moroso Part **No. 68494** All Billet Aluminum Valve Covers that have the integral coil pack mounts that accept LS2, LS3, LS7, & L98 style coils
- Wire Sets are constructed out of Moroso ULTRA 40, 7 mm Diameter Ignition Wire with 40 ohms of resistance per foot
- The black wire sets are sleeved which extends spark plug life and protects against exhaust header heat, chaffing and contaminants
- Sleeving also adds extra dielectric strength which is the wire's ability to not to be affected by outside electrical pulses
- Each wire is terminated with heavy duty, high temperature, easy-pull/positive engagement spark plug boots and on the other end with matching coil boots
- Complete, ready to install



No. 73848



WARNING Prop. 65
This product contains a chemical known to the state of California to cause cancer, birth defects, or reproductive harm.

PART # DESCRIPTION

73848* Wire Set, Ultra 40, Sleeved In Black, for Moroso Part **No. 68494**

CRANK TRIGGER ULTRA SERIES UNIVERSAL KIT, NO WHEEL

- Moroso has designed the adjuster arm to allow for infinite timing settings while still giving you the ability to position the sensor for the greatest range of adjustment for your combination. No more having the sensor run out of adjustment before you even start the engine up
- To be used with dampers that have built in crank trigger shells or EFI trigger wheels
- Crank trigger kit is based on the popular flying magnet style kit
- Compact adjuster arm for better fitment with chassis restrictions pans and containment devices
- The trigger arm is constructed out of billet aluminum with a black anodized finish for long lasting good looks
- The sensor mounting block is designed so that it will not stick out of the back of the arm and interfere with the oil pan
- Moroso crank trigger sensor comes with a more common plug to easily hook to any popular ignition box with no modifications
- Kit mounts to passenger side of block only, and has two sensor locations for non-motorplate applications
- Includes all necessary hardware



No. 60016

WARNING Prop. 65
This product contains a chemical known to the state of California to cause cancer, birth defects, or reproductive harm.

PART # DESCRIPTION

60016* Crank Trigger Ultra Series Kit, No Wheel

***Note:** Not Legal for sale or use on pollution-controlled vehicles

HOW A MOROSO OIL PAN IS MANUFACTURED

REPRINTED FROM DRAG RACER MAGAZINE

TEXT AND PHOTOS BY RANDY FISH

Moroso Performance Products was the first to manufacture racing oil pans with deep and kicked-out sumps, solving the lubrication problems of racers. The following details the manufacture of a Pro Eliminator Oil Pan. While automated machinery is used to make individual components, **Moroso Oil Pans are precision welded, one at a time, by skilled craftsmen.**



The turret punch press machine is where Moroso's precision manufacturing process begins. Reference holes become precision cuts resulting in a sheet of pre-cut aluminum components. Once a design is entered into the machine's computerized interface, the exacting tolerances of the original pan can be repeated endlessly. **Inset:** Individual pieces are detached manually in preparation for assembly.



Billet aluminum end caps are milled on Moroso's bank of CNC machines. They are then computer checked for dimensional accuracy before transfer to manufacturing. Here, a Quality Control Tech uses computerized digital probes to perform a battery of tests on a CMM machine, a staple in the aerospace industry. Another computer driven sheet metal brake makes the prescribed bends and angles for various component pieces.

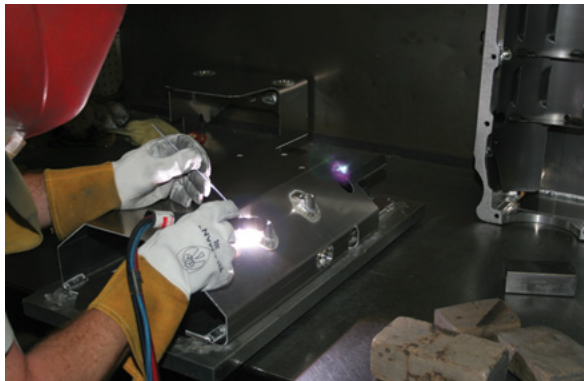

Skilled craftsmen precision-make each Moroso Oil Pans which could not be mass produced with the same degree of accuracy and workmanship. **Pro Eliminator Oil Pan (Part No. 20385)** uses several welded bungs for its various attaching points. It also features a billet rail for optimum sealing. The fixture utilizes one-inch thick plate to absorb heat and ensure proper alignment, while preventing warpage.

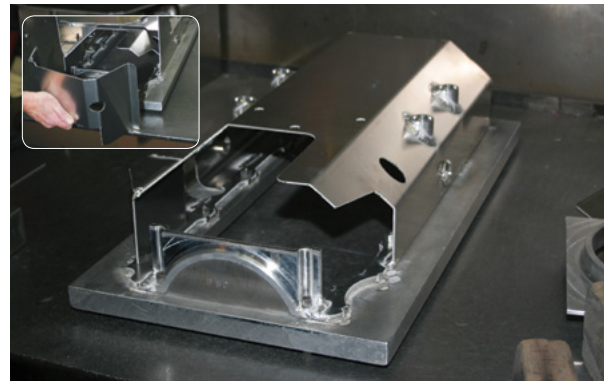

Oil pan foundation after one billet end rail has been welded into place. Moroso's efficient manufacturing processes ensure that each part is made to close tolerances, which means the actual welded seam is minimal. **Inset:** Moroso pioneered the deep and kick-out sump oil pan; here, the deepest section of the pan begins to take shape.



With all surfaces carefully welded, the completed pan is fitment checked on a real engine block. Moroso performs high-pressure leak tests on all machined Oil Pans.



Shown here are the individual components, along with a completed **Pro Eliminator Oil Pan (Part No. 20385)** for Big-Block Chevy-powered Super Class cars, Bracket cars, and Comp Eliminator racers. One of our more popular wet-sump Mark IV Big-Block Chevy offerings, this pan gives racers eight-to-nine quart capacity and will accommodate up to 4- $\frac{3}{4}$ " stroke with aluminum rods.



OIL PANS

MANUFACTURING



The use of a wet or dry sump oiling system is often determined by the level of competition and the racer's budget. A wet sump system is based on the original equipment oiling system, and can be enhanced with certain components to improve oil control and increase power. A dry sump system is designed for the top levels of racing where maximum power and oil control are absolutely essential.

TYPICAL WET SUMP SYSTEM

In a typical Wet Sump system, oil is stored in the bottom of the pan and distributed throughout the engine by an internally-mounted pump. An oil pump pickup, mounted to the pump, extends to within a quarter inch of the pan's bottom to "pickup" the oil. Although a Wet Sump system is essentially the same system used in production cars, it can be enhanced significantly with components that improve oil control and increase power. For performance street and racing applications, these components include high capacity pans, extended oil pump pickups, racing oil pumps, windage trays, oil control kits, racing oil filters and other components. In some racing applications an external oil pump is used, allowing the windage tray or screen to run the pan's full length.

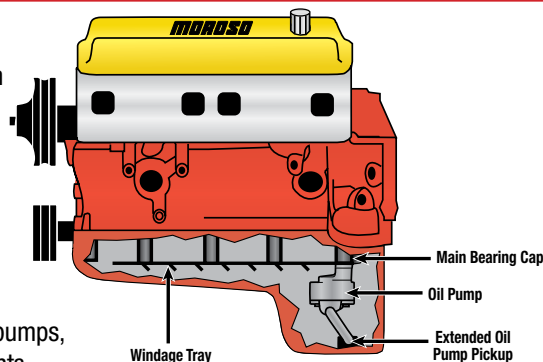

Moroso Wet Sump Oiling System components are race proven, designed to keep the engine properly supplied with oil during the most demanding conditions.

OIL PAN CAPACITIES

Capacities listed for Moroso Wet Sump Oil Pans include the capacity of the pan only, measured at or below the normal fill mark on a stock dipstick. Additional oil must be added to compensate for filters, coolers, tanks, etc.

TYPICAL DRY SUMP SYSTEM

Unlike a wet sump system where oil is stored in the pan, a Dry Sump Oiling System stores oil in a separate tank — leaving the pan essentially "dry." An externally mounted pump, generally with three or four stages, is used to "scavenge" or remove oil from the pan, deliver it to the storage tank, and send it back through the engine. In a typical setup, all but one of the stages is used to scavenge oil from the pan. A single pressure stage is normally used to return oil from the tank to the engine. The primary advantage of a Dry Sump System is its ability to make more power. With very little oil in the pan, the rotating assembly is not burdened with

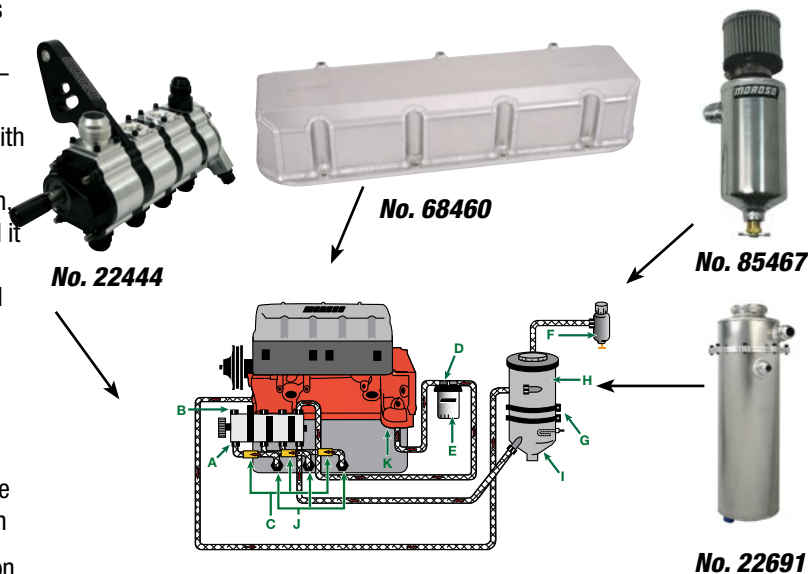

the weight of excess oil (a phenomenon commonly referred to as "windage").

Because there is no internal pump, the windage tray or screen which serves to isolate sump oil from the rotating assembly, is allowed to run the full length of the pan. Keeping the rotating assembly free of windage allows it to spin freely and make more power. In addition, the extra crankcase vacuum created by the dry sump pump helps to improve ring seal for additional power gain. Other advantages of a Dry Sump System include increased oil capacity, more consistent oil pressure, the ability to easily add remote coolers, and adjustable oil pressure. And because the pan doesn't store oil, it can be relatively shallow in depth to allow lower engine placement for improved weight distribution and handling. Moroso manufactures a full range of Dry Sump Oiling System components, all of which are engineered to be fully compatible with one another. This allows the engine builder to select the best combination of equipment and avoid the costly problems that often occur when "mixing and matching" components from various manufacturers.

NOTE: Oil pan rules vary from track to track. Check with your race track and/or sanctioning body before purchasing.

CHEVROLET SMALL BLOCK

Steel, Wet Sump, 5 Quart Capacity, 7-1/2" Deep

Fits: Stock Replacement

- Clears 4.125" stroke with most steel rods
- Fits 4 bolt Dart, GM and Merlin main caps
- Trap door baffle for improved oil control

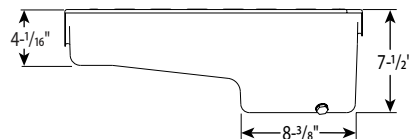
PART # DESCRIPTION**20170** Oil Pan, Steel, Clear Zinc, Stock Configuration**Engine Application:** Pre-1980 blocks with driver-side dipstick**20171** Oil Pan, Steel, Clear Zinc, Stock Configuration**Engine Application:** 1980-'85 blocks with passenger-side dipstick**20172** Oil Pan, Steel, Clear Zinc, Stock Configuration**Engine Application:** 1986 and newer blocks with one-piece rear main seal**PART # RECOMMENDED PICKUPS****24185** Fits: Moroso SBC, 3/4" Inlet, M10552/M10555 style pumps**24212** Fits: Moroso SBC Race Pump Nos. 22099, 22101 or M55 style pump**24213** Fits: Moroso SBC HV Race Pump Nos. 22109, 22111 or M55HV style pump**24813** Fits: Moroso SBC, 3/4" Inlet, M155HV style pump**PART # OIL PUMP/PICKUP PACKAGE****22144** Moroso High Volume Package**PART # AVAILABLE OPTIONS****23020** Windage Tray**23000** Oil Pan Baffle**25800** Crank Scraper**PART # AVAILABLE OPTIONS****38551** Oil Pan Flange Head Bolts, SBC**93150** Oil Pan Gasket, Pre-'85 block with a 2 piece rear main seal**93151** Oil Pan Gasket, '86-up block with a 1 piece rear main seal**No. 20171****CHEVROLET SMALL BLOCK**

Steel, Deep Sump, 6 Quart Capacity, 8-1/4" Deep

Fits: Most chassis (except '62-67 Chevy II, V8 Vega and Monza)

- Clears 4.125" stroke with most steel rods
- Fits 4 bolt Dart, GM and Merlin main caps
- Trap door baffle for improved oil control

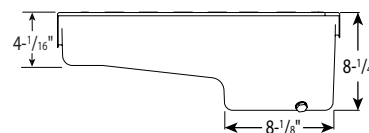
PART # DESCRIPTION**20180** Oil Pan, Steel, Clear Zinc, Street Performance, Deep Sump**Engine Application:** Pre-1980 blocks with driver-side dipstick**20181** Oil Pan, Steel, Clear Zinc, Street Performance, Deep Sump**Engine Application:** 1980-'85 blocks with passenger-side dipstick**20182** Oil Pan, Steel, Clear Zinc, Street Performance, Deep Sump**Engine Application:** 1986 and newer blocks with one-piece rear main seal**PART # RECOMMENDED PICKUPS****24170** Fits: Moroso SBC Race Pump Nos. 22099, 22101 or M55 style pump**24181** Fits: Moroso SBC, 3/4" Inlet, M10552/M10555 style pumps**24350** Fits: Moroso SBC HV Race Pump Nos. 22109, 22111 or M55HV style pump**24320** Fits: Moroso BBC Race Pump No. 22150 or M77HV style pump**24360** Fits: M155HV style pump**PART # OIL PUMP/PICKUP PACKAGE****22124** Moroso Standard Volume Package**22134** Moroso High Volume Package**22146** Moroso High Volume Package w/ 3/4" dia. inlet**22139** Moroso High Volume with Anti-Cavitation Grooves Package**22171** Moroso Billet Aluminum Oil Pump**PART # AVAILABLE OPTIONS****23020** Windage Tray**23000** Oil Pan Baffle**25800** Crank Scraper**38551** Oil Pan Flange Head Bolts, SBC**93150** Oil Pan Gasket, Pre-'85 block with a 2 piece rear main seal**93151** Oil Pan Gasket, '86-up block with a 1 piece rear main seal**No. 20180**

NOTE: Oil Pan Capacities DO NOT include oil filter capacity. All Moroso Pans include a Magnetic Drain Plug.



OIL PANS

CHEVY SMALL BLOCK

**CHEVROLET SMALL BLOCK**

Steel, Wet Sump, 7 Quart Capacity, 9-1/2" Deep

Fits: Most Chassis (except '62-'67 Chevy II, V8 Vega and Monza)

- Accepts up to 4.125" stroke with steel rods
- Fits 4 bolt Dart, GM and Merlin main caps
- Trap door baffle for improved oil control
- Increases capacity which reduces oil temperature
- Compatible with most starter/flywheel combinations

PART # DESCRIPTION

20160 Oil Pan, Steel, Clear Zinc, Street Performance, Deep Sump
Engine Application: Pre-1980 blocks with driver-side dipstick

20165 Oil Pan, Steel, Clear Zinc, Street Performance, Deep Sump
Engine Application: 1980-'85 blocks with passenger-side dipstick

PART # RECOMMENDED PICKUPS

24150 Fits: Stock Oil Pumps or Moroso SBC Race Pump Nos. 22099, 22101 or M55 style pump

24340 Fits: Moroso SBC HV Race Pump Nos. 22109, 22111 or M55HV style pump

PART # AVAILABLE OPTIONS

23020 Windage Tray

23000 Oil Pan Baffle

25800 Crank Scraper

38551 Oil Pan Flange Head Bolts, SBC

93150 Oil Pan Gasket, Pre-'85 block with a 2 piece rear main seal

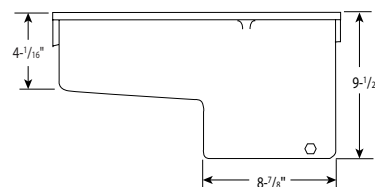
**No. 20165****CHEVROLET SMALL BLOCK**

Steel, Wet Sump, 7 Quart Capacity, 8-1/4" deep

Fits: Most Chassis (except '62-'67 Chevy II, V8 Vega and Monza)

- Accepts 4.125" stroke with most steel rods
- Fits 4 bolt Dart, GM and Merlin main caps
- Kicked-out sump
- Trap door baffle for improved oil control
- Compatible with most starter/flywheel combinations
- Will clear most stock exhaust, Borla, Hedman and Hooker headers

PART # DESCRIPTION

20190 Oil Pan, Steel, Clear Zinc, **Engine Application:** Pre-1980 blocks w/ driver-side dipstick

20200 Oil Pan, Steel, Clear Zinc, **Engine Application:** 1980-'85 blocks w/ passenger-side dipstick

20205 Oil Pan, Steel, Clear Zinc, **Engine Application:** 1986 and newer blocks w/ one-piece rear main seal; passenger-side dipstick

PART # RECOMMENDED PICKUPS

24170 Fits: Moroso SBC Race Pump Nos. 22099, 22101 or M55 style pump

24181 Fits: Moroso SBC, 3/4" Inlet, M10552/M10555 style pumps

24350 Fits: Moroso SBC HV Race Pump Nos. 22109, 22111 or M55HV style pump

24320 Fits: Moroso BBC Race Pump No. 22150 or M77HV style pump

24360 Fits: M155HV/M10551 style pump

PART # OIL PUMP/PICKUP PACKAGE

22124 Moroso Standard Volume Package

22134 Moroso High Volume Package

22146 Moroso High Volume Package w/ 3/4" dia. inlet

22139 Moroso High Volume with Anti-Cavitation Grooves Package

22171 Moroso Billet Aluminum Oil Pump

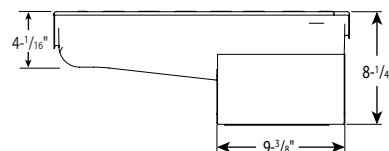
**No. 20190****PART # AVAILABLE OPTIONS**

23020 Windage Tray

23000 Oil Pan Baffle

25800 Crank Scraper

38551 Oil Pan Flange Head Bolts, SBC

93150 Oil Pan Gasket, Pre-'85 block with a 2 piece rear main seal

93151 Oil Pan Gasket, '86-up block with a 1 piece rear main seal

NOTE: Oil Pan Capacities DO NOT include oil filter capacity. All Moroso Pans include a Magnetic Drain Plug.

CHEVROLET SMALL BLOCK

Steel, Wet Sump, 7 Quart Capacity, 8-1/4" deep
 Fits: Most Chassis (except '62-'67 Chevy II, V8 Vega and Monza)

- Accepts 4.125" stroke with most steel rods
- Fits 4 bolt Dart, GM and Merlin main caps
- Kicked-out sump
- Crank scraper welded to pan
- Uni-directional windage tray screen
- Trap door baffle for improved oil control
- Will clear most stock manifolds; Borla®, Hedman® and Hooker® headers
- Compatible with most starter/flywheel combinations

PART # DESCRIPTION

- 20191** Oil Pan, Steel, Clear Zinc, **Engine Application:** Pre-1980 blocks w/ driver-side dipstick
- 20201** Oil Pan, Steel, Clear Zinc, **Engine Application:** 1980-'85 blocks w/ two-piece rear main seal; passenger-side dipstick
- 20206** Oil Pan, Steel, Clear Zinc, **Engine Application:** 1986 and newer blocks w/ one-piece rear main seal; passenger-side dipstick

PART # RECOMMENDED PICKUPS

- 24170** Fits: Moroso SBC Race Pump Nos. 22099, 22101 or M55 style pump
- 24181** Fits: Moroso SBC, 3/4" Inlet, M10552/M10555 style pumps
- 24350** Fits: Moroso SBC HV Race Pump Nos. 22109, 22111 or M55HV style pump
- 24320** Fits: Moroso BBC Race Pump No. 22150 or M77HV style pump
- 24360** Fits: M155HV/M10551 style pump

PART # OIL PUMP/PICKUP PACKAGE

- 22124** Moroso Standard Volume Package
- 22134** Moroso High Volume Package
- 22146** Moroso High Volume Package w/ 3/4" dia. inlet
- 22139** Moroso High Volume with Anti-Cavitation Grooves Package
- 22171** Moroso Billet Aluminum Oil Pump



No. 20191

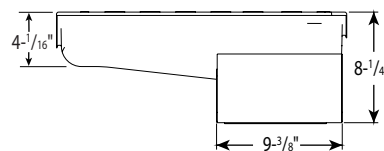

PART # AVAILABLE OPTIONS

- 23000** Oil Pan Baffle
- 38551** Oil Pan Flange Head Bolts, SBC
- 93150** Oil Pan Gasket, Pre-'85 block with a 2 piece rear main seal
- 93151** Oil Pan Gasket, '86-up block with a 1 piece rear main seal

CHEVROLET SMALL BLOCK

Steel, Wet Sump, 7 Quart Capacity, 8-1/4" Deep
 Engine Application: Pre-1985 with 2 piece rear main seal
 Fits: Most chassis (may require cross-member modification)

- Kicked-out sump
- Accepts strokes up to 4.125" with steel rods
- Fits 4 bolt Dart, GM and Merlin main caps
- Provision for Universal Dipstick Kits Nos. 25970, 25971 or 25973
- Compatible with most starter/flywheel combinations

PART # DESCRIPTION

- 20195** Oil Pan, Steel, Clear Zinc, Street Performance, Deep Sump

PART # RECOMMENDED PICKUPS

- 24170** Fits: Moroso SBC Race Pump Nos. 22099, 22101 or M55 style pump
- 24181** Fits: Moroso SBC, 3/4" Inlet, M10552/M10555 style pumps
- 24350** Fits: Moroso SBC HV Race Pump Nos. 22109, 22111 or M55HV style pump
- 24320** Fits: Moroso BBC Race Pump No. 22150 or M77HV style pump, with baffle modification
- 24360** Fits: M155HV/M10551 style pump, with baffle modification

PART # OIL PUMP/PICKUP PACKAGE

- 22124** Moroso Standard Volume Package
- 22134** Moroso High Volume Package
- 22146** Moroso High Volume Package w/ 3/4" dia. inlet
- 22139** Moroso High Volume with Anti-Cavitation Grooves Package
- 22171** Moroso Billet Aluminum Oil Pump



No. 20195

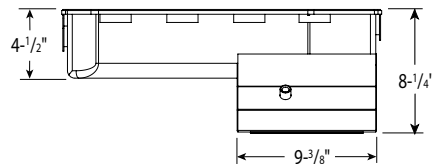

PART # AVAILABLE OPTIONS

- 23020** Windage Tray
- 23000** Oil Pan Baffle
- 25800** Crank Scraper
- 25970** Universal Dipstick Kit

PART # AVAILABLE OPTIONS

- 25971** Universal Dipstick Kit, Braided Stainless Flex Tube
- 25973** Universal Dipstick Kit, Twist Lock
- 38551** Oil Pan Flange Head Bolts, SBC
- 93150** Oil Pan Gasket, Pre-'85 block with a 2 piece rear main seal



OIL PANS

CHEVY SMALL BLOCK

**CHEVROLET SMALL BLOCK**

Steel, Wet Sump, 7 Quart Capacity, 8-1/4" Deep
 Engine Application: Pre-1985 with 2 piece rear seal
 Fits: Most chassis (may require cross-member modification)

- Kicked-out sump
- Accepts up to 4.125" stroke with steel rods
- Fits 4 bolt Dart, GM and Merlin main caps
- Louvered windage tray
- Compatible with most starter/flywheel combinations
- Provision for Universal Dipstick Kits **Nos. 25970, 25971** or **25973**

PART # DESCRIPTION

20196 Oil Pan, Steel, Clear Zinc, Deep Sump

PART # RECOMMENDED PICKUPS

24170 Fits: Moroso SBC Race Pump **Nos. 22099, 22101** or M55 style pump

24181 Fits: Moroso SBC, 3/4" Inlet, M10552/M10555 style pumps

24350 Fits: Moroso SBC HV Race Pump **Nos. 22109, 22111** or M55HV style pump

24320 Fits: Moroso BBC Race Pump **No. 22150** or M77HV style pump, with baffle modification

24360 Fits: M155HV/M10551 style pump, with baffle modification

PART # OIL PUMP/PICKUP PACKAGE

22124 Moroso Standard Volume Package

22134 Moroso High Volume Package

22146* Moroso High Volume Package w/ 3/4" dia. inlet

22139* Moroso High Volume with Anti-Cavitation Grooves Package

22171 Moroso Billet Aluminum Oil Pump

PART # AVAILABLE OPTIONS

23000 Oil Pan Baffle

25800 Crank Scraper

25970 Universal Dipstick Kit

25971 Universal Dipstick Kit, Braided Stainless Flex Tube

25973 Universal Dipstick Kit, Twist Lock

38551 Oil Pan Flange Head Bolts, SBC

93150 Oil Pan Gasket, Pre-'85 block with a 2 piece rear main seal

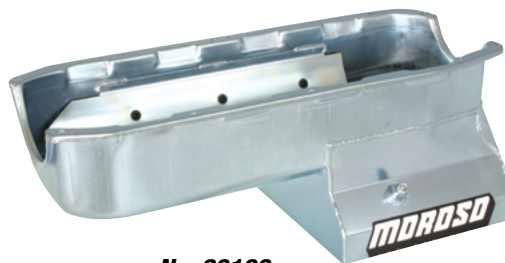
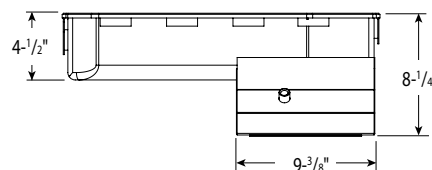
**No. 20196****CHEVROLET SMALL BLOCK**

Steel, Wet Sump, 6 Quart Capacity, 9" Deep
 Fits: '62-'67 Chevy II (without power steering)

- Clears 4.125" stroke with most steel rods
- Fits 4 bolt Dart, GM and Merlin main caps
- Notched sump clears steering linkage
- Compatible with most starter/flywheel combinations
- Reduces oil temperature

PART # DESCRIPTION

20211 Oil Pan, Steel, Clear Zinc, Street Performance, Deep Sump

Engine Application: Pre-1980 blocks with driver-side dipstick

20212 Oil Pan, Steel, Clear Zinc, Street Performance, Deep Sump

Engine Application: 1986 & newer blocks with one-piece rear main seal

PART # RECOMMENDED PICKUPS

24120 Fits: Moroso SBC Race Pump **Nos. 22099, 22101** or M55 style pump

24122 Fits: Moroso SBC HV Race Pump **Nos. 22109, 22111** or M55HV style pump

PART # AVAILABLE OPTIONS

23000 Oil Pan Baffle

25800 Crank Scraper

38551 Oil Pan Flange Head Bolts, SBC

93150 Oil Pan Gasket, Pre-'85 block with a 2 piece rear main seal

93151 Oil Pan Gasket, '86-up block with a 1 piece rear main seal

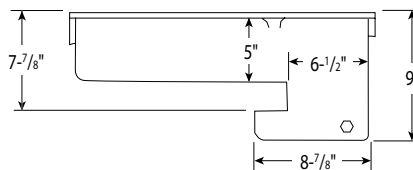
**No. 20211**

NOTE: Oil Pan Capacities DO NOT include oil filter capacity. All Moroso Pans include a Magnetic Drain Plug.

CHEVROLET SMALL BLOCK

Steel, Wet Sump, 6 Quart Capacity, 8-1/4" Deep
 Engine Application: Up to '85 with driver-side dipstick
 Fits: V8 Vega/Monza chassis

- Accepts up to 3.48" stroke with steel rods; will not work with 400 cid (3.75" stroke)
- Fits 4 bolt Dart, GM and Merlin main caps
- Trap door baffling for improved oil control
- Specially designed to fit with stock Vega & Monza cross-member
- Reduces oil temperature
- Compatible with most starter/flywheel combinations



No. 20230

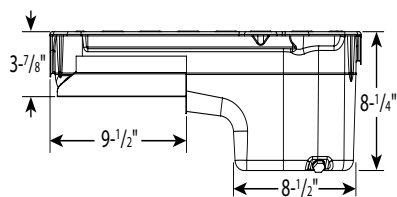

PART # DESCRIPTION

20230 Oil Pan, Steel, Clear Zinc, Street Performance, Deep Sump

PART # RECOMMENDED PICKUPS

- 24170** Fits: Moroso SBC Race Pump Nos. 22099, 22101 or M55 style pump
24181 Fits: Moroso SBC, 3/4" Inlet, M10552/M10555 style pumps
24350 Fits: Moroso SBC HV Race Pump Nos. 22109, 22111 or M55HV style pump
24320 Fits: Moroso BBC Race Pump No. 22150 or M77HV style pump
24360 Fits: M155HV/M10551 style pump

PART # OIL PUMP/PICKUP PACKAGE

- 22124** Moroso Standard Volume Package
22134 Moroso High Volume Package
22146 Moroso High Volume Package w/ 3/4" dia. inlet
22139 Moroso High Volume with Anti-Cavitation Grooves Package
22171 Moroso Billet Aluminum Oil Pump

PART # AVAILABLE OPTIONS

- 23000** Oil Pan Baffle
25800 Crank Scraper
38551 Oil Pan Flange Head Bolts, SBC
93150 Oil Pan Gasket, Pre-'85 block with a 2 piece rear main seal

DRAG RACE

CHEVROLET SMALL BLOCK

Steel, Wet Sump, 7 Quart Capacity, 8-1/4" Deep
 Fits: Super Stock/Bracket Cars, Dragsters, Roadsters or Body Cars

- Accepts 4" strokes with steel rods
- Core based oil pan utilizing stock pan rail bolt pattern
- Passenger-side kick-out for increased horsepower
- Solid louvered tray with main cap partitions for maximum power and oil control
- For use with 168 and 153-tooth flywheel combinations



No. 21015

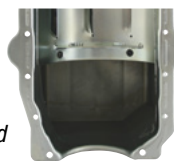

No. 21017



No. 21015

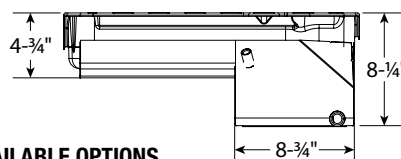

PART # DESCRIPTION

- 21015** Oil Pan, Steel, Clear Zinc
 Engine Application: Pre-1980 engine blocks with driver-side dipstick and Dart Little M engine blocks with 4 bolt non-radiused front main caps
21017 Oil Pan, Steel, Clear Zinc
 Engine Application: Up to '85 and aftermarket engine blocks with stock width oil pan rails

PART # RECOMMENDED PICKUPS

- 24170** Fits: Moroso SBC Race Pump Nos. 22099, 22101 or M55 style pump
24181 Fits: Moroso SBC, 3/4" Inlet, M10552/M10555 style pumps
24350 Fits: Moroso SBC HV Race Pump Nos. 22109, 22111 or M55HV style pump
24320 Fits: Moroso BBC Race Pump No. 22150 or M77HV style pump
24360 Fits: M155HV/M10551 style pump, with slight tray modifications

PART # OIL PUMP/PICKUP PACKAGE

- 22124** Moroso Standard Volume Package
22134 Moroso High Volume Package
22146 Moroso High Volume Package w/ 3/4" dia. inlet
22139 Moroso High Volume with Anti-Cavitation Grooves Package
22171 Moroso Billet Aluminum Oil Pump

PART # AVAILABLE OPTIONS

- 25970** Universal Dipstick Kit
25971 Universal Dipstick Kit, Braided Stainless Flex Tube
25973 Universal Dipstick Kit, Twist Lock
38551 Oil Pan Flange Head Bolts, SBC
93150 Oil Pan Gasket, Pre-'85 block with a 2 piece rear main seal

CHEVROLET SMALL BLOCK

Aluminum, Wet Sump, 8 Quart Capacity, 8-1/4" Deep
 Engine Application: Up to 1985 Engine Blocks including Dart and Merlin
 Fits: Super Stock/Bracket Cars, Dragsters, Roadsters or Body Cars

- Aluminum, fully fabricated oil pan accepts 4.25" strokes with steel rods
- Double kick-out design ensures large stroke clearance, wide main cap clearance and maximum horsepower
- Billet end seals ensure consistent sealing surface to billet front covers and rear main caps
- For use with 168-tooth flywheel combination
- Louvered windage tray with main cap partitions for maximum power and oil control
- Features O-ring magnetic drain plug, two -8AN N.P.T. drain backs and dipstick bung



No. 21234



PART # DESCRIPTION

21234 Oil Pan, SBC, Two Piece Rear Main Seal Engine Blocks

PART # RECOMMENDED PICKUPS

- 24170** Fits: Moroso SBC Race Pump Nos. **22099, 22101** or M55 style pump
24181 Fits: Moroso SBC, 3/4" Inlet, M10552/M10555 & 10551M style pumps
24350 Fits: Moroso SBC HV Race Pump, 5/8" Inlet, Nos. **22109, 22111** or M55HV style pump

PART # OIL PUMP/PICKUP PACKAGE

- 22124** Moroso Standard Volume Package
22134 Moroso High Volume Package
22171 Moroso Billet Aluminum Oil Pump

PART # AVAILABLE OPTIONS

- 25970** Universal Dipstick Kit
25971 Universal Dipstick Kit, Braided Stainless Flex Tube
25973 Universal Dipstick Kit, Twist Lock
38385 Bullet Nose Oil Pan Stud Kit
62256 Wrench, Oil Pan T-Handle, 7/16", 6 PT
93150 Oil Pan Gasket, Pre-'85 block with a 2 piece rear main seal

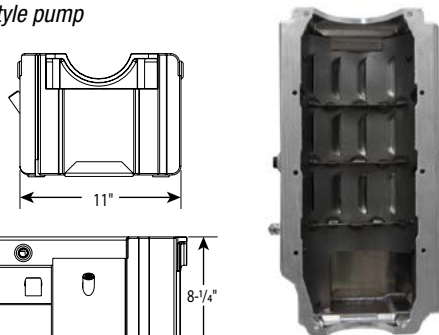

CHEVROLET SMALL BLOCK

Aluminum Wet Sump/External P/U, 8 Quart Capacity, 8-1/4" Deep
 Engine Application: SBC up to 1985 Engine Blocks including Dart and Merlin
 Fits: Super Stock/Bracket Cars, Dragsters, Roadsters or Body Cars

- Aluminum, fully fabricated oil pan accepts 4.25" stroke with steel or aluminum rods
- Double kick-out design ensures large stroke clearance, wide main cap clearance and maximum horsepower
- Billet end seals ensure consistent sealing surface to billet front covers and rear main caps
- For use with 168-tooth flywheel combination
- Full length solid louvered windage tray with main cap partitions for maximum power and oil control
- Features -16AN External Pickup
- Includes O-ring magnetic drain plug, two -8AN drain backs and dipstick bung



No. 21240



PART # DESCRIPTION

21240 Oil Pan, SBC, Power Kickouts, Aluminum, Divided Tray, -16AN External Pickup

PART # AVAILABLE OPTIONS

- 23962** Filter Fitting, -16 AN Male to -16 AN Male, with External Screen
23963 Filter Fitting, -12 AN Male to -16 AN Male with External Screen
25970 Universal Dipstick Kit
25971 Universal Dipstick Kit, Braided Stainless Flex Tube
25973 Universal Dipstick Kit, Twist Lock
38385 Bullet Nose Oil Pan Stud Kit
62256 Wrench, Oil Pan T-Handle, 7/16", 6 PT
93150 Oil Pan Gasket, Pre-'85 block with a 2 piece rear main seal

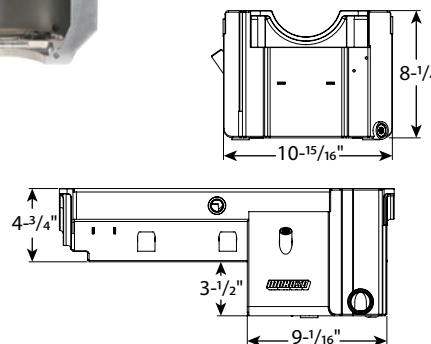

CHEVROLET SMALL BLOCK

Steel, Wet Sump, 7 Quart Capacity, 7-1/2" Deep, Road Race Baffled
 Fits: Most GM chassis (except '62-'67 Chevy II, V-8 Vega and Monza)

- Clears 4.125" stroke with most steel rods
- Fits 4 bolt Dart, GM and Merlin main caps
- 3 trap door baffles, 2 runners for oil control in Road Racing, also an excellent Drag Race oil pan
- Compatible with most starter/flywheel combinations
- Has a built in crank scraper, removable screen windage tray and anti-slosh baffle to free up horsepower

PART # DESCRIPTION

- 21813** Oil Pan, Steel, Clear Zinc, Road Race Baffled
Engine Application: Pre- 1980 engine blocks with two piece seal/driver side dipstick
- 21814** Oil Pan, Steel, Clear Zinc, Road Race Baffled
Engine Application: SBC '80-'85 engine blocks with two piece seal/passenger side dipstick & Dart SHP Blocks
- 21815** Oil Pan, Steel, Clear Zinc, Road Race baffled
Engine Application: SBC 1986 & Newer engine blocks with one piece seal/passenger side dipstick

PART # RECOMMENDED PICKUPS

- 24185** Fits: Moroso SBC, 3/4" Inlet, M10552/M10555 style pumps
- 24212** Fits: Moroso SBC Race Pump Nos. 22099, 22101 or M55 style pump
- 24213** Fits: Moroso SBC HV Race Pump Nos. 22109, 22111 or M55HV style pump
- 24813** Fits: Moroso SBC, 3/4" Inlet, M155 HV style pump

PART # AVAILABLE OPTIONS

- 38551** Oil Pan Flange Head Bolts, SBC
- 93150** Oil Pan Gasket, Pre-'85 block with a 2 piece rear main seal
- 93151** Oil Pan Gasket, '86-up block with a 1 piece rear main seal

*If the factory low oil warning sensor is not going to be used, Part #22738, 20mm Plug with copper washer is available.



No. 21813

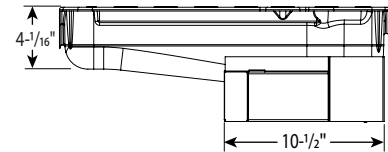
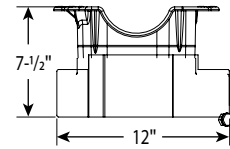

CHEVROLET SMALL BLOCK

Steel, Wet Sump, 5.5 Quart Capacity
 Fits: '93-'97 F-Body, Impala

- Kicked-out sump and trap door baffling for improved oil control in drag racing, road racing and street applications
- Clears 4.125" stroke with most steel rods
- Windage screen
- 20mm fitting for the factory oil level sensor*
- Clears stock exhaust and Hedman®, Hooker®, Borla® and similar-type headers
- Part No. 20179 has a 1/4" NPT fitting for Moroso Univ. Dipsticks Nos. 25970, 25971 & 25973, Part No. 20185 uses stock dipstick



No. 20185

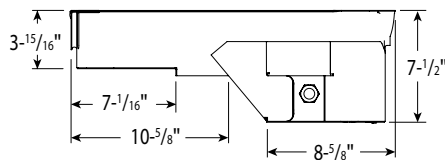

PART # DESCRIPTION

- 20179** Oil Pan, Steel Clear Zinc, Road Race Baffled
Engine Application: SBC, Pre-'85 Block with a 2 piece rear main seal and Dart SHP engine blocks
- 20185** Oil Pan, Steel, Clear Zinc, Road Race Baffled
Engine Application: SBC 1986 & newer engine blocks with a 1 piece seal and passenger side dipstick

PART # RECOMMENDED PICKUPS

- 24185** Fits: Moroso SBC, 3/4" Inlet, M10552/M10555 style pumps
- 24212** Fits: Moroso SBC Race Pump Nos. 22099, 22101 or M55 style pump
- 24213** Fits: Moroso SBC HV Race Pump Nos. 22109, 22111 or M55HV style pump
- 24813** Fits: Moroso SBC, 3/4" Inlet, M155HV style pump

PART # AVAILABLE OPTIONS

- 22738** Plug, 20mm x 1.5, Male with Copper Washer
- 25970** Universal Dipstick Kit
- 25971** Universal Dipstick Kit, Braided Stainless Flex Tube
- 25973** Universal Dipstick Kit, Twist Lock
- 38551** Oil Pan Flange Head Bolts, SBC
- 93150** Oil Pan Gasket, Pre-'85 block with a 2 piece rear main seal
- 93151** Oil Pan Gasket, '86-up block with a 1 piece rear main seal

NOTE: Oil Pan Capacities DO NOT include oil filter capacity. All Moroso Pans include a Magnetic Drain Plug.



OIL PANS

CHEVY SMALL BLOCK

CHEVROLET SMALL BLOCK

Steel, Wet Sump, 7 Quart Capacity, 7" Deep Sump, Road Race Baffled
Fits: C-3 & C-4 Corvettes, Kit Cars and other low ground clearance applications

- Clears 4.125" stroke with most steel rods
- Fits 4 bolt Dart, GM and Merlin main caps
- 5 trap door baffles for oil control in Road Racing, also Drag Racing
- Use stock dipstick; also has a 1/4" NPT fitting for Moroso Universal Dipsticks **Nos. 25970, 25971 & 25973**
- Has a built-in crank scraper, removable louvered windage tray for horsepower
- Includes 20mm fitting for oil level sensor, optional 20mm plug **No. 22738** available for use when the factory low warning sensor is not going to be utilized
- Steel with a clear zinc finish
- Compatible with most starter/flywheel combinations

No. 21811



PART # DESCRIPTION

- 21811** Oil Pan, Steel, Clear Zinc, 7" Deep, Road Race Baffled
Engine Application: SBC '86 & up engine blocks with 1 piece seal and passenger side dipstick
- 21816** Oil Pan, Steel, Clear Zinc, 7" Deep, Road Race Baffled
Engine Application: SBC '80-85 engine blocks with 2 piece seal/passenger side dipstick & Dart SHP blocks
- 21812** Oil Pan, Steel, Clear Zinc, 7" Deep, Road Race Baffled
Engine Application: Pre-1980 engine blocks with two-piece seal and driver-side dipstick

PART # RECOMMENDED PICKUPS

- 24811** Fits: M55 style Standard Volume Oil Pump
- 24814** Fits: M55HV style High Volume Oil Pump
- 24817** Fits: M155HV style pumps
- 24819** Fits: 3/4" Inlet, M10552/M10555 style pumps

PART # AVAILABLE OPTIONS

- 22738** Plug, 20mm x 1.5, Male with Copper Washer
- 25970** Universal Dipstick Kit
- 25971** Universal Dipstick Kit, Braided Stainless Flex Tube
- 25973** Universal Dipstick Kit, Twist Lock
- 38551** Oil Pan Flange Head Bolts, SBC
- 93150** Oil Pan Gasket, Pre-'85 block with a 2 piece rear main seal
- 93151** Oil Pan Gasket, '86-up block with a 1 piece rear main seal

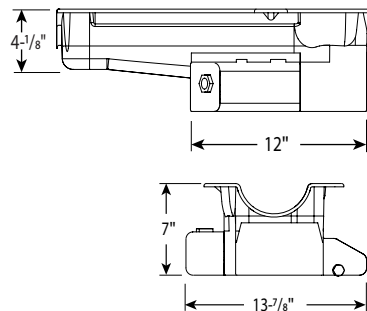

**If the factory low oil warning sensor is not going to be used, Part #22738, 20mm Plug with copper washer is available.*

CIRCLE TRACK

CHEVROLET SMALL BLOCK

Steel, Wet Sump, 7 Quart Capacity, 8" Deep
Engine Application: Pre-1980 with two-piece rear main seal or '80-'85 with passenger-side dipstick
Fits: GM Metric Chassis, Hobby Stock/Super Stock

- Three trap door baffles for oil control
- Built-in crank scraper
- Oil level sight plug
- Accepts most starter and flywheel combinations
- Accepts 3.80" stroke with steel rods

No. 21308



PART # DESCRIPTION

- 21308** Oil Pan, Steel, Clear Zinc, Kicked-Out Sump

PART # RECOMMENDED PICKUPS

- 24308** Fits: Moroso SBC HV Race Pump **Nos. 22109, 22111** or M55HV style pump

PART # AVAILABLE OPTIONS

- 38551** Oil Pan Flange Head Bolts, SBC
- 93150** Oil Pan Gasket, Pre-'85 block with a 2 piece rear main seal

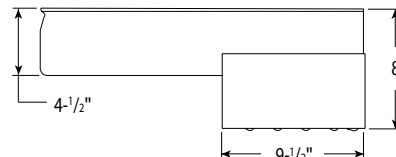
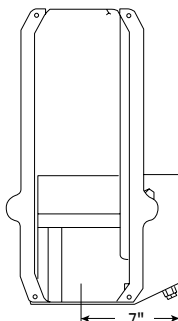

NOTE: Oil Pan Capacities DO NOT include oil filter capacity. All Moroso Pans include a Magnetic Drain Plug.



CHEVROLET SMALL BLOCK

Steel, Wet Sump, 7 Quart Capacity, 7-1/2" Deep
Fits: GM 1978-'87 Metric Chassis, aftermarket and Camaro front ends

- Cost-effective Circle Track oil pan with Moroso quality and performance
- Accepts 4.125" stroke with steel rods
- Fits 4 bolt Dart, GM and Merlin main caps
- Trap door baffles for oil control
- Removable louvered windage tray
- Built-in crank scraper
- Accepts most starter and flywheel combinations

PART # DESCRIPTION

- 21316** Oil Pan, Steel, Clear Zinc, Kicked-Out Sump
Engine Application: Pre-1980 blocks with driver-side dipstick
- 21317** Oil Pan, Steel, Clear Zinc, Kicked-Out Sump
Engine Application: 1980-'85 blocks with passenger-side dipstick & Dart SHP Block
- 21320** Oil Pan, Steel, Clear Zinc, Kicked-Out Sump
Engine Application: 1986 and newer blocks with one-piece rear main seal

PART # RECOMMENDED PICKUPS

- 24316** Fits: Melling Oil Pump No. M55HV
24317 Fits: Melling Oil Pump No. M55

PART # AVAILABLE OPTIONS

- 38555** Self-Locking Oil Pan Bolts
93150 Oil Pan Gasket, Pre-'85 block with a 2 piece rear main seal
93151 Oil Pan Gasket, '86-up block with a 1 piece rear main seal



No. 21316

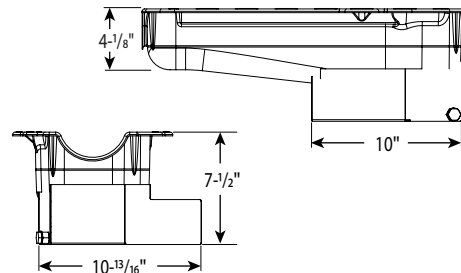

CHEVROLET SMALL BLOCK

Steel, Wet Sump, 7 Quart Capacity, 7-1/2" Deep
With 1" Inspection Bung to meet 2011 - Up IMCA Rules
Fits: GM '78-'87 Metric Chassis, aftermarket and Camaro front ends

- Accepts 4.125" stroke with steel rods, accepts most starter and flywheel combinations
- Fits 4 bolt Dart, GM and Merlin main caps
- Integrated 1" inspection bung with plug, no need for extra welding
- A cost-effective Circle Track Oil Pan with Moroso quality & performance was unavailable until now
- Trap doors for oil control, removable louvered windage tray and built-in crank scraper

PART # DESCRIPTION

- 21322** Oil Pan, Steel, Clear Zinc, Circle Track
Engine Application: Pre-1980 blocks with driver-side dipstick
- 21323** Oil Pan, Steel, Clear Zinc, Circle Track
Engine Application: 1980-'85 blocks with passenger side dipstick & Dart SHP Blocks
- 21324** Oil Pan, Steel, Clear Zinc, Circle Track
Engine Application: 1986 and newer blocks with a one-piece rear main seal

PART # RECOMMENDED PICKUPS

- 24316** Fits: M55HV style Oil Pump Pickup
24317 Fits: M55 style Oil Pump Pickup

PART # AVAILABLE OPTIONS

- 23000** Oil Pan Baffle
38555 Self-Locking Oil Pan Bolts
93150 Oil Pan Gasket, Pre-'85 block with a 2 piece rear main seal
93151 Oil Pan Gasket, '86-up block with a 1 piece rear main seal



No. 21322

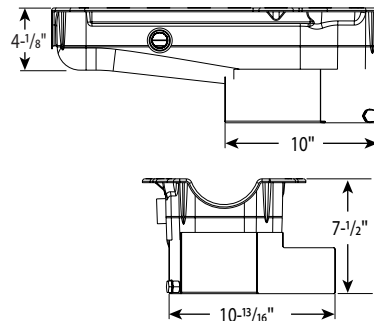

NOTE: Oil Pan Capacities DO NOT include oil filter capacity. All Moroso Pans include a Magnetic Drain Plug.

CHEVROLET SMALL BLOCK

*Steel, Wet Sump, 8 Quart Capacity, 6-1/2" Deep
With 1" Inspection Bung to meet 2011-Up IMCA Rules
Fits: Limited Sprints and other low ground clearance chassis
without cross members*

- Offset sump contains 5 trap door baffles for superior oil control in Circle Track Racing
- Clears 4.125" stroke with most steel rods
- Fits 4 bolt Dart, GM and Merlin main caps
- Has a built in crank scraper, removable louvered windage tray for horsepower
- 1/2" NPT oil temperature bung and oil level check

PART # DESCRIPTION

- 21325** Oil Pan, Steel, Clear Zinc, 6-1/2" Deep, Offset Circle Track Sump
Engine Application: SBC Pre-1980 engine blocks with two-piece seal and driver-side dipstick
- 21326** Oil Pan, Steel, Clear Zinc, 6-1/2" Deep, Offset Circle Track Sump
Engine Application: SBC 1980-85 engine blocks with two piece seal/passenger side dipstick & Dart SHP blocks
- 21327** Oil Pan, Steel, Clear Zinc, 6-1/2" Deep, Offset Circle Track Sump
Engine Application: SBC 1986 & Newer engine blocks with one-piece seal/passenger side dipstick

PART # RECOMMENDED PICKUPS

- 24314** *Fits: Moroso SBC Race Pumps Nos. 22099, 22101 or M55 Style Standard Volume Oil Pump*
- 24315** *Fits: Melling M55HV style pump, pump housing may require slight clearancing to clear bottom of the oil pan*

PART # AVAILABLE OPTIONS

- 38551** Oil Pan Flange Head Bolts, SBC
- 93150** Oil Pan Gasket, Pre-'85 block with a 2 piece rear main seal
- 93151** Oil Pan Gasket, '86-up block with a 1 piece rear main seal

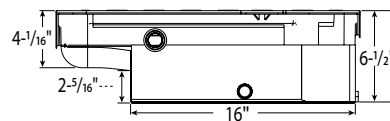
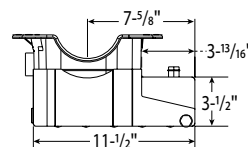

CHEVROLET SMALL BLOCK

*Steel, Wet Sump, 7 Quart Capacity, 7-1/8" Deep
Fits: GM Metric G-Body chassis, Street Stock and Late Model*

- Five trap door baffles for oil control
- Engineered louvered tray system
- Oil level sight plug
- Accepts most starter and flywheel combinations
- Accepts 3.80" stroke with steel rods

PART # DESCRIPTION

- 21318** Oil Pan, Steel, Clear Zinc, Kicked-out Sump
Engine Application: Pre-1980 blocks with two-piece rear main seal or 1980-'85 blocks with passenger-side dipstick
- 21319** Oil Pan, Steel, Clear Zinc, Kicked-out Sump
Engine Application: 1986 and newer blocks with one-piece rear main seal

PART # RECOMMENDED PICKUPS

- 24101** *Fits: Flange Type Melling SBC Oil Pump M10555*
- 24103** *Fits: Moroso SBC Race Pump Nos. 22099, 22101 or M55 style pump*
- 24104** *Fits: Moroso SBC HV Race Pump Nos. 22109, 22111 or M55HV style pump*
- 24318** *Fits: Moroso SBC HV Blueprinted Pump with 3/4" dia. inlet, Melling M155HV/M10551 style pump*
- 22147** *Fits: Moroso High Volume Package with 3/4" dia. inlet*

PART # AVAILABLE OPTIONS

- 38551** Oil Pan Flange Head Bolts, SBC
- 93150** Oil Pan Gasket, Pre-'85 block with a 2 piece rear main seal
- 93151** Oil Pan Gasket, '86-up block with a 1 piece rear main seal



No. 21318

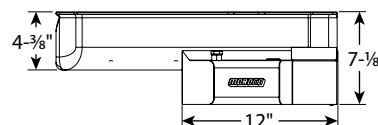
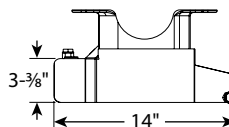

NOTE: Oil Pan Capacities DO NOT include oil filter capacity. All Moroso Pans include a Magnetic Drain Plug.



CHEVROLET SMALL BLOCK

Steel, Wet Sump, 6 Quart Capacity, 6-1/2" Deep
 Fits: Fabricated tube chassis cars with lower engines

- Passenger-side kick-out for more horsepower
- Five trap door baffles for oil control
- Engineered louvered tray system
- Oil level sight plug
- Accepts most starter and flywheel combinations
- Accepts 3.80" stroke with steel rods

PART #	DESCRIPTION
21314	Oil Pan, Steel, Clear Zinc, Kicked-Out Sump Engine Application: Pre-1980 blocks with driver-side dipstick or 1980-'85 blocks with passenger-side dipstick
21315	Oil Pan, Steel, Clear Zinc, Kicked-Out Sump Engine Application: 1986 and newer blocks with one-piece rear main seal
PART #	RECOMMENDED PICKUPS
24314	Fits: Moroso SBC Race Pump Nos. 22099, 22101 or M55 style pump
24315	Fits: Melling M55HV style pump, pump housing may require slight modification to clear bottom of the oil pan
PART #	AVAILABLE OPTIONS
38551	Oil Pan Flange Head Bolts, SBC
93150	Oil Pan Gasket, Pre-'85 block with a 2 piece rear main seal
93151	Oil Pan Gasket, '86-up block with a 1 piece rear main seal



No. 21314

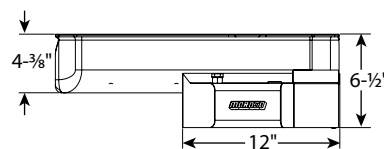
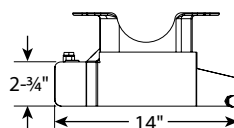

CHEVROLET SMALL BLOCK

Steel, Wet Sump, 7 Quart Capacity, 7-1/8" Deep
 Fits: GM Metric G-Body chassis, Street Stock and Late Model

- Passenger-side kick-out for more horsepower
- Five trap door baffles for oil control
- Engineered louvered tray system
- Accepts most starter and flywheel combinations
- Oil level sight plug
- Accepts 3.80" stroke with steel rods

PART #	DESCRIPTION
21312	Oil Pan, Steel, Clear Zinc, Kicked-Out Sump Engine Application: Pre-1980 blocks with driver-side dipstick or 1980-'85 blocks with passenger-side dipstick
PART #	RECOMMENDED PICKUPS
24101	Fits: Flange Type Melling SBC Oil Pump M10555
24103	Fits: Moroso SBC Race Pump Nos. 22099, 22101 or M55 style pump
24104	Fits: Moroso SBC HV Race Pump Nos. 22109, 22111 or M55HV style pump
24318	Fits: Moroso SBC HV Blueprinted Pump with 3/4" dia. inlet, Melling M155HV/M10551 style pump
22147	Fits: Moroso High Volume Package with 3/4" dia. inlet
PART #	AVAILABLE OPTIONS
38551	Oil Pan Flange Head Bolts, SBC
93150	Oil Pan Gasket, Pre-'85 block with a 2 piece rear main seal



No. 21312

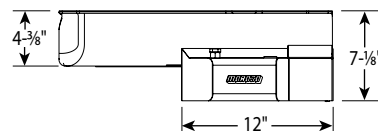
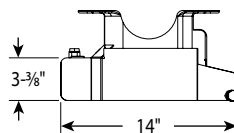

NOTE: Oil Pan Capacities DO NOT include oil filter capacity. All Moroso Pans include a Magnetic Drain Plug.



CHEVROLET SMALL BLOCK

Aluminum, Wet Sump, 9.5 Quart Capacity, 7- $\frac{1}{4}$ " Deep

Fits: Sprint Car and any chassis with no cross-member under the engine

- Fully fabricated aluminum with billet end seals to ensure a consistent sealing surface
- Fits 4 bolt main cap blocks
- Large kick out design for maximum horsepower and oil temperature reduction
- Advanced oil containment system comprised of 5 Trap Doors & a diagonal runner
- Pan rail crank scraper & windage tray
- Inspection bung with plug
- Oil level check and a magnetic drain plug



No. 21330



PART # DESCRIPTION

21330 SBC Oil Pan Fully Fabricated Aluminum with billet end seals, Wet Sump, Sprint Car

PART # RECOMMENDED PICKUPS

24101 Fits: Flange Type Melling SBC Oil Pump M10555

24103 Fits: Moroso SBC Race Pump Nos. 22099, 22101 or M55 style pump

24104 Fits: Moroso SBC HV Race Pump Nos. 22109, 22111 or M55HV style pump

24325 Fits: Moroso Part Nos. 22149, 22159, 22150, 22160 & 22162 and Melling 77/77HV style oil pumps

PART # AVAILABLE OPTIONS

62256 Wrench, Oil Pan T-Handle, $\frac{7}{16}$ ", 6 PT

38385 Bullet Nose Oil Pan Stud Kit

93150 Oil Pan Gasket, Pre-'85 block with a 2 piece rear main seal

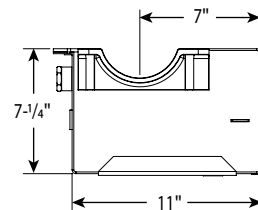
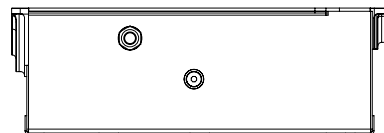

360/410 SPRINT CAR

Aluminum, Dry Sump, 6- $\frac{1}{2}$ " Deep

Fits: Sprint Car and any chassis with no cross-member under the engine

- Fully fabricated aluminum with billet end seals to ensure a consistent sealing surface
- Fits 4 bolt main cap blocks
- Large kick out design for maximum horsepower and oil temperature reduction
- Forward facing -12 AN female pickups
- Inspection bung with plug
- Internal runners to direct oil to the pickups
- Internal rear baffle that prevents oil from climbing up the back of the oil pan



No. 21555

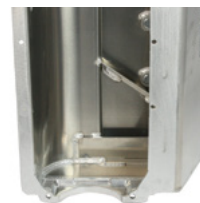

PART # DESCRIPTION

21553 Oil Pan, Fully Fabricated Aluminum with billet end seals

Engine Application: SBC, 3 P/U, Sprint Car

21554 Oil Pan, Fully Fabricated Aluminum with billet end seals

Engine Application: SBC, 2 P/U, Sprint Car

21555 Oil Pan, Fully Fabricated Aluminum with billet end seals

Engine Application: Donovan H/C 410, 3 P/U, Sprint Car

21556 Oil Pan, Fully Fabricated Aluminum with billet end seals,

Engine Application: Donovan H/C 410, 2 P/U, Sprint Car

PART # AVAILABLE OPTIONS

38385 Bullet Nose Oil Pan Stud Kit

62256 Wrench, Oil Pan T-Handle, $\frac{7}{16}$ ", 6 PT

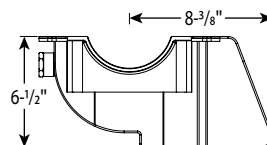

NOTE: Oil Pan Capacities DO NOT include oil filter capacity. All Moroso Pans include a Magnetic Drain Plug.

DART/ROCKET SMALL BLOCK

Steel, Wet Sump, 7 Quart Capacity, 8-1/4" Deep

Engine Application: Small Block Style Dart Iron Eagle/Rocket

Fits: Most chassis with Dart/Rocket Blocks

(may require cross-member modification)

- Kicked-out sump
- Trap door baffle for improved oil control
- Crank scraper welded to pan
- Uni-directional screen windage tray
- Compatible with most starter/flywheel combinations
- Requires BBC standard height oil pump shaft, Moroso **No. 22080**
- Recommended oil pan gasket Fel-Pro Part No. 1839

PART # DESCRIPTION

20193 Oil Pan, Steel, Fully Fabricated, Clear Zinc, Street Performance, Deep Sump

PART # RECOMMENDED PICKUPS

24171 Fits: Moroso SBC Race Pump Nos. **22099**, **22101** or M55 style pump

24351 Fits: Moroso SBC HV Race Pump Nos. **22109**, **22111** or M55HV style pump

PART # OIL PUMP/PICKUP PACKAGE

22163 Moroso Billet Aluminum Oil Pump, High Volume

22164 Moroso Billet Aluminum Oil Pump, BBC, Standard Volume

PART # AVAILABLE OPTIONS

22080 Oil Pump Shaft

25970 Universal Dipstick Kit

25971 Universal Dipstick Kit, Braided Stainless Flex Tube

25973 Universal Dipstick Kit, Twist Lock

38551 Oil Pan Flange Head Bolts, SBC

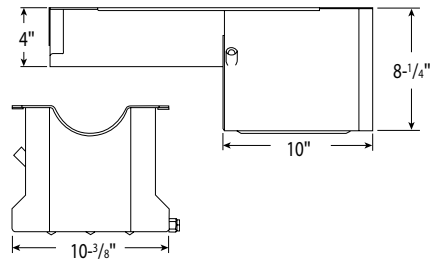
**No. 20193**

DRAG RACE

DART ROCKET SMALL BLOCK

Steel, Wet Sump, 7 Quart Capacity, 8-1/4" Deep

Engine Application: Small Block Style Dart Iron Eagle/Rocket

Fits: Most chassis (may require cross-member modification)

- Accepts 4.25" strokes with steel rods
- For use with 168-tooth flywheel combination
- Partition-louvered windage tray
- Cross-member modifications may be required
- Requires BBC standard height oil pump shaft, Moroso **No. 22080**
- Recommended oil pan gasket Fel-Pro Part No. 1839

PART # DESCRIPTION

21019 Oil Pan, Steel, Clear Zinc, Fully Fabricated

PART # RECOMMENDED PICKUPS

24171 Fits: Moroso SBC Race Pump Nos. **22099**, **22101** or M55 style pump

24351 Fits: Moroso SBC HV Race Pump Nos. **22109**, **22111** or M55HV style pump

PART # OIL PUMP/PICKUP PACKAGE

22163 Moroso Billet Aluminum Oil Pump, BBC, High Volume

22164 Moroso Billet Aluminum Oil Pump, BBC, Standard Volume

PART # AVAILABLE OPTIONS

22080 Oil Pump Shaft

25970 Universal Dipstick Kit

25971 Universal Dipstick Kit, Braided Stainless Flex Tube

25973 Universal Dipstick Kit, Twist Lock

38551 Oil Pan Flange Head Bolts, SBC

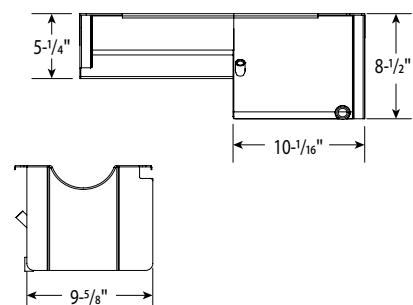
**No. 21019**

DART/ROCKET SMALL BLOCK

Aluminum, Wet Sump, 8 Quart Capacity, 8-1/2" Deep
 Engine Application: Small Block Style Dart Iron Eagle/Rocket
 Fits: Super Stock/Bracket Cars, Dragsters, Roadsters or Body Cars

- Aluminum, fully fabricated oil pan accepts 4.25" strokes with steel or alum. rods
- Double kickout design ensures large stroke clearance, wide main cap clearance and maximum horsepower
- Billet end seals to ensure consistent sealing surface to billet front covers and rear main caps
- For use with 168-tooth flywheel combination
- Louvered windage tray with main cap partitions for maximum power and oil control
- Features O-ring magnetic drain plug, two -8AN drain backs and dipstick bung
- Recommended oil pan gasket Fel-Pro Part No. 1839

PART #	DESCRIPTION
21247	Oil Pan, Dart/Rocket, Alum. with Divided Tray
21248	Oil Pan, Dart/Rocket Small Block, Power Kickouts, Aluminum, Windage Tray, -16AN Ext. P/U

PART #	RECOMMENDED PICKUPS FOR PART NO. 21247
24170	Fits: Moroso SBC Race Pump Nos. 22099, 22101 or M55 style pump
24181	Fits: Moroso SBC, 3/4" Inlet, M10552/M10555 style pumps
24350	Fits: Moroso SBC HV Race Pump Nos. 22109, 22111 or M55HV style pump
24320	Fits: Moroso BBC Race Pump No. 22150 or M77HV style pump

PART #	OIL PUMP/PICKUP PACKAGE PART NO. 21247
22124	Moroso Standard Volume Package
22134	Moroso High Volume Package
22146	Moroso High Volume Package w/ 3/4" dia. inlet
22139	Moroso High Volume with Anti-Cavitation Grooves Package
22171	Moroso Billet Aluminum Oil Pump

PART #	AVAILABLE OPTIONS
23962	Fitting, -16 AN Male to -16 AN Male, External Screen
23963	Fitting, -12 AN Male to -16 AN Male External Screen
25970	Universal Dipstick Kit
25971	Universal Dipstick Kit, Braided Stainless Flex Tube
25973	Universal Dipstick Kit, Twist Lock
38551	Oil Pan Flange Head Bolts, SBC



No. 21247



No. 21248

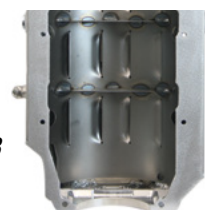

Drawing shown for No. 21247

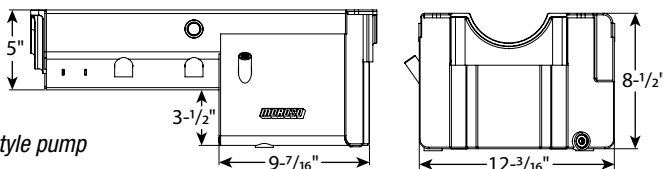

CIRCLE TRACK

DART/BRODIX/ROCKET SMALL BLOCK

Aluminum, Spread Rail
 Fits: Sprint Car and any chassis with no cross-member under the engine

- Fully fabricated aluminum with billet end seals to ensure a consistent sealing surface
- Fits 4 bolt main caps
- Large kick out design for maximum horsepower and oil temperature reduction
- Forward facing -12 AN female pickups
- Inspection plug
- Internal runners to direct oil to the pickups
- Internal rear baffle that prevents oil from climbing up the back of the oil pan
- Recommended oil pan gasket Fel-Pro Part No. 1839

PART #	DESCRIPTION
21551	Oil Pan, Fully Fabricated Aluminum with billet end seals Engine Application: Dart/Brodix (Spread Rail), 3 P/U, Sprint Car
21552	Oil Pan, Fully Fabricated Aluminum with billet end seals Engine Application: Dart/Brodix (Spread Rail), 2 P/U, Sprint Car

PART #	AVAILABLE OPTIONS
62255	Wrench, Oil Pan T-Handle, 1/2", 6 PT
62256	Wrench, Oil Pan T-Handle, 7/16", 6 PT
38551	Oil Pan Flange Head Bolts, SBC



No. 21551

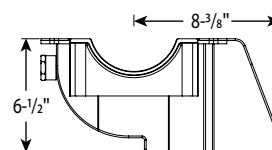
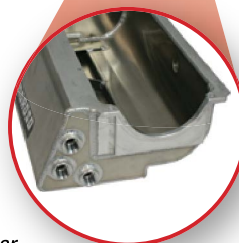

GM LS, CAST ALUMINUM, SWAP, OIL PAN KIT WITH SPIN-ON OIL FILTER PROVISION

Aluminum, Wet Sump, 6 Quart Capacity, 5-3/4" Deep
 Engine Application: GM LS Series

Fits: LS Engine Conversions such as '55-'87 GM Cars & Trucks (except G-Body) that require a Rear Sump Oil Pan with a Spin-On Filter provision (Check Measurements)

- Based on customer inquires, this product is for the individual who prefers the O.E.M. look of a cast aluminum oil pan
- The oil pan is cast, then machined from aluminum
- Clears 4.25" stroke with most steel rods
- Includes a removable, heavy duty, stainless steel anti-slosh baffle
- Features a heavy duty, high flow oil pump pickup
- Integral Spin-On oil filter provision with a O.E.M. oil cooler port that accepts a 22mm-1.5 thread Moroso Part No. 22463 or O.E.M. Spin-On oil filter
- Includes oil pan gasket, mounting bolts and nuts
- Use stock dipstick

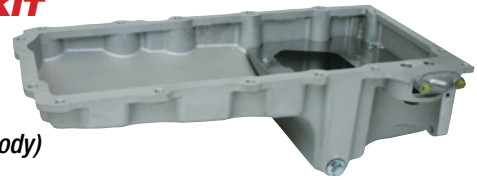

NEW!

No. 20105

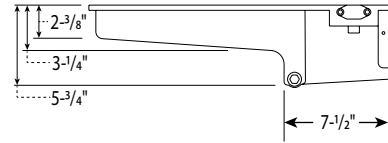
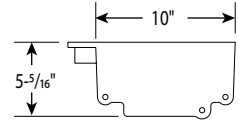

PART #	DESCRIPTION
20105	Oil Pan, Cast Aluminum, GM LS, Rear Sump Swap Kit, Spin-On Oil Filter

PART #	AVAILABLE OPTIONS
22120	Oil Pump, GM LS, High Volume
24890	Oil Pump Flange Reinforcement

WARNING Prop. 65
 This product contains a chemical known to the state of California to cause cancer, birth defects, or reproductive harm.

GM LS SERIES

Steel, Wet Sump, 7 Quart Capacity, 6" Deep, Baffled
 Engine Application: GM LS Series
 Fits: '68-'72 Nova, '65-'72 Chevelle, '67-'69 Camaro, can also be used in additional applications; check dimensions for clearance

- Trap door baffling for improved oil control
- Clears 4.25" stroke with most steel rods and can be used with Moroso Nos. 22941 & 22943 Windage Tray
- Two -10AN fittings for remote filter installation
- Use stock dipstick



No. 20140

PART #	DESCRIPTION
20140	Oil Pan, Steel, Clear Zinc

PART #	RECOMMENDED PICKUP
24050	Fits: Stock Oil Pumps or Moroso GM LS Series High Volume Race Pump No. 22120

PART #	AVAILABLE OPTIONS
22120	Oil Pump GM LS, Race
22941	Windage Tray, GM Studs
22943	Windage Tray, ARP Studs
23694	Oil Cooler/Filter Sandwich Adapter
23700	Remote Oil Filter Mount
23710	Remote Oil Filter Mount
23750	Remote Oil Filter Mount
23760	Remote Oil Filter Mount
23766	Remote Oil Filter Mount

PART #	AVAILABLE OPTIONS
24890	GM LS Oil Pump Flange Reinforcement
38541	Oil Pan Stud Kit
71162	Dust Shield for Moroso & Aftermarket Oil Pans
93152	Oil Pan Gasket, One Piece Design, Steel Reinforced, GM LS Series (Except LS7 & LS9)

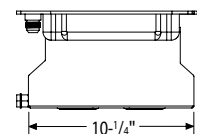
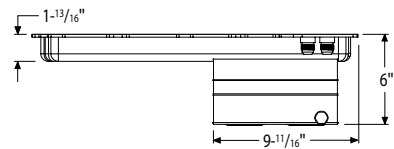
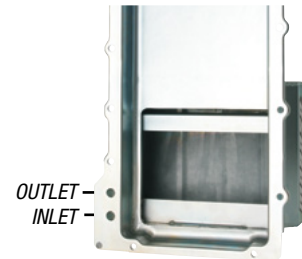

NOTE: Front fitting is pressure, and the rear fitting is return.



OIL PANS

GM LS SERIES

**GM LS SERIES****Steel, Wet Sump, 7 Quart Capacity, 6" Deep, Angled Sump****Engine Application: GM LS Series**

Fits: '67-'92 Camaro, '68-'78 Nova, '65-'72 Chevelle, '53-'96 Corvette, '78-'88 G-Body and GM S-10/S-15 Two Wheel Drive Blazer/Truck. Can also be used in additional applications, check dimensions for clearance.

- Designed with a deeper front sump allowing the installation of Windage Trays (**Nos. 22941 & 22943** sold separately, see pgs. 110-111)
- Trap-door baffling for improved oil control
- Clears 4.25" stroke with most steel rods
- Two -10AN fittings for remote filter installation
- Use stock dipstick

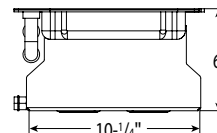
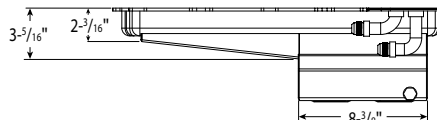
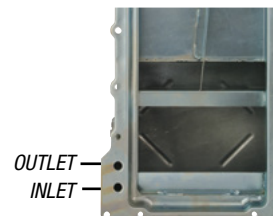
PART # DESCRIPTION**20141** Oil Pan, Steel, Clear Zinc Plated, GM LS Series**PART # RECOMMENDED PICKUP****24050** **Fits: Stock Oil Pumps or Moroso GM LS Series High Volume Race Pump No. 22120****PART # AVAILABLE OPTIONS****22120** Oil Pump GM LS, Race**22941** Windage Tray, GM Studs**22943** Windage Tray, ARP Studs**24890** GM LS Oil Pump Flange Reinforcement**38541** Oil Pan Stud Kit**71162** Dust Shield for Moroso & Aftermarket Oil Pans**93152** Oil Pan Gasket, One Piece Design, Steel Reinforced, GM LS Series (Except LS7 & LS9)**NOTE: Front fitting is pressure, and the rear fitting is return.****No. 20141****GM LS SERIES, REAR SUMP SWAP****Steel, Wet Sump, 5 Quart Capacity, 6" Deep****Engine Application: GM LS Series****Fits: LS Engine Conversions that require a Rear Sump (Check Measurements)**

- Oil pan has a thick precision laser cut steel rail with a durable fabricated steel sump plated with a clear zinc finish
- Fabricated, durable steel construction is more adaptable to add fittings, change finishes and weighs less than cast aluminum construction
- Clears 4.25" stroke with most steel rods
- Anti-climb baffle; magnetic drain plug and uses a stock dipstick
- Features a billet aluminum adapter that allows a 22mm thread Moroso **No. 22463** or O.E.M. oil filter to be mounted in the stock location, no need to run a remote oil filter
- Included billet aluminum oil filter adapter has a 1/4" N.P.T. sensor port

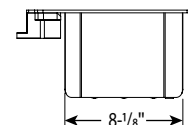
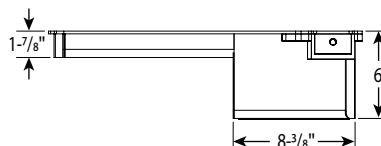
PART # DESCRIPTION**20145** Oil Pan, Steel, Clear Zinc, Rear Sump**PART # RECOMMENDED PICKUP****24050** **Fits: Stock Oil Pumps or Moroso GM LS Series High Volume Race Pump No. 22120****PART # AVAILABLE OPTIONS****22120** Oil Pump GM LS, Race**22463** Racing Oil Filter**23711** Spin-On Oil filter Adapter, Sideways Mount**24890** GM LS Oil Pump Flange Reinforcement**38541** Oil Pan Mounting Stud Kit**71162** Dust Shield for Moroso & Aftermarket Oil Pans**93152** Oil Pan Gasket, GM LS**No. 20145**

GM LS SERIES, REAR SUMP SWAP, NARROW SUMP

Steel, Wet Sump, 5 Quart Capacity

Engine Application: GM LS Series

Fits: LS Engine Conversions that require a narrower Rear Sump
(Check Measurements) for "Block Hugger" headers

AVAILABLE IN SPIN ON AND REMOTE OIL FILTER VERSIONS

- Oil pans both feature a thick precision laser cut steel rail with a durable fabricated steel sump plated with a clear zinc finish
- Fabricated, durable steel construction is more adaptable to add fittings, change finishes and weighs less than cast aluminum construction
- Clears 4.25" stroke with most steel rods
- Anti-climb baffle; magnetic drain plug and uses a stock dipstick



No. 20147
For remote filter



No. 20150
For spin-on filter

PART # DESCRIPTION

- 20147** Oil Pan, Steel, Clear Zinc, Narrow Rear Sump Swap With Billet Aluminum Remote Oil Filter Adapter With -10 AN Female Ports
- 20150** Oil Pan, Steel, Clear Zinc, Narrow Rear Sump Swap with Billet Aluminum Spin-On Oil Filter Adapter that accepts 22mm thread Moroso **No. 22463** or O.E.M. oil filter

PART # RECOMMENDED PICKUP

- 24050** Fits: Stock Oil Pumps or Moroso GM LS Series High Volume Race Pump **No. 22120**

PART # AVAILABLE OPTIONS

- 22120** Oil Pump GM LS, Race
- 22463** Oil Filter, Racing, For Part **No. 20150**
- 22605** -10AN to -10AN Fittings, For Part **No. 20147**
- 22941** Windage Tray, GM Studs
- 22943** Windage Tray, ARP Studs
- 23711** Spin-On Oil filter Adapter, Sideways Mount
- 24890** GM LS Oil Pump Flange Reinforcement
- 38541** Oil Pan Mounting Stud Kit
- 71162** Dust Shield for Moroso & Aftermarket Oil Pans
- 93152** Oil Pan Gasket, GM LS



OUTLET
INLET

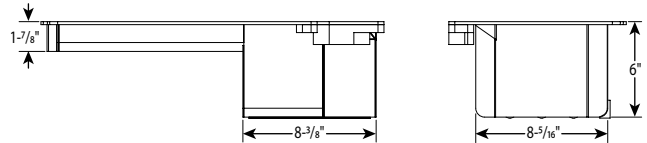

NOTE: Front fitting is pressure, and the rear fitting is return.

DRAG RACE

GM LS SERIES

Aluminum, Wet Sump, 6 Quart Capacity, 6" Deep, Baffled

Engine Application: GM LS Series

Fits: Late Model F-Body Camaro, Firebird, Camaro '93 - '02

- Includes tray and pickup
- Trap door baffle for improved oil control
- Clears 4.25" stroke with most steel rods
- Louvered windage tray
- -10AN fitting for remote oil filter
- Uses stock dipstick



No. 21150

PART # DESCRIPTION

- 21150** Oil Pan, Aluminum, Fully Fabricated with Billet Rail, Deep Sump, Tray and Pickup

PART # REPLACEMENT PART

- 24050** Pickup, Fits: Stock Oil Pumps or Moroso GM LS Series High Volume Race Pump **No. 22120**

PART # AVAILABLE OPTIONS

- 22120** Oil Pump GM LS, Race
- 24890** GM LS Oil Pump Flange Reinforcement
- 38542** Oil Pan Stud Kit
- 71162** Dust Shield for Moroso & Aftermarket Oil Pans
- 93152** Oil Pan Gasket, One Piece Design, Steel Reinforced, GM LS Series (Except LS7 & LS9)
- 22941** Windage Tray, Louvered, LS Engine

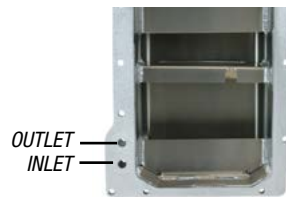

OUTLET
INLET

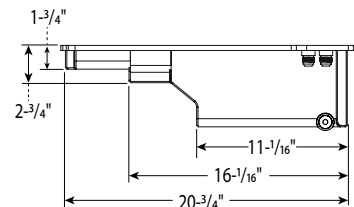
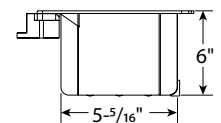

OIL PANS

GM LS SERIES

GM LS SERIES

Steel, Wet Sump, 7 Quart Capacity, 6" Deep

Fits: Camaro and Firebird '98-02 with GM LS Engines, Camaro and Firebird '93-'02 with LS Swap

- Features a drag race proven trap door assembly and anti-slosh baffle that keeps oil contained in oil pump pick up area
- Oil pan has a thick precision laser cut steel rail with a clear zinc finish
- Clears 4.25" stroke with most steel rods
- The 7 Quart Capacity moves the oil away from the rotating assembly for oil control and horsepower saving
- Features a billet aluminum adapter that allows a 22mm thread Moroso **No. 22463** or O.E.M. oil filter to be mounted in the stock location, no need to run a remote oil filter
- Included billet aluminum oil filter adapter has a 1/4" N.P.T. sensor port
- Uses stock dipstick

PART # DESCRIPTION

20139 Oil Pan, Steel, Clear Zinc, Drag Race Baffled

PART # RECOMMENDED PICKUP

24050 Fits: Stock Oil Pumps or Moroso GM LS Series High Volume Race Pump **No. 22120**

PART # AVAILABLE OPTIONS

- 22120** Oil Pump GM LS, Race
- 22463** Oil Filter, Moroso Racing
- 22941** Windage Tray, GM Studs
- 22943** Windage Tray, ARP Studs
- 23711** Spin-On Oil filter Adapter, Sideways Mount
- 93152** Oil Pan Gasket, GM LS Series (Except LS7 & LS9)
- 38541** Oil Pan Stud Kit
- 24890** GM LS Oil Pump Flange Reinforcement
- 71162** Dust Shield for Moroso & Aftermarket Oil Pans



No. 20139

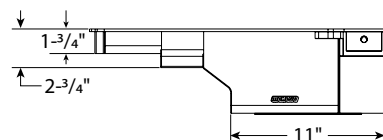
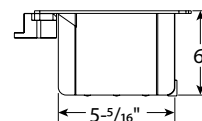

GM LS SERIES

Aluminum, Wet Sump, 7 Quart Capacity, 6" Deep

Fits: Camaro and Firebird '98-02 with GM LS Engines, Camaro and Firebird '93-'02 with LS Swap

- Features a drag race proven trap door assembly and anti-slosh baffle that keeps oil contained in oil pump pickup area
- Oil pan has a thick CNC machined aluminum rail
- Clears 4.25" stroke with most steel rods
- The 7 Quart Capacity moves the oil away from the rotating assembly for oil control and horsepower saving
- Features a billet aluminum adapter that allows a 22mm thread Moroso **No. 22463** or O.E.M. oil filter to be mounted in the stock location, no need to run a remote oil filter
- Included billet aluminum oil filter adapter has a 1/4" NPT sensor port
- Uses stock dipstick

PART # DESCRIPTION

21149 Oil Pan, Aluminum, Drag Race Baffled

PART # RECOMMENDED PICKUP

24050 Fits: Stock Oil Pumps or Moroso GM LS Series High Volume Race Pump **No. 22120**

PART # AVAILABLE OPTIONS

- 22120** Oil Pump GM LS, Race
- 22463** Oil Filter, Moroso Racing
- 22941** Windage Tray, GM Studs
- 22943** Windage Tray, ARP Studs
- 23711** Spin-On Oil filter Adapter, Sideways Mount
- 93152** Oil Pan Gasket, GM LS Series (Except LS7 & LS9)
- 38541** Oil Pan Stud Kit
- 24890** GM LS Oil Pump Flange Reinforcement
- 71162** Dust Shield for Moroso & Aftermarket Oil Pans



No. 21149

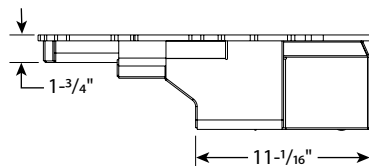
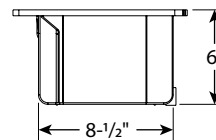

GM LS SERIES, CAMARO COPO

Aluminum, Wet Sump, 7 Quart Capacity, 7-1/2" Deep

Engine Application: GM LS Series

Fits: '12-'15 COPO Camaro, Rear Sump Applications
(Check Measurements)

- Part No. 21151 is standard equipment on the 2014 COPO Camaros, can be used to upgrade earlier cars or used on COPO tribute cars
- Is 6 lbs lighter than the cast aluminum oil pan that was used on the 2012 and 2013 cars
- Has a thick oil pan rail machined from billet aluminum with a fabricated aluminum sump with an internal anti-slosh baffle
- Features a billet aluminum Spin-On oil filter adapter with a 1/4" N.P.T. sensor port that accepts a 22mm thread Moroso Part No. 22463 or O.E.M. Spin-On oil filter
- NHRA legal for stock eliminator & factory showdown

PART # DESCRIPTION

21151 Oil Pan, Aluminum, Fully Fabricated

REQUIRES THESE GM PARTS FOR INSTALLATION

GM PART# DESCRIPTION

- 12608579 Oil Pump Pick Up
- 12570788 Dipstick
- 12570787 Dipstick Tube
- 12611129 Windage Tray*

*A.R.P. Part #200-8587 is required to space Windage Tray on 427 engine



No. 21151

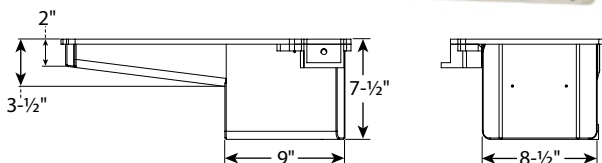

PART # AVAILABLE OPTIONS

- 22120 Oil Pump GM LS, Race
- 24890 GM LS Oil Pump Flange Reinforcement
- 93152 Oil Pan Gasket, GM LS
- 22463 Oil Filter, Moroso Racing
- 38542 Oil Pan, Mounting Stud Kit
- 71162 Dust Shield for Moroso & Aftermarket Oil Pans

GM LS DRAG RACE/ CAMARO '10-'15, COPO '12-'15

Aluminum, Wet Sump, 7 Quart Capacity, 7-1/2" Deep

Engine Application: GM LS Series

Fits: Camaro '10-'15, COPO Camaro '12-'15 & rear sump applications
(check measurements)

- Features trap door baffle assembly, anti-climb baffle and anti-slosh baffle to keep oil contained in the oil pump pickup area during Drag Racing
- Oil pan has a thick aluminum rail with a fabricated aluminum sump
- Clears 4.25" stroke with most steel rods and can be used with Moroso Part Nos. 22941, 22943 or O.E.M. windage trays Part Nos. 12611129, 19244049, 19202609 - check clearances first
- Features a billet aluminum Spin-On oil filter adapter with a 1/4" N.P.T. sensor port that accepts a 22mm thread Moroso Part No. 22463 or O.E.M. Spin-On oil filter
- NHRA legal for stock eliminator & factory showdown

PART # DESCRIPTION

21158 Oil Pan, GM LS, Drag Race, Camaro '10-'15, COPO '12-'15

PART # RECOMMENDED PICKUP

24153 Fits: Stock Oil Pumps or Moroso GM LS Series High Volume Race Pump No. 22120

PART # AVAILABLE OPTIONS

- 22120 Oil Pump GM LS, Race
- 22941 Windage Tray, GM Studs
- 22943 Windage Tray, ARP Studs
- 23711 Spin-On Oil filter Adapter, Sideways Mount
- 24890 GM LS Oil Pump Flange Reinforcement
- 38542 Oil Pan Stud Kit

REQUIRES THESE GM PARTS FOR INSTALLATION

GM PART# DESCRIPTION

- 12570788 Dipstick
- 12570787 Dipstick Tube

PART # AVAILABLE OPTIONS

- 71162 Dust Shield for Moroso & Aftermarket Oil Pans
- 93152 Oil Pan Gasket, One Piece Design, Steel Reinforced, GM LS Series (Except LS7 & LS9)

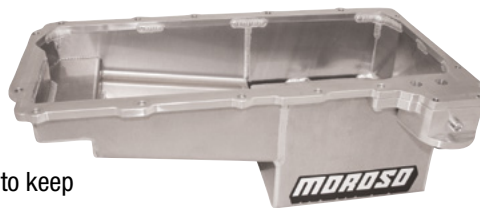

No. 21158

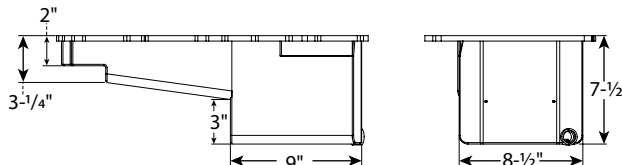

OIL PANS

GM LS SERIES

GM LS COPO CAMARO '16-UP

Aluminum Wet Sump, 7 Quart Capacity, 7-1/2" Deep

Engine Application: GM LS Series

Fits: COPO Camaro '16-Up and rear sump applications (check measurements)

- Features trap door baffle assembly, anti-climb baffle and anti-slosh baffle to keep oil contained in the oil pump pickup area during Drag Racing.
- Oil pan has a thick aluminum rail with a fabricated aluminum sump
- Clears 4.25" stroke with most steel rods and can be used with Moroso Part Nos. 22941, 22943 or O.E.M. windage trays Part Nos. 12611129, 19244049, 19202609 - check clearances first
- Features a billet aluminum Spin-On oil filter adapter with a 1/4" N.P.T. sensor port that accepts a 22mm thread Moroso Part No. 22463 or O.E.M. Spin-On oil filter
- NHRA legal for stock eliminator & factory showdown

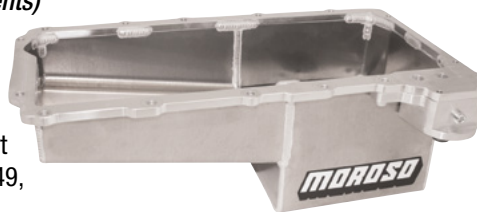

No. 21153

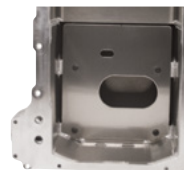

PART # DESCRIPTION
21153 Oil Pan, GM LS, Drag Race, COPO Camaro '16-up

PART # RECOMMENDED PICKUP
24153 Fits: Stock Oil Pumps or Moroso GM LS Series High Volume Race Pump No. 22120

PART # AVAILABLE OPTIONS
22120 Oil Pump GM LS, Race
93152 Oil Pan Gasket, GM LS Series (Except LS7 & LS9)

24154 Fits: Stock Oil Pumps or Moroso GM LS Series High Volume Race Pump No. 22120, requires GM Part No. 19202609 windage tray and GM main cap mounting hardware **NEW!**

38541 Oil Pan Stud Kit
22463 Racing Oil Filter
24890 GM LS Oil Pump Flange Reinforcement
71162 Dust Shield for Moroso & Aftermarket Oil Pans
22941 Windage Tray, GM Studs
22943 Windage Tray, ARP Studs
23711 Spin-On Oil Filter Adapter, Sideways Mount

REQUIRES THESE GM PARTS FOR INSTALLATION

GM PART# DESCRIPTION
12570788 Dipstick
12570787 Dipstick Tube

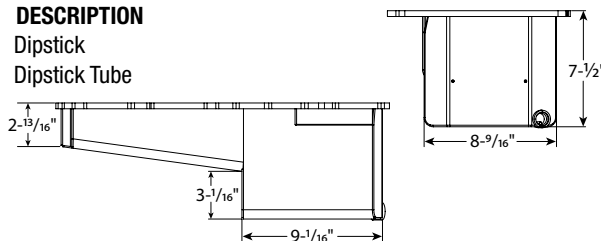

GM LS COPO CAMARO '16-UP, -16AN EXT. P/U

Aluminum Wet Sump, 7 Quart Capacity, 7-1/2" Deep

Engine Application: GM LS Series

Fits: COPO Camaro '16-up and rear sump applications (check measurements)

- Features trap door baffle assembly, anti-climb baffle and anti-slosh baffle to keep oil contained in the oil pump pickup area during Drag Racing
- Oil pan has a thick aluminum rail with a fabricated aluminum sump
- Clears 4.25" stroke with most steel rods and can be used with Moroso Part Nos. 22941, 22943 or O.E.M. windage trays Part Nos. 12611129, 19244049, 19202609 - check clearances first
- Features a billet aluminum adapter that allows a 22mm thread Moroso No. 22463 or O.E.M. oil filter to be mounted in the stock location, no need to run a remote oil filter
- Features a billet aluminum Spin-On oil filter adapter with a 1/4" N.P.T. sensor port that accepts a 22mm thread Moroso Part No. 22463 or O.E.M. Spin-On oil filter



No. 21157



PART # DESCRIPTION
21157 Oil Pan, GM LS, Drag Race, COPO Camaro '16-up, -16AN Ext. P/U

REQUIRES THESE GM PARTS FOR INSTALLATION

GM PART# DESCRIPTION
12570788 Dipstick
12570787 Dipstick Tube

PART # AVAILABLE OPTIONS
23962 Fitting, -16 AN Male to -16 AN Male, External Screen
23963 Fitting, -12 AN Male to -16 AN Male External Screen
93152 Oil Pan Gasket, One Piece Design, Steel Reinforced GM LS Series (Except LS7 & LS9)
38541 Oil Pan Stud Kit
22463 Racing Oil Filter
71162 Dust Shield for Moroso & Aftermarket Oil Pans
22941 Windage Tray, GM Studs
22943 Windage Tray, ARP Studs
23711 Spin-On Oil Filter Adapter, Sideways Mount

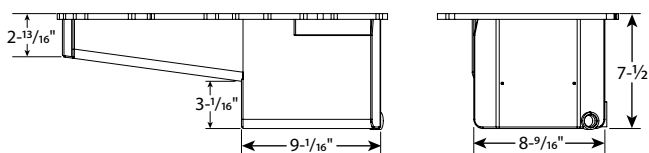

GM LS SERIES, FRONT SUMP SWAP

Steel, Wet Sump, 6.5 Quart Capacity, 6" Deep, Baffled

Engine Application: GM LS Series

Fits: LS Engine Conversions that require a Front Sump (Check Measurements)

- Oil pan has a thick precision laser cut steel rail with a clear zinc finish
- Clears 4.25" stroke with most steel rods
- Features a race proven diamond shape four trap door assembly and removable anti-slosh baffle that keeps oil contained in oil pump pick up area during Drifting, Road Racing and Drag Racing
- Oil Pan Design moves oil away from the rotating assembly for oil control and horsepower saving
- Accepts GM Part # 12558253 Windage Tray with modification
- Two straight -10AN ports for remote filter installation
- Dipstick Fitting for required oil pan mounted dipstick
- Magnetic Drain Plug

PART # DESCRIPTION
20146 Oil Pan, GM LS, Front Sump Swap, Race Baffled, Fully Fabricated, Steel

PART # RECOMMENDED PICKUP
24052 Fits: Stock Oil Pumps Or Moroso GM LS Series High Volume Race Pump No. 22120

PART # AVAILABLE OPTIONS
22120 Oil Pump GM LS, Race
22605 -10AN to -10AN Fittings
23711 Spin-On Oil filter Adapter, Sideways Mount
24890 GM LS Oil Pump Flange Reinforcement
25970 Universal Dipstick Kit
25971 Universal Dipstick Kit, Braided Stainless Flex Tube
25973 Universal Dipstick Kit, Twist Lock
38541 Oil Pan Mounting Stud Kit
71162 Dust Shield for Moroso & Aftermarket Oil Pans
93152 Oil Pan Gasket, One Piece Design, Steel Reinforced, GM LS Series (Except LS7 & LS9)

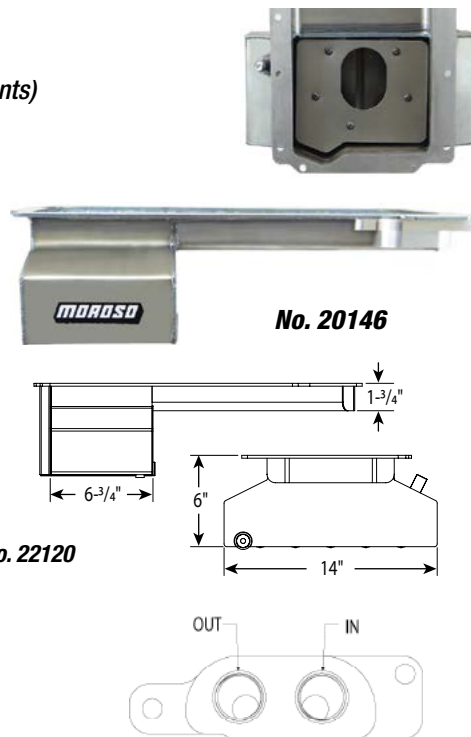

No. 23688
 Remote Oil Filter Adapter, GM LS Series, Included with No. 20146

GM LS SERIES, FRONT SUMP SWAP, SPIN-ON OIL FILTER ADAPTER

Steel, Wet Sump, 6.5 Quart Capacity, 6" Deep, Baffled

Engine Application: GM LS Series

Fits: LS Engine Conversions that require a Front Sump Oil Pan with a Spin-On Filter provision (Check Measurements)

- Oil pan has a thick precision laser cut steel rail with a clear zinc finish
- Clears 4.25" stroke with most steel rods
- Features a race proven diamond shape four trap door assembly and removable anti-slosh baffle that keeps oil contained in oil pump pick up area during Drifting, Road Racing and Drag Racing
- Oil Pan Design moves oil away from the rotating assembly for oil control and horsepower saving
- Accepts GM Part #12558253 Windage Tray with modification
- Features a billet aluminum adapter that allows a 22mm thread Moroso No. 22463 or O.E.M. oil filter to be mounted in the stock location, no need to run a remote oil filter
- Included billet aluminum oil filter adapter has a 1/4" N.P.T. sensor port
- Dipstick Fitting for required oil pan mounted dipstick

PART# DESCRIPTION
20138 Oil Pan, Steel, GM LS, Front Sump Swap, Race Baffled, Fully Fabricated, Spin-On Oil Filter Adapter

PART # RECOMMENDED PICKUP
24052 Fits: Front Sump For Stock Oil Pumps or Moroso LS Series High Volume Race Pump No. 22120

PART# AVAILABLE OPTIONS
22120 Oil Pump GM LS, Race
22463 Oil Filter, Moroso Racing
23711 Spin-On Oil filter Adapter, Sideways Mount
24890 GM LS Oil Pump Flange Reinforcement
25970 Universal Dipstick Kit
25971 Universal Dipstick Kit, Braided Stainless Flex Tube
25973 Universal Dipstick Kit, Twist Lock
38541 Oil Pan Mounting Stud Kit.
71162 Dust Shield for Moroso & Aftermarket Oil Pans
93152 Oil Pan Gasket, One Piece Design, Steel Reinforced, GM LS Series (Except LS7 & LS9)



No. 20138

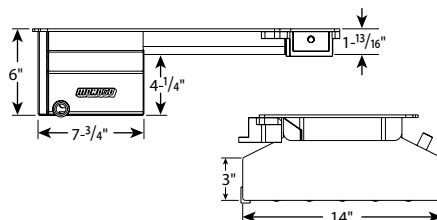

MOROSO OIL PANS
GM LS SERIES

GM LS, EARLY F-BODY, ROAD RACE BAFFLED

Steel, Wet Sump, 7 Quart Capacity

Early F-Body/Swap

Engine Application: GM LS Series

Fits: '67-'15 Camaro/Firebird, '68-'78 Nova, '65-'72 Chevelle, '53-'96 Corvette, '78-'88 G-Body and GM S10/S15 Two Wheel Drive Blazer/Truck. Can also be used in additional applications; check dimensions for clearance

AVAILABLE IN SPIN ON AND REMOTE OIL FILTER VERSIONS

- Two versions available:
 - No. 20142** has a Billet Aluminum Spin-on Oil Filter Adapter that accepts a 22mm thread. Moroso **No. 22463** or O.E.M. oil filter to be mounted in the stock location, clears 4.25" stroke
 - No. 20148** has a Billet Aluminum Remote Oil Filter Adapter that has two straight -10AN ports for remote filter installation, clears 4.25 stroke
- Oil pan has a thick precision laser cut steel rail and a clear zinc finish
- Features a race proven diamond shape four trap door assembly and anti-slosh baffle that keeps oil contained in oil pump pick up area during road racing and drag racing
- The 7 Quart Capacity moves the oil away from the rotating assembly for oil control and horsepower saving
- Uses stock dipstick

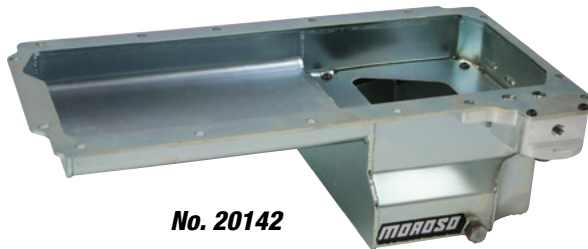

No. 20142

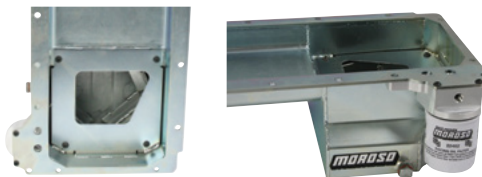

No. 20148

PART #	DESCRIPTION
20142	Oil Pan, GM LS, Early/Swap F-Body Race Baffled, Spin-on Oil Filter Adapter that accepts 22mm thread Moroso No. 22463 or O.E.M. oil filter
20148	Oil Pan GM LS Early/Swap F-Body Race Baffled, Remote Oil Filter Adapter that accepts -10AN to -10AN Fittings

PART #	RECOMMENDED PICKUP
24050	Fits: Stock Oil Pumps or Moroso GM LS Series High Volume Race Pump No. 22120

PART #	AVAILABLE OPTIONS
22120	Oil Pump GM LS, Race
22463	Oil Filter for Part No. 20142 Only
22941	Windage Tray, GM Studs
22943	Windage Tray, ARP Studs
22605	-10AN to -10AN Fittings, For Part No. 20148 Only
23711	Spin-On Oil filter Adapter, Sideways Mount
24890	GM LS Oil Pump Flange Reinforcement
38541	Oil Pan Stud Kit
71162	Dust Shield for Moroso & Aftermarket Oil Pans
93152	Oil Pan Gasket, One Piece Design, Steel Reinforced, GM LS Series (Except LS7 & LS9)

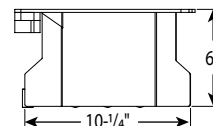
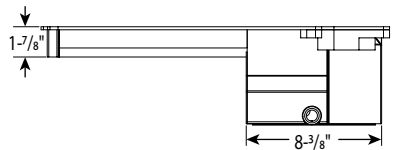

No. 20142

Spin-on Oil Filter Adapter



No. 20148

Remote Filter Adapter

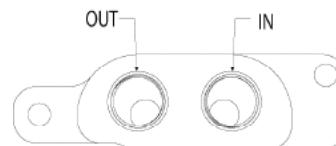

No. 23688

Remote Oil Filter Adapter, GM LS Series, Included with **No. 20148**

NOTE: Front fitting is pressure, and the rear fitting is return.

GM LS, SWAP, ROAD RACE BAFFLED

Steel, Wet Sump, 7 Quart Capacity

Engine Conversion Race Baffled, Angled Sump, Fully Fabricated Steel Oil Pan

Engine Application: GM LS Series

Fits: '67-'15 Camaro/Firebird, '68-'78 Nova, '65-'72 Chevelle, '53-'96 Corvette, '78-'88 G-Body and GM S10/S15 Two Wheel Drive Blazer/Truck. Can also be used in additional applications; check dimensions for clearance

AVAILABLE IN SPIN ON AND REMOTE OIL FILTER VERSIONS



No. 20143



No. 20149

- Two versions available:
 - No. 20143** has a Billet Aluminum Spin-on Oil Filter Adapter that accepts a 22mm thread. Moroso **No. 22463** or O.E.M. oil filter to be mounted in the stock location, clears 4.25" stroke
 - No. 20149** has a Billet Aluminum Remote Oil Filter Adapter that has two straight -10AN ports for remote filter installation, clears 4.25 stroke
- Oil pan has a thick precision laser cut steel rail and a clear zinc finish
- Features a race proven diamond shape four trap door assembly and anti-slosh baffle that keeps oil contained in oil pump pickup area during road racing and drag racing
- The 7 Quart Capacity moves the oil away from the rotating assembly for oil control and horsepower saving
- Uses stock dipstick

PART #	DESCRIPTION
20143	Oil Pan, GM LS, Engine Conv. Race Baffled, Angled Sump, Spin-on Oil Filter Adapter that accepts 22mm thread Moroso No. 22463 or O.E.M. oil filter
20149	Oil Pan, GM LS, Engine Conv. Race Baffled, Angled Sump, Remote Oil Filter Adapter that accepts -10AN to -10AN Fittings

PART #	RECOMMENDED PICKUP
24050	Fits: Stock Oil Pumps or Moroso GM LS Series High Volume Race Pump No. 22120

Part #	AVAILABLE OPTIONS
22120	Oil Pump GM LS, Race
22463	Oil Filter for Part No. 20143 Only
22941	Windage Tray, GM Studs
22943	Windage Tray, ARP Studs
22605	-10AN to -10AN Fittings, For Part No. 20149 Only
23711	Spin-On Oil filter Adapter, Sideways Mount
24890	GM LS Oil Pump Flange Reinforcement
38541	Oil Pan Stud Kit
71162	Dust Shield for Moroso & Aftermarket Oil Pans
93152	Oil Pan Gasket, One Piece Design, Steel Reinforced, GM LS Series (Except LS7 & LS9)

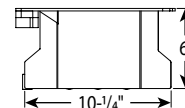
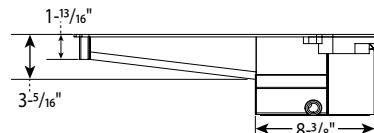

No. 20143

Spin-on Oil Filter Adapter



No. 20149

Remote Filter Adapter

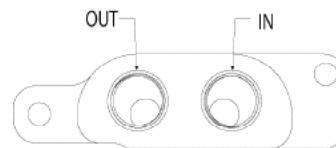

No. 23688

Remote Oil Filter Adapter, GM LS Series, Included with **No. 20149**

NOTE: Front fitting is pressure, and the rear fitting is return.



OIL PANS

GM LS SERIES



GM LS EARLY F-BODY ROAD RACED BAFFLED

Aluminum, Wet Sump, 7 Quart Capacity, 6" Deep Sump

Fits: '67-'15 Camaro/Firebird, '68-'78 Nova, '65-'72 Chevelle, '53-'96 Corvette, '78-'88 G-Body and GM S10/S15 Two Wheel Drive Blazer/Truck. Can also be used in additional applications; check dimensions for clearance

- Features a race proven diamond shape four trap door assembly and anti-slosh baffle that keeps oil contained in oil pump pickup area during road racing and drag racing
- Oil pan has a thick aluminum rail with a fabricated aluminum sump
- Clears 4.25" stroke with most steel rods and can be used with Moroso Part Nos. 22941 and 22943 Windage Tray
- Features a billet aluminum adapter that allows a 22mm thread Moroso No. 22463 or O.E.M. oil filter to be mounted in the stock location, no need to run a remote oil filter
- Included billet aluminum oil filter adapter has a 1/4" N.P.T. sensor port
- Uses stock dipstick



No. 21152



PART # DESCRIPTION
21152 Oil Pan, Aluminum, GM LS, EARLY F-BODY Race Baffled

PART # RECOMMENDED PICKUP
24050 Fits: Stock Oil Pumps or Moroso GM LS Series High Volume Race Pump No. 22120

PART # AVAILABLE OPTIONS
22120 Oil Pump GM LS, Race
23688 Remote Oil Filter Adapter, GM LS
23711 Spin-On Oil filter Adapter, Sideways Mount
93152 Oil Pan Gasket, GM LS Series (Except LS7 & LS9)
38541 Oil Pan Stud Kit
22463 Racing Oil Filter
24890 GM LS Oil Pump Flange Reinforcement
71162 Dust Shield for Moroso & Aftermarket Oil Pans
22941 Windage Tray, GM Studs, Louvered, LS Engine
22943 Windage Tray, ARP Studs, Louvered, LS Engine

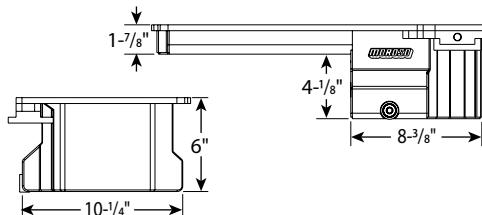

GM LS, SWAP, ROAD RACE BAFFLED

Aluminum, Wet Sump, 7 Quart Capacity, 6" Deep

Engine Application: GM LS Series

Fits: '67-'15 Camaro/Firebird, '68-'78 Nova, '65-'72 Chevelle, '53-'96 Corvette, '78-'88 G-Body and GM S10/S15 Two Wheel Drive Blazer/Truck Can also be used in additional applications; check dimensions for clearance

- Oil pan has a thick aluminum rail with a fabricated aluminum sump
- Clears 4.25" stroke with most steel rods and can be used with Moroso Nos. 22941 and 22943 Windage Tray
- Features a race proven diamond shape four trap door assembly and anti-slosh baffle that keeps oil contained in oil pump pickup area during road racing and drag racing
- The 7 Quart Capacity moves the oil away from the rotating assembly for oil control and horsepower saving
- Features a billet aluminum adapter that allows a 22mm thread Moroso No. 22463 or O.E.M. oil filter to be mounted in the stock location, no need to run a remote oil filter
- Included billet aluminum oil filter adapter has a 1/4" N.P.T. sensor port
- Uses stock dipstick



No. 21159

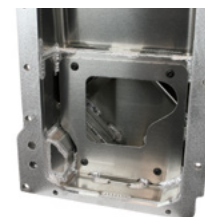

PART # DESCRIPTION
21159 Oil Pan, GM LS, Engine Conversion, Race Baffled, Aluminum Angled Sump

PART # RECOMMENDED PICKUP
24050 Fits: Stock Oil Pumps or Moroso GM LS Series High Volume Race Pump No. 22120

PART # AVAILABLE OIL PAN OPTIONS
22941 Windage Tray, GM Studs, Louvered, LS Engine
22943 Windage Tray, ARP Studs, Louvered, LS Engine
23688 Remote Oil Filter Adapter, GM LS
23711 Spin-On Oil filter Adapter, Sideways Mount
38541 Oil Pan Stud Kit
93152 Oil Pan Gasket, GM LS Series (Except LS7 & LS9)

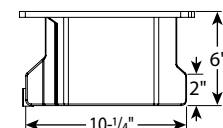
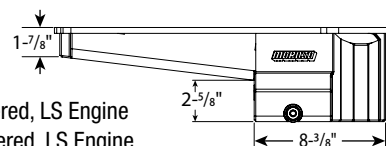

GM LS SERIES

Steel, Dry Sump, Fully Fabricated Steel

- For GM LS Series Engine Blocks
- Has versatile 3 scavenger –12 AN male pick up design allows the oil pan to be used as a Circle Track or Road Race Oil Pan, would also make an excellent Drag Race or Off Road oil pan
- Oil pan has a 3/16" thick precision laser cut steel rail with a 14 gauge steel sump to stand up to the toughest racing conditions
- Clears 4.25" stroke with most steel rods
- Wrap around Anti-Slosh Baffle
- Has a –10 AN male fitting for a oil return

PART # DESCRIPTION

- 21155** Oil Pan, Fully Fabricated Steel left side pickups
- 21156** Oil Pan, Fully Fabricated Steel right side pickups

PART # AVAILABLE OPTIONS

- 23700** Remote Oil Filter Mount
- 23710** Remote Oil Filter Mount
- 23750** Remote Oil Filter Mount
- 23760** Remote Oil Filter Mount
- 23766** Remote Oil Filter Mount
- 38541** Oil Pan Stud Kit
- 93152** Oil Pan Gasket, One Piece Design, Steel Reinforced, GM LS Series (Except LS7 & LS9)



No. 21155

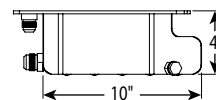
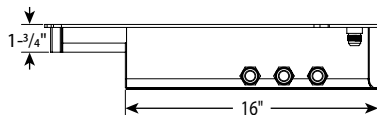

No. 21156

GM LS OIL PAN & PICKUP ACCESORIES

GM LS OIL PUMP FLANGE REINFORCEMENT

- Based on customer inquiries, this product is for the individual who would like their O.E.M. or aftermarket oil pump pick up to be secured in two locations
- Flange reinforcement is installed by screwing in the supplied hardware into the unused screw hole in the Moroso, GM or Melling LS oil pump
- Can be installed without removing an already installed oil pump pickup

PART # DESCRIPTION

- 24890** GM LS Oil Pump Flange Reinforcement

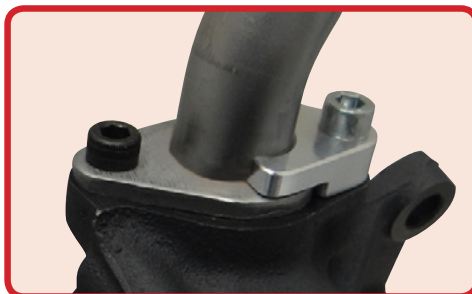

No. 24890

DUST SHIELD, GM LS SERIES

- Covers the exposed flywheel (and clutch in standard transmission vehicles) when using an aftermarket oil pan on a GM LS Series Engine
- Manufactured from .100 thick aluminum
- Includes mounting hardware

PART # DESCRIPTION

- 71162** Dust Shield, GM LS Series



No. 71162



OIL PANS

GM LS SERIES

DART LS NEXT

*Steel, Wet Sump, 7 Quart Capacity, Baffled
 Engine Application: Dart LS Next Engine Blocks
 Fits: '67-'92 Camaro, '68-'78 Nova, '65-'72 Chevelle,
 '53-'96 Corvette, '78-'88 G-Body, and GM S10/S15
 Two Wheel Drive Blazer/Truck*

- Kit includes Dart LS Next oil pan and Moroso **No. 22934**, Billet Aluminum Spacers with mounting hardware
- Oil pan has a 3/16" thick precision laser cut steel rail specifically designed for the LS Next Engine Block
- Features a trap door baffle and a removable windage tray that wraps around the oil pump for horsepower savings and oil control
- Has a 16 gauge steel sump to stand up to the toughest racing conditions
- Clears 4.25" stroke with most steel rods
- The included billet aluminum spacers that mount between the engine block and the oil pan with the supplied mounting hardware, sealing via the built in O-ring groove and requires a GM LS Gasket
- Billet aluminum spacers have mounting holes for A/C and P/S brackets
- Uses stock OEM LS dipstick

PART # DESCRIPTION

20144 Oil Pan, Fully Fabricated Steel

PART # RECOMMENDED PICKUP

24144 *Fits: Stock Oil Pumps or Moroso GM LS Series High Volume Race Pump No. 22120*

PART # AVAILABLE OPTIONS

22120 Oil Pump GM LS, Race

24890 GM LS Oil Pump Flange Reinforcement

93152 Oil Pan Gasket, One Piece Design, Steel Reinforced, GM LS Series (Except LS7 & LS9)



No. 20144

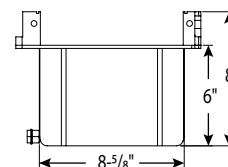
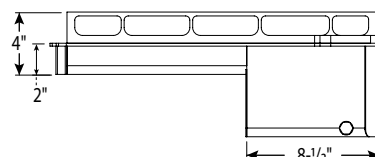

DART LS NEXT

*Steel, Wet Sump, 7 Quart Capacity, 6" Deep, Baffled
 Engine Application: Dart LS Next Non-skirted Engine
 Blocks with Moroso Billet Aluminum Spacer Kit
 Fits: '67-'92 Camaro, '68-'78 Nova, '65-'72 Chevelle, '53-'96
 Corvette, '78-'88 G-Body, and GM S10/S15 Two Wheel Drive
 Blazer/Truck*

- Pan does not include Moroso Oil Pan Spacer Kit **No. 22934**
- Oil pan has a 3/16" thick precision laser cut steel rail specifically designed for the LS Next Engine Block
- Features a trap door baffle and a removable windage tray that wraps around the oil pump for horsepower savings and oil control
- Has a 16 gauge steel sump to stand up to the toughest racing conditions
- Clears 4.25" stroke with most steel rods

PART # DESCRIPTION

20151 Oil Pan, DART LS NEXT, Fully Fabricated Steel

PART # RECOMMENDED PICKUP

24144 *Fits: Stock Oil Pumps or Moroso GM LS Series High Volume Race Pump No. 22120*

PART # AVAILABLE OPTIONS

22120 Oil Pump GM LS, Race

22934 Oil Pan Spacer Kit

24890 GM LS Oil Pump Flange Reinforcement

93152 Oil Pan Gasket, One Piece Design, Steel Reinforced, GM LS Series (Except LS7 & LS9)



No. 20151

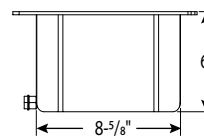
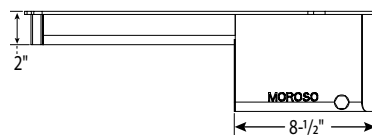

NOTE: Oil Pan Capacities DO NOT include oil filter capacity. All Moroso Pans include a Magnetic Drain Plug.

GM LT SERIES, REAR SUMP SWAP

Aluminum, Wet Sump, 5 Quart Capacity, 5-7/8" Deep

Engine Application: GM LT Series

Fits: LT Engine Conversions that require a Rear Sump (Check Measurements)

- Due to the O.E.M. GM LT oil pans having the oil pump pickup built into the oil pan, our LT oil pan has a thick billet aluminum O-ringed rail incorporates a removable pick up, a billet front sump and a location to mount our billet aluminum spin-on oil filter adapter
- Fabricated aluminum construction is more adaptable to add fittings, change finishes and weighs less than cast aluminum construction
- Features a trap door baffle and a removable windage tray that wraps around the oil pump pick up for horsepower savings and oil control
- Includes a billet aluminum adapter that allows a 22mm thread Moroso **No. 22463** Racing or O.E.M. oil filter to be mounted in the stock location, no need to run a remote oil filter
- For dipstick, use GM part No.12643278 dipstick and GM part No.12652951 dipstick tube
- The included dip stick bung is designed to be use with GM Part # 12652951 Dipstick Tube and 12643278 Dipstick

PART # DESCRIPTION
20155 Oil Pan,GM LT, Rear Sump, Swap, Aluminum

PART# AVAILABLE OPTIONS
22463 Oil Filter, Moroso Racing

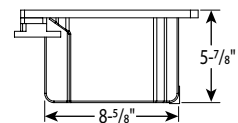
**No. 20155****DRAG RACE****GM LT COPO CAMARO '16-UP**

Aluminum Wet Sump, 7 Quart Capacity, 7-1/2" Deep

Engine Application: GM LT Series

Fits: COPO Camaro '16-Up and rear sump applications (check measurements)

- Due to the O.E.M. GM LT oil pans having the oil pump pickup built into the oil pan, our LT oil pan has a thick billet aluminum O-ringed rail that incorporates a removable pickup, a billet front sump and a location to mount our billet aluminum spin-on oil filter adapter
- Fabricated aluminum construction is more adaptable to add fittings, change finishes and weighs less than cast aluminum construction
- Features trap door baffle assembly, anti-climb baffle and anti-slosh baffle to keep oil contained in the oil pump pickup area during Drag Racing
- Features a trap door baffle and a removable windage tray that wraps around the oil pump pickup for horsepower savings and to keep oil contained in the oil pump pickup area during Drag Racing
- Features a billet aluminum adapter that allows a 22mm thread Moroso **No. 22463** or O.E.M. oil filter to be mounted in the stock location, no need to run a remote oil filter
- Included billet aluminum oil filter adapter has a 1/4" N.P.T. sensor port
- The included dip stick bung is designed to be use with GM Part # 12652951 Dipstick Tube and 12643278 Dipstick

PART # DESCRIPTION
21154 Oil Pan, GM LT, Drag Race, COPO Camaro '16-up

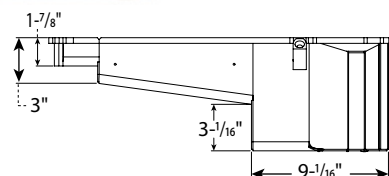
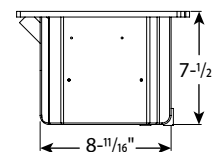
**No. 21154**

**CHEVROLET BIG BLOCK**

Steel, Wet Sump, 5 Quart Capacity, 7-3/4" Deep
Engine Application: Stock Replacement for GM Stock
2 or 4-Bolt Main Blocks
Fits: Most Chassis w/Mark IV Engines

- Can be used with GM 2-bolt and 4-bolt blocks
- Anti-slosh internal baffling
- Accepts up to a 4.0" stroke with steel rods
- Uses O.E.M. Dipstick/ Grommet

PART # DESCRIPTION

20449 Oil Pan, Steel, Clear Zinc, Stock Configuration

PART # RECOMMENDED PICKUPS

24448 *Fits: Moroso BBC Race Pump Nos. 22149, 22150, 22159, 22160 and 22162 or M77/M77HV style pump*

PART # OIL PUMP/PICKUP PACKAGE

22195 Moroso High-Volume Package

PART # AVAILABLE OPTION

23030 Windage Tray (may require some modification)

23010 Oil Pan Baffle

25830 Crank Scraper

38361 Oil Pan Fastener Kit, BBC Race Pans

93153 Oil Pan Gasket, One Piece Design, Steel Reinforced, BBC Mark IV, notched for stroker cranks

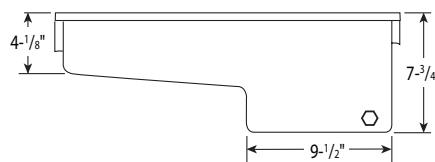
**No. 20449****CHEVROLET BIG BLOCK**

Steel, Wet Sump, 7 Quart Capacity, 9" Deep
Engine Application: Mark IV style (except Gen V and Gen VI)
Fits: Most chassis except '62-'67 Chevy II, V8 Vega/Monza and '55-'57 Chevy

- Stock style baffle
- Accepts up to a 4.25" stroke with steel rods and a 4.090" stroke with aluminum rods
- Compatible with most starter/flywheel combinations

PART # DESCRIPTION

20451 Oil Pan, Steel, Clear Zinc, Street Performance, Deep Sump

PART # RECOMMENDED PICKUPS

24430 *Fits: Moroso BBC Race Pump Nos. 22149, 22150, 22159, 22160, 22162 or M77/M77HV style pump*

PART # AVAILABLE OPTIONS

23030 Windage Tray (may require some modification)

23010 Oil Pan Baffle

25830 Crank Scraper

25970 Universal Dipstick Kit

25971 Universal Dipstick Kit, Braided Stainless Flex Tube

25973 Universal Dipstick Kit, Twist Lock

38361 Oil Pan Fastener Kit, BBC Race Pans

93153 Oil Pan Gasket, One Piece Design, Steel Reinforced, BBC Mark IV, notched for stroker cranks

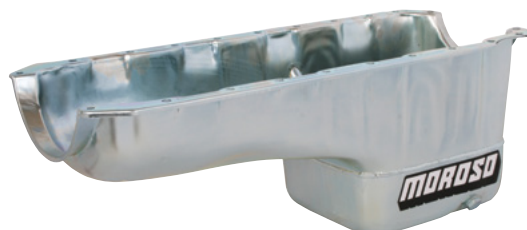
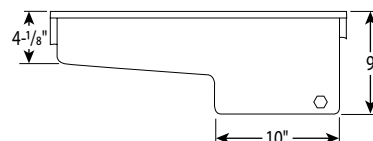
**No. 20451**

NOTE: Oil Pan Capacities DO NOT include oil filter capacity. All Moroso Pans include a Magnetic Drain Plug.

CHEVROLET BIG BLOCK

Steel, Wet Sump, 8 Quart Capacity, 9-³/₄" Deep
 Engine Application: Mark IV style (except Gen V and Gen VI)
 Fits: Most chassis except '62-'67 Chevy II, V8 Vega/Monza
 and '55-'57 Chevy

- Stock style baffle
- Accepts up to a 4.25" stroke with steel rods and a 4.090" stroke with aluminum rods
- Compatible with most starter/flywheel combinations

PART # DESCRIPTION

20460 Oil Pan, Steel, Clear Zinc, Street Performance Sump

PART # RECOMMENDED PICKUPS

24450 Fits: Moroso BBC Race Pump Nos. 22149, 22150, 22159, 22160, 22162 or M77/M77HV style pump

PART # AVAILABLE OPTIONS

23030 Windage Tray (may require some modification)
23010 Oil Pan Baffle
25830 Crank Scraper
25970 Universal Dipstick Kit
25971 Universal Dipstick Kit, Braided Stainless Flex Tube
25973 Universal Dipstick Kit, Twist Lock
93153 Oil Pan Gasket, One Piece Design, Steel Reinforced, BBC Mark IV, notched for stroker cranks

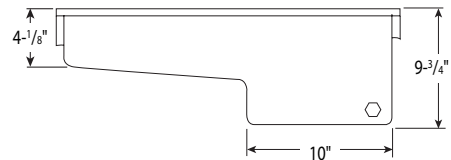
**No. 20460****CHEVROLET BIG BLOCK**

Steel, Wet Sump, 6.5 Quart Capacity, 8" Deep, 10" Long Sump
 Engine Application: Mark IV Style (except for Gen V and Gen VI)
 Fits: Most Chassis (except '62-'67 Chevy II, V-8 Vega/Monza,
 and '55-'57 Chevy)

- Designed with a sump that has flat sides to alleviate header clearance problems with some exhaust header brands
- Flat sides eliminate the need to change headers or perform fabrication work to the kicked-out sump of the oil pan
- Accepts up to a 4.25" stroke with steel rods and a 4.090" stroke with aluminum rods
- Features a crank scraper and uni-directional windage tray for horsepower
- Trap door baffling and an anti-climb baffle for oil control under hard acceleration and de-acceleration

PART # DESCRIPTION

20408 Oil Pan, Steel, Clear Zinc

PART # RECOMMENDED PICKUPS

24440 Fits: Stock Oil Pumps, Moroso BBC Race Pump Nos. 22149, 22150, 22159, 22160, 22162 or M77/M77HV style pump

24441* Fits: Stock Oil Pumps, Moroso BBC Race Pump Nos. 22149, 22150, 22159, 22160, 22162 or M77/M77HV style pump

PART # OIL PUMP/PICKUP PACKAGE

22175 Moroso Standard Volume Package
22185 Moroso High Volume Package
22186* Moroso High Volume Package with Front Style Offset Pickup
22163 Moroso Billet Aluminum Oil Pump, BBC, High Volume
22164 Moroso Billet Aluminum Oil Pump, BBC, Standard Volume

*Offset to middle of sump for more consistent oil pressure under braking

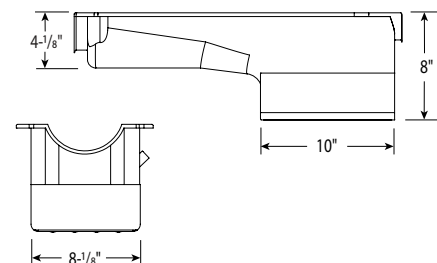
**No. 20408****PART # AVAILABLE OPTIONS**

25970 Universal Dipstick Kit
25971 Universal Dipstick Kit, Braided Stainless Flex Tube
25973 Universal Dipstick Kit, Twist Lock
93153 Oil Pan Gasket, One Piece Design, Steel Reinforced, BBC Mark IV, notched for stroker cranks

NOTE: Oil Pan Capacities DO NOT include oil filter capacity. All Moroso Pans include a Magnetic Drain Plug.



OIL PANS

CHEVY BIG BLOCK

**CHEVROLET BIG BLOCK***Steel, Wet Sump, 7 Quart Capacity, 8" Deep**Engine Application: Mark IV style (except Gen V and Gen VI)**Fits: Most chassis except '62-'67 Chevy II, V8 Vega/Monza and '55-'57 Chevy*

- Kicked-out sump
- Trap door baffling for improved oil control
- Accepts up to a 4.25" stroke with steel rods and a 4.090" stroke with aluminum rods
- Compatible with most starter/flywheel combinations

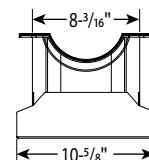
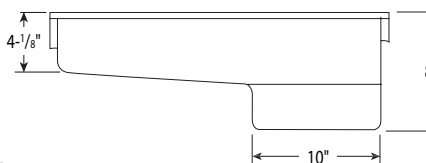
PART # DESCRIPTION**20401** Oil Pan, Steel, Clear Zinc, Street Performance, Deep Sump**PART # RECOMMENDED PICKUPS****24440** *Fits: Moroso BBC Race Pump Nos. 22149, 22150, 22159, 22160, 22162 or M77/M77HV style pump***24441*** *Fits: Moroso BBC Race Pump Nos. 22149, 22150, 22159, 22160, 22162 or M77/M77HV style pump***PART # OIL PUMP/PICKUP PACKAGE****22175** Moroso Standard Volume Package**22185** Moroso High Volume Package**22186*** Moroso High Volume Package/Front Style Offset Pickup**22163** Moroso Billet Aluminum Oil Pump, BBC, High Volume**22164** Moroso Billet Aluminum Oil Pump, BBC, Standard Volume**PART # AVAILABLE OPTIONS****23030** Windage Tray**23010** Oil Pan Baffle**25830** Crank Scraper**25970** Universal Dipstick Kit**PART # AVAILABLE OPTIONS****25971** Universal Dipstick Kit, Braided Stainless Flex Tube**25973** Universal Dipstick Kit, Twist Lock**93153** Oil Pan Gasket, One Piece Design, Steel Reinforced, BBC Mark IV, notched for stroker cranks**Offset to middle of sump for more consistent oil pressure under braking***No. 20401****CHEVROLET BIG BLOCK***Steel, Wet Sump, 7 Quart Capacity, 8" Deep**Engine Application: Mark IV style (except Gen V and Gen VI)**Fits: Most chassis except '62-'67 Chevy II, V8 Vega/Monza and '55-'57 Chevy*

- Kicked-out sump and crank scraper
- Uni-directional windage screen
- Rear anti-climb baffle
- Trap door baffling for improved oil control
- Accepts up to a 4.25" stroke with steel rods and a 4.090" stroke with aluminum rods
- Compatible with most starter/flywheel combinations

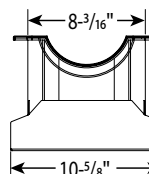
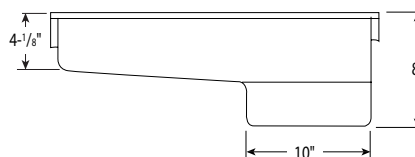
PART # DESCRIPTION**20403** Oil Pan, Steel, Clear Zinc, Street Performance, Deep Sump**PART # RECOMMENDED PICKUPS****24440** *Fits: Moroso BBC Race Pump Nos. 22149, 22150, 22159, 22160, 22162 or M77/M77HV style pump***24441*** *Fits: Moroso BBC Race Pump Nos. 22149, 22150, 22159, 22160, 22162 or M77/M77HV style pump***PART # OIL PUMP/PICKUP PACKAGE****22175** Moroso Standard Volume Package**22185** Moroso High Volume Package**22186*** Moroso High Volume Package/Front Style Offset Pickup**22163** Moroso Billet Aluminum Oil Pump, BBC, High Volume**22164** Moroso Billet Aluminum Oil Pump, BBC, Standard Volume**PART # AVAILABLE OPTIONS****23010** Oil Pan Baffle**25970** Universal Dipstick Kit**25971** Universal Dipstick Kit, Braided Stainless Flex Tube**25973** Universal Dipstick Kit, Twist Lock**38361** Oil Pan Fastener Kit, BBC Race Pans**93153** Oil Pan Gasket, One Piece Design, Steel Reinforced, BBC Mark IV, notched for stroker cranks**Offset to middle of sump for more consistent oil pressure under braking***No. 20403**

CHEVROLET BIG BLOCK**Steel, Wet Sump, 6 Quart Capacity, 8" Deep****Engine Application: Mark IV style (except Gen V and Gen VI)****Fits: Most chassis including '65-'72 Chevelle, Cutlass, Skylark, Tempest and GTO, except '62-'67 Chevy II, V8 Vega/Monza and '55-'57 Chevy**

- Clears rear steer center links in GM A-Body cars
- Rear sump has been shortened 1-1/4" for additional cross-member clearance
- Trap door baffling for improved oil control
- Accepts up to a 4.25" stroke with steel rods and a 4.090" stroke with aluminum rods
- Compatible with most starter/flywheel combinations

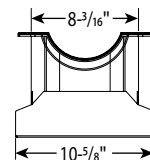
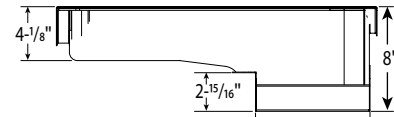
PART # DESCRIPTION**20412** Oil Pan, Steel, Clear Zinc, Rear Sump**PART # RECOMMENDED PICKUPS****24440** Fits: Moroso BBC Race Pump Nos. 22149, 22150, 22159, 22160, 22162 or M77/M77HV style pump**24441*** Fits: Moroso BBC Race Pump Nos. 22149, 22150, 22159, 22160, 22162 or M77/M77HV style pump**PART # OIL PUMP/PICKUP PACKAGE****22175** Moroso Standard Volume Package or M77 style pump**22185** Moroso High Volume Package or M77HV style pump**22186*** Moroso High Volume Package/Front Style Offset Pickup or M77HV style pump**22163** Moroso Billet Aluminum Oil Pump, BBC, High Volume**22164** Moroso Billet Aluminum Oil Pump, BBC, Standard Volume**Offset to middle of sump for more consistent oil pressure under braking***No. 20412****PART # AVAILABLE OPTIONS****23030** Windage Tray**23010** Oil Pan Baffle**25830** Crank Scraper**25970** Universal Dipstick Kit**25971** Universal Dipstick Kit, Braided Stainless Flex Tube**25973** Universal Dipstick Kit, Twist Lock**38361** Oil Pan Fastener Kit, BBC Race Pans**93153** Oil Pan Gasket, One Piece Design, Steel Reinforced, BBC Mark IV, notched for stroker cranks**CHEVROLET BIG BLOCK****Steel, Wet Sump, 6 Quart Capacity, 8" Deep****Engine Application: Mark IV style (except Gen V and Gen VI)****Fits: Most chassis including '65-'72 Chevelle, Cutlass, Skylark, Tempest and GTO, except '62-'67 Chevy II, V8 Vega/Monza and '55-'57 Chevy**

- Clears rear steer center links in GM A-Body cars
- Trap door baffling and an anti-climb baffle for oil control under hard acceleration and de-acceleration
- Accepts up to a 4.25" stroke with steel rods and a 4.090" stroke with aluminum rods
- Features a crank scraper and uni-directional windage tray for horsepower
- Compatible with most starter/flywheel combinations

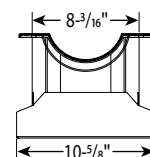
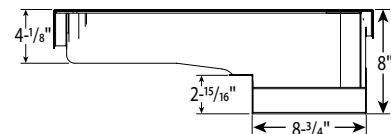
PART # DESCRIPTION**20416** Oil Pan, Steel, Clear Zinc, Rear Sump, Windage Tray**PART # RECOMMENDED PICKUPS****24440** Fits: Moroso BBC Race Pump Nos. 22149, 22150, 22159, 22160, 22162 or M77/M77HV style pump**24441*** Fits: Moroso BBC Race Pump Nos. 22149, 22150, 22159, 22160, 22162 or M77/M77HV style pump**PART # OIL PUMP/PICKUP PACKAGE****22175** Moroso Standard Volume Package or M77 style pump**22185** Moroso High Volume Package or M77HV style pump**22186*** Moroso High Volume Package/Front Style Offset Pickup or M77HV style pump**22163** Moroso Billet Aluminum Oil Pump, BBC, High Volume**22164** Moroso Billet Aluminum Oil Pump, BBC, Standard Volume**Offset to middle of sump for more consistent oil pressure under braking***No. 20416****PART # AVAILABLE OPTIONS****25970** Universal Dipstick Kit**25971** Universal Dipstick Kit, Braided Stainless**25973** Universal Dipstick Kit, Twist Lock**93153** Oil Pan Gasket, One Piece Design, Steel Reinforced, BBC Mark IV, notched for stroker cranks

**CHEVROLET BIG BLOCK***Steel, Wet Sump, 7 Quart Capacity, 9" Deep**Engine Application: Mark IV style (except Gen V and Gen VI)**Fits: '62-'67 Chevy II (without power steering) and '55-'57 Chevys; transmission must be in stock location*

- Notched rear sump clears steering linkage
- Accepts up to a 4.25" stroke with steel rods and a 4.090" stroke with aluminum rods
- Compatible with most starter/flywheel combinations

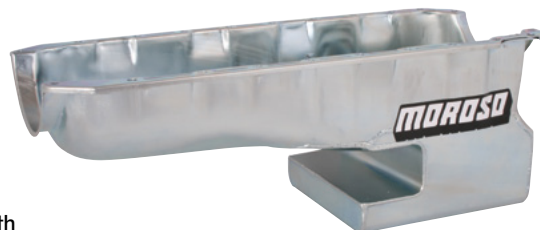
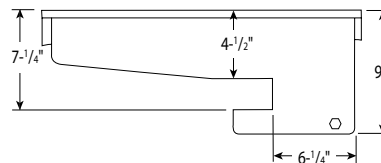
PART # DESCRIPTION**20431** Oil Pan, Steel, Clear Zinc, Street Performance, Deep Sump, Core Based**PART # RECOMMENDED PICKUP****24430** *Fits: Moroso BBC Race Pump Nos. 22149, 22150, 22159, 22160, 22162 or M77/M77HV style pump***PART # AVAILABLE OPTIONS****23010** Oil Pan Baffle**25970** Universal Dipstick Kit**25971** Universal Dipstick Kit, Braided Stainless Flex Tube**25973** Universal Dipstick Kit, Twist Lock**38361** Oil Pan Fastener Kit, BBC Race Pans**93153** Oil Pan Gasket, One Piece Design, Steel Reinforced, BBC Mark IV, notched for stroker cranks**No. 20431****DRAG RACE****CHEVROLET BIG BLOCK***Steel, Wet Sump, 6 Quart Capacity, 8" Deep**Engine Application: Mark IV style (except Gen V and Gen VI)**Fits: Most chassis (may require cross-member modification)*

- Kicked-out sump
- Accepts up to a 4.75" stroke with steel rods and a 4.5" stroke with aluminum rods
- Anti-slosh baffling
- Compatible most starter/flywheel combinations

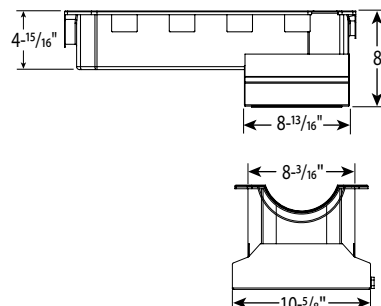
PART # DESCRIPTION**20406** Oil Pan, Steel, Clear Zinc, Deep Sump, Core Based**PART # RECOMMENDED PICKUPS****24440** *Fits: Moroso BBC Race Pump Nos. 22149, 22150, 22159, 22160, 22162 or M77/M77HV style pump***24441*** *Fits: Moroso BBC Race Pump Nos. 22149, 22150, 22159, 22160, 22162 or M77/M77HV style pump***PART # OIL PUMP/PICKUP PACKAGE****22175** Moroso Standard Volume Package**22185** Moroso High Volume Package**22186*** Moroso High Volume Package/Front Style Offset Pickup**22163** Moroso Billet Aluminum Oil Pump, BBC, High Volume**22164** Moroso Billet Aluminum Oil Pump, BBC, Standard Volume**PART # AVAILABLE OPTIONS****23030** Windage Tray**23010** Oil Pan Baffle**25830** Crank Scraper**25970** Universal Dipstick Kit**25971** Universal Dipstick Kit, Braided Stainless Flex Tube**25973** Universal Dipstick Kit, Twist Lock**38361** Oil Pan Fastener Kit, BBC Race Pans**93153** Oil Pan Gasket, One Piece Design, Steel Reinforced, BBC Mark IV, notched for stroker cranks**No. 20406****Offset to middle of sump for more consistent oil pressure under braking*

CHEVROLET BIG BLOCK

Steel, Wet Sump, 6 Quart Capacity, 8" Deep
 Engine Application: Mark IV style (except Gen V and Gen VI)
 Fits: Most chassis (may require cross-member modification)

- Kicked-out sump
- Trap door baffling for improved oil control
- Modified front sump to accept larger stroke
- Accepts up to a 4.75" stroke with steel rods and a 4.5" stroke with aluminum rods
- Compatible with most starter/flywheel combinations

PART # DESCRIPTION

20405 Oil Pan, Steel, Clear Zinc, Street Performance, Deep Sump, Stroker Pan, Core Based

PART # RECOMMENDED PICKUPS

24440 Fits: Moroso BBC Race Pump Nos. 22149, 22150, 22159, 22160, 22162 or M77/M77HV style pump

24441* Fits: Moroso BBC Race Pump Nos. 22149, 22150, 22159, 22160, 22162 or M77/M77HV style pump

PART # OIL PUMP/PICKUP PACKAGE

22175 Moroso Standard Volume Package
22185 Moroso High Volume Package
22186* Moroso High Volume Package/Front Style Offset Pickup
22163 Moroso Billet Aluminum Oil Pump, BBC, High Volume
22164 Moroso Billet Aluminum Oil Pump, BBC, Standard Volume

PART # AVAILABLE OPTIONS

23030 Windage Tray
23010 Oil Pan Baffle
25830 Crank Scraper
25970 Universal Dipstick Kit



No. 20405

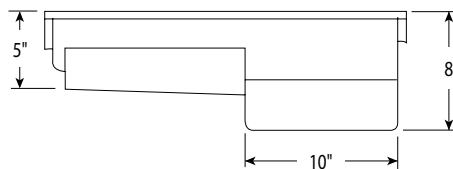

PART # AVAILABLE OPTIONS

25971 Universal Dipstick Kit, Braided Stainless Flex Tube
25973 Universal Dipstick Kit, Twist Lock
93153 Oil Pan Gasket, One Piece Design, Steel Reinforced, BBC Mark IV, notched for stroker cranks

*Offset to middle of sump for more consistent oil pressure under braking

CHEVROLET BIG BLOCK

Steel, Wet Sump, 6 Quart Capacity w/ Standard Volume Pump,
 7 Quart Capacity w/ High Volume Pump, 8" Deep
 Engine Application: Mark IV style (except Gen V and Gen VI)
 Fits: Bracket Race cars and Budget Super Stock cars;
 Some modifications necessary to fit cross-membered cars

- Core based oil pan, utilizing stock pan rail bolt pattern
- Passenger-side kick-out for horsepower savings
- 8" rear depth, 5" front depth
- Louvered steel tray with main cap partitions for maximum power and oil control
- For use with 168 and 153-tooth flywheel combinations
- Clears most cross-members
- Accepts up to a 4.75" stroke with steel rods and a 4.5" stroke with aluminum rods

PART # DESCRIPTION

21047 Oil Pan, Steel, Clear Zinc

PART # RECOMMENDED PICKUPS

24440 Fits: Moroso BBC Race Pump Nos. 22149, 22150, 22159, 22160, 22162 or M77/M77HV style pump

24441* Fits: Moroso BBC Race Pump Nos. 22149, 22150, 22159, 22160, 22162 or M77/M77HV style pump

PART # OIL PUMP/PICKUP PACKAGE

22175 Moroso Standard Volume Package
22185 Moroso High Volume Package
22186* Moroso High Volume Package/Front Style Offset Pickup
22163 Moroso Billet Aluminum Oil Pump, BBC, High Volume
22164 Moroso Billet Aluminum Oil Pump, BBC, Standard Volume
22187 Moroso High Volume Package with Windage Shield



No. 21047

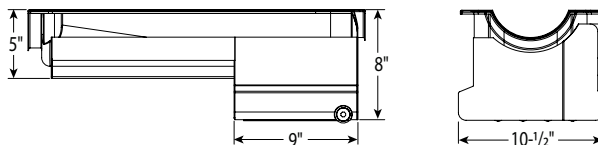

PART # AVAILABLE OPTIONS

25970 Universal Dipstick Kit
25971 Universal Dipstick Kit, Braided Stainless Flex Tube
25973 Universal Dipstick Kit, Twist Lock
93153 Oil Pan Gasket, One Piece Design, Steel Reinforced, BBC Mark IV, notched for stroker cranks

*Offset to middle of sump for more consistent oil pressure under braking

NOTE: Oil Pan Capacities DO NOT include oil filter capacity. All Moroso Pans include a Magnetic Drain Plug.

CHEVROLET BIG BLOCK

Steel, Wet Sump, 7 Quart Capacity, 6" Front Depth, 8" Rear Depth
 Engine Application: Mark IV Style (except Gen V & Gen VI)
 Fits: Bracket and Budget Super Stock cars. Some modifications may be necessary to fit crossmembered cars.

- Core based oil pan
- Kick-out for horsepower savings
- Accepts up to a 4.75" stroke with steel rods and a 4.5" stroke with aluminum rods
- Partitioned and louvered windage tray with main cap dividers separates oil quickly from rotating assembly for ultimate oil control and maximum horsepower gain
- Includes provisions to accept Moroso Dipstick Kit Parts **Nos. 25970, 25971, 25973**
- Used with GM-style or Tilton-style starter and 168-tooth flywheel
- Clear zinc plating for durability and corrosion resistance



No. 21048



PART # DESCRIPTION

21048 Oil Pan, Steel, Clear Zinc Plated, Wet Sump, Mark IV Style

PART # RECOMMENDED PICKUPS

24440 Fits: Moroso BBC Race Pump Nos. **22149, 22150, 22159, 22160, 22162** or M77/M77HV style pump

24441* Fits: Moroso BBC Race Pump Nos. **22149, 22150, 22159, 22160, 22162** or M77/M77HV style pump

PART # OIL PUMP/PICKUP PACKAGE

- 22175** Moroso Standard Volume Package
- 22185** Moroso High Volume Package
- 22186** Moroso High Volume Package/Front Style Offset Pickup*
- 22163** Moroso Billet Aluminum Oil Pump, BBC, High Volume
- 22164** Moroso Billet Aluminum Oil Pump, BBC, Standard Volume
- 22187** Moroso High Volume Package with Windage Shield

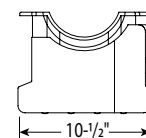
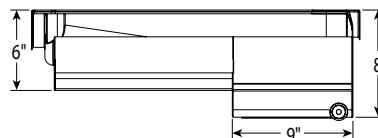

PART # AVAILABLE OPTIONS

- 25970** Universal Dipstick Kit
- 25971** Universal Dipstick Kit, Braided Stainless Flex Tube
- 25973** Universal Dipstick Kit, Twist Lock
- 93153** Oil Pan Gasket, One Piece Design, Steel Reinforced, BBC Mark 4, notched for stroker cranks

*Offset to middle of sump for more consistent oil pressure under braking

CHEVROLET BIG BLOCK

Steel, Wet Sump, 6 Quart Capacity with Standard Volume Pump, 7 Quart Capacity with High Volume Pump, 8" Deep
 Engine Application: Mark IV Style (except Gen V & Gen VI)
 Fits: Bracket Race cars and Budget Super Stock cars;
 Some modifications necessary to fit cross-membered cars

- Core based oil pan
- Kick-out for horsepower savings
- 8" rear depth, 5" front depth with louvered steel tray
- Directional baffle across front of pan to direct oil to sump for oil control under hard acceleration
- For use with 168 and 153-tooth flywheel combinations
- Accepts up to a 4.75" stroke with steel rods and a 4.5" stroke with aluminum rods



No. 21049



PART # DESCRIPTION

21049 Oil Pan, Steel, Clear Zinc, Mark IV Style

PART # RECOMMENDED PICKUPS

24440 Fits: Moroso BBC Race Pump Nos. **22149, 22150, 22159, 22160, 22162** or M77/M77HV style pump

24441* Fits: Moroso BBC Race Pump Nos. **22149, 22150, 22159, 22160, 22162** or M77/M77HV style pump

PART # OIL PUMP/PICKUP PACKAGE

- 22175** Moroso Standard Volume Package
- 22185** Moroso High Volume Package
- 22186*** Moroso High Volume Package with Front Style Offset Pickup
- 22187** Moroso High Volume Package with Windage Shield
- 22163** Moroso Billet Aluminum Oil Pump, BBC, High Volume
- 22164** Moroso Billet Aluminum Oil Pump, BBC, Standard Volume

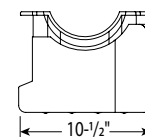
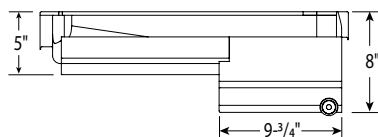

PART # AVAILABLE OPTIONS

- 25970** Universal Dipstick Kit
- 25971** Universal Dipstick Kit, Braided Stainless Flex Tube
- 25973** Universal Dipstick Kit, Twist Lock
- 93153** Oil Pan Gasket, One Piece Design, Steel Reinforced, BBC Mark 4, notched for stroker cranks

*Offset to middle of sump for more consistent oil pressure under braking

CHEVROLET BIG BLOCK

Aluminum, Wet Sump, 6 Quart Capacity w/ Standard Volume Pump, 7 Quart Capacity w/ High Volume Pump, 8" Deep
 Engine Application: Mark IV style (except Gen V and Gen VI)
 Fits: Competition Eliminator, Super Gas, Super Comp and Bracket cars. Installation may require modifications to cross-member; check dimensions carefully before ordering



No. 20385



- Fully fabricated aluminum, billet end seals to ensure consistent sealing surface to billet front covers and rear main caps
- Utilizes "race" pan rail bolt pattern
- Double kick-out design ensures large stroke clearance and wide main cap clearance
- Solid louvered tray w/ main cap partitions for maximum power and oil control
- For use with 168-tooth flywheel combination
- Sump design works with Moroso spur gear and gerotor billet oil pumps
- Billet end seals ensure consistent sealing surface to billet front covers and rear main caps
- Accepts 4.75" stroke with aluminum rods
- Features two 1/2" NPT Drainbacks

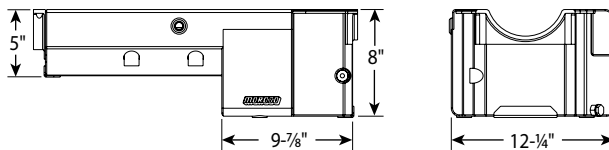

PART # DESCRIPTION

20385 Oil Pan, Aluminum, Internal Wet Sump

PART # RECOMMENDED PICKUPS

24440 Fits: Moroso BBC Race Pump Nos. 22149, 22150, 22159, 22160, 22162 or M77/M77HV style pump

24441* Fits: Moroso BBC Race Pump Nos. 22149, 22150, 22159, 22160, 22162 or M77/M77HV style pump

PART # OIL PUMP/PICKUP PACKAGE

22175 Moroso Standard Volume Package
22185 Moroso High Volume Package
22186* Moroso High Volume Package/Front Style Offset Pickup
22163 Moroso Billet Aluminum Oil Pump, BBC, High Volume
22164 Moroso Billet Aluminum Oil Pump, BBC, Standard Volume
22167 Moroso Billet Aluminum High Volume Oil Pump

PART # AVAILABLE OPTIONS

25970 Universal Dipstick Kit
25971 Universal Dipstick Kit, Braided Stainless Flex Tube
25973 Universal Dipstick Kit, Twist Lock
62255 Wrench, Oil Pan T-Handle, 1/2", 6 PT
38361 Oil Pan Fastener Kit, BBC Race Pans
93156 Oil Pan Gasket, 4 Piece Design, BBC IV, With Race Bolt Pattern

**Offset to middle of sump for more consistent oil pressure under braking*

CHEVROLET BIG BLOCK

Aluminum, Wet Sump, 6 Quart Capacity w/ Standard Volume Pump, 7 Quart Capacity w/ High Volume Pump, 8" Deep
 Engine Application: Mark IV style (except Gen V and Gen VI)
 Fits: Competition Eliminator, Super Gas, Super Comp and Bracket Cars.
 Installation may require modifications to cross-member;



No. 20485

- Fully fabricated aluminum, billet end seals to ensure consistent sealing surface to billet front covers and rear main caps
- Utilizes "race" pan rail bolt pattern
- Double kick-out design ensures up to 4.75" stroke with aluminum rods, wide main cap clearance and maximum horsepower
- Solid louvered windage tray w/main cap partitions for maximum power and oil control
- Sump design works with Moroso spur gear and gerotor billet oil pumps
- Features two O-ring magnetic drain plugs, two -8AN drain backs, alternator notch
- For use with 168-tooth flywheel combination
- Pump adjustment bung with plug

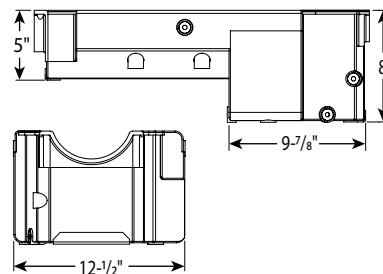

PART # DESCRIPTION

20485 Oil Pan, BBC Gen IV, Alum. w/Div. Tray

PART # OIL PUMP/PICKUP PACKAGE

22175 Moroso Standard Volume Package
22185 Moroso High Volume Package
22186* Moroso High Volume Package/Front Style Offset Pickup
22163 Moroso Billet Aluminum Oil Pump, BBC, High Volume
22164 Moroso Billet Aluminum Oil Pump, BBC, Standard Volume
22167 Moroso Billet Aluminum High Volume Oil Pump

PART # RECOMMENDED PICKUPS

24440 Fits: Moroso BBC Race Pump Nos. 22149, 22150, 22159, 22160, 22162 or M77/M77HV style pump
24441* Fits: Moroso BBC Race Pump Nos. 22149, 22150, 22159, 22160, 22162 or M77/M77HV style pump

PART # AVAILABLE OPTIONS

62255 Wrench, Oil Pan T-Handle, 1/2", 6 PT
38361 Oil Pan Fastener Kit, BBC Race Pans
93156 Oil Pan Gasket, 4 Piece Design, BBC IV, With Race Bolt Pattern

**Offset to middle of sump for more consistent oil pressure under braking*

BBC MARK IV, -16 AN EXTERNAL PICKUP

Aluminum, Wet Sump, 7 Quart Capacity, 8" Deep
 Engine Application: BBC Mark IV style (except Gen V and Gen VI)
 Fits: Competition Eliminator, Super Gas, Super Comp and Bracket Cars. Installation may require modifications to cross-member
 Check dimensions carefully before ordering

- Designed to be used with an External Oil Pump, oil pan has a sump mounted billet aluminum pickup that accepts a -16AN Male Fitting
- Fully fabricated aluminum with billet end seals to ensure consistent sealing surface to billet front covers and rear main caps
- Utilizes "race" pan rail bolt pattern, recommended oil pan gasket, Moroso No. 93156
- Double kick-out design ensures up to 4.75" stroke with aluminum rods, wide main cap clearance and maximum horsepower
- Full length solid louvered windage tray with main cap partitions for maximum power and oil control
- Features one O-ring magnetic drain plug, two -8AN drain backs, alternator notch
- For use with 168-tooth flywheel combination

PART # DESCRIPTION
20486 Oil Pan, BBC Mark IV, Aluminum Divided Tray, External -16 AN Pickup

PART # AVAILABLE OPTIONS
38361 Oil Pan Fastener Kit, BBC Race Pans
93156 Oil Pan Gasket, 4 Piece Design, BBC IV, With Race Bolt Pattern

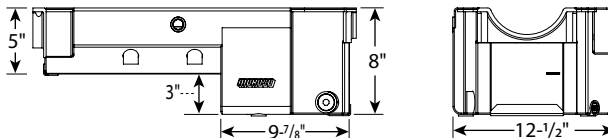

No. 20486



CHEVROLET BIG BLOCK

Steel, Wet Sump, 7 Quart Capacity, 7-3/4" Deep
 Engine Application: Mark IV style (except Gen V and Gen VI)
 Fits: Alcohol Funny Car, Dragster, Tractor Pull, Racing Boats and 4x4s

- Core based oil pan, utilizing stock pan rail bolt pattern
- Box design sump for high capacity applications
- Accepts up to a 4.5" stroke with steel rods and a 4.25" stroke with aluminum rods
- Solid louvered tray for increased oil control
- For use with 168 and 153-tooth flywheel combinations

PART # DESCRIPTION
20032 Oil Pan, Steel, Clear Zinc
PART # RECOMMENDED PICKUP
24446 Fits: Moroso BBC Race Pump Nos. 22149, 22150, 22159, 22160, 22162 or M77/M77HV style pump

PART # AVAILABLE OPTIONS
38361 Oil Pan Fastener Kit, BBC Race Pans
93153 Oil Pan Gasket, One Piece Design, Steel Reinforced, BBC Mark 4, notched for stroker cranks



No. 20032

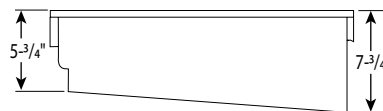

NOTE: Oil Pan Capacities DO NOT include oil filter capacity. All Moroso Pans include a Magnetic Drain Plug.

CHEVROLET BIG BLOCK

Aluminum, Wet Sump, 6 Quart Capacity w/ Standard Volume Pump, 7 Quart Capacity w/ High Volume Pump, 8" Deep
 Engine Application: Mark IV style (except Gen V and Gen VI)
 Fits: Competition Eliminator, Super Gas, Super Comp and Bracket cars with no cross-member under engine

- Fully fabricated, aluminum; utilizes "race" pan rail bolt pattern
- Double kick-out design ensures large stroke clearance, wide main cap clearance and maximum horsepower
- Internal uni-directional screen and pan rail bolt access bungs
- For use with 168-tooth flywheel combination
- 1" deep mini sump design works with Moroso spur gear and gerotor billet oil pumps
- Billet end seals ensure consistent sealing surface to billet front covers and rear main caps
- Accepts 4.75" stroke with aluminum rods

PART # DESCRIPTION

21600 Oil Pan, Aluminum, Internal Oil Pump

PART # RECOMMENDED PICKUPS

24440 Fits: Moroso BBC Race Pump Nos. 22149, 22150, 22159, 22160, 22162 or M77/M77HV style pump

24441* Fits: Moroso BBC Race Pump Nos. 22149, 22150, 22159, 22160, 22162 or M77/M77HV style pump

PART # OIL PUMP/PICKUP PACKAGE

22167 Moroso Billet Aluminum High Volume Oil Pump

22175 Moroso Standard Volume Package

22185 Moroso High Volume Package



No. 21600

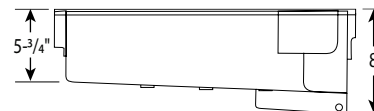

PART # OIL PUMP/PICKUP PACKAGE

22186* Moroso High Volume Package/Front Style Offset Pickup

22163 Moroso Billet Aluminum Oil Pump, BBC, High Volume

22164 Moroso Billet Aluminum Oil Pump, BBC, Standard Volume

PART # AVAILABLE OPTIONS

22704 Fitting, -12AN to -16AN Adapter

62255 Wrench, Oil Pan T-Handle, 1/2", 6 PT

38361 Oil Pan Fastener Kit, BBC Race Pans

93156 Oil Pan Gasket, 4 Piece Design, BBC IV, With Race Bolt Pattern

**Offset to middle of sump for more consistent oil pressure under braking*

CHEVROLET BIG BLOCK

Aluminum, Wet Sump, 6 Quart Capacity w/ Standard Volume Pump, 7 Quart Capacity w/ High Volume Pump, 8" Deep
 Engine Application: Mark IV style (except Gen V and Gen VI)
 Fits: Top Sportsman, Top Dragster, Pro Mods, needing wet sump and ability for frequent lower-end inspection

- Fully fabricated, aluminum; utilizes "race" pan rail bolt pattern
- Removable bottom with o-ringed billet flange
- Internal uni-directional screen
- Power kick-out design for maximum horsepower
- For use with 168-tooth flywheel combination
- Sump design works with Moroso spur gear and gerotor billet oil pumps
- Billet end seals ensure consistent sealing surface to billet front covers and rear main caps
- Accepts 4.75" stroke with aluminum rods

PART # DESCRIPTION

20376 Oil Pan, Two-piece, Gen IV Block, Mark IV Style

PART # RECOMMENDED PICKUPS

24440 Fits: Moroso BBC Race Pump Nos. 22149, 22159 or M77/M77HV style pump

24441* Fits: Moroso BBC Race Pump Nos. 22149, 22159 or M77/M77HV style pump

PART # OIL PUMP/PICKUP PACKAGE

22167 Moroso Billet Aluminum High Volume Oil Pump

22175 Moroso Standard Volume Package

22185 Moroso High Volume Package

22186* Moroso High Volume Package/Front Style Offset Pickup

22163 Moroso Billet Aluminum Oil Pump, BBC, High Volume

22164 Moroso Billet Aluminum Oil Pump, BBC, Standard Volume



No. 20376

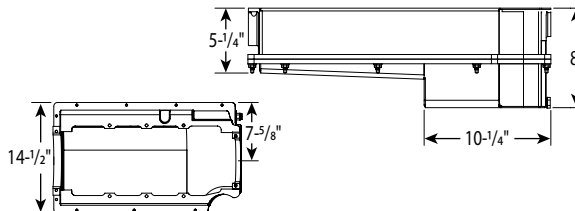

PART # REPLACEMENT PART

97319 Square O-Ring

97326 Round O-Ring

PART # AVAILABLE OPTIONS

38361 Oil Pan Fastener Kit, BBC Race Pans

93156 Oil Pan Gasket, 4 Piece Design, BBC IV, With Race Bolt Pattern

**Offset to middle of sump for more consistent oil pressure under braking*



OIL PANS

CHEVY BIG BLOCK

CHEVROLET BIG BLOCK

Aluminum, Dry Sump, 7-1/2" Deep

Engine Application: Mark IV style (except Gen V and Gen VI)

Fits: Competition Eliminator, Top Dragster, Top Sportsman, Super Comp, Super Gas & Bracket Cars

- 7-1/2" deep for diaper clearance
- Fully fabricated, aluminum
- (4) -12AN female billet aluminum pickups
- Power kick-out design for maximum horsepower
- For use with 153 and 168-tooth flywheel combination
- Billet end seals ensure consistent sealing surface to billet front covers and rear main caps
- Accepts 5.00" stroke with aluminum rods



No. 21581

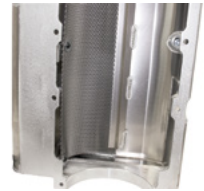
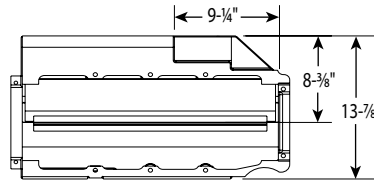

PART # DESCRIPTION
21581 Oil Pan, Aluminum, 4-Stage

PART # AVAILABLE OPTIONS
23961 -12AN Filter Pickup Fittings
23963 -16AN Filter Pickup Fittings
38361 Oil Pan Fastener Kit, BBC Race Pans
62255 Wrench, Oil Pan T-Handle, 1/2", 6 PT
93156 Oil Pan Gasket, 4 Piece Design, BBC IV, With Race Bolt Pattern

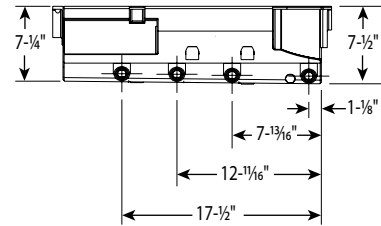
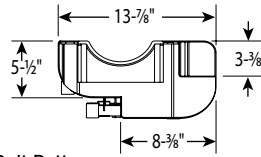

NOTE: Always check dimensions for chassis clearance



**DRY SUMP PUMP SECTION
ON PGS. 126-137**

ROAD RACE / DRAG RACE

CHEVROLET BIG BLOCK

Steel, Wet Sump, 6.5 Quart Capacity, 8" Deep

Engine Application: Mark IV style (except Gen V and Gen VI)

Fits: Most chassis except '62-'67 Chevy II, V-8 Vega/Monza & '55-'57 Chevy

- 3 trap door baffles, 2 runners for oil control in Road Racing, also an excellent Drag Race oil pan
- Accepts up to a 4.25" stroke with steel rods and a 4.090" stroke with aluminum rods
- Has a built in crank scraper, removable screen windage tray, anti-slosh and anti-climb baffles to free up horsepower
- Compatible with most starter/flywheel combinations



No. 20420



PART # DESCRIPTION
20420 Oil Pan, Steel, Clear Zinc, Rear Sump, Road Race Baffling, Windage Tray

PART # RECOMMENDED PICKUP
24440 Fits: Moroso BBC Race Pump Nos. 22149, 22150, 22159, 22160, 22162 or M77/M77HV style pump

PART # OIL PUMP/PICKUP PACKAGE
22175 Moroso Standard Volume Package or M77 style pump
22185 Moroso High Volume Package or M77HV style pump
22163 Moroso Billet Aluminum Oil Pump, BBC, High Volume
22164 Moroso Billet Aluminum Oil Pump, BBC, Standard Volume

PART # AVAILABLE OPTIONS
25970 Universal Dipstick Kit
25971 Universal Dipstick Kit, Braided Stainless Flex Tube
25973 Universal Dipstick Kit, Twist Lock
93153 Oil Pan Gasket, One Piece Design, Steel Reinforced, BBC Mark IV, notched for stroker cranks

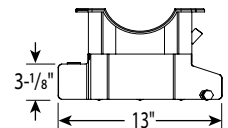
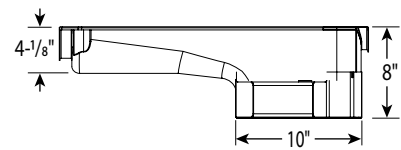

NOTE: Oil Pan Capacities DO NOT include oil filter capacity. All Moroso Pans include a Magnetic Drain Plug.

CHEVROLET BIG BLOCK

Steel, Wet Sump, 6.25 Quart Capacity, 8" Deep, 10" Long Sump
 Engine Application: Gen V/Gen VI
 Fits: Most GM Chassis, front steering; including '65-'72 Chevelle,
 Cutlass, Skylark, Tempest/GTO

- Kicked-out sump
- Accommodates stock GM main cap mounted windage tray
- Removable anti-slosh tray
- Trap door baffling for improved oil control
- Rear anti-climb baffle
- Accepts up to a 4.25" stroke with steel rods and a 4.090" stroke with aluminum rods
- Compatible with most starter/flywheel combinations

PART # DESCRIPTION

20411 Oil Pan, Steel, Fully Fabricated, Clear Zinc, Street Performance, Deep Sump

PART # RECOMMENDED PICKUPS

24440 Fits: Moroso BBC Race Pump Nos. 22149, 22150, 22159, 22160, 22162 or M77/M77HV style pump

24441* Fits: Moroso BBC Race Pump Nos. 22149, 22150, 22159, 22160, 22162 or M77/M77HV style pump

PART # OIL PUMP/PICKUP PACKAGE

22175 Moroso Standard Volume Package

22185 Moroso High Volume Package

22186* Moroso High Volume Package/Front Style Offset Pickup

22163 Moroso Billet Aluminum Oil Pump, BBC, High Volume

22164 Moroso Billet Aluminum Oil Pump, BBC, Standard Volume

PART # AVAILABLE OPTIONS

25970 Universal Dipstick Kit

25971 Universal Dipstick Kit, Braided Stainless Flex Tube

25973 Universal Dipstick Kit, Twist Lock

93154 Oil Pan Gasket, One Piece Design, Steel Reinforced, BBC Gen 5 & 6

*Offset to middle of sump for more consistent oil pressure under braking

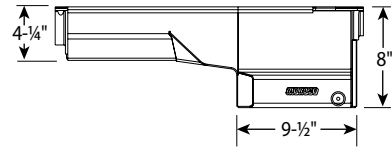
**No. 20411****CHEVROLET BIG BLOCK**

Steel, Wet Sump, 6 Quart Capacity, 8" Deep
 Engine Application: Gen V/Gen VI
 Fits: Most GM Chassis, most rear steering; including '64-'72
 Chevelle, Cutlass, Skylark, Tempest/GTO

- Kicked-out sump
- Accommodates the stock GM main cap mounted windage tray
- Accepts up to a 4.625" stroke with steel rods and a 4.25" stroke with aluminum rods
- Compatible with most starter/flywheel combinations

PART # DESCRIPTION

20413 Oil Pan, Steel, Clear Zinc, Street Performance, Deep Sump, Core Based

PART # RECOMMENDED PICKUPS

24440 Fits: Moroso BBC Race Pump Nos. 22149, 22150, 22159, 22160, 22162 or M77/M77HV style pump

24441* Fits: Moroso BBC Race Pump Nos. 22149, 22150, 22159, 22160, 22162 or M77/M77HV style pump

PART # OIL PUMP/PICKUP PACKAGE

22175 Moroso Standard Volume Package

22185 Moroso High Volume Package

22186* Moroso High Volume Package/Front Style Offset Pickup

22163 Moroso Billet Aluminum Oil Pump, BBC, High Volume

22164 Moroso Billet Aluminum Oil Pump, BBC, Standard Volume

PART # AVAILABLE OPTIONS

25830 Crank Scraper

25970 Universal Dipstick Kit

25971 Universal Dipstick Kit, Braided Stainless Flex Tube

25973 Universal Dipstick Kit, Twist Lock

93154 Oil Pan Gasket, One Piece Design, Steel Reinforced, BBC Gen 5 & 6

*Offset to middle of sump for more consistent oil pressure under braking

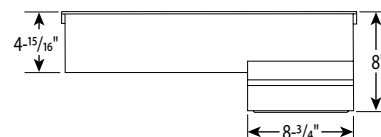
**No. 20413**

OIL PANS

BBC GEN V / GEN VI

CHEVROLET BIG BLOCK

Steel, Wet Sump, 6.5 Quart Capacity, 8" Deep, 10" Long Sump

Engine Application: Gen V and Gen VI

Fits: Most Chassis (except '62-'67 Chevy II, V-8 Vega/Monza, and '55-'57 Chevy)

- Designed with a sump that has flat sides to alleviate header clearance problems with some exhaust header brands
- Flat sides eliminate the need to change headers or perform fabrication work to the kicked-out sump of the oil pan
- Accepts up to a 4.25" stroke with steel rods and a 4.090" stroke with aluminum rods
- Features a crank scraper and uni-directional windage tray for horsepower
- Trap door baffling and an anti-climb baffle for oil control under hard acceleration and de-acceleration



No. 20409

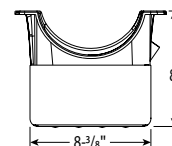
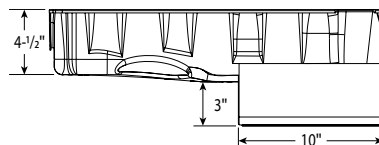

PART # DESCRIPTION

20409 Oil Pan, Steel, Clear Zinc

PART # RECOMMENDED PICKUPS

- 24440 Fits: Stock Oil Pumps, Moroso BBC Race Pump Nos. 22149, 22150, 22159, 22160, 22162 or M77/M77HV style pump
- 24441* Fits: Stock Oil Pumps, Moroso BBC Race Pump Nos. 22149, 22150, 22159, 22160, 22162 or M77/M77HV style pump

PART # OIL PUMP/PICKUP PACKAGE

- 22175 Moroso Standard Volume Package
- 22185 Moroso High Volume Package
- 22186* Moroso High Volume Package with Front Style Offset Pickup
- 22163 Moroso Billet Aluminum Oil Pump, BBC, High Volume
- 22164 Moroso Billet Aluminum Oil Pump, BBC, Standard Volume

PART # AVAILABLE OPTIONS

- 25970 Universal Dipstick Kit
- 25971 Universal Dipstick Kit, Braided Stainless Flex Tube
- 25973 Universal Dipstick Kit, Twist Lock
- 93154 Oil Pan Gasket, One Piece Design, Steel Reinforced, BBC Gen V and VI

*Offset to middle of sump for more consistent oil pressure under braking

CHEVROLET BIG BLOCK

Steel, Wet Sump, 7 Quart Capacity, 9" Deep

Engine Application: Gen V and Gen VI

Fits: '62-'67 Chevy II (without power steering) and '55-'57 Chevys; transmission must be in stock location

- Notched rear sump
- Accepts up to a 4.25" stroke with steel rods and a 4.090" stroke with aluminum rods
- Compatible with most starter/flywheel combinations



No. 20433

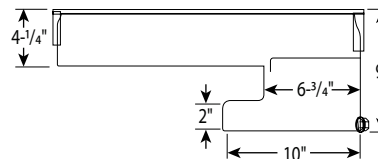

PART # DESCRIPTION

20433 Oil Pan, Steel, Fully Fabricated, Clear Zinc, Street Performance, Deep Sump

PART # RECOMMENDED PICKUP

24430 Fits: Moroso BBC Race Pump Nos. 22149, 22150, 22159, 22160, 22162 or M77/M77HV style pump

PART # AVAILABLE OPTIONS

- 23010 Oil Pan Baffle
- 25970 Universal Dipstick Kit
- 25971 Universal Dipstick Kit, Braided Stainless Flex Tube
- 25973 Universal Dipstick Kit, Twist Lock
- 93154 Oil Pan Gasket, One Piece Design, Steel Reinforced, BBC Gen 5 & 6



WET SUMP PUMP SECTION
ON PGS. 114-125

CHEVROLET BIG BLOCK OIL PAN, ROAD RACE BAFFLED

Steel, Wet Sump, 6.5 Quart Capacity, 8" Deep

Engine Application: Gen V/Gen VI

Fits: Most chassis except '62-'67 Chevy II, V-8 Vega/Monza and '55-'57 Chevy

- 3 trap door baffles, 2 runners for oil control in Road Racing, also an excellent Drag Race oil pan
- Accepts up to a 4.25" stroke with steel rods and a 4.090" stroke with aluminum rods
- Has a built in crank scraper, removable screen windage tray, anti-slosh and anti-climb baffles to free up horsepower
- Compatible with most starter/flywheel combinations

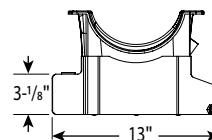
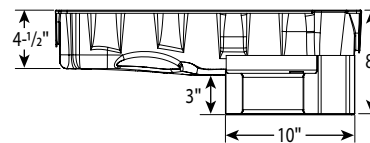
PART # DESCRIPTION**20421** Oil Pan, Steel, Clear Zinc, Rear Sump, Road Race Baffling, Windage Tray**PART # RECOMMENDED PICKUP****24440** Fits: Moroso BBC Race Pump Nos. 22149, 22150, 22159, 22160, 22162 or M77/M77HV style pump**PART # OIL PUMP/PICKUP PACKAGE****22175** Moroso Standard Volume Package or M77 style pump**22185** Moroso High Volume Package or M77HV style pump**22163** Moroso Billet Aluminum Oil Pump, BBC, High Volume**22164** Moroso Billet Aluminum Oil Pump, BBC, Standard Volume**PART # AVAILABLE OPTIONS****25970** Universal Dipstick Kit**25971** Universal Dipstick Kit, Braided Stainless Flex Tube**25973** Universal Dipstick Kit, Twist Lock**93154** Oil Pan Gasket, One Piece Design, Steel Reinforced, BBC Gen V & VI**No. 20421****DRAG RACE****DONOVAN, DRC2, MERLIN**

Aluminum, Wet Sump, 6 Quart Capacity w/ Standard Volume Pump,

7 Quart Capacity w/ High Volume Pump, 8" Deep

Fits: Competition Eliminator, Super Gas, Super Comp, and Bracket cars.

Installation may require modifications to cross-member; check dimensions carefully before ordering

- Fully fabricated, aluminum
- Internal uni-directional screen and pan rail bolt access bungs
- For use with 168-tooth flywheel combinations
- Sump design works with Moroso spur gear & gerotor billet oil pumps
- Billet end seals ensure consistent sealing surface to billet front covers and rear main caps
- Double kick-out design ensures large stroke and wide main cap clearance and max horsepower
- Accepts 5.00" stroke with aluminum rods

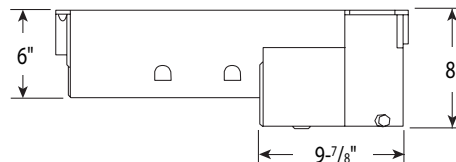
PART # DESCRIPTION**20372** Oil Pan, Aluminum, Internal Oil Pump. **Engine Application:** Donovan 700, DRC2 Pan Rail**PART # RECOMMENDED PICKUPS****24440** Fits: Moroso BBC Race Pump Nos. 22149, 22150, 22159, 22160, 22162 or M77/M77HV style pump**24441*** Fits: Moroso BBC Race Pump Nos. 22149, 22150, 22159, 22160, 22162 or M77/M77HV style pump**PART # OIL PUMP/PICKUP PACKAGE****22175** Moroso Standard Volume Package**22185** Moroso High Volume Package**22186*** Moroso High Volume Package/Front Style Offset Pickup**22163** Moroso Billet Aluminum Oil Pump, BBC, High Volume**22164** Moroso Billet Aluminum Oil Pump, BBC, Standard Volume**22167** Moroso Billet Aluminum High Volume Oil Pump**No. 20372****PART # AVAILABLE OPTIONS****25970** Universal Dipstick Kit**25971** Universal Dipstick Kit, Braided Stainless Flex Tube**25973** Universal Dipstick Kit, Twist Lock**62255** Wrench, Oil Pan T-Handle, 1/2", 6 PT**38361** Oil Pan Fastener Kit, BBC Race Pans

*Offset to middle of sump for more consistent oil pressure under braking

**OIL PANS****BBC GEN V / GEN VI / DONOVAN DRC2 MERLIN**

DONOVAN, DRC2, MERLIN

Aluminum, Dry Sump

Engine Application: Donovan 700, DRC2,
Donovan Style blocks with 10" and 10-3/8" wide
pan rails and 2-piece rear main seal

Fits: Competition Eliminator, Super Gas, Super Comp and Bracket
cars with no cross-member under engine

- Fully fabricated, aluminum; utilizes "race" pan rail bolt pattern
- (4) -12AN female pickups
- Power kick-out design for maximum horsepower
- Internal uni-directional screen
- For use with 168-tooth flywheel combination
- Billet end seals ensure consistent sealing surface to billet front covers and rear main caps
- Accepts 5.30" stroke with aluminum rods



PART #	DESCRIPTION
21592	Oil Pan, Aluminum, 5-Stage, Passenger-Side Starter

PART #	AVAILABLE OPTIONS
23961	-12AN Filter Pickup Fittings
23963	-16AN Filter Pickup Fittings
62255	Wrench, Oil Pan T-Handle, 1/2", 6 PT
38361	Oil Pan Fastener Kit, BBC Race Pans



No. 21592

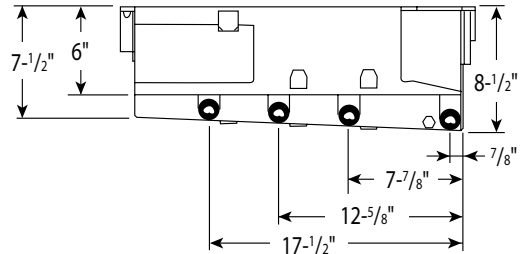

DONOVAN, DRC2, MERLIN

Aluminum, Dry Sump

Engine Application: Donovan 700, DRC2,
Donovan Style blocks with 10" and 10-3/8" wide
pan rails and 2-piece rear main seal

- Fully fabricated, aluminum
- Removable bottom with o-ring billet flange
- Available with either (3) or (4) -12AN female pickups
- Power kick-out design for maximum horsepower
- Internal uni-directional screen
- For use with 168-tooth flywheel combination
- Billet end seals ensure consistent sealing surface to billet front covers and rear main caps
- Accepts 5.30" stroke with aluminum rods



No. 21598



PART #	DESCRIPTION
21597	Oil Pan, Donovan, DRC2, Merlin Big Block, Two Piece, 3 Pickups, Drag Race, Dry Sump
21598	Oil Pan, Donovan, DRC2, Merlin Big Block, Two Piece, 4 Pickups, Drag Race, Dry Sump

PART #	AVAILABLE OPTIONS
23961	-12AN Filter Pickup Fittings
23963	-16AN Filter Pickup Fittings
38361	Oil Pan Fastener Kit, BBC Race Pans

PART #	REPLACEMENT PART
97319	Square O-Ring
97326	Round O-Ring

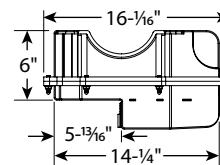

No. 21598

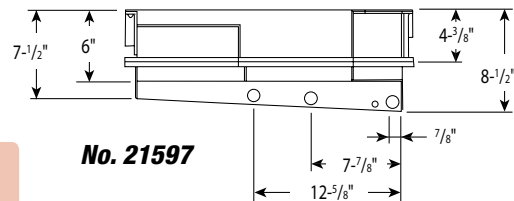
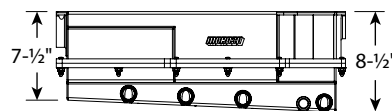

No. 21597

This pan design is also available for other engines and engine combinations.
Call Moroso Custom Sales at 203-453-6571 for information.



CHRYSLER SMALL BLOCK

Steel, Wet Sump, 8 Quart Capacity, 10" Deep
 Engine Application: 273-340, 360 Magnum
 Fits: Most production chassis

- Anti-slosh baffling
- Compatible with most starter/flywheel combinations

PART # DESCRIPTION
20710 Oil Pan, Steel, Clear Zinc, Street Performance, Deep Sump, Stock Core Based

PART # RECOMMENDED PICKUP
24700 Fits: Stock Oil Pumps or Chrysler 2468489 Pump



No. 20710

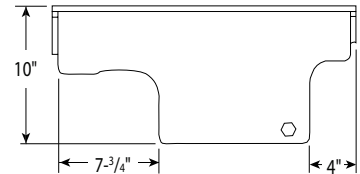

CHRYSLER SMALL BLOCK

Steel, Wet Sump, 8 Quart Capacity, 10" Deep
 Engine Application: 360, Non-360 Magnum
 Fits: Most production chassis

- Anti-slosh baffling
- Clears 4" stroke with steel rods
- Compatible with most starter/flywheel combinations

PART # DESCRIPTION
20730 Oil Pan, Steel, Clear Zinc, Street Performance, Deep Sump, Stock Core Based

PART # RECOMMENDED PICKUP
24700 Fits: Stock Oil Pumps or Chrysler 2468489 Pump



No. 20730

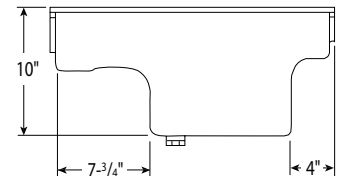

NOTE: Oil Pan Capacities DO NOT include oil filter capacity. All Moroso Pans include a Magnetic Drain Plug.

GEN III HEMI OIL PAN ACCESSORY

DUST SHIELD

- Fits Dodge auto and manual transmissions when using Moroso Oil Pan No. 21161
- Manufactured from stainless steel

PART # DESCRIPTION
71161 Dust Shield



No. 71161

⚠ **WARNING Prop. 65**
 This product contains a chemical known to the state of California to cause cancer, birth defects, or reproductive harm.

CHRYSLER GEN III HEMI

Aluminum, Wet Sump, 11 Quart Capacity

Engine Application: Chrysler 5.7/6.1/6.4

Fits: Chrysler 5.7/6.1/6.4 based engines In the Chrysler LX Series platform, with front sump K-members, including 300C, Challenger, Charger and Magnum

- Robust billet aluminum oil pan rail with a fabricated aluminum "T" sump
- Has road race trap door baffles, which provide oil control in both Drag and Road Racing and spirited driving
- Extra oil capacity over stock oil pans is essential due to this engine family holding extra oil in the heads
- Features anti-slosh baffle, oil temperature fitting and a super charger drain back fitting
- To be used with Moroso **No. 71161**, Stainless Steel Dust Shield



No. 21161

PART # DESCRIPTION
21161 Oil Pan, Aluminum, Front Sump

PART # RECOMMENDED PICKUPS
24161 Fits: 5.7/6.1 Stock Oil Pumps

24162 Oil Pump Pickup,
 Fits: Chrysler 6.2/6.4 Part Nos. 68195993AC,
 5038398AE, Oil Pumps

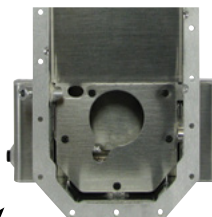
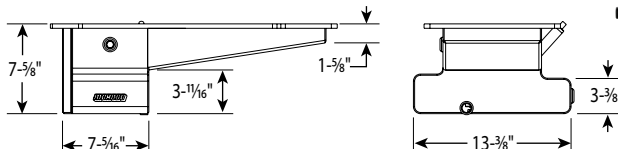

DRAG RACE

CHRYSLER GEN III HEMI

Aluminum, Wet Sump, 10 Quart Capacity

Engine Application: Chrysler 5.7/6.1/6.4

Fits: Chrysler LX Chassis with Drag Pack or modified cross member, also can be used in other rear sump applications, check measurements for fit

- Robust billet aluminum oil pan rail with a fabricated aluminum straight sided sump
- Front of the oil pan is 2" Deep sloping down to 4" Deep where it meets the 7-1/2" Deep, 8-3/8" Wide, and 9-1/2" Long sump
- Features factory "Drag Pack Race Proven" trap door baffle and anti-climb baffle
- To be used with Moroso **No. 71161**, Stainless Steel Dust Shield



No. 27601

PART # DESCRIPTION
27601 Oil Pan, Aluminum, Rear Sump

PART # RECOMMENDED PICKUPS
24601 Fits: 5.7/6.1 Stock Oil Pumps

24602 Fits: Block with Bed plate or Stock Oil Pump

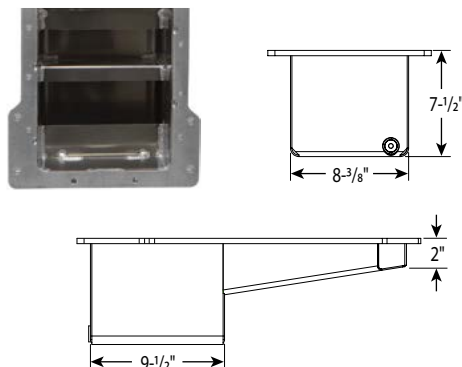

CHRYSLER HELLCAT, DRAG RACE, OIL PAN

Aluminum, Wet Sump, 7-1/2" Deep, 10 Quart Capacity

Engine Application: Chrysler 6.2 & Gen. 3 Hemi with the

Hellcat front timing cover

Fits: Chrysler Hellcat with Drag Pack or modified cross member, also can be used in other rear sump applications, check measurements for fit

- Robust billet aluminum oil pan rail with billet front seal area and a fabricated aluminum straight sided sump
- Features factory "Drag Pack Race Proven" internals
- To be used with Moroso Part **No. 71161**, Stainless Steel Dust Shield (see page 67)

NEW! **No. 21166**



BILLET FRONT SEAL

PART # DESCRIPTION
21166 Oil Pan, Aluminum,
 Chrysler Hellcat, Rear Sump

PART # RECOMMENDED PICKUP
24166 Pickup, Oil Pump, Hellcat Rear Sump

Fits: Chrysler Part Nos.
 68195993AC, 5038398AE Oil Pumps

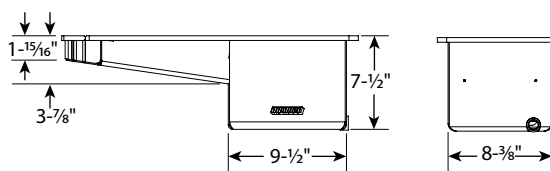

CHRYSLER 361-440, 426 HEMI

Steel, Wet Sump, 5 Quart Capacity, 5" Deep

Engine Application: 361-440 and 426 Street Hemi

Fits: Work well in chassis with extra-low front suspensions, Will not fit '62-'65 production chassis and is not recommended for racing applications due to it's shallow sump design

- Anti-slosh baffling
- Compatible with most starter/flywheel combinations

PART # DESCRIPTION

20766 Oil Pan, Chrysler 361-440, 426 Hemi

PART# RECOMMENDED PICKUP

24766 Fits: Stock R/RB Pumps

PART # AVAILABLE OPTION

93174 Oil Pan Gasket, One Piece Design, Steel Reinforced, Chrysler 361-440, Hemi, KB, BAE & Wedge

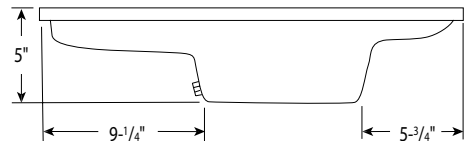
**No. 20766****CHRYSLER BIG BLOCK**

Steel, Wet Sump, 7 Quart Capacity, 7" Deep

Engine Application: 361-440 and 426 Street Hemi

Fits: Most '66-Up production chassis

- Anti-slosh baffling
- Compatible with most starter/flywheel combinations

PART # DESCRIPTION

20760 Oil Pan, Steel, Zinc, Street Performance, Deep Sump, Stock Core Based

PART # RECOMMENDED PICKUPS

24750 Fits: Stock B/RB Pumps (5/8" NPT-18 thread)

24800 Fits: Stock Hemi Pumps (1/2" NPT-14 thread)

PART # AVAILABLE OPTION

93174 Oil Pan Gasket, One Piece Design, Steel Reinforced, Chrysler 361-440, Hemi, KB, BAE & Wedge

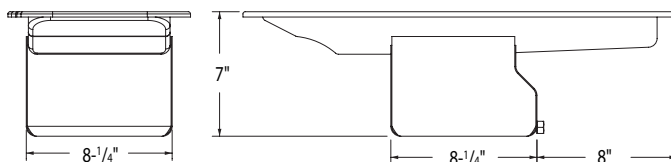
**No. 20760**

NOTE: Oil Pan Capacities DO NOT include oil filter capacity. All Moroso Pans include a Magnetic Drain Plug.

**OIL PANS****CHRYSLER**

CHRYSLER

Aluminum, Wet Sump

Engine Application: Chrysler and most aftermarket Hemi Blocks including Keith Black and JP-1 used in Top Fuel-Alcohol Dragsters

- One-piece billet rail with steel inserts prevents annoying leaks after repeated R&R
- -20AN pickup
- With steel inserts at the mounting points provide a rigid flange that won't bend, move or leak after repeated removals
- Internal baffling keeps oil contained in pickup area during hard acceleration and de-acceleration
- Baffling also increases pan's lower-end strength to prevent "ballooning" during engine failures
- Removable windage tray built into oil pan
- Built-in crank scraper removes excess oil to reduce windage and increase power



No. 20043



PART # DESCRIPTION

20043◊ Oil Pan, Aluminum, BAE, KB Pan Rail, Dragster, Single -20AN built-in pickup, Camlock Fasteners

PART # REPLACEMENT PART

23143◊ Louvered Windage Tray

PART # RECOMMENDED FITTING

22625 -20AN to -20AN Fitting

PART # AVAILABLE OPTION

93174 Oil Pan Gasket, One Piece Design, Steel Reinforced, Chrysler 361-440, Hemi, KB, BAE & Wedge

◊ **WARNING Prop. 65**
This product contains a chemical known to the state of California to cause cancer, birth defects, or reproductive harm-



CHRYSLER

Aluminum, Wet Sump

Engine Application: Chrysler and most aftermarket Hemi blocks including Keith Black, BAE and JP-1 used in Funny Cars

- Billet rail with steel inserts
- Removable windage tray built into oil pan baffling
- Commonly used for wet sump applications



No. 20045

PART # DESCRIPTION

20045◊ Oil Pan, Aluminum, BAE, KB Pan Rail, Pro-Modified/Funny Car, single -20AN built-in pickup, camlock fasteners

PART # REPLACEMENT PART

23145◊ Louvered Windage Tray

PART # RECOMMENDED FITTING

22625 -20AN to -20AN Fitting

PART # AVAILABLE OPTION

93174 Oil Pan Gasket, One Piece Design, Steel Reinforced, Chrysler 361-440, Hemi, KB, BAE & Wedge

◊ **WARNING Prop. 65**
This product contains a chemical known to the state of California to cause cancer, birth defects, or reproductive harm-

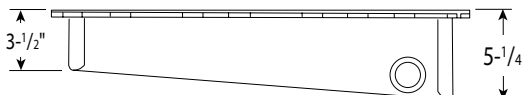

CHRYSLER

Aluminum, Dry Sump

Engine Application: Chrysler and most aftermarket Hemi blocks including Keith Black, BAE and JP-1 style engines, Funny Cars

- One-piece billet rail, skirted, steel inserts
- Removable windage tray built into oil pan baffling



No. 20044

PART # DESCRIPTION

20044◊ Oil Pan, Aluminum, BAE, KB Pan Rail, Single -16AN built-in pickup, Camlock Fasteners

PART # REPLACEMENT PART

23144◊ Windage Tray

PART # RECOMMENDED FITTING

22622 -16AN to -16AN Fitting

PART # AVAILABLE OPTION

93174 Oil Pan Gasket, One Piece Design, Steel Reinforced, Chrysler 361-440, Hemi, KB, BAE & Wedge

◊ **WARNING Prop. 65**
This product contains a chemical known to the state of California to cause cancer, birth defects, or reproductive harm-

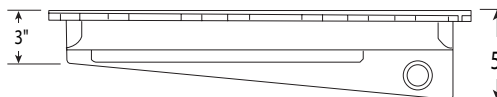

CHRYSLER, KEITH BLACK, BAE AND JP-1

Aluminum, Dry Sump

Engine Application: Chrysler and most aftermarket Hemi blocks including Keith Black, BAE and JP-1 style engines, Funny Cars

- One-piece billet rail, skirted, steel inserts
- Removable windage tray built into oil pan baffling
- Crankscraper

PART # DESCRIPTION

20049 Oil Pan, Aluminum, BAE, KB Pan Rail, Single -16AN built-in pickup, Camlock Fasteners

PART # REPLACEMENT PART

23144 Windage Tray

PART # RECOMMENDED FITTING

22622 -16AN to -16AN Fitting

PART # AVAILABLE OPTION

93174 Oil Pan Gasket, One Piece Design, Steel Reinforced, Chrysler 361-440, Hemi, KB, BAE & Wedge

 **WARNING Prop. 65**
This product contains a chemical known to the state of California to cause cancer, birth defects, or reproductive harm-

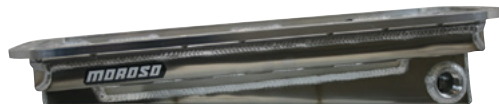

No. 20049

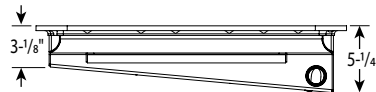
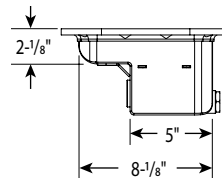

AJPE TFX 96, TFX2000 & TFX 2002 DRAGSTER OIL PAN

Aluminum, Wet Sump

Engine Application: AJPE TFX 96, TFX2000 & TFX 2002 (does not fit TFX 92 blocks)

- Features "L" shaped billet aluminum, o-ringed oil pan rail for strength on the track and in the pits during repeated installation and removal
- -20AN pickup, recessed pickup area
- Internal baffling keeps oil contained in pickup area during hard acceleration and de-acceleration
- Baffling also increases pan's lower-end strength to prevent "ballooning" during engine failures
- Removable windage tray built into oil pan

PART # DESCRIPTION

20055 Oil Pan, AJPE TFX 96, TFX2000 & TFX 2002, Dragster

PART # RECOMMENDED FITTING

22625 -20AN to -20AN Fitting

 **WARNING Prop. 65**
This product contains a chemical known to the state of California to cause cancer, birth defects, or reproductive harm-



No. 20055

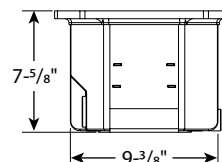
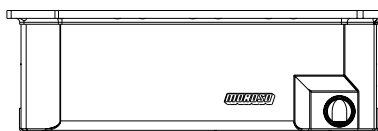

OIL PANS

CHRYSLER / AFTERMARKET



AJPE TFX 96, TFX2000 & TFX 2002 FUNNY CAR OIL PAN

Aluminum, Dry Sump

Engine Application: AJPE TFX 96, TFX2000 & TFX 2002 (does not fit TFX 92 blocks)

- Features "L" shaped billet aluminum, o-ringed oil pan rail for strength on the track and in the pits during repeated installation and removal
- -16AN pickup
- Internal baffling keeps oil contained in pickup area during hard acceleration and de-acceleration
- Baffling also increases pan's lower-end strength to prevent "ballooning" during engine failures
- Removable windage tray built into oil pan



No. 20054



PART #	DESCRIPTION
20054	Oil Pan, AJPE TFX 96, TFX2000 & TFX 2002, Funny Car
PART #	RECOMMENDED FITTING
22622	-16AN to -16AN Fitting

WARNING Prop. 65
This product contains a chemical known to the state of California to cause cancer, birth defects, or reproductive harm-

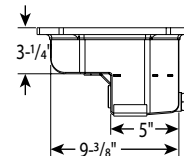
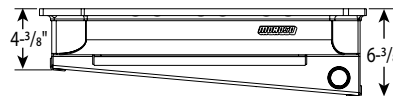

OFF ROAD

JEEP

Steel, 4.0 Multi-Baffled

- Designed for 1991-2006 Jeep Wranglers, 1987-2001 Jeep Cherokees and 1987-1992 Comanches with 4.0 liter engines, including stock exhaust manifolds with the integral catalytic converters
- Features a race proven 3 trap door assembly and removable anti-slosh baffle that keeps oil contained in oil pump pickup area during harshest off road conditions
- The rear sump of the oil pan extends out on both sides to hold 7.25 quarts to reduce oil temperature
- Oil Pan is designed to work with your existing oil pump and pickup tube
- Depth of the oil pan remains at the stock depth is maintained to allow fitment for aftermarket skid plates and to maximize ground clearance
- Constructed from heavy duty 16 gauge steel with a clear zinc finish to resist corrosion



No. 27862

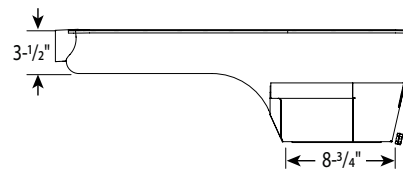
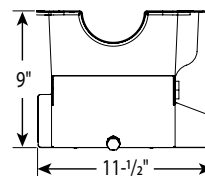

PART #	DESCRIPTION
27862	Oil Pan, Steel, Clear Zinc, Jeep 4.0 Multi-Baffled
PART #	AVAILABLE OPTION
93175	Oil Pan Gasket

NOTE: Oil Pan Capacities DO NOT include oil filter capacity. All Moroso Pans include a Magnetic Drain Plug.

FORD SMALL BLOCK

Steel, Wet Sump, Front Sump, 7 Quart Capacity, 8" Deep
 Engine Applications: Ford 289-302

Fits: Ford and Mercury cars and trucks originally equipped
 with front sump pans (except Mustang II)

- Kicked-out sump
- Oil retention baffle
- Will clear 302 4-bolt center mains only
- Will not clear 302 4-bolt front and rear main caps without modification to pan or main caps
- Compatible with most starter/flywheel combinations

PART # DESCRIPTION

20502 Oil Pan, Steel, Clear Zinc, Front Sump
Engine Application: 289-302 Engines

PART # RECOMMENDED PICKUP

24520 *Fits: Stock or M68, M68HV or M10688 style pumps*

PART # AVAILABLE OPTIONS

22928 Main Cap Girdle for 289-302
22930 Louvered Windage Tray, 289-302
25970 Universal Dipstick Kit
25971 Universal Dipstick Kit, Braided Stainless
25973 Universal Dipstick Kit, Twist Lock
38191 Windage Tray, Mounting Studs, 289-302
38390 Oil Pan Mounting Stud Kit, Bullet Nose
93161 Oil Pan Gasket, Ford 302, Early, Dimpled Rail

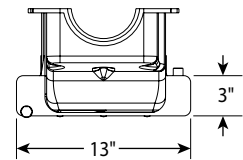
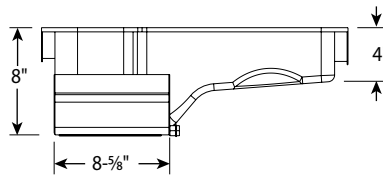
**No. 20502**

DRAG / ROAD RACE

FORD SMALL BLOCK

Steel, Street/Strip & Road Race, Front Sump, 9 Quart Capacity, 8" Deep
 Engine Applications: Ford 289-302

Fits: Ford, Mercury and Cobra Kit Car Front Sump applications
 (except Mustang II)

- Kicked-out sump increases capacity to 9 quarts, which reduces oil temperature and ensures adequate supply to pickup area
- Baffling designed for street/strip & road racing
- Will clear 302 with 4-bolt center mains only; will NOT clear 302 with 4-bolt front and rear main caps
- Compatible with most starter/flywheel combinations

PART # DESCRIPTION

20503 Oil Pan, Steel, Clear Zinc, Kicked-Out Front Sump
Engine Application: 289-302 Engines

PART # RECOMMENDED PICKUP

24523 *Fits: Stock or M68 or M68HV style pumps*

PART # AVAILABLE OPTIONS

22928 Main Cap Girdle for 289-302
22930 Louvered Windage Tray, 289-302
25970 Universal Dipstick Kit
25971 Universal Dipstick Kit, Braided Stainless
25973 Universal Dipstick Kit, Twist Lock
38191 Windage Tray, Mounting Studs, 289-302
38390 Oil Pan Mounting Stud Kit, Bullet Nose
93161 Oil Pan Gasket, Ford 302, Early, Dimpled Rail

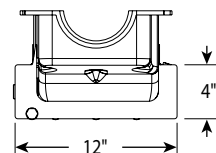
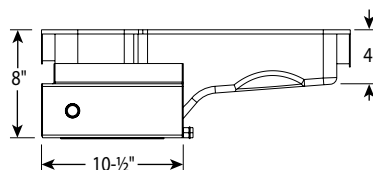
**No. 20503**

NOTE: Oil Pan Capacities DO NOT include oil filter capacity. All Moroso Pans include a Magnetic Drain Plug.

FORD SMALL BLOCK

Steel, Wet Sump, Front Sump, 7 Quart Capacity, 8" Deep
 Engine Application: 289-302

Fits: Ford including Australian, Mercury and Cobra Kit Car front sump applications (except Mustang II) Usage: Road and Drag Race, including street

- Billet end seals for greater sealing
- Clears all 4-bolt main caps including 4-bolt rear
- Accepts 3.40 stroke with most steel rods
- Four Trap Doors keep oil contained in oil pump pick up area
- Anti-slosh baffle keeps oil from leaving the sump
- Features oil temperature fitting and drain plug
- Compatible with most starter/flywheel combinations
- For use with 1-piece, rear sump oil pan gasket
- Includes O-ring drain plugs

PART # DESCRIPTION
 20535 Ford 302 Front Sump Oil Pan, Road Race, clears 4-Bolt Blocks

PART# RECOMMENDED PICKUP
 24523 Fits: Stock or M68, M68HV or M10688 style pumps

PART# AVAILABLE OPTIONS
 22928 Main Cap Girdle for 289-302
 22930 Louvered Windage Tray, 289-302
 25970 Universal Dipstick Kit
 25971 Universal Dipstick Kit, Braided Stainless
 25973 Universal Dipstick Kit, Twist Lock
 38191 Windage Tray, Mounting Studs, 289-302
 38390 Oil Pan Mounting Stud Kit, Bullet Nose
 93160 Oil Pan Gasket, Ford 302, Late, Smooth Rail

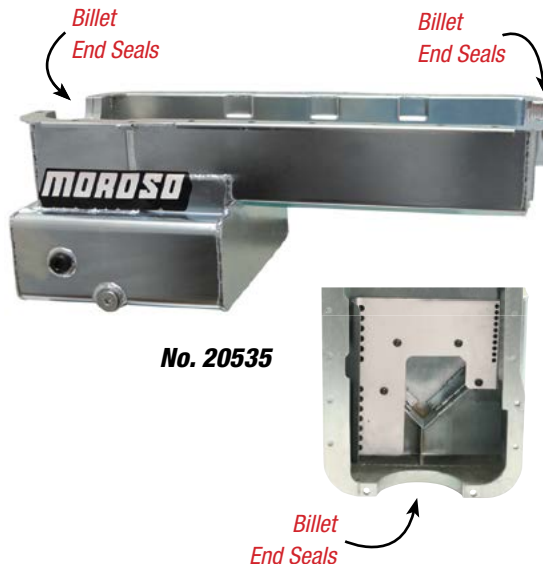

No. 20535

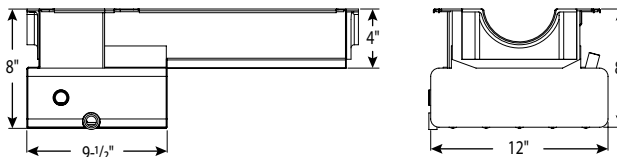

STREET / STRIP

FORD SMALL BLOCK

Steel, Wet Sump, Rear Sump, 7 Quart Capacity, 7-1/2" Deep
 Engine Application: 289-302

Fits: '79-Up Mustang, '81-'88 Thunderbird, Cougar, '79-'86 Capri and other Ford Rear Sump applications

- Will clear 4-bolt center mains only
- Will not clear 4-bolt front and rear main caps
- Oil retaining baffle
- Engineered to supply oil to sump at all times
- Compatible with most starter/flywheel combinations

PART # DESCRIPTION
 20506 Oil Pan, Steel, Clear Zinc, Kicked-out Sump

PART # RECOMMENDED PICKUPS
 24517 Fits: Stock or M68, M68HV or M10688 style pumps
 24518* Fits: Stock or M68, M68HV or M10688 style pumps with Main Support

*Must use Moroso Main Cap Girdle Part No. 22928

PART # AVAILABLE OPTIONS
 22928 Main Cap Girdle for 289-302
 22930 Louvered Windage Tray, 289-302
 25970 Universal Dipstick Kit
 25971 Universal Dipstick Kit, Braided Stainless
 25973 Universal Dipstick Kit, Twist Lock
 38191 Windage Tray, Mounting Studs, 289-302
 38390 Oil Pan Mounting Stud Kit, Bullet Nose
 93160 Oil Pan Gasket, Ford 302, Late, Smooth Rail



No. 20506

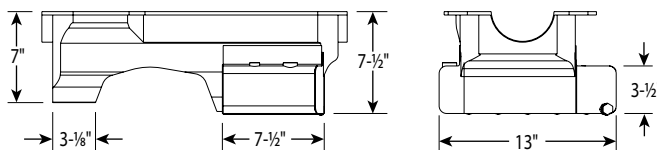
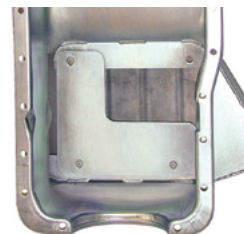

NOTE: Oil Pan Capacities DO NOT include oil filter capacity. All Moroso Pans include a Magnetic Drain Plug.

FORD SMALL BLOCK

Steel, Wet Sump, Rear Sump, 7 Quart Capacity, 9" Deep
 Engine Application: 289-302

Fits: '79-Up Mustang, '81-'88 Thunderbird, Cougar, '79-'86 Capri and other Ford Rear Sump applications

- Will clear 4-bolt center mains only
- Clears 3.40" stroke with most steel rods
- Will not clear 4-bolt front and rear main caps without modification to pan or main caps
- Oil sump retaining system
- Engineered to supply oil to sump at all times
- Compatible with most starter/flywheel combinations

PART # DESCRIPTION

20521 Oil Pan, Steel, Clear Zinc, Deep Sump Rear

PART # RECOMMENDED PICKUP

24516* Fits: Stock or M68, M68HV or M10688 Style Oil Pumps

*Fits with or without main support girdle

PART # AVAILABLE OPTIONS

22928 Main Cap Girdle for 289-302
22930 Louvered Windage Tray, 289-302
25970 Universal Dipstick Kit
25971 Universal Dipstick Kit, Braided Stainless
25973 Universal Dipstick Kit, Twist Lock
38191 Windage Tray, Mounting Studs, 289-302
38390 Oil Pan Mounting Stud Kit, Bullet Nose
93160 Oil Pan Gasket, Ford 302, Late, Smooth Rail

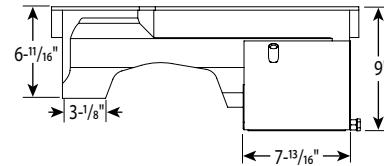
**No. 20521****FORD SMALL BLOCK**

Steel, Wet Sump, Rear Sump, 7 Quart Capacity, 9" Deep
 Engine Application: 289-302

Fits: '79-Up Mustang, '81-'88 Thunderbird & Cougar, '79-'86 Capri and other Ford rear sump applications

Now with billet end seals for greater sealing!

- 9" deep rear sump
- Clears all 4-bolt main caps including 4-bolt rear
- Accepts 3.40" stroke with most steel rods
- Oil sump retaining system
- Compatible with most starter/flywheel combinations
- Includes O-ring drain plugs

PART # DESCRIPTION

20511 Oil Pan, Steel, Fully Fabricated, Clear Zinc, Rear Sump

PART # RECOMMENDED PICKUP

24516* Fits: Stock or M68, M68HV or M10688 Style Oil Pumps

*Fits with or without main support girdle

PART # AVAILABLE OPTIONS

22928 Main Cap Girdle for 289-302
22930 Louvered Windage Tray, 289-302
25970 Universal Dipstick Kit
25971 Universal Dipstick Kit, Braided Stainless
25973 Universal Dipstick Kit, Twist Lock
38191 Windage Tray, Mounting Studs, 289-302
38390 Oil Pan Mounting Stud Kit, Bullet Nose
93160 Oil Pan Gasket, Ford 302, Late, Smooth Rail

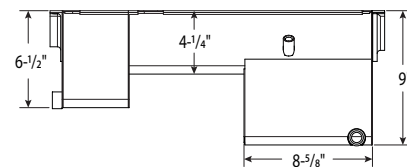
**No. 20511****Billet End Seals**

NOTE: Oil Pan Capacities DO NOT include oil filter capacity. All Moroso Pans include a Magnetic Drain Plug.

**OIL PANS****FORD 302 REAR SUMP**

FORD SMALL BLOCK

Steel, Wet Sump, Rear Sump, Kick-Out, 7 Quart Cap., 9" Deep
 Engine Applications: Ford 289-302
 Fits: '79-Up Mustang, '81-'88 Thunderbird & Cougar,
 '79-'86 Capri and other Ford rear sump applications

- Billet end seals for greater sealing than a core based oil pan
- Kick-out for maximum horsepower gains
- 9" deep rear straight sided sump to clear headers
- Clears all 4-bolt main caps including 4-bolt rear
- Accepts 3.40" stroke with most steel rods
- Oil sump retaining system
- Compatible with most starter/flywheel combinations
- For use with oil pan gasket Moroso No. 93160

PART # DESCRIPTION

20528 Oil Pan, Steel, Clear Zinc

PART # RECOMMENDED PICKUP

24516* Fits: Stock or M68, M68HV or M10688 Style Oil Pumps

**Fits with or without main support girdle*

PART# AVAILABLE OPTIONS

- 22928** Main Cap Girdle for 289-302
- 22930** Louvered Windage Tray, 289-302
- 25970** Universal Dipstick Kit
- 25971** Universal Dipstick Kit, Braided Stainless
- 25973** Universal Dipstick Kit, Twist Lock
- 38191** Windage Tray, Mounting Studs, 289-302
- 38390** Oil Pan Mounting Stud Kit, Bullet Nose
- 93160** Oil Pan Gasket, Ford 302, Late, Smooth Rail

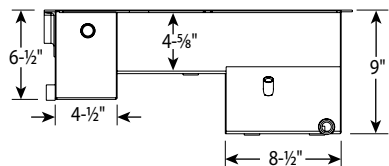
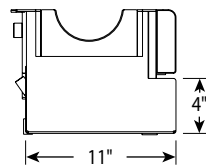

DRAG / ROAD RACE

FORD SMALL BLOCK

Steel, Wet Sump, Rear Sump, 7 Quart Capacity, 7-1/2" Deep
 Engine Application: 289-302
 Fits: '79-Up Mustang, '81-'88 Thunderbird, Cougar, '79-'86 Capri
 and other Ford Rear Sump applications

- Features 4 trap doors, 2 baffles and removable sump tray that keeps the oil contained in the pickup area during hard acceleration, cornering and braking
- Fits 2005-Up SCCA and NASA race cars with 302 engines
- Designed for Road Racing, makes an excellent Drag Race or Kit Car oil pan
- Will clear center 4-bolt main caps
- Includes 1/2" NPT oil temperature bung
- Compatible with most starter/flywheel combinations

PART # DESCRIPTION

20527 Oil Pan, Steel, Clear Zinc, Kicked-out Sump, Road Race Baffled

PART # RECOMMENDED PICKUPS

24527 Fits: Stock or M68, M68HV or M10688 Style Oil Pumps

24528* Fits: Stock or M68 or M68HV Style Oil Pumps w/ Main Support

**Must use Moroso Main Cap Girdle Part No. 22928*

PART # AVAILABLE OPTIONS

- 22928** Main Cap Girdle for 289-302
- 22930** Louvered Windage Tray, 289-302
- 25970** Universal Dipstick Kit
- 25971** Universal Dipstick Kit, Braided Stainless
- 25973** Universal Dipstick Kit, Twist Lock
- 38191** Windage Tray, Mounting Studs, 289-302
- 38390** Oil Pan Mounting Stud Kit, Bullet Nose
- 93160** Oil Pan Gasket, Ford 302, Late, Smooth Rail

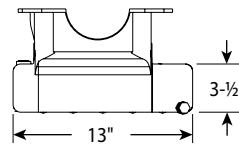
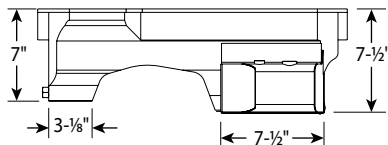

FORD SMALL BLOCK

Steel, Wet Sump, Rear Sump, 7 Quart Capacity, 7-1/2" Deep
 Engine Applications: Ford 289-302

Fits: '79-up Mustang, '81-'88 Thunderbird & Cougar, '79-'86 Capri and other Ford rear sump applications

- Oil pans have thick precision laser cut steel rails with a clear zinc finish
- Billet end seals for greater sealing than a core based oil pan
- Clears all 4-bolt main caps including 4-bolt rear
- Accepts 3.40" stroke with most steel rods
- Feature a race proven diamond shape four trap door assembly and anti-slosh baffle that keeps oil contained in the oil pump pickup area during hard acceleration, cornering and braking
- Designed for Road Racing, makes an excellent Drag Race or Kit Car oil pan
- Fits 2005-up Mustang SCCA and NASA racecars with 302 engines
- Includes 1/2" N.P.T. oil temperature bung and magnetic drain plugs
- Compatible with most starter/flywheel combinations
- For use with 1 piece, rear sump oil pan gasket such as Part No. 93160 for 302 applications

PART # DESCRIPTION
 20533 Oil Pan , Ford 302, Clear Zinc

PART # RECOMMENDED PICKUPS
 24527 For 302, **Fits:** Stock or M68, M68HV or M10688 Style Oil Pumps
 24528* For 302, **Fits:** Stock or M68, M68HV or M10688 Style Oil Pumps w/ Main Support

*Must use Moroso Main Cap Girdle Part No. 22928



No. 20533

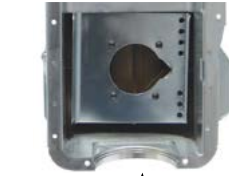

Billet End Seals

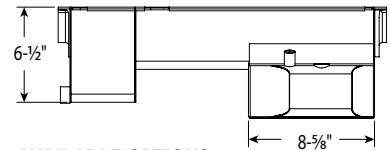
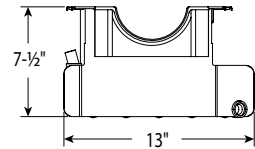

- PART # AVAILABLE OPTIONS**
- 22928 Main Cap Girdle for 289-302
 - 22930 Louvered Windage Tray, 289-302
 - 25970 Universal Dipstick Kit
 - 25971 Universal Dipstick Kit, Braided Stainless
 - 25973 Universal Dipstick Kit, Twist Lock
 - 38191 Windage Tray, Mounting Studs, 289-302
 - 38390 Oil Pan Mounting Stud Kit, Bullet Nose
 - 93160 Oil Pan Gasket, Ford 302, Late, Smooth Rail

STREET / STRIP

FORD SMALL BLOCK

Steel, Wet Sump, Front Sump, 7 Quart Capacity, 8" Deep
 Engine Application: 351W

Fits: Ford and Mercury cars and trucks originally equipped with front sump pans (except Mustang II)

- Kicked-out sump
- Oil retention baffle
- Will clear 351W 4-bolt center mains only
- Will not clear 351W 4-bolt front and rear main caps without modification to pan or main caps
- Compatible with most starter/flywheel combinations

PART # DESCRIPTION
 20507 Oil Pan, Steel, Clear Zinc, Front Sump
Engine Application: 351W Engines

PART # RECOMMENDED PICKUP
 24507 **Fits:** Stock or M83, M83HV or M10833 style pumps

PART # AVAILABLE OPTIONS

- 25970 Universal Dipstick Kit
- 25971 Universal Dipstick Kit, Braided Stainless
- 25973 Universal Dipstick Kit, Twist Lock
- 38192 Windage Tray, Mounting Studs, 351W
- 38194 Oil Pump Pickup Stud, 351W
- 38390 Oil Pan Mounting Stud Kit, Bullet Nose
- 93163 Oil Pan Gasket, Ford 351 W, Early, Dimpled Rail



No. 20507

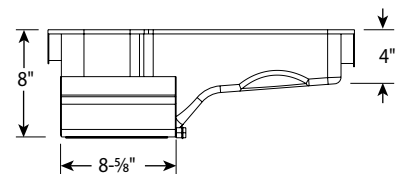
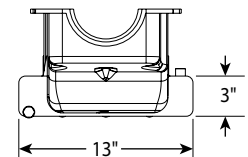

NOTE: Oil Pan Capacities DO NOT include oil filter capacity. All Moroso Pans include a Magnetic Drain Plug.



OIL PANS

FORD 302 REAR SUMP & 351W FRONT SUMP

FORD SMALL BLOCK

Steel, Street/Strip & Road Race, Front Sump, 9 Quart Capacity, 8" Deep
 Engine Application: 351W
 Fits: Ford, Mercury and Cobra Kit Car Front Sump applications
 (except Mustang II)

- Kicked-out sump increases capacity to 9 quarts, which reduces oil temperature and insures adequate supply to pickup area
- Baffling designed for street/strip & road racing
- Will clear 351W with 4-bolt center mains only; will NOT clear 351W with 4-bolt front and rear main caps
- Works with most starter/flywheel combinations
- Clear zinc plating for durability and corrosion resistance

PART # DESCRIPTION
20501 Oil Pan, Steel, Clear Zinc, Kicked-Out Front Sump
Engine Application: 351W engines

PART # RECOMMENDED PICKUP
24507 *Fits: Stock or M83, M83HV or M10833 style pumps*

PART # AVAILABLE OPTIONS
25970 Universal Dipstick Kit
25971 Universal Dipstick Kit, Braided Stainless
25973 Universal Dipstick Kit, Twist Lock
38192 Windage Tray, Mounting Studs, 351W
38194 Oil Pump Pickup Stud, 351W
38390 Oil Pan Mounting Stud Kit, Bullet Nose
93163 Oil Pan Gasket, Ford 351W, Early, Dimpled Rail



No. 20501

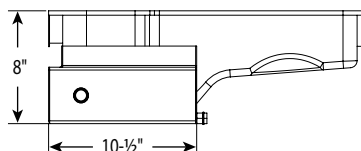
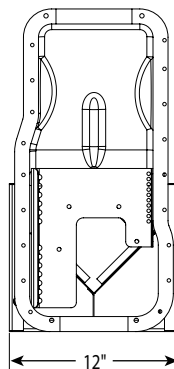

FORD SMALL BLOCK

Steel, Wet Sump, Front Sump, 7 Quart Capacity, 8" Deep
 Engine Application: 351W
 Fits: Ford including Australian, Mercury and Cobra Kit Car front sump applications (except Mustang II)
 Useage: Road and Drag Race, including street

- Fully Fabricated steel with a clear zinc finish
- Billet end seals for greater sealing
- Clears all 4-bolt main caps including 4-bolt rear
- Accepts 4.0 stroke with most steel rods
- Four Trap Doors keep oil contained in oil pump pick up area
- Anti-slosh baffle keeps oil from leaving the sump
- Features oil temperature fitting and drain plug
- Compatible with most starter/flywheel combinations
- For use with 1-piece, rear sump oil pan gasket
- Includes O-ring drain plugs

PART # DESCRIPTION
20536 Ford 351W Front Sump Oil Pan, Road Race, clears 4-Bolt Blocks

PART# RECOMMENDED PICKUP
24507 *Fits: Stock or M83, M83HV or M10833 style pumps*

PART# AVAILABLE OPTIONS
22935 Louvered Windage Tray, 351W
25970 Universal Dipstick Kit
25971 Universal Dipstick Kit, Braided Stainless
25973 Universal Dipstick Kit, Twist Lock
38192 Windage Tray, Mounting Studs, 351W
38194 Oil Pump Pickup Stud, 351W
38390 Oil Pan Mounting Stud Kit, Bullet Nose
93162 Oil Pan Gasket, Ford 351W, Late, Smooth Rail



No. 20536

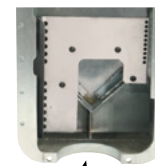

Billet End Seals

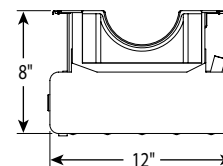
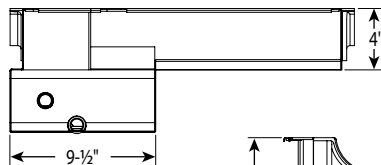

NOTE: Oil Pan Capacities DO NOT include oil filter capacity. All Moroso Pans include a Magnetic Drain Plug.

FORD SMALL BLOCK

Steel, Wet Sump, Rear Sump, 7 Quart Capacity, 9" Deep

Engine Application: 351W

Fits: '79-Up Mustang, '81-'88 Thunderbird, Cougar, '79-'86 Capri and other Ford Rear Sump applications

- Rear sump design
- Will clear 351W 4-bolt center mains only
- Will not clear 351W 4-bolt front and rear main caps
- Oil sump retaining system and anti-slosh baffle
- Reduced oil temperature

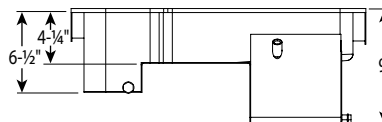
PART # DESCRIPTION**20523** Oil Pan, Steel, Clear Zinc, Deep Rear Sump**PART # RECOMMENDED PICKUP****24532** Fits: Stock or M83, M83HV or M10833 Style Oil Pump**PART # AVAILABLE OPTIONS****22935** Louvered Windage Tray, 351W**25970** Universal Dipstick Kit**25971** Universal Dipstick Kit, Braided Stainless**25973** Universal Dipstick Kit, Twist Lock**38192** Windage Tray, Mounting Studs, 351W**38194** Oil Pump Pickup Stud, 351W**38390** Oil Pan Mounting Stud Kit, Bullet Nose**93163** Oil Pan Gasket, Ford 351W, Early, Dimpled Rail**No. 20523****FORD SMALL BLOCK**

Steel, Wet Sump, Rear Sump, 7 Quart Capacity, 9" Deep

Engine Application: 351W

Fits: '79-Up Mustang, '81-'88 Thunderbird & Cougar, '79-'86 Capri and other Ford rear sump applications

Now with billet end seals for greater sealing!

- Steel with a clear zinc finish
- 9" deep rear sump
- Clears all 4-bolt main caps including 4-bolt rear
- Accepts 4.0" stroke with most steel rods
- Oil sump retaining system
- Compatible with most starter/flywheel combinations
- Includes O-ring drain plugs

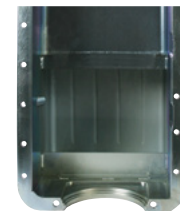
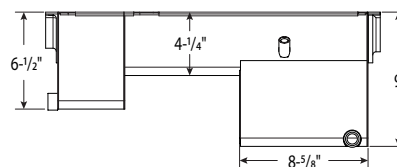
PART # DESCRIPTION**20520** Oil Pan, Steel, Fully Fabricated, Clear Zinc, Deep Sump**PART # RECOMMENDED PICKUP****24532*** Fits: Stock or M83, M83HV or M10833 Style Oil Pump**Does not fit World Products Man O' War Engine Block***PART # AVAILABLE OPTIONS****22935** Louvered Windage Tray, 351W**25970** Universal Dipstick Kit**25971** Universal Dipstick Kit, Braided Stainless**25973** Universal Dipstick Kit, Twist Lock**38192** Windage Tray, Mounting Studs, 351W**38194** Oil Pump Pickup Stud, 351W**38390** Oil Pan Mounting Stud Kit, Bullet Nose**93162** Oil Pan Gasket, Ford 351W, Late, Smooth Rail**No. 20520****Billet End Seals****NOTE:** Oil Pan Capacities DO NOT include oil filter capacity. All Moroso Pans include a Magnetic Drain Plug.**OIL PANS****FORD 351W REAR SUMP**

FORD SMALL BLOCK

Steel, Wet Sump, Rear Sump, Kick Out, 7 Quart Capacity, 9" Deep
 Engine Application: 351W
 Fits: '79-Up Mustang, '81-'88 Thunderbird & Cougar, '79-'86 Capri
 and other Ford rear sump applications

- Steel with a clear zinc finish
- Billet end seals for greater sealing than a core based oil pan
- Kick-out for maximum horsepower
- 9" deep rear straight sided sump to clear headers
- Clears all 4-bolt main caps including 4-bolt rear
- Accepts 4.0" stroke with most steel rods
- Oil sump retaining system
- Compatible with most starter/flywheel combinations
- For use with oil pan gasket Moroso **No. 93162**

PART # DESCRIPTION
20529 Oil Pan, Ford 351W Rear Sump Kick-Out, Clears 4-Bolt Blocks

PART# RECOMMENDED PICKUP
24532 Fits: Stock or M83, M83HV or M10833 Style Oil Pumps

PART# AVAILABLE OPTIONS
93162 Oil Pan Gasket, Ford 351W, Late Oil Pan
25970 Universal Dipstick Kit
25971 Universal Dipstick Kit, Braided Stainless
25973 Universal Dipstick Kit, Twist Lock
38194 Oil Pump Pickup Stud, 351W

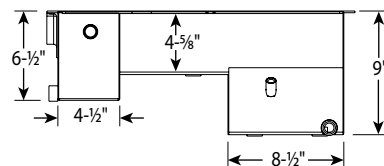
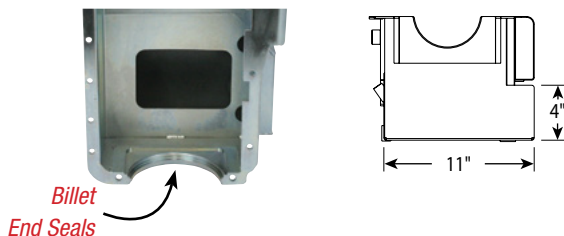

DRAG / ROAD RACE

FORD SMALL BLOCK

Steel, Wet Sump, Rear Sump, 7 Quart Capacity, 7-1/2" Deep
 Engine Applications: Ford 351W
 Fits: '79-Up Mustang, '81-'88 Thunderbird & Cougar, '79-'86
 Capri and other Ford rear sump applications

- Oil pans have thick precision laser cut steel rails with a clear zinc finish
- Billet end seals for greater sealing than a core based oil pan
- Clears all 4-bolt main caps including 4-bolt rear
- Accepts 4.0" stroke with most steel rods
- Feature a race proven diamond shape four trap door assembly and anti-slosh baffle that keeps oil contained in the oil pump pick up area during hard acceleration, cornering and braking
- Designed for Road Racing, makes an excellent Drag Race or Kit Car oil pan
- Fits 2005-up Mustang SCCA and NASA racecars with 351W engines
- Includes 1/2" N.P.T. oil temperature bung and magnetic drain plugs
- Compatible with most starter/flywheel combinations
- For use with 1 piece, rear sump oil pan gasket Moroso **No. 93162**

PART # DESCRIPTION
20534 Oil Pan, Ford 351W, Clear Zinc

PART # RECOMMENDED PICKUP
24534 For 351W, Fits: Stock or M83, M83HV or M10833 Style Oil Pumps

PART # AVAILABLE OPTIONS
25970 Universal Dipstick Kit
25971 Universal Dipstick Kit, Braided Stainless
25973 Universal Dipstick Kit, Twist Lock
38192 Windage Tray, Mounting Studs, 351W
38194 Oil Pump Pickup Stud, 351W
38390 Oil Pan Mounting Stud Kit, Bullet Nose
93162 Oil Pan Gasket, Ford 351W, Late, Smooth Rail

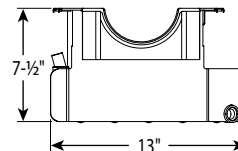
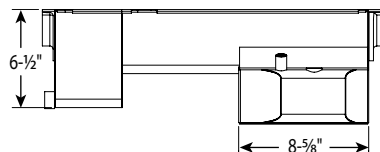
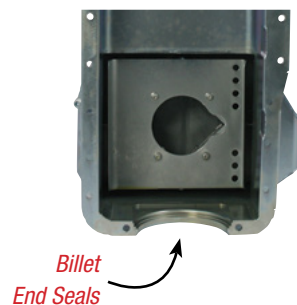

FORD SMALL BLOCK

Steel, Wet Sump, Front Sump, 9 Quart Capacity, 7-1/2" Deep

Engine Application: 351W

Fits: Late Model, Pro Stock, SK Modified® with tube snout chassis and no cross-members or steering linkages located under engine

- Five trap door baffling for oil control
- Built-in scraper on passenger-side
- Built-in dipstick
- Clears all 4-bolt main caps including 4-bolt rear
- Accepts 4.250" stroke with steel rods with scraper modification
- Accepts most starter and flywheel combinations

PART # DESCRIPTION
20522 Oil Pan, Steel, Clear Zinc, Fully Fabricated, Kicked-out Sump

PART # RECOMMENDED PICKUP
24515 Fits: Stock or M83, M83HV or M10833 Style Oil Pumps

PART# AVAILABLE OPTIONS
22935 Louvered Windage Tray, 351W
25970 Universal Dipstick Kit
25971 Universal Dipstick Kit, Braided Stainless
25973 Universal Dipstick Kit, Twist Lock
38192 Windage Tray, Mounting Studs, 351W
38194 Oil Pump Pickup Stud, 351W
38390 Oil Pan Mounting Stud Kit, Bullet Nose
93162 Oil Pan Gasket, Ford 351W, Late, Smooth Rail



No. 20522

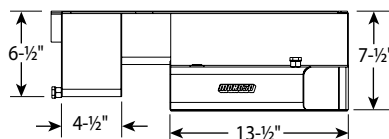
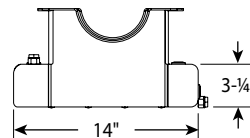

STREET / STRIP

FORD SMALL BLOCK

Steel, Wet Sump, 7 Quart Capacity, 8" Deep

Engine Application: 351C and 351M

Fits: 351C & 351M into most front sump production chassis (except Mustang II)

- Oil sump retaining system
- Reduces oil temperature
- Compatible with most starter/flywheel combinations
- Magnetic drain plug

PART # DESCRIPTION
20558 Oil Pan, Steel, Clear Zinc, Kicked-out Front Sump

PART # RECOMMENDED PICKUP
24558 Fits: Stock Oil Pumps

PART # AVAILABLE OPTIONS
38192 Tray Mounting Studs
38194 Oil Pump Pickup Stud, 351W



No. 20558

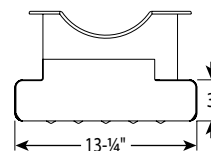
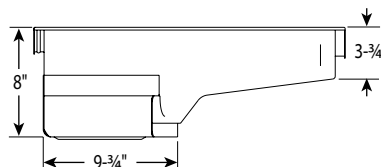

STREET

FORD SMALL BLOCK

Steel, Wet Sump, 6 Quart Capacity, 8-1/4" Deep

Engine Application: 351C and 351M

Fits: Most Front Sump Production Chassis

- Oil sump retaining system
- Magnetic drain plug
- Compatible with most starter/flywheel combinations
- Uses stock pickup

PART # DESCRIPTION
20557 Oil Pan, Unplated Steel, Stock Configuration, Front Sump

PART # AVAILABLE OPTIONS
38192 Tray Mounting Studs
38194 Oil Pump Pickup Stud



No. 20557

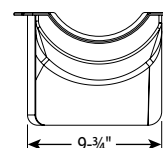
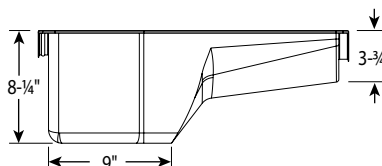

OIL PANS

FORD 351W / 351C / 351M

**FORD SMALL BLOCK**

Steel, Wet Sump, 8 Quart Capacity, 9" Deep
 Engine Application: Ford 351C, 351M, and 400 block
 Fits: '79-Up Mustang, '81-'88 Thunderbird, Cougar,
 '79-'86 Capri and other Ford Rear Sump applications
 (except Mustang II)

- Core based oil pan, utilizing stock pan rail bolt pattern
- Increased sump capacity, full length scraper
- Compatible with most starter and flywheel combinations

PART # DESCRIPTION
20530 Oil Pan, Steel, Clear Zinc

PART # RECOMMENDED PICKUP
24530 Fits: Melling M84AHV, Speed Pro 224-103R or similar pumps

PART # AVAILABLE OPTIONS
25970 Universal Dipstick Kit
25971 Universal Dipstick Kit, Braided Stainless Flex Tube
25973 Universal Dipstick Kit, Twist Lock
38194 Oil Pump Pickup Stud, 351W

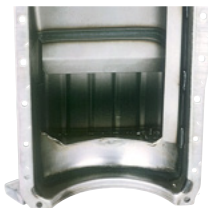
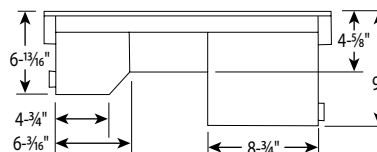
**No. 20530****DRAG / ROAD RACE****FORD 4.6/5.4L, COBRA REPLICA**

Steel, Wet Sump, 7 Quart Capacity
 Engine Application: 4.6/5.4L SOHC/DOHC
 Fits: Cobra Kit Cars that require a rear sump oil pan

- For Ford 4.6/5.4 SOHC/DOHC
- Designed for Cobra Replicas that require a shallow rear sump oil pan
- Features a race proven four trap door assembly and anti-slosh baffle that keeps oil contained in oil pump pick up area during road racing and drag racing
- Steel with a clear zinc finish
- Designed to be used with the Moroso **No. 22933** windage tray
- Uses the factory Mustang Dipstick
- Extra capacity; holds 1 more quart than the Mustang O.E.M. oil pan
- 1/2" NPT fitting for supercharger drain back
- 1/2" NPT fitting for oil temperature sender

PART # DESCRIPTION
20549 Oil Pan, Steel, Ford 4.6/5.4 Modular, Cobra Replica Race Baffled

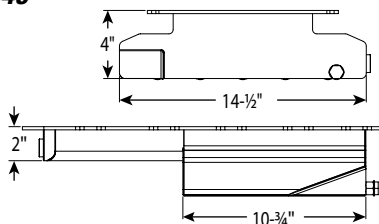
**No. 20549**

PART # RECOMMENDED PICKUPS
24547 Fits: Factory 4.6/5.4, 2 Valve Engine Oil Pumps
24548 Fits: Factory 4.6/5.4, 4 Valve Engine Oil Pumps

PART # AVAILABLE OPTIONS
22933 Louvered Windage Tray 4.6/5.4
93164 Oil Pan Gasket, Ford 4.6/5.4

TRUCK**FORD 4.6/5.4L**

Aluminum, Wet Sump, 7 Quart Capacity
 Engine Application: 4.6/5.4L SOHC/DOHC
 Fits: '99-'04 Lightning, '97-'04 F-150 (2-Wheel Drive)

- Fully fabricated, all-aluminum construction offers exceptional strength without the added weight
- Billet rail, kicked-out and lengthened sump adds extra capacity to help cool oil better
- Baffling system confines oil flow within the pickup area during hard acceleration, cornering and braking
- Designed to work with Ford Pickup No. F65Z-6622-CA and Ford Pickup Spacer No. N806180S2
- Uses factory dipstick
- Includes magnetic drain plug

PART # DESCRIPTION
20554 Oil Pan, Aluminum

PART # AVAILABLE OPTIONS
22933 Louvered Windage Tray, 4.6/5.4
93164 Oil Pan Gasket, Ford 4.6/5.4

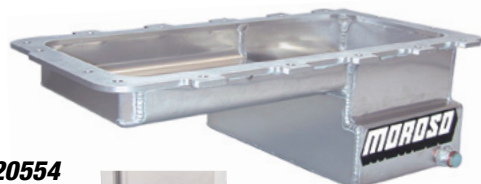
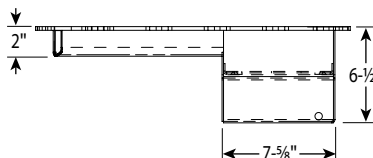
**No. 20554**

FORD 4.6/5.4L

Steel, Wet Sump, 8 Quart Capacity, 6- $\frac{1}{4}$ " Deep
 Engine Application: 4.6/5.4L SOHC/DOHC
 Fits: Rear Sump Mustang

- Increased oil capacity
- Oil sump retaining system
- Designed to work with factory 2v, 3v and 4v oil pump pickup
- Included $\frac{1}{2}$ " NPT drain back in front of pan

PART #	DESCRIPTION
20546	Oil Pan, Steel, Clear Zinc, Kicked-out Rear Sump
PART #	AVAILABLE OPTIONS
22933	Louvered Windage Tray, 4.6/5.4
93164	Oil Pan Gasket, Ford 4.6/5.4

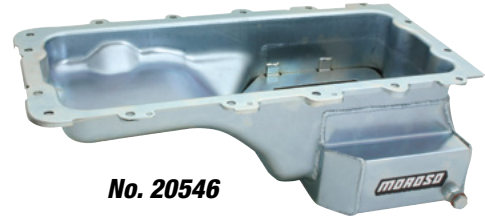
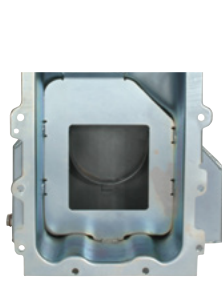

No. 20546

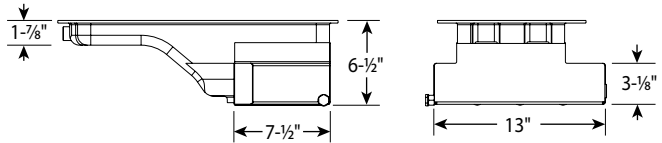

DRAG RACE

FORD 4.6/5.4L

Aluminum, Wet Sump, 7 Quart Capacity, 6- $\frac{1}{2}$ " Deep
 Engine Application: 4.6/5.4L SOHC/DOHC
 Fits: Rear Sump Mustang

- Fully fabricated, billet rail works with stock gasket
- Increased sump capacity, and trap door baffling
- Designed to work with factory 2v, 3v and 4v oil pump pickup
- Included $\frac{1}{2}$ " NPT drain back in front of pan

PART #	DESCRIPTION
20555	Oil Pan, Aluminum, Internal Wet Sump
PART #	AVAILABLE OPTIONS
22933	Louvered Windage Tray, 4.6/5.4
93164	Oil Pan Gasket, Ford 4.6/5.4

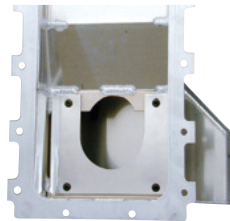

No. 20555

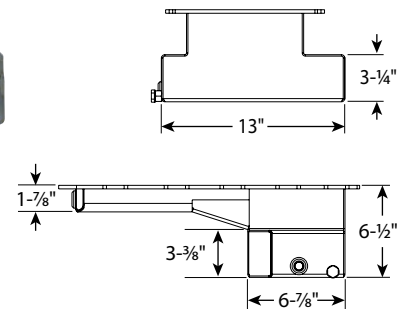

DRAG / ROAD RACE

FORD 4.6/5.4L

Steel, Wet Sump, 8 Quart Capacity, 6- $\frac{1}{4}$ " Deep
 Engine Application: 4.6/5.4 Liter
 Fits: '79-Up, including '05-Up Mustang

- Four trap door baffles for Drag and Road Race Applications
- Anti-slosh baffle
- Increased oil capacity over stock
- Designed to work with factory 2v, 3v and 4v oil pump pickup
- Uses factory dipstick
- $\frac{1}{2}$ " NPT fitting for supercharger drain back
- $\frac{1}{2}$ " NPT fitting for oil temperature sender
- Includes magnetic drain plug

PART #	DESCRIPTION
20548	Oil Pan, Steel, Clear Zinc Plated, Baffled Rear Sump
PART #	AVAILABLE OPTIONS
22933	Louvered Windage Tray, 4.6/5.4
93164	Oil Pan Gasket, Ford 4.6/5.4



No. 20548

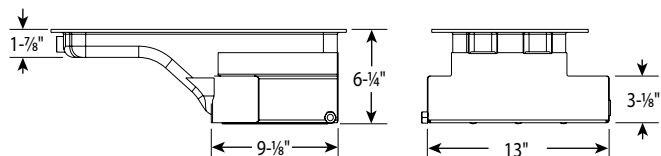

**FORD 5.0 COYOTE / 5.2 VOODOO,
FRONT SUMP***Steel, Wet Sump, 7 Quart Capacity**Engine Application: Ford 5.0 Modular "Coyote" Engines**Fits: Early Ford Chassis that require a front sump oil pan
(check measurements)*

- For Ford 5.0 "Coyote" Engine Blocks
- Designed to install Ford 5.0 "Coyote" Engines into early Ford chassis that require a front sump oil pan
- Oil pan has a thick steel rail with a fabricated steel sump
- Designed to be used with the 5.0 "Coyote" factory windage tray and dipstick
- Features a race proven trap door assembly and anti-slosh baffle that keeps oil contained in oil pump pickup area during road racing and drag racing
- 1/2" NPT fitting for oil temperature sender and dipstick provision
- 20 mm fitting for the factory oil level sensor

PART # DESCRIPTION
20573 Ford 5.0 Coyote, Front Sump Race
 Baffled Fabricated Steel Oil Pan

PART # REQUIRED PICKUPS
24573 *Fits: Factory 5.0/5.2 Gen 1 & 2 Oil Pumps*
24576 *Fits: Factory 5.0/5.2 Gen 3 Oil Pumps* **NEW!**

PART # AVAILABLE OPTIONS
22936 Windage Tray & Oil Pan
 Gasket, Ford 5.0 Coyote,
 Ford 5.2 Voodoo, with modification **NEW!**
22738 Factory Low Oil Warning Sensor Plug, 20mm
25970 Universal Dipstick Kit
25971 Universal Dipstick Kit, Braided Stainless Flex Tube
25973 Universal Dipstick Kit, Twist Lock

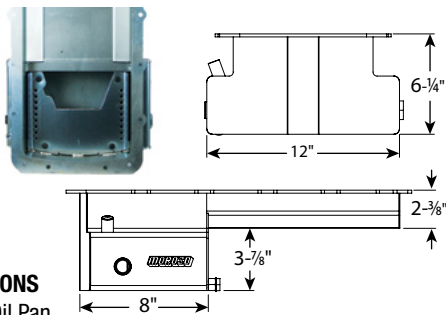
**No. 20573****FORD 5.0 COYOTE / 5.2 VOODOO,
COBRA REPLICA***Wet Sump, 9-1/2 Quart Capacity**Engine Application: Ford 5.0 "Coyote"/5.2 "Voodoo" Engines**Fits: Cobra Kit Cars that require a rear sump oil pan*

- Designed for Cobra Replicas that require a shallow, rear sump oil pan
- Available in either fully fabricated steel with a clear zinc finish or fabricated aluminum sump with a thick rail
- Designed to be used with the 5.0 "Coyote"/ 5.2 "Voodoo" Gen 1 or 2 factory windage tray and dipstick
- Features a race-proven, four trap door assembly and anti-slosh baffle that keeps oil contained in oil pump pickup area during road racing and drag racing
- 1/2" NPT fitting for supercharger drain back
- 1/2" NPT fitting for oil temperature sender
- 20 mm fitting for the factory oil level sensor

PART # DESCRIPTION
20569 Oil Pan, Fabricated Aluminum, Race Baffled
20570 Oil Pan, Fabricated Steel, Clear Zinc, Race Baffled

PART # REQUIRED PICKUPS
24570 *Fits: Factory 5.0/5.2 Gen 1 & 2 Oil Pumps*
24577 *Fits: Factory 5.0/5.2 Gen 3 Oil Pumps* **NEW!**

PART # AVAILABLE OPTIONS
22738 Factory Low Oil Warning Sensor Plug, 20mm
22936 Windage Tray & Oil Pan Gasket, Ford 5.0 **NEW!**
 Coyote, Ford 5.2 Voodoo

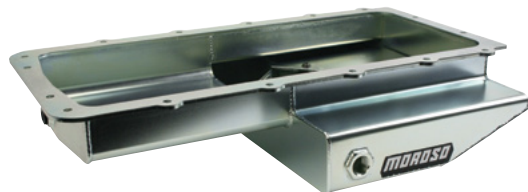
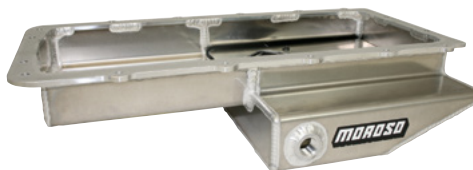
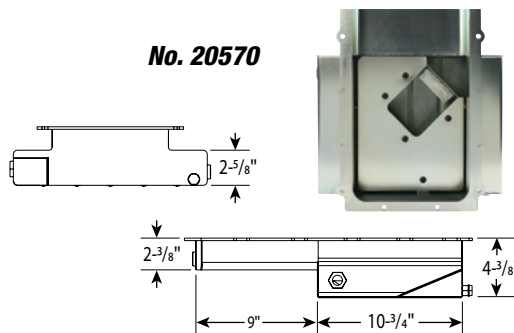
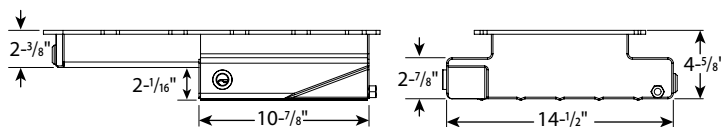
**No. 20570****No. 20569**

If the factory low oil warning sensor is not going to be used, **Part #22738**, 20mm Plug with copper washer is available

FORD 5.0 COYOTE / 5.2 VOODOO MUSTANG AND REAR SUMP APPLICATIONS

Steel/Aluminum, Wet Sump

Engine Application: Ford 5.0 Modular "Coyote" Engines

Fits: Mustang, '11-Up; Mustang, '79-Up & other Ford Rear Sump conversions with Ford "Coyote" or "Voodoo" Engines, (check measurements)

- Available in either fully fabricated steel with a clear zinc finish or fabricated aluminum sump with a thick rail
- Pans have a thick steel or billet aluminum rail
- Designed to be used with the 5.0 "Coyote" / 5.2 "Voodoo" Gen 1 or 2 factory windage tray and dipstick
- Features a race-proven, trap door assembly and anti-slosh baffle that keeps oil contained in oil pump pickup area during road racing and drag racing
- 1/2" NPT fitting for supercharger drain back
- 1/2" NPT fitting for oil temperature sender
- 20mm fitting for the factory oil level sensor*
- On Gen 1 & 2 Coyote/Voodoo engines use factory oil pump pickup and on Gen 3 Coyote/Voodoo engines use Part No. 24578

PART # DESCRIPTION

- 20571** Oil Pan, Steel, Clear Zinc, Fully Fabricated, 9 Qt. Capacity
Fits: '11-Up Mustang & Rear Sump Conversions
- 20572** Oil Pan, Aluminum, Fully Fabricated, 9 Qt. Capacity
Fits: '11-Up Mustang & Rear Sump Conversions
- 20575** Oil Pan, Steel, Clear Zinc, Fully Fabricated, 7.5 Qt. Capacity **NEW!**
Fits: '79-'93 Mustang with 5.0 Coyote / 5.2 Voodoo Swaps using BBK or American Racing Headers
- 20576** Oil Pan, Aluminum, Fully Fabricated, 7.5 Qt. Capacity **NEW!**
Fits: '79-'93 Mustang with 5.0 Coyote / 5.2 Voodoo Swaps using BBK or American Racing Headers

PART # RECOMMENDED PICKUP

24578 *Fits: Factory 5.0/5.2 Gen 3 Oil Pumps* **NEW!**

PART # AVAILABLE OPTIONS

- 22738** Factory Low Oil Warning Sensor Plug, 20mm
- 22936** Windage Tray & Oil Pan Gasket, Ford 5.0 Coyote, Ford 5.2 Voodoo **NEW!**



No. 20571



No. 20572

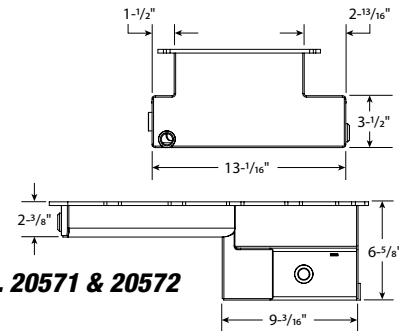

Nos. 20571 & 20572



No. 20575



No. 20576

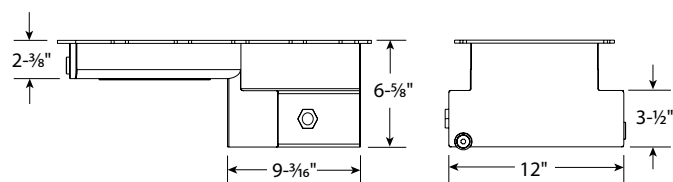

Nos. 20575 & 20576

**If the factory low oil warning sensor is not going to be used, Part No. 22738, 20mm Plug with copper washer is available*

OIL PUMP PICKUP KITS, FORD COYOTE GEN 3, GT 350 ENGINES WITH GEN 3 OIL PUMPS

- Pickup's machined steel bung inserts into a Gen. 3 oil pump, is retained by the bung's machined steps, o-ring and it's integral bracket, kit includes pickup tube, o-ring, main cap bolt, standoff and 8mm flange head screw
- Pickup has a large 1-1/4" diameter tube so that there is no restriction of flow during continuous high rpm track events
- Must use with Moroso Part No. 22936 or Ford Part No. BR3Z-6710-A windage tray/gasket

PART # DESCRIPTION

- 24576** Oil Pump Pickup Kit, FORD Coyote Gen 3, GT 350 Engines
Fits: Moroso Part No. 20573 Oil Pan
- 24577** Oil Pump Pickup Kit, FORD Coyote Gen 3, GT 350 Engines
Fits: Moroso Part Nos. 20569 and 20570 Oil Pans
- 24578** Oil Pump Pickup Kit, FORD Coyote Gen 3, GT 350 Engines
Fits: Moroso Part Nos. 20571, 20572, 20575 and 20576
- 24579** Oil Pump Pickup Kit, FORD Coyote Gen 3, GT 350 Engines
Fits: Moroso Part Nos. 20574 and 20577 Oil Pans

NEW!

FEATURES

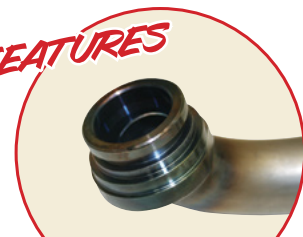

MACHINED STEEL BUNG



OIL PANS

FORD 5.0 COYOTE / 5.2 VOODOO



FORD 5.0 COYOTE / 5.2 VOODOO MUSTANG AND REAR SUMP APPLICATIONS

Aluminum, Wet Sump, 9 Quart Capacity

Engine Application: Ford 5.0 Modular "Coyote" Engines

Fits: Mustang, '11-Up; Mustang, '79-Up & other Ford Rear Sump conversions with Ford "Coyote" or "Voodoo" Engines, (check measurements)

- Oil pan has a thick aluminum rail with a fabricated aluminum sump
- Designed to be used with the 5.0 "Coyote"/ 5.2 "Voodoo" Gen 1 or 2 factory windage tray and dipstick
- Features a Drag Race proven trap door assembly and anti-slosh baffle that keeps oil contained in oil pump pickup area during launches and deceleration
- 1/2" NPT fitting for supercharger drain back
- 1/2" NPT fitting for oil temperature sender
- 20 mm fitting for the factory oil level sensor*

PART # DESCRIPTION

- 20574** Oil Pan, Aluminum, Fully Fabricated
Fits: '11-Up Mustang & Rear Sump Conversions
- 20577** Oil Pan, Aluminum, Fully Fabricated **NEW!**
Fits: '79-'93 Mustang with 5.0 Coyote / 5.2 Voodoo Swaps using BBK or American Racing Headers

PART # REQUIRED PICKUPS

- 24574** *Fits: Factory 5.0 Coyote/5.2 Voodoo Gen1 & Gen 2 Oil Pumps*
- 24579** *Fits: Factory 5.0/5.2 Gen 3 Oil Pumps* **NEW!**

PART # AVAILABLE OPTIONS

- 22738** Factory Low Oil Warning Sensor Plug, 20mm
- 22936** Windage Tray & Oil Pan Gasket, Ford 5.0 Coyote, Ford 5.2 Voodoo **NEW!**

*If the factory low oil warning sensor is not going to be used, Part No. 22738, 20mm Plug with copper washer is available



No. 20574

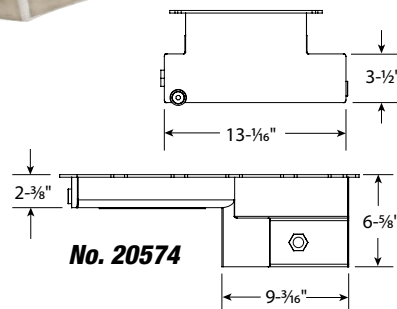
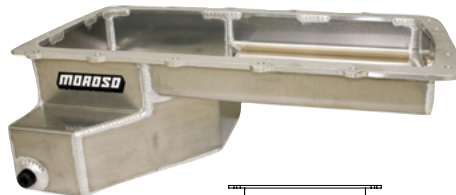

No. 20574



No. 20577



NEW!

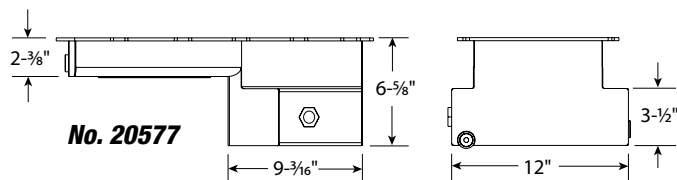

No. 20577

WINDAGE TRAY AND OIL PAN GASKET

Fits: Ford 5.0 Coyote, 5.2 Voodoo

- Required when installing a Moroso oil pan and oil pump pickup on a Gen. 3 engine or is a replacement windage tray/oil pan gasket on a Gen. 1 or Gen. 2 engine
- Goes between the engine block and oil pan

PART # DESCRIPTION

- 22936** Windage Tray & Oil Pan Gasket, Ford 5.0 Coyote, 5.2 Voodoo

No. 22936



NEW!

FORD BIG BLOCK

Steel, Wet Sump, 5 Quart Capacity, 5" Deep

Engine Application: 352-428 FE

Fits: Most Production Chassis

- Front sump
- Built-in oil baffle
- Uses stock pickup
- Magnetic drain plug

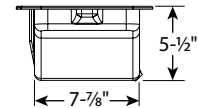
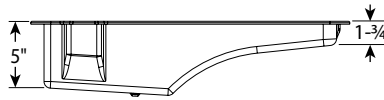
PART # DESCRIPTION**20606** Oil Pan, Steel, Clear Zinc, Stock Configuration**PART # AVAILABLE OPTION****22940** Louvered Windage Tray**No. 20606****FORD BIG BLOCK**

Steel, Wet Sump, 7 Quart Capacity, 7-1/2" Deep

Engine Application: 352-428 FE

Fits: Most Production Chassis

- Oil sump retaining system
- Removable oil sump tray
- Reduces oil temperature
- Magnetic drain plug

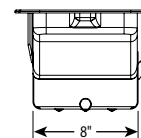
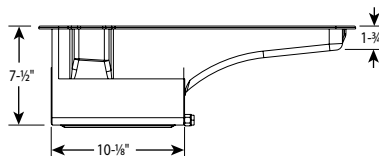
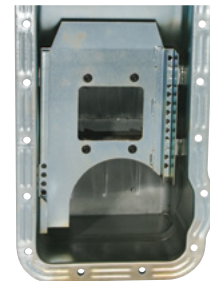
PART # DESCRIPTION**20609** Oil Pan, Steel, Clear Zinc, Deep Front Sump**PART # RECOMMENDED PICKUP****24609** Fits: Melling M57HV**PART # AVAILABLE OPTIONS****22940** Louvered Windage Tray**25970** Universal Dipstick Kit**25971** Universal Dipstick Kit, Braided Stainless Flex Tube**25973** Universal Dipstick Kit, Twist Lock**No. 20609**

NOTE: Oil Pan Capacities DO NOT include oil filter capacity. All Moroso Pans include a Magnetic Drain Plug.

**OIL PANS****FORD 352 - 428FE**

**FORD BIG BLOCK***Steel, Wet Sump, 8 Quart Capacity, 6" Deep**Engine Application: 352-428 FE**Fits: Most front sump production chassis and kit cars*

- Anti-slosh baffle
- Oil temperature bung
- Reduces oil temperature
- Magnetic drain plug

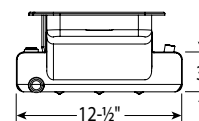
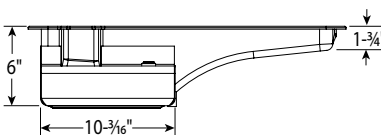
PART # DESCRIPTION**20607** Oil Pan, Steel, Clear Zinc, Kicked-out Front Sump**PART # RECOMMENDED PICKUP****24608** *Fits: Melling M57HV***PART # AVAILABLE OPTIONS****22940** Louvered Windage Tray**25970** Universal Dipstick Kit**25971** Universal Dipstick Kit, Braided Stainless Flex Tube**25973** Universal Dipstick Kit, Twist Lock**No. 20607****DRAG / ROAD RACE****FORD BIG BLOCK***Steel, Wet Sump, 8 Quart Capacity, 6" Deep**Street/Strip & Road Race, Kicked-Out Front Sump,**Enhanced Road Race Baffling**Engine Application: 352-428 FE**Fits: Most front sump production chassis and kit cars*

- Kicked-out front sump increases oil capacity to 8 quarts which reduces oil temperature and insures adequate supply to the oil pump pickup
- Includes 6 trap doors, 2 baffles and a removable sump tray that keeps the oil contained in the pickup area during hard acceleration, cornering and braking
- Features a magnetic drain plug and oil temperature bung
- Dipstick bung

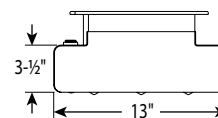
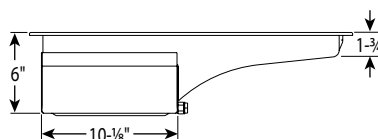
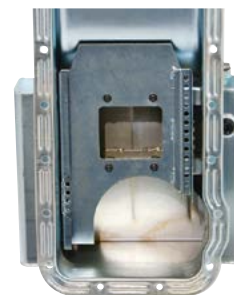
PART # DESCRIPTION**20608** Oil Pan, Steel, Clear Zinc, 6" Kicked-Out Front Sump, Wet Sump**PART # RECOMMENDED PICKUP****24608** *Fits: Melling M57HV***PART # AVAILABLE OPTIONS****22940** Louvered Windage Tray**25970** Universal Dipstick Kit**25971** Universal Dipstick Kit, Braided Stainless Flex Tube**25973** Universal Dipstick Kit, Twist Lock**No. 20608****NOTE:** Oil Pan Capacities DO NOT include oil filter capacity. All Moroso Pans include a Magnetic Drain Plug.

FORD BIG BLOCK

Steel, Wet Sump, 8 Quart Capacity, 9" Deep

Engine Application: 429-460

Fits: '79-Up Mustang, '81-'88 Thunderbird, Cougar,
'79-'86 Capri and other Ford Rear Sump applications

- Oil sump retaining system
- Clears stock cross-member and steering linkage
- Reduces oil temperature

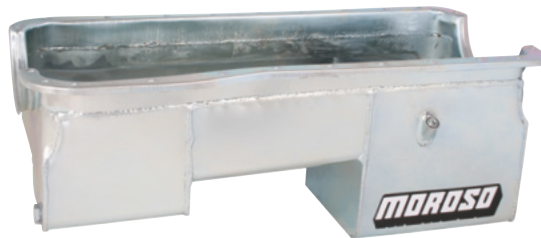
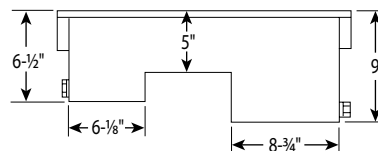
PART # DESCRIPTION**20620** Oil Pan, Steel, Clear Zinc**PART # RECOMMENDED PICKUP****24509*** Fits: Ford SVO M-6600-A460 or M84D or M84DHV Style Pumps**PART # AVAILABLE OPTIONS****25970** Universal Dipstick Kit**25971** Universal Dipstick Kit, Braided Stainless Flex Tube**25973** Universal Dipstick Kit, Twist Lock**93166** Oil Pan Gasket, 460 Late, Smooth Rail**Fits only 4-bolt mains (SVO Block)***No. 20620****DRAG RACE****FORD BIG BLOCK**

Steel, Wet Sump, 7 Quart Capacity, 9" Deep

Engine Application: 429-460

Fits: '79-Up Mustang, '81-'88 Thunderbird, Cougar,
'79-'86 Capri and other Ford Rear Sump applications

- Core based oil pan, utilizing stock pan rail bolt pattern
- Increased sump capacity and trap door baffling
- Stock starter with 184-tooth flywheel

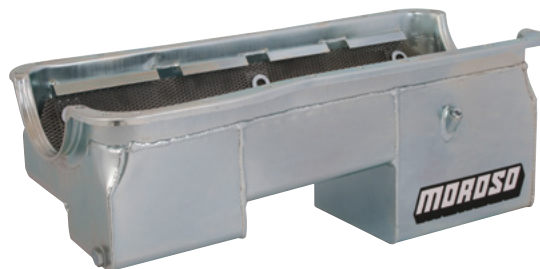
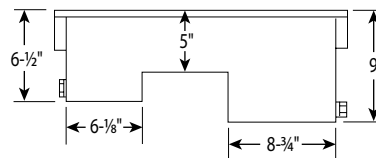
PART # DESCRIPTION**20625** Oil Pan, Steel, Clear Zinc**PART # RECOMMENDED PICKUP****24508*** Fits: Ford SVO M-6600-A460 or M84D or M84DHV Style Pumps**PART # AVAILABLE OPTIONS****25970** Universal Dipstick Kit**25971** Universal Dipstick Kit, Braided Stainless Flex Tube**25973** Universal Dipstick Kit, Twist Lock**93166** Oil Pan Gasket, 460 Late, Smooth Rail**Fits only 4-bolt mains (SVO Block)***No. 20625****NOTE:** Oil Pan Capacities DO NOT include oil filter capacity. All Moroso Pans include a Magnetic Drain Plug.**OIL PANS****FORD 429 - 460**

FORD BIG BLOCK

Steel, Wet Sump, 7 Quart Capacity, 8-1/2" Deep

Engine Application: 429-460

Fits: Tube-chassis Bracket and Super Classes including dragsters, roadsters, door slammers, etc.

- Core based oil pan, utilizing stock pan rail bolt pattern
- Increased sump capacity, and trap door baffling
- Stock starter with 184-tooth flywheel

PART # DESCRIPTION

20614 Oil Pan, Steel, Clear Zinc

PART # RECOMMENDED PICKUP

24511 Fits: Ford SVO M-6600-A460 or M84D or M84DHV Style Pumps

PART # AVAILABLE OPTIONS

25970 Universal Dipstick Kit

25971 Universal Dipstick Kit, Braided Stainless Flex Tube

25973 Universal Dipstick Kit, Twist Lock

93166 Oil Pan Gasket, 460 Late, Smooth Rail

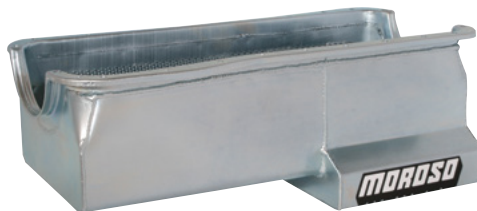

No. 20614

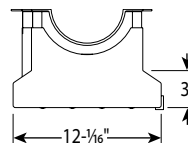
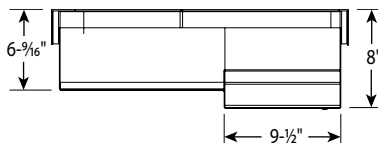
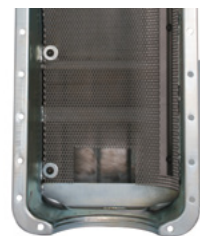

FORD BIG BLOCK

Steel, Wet Sump, 9 Quart Capacity, 7- 7/8" Deep

Engine Application: 429-460

Fits: Tube-chassis Bracket and Super Classes including dragsters, roadsters, door slammers, etc.

- Steel fully fabricated oil pan, utilizing "race" pan rail bolt pattern
- Power kick-out for increased horsepower
- Increased sump capacity, solid louvered tray
- Clears all 4-bolt main caps
- Accepts 4.75" stroke with aluminum rods
- Compatible with Tilton starter and 184-tooth flywheel

PART # DESCRIPTION

20616 Oil Pan, Steel, Clear Zinc

PART # RECOMMENDED PICKUPS

24505 Fits: Ford SVO M-6600-A460 or M84D or M84DHV Style Pumps with 4-bolt Main Blocks

24522 Fits: Ford SVO M-6600-A460 or M84D or M84DHV Style Pumps with 2-bolt Main Blocks

PART # AVAILABLE OPTIONS

62255 Wrench, Oil Pan T-Handle, 1/2", 6 PT

62256 Wrench, Oil Pan T-Handle, 7/16", 6 PT

93166 Oil Pan Gasket, 460 Late, Smooth Rail



No. 20616

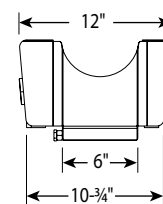
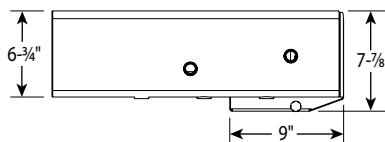

NOTE: Oil Pan Capacities DO NOT include oil filter capacity. All Moroso Pans include a Magnetic Drain Plug.

FORD BIG BLOCK

Steel, Wet Sump, 8 Quart Capacity, 10-3/4" Deep

Engine Application: All 429-460

Fits: Four-wheel drive trucks and vans except Bronco

- Deep sump increases capacity to 8 quarts, which reduces oil temperature and insures ample supply to pickup area
- Relocated rear sump improves oil control during hard acceleration and off-road use
- Accepts 3.85" stroke with most steel rods
- Works with most starter/flywheel combinations
- Use Nos. 25970, 25971 or 25973 for dipstick provision - welding required

PART # DESCRIPTION

20612 Oil Pan, Steel, Clear Zinc, Deep Rear Sump, Off-Road

PART # RECOMMENDED PICKUP

24504 Fits: Only 4 bolt main caps. 2 bolt pickups require a custom product, please inquire

PART # AVAILABLE OPTIONS

93166 Oil Pan Gasket, 460 Late, Smooth Rail

25970 Universal Dipstick Kit

25971 Universal Dipstick Kit, Braided Stainless Flex Tube

25973 Universal Dipstick Kit, Twist Lock



No. 20612

**FORD 7.3 POWERSTROKE, '94-'03**

Steel, Fits: F-250/F-350 '94.5-'03, Super Duty '99-'03,

Excursion '00-'03, Econoline '94.5-'03, Ford E- Series

van/motorhome/bus chassis '94.5-'03

- After hearing that our customers were having premature rusting issues with their O.E.M. oil pans on Ford Powerstroke engines, Moroso knew that they could come up with a longer lasting solution
- Heavy Duty, stamped out of 16 gauge quality steel which is thicker than O.E.M.
- Has a triple coat finishing process of a zinc phosphate which besides creating a durable finish foundation also neutralizes any corrosion started by the welding process itself. The second coat is a black 1-mil thick electrocoat and the last coat is a gloss black epoxy powdercoat. This process has been fine tuned from years of oil pan building experience and from this Moroso oil pan design being subjected to numerous salt spray testing. The O.E.M. oil pan only has a black painted surface
- Features an internal O.E.M. style anti-slosh baffle to keep oil contained in the oil pick up area, dipstick provision on passenger side and notch in front oil pan for clearance
- More cost effective than the O.E.M. piece by it's initial price and that labor dollars will not need to be spent every couple of years on it's replacement
- Oil pan is designed to work with your existing oil pump and pickup tube

PART # DESCRIPTION

27336 Oil Pan

Fits: Ford 7.3 Powerstroke, '94-'03

PART # AVAILABLE OPTIONS

27293 Oil Pan Gasket, Ford 7.3 Powerstroke '94-'03 and International T444E, Patent Pending

97003 Oil Pan Drain Plug, Zinc Finish



*Shown with Optional Gasket

No. 27336

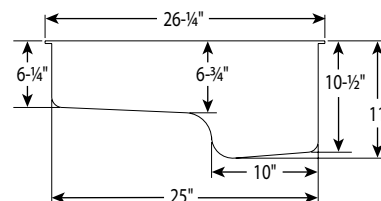

NOTE: Oil Pan Capacities DO NOT include oil filter capacity. All Moroso Pans include a Magnetic Drain Plug.



OIL PANS

FORD 429 - 460 / 7.3 POWERSTROKE

INTERNATIONAL T444E

Steel

Fits: International T444E engines (replacement for IH Part # 1830838C91) International 3600/3700/3800 and other chassis. (Doesn't fit in Ford Excursions, Pick ups or Vans)

- Heavy Duty, stamped out of 16 gauge quality steel which is thicker than O.E.M.
- Has a triple coat finishing process of a zinc phosphate, the second coat is a black 1-mil thick electrocoat and the last coat is a gloss black epoxy powdercoat
- Features an internal O.E.M. style anti-slosh baffle to keep oil contained in the oil pick up area, 18 Quart Capacity, dipstick provision on passenger side and notch in front oil pan for clearance



No. 27264

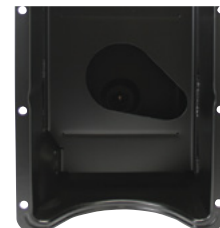

PART # DESCRIPTION
27264 Oil Pan, International T444E

PART # AVAILABLE OPTION
27293 Oil Pan Gasket, One Piece Design, Steel Reinforced
 Ford 7.3 Powerstroke '94-'03 and International T444E, patent pending

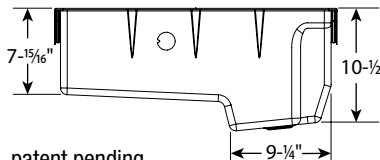

STREET | STRIP

OLDSMOBILE

*Steel, Wet Sump, 7 Quart Capacity, 8-1/2" Deep
 Engine Application: 330-455
 Fits: All '65-later V8's in most stock GM chassis without modifications*

- Reduces oil temperature
- Anti-slosh baffle
- Compatible with most starter/flywheel combinations



No. 20480

PART # DESCRIPTION
20480 Oil Pan, Steel, Clear Zinc, Deep Sump

PART # RECOMMENDED PICKUP
24460 *Fits: For Moroso No. 20480 Oil Pan, Melling M22F or Stock or Sealed Power No.224-41203*

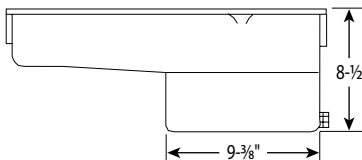

DRAG | MARINE | TRUCK

OLDSMOBILE

*Steel, Flat Bottom Pan
 10 Quart Capacity, 7-1/4" Deep
 Engine Application: 330-455
 Fits: Hulls with flywheel aft and 4-point mounting*

- Full sump increases capacity to 10 quarts, which reduces oil temperature and insures adequate supply to pickup area
- Includes built-in crankshaft scraper and trap door baffling to prevent oil starvation under severe marine conditions
- Removable sump tray allows easy access to the pan's bottom for cleaning
- Works with most starter/flywheel combinations
- Pan features a -12AN drain plug



No. 21631

PART # DESCRIPTION
21631 Oil Pan, Steel, Clear Zinc, Large Marine Pan

PART # RECOMMENDED PICKUP
24463 *Fits: Melling HV Pump M22FHV or Mondello "HV" Pump SP 755*



PONTIAC

Steel, Wet Sump, 8 Quart Capacity, 9-3/4" Deep
 Engine Application: 301-455
 Fits: 1967-'81 Firebird and 1964-'87 mid and full-sized chassis

- Oil retaining system
- Reduces oil temperature
- Compatible with most starter/flywheel combinations

PART # DESCRIPTION
20490 Oil Pan, Steel, Clear Zinc, Deep Sump

PART # RECOMMENDED PICKUP
24480 Fits: M54DS or M10541 Style Pumps

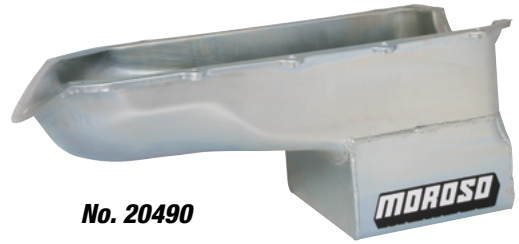

No. 20490

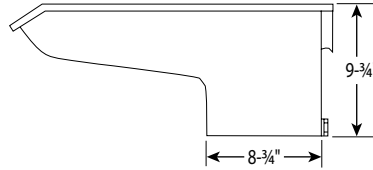

PONTIAC

Steel, Wet Sump, 7-1/8" Deep
 Engine Application: 301-455
 Fits: 1967-'81 Firebird and 1964-'87 mid and full-sized chassis

- Oil sump retaining system
- Magnetic drain plug

PART # DESCRIPTION
20492 Oil Pan, Steel, Clear Zinc, Stock Replacement

PART # RECOMMENDED PICKUP
 Use Stock Oil Pump & Pickup



No. 20492

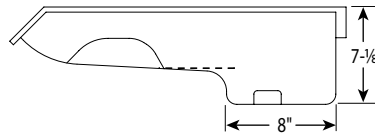

PONTIAC

Steel, Wet Sump, 7 Quart Capacity, 8-1/2" Deep
 Engine Application: 301-455
 Fits: 1967-'81 Firebird and 1964-'87 mid and full-sized chassis

- Oil sump retaining system
- Reduces oil temperature
- Compatible with most starter/flywheel combinations

PART # DESCRIPTION
20500 Oil Pan, Steel, Clear Zinc, Deep Sump

PART # RECOMMENDED PICKUP
24482 Fits: M54DS or M10541 Style Pumps



No. 20500

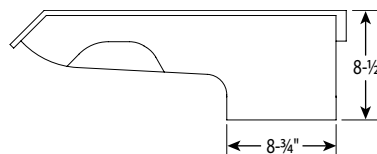

NOTE: Oil Pan Capacities DO NOT include oil filter capacity. All Moroso Pans include a Magnetic Drain Plug.



OIL PANS

PONTIAC 301 - 455

ACURA/HONDA B SERIES

Steel, Wet Sump, 4 Quart Capacity, 6" Deep
 Engine Application: Acura VTEC, Non-VTEC and Honda 1.6L B16A3

- Sump baffle that fully surrounds oil pump pickup
- Turbo/Supercharger oil drain back
- Features a magnetic drain plug and temperature sensor bung
- Works with OEM exhaust manifold and most aftermarket exhaust/header combinations

PART # DESCRIPTION
 20911 Oil Pan, Steel, Clear Zinc, Stock Configuration

PART # RECOMMENDED OIL PUMP & PICKUP
 Use Stock Oil Pump & Pickup

PART # AVAILABLE OPTIONS

- 38366 Oil Pan Stud Kit
- 93200 Oil Pan Gasket, One Piece Design, Acura/Honda B Series

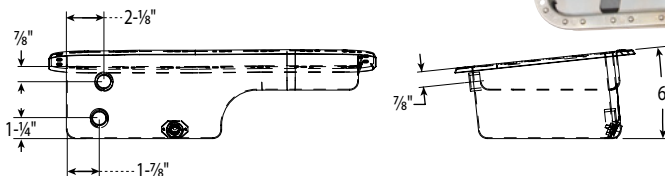

No. 20911

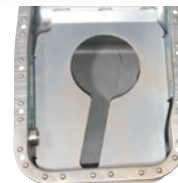

ACURA/HONDA B SERIES

Steel, Wet Sump, 5.5 Quart Capacity, 6" Deep
 Engine Application: Acura VTEC, Non-VTEC and Honda 1.6L B16A3

- Kicked-out sump
- Includes 6 trap doors, 2 baffles and a removable anti-slosh baffle for oil control in Road Racing, also an excellent Drag Race oil pan
- Turbo/Supercharger oil drain back and temperature sensor bung
- Magnetic drain plug
- Works with OEM exhaust manifold and most aftermarket exhaust/header combinations

PART # DESCRIPTION
 20910 Oil Pan, Steel, Clear Zinc

PART # RECOMMENDED PICKUP
 Use Stock Oil Pump & Pickup

- PART # AVAILABLE OPTIONS**
- 38366 Oil Pan Stud Kit
 - 93200 Oil Pan Gasket, One Piece Design, Acura/Honda B Series

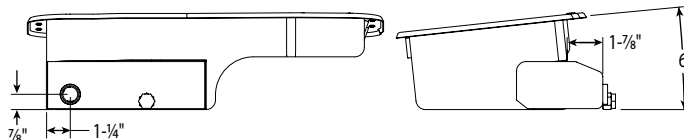

No. 20910



ACURA/HONDA B SERIES

Aluminum, Kicked-out Sump, 5 Quart Capacity, 5-5/8" Deep
 Engine Application: Acura VTEC, Non-VTEC and Honda 1.6L B16A3

- Dynamic trap door baffling for Drag Race & Street
- Aluminum with 1/4" thick pan rail
- Includes 1/2" NPT bung for plumbing turbo oil return line, 1/2" NPT bung for installing oil temperature sender and magnetic drain plug with extra washer
- Includes mounting kit with hex-drive studs and serrated-face flare nuts
- Works with OEM exhaust

PART # DESCRIPTION
 20901 Oil Pan, Aluminum, Fully Fabricated

PART # RECOMMENDED PICKUPS

- 24010 Fits: VTEC Engines
- 24011 Fits: Non-VTEC Engines and 1.6 Liter VTEC

- PART # AVAILABLE OPTIONS**
- 38366 Oil Pan Stud Kit
 - 93200 Oil Pan Gasket, One Piece Design, Acura/Honda B Series

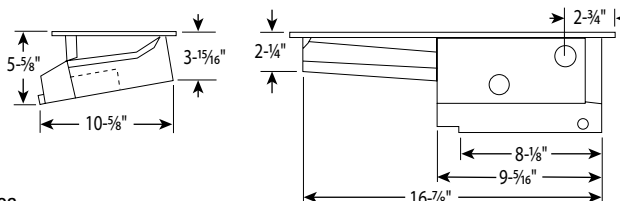

No. 20901



HONDA H-SERIES, OIL PAN

Steel, Wet Sump, 4 Quart Capacity, 5-1/4" Deep
 Engine Application: Honda H Series 2.2L/2.3L

- Sump baffle that fully surrounds the oil pump pickup
- 1/2" NPT fitting for turbo or supercharger drain back
- Features a magnetic drain plug and a 1/2" NPT fitting for a temperature sender
- Works with OEM exhaust manifold and most aftermarket exhaust/header combinations



NEW!

No. 20916

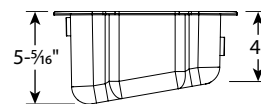
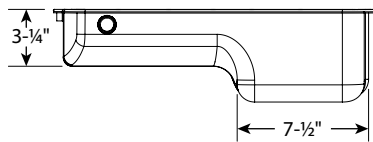

PART #	DESCRIPTION
20916	Oil Pan, Steel, Clear Zinc, Stock Configuration

DRAG RACE

HONDA H-SERIES

Aluminum, Wet Sump, 5.5 Quart Capacity, Race Baffled
 Engine Application: Honda H-Series 2.2L/2.3L

*For engine swaps check dimensions for clearance

Fits: Accord and Prelude (Except 4ws)

- Integral sump tray and large, 6" trap-door baffle for oil control or Drag Race & Street
- Aluminum with 3/8" thick billet aluminum pan rail provides a rigid flange for leak-free sealing; accommodates stock pan gasket
- Includes 1/2" NPT bung for plumbing turbo return line, 1/2" NPT bung for installing oil temperature sender and magnetic drain plug with extra washer (also includes plugs for unused bungs)
- Includes mounting kit with hex-drive studs and serrated-face flare nuts



No. 20912



PART #	DESCRIPTION
20912	Oil Pan, Aluminum, Fully Fabricated

PART #	RECOMMENDED PICKUP
24012	Fits: Stock Oil Pumps

PART #	AVAILABLE OPTION
38366	Oil Pan Stud Kit

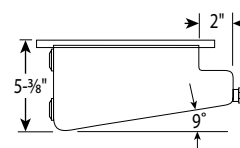
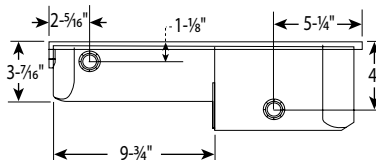

ROAD RACE

HONDA H-SERIES

Steel, Wet Sump, 5.5 Quart Capacity, Race Baffled Fabricated Steel
 Engine Application: Honda H-Series 2.2L/2.3L

Fits: Accord and Prelude (Except 4ws)

- Features a race proven trap door assembly, anti-slosh baffle and a vertical wall that keep oil contained in oil pump pickup area during hard acceleration, cornering and braking
- Designed for Road Racing, makes an excellent Drag Race oil pan
- Based on a thick steel oil pan core with a fabricated steel extra capacity sump.
- Uses O.E.M. oil pump pickup and works with O.E.M. windage tray and main girdle
- Extra capacity: holds 1/2" of a quart more than stock
- 1/2" NPT fitting for supercharger or turbo drain back
- 1/2" NPT fitting for oil temperature sender
- Magnetic drain plug



No. 20917



PART #	DESCRIPTION
20917	Oil Pan, Fabricated Steel, Race Baffled

PART #	RECOMMENDED PICKUP
	Use Stock Oil Pump & Pickup

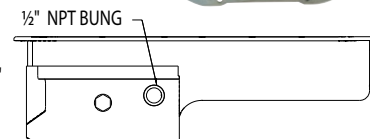
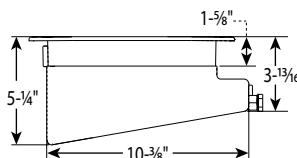

NOTE: Oil Pan Capacities DO NOT include oil filter capacity. All Moroso Pans include a Magnetic Drain Plug.



OIL PANS

IMPORT

ACURA/HONDA K-SERIES

Steel, Wet Sump, 6.5 Quart Capacity, Race Baffled

Engine Application: Acura/Honda K-Series

Fits: K-series Engine Swaps into Integra (DA) '90-'93, Integra (DC)'94-'01, Accord (CB) '90-'93, Accord (CD) '94-'97, Civic/CRX: (EF)'88-'91, Civic (EG) '92-'95, Civic (EK) '96-'00, Civic (ES) '01-'05; Fit (GD) '07-'08, Prelude (BB) '92-'96



No. 20915

- Doesn't fit DC5 chassis "RSX", CL9 "TSX", EP3 "Civic SI"
- Designed to be used with the Acura RSX oil pump assembly* OEM Part #15100-PRB-A01 and Acura RSX Windage Tray OEM Part #11211-PNC-000
- Oil Pan has a thick steel rail with a sump that is 5.5" deep, 16.75" long and 9" wide
- Features a race proven trap door assembly and anti-slosh baffle that keeps oil contained in oil pump pickup area during road racing and drag racing
- Extra capacity: holds two more quarts than stock
- 1/2" NPT fitting for supercharger or turbo drain back
- 1/2" NPT fitting for oil temperature sender
- Magnetic drain plug



PART # DESCRIPTION

20915 Oil Pan, Fabricated Steel, Clear Zinc, Race Baffled

PART # RECOMMENDED OIL PUMP & PICKUP

Use Acura RSX oil pump and pickup assembly* OEM Part #15100-PRB-A01

*Oil pump assembly might require slight notching to clear certain K-series main caps

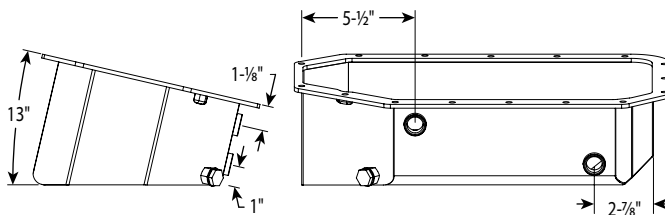

ACURA/HONDA K-SERIES

Steel, Wet Sump, 5.5 Quart Capacity, Race Baffled, Notched for Cross member clearance

Engine Application: Acura/Honda K-Series

Fits: Notched to fit in ACURA/HONDA K-SERIES, RSX (DC5)'02-'06, TSX (CL9) '04-'08, Civic SI (EP3) '02-'05, Accord (CG) '98-'02, Accord '03-'07 and also fits K-series Engine Swaps into Integra (DA) '90-'93, Integra (DC) '94-'01, Accord (CB) '90-'93, Accord (CD) '94-'97, Civic/CRX (EF) '88-'91, Civic (EG) '92-'95, Civic (EK) '96-'00, Civic (ES) '01-'05, Fit (GD) '07-'08, Prelude (BB) '92-'96



No. 20919

- To be used with the Acura RSX oil pump assembly* OEM Part # 15100-PRB-A01 and Acura RSX Windage Tray OEM Part # 11211-PNC-000
- Oil pan has a thick steel rail with a sump that is 5-1/2" deep, 16-3/4" long and 9" wide
- Features a race proven trap door assembly and anti-slosh baffle that keeps oil contained in oil pump pick up area during road racing and drag racing
- Extra capacity: holds one more quart than stock
- 1/2" NPT fitting for supercharger or turbo drain back
- 1/2" NPT fitting for oil temperature sender
- Magnetic drain plug

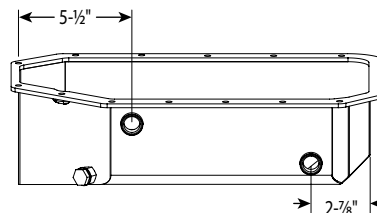

PART # DESCRIPTION

20919 Oil Pan, Fabricated Steel, Clear Zinc, Race Baffled Notched for Cross member clearance

PART # RECOMMENDED OIL PUMP & PICKUP

Use Acura RSX oil pump and pickup assembly* OEM Part #15100-PRB-A01

*Oil pump assembly might require slight notching to clear certain K-series main caps

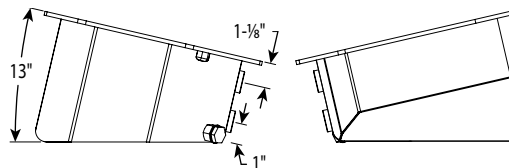

NOTE: Oil Pan Capacities DO NOT include oil filter capacity. All Moroso Pans include a Magnetic Drain Plug.



MAZDA

Aluminum, Wet Sump, 6.25 Quart Capacity (with stock oil cooler installed), 4" Deep
 Engine Application: 13B Rotary (Non FD or Renesis)

Fits: Tube chassis cars and other cars without a cross-member located under engine (check dimensions for clearance)

- Fully fabricated
- 3/8" thick billet rail with integral X-brace greatly strengthens engine assembly to reduce twisting and axial deflection
- Includes .080"-thick aluminum Baffle Plate to de-aerate and cool return oil (other baffles are only .060" thick)
- Includes an oil pump pickup specially designed for this pan; access holes in pan facilitate mounting pickup to the front cover
- For Drag Race & Street
- Includes magnetic drain plug with extra copper washer and pan mounting kit with hex-drive steel studs to eliminate stripping the engine block and serrated-face flare nuts to withstand vibration
- Accommodates stock pan gasket and dipstick with existing oil level marks



No. 20940



PART # DESCRIPTION

20940 Oil Pan, Aluminum, Rear Sump

PART # AVAILABLE OPTION

38366 Oil Pan Stud Kit

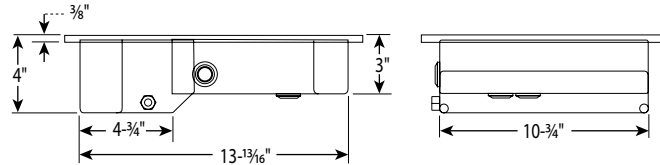

MAZDA

Aluminum, Wet Sump, 6.25 Quart Capacity, 4" Deep
 Engine Application: 13B Rotary (Non FD or Renesis)

Fits: RX-3 & RX-4 models; several rotary engine conversions including 1981-'84 Toyota Starlet, 1964-'83 Toyota Corolla, 1971-'73 Datsun 1200 & others with little or no cross-member modifications; also tube chassis cars

- Rugged 3/8" thick billet aluminum gasket rail with integral cross-brace serves as a girdle to greatly strengthen the entire engine assembly and reduce flexing under hard driving
- Fully fabricated
- Dual trap door baffles for Drag Race & Street
- Enlarged sump increases capacity to 6-1/4 quarts (with stock oil cooler installed) while adding only a quarter-inch in depth to provide ample ground clearance
- Includes oil temperature sender provisions
- Includes magnetic drain plug with extra copper washer, pan mounting kit with hex-drive steel studs to eliminate stripping the engine block and serrated-face flare nuts to withstand vibration
- Accommodates stock pan gasket and dipstick (with modification)



No. 20942



PART # DESCRIPTION

20942 Oil Pan, Aluminum, Front Sump

PART # RECOMMENDED PICKUP

Use Stock Oil Pump & Pickup

PART # AVAILABLE OPTION

38366 Oil Pan Stud Kit

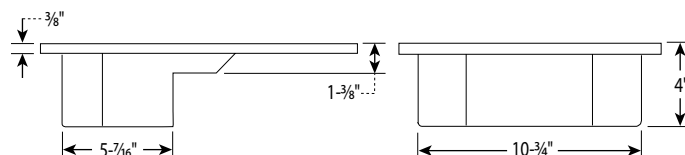

NOTE: Oil Pan Capacities DO NOT include oil filter capacity. All Moroso Pans include a Magnetic Drain Plug.

**MITSUBISHI**

Aluminum, Wet Sump, 6.25 Quart Capacity, 6-1/2" Deep

Engine Application: 2.0L DOHC Turbo 4G63

Fits: 1989-Mid '92 Eclipse

Can be used with Front and All-Wheel Drive

- Aluminum with 3/8" thick billet aluminum pan rail provides a rigid flange for leak-free sealing; accommodates stock pan gasket
- Trap door baffles provide adequate oil control in Drag & Road Racing
- Built-in mounting flange allows the use of the stock turbo drain tube
- 1/2" NPT bung accommodates oil temperature sender
- Includes mounting kit with hex-drive studs and serrated-face flare nuts
- Magnetic drain plug included

PART # DESCRIPTION

20960 Oil Pan, Aluminum, Fully Fabricated, Kicked-Out Sump

PART # RECOMMENDED PICKUP

Use Stock Oil Pump & Pickup

PART # AVAILABLE OPTION

38366 Oil Pan Stud Kit

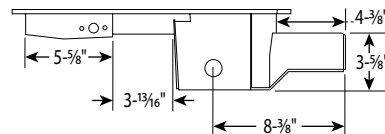
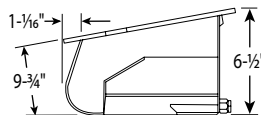
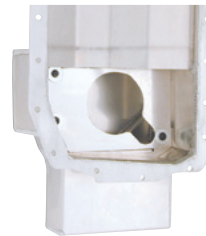
**No. 20960****MITSUBISHI EVO 7, 8, 9, ROAD RACE BAFFLED**

Aluminum, Wet Sump, 6.5 Quart Capacity

Engine Application: Mitsubishi 4G63T I4 Race Baffled

Fits: 2001-'07 Mitsubishi Evo, 7, 8, 9 with aftermarket lower intercooler pipe

- Has a 3/8" thick billet aluminum oil pan rail with a fabricated aluminum sump that is 3/4" deeper than the stock oil pan
- Features a race-proven, trap door assembly and an anti-slosh baffle that keeps oil contained in the oil pump pickup area during road racing and drag racing
- To free up horsepower and to help with oil temps, the oil pan also features a removable windage tray and crank scraper
- Holds 1.5 more quarts than stock, 6.5 quart capacity
- Has an accommodation for stock or aftermarket oil return lines
- Includes a heavy duty, bolt-on oil pump pickup
- Magnetic drain plug and a mounting kit comprised of hex drive steel studs and serrated flange nuts are included
- Uses stock dipstick
- 1/2" NPT fitting for oil temperature sender

PART # DESCRIPTION

20967 Oil Pan, Fabricated Aluminum, Race Baffled for Mitsubishi Evo, 7, 8, 9

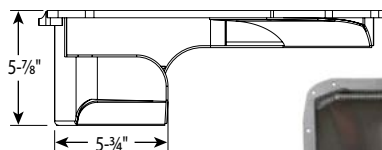
**No. 20967****MITSUBISHI EVO 10**

Aluminum, Race Baffled

Engine Application: Mitsubishi 4B11T engines

Fits: 2008-'16 Mitsubishi Evo 10, will fit with factory air conditioning

- Has a 3/8" thick billet aluminum oil pan rail with a fabricated aluminum sump
- Features a race-proven, three door assembly and removable anti-slosh baffle that keeps oil contained in oil pump pickup area during road racing and drag racing
- Holds 1.5 more quarts than stock
- 1/2" NPT fitting for oil temperature sensor and O-ring style drain plug
- Includes mounting kit with hex drive steel studs and serrated-faced flange nuts
- Reuses stock air conditioning hardware and bedplate

PART # DESCRIPTION

20969 Oil Pan, Fabricated Aluminum, Race Baffled for Mitsubishi Evo 10, 2008-16

PART # RECOMMENDED PICKUP

Use Stock Oil Pump & Pickup

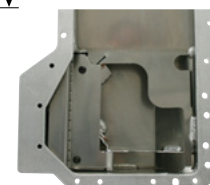
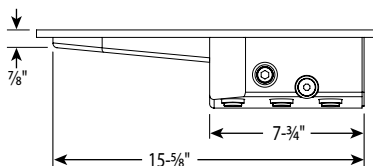
**No. 20969**

DATSUN/NISSAN L24, L26, L28

Steel, Wet Sump, 7 Quart Capacity, 6 1/4" Deep
 Engine Applications: Datsun/Nissan L24, L26, L28
 Fits: 240/260/280/280ZX '70-'83

- Oil pan is fully fabricated steel with a thick pan rail and a clear zinc finish
- Features a race proven trap door assembly that keeps oil contained in oil pump pickup area during road racing and track events
- Windage Tray/Anti-Slosh baffle prevents oil from splashing back to the rotating assembly, robbing vital horsepower
- Magnetic drain plug



No. 20976



PART #	DESCRIPTION
20976	Oil Pan, Steel, Road Race Baffled, Datsun/Nissan L24, L26, L28
PART #	RECOMMENDED PICKUP
24976	Fits: Stock Oil Pump

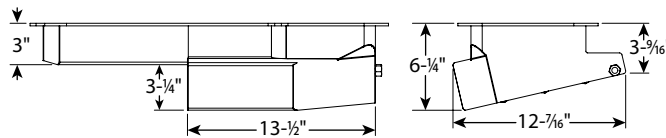

NISSAN SR20, RWD

Aluminum, Wet Sump, 4.75 Quart Capacity, Stock Depth
 Engine Application: Nissan SR20, RWD

- Dual internal baffling insures oil control not present in OE oil pan
- For use in Road Racing, Drifting and Drag Racing
- Bolt-in upgrade replaces OEM steel pan
- 1/4" aluminum rail
- Metric studs and nuts included
- Oil temperature provision (1/2" NPT bung)
- Magnetic drain plug included



No. 20975

PART #	DESCRIPTION
20975	Oil Pan, Aluminum
PART #	RECOMMENDED PICKUP
	Use Stock Oil Pump & Pickup
PART #	AVAILABLE OPTION
38366	Oil Pan Stud Kit

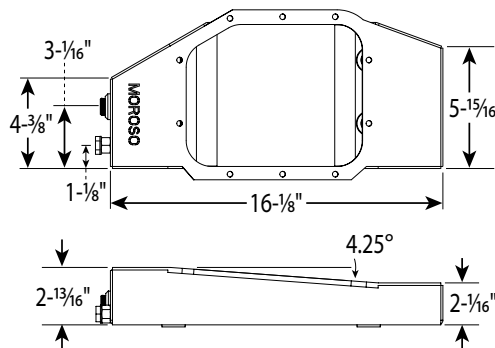

NOTE: Oil Pan Capacities DO NOT include oil filter capacity. All Moroso Pans include a Magnetic Drain Plug.



OIL PANS

IMPORT

SUBARU EJ20, EJ22 & EJ25

Aluminum, Wet Sump, 5 Quart Capacity, Competition Baffled

for Rally, Road Race, Drag Race and Sand Rail

Engine Application: Subaru EJ20, EJ22 & EJ25

Fits: Subaru Impreza 1993-2007, Legacy 1990-2009 and Forester 1997-2008
and universal applications such as Sand Rails & F.F. 818

- One-piece $\frac{3}{8}$ " thick billet aluminum oil pan rail provides a rigid flange for leak-free sealing
- Baffled for Rallying, Road & Drag Racing
- Bottom of oil pan is finned for heat dissipation
- Windage tray for increased horsepower saving and oil control
- $\frac{1}{2}$ " NPT fitting that can be used for crank case ventilation or for head drainback
- $\frac{1}{2}$ " NPT fitting for oil temperature sender
- Oil pan gasket (Fel Pro® # 30656) included
- Uses factory dipstick
- High-grade mounting hardware included
- Includes heavy duty, braced oil pump pickup Part No. 24965 with O-ring

PART # DESCRIPTION
20965 Oil Pan, Aluminum with Billet Rail

PART # AVAILABLE OPTION
38366 Oil Pan Stud Kit

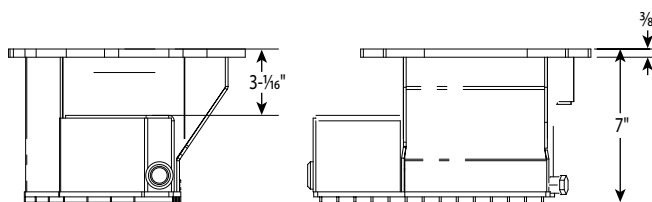
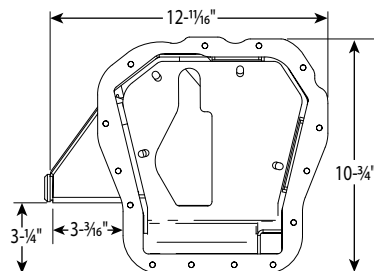

No. 20965

**SUBARU EJ20, EJ22 & EJ25**

Steel/Aluminum, Wet Sump, 6 Quart Capacity, 6- $\frac{15}{16}$ " Deep

Engine Application: Subaru EJ20/EJ22/EJ25

Fits: Subaru WRX 2002-2014, STI 2004-2019, Legacy 2004-2009, Forester 2004-2008 and Universal Applications such as the F.F. 818 and Sand Rails.
On earlier model Subaru(s), check chassis and oil pan dimensions for compatibility

- Designed to work with all popular header combinations currently available
- Aluminum version features a billet rail, steel version has a laser-cut rail
- Anti-slosh baffle for increased horsepower savings and oil control
- Uses factory dipstick
- $\frac{1}{2}$ " NPT fitting for air/oil separator or turbo drain back
- Oversize O-ring style drain plug for ease of oil draining
- Includes heavy duty, braced oil pump pickup with O-ring

PART # DESCRIPTION
20966 Oil Pan, Steel, Clear Zinc
20968 Oil Pan, Fabricated Aluminum



No. 20966



No. 20968

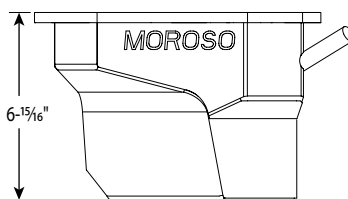

NOTE: Oil Pan Capacities DO NOT include oil filter capacity. All Moroso Pans include a Magnetic Drain Plug.

TOYOTA

Aluminum, Wet Sump, 6 Quart Capacity, 5-1/4" Deep
Engine Application: 3C, 2T and 2C engines
For engine swaps, check dimensions for clearance

- Aluminum with 1/4" thick billet aluminum pan rail
- Trap door baffling for Road & Drag Racing
- Louvered windage tray maximizes horsepower and de-aerates oil
- A separate sump tray helps prevent oil from splashing back and de-aerates oil returning from the turbo
- Includes (2) 1/2" NPT bungs for turbo oil return line and temperature sender
- Two magnetic drain plugs facilitate oil draining when the engine is canted left or right
- Includes mounting hardware



No. 20930

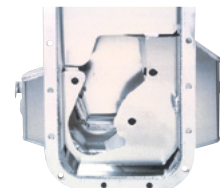

PART # DESCRIPTION
20930 Oil Pan, Aluminum, Kicked-Out Sump

PART # RECOMMENDED PICKUP
 Use Stock Oil Pump & Pickup

PART # AVAILABLE OPTIONS

- 23210** Windage Tray
- 38356** Oil Pan Stud Kit

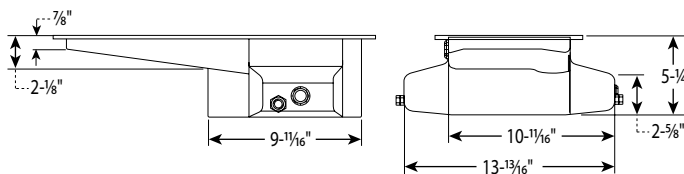

TOYOTA

Aluminum, Wet Sump, 6.25 Quart Capacity, 7-9/16" Deep
Engine Application: Model #3SGT 2.0L Turbo and 5SFE Non-Turbo
Fits: 1990-'95 MR2, Celica and All Track

- Aluminum with 1/4" thick billet aluminum pan rail
- Trap door baffling ensures oil control in Road & Drag Racing
- Solid windage tray with oil drain & dipstick cut out holes prevents oil from splashing back to the rotating assembly, robbing vital horsepower
- Front of pan has 28mm threaded bung for turbo drain back connection
- 3/8" thick billet receptacle for the factory oil level sensor
- Includes mounting hardware



No. 20935



PART # DESCRIPTION
20935 Oil Pan, Aluminum, Kicked-Out Sump

PART # RECOMMENDED PICKUP
 Use Stock Oil Pump & Pickup

PART # AVAILABLE OPTION
38366 Oil Pan Stud Kit

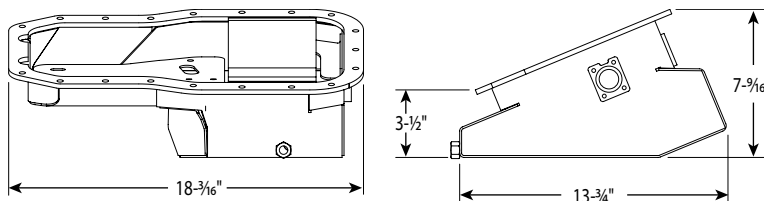

NOTE: Oil Pan Capacities DO NOT include oil filter capacity. All Moroso Pans include a Magnetic Drain Plug.



OIL PANS

IMPORT

OIL PAN, TOYOTA 2RZFE, 3RZFE

Aluminum, Wet Sump, 5 Quart Capacity, 5-1/2" Deep

Engine Applications: Toyota 2RZFE, 3RZFE

For engine swaps, check dimensions for clearance

- Aluminum with 1/4" thick billet aluminum pan rail
- Features a race proven trap door assembly and anti-slosh baffle that keeps oil contained in oil pump pickup area during drag racing and road racing
- Windage tray with oil drain & dipstick cut out holes prevents oil from splashing back on to the rotating assembly, robbing vital horsepower
- 1/2" NPT fitting for supercharger or turbo drain back
- Magnetic drain plug

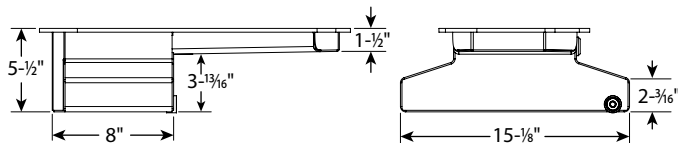
PART # DESCRIPTION**20936** Oil Pan, Fabricated Aluminum, Toyota 2RZFE, 3RZFE, Race Baffled**PART # RECOMMENDED PICKUP****24936** Fits: Stock Oil Pump & Pickup**No. 20936****OIL PAN, TOYOTA 2RZFE, 3RZFE EXT. -12 AN PICKUP**

Engine Applications: Toyota 2RZFE, 3RZFE

For engine swaps, check dimensions for clearance

- Aluminum with 1/4" thick billet aluminum pan rail
- Features a race proven trap door assembly and anti-slosh baffle that keeps oil contained in oil pump pickup area during drag racing and road racing
- Solid windage tray with oil drain & dipstick cut out holes prevents oil from splashing back to the rotating assembly, robbing vital horse horsepower
- Has a -12AN external oil pump pickup
- 1/2" NPT fitting for supercharger or turbo drain back
- Magnetic drain plug

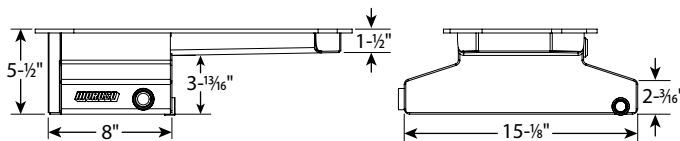
PART # DESCRIPTION**20937** Oil Pan, Fabricated Aluminum, Race Baffled, Toyota 2RZFE, 3RZFE Ext. -12 AN Pickup**PART # AVAILABLE OPTIONS****23961** -12AN Filter Pickup Fittings**23963** -16AN Filter Pickup Fittings**No. 20937****NOTE:** Oil Pan Capacities DO NOT include oil filter capacity. All Moroso Pans include a Magnetic Drain Plug.

TOYOTA-LOTUS ELISE

Aluminum, Wet Sump, 6 Quart Capacity, Stock Depth

Engine Application: 1ZZ/2ZZ Engines, Lotus, Elise

Fits: 2000-'05 Toyota, Celica, Front Wheel Drive, 1999-'05 US,
1999-'07 J.D.M. Japanese Toyota MR2 mid engine cars,
2004-Up Lotus Elise

- Manufactured from thick aluminum
- Internal baffling insures oil control not present in a OE oil pan
- Baffled for Road Racing, also an excellent Drag Race oil pan
- Can be used as a bolt-in replacement for the stock pan
- $\frac{3}{8}$ " Billet Aluminum rail
- Metric studs and nuts included
- Turbo drain, $\frac{1}{2}$ " NPT bung for turbo drainback
- $\frac{1}{2}$ " NPT bung for oil temperature provision

PART # DESCRIPTION

20970 Oil Pan, Billet Aluminum, Wet Sump, Toyota-Lotus

PART # RECOMMENDED PICKUP

Use Stock Oil Pump & Pickup

PART # AVAILABLE OPTION

38366 Oil Pan Stud Kit

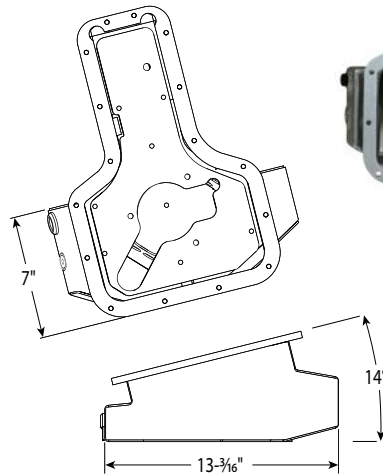
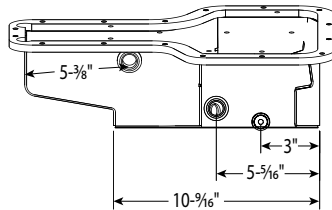
**No. 20970****TOYOTA 2GR-FE/Z, LOTUS EVORA**

Aluminum, Wet Sump, 6.25 Quart Capacity, Stock Depth

Fits: 2010-Up 2GR-FE/Z swaps into MR2 Lotus Evora Supercharged and
Non-Supercharged

- $\frac{3}{8}$ " Thick Billet Aluminum Rail with integral O-ring
- Features a race proven trap door assembly and a removable anti-slosh baffle that keeps oil contained in the oil pump pickup area during road racing and drag racing
- Designed to be used with the factory oil pump pickup
- Two -10 AN female fittings with bungs for supercharger or turbo drain back
- $\frac{1}{8}$ " NPT fitting for oil temperature sender
- O-ringed magnetic drain plug
- Includes 6mm mounting studs and nuts

PART # DESCRIPTION

20971 Oil Pan, Aluminum, Race Baffled

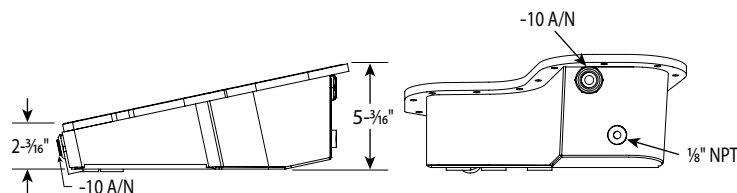
**No. 20971**

OIL PANS, VALVE COVERS, OIL TANKS & MORE

*Mori J2 Seiki
NV5000
Vertical
Machining
center.*

*Dry
Sump
Tanks*



**PUT OUR EXPERIENCE
TO WORK FOR YOU!**

The **Mori J2 Seiki NV5000 Horizontal Machining Center** (shown above) in our machine department provides significant cycle time reduction and improved surface finishes due to a 12,000 RPM spindle, "through the tool" coolant capability and new chip removal technology.

This state-of-the-art equipment provides Moroso customers with the latest in innovative valve cover and oil pan rails, end seals, water pump bodies and impellers, wet and dry sump oil pump components as well as a myriad of billet adapters and bracketry.

This advanced machining capability goes hand-in-hand with our CNC punch and press brakes to enhance the ability of Moroso Performance to produce state-of-the-art custom and production oil pans, valve covers, oil tanks and **virtually any race part that can be imagined.**



*Cup
Oil Pans*



*Pro Stock
Oil Pans*

*Fabricated
Valve Covers*





SOLD TO

Name _____
Attn: _____
Address: _____
City, State, Zip _____
Phone _____ Fax _____
Email: _____

All Custom Orders Must be PrePaid in Full

Please contact Sales Department with your Credit Card Info., we accept Visa/MC/Discover

ENGINE SPECIFICATIONS

Block Manufacturer: _____ Block Model No.: _____
Displacement: _____ Rear Main Seal: _____ 1pc. _____ 2pc. _____
Stroke: _____ Rods: Alum. _____ Steel _____
Starter Location: Passenger _____ Driver _____ None _____
Starter Mfr.: _____
Starter Model: _____ Flywheel - Number of Teeth: _____

OIL PAN CONFIGURATION

Oil Pan Application/Type of Racing: _____
Material: Steel _____ Alum. _____
Pan Style: Wet Sump _____ Dry Sump _____ External Pump _____
One piece or Two piece Oil Pan: _____
Oil Pan Depth: Front _____ Rear _____
Drain Plug Location: _____
Dip Stick Location: _____
Pump Style/Type Used: _____
Number of Pickups: Male _____ Female _____ Fitting Size _____
Location of Pickups: _____
Windage Tray Louvered or Screen: _____
Other Special Instructions: _____

Sketch oil pan on illustrations below. Include all pan dimensions where possible.

← Front of Oil Pan

Rear of Oil Pan →

Front View or Rear View, Please specify

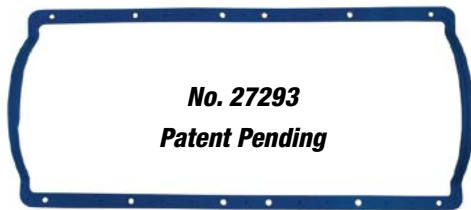
OIL PAN GASKETS*Race Quality**Why go searching for the right oil pan gasket for a Moroso oil pan? Now Moroso offers race quality, reinforced oil pan gaskets that have been verified by Moroso to work with our oil pans*

No. 27293
Patent Pending

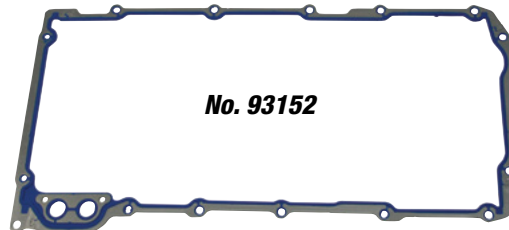

No. 93152



No. 93154

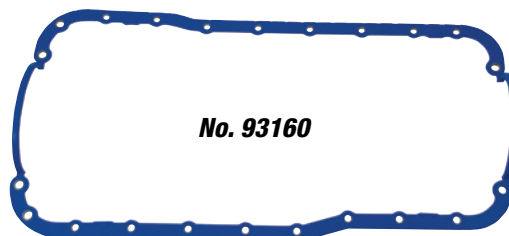

No. 93160

PART #	DESCRIPTION
27293	Oil Pan Gasket, One Piece Design, Steel Reinforced, Ford 7.3 Powerstroke 1994-2003 and International T444E
93150	Oil Pan Gasket, One Piece Design, Steel Reinforced, For SBC, Pre '85 Engine Block with 2 piece rear main seal
93151	Oil Pan Gasket, One Piece Design, Steel Reinforced, SBC '86-Up Engine Block Style with 1 piece rear main seal
93152	Oil Pan Gasket, One Piece Design, Steel Reinforced, GM LS Series (Except LS7 & LS9)
93153	Oil Pan Gasket, One Piece Design, Steel Reinforced, BBC Mark 4, notched for stroker cranks
93154	Oil Pan Gasket, One Piece Design, Steel Reinforced, BBC Gen 5 & 6
93156	Oil Pan Gasket, 4 Piece Design, BBC Mark 4, With Race Bolt Pattern
93160	Oil Pan Gasket, One Piece Design, Steel Reinforced, Ford 289-302 for oil pan core with a smooth rail*
93161	Oil Pan Gasket, One Piece Design, Steel Reinforced, Ford 289-302, for oil pan core with a dimpled rail*
93162	Oil Pan Gasket, One Piece Design, Steel Inserts, Ford 351W, for oil pan core with a smooth rail*
93163	Oil Pan Gasket, One Piece Design, Steel Reinforced, Ford 351W, for oil pan core with a dimpled rail*
93164	Oil Pan Gasket, One Piece Design, Steel Reinforced, Ford 4.6/5.4
93166	Oil Pan Gasket, One Piece Design, Steel Reinforced, Ford 460, for oil pan core with a smooth rail*
93167	Oil Pan Gasket, One Piece Design, Steel Reinforced, Ford 460, for oil pan core with a dimpled rail*
93174	Oil Pan Gasket, One Piece Design, Steel Reinforced, Chrysler 361-440, Hemi, KB, BAE & Wedge (not TFX)
93175	Oil Pan Gasket, One Piece Design, Steel Reinforced, Jeep 4.0L, 232, 242, 258
93200	Oil Pan Gasket, One Piece Design, Honda/Acura B-Series Oil Pans

UNIVERSAL DIPSTICK KIT

- Chrome plated Dipstick Kit fits Moroso and other oil pans with a built-in 1/4" NPT fitting
- 1/4" NPT steel weld-in fitting supplied for pans that do not already have that provision
- Existing "full" and "fill" dipstick marks can be used "as is" or new marks can be added to indicate desired oil level
- Tube and universal mounting tab can be bent or modified to accommodate engine compartment clearances and mounting location
- Seal keeps the dipstick secure in tube
- Dimensions: overall length including exposed portion of dipstick 24"



No. 25970

PART #	DESCRIPTION
25970	Universal Dipstick Kit, 1/4" NPT fitting and pan adapter

WARNING Prop. 65
This product contains a chemical known to the state of California to cause cancer, birth defects, or reproductive harm-



OIL PAN DIPSTICK

Flex Tube, Stainless Steel, Universal

Fits: Moroso Oil Pans with 1/4" NPT dipstick bung



No. 25971

- Oil Pan Dipstick features braided stainless flex tube with 1/4" NPT fitting and a machined aluminum handle
- Existing "full" and "fill" dipstick marks can be used as-is, or new marks can be added to indicate desired oil level
- Flexible tube and universal mounting tab can be bent or modified to accommodate engine compartment clearances and mounting location
- O-Ring seal keeps dipstick secured in tube and prevents crankcase gasses from escaping
- Dimensions: exposed portion of dipstick is 14" long, overall 20-3/4" long

WARNING Prop. 65
This product contains a chemical known to the state of California to cause cancer, birth defects, or reproductive harm-

PART # DESCRIPTION

25971 Oil Pan Dipstick, Flex Tube, Stainless Steel, Universal

UNIVERSAL DIPSTICK KIT

Twist-Lock

- Efficient twist-lock design eliminates oil leakage, blowing out of handle and prevents crankcase gasses from escaping
- In Dyno testing, engines equipped with our twist-lock dipstick pulled more vacuum than engines equipped with standard, non-locking dipstick
- High temperature nylon handle dissipates heat for checking oil level on hot engines
- Flexible stick; zinc-plated, bendable outer tube; adjustable clamp
- 1/4" NPT steel, weld-in fitting supplied for pans that do not already have that provision
- Existing "full" and "fill" dipstick marks can be used as-is, or new marks can be added to indicate desired oil level
- Tube and universal mounting tab can be bent or modified to accommodate engine compartment clearances and mounting location
- Dimensions: overall length, including exposed portion of dipstick 24"

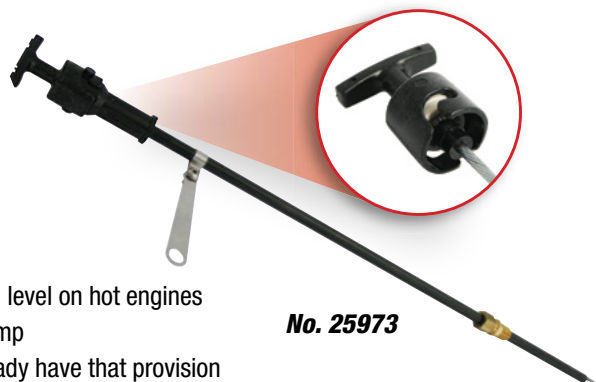

No. 25973

WARNING Prop. 65
This product contains a chemical known to the state of California to cause cancer, birth defects, or reproductive harm-

PART # DESCRIPTION

25973 Universal Dipstick Kit, Twist Lock

REPLACEMENT OIL PAN AND TRANSMISSION DRAIN PLUGS

- 3/4" hex head with 1/2" x 20 threads
- Replacement for Moroso Oil and Transmission Pans and others
- Extra strength, rare earth magnetic tip holds metal particles

PART # DESCRIPTION

97000 Oil Pan Drain Plug. Chrome-Plated. Includes Nylon Washer

97001 Oil Pan Drain Plug. Clear Zinc. Includes Nylon Washer

97002 Oil Pan and Transmission Drain Plug. Clear Zinc. Includes Copper Washer

WARNING Prop. 65
This product contains a chemical known to the state of California to cause cancer, birth defects, or reproductive harm-



No. 97000



No. 97002

OIL PAN DRAIN PLUG

14MM, 1.5 Thread

- 14 MM, 1.5 thread pitch with a 17 MM hex head
- Replacement for Moroso **Nos. 20911 & 20980**, also is an excellent drain plug upgrade to O.E.M. oil pans that take this thread size
- Strong Rare Earth Magnetic tip holds metal particles
- Zinc Finish
- Includes a Nylon washer



No. 97003

PART # DESCRIPTION

97003 Oil Pan Drain Plug, Zinc Finish

OIL PAN DRAIN PLUG, MAGNETIC

- 3/4" inch -16 thread (-8 AN) with O-Ring
- Replacement for Moroso Oil Pans with kick out designs



No. 97006

PART # DESCRIPTION

97006 Oil Pan Drain Plug, 1 per pack, Magnetic

REPLACEMENT DRAIN PLUG WASHERS

- High quality washers ensure a leak-free seal
- ½" I.D. x ⅞" O.D.
- Fits Moroso Drain Plug Nos. 97000 and No. 97001 and others

PART # DESCRIPTION

- 97010** Replacement Drain Plug Washers, Copper, Ten per Pack
97011 Replacement Drain Plug Washers, Nylon, Ten per Pack

**No. 97011****No. 97010****OIL PAN ACCESS PLUG**

- ¾" inch -16 thread (-8 AN) with O-Ring
- Replacement for Moroso Oil Pans with kick out designs

PART # DESCRIPTION

- 97005** Oil Pan Access Plug, Six per pack

**No. 97005****OIL PAN INSPECTION PLUG KIT**

- Allows sanctioning bodies to conduct post-race inspections of connecting rods without removing oil pan
- Kit is easy to install
- Includes steel fitting to be welded to side of oil pan and a removable, lightweight 1" NPT aluminum inspection plug

PART # DESCRIPTION

- 23970** Oil Pan Inspection Plug

**No. 23970****PLUG****20MM x 1.5, Male with Copper Washer**

- On certain models from GM and Ford, a low oil warning sensor screws into a 20mm female fitting in the O.E.M. oil pan
- Moroso Oil Pans Nos. 20179, 20185, 20569, 20570, 20571, 20572, 20574, 21811, 21812 and 21816 include the 20mm female fitting for the factory sensor
- This male plug is for use when the factory low warning sensor is not going to be utilized
- Includes a copper washer

PART # DESCRIPTION

- 22738** Plug, 20mm x 1.5, Male with Copper Washer

**No. 22738****-10AN MALE FITTING****Non-Weld**

- Non-weld kit, makes it easy to add a leak proof fitting to oil pans for oil returns, valve covers etc., without having to actually weld the fitting
- Perfect for adding a fitting to steel or aluminum with up to a ⅛" max. wall thickness
- O-ring seal to prevent leaks

PART # DESCRIPTION

- 22753** -10AN Male Fitting, Non-Weld

**No. 22753**

**REAR SEAL ADAPTERS**

- Converts one-piece rear main seal on 1986 and newer Small Block Chevy blocks to the old style, two-piece rear seal when installing the old style crankshaft in the newer style blocks
- Available for use with both new style oil pan (1986 and newer blocks with one-piece rear seal), and old style oil pan (pre-1980 blocks with driver-side dipstick)
- Manufactured from billet aluminum
- Includes fasteners

PART # DESCRIPTION

- 38315** Rear Seal Adapter, Small Block Chevy, use with new style oil pan (1986 and newer blocks with one-piece rear seal)
- 38415** Rear Seal Adapter, Small Block Chevy, use with old style oil pan (pre-1980 blocks with driver-side dipstick)

**No. 38315****OIL PAN SPACER KIT****Dart LS Next Non-skirted Engine Block**

- This oil pan spacer kit contains a right and left billet aluminum spacers, mounting hardware that is included in Moroso No. 20144 Dart LS Next Oil Pan Kit
- This spacer kit is designed to mount the following GM LS oil pans*; Moroso, O.E.M. or other aftermarket oil pans to DART LS Next engine blocks
- Billet Aluminum Spacers have a built in oil ring groove on the side that mounts between the spacer and the engine block, on the other side of the spacer is a smooth surface that oil pan gasket mounts between it and the oil pan
- Includes mounting hardware, billet aluminum spacers have mounting holes for A/C and P/S brackets

**No. 22934****PART # DESCRIPTION**

- 22934** Oil Pan Spacer Kit, Dart LS Next, non-skirted engine block

PART # AVAILABLE OPTION

- 93152** Oil Pan Gasket, GM LS Series (Except LS7 & LS9)

**Any oil pan besides Moroso Part Nos. 20144 or 20155 will require modification to itself or the oiling system*

CHEVROLET CRANKSHAFT WIPERS

- Removes excess oil from crankshaft to reduce horsepower-robbing windage
- .035" steel plate comes pre-fit so only slight amounts of material must be removed
- Trim to within .045" of the connecting rods and counterweights for best results

PART # DESCRIPTION

- 25800** Crankshaft Wiper, Small Block Chevy
- 25830** Crankshaft Wiper, Big Block Chevy

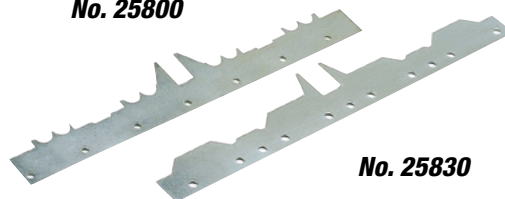
No. 25800**No. 25830****UNIVERSAL WINDAGE TRAY SCREEN**

- Keeps rotating assembly free of unwanted oil to reduce horsepower robbing windage
- Screen must be trimmed for each engine application

PART # DESCRIPTION

- 22912** Uni-Directional Windage Tray Screen, 23" x 16", Universal Application

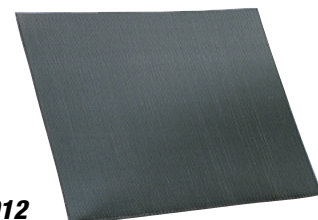
**No. 22912**

CHEVY V8 LOUVERED WINDAGE TRAYS

- Louvered design allows oil thrown from rotating assembly to drain into sump without splashing back
- Teflon coated for quick drainage
- Improved drainage reduces windage, increases power
- Mount with aftermarket stud kits or with stock extended main cap studs
- Fits Moroso Oil Pans, some trimming may be required

PART #	DESCRIPTION
23020	Louvered Windage Tray, SBC and 400 block, with either driver or passenger side dipstick
23030	Louvered Windage Tray, BBC, Mark IV

**No. 23020****No. 23030****CHEVY V8 OIL CONTROL KITS**

- Kits convert stock-type oil pan into competition style pan for proper oil control, consistent oil pressure and horsepower gain
- Includes Teflon coated windage tray, which attaches to stock type main cap studs with standoffs
- Also includes crankshaft scraper and bolt-on rear pan baffle
- Fits Moroso Oil Pans, some trimming may be required

PART #	DESCRIPTION
23035	Oil Control Kit, SBC with either driver or passenger side dipstick
23036	Oil Control Kit, BBC

**No. 23036****MAIN CAP BAFFLES**

- Mounts between rear main bearing cap and oil pump to prevent sump oil from reaching crankshaft during hard acceleration

PART #	DESCRIPTION
23000	Main Cap Baffle, Small Block and 90° V6 Chevy
23010	Main Cap Baffle, Big Block Chevy

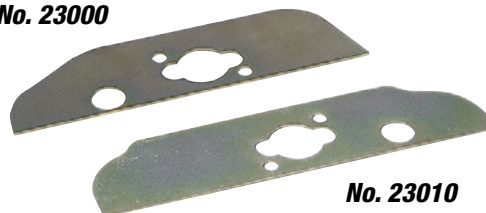
No. 23000**No. 23010**

NOTE: Baffles must be trimmed to fit oil pan

LOUVERED WINDAGE TRAY, GM LS ENGINE

Fits: GM LS Engines with GM Main Cap Studs & Moroso Rear Sump Oil Pans

- Louvered design allows oil thrown from rotating assembly to drain into sump without splashing back, reducing windage, increasing power and cutting down oil temperature
- Manufactured from 16 gauge steel
- Mounts right to the main caps
- Fits Moroso Oil Pan **Nos. 20139, 20140, 20141, 20142, 20143, 20145, 20147, 20148, 20149, 20150, 21150, 21152, 21153, 21157 and 21158**
- Must use Corvette C-6 Dipstick and tube Part Nos. 12570788 & 12570787

PART #	DESCRIPTION
22941	Louvered Windage Tray, LS Engine

Also a replacement part for Moroso Pan No. 21150

**No. 22941**



LOUVERED WINDAGE TRAY, GM LS

Fits: GM LS Engines with ARP Main Cap Studs and Moroso Rear Sump Oil Pans

- Louvered design allows oil thrown from the rotating assembly to drain into the sump without splashing back, reducing windage, increasing power and cutting down on oil temperature
- Manufactured from 16 gauge steel
- Mounts right to the main caps with the customer supplied ARP Main Stud Kits
- Fits Moroso Oil Pan **Nos. 20139, 20140, 20141, 20142, 20143, 20145, 20147, 20148, 20149, 20150, 21150, 21152, 21153, 21157** and **21158**
- Must use Corvette C-6 Dipstick and tube Part Nos. 12570788 & 12570787

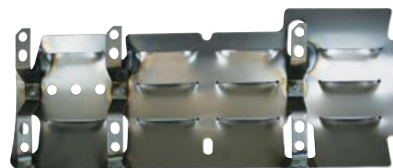

No. 22943

PART # DESCRIPTION

22943 Louvered Windage Tray, GM LS with ARP Main Cap Studs, for Rear Sump

LOUVERED WINDAGE TRAY

Fits: Ford 302 Engines with Rear Sump Oil Pans

- Louvered design allows oil thrown from rotating assembly to drain into sump without splashing back, reducing windage and increasing power
- Mount with Moroso Windage Tray Stud Kit **No. 38191**

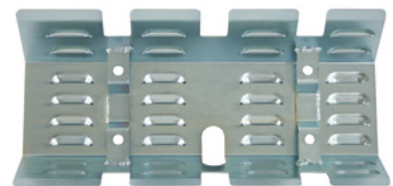

No. 22930

PART # DESCRIPTION

22930 Louvered Windage Tray, Ford 302

**NOTE: Will not fit 4-bolt engine blocks such as: Ford Boss 301, 302 Ford R302 and Dart*

LOUVERED WINDAGE TRAY

*Fits: Ford 351W/SVO with Rear Sump Oil Pans**

- Louvered design allows oil thrown from rotating assembly to drain into sump without splashing back, reducing windage and increasing power
- Mount with Moroso Windage Tray Stud Kit **No. 38192**

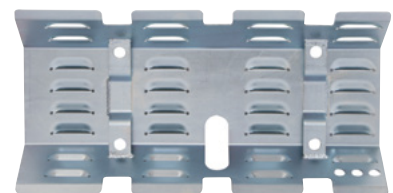

No. 22935

PART # DESCRIPTION

22935 Louvered Windage Tray, Ford 351W

**NOTE: Will fit Dart 4 bolt engine blocks by slotting the mounting holes*



Windage Tray Mounting Stud Kits on pg. 216

LOUVERED WINDAGE TRAY

Fits: Ford 351C & 351M Engines with Rear Sump Oil Pans

- Louvered design allows oil thrown from rotating assembly to drain into sump without splashing back, reducing windage and increasing power
- Mount with Moroso Windage Tray Stud Kit. **No. 38192**

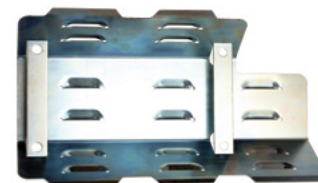

No. 22939

PART # DESCRIPTION

22939 Louvered Windage Tray, Ford 351C & 351M

HIGH-PRESSURE OIL PUMP RELIEF SPRING

Designed by Jack Roush

Fits: Ford 351C & 400 Engines

- Fits Melling M84A and M84AHV oil pumps
- Increases oil pressure to approximately 100 psi for proper lubrication under sustained high rpm conditions



No. 22850

PART # DESCRIPTION

22850 High-Pressure Oil Pump Relief Spring, Ford 351C and 400

LOUVERED WINDAGE TRAY

Fits: Ford 4.6/5.4

- Fits both stock* and aftermarket oil pans
- Louvered design allows oil thrown from the rotating assembly to drain into the sump without splashing back, reducing the windage and increasing power
- Features dual cylinder bank drain back for superior oil control and horsepower gains
- Goes between the engine block and oil pan
- Constructed out of 14 gauge steel with a clear zinc finish
- Includes oil pan studs and nuts

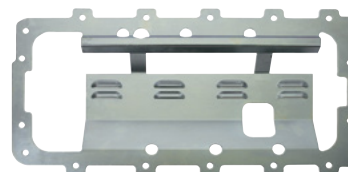
**No. 22933****PART # DESCRIPTION****22933** Ford 4.6/5.4 Louvered Windage Tray

***NOTE:** On some Mustang Cobra applications, diverters in factory oil pan and oil pump pickup need to be trimmed

WINDAGE TRAY AND OIL PAN GASKET

Fits: Ford 5.0 Coyote, 5.2 Voodoo

NEW!

- Required when installing a Moroso oil pan and oil pump pickup on a Gen. 3 engine or is a replacement windage tray/oil pan gasket on a Gen. 1 or Gen. 2 engine
- Goes between the engine block and oil pan

PART # DESCRIPTION**22936** Windage Tray & Oil Pan Gasket,
Ford 5.0 Coyote, 5.2 Voodoo**No. 22936****LOUVERED WINDAGE TRAY**

Fits: Ford 352-428 FE Engines

- Fits Moroso Oil Pan Nos. 20606, 20607, 20608 and 20609
- Louvered design allows oil thrown from rotating assembly to drain into sump without splashing back, reducing windage and increasing power

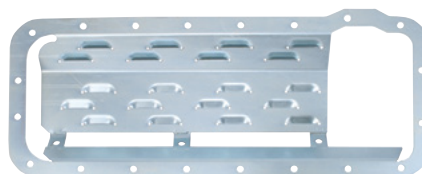
PART # DESCRIPTION**22940** Louvered Windage Tray, Ford 352-428 FE engines**No. 22940****MAIN CAP GIRDLE FOR 289-302 FORDS**

- Manufactured from 1/2" thick steel
- Girdle to be profiled to fit over engine main caps without the need of spacers
- Designed to work with up to a 3.40" stroke
- Includes necessary hardware
- Works with any standard Melling M68 or M68HV oil pump

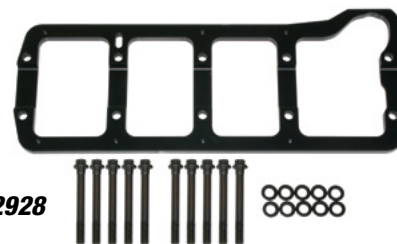
PART # DESCRIPTION**22928** Main Cap Girdle**No. 22928****OIL PAN BAFFLE KIT, HONDA S2000 AP1/AP2**

Trap Doors, Weld-In

Fits: Honda S2000, 1999-'09

- The Moroso Drop and Weld in trap door baffle assembly fits both AP1 and AP2 Honda S2000 oil pans
- The baffle assembly creates an oil containment area that is fed by 3 Trap Doors and 2 anti-slosh plates
- Constructed out of heavy gauge aluminum with aluminum trap doors
- Installation of the baffle assembly is accomplished by placing the self positioning assembly in a clean degreased factory S2000 oil pan and having the assembly stitch welded in by a proficient aluminum welder

PART # DESCRIPTION**23040** Oil Pan Baffle Kit, Honda S2000 AP1/AP2**No. 23040**



TOYOTA LOUVERED WINDAGE TRAY

Fits: Stock style oil pans used in Toyota 3TC, 2T & 2TC engines

- Louvered design directs oil into pickup area to prevent starvation, increases horsepower by preventing sump oil from splashing back onto rotating crank and rod assembly
- Mounts directly to front and rear main caps
- Includes notches to accept most stroke combinations



No. 23210

PART #	DESCRIPTION
23210	Louvered Windage Tray, Toyota 3TC, 2T & 2TC engines. Also a replacement part for Moroso Pan No. 20930

OIL PAN BAFFLE, SUBARU BRZ / SCION FRS / TOYOTA 86

- The Moroso Double Tier, Drop in baffle assembly fits the O.E.M. oil pan without modification by sandwiching between the engine block and oil pan
- The baffle assembly with directional oil return flaps creates an oil containment area that keeps the oil pump pick up fed and oil off the rotating assembly to free up horsepower and cut down on oil temperatures
- Baffle Kit will help protect the engine from oil pressure surges in prolonged corners with high lateral G forces or long acceleration runs
- Constructed out of aluminum and comes with 2 sealing washers for the internal drain tubes

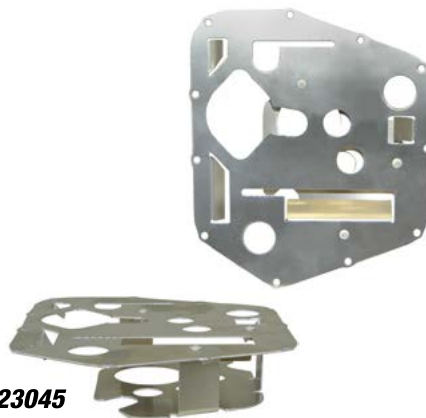

No. 23045

PART #	DESCRIPTION
23045	Oil Pan Baffle Kit, Subaru BRZ/SCION FRS/Toyota 86, DROP IN



Subaru/Scion/Toyota Baffle Assembly



- Keeps oil off the rotating assembly to free up horsepower & cut down oil temperature
- Creates an oil containment area that keeps the oil pump fed during cornering & acceleration
- Drops in O.E.M. oil pan

No. 23045

Fits: Subaru BRZ/Scion FRS/Toyota 86



REPLACEMENT WINDAGE TRAYS FOR MOROSO OIL PANS

Replacement Trays are available directly from Moroso for current and some obsolete oil pans. Please allow plenty of time when ordering. Call our **Tech Support Department** for more specific product information.

Moroso, the leader in oil system technology, has taken proven high volume oil pumps to the next level. Moroso engineers have incorporated the proven spur gear technology into a billet machined housing that solves the problems faced by today's racers. Broken pickups are a thing of the past for racers using Moroso's Small Block and Big Block Chevrolet Billet Oil Pumps.



No. 22171

SBC SPUR GEAR PUMP

High Volume

- 6061-T6 billet housing with 3 times larger mounting boss area to prevent breaking
- Weight 1 lb. less than stock oil pump with pickup
- Inlet area is increased to prevent cavitation
- Thrust bearing assembly increases housing and gear life due to drive shaft axial forces on the drive gear
- Pump will clear 4-1/4" stroke with most steel rods
- Engineered to fit 8-1/4" deep oil pans

PART #	DESCRIPTION
22171	Oil Pump, Billet, SBC, High Volume



WHAT DETERMINES WHICH OIL PUMP I NEED?

When choosing a spur gear or gerotor wet sump this is the most asked question. The answer is the oil pressure wanted and the additional amount of volume your engine requires. On Nitrous or Blown engines, additional oil pressure is desired. Our gerotor pump easily gives that extra amount by adjusting the bypass pressure. Many engines require more oil volume. Larger strokes and bigger valve train assemblies often require one to two gallons a minute more than required just five years ago. Typically an engine over 565 cu. in. can benefit by a gerotor pump, but a spur gear pump can maintain great oil pressure in 598 cu. in. Every engine has different requirements, and installing too big a pump can cause oil pressure problems by overworking the bypass assembly.



No. 22163



No. 22164

BBC SPUR GEAR PUMP

High or Standard Volume (Patent No. 5,810,571)

- 6061-T6 billet housing with 3 times larger mounting boss area to prevent breaking
- Weights 1 lb. less than stock oil pump with pickup
- Inlet area is increased to prevent cavitation
- Thrust bearing assembly increases housing and gear life due to drive shaft axial forces on the drive gear
- Pump will clear 4-3/4" stroke with most steel rods
- Engineered to fit 8" deep oil pans

PART #	DESCRIPTION
22163	Oil Pump, Billet Aluminum, BBC, High Volume
22164	Oil Pump, Billet Aluminum, BBC, Standard Volume



OIL PUMP DRIVE SHAFTS
ON PG. 125



No. 22167



BBC GEROTOR PUMP

High Volume

- 6061-T6 billet housing with 5.7 times larger mounting boss area to prevent breaking
- Hard Coated Finish
- 1.100" Gerotor puts out 25% more volume to maintain ideal oil pressure round after round
- External adjustment allows fine-tuning of oil pump bypass pressure
- Inlet area is increased to prevent cavitation
- Thrust bearing assembly increases housing and gear life due to drive shaft axial forces on the drive gear
- Pump will clear 5.25" stroke with most aluminum rods
- Engineered to fit 8" deep fabricated aluminum oil pans

PART #	DESCRIPTION
22167	Oil Pump, BBC, High Volume



OIL PUMPS

WET SUMP

OIL PUMP/PICKUP COMBINATIONS

Fits: SBC and BBC

- Package includes the Moroso pickup welded to the oil pump for a simple bolt-on installation
- Pickup orientation ensures proper clearance from pickup to bottom of any Moroso oil pan

**HEAVY
DUTY**

PART #	DESCRIPTION
22124	Oil Pump and Pickup Package, Small Block Chevy, Moroso Part No. 22099 Standard Volume Pump, Fits: 8-1/4" Deep Oil Pan
22134	Oil Pump and Pickup Package, Small Block Chevy, Moroso Part No. 22109 High Volume Pump, Fits: 8-1/4" Deep Oil Pan
22144	Oil Pump and Pickup Package, Small Block Chevy, Moroso Part No. 22109 High Volume Pump, Fits: stock 7-1/2" Deep Oil Pan
22175	Oil Pump and Pickup Package, Big Block Chevy, Moroso Part No. 22149 Standard Volume Pump, Fits: 8" Deep Oil Pan
22185	Oil Pump and Pickup Package, Big Block Chevy, Moroso Part No. 22159 High Volume Pump, Fits: 8" Deep Oil Pan
22186	Oil Pump and Offset Pickup Package, Big Block Chevy, Moroso Part No. 22159 High Volume Pump, Fits: 8" Deep Oil Pan
22195	Oil Pump and Pickup Package, Big Block Chevy, Moroso Part No. 22159 High Volume Pump, Fits: 7-3/4" Deep Oil Pan



No. 22124



No. 22134



No. 22144



No. 22175



No. 22185



No. 22186



No. 22195



OIL PUMPS

WET SUMP

SMALL BLOCK CHEVY 3/4" DIAMETER INLET OIL PUMP/PICKUP COMBINATIONS

- 3/4" Diameter inlet area reduces cavitation in high RPM applications
- Features a Moroso "Tough Neck" oil pump, a thick neck to guard against pump breakage
- Pickup orientation ensures proper clearance from pickup to bottom of any Moroso oil pan

PART # DESCRIPTION

- 22146** High Volume Small Block Chevy Oil Pump with 3/4" diameter inlet area and pickup for 8-1/4" deep oil pan
- 22147** High Volume Small Block Chevy Oil Pump with 3/4" diameter inlet area and pickup for 7-1/8" deep oil pan, for Oval Track applications. Fits Moroso Pan Nos. 21312, 21313, 21318, & 21319

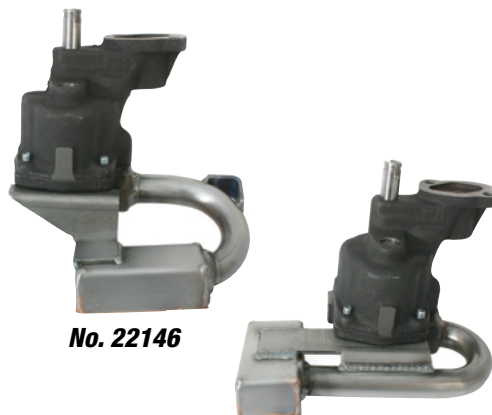
**No. 22146****No. 22147****SMALL BLOCK CHEVY 3/4" DIAMETER INLET OIL PUMP/PICKUP COMBINATION**

- 3/4" Diameter inlet area reduces cavitation in high RPM applications
- Pump and pickup are built to fit 8-1/4" deep oil pans. Will not work on "Rocket" blocks
- Drive shaft and idler shafts are extended to locate in the bottom cover, preventing dynamic shaft deflection
- Pickup orientation ensures proper clearance from pickup to bottom of any Moroso oil pan
- Bottom cover is doweled to properly locate the extended shafts
- A threaded plug blocks off bypass spring and cross-drilled relief hole

PART # DESCRIPTION

- 22139** High Volume Small Block Chevy Oil Pump with Heavy Duty Housing with anti-cavitation grooves

**No. 22139****BIG BLOCK CHEVY/OIL PUMP/PICKUP COMBINATION WITH WINDAGE SHIELD**

- To be used with Moroso Part Nos. 21049, 21047, 21048 and 21049 Chevrolet Big Block Oil Pans
- Package includes the Moroso pickup welded to the oil pump for a simple bolt-on installation
- Moroso Part No. 22159 High Volume oil pump is used
- Revolutionary windage shield was developed from extensive in house dyno sessions, at top engine builders and on the track by race teams
- The windage shield protects oil pump pickup from windage for steady oil pressure throughout RPM range
- Pickup orientation ensures proper clearance from pickup to bottom of any Moroso oil pan
- Offset pickup location for more consistent oil pressure under braking

PART # DESCRIPTION

- 22187** Oil Pump and Pickup Package, Big Block Chevy, 8" pan depth, high-volume pump

**No. 22187****OIL PUMPS****WET SUMP**

CHART LISTS THE MOROSO OIL PANS THAT NEED A MOROSO OIL PUMP PICK UP

* Please note that the oil pans that do not require a Moroso Oil Pump Pick up are not listed on this chart and would take a stock oil pump pick up

CHEVROLET SMALL BLOCK - INC. DART/ROCKET

MOROSO OIL PAN PART #	SBC, STANDARD VOLUME PUMPS MOROSO #22101 MEL. #M55 MEL. #M55A MEL. #M10553	SBC, HIGH VOLUME PUMPS MOROSO #22111 MEL. #M55HV MEL. #M10550 MEL. #10550ST	SBC, HIGH VOLUME PUMP MEL. #M155HV MEL. #M10551 MEL. #10551ST	SBC, HIGH VOLUME FLANGE STYLE PUMP MEL. #M10552 MEL. #M10555 MEL. #10552ST MEL. #10555ST	BBC, STANDARD VOLUME PUMPS MOROSO #22150 MEL. #M77 MEL. #M10774	BBC, HIGH VOLUME PUMPS MOROSO #22160 MEL. #M77HV MEL. #M10774HV
PART #	5/8" DIA. INLET	5/8" DIA. INLET	3/4" DIA. INLET	3/4" DIA. INLET	3/4" DIA. INLET	3/4" DIA. INLET
20110	24100	24330				
20160	24150	24340				
20165	24150	24340				
20170	24212	24213	24813	24185		
20171	24212	24213	24813	24185		
20172	24212	24213	24813	24185		
20179	24212	24213	24813	24185		
20180	24170	24350	24360	24181	24320	24320
20181	24170	24350	24360	24181	24320	24320
20182	24170	24350	24360	24181	24320	24320
20185	24212	24213	24813	24185		
20186	24170	24350	24360	24181	24320	24320
20190	24170	24350	24360	24181	24320	24320
20191	24170	24350	24360	24181	24320	24320
20193	24171	24351				
20195	24170	24350	24360	24181	24320	24320
20196	24170	24350	24360	24181	24320	24320
20200	24170	24350	24360	24181	24320	24320
20201	24170	24350	24360	24181	24320	24320
20205	24170	24350	24360	24181	24320	24320
20206	24170	24350	24360	24181	24320	24320
20210	24100	24330				
20211	24120	24122				
20212	24120	24122				
20230	24170	24350	24360	24181	24320	24320
21015	24170	24350	24360	24181	24320	24320
21017	24170	24350	24360	24181	24320	24320
21019	24171	24351				
21234	24170	24350		24181	24320	24320
21235	24170	24350	24360	24181	24320	24320
21237	24170	24350	24360	24181	24320	24320
21245	24171	24351				
21247	24170	24350		24181	24320	24320
21308		24308				



No. 22146



No. 22139



No. 22171



OIL PUMPS

WET SUMP

CHEVROLET SMALL BLOCK - INC. DART/ROCKET, CONTINUED

MOROSO OIL PAN PART #	SBC, STANDARD VOLUME PUMPS MOROSO #22101 MEL. #M55 MEL. #M55A MEL. #M10553	SBC, HIGH VOLUME PUMPS MOROSO #22111 MEL. #M55HV MEL. #M10550 MEL. #10550ST	SBC, HIGH VOLUME PUMP MEL. #M155HV MEL. #M10551 MEL. #10551ST	SBC, HIGH VOLUME FLANGE STYLE PUMP MEL. #M10552 MEL. #M10555 MEL. #10552ST MEL. #10555ST	BBC, STANDARD VOLUME PUMPS MOROSO #22150 MEL. #M77 MEL. #M10774	BBC, HIGH VOLUME PUMPS MOROSO #22160 MEL. #M77HV MEL. #M10774HV
PART #	5/8" DIA. INLET	5/8" DIA. INLET	3/4" DIA. INLET	3/4" DIA. INLET	3/4" DIA. INLET	3/4" DIA. INLET
21312	24103	24104	24318	24101		
21313	24103	24104	24318	24101		
21314	24314	24315				
21315	24314	24315				
21316	24316	24317				
21317	24316	24317				
21318	24103	24104	24318	24101		
21319	24103	24104	24318	24101		
21320	24316	24317				
21322	24316	24317				
21323	24316	24317				
21324	24316	24317				
21325	24314	24315				
21326	24314	24315				
21327	24314	24315				
21330	24103	24104	24318	24101	24325	24325
21804	24212	24213				
21808	24212	24213				
21811	24811	24814	24817		24819	
21812	24811	24814	24817		24819	
21813	24212	24213	24813	24185		
21814	24212	24213	24813	24185		
21815	24212	24213	24813	24185		
21816	24811	24814	24817		24819	

STEEL OIL PUMPS

SMALL BLOCK CHEVY HEAVY DUTY RACING OIL PUMPS

- More material and are thicker in the neck area than standard SBC oil pumps. Casting is like “older style” pumps with more material in the neck area
- Benefits of a stronger casting with the features and price that the racer is looking for
- Same oil pumps that are used in our SBC welded together Oil Pump/Pickup combinations

PART #	DESCRIPTION
22099	SBC Standard Volume, Oil Pump, 5/8" Inlet
22109	SBC High Volume, Oil Pump, 5/8" Inlet



No. 22099

BIG BLOCK CHEVY HEAVY DUTY RACING OIL PUMPS

- Same oil pumps that are used in our BBC welded together Oil Pump/Pickup combinations
- Have a long track record of providing solid performance at an appealing price point

PART #	DESCRIPTION
22149	BBC Standard Volume, Oil Pump
22159	BBC High Volume, Oil Pump



No. 22159



OIL PUMPS

WET SUMP

ANTI-CAVITATION RACING OIL PUMPS

Fits: SBC and BBC

- Moroso "Race" Oil Pumps are designed to accommodate consistent oil pressure and volume requirements for today's racing engine
- Moroso engineered anti-cavitation grooves into the pump housing to prevent pump chatter, which will lead to broken pickups and inconsistent oil pressure
- Anti-cavitation slots are machined to bleed oil back to the inlet side of the pump, and an enlarged bypass area ensure a smooth flow rate throughout any RPM range

PART #	DESCRIPTION
22101	SBC, Standard Volume
22111	SBC, High Volume
22150	BBC, Standard Volume
22160	BBC, High Volume



No. 22150

HEAVY DUTY



No. 22111

BIG BLOCK CHEVY/ANTI-CAVITATION BLUEPRINTED RACING OIL PUMP

Our Blueprinted Oil Pumps were developed in association with racing's most respected engine builders. Our CNC machined blueprinted oil pumps ensure the tightest tolerances and most consistent performance of any cast oil pump in its class that's produced.

Check Out All The Features:

- Anti-cavitation slots and enlarged feeder grooves are ball milled smooth, providing steady oil flow to each side of the gears for high RPM lubrication, cavitation relief and reduced spark scatter
- Distortion-free cast iron housing resists wear after extended use
- Parkerized™ coating retains oil for extra lubrication during break-in and cold starts
- Socket head screw makes it easy to change pressure; includes additional springs
- Individually tested with oil to ensure proper functionality

PART #	DESCRIPTION
22162	Blueprinted High Volume Racing Oil Pump, BBC

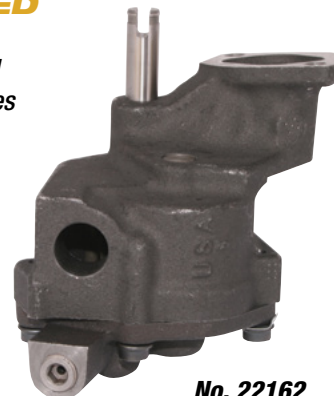

No. 22162

GM LS SERIES RACING OIL PUMP

Fits: Gen III and Gen IV, 4.8L, 5.3L, 6.0L, 6.2L

- Volume will increase by 18% over stock oil pumps
- Hard anodized coating for wear and performance
- Will fit with stock timing cover

PART #	DESCRIPTION
22120	Oil Pump, GM LS



No. 22120



OIL PUMPS

WET SUMP

GM LS SERIES, DART LS NEXT

MOROSO OIL PAN PART #	STOCK OIL PUMPS	HIGH VOLUME RACE PUMP MOROSO #24050	OIL PAN COMES WITH PICK UP
20105	KIT	KIT	YES
20138	24052	24052	NO
20139	24050	24050	NO
20140	24050	24050	NO
20141	24050	24050	NO
20142	24050	24050	NO
20143	24050	24050	NO
20144	24144	24144	NO
20145	24050	24050	NO
20146	24052	24052	NO
20147	24050	24050	NO
20148	24050	24050	NO
20149	24050	24050	NO
20150	24050	24050	NO
21149	24050	24050	NO
21150	24050	24050	YES
21151	GM PART# 12608579	GM PART# 12608579	NO
21152	24050	24050	NO
21153	24154	24154	NO
21158	24153	24153	NO
21159	24050	24050	NO
21340	21051	21051	NO

CHEVROLET BIG BLOCK - INC. DONOVAN, DRC2 & MERLIN

MOROSO OIL PAN PART #	STANDARD PICKUP LOCATION			OFFSET PICKUP LOCATION		
	BBC, STANDARD VOLUME PUMPS MOROSO #22150 MEL. #M77 MEL. #M10774	BBC, HIGH VOLUME PUMPS MOROSO #22160 MEL. #M77HV	BBC, HIGH VOL. BLUEPRINTED RACE PUMP MOROSO #22162 MEL. #M10770 MEL. #M10778	BBC, STANDARD VOLUME PUMPS MOROSO #22150 MEL. #M77 MEL. #M10774	BBC, HIGH VOLUME PUMPS MOROSO #22160 MEL. #M77HV	BBC, HIGH VOLUME PUMPS MOROSO #22162 MEL. #M10770 MEL. #M10778
PART #	3/4" DIA. INLET	3/4" DIA. INLET	3/4" DIA. INLET	3/4" DIA. INLET	3/4" DIA. INLET	3/4" DIA. INLET
20032	24446	24446	24446			
20376	24440	24440	24440	24441	24441	24441
20380	24440	24440	24440	24441	24441	24441
20385	24440	24440	24440	24441	24441	24441
20401	24440	24440	24440	24441	24441	24441
20403	24440	24440	24440	24441	24441	24441
20405	24440	24440	24440	24441	24441	24441
20406	24440	24440	24440	24441	24441	24441
20408	24440	24440	24440	24441	24441	24441
20409	24440	24440	24440	24441	24441	24441
20411	24440	24440	24440	24441	24441	24441
20412	24440	24440	24440	24441	24441	24441
20413	24440	24440	24440	24441	24441	24441
20416	24440	24440	24440	24441	24441	24441
20420	24440	24440	24440	24441	24441	24441
20421	24440	24440	24440	24441	24441	24441
20431	24430	24430	24430			
20433	24430	24430	24430			
20449	24448	24448	24448			
20451	24430	24430	24430			
20460	24450	24450	24450			
20485	24440	24440	24440	24441	24441	24441
21047	24440	24440	24440	24441	24441	24441
21048	24440	24440	24440	24441	24441	24441
21049	24440	24440	24440	24441	24441	24441
21600	24440	24440	24440	24441	24441	24441
21602	24440	24440	24440	24441	24441	24441
21604	24440	24440	24440	24441	24441	24441



OIL PUMPS

WET SUMP

OLDSMOBILE - 330-455

MOROSO OIL PAN PART #	HIGH VOLUME PUMP MEL. #M22F	HIGH VOLUME PUMP MEL. #M22MHV	MONDELLO HIGH VOLUME PUMP SP755
20480	24460		
21631		24463	24463

PONTIAC - 301-455

MOROSO OIL PAN PART #	HIGH PRESSURE PUMP MEL. #54DS	HIGH VOLUME PUMP MEL. #10541
20490	24480	24480
20500	24482	24482

CHRYSLER - 273-340, 360 & 360 MAGNUM

MOROSO OIL PAN PART #	STOCK OIL PUMPS	CHRYSLER 2468489 PUMP
20710	24700	24700
20730	24700	24700

CHRYSLER - 5.7-6.4 HEMI

MOROSO OIL PAN PART #	STOCK NON-MDS/VCT (UP TO '08)	STOCK NON-MDS/VCT (UP TO '08) OIL PUMPS WITH BED PLATE/GIRDLE	PART NOS. 68195993AC, 5038398AE, 53021622BF OIL PUMPS WITH NON-HELLCAT FRONT TIMING COVER	PART NO. 68195993AC OIL PUMP WITH HELLCAT FRONT TIMING COVER
21161	24161		24162	
21165			24165	
21166				24166
27601	24601	24602	24603	

CHRYSLER - 361-440 & 426 HEMI

MOROSO OIL PAN PART #	STOCK-STYLE B/RB PUMP 3/8-18 THREAD	STOCK-STYLE HEMI PUMP 1/2-14 THREAD
20760	24750	24800
20766	24766	

FORD - 289-302

MOROSO OIL PAN PART #	STOCK OIL PUMPS	STOCK OIL PUMPS WITH MAIN SUPPORT	MELLING PUMP #M68 #M68HV #M10688	MELLING PUMP #M68 #M68HV #M10688 WITH MAIN SUPPORT
20502	24520		24520	
20503	24523			
20506	24517	24518	24517	24518
20511	24516	24516	24516	24516
20521	24516	24516	24516	24516
20527	24527	24528	24527	24528
20528	24516	24516	24516	24516
20533	24527	24528	24527	24528
20535	24523		24523	



OIL PUMPS

WET SUMP

FORD - 351W-SV0

MOROSO OIL PAN PART #	STOCK OIL PUMPS	MELLING PUMP #M83, #M83HV, #M10833
20501	24507	24507
20507	24507	24507
20508	24501	24501
20520	24532*	24532*
20522	24515	24515
20523	24532	24532
20529	24532	24532
20532	24532*	24532*
20534	24534	24534
20536	24507	24507

* Does not fit World Products Man-O-War Engine Block

FORD - 4.6L & 5.4L

MOROSO OIL PAN PART #	OIL PAN USES STOCK 2V, 3V OR 4V OIL PUMP & PICKUP	STOCK OIL PUMP
20546	YES	
20548	YES	
20549	2V	24547
20549	4V	24548
20554	YES	
20555	YES	

FORD - 5.0L & 5.2L

MOROSO OIL PAN PART #	GEN I & II OIL PUMP PICKUP	GEN III OIL PUMP PICKUP
20569	24570	24577
20570	24570	24577
20571	STOCK	24578
20572	STOCK	24578
20573	24573	24576
20574	24574	24579
20575	STOCK	24578
20576	STOCK	24578
20577	24574	24579

FORD - 351C/351M & 400

MOROSO OIL PAN PART #	STOCK OIL PUMPS	MELLING PUMP #M84AHV
20530	24530	24530
20558	24558	24558

FORD - 352-428

MOROSO OIL PAN PART #	STOCK OIL PUMPS	MELLING PUMP #M57HV
20607	24608	24608
20608	24608	24608
20609	24609	24609

FORD - 429-460

MOROSO OIL PAN PART #	FORD MOTORSPORTS PUMP #M-6600-A460 MELLING #M84D/84DHV
20612	24504
20614	24511
20616	24505/24522
20620	24509
20625	24508



OIL PUMPS

WET SUMP

IMPORT

OIL PAN PART #	STOCK OIL PUMP 1.8 VTEC ENGINES	STOCK OIL PUMPS	STOCK OIL PUMPS OPTIONAL PICK UP	OIL PAN USES STOCK OIL PUMP & PICK UP	OIL PAN COMES WITH PICK UP
20901	24010	24011		NO	NO
20910				YES	NO
20911				YES	NO
20912	24012	24012		NO	NO
20915				YES*	NO
20916				YES*	NO
20917				YES	NO
20919				YES*	NO
20930				YES	NO
20935				YES	NO
20936			24936	YES	NO
20940				NO	YES
20942				YES	NO
20960				YES	NO
20965			24965	NO	YES
20966				NO	YES
20967				NO	YES
20968				NO	YES
20969				YES	NO
20970				YES	NO
20975				YES	NO
20976			24976	YES	NO

*To be used with Acura RSX oil pump assembly, OEM Part # 15100-PRB-A01, oil pump assembly might require slight notching to clear certain K-Series main caps

OIL PUMP PICKUP & ACCESSORIES

U-WELD-IT EXTENDED OIL PUMP PICKUPS

- U-Weld-It Kits can be tailored for either standard or high volume pumps
- Use in oil pans up to 10-3/4" deep
- Intended for Street/Strip use

PART #	DESCRIPTION
24861	U-Weld-It Extended Oil Pump Pickup, Small Block and 90° Chevy V6. Includes: one 5/8" tube, one bracket, one box, two 1/4" -20 x 3/4" allen head screws, two hex head cap screws and two 1/4" lock washers
24862	U-Weld-It Extended Oil Pump Pickup, Big Block Chevy. Includes one 3/4" tube, one bracket, one box



EXTERNAL OIL PUMP PICKUP KIT, STEEL OIL PANS

- Complete kit includes everything needed to convert steel wet sump oil pan for use with external pump
- Includes screened pickup box, pickup tube and specially machined -12AN fitting
- Adapts to a variety of pans, welding required
- Recommended for wet sump pans with power kickouts

PART #	DESCRIPTION
24840	External Oil Pump Pickup Kit, Steel Oil Pans



EXTERNAL OIL PUMP & DRY SUMP PICKUP KITS, TO ADD PICKUP TO ALUMINUM OIL PANS

- Complete kit includes everything needed to convert an aluminum wet sump oil pan for use with external oil pump
- Includes 7" long billet aluminum slotted pickup tube, mounting foot, and removable/cleanable male A.N. fitting
- Also makes a convenient way to add extra pickup to an aluminum dry sump oil pan
- Adapts to a variety of oil pans, welding required

PART #	DESCRIPTION
24865	External Oil Pump Pickup Kit, Aluminum Pans, -12AN Male Fitting
24866	External Oil Pump Pickup Kit, Aluminum Pans, -16AN Male Fitting



WARNING Prop. 65
This product contains a chemical known to the state of California to cause cancer, birth defects, or reproductive harm.

No. 24865



OIL PUMPS

WET SUMP

OIL PUMP PICKUPS, SUBARU

- Designed to replace factory oil pump pickups which have had cases of failure
- These Heavy Duty designs have thicker tubing and flanges, plus the pickup box and bracket are constructed out of thicker steel with a zinc plated finish
- Mates to oil pump exactly like the factory pickup and includes an O-Ring

PART#	DESCRIPTION
24964	Oil Pump Pickup, Subaru '02-'05 WRX O.E.M. Oil Pans
24965	Oil Pump Pickup, Subaru EJ25 Turbo Applications, '04-'05 STI, '06-Up WRX, STI, Forester, Baja, Fits Moroso No. 20965 & O.E.M. Configuration Oil Pans

No. 24964



No. 24965



No. 22070



No. 22077



No. 22090



No. 22072



No. 22074

OIL PUMP DRIVE SHAFTS

- High-quality steel for extended reliability, with steel sleeve
- Steel sleeve is pinned to maintain correct alignment between oil pump and shaft

PART #	OVERALL LENGTH	APPLICATION	PUMP DRIVE	USE ON PUMPS
22070*	5.985"	SBC, Chevy V-6 (Stock)	Blade	22101, 22111, 22124, 22134, 22171,
22080	6.691"	BBC, Stock Height	Blade	22150, 22160, 22144, 22175, 22185, 22162, 22163
22082	7.153"	BBC, .400" raised cam	Blade	22150, 22160, 22144, 22175, 22185, 22163
22090*	5.878"	SBC using BBC Pump	Blade	22150, 22160, 22144, 22175, 22185, 22163
22072	7.353"	BBC DART Block, .600" raised cam	Blade	22150, 22160, 22144, 22175, 22185, 22163
22074	9.136"	BBC, .400" raised cam	Hex	22167
22077	6.394"	SBC DART Block, .391" raised cam	Blade	22101, 22111, 22124, 22134, 22171

*400 cubic inch small block requires the oil pump drive shaft opening to be machined to $\frac{1}{16}$ "



Dry Sump Oiling Systems are the safest, most dependable oiling systems available. They're popular in all forms of racing, especially where low chassis height is important for good handling. Horsepower gain is maximized because there is virtually no oil in the pan and no internal pump, allowing the windage tray or screen to run the full length of the pan. Other advantages of a dry sump system include a remotely mounted oil tank for increased capacity, the ability to easily add remote oil coolers, more consistent oil pressure, adjustable oil pressure, improved scavenging and increased ring seal due to greater pan vacuum.

TYPICAL 4 STAGE DRY SUMP SYSTEM

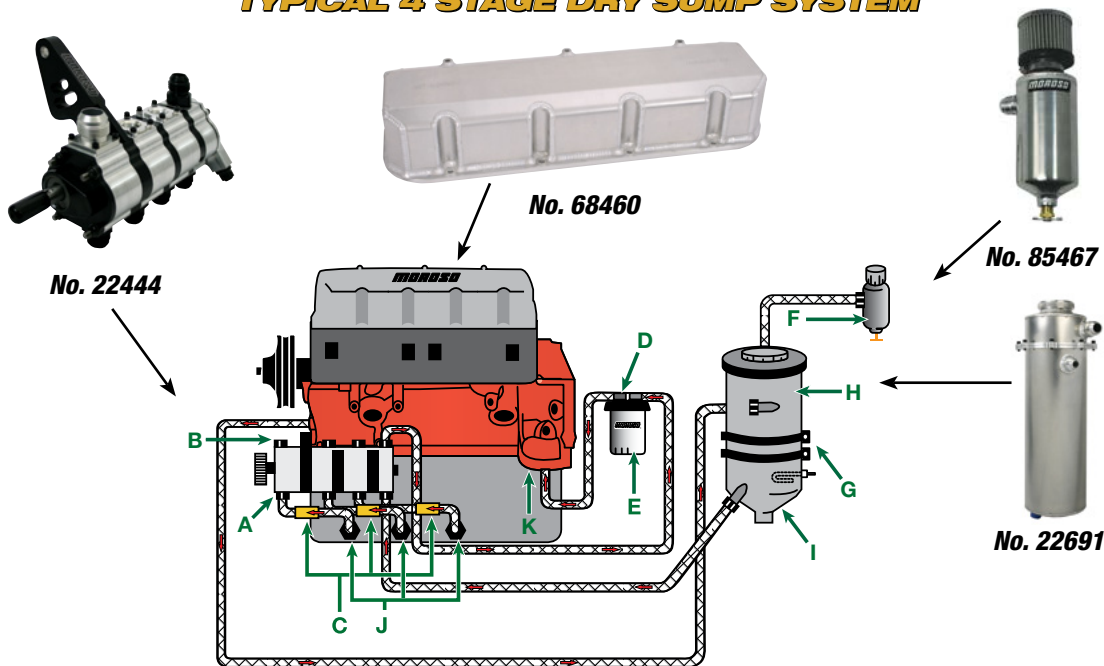

CATEGORY	PART # AND DESCRIPTION	CATEGORY	PART # AND DESCRIPTION		
A Dry Sump Oil Pumps	No. 22343, Tri-Lobe, Door Car, 3 Stage	Oil Preheaters	No. 23980, In Tank w/ Aluminum Fitting		
	No. 22443, Tri-Lobe, Dragster, 3 Stage		No. 23990, In Tank w/ Steel Fitting		
	No. 22253, Door Car, 3 Stage		No. 23995, External Heating Pad, 6" x 12"		
	No. 22523, Dragster, 3 Stage		No. 23996, External Heating Pad, 5" x 7"		
	No. 22344, Tri-Lobe, Door Car, 4 Stage		No. 23997, External Heating Pad, 2" x 15"		
	No. 22444, Tri-Lobe, Dragster, 4 Stage		H Oil Tanks	No. 22681, 13", 5 qt., (1) -16AN w/o Integral Breather	
	No. 22254, Door Car, 4 Stage			No. 22682, 13", 5 qt., (1) -16AN w/ Integral Breather	
	No. 22524, Dragster, 4 Stage			No. 22682, 13", 5 qt., (3) -12AN w/o Integral Breather	
	B Pump Fittings			No. 22741, Replacement Fitting -10AN	No. 22684, 13", 5 qt., (3) -12AN w/ Integral Breather
				No. 22742, Replacement Fitting -12AN	No. 22686, 15", 6 qt., (1) -16AN w/o Integral Breather
No. 22743, Replacement Fitting -16AN		No. 22687, 15", 6 qt., (1) -16AN w/ Integral Breather			
No. 22744, Replacement Fitting -16AN W/-12 AN		No. 22688, 15", 6 qt., (3) -12AN w/o Breather			
C In-Line Screened Oil Filters	No. 23850, -10AN fittings, 5/8"	No. 22689, 15", 6 qt., (3) -12AN w/ Integral Breather			
	No. 23860, -12AN fitting, 3/4"	I Filter Fittings		No. 23960, 3/4" NPT Male to -12AN Male	
	No. 23870, -8AN fitting, 1/2"			No. 23961, -12AN Male to -12AN Male	
D Remote Filter Mounts	Nos. 23700/23710, Ford/Chrysler Style		J Filter Block-Off/ Bypass Plates	No. 23690, Filter Adaptor, Chevy	
	Nos. 23750/23760, Chevy Style			No. 23770, Bypass, SBC & BBC	
E Racing Oil Filters	No. 23766, Large Diameter Style			No. 23782, Bypass, Merlin Block	
	No. 22459, Chevy, 4-5/32" high			No. 23780, Block-Off SBC & BBC	
	No. 22460, Chevy, 5-1/4" high			No. 23840, Block-Off BBC (Gen V)	
	No. 22461, Chevy, 8" high			No. 23820, Block-Off Ford/Chrysler	
	No. 22470, Ford/Chrysler, 5-1/4" high				
F Breather Tanks	No. 22465, Large Dia. (Fram HP-6 replacement), 6-1/4" high				
	No. 85465, -12AN Inlet				
	No. 85466, Dual -12AN Inlet Fittings				
	No. 85470, 3/8" NPT Inlet				
G Tank Mounts	No. 85475, -16AN Inlet				
	Nos. 22677, 22678, 22679				
	(Straight, Offset or U-Weld-It Kits)				



OIL PUMPS

DRY SUMP

MOROSO TRI-LOBE LINE OF EXTERNAL PUMPS ARE THE LATEST IN OUR RICH HISTORY OF INNOVATIVE OIL PUMP DESIGNS!

EXTERNAL OIL PUMPS

Single Stage

These Oil Pumps Feature:

- Spur gear pressure section
- Lightweight and efficient
- Includes replaceable fittings, -16AN inlet, -12AN outlet
- External oil pumps run cooler than internal pumps and features an external bypass for ease of adjustment
- External pumps eliminate the spark scatter and camshaft loads that are associated with an internal pump



BEST

**Single Stage
No. 22341**



**Single Stage
No. 22441**

**Single Stage
No. 22321**



EXTERNAL PUMPS				
PART #	DESCRIPTION	STAGE	STYLE OF BRACKET & ORIENTATION	PRESSURE SECTION
22341	Dry Sump Pump, T3 Series	SINGLE	FULL BODY, DRIVER'S/LEFT SIDE	1.200
22321	Dry Sump Pump, T3 Series	SINGLE	FULL BODY, PASSENGER/RIGHT SIDE	1.200
22441	Dry Sump Pump, T3 Series	SINGLE	DRAGSTER, LEFT SIDE	1.200

PART # AVAILABLE OPTIONS

- 22606 AN Fittings, -10AN to -12AN, 2 per package
- 62208 Dry Sump/External Oil Pump Primer For a 5/8" Diameter Shaft

EXTERNAL OIL PUMP, SINGLE STAGE, FUEL PUMP DRIVE

Driver's/Left Side Door Car Style Bracket

- Rear 3/8" hex fuel pump drive with 1:1 ratio that accepts the popular 1.450 ID, 3 bolt, fuel pump swivel clamps
- Spur gear 1.200 pressure section
- Light weight and efficient
- Includes replaceable fittings, -16AN inlet, -12AN outlet
- External oil pumps run cooler than internal pumps and features an external bypass for ease of adjustment
- External pumps eliminate the spark scatter and camshaft loads that come with an internal pump

PART # DESCRIPTION

22361 External Oil Pump, with Fuel Pump Drive, Left Side Bracket, 1.200 Pressure

PART # AVAILABLE OPTIONS

- 22606 AN Fittings, -10AN to -12AN, 2 per package
- 62208 Dry Sump/External Oil Pump Primer For a 5/8" Diameter Shaft

BEST



No. 22361



OIL PUMPS

DRY SUMP

EXTERNAL OIL PUMPS, SINGLE STAGE, V-BAND MOUNTING FLANGE

Fits: Alston Front Accessory Drives

- Two different gear sets are available, 1.200 or 1.800
- External pumps eliminate the camshaft loads that come with an internal pump
- V-Band mounting flange to mount External Oil Pump to Alston front drives
- Light weight and efficient
- Includes all replacement fittings, -16AN inlet, -12AN outlet
- External oil pumps run cooler than internal pumps and features an external bypass for ease of adjustment

NEW!



No. 22413

PART #	DESCRIPTION
22411	External Oil Pump, with V-Band Mounting Flange for Alston Front Drives, 1.200 Pressure
22413	External Oil Pump, with V-Band Mounting Flange for Alston Front Drives, 1.800 Pressure

EXTERNAL OIL PUMPS, SINGLE STAGE, V-BAND MOUNTING FLANGE

Fits: ProCharger Front Accessory Drives

- Two different gear sets are available, 1.200 or 1.800
- External pumps eliminate the camshaft loads that come with an internal pump
- V-Band mounting flange to mount External Oil Pump to ProCharger and other supercharger front drives
- Light weight and efficient
- Includes all necessary fittings
- External oil pumps run cooler than internal pumps and features an external bypass for ease of adjustment
- ProCharger Part No. 3PCCD-032 is required for installation

NEW!



No. 22311

PART #	DESCRIPTION
22311	External Oil Pump, Mounts to ProCharger Front Drives, V-Band Mounting Flange, 1.200 Pressure
22313	External Oil Pump, Mounts to ProCharger Front Drives, V-Band Mounting Flange, 1.800 Pressure

EXTERNAL OIL PUMP, SINGLE STAGE, REVERSE ROTATION V-BAND MOUNTING FLANGE

Fits: Alston Front Accessory Drives, Pump Mounted Towards Front of Car

- V-Band mounting flange to mount External Oil Pump to Alston front drives
- Spur gear 1.200 pressure section
- External pumps eliminate the camshaft loads that come with an internal pump
- Light weight and efficient
- Includes all necessary fittings
- External oil pumps run cooler than internal pumps and features an external bypass for ease of adjustment

NEW!



No. 22412

PART #	DESCRIPTION
22412	External Oil Pump, Reverse Rotation, Alston Front Drives, V-Band Mounting Flange for 1.200 Pressure

EXTERNAL OIL PUMP, SINGLE STAGE, REVERSE ROTATION, V-BAND MOUNTING FLANGE

Fits: ProCharger Front Accessory Drives, Pump Mounted Towards Front of Car

- V-Band mounting flange to mount External Oil Pump to ProCharger supercharger front drives
- Spur gear 1.200 pressure section
- External pumps eliminate the camshaft loads that come with an internal pump
- Light weight and efficient
- Includes all necessary fittings
- External oil pumps run cooler than internal pumps and features an external bypass for ease of adjustment
- ProCharger Part No. 3PCCD-032 is required for installation

NEW!



No. 22312

PART #	DESCRIPTION
22312	External Oil Pump, Reverse Rotation, ProCharger Front Drives, V-Band Mounting Flange, 1.200 Pressure

EXTERNAL OIL PUMPS, TWO STAGE, FUEL PUMP DRIVE

Driver's/Left Side Door Car Style Bracket

An expansion to our popular line of external oil pumps. This pump gives you the option of scavenging oil from the oil pan with one stage and using the second stage to scavenge oil from turbos or superchargers and areas that require oil to be scavenged.

- Two different gear sets are available, 1.200 or 1.800
- Light weight and efficient
- Includes replaceable fittings, -16AN inlet, -12AN inlet, -12AN outlets
- External oil pumps run cooler than internal pumps and features an external bypass for ease of adjustment
- External pumps can help eliminate the spark scatter and camshaft loads that come with an internal pump
- Rear 3/8" hex fuel pump drive with 1:1 ratio that accepts the popular 1.450 ID, 3 bolt, fuel pump swivel clamps

NEW!

BEST



No. 22342

PART # DESCRIPTION

- 22362** External Oil Pump, Two Stage, Fuel Pump Drive, Left Side Bracket, 1.200 Pressure/1.700 Scavenge
- 22342** External Oil Pump, Two Stage, Fuel Pump Drive, Left Side Bracket, 1.800 Pressure/1.700 Scavenge

PART # AVAILABLE OPTIONS

- 22606** AN Fittings, -10AN to -12AN, 2 per package
- 62208** Dry Sump/External Oil Pump Primer For a 3/8" Diameter Shaft

DRY SUMP PUMPS, TRI-LOBE, FIVE STAGE, V-BAND MOUNTING FLANGE

Available in Standard or Reverse Rotation (pump mounted towards front of car) for Alston and ProCharger Front Accessory Drives

- V-Band mounting flange to mount Dry Sump Pump to front drives
- Tri-lobe aluminum scavenge sections featuring individual timing gears to ensure proper clearance at the highest of RPM's
- Spur gear pressure section based off Moroso's billet wet sump pump design
- Variable spring rates optimize your oil pressure for smooth, reliable oil pressure readings
- Saves weight and make big crankcase vacuum
- Includes replaceable fittings: Pressure Section -12AN Inlet, -12AN Outlet, Scavenge inlets -12AN Return -16AN
- Pumps weigh almost half of gerotor pumps, and takes up to 40% less power to drive
- Includes all necessary fittings
- On ProCharger applications, ProCharger Part No. 3PCCD-032 is required for installation

NEW!



No. 22517

PART # DESCRIPTION

- 22515** Dry Sump Pump Five Stage, V-Band Mounting Flange, Standard Rotation, Alston Front Drives, 1.200 Pressure/1.700 Scavenge
- 22315** Dry Sump Pump Five Stage, V-Band Mounting Flange, Standard Rotation, ProCharger Front Drives, 1.200 Pressure/1.700 Scavenge
- 22517** Dry Sump Pump Five Stage, V-Band Mounting Flange, Reverse Rotation (pump mounted towards front of car), Alston Front Drives, 1.200 Pressure/1.700 Scavenge
- 22518** Dry Sump Pump Five Stage, V-Band Mounting Flange, Reverse Rotation (pump mounted towards front of car), ProCharger Front Drives, 1.200 Pressure/1.700 Scavenge

Optional Replacement Fittings available for -10AN through -16AN

- PART # AVAILABLE FITTINGS**
- 22741** Replacement Fitting -10AN
- 22742** Replacement Fitting -12AN
- 22743** Replacement Fitting -16AN
- 22744** Replacement Fitting -16AN with a -12AN

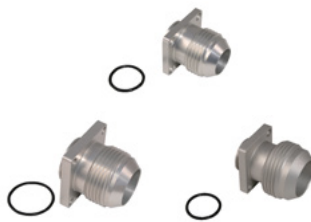

OIL PUMPS

DRY SUMP

MOROSO TRI-LOBE LINE OF DRY SUMP PUMPS ARE THE LATEST IN OUR RICH HISTORY OF INNOVATIVE OIL PUMP DESIGNS!

DRY SUMP PUMPS, TRI-LOBE

Left or Right Side Door Car Style Brackets
Three, Four, Five and Six Stage



The best performing dry sump pump line that Moroso has ever produced!

Moroso's new aluminum dry sump pumps have been developed with our decades of oiling system expertise to give you a lighter, better performing oil pump that will save weight and make more crankcase vacuum!

These Oil Pumps Feature:

- Tri-lobe aluminum scavenge sections featuring individual timing gears to ensure proper clearance at the highest RPM's
- Spur gear pressure section based off Moroso's highly successful billet wet sump pump design.
- Designed to be driven at 70-80% of engine speed.
- Variable spring rates optimize your oil pressure for smooth, reliable oil pressure readings
- Includes replaceable fittings; Pressure Section -12AN Inlet, -12AN Outlet, Scavenge Inlets -12AN, Return -16AN
- Pump weighs almost half of gerotor pumps, and takes up to 40% less power to drive!
- Custom pressure section sizes for increased efficiency with different pump speeds
- Includes all necessary fittings



**Three Stage-Driver's/Left Side
No. 22343**



**Three Stage-Passenger/Right Side
No. 22323**



**Four Stage-Passenger/Right Side
No. 22324**



**Four Stage-Driver's/Left Side
No. 22344**



**Five Stage-Driver's/Left Side
No. 22345**



**Five Stage-Passenger/Right Side
No. 22325**



**Six Stage-Driver's/Left Side
No. 22346**



**Six Stage-Passenger/Right Side
No. 22326**

DOOR CAR BRACKET STYLE PUMPS

PART #	DESCRIPTION	STAGE	BRACKET ORIENTATION	PRESSURE SECTION	SCAVENGE SECTION
22343	DRY SUMP PUMP, T3 SERIES	THREE	DRIVER'S/LEFT SIDE	1.200	1.700
22323	DRY SUMP PUMP, T3 SERIES	THREE	PASSENGER/RIGHT SIDE	1.200	1.700
22344	DRY SUMP PUMP, T3 SERIES	FOUR	DRIVER'S/LEFT SIDE	1.200	1.700
22324	DRY SUMP PUMP, T3 SERIES	FOUR	PASSENGER/RIGHT SIDE	1.200	1.700
22345	DRY SUMP PUMP, T3 SERIES	FIVE	DRIVER'S/LEFT SIDE	1.200	1.700
22325	DRY SUMP PUMP, T3 SERIES	FIVE	PASSENGER/RIGHT SIDE	1.200	1.700
22346	DRY SUMP PUMP, T3 SERIES	SIX	DRIVER'S/LEFT SIDE	1.200	1.700
22326	DRY SUMP PUMP, T3 SERIES	SIX	PASSENGER/RIGHT SIDE	1.200	1.700

PART # AVAILABLE OPTION

62208 Dry Sump/External Oil Pump Primer For a 5/8" Diameter Shaft



OIL PUMPS

DRY SUMP

MOROSO TRI-LOBE LINE OF DRY SUMP PUMPS ARE THE LATEST IN OUR RICH HISTORY OF INNOVATIVE OIL PUMP DESIGNS!

DRY SUMP PUMPS, TRI-LOBE

Driver's/Left Dragster Style Brackets
Three, Four, Five and Six Stage



The best performing dry sump pump line that Moroso has ever produced!

Moroso's new aluminum dry sump pumps have been developed with our decades of oiling system expertise to give you a lighter, better performing oil pump that will save weight and make more crankcase vacuum!

These Oil Pumps Feature:

- Tri-lobe aluminum scavenge sections featuring individual timing gears to ensure proper clearance at the highest RPM's
- Spur gear pressure section based off Moroso's highly successful billet wet sump pump design. Designed to be driven at 70-80% of engine speed.
- Variable spring rates optimize your oil pressure for smooth, reliable oil pressure readings
- Includes replaceable fittings; Pressure Section -12AN Inlet, -12AN Outlet, Scavenge Inlets -12AN, Return -16AN
- Pump weighs almost half of gerotor pumps, and takes up to 40% less power to drive!
- Custom pressure section sizes for increased efficiency with different pump speeds
- Includes all necessary fittings



**Three Stage- Driver's/Left Side
No. 22443**



**Four Stage- Driver's/Left Side
No. 22444**



**Five Stage- Driver's/Left Side
No. 22445**



**Six Stage- Driver's/Left Side
No. 22446**

DRAGSTER CAR BRACKET STYLE PUMPS

PART #	DESCRIPTION	STAGE	BRACKET ORIENTATION	PRESSURE SECTION	SCAVENGE SECTION
22443	DRY SUMP PUMP, T3 SERIES	THREE	DRIVER'S/LEFT SIDE	1.200	1.700
22444	DRY SUMP PUMP, T3 SERIES	FOUR	DRIVER'S/LEFT SIDE	1.200	1.700
22445	DRY SUMP PUMP, T3 SERIES	FIVE	DRIVER'S/LEFT SIDE	1.200	1.700
22446	DRY SUMP PUMP, T3 SERIES	SIX	DRIVER'S/LEFT SIDE	1.200	1.700

PART # AVAILABLE OPTION
62208 Dry Sump/External Oil Pump Primer For a 5/8" Diameter Shaft



OIL PUMPS

DRY SUMP

DRY SUMP PUMPS, TRI-LOBE, FUEL PUMP DRIVE

Driver's/Left Side Door Car Style Bracket



- Rear 3/8" hex fuel pump drive with 1:1 ratio that accepts the popular 1.450 ID, 3 bolt, fuel pump swivel clamps
- Tri-lobe aluminum scavenge sections featuring individual timing gears to ensure proper clearance at the highest of RPM's
- Spur gear pressure section based off Moroso's billet wet sump pump design
- Variable spring rates optimize your oil pressure for smooth, reliable oil pressure readings
- Saves weight and make big crankcase vacuum
- Includes replaceable fittings; Pressure Section -12AN Inlet, -12AN Outlet, Scavenge Inlets -12AN, Return -16AN
- Pumps weights almost half of gerotor pumps, and takes up to 40% less power to drive
- Includes all necessary fittings



No. 22363



No. 22364



BACK



No. 22365



No. 22366

Optional Replacement Fittings available for -10AN through -16AN

- | PART # | AVAILABLE FITTINGS |
|--------|--|
| 22741 | Replacement Fitting -10AN |
| 22742 | Replacement Fitting -12AN |
| 22743 | Replacement Fitting -16AN |
| 22744 | Replacement Fitting -16AN with a -12AN |

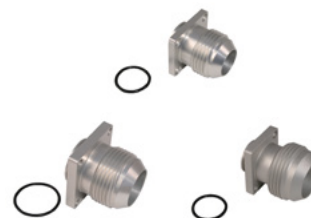

DRIVER'S/LEFT SIDE DOOR CAR STYLE BRACKET

PART #	DESCRIPTION	STAGE	BRACKET ORIENTATION	PRESSURE SECTION	SCAVENGE SECTION
22363	DRY SUMP PUMP, FUEL PUMP DRIVE	THREE	DRIVER'S/LEFT SIDE	1.200	1.700
22364	DRY SUMP PUMP, FUEL PUMP DRIVE	FOUR	DRIVER'S/LEFT SIDE	1.200	1.700
22365	DRY SUMP PUMP, FUEL PUMP DRIVE	FIVE	DRIVER'S/LEFT SIDE	1.200	1.700
22366	DRY SUMP PUMP, FUEL PUMP DRIVE	SIX	DRIVER'S/LEFT SIDE	1.200	1.700

PART # AVAILABLE OPTION

- 62208 Dry Sump/External Oil Pump Primer For a 5/8" Diameter Shaft



OIL PUMPS

DRY SUMP

DRY SUMP PUMPS, TRI-LOBE, DUAL MOUNTS

Heavy Duty Dual Mount Bracket

- Features two of our driver's side/left side door car mounting brackets for circle track, marine and road racing applications where the extra weight of the second bracket isn't an issue
- Tri-lobe aluminum scavenge sections featuring individual timing gears to ensure proper clearance at the highest of RPM's
- Spur gear pressure section based off Moroso's billet wet sump pump design
- Variable spring rates optimize oil pressure for smooth, reliable oil pressure readings
- Saves weight and make big crankcase vacuum
- Includes replaceable fittings; Pressure Section -12AN Inlet, -12AN Outlet, Scavenge Inlets -12AN, Return -16AN
- Pumps weigh almost half of gerotor pumps, and takes up to 40% less power to drive
- Includes all necessary fittings

NEW!



No. 22414

PART # DESCRIPTION

- 22414** Dry Sump Pump Four Stage, dual mount double driver's/left side door car mounting brackets 1.200 Pressure/1.700 Scavenge
- 22415** Dry Sump Pump Five Stage, dual mount double driver's/left side door car mounting brackets 1.200 Pressure/1.700 Scavenge

DRY SUMP PUMP, TRI-LOBE, FIVE STAGE

Brinn/Bert Bellhousing Bracket

- Designed to mount Dry Sump Pump to Bert or Brinn Bellhousings
- Tri-lobe aluminum scavenge sections featuring individual timing gear to ensure proper clearance at the highest of RPM's
- Spur gear pressure section based off Moroso's billet wet sump pump design
- Variable spring rates optimize your oil pressure for smooth, reliable oil pressure readings
- This design saves weight and makes more crankcase vacuum than previous designs
- This Tri-Lobe Pump weighs almost half of gerotor pumps, and takes up to 40% less power to drive
- Includes replaceable fittings; Pressure Section -12AN Inlet, -12AN Outlet, Scavenge Inlets -12AN, Return -16AN

NEW!



No. 22405

PART # DESCRIPTION

- 22405** Dry Sump Pump Five Stage, Bert or Brinn Bellhousing Mount, 1.200 Pressure/1.700 Scavenge

DRY SUMP PUMP, TRI-LOBE, FIVE STAGE FUEL PUMP DRIVE

Brinn/Bert Bellhousing Bracket

- Rear 3/8" hex fuel pump drive with 1:1 ratio that accepts the popular 1.450 ID, 3 bolt, fuel pump swivel clamps
- Tri-lobe aluminum scavenge sections featuring individual timing gears to ensure proper clearance at the highest of RPM's
- Spur gear pressure section based off Moroso's billet wet sump pump design
- Variable spring rates optimize your oil pressure for smooth, reliable oil pressure readings
- Saves weight and makes big crankcase vacuum
- Includes replaceable fittings: Pressure Section -12AN Inlet, -12AN Outlet, Scavenge Inlets -12AN Return -16AN
- Pump weighs almost half of gerotor pumps, and takes up to 40% less power to drive
- Includes all necessary fittings

NEW!



No. 22367

PART # DESCRIPTION

- 22367** Dry Sump Pump Five Stage, Fuel Pump Drive, 1.200 Pressure/1.700 Scavenge



OIL PUMPS

DRY SUMP

DRY SUMP PUMPS, TRI-LOBE, FIVE STAGE, .900 PRESSURE SECTION

Available with either Driver's/Left Side Door Car or Dragster Style Bracket

- Tri-lobe aluminum scavenge sections featuring individual timing gears to ensure proper clearance at the highest of RPM's
- Spur gear pressure section based off Moroso's billet wet sump pump design
- Variable spring rates optimize your oil pressure for smooth, reliable oil pressure readings
- Saves weight and makes big crankcase vacuum
- Includes replaceable fittings; Pressure Section -12AN Inlet, -12AN Outlet, Scavenge Inlets -12AN, Return -16AN
- Pumps weights almost half of gerotor pumps, and takes up to 40% less power to drive
- Includes all necessary fittings

PART #	DESCRIPTION
22335	Dry Sump Pump, Five Stage, Driver's Side/Door Car Bracket, .900 Pressure/1.700 Scavenge
22435	Dry Sump Pump, Five Stage, Driver's Side/Dragster Bracket, .900 Pressure/1.700 Scavenge

PART #	AVAILABLE OPTION
62208	Dry Sump/External Oil Pump Primer For a 5/8" Diameter Shaft

No. 22335



No. 22435



DRY SUMP PUMP | VACUUM PUMP COMBOS

EXTERNAL SINGLE STAGE OIL PUMP/VACUUM PUMP KIT

SBC, Driver's/Left Bracket

- This kit includes a Moroso Tri-lobe Single Stage Oil Pump with a Moroso Enhanced Design 4-Vane Vacuum Pump driven off the back
- By driving the V-band clamp attached vacuum pump off the back of the oil pump this creates a compact weight saving design with one belt only being utilized
- Single stage external Tri-lobe oil pump is included that has a spur gear 1.200 pressure section, eliminates the camshaft loads that occur with an internal pump. Has replaceable fittings, -16AN inlet, -12AN outlet
- Enhanced Design 4-Vane Vacuum Pump is included that pulls more vacuum and is designed with maintenance-free precision sealed roller bearings. Has replaceable -12AN Inlet and Outlet fittings
- V-band clamp is included

PART #	DESCRIPTION
22652	External Oil Pump, Single Stage, Tri-Lobe, Vacuum Pump, SBC Left Side Bracket

NEW!



EXTERNAL SINGLE STAGE OIL PUMP/VACUUM PUMP KIT

BBC, Driver's/Left Bracket

- This kit includes a Moroso Tri-lobe Single Stage Oil Pump with a Moroso Enhanced Design 4-Vane Vacuum Pump driven off the back of it
- By driving the V-band clamp attached vacuum pump off the back of the oil pump this creates a compact weight saving design
- Single stage external Tri-lobe oil pump is included that has a spur gear 1.200 pressure section, eliminates the camshaft loads that occur with an internal pump. Has replaceable fittings, -16AN inlet, -12AN outlet
- Enhanced Design 4-Vane Vacuum Pump is included that pulls more vacuum and is designed with maintenance-free precision sealed roller bearings. Has replaceable -12AN Inlet and Outlet fittings
- V-band clamp is included

PART #	DESCRIPTION
22654	External Oil Pump, Single Stage, Tri-Lobe, Vacuum Pump, BBC Left Side Bracket

NEW!





Single Stage
No. 22251 / No. 22241

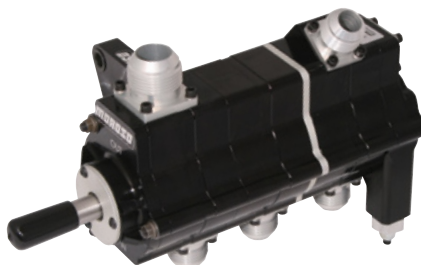

GOOD

Three Stage
No. 22253 / No. 22243



Four Stage
No. 22254 / No. 22244



Five Stage
No. 22255 / No. 22245

DRY SUMP OIL PUMPS, DOOR CAR

Single, Three, Four, Five and Six Stage

Fits: Chevrolet-based Small Block & Big Block Door Car applications

- Steady oil pressure throughout RPM range
- Consistent oil pressure at high heat levels
- Increased vacuum
- Consistent oil pressure at high vacuum levels
- Oil pressure adjustability, allows for finer tuning of pressure levels
- Internal manifold with -16AN return, no need for separate manifold
- Built-in mounting bracket designed for engine compartment constraints
- Two pressure outlet locations for easier plumbing
- Includes all necessary fittings
- Vertical oil pressure adjuster makes it easier to change oil pressure settings



.875 Pressure / 1.100 Scavenge

PART # DESCRIPTION

- 22251** Single Stage
- 22253** Three Stage
- 22254** Four Stage
- 22255** Five Stage

1.100 Pressure / 1.100 Scavenge

PART # DESCRIPTION

- 22241** Single Stage
- 22243** Three State
- 22244** Four Stage
- 22245** Five Stage

PART # AVAILABLE OPTION

- 62208** Dry Sump/External Oil Pump Primer For a 5/8" Diameter Shaft

Optional Replacement Fittings available for -10AN through -16AN



- | PART # | AVAILABLE FITTINGS |
|---------------|--|
| 22741 | Replacement Fitting -10AN |
| 22742 | Replacement Fitting -12AN |
| 22743 | Replacement Fitting -16AN |
| 22744 | Replacement Fitting -16AN with a -12AN |



OIL PUMPS

DRY SUMP

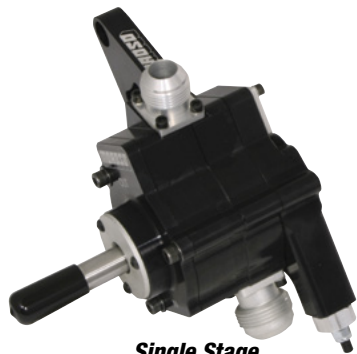

Single Stage
No. 22521 / No. 22421



Three Stage
No. 22523 / No. 22423

6000

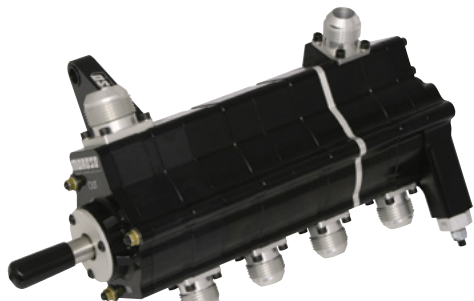

Four Stage
No. 22524 / No. 22424



Five Stage
No. 22525 / No. 22425



OIL PUMPS

DRY SUMP

DRY SUMP OIL PUMPS, DRAGSTER

Single, Three, Four, Five and Six Stage
Fits: Chevrolet-based Small Block & Big Block Dragster applications

- Steady oil pressure throughout RPM range
- Consistent oil pressure at high heat levels
- Increased vacuum
- Consistent oil pressure at high vacuum levels
- Oil pressure adjustability, allows for finer tuning of pressure levels
- Internal manifold with -16AN return, no need for separate manifold
- Built-in bracket mounts pump higher and closer to the engine, for better engine compartment packaging in a Dragster
- Two pressure outlet locations for easier plumbing
- Includes all necessary fittings
- Vertical oil pressure adjuster makes it easier to change oil pressure settings

.875 Pressure / 1.100 Scavenge

PART #	DESCRIPTION
22521	Single Stage
22523	Three Stage
22524	Four Stage
22525	Five Stage

1.100 Pressure / 1.100 Scavenge

PART #	DESCRIPTION
22421	Single Stage
22423	Three State
22424	Four Stage
22425	Five Stage

Optional Replacement
Fittings available for
-10AN through -16AN



PART #	AVAILABLE FITTINGS
22741	Replacement Fitting -10AN
22742	Replacement Fitting -12AN
22743	Replacement Fitting -16AN
22744	Replacement Fitting -16AN with a -12AN

PART #	AVAILABLE OPTION
62208	Dry Sump/External Oil Pump Primer For a 5/8" Diameter Shaft

DRY SUMP/EXTERNAL OIL PUMP PRIMER FOR A 5/8 INCH DIAMETER SHAFT

- Makes the task of priming a pump quick and easy using this drive
- Attaches to a 5/8" diameter shaft of a Dry Sump or External Oil Pump
- Adapter is machined out of stainless steel for years of use
- Includes Hardware

PART #	DESCRIPTION
62208	Dry Sump/External Oil Pump Primer For a 5/8" Diameter Shaft



No. 62208

WARNING Prop. 65
This product contains a chemical known to the state of California to cause cancer, birth defects, or reproductive harm-

SPRINT CAR FRONT MAGNETO DRIVE ASSEMBLY*Patent Pending*

Moroso Performance Products has developed a Magneto re-location kit that has solved inherent problems related to standard rear mounted magnetos.

Issues of unstable timing, magneto flex and movement, shaft failure, drive gear failure and the inability to perform in-car timing adjustments, have all been addressed.

Front Magneto Drive Assembly has been designed to work with:

- Standard Shaver - Wesmar gear drive assemblies
- Moroso cam driven dry sump pumps, as well as other commonly used oil pumps
- Commonly used crank driven water pumps
- Designed to be used with MSD 12 LT Generator or MSD Part No. 7904 Generator Kit
- Now legal for most racing organizations

PART # DESCRIPTION

60205	Timing Cover Magneto Kit, Sprint Car, SBC, Non-Raised Cam
60206	Timing Cover Magneto Kit, Sprint Car, SBC, .390 Raised Cam

**No. 60205****BENEFITS INCLUDE:**

- Increased timing accuracy
- The ability to eliminate costly crank trigger systems
- Improved access to Magneto for timing adjustments
- Increased area at the rear of engine allows for induction system improvements

ASSEMBLY INCLUDES:

- Billet Timing Cover
- Magneto Drive Adapter
- Magneto Billet Relocation Mount
- Magneto Drive Stem
- Billet Distributor Hole Plug
- Mounting Hardware

SPRINT CAR BILLET ALUMINUM TIMING COVER, SBC NON-RAISED CAM & RAISED CAM

- Strong and Lightweight, machined from a solid bar of Aluminum
- Designed to work with all gear and chain cam drive systems, including Standard Shaver and Wesmar gear drive assemblies
- Timing Cover's bolt pattern is designed to accept Moroso cam driven dry sump pumps as well as others
- Is included in the Moroso Sprint Car Front Magneto Drive Assembly
- Cover accommodates commonly used Sprint Car crank driven water pumps
- Has a top timing port
- Black anodized finish for good looks and protection

PART # DESCRIPTION

60200	Timing Cover, SBC, Sprint Car, Non-Raised Cam
60201	Timing Cover, SBC, Sprint Car, .390 Raised Cam

**No. 60200**

OIL PUMP BLOCK-OFF PLATE

Fits: Small Block, Big Block and 90° Chevy V6

- Easy, bolt-on anodized aluminum plate seals oil passage on rear main cap when dry sump systems are used
- Requires no drilling or tapping for installation

PART # DESCRIPTION**23790** Oil Pump Block-Off Plate. Chevy V8 & 90° V6**No. 23790****OIL BYPASS ELIMINATOR, CHEVY**

- Designed to eliminate the oil bypass found on Chevrolet engines
- Does not allow unfiltered oil back into the engine
- A stock type spin-on oil filter can be used with this part installed
- Machined from billet aluminum for strength
- Features a single inlet and easy two bolt installation

PART # DESCRIPTION**23775** Oil Bypass Eliminator, SBC, BBC (except Gen V and Gen VI)**No. 23775****EXTERNAL PUMP ADAPTER, REMOTE FILTER, CAST**

Fits: SBC & BBC (Mark IV)

- Aluminum bypass replaces engine-mounted oil filter in wet sump oiling system and directs oil to remote oil filter or oil cooler
- Drilled and tapped for 1/2" NPT inlet and outlet fittings
- Includes all mounting hardware, gaskets and o-ring

PART # DESCRIPTION**23770** Oil Filter Bypass**PART # REPLACEMENT PARTS****97321** Square O-Ring**97322** Gasket**No. 23770****EXTERNAL PUMP ADAPTER, REMOTE FILTER, BILLET**Fits: World Products Merlin Big Block or standard Small Block and Big Block (Mark IV)
Chevy applications without bolt hole at center of the filter pad

- Machined billet anodized aluminum Bypass Plate is needed when using a remote oil filter or returning oil from dry sump oiling system
- Sealing o-rings are captured in the plate for a tight seal against block's surface, washers are installed under bolt heads for a leak-free performance
- Drilled and tapped to accept male -10AN fittings
- Includes all mounting hardware and o-rings

PART # DESCRIPTION**23782** Billet Oil Filter Bypass Plate**PART # AVAILABLE OPTION****22606** Fitting, -10AN to -12AN**PART # REPLACEMENT PARTS****97323** O-Ring, Oil Adapter, Repl. 1.75" I.D.**97324** O-Ring, Oil Adapter, Repl. 3.5" I.D.**97325** O-Ring, Oil Block-off, Repl. **No. 23782****No. 23782**

EXTERNAL PUMP ADAPTER, REMOTE FILTER

- Aluminum Block-Off Plates designed for Moroso Dry Sump Oiling System or External Oil Pump
- Drilled and tapped to accept 1/2" NPT fitting to provide increased clearance for installing input pressure line
- Includes all mounting hardware and o-rings

PART # DESCRIPTION

- 23840** Oil Filter Block-Off Plate
Fits: Small Block and Big Block (exc. Gen V and Gen VI) Chevy applications without bolt hole at center of pad
- 23820** Oil Filter Block-Off Plate
Fits: 1957-01 Ford 8, 6, 4 cyl; 1959-03 Dodge; Chrysler 8, 6, 4, cyl; 1970-86 Toyota 4 cyl; 1986-96 Toyota 6 cyl. Others: All engines with 2-1/2" I.D. x 2-7/8" O.D. Sealing Area and 3/4" -16 UNF Block Thread. -12AN fitting size

PART # REPLACEMENT PART

- 97321** Square O-Ring (Except No. 23820)

PART # AVAILABLE OPTIONS

- 22706** Fitting, 1/2" NPT to -10AN
22708 Fitting, 1/2" NPT to -12AN
22709 Fitting, -12AN to -10AN, 1 per package



No. 23820



No. 23840

EXTERNAL PUMP, ACCUMULATOR, FILTER SANDWICH ADAPTERS

Fits: Small Block and Big Block Chevy Mark 4 including aftermarket engine blocks

- Mount in spin-on oil filter pocket, between the oil filter and the engine block to eliminate the need for a remote oil filter
- Machined out of billet aluminum with a black anodized finish for durability and long-lasting looks
- Eliminates the need for an oil bypass eliminator, so unfiltered oil does not go back into the engine
- Includes full instructions, mounting bolts and o-rings

PART # DESCRIPTION

- 23690** Oil Filter Adapter, SBC, for plumbing Accumulators and External or Dry Sump Oil Pumps. Lowers oil filter by 1-1/2", has 1/2" NPT inlet and outlet port
- 23701** Oil Filter Adapter, BBC Mark 4, for plumbing Accumulators and External or Dry Sump Oil Pumps. Lowers oil filter by 2-1/2", has -10AN inlet and outlet ports, one before filtration and one after filtration

PART # AVAILABLE OPTIONS

- 22459** Racing Oil Filter, Chevy and others, 13/16" -16 UNF thread, short design (4-9/32" high), burst strength: 350 psi (max.)
- 22460** Racing Oil Filter, Chevy and others, 13/16" -16 UNF thread, long design (5-1/4" high), burst strength: 350 psi (max.)



No. 23690



No. 23701

ACCUMULATOR ADAPTERS

- Provides a convenient way to plumb an Accumulator into the oiling system
- The adapter has one -10 AN oil input port that provides filtered oil to the Accumulator
- Mounts on the spin-on filter pad between the oil filter and engine block, lowering the spin-on filter by 1-1/4"

PART # DESCRIPTION

- 23675** Accumulator Adapter, 3/4"-16 thread and 2-5/8" O-ring - Fits: Ford, Chrysler and 4 and 6 cylinder applications
- 23676** Accumulator Adapter, 13/16" thread and 2-5/8" O-ring - Fits: Chevy, LS1 through 2006 Small Block
- 23677** Accumulator Adapter, 18MM -1.5 thread and 2-5/8" O-ring - Fits: Chevy, LT1 and G.M. 4 and 6 cylinder applications
- 23678** Accumulator Adapter, 20MM-1.5 thread and 2-5/8" O-ring - Fits: Honda and other 4 and 6 cylinder applications
- 23679** Accumulator Adapter, 22MM-1.5 thread and 2-5/8" O-ring - Fits: New Ford, GM LS



No. 23675



OIL COOLER AND FILTER SANDWICH ADAPTERS

Fits: Small Block, Big Block Chevy Mark IV and most aftermarket blocks of each

- Mounts in spin-on oil filter pocket, between the oil filter and the engine block to eliminate the need for a remote filter
- Machined out of billet aluminum with a black anodized finish for durability and long-lasting looks
- Eliminates the need for an oil-bypass eliminator, so unfiltered oil does not go back into the engine
- Includes mounting hardware and O-rings

PART # DESCRIPTION

- 23691** Oil Filter Adapter, BBC Mark IV and Aftermarket Engine Blocks with a deep oil filter pocket, for plumbing a remote oil cooler for wet sump oiling systems. Lowers oil filter by 2-1/2", has -10AN inlet and outlet ports
- 23692** Oil Filter Adapter, SBC, for plumbing a Remote Oil Cooler for wet sump oiling systems. Lowers oil filter by 1-1/2", has 1/2" NPT inlet and outlet ports



No. 23691

OIL COOLER AND FILTER SANDWICH ADAPTER

Fits: Big Block Chevy Gen. 5, Gen. 6

- Mounts in the spin-on oil filter pocket, between the oil filter and the engine block to eliminate the need for a remote filter mount
- Machined out of billet aluminum with a black anodized finish for durability and long-lasting looks
- Eliminates the need for an oil-bypass eliminator, so unfiltered oil does not go back into the engine
- Features -10 AN female ports, Marked with "IN" and "Out"
- Includes mounting hardware and O-rings



No. 23705

PART # DESCRIPTION

- 23705** Oil Cooler & Filter Adapter, Big Block Chevy Gen 5, Gen. 6

OIL COOLER/FILTER SANDWICH ADAPTERS

Fits: Small Block, Big Block Chevy Mark IV, Mark V & Gen VI including most aftermarket blocks of each

- Mounts in spin-on oil filter pocket, between the oil filter and the engine block to eliminate the need for a remote filter
- Machined out of billet aluminum with a black anodized finish for durability and long-lasting looks
- Eliminates the need for an oil-bypass eliminator, so unfiltered oil does not go back into the engine
- Includes mounting hardware and O-rings

PART # DESCRIPTION

- 23693** Universal Oil Cooler/Filter Adapter, 3/4"-16 thread and 2-5/8" O-ring
Fits: Ford, Chrysler and 4 and 6 cylinder applications
- 23694** Universal Oil Cooler/Filter Adapter, 13/16"-16 thread and 2-5/8" O-ring
Fits: Chevy, LS1 through 2006 Small Block
- 23695** Universal Oil Cooler/Filter Adapter, 18mm-1.5 thread and 2-5/8" O-ring
Fits: Chevy, LT1 and G.M. 4 and 6 cylinder applications
- 23698** Universal Oil Cooler/Filter Adapter, 20mm-1.5 thread and 2-5/8" O-ring
Fits: Honda and other 4 and 6 cylinder applications
- 23699** Universal Oil Cooler/Filter Adapter, 22mm-1.5 thread and 2-5/8" O-ring
Fits: New Ford, GM LS



No. 23693

PART # REPLACEMENT PARTS

- 22605** Fitting, -10AN to -10AN
- 22606** Fitting, -10AN to -12AN

REMOTE OIL FILTER, ROTATING 90 DEGREE ADAPTER

- Manufactured from Billet Aluminum with a black anodized finish
- Marked -10AN inlet/outlet to plumb a remote oil filter—easier to plumb oil cooler/accumulator
- Mounts on the engine block's spin-on oil filter pad

PART # DESCRIPTION

- 23682** Universal Remote Oil Filter Adapter, 3/4"-16 thread and 2-5/8" O-ring
Fits: Ford, Chrysler and most 4 and 6 cylinder applications
- 23683** Universal Remote Oil Filter Adapter, 13/16"-16 thread and 2-5/8" O-ring
Fits: American Motors V-8, GM LS through 2006, Oldsmobile V-8 and Pontiac V-8
- 23684** Universal Remote Oil Filter Adapter, 18mm-1.5 thread and 2-5/8" O-ring
Fits: GM LTI and GM 4 and 6 cylinder applications
- 23685** Universal Remote Oil Filter Adapter, 20mm-1.5 thread and 2-5/8" O-ring
Fits: Honda and other 4 and 6 cylinder applications
- 23686** Universal Remote Oil Filter Adapter, 22mm-1.5 thread and 2-5/8" O-ring
Fits: New Ford Applications, GM LS 2006 Corvette "E" Code 2007 & up
- 23703** Universal Remote Oil Filter Adapter, 13/16" thread and 3 1/4" O-ring
Fits: Small Block and Big Block Chevy Gen. V and Gen. VI including aftermarket engine blocks



No. 23682

PART # RECOMMENDED OPTIONS

- 22605** Fitting, -10AN to -10AN
- 22606** Fitting, -10AN to -12AN

REMOTE OIL FILTER ADAPTER

GM LS Series

- Replaces Moroso Spin-On oil filter adapter on Moroso Part Nos. 20142, 20143, 21151 & 21152 oil pans, comes standard on Moroso Part Nos. 20146, 20147, 20148 & 20149 oil pan
- Ideal when chassis restrictions don't allow the use of block mounted filter or when a larger external filter is desired
- Billet aluminum construction
- -10 AN "IN" and "OUT" ports
- Includes mounting hardware and engine block sealing O-rings

PART # DESCRIPTION
23688 Remote Oil Filter Adapter, GM LS Series

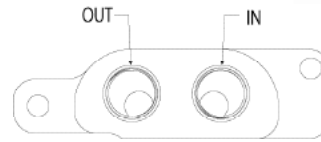

No. 23688

GM LS SERIES SPIN-ON OIL FILTER ADAPTER

- Designed for applications that require a Spin-On Oil Filter but don't have the room for one that mounts north to south
- Fits Moroso Part Nos. 20138, 20145, 21046, 20147, 20150, 21151, 21157 & 21158 oil pans
- Billet aluminum construction
- Accepts 22mm thread Moroso No. 22463 or O.E.M. oil filter
- Includes mounting hardware and engine block sealing O-rings

PART # DESCRIPTION
23712 GM LS Series Spin-On Oil Filter Adapter



No. 23712



GM LS SERIES SPIN-ON OIL FILTER ADAPTER, MOUNTS FILTER SIDEWAYS

- Designed for applications that require a Spin-On Oil Filter but don't have the room for one that mounts north to south
- Fits Moroso Part Nos. 20138, 20139, 20142, 20143, 20145, 21046, 20147, 20148, 20149, 20150, 21151, 21152, 21153, 21154, 21157 & 21158 oil pans
- Allows for a different plumbing option than was provided with the oil pan originally
- Accepts 22mm thread Moroso No. 22463 or O.E.M. oil filter
- Includes mounting hardware and engine block sealing O-rings
- Billet aluminum construction

PART # DESCRIPTION
23711 Oil Filter Adapter, Spin-On, GM LS Series, Mounts Filter Sideways



No. 23711

REMOTE OIL FILTER ADAPTER

Ford 4.6/5.4 modular

- Anodized adapter replaces larger factory casting
- Provides for easy plumbing of remote oil filters and coolers
- Enables the plumbing of external, wet or dry sump oil pumps when lower port is plugged
- -16AN fitting supplied for water outlet to radiator
- Includes 2 -10AN to -12AN Fittings for oil line plumbing and 1-10AN Plug

PART # DESCRIPTION
23681 Remote Oil Filter Adapter, Ford 4.6/5.4 modular



No. 23681

REMOTE OIL FILTER ADAPTER

Ford 5.0 Coyote

- Replaces factory spin-on oil filter mount on engine
- Ideal when chassis restrictions don't allow the use of block mounted filter or when a larger external filter is desired
- Billet aluminum construction with an anodized finish
- Includes mounting hardware and engine block sealing O-rings
- -10 AN "IN" and "OUT" ports

PART # DESCRIPTION
23687 Remote Oil Filter Adapter, Ford 5.0 Coyote 2011-'14

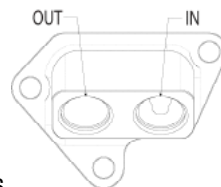

... 23687



REMOTE OIL FILTER ADAPTER, FORD 5.0 COYOTE GEN 1, GEN 2, GEN 3

- Replaces factory spin-on oil filter mount on engine
- Ideal when chassis restrictions don't allow the use of block mounted filter or when a larger external filter is desired
- Billet aluminum construction with a black anodized finish
- Marked -10 AN "IN" and "OUT" ports
- 1/4" NPT port for Supercharger/Turbo oil feed or Oil Pressure Sender
- Includes mounting hardware and engine block sealing O-rings

PART #	DESCRIPTION
23689	Ford 5.0 Modular Remote Oil Filter Adapter

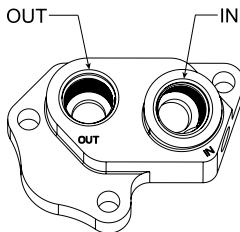

No. 23689

REMOTE OIL FILTER MOUNTS 1/2" NPT

- Excellent choice for dry sump oiling systems or wherever installation limitations require a remote mounted filter
- Cast aluminum design tapped for 1/2" NPT inlet and outlet pipe adapters, uses spin-on type oil filters
- Center port available for pressure or temp gauge

PART #	DESCRIPTION
23700	Remote Oil Filter Mount, Accepts Ford or Chrysler V8 type spin-on filters. Flow direction: inlet right side, outlet left side
23710	Remote Oil Filter Mount, Accepts Ford or Chrysler V8 type spin-on filters. Flow direction: inlet left side, outlet right side
23750	Remote Oil Filter Mount, Accepts Chevy V8 type spin-on oil filters. Flow direction: inlet right side, outlet left side
23760	Remote Oil Filter Mount, Accepts Chevy V8 type spin-on filter. Flow direction: inlet left side, outlet right side

PART #	AVAILABLE OPTIONS
22706	Fitting, 1/2" NPT to -10AN
22708	Fitting, 1/2" NPT to -12AN
22709	Fitting, -12AN to -10AN, 1 per package



No. 23750

REMOTE OIL FILTER MOUNT, TOP PORTS, ACCEPTS 13/16", 3/4", 22MM OIL FILTERS

- Excellent choice for dry sump oiling systems or wherever installation limitations require a remote mounted oil filter
- Includes three screw-in center nipples for different types of Spin-On Oil Filters; Chevy (13/16"), Early Chrysler/Fords/Imports (3/4"), GM LS and late Ford (22mm)
- Has a black anodized finish for durability/long-lasting looks and features marked -10AN inlet/outlet ports

PART #	DESCRIPTION
23767	Remote Oil Filter Mount, Top Ports, Accepts 13/16", 3/4" & 22mm Oil Filters



No. 23767

REMOTE OIL FILTER MOUNTS

Revised Design, Now accepts 22mm Filter

- Now accepts Chevy style spin-on filters ($1\frac{3}{16}$ " -3- $\frac{1}{4}$ " O-ring) and others with $\frac{3}{4}$ " -16 thread, 2- $\frac{5}{8}$ " O-ring, such as early Ford & imports and 22mm GM LS and Late Ford
- Includes three screw-in center nipples
- Manufactured from billet aluminum for strength
- Black anodized finish to protect against corrosion
- Designed with two -12AN inlets and three outlets, one -12AN and two $\frac{1}{4}$ " NPT
- Includes one -12AN port plug and two $\frac{1}{4}$ " NPT plugs
- Easy plumbing of oil pressure lines to turbos, superchargers, and valve spring oilers

PART #	DESCRIPTION	PART #	AVAILABLE OPTIONS
23763	Billet Aluminum Remote Oil Filter Mount, Side Port Style	22709	Fitting, -12AN male to -10AN male
23764	Billet Aluminum Remote Oil Filter Mount, Front Port Style	97641	Fitting, -12AN male to -12AN male
		22749	Port Plug, -12AN with O-ring Seal



No. 23764



No. 23763

REMOTE, LARGE DIAMETER OIL FILTER MOUNT

- Machined from 6061-T6 billet aluminum for exceptional strength and weight reduction (1.3 lbs w/out fittings)
- Compact, low profile design ($\frac{3}{4}$ " body height) facilitates installation in crowded areas; includes two $\frac{3}{8}$ "-16 threaded holes on backside for mounting
- Anodized finish
- Includes two screw-in adapters to accept a wide range of large-diameter filters including Fram HP-6, Motorcraft FL 784, STP 43R, (Purolator PER 288/L30288), (AC PF1054) and (WIX 51742)
- -12AN inlet and outlet threaded ports are positioned vertically to improve laminar flow
- Includes $\frac{1}{8}$ "NPT port for gauge

PART #	DESCRIPTION
23766	Remote, Large-Diameter Oil Filter Mount, Billet Aluminum

PART #	REPLACEMENT PART
97641	Fitting, -12AN male to -12AN male

PART #	AVAILABLE OPTIONS
22706	Fitting, $\frac{1}{2}$ "NPT to -10AN
22708	Fitting, $\frac{1}{2}$ "NPT to -12AN



No. 23766

OIL ACCUMULATORS

HOW THE ACCUMULATOR WORKS:

The Accumulator is tapped to the pressure side of the engine's oiling system. When the engine is running, oil pressure forces reserve oil into the accumulator and compresses the air ahead of it. If oil pressure should suddenly drop because of hard acceleration, severe cornering or hard braking, the air pressure immediately sends oil to the main galleries. When the danger is over and the pump is once again primed with oil, the oil pressure forces oil back into the Accumulator where it is ready for the next emergency.

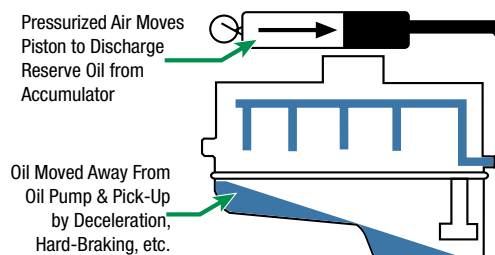
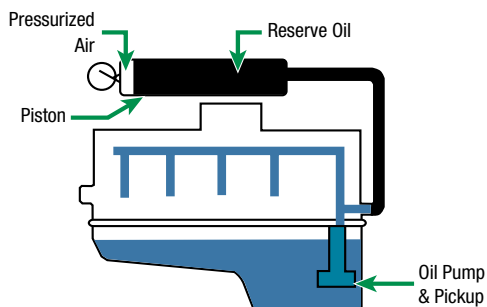

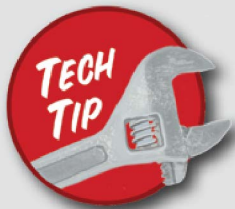

WHAT ARE MOROSO ACCUMULATORS AND HOW ARE THEY USED ON A RACE CAR OR HIGH PERFORMANCE VEHICLE ENGINE?

- Oil accumulators are oil storage tanks, connected into the engine's oiling system that have pressurized air on one side, and engine oil on the other side of a movable piston.
- When engine pressure fluctuates due to oil surging away from the pickup during hard acceleration, severe cornering or hard braking, a **Moroso Accumulator** equipped engine provides an instantaneous supply of oil to the engine.
- When the fluctuation is over and the oil pump is once again primed with oil, the engine's oil pressure forces this reserve of oil back into the Accumulator. When the engine returns to normal pressure, the Accumulator refills automatically, ready for the next possible occurrence.

HOW ARE MOROSO ACCUMULATORS CONSTRUCTED?

- The main body of a **Moroso Accumulator** is constructed out of heavy-wall, high pressure hydraulic cylinder aluminum tubing that has an interior bore which has been micro-rolled and polished with a hardcoat finish.
- Inside the Accumulator is a movable, billet aluminum double o-ringed piston, which keeps the air from mixing with the oil.
- The difference between the **Moroso Accumulator** and the **Moroso Heavy Duty Accumulator** is the design and construction of the billet aluminum o-ringed end caps. The Accumulators have end caps that hold in the Accumulator body with high tension snap rings. The end caps on the Heavy Duty Accumulator are actually designed like threaded cups, the body threads into these end caps, encompassing the ends of the Accumulator
- On all **Moroso Accumulators**, the end cap on the air side has an air gauge and Schrader valve and on the oil side, a 1/2" NPT fitting end cap for plumbing in the oiling system.

WHAT ARE DIFFERENT VALVING OPTIONS FOR MOROSO ACCUMULATORS?

- For an Accumulator to function at their fullest, it needs to have a valve assembly and each **Moroso Accumulator** comes a manual ball valve. The valve has to be manually opened by hand before starting the car to pre-oil the engine, offering surge protection while the vehicle is in use and will close when the engine is turned off.
- Moroso offers two styles of optional electric valves: **Solenoid Valve** (electric), allows remote control of the Accumulator. **Solenoid Pressure Valve Kits** are the best performing for competition vehicles and are offered in different oil pressure ranges of 15-24 PSI, 35-40 PSI discharge and refill. They have all the benefits of the **Solenoid Valve** but with quicker reaction times because the **Solenoid Pressure Valve** allows only the needed volume of oil to be released for faster filling and discharging. An internal sensor electronically activates when engine oil pressure drops below normal

CAN I CAUSE ENGINE WEAR JUST BY STARTING MY ENGINE?

- Independent tests have shown that on street cars, over 85% of engine wear is caused by starting an engine, and that these "dry starts" cause premature engine wear
- **Moroso Accumulators** can prevent cold start scuffing by pre-oiling the engine before start up, thus producing a dramatic increase in cylinder wall, piston ring and bearing longevity.

WHICH ACCUMULATOR IS BEST FOR MY APPLICATION?

- 3-Quart capacity **Moroso Accumulators** are for V-8 and larger, high performance 6 cylinder applications
- 1.5-Quart capacity Accumulators are for 4 & 6 cylinders, applications where a 3-quart capacity will not fit and when the Accumulator's main function is to pre-oil the engine before start up

HOW CAN I PLUMB AN ACCUMULATOR INTO THE ENGINE'S OILING SYSTEM?

Moroso Accumulators require only one line which can be:

- Plumbed into the return line of an oil cooler and/or remote oil filter
- Run through an **Accumulator Adapter** (page 137 that mounts between the engine's spin-on oil filter and the engine,

OR

- Run directly into a oil galley in the engine block that is on the pressure side of the engine's oiling system

CAN I FREE UP HORSEPOWER WITH AN ACCUMULATOR?

- Drag Racers have successfully used **Moroso Accumulators** to free up horsepower by running less oil in the oil pan



ACCUMULATOR

Protects Against Oil Pressure Loss!

Automatic Operation!

- Three quarts of oil under pressure provides emergency supply instantaneously when needed
- Air Pressure gauge verifies that Accumulator is ready for use
- Cold start valve releases oil into cold engine for reduced wear
- Tapped for 1/2" NPT fitting
- Can be mounted in any position using Moroso Accumulator Mounts (see below)
- Includes a manual ball valve

 **WARNING Prop. 65**
This product contains a chemical known to the state of California to cause cancer, birth defects, or reproductive harm-

PART # DESCRIPTION

- 23900**↔ Accumulator, 3 quart capacity, 20-1/8" x 4-1/4" cylinder
23901↔ Accumulator, 1.5 quart capacity, 10" x 4-1/4" cylinder



No. 23900

PART #	AVAILABLE OPTIONS
22706	Fitting, 1/2" NPT to -10AN
22708	Fitting, 1/2" NPT to -12AN
22709	Fitting, -12AN to -10AN, 1 per package
23920	Accumulator Mount

PART #	REPLACEMENT PART
97530	O-rings, 4 per package

HEAVY DUTY ACCUMULATORS

Protects Against Oil Pressure Loss!

Automatic Operation!

- For extreme applications—specially designed caps withstand high pressure
- Smaller size allows installation in vehicles with limited space
- 3 or 1.5 quarts of oil under pressure provide emergency supply instantaneously when needed
- Air Pressure gauge verifies that Accumulator is ready for use
- Cold start valve releases oil into cold engine for reduced wear
- Tapped for 1/2" NPT fitting
- Can be mounted in any position using Moroso Accumulator Mount **No. 23921**
- Includes a manual ball valve

PART # DESCRIPTION

- 23902**↔ Heavy Duty Accumulator, 3 quart capacity, 23" x 4-3/4" cylinder
23903↔ Heavy Duty Accumulator, 1.5 quart capacity, 12" X 4-1/4" cylinder

PART # AVAILABLE OPTION

- 23921**↔ Accumulator Mount for Heavy Duty Style



No. 23902



No. 23903

 **WARNING Prop. 65**
This product contains a chemical known to the state of California to cause cancer, birth defects, or reproductive harm-

ACCUMULATOR MOUNTS

- Brackets provide safe, sure mount for Moroso Accumulators
- Designed to be easily fastened to any flat surface
- Includes T-Bolt type clamps accepted by NHRA
- Two per package

PART # DESCRIPTION

- 23920**↔ Accumulator Mount for Nos. **23900**, **23901** and **23930**
23921↔ Accumulator Mount for Heavy Duty Style No. **23902** and **23903**

 **WARNING Prop. 65**
This product contains a chemical known to the state of California to cause cancer, birth defects, or reproductive harm-



No. 23920



OIL CHECK VALVE, ONE WAY

- 1/2" NPT to 1/2" NPT One Way
- For use with oil accumulators and oil coolers
- For prevention of oil drain-back

PART #	DESCRIPTION
23875	Check Valve, One Way

WARNING Prop. 65
 This product contains a chemical known to the state of California to cause cancer, birth defects, or reproductive harm-



No. 23875

SOLENOID PRESSURE VALVE KIT

Best for Competition—kit includes Moroso Part No. 23905 Solenoid Valve plus a Pressure Valve

- Better than a regular manual electric valve—our Solenoid Pressure Valve allows only the needed volume of oil to be released for quicker filling and discharging
- Screw-in sensor electronically activates when engine oil pressure drops below normal. When engine returns to normal pressure, the accumulator refills automatically, ready for the next possible occurrence
- Best to use in remote mount situations, where accessing a manual valve is not an option
- Easy three-wire hookup
- Comes in two pressure ranges: choose the one that best suits your engine combination

PART #	DESCRIPTION
23907	Electronic Pressure Control Accumulator Solenoid Valve, 12 volt, 15-24 PSI discharge and refill
23908	Electronic Pressure Control Accumulator Solenoid Valve, 12 volt, 35-40 PSI discharge and refill



No. 23907

CAUTION!
 Do not use with fuels.

WARNING Prop. 65
 This product contains a chemical known to the state of California to cause cancer, birth defects, or reproductive harm-

SOLENOID VALVE

- Allows remote control of fluid flow from the driver's seat
- Each side of the solenoid valve contains a 1/2" NPT female port
- 1/2" NPT male nipple also included if required for elbows or for other plumbing needs
- Solenoid Valve is open when toggle switch is on, when switched off remains closed regardless of ignition switch position
- Use the toggle switch and 16 gauge wire included in the kit to wire the valve (use one of Moroso's many Switch Panels for a professional installation)
- A 20-amp fuse must be used between the power source and the switch
- Use a power source that is active (i.e., "hot") only when the ignition switch is in the "on" position

PART #	DESCRIPTION
23905	Solenoid Valve, 12 volt, with 1/2" NPT female ports

PART #	AVAILABLE OPTIONS
22706	Fitting, 1/2" NPT to -10AN, 1 per package
22708	Fitting, 1/2" NPT to -12AN, 1 per package
22709	Fitting, -12AN to -10AN, 1 per package

CAUTION!
 Do not use with fuels.



No. 23905

WARNING Prop. 65
 This product contains a chemical known to the state of California to cause cancer, birth defects, or reproductive harm-

When good looks are important, Moroso's Chrome Oil Filters are the way to go! Outside is a triple process chrome plated steel housing that's hand polished and rack nickled before chroming to insure the highest luster possible. Inside is a heat cured, resin impregnated filter element that has been engineered to exceed OEM specifications for filtration efficiency.

ENGINEERED FOR HIGH FILTRATION EFFICIENCY!

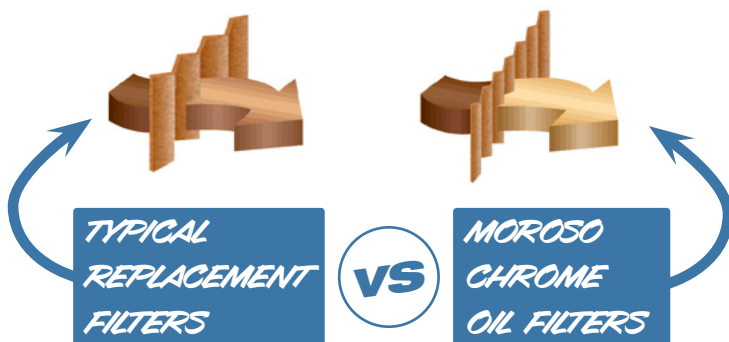

With Moroso Chrome Oil Filters, harmful particles are trapped within the high performance filter pleating configuration, resulting in cleaner oil for your engine.

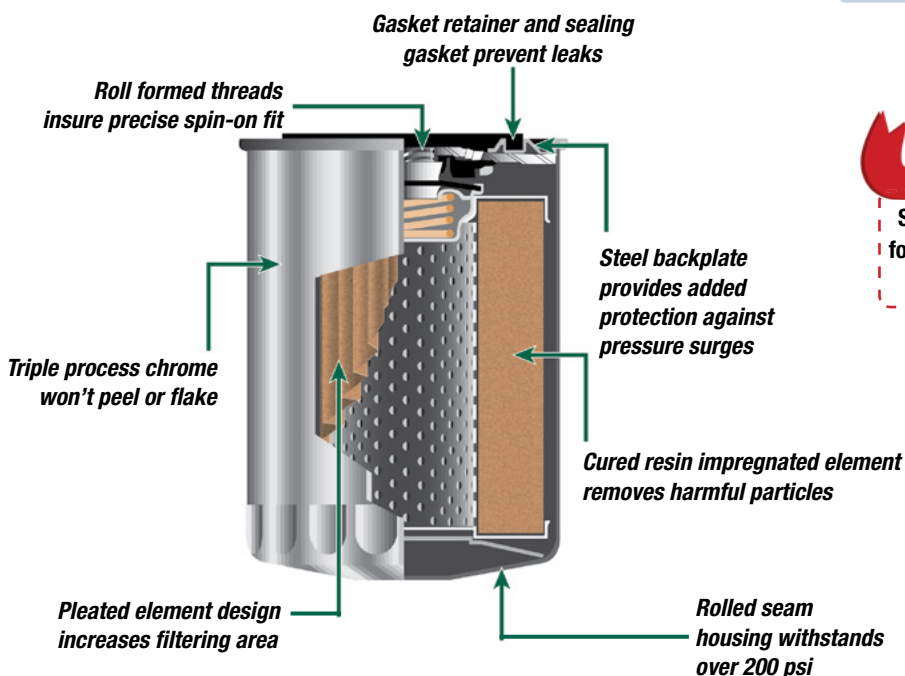

SEE MORE
Specific Vehicle Applications for Chrome & Racing Oil Filters on pg 149

- PART # DESCRIPTION**
22300◀ Chrome Oil Filter, Chevy type, Short Design (4-⁹/₃₂" high), ¹³/₁₆" -16UNF thread
22305◀ Chrome Oil Filter, GM LS Series, 1997-2006, ¹³/₁₆" -16UNF thread
22320◀ Chrome Oil Filter, Chevy type, Long Design (5-¹/₄" high), ¹³/₁₆" -16UNF thread
22400◀ Chrome Oil Filter, Ford/Chrysler type, Long Design (5-¹/₄" high), ³/₄" -16UNF thread

WARNING Prop. 65
This product contains a chemical known to the state of California to cause cancer, birth defects, or reproductive harm-

CHROME OIL FILTER CROSS REFERENCE

MOROSO	FRAM	PUROLATOR	MOTORCRAFT	WIX	AC	GM	LEE	HASTINGS	CHRYSLER	FORD	STP
22300	PH30	L20049	FL10	51069	PF25	6438261	LF25, LF25HP	LF225			S-025
22305	PH3506	L14006	FL330	51042	PF46	25010251 6439857	LF44	LF232	L321		S-3506
22320	PH13 HP4	L30040	FL12	51061	PF35	6438384 6437946 6435679	LF29, LF29HP	LF24, LF224			S-029
22400	PH8A HP1	L30001	FL1A	51515	PF2		LF1, LF1HP	LF15, LF115	185658	C1AZ-6731A D9AZ-6731A	S-01A

After many years of designing and testing racing oil systems and related components, we've determined what's most important to oil filtration. Many filter manufacturers stress the importance of filtering the smallest particles out of your engine's oil, with references to "micron ratings" of 10 or less for a filter's efficiency. With the help of research performed by filtration technology experts, Moroso engineers have determined that particles smaller than 20 microns in diameter are not large enough to produce engine wear. Furthermore, we've found that filters with extremely low micron ratings create an excessive pressure drop across the filter. They can be so restrictive that the filter by-pass valve can open. With the by-pass valve open, unknown to you—NO FILTRATION will occur!

To maximize filter performance, Moroso Racing Oil Filters have a rating of 27 microns, which produces a maximum initial restriction of only 2.5 psi when tested to SAE J806! The result is less pressure drop, more flow, less oil by-pass and maximum filtration performance important in severe racing conditions.

ENGINEERED FOR HIGH FILTRATION EFFICIENCY!

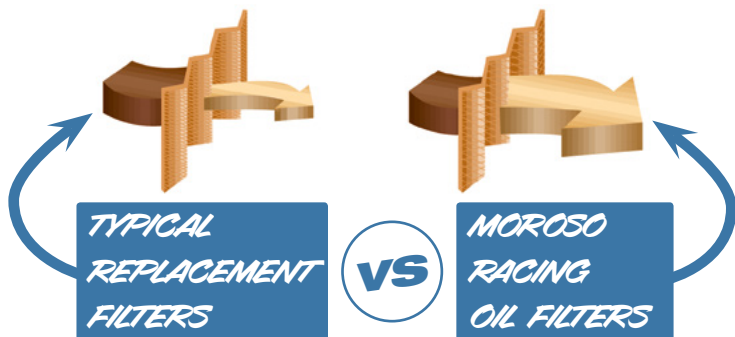

Buna-N gasket compatible with all racing fuels and lubricants

Extra thick housing with tuck seam withstands higher burst pressure

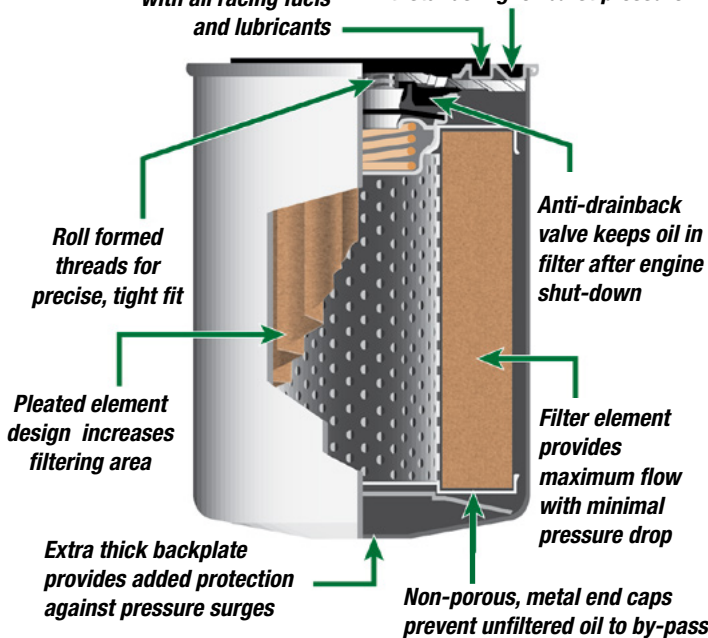

Moroso's Oil Filter design insures full filtration with minimal restriction under the most severe operating conditions!

PART # DESCRIPTION

- 22459** Racing Oil Filter, Chevy and others, 13/16" -16 UNF thread, short design (4-9/32" high), burst strength: 350 psi (max.)
- 22460** Racing Oil Filter, Chevy and others, 13/16" -16 UNF thread, long design (5-1/4" high), burst strength: 350 psi (max.)
- 22461** Racing Oil Filter, Chevy and others where space allows, 2 quart capacity, 13/16" -16 UNF thread, extra long design (8" high), burst strength: 350 psi (max.)
- 22462** Racing Oil Filter, GM LS Series, 1997-2006 with 13/16" -16 UNF thread, short design (3-1/2" high), burst strength: 300 psi (max.), 140 sq. in. of filter area
- 22463** Racing Oil Filter, Ford 4.6/5.4, GM LS Series 2007 & up, 22 mm-1.5 thread, short design (3-1/2" high), burst strength: 280 psi (max.) 170 sq. in. of filter area
- 22470** Racing Oil Filter, Ford and Chrysler, 3/4" -16 UNF thread, long design (5-1/4" high), burst strength: 500 psi (max.)

WARNING Prop. 65
This product contains a chemical known to the state of California to cause cancer.

RACING OIL FILTER CROSS REFERENCE

MOROSO	FRAM	PUROLATOR	MOTORCRAFT	WIX	AC	GM	K&N	HASTINGS	CHRYSLER	FORD	STP
22459	PH30 TG30	L20049	FL10	51069	PF25	6438261	HP-2002	LF225			S-025
22460	PH13 TG13 HP4	L30040	FL12	51061	PF35	6438384 6437946 6435679	HP-3002	LF24, LF224			S-029
22461	PH373	L40084	FL308	51794	PF932	6439034	HP-6002	LF226			
22462	PH3506	L14006	FL330	51042	PF46	25010251 6439857	HP-1007	LF232	L321		S3506
22463	PH2 PH10060	L1222 L24651	FL820S	57060 51372	PF48 PF1250	19160693 89017524	HP-2010	LF110 LF636	4884899AB 4892339A	FL820 F1AZ6731A	S2 S10060
22470	PH8A TG8A	L30001	FL1A	51515	PF2		HP-3001	LF15, LF115	185658	C1AZ-6731A D9AZ-6731A	S-01A

ENGINE SAVER

Pre-Filter Screen

- Fits all Small Block, Big Block and 90° V6 Chevy engines with spin-on oil filters
- Unique stainless steel screen locates on top of spin-on oil filters to trap debris before it enters the filter element undetected
- Particulate matter trapped in the screen and detected during periodic inspections serves as an "early warning signal" for impending engine failures
- 304 stainless steel filtration-grade screen traps contaminants down to the 280 micron range without affecting oil flow or oil pressure
- Crimped rings at both outside and inside diameters provide increased strength and extended durability
- Designed in cooperation with Jomar Racing Engines



No. 23845

WARNING Prop. 65
 This product contains a chemical known to the state of California to cause cancer, birth defects, or reproductive harm-

PART # DESCRIPTION

23845 "Engine Saver" Pre-Filter Screen. Small Block, Big Block and 90° V6 Chevy

IN-LINE SCREENED OIL FILTERS

- Prevents metal chips and other debris from entering dry sump pumps, rear end pumps & other oiling system components
- Ideal for use in oiling system scavenge lines
- Disassembles for easy cleaning
- Manufactured from lightweight aluminum
- 304 stainless steel screen uses .018" diameter 16 mesh wire



No. 23870

WARNING Prop. 65
 This product contains a chemical known to the state of California to cause cancer, birth defects, or reproductive harm-

PART # DESCRIPTION

23850 In-Line Screened Oil Filter, -10AN fittings

23860 In-Line Screened Oil Filter, -12AN fittings

23870 In-Line Screened Oil Filter, -8AN fittings

PART # REPLACEMENT PART

97050 Filter Element



FILTER FITTING SCREEN KIT

- Install in fittings to trap metal chips and debris
- Ideal for use on dry sump pumps, external oil pumps, rear end pumps, etc.
- 304 stainless steel screen uses .015" diameter 16 mesh wire
- Dimensions: .817" O.D. x 1.75" long
- Includes epoxy cement and 4 screens per kit
- Machining required for installation



No. 23965

WARNING Prop. 65
 This product contains a chemical known to the state of California to cause cancer, birth defects, or reproductive harm-

PART # DESCRIPTION

23965 Filter Fitting Screen Kit

OIL RETURN SCREEN KITS

- Inexpensive engine insurance!
- Traps metal fragments or loose components resulting from valvetrain failure before reaching vital engine parts
- Stainless steel mesh screens are fitted over holes in lifter valley with supplied epoxy

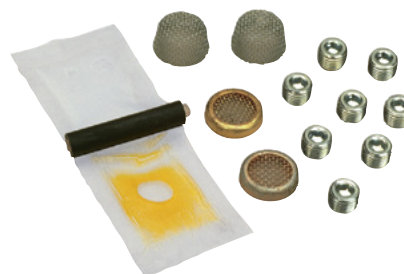

No. 25000

WARNING Prop. 65
 This product contains a chemical known to the state of California to cause cancer, birth defects, or reproductive harm-

PART # DESCRIPTION

25000 Oil Return Screen Kit, Small Block Chevy. Includes 8 oil return hole plugs to redirect oil to front/rear return galleries. Includes filter screens and epoxy

25001 Oil Return Screen Kit, Big Block Chevy. Includes 4 screens and epoxy

25026 Oil Return Screen Kit, Dart SHP SBC

ENGINE MAGNET KIT

- Use with any engine to minimize damage caused by valvetrain failures
- Magnets pick up metal fragments before reaching critical areas
- Place them in strategic locations near cylinder head and lifter valley drainback holes or in dry sump tank
- Includes: 4 each of 2-sized magnets (1-1/8" O.D. 3/8" I.D. and 7/8" O.D. 3/8" I.D.) and Epoxy

PART # DESCRIPTION
22710 Engine Magnet Kit

 **WARNING Prop. 65**
 This product contains a chemical known to the state of California to cause cancer, birth defects, or reproductive harm-



No. 22710

LOW OIL PRESSURE WARNING LIGHT

- Quick-response switch immediately alerts the racer to a low oil pressure condition
- Sending unit is factory set at 15 PSI. If a setting other than 15 PSI is desired, this Sending unit is easily adjustable by removing rubber cap and adjusting with Allen wrench
- Extra large 2-1/2" diameter Lexan lens is impossible to ignore
- Light assembly is rubber-mounted to protect against shock

PART # DESCRIPTION
49500 Low Oil Pressure Warning Light Kit

PART # REPLACEMENT PART
97015 Low Oil Pressure Switch

 **WARNING Prop. 65**
 This product contains a chemical known to the state of California to cause cancer, birth defects, or reproductive harm-



No. 49500

OIL PRESSURE GAUGE

1.5" Diameter, 0-120 PSI

- Necessary for racing applications where high oil pressures—above the range of typical oil pressure gauges—are used
- Will fit any 1/8" NPT male thread
- Excellent vibration and shock resistance

PART # DESCRIPTION
89611 Oil Pressure Gauge, 1.5" Diameter, 0-120 PSI

 **WARNING Prop. 65**
 This product contains a chemical known to the state of California to cause cancer, birth defects, or reproductive harm-



No. 89611

CRANKCASE EVACUATION SYSTEM

- Reduces crankcase pressure throughout entire rpm range for increased piston ring seal, reduced intake charge contamination, and fewer oil leaks
- Track and dyno tests prove increases in engine performance
- Includes 2 each: Oil Separators/Breathers, Breather/Filler Cap Grommets, One-Way Check Valve and Weld-In Nipple for header collector, use with 5/8" dia. hose

PART # DESCRIPTION
25900* Crankcase Evacuation System

PART # ACCESSORIES
68788 Breather

PART # REPLACEMENT PARTS
68780 Oil Separator/Breathers
97800 Check Valve for Header Collector
97810 Weld-in Nipple for Header Collector

 **WARNING Prop. 65**
 This product contains a chemical known to the state of California to cause cancer, birth defects, or reproductive harm-



No. 25900

**Cannot be used on cars with mufflers*



LIFTER VALLEY OIL BAFFLES

- Increases horsepower by shielding bottom of intake manifold from hot oil
- Keeps surplus oil out of valve covers by eliminating oil splash
- Maintains oil pressure during pushrod or rocker arm failure by keeping lifters in their bores (except with roller cam)
- Due to slight variations in blocks, the baffle may have to be trimmed .060"-.100" before it will "snap" into place
- Cannot be used with roller lifters

PART # DESCRIPTION

25050	Lifter Valley Oil Baffle, Small Block Chevy, including 18° heads
25100	Lifter Valley Oil Baffle, Big Block Chevy
25150	Lifter Valley Oil Baffle, Chrysler 273-360

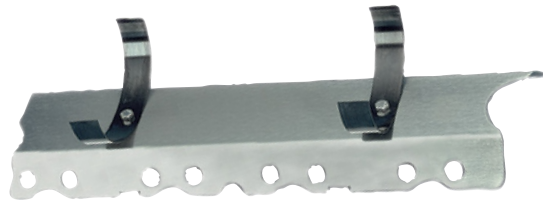
**No. 25050****LIFTER VALLEY VENTS**

- Positive ventilation to upper engine
- Prevents drainback to crankshaft
- Helps stop excessive windage and horsepower loss
- All aluminum – 8 per kit

PART # DESCRIPTION

25025	Lifter Valley Vents. Fits SBC and others, ¼" NPT with Hex Head
--------------	--

**No. 25025****GM VALLEY PLATES**

Aluminum, ¼" Thick

- Cost-effective alternatives to the factory GM pieces
- Does not have the two provisions for knock sensors, which are usually not used in racing applications, as open headers, solid lifter cams and stiff suspensions can false trigger them
- Engines that are using a carburetor and distributor also do not need the provisions for the knock sensors, which creates a cleaner installation
- Aluminum plate construction weighs less than the factory cast piece and allows specific bungs to be added
- Can be used on factory and aftermarket GM LS Series style engine blocks

PART # DESCRIPTION

25177	Valley Plate, Aluminum For GM LS1, LS2, LS6 & C5R
25178	Valley Plate, Aluminum For GM LSX, LS3 & LS7

**No. 25177****No. 25178**

OIL RESTRICTOR KITS

- Reduces oil flow to upper engine assembly, leaving more oil available for the rod and main bearings
- Reduces power-robbing windage by reducing the volume of oil passing by the rotating assembly on its return to the pan
- Do not use with hydraulic lifters

PART #	DESCRIPTION
22000	Oil Restrictor Kit. SBC and BBC engines, .060" orifice dia. Oil delivery holes at rear cam bearing must be tapped to install. Two per pack
22010	Oil Restrictor Kit. SBC and BBC engines, .0625" orifice dia. Screws into existing lifter galley cleaning plug holes at back of block. Two per pack
22016	Oil Restrictor Kit. Fits newer GM-Style blocks (including Mark V and Gen VI), .0625" orifice diameter with oil lifter galley bosses flush with bell housing face. Two per pack
22017	Oil Restrictor Kit. Fits Merlin II blocks, .0625" orifice diameter. Screws into existing lifter galley cleaning plug holes at back of block. Two per pack
22018	Oil Restrictors, Dart SHP SBC, fits stock lifter bore .843 only
22045	Oil Restrictor Kit. Ford 302-351W and Dart Iron Eagle Ford blocks. Kit includes: Four - Cam Bearing Restrictors (used in Ford & Dart Blocks); One - 7/16" -14 Restrictor for Lifter Gallies (Ford Only); One - 1/8" NPT Restrictor for Lifter Gallies (Dart); One - 1/8" NPT Plug for Lifter Gallies (Dart)
22050	Oil Restrictor Kit. Ford 351 Cleveland, designed and used by Roush-Fenway Racing. Five per pack



VALVETRAIN OIL DEFLECTOR

Fits: All SBC and Ford 289-302 engines with stamped rocker arms

- Redirects oil from pushrod to fulcrum balls, rockers and springs to provide maximum lubrication and cooling
- Extends life of stock valvetrain assembly
- Helps eliminate excessive oil accumulation in breather tank when vacuum pump is used
- Manufactured from lightweight .100" aluminum
- Mounts easily to stock rocker arm studs
- Includes mounting hardware
- Can be easily adapted to many other applications

PART #	DESCRIPTION
67700	Valvetrain Oil Deflector, Must use with tall valve covers. Polylocks not included

No. 67700

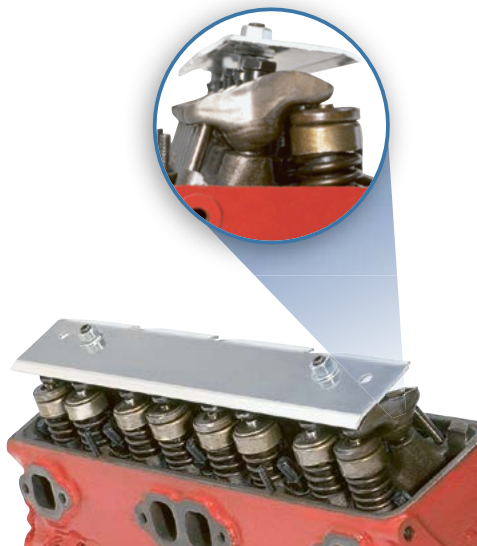

HIGH-PRESSURE OIL PUMP RELIEF SPRING

Designed by Jack Roush

Fits: Ford 351C & 400 Engines

- Fits Melling M84A and M84AHV oil pumps
- Increases oil pressure to approximately 100 psi for proper lubrication under sustained high rpm conditions

PART #	DESCRIPTION
22850	High-Pressure Oil Pump Relief Spring, Ford 351C and 400

No. 22850



OIL PREHEATERS

- Heater element designed specifically for heating oil; does not scorch or boil the oil like "converted water heater" designs
- 212 watts of power raises temperature of 12 quarts of oil 60°F in about 30 minutes
- Element screws into place; available with aluminum or steel 1" NPT fitting
- 120 volt rating; includes detachable 7-foot cord
- Length of heating element is 4-1/2" from fitting to tip

PART #	DESCRIPTION
23980	Oil Preheater, Internal, Aluminum Fitting
23990	Oil Preheater, Internal, Steel Fitting
PART #	REPLACEMENT PART
97590	Electric Cord

 **WARNING Prop. 65**
This product contains a chemical known to the state of California to cause cancer, birth defects, or reproductive harm-



No. 23990

OIL PREHEATER, SELF-CONTAINED

- Heater element designed specifically for heating oil; does not scorch or boil the oil like "converted water heater" designs
- 212 watts of power raises temperature of 12 quarts of oil 60°F in about 25 minutes
- 400 watts of power, 110-120 volt rating
- Aluminum, 1/2" -14 NPT weld-in bung and 3 ft. cord included
- Length of heating element is 4-3/4" from fitting to tip

PART #	DESCRIPTION
23991	Oil Preheater, Self Contained
PART #	AVAILABLE OPTION
22737	Steel Weld-In Bung, 1/2" -14 NPT

 **WARNING Prop. 65**
This product contains a chemical known to the state of California to cause cancer, birth defects, or reproductive harm-



No. 23991

EXTERNAL HEATING PADS

- New and improved lamination process
- Excellent for pre-heating of oil pans, tanks and automatic transmission pans
- Available with self-adhesive or hook/spring attachment methods
- Etched foil design distributes heat evenly
- Superior grade silicone outer shell resists oil and dirt

PART #	DESCRIPTION
23995	External Heating Pad, 6" x 12", hook and spring attachment. 360 Watts. 8" 110V cord
23996	External Heating Pad, 5" x 7", self-adhesive. 400 Watts (min). Heats oil from 66°F to 160°F in only 25 minutes. 36" 110V cord
23997	External Heating Pad, 2" x 15", self-adhesive. 150 Watts. Perfect for slender areas of oil pans/dry sump tanks. 36" 110V cord
PART #	AVAILABLE OPTION
64929	Throttle Return Springs For Part No. 23995

 **WARNING Prop. 65**
This product contains a chemical known to the state of California to cause cancer, birth defects, or reproductive harm-

No. 23995



No. 23996



No. 23997



AN ALUMINUM PORT PLUGS

Aluminum -12AN Port Plugs are used to seal threaded female ports in fluid systems

- Billet Aluminum, anodized
- Comes with O-ring seal

PART #	DESCRIPTION
22749	Port Plug, -12 AN With O-Ring Seal, Anodized



No. 22749

-AN FITTINGS

Aluminum

- Can be used on oil system components, Moroso Part Nos. 23700, 23710, 23750, 23760, 23770, 23782, 23780, 23690, 23692, 23840, 23900, 23901 or 23905
- Can be used with cooling system components, Moroso Part Nos. 63650, 63651, 63655, 63656, 63420, 63421
- Part No. 22709 can be used with No. 23766

PART #	DESCRIPTION
22706	Fitting, 1/2" NPT to -10AN, 1 per package
22708	Fitting, 1/2" NPT to -12AN, 1 per package
22709	Fitting, -12AN to -10AN, 1 per package



AN FITTINGS WITH O-RING

For Dry Sump Pumps, Tanks and Other Applications

- Radiused on inlets to reduce restriction for greater flow
- Black anodized billet aluminum
- Includes O-ring seal

WARNING Prop. 65
This product contains a chemical known to the state of California to cause cancer, birth defects, or reproductive harm-

PART #	DESCRIPTION
22604	Fitting, -8AN Male to -8AN Straight O-ring Side NEW!
22605	AN Fittings, -10AN to -10AN, 2 per package
22606	AN Fittings, -10AN to -12AN, 2 per package
22620	AN Fitting, -12AN to -12AN, 1 per package
22622	AN Fitting, -16AN to -16AN, 1 per package



-20AN HEMI PAN FITTING

- Designed to plumb oil lines to -20AN pickups in Hemi oil pans
- Black anodized billet aluminum
- Radiused inlet increases flow for improved oiling
- Includes O-ring

PART #	DESCRIPTION
22625	Hemi Pan Fitting, -20AN to -20AN, 1 per package



SPECIAL REPLACEMENT FITTINGS

- Special clearanced Fittings
- -12AN for Moroso Vacuum Pumps Nos. 22640, 22641 and 22642 and Remote Oil Filter Mount No. 23766
- -16AN for Moroso Vacuum Pump No. 22643
- Black anodized billet aluminum
- Radiused inlets to reduce restriction for greater flow
- Includes O-ring

PART #	DESCRIPTION
97641	Replacement Threaded Fitting, -12AN, 2 per package
22626	Threaded Fittings for No. 22643, -16AN, 2 per package



EXTERNAL WET SUMP OIL PUMP FITTINGS

- Helps prevent cavitation by allowing a larger diameter hose to be used, which acts as a storage container
- For use with external wet sump pumps and pans with -10AN or -12AN fittings
- Includes O-ring

PART #	DESCRIPTION
22703	Fitting, -10AN to -16AN Adapter, 1 per package
22704	Fitting, -12AN to -16AN Adapter, 1 per package



OILING SYSTEM EQUIPMENT

FILTER FITTINGS

Designed to trap metal chips and debris before reaching external or dry sump oil pumps, or rear end lube pumps

- 304 stainless steel screen uses .015" diameter, 16 mesh wire
- **Two styles available:** External Screen for oil pan and tank outlets and Internal Screen for inlet sides of oil pumps
- Useful in applications where space limitations prevent the use of an in-line filter
- Easily removed for cleaning

PART # DESCRIPTION

- 23960◉ Filter Fitting, External Screen, 3/4" NPT to -12AN male, one per package
- 23961◉ Filter Fitting, External Screen, -12AN male to -12AN male, one per package
- 23962◉ Filter Fitting, External Screen, -16AN to -16AN, one per package
- 22610◉ Filter Fittings, Internal Screen, -10AN to -12AN, two per package
- 23963◉ Fitting, -12 AN Male to -16 AN Male with External Screen, one per package

PART # AVAILABLE OPTIONS

- 22706 Fitting, 1/2" NPT to -10AN, 1 per package
- 22708 Fitting, 1/2" NPT to -12AN, 1 per package
- 22709 Fitting, -12AN to -10AN, 1 per package

 **WARNING Prop. 65**
This product contains a chemical known to the state of California to cause cancer, birth defects, or reproductive harm-



WELD-ON -AN BUNGS

- Weld-on bungs for use with aluminum radiators, overflow tanks, oil tanks, oil pans, etc.
- Provides adapters for return or feed hoses, pressure gauges, turbo drainbacks or other custom plumbing requirements
- Aluminum
- One per package

APPLICATION CHART			
DESCRIPTION	MALE	FEMALE	
PART #	22711	22718	-4AN
	22712	22719	-6AN
	22713	22720	-8AN
	22714		-10AN
	22715	22722	-12AN
	22716		-16AN
	22717		-20AN



WELD-ON NPT BUNGS

- Weld-on for use with oil pans, fuel tanks/fuel sump, turbo drainbacks, feed hoses, pressure gauges or other requirements
- One per package, female

PART # DESCRIPTION

- 22724 Weld-On Bung, 1/8" NPT, Aluminum
- 22725 Weld-On Bung, 1/4" NPT, Aluminum
- 22726 Weld-On Bung, 3/8" NPT, Aluminum
- 22727 Weld-On Bung, 1/2" NPT, Aluminum
- 22728 Weld-On Bung, 3/4" NPT, Aluminum
- 22729 Weld-On Bung, 1" NPT, Aluminum
- 22737 Weld-On Bung, 1/2" NPT, Steel



-12AN MALE NON-WELD, BAFFLED FITTING KIT

- Provides an easy way of adding a -12AN male fitting to a steel or aluminum flat surface without welding
- Since no welding is required then there is not the possibility of heat damage to the surface or the need to take the piece to get welded
- Billet aluminum mounting plate features an o-ring and hardware for leak free sealing
- Includes optional interior baffle and mounting hardware
- -12AN fitting screws into base plate and can be tightened down with built-in hex



PART # DESCRIPTION

- 22754 Fitting Kit, -12AN Male Non-Weld Baffled

No. 22754



PROPERLY MAINTAIN YOUR MOROSO VACUUM PUMP

Moroso recommends that your Vacuum Pump be cleaned on a regular basis for optimum performance. When performing any maintenance, wear approved safety glasses. Loosen the vacuum pump pulley bolts and remove the pulley. Remove the vacuum pump from engine and remove bearing cap from the back of the pump.

Remove the rear cover from the pump housing, remove the vanes from the rotor slots noting the notches on the bottom and top of the vanes face towards the shaft and the worn in edge of the vane curves to match the shape of the rotor. Remove the front cover and rotor shaft assembly. Disassemble rotor from shaft. Clean all pieces, (vanes, housing, rotor & shaft, front & rear covers, bearing cap), using a mild part cleaning solvent or soap and water. Inspect parts for wear or damage. If rebuilding is necessary use the correct rebuild kit for your 3-vane or 4-vane pump or contact Moroso Performance Technical Service Department at for information on how we can service your pump. When all pieces are cleaned and ready for assembly, place the rotor shaft keys onto the shaft. Install rotor onto shaft being careful to keep the shaft keys in place.

Next, place the rotor, shaft and front cover assembly into the housing. Replace the vanes making sure the vane notches are facing the shaft and the curved "worn-in" surfaces are facing the housing. If you are using new vanes, they will not have a curved end, follow the instructions provided with the Rebuild Kit. Replace rear cover and bearing cap. Install and tighten the front and rear cover hardware and bearing cap screw. Re-install pump onto your engine.



Q: HOW FAST SHOULD I DRIVE THE VACUUM PUMP FOR BEST RESULTS? A: As a base line, all Moroso Vacuum Pumps will work at 50% of engine speed. Our Drive Kits are designed to work with the pump pulleys to achieve the proper ratio.

Q: WHAT IF I NEED MORE VACUUM? A: In applications that require more vacuum at a lower engine RPM (i.e. at idle or at staging RPM) or through the entire RPM range it may be necessary to increase the drive ratio of the pump. Consult your Moroso Technical Advisor for assistance in choosing the proper drive ratio.

Q: HOW FAST CAN I DRIVE MY VACUUM PUMP? A: Moroso Vacuum Pumps Part Nos. **22640** and **22641** can turn no more than 6500 RPM shaft speed. Moroso Vacuum Pump Nos. **22642** and **22643** can turn 8000 RPM maximum shaft speed.

Q: WHAT IS THE BEST WAY TO CARE FOR MY NEW MOROSO VACUUM PUMP? A: Keep it clean.

Q: HOW OFTEN SHOULD I REBUILD MY VACUUM PUMP? A: As a "rule of thumb", it is generally good practice to rebuild your vacuum pump after 300 runs. Upon physical inspection it is recommended to rebuild your pump when the vanes are sitting below the rotor surface .100" or greater. Other key indicators for rebuild are excessive bearing or shaft wear. Rebuild kits are available from Moroso. Moroso Vacuum Pumps, like any part on a race car, require some up keep to ensure good performance.

Q: HOW MUCH VACUUM IS ENOUGH? A: Leading engine builders and race teams confirm that on wet sump systems, 10" to 14" of vacuum will create additional horsepower and minimize oiling system related problems. Dry sump engines should be kept in the range of 18" to 22" Hg. Although normally capable of achieving greater vacuum levels, it is best to consult a professional engine builder if higher levels of vacuum are desired. Moroso carries a variety of vacuum relief valves to adjust the maximum amount of vacuum an engine will make.

Q: WHY DOES MY ALCOHOL ENGINE MAKE LESS VACUUM? A: Engines running alcohol typically see less vacuum than an engine that runs on gasoline. This is from the ring sealing characteristics between the two fuels.

Q: WHEN IS THE BEST TIME TO CHECK MY VACUUM AND OIL PRESSURE? A: The best time to check vacuum and oil pressure together is during your trans brake check. At your staging RPM, monitor what your vacuum and oil pressure is. This is the most consistent way of knowing what condition your system is in.

Q: WHERE SHOULD THE INLET OF MY MOROSO VACUUM PUMP BE PLUMBED? A: Moroso Vacuum Pumps are most commonly plumbed to the front or top of a valve cover. Using Moroso Part Nos. **22634** or **22635** Positive Seal Fitting with a built-in baffle, no welding is required on the valve cover. This fitting allows a small amount of oil to flow through the pump for increased lubrication. Be sure to consult the Moroso catalog for a listing of all the accessories needed for your application.

The nature of a vacuum pump is to remove air, blow-by gasses and other contaminants from the crankcase of an engine. Crankcase vacuum will increase horsepower by allowing the use of low-tension compression and oil control rings. In which the use of reduces frictional horsepower losses, blow-by, intake charge contamination and aids in detonation prevention. Moroso's "purpose built" racing pumps offer all these advantages and more. Whether you have a normally aspirated Small Block or a nitrous equipped Pro-Mod, one of Moroso's vacuum pump offerings with all the needed accessories has you covered. These pumps will suit nearly any engine combination and requirement.

ORIGINAL DESIGN 3-VANE VACUUM PUMP

- Versatile Billet aluminum design
- Engineered vane material for improved efficiency and wear
- Completely rebuildable in 15 minutes
- Mounting bracket not included
- 4.150" O.D. body, 5.050" from back of pump to pulley mounting flange

PART #	DESCRIPTION
22640*	Original Design 3-Vane Vacuum Pump, -12AN Fittings



No. 22640

ENHANCED DESIGN 3-VANE VACUUM PUMP

We've taken our popular 3-Vane Vacuum Pump and added tricks that we learned when designing our "Enhanced Design" 4 Vane Vacuum Pump and through continual development of our Vacuum Pump line.

The end result is:

- The "Enhanced Design" features allow the pump to pull more vacuum than the "Original" style 3-Vane pump
- Achieves greater vacuum sooner
- 3-Vane Design weighs less than "original" style pumps
- Virtually maintenance free
- Designed with maintenance-free precision sealed roller bearings
- Includes -12AN Fittings
- Mounting bracket not included
- 4.375" O.D. body, 5.050" from back of pump to pulley mounting flange

PART #	DESCRIPTION
22840*	Enhanced Design 3-Vane Vacuum Pump, -12AN Fittings, Hard Anodized Finish

PART #	AVAILABLE OPTIONS
63903	Vacuum Pump Idler Pulley Kit



No. 22840



SEE MORE
Mounting Brackets
on pgs. 165-169

ORIGINAL DESIGN 4-VANE VACUUM PUMP

- Versatile Billet aluminum design, well suited for wet or dry sump applications
- Engineered vane material for improved efficiency and wear
- Completely rebuildable in 15 minutes
- Mounting bracket not included
- 4.150" O.D. body, 5.900" from back of pump to pulley mounting flange

PART #	DESCRIPTION
22641*	Original Design 4-Vane Vacuum Pump, -12AN Fittings



No. 22641

REPLACEMENT PARTS FOR MOROSO VACUUM PUMPS

PART #	REPLACEMENT PARTS
97641	Replacement Fittings, -12AN
22626	Replacement Fittings, -16AN
22645	Vacuum Pump Rebuild Kit, Includes Bearing, Seals & Vanes For No. 22640
22646	Vacuum Pump Rebuild Kit, Includes Bearing, Seals & Vanes For No. 22641
97180	Rebuild Kit, Excluding Vanes, Includes Shaft & Hub, For Nos. 22640, 22641
97181	Rebuild Kit, Excluding Vanes, Includes Shaft & Hub, For Nos. 22642, 22644, 22840, 22842
97642	Vacuum Pump, Vane Kit, For Nos. 22642, 22644, 22840, 22842
97644	Vacuum Pump, Vane Kit, For No. 22643

*Note: Not Legal for sale or use on pollution-controlled vehicles

ENHANCED DESIGN 4-VANE VACUUM PUMPS

- "Enhanced Design" pulls 13.9% more vacuum
- Can be used efficiently on wet or dry-sump engines
- Achieves greater vacuum sooner, virtually maintenance free
- 4-Vane design weighs less than "original" style pumps
- Designed with maintenance-free precision sealed roller bearings
- Pump **No. 22644** is natural aluminum finish designed to be polished, interior is hard coated for wear resistance
- 4.375" O.D. body, 5.050" from back of pump to pulley mounting flange

PART #	DESCRIPTION
22842*	Enhanced Design 4-Vane Vacuum Pump, -12AN Fitting, Mounting Bracket not included, Hard Anodized Finish
22642*	Enhanced Design 4-Vane Vacuum Pump Kit, -12AN Fitting, Mounting Bracket, Hard Anodized Finish
22644*	Enhanced Design 4-Vane Vacuum Pump Kit, -12AN Fitting, Mounting Bracket, Natural Aluminum Finish

PART #	AVAILABLE OPTIONS
63903	Vacuum Pump Idler Pulley Kit



No. 22842



No. 22642



No. 22644

LARGE STYLE 4-VANE VACUUM PUMP

with Dual Line Manifold

This "large style" 4-Vane Vacuum Pump was released from feedback by racers and engine builders who craved the performance of the Moroso "Pro-Mod Style" vacuum pump but needed a pump that was physically smaller and lighter.

- Pulls large consistent vacuum numbers
- Creates vacuum quickly and linearly
- Virtually maintenance free, designed with maintenance-free precision sealed roller bearings
- Includes a manifold for dual feed applications or installation of a relief valve
- Comes with a 36 tooth $\frac{3}{8}$ " pitch $\frac{1}{2}$ " wide Gilmer pulley, adjustable mounting bracket and -12AN fittings
- 5.030" O.D. body, 6.175" from back of mounting bracket to end of slot on front of pulley

PART #	DESCRIPTION
22843*	Large Style 4-Vane Vacuum Pump

PART #	AVAILABLE OPTIONS
22630	Vacuum Relief Valve, -12 AN Adjustable
97172	Crankshaft Drive Pulley, 18 tooth, $\frac{1}{2}$ " wide, Gilmer



No. 22843



PRO-MOD STYLE LARGE CUBIC INCH ENGINES & BLOWER MOTOR PUMP

- Large displacement creates incredible vacuum
- Flows up to 150% more than Original Design
- Capable of flowing 100 CFM with -16AN fitting
- Utilizes sealed maintenance free bearings
- Adjustable bracket and fittings included
- 5.300" O.D. body, 6.550" from back of pump to pulley mounting flange

PART #	DESCRIPTION
22643*	Pro Mod Style Large Cubic Inch & Blower Motor Pump, 1- $\frac{1}{4}$ " beaded hose fitting with -16AN Inlet and Outlet Fitting



No. 22643

**Note: Not Legal for sale or use on pollution-controlled vehicles*



EXTERNAL SINGLE STAGE OIL PUMP/VACUUM PUMP KIT

SBC, Driver's/Left Bracket

- This kit includes a Moroso Tri-lobe Single Stage Oil Pump with a Moroso Enhanced Design 4-Vane Vacuum Pump driven off the back
- By driving the V-band clamp attached vacuum pump off the back of the oil pump this creates a compact weight saving design with one belt only being utilized
- Single stage external Tri-lobe oil pump is included that has a spur gear 1.200 pressure section, eliminates the camshaft loads that occur with an internal pump. Has replaceable fittings, -16AN inlet, -12AN outlet
- Enhanced Design 4-Vane Vacuum Pump is included that pulls more vacuum and is designed with maintenance-free precision sealed roller bearings. Has replaceable -12AN Inlet and Outlet fittings
- V-band clamp is included

NEW!

No. 22652



PART # DESCRIPTION

22652 External Oil Pump, Single Stage, Tri-Lobe, Vacuum Pump, SBC Left Side Bracket

EXTERNAL SINGLE STAGE OIL PUMP/VACUUM PUMP KIT

BBC, Driver's/Left Bracket

- This kit includes a Moroso Tri-lobe Single Stage Oil Pump with a Moroso Enhanced Design 4-Vane Vacuum Pump driven off the back of it
- By driving the V-band clamp attached vacuum pump off the back of the oil pump this creates a compact weight saving design
- Single stage external Tri-lobe oil pump is included that has a spur gear 1.200 pressure section, eliminates the camshaft loads that occur with an internal pump. Has replaceable fittings, -16AN inlet, -12AN outlet
- Enhanced Design 4-Vane Vacuum Pump is included that pulls more vacuum and is designed with maintenance-free precision sealed roller bearings. Has replaceable -12AN Inlet and Outlet fittings
- V-band clamp is included

NEW!

No. 22654



PART # DESCRIPTION

22654 External Oil Pump, Single Stage, Tri-Lobe, Vacuum Pump, BBC Left Side Bracket

VACUUM PUMP ACCESSORIES

CLAMP ON BREATHER

- Clamps onto a 1" outside dia. tube, clamp included
- Fits Moroso Billet Alum. Vacuum Relief Valves **Nos. 22633, 22636 and 22637**
- Provides maximum protection against dirt and airborne debris without restricting air flow
- Cleanable and re-usable: oil before use

PART # DESCRIPTION

68791 ◊ Clamp On Breather, 1" I.D.

◊ **WARNING Prop. 65**
This product contains a chemical known to the state of California to cause cancer, birth defects, or reproductive harm-



No. 68791

VACUUM & OIL PRESSURE GAUGES

- **No. 89610** is used to determine vacuum in your engine
- **No. 89611** is for racing applications where high pressures, above the range of typical oil pressure gauges are used
- Have 1/8" NPT male thread
- Excellent vibration and shock resistance

PART # DESCRIPTION

89610 ◊ Vacuum Gauge, 1.5" Diameter, 0-30" Hg

89611 ◊ Oil Pressure Gauge, 1.5" Diameter, 0-120 PSI

◊ **WARNING Prop. 65**
This product contains a chemical known to the state of California to cause cancer, birth defects, or reproductive harm-



No. 89610



No. 89611



VACUUM RELIEF VALVES

With Easy Adjustable Knob

- Vacuum relief point is adjustable by turning the built-in adjustment knob to get the precise amount of vacuum desired. Tightening the integral locknut keeps the adjustment locked until the next adjustment is needed
- Can be disassembled for easy cleaning and maintenance and will work with any vacuum level
- They are made of 6061 aluminum and have a smooth, attractive finish

PART # DESCRIPTION

- 22630*** Vacuum Relief Valve with Easy Adjustable Knob, Gland Seal (-12AN Female)
22631* Vacuum Relief Valve with Easy Adjustable Knob, Face Seal ("Face to Face" thru sheetmetal)



No. 22630

No. 22631

BILLET ALUMINUM VACUUM RELIEF VALVES

Shim-able Spring Style

- Two styles allow fastening through valve covers (**No. 22637**) or threaded directly into lifter valley (**No. 22636**)
- Vacuum relief point is adjustable by shimming an internal spring to get the precise amount of vacuum desired
- Can be disassembled for easy cleaning and maintenance and works with any vacuum level
- They are made of 6061 T6 Billet aluminum and have a clear, attractive finish

PART # DESCRIPTION

- 22636*** Billet Aluminum Vacuum Relief Valve, Shim-able Spring Style, 3/8" NPT
22637* Billet Aluminum Vacuum Relief Valve, Shim-able Spring Style, 3/4"-16 Thread



No. 22636

No. 22637

VACUUM PUMP REGULATOR

Shim-able Spring Style

- Regulator screws directly into vacuum pump's -12AN inlet
- 360° directional adjustability
- Prevents the need for drilling additional holes in the valve cover
- Anodized - clear
- Prevents pulling excess oil out of the crankcase

PART # DESCRIPTION

- 22633*** Vacuum Pump Regulator, Shim-able Spring Style



No. 22633

VACUUM PUMP REGULATOR

With Easy Adjustable Knob

- Regulator screws directly into vacuum pump's -12AN inlet no need to drill additional holes in the valve cover
- 360° directional adjustability by turning the built-in adjustment knob to get the precise amount of vacuum desired
- Tightening the integral locknut keeps the adjustment locked until the next adjustment is needed
- Can be disassembled for easy cleaning and maintenance and will work with any vacuum level
- Made from 6061 billet aluminum with a clear anodized finish
- Prevents pulling excess oil out of the crankcase

PART # DESCRIPTION

- 22629*** Vacuum Pump Regulator with Easy Adjustable Knob



No. 22629

**Note: Not Legal for sale or use on pollution-controlled vehicles*

POSITIVE SEAL VENTED FITTING -12AN/-16AN

- Designed to greatly simplify the plumbing of a vacuum pump
- Screws into side of valve cover
- Provides leak free O-ring seal on any flat valve cover surface
- No welding required
- Anodized to prevent corrosion

PART #	DESCRIPTION
22634	-16AN Fitting, Positive Sealing, one per package
22635	-12AN Fitting, Positive Sealing, one per package

PART #	REPLACEMENT PARTS
97641	-12AN Replacement Fitting, two per package
22626	-16AN Replacement Fitting, two per package



POSITIVE SEAL VENTED -8AN & -10AN FITTINGS, NON-WELD

Fits: 3/4" Holes

- Designed to greatly simplify the plumbing of a vacuum pump
- Screws into side of valve cover
- Provides leak free O-ring seal on any flat cover surface
- No welding required
- Anodized to prevent corrosion

PART #	DESCRIPTION
22624	Fitting, -10AN Male, Positive Seal, Non-Weld
22627	Fitting, -8AN Male, Positive Seal, Non-Weld

WARNING Prop. 65
 This product contains a chemical known to the state of California to cause cancer, birth defects, or reproductive harm.



-16AN FITTINGS FOR VACUUM PUMPS

- -16AN for Moroso Vacuum Pump **No. 22643**
- Anodized to prevent corrosion
- Radiused inlets to reduce restriction for greater flow
- Includes O-rings
- Two per package

PART #	DESCRIPTION
22626	Fitting, Vacuum Pump, -16AN



POSITIVE SEAL 1/8" NPT FITTING

- Designed to facilitate connection of vacuum gauge to the valve cover without welding
- Use with Moroso Vacuum Gauge **No. 89610**
- Includes O-rings

PART #	DESCRIPTION
22632	Positive Seal 1/8" NPT Fitting



-10AN MALE FITTING, NON-WELD

- Non-weld kit, makes it easy to add a leak-proof fitting to oil pans for oil returns, valve covers, etc., without having to actually weld the fitting
- Perfect for adding a fitting to steel or aluminum with up to a 1/8" max. wall thickness
- O-ring seal to prevent leaks

PART #	DESCRIPTION
22753	-10AN Male Fitting, Non-Weld





VACUUM PUMP LINE KIT

- Includes 6 feet of steel reinforced hose, two 90 degree hose fittings and two -12AN straight hose fittings
- Designed to simplify Vacuum Pump installation

PART # DESCRIPTION
22649 Vacuum Pump Line Kit

PART # REPLACEMENT PARTS
22651 Vacuum Pump Replacement Line

WARNING Prop. 65
 This product contains a chemical known to the state of California to cause cancer, birth defects, or reproductive harm-



No. 22649

VACUUM LINE CAP KIT

- Convenient kit provides a quick, sure way to seal vacuum line connections at carburetors, manifolds, etc. when vacuum lines have been removed
- Kit consists of color-coded soft plastic caps in quantities and inside dimensions as follows: two 1/8", six 3/16", six 1/4", two 5/16", four 3/8"

PART # DESCRIPTION
41090 Vacuum Line Cap Kit

WARNING Prop. 65
 This product contains a chemical known to the state of California to cause cancer, birth defects, or reproductive harm-



No. 41090

VACUUM LINE CAP KIT, BLACK CAPS

- Convenient kit provides a quick, sure way to seal vacuum line connections at carburetors, manifolds, etc. when vacuum lines have been removed
- Kit consists of black soft plastic caps in quantities and inside dimensions as follows: two 1/8", six 3/16", six 1/4", two 5/16", four 3/8"

PART # DESCRIPTION
41091 Vacuum Line Cap Kit, Black

WARNING Prop. 65
 This product contains a chemical known to the state of California to cause cancer, birth defects, or reproductive harm-



No. 41091

BILLET ALUMINUM EQUALIZING PLATES WITH FITTINGS

- Includes 1/8" NPT Fitting and -12AN Fitting
- Allows the vacuum pump and vacuum gauge to be connected*
- Can also be used as a drain back location
- Black Anodized
- Includes gaskets and stainless steel socket head screws

PART # DESCRIPTION
65397 Fuel Pump Block-Off Plate, SBC
65398 Fuel Pump Block-Off Plate, BBC, 273-440 Chrysler, and all Fords except 351C, 351M and 400

WARNING Prop. 65
 This product contains a chemical known to the state of California to cause cancer, birth defects, or reproductive harm-



No. 65397



No. 65398

***Note:** Installation of this product requires pulling vacuum from a valve cover as well

VACUUM PUMP MOUNTING BRACKETS

Moroso offers Anodized Billet Aluminum Vacuum Pump Mounting Brackets that fit a variety of engine and vacuum pump combinations. These brackets fit the engines directly, or mount to a motor plate. Refer to the chart below for complete application details.

VACUUM PUMP BRACKET APPLICATION CHART

PART #	ENGINE APPLICATION	MOROSO PUMP BRACKET WAS DESIGNED FOR		MOUNTING LOCATION
		22640	22641	
63910	All Engines	22640	22641	With a motorplate
63917	All Engines	22642 22840	22644 22842	With a motorplate
63910	Small & Big Block Chevy	22640	22641	Driver/passenger cyl. heads
63917	Small & Big Block Chevy	22642 22840	22644 22842	Driver/passenger cylinder heads
63922	GM LS	22640	22641	Driver side cylinder head
63923	GM LS	22640	22641	Passenger side cylinder head
63924*	GM LS	22642 22840	22644 22842	Driver/passenger cylinder heads
63911	Small Block Ford	22640	22641	Driver or Passenger cylinder heads
63916*	Small Block Ford	22642 22840	22644 22842	Passenger cylinder heads
63921*	Ford 4.6/5.4	22640 22642 22840	22641 22644 22842	OEM, Power Steering Pump Location
63909	Big Block Ford	22640	22641	Driver or Passenger cylinder heads



No. 63909



No. 63910

No. 63911



No. 63917

* Part No.63917 needed with 63914, 63916, 63921 & 63924 to mount enhanced pumps to the mounting bracket.



No. 63917



No. 63921

FOR ALL VACUUM PUMP MOUNTING BRACKETS:

All necessary *spacers & hardware* included for each Mounting Bracket!



No. 63922

No. 63924



No. 63916



No. 63923

PART # REPLACEMENT PARTS
63917 Replacement Bracket for Moroso "Enhanced Design" Vacuum Pump **Nos. 22642 and 22842**

PART # AVAILABLE OPTIONS
63918 Adapter Ring. Allows the use of a Moroso "Original" Style Vacuum Pump with **No. 63917** Mounting Brackets

GM LS ENGINE ALTERNATOR MOUNT

For GM LS Series engines with Moroso No. 63566 Electric Water Pump & 130mm style alternators

- Two mounts incorporated into one billet aluminum frame with belt adjustment for alternator
- Works with Moroso and other similar drive mandrels
- Includes all spacers and hardware

PART #	DESCRIPTION
63839	Alternator Mount, GM LS With Moroso Electric Water Pump

No. 63839

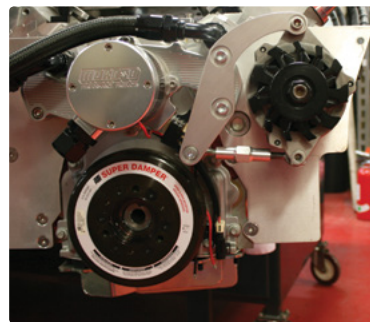

ALTERNATOR MOUNT KITS PATENT NO. D600,720

For SBC and BBC, Nippondenso 93 mm, Aftermarket

- These bracket kits are designed to mount mini ND-style and 93mm alternators to either side of the motor, while clearing the electric water pump
- Works with Moroso old and new style drive mandrel kits
- Includes all spacers and hardware

PART #	DESCRIPTION
63827	Alternator Mounting Kit, SBC, Moroso Electric Water Pumps
63828	Alternator Mounting Kit, SBC, CSR Electric Water Pumps
63829	Alternator Mounting Kit, SBC, Meziere Electric Water Pumps
63832	Alternator Mounting Kit, BBC, Moroso Electric Water Pumps
63833	Alternator Mounting Kit, BBC, CSR Electric Water Pumps
63834	Alternator Mounting Kit, BBC, Meziere Electric Water Pumps



No. 63832

ALTERNATOR/VACUUM PUMP MOUNTING KIT, GM LS WITH FRONT DRIVE DISTRIBUTOR, FOR MOROSO ENHANCED VACUUM PUMPS, MOROSO ELECTRIC WATER PUMP & 93MM ALTERNATORS

- Two mounts are incorporated into one billet aluminum frame with belt adjustment for alternator, vacuum pump and includes all spacers and hardware
- Bracket kit was designed to mount mini ND-style 93 mm alternators and Moroso Nos. 22642, 22644, 22840 or 22842 Enhanced Design Vacuum Pumps
- Mounts Alternator on driver's side and Vacuum Pump on passenger's side while clearing the required Moroso No. 63547 electric water pump, No. 63615 water pump adapter kit and No. 63849 drive mandrel kit

PART #	DESCRIPTION
63870	Alternator/Vacuum Pump Mounting Kit, GM LS With Distributor, Moroso Enhanced Vacuum Pumps & Electric Water Pump & 93mm Alt.

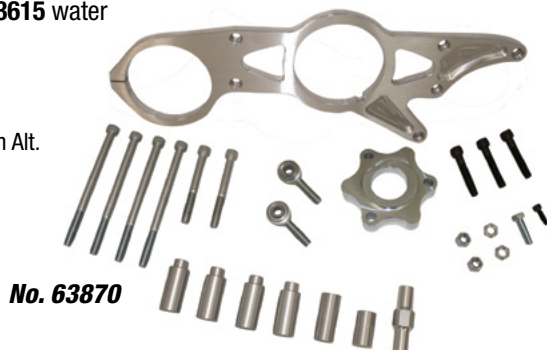

No. 63870



ALTERNATOR AND VACUUM PUMP MOUNTING KITS PATENT NO. D600,720

For SBC and BBC, Nippondenso 93 mm, Aftermarket

- Two mounts incorporated into one billet aluminum frame with belt adjustment for alternator and vacuum pump
- These bracket kits are designed to mount mini ND-style 93mm alternators and Moroso Nos. 22642, 22644, 22840 or 22842 Enhanced Design Vacuum Pumps

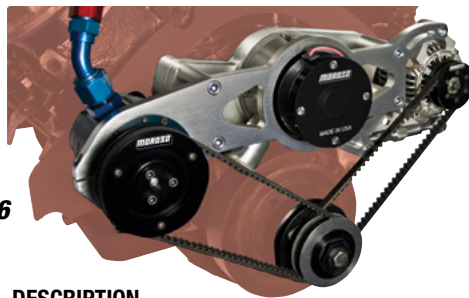

No. 63836

PART #	DESCRIPTION
63817	Alternator/Vacuum Pump Mounting Kit, SBC, Moroso Electric Water Pumps 93mm style alternators, Moroso Enhanced Vacuum Pumps
63818	Alternator/Vacuum Pump Mounting Kit, SBC, CSR Electric Water Pumps 93mm style alternators, Moroso Enhanced Vacuum Pumps
63819	Alternator/Vacuum Pump Mounting Kit, SBC, Meziere Electric Water Pumps 93mm style alternators, Moroso Enhanced Vacuum Pumps

PART #	DESCRIPTION
63836	Alternator/Vacuum Pump Mounting Kit, BBC, Moroso Electric Water Pumps 93mm style alternators, Moroso Enhanced Vacuum Pumps
63837	Alternator/Vacuum Pump Mounting Kit, BBC, CSR Electric Water Pumps 93mm style alternators, Moroso Enhanced Vacuum Pumps
63838	Alternator/Vacuum Pump Mounting Kit, BBC, Meziere Electric Water Pumps 93mm style alternators, Moroso Enhanced Vacuum Pumps



MOUNTING BRACKETS

ALTERNATOR AND VACUUM PUMP MOUNTING KITS

For BBC Chevy with Moroso Enhanced Vacuum Pumps & 130mm style alternators

Patent No. D600,720

- Two mounts are incorporated into one billet aluminum frame with belt adjustment for alternator and vacuum pump
- Bracket kit was designed to mount full size 130 mm Alternators such as East Coast 2007, 2008 & 2009 series, also fits CS121 style Alternators and Moroso Part Nos. 22642, 22644, 22840 or 22842 Enhanced Design Vacuum Pumps
- Mounts Alternator on driver's side and Vacuum Pump on passenger's side while clearing the electric water pump
- Works with most styles of drive mandrel kits
- Includes all spacers and hardware

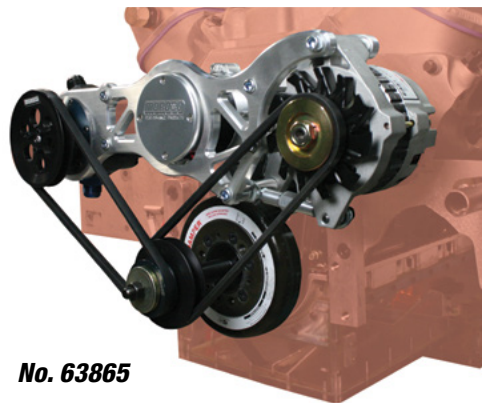

No. 63865

PART #	DESCRIPTION
63865	Alternator/Vacuum Pump Mounting Kit, Moroso Electric Water Pumps, 130mm style alternators, Moroso Enhanced Vacuum Pumps
63866	Alternator/Vacuum Pump Mounting Kit, BBC, CSR Electric Water Pumps the latest version of, which have a profiled silhouette and countersunk fasteners, 130mm style alternators, Moroso Enhanced Vacuum Pumps
63867	Alternator/Vacuum Pump Mounting Kit, BBC, Meziere Electric Water Pumps, 130mm style alternators, Moroso Enhanced Vacuum Pumps



No. 63867

ALTERNATOR AND VACUUM PUMP MOUNTING KITS

For Ford 289-302, 351W

Patent No. D600,720

- Two mounts incorporated into one billet aluminum frame with belt adjustment for alternator and vacuum pump
- These bracket kits are designed to mount mini ND Style 93mm Alternators and Moroso **No. 22642, No. 22644, No. 22840** or **No. 22842** Enhanced Design Vacuum Pumps
- Mounts alternator on driver-side and vacuum pump on passenger-side, while clearing the electric water pump
- Works with most old and new style drive mandrel kits, with recommended pulleys (see options, above)

PART # DESCRIPTION

63821	Alternator and Vacuum Pump Mounting Kit, Ford 289/302/351W, use with Meziere Electric Water Pumps and Moroso Enhanced Design Vacuum Pumps
63822	Alternator and Vacuum Pump Mounting Kit, Ford 289/302/351W, use with Moroso Electric Water Pumps and Moroso Enhanced Design Vacuum Pumps
63823	Alternator and Vacuum Pump Mounting Kit, Ford 289/302/351W, use with CSR Electric Water Pumps and Moroso Enhanced Design Vacuum Pumps



Brackets



Brackets shown mounted to CSR™ Electric Water Pump



Radius Tooth Drive Pulleys on pgs. 178-179

ALTERNATOR/VACUUM PUMP MOUNTING KIT

Fits: Ford 289, 302, 351W, CSR Electric Water Pumps (Latest Version)

Patent No. D600,720

- Fits the latest version of the CSR Ford 289, 302, 351W Electric Water Pumps which have a profiled silhouette and countersunk fasteners
- For earlier design CSR Ford 289, 302, 351W Electric Water Pumps use Part **No. 63823**
- Two mounts are incorporated into one billet aluminum frame with belt adjustment for alternator and vacuum pump
- Bracket kit was designed to mount mini ND Style 93mm Alternators and Moroso Part **Nos. 22642, 22644, 22840** or **22842** Enhanced Design Vacuum Pumps
- Mounts Alternator on driver's side and Vacuum Pump on passenger's side while clearing the electric water pump
- Works with most styles of drive mandrel kits
- Includes all spacers and hardware

PART # DESCRIPTION

63824	Alternator/Vacuum Pump Mounting Kit, Ford 289, 302, 351W use with CSR Electric Water Pumps (Latest Version) and Moroso Enhanced Design Vacuum Pumps
--------------	---

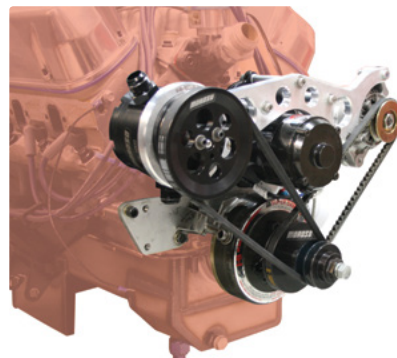

No. 63824



MOUNTING BRACKETS

GM DELCOTRON/CHEVY V8

90° V6-V8

- This bracket kit is designed to mount any GM Delcotron alternator to Small Block and 90° V6 Chevy with a short water pump (right side mount)
- Although designed primarily for Circle Track, this kit can be used in many other applications where a compact, rugged alternator mount is needed
- Use with Moroso Alternator Pulley **No. 64800**
- Early model heads need to be drilled and tapped

PART #	DESCRIPTION
63825	Alternator Mount Kit, GM Delcotron

No. 63825
(typical installation)

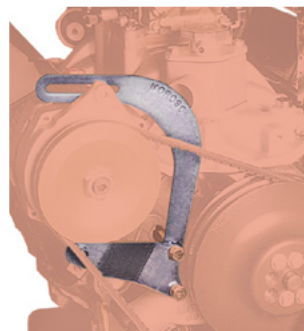

SMALL BLOCK CHRYSLER

- This kit enables the racer/enthusiast to mount either a 93mm or 15mm Nipondenso alternator to a Chrysler "A" series engine, (318, 340 & 360) in as many as fourteen different configurations
- Fits with stock mechanical water pumps and Moroso electric water pumps
- Mounts alternator to either side of engine
- Enables the use of lighter weight alternators
- Adjustable turnbuckle makes for easy and accurate belt tension adjustments
- Use with Moroso Drive Kit **No. 63848**
- Kit Includes all mounting hardware

PART #	DESCRIPTION
63815	Billet Aluminum Alternator Mounting Bracket, Small Block Chrysler

No. 63815

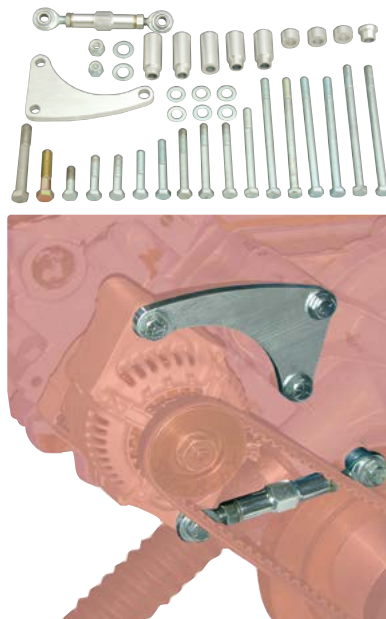

SMALL BLOCK FORD

- Will mount standard Ford or ND-style alternator on either side of engine
- Fits with mechanical and electric water pumps from all major manufacturers with V-belt pulley systems
- Provides an alternative to running the stock serpentine belt
- Use with Moroso Drive Kit **No. 63846**
- Kit Includes all mounting hardware

PART #	DESCRIPTION
63810	Aluminum Alternator Mounting Bracket, Small Block Ford

PART #	AVAILABLE OPTIONS
23523	4" O.D. Mandrel Pulley, V-Belt

No. 63810

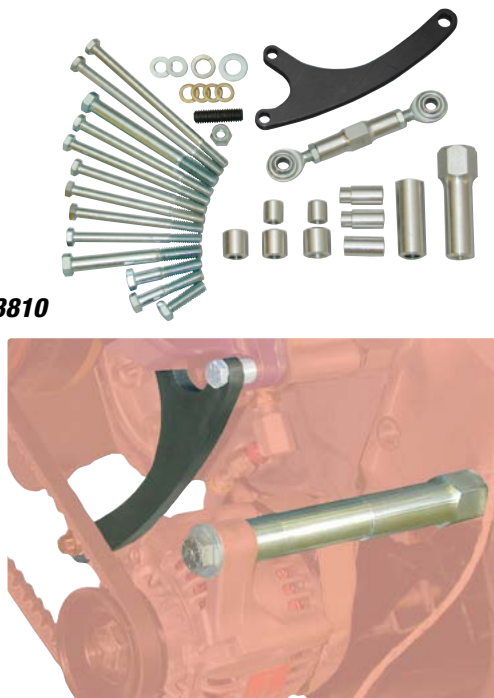

Moroso has engineered Alternator Mount Kits and Alternator Drive Kits for popular engines using an electric water pump or electric water pump drive kit. The Drive Kits work with or without crank triggers or engine plates.

- Alternator Mount Kits include all hardware needed to mount old-style Delco alternators to the driver's side of the engine
- Alternator Drive Kits are crankshaft-mounted and designed with spacers that can be replaced with pulleys to drive other accessories such as external oil pumps and vacuum pumps

SMALL BLOCK CHEVY

PART # DESCRIPTION

- 63842** Alternator Mount Kit, SBC
63843 Alternator Drive Kit, SBC, use **No. 97170** Gilmer Drive Pulley if external oil pump is used. Comes complete with all spacers and hardware

RECOMMENDED USAGE WITH

- PART # DESCRIPTION**
63750 Universal Electric Water Pump Drive Kit
63500 SBC Aluminum Water Pump
63539, Electric Water Pump
63555, 63557

ADDITIONAL PART

- 23523** 4" Crank Pulley



No. 63842



No. 63843

WARNING Prop. 65
 This product contains a chemical known to the state of California to cause cancer, birth defects, or reproductive harm-

BIG BLOCK CHEVY

PART # DESCRIPTION

- 63840** Alternator Mount Kit, Big Block Chevy with early style Delco alternator
63841 Alternator Drive Kit, Big Block Chevy, use **No. 97170** Gilmer Drive Pulley if external oil pump is used. Comes complete with all spacers and hardware.

RECOMMENDED USAGE WITH

- PART # DESCRIPTION**
63750 Universal Electric Water Pump Drive Kit
63546, 63547 Electric Water Pumps

ADDITIONAL PART

- 23523** 4" Crank Pulley

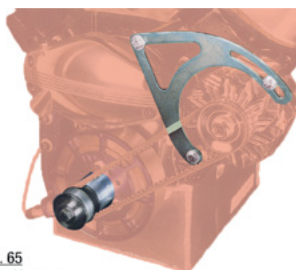

No. 63840



No. 63841

WARNING Prop. 65
 This product contains a chemical known to the state of California to cause cancer, birth defects, or reproductive harm-

POWER STEERING PUMP MOUNT

SMALL BLOCK CHEVY

Early Model GM Pump

- This kit mounts an early-style GM Power Steering Pump (with integral reservoir removed) or a Lee, Profile or Cavalier racing power steering pump to the driver's side head of a Small Block Chevy
- Manufactured from 3/8" 6061-T6 aluminum, anodized
- Can be shimmed to align any pulley combination
- Comes complete with all necessary fasteners

PART # DESCRIPTION

- 63895** Power Steering Pump Mounting Bracket, Small Block Chevy, Early-Style GM Pump



No. 63895



SMALL BLOCK CHEVY

Late Model GM Pump With 18° or 23° Cylinder Head

- This kit mounts a late-model, small-style GM power steering pump (with remote reservoir) or Sweet-type pumps to the driver's side cylinder head of a Small Block Chevy. Use with Moroso Pump Pulley **No. 64860**
- Manufactured from 3/8" 6061-T6 aluminum, anodized
- Comes complete with all necessary spacers and hardware

PART # DESCRIPTION

- 63897** Power Steering Pump Mounting Bracket, SBC, Late Model GM Pump

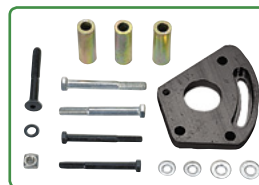

No. 63897

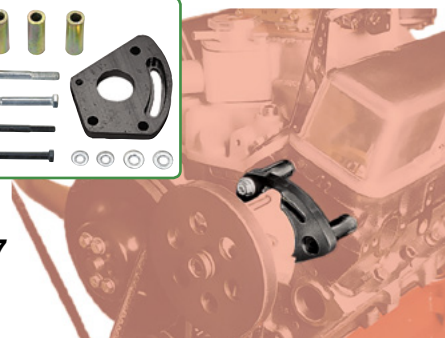

MOUNTING BRACKETS

VACUUM PUMP, DRY SUMP PUMP DRIVE KITS

Big and Small Block Chevy

- Extra long to accommodate any combination
- Steel, self-centering mandrel bolts directly to harmonic balancer for dead-accurate concentricity
- Pulleys are 6061-T6 aluminum and hard coat anodized for exceptional strength and extended service life
- Includes: 2 ½" V-belt pulley for vacuum pump, 1" (16-tooth) Gilmer pulley for external oil pump, guide plates, assorted spacers, belt guides & hardware
- For optimum accessory speed, use with Moroso Dry Sump Gilmer Pulleys, and Vacuum Pump V-Belt Pulley **No. 64885**



No. 63844

PART # DESCRIPTION

- 63844** Vacuum Pump, Dry Sump Pump Kit, BBC, uses 5" mandrel length
- 63845** Vacuum Pump, Dry Sump Pump Kit, SBC, uses 4.75" mandrel length

PART # REPLACEMENT PARTS

- 23528** Pulley, Gilmer Drive, 28-Tooth
- 23532** Pulley, Gilmer Drive, 32-Tooth
- 97170** Pulley, Gilmer Drive Crankshaft, 16-Tooth

PART # AVAILABLE OPTIONS

- 23523** 4" O.D. Mandrel Pulley, V-Belt
- 64885** Vacuum Pump V-Belt Pulley

WARNING Prop. 65
 This product contains a chemical known to the state of California to cause cancer, birth defects, or reproductive harm-



No. 63845

VACUUM PUMP, DRY SUMP PUMP DRIVE KIT

Fits: Small Block Ford 302-351W with either three or four mounting bolts (3.30" bolt circle, 2.432" male register—will NOT fit 289)

- Hub mounted to harmonic balancer
- 6061-T6 Aluminum Pulleys are hard coat anodized for strength and extended service life
- Includes: 2 ½" V-belt pulley for vacuum pump, 1" (16-tooth) Gilmer pulley for external oil pump, guide plates, assorted spacers, belt guides and hardware



No. 63846

PART # DESCRIPTION

- 63846** Vacuum Pump, Dry Sump Pump Kit, 5.80" overall length (with spacer)

PART # AVAILABLE OPTION

- 23523** 4" O.D. Mandrel Pulley, V-Belt

WARNING Prop. 65
 This product contains a chemical known to the state of California to cause cancer, birth defects, or reproductive harm-

VACUUM PUMP, DRY SUMP PUMP DRIVE KIT

Big and Small Block Chrysler

- Pulleys are 6061-T6 aluminum and hard coat anodized and mandrel is black anodized for exceptional strength and extended service life
- Extra long to accommodate any combination
- 6-bolt self-centering aluminum hub fastens to balancer; steel mandrel mounts to hub and provides rigid pulley mounting
- Includes: Steel Mandrel, 4" V-belt pulley for alternator, 2 ½" V-belt pulley for vacuum pump, 1" (16-tooth) Gilmer pulley for external oil pump, guide plates, assorted spacers, belt guides and hardware



No. 63848

PART # DESCRIPTION

- 63848** Vacuum Pump, Dry Sump Pump Kit, 5.70" overall length

WARNING Prop. 65
 This product contains a chemical known to the state of California to cause cancer, birth defects, or reproductive harm-



OIL PUMP AND VACUUM PUMP DRIVE KITS

Flange Style

 **WARNING Prop. 65**
This product contains a chemical known to the state of California to cause cancer, birth defects, or reproductive harm-

- Bolts to balancer—balancer does not need to be drilled like older designs
- Pulleys are hard coat anodized and mandrel is black oxide for exceptional strength and extended service life
- Kits include: one-piece, forged steel drive mandrel, 4" V-belt pulley for alternator, 2 1/2" V-belt pulley for vacuum pump, 1" (16 tooth) Gilmer pulley for external oil pump, assorted spacers, belt guides and hardware

APPLICATION CHART					
ENGINE APPLICATION	PART #	STYLE	MANDREL LENGTH MINUS FLANGE	OVERALL	REQUIRED BALANCER
Small Block Chevy*	63857	Short	2.990"	3.380"	3-Bolt, 3.20" bolt circle**
Small Block Chevy*	63859	Long	4.000"	4.655"	3-Bolt, 3.20" bolt circle**
GM LS Series	63860	Short	2.990"	3.645"	Aftermarket, using BBC 3-Bolt, 3.20" bolt circle, 2.050" female register pattern
GM LS Series	63858	Short	2.990"	3.645"	3-Bolt, 3.20" bolt circle, 2.275" female register, when using ARP Balancer Bolt use Moroso Spacer Part No. 63890
GM LS Series	63849	Long	4.000"	4.655"	3-Bolt, 3.20" bolt circle, 2.275" female register, when using ARP Balancer Bolt use Moroso Spacer Part No. 63890
Big Block Chevy	63858	Short	2.990"	3.645"	3-Bolt, 3.20" bolt circle, 2.275" female register
Big Block Chevy	63849	Long	4.000"	4.655"	3-Bolt, 3.20" bolt circle, 2.275" female register
Small Block Ford	63853	Short	3.500"	4.125"	4-Bolt, 3.30" bolt circle, 2.382" male register
Big Block Ford, 429-460	63847	Long	3.500"	5.285"	4-Bolt, 3.30" bolt circle, 2.180" male register
Domestic and Import using BBC bolt pattern and register balancer	63858	Short	2.990"	3.645"	3-Bolt, 3.20" bolt circle, 2.275" female register
Domestic and Import using BBC bolt pattern and register balancer	63849	Long	4.000"	4.655"	3-Bolt, 3.20" bolt circle, 2.275" female register

*Centers off of I.D. of Balancer Bore via Supplied Crankbolt Washer

**Centers off of I.D. of Balancer, via Supplied Crankbolt Washer



DRIVE MANDREL SPACER KIT, FOR 2.275" FEMALE REGISTER

- This 5/8" thick spacer comes handy when creating a custom drive set-up or when contending with oversized hardware
- Designed to be used with Moroso and other bolt-on flange style mandrels that have a 2.275" female register
- Billet aluminum construction, includes hardware

PART # DESCRIPTION
63890 Drive Mandrel Spacer Kit



DRIVE MANDREL SPACER KIT

- For use with Moroso Nos. 63857 & 63859 drive mandrels
- Maintains register of mandrel when using a 1/4" thick crank trigger
- Comes with a 1/4" longer crankshaft bolt
- Constructed out of stress-proof steel with a black oxide finish

PART # DESCRIPTION
63861 Drive Mandrel Spacer Kit, SBC, for 1/4" Thick Crank Trigger Wheels



OIL PUMP & VACUUM PUMP DRIVE KITS AND PULLEYS

DRIVE MANDRELS, FLANGE STYLE

- Bolts to the balancer –balancer does not need to be drilled like older designs
- Using our optional pulleys, custom tailored drives can be created
- Includes one-piece, forged steel drive mandrel, guide plates, assorted spacers, belt guides and hardware



No. 63880



No. 63882



No. 63881



No. 63883



No. 63884



No. 63885



No. 63886

APPLICATION CHART

ENGINE APPLICATION	PART #	STYLE	MANDREL LENGTH MINUS FLANGE	OVERALL LENGTH	REQUIRED BALANCER
Small Block Chevy*	63880	Short	2.990"	3.645"	3-Bolt, 3.20" bolt circle, 1.250" Female Register**
Small Block Chevy*	63881	Long	4.000"	4.655"	3-Bolt, 3.20" bolt circle, 1.250" Female Register**
GM LS Series	63882	Short	2.990"	3.645"	Aftermarket using GM BBC 3- bolt, 3.20" bolt circle, 2.050" female register pattern using a GM Balancer Bolt
GM LS Series	63883	Short	2.990"	3.645"	3-Bolt, 3.20" bolt circle, 2.275" Female Register, when using ARP Balancer Bolt use Moroso Spacer Part No. 63890
GM LS Series	63884	Long	4.000"	4.655"	3-Bolt, 3.20" bolt circle, 2.275" Female Register, when using ARP Balancer Bolt use Moroso Spacer Part No. 63890
Big Block Chevy	63883	Short	2.990"	3.645"	3-Bolt, 3.20" bolt circle, 2.275" Female Register
Big Block Chevy	63884	Long	4.000"	4.655"	3-Bolt, 3.20" bolt circle, 2.275" Female Register
Small Block Ford	63885	Short	3.500"	4.125"	4-Bolt, 3.30" bolt circle, 2.382" Male Register
Big Block Ford, 429-460	63886	Long	3.500"	5.285"	4-Bolt, 3.30" bolt circle, 2.180" Male Register
Domestic and Import using BBC bolt pattern and register balancer	63883	Short	2.990"	3.645"	3-Bolt, 3.20" bolt circle, 2.275" Female Register
Domestic and Import using BBC bolt pattern and register balancer	63884	Long	4.000"	4.655"	3-Bolt, 3.20" bolt circle, 2.275" female register

*Centers off of I.D. of Balancer Bore via Supplied Crankbolt Washer

**Centers off of I.D. of Balancer, via Supplied Crankbolt Washer



LOWER BLOWER DRIVE MANDREL KIT, CHRYSLER GEN. 2 HEMI CRANK SNOOT

Fits: Chrysler Gen. 2 and most aftermarket Hemis

- Drive kit designed for all Chrysler and RCD based crankshaft pulley snouts
- Steel mandrel bolts to aluminum spacer for maximum strength for two-step and high torque applications
- 3/8" Bolt on a 2.782" bolt pattern and clears a 2.000" crankshaft hub register
- Will clear a 1.00" tall crankshaft bolt head
- Includes Top Fuel spec. blower pulley bolts with full shoulder and radius head for complete and correct installation the first time
- Drive pulleys not included

NEW!

No. 63887



PART #	DESCRIPTION
63887	Drive Mandrel Kit, Chrysler Gen. 2 Hemi with Blower

WARNING Prop. 65
This product contains a chemical known to the state of California to cause cancer, birth defects, or reproductive harm-

REPLACEMENT PARTS FOR DRY SUMP DRIVE KITS

With Crank-Driven Power Steering

PART #	DESCRIPTION
97110	Gilmer Drive Belt - 22.5" long
97120	Gilmer Drive Belt - 24.0" long
97130	Gilmer Drive Belt - 25.5" long
97140	Gilmer Drive Belt - 27.0" long
23528	Gilmer Drive Pump Pulley - 28-tooth. For Nos. 23600, 23610, 23620, 23630, 23660, 23670 and 23672
23532	Gilmer Drive Pump Pulley - 32-tooth
97170	Gilmer Drive Crankshaft Pulley - 16-tooth. For Nos. 23600, 23610, 23620, 23630, 23660, 23670 and 23672
23520	V-Belt Crankshaft Pulley - 2.5" long
23523	V-Belt Crankshaft Pulley - 4" long

WARNING Prop. 65
This product contains a chemical known to the state of California to cause cancer, birth defects, or reproductive harm-

BELT GUIDES

- Made from 6061-T6 Aluminum
- .062 thick with 1.00 hole in center and provision for 1/8" keyway
- 2 per package

PART #	DESCRIPTION
23560	Belt Guide, 2.50" Diameter
23561	Belt Guide, 3.50" Diameter
23562	Belt Guide, 4.50" Diameter

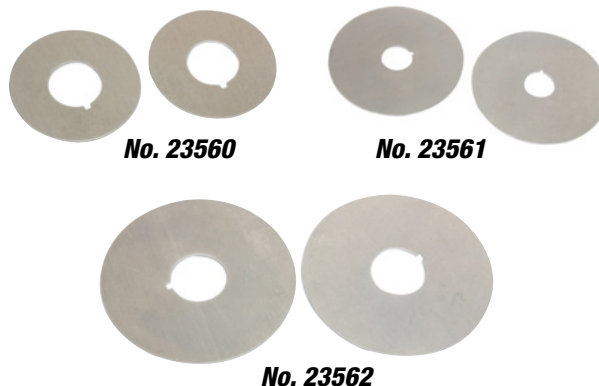

CRANK PULLEY SHIM KIT

Fits: Small and Big Block Chevrolet engines

- Includes 3 shims per pack, 1/16", 1/8" and 3/16"

PART #	DESCRIPTION
64031	Crank Pulley Shim Kit

No. 64031

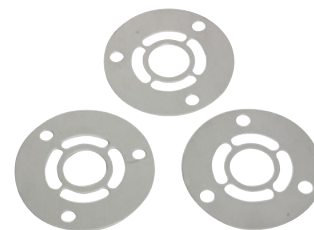

UNIVERSAL WATER PUMP PULLEY SHIM KIT

Fits: All GM and Ford water pumps with either a 3/4" or 5/8" shaft

- Kit provides proper drive belt alignment with water pump
- Shims are installed between the water pump pulley and drive flange
- Kit contains two 1/16" spacers and one 1/8" spacer

PART #	DESCRIPTION
64035	Universal Aluminum Water Pump Pulley Shim Kit

No. 64035



OIL PUMP & VACUUM PUMP DRIVE KITS AND PULLEYS

CRANKSHAFT PULLEYS, CAST ALUMINUM

V-Belt Design

- Precision machined from high grade, lightweight aluminum castings
- Extra-deep belt grooves provide added belt retention during rapid changes in engine RPM
- Small pulley diameter slows fan, water pump, and alternator speed to reduce horsepower-robbing drag
- High RPM water pump operation is improved, reducing impeller speed below cavitation threshold
- Use 36° x 17/32" wide belt

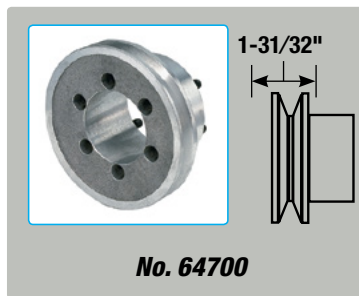

PART #	DESCRIPTION
64050	Crankshaft Pulley, single groove, 30% reduction, 5.25" O.D. <i>Fits: SBC, 1968-earlier (with short water pump)</i>
64060	Crankshaft Pulley, double groove, 25% reduction, 5.40" O.D. <i>Fits: SBC, 1968-earlier (with short water pump)</i>
64070	Crankshaft Pulley, single groove, 50% reduction, 4.00" O.D. <i>Fits: SBC, 1968-earlier (with short water pump)</i>
64100	Crankshaft Pulley, single groove, 50% reduction, 4.00" O.D. <i>Fits: SBC, 1969-later (with long water pump)</i>
64110	Crankshaft Pulley, double groove, 50% reduction, 4.04" O.D. <i>Fits: SBC and 90° V6 Chevys, 1969-later (with long water pump)</i>
64120	Crankshaft Pulley, single groove, 30% reduction, 4.95" O.D. <i>Fits: Chevrolet 302-350, 1969-later (with long water pump)</i>
64200	Crankshaft Pulley, single groove, 30% reduction, 5.25" O.D. <i>Fits: Chevrolet 396-454, pre-1969 (with short water pump)</i>
64210	Crankshaft Pulley, double groove, 25% reduction, 5.40" O.D. <i>Fits: Chevrolet 396-454, pre-1969 (with short water pump)</i>
64550	Crankshaft Pulley, double groove, 4" dia., fits all 4 bolt dampeners, reduction ratio varies, 4.00" O.D. <i>Fits: Ford 351-400 Cleveland, Boss 302</i>
64700	Crankshaft Pulley, single groove, with standard dampener, 30% reduction, 5.00" O.D. <i>Fits: Chrysler 340-440, pre-1972</i>



ALTERNATOR PULLEY, CAST ALUMINUM

V-Belt Design

- Large diameter reduces alternator speed for high engine RPM applications
- Machined from high grade, lightweight aluminum to reduce alternator bearing loads
- Deep groove helps retain V-belt at high RPM
- Uses 36° x 17/32" V-belts

PART #	DESCRIPTION
64800	Alternator Pulley, single groove V-belt. 5.00" O.D. <i>Fits: For GM and Ford Alternators with 21/32" dia. shaft</i>



OEM CRANKSHAFT PULLEY REINFORCEMENT PLATE

Fits: Chevrolet V8 and 90° V6 with OEM crank pulley (GM #3858533), also fits some inline Chevy 6's

- Strengthens stock GM crank pulleys
- Precision stamped from 6061-T6 aluminum and black anodized

PART #	DESCRIPTION
64030	Crankshaft Pulley Reinforcement Plate



CRANKSHAFT PULLEYS, BILLET ALUMINUM

V-Belt Design

- Machined from the highest grade aircraft billet aluminum for maximum durability
- Deep precision machined grooves ensure belt retention even during extreme changes in engine RPM
- When crankshaft and water pump pulleys are used together, water pump speed is reduced by approximately 30%
- Hard-coat anodized for extended life
- Uses 36° x 1 7/32" wide belt

PART #	DESCRIPTION
64051	Crankshaft Pulley, Billet, single groove, 30% reduction, 5.25" O.D. <i>Fits: SBC, 1968-earlier (with short water pump)</i>
64111	Crankshaft Pulley, Billet, double groove, 50% reduction, 4.04" O.D. <i>Fits: SBC and 90° V6 Chevys, 1969-later (with long water pump)</i>
64201	Crankshaft Pulley, Billet, single groove, 30% reduction, 5.25" O.D. <i>Fits: BBC, 1968-earlier (with short water pump)</i>
64211	Crankshaft Pulley, Billet, double groove, 25% reduction, 5.40" O.D. <i>Fits: BBC, 1968-earlier (with short water pump)</i>
64551	Crankshaft Pulley, Billet, double groove, 4" dia. fits all 4-bolt dampeners, reduction ratio varies, 4.00" O.D. <i>Fits: Ford 351-400 Cleveland, Boss 302</i>



No. 64551



No. 64051



No. 64111



No. 64201



No. 64211

CRANKSHAFT PULLEY, BILLET ALUMINUM

V-Belt Design

- Ideal for driving alternators and/or vacuum pumps at optimum speed
- Fits any 1" dia. crank-driven mandrel with 1/8" x 1/8" keyway
- CNC machined from billet aluminum with hard-coat anodized finish
- May be used with Moroso Vacuum Pumps Nos. 22640, 22641, 22642, 22644, 22840, 22842, 22843 and Vacuum Pump Pulley Nos. 64885 and 64887

PART #	DESCRIPTION
23520	2.5" V-Belt Crankshaft Pulley
23523	4" V-Belt Crankshaft Pulley

 **WARNING Prop. 65**
This product contains a chemical known to the state of California to cause cancer, birth defects, or reproductive harm.



No. 23523



No. 23520

POWER STEERING PULLEY, BILLET ALUMINUM

V-Belt Design

Fits: Late model GM pumps

- Designed for Oval Track and Road Race applications using the late model, small GM power steering pump with remote reservoir
- 6" diameter, hard-coat anodized billet aluminum
- Deep-grooved to ensure belt retention under extreme racing conditions
- Can be used as replacement pulley for Sweet-type pumps
- Use with 36° x 1/2" wide belt

PART #	DESCRIPTION
64860	Power Steering Pulley



No. 64860



OIL PUMP & VACUUM PUMP DRIVE KITS AND PULLEYS

ALTERNATOR PULLEY, BILLET ALUMINUM

V-Belt Design

- Machined from the highest grade aircraft billet aluminum for maximum durability
- Deep precision machined grooves ensure belt retention even during extreme changes in engine RPM
- When crankshaft and water pump pulleys are used together, water pump speed is reduced by approximately 30%
- Hard-coat anodized for extended life

PART # DESCRIPTION

64870 Billet Aluminum Alternator Pulley. Single groove, 5" O.D. Use 36° x 1/2" wide belt
Fits: GM and Ford Alternators with 21/32" dia. shaft



No. 64870

VACUUM PUMP DESIGN, BILLET ALUMINUM

V-Belt Design

- Fits Moroso Racing Vacuum Pumps or similar "smog" pumps that use OE-style, 3-bolt mounting pattern
- Precision machined from the highest grade aircraft aluminum and hard-coat anodized for extended service life
- Deep V-groove ensures belt retention under all racing conditions
- Machined with six holes to reduce weight
- 5" diameter pulley uses stock (3-bolt) mounting pattern with 1.16" bolt circle
- Use with Moroso Vacuum Pump **Nos. 22640, 22641, 22642, 22644, 22840, 22842 and 22843**

PART # DESCRIPTION

64885 Vacuum Pump V-Belt Pulley



No. 64885

VACUUM PUMP PULLEY, OFFSET, BILLET ALUMINUM

V-Belt Design

- Allows Moroso Vacuum Pumps to be installed in cars with minimal drive mandrel space
- Hard coat anodized
- Offset 7/8", 5" diameter pulley uses stock (3-bolt) mounting pattern with 1.16" bolt circle
- Use with Moroso Vacuum Pump **Nos. 22640, 22641, 22642, 22644, 22840, 22842 and 22843**

PART # DESCRIPTION

64887 Vacuum Pump Pulley, Offset



No. 64887



CRANKSHAFT PULLEYS

Gilmer Style

- 3/8" pitch pulley fits 1" diameter keyed drive mandrels
- Machined from billet aluminum for unmatched precision
- Anodized for extended durability

PART #	DESCRIPTION
97170	Crankshaft Pulley, Gilmer Style, 3/8" Pitch, 1" Wide, 16-teeth
97171	Crankshaft Pulley, Gilmer Style, 3/8" Pitch, 1" Wide, 18-teeth
97172	Crankshaft Pulley, Gilmer Style, 3/8" Pitch, 1/2" Wide, 18-teeth



No. 97170

DRY SUMP PUMP PULLEYS

Gilmer Style

- Machined from billet aluminum for unmatched precision
- Hard-coat anodized for extended durability
- 3/8" pitch pulleys fit 5/8" diameter shafts
- Use with Moroso Gilmer Drive Pulleys to suit desired drive ratio
- Compatible with 3/8" pitch gilmer tooth drive pulleys and belts manufactured by Moroso and others
- Includes key and 4 set screws to lock pulley to the shaft

PART #	DESCRIPTION
23528	Dry Sump Pump Pulley, Gilmer Style, 1" Wide, 28-teeth
23532	Dry Sump Pump Pulley, Gilmer Style, 1" Wide, 32-teeth



No. 23532

VACUUM PUMP PULLEY

Gilmer Type, 28 Tooth

- Fits Moroso Racing Vacuum Pumps or similar "smog" pumps that use OE-style, 3-bolt mounting pattern; accepts standard gilmer belts with 3/4" width or less
- Precision machined from aircraft-quality aluminum with hard-coat anodized finish for extended service life and features direct, bolt-on installation
- Use with Moroso 3- or 4-Vane Racing Vacuum Pump Nos. 22640, 22641, 22642, 22643, 22644, 22840, 22842, 22843 and interchangeable drive components

PART #	DESCRIPTION
64886	Vacuum Pump Pulley, Gilmer Type, 28 Tooth

PART #	AVAILABLE OPTION
97172	Crankshaft Pulley



No. 64886

VACUUM PUMP PULLEY

Gilmer Type, 36 Tooth

- Fits Moroso Racing Vacuum Pumps or similar "smog" pumps that use OE-style, 3-bolt mounting pattern; accepts standard Gilmer belts with 1/2" width or less
- Precision machined from aircraft-quality aluminum and features direct, bolt-on installation
- Use with Moroso 3- or 4-Vane Vacuum Pump Nos. 22640, 22641, 22642, 22643, 22644, 22840, 22842 and interchangeable drive components

PART #	DESCRIPTION
64888	Vacuum Pump Pulley, Gilmer Type, 36 Tooth

PART #	AVAILABLE OPTION
97172	Crankshaft Pulley



No. 64888



OIL PUMP & VACUUM PUMP DRIVE KITS AND PULLEYS

RADIUS TOOTH DRY SUMP PUMP PULLEYS AND DRIVE PULLEYS

Moroso black anodized Radius Tooth Pump Pulleys are designed to work more efficiently and take less power to drive your dry sump pump. These Pulleys are made to use a 1.00" wide drive belt, and with a wide variety of sizes, most drive ratios you may need are achievable. All dry sump pulleys are made to accept a 5/8" shaft, and come with 4 set screws to lock the pulley to the shaft. Moroso Radius Tooth Pump Pulleys are designed with the same 8mm tooth technology, and will add to the efficiency of the entire round tooth drive combination.

DRY SUMP PUMP PULLEY CHART

PUMP PULLEY PART #	NO. OF TEETH	DRIVE PULLEY PART #	NO. OF TEETH	DRIVE RATIO
23544	30	23541	20	67%
	30	23542	22	73%
	30	23543	24	80%
23545	32	23541	20	63%
	32	23542	22	69%
	32	23543	24	75%
23546	34	23541	20	59%
	34	23542	22	65%
	34	23543	24	71%
23547	36	23541	20	56%
	36	23542	22	61%
	36	23543	24	67%
23548	40	23541	20	50%
	40	23542	22	55%
	40	23543	24	60%

Available in sizes that will not only give you the ratio you want, but will adjust the centerline measurement between your pump and crankshaft center. This will help in tight fitting conditions while allowing you to have the correct drive ratio. Moroso drive pulleys fit any 1.00" mandrel with a 1/8" keyway slot.



No. 23544



No. 23541

RADIUS TOOTH VACUUM PUMP PULLEYS AND DRIVE PULLEYS

Moroso black anodized Radius Tooth Vacuum Pump Pulleys are designed to work more efficiently and take less power to drive your vacuum pump. Moroso Radius Tooth Vacuum Pump Pulleys are made to use a .500" wide drive belt, and with a wide variety of drive pulley sizes, most drive ratios you may need are achievable. This pulley is made to accept a 1/2" shaft, 3-hole OEM design.

Moroso Radius Tooth Drive Pulleys are designed with the latest 8mm tooth technology, and will add to the efficiency of the entire round tooth drive combination. Available in sizes that will not only give you the ratio you want, but will adjust the centerline measurement between your pump and crankshaft center. Moroso Drive Pulleys fit any 1.00" mandrel with a 1/8" keyway slot.

VACUUM PUMP PULLEY RATIO CHART

DRIVE PULLEY PART #	NO. OF TEETH	PUMP PULLEY PART #	NO. OF TEETH	DRIVE RATIO
23533	20	23540	40	50%
23534	22	23540	40	55%
23535	24	23540	40	60%



No. 23540



No. 23533

RADIUS TOOTH ALTERNATOR PULLEY

Moroso Radius Tooth Alternator Pulley is designed to work more efficiently and take less power to drive. Moroso Radius Tooth Alternator Pulley is made to use a .500" wide drive belt, and with a wide variety of drive pulley sizes, any drive ratio you may need is achievable. This pulley is made to accept a .590" diameter shaft alternator.

ALTERNATOR PULLEY CHART

ALT. PULLEY PART #	NO. OF TEETH	DRIVE PULLEY PART #	NO. OF TEETH	DRIVE RATIO
23556	20	23558	40	200%



No. 23556

RADIUS TOOTH BELTS

Fits: Radius Tooth Pulleys with 8mm Pitch

- Provides higher power and torque transmission, improved meshing to reduce tooth jump, greater resistance to tooth shear and reduced friction to extend belt life
- Fiberglass cord is wound across the entire width of the belt to minimize stretching
- Belt body is manufactured from a synthetic neoprene compound that resists heat, oils, ozone and aging
- Tough nylon fabric is bonded to the tooth surface for greater wear resistance

No. 97125



PART #	DESCRIPTION	LENGTH X WIDTH (MM)	TEETH
97105	Radius Tooth Belt	21" x 1" (533 x 25.4)	67
97125	Radius Tooth Belt	23.6" x 1" (599 x 25.4)	75
97135	Radius Tooth Belt	25.2" x 1" (641 x 25.4)	80
97136	Radius Tooth Belt	25.8" x 1" (655 x 25.4)	82
97138	Radius Tooth Belt	26.8" x 1" (681 x 25.4)	85

GILMER DRIVE BELTS

- For Moroso Dry Sump Pump setups
- Will also work with other manufacturers' 3/8" pitch Gilmer Drive setups

No. 97110



PART #	DESCRIPTION	LENGTH X WIDTH (MM)	TEETH
97110	Gilmer Drive Belt	22.5" x 1" (572 x 25.4)	60
97120	Gilmer Drive Belt	24" x 1" (610 x 25.4)	64
97130	Gilmer Drive Belt	25.5" x 1" (648 x 25.4)	68
97140	Gilmer Drive Belt	27" x 1" (686 x 25.4)	72
97113	Gilmer Drive Belt	22.5" long x 1/2" wide	60
97123	Gilmer Drive Belt	24" long x 1/2" wide	64
97133	Gilmer Drive Belt	25.5" long x 1/2" wide	68
97143	Gilmer Drive Belt	27" long x 1/2" wide	72

RADIUS TOOTH BELTS

Fits: Radius Tooth Pulleys with 8mm Pitch

- Thin Series Belts for Moroso Vacuum Pump and Alternator Pulleys
- Fits 1/2" wide or greater pulleys
- Strong and lightweight with less belt stretch
- Provides lower tension with positive engagement and no slippage

PART #	DESCRIPTION	LENGTH X WIDTH (MM)	TEETH
97141	Radius Tooth Belt	23.3" x 1/2" (592 x 12.7)	74
97142	Radius Tooth Belt	23.9" x 1/2" (608 x 12.7)	78
97144	Radius Tooth Belt	25.2" x 1/2" (640 x 12.7)	80
97146	Radius Tooth Belt	26.5" x 1/2" (672 x 12.7)	83
97147	Radius Tooth Belt	26.8" x 1/2" (680 x 12.7)	85
97149	Radius Tooth Belt	28.3" x 1/2" (720 x 12.7)	90
97151	Radius Tooth Belt	29.9" x 1/2" (760 x 12.7)	97
97152	Radius Tooth Belt	30.6" x 1/2" (776 x 12.7)	99
97154	Radius Tooth Belt	31.5" x 1/2" (800 x 12.7)	100
97157	Radius Tooth Belt	33.7" x 1/2" (856 x 12.7)	106
97159	Radius Tooth Belt	34.7" x 1/2" (880 x 12.7)	110
97164	Radius Tooth Belt	37.8" x 1/2" (960 x 12.7)	120



No. 97141

REPLACEMENT PARTS FOR DRY SUMP DRIVE KITS

PART #	DESCRIPTION
97110	Gilmer Drive Belt - 22.5" long
97120	Gilmer Drive Belt - 24.0" long
97130	Gilmer Drive Belt - 25.5" long
97140	Gilmer Drive Belt - 27.0" long
23528	Gilmer Drive Pump Pulley - 28-tooth. For Nos. 23600, 23610, 23620, 23630, 23660, 23670 and 23672

PART #	DESCRIPTION
23532	Gilmer Drive Pump Pulley - 32-tooth
97170	Gilmer Drive Crankshaft Pulley - 16-tooth. For Nos. 23600, 23610, 23620, 23630, 23660, 23670 and 23672
23520	V-Belt Crankshaft Pulley - 2.5" long
23523	V-Belt Crankshaft Pulley - 4" long

WARNING Prop. 65
 This product contains a chemical known to the state of California to cause cancer, birth defects, or reproductive harm.



AIR-OIL SEPARATOR TANK

Universal, Vacuum Pump, Fabricated

- Designed to be plumbed between the valve cover and the inlet side of the vacuum pump
- Features -12AN inlets and outlets and has a -6AN Drain
- Dimensions: 3-1/8" dia., 6-3/4" overall height

PART #	DESCRIPTION
85471	Air-Oil Separator Tank

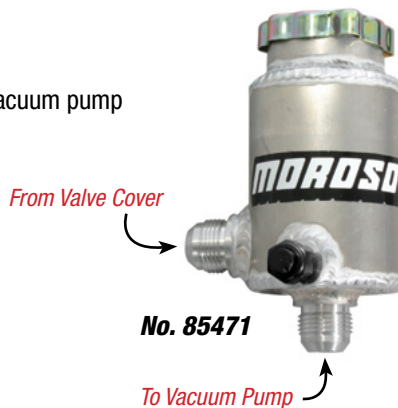

AIR-OIL SEPARATOR

Universal, Vacuum Pump

- Moroso Vacuum Pump Air-Oil Separator is designed to be plumbed between the valve cover and the inlet side of the vacuum pump
- Features internal baffling with mesh media for superior separation of air and oil
- Billet Aluminum body compliments any engine compartment and can be polished, chromed or powder coated for a custom look
- -12AN inlet and outlet fittings for plumbing the Air-Oil Separator inline
- Includes a billet aluminum mounting clamp for the body of the air-oil separator, a stainless steel bracket for non-accessible behind the panel mount applications and an O-ringed drain bung

PART #	DESCRIPTION
85495	Air-Oil Separator, Universal, -12AN Fittings

WARNING Prop. 65
 This product contains a chemical known to the state of California to cause cancer, birth defects, or reproductive harm-



AIR-OIL SEPARATOR KITS, LARGE BODY

Universal

- Plumbed into a vehicle's PCV system to capture the excess crankcase vapors and the residual oil mist from re-entering the intake track
- Vehicles from the factory vent these excess crankcase vapors and residual oil right back into the intake manifold which could cause detonation and oil deposits to form in the intake track including the valves themselves
- Features billet aluminum housing and includes 3/8" 90° inlet & outlet fittings, 36" of 3/8" rubber hose for plumbing the Air-Oil Separator inline, and a billet aluminum mounting clamp for the body of the Separator
- Features a bottom drain with elbow that makes draining the collected oil virtually mess-free

PART #	DESCRIPTION
85474	Air-Oil Separator, Universal Fit, Polished Body
85531	Air-Oil Separator, Universal Fit, Black Anodized Body
PART #	REPLACEMENT PART
97200	Ball Valve, 3/8" Male and Female Ports

WARNING Prop. 65
 This product contains a chemical known to the state of California to cause cancer, birth defects, or reproductive harm-

NOTE: Not legal for sale or use on pollution-controlled vehicles.

AIR-OIL SEPARATOR KITS

Universal, Small Body

- Moroso Air-Oil Separator is plumbed into a vehicle's PCV system and captures the excess crankcase vapors and the residual oil mist from re-entering the intake tract
- Vehicles from the factory vent these excess crankcase vapors and residual oil right back into the intake manifold which could cause detonation and oil deposits to form in the intake tract including the valves themselves
- Ethanol enriched fuels put off more moisture during the combustion process, the Moroso Air-Oil Separator is an excellent tool for collecting this extra moisture
- Billet Aluminum body is available either with raw or black anodized finish
- 4.5" tall by 3.75" (clamp installed) diameter body, fits in more places than our standard air-oil separators
- Supplied 3/8", 90° inlet & outlet fittings, 36" of 3/8" rubber hose and includes a billet aluminum mounting clamp
- Two piece body of the Air-Oil Separator unscrews for cleaning and draining



No. 85497
Black Anodized



No. 85496
Polished



No. 85683
Clear Bottom

PART # DESCRIPTION

- 85682** Air-Oil Separator, Small Body, Universal, Clear Bottom
- 85683** Air-Oil Separator, Small Body, Universal, Black Anodized Finish Upper, Clear Bottom
- 85496** Air-Oil Separator, Small Body, Polished Finish
- 85497** Air-Oil Separator, Small Body, Black Anodized Finish

PART # REPLACEMENT PART

- 97301** Air-Oil Separator Small Body Replacement Clear Bottom

WARNING Prop. 65
This product contains a chemical known to the state of California to cause cancer, birth defects, or reproductive harm-

CUSTOM FIT AIR-OIL SEPARATORS

AIR-OIL SEPARATOR PCV DELETE KIT FOR SUBARU

From the factory, a vehicle's PCV system vents excess crankcase vapors, residual oil and moisture back into the intake manifold which compromises performance and durability

- Kit allows Air-Oil Separators to work at greater efficiency at all rpm levels
- Enables full filtration of Blow By gases entering turbo inlet
- Kit is designed to work with all Moroso Air-Oil Separators for Subaru Applications
- Deletes O.E.M. PCV System including Intake Manifold PCV Inlet
- Not for use on Emission Controlled Vehicles, off road use only



No. 85699

PART # DESCRIPTION

- 85699** Air-Oil Separator PCV Delete for Subaru

WARNING Prop. 65
This product contains a chemical known to the state of California to cause cancer, birth defects, or reproductive harm-

AIR-OIL SEPARATOR, CLEAR BOTTOM

- A replacement clear bottom for Moroso Nos. 85682 or 85683 and is an option if someone wants to change out their standard billet aluminum bottom on a Moroso Small Bodied kit
- Allows the user to see how much oil is collected without unscrewing the bottom of a Moroso small body Air-Oil Separator

PART # REPLACEMENT PART

- 97301** Air-Oil Separator Small Body Replacement Clear Bottom



No. 97301

NOTE: Not legal for sale or use on pollution-controlled vehicles.

AIR-OIL SEPARATOR KITS

Fits: Custom Fit Applications

- Plumbed into a vehicle's PCV system to capture the excess crankcase vapors, residual oil mist and moisture from re-entering the intake tract
- Vehicles from the factory vent these excess crankcase vapors, residual oil mist and moisture right back into the intake manifold which could cause: detonation, oil deposits in the intake tract including the valves themselves, and decreased intercooler efficiency
- Increases engine performance from cleaner intake air
- Air-Oil Separators have billet aluminum bodies with internal baffling and mesh media
- Includes heavy duty brass inlet and outlet fittings, Fuel/Emission/PCV Vapor hose, stainless steel mounting bracket and billet aluminum mounting clamp for the body of the separator
- Some vehicle crankcase ventilation systems require that 2 Air-Oil Separator bodies be used to properly capture and ventilate the system



Large Body



Small Body Polished Finished



Dual Small Body
Black Anodized Finish

 **WARNING Prop. 65**
This product contains a chemical known to the state of California to cause cancer, birth defects, or reproductive harm-

Moroso Air-Oil Separators are available in 2 sizes, not all kits are available with both size body, please see Air-Oil Separator Application Chart on the next page for more information

AIR-OIL SEPARATOR KITS, LARGE BODY

- The original size, 43% more capacity than the Small Body version
- Features a bottom drain with elbow that makes draining the collected oil virtually mess-free
- Available with a polished or black anodized finish

AIR-OIL SEPARATOR KITS, SMALL BODY

- Smaller size fits in more applications and some customers prefer the smaller size body
- Two piece body unscrews for draining
- Available with a polished or black anodized finish

PART # REPLACEMENT PARTS

- 97200** Ball Valve, 3/8" Male and Female Ports
- 97300** Replacement Cap, Air-Oil Separator Large Body Drain, Black
- 97301** Air-Oil Separator Small Body Replacement Clear Bottom
- 65388** Air-Oil Sep, 3/8" To 1/2" Hose 90 Deg., Black
- 65389** Air-Oil Sep, 3/8" To 1/2" Hose, Straight, Black
- 65131** Air-Oil Sep, 3/8" To 1/2" Hose, 90 Deg. Streamline, Black
- 65381** Air-Oil Sep, 3/8" To 3/8" Hose, Straight, Black
- 65382** Air-Oil Sep, 3/8" To 3/8" Hose, 90 Deg., Black



No. 97301



No. 97300



No. 65382



No. 65131



No. 65381



No. 65388



No. 65389

NOTE: Not legal for sale or use on pollution-controlled vehicles.



AIR-OIL SEPARATOR CHART

FITS:

◦ Not legal for sale or use on pollution-controlled vehicles

◦ **WARNING Prop. 65**
This product contains a chemical known to the state of California to cause cancer, birth defects, or reproductive harm-

	# OF AIR-OIL SEPARATORS IN KIT	LARGE BODY PART #	BLACK ANODIZED LARGE BODY PART #	POLISHED SMALL BODY PART #	BLACK ANODIZED SMALL BODY PART #
BMW M3, 1995-1999	1	85499◦	N/A	85648◦	85649◦
CADILLAC CTS V, 2008-2014	1	N/A	N/A	85602◦	85603◦
CHEVY CAMARO SS, 2010-2015, ZL1, 2012-2015	1	85487◦	N/A	85652◦	85653◦
CHEVY CAMARO SS WITH EDELBROCK SUPERCHARGER, 2010-2015	1	85493◦	N/A	85634◦	85635◦
CHEVY CORVETTE NON Z06 2014-2019	1	85524◦	N/A	85686◦	85687◦
CHEVY CORVETTE Z06 2006-2013	1	85521◦	N/A	85678◦	85679◦
CHEVY CORVETTE, 1997-2004	1	85516◦	N/A	N/A	N/A
CHEVY CORVETTE LT1/LT4, 1992-1996	1	N/A	N/A	85642◦	85643◦
CHEVY/GM TRUCK WITH LS ENGINES, 1999-2018	1	85481◦	N/A	N/A	N/A
CHRYSLER 300C 6.1, 2005-2010	1	85472◦	N/A	85612◦	85613◦
CHRYSLER 300C 5.7 WITH AFTERMARKET INTAKE, 2005-2010	1	85472◦	N/A	85640◦	85641◦
CHRYSLER 300C 5.7 WITH FACTORY INTAKE, 2005-2010	1	N/A	N/A	85632◦	85633◦
DODGE CHALLENGER 6.1/6.4 NON HELLCAT, NON SHAKER HOOD 2008-2019	1	85472◦	N/A	85612◦	85613◦
DODGE CHALLENGER 5.7/6.4 SHAKER HOOD 2015-2019	1	85530◦	N/A	85696◦	85697◦
DODGE CHALLENGER HELLCAT 2015-2019	1	85532◦	N/A	85702◦	85703◦
DODGE CHALLENGER 5.7 WITH AFTERMARKET INTAKE, 2008-2012	1	85472◦	N/A	85640◦	85641◦
DODGE CHALLENGER 5.7 WITH FACTORY INTAKE, 2008-2012	1	N/A	N/A	85632◦	85633◦
DODGE CHARGER 6.1/6.4 NON HELLCAT, 2008-2019	1	85472◦	N/A	85612◦	85613◦
DODGE CHARGER HELLCAT 2015-2019	1	85532◦	N/A	85702◦	85703◦
DODGE CHARGER 5.7 WITH AFTERMARKET INTAKE, 2006-2010	1	85472◦	N/A	85640◦	85641◦
DODGE CHARGER 5.7 WITH FACTORY INTAKE, 2006-2010	1	N/A	N/A	85632◦	85633◦
DODGE MAGNUM 6.1, 2005-2008	1	85472◦	N/A	85612◦	85613◦
DODGE MAGNUM 5.7 WITH AFTERMARKET INTAKE, 2005-2008	1	85472◦	N/A	85640◦	85641◦
DODGE MAGNUM 5.7 WITH FACTORY INTAKE, 2005-2008	1	N/A	N/A	85632◦	85633◦
DODGE RAM PICKUP, 2009-2018, HEMI ENGINE	1	85479◦	N/A	N/A	N/A
FORD FOCUS ST, 2013-2018	1	N/A	N/A	85664◦	85665◦



BMW M3, 1995-1999,
Part No. 85499



Cadillac CTS V, 2008-2014,
Part No. 85603



Chevy Corvette non Z06 2014-2017
Part No. 85524

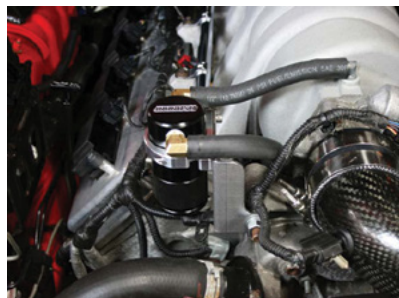

Dodge Magnum, Charger, Challenger,
Part No. 85613



Dodge Ram Truck 1500 2009-2018,
Part No. 85479



Ford Focus ST, 2013-2017,
Part No. 85665

AIR-OIL SEPARATOR CHART (CON'T)

FITS:

◦ Not legal for sale or use on pollution-controlled vehicles

 **WARNING Prop. 65**
This product contains a chemical known to the state of California to cause cancer, birth defects, or reproductive harm-

	# OF AIR-OIL SEPARATORS IN KIT	LARGE BODY PART #	BLACK ANODIZED LARGE BODY PART #	POLISHED SMALL BODY PART #	BLACK ANODIZED SMALL BODY PART #
FORD MUSTANG GT, 2015-2019	1	85522◦	N/A	85680◦	85681◦
FORD MUSTANG ECOBOOST 2015-2019	1	85523◦	N/A	85684◦	85685◦
FORD MUSTANG GT, 2011-2014	1	85485◦	N/A	85628◦	85629◦
FORD MUSTANG GT WITH ROUSH SUPERCHARGER, 2011-2014	1	85491◦	N/A	85604◦	85605◦
FORD MUSTANG SHELBY GT 500, 2007-2014	1	85478◦	N/A	85616◦	85617◦
FORD MUSTANG V-6, 2011-2014	1	85498◦	N/A	85638◦	85639◦
FORD MUSTANG GT, 2005-2010	1	85477◦	N/A	N/A	N/A
FORD MUSTANG GT, 1996-2004	1	85486◦	N/A	N/A	N/A
FORD MUSTANG GT/LX 5.0, 1987-1993	1	85514◦	N/A	85660◦	85661◦
FORD F-150 ECOBOOST 2011-14	1	85520◦	N/A	85676◦	85677◦
FORD F-150, 5.4, 2004-2008	1	85513◦	N/A	N/A	N/A
FORD RAPTOR TRUCK 6.2, 2010-2014	1	85492◦	N/A	85606◦	85607◦
HUMMER H2, 2003-2009	1	85481◦	N/A	N/A	N/A
JEEP JK, 3.6, 2012-2018	1	85518◦	N/A	85670◦	85671◦
JEEP JK, 3.8, 2007-2011	1	85517◦	N/A	85668◦	85669◦
JEEP SRT8, 2006-2010	1	85482◦	N/A	N/A	N/A
LOTUS ELISE/EXIGE, 2005-2011	2	85494◦	N/A	85636◦	85637◦
MAZDA MIATA, 1990-2005	1	85488◦	N/A	85600◦	85601◦
MINI COOPER S/CLUBMAN S, 2007-2015	1	N/A	N/A	85608◦	85609◦
MINI COOPER S/CLUBMAN S, 2007-2015	1	N/A	N/A	85608◦	85609◦
MINI COOPER S/CLUBMAN S, 2007-2015	1	N/A	N/A	85608◦	85609◦
MITSUBISHI EVO 10, 2008-2015	1	85483◦	N/A	N/A	N/A
SUBARU BRZ, SCION FRS, 2012-2015	1	85515◦	N/A	85666◦	85667◦
SUBARU STI, 2008-2014, TOP MOUNT INTERCOOLER	2	85510◦	N/A	85644◦	85645◦
SUBARU STI, 2008-2014, FRONT MOUNT INTERCOOLER	2	N/A	N/A	85646◦	85647◦
SUBARU WRX, 2008-2014	2	85489◦	N/A	85610◦	85611◦
SUBARU WRX, 2006-2007, STI, 2004-2007 TOP MOUNT INTERCOOLER	2	85484◦	N/A	85626◦	85627◦
SUBARU WRX, 2006-2007, STI, 2004-2007 FRONT MOUNT INTERCOOLER	2	N/A	N/A	85654◦	85655◦
SUBARU WRX, 2015-2018	1	N/A	N/A	85672◦	85673◦
TOYOTA TUNDRA, 2007-2014, 5.7 & TOYOTA SEQUOIA, 2008-2014	1	85511◦	N/A	85650◦	85651◦
VOLKSWAGEN GOLF/JETTA, 2.0 T, 2010-2014	1	85519◦	N/A	85674◦	85675◦
UNIVERSAL	1	85474◦	85531	85496◦	85497◦
UNIVERSAL, -12AN	1	85495◦	N/A	N/A	N/A



Ford Mustang GT 2015-2019,
Part No. 85522



Jeep JK 2012-2018,
Part No. 85671



Mazda Miata, 1990-2005,
Part No. 85488



Subaru WRX 2006-2007, STI 2004-2007
Top Mount Intercooler, Part No. 85484



Volkswagen Golf/Jetta 2010-2014
Part No. 85519



Universal Air-Separator installed on
a custom Harley-Davidson

DRY SUMP TANKS

- Tall design capacity: 6 quarts; short design capacity: 5 quarts
- Oil tanks without integral breathers and #12 breather fitting use **Nos. 85465, 85466 or 85467** Overflow Breather Tanks
- Large diameter, billet aluminum, screw-on cap with O-ring
- Body height: 13" Tank measures 11.1"; 15" Tank measures 12.9"
- Use Moroso Mount **Nos. 22674, 22677, 22678** and **22679**

SINGLE INLET DRY SUMP TANKS

Single -16AN inlet without Breather

PART # DESCRIPTION

- 22681*** Dry Sump Tank, 13", 5 Quart, (1) -16AN. Oil tanks without integral breathers and -12AN breather fitting use **Nos. 85465, 85466, 85467** Overflow Breather Tanks
- 22686*** Dry Sump Tank, 15", 6 Quart, (1) -16AN. Oil tanks without integral breathers and -12AN breather fitting use **Nos. 85465, 85466, 85467** Overflow Breather Tanks

Single -16AN inlet with Breather

PART # DESCRIPTION

- 22682*** Dry Sump Tank, 13", 5 Quart, (1) -16AN with Integral Breather Tank
- 22687*** Dry Sump Tank, 15", 6 Quart, (1) -16AN with Integral Breather Tank

WARNING Prop. 65
This product contains a chemical known to the state of California to cause cancer, birth defects, or reproductive harm.



No. 22681/22686



No. 22682/22687

TRIPLE INLET DRY SUMP TANKS

Three -12AN inlets without Breather

PART # DESCRIPTION

- 22683*** Dry Sump Tank, 13", 5 Quart, (3) -12AN. Oil tanks without integral breathers and -12AN breather fitting use **Nos. 85465, 85466, 85467** Overflow Breather Tanks
- 22688*** Dry Sump Tank, 15", 6 Quart, (3) -12AN. Oil tanks without integral breathers and -12AN breather fitting use **Nos. 85465, 85466, 85467** Overflow Breather Tanks

Three -12AN inlets with Breather

PART # DESCRIPTION

- 22684*** Dry Sump Tank, 13", 5 Quart, (3) -12AN with Integral Breather Tank
- 22689*** Dry Sump Tank, 15", 6 Quart, (3) -12AN with Integral Breather Tank

**Not legal for sale or use on pollution-controlled vehicles*

WARNING Prop. 65
This product contains a chemical known to the state of California to cause cancer, birth defects, or reproductive harm.



No. 22683/22688



No. 22684/22689

PART # AVAILABLE OPTIONS

- 22674*** Dry Sump Tank Mount, 7" Diameter
- 22677*** Straight Extended Tank Mount, 7" Diameter
- 22678*** 30° Angle Extended Tank Mount, 7" Diameter
- 22679*** U-Weld-It Tank Mount, 7" Diameter

PART # REPLACEMENT PARTS

- 68815*** Non-Hooded Breather
- 97571** Replacement lid with O-ring
- 97751** Replacement O-ring

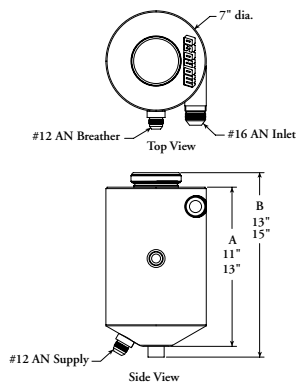

No. 22681/22686

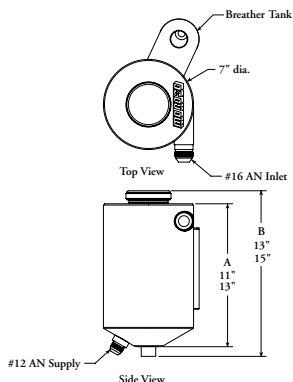

No. 22682/22687

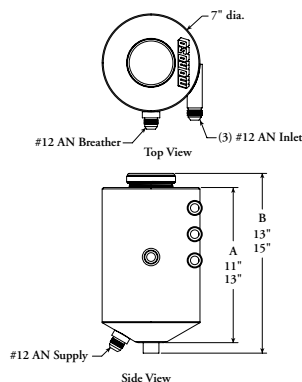

No. 22683/22688

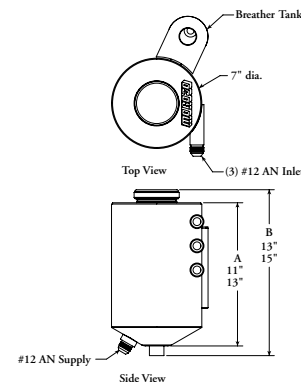

No. 22684/22689



TANKS & COVERS

DRAGSTER 6 QUART TWO-PIECE DRY SUMP TANK

- Tank body is 20" tall and 6" diameter with a six quart capacity
- -16AN inlet and -12AN outlet
- -12AN Breather tank fitting
- O-ring drain bung
- Tank comes apart for ease of cleaning or inspection
- Top of tank can be clocked for plumbing routing
- Top and bottom of tank are joined together by billet aluminum O-ringed sealing flanges
- Large diameter, billet aluminum, screw-on cap with O-ring for positive sealing



No. 22691

PART # DESCRIPTION

22691* Dragster 6 Quart, Two-Piece Dry Sump Tank

PART # REPLACEMENT PARTS

97571 Replacement lid with O-ring

97751 Replacement O-ring

PART # AVAILABLE OPTION

22699 Dry Sump Tank Mount, 6" diameter



No. 22677
STRAIGHT

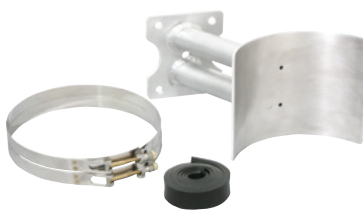

No. 22678
30° ANGLE



No. 22679
U-WELD-IT

DRY SUMP TANK MOUNT KITS

Moroso offers aluminum Dry Sump Tank Mount Kits for all 7" diameter Moroso tanks. The kits include a .250" thick billet aluminum mounting flange to mount to any motor plate application. The rounded aluminum saddle ensures proper contact to the tank and along with the rubber strips, vibration is reduced to a minimum. The stainless steel clamps are sanctioning body legal, and will hold the tank securely to the mount

PART # DESCRIPTION

22677 Straight extended Tank Mount. Mount is 5.25" from flange mount to saddle base

22678 30 Degree extended Tank Mount. Mount is 5.25" from flange mount to saddle base

22679 U-Weld-It Tank Mount. Maximum mount length is 5.25" from flange mount to saddle base

WARNING Prop. 65
This product contains a chemical known to the state of California to cause cancer, birth defects, or reproductive harm.

DRY SUMP TANK REMOVABLE MOUNTING KITS, FOR 7" DIAMETER TANKS

- Mounting kit helps in the installation of 7" diameter dry sump tanks
- The kits contains a steel "I" shaped piece that allows the dry sump tank to be quickly removed and reinstalled in the vehicle
- Also this "I" shaped piece allows the installer to set what distance they would like their tank to be from the mounting surface
- Outer tube is drilled, inner tube needs to be drilled by customer
- Included in the mounting kit is the tank mount itself which has a billet aluminum base for strength
- A stainless steel band clamp with interlocking rubber for cushioning

NEW!



No. 22698



No. 22697

PART # DESCRIPTION

22697 Dry Sump Tank Removable Mounting Kit, Aluminum

22698 Dry Sump Tank Removable Mounting Kit, Steel

WARNING Prop. 65
This product contains a chemical known to the state of California to cause cancer, birth defects, or reproductive harm.

**Note: Not legal for sale or use on pollution-controlled vehicles.*

DRY SUMP TANK MOUNTS

- Billet aluminum base for strength
- Includes stainless steel band clamp with interlocking rubber for cushioning
- Available in single and two packs

PART #	DESCRIPTION
22699*	Dry Sump Tank Mount, 6" diameter, 2 per
22701*	Dry Sump Tank Mount, 6" diameter, single NEW!
22674*	Dry Sump Tank Mount, 7" diameter, 2 per
22739*	Dry Sump Tank Mount, 7" diameter, single NEW!

*Fits Moroso Part No. 22691

 **WARNING Prop. 65**
This product contains a chemical known to the state of California to cause cancer, birth defects, or reproductive harm-



No. 22674

BREATHER TANKS

BREATHER TANKS, PLASTIC

Dry Sump, Vacuum Pump Systems, Air/Oil Separation

- Black polyethylene for light weight
- 2" Breather filter mounted on top
- Four sizes of inlet fittings available
- Can be modified for additional fitting for dual vent hoses
- Works with Mounting Bracket Part No. 63401
- Dimensions: 3-1/8" Dia. 7-1/2" tank height without Breather, 10-1/2" with Breather

PART #	DESCRIPTION	PART #	OPTIONS/REPLACEMENT PARTS
85400*	Breather Tank, -12AN Fitting	97200	Ball Valve, 3/8" Male and Female Ports
85402*	Breather Tank, -10AN Fitting	68818*	Non-Hooded Breather
85404*	Breather Tank, -8AN Fitting		
85406*	Breather Tank, -6AN Fitting		

 **WARNING Prop. 65**
This product contains a chemical known to the state of California to cause cancer, birth defects, or reproductive harm-

SEE MORE
Universal Tank Mounting Brackets on pg. 191



No. 85400

FILTERED BREATHER

2" O.D. Tubes, Non-Hooded

- Provides maximum protection against dirt and airborne debris without restricting air flow
- Clamp on type, includes clamps (one per pack)
- Fits 2" O.D. tubes: is a replacement breather for Moroso Breather Tanks, Part Nos. 85400, 85402, 85404 & 85406
- Cleanable and re-usable: oil before use

PART #	DESCRIPTION
68818*	Filtered Breather, non-hooded style, clamp-on type. For Moroso Breather Tanks, 2" O.D.

 **WARNING Prop. 65**
This product contains a chemical known to the state of California to cause cancer, birth defects, or reproductive harm-



No. 68818

BREATHER TANK

Dry Sump, Vacuum Pump Systems, Air/Oil Separation

- Remote breather tank is a perfect companion for Moroso's Racing Vacuum Pumps or Dry Sump Tanks
- Includes non-hooded, clamp-on style Filtered Breather that traps oil while allowing air to escape freely
- Petcock facilitates tank draining
- Dimensions: 3-1/8" diameter, 6-1/2" tank height (without filter), 11-1/2" overall height

PART #	DESCRIPTION	PART #	OPTIONS/REPLACEMENT PARTS
85465*	Breather Tank, -12AN fitting, male	68815*	Non-Hooded Breather
85470*	Breather Tank, 3/8" NPT fitting, female	68811*	Half-Hooded Breather
85456*	Breather Tank, -6AN fitting, male	97200	Ball Valve, 3/8" Male and Female Ports
85458*	Breather Tank, -8AN fitting, male		
85459*	Breather Tank, -10AN fitting, male		
85475*	Breather Tank, -16AN fitting, male		

 **WARNING Prop. 65**
This product contains a chemical known to the state of California to cause cancer, birth defects, or reproductive harm-



No. 85465

*Note: Not legal for sale or use on pollution-controlled vehicles.

TANKS & COVERS

BREATHER TANK

Dry Sump, Vacuum Pump Systems, Air/Oil Separation

- A perfect companion for engines equipped with dry sump pumps, vacuum pumps or non-dry sump or non-vacuum pump equipped engines that historically have “pushed oil” with other breather tanks
- Features internal baffling with mesh media for superior separation of air and oil
- -12AN male side fitting and petcock facilitates tank draining
- Includes a panel mount, billet aluminum clamp that has two supplied 1/4" -20 mounting hardware
- Dimensions: 3-1/8" dia., 6-1/2" tank height (without filter), 11-1/2" overall height

PART # DESCRIPTION
85467*◊ Breather Tank

◊  **WARNING Prop. 65**
This product contains a chemical known to the state of California to cause cancer, birth defects, or reproductive harm-

PART # OPTIONS/REPLACEMENT PARTS
63403 Billet Aluminum Mounting Bracket, Universal
68815◊ Non-Hooded Breather
68811◊ Half-Hooded Breather
97200 Ball Valve, 3/8" Male and Female Ports



No. 85467

BREATHER TANK, BILLET

Dry Sump, Vacuum Pump Systems, Air/Oil Separation

- All billet aluminum, lightweight tank features mounting strap to simplify installation
- Includes non-hooded, clamp-on-style Filtered Breather that traps oil while allowing air to escape freely
- Petcock facilitates tank draining
- Dimensions: 3" dia., 6-1/2" tank height (without filter), 11-1/2" overall height

PART # DESCRIPTION
85500*◊ Billet Breather Tank

◊  **WARNING Prop. 65**
This product contains a chemical known to the state of California to cause cancer, birth defects, or reproductive harm-

PART # OPTIONS/REPLACEMENT PARTS
68815◊ Non-Hooded Breather
68811◊ Half-Hooded Breather
97200 Ball Valve, 3/8" Male and Female Ports



No. 85500

BREATHER TANKS, MULTI-INLET

Dry Sump, Vacuum Pump Systems, Air/Oil Separation

- Multi-inlet tank can collect from different sources to save on weight and plumbing complexity
- All aluminum, lightweight tank features mounting straps to simplify installation
- Includes non-hooded, clamp-on style Filtered Breather that traps oil while allowing air to escape freely
- Petcock facilitates tank draining
- Dimensions: 3-1/8" diameter, 6-1/2" tank height (without filter), 11-1/2" overall height

PART # DESCRIPTION
85455◊ Breather Tank, Two 1/2" NPT fittings, female 180° apart **NEW!**
85469◊ Breather Tank, Two -12AN fittings, male 180° apart
85468◊ Breather Tank, Two -10AN fittings, male 180° apart
85473*◊ Dry Sump Breather Tank, Two 3/8" NPT, female 180° apart

PART # OPTIONS/REPLACEMENT PARTS
68815◊ Non-Hooded Breather
68811◊ Half-Hooded Breather
97200 Ball Valve, 3/8" Male and Female Ports

◊  **WARNING Prop. 65**
This product contains a chemical known to the state of California to cause cancer, birth defects, or reproductive harm-



No. 85469

No. 85473

FITTINGS, 1/2" NPT MALE TO 5/8" BARBED HOSE

- A valve cover breather assembly can be created easily by using these fittings with a Moroso Part No. 85455 Breather Tank, the following breathers; Part Nos. 68780, 68785 or 68788, plumbed together with 5/8" lines
- Brass construction
- One per package

PART # DESCRIPTION
22735◊ Fitting, 1/2" NPT Male to 5/8" Barbed Hose, Straight
22736◊ Fitting, 1/2" NPT Male to 5/8" Barbed Hose, 90 Deg.

◊  **WARNING Prop. 65**
This product contains a chemical known to the state of California to cause cancer, birth defects, or reproductive harm-



No. 22735

No. 22736

*Note: Not legal for sale or use on pollution-controlled vehicles.

VACUUM PUMP BREATHER TANK, TWO BREATHERS

- Bigger than your typical breather tank for capturing large amounts of vapor expelled by big cube, high boosted, big shot of nitrous, loose tolerances, high stressed types of engines
- Aluminum, lightweight tank features internal baffling with mesh media for separation of air and oil
- Includes two non-hooded, clamp-on filtered breathers, built-in mounting bracket and a easy to drain ball valve drain
- Dimensions: 7" wide (without mount), 4" deep, 11" tank height (without filter or drain), 15" overall height

NEW!

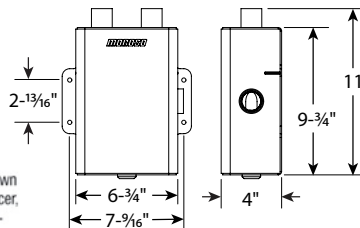

WARNING Prop. 65
This product contains a chemical known to the state of California to cause cancer, birth defects, or reproductive harm-



No. 85390

PART #	DESCRIPTION
85390	Breather Tank, Vacuum Pump, Two Breathers, -16AN Inlet

BREATHER TANK, MULTI-INLET, 2.5 QUART

Dry Sump, Vacuum Pump Systems, Air/Oil Separation

- Eliminates the need for two tanks
- Larger capacity 2.5 quart tank complete with dual -12AN fittings, allows hookup from Vacuum Pump and Dry Sump Pump
- All-aluminum, lightweight 3" x 17-1/2" (installed) tank includes mounting clamp to simplify installation
- Includes non-hooded, clamp-on-style Filtered Breather that traps oil while allowing air to escape freely
- Petcock facilitates tank draining

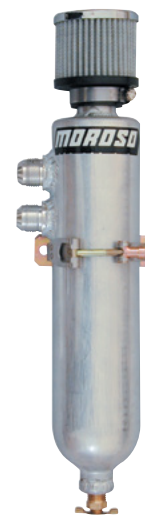

No. 85466

PART #	DESCRIPTION
85466	Breather Tank, Vacuum/Dry Sump Pump, 2.5 Quart
PART #	OPTIONS/REPLACEMENT PARTS
63401	Universal Tank Mounting Bracket, 3" to 3.25" dia.
68815	Non-Hooded Breather
68811	Half-Hooded Breather
97200	Ball Valve, 3/8" Male and Female Ports

WARNING Prop. 65
This product contains a chemical known to the state of California to cause cancer, birth defects, or reproductive harm-

FILLER/BREATHER TANK

- Provides remote filling capabilities and breathing capacity
- Mounted so that its bottom outlet, with 3/4" NPT female fitting, is higher than the inlet to the steering pump, rear axle housing, etc.
- The 3/8" NPT fitting located at the top of the tank can be used to connect a vent line to the rear axle housing for quicker filling or as a return line when the tank is used as a radiator catch can
- Dimensions: 8" length, 3-1/8" diameter, 1 qt. capacity



No. 85450

PART #	DESCRIPTION
85450	Filler/Breather Tank, panel mount
PART #	REPLACEMENT PART
97580	Cap

WARNING Prop. 65
This product contains a chemical known to the state of California to cause cancer, birth defects, or reproductive harm-

*Note: Not legal for sale or use on pollution-controlled vehicles.

TANKS & COVERS

BREATHER TANKS, ROLL BAR MOUNT

Are available with several different side mounted fitting options for ease of plumbing

- Remote breather tank is a perfect companion for Vacuum Pumps, Dry Sump Tanks or Rear Ends
- Aluminum, lightweight tank features a roll bar/chassis tube mount to simplify installation
- Features internal baffling with mesh media for separation of air and oil
- Includes non-hooded, clamp-on style, filtered breather and a bottom petcock drain
- Dimensions: 3-1/8" diameter (without mount), 6-1/2" tank height, 11-1/2" overall height

PART # DESCRIPTION

- 85461*◊ Breather Tank, Roll Bar Mount, -12AN Male
- 85462*◊ Breather Tank, Roll Bar Mount, 3/8" NPT Female
- 85463*◊ Breather Tank, Roll Bar Mount, 1/2" NPT Female

PART # OPTIONAL PART

- 97200 Ball Valve, 3/8" Male and Female Port

*Not legal for sale or use on pollution-controlled vehicles

◊ **WARNING Prop. 65**
This product contains a chemical known to the state of California to cause cancer, birth defects, or reproductive harm-



No. 85461

Integral Tube Mount

MULTI-INLET BREATHER TANK, ROLL BAR MOUNT

Fits: Breather Tank, Roll Bar Mount, 1/2" & 3/8" NPT

- Remote breather tank is a perfect companion for Vacuum Pumps, Dry Sump Tanks or Rear Ends
- Side mounted 3/8" female fitting and 1/2" female fitting on roll bar mount side, that are 180 Degrees apart for ease of plumbing
- Aluminum, lightweight tank features a roll bar/chassis tube mount to simplify installation
- Features internal baffling with mesh media for separation of air and oil
- Includes non-hooded, clamp-on style, filtered breather and a bottom petcock drain
- Dimensions: 3-1/8" diameter (without mount), 6-1/2" tank height, 11-1/2" overall height

PART # DESCRIPTION

- 85464*◊ Breather Tank, Roll Bar Mount, 1/2" & 3/8" NPT

PART # OPTIONAL PART

- 97200 Ball Valve, 3/8" Male and Female Ports

*Not legal for sale or use on pollution-controlled vehicles

◊ **WARNING Prop. 65**
This product contains a chemical known to the state of California to cause cancer, birth defects, or reproductive harm-



No. 85464

Integral Tube Mount

UNIVERSAL FIT AIR-OIL SEPARATORS

AIR-OIL SEPARATOR TANK

Use this tank as a remote Air/Oil Separator on Vacuum Pump Systems

- Designed to be plumbed between the valve cover and the inlet side of the vacuum pump
- Features -12AN inlets and outlets and has a -6AN Drain
- Dimensions: 3-3/8" dia., 6-3/4" overall height

PART # DESCRIPTION

- 85471* Air-Oil Separator Tank

*Not legal for sale or use on pollution-controlled vehicles

SEE MORE
Air-Oil Separators
on pgs. 180-184

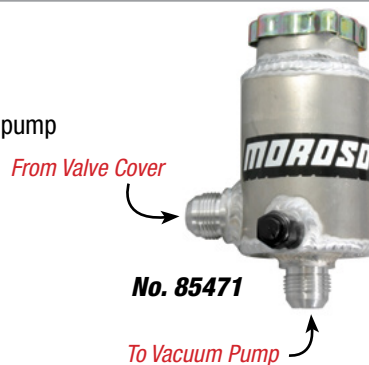

No. 85471

To Vacuum Pump

AIR-OIL SEPARATOR

Universal, Vacuum Pump

- Moroso Vacuum Pump Air-Oil Separator is designed to be plumbed between the valve cover and the inlet side of the vacuum pump
- Features internal baffling with mesh media for superior separation of air and oil
- Billet Aluminum body compliments any engine compartment and can be polished, chromed or powder coated for a custom look
- -12 AN inlet and outlet fittings for plumbing the Air-Oil Separator inline
- Includes a billet aluminum mounting clamp for the body of the air-oil separator, a stainless steel bracket for non-accessible behind the panel mount applications and an O-ringed drain bung

PART # DESCRIPTION

- 85495◊ Air-Oil Separator, Universal, -12 AN Fittings

◊ **WARNING Prop. 65**
This product contains a chemical known to the state of California to cause cancer, birth defects, or reproductive harm-



No. 85495

TRANSMISSION EXPANSION TANK

Billet Aluminum

- Both heavy duty and good looking—finish can be left as is, polished, powder coated or painted
- Meets requirements of 1-½ pint transmission NHRA overflow rule
- Prevents fluid mist from spraying on the race surface, behind your car and tires
- Pressurized fluid is captured in the Tank and will drain back into the transmission as it cools
- Includes breather and billet aluminum mounting bracket
- Designed with an integral baffle

PART # DESCRIPTION

41221* Transmission Expansion Tank, Billet Aluminum, 2.75" O.D., 2.715" I.D. x 7.050" long

PART # REPLACEMENT PARTS

68791 Clamp on breather

**Not legal for sale or use on pollution-controlled vehicles*



No. 41221

WARNING Prop. 65
This product contains a chemical known to the state of California to cause cancer, birth defects, or reproductive harm-

UNIVERSAL FIT BRACKETS

UNIVERSAL TANK MOUNTING BRACKETS

- **No. 63401** fits all 3" to 3.25" diameter tanks, including Moroso Overflow Tank **No. 63657**
- **No. 63402** fits all tanks with a 2.44" to 2.69" diameter
- Manufactured from a one-piece, zinc plated steel bracket with 1/32" mounting holes and a sliding, stainless steel T-Bolt clamp
- Features a locking nut to prevent loosening and a quick disconnect strap
- Meets the requirements of all sanctioning bodies

PART # DESCRIPTION

63401 Universal Tank Mounting Bracket. 3" to 3.25" dia.

63402 Universal Tank Mounting Bracket. 2.44" to 2.69" dia



No. 63401

WARNING Prop. 65
This product contains a chemical known to the state of California to cause cancer, birth defects, or reproductive harm-

BILLET ALUMINUM MOUNTING BRACKET

Universal

Fits: All 3-1/8" diameter tanks such as Moroso Nos. 63660, 85400, 85402, 85404, 85406, 85450, 85465, 85466, 85467, 85470, 85471, 85473

- Manufactured from Billet Aluminum
- Back of Bracket has two panel mounting holes for the supplied 1/4" -20 mounting hardware

PART # DESCRIPTION

63403 Billet Aluminum Mounting Bracket, Universal



No. 63403

LOOKING FOR A CUSTOM TANK?

Moroso can custom build dry sump, breather, coolant, expansion, overflow and power steering tanks to your unique specifications. A Technical Representative is available to discuss options, finishes and pricing for your custom tank.

TANKS & COVERS

POWER STEERING TANKS

Fits: Universal Panel Mount

- Fabricated of aluminum for strength – can be polished, chromed, powder coated or left as-is for a race look
- Built in bracket allows convenient mounting on a panel
- -6 AN inlet and -10AN outlet with an internal baffle
- Includes a heavy duty vented screw on cap

PART # DESCRIPTION

- 63506** Power Steering Tank, Universal Panel Mount, Inlet left side
63507 Power Steering Tank, Universal Panel Mount, Inlet right side



No. 63506

No. 63507

RADIATOR RECOVERY TANKS

RADIATOR RECOVERY TANK

1 Quart Capacity

Features built-in mounting Inserts

- Lightweight durable design has a full quart capacity
- Tank features 2 molded in 3" on center mounting inserts with 5/16"-18 thread
- Can be used in many forms of competition: NHRA & IHRA accepted
- Vented tank includes 3/8" NPT hose fitting and drain cock
- Dimensions: 10-1/2" high (overall), 3" tank diameter
- Mounting hardware included

PART # DESCRIPTION

- 63657** Overflow Tank, 1 Quart, Built-In Mounting Inserts

 **WARNING Prop. 65**
 This product contains a chemical known to the state of California to cause cancer, birth defects, or reproductive harm-



No. 63657

RADIATOR RECOVERY TANK

- Lightweight Aluminum design holds one full quart capacity
- Can be used in many forms of competition: NHRA, IHRA & SCCA accepted
- Vented recirculating tank includes push-lock fitting (for 1/4" O.D. flexible tubing), barbed fitting (for 3/8" rubber hose), siphon tube and drain fitting
- Dimensions: 9" high (overall), 3-1/8" tank diameter

PART # DESCRIPTION

- 63660** Radiator Recovery Tank

PART # AVAILABLE OPTIONS

- 63401** Universal Tank Mounting Bracket, 3" to 3 1/4" dia.
63403 Billet Aluminum Mounting Bracket, Universal
97200 Ball Valve, 3/8" Male and Female Ports

 **WARNING Prop. 65**
 This product contains a chemical known to the state of California to cause cancer, birth defects, or reproductive harm-



No. 63660

BILLET RADIATOR RECOVERY TANK

- Billet Aluminum design holds one full quart capacity
- Can be used in many forms of competition: NHRA, IHRA & SCCA accepted
- Vented recirculating tank includes:
 push-lock fitting (for 1/4" O.D. flexible tubing), barbed fitting (for 3/8" rubber hose), siphon tube and drain fitting
- Dimensions: 9" high (overall), 3" tank diameter
- Billet mount included

PART # DESCRIPTION

- 85505** Billet Radiator Recovery Tank

PART # OPTIONAL PART

- 97200** Ball Valve, 3/8" Male and Female Ports

 **WARNING Prop. 65**
 This product contains a chemical known to the state of California to cause cancer, birth defects, or reproductive harm-



No. 85505

COOLING SYSTEM EXPANSION TANKS

- Perfect for cars with low-mount radiators to provide convenient filling location and to bleed off unwanted air
- Available with rugged 6061-T6 billet aluminum filler necks welded to tank to withstand continuous removal and installation of cap
- Available in two sizes to simplify installation in tight areas
- Each tank includes a 1/8" pipe overflow fitting at neck, a 1/4" NPT water intake bung, and a 1/2" bung at the bottom for plumbing a line to the radiator
- 100% pressure tested to eliminate leaks
- Accepts a standard-size radiator cap
- Dimensions: 6-1/2" H x 7" W



No. 63656

PART #	DESCRIPTION	FILLER NECK	CAPACITY	DEPTH
63650	Expansion Tank	Stamped	1-1/2 quart	3-5/8"
63651	Expansion Tank	Billet Aluminum	1-1/2 quart	3-5/8"
63655	Expansion Tank	Stamped	1 quart, low-profile	2-5/8"
63656	Expansion Tank	Billet Aluminum	1 quart, low-profile	2-5/8"

UNIVERSAL COOLANT EXPANSION TANK

- Designed for several applications where a small volume remote tank is necessary
- Fabricated aluminum with integral mounting bracket
- 1-1/4" quart capacity
- One 1/2" NPT female fitting on bottom of tank and one 3/8" NPT female fitting on side
- Billet filler neck with barbed fitting for overflow hose

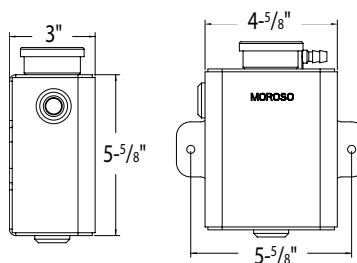

No. 63766

PART #	DESCRIPTION
63766	Universal Coolant Expansion Tank

UNIVERSAL COOLANT EXPANSION TANK, WITH SIGHT TUBE

- Designed for several applications where a small volume remote tank is necessary
- Sight Tube is constructed out of high quality tubing, allows the user to visually check the fluid level for years to come
- Fabricated aluminum with integral mounting bracket
- 1-1/4 quart capacity
- One 1/2" NPT female fitting on bottom of the tank and one 3/8" NPT female fitting on the side
- Billet radiator filler neck accepts Moroso Racing Radiator Caps and standard size radiator caps, has a barbed fitting for overflow hose



No. 63773

PART #	DESCRIPTION
63773	Coolant Expansion Tank, Universal with Sight Tube

WARNING Prop. 65
 This product contains a chemical known to the state of California to cause cancer, birth defects, or reproductive harm-

SEE MORE → **Racing Radiator Caps on pg. 258**

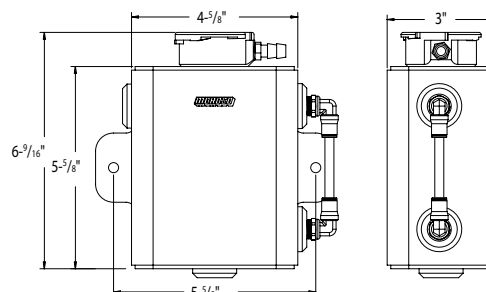

TANKS & COVERS

UNIVERSAL COOLANT EXPANSION & RECOVERY TANK SYSTEM

Until now to follow the rules of most sanctioning bodies a remote recovery tank would have to be plumbed off the overflow hose. No need with this dual tank system which has a 1-1/4" quart expansion tank with an attached 1 quart recovery tank. An added bonus is that the recovery tank has a built-in siphon tube which draws the overflowed coolant back into the expansion tank as the coolant cools down. The end result is savings in complexity, weight, clutter, cost, maintenance and forgetting to install a recovery tank off the expansion tank.

- Tank system is fabricated out of aluminum with integral mounting bracket
- Expansion Tank section features:
 - 1-1/4 quart capacity
 - One 1/2" NPT female fitting on bottom of the tank and one 3/8" NPT female fitting on the side
 - Billet radiator filler neck accepts Moroso Racing Radiator Caps and standard size radiator caps
- Recovery Tank section features:
 - 1 quart capacity
 - Internal Siphon Tube which allows the coolant to recirculate from the recovery tank back into the expansion tank 3/8" NPT female fitting, with ball valve on bottom of the tank

No. 63772

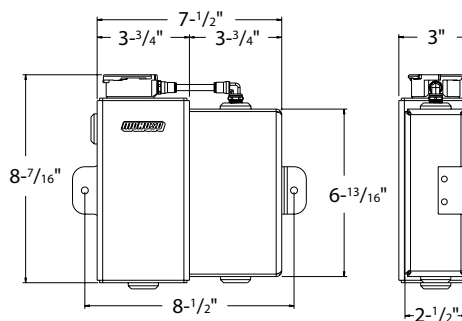

PART #	DESCRIPTION
63772	Coolant Expansion & Recovery Tank System, Universal

WARNING Prop. 65
This product contains a chemical known to the state of California to cause cancer, birth defects, or reproductive harm.

UNIVERSAL CATCH/OVERFLOW/RECOVERY TANK

- Fabricated of aluminum for strength with integral mounting brackets and a clear coolant level check
- Versatile tank can be used for different applications depending how it is plumbed
- Side bung 1/4" NPT
- With straight barbed fitting,
- Bottom bung, 1/4" NPT w/ petcock, 1/4" NPT plug & 1/4" NPT 90° fitting



No. 63769

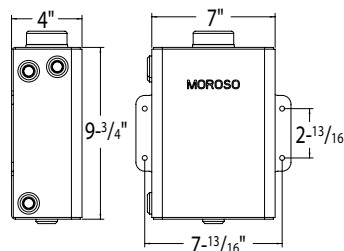

PART #	DESCRIPTION
63769	Catch/Overflow/Recovery Tank, Universal Fit

WARNING Prop. 65
This product contains a chemical known to the state of California to cause cancer, birth defects, or reproductive harm.

COOLANT EXPANSION TANK

Fits: Roll Bar Mount, 1/2" NPT

- Aluminum, lightweight tank features a roll bar/chassis tube mount to simplify installation
- 22.6 oz capacity
- Side mounted 1/2" NPT female fitting for ease of plumbing
- Features billet aluminum radiator neck that accepts standard size radiator caps
- Billet aluminum neck has screw-in 1/8" NPT hose fitting
- Has a bottom 3/8" drain with plug
- Dimensions: 3-1/8" diameter (without mount), 6-1/2" tank height (without billet neck), 7-1/2" overall height



No. 63771

PART #	DESCRIPTION	PART #	REPLACEMENT PARTS
63771	Coolant Expansion Tank, Roll Bar Mount, 1/2" NPT	97200	Ball Valve, 3/8" Male and Female Ports

WARNING Prop. 65
This product contains a chemical known to the state of California to cause cancer, birth defects, or reproductive harm.

COOLANT EXPANSION TANK

Fits: Camaro '16-Up, Cadillac ATS '13-Up, CTS '14-Up

- Direct bolt-in replacement to stock 2 piece plastic tank, ACDelco Part No. 22948113
- Fabricated Aluminum for strength, factory tanks fail after repeated high heat situations
- This Aluminum tank can be polished, chromed, painted, powder coated or left as-is for a race look
- Features a billet aluminum radiator neck that accepts the factory cap
- Includes sight tube to check coolant level



No. 63813

PART # DESCRIPTION

63813 Coolant Expansion Tank, Camaro, '16-Up

SUPERCHARGER TANK

Fits: Camaro SS with Edelbrock Supercharger, '10-'15

- Direct bolt-in to factory Edelbrock tank
- Fabricated of aluminum for strength – can be polished, chromed, powder coated or left as-is for a race look
- Can be packed with ice for the track or dyno pulls for quicker E.T'S and more horsepower
- Accepts factory screw on cap



No. 63503

PART # DESCRIPTION

63503 Supercharger Tank, Camaro SS with EDELBROCK Supercharger, '10-'15

SUPERCHARGER TANK, CAMARO COPO '12-UP, CAMARO '10-UP BEING CONVERTED TO A COPO SPEC.

- Bolt-in replacement for the plastic tank that comes in earlier Supercharged COPO Camaros, the plastic tank can crack or deform over time
- Can also be used instead of or as a bolt-in replacement to GM Part No. TK40025
- Fabricated of aluminum for strength – can be polished, chromed, powder coated or left as-is for a race look
- Can be packed with ice for the track or dyno pulls for quicker E.T'S and more horsepower
- Features a easy to turn, see through screw on cap that makes checking fluid and ice levels simple
- Mounting hardware included



No. 63531

PART # DESCRIPTION

63531 Supercharger Tank, Camaro Copo '12-Up, Camaro '10-Up

FUSE BOX, BRAKE RESERVOIR & ABS PUMP COVERS

Fits: Camaro V-6, SS, '10-'15

- Fits over factory plastic fuse box lid, brake reservoir or ABS Pump tank and can be installed in just minutes
- Fabricated out of .100" thick aluminum with TIG welded corners
- Improves under-hood appearance, matches Moroso tank line *(sold separately)*
- Can be polished, chromed, powder coated, painted or left as-is for a race look

No. 74246



PART # DESCRIPTION

74246 Brake Reservoir Cover.

Fits: Camaro V-6, SS, '10-'15

74247 Fuse Box Cover. *Fits: Camaro V-6, SS '10-'11*

74248 ABS Pump Cover, Camaro V-6, SS,

Hardtop Only, '10-'15

74258 ABS Pump Cover, Camaro V-6, '10-'15



No. 74258



No. 74247

TANKS & COVERS

COOLANT EXPANSION TANKS

Fits: Corvette, '97-'13

- Direct, bolt-in replacement for stock, cracked or mis-colored tanks
- Utilizes O.E.M. mounting points
- Fabricated aluminum for strength, factory tanks fail after repeated high heat situations, especially in supercharged or turbocharged applications
- Billet aluminum neck accepts stock vented cap, bleeds pressure like the factory intended
- This aluminum tank can be polished, chromed, painted, powder coated or left as-is for a race look
- Does not allow use of factory coolant level sensor if equipped



No. 63787

PART # DESCRIPTION

63787	Coolant Expansion Tank, Corvette, '97-'04
63808	Coolant Expansion Tank, Corvette, '05-'13

No. 63808



POWER STEERING TANK

Fits: Corvette '97-'13 (Except ZR1)

- Direct, bolt-in replacement for O.E.M. tank, also fits GM Accessory Drive Kits 19155066 & 19155967
- Fabricated aluminum for strength, factory tanks fail after repeated high heat situations
- Billet aluminum neck accepts the stock cap
- This aluminum tank can be polished, chromed, painted, powder coated or left as-is for a race look
- Tank is baffled, includes integral mounting bracket and billet aluminum hose fittings that are better looking and more trouble-free than screw-in fittings



No. 63788

PART # DESCRIPTION

63788	Power Steering Tank, Corvette, '97-'13 (except ZR1)
--------------	---

Note: Shown with O.E.M. cap, not included

BRAKE RESERVOIR & FUSE BOX COVERS

Fits: Corvette, '97-'08 & Cadillac XLR, '04-'08

- Fabricated .100" thick aluminum, fits over existing plastic brake reservoir cover
- Improves under-hood appearance, matching Moroso tank line (*sold separately*)
- Can be polished, chromed, powder coated, painted or left as-is for a race look



No. 74241



No. 74240

PART # DESCRIPTION

74240	Brake Reservoir Cover, Corvette, '97-'08 & Cadillac XLR, '04-'08
74241	Fuse Box Cover, Corvette, '97-'04

COOLANT EXPANSION TANKS

Fits: GAS '07-'16, GAS 2500 '99-'07, GAS 3500 '01-'07

- Direct bolt-in replacement to stock 2 piece plastic tank
- Fabricated Aluminum for strength, factory tanks fail after repeated high heat situations
- This Aluminum tank can be polished, chromed, painted, powder coated or left as is for a race look.
- Features a billet aluminum radiator neck that accepts the factory cap

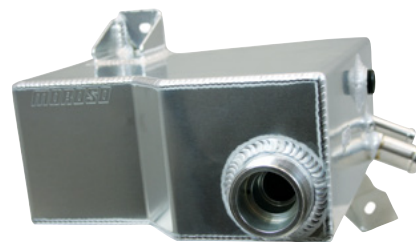

No. 63856

PART # DESCRIPTION

63854	Coolant Expansion Tank, GM P/U SUV, GAS '07-'16
63856	Coolant Expansion Tank, GM P/U GAS 2500 '99-'07, 3500 '01-'07*

**Has port for Moroso Part No. 63950 low coolant sensor*

No. 63950



COOLANT EXPANSION TANKS

For Dodge/Chrysler 300C, Challenger, Charger Hellcat, Magnum

- Direct bolt-in replacement to stock plastic tanks
- Fabricated of aluminum for strength – can be polished, chromed, powder coated or left as-is for a race look
- Plastic coolant tanks fail after repeated high heat situations
- Has a built-in overflow expansion reservoir like the factory tank (except Moroso **No. 63796**)
- Features a robust billet aluminum filler neck, fittings and power steering tabs
- Increased coolant capacity over stock tanks
- Optional Moroso Racing Radiator Caps, see page 258

PART # DESCRIPTION

63796 Coolant Expansion Tank.

Fits: Dodge/Chrysler 300C, Challenger, Charger, '11-'14

63497 Coolant Expansion Tank, with two power steering tab locations, for mounting an aftermarket intake shield, can be used with a stock intake.

Fits: Dodge/Chrysler Challenger, Charger, Magnum with 2.7, 3.5, 5.7 and 6.1L Engines, '05-'10

63499 Coolant Expansion Tank, with one power steering tab location, for use with a stock intake or aftermarket intake that does not use the power steering tab to mount the intake shield.

Fits: Dodge/Chrysler Challenger, Charger, Magnum with 2.7, 3.5, 5.7 and 6.1L Engines, '05-'10

63812 Coolant Expansion Tank.

Fits: Dodge/Chrysler Challenger & Charger, SRT8, Hellcat, '15-'18,

 **WARNING Prop. 65**
This product contains a chemical known to the state of California to cause cancer, birth defects, or reproductive harm-

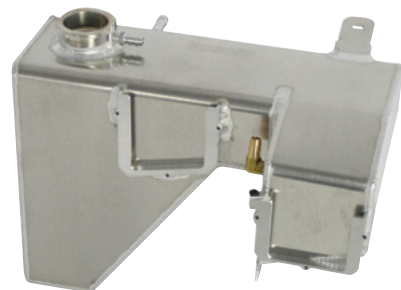

No. 63497



No. 63812



Racing Radiator Caps
pg. 258



No. 63809

SUPERCHARGER TANK, DODGE/CHRYSLER CHALLENGER & CHARGER HELLCAT, '15-'18

- Supercharged cars run hot so increased cooling capacity is a must for horsepower
- Direct bolt-in replacement, uses factory mounting bracket
- Fabricated of aluminum for strength – can be polished, chromed, powder coated or left as-is for a race look
- Can be packed with ice for the track or dyno pulls for quicker E.T'S and more horsepower
- Features billet aluminum neck and comes with Moroso Radiator Cap

PART # DESCRIPTION

63809 Supercharger Tank, Dodge/Chrysler Challenger & Charger Hellcat, '15-'18

POWER STEERING TANK

For Dodge/Chrysler 300C, Challenger, Charger, Magnum

- Manufactured from aluminum for strength
- Direct bolt-in to factory tank
- A much stronger and better looking tank than the plastic factory tank
- Baffled and complete with integral mounting bracket & fittings
- Accepts factory screw-on cap
- Finish can be polished, chromed, painted, powder coated or left as-is for a race look
- Fits on Moroso **No. 63497** or stock

PART # DESCRIPTION

63498 Power Steering Tank.

Fits: Dodge Cars with 2.7, 3.5, 5.7 and 6.1L Engines, '05 -'10



No. 63498



TANKS & COVERS

FUSE BOX COVER

Fits: Dodge Challenger, '08-'14

- Fabricated .100" thick Aluminum, fits over existing plastic fuse box lid
- Improves under-hood appearance, matches Moroso tank line (*sold separately*)
- Can be polished, chromed, powder coated, painted or left as is for a race look

PART #	DESCRIPTION
74226	Fuse Box Cover



No. 74226

RADIATOR & INTERCOOLER CAP COVERS

Billet Aluminum

- Billet Aluminum cap cover snaps right on to factory radiator and intercooler caps
- Nos. 63802 and 63803 have knurled, easy-grip design
- Moroso Cap Covers complete the look and complement your upgraded tank
- Can be polished, chromed, painted, anodized, powder coated or left as-is for a race look

PART #	DESCRIPTION
--------	-------------

63800 Radiator & Intercooler Cap Cover.

Fits: Ford Radiator and Intercooler Cap Nos. 1W138101AA, F6DZ8100A, RS103, RS527, XL3V8101AA, XL3Z8100AA, 9C3Z-8101B

63801 Radiator & Intercooler Cap Cover.

Fits: Chevrolet Radiator Cap Nos. 10305080, 20838623, 25713160, RC87, RC107

63802 Radiator & Intercooler Cap Cover, Knurled Grip.

Fits: Ford Radiator and Intercooler Cap Nos. 1W138101AA, F6DZ8100A, RS103, RS527, XL3V8101AA, XL3Z8100AA, 9C3Z-8101B

63803 Radiator & Intercooler Cap Cover, Knurled Grip.

Fits: Chevrolet Radiator Cap Nos. 10305080, 20838623, 25713160, RC87, RC107



No. 63800 - 63801



No. 63802- 63803

SUPERCHARGER CAP KIT, FUEL CAP STYLE

- Contains all of the parts necessary to replace broken or missing fuel cap style caps in Moroso or other tanks with this style of cap and neck
- Can also be used when an individual is producing a custom tank
- Cap is black so the kit can be used to change out red caps
- Kit contains; black fuel cap, neck, gasket, hardware and bonded sealing washers

PART #	DESCRIPTION
--------	-------------

97092 Supercharger Cap Kit, Fuel Cap Style

WARNING Prop. 65
This product contains a chemical known to the state of California to cause cancer, birth defects, or reproductive harm-

No. 97092



COOLANT EXPANSION TANK, FORD F-150 '15-'19 & RAPTOR '17-'19

Fits: F-150 (2.7, 3.5, 5.0) '15-'19 & Raptor '17-'19

- Direct bolt-in replacement to stock multi-piece plastic tank
- Fabricated aluminum for strength, factory tanks fail after repeated high heat situations
- This aluminum tank can be polished, chromed, painted, powder coated or left as is for a race look
- Features a billet aluminum radiator neck that accepts the factory cap

PART #	DESCRIPTION
--------	-------------

63852 Coolant Expansion Tank, Ford F-150 '15-'19 & Raptor '17-'19



No. 63852

COOLANT EXPANSION TANK

Fits: Ford Mustang, '86-'93

** Requires the use of '90-'93 Mustang Low Coolant Sensor, Ford Replacement Part No. 10D968*

- Direct bolt-in replacement for stock, cracked or discolored tanks
- Fabricated Aluminum for strength, factory tanks fail after repeated high heat situations
- Billet aluminum neck accepts stock cap with sensor or stock cap without sensor
- This Aluminum tank can be polished, chromed, painted, powder coated or left as is for a race look.
- Includes integral billet aluminum hose fittings that are better looking and more trouble free than screw in fittings.

PART # DESCRIPTION
63786 Coolant Expansion Tank.
Fits: Ford Mustang, '86-'93



No. 63786



No. 63767



No. 63768



No. 63782

COOLANT EXPANSION TANKS

Fits: Ford Mustangs

- Direct bolt-in replacement for stock, cracked or discolored tanks
- Fabricated aluminum for strength, factory tanks fail after repeated high heat situations
- This aluminum tank can be polished, chromed, powder coated or left as-is for a race look
- Uses factory stock vented cap, bleeds pressure like the factory intended, except **No. 63782**
- Integral fittings are more reliable than screw-in style on competitor tanks

PART # DESCRIPTION
63767 Coolant Expansion Tank.
Fits: Ford Mustang, '96-'04
63768 Coolant Expansion Tank.
Fits: Ford Mustang, V6 & GT, '05-'10, GT500, '07-'10
63782 Coolant Expansion Tank with Built-in Overflow Reservoir as required by NHRA & SCCA.
Fits: Ford Mustang, '05-'10
63783 Coolant Expansion Tank.
*Fits: Ford Mustang, V6 & GT, '11-'14**
63806 Coolant Expansion Tank.
Fits: Mustang, '15-Up

WARNING Prop. 65
 This product contains a chemical known to the state of California to cause cancer, birth defects, or reproductive harm-



No. 63783



No. 63806

**For GT 500, 2011-'14, use Moroso No. 63768*

POWER STEERING TANKS

Fits: Ford including Mustang

- Direct bolt-in replacement for stock, cracked or discolored tanks
- Manufactured from aluminum for strength
- A much stronger and better looking tank than the plastic factory tank
- Baffled and complete with cap, integral mounting bracket and fittings to ensure a factory replacement part
- Can be polished, chromed, painted, powder coated or left as-is for a race look
- Integral fittings are more reliable than screw-in style on competitors tanks

PART # DESCRIPTION
63490 Power Steering Tank.
Fits: Mustang, '99-'04, Expedition, '97-'02, F-150, '97-'03, Ranger, '98-'01, Explorer, '95-'01, Crown Victoria, '98-'04
63491 Power Steering Tank.
Fits: Mustang, '05-'10
63501 Power Steering Tank.
Fits: Mustang Shelby GT500, '07-'10



No. 63490



No. 63491

WARNING Prop. 65
 This product contains a chemical known to the state of California to cause cancer, birth defects, or reproductive harm-

TANKS & COVERS



No. 63492



No. 63493



No. 63508

SUPERCHARGER COOLANT TANKS

Keeps Supercharged Engines Running Cooler

- Supercharged cars run hot so increased cooling capacity is a must for horsepower
- Fabricated of aluminum for strength—can be polished, chromed, powder coated or left as-is for a race look
- Nos. 63492, 63493, 63494 and 63495 include a fuel cell style filler cap
Nos. 63496 and 63502 accepts factory cap
Nos. 63492, 63493 and 63508 have filtered outlet strainer
- Tanks can be packed with dry ice or ice for the track or dyno pulls for quicker E.T'S and more horsepower
- Increased coolant capacity over stock tanks
- Nos. 63492, 63493, 63496, 63502 and 63508 are direct bolt-in replacement to stock plastic tank
- For Nos. 63494 and 63495 battery needs to be relocated—use Moroso Sealed Battery Box No. 74051



No. 63494



No. 63502



No. 63496

PART # DESCRIPTION

63492 Supercharger Coolant Tank. *Fits: Mustang Cobra, '03-'04*

63493 Supercharger Coolant Tank. *Fits: GT500, '07-'12*

63494 Supercharger Coolant Tank. *Fits: Mustang, '05-'14*

63495 Supercharger Coolant Tank. *Fits: Mustang, '96-'04*

63496 Roush® Supercharger Tank.

Fits: Roush® Mustang, '05-'09, Ford Racing Mustang Supercharger, '11-'14 and Camaro SS, '10-'13 with Whipple Supercharger

63502 Supercharger Coolant Tank. *Fits: Roush® Mustang, '10-'14*

63508 Supercharger Tank. *Fits: Mustang GT 500, '13-'14*

PART # AVAILABLE OPTION

74051 Sealed Battery Box

 **WARNING Prop. 65**
This product contains a chemical known to the state of California to cause cancer, birth defects, or reproductive harm-

SUPERCHARGER TANK, MUSTANG '15-'18, WITH FORD PERFORMANCE & ROUSH® PERFORMANCE SUPERCHARGER KITS

- Direct bolt-in replacement for the tank that comes in the Ford Performance Part No. M-6066-M8627 supercharger kit or Roush® Performance Part Nos. 421542, 421823 & 422001 supercharger kits or tanks factory installed on Roush® supercharged Mustangs
- Fabricated of aluminum for strength – can be polished, chromed, powder coated or left as-is for a race look
- Can be packed with ice for the track or dyno pulls for quicker E.T'S and more horsepower
- Accepts factory screw on cap

PART # DESCRIPTION

63509 Supercharger Tank, Mustang '15-'18



No. 63509

SUPERCHARGER TANK, MUSTANG '05 - UP, WITH PAXTON / PROCHARGER / VORTECH SUPERCHARGER KITS

- Direct bolt-in replacement for the plastic relocation tank that comes in the Paxton, Procharger and Vortech supercharger kits
- Fabricated of aluminum for strength, will not split open like the kit supplied tanks
- Can be polished, chromed, powder coated or left as-is for a race look
- Can be packed with ice for the track or dyno pulls for quicker E.T'S and more horsepower

PART #	DESCRIPTION
63530	Supercharger Tank, Mustang '05-Up, with Paxton/Procharger/Vortech Supercharger Kits



No. 63530

MUSTANG GT 500, '07-'12, DUAL TANK, STOCK CAPS

Combines A Coolant & Supercharger Tank Into One Unit

- Two separate tanks integrated together to look like one
- Directly bolts in place of factory installed coolant and supercharger tanks
- Tanks are oversized to aid in cooling, supercharged cars run hot so increased cooling capacity is a must for horsepower
- Fabricated of aluminum for strength – can be polished, chromed, powder coated or left as-is for a race look
- Can be packed with ice for the track or dyno pulls for quicker E.T'S and more horsepower
- Includes heavy duty mounting bracket

PART #	DESCRIPTION
63804	Dual Tank, Mustang GT 500, '07-'12, stock caps
63805	Dual Tank, Mustang GT 500, '07-'12, stock cap with fuel cell style cap on Supercharger Tank



No. 63804

*U.S. Patent No. D643,796
For Nos. 63804 & 63805*

COOLANT EXPANSION TANK FORD FOCUS RS, '16-'18, FOCUS ST, '13-'18

- Direct bolt-in replacement to stock 2 piece plastic tank
- Fabricated Aluminum for strength, factory tanks fail after repeated high heat situations
- This Aluminum tank can be polished, chromed, painted, powder coated or left as is for a race look.
- Features a billet aluminum radiator neck that accepts the factory cap

PART #	DESCRIPTION
63820	Coolant Expansion Tank, Ford Focus RS '16-'18, Focus ST '13-'18



No. 63820



BRAKE RESERVOIR, FUSE BOX COVERS, MUSTANG, '15-'17

Fits: Mustang GT/ECoboost/ V-6, '15-'17

- Fuse Box Cover, Fabricated .100 thick Alum., fits over existing plastic fuse box lid
- Brake Reservoir Cover, Fabricated .100 thick Alum., fits over factory reservoir
- Improves under-hood appearance, Matching Moroso tank line (sold separately)
- Can be polished, chromed, powder coated, painted or left as is for a race look

PART#	DESCRIPTION
74255	Fuse Box Cover, Mustang, '15-'17
74256	Brake Reservoir Cover, Mustang, '15-'17



No. 74255



No. 74256

BATTERY, BRAKE RESERVOIR, COIL SHIELD & FUSE BOX COVERS

Fits: Mustang, '79 -'14

- Fits over the factory plastic and can be installed in just minutes
- Fabricated from .100 thick Aluminum with TIG Welded Corners
- Improves under-hood appearance, Matching Moroso tank line (sold separately)
- Can be polished, chromed, powder coated, painted or left as is for a race look

PART #	DESCRIPTION
74220	Fuse Box Cover. <i>Fits: Mustang, '05-'09</i>
74221*	Brake Reservoir Cover. <i>Fits: Mustang, '05-Mid '08</i>
74222+	Brake Reservoir Cover. <i>Fits: Mustang, Mid '08-'14</i>
74224	Fuse Box Cover. <i>Fits: Mustang GT 500, '07-'09</i>
74225	Battery Cover. <i>Fits: Mustang, '05-'14</i>
74228	Fuse Box Cover. <i>Fits: Mustang, '10-'14</i>
74229	Brake Reservoir Cover. <i>Fits: Mustang, '96-'04</i>
74230	Fuse Box Cover. <i>Fits: Mustang, '99-'04</i>
74253	Brake Reservoir Cover. <i>Fits: Mustang, '79-'93</i>
74254	Coil Shield Cover. <i>Fits: Mustang, '86-'93</i>



No. 74220



No. 74221

**Note: Fits cars produced to 5/26/08. +Note: Fits cars produced 5/27/08 and later.*



No. 74222



No. 74224



No. 74228



No. 74229



No. 74230



No. 74253



No. 74225



No. 74254

COOLANT EXPANSION TANKS

Fits: BMW E36, '92-'99, Z3 and BMW E46 M3, '01-'06

- Direct bolt-in replacement for stock, cracked or discolored tanks
- Fabricated Aluminum for strength, factory tanks fail after repeated high heat situations and age
- No cutting of factory hoses is required and accepts the factory clip-on hose
- Included is a Moroso **No. 63324** racing radiator cap that operates in the same pressure range as the factory cap
- The Moroso radiator cap mounts to a billet aluminum neck that will not strip out like plastic threaded necks
- This Aluminum tank can be polished, chromed, painted, powder coated or left as is for a race look



PART # DESCRIPTION

- 63791** Coolant Expansion Tank,
Fits: BMW E36, '92-'99, Z3
- 63793** Coolant Expansion Tank,
Includes Sight Gauge,
Fits: BMW E46 M3, '01-'06



No. 63791

 **WARNING Prop. 65**
This product contains a chemical known to the state of California to cause cancer, birth defects, or reproductive harm-

No. 63793



COOLANT EXPANSION TANK

Fits: Lotus Elise, Exige, '05-'11

- Direct bolt-in replacement for stock, cracked or discolored tanks
- Fits Normally Aspirated, OEM and Aftermarket Forced Induction vehicles
- Fabricated aluminum for strength, factory tanks fail after repeated high heat situations
- This aluminum tank can be polished, chromed, painted, powder coated or left as is for a race look
- Features billet aluminum radiator neck, sight glass to check the level of coolant and manual bleed valve
- Includes Part **No. 63316** radiator cap

PART # DESCRIPTION

- 63797** Coolant Expansion Tank,
Lotus Elise/Exige, '05-'11

 **WARNING Prop. 65**
This product contains a chemical known to the state of California to cause cancer, birth defects, or reproductive harm-



No. 63797

COOLANT EXPANSION TANK, NISSAN R35 GT-R, '09-'18

- Direct bolt-in replacement for stock, cracked or discolored tanks
- Fabricated Aluminum for strength, factory tanks fail after repeated high heat situations
- This Aluminum tank can be polished, chromed, painted, powder coated or left as is for a race look
- Billet aluminum neck accepts the factory stock vented cap
- Has 50% more capacity than the stock plastic tank

PART # DESCRIPTION

- 63811** Coolant Expansion Tank, Nissan R35 GT-R, '09-'18



No. 63811

TANKS & COVERS

COOLANT EXPANSION TANKS

Fits: Mazda Miata/MX-5 '06-'15 and '16-Up

- Direct bolt-in replacement for stock, cracked or discolored tanks
- Fabricated Aluminum for strength, factory tanks fail after repeated high heat situations
- This Aluminum tank can be polished, chromed, painted, powder coated or left as is for a race look
- Features a billet aluminum radiator neck that accepts the factory cap

PART #	DESCRIPTION
63778	Coolant Expansion Tank, Mazda MX-5 '16-Up
63779	Coolant Expansion Tank, Mazda Miata '06-'15



No. 63779



No. 63778



TANKS & COVERS

POWER STEERING TANK, MAZDA MIATA, '06-'15

- Direct bolt-in replacement for stock, cracked or discolored tanks
- Fabricated Aluminum for strength, factory tanks fail after repeated high heat situations
- Billet aluminum neck accepts factory O.E.M. cap
- Tank is baffled, includes integral billet aluminum mounting bracket and billet aluminum hose fittings
- This aluminum tank can be polished, chromed, painted, powder coated or left as is for a race look

PART #	DESCRIPTION
63777	Power Steering Tank, Mazda Miata, '06-'15



No. 63777

COOLANT EXPANSION TANKS

Fits: Mazda Miata, '90-'97 and '99-'05

- Direct bolt-in replacement for stock, cracked or discolored tanks
- Fabricated Aluminum for strength, factory tanks fail after repeated high heat situations
- This aluminum tank can be polished, chromed, powder coated or left as-is for a race look
- Comes with billet aluminum cap

PART #	DESCRIPTION
63780	Coolant Expansion Tank. <i>Fits: Mazda Miata, '90-'97</i>
63781	Coolant Expansion Tank. <i>Fits: Mazda Miata '99-'05</i>



No. 63780



No. 63781

 **WARNING Prop. 65**
 This product contains a chemical known to the state of California to cause cancer, birth defects, or reproductive harm-

**COOLANT EXPANSION TANK,
MAZDA RX-8, '03-'12**

- Direct bolt-in replacement for stock, cracked or discolored tanks
- Fabricated Aluminum for strength, factory tanks fail after repeated high heat situations by either separating or from the neck deforming
- Features a billet aluminum radiator neck that accepts O.E.M. Small radiator caps (SAE Type B/43mm)
- This Aluminum tank can be polished, chromed, painted, powder coated or left as is for a race look



No. 63814

PART # DESCRIPTION

63814 Coolant Expansion Tank, Mazda RX-8 '03-'12

**COOLANT TANK, SUBARU IMPREZA,
WRX/STI '08-'19**

- Direct bolt-in replacement for stock cracked or mis-colored tanks
- Fabricated aluminum for strength, factory tanks fail after repeated high heat situations
- This aluminum tank can be polished, chromed, painted, powder coated or left as is for a race look
- Has a provision for the factory siphon hose
- Includes a billet aluminum cap

NEW!



No. 63871

PART # DESCRIPTION

63871 Coolant Tank, Subaru Impreza WRX/STI '08-'19

COOLANT EXPANSION TANK

Fits: Subaru Impreza, WRX/STI, '02-'07

- Direct bolt-in replacement for stock, cracked or discolored tanks
- Fabricated Aluminum for strength, factory tanks fail after repeated high heat situations
- This aluminum tank can be polished, chromed, painted, powder coated or left as-is for a race look
- Has a provision for the factory siphon hose
- Includes a billet aluminum cap with O-ring



No. 63785

PART # DESCRIPTION

63785 Coolant Tank

 **WARNING Prop. 65**
This product contains a chemical known to the state of California to cause cancer, birth defects, or reproductive harm-



TANKS & COVERS

INTERCOOLER TANK

Fits: Subaru WRX '02-'07, STI '04-'19 (without sound tubes), Forester XT Turbo '04-'08

- Direct bolt-in replacement for stock, cracked or discolored tanks
- Fabricated Aluminum for strength, factory tanks fail after repeated high heat situations
- Has 50% more capacity than Subaru stock tank
- Finish can be polished, chromed, painted, powder coated or left as-is for a race look
- Includes billet aluminum filler neck, Moroso Racing Radiator Cap in the stock pressure range and integral billet aluminum hose fittings that are better looking and more trouble-free than screw in fittings
- By having this style of radiator neck, the user can change the operating pressure by purchasing Moroso's **No. 63328** Racing Radiator Cap in the 27-29 lbs. range



No. 63784

PART # DESCRIPTION
63784 Intercooler Tank

PART # AVAILABLE OPTION
63328 Racing Radiator Cap, 27-29 lbs.



TANKS & COVERS

INTERCOOLER TANK

Fits: Subaru WRX '08-'14, Forester XT Turbo '09-'13, Legacy GT '05-'09

- Direct bolt-in replacement to stock tank with increased capacity
- Fabricated Aluminum for strength, factory tanks fail after repeated high heat situations
- This Aluminum tank can be polished, chromed, painted, powder coated or left as is for a race look
- Includes Moroso Racing Radiator Cap in the stock pressure range and integral billet aluminum hose fittings that are better looking and more trouble free than screw in fittings
- With this style of radiator neck, you can change the operating pressure using Moroso Part **No. 63328** Racing Radiator Cap in the 27-29 lbs range
- Tank is designed to be used with an Aftermarket "Cone Air Filter" intake, doesn't fit with O.E.M. Panel Air Filter Intake



No. 63795

PART # DESCRIPTION
63795 Intercooler Tank

PART # AVAILABLE OPTION
63328 Racing Radiator Cap, 27-29 lbs.

FUSE BOX COVER

Fits: Subaru WRX/STI/Impreza 2.5 RS, '06-'07

- Fabricated .100" thick Aluminum, fits over existing plastic fuse box lid
- Improves under-hood appearance, matches Moroso tank line (*sold separately*)
- Can be polished, chromed, powder coated, painted or left as is for a race look

PART # DESCRIPTION
74231 Fuse Box Cover



No. 74231

ALUMINUM TRANSMISSION PANS

- Fully fabricated with one-piece billet rail
- Reduce temperature and improve oil control
- Features dual fittings with magnetic drain plugs
- Includes serrated flange hex bolts (No. 42050 includes metric studs)



Perm-Align Transmission Pan Gaskets on pg. 209

No. 42000

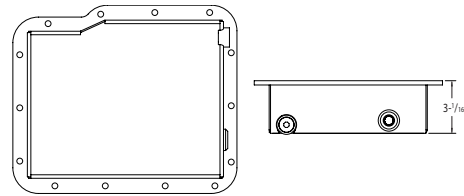

No. 42001

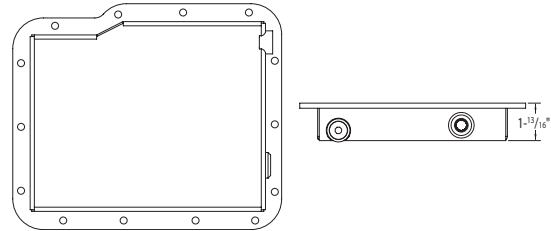

No. 42010

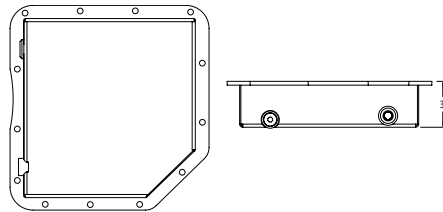

No. 42020

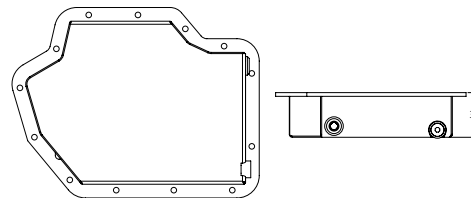

No. 42025

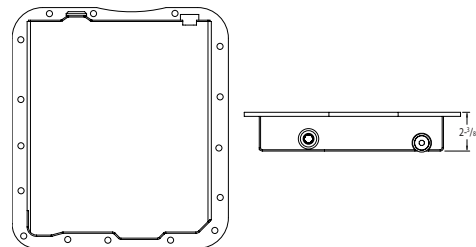

No. 42030

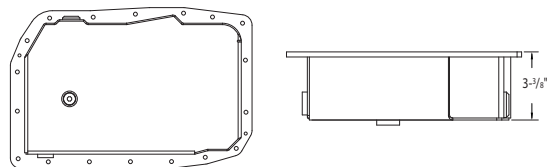

No. 42031

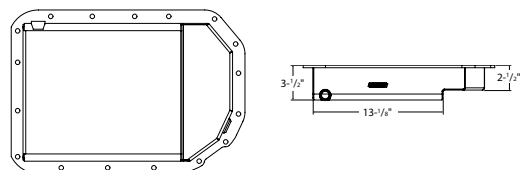

No. 42040

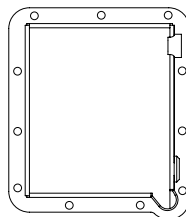

No. 42050

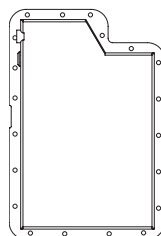

No. 42060

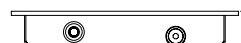
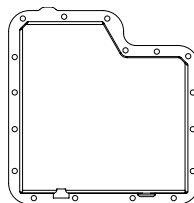

No. 42080

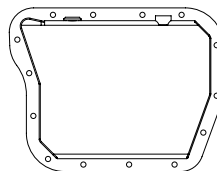

No. 42090

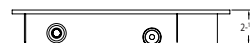
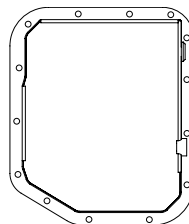

TRANSMISSION PAN & GASKET CHART

TRANSMISSION TYPE	TRANSMISSION PAN PART #	DEPTH	INCLUDED	FILTER RECOMMENDED	GASKET PART #	REPLACEMENT DRAIN PLUG
GM Powerglide	42000	3.080"	Filter Spacer	Fram FT1017	93100	97006
GM Powerglide	42001	1.830"	N/A	Fram FT1017	93100	97006
GM Turbo 350	42010	3.000"	Filter Spacer	Fram FT1021	93102	97006
GM Turbo 400	42020	3.000"	Filter Extension	Fram FT1020	93103	97006
GM 3L80	42020	3.000"	Filter Extension	Fram FT1074	93103	97006
GM 700R4	42025	2.375"	N/A	Fram FT1074	93104	97006
GM 6L80 Camaro SS '10-'15	42030	3.350"	N/A	AC Delco 24236931	N/A	97006
GM 4L80E	42031	3.500"	Filter Spacer	AC Delco 24208576	N/A	97006
FORD C4 '70-up	42040	3.080"	N/A	Fram FT1028, Fram FT1035	93107	97006
FORD C4 Pre-'70	42040	3.080"	N/A	Fram FT1027A	93107	97006
FORD E40D/4R100	42050	3.642"	N/A	Motorcraft FT113	N/A	97006
FORD C6	42060	2.000"	N/A	Ford D3TZ7A098B, Fram FT1035	93108	97006
CHRYSLER A-904	42090	2.250"	Filter Spacer	Fram FT1039	N/A	97006
CHRYSLER 727	42080	2.330"	Filter Spacer	Fram FT1039	93110	97006

See Moroso Transmission Pan Gaskets on pg.209 and Replacement Drain Plugs on pg. 107



PERM-ALIGN TRANSMISSION GASKETS

- Manufactured from 40 durometer rubber that is vulcanized to a rigid steel frame
- The extra-strength design will not leak, split or fail like O.E.M., stock or inferior quality aftermarket gaskets
- Gaskets require no sealant, which allows for quick removal and installation of transmission pans
- Rubber/Steel gasket outlast cork composites to provide years of dependable service
- Full 3/16" thick
- One per package

PART # DESCRIPTION

93100	Perm-Align Transmission Gasket
93102	Perm-Align Transmission Gasket
93103	Perm-Align Transmission Gasket
93104	Perm-Align Transmission Gasket
93105	Perm-Align Transmission Gasket
93106	Perm-Align Transmission Gasket
93107	Perm-Align Transmission Gasket
93108	Perm-Align Transmission Gasket
93110	Perm-Align Transmission Gasket

Fits: Moroso Powerglide Pans **No. 42000 and 42001**

Fits: GM Turbo 350, Moroso Transmission Pan **No. 42010**

Fits: GM Turbo 400, Moroso Transmission Pan **No. 42020**

Fits: GM 4L60E, 4L65E, 700R4, Moroso Transmission Pan **No. 42025**

Fits: Ford E40D/4R100, Moroso Transmission Pan **No. 42050**

Fits: Ford AOD, AODE and 4R70W

Fits: Ford C4, Moroso Transmission Pan **No. 42040**

Fits: Ford C6, Moroso Transmission Pan **No. 42060**

Fits: Chrysler Torqueflite 727, Moroso Transmission Pan **No. 42080**

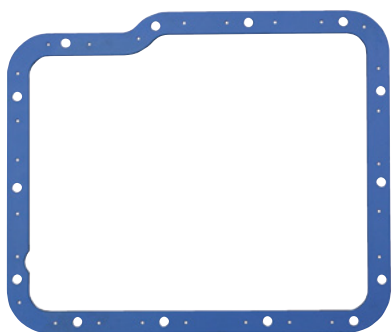

No. 93100

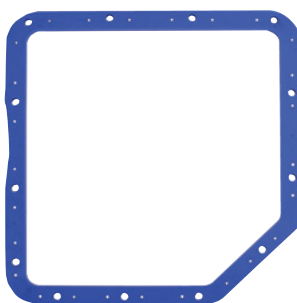

No. 93102

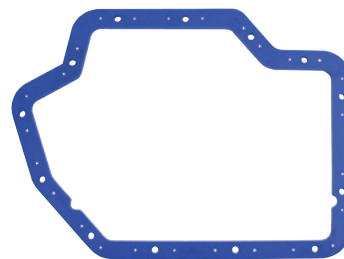

No. 93103



No. 93105

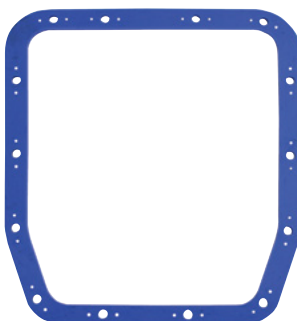

No. 93106

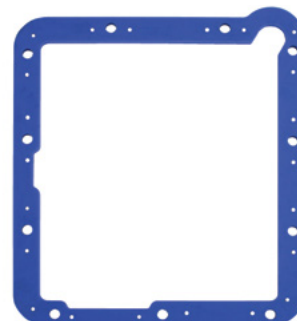

No. 93107



No. 93108



No. 93110



No. 93104



TRANSMISSION DIPSTICKS

- Custom designed for each transmission application listed, to work with the popular shields being used
- Each assembly is constructed out of heavy duty hydraulic tubing, fixture welded for a precision fit and black powder coated
- Threaded knob design stays locked to tube under high transmission pressure and vibration levels
- Heavy duty cable with a "full" and "fill" area to indicate desired fluid level
- Required by NHRA/IHRA for cars running 10.99 or quicker



PART # DESCRIPTION

- 41300** Transmission Dipstick, Locking Style, OE Long Style. **Fits:** GM Powerglide
- 41301** Transmission Dipstick, Locking Style, Short Dragster Style. **Fits:** GM Powerglide
- 41302** Transmission Dipstick, Locking Style, OE Long Style. **Fits:** GM Turbo 350
- 41303** Transmission Dipstick, Locking Style, OE Long Style. **Fits:** GM Turbo 400
- 41305** Transmission Dipstick, Locking Style, OE Long Style/Case Style. **Fits:** Ford C4



No. 41301



No. 41300



No. 41302



No. 41303



No. 41305

ROLLER PILOT BEARING

- Unlike other roller pilot bearings, this high speed bearing is designed as a direct replacement in all Chevrolet V8's and 90° V6's (also fits 1976 and later V6 Buick)
- Requires no modification to either crank or input shafts
- Eliminates premature bearing failure and insures clean clutch release by maintaining true alignment of clutch disc to flywheel
- Packed with high temperature grease for proper lubrication under extreme high heat conditions
- Suitable for all high performance applications including drag, oval track/road race and street
- 1.093" O.D. x .591" I.D. x .72" Depth
- One per package



No. 41100

PART # DESCRIPTION

- 41100** Roller Pilot Bearing, Chevrolet V8 and 90° V6



AUTOMATIC TRANSMISSION COOLERS

Available With & Without Filters

- Heat sink design dissipates the excessive heat build up in racing transmissions
- Can be used on the street as an auxiliary cooler in conjunction with a stock cooler
- Withstands up to 100 lbs of pressure
- Made of aluminum, very easy to install with built-in mounting tabs
- Includes two- 6 AN O-ring fittings and all necessary installation instructions

APPLICATION CHART

PART #	INCLUDES A FILTER WITH A MAGNET	WEAR PARTICLES ARE FILTERED DOWN TO	SQUARE INCHES OF RADIATION SURFACE	DIMENSIONS	WEIGHT
41200	Yes	10 MICRONS	500	3" H x 3" W x 12" L	1.00
41201	No	N/A	500	3" H x 3" W x 12" L	1.00
41205	Yes	10 MICRONS	1072	3 -1/2" H x 6-1/4" W x 18" L	4.70



No. 41200



No. 41201



No. 41205

PART #	REPLACEMENT PARTS
97290	Filter Cartridge for part No. 41200
97291	Filter Cartridge for part No. 41205

TRANSMISSION TAILSHAFT PLUG

- Another time saver from Moroso
- Eliminates the messy spilling of transmission fluid during transmission removal, replacement and storage
- One per package

PART #	DESCRIPTION
41060	Transmission Tailshaft Plug, 1-1/2" O.D., Early Muncie, Borg-Warner, Ford, Chrysler, Chevrolet Powerglide



No. 41060

TORQUE CONVERTER BOLTS

- Special fasteners provide maximum holding strength & eliminate the possibility of shearing

PART #	DESCRIPTION
38764	Torque Converter Bolts, Grade 8 bolts with nuts for Turbo 350, 400 flex plates without tapped holes, 3/8" -24 x 5/8". Set of 3.
38765	Torque Converter Bolts, Grade 5 bolts for Turbo 350, 400 flex plates w/tapped holes, 3/8" -16 x 5/8", Set of 3



No. 38764



**A & B EPOXY**

- Two-part bonding product molds like putty, yet hardens to steel-like consistency
- Does not shrink and is not affected by solvents, oils or gasoline
- Maximum use temperature of 250°F makes it perfect for repairing intake manifolds, cylinder head intake ports, heads and blocks
- Also useful for filling crevices in lifter galleries and installing filter screens
- Can be drilled and tapped when hard
- Adheres to almost any clean surface and hardens in 60 min. at 75°F
- One year shelf life
- Not recommended to be used with E85

PART #	DESCRIPTION
35560	A & B Epoxy, 1 lb.

WARNING Prop. 65
This product contains a chemical known to the state of California to cause cancer, birth defects, or reproductive harm-

**No. 35560****No. 34800****CLIMBING GEAR LUBE**

- High-performance, extreme high-pressure gear lube
- Multi-purpose applications including manual transmissions and both conventional and posi-traction differentials
- Contains special "clinging" agents that provide direct adhesion to all moving parts; whereas conventional lubes rely on "splashing and sloshing" to distribute lubricant
- Increased speed of rotating parts causes continuous film of oil to "climb" and spread over surfaces
- Insures complete lubrication of gears, bearings, bushings, shift yokes, synchros, etc.

PART #	DESCRIPTION
34800	Climbing Gear Lube, 1 quart

WARNING Prop. 65
This product contains a chemical known to the state of California to cause cancer, birth defects, or reproductive harm-

MOLY PASTE ASSEMBLY LUBE

- Heavy-duty assembly lubricant is specially formulated to reduce friction and wear on all metal surfaces
- Extends the life of parts subjected to extreme heat during racing
- Contains molybdenum disulfide (MoS₂), which greatly reduces friction and wear
- Moly formula coats surfaces with film that chemically bonds itself to metals, filling in the microscopic "hills and valleys" present in all metal surfaces
- Surface areas coated with Moly Paste™ retain an unbroken film of lubricant that reduces metal to metal contact and reduces risk of component failure
- Recommended for use on cams, lifters, bearings, gears, etc. Very effective when storing an engine

PART #	DESCRIPTION
35000	Moly Paste™ Assembly Lube, 4 oz. tube

**No. 35000**

WARNING Prop. 65
This product contains a chemical known to the state of California to cause cancer-



ENGINE BLOCK FILLER

- Just fill with water, mix and pour into block before machining
- Helps prevent thin cylinder walls from cracking and improves ring seal by keeping cylinders round
- Also dampens unwanted vibrations
- Has expansion rate very similar to cast-iron
- Highly regarded by "Mountain Motor" authority Scott Shafiroff
- Easy to follow, detailed instructions



No. 35571

PART #	DESCRIPTION
35570	Engine Block Filler. One case of four one-gallon containers; enough for one block
35571	Engine Block Filler. One-gallon container

◦ **WARNING Prop. 65**
This product contains a chemical known to the state of California to cause cancer-

RACE WRITE

Goes on smoothly and evenly with a bright white finish

- A single marker for use on both tires and windows
- Use on windows to mark dial-in/class
- Use on tires to check slippage and sidewall deflection
- Use on Wheel-E-Bars™ to aid in chassis tuning
- Use on the car when it's time to sell
- Easy to apply applicator, safe on glass and Lexan®
- Wipes clean with a dry rag



No. 35581

PART #	DESCRIPTION
35581	Race Write. 3 oz. single bottle with applicator

CERAMIC ENGINE SEAL

- The best Chemical Sealer you can buy to stop cooling system leaks
- Works equally well in aluminum or cast-iron blocks
- Cooling system must be thoroughly clean before use
- Does not work with antifreeze
- If this doesn't stop the leaks, find yourself a welder!



No. 35500

PART #	DESCRIPTION
35500*	Ceramic Engine Seal. One pint plastic bottle. Do not use with antifreeze

◦ **WARNING Prop. 65**
This product contains a chemical known to the state of California to cause cancer, birth defects, or reproductive harm-

ALL WEATHER SEAL

- Specially formulated to stop cooling system leaks when antifreeze is present
- Ideal for stopping radiator leaks and sealing cracked blocks in sub-freezing conditions
- Works best when cooling system has been thoroughly cleaned and flushed



No. 35520

PART #	DESCRIPTION
35520*	All Weather Seal. One pint plastic bottle. Can be used with antifreeze

◦ **WARNING Prop. 65**
This product contains a chemical known to the state of California to cause cancer, birth defects, or reproductive harm-

CAUTION

*Never remove a radiator cap when engine is hot and under pressure!
Open the petcock slowly to relieve pressure, then carefully take off radiator cap.*

WARNING!

No. 35500 and 35520 — Avoid contact with eyes or skin. Do not take internally. If splashed on skin, wash thoroughly with cold water. If splashed in eyes, flush thoroughly for 15 minutes with cool water and consult a physician

*If taken internally, drink 3 or 4 glasses of milk or water.
DO NOT induce vomiting.
Call a physician immediately.
ALWAYS KEEP OUT OF CHILDREN'S REACH.*



USING MOROSO CERAMIC ENGINE SEAL & ALL WEATHER SEAL SAFELY

For best results, open the petcock and drain coolant into container for safe disposal. Remove radiator cap. Use a hose to add water keeping radiator full with petcock open and draining. Start engine and continue draining until water runs clear. Close petcock and refill with clear water leaving enough room for sealer additive.

NOTE: Ceramic Engine Seal and All Weather Seal cannot remain in cooling system for more than 24 hours!

DECK PLUG KIT

- Upper cylinder wall distortion is greatly reduced when these 3/4" NPT plugs are installed in the water passage holes in the decks of Small Block and 90° V6 Chevy engines
- Water holes must be tapped before the plugs are screwed in; block must also be decked after installation
- Plugs also restrict water flow to the cylinder heads by reducing size of water passage holes to 5/16"
- Packaged six to a kit



No. 37800

PART # DESCRIPTION

37800 Plug Kit, Small Block and 90° V6 Chevy

ALUMINUM PIPE PLUGS

- Use on most aftermarket aluminum blocks and heads to replace plugs removed or damaged during machining, cleaning, etc.
- Available in two sizes, each with 3/8" hex socket drive for ease of installation and removal
- Two per package



No. 37810



No. 37812

PART # DESCRIPTION

37810 Aluminum Pipe Plugs, 1/2" NPT thread

37812 Aluminum Pipe Plugs, 3/8" NPT thread

CHROME PLATED PIPE PLUGS

- Chrome plated steel pipe plugs dress up often forgotten areas
- Available for several NPT sizes
- Use to plug vacuum accessory holes in manifolds, fill plug holes in transmissions and rear ends, or any other spot that accepts a pipe plug



No. 39152

No. 39153

No. 39154

PART # DESCRIPTION

39152 Chrome Plated Pipe Plugs, 3/8" NPT, four per pack

39153 Chrome Plated Pipe Plugs, 1/2" NPT, two per pack

39154 Chrome Plated Pipe Plugs, 3/4" NPT, two per pack

WARNING Prop. 65
This product contains a chemical known to the state of California to cause cancer, birth defects, or reproductive harm-

OFFSET CYLINDER HEAD DOWELS

Offset cylinder head dowels reposition the cylinder heads upwards on the block (toward the lifter valley), moving valves away from cylinder wall for improved intake flow

- One package contains 4 alloy steel dowels

PART # DESCRIPTION

37900 Offset Cylinder Head Dowels, Big Block Chevy and Big Block Chrysler .030" offset

37920 Offset Cylinder Head Dowels, Small Block Chevy and Small Block Chrysler .015" offset

37930 Offset Cylinder Head Dowels, Small Block Chevy and Small Block Chrysler .030" offset



No. 37920

EXTRA LONG BELLHOUSING DOWEL PINS

- Provides an easy method of properly aligning the transmission input shaft to the crankshaft pilot bearing
- Extra long to simplify the task of installing a bellhousing on the engine block
- Offset Dowel Pins include set screws and instructions for locking pins into place; drilling and tapping of block required
- Getting alignment concentric to within $\pm .005$ " insures a clean clutch release, maximum pilot bearing and transmission life and reduced shifting problems
- .625" diameter
- Two per package
- Fits virtually all GM V8 and V6 blocks

PART #	DESCRIPTION
37932	Bellhousing Dowel Pins, standard, 1.500 long
37934	Bellhousing Dowel Pins, .007 offset, 1.328 long
37936	Bellhousing Dowel Pins, .014 offset, 1.328 long
37938	Bellhousing Dowel Pins, .021 offset, 1.328 long



CHROME-MOLY HEAD BOLT WASHERS

- Not your ordinary hardware store variety!
- Moroso Head Bolt Washers are designed for the racer; machined from tough 4130 chrome moly steel, heat treated to proper hardness and parallel-ground
- Stress loads are more evenly distributed and torque readings more accurate
- Can also be used on main bearing caps, rocker arm stands, and other engine components
- Use them over and over again



PART #	DESCRIPTION
38300	Chrome-Moly Head Bolt Washers, $\frac{7}{16}$ ", Small Block and 90° V6 Chevy, Pack of 34
38310	Chrome-Moly Head Bolt Washers, $\frac{1}{2}$ ", Pack of 30

No. 38300

NOTE: These washers are a must when using aluminum heads. Chamfered side of the washer should be toward the head of the bolt.

VALVE COVER NUTS

Fits: BBC with Moroso Part Nos. 68420, 68425, 68426, 68429 and 68432 valve covers

- Set includes Lock Nuts, Studs $\frac{1}{4}$ "-20 x 3- $\frac{1}{4}$ ", and Set Screws
- Lock Nuts have a clear zinc finish

PART #	DESCRIPTION
68562	Valve Cover Lock Nuts for BBC

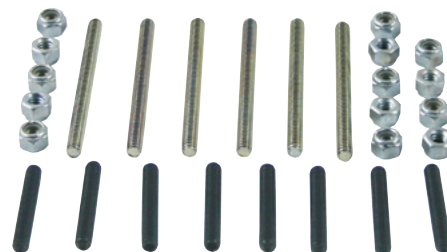

No. 68562

OIL PUMP STUD KIT, CHEVROLET

- Wet sump oil pump stud ($\frac{7}{16}$ " x 3- $\frac{3}{16}$ ") is manufactured from 4130 chrome moly steel
- Provides improved mounting for all Moroso oil pumps or stock pumps on Small Block, Big Block and 90° V6 Chevy engines
- Kit includes a nut and hardened/ground washer

PART #	DESCRIPTION
38150	Oil Pump Stud Kit, SBC, BBC and 90° V6 Chevy



No. 38150



FASTENERS

OIL PUMP PICKUP MOUNTING STUD KITS, FORD

- Studs are stronger and better at maintaining torque than factory bolts
- Provides secure mounting for Moroso oil pump pickups or stock pump pickups
- Kit includes flat washer and hex nut and serrated nut for windage tray

PART #	DESCRIPTION
38193	Oil Pump Pickup Stud Kit, 7/16" -14, Ford 302
38194	Oil Pump Pickup Stud Kit, 1/2" -20, Ford 351W, 302R



No. 38193

WINDAGE TRAY MOUNTING STUD KIT, FORD

- Required to fasten a Moroso No. 22930 or 22935 Windage Tray to the main caps
- Kits include quantity 4 of; studs, main cap nuts, windage tray nuts and 8 washers
- Engineered to allow adjustment of the distance of the Windage Tray from the rotating assembly

PART #	DESCRIPTION
38191	Windage Tray Mounting Stud Kit for No. 22930, Ford 289-302
38192	Windage Tray Mounting Stud Kit for No. 22935, Ford 351W, Ford 302R



No. 38192

FASTENERS



No. 37950



No. 37960

BULLET NOSE CARBURETOR STUD KITS

- "Bullet Nose" studs are rounded on one end, making it easy to start nuts
- Kits include 4 studs, hardened flat washers and jam nuts

PART #	DESCRIPTION
37950	Carburetor Stud Kit, Fits carbs. with 1/2" thick flange base, 5/16" -18 and 24 x 1-3/8" long
37955	Carburetor Stud Kit, for 1/2" thick carburetor spacers 5/16" - 18 thread and 2" Long
37960	Carburetor Stud Kit, Fits carbs. with 1/2" thick flange base with a 1" spacer or with one or two, 1/2" spacers, 5/16" -18 and 24 x 2-1/2" long
37961	Carburetor Stud Kit, Fits carbs. with 1/2" thick flange base with a 2" spacer or with three or four 1/2" thick spacers, 5/16" -18 and 24 x 3-1/2" long

IMPORT/SPORT COMPACT OIL PAN STUD KITS

- Steel studs allow repeated R&R of pan without stripping blocks
- Simplifies pan installation and extends gasket life
- Studs have an Allen Head socket at one end to facilitate installation
- Lock nuts feature attached washers with serrated faces
- Studs finished with black oxide and nuts are zinc plated to resist corrosion



No. 38356

PART # DESCRIPTION

- 38356** Oil Pan Stud Kit, 8mm. Fits Toyota 2TC, 3TC, 2TG, 3TG and others; includes 20 studs and nuts, M8 x 1.25 x 35mm.
- 38366** Oil Pan Stud Kit, 6mm. Fits Honda, Acura, Mazda Rotary, Dodge Neon, Toyota MR2 and others; includes 22 studs and nuts, M6 x 1.00 x 35mm.

OIL PAN STUD KITS

- These stud kits make pan installation easy and prolong gasket life
- Lock nuts feature attached washers with serrated faces to provide a positive grip on the pan rail
- Studs are made of heat treated Grade 8 steel with black oxide finish; nuts are zinc-plated
- Highly recommended for use with our fabricated pans



No. 38350

PART # DESCRIPTION

- 38350** Oil Pan Stud Kit, Small Block and 90° V6 Chevy and Oldsmobile V8, Set of 18
- 38360** Oil Pan Stud Kit, Big Block Chevy and Pontiac V8, Set of 22

OIL PAN STUD KITS, GM LS

- For installing a Moroso or other brand billet aluminum or steel fabricated oil pans on a GM LS engine
- Designed to make pan installation easy and prolong gasket life
- Lock nuts feature attached washers with serrated faces to provide a positive grip on the pan rail
- Studs are made from heat-treated Grade 8 steel with a durable finish, nuts are zinc plated
- Part **No. 38541** for fabricated steel oil pans, contains:
Quantity 13, 8mm x 1.25 x 40mm studs with matching nuts
Quantity 2, 6mm x 1 x 40mm studs with matching nuts
- Part **No. 38542** for fabricated aluminum billet rail oil pans, contains:
Quantity 13, 8mm x 1.25 x 45mm studs with matching nuts
Quantity 2, 6mm x 1 x 50mm studs with matching nuts



No. 38541



No. 38542

PART # DESCRIPTION

- 38541** Oil Pan Stud Kit, for Steel Fabricated GM LS oil pans
- 38542** Oil Pan Stud Kit, for Aluminum, Fabricated Billet Rail GM LS oil pans

VALVE COVER HARDWARE KIT FOR MOROSO GM LT BILLET VALVE COVERS

Fits: GM LT with Moroso GM LT Billet Valve Covers

- Kit includes (20) Clear Zinced Socket Head Cap Screws and (20) Washers

PART # DESCRIPTION

- 68832** Valve Cover Hardware Kit, Moroso GM LT Billet Valve Covers

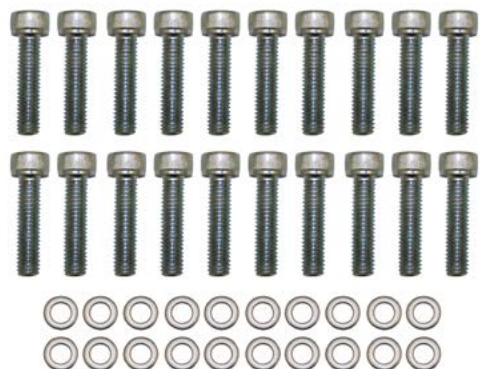

No. 68832



FASTENERS

OIL PAN FASTENER KIT

Fits: Big Block Chevy Race Pans

- For use with Moroso Oil Pan Numbers **20370, 20371, 20385, 21600, 21601, 20372, 20373, 20374, 20375, 20376, 20378, 20380, 20485, 21581, 21591, 21592, 21597, 21602, 21604** and **21605**
- Studs and 12 point nuts to fasten all BBC/DRC/Merlin/CN blocks wet sump and dry sump oil pans
- Studs are made of heat treated Grade 8 steel with black oxide finish
- Makes installing the nuts through the access bungs easy with bullet nose studs and makes initial line up easier with studs on all bolt holes



No. 38361

PART #	DESCRIPTION
38361	Oil Pan Fastener Kit, BBC Race Pans

BULLET NOSE OIL PAN STUD KITS

- "Bullet Nose" Studs are rounded on one end for easier starting of oil pan mounting nuts
- Kits include heat treated Grade 8 steel studs with a black oxide finish, and special-design nuts



No. 38385

PART #	DESCRIPTION
38385	Bullet Nose Oil Pan Stud Kit, specially designed for Moroso Aluminum Oil Pans No. 21234 and includes six studs with 12-point nuts for the pan rail and four longer studs with Allen Head nuts for the investment-cast end caps found on Moroso's innovative line of oil pans
38387	Bullet Nose Oil Pan Stud Kit, specially designed for Moroso Aluminum Oil Pans Nos. 21581 and 21592 , includes 6 studs and serrated nuts for pan rails, and 2 each, socket head cap screws for the timing cover and rear pan rail area
38390	Bullet Nose Oil Pan Stud Kit, for Small and Big Block Ford Engines, special nuts included to fit flat against pan rail on tight corners, use with Moroso Oil Pan Nos. 20502, 20507, 20508, 20510 and 20521 , 23 to a kit

NUTS, OIL PANS

- Popular size nuts, **No. 97036** is used in Part **No. 38361**, Oil Pan Fastener Kit
- **No. 97037** is used in Part **Nos. 38360 & 38390**

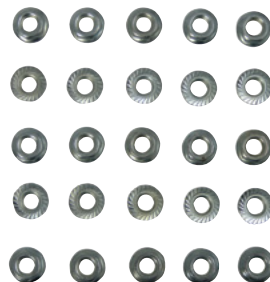

No. 97036

PART #	DESCRIPTION
97036	Nuts, 5/16"-24", 25 Pack , Washer Face Serrated
97037	Nuts, 1/4"-28", 20 Pack , Washer Face Serrated

SELF-LOCKING OIL PAN BOLTS

- Self-Locking Oil Pan Bolts manufactured from Grade 8 steel
- Integral serrated washer face provides self-locking effect
- Hex head flange bolts are zinc plated



No. 38555

PART #	DESCRIPTION
38550	Self-Locking Oil Pan Bolts, Small Block and 90 V6 Chevy and Oldsmobile V8's, For One-Piece Gaskets, Fourteen 1/4"-20 x 3/4" and Four 5/16"-18 x 3/4" bolts
38555	Self-Locking Oil Pan Bolts, Small Block and 90 V6 Chevy and Oldsmobile V8's, For Multi-piece Gaskets, Fourteen 1/4"-20 x 1/2" and Four 5/16"-18 x 3/4" bolts
38560	Self-Locking Oil Pan Bolts, Big Block Chevy and Pontiac V8's, For One piece and Multi-piece Gaskets, Twenty 5/16"-18 x 1/2" bolts and Two 1/4"-20 x 3/4" bolts

OIL PAN FLANGE HEAD BOLTS

Fits: Small Block Chevy Oil Pans

- For use with Moroso Oil Pan Nos. 20173, 20175, 20183, 20184, 20186, 21325, 21326, 21327, 21811, 21812, 21813, 21814 and 21815
- Fasteners are short enough to fit in kick-out style oil pans
- Economical alternative to stud kits
- 12 point flange head, black, grade 8
- 18 to a set; 4 of 5/16-18 x 3/4", 14 of 1/4-20 x 3/4"

PART # DESCRIPTION

38551 Oil Pan Flange Head Bolts, SBC



No. 38551

INTAKE MANIFOLD BOLT KITS

- 3/8" diameter, 12-point headed intake manifold bolts simplify the job of installing and removing many of today's aftermarket intake manifolds designed with extremely tight fastener clearances
- Kits are manufactured of Grade 8 steel and come complete with close-tolerance washers

PART # DESCRIPTION

38400 Intake Manifold Bolt Kit, SBC and 90° Chevy V6, and Small Block Chrysler with single plane manifold, set of 12; 3/8" -16 x 1-1/8"

38410 Intake Manifold Bolt Kit, BBC, set of 16; 3/8" -16 x 1-1/4"

38420 Intake Manifold Bolt Kit, BBC, set of 12; 3/8" -16 x 1-1/4" and set of 4 of 3/8" -16 x 1-3/4"



No. 38400

TIMING COVER BOLTS

- 1/4" -20 hex head timing cover bolts manufactured of zinc-plated Grade 8 steel
- Integral serrated washer face insures positive locking against the timing cover
- Ten per package

PART # DESCRIPTION

38590 Timing Cover Bolts, Small Block, Big Block and 90° V6 Chevy



No. 38590

HEADER BOLTS

- Grade 8 header bolts are heat treated with black oxide finish
- Uses 7/16" hex head for quick installation and removal of headers

PART # DESCRIPTION

38710 Header Bolts, 3/8" -16 x 3/4" hex head bolts for SBC, BBC and 90° V6 Chevy engines, Small Block Ford and other engines where a 3/8" -16 bolt is used, pack of 16



No. 38710

TORQUE CONVERTER BOLTS

- Specially designed fasteners provide maximum holding strength and eliminate the possibility of shearing

PART # DESCRIPTION

38764 Torque Converter Bolts, Grade 8 bolts with nuts for Turbo 350, 400 flex plates without tapped holes, 3/8" -24 x 5/8". Three per pack

38765 Torque Converter Bolts, Grade 5 bolts for Turbo 350, 400 flex plates with tapped holes, 3/8" -16 x 5/8". Three per pack



No. 38764



FASTENERS

ULTIMATE-DUTY BALANCER BOLT KITS

- Extra-strength chrome moly steel bolt with large, built-in washer flange exerts 200,000 psi of clamping force to secure balancer firmly in place under severe conditions
- Unlike other brands, the bolt is machined and thread rolled after heat treating for superior strength, accuracy and longevity
- Extra-tall 12-point head accepts deep 5/8" socket to provide positive grip for removal/installation without stripping
- Large, 2" diameter washer is .275" thick and machined perfectly flat to spread the fastening load over a larger surface area
- Black oxide finish

PART #	DESCRIPTION
38772	Ultimate-Duty Balancer Bolt Kit, SBC, 7/16" -20 threads
38775	Ultimate-Duty Balancer Bolt Kit, BBC, 1/2" -20 threads



No. 38775

BALANCER BOLT

- The thicker 3/4" hex head on this 7/16"-20 x 2-1/4" balancer bolt provides a larger contact surface for increased positive socket engagement
- Especially important when crankshaft is being rotated by hand with the use of a socket and breaker bar or ratchet handle
- Manufactured of Grade 8 steel

PART #	DESCRIPTION
38770	Balancer Bolt, Small Block Chevy



No. 38770

FLYWHEEL/FLEX PLATE BOLTS

- Bolts manufactured using Grade 8 steel and heat treated for maximum strength
- Black oxide finish provides corrosion resistance

PART #	DESCRIPTION
38755	Flywheel Bolts, 12-point, manufactured of special high strength steel alloy for use in Chevrolet V8 and 90° V6 engines on flywheels with a counter-sunk crankshaft flange, Black oxide finish, Each package has six 7/16"-20 x 1" bolts
38760	Flex Plate Bolts, SBC, BBC and 90° Chevy V6 engines, 7/16"-20 x 3/4", Each package has 6 bolts and washers



No. 38755

FIREWALL GROMMETS

- Black, thermoplastic grommets will fit five different size holes for wires and cables passing through the firewall
- They not only insulate, but provide mechanical protection against chafing
- Outside dimensions range from 1/2" to 1", the inside from .41" to .89"
- Package of 25; five of each size

PART #	DESCRIPTION
39050	Firewall Grommets



No. 39050

LIGHTWEIGHT ALUMINUM HOOD PIN SET

- Set consists of two 3/8" diameter pins with all necessary mounting hardware
- Pins are manufactured from high strength aluminum alloy
- We recommend 6 to 8 per hood

PART #	DESCRIPTION
39000	Hood Pin Set

PART #	AVAILABLE OPTION
39025	Hood Pin Bracket, 3/8" Diameter Pins

WARNING Prop. 65
 This product contains a chemical known to the state of California to cause cancer, birth defects, or reproductive harm-



No. 39000

HOOD PIN SET, ALUMINUM, BLACK

1/2" Diameter Pins

- Set consists of two 1/2" diameter pins with all necessary mounting hardware
- The included pins and scuff plates have a black finish, the clips have a chrome plated finish
- Pins are manufactured from high strength aluminum alloy

PART# DESCRIPTION
39005 Hood Pin Set, Aluminum, 1/2", Black

 **WARNING Prop. 65**
 This product contains a chemical known to the state of California to cause cancer, birth defects, or reproductive harm-



No. 39005

QUICK RELEASE HOOD PIN SET

- A quick, self-contained hood clamping device
- No pins or lanyards to lose or cause hood damage
- We recommend 6 to 8 to a hood
- 3/8" diameter aluminum pins; easy bolt-on installation may be used or many other applications where quick access to a trouble spot is absolutely essential
- Two per set

PART # DESCRIPTION
39010 Quick Release Hood Pin Set

PART # AVAILABLE OPTION
39025 Hood Pin Bracket, 3/8" Diameter Pins

 **WARNING Prop. 65**
 This product contains a chemical known to the state of California to cause cancer, birth defects, or reproductive harm-



No. 39010

OVAL TRACK HOOD PIN SETS

- Compact and lightweight Hood Pin Sets consist of 3/8" dia. chrome plated steel pins with clips, 1-1/2" dia. stainless steel scuff plates and vinyl-coated stainless steel lanyards
- Available in 3" and 4" pin lengths
- Ideal for any full-bodied race cars
- Two per set

PART # DESCRIPTION
39015 Oval Track Hood Pin Set, 3"
39016 Oval Track Hood Pin Set, 4"

 **WARNING Prop. 65**
 This product contains a chemical known to the state of California to cause cancer, birth defects, or reproductive harm-



No. 39015

PART # REPLACEMENT PARTS

39022 Hood Pin Clips, 1/8" wire dia., chrome plated, two per set
39023 Hood Pin Scuff Plates, 2-1/2" dia., chrome plated, two per set

PART # AVAILABLE OPTION
39025 Hood Pin Bracket, 3/8" Diameter Pins

CHROME HOOD PIN SET

- Hood Pin Sets consist of two chrome plated steel hood pins (5" long with 3" of thread), two 1/8" hitch pins, four cadmium-plated mounting nuts, two scuff plates, two 12" vinyl-coated stainless steel lanyards and two rivet eyelets

PART # DESCRIPTION
39020 Heavy-Duty Hood Pin Set, 1/2" dia. pins
39021 Standard-Duty Hood Pin Set, 7/16" dia. hood pins

PART # REPLACEMENT PARTS

39022 Hood Pin Clips, 1/8" wire dia., chrome plated, two per set
39023 Hood Pin Scuff Plates, 2-1/2" dia., chrome plated, two per set



No. 39020

 **WARNING Prop. 65**
 This product contains a chemical known to the state of California to cause cancer, birth defects, or reproductive harm-

HOOD PIN BRACKET, 3/8 INCH DIAMETER PINS

- Makes mounting and aligning a 3/8" Diameter hood pin easier than previous methods
- Made out of 1/8" thick Stainless Steel
- Can be bolted and/or welded into place
- Finish of the bracket can be painted, polished or left as is

PART # DESCRIPTION
39025 Hood Pin Bracket, 3/8" Diameter Pins

 **WARNING Prop. 65**
 This product contains a chemical known to the state of California to cause cancer, birth defects, or reproductive harm-



No. 39025



FASTENERS

QUICK FASTENERS, 5/16", 7/16"

- Fasteners Provide Quick Fastening Of Body Panels, Door, Tilt Front Ends, Fiberglass To Metal, Metal To Metal, Etc.
- Ten Per Package
- Use with Spring Nos. 71400, 71410, 71420, 71425 or 71430

Style of Head	Size	Body	Material	Finish	Part #
Flush Head, Slotted	5/16"	.400" Short Body	Steel	Silver	71291
Flush Head, Slotted	5/16"	.400" Short Body	Aluminum	Aluminum	71295
Flush Head, Slotted	5/16"	.450" Short Body	Steel	Silver	71293
Flush Head, Slotted	5/16"	.450" Short Body	Aluminum	Aluminum	71296
Flush Head, Slotted	5/16"	.500" Medium Body	Steel	Silver	71294
Flush Head, Slotted	5/16"	.500" Medium Body	Aluminum	Aluminum	71297
Flush Head, Slotted	5/16"	.550" Long Body	Steel	Silver	71299
Flush Head, Slotted	5/16"	.550" Long Body	Aluminum	Aluminum	71298
Flush Head, Slotted	7/16"	.400" Short Body	Steel	Silver	71280
Flush Head, Slotted	7/16"	.400" Short Body	Aluminum	Aluminum	71302
Flush Head, Slotted	7/16"	.450" Short Body	Steel	Silver	71290
Flush Head, Slotted	7/16"	.450" Short Body	Aluminum	Aluminum	71312
Flush Head, Slotted	7/16"	.500" Medium Body	Steel	Silver	71300
Flush Head, Slotted	7/16"	.500" Medium Body	Aluminum	Aluminum	71301
Flush Head, Slotted	7/16"	.550" Long Body	Steel	Silver	71310
Flush Head, Slotted	7/16"	.550" Long Body	Aluminum	Aluminum	71311
Oval Head, Slotted	5/16"	.300" Short Body, Undercut	Steel	Silver	71341*
Oval Head, Slotted	5/16"	.400" Short Body, Undercut	Steel	Silver	71340*
Oval Head, Slotted	5/16"	.400" Short Body	Aluminum	Aluminum	71329
Oval Head, Slotted	5/16"	.450" Short Body	Steel	Silver	71325
Oval Head, Slotted	5/16"	.450" Short Body	Aluminum	Aluminum	71330
Oval Head, Slotted	5/16"	.450" Short Body	Aluminum	Black	71327
Oval Head, Slotted	5/16"	.500" Medium Body	Steel	Silver	71345
Oval Head, Slotted	5/16"	.500" Medium Body	Steel	Black	71346
Oval Head, Slotted	5/16"	.500" Medium Body	Aluminum	Aluminum	71331
Oval Head, Slotted	5/16"	.500" Medium Body	Aluminum	Black	71333
Oval Head, Slotted	5/16"	.550" Long Body	Aluminum	Aluminum	71332
Oval Head, Slotted	7/16"	.400" Short Body	Steel	Silver	71349
Oval Head, Slotted	7/16"	.400" Short Body	Aluminum	Aluminum	71353
Oval Head, Slotted	7/16"	.450" Short Body	Steel	Silver	71359
Oval Head, Slotted	7/16"	.450" Short Body	Steel	Black	71358
Oval Head, Slotted	7/16"	.450" Short Body	Aluminum	Aluminum	71363
Oval Head, Slotted	7/16"	.450" Short Body	Aluminum	Black	71365
Oval Head, Slotted	7/16"	.500" Medium Body	Steel	Silver	71350
Oval Head, Slotted	7/16"	.500" Medium Body	Steel	Black	71354
Oval Head, Slotted	7/16"	.500" Medium Body	Aluminum	Aluminum	71351
Oval Head, Slotted	7/16"	.500" Medium Body	Aluminum	Black	71355
Oval Head, Slotted	7/16"	.550" Long Body	Steel	Silver	71360
Oval Head, Slotted	7/16"	.550" Long Body	Aluminum	Aluminum	71361
Oval Head, Slotted	7/16"	.550" Long Body	Aluminum	Black	71364
Oval Head, 3/16" Hex Drive	7/16"	.400" Short Body	Steel	Silver	71274
Oval Head, 3/16" Hex Drive	7/16"	.450" Short Body	Steel	Silver	71275
Oval Head, 3/16" Hex Drive	7/16"	.500" Medium Body	Steel	Silver	71352
Oval Head, 3/16" Hex Drive	7/16"	.500" Medium Body	Aluminum	Black	71356
Oval Head, 3/16" Hex Drive	7/16"	.550" Long Body	Steel	Silver	71362
Butterfly Head	5/16"	.400" Short Body	Steel	Silver	71276
Butterfly Head	5/16"	.450" Short Body	Steel	Silver	71277
Butterfly Head	5/16"	.500" Medium Body	Steel	Silver	71278
Butterfly Head	5/16"	.550" Long Body	Steel	Silver	71279
Butterfly Head	7/16"	.400" Short Body	Steel	Silver	71260
Butterfly Head	7/16"	.450" Short Body	Steel	Silver	71270
Butterfly Head	7/16"	.500" Medium Body	Steel	Silver	71271
Butterfly Head	7/16"	.550" Long Body	Steel	Silver	71272



No. 71291



No. 71311



No. 71351



No. 71354



No. 71355



No. 71356



No. 71362



No. 71260

* Use with Fastener Spring Nos. 71425 and 71430

FASTENERS

SELF-EJECTING QUICK FASTENERS, 5/16"

- These Spring Loaded Buttons Guarantee A Quick Release
- The spring holds the button captive so that it can't be dropped underneath the car or into some hard-to-get-at area of the chassis
- A necessity for quick pit work in racing
- Use Spring **No. 71430** as a replacement
- Ten per package

Style of Head	Size	Body & Grip Range	Material	Finish	Part #
Flush Head, Slotted	5/16"	.400" Short Body, .098" to .133"	Steel	Silver	71440
Flush Head, Slotted	5/16"	.400" Short Body, .098" to .133"	Aluminum	Black	71441
Flush Head, Slotted	5/16"	.450" Short Body, .148" to .183"	Steel	Silver	71450
Flush Head, Slotted	5/16"	.450" Short Body, .148" to .183"	Aluminum	Black	71451
Flush Head, Slotted	5/16"	.500" Medium Body, .198" to .233"	Steel	Silver	71500
Flush Head, Slotted	5/16"	.500" Medium Body, .198" to .233"	Aluminum	Aluminum	71501
Flush Head, Slotted	5/16"	.500" Medium Body, .198" to .233"	Aluminum	Black	71502
Flush Head, Slotted	5/16"	.550" Long Body, .250" to .325"	Steel	Silver	71505
Flush Head, Slotted	5/16"	.550" Long Body, .250" to .325"	Aluminum	Aluminum	71506
Flush Head, Slotted	5/16"	.550" Long Body, .250" to .325"	Aluminum	Black	71507
Flush Head, Slotted	5/16"	.650" Long Body, .348" to .383"	Steel	Silver	71530
Flush Head, Slotted	5/16"	.650" Long Body, .348" to .383"	Aluminum	Aluminum	71531
Flush Head, Slotted	5/16"	.650" Long Body, .348" to .383"	Aluminum	Black	71532
Butterfly Head	5/16"	.400" Short Body, .098" to .133"	Steel	Silver	71460
Butterfly Head	5/16"	.450" Short Body, .148" to .183"	Steel	Silver	71470
Butterfly Head	5/16"	.500" Medium Body, .198" to .233"	Steel	Silver	71510
Butterfly Head	5/16"	.650" long body, .348" to .383"	Steel	Silver	71540



No. 71441



No. 71501



No. 71510

LARGE HEAD SELF-EJECTING QUICK FASTENERS, 7/16"

- Heavy duty to allow repeated use with a fastener tool allen wrench or a ratchet without stripping
- A Larger size distributes the load over a larger area to avoid pull-through
- The spring holds the button captive so that it can't be dropped underneath the car or into some hard-to-get-at area of the chassis
- A necessity for quick pit work in racing
- Use Spring **Nos. 71400, 71410, 71420, 71425, or 71430**
- Ten per package

Style of Head	Size	Body & Grip Range	Material	Finish	Part #
Large Flush Head, Slotted	7/16"	.500" Medium Body, .198" to .233"	Steel	Silver	71370
Large Flush Head, Slotted	7/16"	.500" Medium Body, .198" to .233"	Steel	Gold	71371
Large Flush Head, Slotted	7/16"	.500" Medium Body, .198" to .233"	Steel	Black	71372
Large Flush Head, Slotted	7/16"	.500" Medium Body, .198" to .233"	Aluminum	Aluminum	71373
Large Flush Head, Slotted	7/16"	.550" Long Body, .250" to .325"	Steel	Silver	71375
Large Flush Head, Slotted	7/16"	.550" Long Body, .250" to .325"	Steel	Gold	71376
Large Flush Head, Slotted	7/16"	.550" Long Body, .250" to .325"	Steel	Black	71377
Large Flush Head, Slotted	7/16"	.550" Long Body, .250" to .325"	Aluminum	Aluminum	71378
Large Flush Head, Slotted	7/16"	.550" Long Body, .250" to .325"	Aluminum	Black	71379
Large Flush Head, 3/16" Hex Drive	7/16"	.500" Medium Body, .198" to .233"	Steel	Silver	71380
Large Flush Head, 3/16" Hex Drive	7/16"	.500" Medium Body, .198" to .233"	Steel	Gold	71381
Large Flush Head, 3/16" Hex Drive	7/16"	.550" Long Body, .250" to .325"	Steel	Silver	71382
Large Flush Head, 3/16" Hex Drive	7/16"	.550" Long Body, .250" to .325"	Steel	Gold	71383



No. 71370



No. 71322



No. 71371



No. 71410

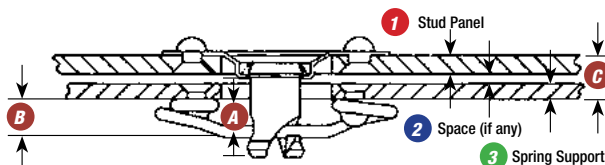

REPLACEMENT FASTENER SPRING

- Designed for use with Moroso's flush, oval head and butterfly fasteners
- Ten per package
- Determine **C TOTAL THICKNESS** of panels being joined (including space in between if any)
- Select the appropriate **A BODY LENGTH** and **B SPRING HEIGHT** combination to provide the desired thickness range

- A BODY LENGTH**
- B SPRING HEIGHT**
- C TOTAL THICKNESS**
= 1 + 2 + 3

FASTENER SELECTION CHART

PART NUMBER	WIRE DIA.	SPRING HEIGHT	BODY LENGTH .400" BODY	.450" BODY	.500" BODY	.550" BODY	.650" BODY
1" Springs							
C TOTAL MATERIAL THICKNESS RANGE							
71425	.080"	(.250")	.165 - .200"	.215 - .250"	.265 - .300"	.315 - .350"	.365 - .400"
71430	.080"	(.325")	.098 - .133"	.148 - .183"	.198 - .233"	.248 - .283"	.348 - .383"
1-3/8" Springs							
71420	.090"	(.325")	.105 - .148"	.155 - .198"	.205 - .248"	.255 - .298"	.355 - .398"
71410	.090"	(.375")	.055 - .098"	.105 - .148"	.155 - .198"	.205 - .248"	.305 - .348"
71400	.090"	(.425")	.005 - .048"	.055 - .098"	.105 - .148"	.155 - .198"	.255 - .298"

FASTENERS

QUICK FASTENER REINFORCING PLATES

- Reinforcement plates provide a secure metal backing for long lasting service
- Solves the problem of quick release fastener attachment rivets pulling out of fiberglass hood and body panels after repeated usage
- Also prevents fastener spring brackets from cutting into body panels
- Use with Quick Fastener Nos. 71280, 71290, 71300, 71310, 71350, or 71360



No. 71490

PART # DESCRIPTION

71490 Quick Fastener Reinforcing Plates, .022" Thick, Ten per package

LARGE DIAMETER QUICK FASTENER REINFORCING PLATES

- Large 1-3/4" diameter aluminum reinforcement plates provide a sure foundation for quick fasteners
- Use them on thin gauge fiberglass and metal
- Ten per package



No. 71495

PART # DESCRIPTION

71495 Large Diameter Quick Fastener Reinforcing Plates, .032" thick

QUICK FASTENER MOUNTING BRACKETS, 5/16"

For Self-Eject Fasteners

- Brackets can be welded or fastened to any member of the car to provide a convenient pop rivet mount for self-ejecting fastener springs
- Use with Nos. 71340, 71345, 71430, 71425, 71440, 71450, 71460, 71470, 71500, 71510, 71530 or 71540



No. 71550

PART # DESCRIPTION

71550 Quick Fastener Mounting Bracket, Steel, Ten per pack, Use with Nos. 71430 or 71425 springs, .062" thick

71551 Quick Fastener Mounting Bracket, Steel, Ten per pack, .059" thick, accepts 1" or 1.375" springs, Flat

71552 Quick Fastener Mounting Bracket, same as No. 71551 except bent at 90° angle for mounting to firewalls, frame tubes, etc. Ten per pack, .059" thick, accepts 1" or 1.375" springs

71553 Quick Fastener Mounting Bracket, Steel, Lightweight 45°, accepts 1" springs, Ten per pack, .069" thick

71555 Quick Fastener Mounting Bracket, Use these steel brackets anywhere a strong mounting tab is needed for a neat installation, e.g., hood mounts, panel mounts, accessory mounts, etc. Two per pack, .100" thick

71556 Quick Fastener Mounting Bracket, Same as No. 71555 in Aluminum, Two per pack, .100" thick



No. 71552



No. 71553



No. 71555

QUICK FASTENER MOUNTING BRACKETS, 7/16"

For Standard & Self-Eject Fasteners

- Steel bracket can be welded or fastened to any member of the car to provide a convenient pop rivet mount for fastener springs
- Use with Nos. 71301, 71311, 71351, 71361, 71352, 71362, 71371, 71376, 71380, 71381, 71382, or 71383
- Ten per package



No. 71554

PART # DESCRIPTION

71554 Quick Fastener Mounting Bracket, .069" thick, accepts 1.375" springs, dimpled, standard fasteners

71557 Quick Fastener Mounting Bracket, .060" thick, accepts 1.375" springs, dimpled, Self E-ject fasteners

QUICK FASTENER MOUNTING BRACKET, 7/16"

For Standard Fasteners

- Aluminum bracket can be welded or fastened to any member of the car to provide a convenient pop rivet mount for standard fastener springs
- Use with Moroso Nos. 71370, 71371, 71372, 71375, 71376, 71377, 71380, 71381, 71382 or 71383
- Ten per package



No. 71559

PART # DESCRIPTION

71559 Quick Fastener Mounting Bracket, Aluminum, .120" thick, for 7/16" Fasteners & 1-3/8" Springs

QUICK FASTENER WASHERS

- One of these tough Teflon washers under each quick fastener will protect your car's finish from otherwise hard-to-prevent scratches
- A must for the conscientious car owner
- Package of 25
- Fits all quick fasteners

PART #	DESCRIPTION
71610	Quick Fastener Washers

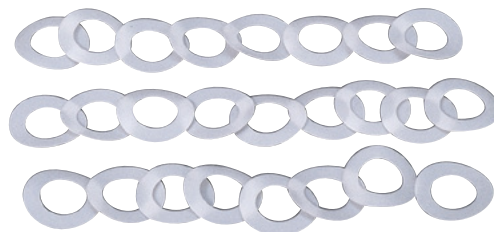

No. 71610

QUICK FASTENER WRENCH

- This tool fits slot-head 1/4-turn fasteners far better than a screwdriver, reducing the possibility of damaged fasteners and body panels
- Manufactured of zinc plated spring steel with three different sized radii to match the slots in various 1/4-turn fasteners
- Includes non-slip, plastic hand grip
- One tool per pack

PART #	DESCRIPTION
71600	Quick Fastener Wrench

 **WARNING Prop. 65**
This product contains a chemical known to the state of California to cause cancer, birth defects, or reproductive harm-



No. 71600

QUICK FASTENER WRENCHES

With Easy Grip Handles

- Allows for faster removal of 1/4-turn fasteners
- Features include a high strength steel shank plated with black zinc for durability
- The slot head blade on No. 71606 is contoured to fit inside the 1/4-turn fastener without stripping the slot
- One per package

PART #	DESCRIPTION
71606	Quick Fastener Wrench, 3/8" Slot Head
71607	Quick Fastener Wrench, 3/16" Hex Drive



No. 71606

No. 71607

QUICK FASTENER SINKING TOOL

- Ideal for sinking flush-mount quick fasteners
- The two piece steel tool dimples a single metal panel using one end and a double panel using the other
- Zinc-plated
- One tool per package

PART #	DESCRIPTION
71605	Quick Fastener Sinking Tool



No. 71605

QUICK FASTENER TRANSFER STUD PUNCH KITS

Place the Transfer Stud Punch in a weld plate or body panel. Then position your panel over top of it and lightly tap the panel with a hammer and you'll be left with a mark in your panel where you drill your hole.

- 5 per pack

PART #	DESCRIPTION
71601	Transfer Stud Punch Kit for 5/16" Buttons, 5 per kit
71602	Transfer Stud Punch Kit for 7/16" Buttons, 5 per kit



No. 71601



No. 71602

FASTENERS

CAM STOP BUTTONS

- Professional engine builders are familiar with camshaft "walk" — when excessive end play produces erratic spark timing and the timing chain/gear "eats" the timing cover
- Moroso solves the problem with a highly wear resistant button mounted in an aluminum holder and bolted to the cam timing gear by way of a retaining plate
- The button assembly does not allow the cam to "walk" forward, stabilizing ignition timing and preventing costly engine repair

PART # DESCRIPTION

- 60460** Cam Stop Button and Retaining Plate, SBC and 90° V6 Chevy with early ribbed style timing cover, Cam bolts included
- 60461** Cam Stop Button and Retaining Plate, SBC and 90° V6 Chevy with late style flat timing cover, Cam bolts included
- 60462** Cam Stop Button and Retaining Plate, BBC, Cam bolts included



No. 60460

CAMSHAFT BOLT

- Don't let a broken camshaft bolt ruin your motor!
- Hex head 5/16"-18 camshaft bolts are manufactured from tough Grade 8 steel with a black oxide finish
- Three per pack; includes retaining plate
- Should be used with Cam Stop Button Nos. **60460**, **60461** and **60462** shown above

PART # DESCRIPTION

- 60464** Chevy Camshaft Bolts with Retainer



No. 60464

QUICK RELEASE PINS

Heavy-Duty, Aircraft Quality

- These "T" handle quick release pins offer the racer the ultimate in quick release fastening
- Supplied in all popular sizes
- Single pack



No. 90366

APPLICATION CHART

DIMENSIONS	LOAD SPECIFICATIONS	PART # FOR SINGLE PACK
1/4" DIA. X 1" LONG	DOUBLE SHEAR LOAD OF 8,200 LBS WHEN PROPERLY MOUNTED	90366
1/4" DIA. X 1-1/2" LONG	DOUBLE SHEAR LOAD OF 8,200 LBS WHEN PROPERLY MOUNTED	90367
1/4" DIA. X 2" LONG	DOUBLE SHEAR LOAD OF 8,200 LBS WHEN PROPERLY MOUNTED	90368
5/16" DIA. X 1" LONG	DOUBLE SHEAR LOAD OF 12,800 LBS WHEN PROPERLY MOUNTED	90369
5/16" DIA. X 1-1/2" LONG	DOUBLE SHEAR LOAD OF 12,800 LBS WHEN PROPERLY MOUNTED	90370
5/16" DIA. X 2" LONG	DOUBLE SHEAR LOAD OF 12,800 LBS WHEN PROPERLY MOUNTED	90371
5/16" DIA. X 3" LONG	DOUBLE SHEAR LOAD OF 12,800 LBS WHEN PROPERLY MOUNTED	90372
3/8" DIA. X 1" LONG	DOUBLE SHEAR LOAD OF 18,400 LBS WHEN PROPERLY MOUNTED	90373
3/8" DIA. X 1-1/2" LONG	DOUBLE SHEAR LOAD OF 18,400 LBS WHEN PROPERLY MOUNTED	90374
3/8" DIA. X 2" LONG	DOUBLE SHEAR LOAD OF 18,400 LBS WHEN PROPERLY MOUNTED	90375
3/8" DIA. X 2 1/2" LONG	DOUBLE SHEAR LOAD OF 18,400 LBS WHEN PROPERLY MOUNTED	90378
3/8" DIA. X 3" LONG	DOUBLE SHEAR LOAD OF 18,400 LBS WHEN PROPERLY MOUNTED	90376
1/2" DIA. X 2-1/2" LONG	DOUBLE SHEAR LOAD OF 32,800 LBS WHEN PROPERLY MOUNTED	90377



FASTENERS

CLEVIS ENDS

Moroso Clevis End are designed to help solve all kinds of fastening and suspension problems where rod ends would not be practical.

- Allows adjustment both radially & laterally while placing the holding bolt under shear load
- Made from 4130 chrome moly steel with iridite finish
- Two per package

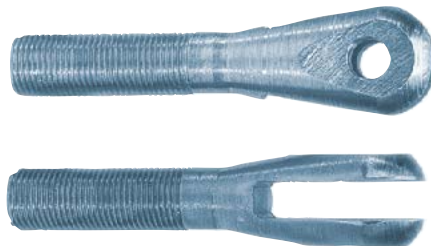

No. 90770

PART #	DESCRIPTION
90770	Clevis Ends, 1/2" -20 thread on shank, 5/16" bolt holes, 1/4" slot

UNIVERSAL ANTI-ROLL KITS

- Brake line locks are used in Drag Racing to lock the front wheels and hold the car in the water box for the burnout, or to prevent creeping in the lights
- Anti-roll design has better holding power than any other unit currently available
- Enhanced version (No. 44052) has a check valve which allows you to pump up the brakes while actuated
- Will work in applications with ABS
- Kit contains a heavy duty push button switch, switch bracket, coiled wire, rebuildable line-lock valve, fuse holder, and indicator light
- Extruded aluminum shifter handle mounting bracket is far superior to any other in use today
- Heavy-duty construction and quality components provide reliable operation after repeated use
- Universal Momentary Switch No. 74122 available separately



No. 44052

PART #	DESCRIPTION
44050	Universal Anti-Roll Kit
44052	Universal Anti-Roll Kit, Enhanced

WARNING Prop. 65
 This product contains a chemical known to the state of California to cause cancer, birth defects, or reproductive harm.

NOTE: Continuous use of solenoid for more than 30 seconds will damage the coil.

ANTI-ROLL VALVE, ENHANCED VERSION

Now Moroso offers it's Anti-Roll/Brake Line Lock Enhanced Version Valve by itself. Ideal for the installer who wants to wire/plumb their Anti-Roll switch a certain way.

- Brake line locks are used in Drag Racing to lock the front wheels and hold the car in the water box for the burnout or to prevent creeping into the starting lights
- Anti-Roll design has better holding power than any other unit currently available
- Enhanced version valve has an internal check valve which allows the driver to pump up the brakes when actuated
- Will work in applications with ABS
- Heavy-duty construction and quality components provide reliable operation after repeated use

PART #	DESCRIPTION
44056	Anti-Roll Valve, Enhanced



No. 44056





No. 46150 No. 46160 No. 46180 No. 46190 No. 46220 No. 46240 No. 46245 No. 46185

PRESS-IN WHEEL STUDS

Exceeds sanctioning bodies requirements on the use of extra long wheel studs with thick-hub racing wheels

- Manufactured from high grade SAE 8740 steel, 190,000 psi tensile strength (which exceeds Grade 8 specifications)
- Feature a "quick start dog end" for easier starting of lug nut installation
- 5 per package
- Made in the U.S.A.

PRESS-IN WHEEL STUD LUG NUTS

- Manufactured from high grade steel for resistance to fatigue and stress
- Meets NHRA 5.2 rule of hex being length of diameter of stud
- 60° Seat
- Black Oxide finish
- 5 per package
- Made in the U.S.A.



FITS OUR PRESS-IN WHEEL STUDS!

Left to right: Nos. 46345, 46320, 46340, 46330



PRESS-IN WHEEL STUD / LUG NUT APPLICATION CHART

APPLICATION DESCRIPTION	STANDARD HOLE SIZE	WHEEL STUD (5 PER PACK) PART #	WHEEL STUD (100 PER PACK) PART #	LUG NUT (5 PER PACK) PART #	COMB. WHEEL STUD/LUG NUT (FIVE PER PACK) PART #
7/16" -20 x 2-7/8", .480" diameter knurled stud, 3/4" hex nut <i>Fits: Most late model GM drum brake applications</i>	.472" to .479"	46150	46151	46320	46450
7/16" -20 x 2-7/8", .560" diameter knurled stud, 3/4" hex nut <i>Fits: Most late model GM disc brake and early drum applications</i>	.552" to .559"	46160		46320	46460
1/2" -20 x 3", .615" diameter knurled stud, 13/16" hex nut <i>Fits: Most late model Ford front and rear disc brake, 2005-Up Mustang rear and Chrysler front</i>	.606" to .613"	46180		46330	46480
1/2" -20 x 3", .594" diameter knurled stud, 13/16" hex nut <i>Fits: 1979-04 Mustang, 2005 and up Mustang front. Also has a flat on head for front hubs with ABS</i>	.590" (15mm)	46185		46330	46485
1/2" -20 x 3", .685" diameter knurled stud, 13/16" hex nut <i>Fits: Most Chrysler rears with 1/2" stud</i>	.676" to .683"	46190		46330	46490
1/2" -20 x 3", .563" diameter knurled stud, 13/16" hex nut <i>Fits: 1/2" Frankland hubs</i>	.554" to .561"	46220		46330	46420
5/8" - 18 x 3", .672" diameter knurled stud, 7/8" hex nut <i>Fits: Circle Track applications</i>	.663" to .670"	46240	46241	46340	46440
12 mm x 1.5 x 3.25", .509" diameter knurled stud, 19mm hex nut <i>Fits: Late model Corvette, 3rd, 4th Gen. Camaro & Firebird</i>	.482" to .492"	46245		46345	46445
14 mm x 1.5 x 3", .625" diameter knurled stud <i>Fits: Mustang S550</i>	.616" to .625"	46247	NEW!		

NOTE: All Stud lengths are measured from the base of the knurl to the end of the stud.





When installing a set of Moroso Wheel Studs, it is necessary to measure the knurl diameter of the stud and hole size in the rotor or axle. The hole size in the rotor or axle may have to be opened up with a drill bit or ream to achieve the proper .002"-.009" press fit.

SCREW-IN TYPE WHEEL STUDS

- Larger shank diameter provides additional metal to metal contact with the wheel for reduced stud flex and increases strength
- Eliminates the need for aftermarket shoulder type lug nuts and simplifies wheel installation
- Set comes complete with flat type lug nuts and stud spacers to fit various thicknesses of disc brake hats
- 5 per pack

PART # DESCRIPTION

46140 Wheel Studs, Overall Length 5/8" -18 x 4-13/32", Screw-in, 1 1/16" dia. center shank between two 5/8" -18 threaded ends; Drag Race only

PART # REPLACEMENT PARTS

97730 Flange Nut
97731 Wheel Stud Spacer, .567"
97732 Wheel Stud Spacer, 1.25"



No. 46140

SOCKET HEAD SCREW-IN TYPE WHEEL STUDS

- 5 per pack

PART # DESCRIPTION

46200 Wheel Studs, 1/2" -20 x 3" Screw-in, Socket Head Cap Screw, fits all aftermarket axles with 1/2" -20 threads



No. 46200



The Perfect Combination

PRESS IN WHEEL STUDS

- Exceeds sanctioning body's requirements on the use of extra long wheel studs with thick-hub racing wheels



PRESS IN WHEEL STUD LUG NUTS

- Meets NHRA 5.2 rule of hex being length of diameter of stud



COMPARE BEFORE YOU BUY... THERE IS A DIFFERENCE!

See Moroso Catalog or website for complete application listing and part number interchange.





DOUBLE END LUG NUTS

- Double end lug nuts designed for oval track racers
- Both ends are chamfered to a 45° angle, thus eliminating the possibility of putting the lug nut on backwards during quick pit stops
- Five per package
- Use with Pit Socket **No. 62010** for even faster pit stops (**No. 46310** only)

PART #	DESCRIPTION
46300	Double End Lug Nut, 1 ³ / ₁₆ " Hex x 1/2" -20
46310	Double End Lug Nut, 1" Hex x 5/8" -18



No. 46300

PIT SOCKET

- Thick-walled socket with six-point surface contact and large chamfer ensures fast, clean engagement on the lug nut
- Manufactured of alloy steel and carefully heat treated for maximum strength to prevent lug nut damage
- Accepts 1/2" drive, and fits 1" lug nuts

PART #	DESCRIPTION
62010	Pit Socket



No. 62010

INSIDE

WHEEL RIM SCREWS

- Manufactured from rugged Grade 8 steel to withstand the extreme loading placed on today's racing tires
- Self-tapping screws feature a built-in washer face for maximum holding strength
- Finished in gold iridite
- Use with 3/8" Socket

PART #	DESCRIPTION
90100	Wheel Rim Screws, 1/4" dia. x 3/4" long. Pack of 35
90110	Wheel Rim Screws, 1/4" dia. x 3/4" long. Pack of 500



No. 90100

NOTE: Drill wheels with 1³/₆₄" drill bit (not included). Do not drill oversize.



TRICK FRONT SPRINGS

- Designed for Drag Racing where maximum weight transfer is needed
- Trick Front Springs are tall, small wire diameter coil springs that hold a great amount of stored energy for instant weight transfer
- Replaces stock OEM springs with no modifications required
- Two per package

CAUTION!For drag use only,
NOT for street use!**No. 47140****TRICK SPRINGS****TRICK FRONT SPRINGS APPLICATION CHART**

MAKE/MODEL	Years	Front End Weight (LBS.)*	Coil Spring Rate (LBS./IN.)	Trick Front Spring Part #	MAKE/MODEL	Years	Front End Weight (LBS.)*	Coil Spring Rate (LBS./IN.)	Trick Front Spring Part #		
Buick Apollo	1975-79	1840-1910	212	47180	Chevrolet El Camino	1978-88	1600-1660	212	47130		
		1910-1970	230	47175			1660-1720	242	47205		
		2010-2100	270	47170			1720-1800	250	47135		
	1968-74	1550-1640	213	47150		1968-72	1610-1680	242	47160		
		1690-1750	240	47140			1680-1750	250	47190		
		1700-1750	241	47165			1750-1810	260	47200		
		1730-1780	250	47195			1964-67	1550-1640	213	47150	
Buick G.N.	1978-88	1600-1660	212	47130	1690-1750	240	47140				
		1660-1720	242	47205	1700-1750	241	47165				
		1720-1800	250	47135	1730-1780	250	47195				
Buick GS	1968-72	1610-1680	242	47160	Chevrolet Malibu	1978-88	1600-1660	212	47130		
		1680-1750	250	47190			1660-1720	242	47205		
		1750-1810	260	47200			1720-1800	250	47135		
	1964-67	1550-1640	213	47150		1968-72	1610-1680	242	47160		
		1690-1750	240	47140			1680-1750	250	47190		
		1700-1750	241	47165			1750-1810	260	47200		
Buick Regal	1978-88	1600-1660	212	47130	1964-67	1550-1640	213	47150			
		1660-1720	242	47205		1690-1750	240	47140			
		1720-1800	250	47135		1700-1750	241	47165			
		1730-1780	250	47195		1730-1780	250	47195			
Buick Skylark	1968-72	1610-1680	242	47160	Chevrolet Monte Carlo	1978-88	1600-1660	212	47130		
		1680-1750	250	47190			1660-1720	242	47205		
		1750-1810	260	47200			1720-1800	250	47135		
	1964-67	1550-1640	213	47150		1968-72	1610-1680	242	47160		
		1690-1750	240	47140			1680-1750	250	47190		
Buick Special	1968-72	1690-1750	240	47140	1750-1810	260	47200				
		1700-1750	241	47165	Chevrolet Nova	1975-79	1840-1910	212	47180		
		1730-1780	250	47195			1910-1970	230	47175		
		1750-1810	260	47200			2010-2100	270	47170		
		Chevrolet Bel Air	1955-57	1550-1640		213	47150	1968-74	1550-1640	213	47150
				1690-1750		240	47140		1690-1750	240	47140
				1700-1750		241	47165		1700-1750	241	47165
1730-1780	250			47195		1730-1780	250		47195		
Chevrolet Camaro	1982-92	1680-1750	220	47210	Chevrolet Nova/Chevy II	1962-67	1200-1250	217	47230		
		1750-1870	250	47215			Ford Fairlane	1966-70	1610-1680	242	47160
		1970-81	1840-1910	212					47180	1680-1750	250
		1910-1970	230	47175	1750-1810	260			47200		
		2010-2100	270	47170	Ford Mustang	1979-04			1750-1900	250	47220
	1967-69	1550-1640	213	47150			1964-73	1610-1680	242	47160	
		1690-1750	240	47140				1680-1750	250	47190	
Chevrolet Chevelle	1968-72	1700-1750	241	47165				1750-1810	260	47200	
		1730-1780	250	47195	Mercury Capri	1979-86		1750-1900	250	47220	
		1610-1680	242	47160			Mercury Comet	1966-69	1610-1680	242	47160
		1680-1750	250	47190					1680-1750	250	47190
		1750-1810	260	47200					1750-1810	260	47200
1964-67	1550-1640	213	47150	Oldsmobile Cutlass					1978-88	1600-1660	212
	1690-1750	240	47140		1660-1720	242				47205	
	1700-1750	241	47165		1720-1800	250	47135				
1730-1780	250	47195	1968-72		1610-1680	242	47160				
					1680-1750	250	47190				
				1750-1810	260	47200					
				1964-67	1550-1640	213	47150				
					1690-1750	240	47140				
					1700-1750	241	47165				
					1730-1780	250	47195				

CONTINUED ON NEXT PAGE

* NOTE: Front End Weight is as raced with driver

FRONT SPRINGS - CON'T

MAKE/MODEL	Years	Front End Weight (LBS.)*	Coil Spring Rate (LBS./IN.)	Trick Front Spring Part #
Oldsmobile 442	1978-88	1600-1660	212	47130
		1660-1720	242	47205
		1720-1800	250	47135
	1968-72	1610-1680	242	47160
		1680-1750	250	47190
		1750-1810	260	47200
	1964-67	1550-1640	213	47150
		1690-1750	240	47140
		1700-1750	241	47165
1730-1780		250	47195	
Oldsmobile Omega	1975-79	1840-1910	212	47180
		1910-1970	230	47175
		2010-2100	270	47170
	1973-74	1550-1640	213	47150
		1690-1750	240	47140
		1700-1750	241	47165
Pontiac Firebird	1982-92	1680-1750	220	47210
		1750-1870	250	47215
	1970-81	1840-1910	212	47180
		1910-1970	230	47175
		2010-2100	270	47170
	1967-69	1550-1640	213	47150
1690-1750		240	47140	
1700-1750		241	47165	
1730-1780		250	47195	
Pontiac Grand Am	1978-88	1600-1660	212	47130
		1660-1720	242	47205
		1720-1800	250	47135
Pontiac Grand Prix	1978-88	1600-1660	212	47130
		1660-1720	242	47205
		1720-1800	250	47135
Pontiac GTO	1968-72	1610-1680	242	47160
		1680-1750	250	47190
		1750-1810	260	47200
	1964-67	1550-1640	213	47150
		1690-1750	240	47140
		1700-1750	241	47165
Pontiac LeMans	1978-88	1600-1660	212	47130
		1660-1720	242	47205
		1720-1800	250	47135
	1968-72	1610-1680	242	47160
		1680-1750	250	47190
		1750-1810	260	47200
1964-67	1550-1640	213	47150	
	1690-1750	240	47140	
	1700-1750	241	47165	
	1730-1780	250	47195	
Pontiac Tempest	1968-72	1610-1680	242	47160
		1680-1750	250	47190
		1750-1810	260	47200
	1964-67	1550-1640	213	47150
		1690-1750	240	47140
Pontiac Ventura	1975-79	1840-1910	212	47180
		1910-1970	230	47175
		2010-2100	270	47170
	1971-74	1550-1640	213	47150
		1690-1750	240	47140
		1700-1750	241	47165
1730-1780	250	47195		

* NOTE: Front End Weight is as raced with driver

TRICK REAR SPRINGS

- Computer designed rear springs engineered to compress at a controlled rate when car is launched for optimum "squat"
- Right-side spring is stronger than left, allowing the car to lift evenly upon launch for balanced weight transfer and more consistent 60-foot times
- CNC-wound from high-strength chrome silicon wire to maintain accurate spring rate and to handle the abuse of hard launches
- Replaces stock OEM springs with no modifications required
- Track proven by professional racers for optimum performance
- Two per package with black painted finish



No. 47500

TRICK REAR SPRINGS APPLICATION CHART

MAKE	MODEL	YEAR	PART
GENERAL MOTORS INTERMEDIATE	Chevelle, GTO, LeMans, Cutlass, 442, Skylark, Gran Sport, Malibu, Monte Carlo, Grand Prix, Regal, Grand National	1968-'72	47500
		1978-'87	47520
FORD	Mustang (non i.r.s.)	1979-'04	47510

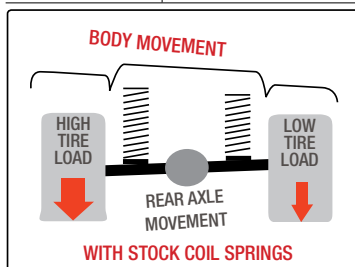

With a stock coil spring setup, unequal forces cause unequal traction

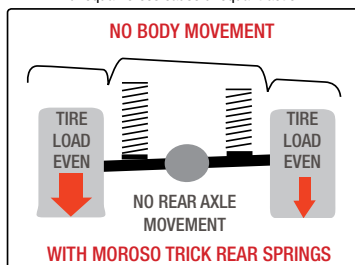

Moroso Trick Rear Springs equalize these forces to provide balanced traction, eliminating the need for "air bags"

CAUTION!
For drag use only,
NOT for street use!

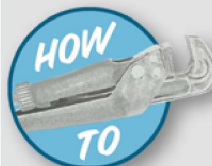

MODIFYING MOROSO TRICK FRONT SPRINGS TO GET THE DESIRED HEIGHT

If Front Springs are too high, they may be lowered by cutting off one-half of a coil. Many factors affect the front end height. Wheel offset is a major consideration. A front wheel offset to the outside will increase leverage of the lower A-frame against the coil spring, and the nose of the car will be lower. Disc brake spacers will further affect the height. Adding or removing as little as 50 lbs. can also make a big difference. Take this into consideration when adding a fiberglass hood, aluminum heads, or when putting the battery in the trunk. Although these changes will affect the height of the car, the spring rates will be unaffected as long as you stay within the guidelines of our definitions.

HARMONIC BALANCER INSTALLATION TOOLS

- Our Universal Tool (**No. 61744**) has adapters to fit most popular engines including Chevrolet, Ford, Mopar, KB Hemi, Pontiac, Oldsmobile and Buick
- Choose from several tools designed for specific engine applications
- Each tool uses a pilot stud, which keeps the harmonic balancer perpendicular to the crankshaft's centerline for a bind-free installation
- Thrust bearing and protective washer allows the drive nut to rotate freely so the balancer is pressed on smoothly and evenly

PART # DESCRIPTION

61740	Harmonic Balancer Installation Tool, SBC or any engine with a 7/16" -20 threaded hole in the crank
61741	Harmonic Balancer Installation Tool, BBC or any engine with a 1/2" -20 threaded hole in the crank
61742	Harmonic Balancer Installation Tool, all Fords or any engine with a 5/8" -18 threaded hole in the crank
61744	Universal Harmonic Balancer Installation Tool, includes screw-in inserts for 7/16", 1/2", 5/8" and 3/4" threaded openings



No. 61740



No. 61744

HARMONIC BALANCER INSTALLATION & REMOVAL TOOL KIT

- Innovative tool with multiple adapters installs and removes harmonic balancers quickly and easily without causing damage
- Four heat-treated chrome moly inserts (1/2", 7/16", 5/8" and 3/4") fit most popular engines including Chevrolet, Ford, Mopar, KB Hemi, Pontiac, Oldsmobile and Buick
- The CNC-machined tool provides a large contact area to keep the harmonic balancer perpendicular with the centerline of the crankshaft for bind-free action
- Roller thrust bearing allows drive nut to rotate freely so the balancer is pressed on or pulled off smoothly and evenly
- Compact storage case keeps tool and all attachments organized and rust free for years of dependable service
- Black oxide finish

PART # DESCRIPTION

61743	Harmonic Balancer Installation and Removal Tool Kit, Chevy, Ford, Mopar, KB Hemi, Pontiac, Oldsmobile and Buick
--------------	---



No. 61743



HARMONIC BALANCER INSTALLATION & REMOVAL TOOL KIT, GM LS & LT

- Innovative tool makes installing and removing GM LS & LT harmonic balancers quick and easy without causing damage
- The CNC-machined tool provides a large contact area to keep the harmonic balancer perpendicular with the centerline of the crankshaft for bind-free action
- Roller thrust bearing allows drive nut to rotate freely so the balancer is pressed on or pulled off smoothly and evenly
- Compact storage case keeps tool and all attachments organized and rust free for years of dependable service
- Black oxide finish

PART # DESCRIPTION

61745	Harmonic Balancer Installation & Removal Tool Kit, GM LS & LT
--------------	---



No. 61745



HARMONIC BALANCER INSTALLATION & REMOVAL ADAPTER, GM LS & LT

- This adapter allows a Moroso **Part No. 61743** Harmonic Installation & Removal Tool Kit work with the GM LS & LT Series of engines
- Like all of the adapters in the kit this adapter will now make it possible to install and remove GM LS & LT harmonic balancers quickly and easily without causing damage
- Black oxide finish

PART # DESCRIPTION

61746	Harmonic Balancer Installation & Removal Adapter, GM LS & LT
--------------	--



No. 61746



CRANKSHAFT SOCKET TOOLS

- Designed to simplify the task of crankshaft rotation during short block assembly with the balancer removed
- Features full steel construction with a zinc-plated finish for corrosion resistance
- Accepts 1/2" drive

PART # DESCRIPTION

- 61760** Crankshaft Socket Tool, Small Block and 90° V6 Chevy and Super-Duty Pontiac/GM 4 Cyl.
61770 Crankshaft Socket Tool, Big Block Chevy
61790 Crankshaft Socket Tool, all Small Block Ford, Buick and Pontiac

**No. 61760****HONDA/ACURA CRANKSHAFT PULLEY WRENCH**

- Fits Honda 1.5L, 1.6L and Acura 1.8L engines
- A cost-effective alternative to the factory tool for turning the engine over or holding the crankshaft pulley in place while removing the pulley bolt
- CNC machined hex fits perfectly into the crankshaft pulley for positive engagement, while the hollow center allows a socket to pass through and unfasten the bolt
- Extra long handle with coated grip supplies the leverage needed to prevent the pulley from moving
- All steel construction with protective black zinc finish will provide years of rust-free, dependable service

**No. 61805**

 **WARNING Prop. 65**
 This product contains a chemical known to the state of California to cause cancer, birth defects, or reproductive harm-

PART # DESCRIPTION

- 61805** Honda/Acura Crankshaft Pulley Wrench

CRANKSHAFT SOCKET TOOLS*For Degree Wheel*

- By removing the crank hub or balancer and using a Moroso Crankshaft Socket Tool, engine builders have a positive way to turn over the engine
- Tool makes it easier to locate TDC and BDC when degreasing camshafts
- Broached keyway allows the socket (which fits 1/2" drive) to slide over the crankshaft snout and key. A knurled jam nut is then used to position a degree wheel
- Use with Moroso Degree Wheel **No. 62190** (11"), **No. 62191** (18") or **No. 62192** Dual (18")

**No. 61757****PART # DESCRIPTION**

- 61755** Crankshaft Socket for Degree Wheel.
Fits: Small Block and 90° V6 Chevy, Super-Duty Pontiac/GM 4 Cyl.
61756 Crankshaft Socket for Degree Wheel. **Fits: Big Block Chevy**
61757 Crankshaft Socket for Degree Wheel. **Fits: GM LS Series Engines with keyway**

 **WARNING Prop. 65**
 This product contains a chemical known to the state of California to cause cancer, birth defects, or reproductive harm-

DEGREE WHEELS

- These degree wheels are mandatory for professional engine builders
- Accurately measures several timing functions of an engine: camshaft centerline, valve timing, TDC, BDC, etc.
- Made from heavy gauge metal with a silk screen finish for long-lasting use in shop or track environments
- Adapter included to fit virtually any engine
- For mounting Degree Wheels, use Crankshaft Socket **Nos. 61755** or **No. 61756** for Small and Big Block Chevys, and **No. 61757** for LS Series Engines with keyway
- Dual Degree Wheel **No. 62192** easily degrees your camshafts with **NO math and NO calculations**
- Dual Degree Wheel **No. 62192** features an outer wheel developed by automotive writer David Vizard, which allows for more precise location of cam timing values and reassurance you've made the correct cam location adjustments

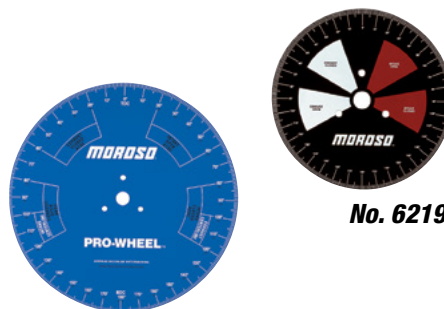
**No. 62190****No. 62191****No. 62192****PART # DESCRIPTION**

- 62190** 11" Degree Wheel, primarily for in-car use at the track
62191 18" Degree "Pro Wheel™", for engine stand use
62192 18" Dual Degree "Pro Wheel™", for precise adjustments



ENGINE CLEANING BRUSHES

- It's important to have a clean block - especially in critical hard-to-get-at areas of the oiling system
- Each brush is designed for a specific purpose; there are two each of the oil gallery brushes since they get the most wear
- Can also be used on crankshaft oil holes, cylinder heads, etc; bristles are made of nylon which cleans as well as wire but does not scratch
- Set of 12 brushes

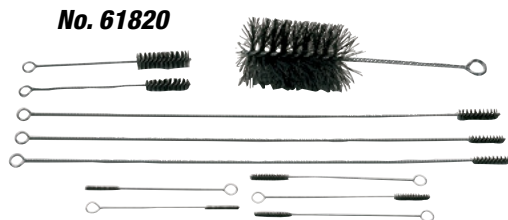

PART # DESCRIPTION
61820 Engine Cleaning Brushes

INCLUDES TWO OF EACH:

1/4" dia.	2" long	10" handle
5/16" dia.	2-1/2" long	12" handle
3/8" dia.	2-1/2" long	12" handle

INCLUDES ONE OF EACH:

1/2" dia.	2-1/2" long	34" handle
5/8" dia.	3" long	34" handle
3/4" dia.	3" long	34" handle
7/8" dia.	3" long	12" handle
1-1/4" dia.	4" long	12" handle
5" dia.	7" long	18" handle

ENGINE STORAGE BAGS

- Manufactured from heavy duty 4 mil thick plastic
- Extra-large sizes cover a complete engine with installed headers
- One per package

PART # DESCRIPTION
99400 Engine Storage Bag, 40" wide x 19-1/2" deep x 47" tall
99401 Engine Storage Bag, 42" wide x 32" deep x 54" tall



No. 99400



No. 99401

OIL PAN T-HANDLE WRENCHES

Made especially for use on oil pans with power kick-outs

- Oil pans with power kick-outs have access plugs in the bottom for fastening to the engine block—Oil Pan T-Handle Wrenches allow for quicker and easier installation and removal
- No more lost socket or dropped fasteners due to one piece design
- A positive locking tool with a magnetized spring loaded socket that fits into the access holes in the pan
- Moroso Oil Pan T-Handle Wrenches have a 6 point socket with a 12" long shaft
- After using this product, power kick-out oil pan owners will never know how they lived without it

PART # DESCRIPTION
62255 Wrench, Oil Pan T-Handle, 1/2", 6 PT
62256 Wrench, Oil Pan T-Handle, 7/16", 6 PT

WARNING Prop. 65
 This product contains a chemical known to the state of California to cause cancer, birth defects, or reproductive harm-



No. 62255

PISTON INSTALLATION TOOLS

- Designed for fast, easy installation of pistons in most popular bore diameters
- Tapered inner diameter of tool compresses piston rings to proper bore size, completely eliminating chances of unseen ring breakage
- Made from aluminum with a hard-coat anodized finish for long wear

PART # DESCRIPTION
61840 Piston Installation Tool for 4.030" Bore
61870 Piston Installation Tool for 4.280" Bore
61880 Piston Installation Tool for 4.310" Bore



No. 61870



TOOLS

DIAL INDICATOR STAND

- Rugged steel fixture is a "must have" for the serious engine builder
- The versatile stand will span cylinder bores up to 4-7/16" and makes it easy to check piston dome and deck heights
- Block and head surface problems can be found by the racer who checks everything
- Other uses include checking for flatness, runout, warping, etc.

PART #	DESCRIPTION
62050	Dial Indicator Stand



No. 62050

CYLINDER HEAD WORK STAND

- Work stand is designed for use with all popular cylinder heads and provides an inexpensive, safe and sure mount for all jobs from porting to cc-ing the chambers
- Disassembles for easy storage in tool box
- Two supports per set

PART #	DESCRIPTION
62080	Cylinder Head Work Stand



No. 62080

CYLINDER LEAKAGE TESTERS

- Quickly diagnoses failed or leaking valves, pistons, rings and head gaskets
- Large-diameter 3-1/2" gauge face indicates percentage of leakage rather than psi, eliminating need for math calculations
- Includes 4-foot hose with quick-disconnect fitting
- No. 89600 includes two zinc-plated adapters for 14mm and 18mm plug sizes
- Accessory Adapter available for 14mm plugs on OHC and HEMI engines

PART #	DESCRIPTION
89600	Cylinder Leakage Tester, Standard Version
89602	Adapter Leak Tester, OHC and HEMI, 7.43" long

PART #	REPLACEMENT PARTS
97500	Gauge Head

◦ **WARNING Prop. 65**
This product contains a chemical known to the state of California to cause cancer, birth defects, or reproductive harm-



No. 89600



No. 89602

CYLINDER LEAKAGE TESTERS

The high performance tool you'll pass down from generation to generation!

Moroso asked top engine builders and race teams to give their input during development. The two biggest results—they immediately asked, "When can I buy one?" and thought of even more uses for this versatile product!

- Top of the line components are used in this precision instrument
- Calibrated for high accuracy and repeatability
- Housed in a stand-up, black powder coated steel case to make taking readings easier and to protect the components themselves
- Comes with 14 mm adapter long, 14 mm and 18 mm adapters short, tapered plug adapter and whip lines

PART #	DESCRIPTION
89603	Cylinder Leak Down Tester

◦ **WARNING Prop. 65**
This product contains a chemical known to the state of California to cause cancer, birth defects, or reproductive harm-



No. 89603



ENGINE LIFT PLATE

- Handy tool provides a quick, easy method of attaching an engine lift chain
- Bolts onto the intake manifold for easy engine lifting and seals up the engine when in storage
- Revised version accommodates most 2bbl. and 4bbl. carburetor bolt patterns
- Made of 3/16" zinc plated steel with 1,000 lb. rating

PART #	DESCRIPTION
62670	Engine Lift Plate

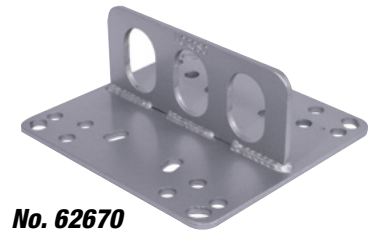

ENGINE LIFT/STORAGE PLATES, GM LS & GM GEN V LT ENGINES

- Handy tool provides a quick, easy method of attaching an engine lift chain
- Bolts onto the non-intake equipped engine block for easy engine lifting and seals up the engine for storage
- Made out of 3/16" thick steel with a durable zinc plated finish, 1000 lb. rating

Part #	DESCRIPTION
62672	Engine Lift/Storage Plate, GM LS1, LS2, LS6 & C5R
62673	Engine Lift/Storage Plate, GM LSX, LS3 & LS7
62674	Engine Lift/Storage Plate, GM Gen V LT1, LT4



ENGINE STORAGE PLATES, GM LS ENGINES

- A convenient way to keep a GM LS engine lifter valley area sealed off from foreign objects during storage
- Plate is constructed out of 1/8" thick steel with a zinc coating for corrosion resistance
- Mounting hardware is included

PART #	DESCRIPTION
25179	Engine Storage Plate, For GM LS1, LS2, LS6 & C5R engines
25180	Engine Storage Plate, For GM LSX, LS3 & LS7 engines

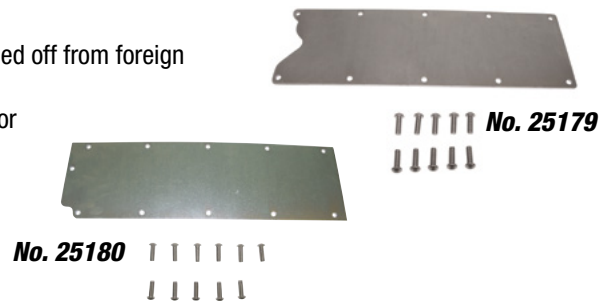

OIL PUMP PRIMERS

- Used to build up oil pressure in a new engine before initial starting
- Remove the distributor and insert the primer to engage the end of the oil pump drive
- The other end of the primer fits a 3/8" chuck in a hand drill to drive the oil pump
- Black oxide finish resists corrosion

PART #	DESCRIPTION
62200	Oil Pump Primer. <i>Fits: Most Chevrolet engines</i>
62210	Oil Pump Primer. <i>Fits: Ford 289, 302, 390, 428 engines. Pump drive end of the primer fits 1/4" hex male end of the oil pump drive</i>

PART #	DESCRIPTION
62220	Oil Pump Primer. <i>Fits: Ford 351W, 351C, 400, 429, 460 engines. Pump drive end of the primer fits 5/16" hex male end of the oil pump drive</i>
62250	Oil Pump Primer. <i>Fits: Most Chrysler engines and Moroso Blueprinted Oil Pump No. 22162</i>



OIL PRIMER TOOL

SBC, BBC and 90° V-6 Engines

- This oil pump primer offers a superior design
- Includes bushing to pressurize the valvetrain
- Primes the oil pump right through the distributor hole using an electric drill



PART #	DESCRIPTION
62205	Oil Primer Tool, with bushing



STUD MOUNT VALVE SPRING COMPRESSOR

Heavy Duty

- Makes valve spring changing quicker and easier than conventional methods
- Unlike models offered by other manufacturers, Moroso's stud mount tool fits both $\frac{3}{8}$ " and $\frac{7}{16}$ " rocker studs
- Heavy Duty version of Moroso Stud Mount Valve Spring Compressor features thick laser cut steel and billet aluminum components for day in and day out use
- The 12" handle gives all leverage needed to compress the strongest springs

PART # DESCRIPTION
62371 Stud Mount Valve Spring Compressor, Heavy Duty

 **WARNING Prop. 65**
 This product contains a chemical known to the state of California to cause cancer, birth defects, or reproductive harm-



No. 62371

STUD MOUNT VALVE SPRING COMPRESSORS

- Simplifies between-rounds valve spring changing
- Unlike models offered by other manufacturers, Moroso's stud mount tool fits both $\frac{3}{8}$ " and $\frac{7}{16}$ " rocker studs
- Strong, durable handle withstands the most extreme high pressure valve springs
- The 12" handle gives all the leverage needed to compress the strongest springs

PART # DESCRIPTION
62370 Stud Mount Valve Spring Compressor

PART # AVAILABLE OPTION
62372 Stud Mount Valve Spring Compressor Conversion Kit. Contains all parts necessary to convert Part **No. 62370** to fit Jesel Rocker Shaft assemblies

 **WARNING Prop. 65**
 This product contains a chemical known to the state of California to cause cancer, birth defects, or reproductive harm-



No. 62372

No. 62370

VALVE CHECKING SPRINGS

- Greatly simplifies the task of cam degreasing, checking valve-to-piston clearance, etc.
- Designed with $\frac{7}{8}$ " diameter and 2" height for most popular race engines
- Can be installed by hand without the use of compression tools
- Sold as a set of 8

PART # DESCRIPTION
62380 Valve Checking Springs

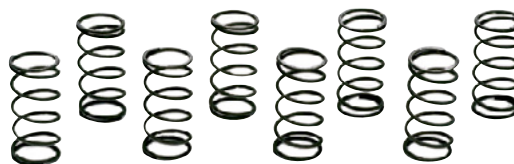

No. 62380

VALVE SEAT PRESSURE TESTER

- The original tool for checking valve seat pressure on an assembled engine!
- Built-in 300-lb. reading scale
- Fits roller rockers on Small Block, Big Block and 90° V6 Chevy; Ford 221-302, 351-400 SVO and Ford Windsor engines, and most other wedge-type engines
- Use with Moroso Stud Mount Valve Spring Compressors **No. 62370** for the most accurate method of maintaining the valvetrain on a fully assembled engine

PART # DESCRIPTION
62390 Valve Seat Pressure Tester



No. 62390

LOW-PROFILE DESIGN VALVE SEAT PRESSURE TESTER

- Similar to **No. 62390** with low-profile design to fit under windshield and cowl of tube-chassis cars
- Designed by Jerry Haas, the tool features a rocker arm "gripper" machined from billet aluminum
- Scale reading from 160 to 400 lbs. allows testing of springs with higher spring pressures
- Use in conjunction with Moroso Stud Mount Valve Spring Compressors **No. 62370** for the most accurate method of maintaining the valvetrain on a fully assembled engine

PART #	DESCRIPTION
62391	Low-Profile Valve Seat Pressure Tester

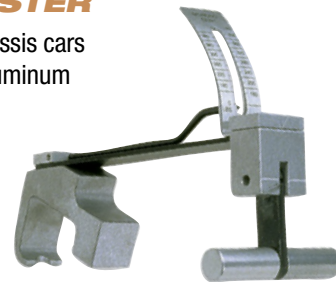
**No. 62391****VALVE SEAT PRESSURE TESTER**

- Built-in 400-lb. reading scale
- Billet aluminum with body pocket to fit taller adjuster nuts used on stud girdles
- Use with Moroso Stud Mount Valve Spring Compressor **No. 62370** for the most accurate method of maintaining the valvetrain on a fully assembled engine

PART #	DESCRIPTION
62388	Valve Seat Pressure Tester
62389	Low-Profile Valve Seat Pressure Tester

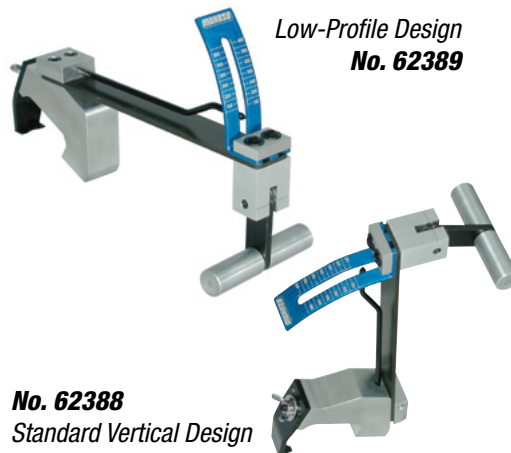

Low-Profile Design
No. 62389

No. 62388
Standard Vertical Design

FENDER COVER

- 34" x 22" Rubber cover printed with Moroso and Competition Engineering Logos
- Non-skid foam backing is safe for your car's finish and will not slide off while working
- Protects fender paint from scratches and grease while working on engine
- Acid/grease resistant, top surface is easily washable with mild solvents or detergents

PART #	DESCRIPTION
99406	Fender Cover

**No. 99406****CARBURETOR WORK STAND**

- Designed to hold Quadrajet and both standard and spread-bore Holley® carbs, this tool greatly simplifies carburetor work
- Manufactured of cast aluminum with open center and mounting pegs

PART #	DESCRIPTION
62070	Carburetor Work Stand

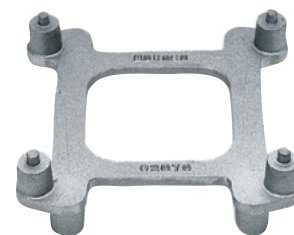
**No. 62070****CARBURETOR WORK STAND, ADJUSTABLE**

- Designed to hold standard and spread bore Holley 4150, Holley 4500, Rochester and Carter Quadrajet, Carter AFB and Edelbrock Carburetors
- This tool simplifies carburetor work and with it's open center allows access for assembly and disassembly
- Manufactured out of thick aluminum for years of service

PART #	DESCRIPTION
62071	Carburetor Work Stand, Adjustable

**No. 62071**

JET TOOL

- Designed with a stronger, fully machined tip that slides over jet, holding it firmly in place
- Short design, sure-grip handle simplifies jet removal and installation in crowded engine compartments
- Fits all Holley® round-head type carb jets

PART # DESCRIPTION
62293 Jet Tool



No. 62293

POWER VALVE TESTER

- Convenient tool checks Holley® Power Valves for ruptured diaphragms to prevent engine flooding
- Remove knurled cap and screw in the Power Valve; cut-away section of tool allows visual inspection of valve's operation
- CNC machined from 6061-T6 aluminum and anodized to prevent corrosion
- Requires the use of a hand-operated vacuum tester (available at most auto parts stores)

PART # DESCRIPTION
62295 Power Valve Tester, for Holley® Carburetor Power Valves



No. 62295

CARBURETOR DRAIN CUP

- Now you don't have to spill fuel all over the engine when removing fuel-bowl screws to service Holley® carburetors
- Gary Williams-designed Carburetor Drain Cup uses a channel handle to catch dripping fuel and direct it to a holding cup
- Made from fuel resistant polyethylene

PART # DESCRIPTION
65805 Carburetor Drain Cup

 **WARNING Prop. 65**
 This product contains a chemical known to the state of California to cause cancer, birth defects, or reproductive harm-



No. 65805

CARB CAPS

- Keeps dust and other foreign material out of carburetors during transportation and storage
- Manufactured from durable, high-impact plastic
- Thumbscrew included

PART # DESCRIPTION
65802 Carburetor Cap, fits Holley®, Thermoquad and Quadrajets Carburetors with 5-1/8" diameter neck

65803 Carburetor Cap, fits Holley®, 4500 Dominator Carburetors with 7-5/16" diameter neck

 **WARNING Prop. 65**
 This product contains a chemical known to the state of California to cause cancer, birth defects, or reproductive harm-



No. 65802



No. 65803

CARB-TOP TOOL TRAYS

- Made from lightweight, durable, .063" aluminum in two styles for Holley® 5-1/8" and 7-5/16" Dominator carburetors
- Also fits other carburetors with similar neck diameters
- Each Tool Tray sits just 2-1/2" above the carburetor and features a convenient handle, 1/8" rubber mat, 16 spark plug holders, 8 plug wire holders and enough room to store a variety of tools for working on just about any engine
- Inside tray dimensions: 10" x 13"

PART # DESCRIPTION
65800 Carb-Top Tool Tray, 5-1/8" diameter carburetors
65801 Carb-Top Tool Tray, 7-5/16" diameter carburetors

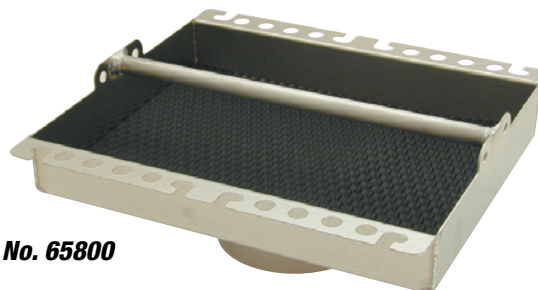

No. 65800

SPARK PLUG INDEXER

- High-compression drag race engines require "indexing" of spark plugs to prevent contact between piston dome and ground wire of the spark plugs
- Moroso's "Indexer," designed for both flat and taper-seat 14mm spark plugs, enables selection of spark plugs that will not make such contact
- Once a given plug is selected (placed in a cylinder head and found to have the correct ground wire position), it is placed in the Moroso Plug Indexer and the position of the ground electrode marked on the black anodized surface
- Marking provides a reference for checking other plugs to be used in the same cylinder
- The hex-head design allows it to be held in a vise

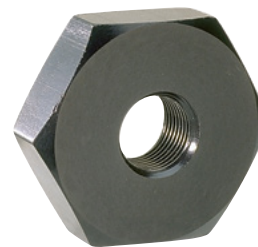

No. 62160

PART # DESCRIPTION

62160 Spark Plug Indexer

PART # AVAILABLE OPTIONS

71900 Spark Plug Indexing Washers, Tapered Seat, .010", .021", .032"

71910 Spark Plug Indexing Washers, Flat Seat, .040", .050", .064"



Spark Plug Indexing Washers on pg. 345

UNIVERSAL SPARK PLUG HOLE AIR HOSE KIT

- Air hose kit makes it easy to pressurize the cylinder to hold the valve closed when changing a valve spring
- Fits all 14mm and 18mm spark plug holes
- Includes a 12" hose and 3 spark plug adapters

PART # DESCRIPTION

62385 Universal Spark Plug Hole Air Hose Kit



No. 62385

 **WARNING Prop. 65**
This product contains a chemical known to the state of California to cause cancer, birth defects, or reproductive harm-

POWER SPEED CALCULATOR

Moroso's Power-Speed Calculator is like having a dyno in your back pocket!

Using information such as tire size, gear ratios, horsepower and displacement, this handy slide tool works out the relationship between:

- E.T., M.P.H. and power to weight ratios
- Tire diameter to speed and gear ratio
- Engine displacement to compression ratio
- Horsepower measured at flywheel

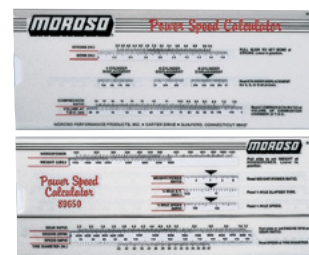

PART # DESCRIPTION

89650 Power-Speed Calculator

No. 89650

EXHAUST BLOCK OFF STORAGE PLATES

Fits: BBC Mark IV with conventional cylinder heads

- A convenient way to keep engines sealed up from foreign objects during storage or when an engine is getting painted
- Durable aluminum construction, come as pairs

PART # DESCRIPTION

25160 Exhaust Block Off, Storage Plates, BBC Mark IV

NEW!



No. 25160



TOOLS

ENHANCED IGNITION WIRE STRIPPING TOOL

Made especially for stripping 8mm & 8.65mm Moroso Ignition Wire and others

- An easy way to strip wire without damage, which is more likely to occur using other methods
- Simple and efficient operation: place the end of the wire in the "mouth" of the tool, twist in a circular pattern until the cut is made around the wire, then pull off sheath
- Heavy-duty construction and quality components provide reliable operation after repeated use
- After using this Enhanced Stripping Tool, you will never go back to using manual strippers for assembling wire sets again

PART #	DESCRIPTION
62272	Enhanced Ignition Wire Stripping Tool, for 8mm & 8.65mm diameter wire



ADJUSTABLE WIRE STRIPPING TOOL

- Strips outer jacket and insulation simultaneously giving a cleaner, precise cut
- For stripping different diameter cable, use the built in hex key adjuster screws to align the blade for desired results
- The V-Block reverses and indication arrow sets to recommended cable size
- The stripper distance can be changed by removing one of the stripping blades

PART #	DESCRIPTION
62271	Adjustable Wire Stripping Tool



WIRE CRIMPING TOOLS

- Crimp a variety of spark plug terminals and other automotive wire hardware

PART #	DESCRIPTION
62260	General Purpose Wire Crimper. Made of high carbon steel with black oxide finish and plastic hand grips
62268	Super-Duty Wire Crimping Tool. Positive ratcheting mechanism adjusted for perfect crimps. Supplied with crimping jaws for Moroso (and others) spark plug wire terminals. Hardened steel frame with blue molded cushion grips. Also comes with additional primary wire crimping jaws



 **WARNING Prop. 65**
This product contains a chemical known to the state of California to cause cancer, birth defects, or reproductive harm.

IGNITION WIRE STRIPPING TOOL

- Ideal for stripping 8mm Moroso ignition wire without damaging the conductor
- Damage to conductor during stripping can cause interruption of spark and misfire
- Moroso's specially-designed tool uses a hard-edge, razor-sharp blade specially positioned in a plastic holder to cut only the insulation—not the conductor

PART #	DESCRIPTION
62270	Wire Stripping Tool, 8mm

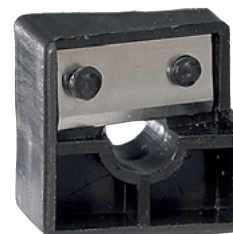

No. 62270

COIL-OVER SHOCK ADJUSTING TOOL

- Makes adjusting coil-over shocks much easier than the commonly used hammer and screwdriver method
- Works with Moroso, Competition Engineering, Avo, Hal, Koni, Bilstein, Carrera, Monroe and most other coil-over shocks with adjusting nuts up to 3-1/4" diameter
- Manufactured of cast steel with finger indents for sure-grip operation

PART # DESCRIPTION
62030 Coil-Over Shock Adjusting Tool



No. 62030

PINION WRENCH, REAR END

For: Ford 8.8" & 9.0", GM 10 & 12 Bolt, Dana 60 and others

- Steel tool with 24" handle, for Bolt-On security to pinion using U-Joint bolt holes, the two sets of slots are .56" wide by 1.5" long and .34" wide by 1 3/8" long, used to hold the rear end pinion yoke while tightening or removing the pinion nut
- Quicker and easier way of changing the pinion seal, re-bushing the case or simply torquing the pinion nut

PART # DESCRIPTION
62027 Wrench Pinion, Bolt-On, Ford 8.8" & 9.0", GM 10 & 12 Bolt, Dana 60



No. 62027

WARNING Prop. 65
 This product contains a chemical known to the state of California to cause cancer, birth defects, or reproductive harm-

WRENCH, PINION COUPLER

- Used to hold the female pinion coupler while tightening and removing the pinion nut on Chrysler 8-3/4", Ford 9", Mark Williams or Strange style pinion assemblies
- Can be used on the tool bench or when the assembly is still in the car
- This quality-built, steel tool features a 20-tooth head and an 18" long handle for years of service
- The correct way of changing the pinion seal, re-bushing the case or simply torquing the pinion nut

PART # DESCRIPTION
62026 Wrench, Pinion Coupler



No. 62026

WARNING Prop. 65
 This product contains a chemical known to the state of California to cause cancer, birth defects, or reproductive harm-

FASTENER TOOLS

QUICK FASTENER SINKING TOOL

- Ideal for sinking flush-mount quick fasteners
- The two piece steel tool dimples a single metal panel using one end and a double panel using the other
- Zinc-plated
- One tool per package

PART # DESCRIPTION
71605 Quick Fastener Sinking Tool



No. 71605

QUICK FASTENER TRANSFER STUD PUNCH KITS

Place the Transfer Stud Punch in a weld plate or body panel. Then position your panel over top of it and lightly tap the panel with a hammer and you'll be left with a mark in your panel where you drill your hole

- 5 per pack

PART # DESCRIPTION
71601 Transfer Stud Punch Kit for 5/16" Buttons, 5 per kit
71602 Transfer Stud Punch Kit for 7/16" Buttons, 5 per kit



No. 71601

No. 71602



TOOLS

QUICK FASTENER WRENCHES

With Easy Grip Handle

- Allows for faster removal of ¼-turn fasteners
- Features include a high strength steel shank plated with black zinc for durability
- The slot head blade on **No. 71606** is contoured to fit inside the ¼-turn fastener without stripping the slot
- One tool per package

PART #	DESCRIPTION
71606	Quick Fastener Wrench, ⅜" Slot Head
71607	Quick Fastener Wrench, ⅜" Hex Drive



No. 71606



No. 71607

QUICK FASTENER WRENCH

- This tool fits slot-head ¼-turn fasteners far better than a screwdriver, reducing the possibility of damaged fasteners and body panels
- Manufactured of zinc plated spring steel with three different sized radii to match the slots in various ¼-turn fasteners
- Includes non-slip, plastic hand grip
- One tool per package

PART #	DESCRIPTION
71600	Quick Fastener Wrench



No. 71600

WARNING Prop. 65
 This product contains a chemical known to the state of California to cause cancer, birth defects, or reproductive harm.

WHEEL & TIRE TOOLS

PIT SOCKET

- Thick walled socket with six point surface-contact and large chamfer insures fast, clean engagement on the lug nut
- Manufactured of alloy steel and carefully heat treated for maximum strength and prevention of lug nut damage
- Accepts ½" drive, and fits 1" lug nuts

PART #	DESCRIPTION
62010	Pit Socket



No. 62010

SEE MORE → **Double End 1" Lug Nuts on pg. 230**

DIGITAL DUROMETER

Includes Case

In racing where thousandth of a second can count, a durometer is used to check on; whether a tire has gotten too hard as it has aged, compare different tire(s) hardness and softness against each other or how a tire responded to a chemical tire softener.

- Calibrated on a Shore type A scale, the scale used to measure the hardness of race and ultra high performance tires.
- Easy to read Digital readout with ½" tall numbers
- Reads to .5 Shore
- Has a hold button to capture the reading on the readout
- Comes with a foam lined plastic case for storage of the unit when not in use

PART #	DESCRIPTION
89585	Digital Durometer with Case



No. 89585



WARNING Prop. 65
 This product contains a chemical known to the state of California to cause cancer, birth defects, or reproductive harm.

TIRE PRESSURE GAUGES, GARAGE SERIES

- A line of gauges that are perfect to check pressures around the garage, where the accuracy of a track air pressure gauge isn't needed and you don't mind your buddies borrowing
- Easy to read 2-1/4" gauge face
- Includes rubber gauge cover
- 16" hose with finger operated air-bleed valve allows you to release pressure quickly
- Hose has easy grip angle chuck end that rotates 360 Deg. for positive valve stem attachment

PART # DESCRIPTION

- 89592**◁ Tire Pressure Gauge, Garage Series, 0-15 psi
- 89593**◁ Tire Pressure Gauge, Garage Series, 0-40 psi
- 89594**◁ Tire Pressure Gauge, Garage Series, 0-60 psi
- 89595**◁ Tire Pressure Gauge, Garage Series, 0-100 psi

PART # REPLACEMENT PART

- 97485**◁ Tire Gauge Replacement Hose

 **WARNING Prop. 65**
This product contains a chemical known to the state of California to cause cancer, birth defects, or reproductive harm-

No. 89592



DIGITAL TIRE PRESSURE BACK LIT GAUGES

Accuracy 1/2%

- Strong back lighted display is easily read in the darkest of pits
- 2-5/8" dia. gauge face
- Reads to .1 psi
- Can be adjusted to read in standard and metric units
- Auto-Off feature to increase battery life
- Battery level on gauge face
- Includes 9 volt battery
- Includes rubber gauge cover
- 16-1/4" hose with finger operated air-bleed valve allows you to release pressure quickly
- Hose has easy grip angle chuck end

PART # DESCRIPTION

- 89574**◁ Digital Tire Pressure Back Lit Gauge, 0-15 psi
- 89575**◁ Digital Tire Pressure Back Lit Gauge, 0-60 psi
- 89576**◁ Digital Tire Pressure Back Lit Gauge, 0-100 psi

PART # REPLACEMENT PART

- 97485**◁ Tire Gauge Replacement Hose

 **WARNING Prop. 65**
This product contains a chemical known to the state of California to cause cancer, birth defects, or reproductive harm-

No. 89576



STRONG BACK LIGHTED DISPLAY IS EASILY READ IN THE DARKEST OF PITS.

TOOL CASE, PLASTIC WITH FOAM INSERT

- Rugged polyethylene plastic tool case is lined with a medium-density, open-cell foam insert to keep tools protected during transportation and storage
- Case's slide clasps have tabs for small padlocks
- Can also be used as replacement case for Moroso Part Nos. 89552 and 89562 Pro Series Tire Pressure Gauges

PART # DESCRIPTION

- 97481** Tool Case, Plastic with Foam Insert

NEW!



No. 97481



TOOLS

TIRE PRESSURE GAUGES

Accuracy 2%

- 16-1/4" hose with a finger operated air-bleed valve allows you to release pressure quickly
- Individually calibrated for accuracy within 2%
- The large 2-5/8" dia. dial face in 1/2 lb. increments is easy to read, while the hardened swivel chuck rotates 360° for positive valve stem attachment

PART # DESCRIPTION

- 89550◊ Tire Pressure Gauge, dial type, 0-15 psi.
- 89555◊ Radial Tire Pressure Gauge, dial type, 0-40 psi.
- 89560◊ Tire Pressure Gauge, dial type, 0-60 psi.
- 89570◊ Tire Pressure Gauge, dial type, 0-100 psi.

PART # AVAILABLE OPTION

- 89590 Tire Pressure Gauge Cover

PART # REPLACEMENT PART

- 97480 Gauge Head for No. 89550
- 97485◊ Tire Gauge Replacement Hose

◊  **WARNING Prop. 65**
This product contains a chemical known to the state of California to cause cancer, birth defects, or reproductive harm-

BETTER



No. 89555

PRO SERIES TIRE PRESSURE GAUGES

Accuracy 1/2%

- Long 16-1/4" hose with pressure release valve and hardened steel swivel chuck is perfect for getting into deep-dish wheels
- Premium high-quality instruments with brass internals and bourdon tube pressure element provide full-range accuracy to within 1/2%
- Extra-large 4" diameter face and knife-edge pointer eliminate human error
- Adjustable pointer can be calibrated at the race track
- Fiberglass-reinforced thermoplastic housing withstands harsh racing environments
- Rugged polyethylene plastic carrying case is lined with a medium-density, open-cell foam insert to keep gauge protected during transportation and storage
- Includes protective gauge cover

PART # DESCRIPTION

- 89552◊ Pro Series Tire Pressure Gauge, 0-15 psi. Major increments at 3 psi with minor increments at 0.1 psi.
- 89562◊ Pro Series Tire Pressure Gauge, 0-60 psi. Major increments at 10 psi with minor increments at 0.5 psi.

PART # REPLACEMENT PART

- 97485◊ Tire Gauge Replacement Hose

◊  **WARNING Prop. 65**
This product contains a chemical known to the state of California to cause cancer, birth defects, or reproductive harm-

BEST



No. 89562

TIRE PRESSURE GAUGE COVER

- Protective rubber cover insures long service and continued accuracy of Moroso 2-5/8" Tire Pressure Gauges
- Specially designed ribs provide superior protection
- A must for anyone who uses Moroso gauge Nos. 89550, 89555, 89560 & 89570 or other 2-5/8" O.D. x 1-1/8" gauges

PART # DESCRIPTION

- 89590◊ Tire Pressure Gauge Cover

◊  **WARNING Prop. 65**
This product contains a chemical known to the state of California to cause cancer, birth defects, or reproductive harm-



No. 89590

NOTE: Not required for Moroso's Lighted Tire Pressure Gauges. Will not fit Pro Series or Digital tire gauges.

TIRE GAUGE, REPLACEMENT HOSE

- Replacement Tire Gauge Hose, fits Moroso Tire Gauges
- The hose is 16-1/4" long and comes with a finger operated air-bleed valve which allows you to release pressure quickly
- Hose has an easy grip angle check end.

PART # DESCRIPTION

- 97485◊ Tire Gauge, Replacement Hose

◊  **WARNING Prop. 65**
This product contains a chemical known to the state of California to cause cancer, birth defects, or reproductive harm-



No. 97485

SAFETY WIRE

- Moroso Safety Wire is widely used to secure all kinds of fasteners and controls from nuts and bolts to check valves, switches and modulators where a loose or lost component might mean disaster
- Made of .032" diameter 304 stainless steel; comes in 1-lb. containers

PART # DESCRIPTION
62280 Safety Wire

 **WARNING Prop. 65**
 This product contains a chemical known to the state of California to cause cancer, birth defects, or reproductive harm-



CAUTION!
 Safety wire should
NOT be reused!



No. 62280

OFFSET ROLL BAR PADDING

Packaged in single 3-foot lengths.

- 3" O.D. padding is extruded from high-density foam
- Inside diameter of 1-5/8" is offset by 7/16" to position extra cushioning towards the driver where it's needed the most
- Available in black, red, blue and orange

PART # DESCRIPTION

80939 Offset Roll Bar Padding, Black
80940 Offset Roll Bar Padding, Blue
80941 Offset Roll Bar Padding, Red
80942 Offset Roll Bar Padding, Orange

 **WARNING Prop. 65**
 This product contains a chemical known to the state of California to cause cancer, birth defects, or reproductive harm-



left to right:
No. 80942 / 80941 / 80940 / 80939

ROLL BAR PADDING, SFI 45.1 APPROVED

Meets the requirements of NHRA, IHRA, SCCA and other organizations

- SFI 45.1 Specified approved padding, approval marked on padding
- Comes in 36" lengths; 7/8" thickness fits 1-5/8"-2" bar diameter
- Padding backed with pressure-sensitive adhesive and can be cut to size to make installation easy
- Padding exceeds SFI 45.1 rating for dripping or melting in a fire, and is self-extinguishing
- SFI 45.1 approved Roll Bar Padding is more dense than traditional padding, and is designed to absorb the impact energy

PART # DESCRIPTION

80944 Roll Bar Padding, SFI 45.1 Approved, Black



No. 80944

RACE CAR TIE-DOWNS

Aircraft quality ratchets and super strong 2" wide nylon webbing are combined to offer the ultimate in race car tie-downs

- Capacity of each tie-down is 5000 lbs.
- Simple to operate

PART # DESCRIPTION

80740 Race Car Tie-Down, short clamping range, 2'4" to 5'7"
80750 Race Car Tie-Down, long clamping range, 4' to 7'7"



No. 80750

AXLE TIE-DOWN LOOP

This strap provides a strong axle loop to hold the vehicle in place on trucks or trailers using a tie-down like Moroso Nos. 80740 or 80750

- 2" wide, 24" long latex-treated woven polyester strap is rated at 3,335 lbs.
- The strap has D-rings at both ends and is protected by a 12" cordura center sleeve to prevent cuts or chafing against bare metal

PART # DESCRIPTION

80700 Axle Tie-Down Loop



No. 80700



TOOLS

CHEVROLET MOTOR MOUNTS

- Replace stock, OEM-style rubber mounts to eliminate torque loss and binding linkages, a common result of excessive engine movement
- Eliminates the need for bulky torque straps and chains
- Protective zinc plated finished steel, two per pack
- Refer to Motor Mount chart and dimensional diagram for your specific application

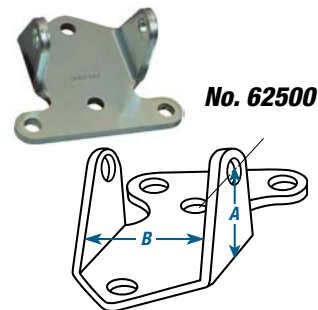

PART #	DESCRIPTION	DIMENSIONS (See diagram, right)	REPLACES
62500	Chevrolet Motor Mounts	A: 1-1/16" B: 2-1/2", 1/4" zinc plated steel	Replaces OEM #3990914
62510	Chevrolet Motor Mounts	A: 2-1/8" B: 2-3/8", 3/16" zinc plated steel	Replaces OEM #3962748
62515	Chevrolet Motor Mounts	A: 2-9/32" B: 2-3/8", 3/16" zinc plated steel	Replaces OEM #332648*
62530	Chevrolet Motor Mounts	A: 1-3/4" B: 2-5/8", 3/16" zinc plated steel	Replaces OEM #6258154

CHEVROLET MOTOR MOUNT APPLICATION CHART

MODEL	YEAR	ENGINE	PART #	MODEL	YEAR	ENGINE	PART #	
FULL SIZE	1958-'60	283, 348	62500	CHEVELLE	1964-'67	283, 327	62500	
	1961	283, 348	62500		396, 427	62530		
		409	62530		1968-'69	307, 327, 350	62510	
		283, 327	62500		396	62530		
	396, 409, 427	62530	1970-'72		307, 350, 402, 454	62510		
	1966-'67	283, 327	62500*	1973-'88	307, 350, 402, 454	62515		
	396, 427	62530	CHEVY II	1964-'67	283, 327	62500		
	1968-'69	307 (Exc. Police)		62500	NOVA	1968-'69	327	62500
	307 (Police)	62530		350		62510		
	327	62500*	396	62530				
396, 427	62510	1970-'72	350 (Exc. Spec. Hi. Perf.)	62500				
CAMARO	1970-'72	350 (w/ 2 bbl. carb.)	62500	350 (Spec. Hi. Perf.)	62510			
		454	62510	396, 402	62530			
		1976-'90	307, 350	62515	1973-'79	307, 305	62515	
	CORVETTE	1967-'68	302	62530	1963-'64	327	62530	
			327	62500	1965	327, 396	62530	
			350, 396	62530	1966-'68	327, 427	62530	
		1969	302	62510	1969	327, 350, 427	62530	
			307	62500	1970-'74	350, 454	62530	
			350	62510	1975-'82	305, 350	62530	
		1970-'73	350 (Exc. Spec. Hi. Perf.)	62500	MONTE CARLO	1970-'72	350, 402, 454	62510
350 (Spec. Hi. Perf.)			62510	1973-'87		307, 350	62515	
396, 402	62530							
1974-'81	307, 350	62515						
1982-'92	305, 350	62510						

Some models use No. 62510, check dimensions of original mounts. #Use with Moroso Frame Mounts No. 62610

***NOTE:** To prevent premature engine mount failure, we recommend using Moroso's Steel Motor Mounts, sold above, with Competition Engineering's Engine Limiter, Part No. C4034, sold on page 415.

MOTOR MOUNT SHIM KIT

- 1/16", 1/8" and 3/16" thick, 2 ea.
- Standard Chevrolet bolt pattern
- Works great with Chevy Motor Mounts 62500, 62510, 62515, 62530 & 62550
- Used to make slight adjustments to engine height to compensate for minor oil pan, linkage and header interference
- Great addition to engine swap kits

PART #	DESCRIPTION
62535	Motor Mount Shim Kit

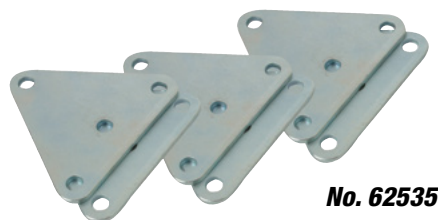

No. 62535

CHEVY SOLID MOTOR MOUNT PAD KITS

- Solid Mount Pads replace soft rubber-cushioned frame mounts supplied as OEM equipment on 1974-'97 Camaro and Firebirds and other GM vehicles
- Control excessive engine movement, prevent linkage binding and eliminate the need for torque straps
- Two per pack

PART # DESCRIPTION

- 62610*** Solid Motor Mount Pad Kit. Zinc Finish
Use with Moroso Motor Mounts **No. 62510**
Fits: 1982-'92 Camaro and Firebird, SBC, BBC and 90° Chevy V6
- 62630*** Solid Motor Mount Pad Kit, Zinc Finish
Use with Moroso Motor Mounts **No. 62515**
Fits: 1974-'81 Camaro, Firebird; 1973-'88 Chevelle, Malibu, Monte Carlo, El Camino; 1973-'79 Nova; 1976-'90 Impala, Caprice; Small Block
- 62635*** Solid Motor Mount Pad Kit. Zinc Finish
Fits: 1993-'97 Camaro and Firebird V8



No. 62630



No. 62635

***NOTE:** Solid Transmission Mounts must be used in conjunction with Solid Motor Mounts to prevent breakage of engine block and transmission case due to torsional stress.

CHEVROLET MOTOR MOUNT

Fabricated Chassis

- Designed primarily for oval track or any fabricated chassis application (they do not fit any particular OEM chassis)
- Allows for quick, easy engine removal and reinstallation
- Manufactured from ¼" thick steel with zinc plating to resist corrosion

PART # DESCRIPTION

- 62550** Chevrolet Motor Mounts, ¼" Zinc Finish, Two per pack
Fits: SBC, BBC and 90° Chevy V6 in fabricated chassis



No. 62550

CHEVY SOLID TRANSMISSION MOUNT

- Replaces stock, OEM-style soft rubber mount to eliminate linkage binding, driveline misalignment and unwanted transmission movement in racing and street performance applications
- Sturdy mount is constructed from ¾" steel and features slotted holes on top for transmission mounting and threaded nuts welded to bottom for crossmember mounting
- Black zinc finish

PART # DESCRIPTION

- 62600*** Solid Transmission Mount
Fits: 1958-'88 Chevy with Powerglide, TH-350, TH-400 and all Borg-Warner, Muncie, Saginaw, Chrysler 4-speed and Doug Nash 5-speed transmissions, except 1982-92 Camaro and Firebird



No. 62600

***NOTE:** Solid Transmission Mounts must be used in conjunction with Solid Motor Mounts to prevent breakage of engine block and transmission case due to torsional stress.



MOTOR MOUNT ADAPTER PLATES FOR LS SERIES

- Simple and efficient way to adapt motor mounts to fit LS Series Engines
- Manufactured from 6061 T-6 Aluminum
- Black anodized finish resists corrosion
- Works with G.M. Factory 3-Bolt Mounts and Moroso Solid Motor Mounts
Nos. 62500, 62510, 62515, 62530 & most aftermarket polyurethane mounts

PART #	DESCRIPTION
62555*	Motor Mount Adapter Plates for LS Series, Two per pack, with hardware



No. 62555

DRIVESHAFT LOOPS

Camaro LS, LT, SS, ZL1, 2010-2015

- Bolt-on design allows easy installation with no modifications required
- Removable loop for easy driveshaft removal
- Meets the requirements of all racing sanctioning bodies
- Will help contain the driveshaft in the event of a front U-joint failure, keeping it from digging into the ground and possibly overturning the vehicle
- Manufactured from heavy-gauge fabricated steel
- Durable gloss black powder finish
- All hardware included

PART #	DESCRIPTION
62640	Driveshaft Loop, Camaro LS, LT, SS, ZL1, 2010-2015, Standard Transmission
62641	Driveshaft Loop, Camaro LS, LT, SS, ZL1, 2010-2015, Automatic Transmission



No. 62640



No. 62641

CHRYSLER MOTOR MOUNTS

PART #	DESCRIPTION
62520	Chrysler Motor Mounts, 3/16" Zinc Plated Steel. Two per pack. Replaces OEM #2536121
62540	Chrysler Motor Mounts, 3/16" Zinc Plated Steel. Two per pack. Replaces OEM #2806779



No. 62540

DODGE, PLYMOUTH MOTOR MOUNT APPLICATION CHART

MODEL	YEAR	ENGINE	PART #
DART, VALIANT, DEMON, DUSTER	1967-'72	273, 318, 340, 360	62540
BARRACUDA, CHALLENGER	1967-'69	273, 318, 340, 360	62540
	1970-'74	All 8 cyl. (exc. Hemi)	62520
CORONET, SUPER BEE, BELVEDERE, FURY ROAD RUNNER, SATELLITE, GTX, POLARA	1966-'72	All 8 cyl. (exc. Hemi)	62520



No. 62520



FORD MOTOR MOUNTS

- Extra-thick 3/16" steel Motor Mounts are gusseted for extra strength
- Pre-welded Grade 8 studs withstand the high-torque, high-horsepower loading encountered during hard acceleration
- Reaction and 60-foot times are improved since engine movement in the chassis is eliminated, instantaneously transferring power to the rear wheels
- Clutch linkage binding is eliminated, ensuring improved shifts
- Manufactured on computer-controlled equipment for unsurpassed quality and precise fit
- Finished with protective zinc plating
- Solid Motor Mounts must be used in conjunction with Solid Transmission Mounts to prevent breakage of engine block and transmission case due to torsional stress
- Two per pack

PART # DESCRIPTION

62544* Ford Motor Mounts, 3/16" Steel
Fits: 1979-'83 & 1993 Mustang 5.0L Engines

62545* Ford Motor Mounts, 3/16" Steel
Fits: 1984-'92 Mustang Hardtops and 1990-'92 Convertibles with 5.0L Engines



No. 62545



No. 62544

FORD SOLID TRANSMISSION MOUNT

- Replaces stock, soft rubber mount to eliminate linkage binding, driveline misalignment and unwanted transmission movement in racing and street performance applications
- Constructed from rugged 3/16" steel with pre-welded studs and protective zinc finish
- Computer-controlled manufacturing insures precise fit and alignment for easy installation

PART # DESCRIPTION

62602* Solid Transmission Mount
Fits: 1987-'93 Mustang, T-Bird and other Ford Models equipped with A.O.D. 4-Speed Automatic or 5-Speed Manual Transmissions



No. 62602

***NOTE:** Solid Transmission Mounts must be used in conjunction with Solid Motor Mounts to prevent breakage of engine block and transmission case due to torsional stress.



BILLET ELECTRIC WATER PUMPS

Our durable and popular line of Water Pumps have been redesigned with an ultra-light housing

- Each Pump plate has been re-profiled and pocketed to remove unnecessary weight
- Average overall pump heights have been shortened by 3/4" and up to 2 lbs. weight reduction on average per pump
- Electric motor with heavy-duty windings, precision balancing, long-life brushes, stainless steel shaft and sealed ball bearings is superior in quality and pumps more water through the system during actual operating conditions than competing pumps
- Mounts directly to stock water pump location, includes stainless steel mounting hardware & gasket for simple installation
- Eliminates drive belt and fan to save weight and horsepower, while providing maximum circulation to improve cooling efficiency during all driving conditions, especially while idling
- Compatible with 12 and 16 volt systems
- High-temperature Viton® seal eliminates leaks
- Machined with -16AN port (except B.B. Mopar) for easier installation of our hose adapters, eliminating the need for teflon tape or pipe sealants
- Pumps can easily accommodate lower radiator hose from either driver or passenger side installations
- Clear anodized 6061-T6 billet aluminum pump housing, impeller, pump plate and motor cap along with powder-coated outer case will provide years of dependable operation
- Draws 8-10 amps in a typical 12V system, so it can be used on drag racing car without an alternator



No. 63547



No. 63557



No. 63565



No. 63585



No. 63575



No. 63595

BILLET ELECTRIC WATER PUMPS APPLICATION CHART

PART#	ENGINE	NOTES	HEIGHT (INCHES)	WEIGHT (WITH SPACERS, HARDWARE, BACKING PLATE, ETC.)
63547	Big Block Chevy		6.375 w/ spacers	7.15 lbs
63557	Small Block Chevy		6.218 w/ spacers	7.03 lbs
63565	Chrysler 273-360		4.600	6.29 lbs
63575	Chrysler 383-440		3.100	4.54 lbs
63585	Ford 289, 302, 351W Pre-'94 & 351W	Standard Rotation only	4.625	6.23 lbs
63595	Ford 429-460		4.75	7.00 lbs

PART # REPLACEMENT FOR 63575
97275 Seal kit

⚠ WARNING Prop. 65
This product contains a chemical known to the state of California to cause cancer-

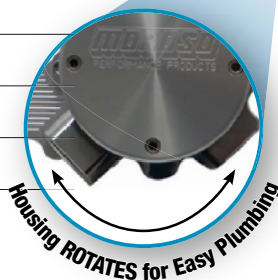

GM LS BILLET ELECTRIC WATER PUMP

Fits: GM LS Series
Patent D645,478

- Mounts directly to the stock water pump location
- Weighs 8.66 lbs.
- Eliminates bulky LS water pump with a more compact, cost-effective pump
- Drive belt is eliminated to save horsepower, while providing maximum circulation for cooling efficiency during all driving conditions, especially while idling
- Can be used with Moroso No. 63836 Alternator/Vacuum Pump Mount
- Compatible with 12 and 16 volt systems
- Draws 8-10 amps in a typical 12V system, so it can be used on drag racing car without an alternator
- Requires the use of a Remote Thermostat Housing such as Part No. 63425 or 63426

PART # DESCRIPTION
63566 Electric Water Pump, GM LS Series



No. 63566

⚠ WARNING Prop. 65
This product contains a chemical known to the state of California to cause cancer-



Remote Thermostat Housings on pg. 264

WATER PUMP, BILLET ELECTRIC

Remote Mount

- Use as a supplemental pump in remote cooling situations when space limits prohibit use of an engine mounted pump
- Weighs 5.94 lbs. with fittings
- Superior electric motor with heavy-duty windings, precision balancing, long life brushes, stainless shaft and sealed ball bearings pumps more water through the system than competitors' pumps!
- Clear anodized 6061-T6 billet aluminum pump housing, impeller and motor cap with a powder-coated outer case will provide years of dependable operation
- Draws 8-10 amps in a typical 12V system, so it can be used on drag racing car without an alternator
- Drive belt is eliminated to save horsepower, while providing efficient circulation for cooling, especially while idling
- Can be mounted vertically or horizontally
- Features a -16 AN O-ring inlet port, four -12 AN outlet ports, two -12 AN port plugs for different plumbing options
- High-temperature Viton® seal eliminates leaks



Rear impeller detail (below)



No. 63570



No. 63571

WARNING Prop. 65
This product contains a chemical known to the state of California to cause cancer, birth defects, or reproductive harm.

PART # DESCRIPTION

63570 Water Pump, Billet Electric, Remote Mount

PART # AVAILABLE OPTION

63571 Stainless Steel Mounting Plate, can be rotated 360° in 45° increments

ELECTRIC WATER PUMP RADIATOR HOSE ADAPTERS



63521



63522



63523



63525



22622



HOSE ADAPTERS for Electric Water Pump Motor BLACK Finish/Anodized Billet ALUMINUM End Cap



HOSE ADAPTERS for Electric Water Pump Motor - BLACK Finish



HOSE ADAPTERS for Electric Water Pump Motor - BLUE Finish

DESCRIPTION	PART #	PART #	PART #
1" NPT to -16AN Male	N/A	63541	63541
1" NPT to 1-1/2" hose	N/A	63542	63542
1" NPT to 1-3/4" hose	N/A	63543	63543
1" NPT to 1-1/4" hose	N/A	63544	63544
-16AN to -20AN Male	63525	N/A	N/A
-16AN to -16AN Male	22622 (see pg. 153)	N/A	N/A
-16AN to 1-3/4" hose	63523	N/A	N/A
-16AN to 1-1/2" hose	63522	N/A	N/A
-16 AN to 1-1/4" hose	63521	N/A	N/A

ELECTRIC WATER PUMP SPACER KIT

REMOTE WATER PUMP KIT, SMALL BLOCK FORD WITH JESEL DRIVE

Fits: Ford 289-302 & 351W with JESEL Part No. 34170 & 34175 Front Belt Drives

- Billet Aluminum 1 Inch adapter plate bolts on to where the water pump would normally reside on an engine, allowing the use of a remote water pump
- The adapter plate has two -12 AN female ports
- Includes o-rings and stainless steel socket head cap screws
- Hardware is long enough to accommodate a front motor plate



No. 63519

PART # DESCRIPTION

63519 Remote Water Pump Kit, Small Block Ford with Jesel Front Belt Drive

PART# AVAILABLE OPTION

63570 Remote Mount Electric Water Pump

22620 AN Fitting, -12AN to -12AN, 1 per package

WARNING Prop. 65
This product contains a chemical known to the state of California to cause cancer-

WATER PUMP ADAPTER KIT

Fits: GM LS Series

Patent D645,478

- Adapts a BBC style electric or conventional water pump to LS series engines
- Eliminates the bulky LS water pump with a more compact, cost effective pump
- Since BBC water pumps have been around for years, many different drive and pulleys are available and now can be used on a GM LS Series engine
- Kit includes: 2 billet aluminum adapter blocks (right and left), 2-¼ pump adapter plates, fasteners, Viton O-rings, and 4 high flow -12AN fittings
- Requires use of a Remote Thermostat Housing, such as Moroso Part No. 63425, or 63426

PART #	DESCRIPTION
63615	Remote Water Pump Adapter Kit, GM LS Series Engines



Remote Thermostat Housings
on pg. 264

WARNING Prop. 65
This product contains a chemical known to the state of California to cause cancer-

**No. 63615****REMOTE WATER PUMP ADAPTER KITS, SBC & BBC**

- In each kit two clear anodized adapters bolt onto where the water pump would normally reside on an engine. Allows the use of a remote water pump
- Spacers are .700" thick
- The Adapters have a -12AN female port
- Includes 4 gaskets and 8 stainless steel cap screws. The 4 extra screws are to accommodate a front motor plate

PART #	DESCRIPTION
63512	Remote Water Pump Adapter Kit, SBC
63513	Remote Water Pump Adapter Kit, BBC

PART #	AVAILABLE OPTIONS
22620	AN Fitting, -12AN to -12AN, 1 per package

WARNING Prop. 65
This product contains a chemical known to the state of California to cause cancer-

**No. 63512****REMOTE WATER PUMP ADAPTER KIT, GM LS**

Patent 8,424,497

- Remote adapters mount in place of the bulky GM LS series water pump
- Frees up space where normally a water pump would reside in race cars and in LS engine conversions
- Allows the use of a more compact, cost-effective remote electric water pump
- Kit includes: 2 billet aluminum adapter blocks (right and left), fasteners, Viton O-rings, and 4 high flow -12 AN fittings
- Requires use of Moroso Remote Mount Electric Water Pump Part No. 63570, and Remote Thermostat Housing, such as Moroso Part No. 63425 or 63426 and mounting bracket No. 63427

PART #	DESCRIPTION
63616	Remote Water Pump Adapter Kit, GM LS Series Engines

WARNING Prop. 65
This product contains a chemical known to the state of California to cause cancer-

**No. 63616****REMOTE WATER PUMP ADAPTER KITS**

Fits: Chrysler & Ford

- Billet Aluminum adapter plate bolts on to where the water pump would normally reside on an engine. Allows the use of a remote water pump
- The adapter plate has two -12AN female ports
- Includes a backing plate, gasket and stainless steel socket head cap screws
- Hardware is long enough to accommodate a front motor plate

PART #	DESCRIPTION
63514	Remote Water Pump Adapter Kit, Chrysler 273-360
63515	Remote Water Pump Adapter Kit, Ford 289-302 Pre '94 Timing Covers
63516	Remote Water Pump Adapter Kit, Ford 429-460

PART #	AVAILABLE OPTIONS
22620	AN Fitting, -12AN to -12AN, 1 per package

WARNING Prop. 65
This product contains a chemical known to the state of California to cause cancer-

**No. 63515**

CHEVROLET ELECTRIC WATER PUMPS

Polished Cover - Cast Aluminum

HIGH FLOW RATE!

- Unique impeller design and polished housing operate as an integral unit to pump approximately 19 gallons per minute

ADDS UP TO 20 HP!

- Powerful 12 volt electric motor eliminates V-belt drive
- Draws only 7 amps, allowing the battery to remain more fully charged during racing without an alternator

LIGHTWEIGHT, EASY TO INSTALL!

- Weighs less than conventional mechanical pump with separate electric drive motor
- Mounts to stock location; alternator and power steering drive kits available separately
- Overall pump height similar to stock pump height
- Use with optional Electric Water Pump Hose Adapters
- Water inlet size 1" NPT



No. 63539

WARNING Prop. 65
 This product contains a chemical known to the state of California to cause cancer, birth defects, or reproductive harm-

PART #	DESCRIPTION	ENGINE	HEIGHT
63539	Electric Water Pump	Small Block Chevy	5"
63546	Electric Water Pump	Big Block Chevy	5"
63555	Electric Water Pump	Small Block Chevy	5-1/4"

(Offset housing clears 8" Harmonic Balancers)

PART # AVAILABLE OPTIONS

63840	Alternator Mount Kit for Electric Water Pump No. 63546
63841	Alternator Drive Kit for Electric Water Pump No. 63546
63842	Alternator Mount Kit for Electric Water Pump No. 63555
63843	Alternator Drive Kit for Electric Water Pump No. 63555

PART # REPLACEMENT PARTS

97255	Seal Kit, Water Pump Electric
97257	Motor, Water Pump Electric

PART # AVAILABLE OPTIONS

63541	1" NPT to -16 AN Male Adapter
63542	1" NPT to 1 1/2" hose Adapter
63543	1" NPT to 1 3/4" hose Adapter
63544	1" NPT to 1 1/4" hose Adapter

ELECTRIC WATER PUMP DRIVE KIT

ELECTRIC WATER PUMP DRIVE KIT

- Engine dynamometer tests prove that many water pumps produce severe drag on the engines at high RPM, absorbing as much as 15-20 HP
- Universal application fits virtually every American V8 or V6 engine, including Chevy V8 and 90° V6 either "short" or "long" design, Ford 351C, 351W, Ford Big Block and Chrysler Small and Big Blocks
- Comes complete with 12 volt electric motor, all drive pulleys, belt, fasteners, and toggle switch
- Intended for Drag Race applications only
- Use with Moroso Thermostatic Switch **No. 63760** and Alternator Mount Drive Kits

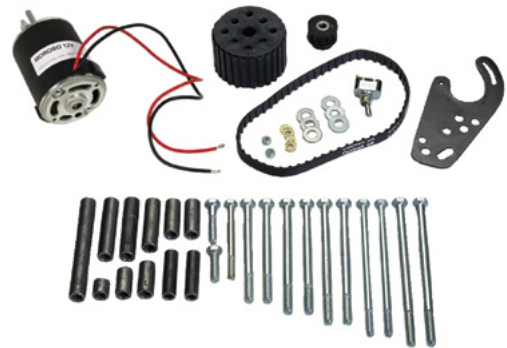

No. 63750

PART # DESCRIPTION

63750 Electric Water Pump Drive Kit

PART # REPLACEMENT PARTS

97210	12-Volt Electric Motor
97220	Water Pump Pulley
97230	21" Belt for Electric Water Pump
97250	Electric Motor Pulley

PART # AVAILABLE OPTIONS

97252	14-Tooth Pulley (to increase pump speed by 28%)
63760	Thermostatic Water Pump Switch

TYPICAL INSTALLATIONS



Small Block and 90° V6 Chevy



289, 302, 351W Ford

Moroso first pioneered the aluminum water pump for racing over 40 years ago. Over the years, continual improvements have resulted in providing the best cooling system components available for competition use. Computer designed housing cast from 356-T6 aluminum and lightweight impellers are engineered to maintain consistent coolant temperature throughout the water jacket, preventing localized boiling, detonation, head warping and cracking, etc.

SMALL BLOCK CHEVROLET

1955-68 "Short" Design, 5/8" Shaft

- Reinforced housing for extra strength
- Lightweight, low drag impeller adds 14HP @ 7,500 RPM
- Includes integral cam stop boss
- Overall length of 5.603" from rear mounting face to hub face

PART # DESCRIPTION

63500 Aluminum Water Pump, Small Block and 90° V6 Chevy 5/8" shaft, 1955-68 "short" design

PART # AVAILABLE OPTIONS

64035 Water Pump Pulley Shims

PART # REPLACEMENT PART

97450 Gasket and Seal Kit



No. 63500

WATER PUMP SPACER KITS

- Converts "short" 1968-earlier design Chevrolet water pumps to longer, 1969-later design
- Includes special heat-treated studs and gaskets

PART # DESCRIPTION

63510 Water Pump Spacer Kit, 1-7/32" Long, SBC and 90° V6 Chevy, Cast Aluminum Converts **Nos. 63500** short water pump to the longer late-model design

63610 Water Pump Spacer Kit, 1-9/16" Long, BBC, Cast Aluminum

63511 Water Pump Spacer Kit, 1-7/32" Long, SBC and 90° V6 Chevy, Billet Aluminum Converts **Nos. 63500** short water pump to the longer late-model design

63611 Water Pump Spacer Kit, 1-9/16" Long, BBC, Billet Aluminum



No. 63510

No. 63511

WATER PUMP GASKETS

WATER PUMP GASKETS, HEAVY DUTY, CHEVROLET

- An excellent way to seal a Moroso electric water pump or a conventional water pump to an engine block
- Race quality water pump gaskets are constructed out of a cellulose composition that conforms to it's mating surface
- Precision die cut design

PART # DESCRIPTION

93230 Water Pump Gasket, SBC, 2 pack

93231 Water Pump Gasket, SBC, 10 pack

93232 Water Pump Gasket, BBC, 2 pack

93233 Water Pump Gasket, BBC, 10 pack



Nos. 93230, 93231



Nos. 93232, 93233

WATER PUMP GASKETS, HEAVY DUTY, CHRYSLER

- An excellent way to seal a Moroso electric water pump or a conventional water pump to an engine block
- Race quality water pump gaskets are constructed out of a cellulose composition that conforms to it's mating surface
- Precision die cut design

PART #	DESCRIPTION
93234	Water Pump Gasket, Chrysler 273-360, single pack
93235	Water Pump Gasket, Chrysler 273-360, 10 pack
93236	Water Pump Gasket, Chrysler 383-440, single pack
93237	Water Pump Gasket, Chrysler 383-440, 10 pack



WATER PUMP GASKETS, HEAVY DUTY, FORD

- An excellent way to seal a Moroso electric water pump or a conventional water pump to an engine block
- Race quality water pump gaskets are constructed out of a cellulose composition that conforms to it's mating surface
- Precision die cut design

PART #	DESCRIPTION
93238	Water Pump Gasket, Ford 289, Standard Rotation 302 & 351W, single pack
93239	Water Pump Gasket, Ford 289, Standard Rotation 302 & 351W, 10 pack
93240	Water Pump Gasket, Ford 429-460, single pack
93241	Water Pump Gasket, Ford 429-460, 10 pack



COOLING SYSTEM ACCESSORIES

AIR BLEED VALVE

- Bleeds air from any cooling system
- Resistant to fuels, oil and anti-freeze
- Brass construction with push button to release pressure
- Fits 1/8" NPT thread

PART #	DESCRIPTION
63765	Air Bleed Valve

WARNING Prop. 65
This product contains a chemical known to the state of California to cause cancer, birth defects, or reproductive harm-



No. 63765

TEMPERATURE GAUGE FITTING

- Corrosion resistant brass; fits standard 1/2" NPT tapped holes in cylinder heads and manifolds
- 5/8" -18 threaded hole in fitting accepts popular sending units

PART #	DESCRIPTION
63645	Temperature Gauge Fitting

WARNING Prop. 65
This product contains a chemical known to the state of California to cause cancer, birth defects, or reproductive harm-



No. 63645

WATER OUTLET RESTRICTOR KIT

- Restricting coolant flow leaving the engine lets you control the amount of heat absorbed by the coolant
- Red, gold and blue anodized aluminum restrictor plates are mounted under the water outlet on the intake manifold
- Kit consists of three restrictor plates with 5/8", 3/4" and 1" I.D. holes for optimum coolant flow, 2-1/8" O.D.

PART #	DESCRIPTION
63440	Water Outlet Restrictor Kit. GM V8, GM V6, Ford 260-302, 351W



No. 63440

THERMOSTATIC WATER PUMP SWITCH

- Provides automatic control of Electric Water Pumps
Nos. 63539, 63546, 63547, 63555, 63557, 63565, 63570, 63575, 63585 and 63595 and Electric Water Pump Drive Kit **No. 63750**
- Eliminates unnecessary battery drain by turning on the electric pump motor when coolant temperature exceeds 160° F (±5°) and turning it off when coolant temperature reaches 140° F (±5°)
- Toggle Switch has three settings: Automatic, Manual and Off. In the "Manual" position, the motor is constantly on.
- Contact rating of switch is 15 amps at 32 volts; use with 10 amp fuse (not included)



No. 63760

WARNING Prop. 65
This product contains a chemical known to the state of California to cause cancer, birth defects, or reproductive harm-

PART #	DESCRIPTION
63760	Thermostatic Switch, Electric Water

RACING RADIATOR CAPS

Fits: Standard-size radiator filler necks, including Moroso Nos. 63420, 63465, 63466, 63467, 63485, 63486, 63650, 63651, 63655, 63656, 63730, 63740 and 63745

- Available with low and high pressure ratings to accommodate the needs of all cooling systems
- Steel spring maintains accurate pressure setting over time
- Six-sided Cap for easy tightening



No. 63324

PART #	DESCRIPTION	PART #	DESCRIPTION
63307	Racing Radiator Cap, 6-8 lbs.	63320	Racing Radiator Cap, 19-21 lbs.
63309	Racing Radiator Cap, 8-10 lbs.	63324	Racing Radiator Cap, 23-25 lbs.
63313	Racing Radiator Cap, 12-16 lbs.	63328	Racing Radiator Cap, 27-29 lbs.
63316	Racing Radiator Cap, 14-18 lbs.	63332	Racing Radiator Cap, 31-33 lbs.

RADIATOR HOSE DRAIN

- Cast aluminum drain adapts the 1-¼" outlet from the popular VW Scirocco radiator to the 1-9/16" inside diameter of the standard lower radiator hose found in most Chevys
- Includes petcock for draining engine coolant
- 100% leak tested



No. 63700

WARNING Prop. 65
This product contains a chemical known to the state of California to cause cancer, birth defects, or reproductive harm-

PART #	DESCRIPTION
63700	Radiator Hose Drain

RADIATOR BLEED OR DRAINS

- Are spliced into the upper radiator hose to add a bleed or spliced into the lower radiator hose to add a drain
- Constructed out of 356-T6 cast aluminum with a 3/8" brass petcock
- 100% leak tested



No. 63731



No. 63746



No. 63741

WARNING Prop. 65
This product contains a chemical known to the state of California to cause cancer, birth defects, or reproductive harm-

PART #	DESCRIPTION
63731	Radiator Bleed or Drain, 1-1/2" to 1-1/2" Hose
63741	Radiator Bleed or Drain, 1-1/2" to 1-1/4" Hose
63746	Radiator Bleed or Drain, 1-1/4" to 1-1/4" Hose

RADIATOR HOSE FILLERS

- 356-T6 cast aluminum Radiator Hose Fillers are spliced into the upper radiator hose to provide more complete cooling system filling
- Standard size radiator cap receptacle is welded to the cast flange (radiator cap not included)
- 100% leak tested



No. 63730



No. 63740

PART #	DESCRIPTION
63730	Radiator Hose Filler, 1-½" hose to 1-½" hose
63740	Radiator Hose Filler, 1-½" hose to 1-¼" hose
63745	Radiator Hose Filler, 1-¼" hose to 1-¼" hose

BOLT-ON WITH -16AN FITTING

Fits: Small Block Ford

- Anodized aluminum
- -16AN fitting for use with steel braid reinforced upper radiator hose
- Includes gasket

PART #	DESCRIPTION
63455	Water Outlet Filler Neck, Ford, -16AN Fitting

No. 63455



WATER OUTLET, BILLET ALUMINUM, O-RING SEAL

Fits: Small Block, Big Block and 90 Deg. V6 Chevy Intake Manifolds

- One piece design machined from a billet bar
- No Gasket needed, designed with an O-Ring Groove & O-Ring included
- Clear Anodized finish
- Includes stainless steel mounting hardware

PART#	DESCRIPTION
63473	Water Outlet, Billet Aluminum, Chevy, -16AN Male Fitting
63474	Water Outlet, Billet Aluminum, Chevy, -20AN Male Fitting
63477	Water Outlet, Billet Aluminum, Chevy, 1.5" Hose Fitting

No. 63473



No. 63477



WARNING Prop. 65
This product contains a chemical known to the state of California to cause cancer-

WATER OUTLET, BILLET ALUMINUM, AN & 3/8" PORTS

Fits: Small Block, Big Block and 90° V6 Chevy Intake Manifolds

- Features two 3/8" NPT female ports to plumb water to cylinder head for cooling
- Includes stainless steel mounting hardware

PART #	DESCRIPTION
63461	Water Outlet, Billet Aluminum, Chevy, -16AN fitting and two 3/8" NPT female ports, Black, Gasket
63475	Water Outlet, Billet Aluminum, Chevy, -16AN Male Fitting, 3/8" NPT Ports, Clear Anodized finish, O-Ring
63476	Water Outlet, Billet Aluminum, Chevy, -20AN Male Fitting, 3/8" NPT Ports, Clear Anodized finish, O-Ring

WARNING Prop. 65
This product contains a chemical known to the state of California to cause cancer, birth defects, or reproductive harm-

No. 63475



BOLT-ON, STAMPED ALUMINUM

- Black anodized aluminum
- Accepts Moroso or standard-size radiator cap (not included)
- Replacement Filler Neck Kit **No. 63420**
- Includes gasket

PART #	DESCRIPTION
63465	Stamped Aluminum Filler Neck, Chevy, Bolt-On

No. 63465



BOLT-ON, BILLET ALUMINUM

- Made from 6061-T6 billet aluminum
- Easily mounts to any Big Block or Small Block Chevy intake manifold, and can be used in all racing and street-performance applications where a heavy-duty filler neck is required
- Includes screw-in 1/8" NPT hose fitting for expansion tanks, and accepts Moroso or standard-size radiator cap (not included)
- Can also be used as a heavy-duty replacement in our Filler Neck Kit **No. 63420**
- Includes gasket

PART #	DESCRIPTION
63466	Billet Aluminum Filler Neck, Chevy, Bolt-On
63468	Billet Aluminum Filler Neck, Chevy, Bolt-On, Black Anodized Finish

No. 63466



WELD-ON, STAMPED ALUMINUM

- Ideal for custom applications
- Accepts Moroso or standard-size radiator cap (not included)
- Multiple applications including race and street performance

PART #	DESCRIPTION
63485	Stamped Aluminum Filler Neck, Weld-On

No. 63485



WELD-ON, BILLET ALUMINUM

- Made from 6061-T6 billet aluminum
- This weld-on version can be used wherever a heavy-duty, custom-application filler neck is required
- Includes screw-in 1/8" NPT hose fitting for expansion tanks, and accepts Moroso or standard-size radiator cap (not included)

PART #	DESCRIPTION
63486	Billet Aluminum Filler Neck, Weld-On

No. 63486



WELD-ON BILLET ALUMINUM FILLER NECK FOR SAE TYPE B RADIATOR CAPS

- Accepts Small Radiator Caps, SAE Type B/43mm
- Made from 6061-T6 billet aluminum
- This weld-on version can be used wherever a heavy-duty, custom-application filler neck is required
- Includes screw-in hose fitting for recovery tanks

PART #	DESCRIPTION
63488	Billet Aluminum Filler Neck, SAE Type B, Weld-On

No. 63488



EXTENDED WATER FILLER NECK

- Extended filler neck raises water fill point 5-3/4" above manifold; ideal for bleeding off cooling system air
- 60° incline of filler tube clears air scoops to provide quick and accessible filling for between-rounds cool down
- Mounting base, extension tube and neck are all manufactured from rugged 6061-T6 billet aluminum to withstand harsh racing environments and continual cap removal/replacement
- Accepts Moroso or standard-size radiator cap (not included)
- Includes gasket and 1/8" NPT to 3/8" I.D. barbed fitting to plumb expansion tanks
- Includes gasket
- Use with Moroso Manifold Filler Neck Kit No. 63420

PART #	DESCRIPTION
63467	Extended Filler Neck, SBC, BBC and 90° V6 Chevy intake manifolds; drag racing and street performance use

No. 63467



FILLER NECK MANIFOLD HOUSING

- Locates filler neck at highest point on cars with low-mount radiators to bleed off air
- Unit can be flipped 180° for either right or left outlet location
- Includes 1/2" NPT fitting for installing water temperature sending unit and two 1/4" NPT fittings for return lines on popular aftermarket cylinder heads
- Made of 356-T6 cast aluminum; 3-1/4" high
- Includes gaskets, bolts and washers, and standard size radiator cap filler neck

PART #	DESCRIPTION
63420	Filler Neck Manifold Housing, Chevrolet V8 & 90° V6

No. 63420



REPLACEMENT PARTS

63465	Filler Neck only (for standard size radiator cap)
63466	Heavy-Duty Filler Neck only (for standard size radiator cap)



Moroso Radiator Caps
on pg. 258



FILLER NECK MANIFOLD HOUSING

- Manifold-mounted filler neck base is identical to the one included in Moroso Kit No. 63420 without the filler neck or mounting hardware
- Allows you to install a variety of bolt-on style filler necks (radiator cap or -AN style) or block-off plates, offering cooling system flexibility for both race and street applications
- 356-T6 cast-aluminum base stands 2-5/16" tall, which locates filler neck at highest point to bleed off air on cars with low-mount radiators
- Includes a 1/2" NPT machined port for installing a water temperature sending unit, and two 1/4" NPT machined ports to plumb return lines on popular aftermarket cylinder heads
- The unit can be flipped 180° for either right or left water hose outlet location
- Use with one of Moroso's Bolt-On Filler Necks Nos. 63461, 63465, 63466 or Block-Off Plate No. 63471

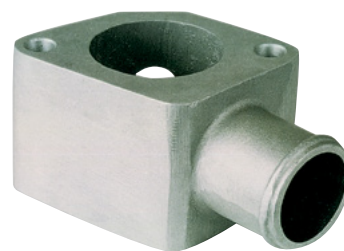

No. 63423

PART # DESCRIPTION

63423 Filler Neck Manifold Housing, Chevrolet V8 & 90° V6 Intake Manifolds

PART # AVAILABLE OPTION

63469 Filler Neck, O-Ring Gasket/Spacer

FILLER NECK MANIFOLD HOUSING

Billet Aluminum Housing with -16AN Port, Billet Aluminum Filler Neck & Hardware, Chevy Pattern, Adaptable Outlet

- -16AN female port is designed to be used with Nos. 22622, 63521, 63522, 63523, 63525
- Black anodized billet aluminum housing with the included bolt-on billet aluminum radiator neck stands 3-1/4" tall, which locates filler neck at highest point to bleed off air on cars with low-mount radiators
- The unit can be flipped 180 Deg. for either right or left water hose outlet location
- No need to worry about gaskets because on the top and bottom of the housing are machined O-ring grooves with included O-rings
- Includes a 1/2" NPT port for installing a water temperature sending unit and two 1/4" NPT ports to plumb return lines on popular aftermarket cylinder heads
- Includes bolts and washers



No. 63424

PART # DESCRIPTION

63424 Filler Neck Manifold Housing, Billet Aluminum, -16AN Female Port

FILLER NECK MANIFOLD HOUSING

Billet Aluminum Housing with -16AN Port, Chevy Pattern, Adaptable Outlet

- -16AN female port is designed to be used with Nos. 22622, 63521, 63522, 63523, 63525
- Black anodized billet aluminum housing stands 2-5/16" tall, which locates filler neck at highest point to bleed off air on cars with low-mount radiators
- No need to worry about gaskets because on the top and bottom of the housing are machined O-ring grooves with included O-rings
- Includes a 1/2" NPT port for installing a water temperature sending unit and two 1/4" NPT ports to plumb return lines on popular aftermarket cylinder heads
- The unit can be flipped 180 Deg. for either right or left water hose outlet location
- Use with one of Moroso's Bolt-On Filler Necks Nos. 63461, 63465, 63466 or Block-Off Plate No. 63471



No. 63422

PART # DESCRIPTION

63422 Filler Neck Manifold Housing, Billet Aluminum, -16AN Female Port

FILLER NECK MANIFOLD HOUSING

Billet Aluminum Housing with 1" NPT Port, Chevy Pattern, Adaptable Outlet

- 1" NPT port is designed to be used with Nos. 63541, 63542, 63543 and 63544
- Black anodized billet aluminum housing stands 2-5/16" tall, which locates filler neck at highest point to bleed off air on cars with low-mount radiators
- Has to be mounted with conventional gaskets or Moroso No. 63469 Filler Neck O-Ring Gasket
- Includes a 1/2" NPT port for installing a water temperature sending unit and two 1/4" NPT ports to plumb return lines on popular aftermarket cylinder heads
- The unit can be flipped 180° for either right or left water hose outlet location
- Use with one of Moroso's Bolt-On Filler Necks Nos. 63461, 63465, 63466 or Block-Off Plate No. 63471



No. 63421

PART # DESCRIPTION

63421 Filler Neck Manifold Housing, Billet Aluminum, 1" NPT

WATER NECK BLEEDER KIT

Cast Aluminum Fits: Chevrolet

- A quick and easy way to remove air from the cooling system
- Design allows the body to be flipped so that the 1-1/2" hose outlet can face right or left
- Features a 1/2" NPT rear port for temperature senders and two 1/4" NPT ports for plumbing return lines to cylinder heads
- Includes filler neck housing with 1-1/2" hose outlet, bleeder, bleeder plate, hardware and gaskets
- Can be used with Moroso Expansion Tank Part Nos. **63650, 63651, 63655 and 63656**

PART #	DESCRIPTION
63430	Water Neck Bleeder Kit, Cast Aluminum

 **WARNING Prop. 65**
This product contains a chemical known to the state of California to cause cancer, birth defects, or reproductive harm-



No. 63430

WATER NECK BLEEDER KIT

Billet Aluminum Fits: Chevrolet

- A quick and easy way to remove air from cooling system
- Allows the use of steel reinforced hose or lightweight hose to be used in cooling system
- Includes anodized billet water neck with 1" NPT outlet, bleeder, bleeder plate, hardware and gaskets
- 1" NPT machined port is designed to use with popular hose adapters (including -AN) sizes, Moroso Nos. **63541, 63542, 63543 and 63544**
- Can be used with Moroso Expansion Tank Nos. **63650, 63651, 63655 or 63656**

PART #	DESCRIPTION
63431	Water Neck Bleeder Kit, Billet Aluminum

 **WARNING Prop. 65**
This product contains a chemical known to the state of California to cause cancer, birth defects, or reproductive harm-



No. 63431

WATER NECK BLEEDER PLATE

Fits: Chevrolet

- Allows quick and easy removal of air from the cooling system at it's highest point
- Includes water neck bleeder plate, petcock with hose adapter and one water neck gasket
- Can be used as a replacement part for Moroso Nos. **63430 and 63431**

PART #	DESCRIPTION
63432	Water Neck Bleeder Plate

 **WARNING Prop. 65**
This product contains a chemical known to the state of California to cause cancer, birth defects, or reproductive harm-



No. 63432

WATER NECK BLOCK-OFF PLATE

- 1/4" aluminum plate provides an ideal base to weld-your-own radiator hose fitting to the intake manifold
- Untreated aluminum makes it easy to drill opening and weld any size fitting of your choice
- Perfect for racing and custom applications
- Gasket included

PART #	DESCRIPTION
63471	Water Neck Block-Off Plate, Chevrolet V8 & 90° V6

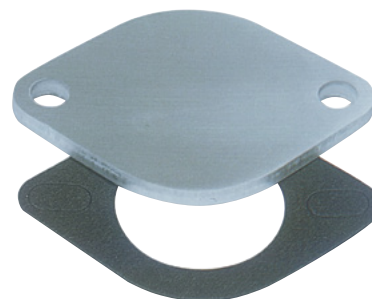

No. 63471

FILLER NECK

O-Ring Gasket/Spacer

- Mounts between filler necks and filler neck manifolds to create a reusable O-ring seal, no need to use gaskets or sealants
- Can also be used as a 1/4" thick spacer when clearance is needed
- Manufactured from billet aluminum with machined O-ring grooves in the top and bottom, anodized finish
- Includes O-rings

PART # DESCRIPTION

63469 Filler Neck, O-Ring Gasket/Spacer



No. 63469

THERMOSTAT SPACER, BRODIX HV SERIES INTAKES INCLUDING SBC & BBC APPLICATIONS

- Spacer solves the issue of trying to use a thermostat on a Brodix HV Series Intake, can also be used on SBC and BBC applications to add water lines and/or raise thermostat to eliminate potential fitment issues
- Manufactured from billet aluminum with a machined O-ring groove on the intake side and thermostat register on top
- 1" thick spacer has two 3/8" NPT female ports for plumbing water lines to cylinder heads, includes O-ring

NEW!

PART # DESCRIPTION

63433 Thermostat Spacer, Brodix HV Series Intakes

No. 63433



PART # AVAILABLE OPTION

63000 Gasket, Thermostat/Water Neck, SBC & BBC

SBC & BBC THERMOSTAT/WATERNECK GASKETS

- Same gasket that comes with Moroso non-o-ring filler/water neck kits
- Fiber construction
- Use as a replacement for Moroso non-o-ring filler/water neck kits or as a high quality replacement gasket for SBC & BBC thermostat housings
- Available as a single pack or 10 pack

NEW!

PART # DESCRIPTION

63000 Gasket, Thermostat/Water Neck, SBC & BBC

63001 Gasket, Thermostat/Water Neck, SBC & BBC, 10 Pack

No. 63000



REMOTE THERMOSTAT HOUSINGS

Allow the street, race or marine enthusiast to have a thermostat in their cooling system away from the engine itself. This could be if the engine has a blower manifold that does not allow the thermostat to be on the engine itself or if Moroso Part Nos. **63615**, **63616** or **63566** water pump adapters for the GM LS series of engines are being used.

- Made from 6061T-6 Billet Aluminum
- The housing has two -12AN female O-ring inlet ports
- Thermostat or restrictor is placed between this housing and a conventional manifold housing such as part **No. 63423**, where a radiator hose connects it to the radiator
- Can be used with Moroso cooling system accessories, Part Nos. **63420**, **63421**, **63423**, **63430**, **63431**, **63432**, **63461**, **63465**, **63466** and **63471**

PART # DESCRIPTION

- 63425** Remote Thermostat Housing, Inlet ports on bottom
63426 Remote Thermostat Housing, Inlet ports on each side

PART # AVAILABLE OPTIONS

- 63427** Mounting Bracket for Remote Thermostat Housings **Nos. 63425** and **63426**
97641 Fittings, -12AN, two pack

**No. 63425****No. 63426****MOUNTING BRACKET**

- Mounts Moroso **No. 63425** and **63426** Remote Thermostat Housings to the front passenger side GM LS Series cylinder heads
- Manufactured from 1/4" 6061 T-6 Aluminum

PART # DESCRIPTION

- 63427** Mounting Bracket for Remote Thermostat Housings

**No. 63427**

SUPER COOL CAN

For Carbureted and Fuel Injected Applications up to 125 PSI working pressure

- Polyethylene shell has a much higher insulating value than cork, allowing ice to last longer and cooling fuel more efficiently for a denser air-fuel mixture
- The higher insulating value of the shell combined with an advanced heat sink design reduces fuel temperature 20% over other cool cans
- The inlet and outlet are -8AN
- Lid is held on by a wing nut with a closed-cell foam seal between the lid and can
- NHRA approved mounting includes two stainless steel straps with T-bolt clamps and lightweight aluminum mounting bracket
- Spacing of steel straps aligns perfectly with mounting bosses molded into the Super Cool Can housing for strong attachment
- Holds ½ quart of fuel, approximate dimensions: 7-3/4" x 7-3/4" x 8" tall

NEW!



No. 65127

WARNING Prop. 65
This product contains a chemical known to the state of California to cause cancer, birth defects, or reproductive harm.

PART # DESCRIPTION

65127 Super Cool Can, -8AN female fittings

PART # REPLACEMENT PART

97817 Super Cool Can Mounting Kit

PART # AVAILABLE OPTION

22604 Fitting, -8AN Male to -8AN Straight O-ring Side

THROTTLE CABLE MOUNTING KIT

Fits: 4500 Series Holley® Dominator 4500 Series and BG King Demon® carburetors

- This unique kit facilitates mounting of throttle cables to a fixed point while providing adjustability to compensate for variances in cable length and cable ends
- Comes complete with Morse-style throttle cable bracket, universal return spring assembly and all necessary installation hardware
- Four-hole under-carb design provides security of a linkage safety plate
- Unlike competitor's products, these accessory brackets bolt to plate separately instead of stacking up on the carb studs
- Separate bolting design allows access for easy carb servicing and the option of additional accessories while providing clearance to linkage
- Designed to be used with Moroso's line of bolt-on brackets and accessories



No. 65047

WARNING Prop. 65
This product contains a chemical known to the state of California to cause cancer, birth defects, or reproductive harm.

PART # DESCRIPTION

65047 Throttle Cable Mounting Kit

PART # AVAILABLE OPTION

93310 Carburetor Gasket, 4500/King Demon Open (2 Required)

PART # REPLACEMENT PARTS

64917 Throttle Return Springs

FUEL REGULATOR MOUNTING BRACKETS

- Lightweight, laser-cut, steel brackets securely mount popular regulators including Holley®, Aeromotive™, MagnaFuel® and Barry Grant®
- Can be used to mount extra regulator for nitrous systems
- Easily formed for custom installation

PART # DESCRIPTION

65052 Fuel Regulator Mounting Bracket for Holley®

65062 Fuel Regulator Mounting Bracket for MagnaFuel® & Barry Grant®

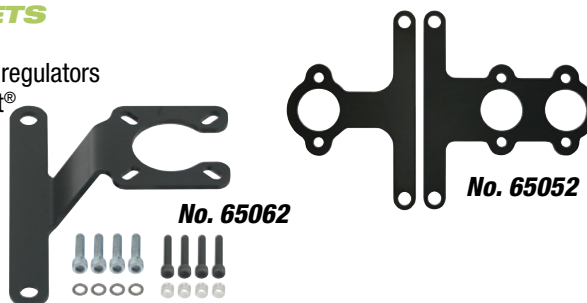

No. 65062

No. 65052

SPARK PLUG RACK

- Easy to mount
- Lightweight, laser cut steel bracket
- Ensures spark plugs are installed in the same cylinder

PART # DESCRIPTION

65064 Spark Plug Rack



Carburetor Tools
on pgs. 239-240

No. 65064



FUEL SYSTEM EQUIPMENT

THROTTLE CABLE MOUNTING KIT

Holley® 4150/4160 series Carbs - Morse® Cables

- Lets the racer easily mount Morse® cable to Holley® 4150/4160 carburetors
- Includes a 1/8" anodized aluminum mounting plate, a special 1/4" bore rod end with 10-32 thread, a quick-release cable mount, and all required hardware
- Throttle Return Spring Kit **Nos. 64925, 64926 or 64927** recommended

PART # DESCRIPTION

65045* Throttle Cable Mounting Kit, for Holley® Carbs with Morse® accelerator cables

PART # AVAILABLE OPTION

93300 Carburetor Gasket, 4150/4160 Open (2 Required)

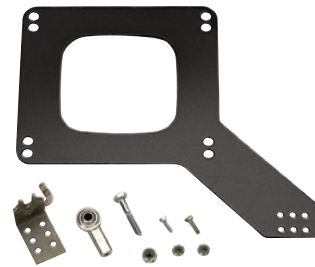

No. 65045

THROTTLE CABLE MOUNTING KIT

Holley® 4150/4160 series Carbs - Late Model GM

- Includes all necessary hardware to mount a Holley® carburetor on a late model GM vehicle
- Comes with a 1/8" anodized aluminum mounting plate and required clips, pivot, nuts and bolts to complete the job
- Throttle Return Spring Kit **Nos. 64925, 64926 or 64927** recommended

PART # DESCRIPTION

65050* Throttle Cable Mounting Kit, for Holley® on late model GM cars and trucks

PART # AVAILABLE OPTION

93300 Carburetor Gasket, 4150/4160 Open (2 Required)

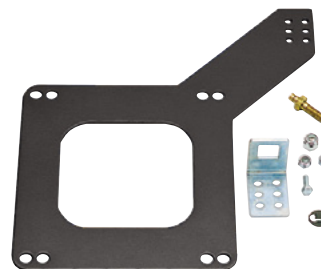

No. 65050

THROTTLE CABLE MOUNT KIT WITH RETURN SPRING

- Designed to less likely bind and hold the throttle open
- Solid rod linkage designs have and will keep the throttle open in certain crash parameters
- Built to take the punishment of Circle Track or Road Racing yet lightweight enough to satisfy the weight conscious Drag Racer
- Manufactured out of thick 12 ga. laser cut steel with a durable E-coat finish
- Provides throttle cable mount and return spring in one under-carburetor plate
- Complete with quick release cable bracket, light and heavy return springs and mounting hardware
- Comes with 1/4" rod end with 10-32 threads for Morse style cables

PART # DESCRIPTION

65070* Throttle Cable Mount Kit with Return Spring, R4412 Style 2BBL Carburetors

65075* Throttle Cable Mount Kit with Return Spring, 4150 Style 4BBL Carburetors

PART # AVAILABLE OPTION

93300 Carburetor Gasket, 4150/4160 Open (2 Required)

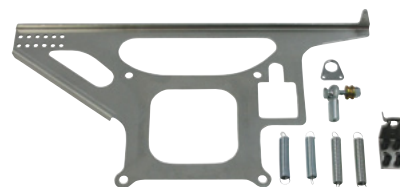

No. 65075

WARNING Prop. 65
This product contains a chemical known to the state of California to cause cancer, birth defects, or reproductive harm-

THROTTLE CABLE MANIFOLD MOUNTED CHEVY V6/ V8

- Provides positive throttle return required by several sanctioning bodies
- Each kit fits Holley® 2 or 4 bbl. single carb applications
- Includes one set of return springs

PART # DESCRIPTION

64922* Throttle Return Spring Kit, 18° SBC Cylinder Heads, Manifold Mount, 5-7/16" Tall

64925* Throttle Return Spring Kit, SBC and 90° V6 Chevy, Manifold Mount, 1-13/16" Tall

64926* Throttle Return Spring Kit, BBC, Manifold Mount, 1-13/16" Tall

64928* Throttle Return Spring Kit, Tall Version to facilitate throttle return on spacer equipped SBC and 90° V6 Chevy engines, Manifold Mount, 4-3/4" Tall

PART # AVAILABLE OPTION

64929* Throttle Return Springs



No. 64922

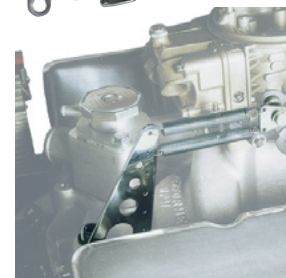

WARNING Prop. 65
This product contains a chemical known to the state of California to cause cancer, birth defects, or reproductive harm-

**Not legal for sale or use on pollution-controlled vehicles.*



FUEL SYSTEM EQUIPMENT

THROTTLE RETURN SPACING KIT, 4500 HOLLEY® SERIES

- Clears most air cleaner combinations and can be used with dual carbs
- Made from sturdy 14-gauge steel and finished in hand-polished chrome
- Kit includes heavy and light sets of stainless steel return springs, all mounting hardware, and complete installation instructions



No. 64923

PART # DESCRIPTION

64923 Throttle Return Spring Kit, Holley® 4500, Carb Mount

PART # REPLACEMENT PARTS

64917 Throttle Return Springs

WARNING Prop. 65
This product contains a chemical known to the state of California to cause cancer, birth defects, or reproductive harm-

THROTTLE RETURN SPACING KIT, 2300/4100 HOLLEY® SERIES ROAD, SPEED, RACE DEMON SERIES

- The answer to your throttle return spring linkage problems if you're running a 2300/2305 series two-barrel or 4150/4160 series 4-barrel Holley® doesn't include HP Series or Road, Speed, Race Demon™ carburetor
- Designed and built rugged enough for competition, yet its polished chrome finish is suitable for the finest show car
- Includes one set of heavy and one set of light springs

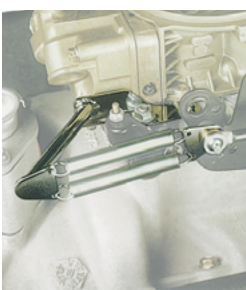
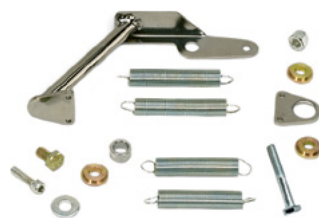

No. 64927

PART # DESCRIPTION

64927 Throttle Return Spring Kit, 2300/4100 Holley® Series, Road, Speed, Race Demon™ Series Carb Mounts

PART # REPLACEMENT PARTS

64917 Throttle Return Springs

WARNING Prop. 65
This product contains a chemical known to the state of California to cause cancer, birth defects, or reproductive harm-

THROTTLE RETURN SPACING KIT, 4500 DOMINATOR & KING DEMON

- Fits a 4500 series and King Demon carburetors
- Made from sturdy 12-gauge steel and finished in (electrostatic paint) E-coat satin black
- Kit includes heavy and light sets of stainless steel return springs, all mounting hardware and complete installation instructions

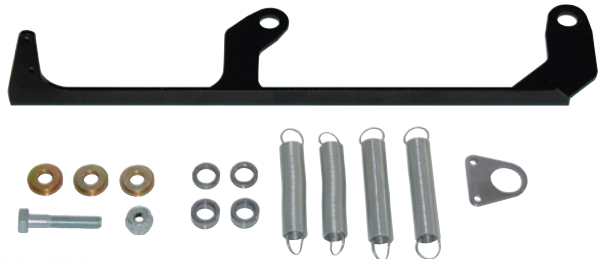

No. 64918

PART # DESCRIPTION

64918 Throttle Return Spring Kit, 4500 Dominator and King Demon Carb Mounts

PART # REPLACEMENT PARTS

64917 Throttle Return Springs

WARNING Prop. 65
This product contains a chemical known to the state of California to cause cancer, birth defects, or reproductive harm-

THROTTLE RETURN SPACING KIT, 4150 HOLLEY® SERIES

Including HP Series

- Made to clear low-profile racing air cleaner, Moroso **No. 65910**
- Manufactured from sturdy 12-gauge steel and finished in (electrostatic paint) E-coat satin black
- Kit includes heavy and light sets of stainless steel return springs, all mounting hardware and complete installation instructions

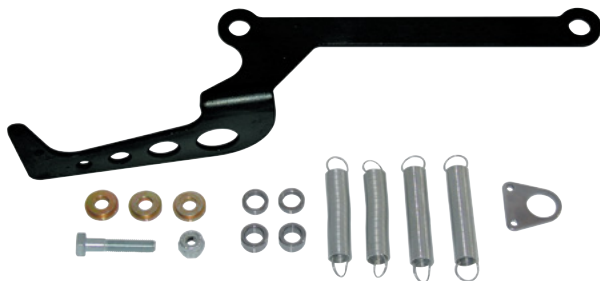

No. 64919

PART # DESCRIPTION

64919 Throttle Return Spring Kit, 4150 Holley® Series Carb including HP Series

PART # REPLACEMENT PARTS

64917 Throttle Return Springs

WARNING Prop. 65
This product contains a chemical known to the state of California to cause cancer, birth defects, or reproductive harm-



FUEL SYSTEM EQUIPMENT

THROTTLE RETURN SPRINGS

- Pack of two stainless steel springs can be used as spares or replacements for Moroso Throttle Return Spring Kit **Nos. 64925, 64926 and 64928**

PART # DESCRIPTION
64929 Throttle Return Springs

 **WARNING Prop. 65**
 This product contains a chemical known to the state of California to cause cancer, birth defects, or reproductive harm-



No. 64929

THROTTLE RETURN SPRING

Replacement Kit

- Replacements for Moroso Throttle Return Spring Kit **Nos. 64918, 64919, 64923, 64927, 65047, 65070 and 65075**
- Kit includes Two 2.5" long and Two 2.75" long springs

PART # DESCRIPTION
64917 Throttle Return Springs, Replacement

 **WARNING Prop. 65**
 This product contains a chemical known to the state of California to cause cancer, birth defects, or reproductive harm-



No. 64917

CARBURETOR SAFETY PLATE

- Fits Holley® Dominator 4500-series Carbs
- Prevents linkage that may become loose from carburetor from falling into intake
- Steel, plated clear zinc

PART # DESCRIPTION
64935 Carburetor Safety Plate, Dominator

PART # AVAILABLE OPTION
93310 Carburetor Gasket, 4500/King Demon Open (2 Required)

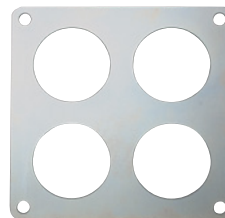

No. 64935

CARBURETOR LINKAGE BUSHING SET

- Steel linkage bushing set allows the fitting of a 1/4" fastener to the 1/2" dia. hole found in the throttle linkage plate of Holley® 4 barrel carbs
- Split bushing design permits simple installation and eliminates the sloppiness present when rubber bushings are used
- Clear zinc finish

PART # DESCRIPTION
64920 Carburetor Linkage Bushing Kit, Holley® 4 bbl carbs



No. 64920

THROTTLE STOP FOR HOLLEY® CARBS

For 4150-Series Carburetors

- Throttle Stop for Holley® 4150-style, 4-bbl. racing carburetors provides a very strong and positive stop
- Also prevents excessive side loading on the throttle shaft, which can easily cause the throttle shaft bores to wear out
- Throttle stop is adjustable, and simply mounts to the carb hold-down stud
- Made from rugged 1/8" steel with a clear zinc finish
- Fits both 1:1 and progressive throttle linkages
- Ideal for all types of racing

PART # DESCRIPTION
65042* Throttle Stop, fits 4150-style Holley® Carbs



No. 65042

**Not legal for sale or use on pollution-controlled vehicles.*



Carburetor Tools
 on pgs. 239-240

CARBURETOR SPACERS

Billet Aluminum

- Extends length of intake mixture column to improve air/fuel distribution
- CNC machined from 6061-T6 billet aluminum to extremely accurate specifications
- Billet aluminum eliminates porosity and improves engine appearance
- Available with 4150/4160 and 4500 Series Holley® bolt patterns to fit a variety of carburetors
- 4150/4160 Series Spacers available in ½", 1" and 2" thicknesses with open plenum and 4-hole designs to suit tuning requirements; 4500 Series (Dominator) Spacer is 1" thick with open plenum
- As a general rule, open designs increase plenum volume for improved high rpm power, while 4-hole designs increase mixture velocity for improved low-speed and mid-range torque
- Gaskets are not included

PART #	CARBURETOR	THICKNESS	PLENUM
64951*	4500	1"	Open Plenum Design
64981*	4150/4160	1"	Open Plenum Design
64985*	4150/4160	½"	Open Plenum Design
64991*	4150/4160	1"	4-Hole Plenum Design w/ 1.696" dia. bores
64996*	4150/4160	1"	4-Hole Plenum Design w/ 1.750" dia. bores

PART #	AVAILABLE OPTIONS (2 REQUIRED)
93300	Carburetor Gasket, 4150/4160 Open
93301	Carburetor Gasket, 4150/4160 4 Hole
93310	Carburetor Gasket, 4500/King Demon Open

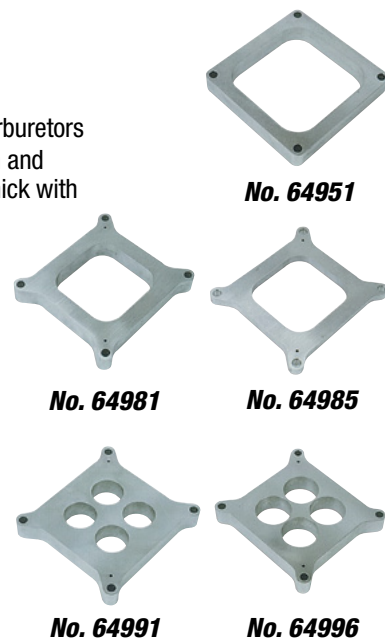

CARBURETOR SPACERS

Cast Aluminum

- Can easily be mounted with one of the Moroso Carburetor Stud Kits **Nos. 37950, 37960 or 37961**
- Open plenum aluminum carb spacers increase plenum volume for high RPM power
- Gaskets are not included

PART #	DESCRIPTION	THICKNESS	PLENUM
64950*	4500	1"	Open Plenum Design
64970*	4150/4160	2"	Open Plenum Design
64980*	4150/4160	1"	Open Plenum Design

PART #	AVAILABLE OPTIONS (2 REQUIRED)
93300	Carburetor Gasket, 4150/4160 Open
93301	Carburetor Gasket, 4150/4160 4 Hole
93310	Carburetor Gasket, 4500/King Demon Open



CARBURETOR ADAPTERS

Aluminum

- Gaskets are not included

PART #	DESCRIPTION
64960*	Carburetor Adapter, 2" Cast Aluminum, adapts Quadrajet carburetor to Holley® 4150/4160 intake manifold bolt pattern
64964*	Carburetor Adapter, 1" Billet Aluminum, adapts Holley® No. 4412 style to a 4150 4 bbl. square flange manifold
64965*	Carburetor Adapter, ¾" Billet Aluminum, adapts Holley® 2300/2305 2 bbl. carburetors to intake manifolds with Holley® 4150/4160 4 bbl. bolt pattern, 2-hole plenum design with 1.50" dia. bores
64966*	Carburetor Adapter, ¾" Billet Aluminum, adapts Holley® 2300/2305 2 bbl. carburetors to intake manifolds with Holley® 4150/4160 4 bbl. bolt pattern, 2-hole plenum design with 1.693" dia. bores
65000*	Carburetor Adapter, 2" Cast Aluminum, adapts Holley® 4500 Dominator carburetor to Holley® 4150/4160 intake manifold bolt pattern

PART #	AVAILABLE OPTIONS (2 REQUIRED)
93300	Carburetor Gasket, 4150/4160 Open
93301	Carburetor Gasket, 4150/4160 4 Hole
93310	Carburetor Gasket, 4500/King Demon Open



*Not legal for sale or use on pollution-controlled vehicles.

CARBURETOR SPACERS

Insulating Plastic & Phenolic

- Advanced plastic and phenolic compounds are specially formulated to reduce heat conductivity 10 times greater than aluminum
- Reducing fuel temperature inside the carburetor results in a denser, more powerful fuel charge to the manifold
- Insulating phenolic spacers come pre-drilled for alignment pins. Moroso Nos. 64930 and 64940 include all mounting hardware
- Gaskets are not included

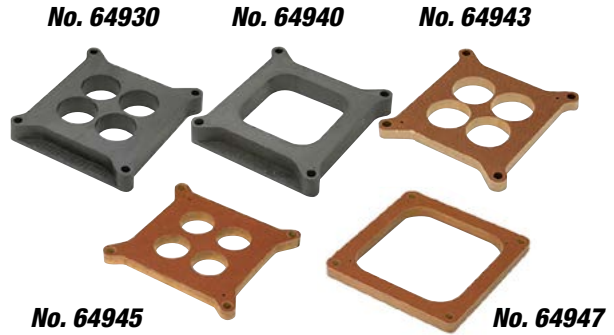

PART #	DESCRIPTION	THICKNESS	PLENUM
64930*	4150/4160	1"	4-Hole Plenum Design with 1.75" dia. bores, Plastic
64940*	4150/4160	1"	Open Plenum Design, Plastic
64943*	4150/4160	½"	4-Hole Plenum Design with 1.75" dia. bores, Phenolic
64945*	4150/4160	½"	4-Hole Plenum Design with 1.467" dia. bores, Phenolic
64947*	4500	½"	Open Plenum Design, Phenolic
64941*	Quadrajets	½"	4-Hole, Phenolic

PART #	AVAILABLE OPTIONS (2 REQUIRED)
93300	Carburetor Gasket, 4150/4160 Open
93301	Carburetor Gasket, 4150/4160 4 Hole
93310	Carburetor Gasket, 4500/King Demon Open

CARBURETOR SPACERS

Wood Design

- Unique ½" spacers are precision machined on state-of-the-art millworking centers, and can be used individually or stacked without the use of gaskets
- Thin layers of choice laminated hardwood, bonded together with resin form a natural thermal barrier
- Top-quality hardwood has a sheet of phenolic resin-impregnated paper bonded to both sides
- Can be easily modified to your particular manifold for optimum performance
- Gaskets are not included

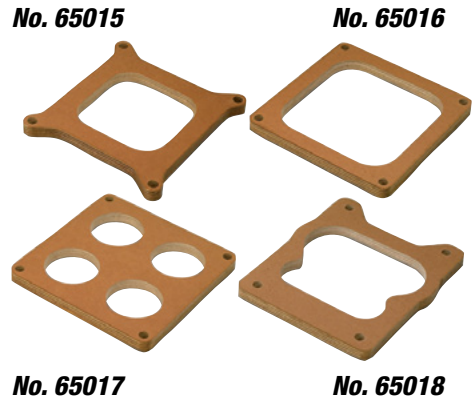

PART #	DESCRIPTION	THICKNESS	PLENUM
65015*	4150/4160	½"	Open
65016*	4500	½"	Open
65017*	4500	½"	4-Hole
65018*	Quadrajets	½"	Open

PART #	AVAILABLE OPTIONS (2 REQUIRED)
93300	Carburetor Gasket, 4150/4160 Open
93301	Carburetor Gasket, 4150/4160 4 Hole
93310	Carburetor Gasket, 4500/King Demon Open

SEE MORE
Carburetor Stud Kits
 on pgs. 216

CARBURETOR ADAPTER

Insulating Phenolic

- Gaskets are not included

PART #	DESCRIPTION
64952*	Carburetor Adapter, 1" Insulating Phenolic. Adapts Holley® No. 4412, 500 cfm, 2 bbl. Carbs to standard Holley 4661 bolt pattern intake manifold

SEE MORE
Carburetor Tools
 on pg. 239-240



*Not legal for sale or use on pollution-controlled vehicles.

CARBURETOR WEDGE PLATE

- .830" thick at its thickest point
- To keep carburetor float-bowls "level" during acceleration, some amount of mounted carburetor angle is necessary
- Moroso's wedge plate tilts the carburetor forward 5° to provide the optimum angle during quick acceleration and front-end lift
- Dual bolt pattern
- Gaskets are not included



No. 65030

PART # DESCRIPTION

65030* Carburetor Wedge Plate, fits standard Holley® Bolt Pattern, Carb AFB/Edelbrock

PART # AVAILABLE OPTIONS

93300 Carburetor Gasket, 4150/4160 Open (2 required)



Carburetor Tools
on pgs. 239-240

CLEAR-VIEW SIGHT PLUGS

The Original! For Holley® Carbs

- Clear Sight Plugs are like having a "window" to your float bowl
- Allows you to check float bowl level without removing the plug and spilling fuel
- Includes O-rings
- After setting float bowl level, replace clear sight screws with original bung plugs



No. 65226

PART # DESCRIPTION

65226 Clear-View Sight Plugs for Holley® Carbs, Two per pack

CARBURETOR JET EXTENSION KIT

For Holley® Carbs

- Developed by carburetor wizard Gary Williams
- Eliminates fuel starvation during hard acceleration or cornering by extending the fuel pickup point of the jet farther into the float bowl
- Each kit contains three sets of two extensions: ½" long for stock float bowls; ¾" and 1" long which can be cut to fit custom applications

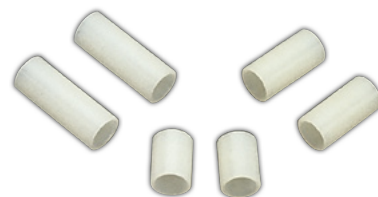

No. 65227

PART # DESCRIPTION

65227 Carburetor Jet Extension Kit, fits Holley® 2bbl. & 4bbl. carbs

HOLLEY® JET EXTENSIONS

- Brass Jet Extensions screw into the metering block to reposition jets farther back into the fuel bowl to eliminate fuel starvation – and they won't fall out!
- CNC machined for precise fit and maximum fuel flow
- Must be used in conjunction with Moroso Drag Race Float Kit **No. 65228** to clear extensions
- Two per package

 **WARNING Prop. 65**
This product contains a chemical known to the state of California to cause cancer, birth defects, or reproductive harm-

PART # DESCRIPTION

65440* Jet Extensions, ¼"-32, STD Holley® Jets

65441* Jet Extensions, ⅝"-32, HP Holley® Jets

No. 65440



No. 65441

***NOTE:** For Drag Racing, use Moroso Float **No. 65228** modified to fit extensions.

NYLON FLOAT BOWL WASHER KIT

- The ultimate cure for the problem of soft, wet, deteriorating fiber, Holley® float bowl washers
- Our nearly indestructible nylon replacement washers are unaffected by fuel, and won't leak or break down under normal usage
- Ten per package



No. 65225

PART # DESCRIPTION

65225 Float Bowl Washer Kit, For Holley® Carbs



FUEL SYSTEM EQUIPMENT

HEX HEAD FUEL BOWL SCREWS

For Holley® Carbs

- Designed for Holley® 4150-4160 and 4500 model carburetors
- Hex head (rather than screwdriver head) allows for easier removal of the fuel bowl
- Four per package
- Screws are 2-½" long

PART # DESCRIPTION

65414 Hex Head Fuel Bowl Screws for Holley® Carbs., four per package



No. 65414

HOLLEY® HIGH FLOW SQUIRTER SCREWS

- Allen head design is streamlined for less turbulence and increased airflow
- Enlarged and repositioned slot provides a clear path to the shooter nozzle, eliminating restrictions and improving throttle response
- One per package

PART # DESCRIPTION

65442* Holley® High Flow Squirter Screw, Cadmium-Plated Steel, Gasoline

65443* Holley® High Flow Squirter Screw, Stainless Steel, Alcohol



No. 65442

No. 65443

HOLLEY® ACCELERATOR PUMP CAM KIT

- Handy kit contains an assortment of color-coded plastic cams to match accelerator pump requirements to individual engine performance needs
- Color coding makes it easy to identify specific cam applications when installed
- Kit includes a helpful tuning chart to assist you in selecting the appropriate accelerator pump cam
- Contains 8 cams and 2 screws

PART # DESCRIPTION

65531 Holley® Accelerator Pump Cam Kit



No. 65531

HOLLEY® VACUUM SECONDARY SPRING KIT

- Provides springs of various rates to allow the racer to custom tailor the vacuum secondary opening and closing rate to best suit their combination
- Contains seven springs; color coded from light to heavy
- Instructions included

PART # DESCRIPTION

65425* Holley® Vacuum Secondary Spring Kit



No. 65425

1:1 SLIP LINK

- Replaces the "progressive" stock link to provide simultaneous, 1:1 primary and secondary opening rates
- Requires drilling of existing primary throttle arm hole
- One per package

PART # DESCRIPTION

65444* Slip Link, 1:1, Holley® 4150



No. 65444

*Not legal for sale or use on pollution-controlled vehicles.

HOLLEY® VACUUM SECONDARY DIAPHRAGM

- Replacement diaphragm fits the most popular Holley® vacuum secondary carburetors including:
0-1849, all 1850, all 3310, 0-4453-1, 0-458,0-6619, 0-6619-1, 0-6909, 0-6919, 0-6979, 0-6979-2, 0-6989, 0-7002, 0-7002-1, 0-7004, 0-7004-1, 0-7004-2, 0-7005, 0-7005-1, 0-7005-2, 0-7006, 0-7006-1, 0-7006-2, 0-7009
- Replaces Holley® diaphragm 135-4



No. 65426

PART #	DESCRIPTION
65426*	Holley® Vacuum Secondary Diaphragm

OVAL TRACK FLOAT KIT

For Holley® Carbs

- Wedge shape compensates for the action of centrifugal force on the fuel and ensures proper needle and seat operation under the most severe left-cornering conditions
- Includes one front and one rear float
- Fits all Holley® center hung float/cathedral bowl carburetors
- Manufactured of Nitrophyl, which doesn't absorb fuel
- Intended primarily for oval track racing, kit can also be used in drag race applications where two Holley® Carbs are mounted sideways on manifold
- Alcohol compatible



No. 65432

PART #	DESCRIPTION
65432*	Oval Track Float Kit, fits Holley® Carbs

DRAG RACE FLOAT KIT

For Holley® Carbs

- Alcohol compatible
- Float is notched to clear ¾" long jet extensions
- Fits all Holley® carburetors with center hung floats
- Manufactured of Nitrophyl, which doesn't absorb fuel
- Saves the racer many hours of notching and epoxy coating
- One per package



No. 65228

PART #	DESCRIPTION
65228	Drag Race Float Kit, fits Holley® Carbs

HOLLEY® ACCELERATOR PUMP DIAPHRAGMS

- One per package

PART #	DESCRIPTION
65532	Holley® Standard 30cc Accelerator Pump Diaphragm
65534	Holley® 50cc Accelerator Pump Diaphragm



No. 65532

*Not legal for sale or use on pollution-controlled vehicles.



CHECKING FLOAT LEVEL

While the engine is running at idle, remove the float-level sight plug. A small amount of fuel should run out from the front half of the carburetor. The level should be slightly higher at the rear. When turned clockwise, the needle-and-seat nut will adjust the float down. When turned counterclockwise, the float is adjusted up. To adjust the needle-and-seat, back off the center screw. Make sure that all of the components that have been adjusted are checked for tightness.

NOTE: Use caution whenever working with fuel system components to minimize spillage and avoid fuel contact with extremely high temperature components.



FUEL SYSTEM EQUIPMENT

HOLLEY® NEEDLE & SEAT HARDWARE KIT

- Includes all the necessary replacement hardware for Holley® needles and seats
- Kit contains: one needle and seat adjusting screw, one screw gasket, one needle and seat adjusting nut, one nut gasket, one needle and seat o-ring

PART #	DESCRIPTION
65413*	Holley® Needle and Seat Hardware Kit



HOLLEY® NEEDLES AND SEATS

- The Viton® needle design is highly recommended for gasoline-fueled engines because it is resistant to dirt and conforms to the seat for superior sealing
- If you use exotic fuels or additives such as alcohol, benzene, acetone, etc., you must use the steel-needle version
- Two per package

PART #	DESCRIPTION
65411*◊	Holley® Needle and Seat, Viton®, .110 orifice, carbs up to 735 cfm. Gasoline only
65412*◊	Holley® Needle and Seat, Steel, .130 orifice, 750 cfm and up. Gasoline, exotic fuels or additives

◊ **WARNING Prop. 65**
This product contains a chemical known to the state of California to cause cancer, birth defects, or reproductive harm-

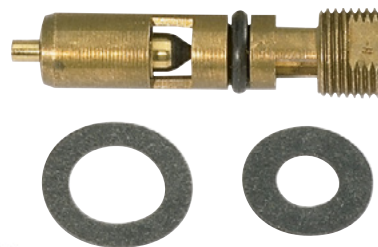

FUEL SYSTEM EQUIPMENT

HOLLEY® POWER VALVE PLUG & GASKET

- Used with Holley® carburetors where fuel enrichment via the power valve is not desired. Full-throttle fuel enrichment is achieved by jetting up the carburetor by approximately 10 jet sizes
- Kit includes 1/2"-28 threaded plug with gasket

PART #	DESCRIPTION
65408*	Holley® Power Valve Plug and Gasket



HOLLEY® POWER VALVE

- One valve and gasket per package

PART #	DESCRIPTION
65401◊	Holley® Power Valve, opens at 3.5" of vacuum

◊ **WARNING Prop. 65**
This product contains a chemical known to the state of California to cause cancer, birth defects, or reproductive harm-



REUSABLE BUNA-N HOLLEY® GASKETS

- Moroso replacement gaskets for Holley® 4150-4160 series carbs are made from high grade Buna-N compound with an anti-wicking nylon backing and for use with alcohol or racing gasoline
- Reuse them over and over
- Also fits other Holley® carburetors (see the Holley® application guide for a complete listing)

PART #	DESCRIPTION
65222	Reusable Buna-N Holley® Metering Plate Gasket, Replaces Holley® Part No. 108-89-2, Pack of 2
65223	Reusable Buna-N Holley® Metering Plate Gasket, Replaces Holley® Part No. 108-90-2, Pack of 2
65224	Reusable Buna-N Holley® Float Bowl Gaskets, Replaces Holley® Part Nos. 108-92-2 and 108-83-2, Pack of 2

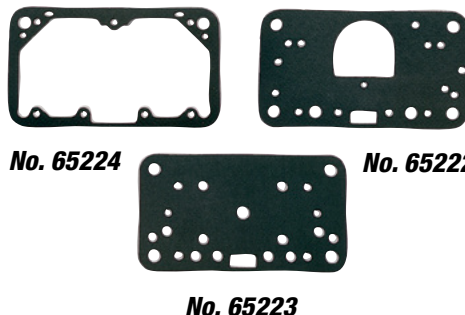

*Not legal for sale or use on pollution-controlled vehicles.

ALUMINUM FUEL LINE

- Lightweight aluminum tubing replaces small diameter fuel lines used in most production automobiles
- Large diameter, .035" thick wall seamless tubing flows more fuel and eliminates fuel starvation
- Legal in all classes; tested to 35 PSI

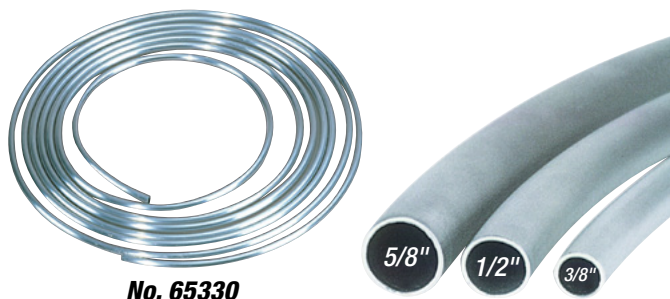

No. 65330

PART #	DESCRIPTION
65330	Aluminum Fuel Line, 25' Coil, 5/8" O.D.
65340	Aluminum Fuel Line, 25' Coil, 1/2" O.D.
65345	Aluminum Fuel Line, 25' Coil, 3/8" O.D.

STREAMLINE FUEL LINE FITTINGS

- 90° streamline fuel line fittings are manufactured of brass and provide a quick, easy fuel hose connection
- Streamline fittings offer the racer improved fuel flow to the carburetor over the right angle fittings more commonly available
- One per package

WARNING Prop. 65
This product contains a chemical known to the state of California to cause cancer, birth defects, or reproductive harm-

PART #	DESCRIPTION
65130	Streamline Fuel Line Fitting, 90°, 3/8" NPT to 1/2" hose
65131	Streamline Fuel Line Fitting, 90°, 3/8" NPT to 1/2" hose, black
65140	Streamline Fuel Line Fitting, 90°, 3/8" NPT to 3/8" hose



No. 65131



No. 65130



No. 65140

FUEL HOSE FITTINGS

- Handy brass fittings can be used on electric fuel pumps and regulators

PART #	DESCRIPTION
65375	Fuel Line Fitting, 1/4" NPT to 3/8" hose, one per package
65380	Fuel Line Fittings, 3/8" NPT to 3/8" hose, two per package
65381	Fuel Line Fitting, 3/8" NPT to 3/8" hose, Straight, black, one per package
65382	Fuel Line Fitting, 3/8" NPT to 3/8" hose, 90 Deg., black, one per package
65388	Fuel Line Fitting, 3/8" NPT to 1/2" hose 90 Deg., black, one per package
65389	Fuel Line Fitting, 3/8" NPT to 1/2" hose, Straight, black, one per package
65390	Fuel Line Fittings, 3/8" NPT to 1/2" hose, two per package



No. 65390

WARNING Prop. 65
This product contains a chemical known to the state of California to cause cancer, birth defects, or reproductive harm-



No. 65381



No. 65382



No. 65388



No. 65389

FUEL INLET FITTINGS

For Holley® Carbs

- These Fuel Inlet Fittings adapt -6AN or -8AN fuel lines to all Holley® single and dual-feed carburetors with 7/8" -20 UNF inlets
- For No. 65144, extended wrench flat location allows for easier installation
- Each aluminum fitting has a black anodized finish for protection

PART #	DESCRIPTION
65141	Fuel Inlet Fittings, Holley® Fuel Bowl to -6AN, two pack with washers
65144	Fuel Inlet Fittings, Holley® Fuel Bowl to -8AN, two pack with washers
65146	Fuel Inlet Fittings, Holley® Fuel Bowl to -8AN, one, no washers

No. 65146



No. 65141



No. 65144



FUEL SYSTEM EQUIPMENT

ALUMINUM FUEL BLOCK KITS

- Universal, high flow Fuel Block Kits easily solve dual gas line problems assuring equal flow and pressure for twin carb setups or dual pickup gas tanks
- Each has a 1/8" NPT provision for a fuel pressure gauge and a socket head pipe plug if a gauge is not used

PART #	DESCRIPTION
65160	Aluminum Fuel Block Kit, 1/2" hose inlet with two 3/8" hose outlets
65170	Aluminum Fuel Block Kit, 1/2" hose inlet with two 1/2" hose outlets

 **WARNING Prop. 65**
This product contains a chemical known to the state of California to cause cancer, birth defects, or reproductive harm-

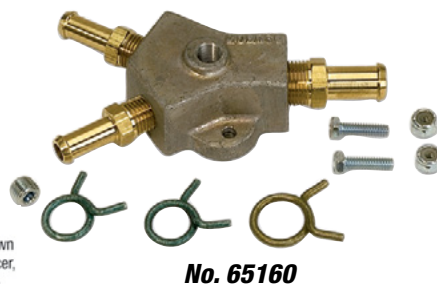

No. 65160

FUEL PRESSURE GAUGE FITTINGS

- Allows easy plumbing up to 1/8" NPT fuel pressure gauge lines
- Saves wear and tear on carb inlet fittings by allowing quick and easy disconnecting of fuel line
- Anodized aluminum

PART #	DESCRIPTION
65300	Fuel Gauge Fitting, -6AN Male to -6AN Male
65310	Fuel Gauge Fitting, 3/8" NPT Female to 3/8" NPT Male
65315	Fuel Gauge Fitting, 3/8" NPT Male to -6AN Male
65360	Fuel Gauge Fitting, 3/8" line with hose fitting



No. 65300

No. 65310



No. 65315

No. 65360

PRESSURE REGULATING FUEL LOG

- Meets the higher fuel delivery demands in today's race engines
- Increases the orifice to nearly twice that of two regulators combined, creating a totally free flowing fuel system that allows the pumps to deliver full capacity at all times
- Standard fuel systems regulate pressure before the fuel reaches the carburetors, while this system regulates pressure after the carburetors have been supplied and requires a return line to the fuel tank
- Shims are included to allow easy pressure adjustment from 6-10 psi, as are complete instructions and tuning tips

PART #	DESCRIPTION
65145	Pressure Regulating Fuel Log

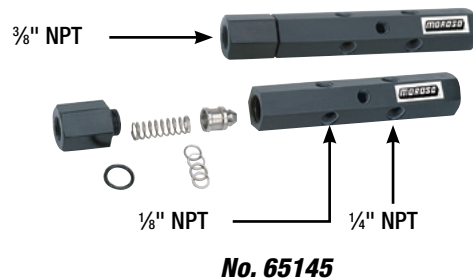

No. 65145

IN-LINE FUEL FILTERS

- Removes dirt and debris from fuel systems with minimum restriction
- The aluminum housing is black anodized with O-ringed removable end caps
- Filter Element itself is constructed out of a Stainless Steel fine screen that filters down to 40 Microns and is washable for re-use

PART #	DESCRIPTION
65230*	In-Line Fuel Filter, -8AN Fittings, 6-1/2" overall length
65231*	In-Line Fuel Filter, accepts 3/8" NPT Fittings, 5-1/8" overall length
65234	In-Line Fuel Filter, -10AN Male Fittings

PART #	REPLACEMENT PARTS
97062	40 Micron Filter Element

 **WARNING Prop. 65**
This product contains a chemical known to the state of California to cause cancer, birth defects, or reproductive harm-



No. 65230



No. 65234

***NOTE:** Not recommended for high-pressure fuel injection systems.

EFI FUEL RETURN LINE KIT

- Allows EFI conversion without welding a return line fitting to the fuel tank
- Simply cut a 2-3/4" section out of any 2" O.D. fuel tank filler tube and insert the 6061-T6 aluminum adapter; installs on most vehicles without removing the fuel tank
- Includes two Buna-N sleeves and four stainless steel hose clamps to seal the connection on each end of the adapter
- 3/8" aluminum fuel fitting is factory welded to the adapter for a leak free seal
- Fuel fitting has a 90° smooth-contour bend inside the adapter to direct return fuel downward into the tank
- Use with Moroso Aluminum Fuel Line **No. 65330** for a return line from the EFI regulator to the fitting located on the filler tube



No. 65385

PART #	DESCRIPTION
65385*	EFI Fuel Return Line Kit

WARNING Prop. 65
 This product contains a chemical known to the state of California to cause cancer, birth defects, or reproductive harm-

FUEL PRESSURE GAUGE

With Flutter Guard

- Vibration controlled dial, not dampened by liquid
- Heavy-duty American made gauge with stainless steel case and bezel will not rust, chip, peel or oxidize like other designs
- Suited for use with alcohol
- Accurate to within 1%; marked in 1/4-pound increments
- Compact 1.5" dia. gauge can be mounted to fuel regulator or fuel block for convenient fuel pressure tuning
- Includes 1/8" NPT Male Fitting



No. 65370

PART #	DESCRIPTION
65370*	Fuel Pressure Gauge, 0-15 psi
65372*	Fuel Pressure Gauge, 0-60 psi
65374*	Fuel Pressure Gauge, 0-100 psi

WARNING Prop. 65
 This product contains a chemical known to the state of California to cause cancer, birth defects, or reproductive harm-

VACUUM GAUGE

1.5" Diameter, 0-30" Hg

- Used to determine vacuum in your engine
- Will fit any 1/8" NPT male fitting
- Excellent vibration and shock resistance



No. 89610

PART #	DESCRIPTION
89610*	Vacuum Gauge, 1.5" Diameter, 0-30" Hg

WARNING Prop. 65
 This product contains a chemical known to the state of California to cause cancer, birth defects, or reproductive harm-

OIL PRESSURE GAUGE

1.5" Diameter, 0-120 PSI

- Necessary for racing applications where high oil pressures, above the range of typical oil pressure gauges are used
- Will fit any 1/8" NPT male fitting
- Excellent vibration and shock resistance



No. 89611

PART #	DESCRIPTION
89611*	Oil Pressure Gauge, 1.5" Diameter, 0-120 PSI

WARNING Prop. 65
 This product contains a chemical known to the state of California to cause cancer, birth defects, or reproductive harm-



FUEL PUMP BLOCK-OFF PLATES

- Designed to block off the fuel pump mounting boss when a mechanical fuel pump is not used
- Available in two popular styles
- Made of anodized aluminum or high luster triple chrome plated steel
- Includes gasket

PART # DESCRIPTION

- 65391** Fuel Pump Block-Off Plate, Anodized Aluminum, SBC
65392 Fuel Pump Block-Off Plate, Anodized Aluminum, BBC, 273-440 Chrysler and all Fords except 351C, 351M and 400
65393 Fuel Pump Block-Off Plate, Chrome Plated Steel, SBC
65394 Fuel Pump Block-Off Plate, Chrome Plated Steel, BBC, 273-440 Chrysler, and all Fords except 351C, 351M and 400



WARNING Prop. 65
 This product contains a chemical known to the state of California to cause cancer, birth defects, or reproductive harm-

BILLET ALUMINUM FUEL PUMP BLOCK-OFF PLATES

- Includes Gaskets and Stainless Steel Socket Head Screws
- Black Anodized

PART # DESCRIPTION

- 65395** Fuel Pump Block-Off Plate, SBC
65396 Fuel Pump Block-Off Plate, BBC, 273-440 Chrysler, and all Fords except 351C, 351M and 400



WARNING Prop. 65
 This product contains a chemical known to the state of California to cause cancer, birth defects, or reproductive harm-

BILLET ALUMINUM EQUALIZING PLATES WITH FITTINGS

- Black anodized, includes 1/8" NPT Fitting and -12AN Fitting
- Allows the vacuum pump and vacuum gauge to be connected
- Can also be used as a drain back location
- Includes Gaskets and Stainless Steel Socket Head Screws

PART # DESCRIPTION

- 65397** Fuel Pump Block-Off Plate, SBC
65398 Fuel Pump Block-Off Plate, BBC, 273-440 Chrysler, and all Fords except 351C, 351M and 400



WARNING Prop. 65
 This product contains a chemical known to the state of California to cause cancer, birth defects, or reproductive harm-

NOTE: Installation of this product requires pulling vacuum from a valve cover as well.

MECHANICAL FUEL PUMP GASKETS

Available for SBC, BBC, Chrysler 273-440, Ford 302, 351W, FE, 429-460

- Same gaskets that comes with Moroso fuel pump block off plates
- Fiber construction
- Use as a replacement for Moroso fuel pump block off plates or as a high quality gasket for mechanical fuel pumps
- Available as a single pack or 10 pack

PART # DESCRIPTION

- 93320** Gasket, Mechanical Fuel Pump, SBC
93321 Gasket, Mechanical Fuel Pump, SBC, 10 Pack
93322 Gasket, Mechanical Fuel Pump, BBC, Chrysler 273-440, Ford 302, 351W, FE, 429-460
93323 Gasket, Mechanical Fuel Pump, BBC, Chrysler 273-440, Ford 302, 351W, FE, 429-460, 10 Pack



FUEL SYSTEM EQUIPMENT

LIGHTWEIGHT FUEL PUMP PUSH RODS

- Lightweight design with hardened ends reduces reciprocating mass to prevent pump arm "float" and subsequent fuel starvation
- For use in Drag, Oval Track and Street-Performance applications

PART #	DESCRIPTION
65750	Lightweight Fuel Pump Push Rod, SBC and BBC
65752	Lightweight Fuel Pump Push Rod, 0.200" longer to fit World Products Merlin and DART Rocket Block



No. 65750

FUEL PUMP SPRING

- This heavy-duty fuel pump spring boosts Holley® electric fuel pump pressure from 12 to 19 psi and increases overall fuel volume

PART #	DESCRIPTION
65770	Fuel Pump Spring, Holley® Electric Fuel Pumps



No. 65770

CARBURETOR GASKETS, HEAVY DUTY

- An excellent way to seal a Moroso carburetor adapter or spacer to an intake or carburetor
- Race quality carburetor gaskets are constructed out of a cellulose composition that conforms to it's mating surface
- Precision die cut design that stands up to pump gasoline, race fuels and alcohol
- One per pack

Part#	DESCRIPTION
93300	Carburetor Gasket, 4150/4160 Open
93301	Carburetor Gasket, 4150/4160 4 Hole
93310	Carburetor Gasket, 4500/King Demon Open

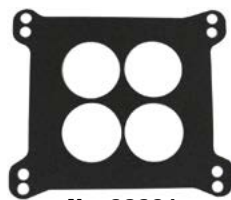

No. 93301



No. 93310



No. 93300

VACUUM LINE CAP KITS

- Convenient kit provides a quick, sure way to seal vacuum line connections at carburetors, manifolds, etc. when vacuum lines have been removed
- Kits consist of soft plastic caps in quantities and inside dimensions as follows: two 1/8", six 3/16", six 1/4", two 5/16", four 3/8"

PART #	DESCRIPTION
41090	Vacuum Line Cap Kit, Color Coated
41091	Vacuum Line Cap Kit, Black



No. 41090



No. 41091

WARNING Prop. 65
This product contains a chemical known to the state of California to cause cancer, birth defects, or reproductive harm.

INTAKE MANIFOLD SPACER PLATES

- Allows you to bolt on conventional, short deck intake manifolds on GM's Chevy tall deck truck blocks, or any Big Block Chevy-style aftermarket block which is .400" taller than stock
- Precision machined aluminum; mounts between the intake manifold and cylinder head

PART #	DESCRIPTION
65090*	Intake Manifold Spacers, Fits Tall Deck (+.400") Big Block Chevy

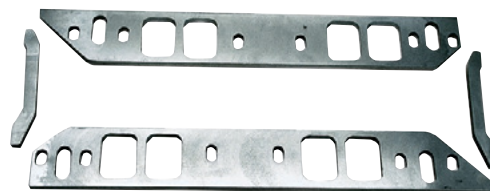

No. 65090

*Not legal for sale or use on pollution-controlled vehicles.



FUEL SYSTEM EQUIPMENT

For years, Moroso Air Cleaners and accessories have set the standard by which all others are judged. Whether in triple process chrome steel, powdercoat or our unique fiber design, Moroso Air Cleaners provide the racer or street performance enthusiast with improved air flow, a lower stacking height, and unequalled fit and finish. Moroso Air Cleaners and accessories are simply the best money can buy!

Other Colors Available:



No. 65910



No. 65904

BETTER AIRFLOW!

- Moroso's unique radiused air inlet design equalizes air pressure past the boosters for uniform air flow
- Radiused air inlet is stamped into air cleaner base to reduce overall height

LOW STACKING HEIGHT!

- Air Cleaners with 3" element have an overall stacking height above the carburetor lip of only 2-1/2", while 5" filters have a 4-1/2" overall height
- Fits all Holley®, Carter®, Rochester®, and Edelbrock® carburetors with 5-1/8" diameter necks & MSD® Atomic EFI

MORE POWER!

- Back to back dyno testing proves a gain of nearly 10 horsepower over running no air cleaner at all

GREAT LOOKS!

- Available accessories including valve covers, breathers and ignition wire sets
- Includes matching wing nut

PART # DESCRIPTION

- 65904* Racing Air Cleaner, 14" dia. with 3" filter, Powder Coated-Black
- 65905* Racing Air Cleaner, 14" dia. with 3" filter, Powder Coated-Red
- 65906* Racing Air Cleaner, 14" dia. with 3" filter, Powder Coated-Blue
- 65910*^o Racing Air Cleaner, 14" dia. with 3" filter, Chrome plated steel, hand polished

PART # REPLACEMENT PARTS

- 97080 3" x 14" Air Cleaner Element
- 97081 4" x 14" Air Cleaner Element
- 97330 5" x 14" Air Cleaner Element (includes stud)

^o **WARNING Prop. 65**
This product contains a chemical known to the state of California to cause cancer, birth defects, or reproductive harm-



FIBER DESIGN LOW-PROFILE AIR CLEANER

- Classic Moroso high flow, low stacking height design
- Increased horsepower with great fiber design look
- Includes wing nut and stud
- Fits all Holley®, Carter®, Rochester®, and Edelbrock® carburetors with 5-1/8" diameter necks & MSD® Atomic EFI

PART # DESCRIPTION

- 65915* Racing Air Cleaner, 14" diameter with 3" filter
Gray/Black Fiber Design

PART # REPLACEMENT PARTS

- 97080 3" x 14" Air Cleaner Element



No. 65915

*Not legal for sale or use on pollution-controlled vehicles unless originally equipped with an open element air cleaner.

AIR CLEANER

Raised bottom for 14" x 3"

- This air cleaner bottom section converts Moroso and other 14" x 3" air cleaner assemblies to the Moroso "Raised Bottom design" that clears Edelbrock® 4 BBL Carburetors and Holley Carburetors with tall throttle return spring brackets
- Features a deep retaining lip that locks the air cleaner element in place
- Aluminum with a raw aluminum finish
- Can be polished, painted, powder coated or chrome painted for a custom look

PART #	DESCRIPTION
97090	Air Cleaner, Raised Bottom Section for 14" X 3" Assemblies



No. 97090

FLAT BOTTOM AIR CLEANERS

- Flat bottom design raises installed height of air cleaner for additional sheet metal clearance in race cars such as NASCAR® Modifieds
- 14" diameter Air Cleaners available with 3" or 5" filter elements
- Chrome plated steel
- Fits Holley®, Carter®, Edelbrock® and Rochester® carburetors

PART #	DESCRIPTION
65911* ^o	Flat Bottom Air Cleaner, 14" dia. with 3" Filter, Chrome. <i>Fits: Holley®, Thermoquad, Quadrajets and similar carburetors with 5-1/8" dia. neck</i>
65945* ^o	Flat Bottom Air Cleaner, 14" dia. with 3" Filter, Chrome. <i>Fits: Holley® 4500 carburetors with 7-5/16" dia. neck</i>
65946* ^o	Flat Bottom Air Cleaner, 14" dia. with 5" Filter, Chrome. <i>Fits: Holley® 4500 carburetors with 7-5/16" dia. neck</i>



No. 65911

PART #	REPLACEMENT PARTS
97080	3" x 14" Air Cleaner Element (does not include stud)
97330	5" x 14" Air Cleaner Element (includes stud)

^o **WARNING Prop. 65**
This product contains a chemical known to the state of California to cause cancer, birth defects, or reproductive harm-

OFFSET AIR CLEANER

- Owners of Small Block Chevy powered cars with 2- and 4-bbl. Holley® carbs with 5-1/8" necks don't have to cut up their air cleaners to make room for large diameter distributors, such as HEI
- Offset forward by 1-1/2" to clear GM HEI distributors
- For IMCA and NASCAR® Modifieds that require air cleaners to be mounted above the hood line, the raised bottom (3/8") design provides an overall height above the carburetor lip of 4-3/4"
- For late model stocks that require under-hood air cleaners, the dropped (1-3/4") design provides an overall height above the carburetor lip of 2-3/4"
- Finished in Chrome plated top, clear anodized bottom and comes complete with 4" filter elements, one 1/4" -20 and one 5/16" -18 offset stud and three 1/4" -20 and three 5/16" -18 hex nuts

PART #	DESCRIPTION
65928* ^o	14" Offset Air Cleaner with Raised Bottom, 4" element, Chrome Plated Top-Clear, 2- and 4-bbl Holley®

PART #	REPLACEMENT PART
97081	4" x 14" Air Cleaner Element

^o **WARNING Prop. 65**
This product contains a chemical known to the state of California to cause cancer, birth defects, or reproductive harm-



No. 65928

*Not legal for sale or use on pollution-controlled vehicles.



AIR CLEANERS, RAISED BOTTOM

14" X 3", Raised Bottom

- Raised bottom design clears Edelbrock® 4 BBL Carburetors and Holley Carburetors with tall throttle return spring brackets
- Air Cleaner top and bottom accept a 14" diameter air cleaner element
- Kits include a Moroso 3" tall element
- Radiused air inlet design equalizes air pressure past the boosters for uniform air flow
- Includes mounting stud, and matching wing nut
- Available with a black powder coat or chrome finish top

PART #	DESCRIPTION
65912	Air Cleaner Kit, 14" X 3", Raised Bottom, Black Powder Coat
65913	Air Cleaner Kit, 14" X 3", Raised Bottom, Chrome



No. 65913

 **WARNING Prop. 65**
This product contains a chemical known to the state of California to cause cancer, birth defects, or reproductive harm.

AIR CLEANERS

11-1/2" and 8-1/2" Diameters

- Available in black, red and blue powdercoat and ultra-high luster, hand polished triple-process, chrome plated steel
- Matching wing nut included
- Fits Holley®, Thermoquad, Quadrajets and similar carburetors with a 5-1/8" diameter neck

PART #	DESCRIPTION
66210*	Race/Street Air Cleaner, 11-1/2" diameter with 2-3/8" filter, Chrome Plated Steel
66303*	Race/Street Air Cleaner, 8-1/2" diameter with 2-3/8" filter, Powder Coated-Black
66304*	Race/Street Air Cleaner, 8-1/2" diameter with 2-3/8" filter, Powder Coated-Red
66305*	Race/Street Air Cleaner, 8-1/2" diameter with 2-3/8" filter, Powder Coated-Blue
66310*	Race/Street Air Cleaner, 8-1/2" diameter with 2-3/8" filter, Chrome Plated Steel

PART #	REPLACEMENT PARTS
97510	Air Cleaner Element. 2-3/8" x 8-1/2" diameter
97520	Air Cleaner Element. 2-3/8" x 11-1/2" diameter



No. 66304

 **WARNING Prop. 65**
This product contains a chemical known to the state of California to cause cancer, birth defects, or reproductive harm.



No. 66305



No. 66310



No. 66210



No. 66303

*Not legal for sale or use on pollution-controlled vehicles unless originally equipped with an open element air cleaner.

LOW PROFILE AIR CLEANER

16" O.D.

- 1-3/4" dropped base to work on carbs with 7-5/16" diameter necks (4500 Series, Dominator, King Demon)
- Filter element for harsh racing environments, including Dirt Tracks
- Works with 3-1/2", 4", 4-1/2" and 5" tall filter elements
- Thick .060" spun aluminum, can be polished, painted or powder coated
- Radiused air inlet for maximum air flow
- Will work with K&N® 16-1/8", 16-1/4" and 16-3/16" O.D. air filter
- Improved filter element retaining lip on base

PART # DESCRIPTION

65920 16" Low Profile Air Cleaner with Dropped Bottom, 4" Element, for 4500 Series, Dominator, King Demon Carbs

PART # REPLACEMENT PART

97085 4" x 16" Air Cleaner Element



No. 65920

AIR CLEANER BASE GASKET, CHANNELED

11-1/2" and 8-1/2" Diameters

- Fits carburetors with 5-1/8" neck
- Designed for Moroso Air Cleaners and other brands with straight lip
- Channel provides extra protection against dust and other harmful elements
- Channel creates a maximum seal for carburetor airflow
- Made from Buna 70 durometer material
- Can be used conventionally on rolled lip air cleaner bases by flipping over

PART # DESCRIPTION

97331 Air Cleaner Base Gasket, Channeled



No. 97331

REUSABLE FOAM FILTER SHIELD

- When dirt and clay oval tracks turn into "dust bowls", even the best racing air cleaners can become clogged with dirt and dust
- Made of open cell foam to keep large debris out of the filter element without restricting airflow
- Fits snugly around 14" x 5" racing filters
- Can be cleaned in the sink or even in the washing machine
- Excellent for off-road truck applications
- One per pack

PART # DESCRIPTION

65947 Reusable Foam Filter Shield, fits 14" x 5" Filters



No. 65947



AIR CLEANER WING NUT

- Can be used with any Moroso Air Cleaner
- They also match our extra long Valve Cover Wing Nuts to add a look of uniformity to engine compartment
- Made to fit only 1/4" -20 studs
- Fits most popular air cleaners
- One per pack

PART # DESCRIPTION
65820 Air Cleaner Wing Nut, Chrome Plated Steel

 **WARNING Prop. 65**
 This product contains a chemical known to the state of California to cause cancer, birth defects, or reproductive harm.



No. 65820

CARBURETOR AIR PAN KITS

- Available for either single or dual carb applications
- Unlike other brands, our Air Pan Kits are designed with a smooth radius at the intake area of the carburetor for improved airflow
- Air Pan-to-hood sealing ring is manufactured of fire retardant foam, for added protection
- All Air Pans measure 12" x 24" fire retardant foam measures 1-1/2" wide x 4" tall x 60" long

PART # DESCRIPTION
65951 Carburetor Air Pan Kit, Dual 4-bbl. Holley® 4500 Dominator Carburetors with 7-5/16" Neck
65960 Carburetor Air Pan Kit, Single 4-bbl. Holley® Carburetors with 5-1/8" Neck
65961 Carburetor Air Pan Kit, Single 4-bbl. Holley® 4500 Dominator Carburetors with 7-5/16" Neck

PART # REPLACEMENT PART
97070 Sealing Foam, 4" x 60"



No. 65960

AIR CLEANER STUD ADAPTER

- Allows Moroso and other air cleaners with 1/4" stud and wing nut to be used on carburetors with a 5/16" mounting hole
- One end of the adapter features a 5/16" -18 male thread that screws into the carburetor, the other end features a 1/4" -20 female thread that accepts a standard air cleaner mounting stud
- Clear zinc plating resists corrosion
- Overall length: 7/8"
- One per pack

PART # DESCRIPTION
66390 Air Cleaner Stud Adapter, Fits: Holley® H.P. Series, DEMON and other Carburetors with 5/16"-18 Air Cleaner Mounting



No. 66390

Using advanced gas dynamics and sophisticated noise cancellation acoustics, Moroso engineers have developed the finest and most durable Racing Mufflers for your Exhaust System. Specially engineered spiral baffles divide the exhaust flow into two separate paths, significantly reducing noise levels with minimal backpressure.



MOROSO SPIRAL FLOW RACING MUFFLERS

- Reduced noise levels with minimal backpressure
- These mufflers offer a 5 - 7 db drop over open collectors and the mufflers flow 850 C.F.M.

PART #	DESCRIPTION
94050	Spiral Flow Racing Muffler, Heavy Duty Steel, 2.5" Inlet/Outlet
94051	Spiral Flow Racing Muffler, Heavy Duty Steel, 3.0" Inlet/Outlet
94052	Spiral Flow Racing Muffler, Heavy Duty Steel, 3.5" Inlet/Outlet

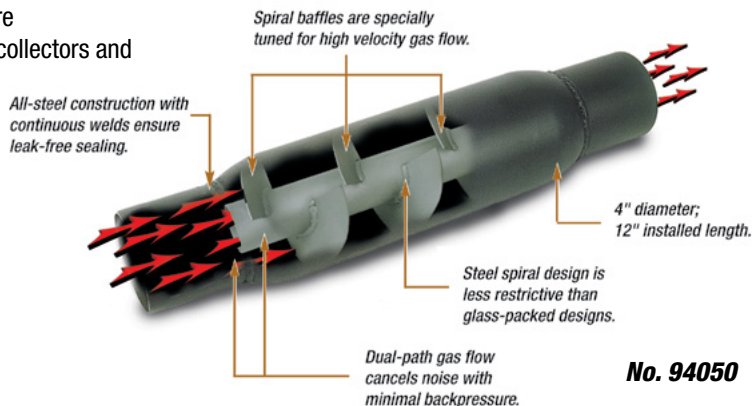

No. 94050

HIGH FLOW POLISHED STAINLESS STEEL MUFFLERS

- Reduced noise levels with minimal back pressure
- Stainless steel construction makes them durable without compromising the looks

PART #	DESCRIPTION
94054	Muffler High Flow, Stainless Steel, 2.5" Inlet/Outlet
94055	Muffler High Flow, Stainless Steel, 3" Inlet/Outlet
94056	Muffler High Flow, Stainless Steel, 3.5" Inlet/Outlet



No. 94055

WARNING Prop. 65
This product contains a chemical known to the state of California to cause cancer, birth defects, or reproductive harm-

OXYGEN SENSOR BUNGS

- Weld-in bung needed when replacing stock exhaust with aftermarket pipes, headers, etc., not equipped for sensor
- M-18 by 1.5 Thread Size

PART #	DESCRIPTION
22730	Oxygen Sensor Bung, Mild Steel, Single
22731	Oxygen Sensor Bung, Mild Steel, 10 per pack
22732	Oxygen Sensor Bung, Stainless Steel, Single
22733	Oxygen Sensor Bung, Stainless Steel, 10 per pack



No. 22730

WARNING Prop. 65
This product contains a chemical known to the state of California to cause cancer, birth defects, or reproductive harm-



No. 22732

PLUG, O2 SENSOR

- Used to plug Oxygen Sensor Bung
- M-18 by 1.5 Thread Size
- Plated steel to match stainless headers

PART #	DESCRIPTION
22734	Plug, steel with 17mm hex head, M-18 thread size by 1.5 Thread Size



No. 22734

WARNING Prop. 65
This product contains a chemical known to the state of California to cause cancer, birth defects, or reproductive harm-

PART #	ACCESSORIES
22730	Oxygen Sensor Bung, Mild Steel, Single
22731	Oxygen Sensor Bung, Mild Steel, 10 per pack
22732	Oxygen Sensor Bung, Stainless Steel, Single
22733	Oxygen Sensor Bung, Stainless Steel, 10 per pack



HEADER FLANGE KIT

- Aluminum plates simplify the task of matching exhaust ports to large tube, dual flange headers on Small Block Chevy engines
- Only 3/8" thick to save weight
- Includes six plates, enough for one engine

PART #	DESCRIPTION
67650	Header Flange Kit, Small Block Chevy

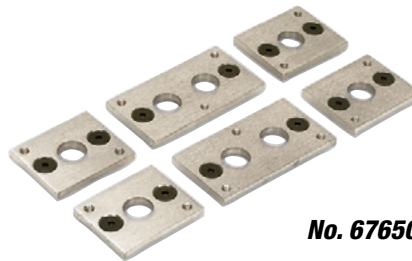

No. 67650

HEAT BARRIER BLANKET

- 1/2" thick, 18" x 24" non-asbestos blanket can be easily cut to any shape with scissors, and wrapped around fuel lines, brake lines, dry sump lines, power steering lines, etc; withstands up to 2300°F
- May also be used on firewalls and floor boards to reduce in-car temperature
- Made from a silica-based formula that contains no asbestos

PART #	DESCRIPTION
80805	Heat Barrier Blanket

WARNING Prop. 65
This product contains a chemical known to the state of California to cause cancer-



No. 80805

INSULATING HEADER WRAP

- Increases exhaust cycle efficiency
- Protects crew members from burns, and prevents starter wires and plug wires from coming into contact with hot header pipes
- Reduces engine compartment temperature
- Highly pliable for a nice, tight wrap
- Made from a silica-based formula that contains no asbestos

PART #	DESCRIPTION
80807	Insulating Header Wrap, 2" x 1/16" x 100' Roll
80808	Insulating Header Wrap, 2" x 1/16" x 50' Roll
80809	Insulating Header Wrap, 1" x 1/16" x 50' Roll

WARNING Prop. 65
This product contains a chemical known to the state of California to cause cancer-



No. 80807

BAND CLAMP TIGHTENING TOOL

- Feed the clamp through the end of the tool into the "mouth" of tool, use a 5/8" socket or wrench to wind in a circular pattern until the clamp is tight, turn further still, then the tool will snip the end of the clamp and then pull off

PART #	DESCRIPTION
62284	Band Clamp Tightening Tool for Band or Boot Clamps



No. 62284

WARNING Prop. 65
This product contains a chemical known to the state of California to cause cancer, birth defects, or reproductive harm-

SINGLE BAR STUD GIRDLE FOR CHEVY V8

- Includes all nuts and hardware

PART # DESCRIPTION

67250 Stud Girdle, use with $\frac{7}{16}$ " studs and roller rocker arms. **Fits:** BBC, also fits aftermarket BBC heads with standard rocker arm stud location

PART # REPLACEMENT PARTS - FOUR PER PACK

67100 U-Bolts, For Stud Girdle, SBC use **No. 67050, 67070**

67300 U-Bolt Assembly, use with **No. 67250**

67320 Slotted Head Adjusting Nuts, use with **No. 67250** on Exhaust Studs

NOTE: All Stud Girdles require the use of tall valve covers

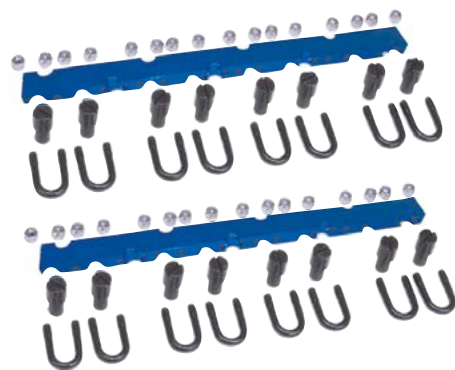
**No. 67250****HEX HEAD MOROSO STUD GIRDLE ADJUSTING NUTS**

- For use with Moroso Stud Girdles
- Hex head design allows easier valve adjustments with a set screw providing a positive lock
- Fits either stock or roller rockers
- Four per pack

PART # DESCRIPTION

67160 Hex Head Adjusting Nuts, fits $\frac{7}{16}$ " Rocker Studs, use with **Nos. 67045** and **67205**, also fits **No. 67295** (Exhaust only)

67170* Hex Head Adjusting Nuts, fits BBC Intakes, use with **No. 67295**

**No. 67160**

NOTE: Use SBC Hex Head Adjusting Nuts **No. 67160** for BBC exhausts

VALVETRAIN OIL DEFLECTOR

- Redirects oil from pushrod to fulcrum balls, rockers and springs to provide maximum lubrication and cooling
- Extends life of stock valvetrain assembly
- Helps eliminate excessive oil accumulation in breather tank when vacuum pump is used
- Manufactured from lightweight .100" aluminum
- Mounts easily to stock rocker arm studs
- Includes mounting hardware
- Can be easily adapted to many other applications

PART # DESCRIPTION

67700 Valvetrain Oil Deflector, must use with tall Valve Covers, Polylocks not included.

Fits: all SBC and Ford 289-302 engines with stamped rocker arms

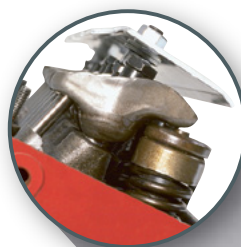
**No. 67700**

Many Moroso Valve Covers are manufactured in the tall style. Taller covers may not fit some engine compartments. Power brake boosters and air conditioning boxes may interfere in some applications. Check hood clearance before ordering. Moroso stock height valve covers are recommended in cases where hood clearance and/or accessory clearance is a problem. However, any Moroso valve cover described as "stockheight" or with "built-in baffles" will not clear stud girdles or shaft rocker assemblies.

CHEVROLET SMALL BLOCK

CHROME PLATED STEEL

Fits: SBC

3.5" Tall Design

- Includes two breather/filler cap grommets and one baffled and one non-baffled PCV grommet

PART # DESCRIPTION

68102*◊ Valve Covers, Stamped Steel, Chrome Plated, Tall Design, without Baffles

PART # REPLACEMENT PARTS

68770 PCV Grommet

68772 PCV Grommet with Baffle

97340 Breather/Filler Cap Grommets

◊  **WARNING Prop. 65**
This product contains a chemical known to the state of California to cause cancer, birth defects, or reproductive harm-



No. 68102

CHROME PLATED STEEL

Fits: SBC

3.5" Tall Design with Baffle

- Includes two breather/filler cap grommets and one baffled and one non-baffled PCV grommet

PART # DESCRIPTION

68103*◊ Valve Covers, Stamped Steel, Chrome Plated, Tall Design. Same as **No. 68102** but with a baffle in the oil fill hole. These covers will not clear stud girdles or some shaft rocker assemblies

PART # REPLACEMENT PARTS

68770 PCV Grommet

68772 PCV Grommet with Baffle

97340 Breather/Filler Cap Grommets

◊  **WARNING Prop. 65**
This product contains a chemical known to the state of California to cause cancer, birth defects, or reproductive harm-



No. 68103

CHROME PLATED STEEL

Fits: SBC

Stock Height with Baffle

- Includes two breather grommets and one non-baffled PCV grommet

PART # DESCRIPTION

68392*◊ Valve Covers, Stamped Steel, Chrome Plated, Stock Height, baffle in the oil fill hole, with Logo

PART # REPLACEMENT PARTS

68770 PCV Grommet

68772 PCV Grommet with Baffle

97340 Breather/Filler Cap Grommets

◊  **WARNING Prop. 65**
This product contains a chemical known to the state of California to cause cancer, birth defects, or reproductive harm-



No. 68392

NOTE: These covers will not clear stud girdles or shaft rocker assemblies.

*Not legal for sale or use on pollution-controlled vehicles.



STAMPED VALVE COVERS

Fits: SBC

Powder Coated, 3.5" Tall Design

- Includes two breather/filler cap grommets and one baffled and one non-baffled PCV grommet

PART #	DESCRIPTION
68003*	Valve Covers, Stamped, Powder Coated-Black, Tall Design
68005*	Valve Covers, Stamped, Powder Coated-Blue, Tall Design
68006*	Valve Covers, Stamped, Powder Coated-Red, Tall Design

PART #	REPLACEMENT PARTS
68770	PCV Grommet
68772	PCV Grommet with Baffle
97340	Breather/Filler Cap Grommets



No. 68005

Other Colors Available:



DIE-CAST ALUMINUM

Fits: SBC

3.5" Tall Design

- Packaged two to a set with rubber breather grommets and eight 1-3/4" long studs
- Includes two breather/filler cap grommets and one baffled and one non-baffled PCV grommet

PART #	DESCRIPTION
68401*	Valve Covers, Die-Cast Aluminum, Polished Finish with Moroso logo, Tall Design
68405*	Valve Covers, Die-Cast Aluminum, Polished Finish without Moroso logo, Tall Design
68411*	Valve Covers, Die-Cast Aluminum, Black Epoxy Finish with Moroso logo, Tall Design

PART #	ACCESSORIES
68771	PCV Grommet, .095"
68773	PCV Grommet/Baffle, .095"
68776	Breather Grommet/Baffle, .095"
97341	Filler Cap Breather Grommet, .095"
68831	Stud Kit, V/C, Bullet Nose, 12 Pt. Nut

PART #	REPLACEMENT PARTS
68770	PCV Grommet
68772	PCV Grommet with Baffle
97020	Studs, 1-3/4" long
97340	Breather/Filler Cap Grommets



No. 68401



No. 68405



No. 68411

*Not legal for sale or use on pollution-controlled vehicles.



DIE-CAST ALUMINUM

*Fits: SBC with Welded Breather Tubes
3.5" Tall without Breather*

- Hooded breathers and studs included

PART # DESCRIPTION

- 68365***◊ Valve Covers, Filtered Breather Set, Polished Die-Cast Aluminum with Moroso logo, Tall Design, two breather tubes, 2-3/8" apart, welded to the radiator end of the driver's side valve cover
- 68370***◊ Valve Covers, Filtered Breather Set, Polished Die-Cast Aluminum with Moroso logo, Tall Design, two breather tubes welded to one cover
- 68371***◊ Valve Covers, Filtered Breather Set, Black Epoxy finish with Moroso logo, Die-Cast Aluminum, Tall Design, two breather tubes welded to one cover
- 68374***◊ Valve Covers, Filtered Breather Set, Polished Die-Cast Aluminum without Moroso logo, Tall Design, two breather tubes welded to one cover
- 68380***◊ Valve Covers, Filtered Breather Set, Polished Die-Cast Aluminum with Moroso logo, Tall Design, two breather tubes welded to each cover
- 68381***◊ Valve Covers, Filtered Breather Set, Black Epoxy finish with Moroso logo, Die-Cast Aluminum, Tall Design, two breather tubes welded to each cover

PART # ACCESSORIES

- 68771** PCV Grommet, .095"
- 68773** PCV Grommet/Baffle, .095"
- 68776** Breather Grommet/Baffle, .095"
- 97341** Filler Cap Breather Grommet, .095"
- 68831** Stud Kit, V/C, Bullet Nose, 12 Pt. Nut

PART # REPLACEMENT PARTS

- 68811**◊ Filtered Breathers 180°
- 68812**◊ Hood Filtered Breathers (for early **No. 68370** with 1-1/2" O.D. tubes)
- 97020** Studs - 1-3/4" long

◊  **WARNING Prop. 65**
This product contains a chemical known to the state of California to cause cancer, birth defects, or reproductive harm-



No. 68365



No. 68370



No. 68374

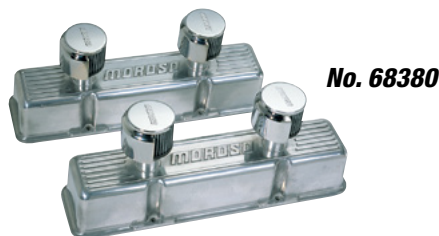

No. 68380



No. 68381

DIE-CAST ALUMINUM

*Fits: SBC with Crossover Breather Tube
3.5" Tall without Breather*

- Includes crossover breather tube, two breathers with chrome plated hoods, hoses and clamps for a simple, bolt-on installation
- Ideal for Sprint Cars and other Oval Track applications

PART # DESCRIPTION

- 68385***◊ Valve Covers, Die-Cast Aluminum with Crossover Breather Tube, Polished Finish with Moroso logo, Tall Design

PART # REPLACEMENT PARTS

- 68811**◊ Filtered Breathers 180°
- 97020** Studs, 1-3/4" long

◊  **WARNING Prop. 65**
This product contains a chemical known to the state of California to cause cancer, birth defects, or reproductive harm-



No. 68385

*Not legal for sale or use on pollution-controlled vehicles.

FABRICATED ALUMINUM, RIGID RAIL*Fits: SBC cylinder heads including 18°, 23°**4" Tall at peak*

- Fabricated entirely from superior quality aluminum, ultra lightweight
- Tall enough to clear all popular rocker combinations
- Mounting is through tubes welded directly to the valve covers to help maintain gasket-rail flatness and to prevent leaks
- Mounting fasteners included

PART # DESCRIPTION

68335* Valve Covers, Fabricated Aluminum, Rigid Rail, fits all SBC cylinder heads

PART # ACCESSORIES

68771 PCV Grommet, .095"
68773 PCV Grommet/Baffle, .095"
68776 Breather Grommet/Baffle, .095"
93020 or **93021** Perm Align V/C Gasket
97341 Filler Cap Breather Grommet, .095"

PART # REPLACEMENT PART

97346 Washers, Stainless with Neoprene Seal

**No. 68335****FABRICATED ALUMINUM, BILLET RAIL, POCKETS***Fits: SBC cylinder heads including 18°, 23°**3.38" Tall*

- Fabricated from superior quality aluminum, ultra lightweight
- One-piece billet rail is machined to ensure a precision flat surface for superior sealing
- Tall enough to clear all popular rocker combinations
- Air-tight sealing allows the engine to pull greater vacuum for improved ring seal and power
- Notched at each mounting location with socket-sized clearances for quick installation and removal
- Mounting fasteners included

PART # DESCRIPTION

68326* Valve Covers, Fabricated Aluminum, Logo
68328* Valve Covers, Fabricated Aluminum, No Logo

PART # ACCESSORIES

68771 PCV Grommet, .095"
68773 PCV Grommet/Baffle, .095"
68776 Breather Grommet/Baffle, .095"
93020 or **93021** Perm Align V/C Gasket
97341 Filler Cap Breather Grommet, .095"

PART # REPLACEMENT PART

97035 Nuts, 12 Pt.

**No. 68328**

**Not legal for sale or use on pollution-controlled vehicles.*

**VALVE COVERS**

FABRICATED ALUMINUM, BILLET RAIL, POCKETS

With Valve Spring Oilers

Fits: SBC Cylinder Heads Including 18°, 23°

4" Tall

- Fabricated entirely from superior quality aluminum, ultra-lightweight
- Custom-built for Oval Track Racing/Offshore Boat Racing
- Built-in oiling system keeps valve springs running cool for extended life, especially when subjected to long races
- An oil regulating jet located at the inlet fitting can be drilled to suit individual oil flow requirements
- -4AN male fitting on each cover allows convenient plumbing of oil supply lines
- One-piece billet rail with machined gasket recess and bosses holds gasket captive when installing and eliminates leaks
- Mounting hardware included



No. 68329



PART # DESCRIPTION

68329* Valve Covers, Fabricated Aluminum, With Valve Spring Oilers, Billet Rail. Use Fel-Pro Gasket No. 1644 or Moroso Part **No. 93021**

PART # REPLACEMENT PART
97035 Nuts, 12 Pt.

SBC VALVE COVERS WITH OILERS, MULTIPLE OIL SUPPLY PORTS

Fits: SBC 13 To 23 Deg. Cylinder Heads with the valves in the conventional location, 3.25" Tall

Please Note: Fits best with T&D Rockers, will not fit with All Pro 270-7 cylinder heads



- Fabricated from superior quality aluminum welded to a one-piece billet rail that is machined to ensure a precision flat surface for superior sealing
- Tall enough to clear all popular rocker combinations
- Air-tight sealing allows the engine to pull greater vacuum for improved ring seal and power
- The spring oilers have removable/replaceable .025" jets
- Each spring oiler has multiple oil supply ports that the supplied -4 AN male fittings or plugs can be screwed into
- Having multiple oil supply ports makes plumbing routing easier in Sprint Cars, Dirt Late Models and other applications

No. 68332



WARNING Prop. 65
This product contains a chemical known to the state of California to cause cancer, birth defects, or reproductive harm-

PART # DESCRIPTION

68332* Valve Cover with Oilers, Fabricated Aluminum, Pair, SBC

SBC 2 PIECE BILLET ALUMINUM VALVE COVERS WITH OILERS, MULTIPLE OIL SUPPLY PORTS

Fits: SBC 13 To 23 Deg. Cylinder Heads with the valves in the conventional location

Please Note: Fits best with T&D Rockers, will not fit with All Pro 270-7 cylinder heads 2-3/4" tall, valve cover and oiler rail

- Billet Aluminum SBC 13 to 23 Deg. Cylinder Head 2 Piece valve covers with valve spring oilers built in to the lower rail. The lower rail bolts to the head with the supplied hardware and the upper portion is removable with an o-ring seal
- Allows you to inspect/maintain valvetrain without spilling oil all over the headers by having to remove the entire cover
- The spring oilers have .025" dia. removable jets
- Each spring oiler has multiple oil supply ports that the supplied -4 AN male fittings or plugs can be screwed into
- Having multiple oil supply ports makes plumbing routing easier in Sprint Cars, Dirt Late Models and other applications
- A single 2 Piece valve cover with valve spring oiler rail, fittings and hardware weights 3.10 lbs
- Anodized finish

No. 68051



WARNING Prop. 65
This product contains a chemical known to the state of California to cause cancer, birth defects, or reproductive harm-

PART # DESCRIPTION

68051* Valve Covers, SBC 2 Piece Billet Aluminum with oilers

PART # AVAILABLE OPTION

68825* Spring Oiler Jet, .015 Dia. Jets, 16 per pack



VALVE COVERS

SBC VALVE COVER SPACER WITH SPRING OILING RAILS

Fits: Small Block Chevy

- Billet aluminum rail sandwiches between the cylinder head and stamped, cast, fabricated and billet SBC valve covers
- The spring oilers have removable/replaceable .025" jets
- Each spring oiler has multiple oil supply ports that the supplied -4 AN male fittings or plugs can be screwed into
- Having multiple oil supply ports makes plumbing routing easier in Sprint Cars, Dirt Late Models and other applications

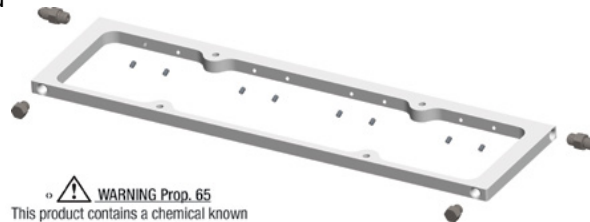

WARNING Prop. 65
This product contains a chemical known to the state of California to cause cancer, birth defects, or reproductive harm-

No. 68330

PART #	DESCRIPTION
68330	Valve Cover Spacer with Spring Oiling Rails, Pair, SBC

ALL SPRINT CAR STYLE, BILLET ALUMINUM

Fits: SBC, 13 To 23 ° Cylinder Heads

- Fits Small Block Chevy with 13 to 23 Degree cylinder heads with the valves in the conventional location
- Each valve cover is CNC machined from a billet aluminum bar
- The end result is that each valve cover weighs 1.69 lbs without sacrificing strength
- Airtight sealing allows the engine to pull greater vacuum for improved ring seal and power
- Black anodized finish
- Designed for Sprint Cars but works in other applications that require strong lightweight valve covers



No. 68050

PART #	DESCRIPTION
68050*	Valve Covers, Billet Aluminum, SBC Fits 13 To 23 Deg. Cylinder Heads, Billet, Black Anodized Finish

PART #	ACCESSORIES
68831	Stud Kit, V/C, Bullet Nose, 12 Pt. Nut
93020	Perm Align V/C Gasket
93021	Perm Align V/C Gasket

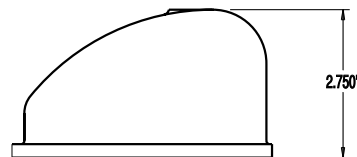

FABRICATED ALUMINUM, BILLET RAIL

*Fits: SBC center bolt Cylinder Heads
4" Tall*

- Fabricated entirely from superior quality aluminum, ultra-lightweight
- Tall enough to clear all popular rocker combinations
- Mounting is through tubes welded directly to the valve covers to help maintain gasket-rail flatness and to prevent leaks
- One-piece billet aluminum rail is CNC machined to ensure a precision flat surface for superior sealing
- Mounting fasteners included
- Use OEM or aftermarket gaskets

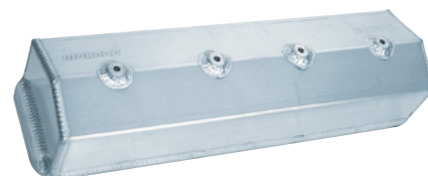

No. 68025



No. 68028

PART #	DESCRIPTION
68025*	Valve Covers, Fabricated Aluminum, Logo
68028*	Valve Covers, Fabricated Aluminum, No Logo
68026*	Valve Covers, Fabricated Aluminum, Logo, two breather tubes welded to driver side cover with Filtered Breather

PART #	ACCESSORIES
68771	PCV Grommet, .095"
68773	PCV Grommet/Baffle, .095"
68776	Breather Grommet/Baffle, .095"
97341	Filler Cap Breather Grommet, .095"

PART #	REPLACEMENT PARTS
68811	Filtered Breathers 180° Hood
97345	Washers, Stainless with Neoprene Seal

WARNING Prop. 65
This product contains a chemical known to the state of California to cause cancer, birth defects, or reproductive harm-



No. 68026

**Not legal for sale or use on pollution-controlled vehicles.*

GM LS SERIES, ALL BILLET ALUMINUM VALVE COVERS

Fits: GM LS Series Stock and Aftermarket Cylinder Heads

- Each valve cover is CNC machined from a solid billet aluminum bar
- Available in 4 different versions:
 - 2.5" tall to clear most aftermarket valve trains without coil mounts
 - 2.5" tall to clear most aftermarket valve trains with integral coil pack mounts that accept LS2, LS3, LS7 & L98 style coils
 - 1.5" tall to clear most engine accessories without coil mounts
 - 1.5" tall to clear most engine accessories with integral coil pack mounts that accept LS2, LS3, LS7 & L98 style coils
- Cylinder head mounting area has an O-Ring groove that accepts Moroso **No. 93025** or GM gasket
- One cover features a oil fill with a CNC machined cap with O-ring
- Even though these valve covers are light in weight, they are thick enough for the engine builder to be able to add fittings at the top and ends
- The covers can be polished, chromed, powder coated or left as-is for a race look
- Includes mounting hardware

PART # DESCRIPTION

- 68470*** Valve Covers, Billet Alum., GM LS Series, 2.5" tall with OEM coil mounts
68471* Valve Covers, Billet Alum., GM LS Series, 2.5" tall w.o. OEM coil mounts
68472* Valve Covers, Billet Alum., GM LS Series, 1.5" tall with OEM coil mounts
68473* Valve Covers, Billet Alum., GM LS Series, 1.5" tall w.o. OEM coil mounts

PART # ACCESSORIES

- 68841*o** Breather Kit for Moroso GM LS Valve Cover
73845o Wire Set, Ultra 40, Sleeved in Black, for Moroso Part **Nos. 68471** and **68473** without OEM coil mounts
73846o Wire Set, Ultra 40, Sleeved in Black, for Moroso Part **Nos. 68488, 68470, 68472** and **68493** with OEM coil mounts
93025 Valve Cover Gasket, GM LS Series



No. 68471



No. 68472

WARNING Prop. 65
 This product contains a chemical known to the state of California to cause cancer, birth defects, or reproductive harm-

COIL MOUNT BRACKET KIT, GM LS SERIES FOR MOROSO 68471/68473 VALVE COVERS

- These Coil Brackets can be used to relocate LS Coils between the top of the valve cover and the intake
- Designed to be used with Moroso valve covers but can be drilled to be used with other valve covers or to remote mount coils in a different location
- Two versions available; One for LS1/LS6 Coils & the Second for LS2, LS3, LS7, L92, L99 Coils
- When used with Moroso valve covers, the valve cover can be removed and installed without disturbing the coils or brackets
- Kit includes black anodized aluminum brackets and metric hardware, one kit does one LS engine



No. 72398

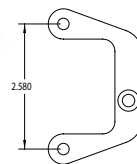

No. 72397

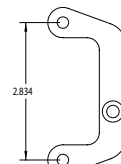

No. 72398

PART # DESCRIPTION

- 72397** Coil Mount Bracket, GM LS Series for **68471/68473**, LS1, LS6 Coils
72398 Coil Mount Bracket, GM LS Series for **68471/68473**, LS2, LS3, LS7, L92, L99 Coils

V/C ADAPTER, GM LS TO SBC V/C, PAIR

- Adapts cast or stamped Small Block Chevy valve covers to GM LS SERIES stock and aftermarket cylinder heads
- This billet aluminum adapter matches the contour of a typical Small Block Chevy valve cover
- Adapter has an encapsulated O-Ring on the side that mounts to the LS cylinder head and is designed to take a traditional Small Block Chevy valve cover gasket such as Moroso Part **No. 93020** between the adapter and the valve cover
- Adapters are 5/8" thick and are machined and qualified, has no through holes which can cause leakage

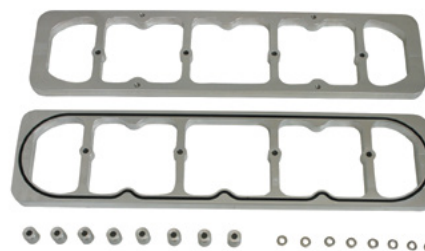

No. 68995



PART# DESCRIPTION

- 68995** Valve Cover Adapter, GM LS To SBC Valve Cover, Pair

*Not legal for sale or use on pollution-controlled vehicles.



GM LS BILLET ALUMINUM VALVE COVERS, 2.5" TALL, COIL PACK MOUNTS, OIL FILL EACH COVER

- Fits GM LS SERIES stock and aftermarket cylinder heads
- Can be used on 2013-up COPO Camaro's* and other applications
- 2-1/2" tall to clear most aftermarket valvetrains
- The integral coil pack mounts accept LS2, LS3, LS7 & L98 style coils
- Each valve cover is CNC machined from a billet aluminum bar
- Cylinder head mounting area has an o-ring groove that accepts Moroso **No.93025** or GM gasket
- Even though these valve covers are light in weight, they are thick enough for the engine builder to be able to add fittings at the top and ends
- The covers can be polished, chromed, powder coated or left as-is for a race look



No. 68488

WARNING Prop. 65
 This product contains a chemical known to the state of California to cause cancer, birth defects, or reproductive harm.

PART # DESCRIPTION

68488 Billet Aluminum Valve Covers, Coil Mounts, Oil Fills, GM LS Series

PART # ACCESSORIES

68841 Breather Kit for Moroso GM LS Valve Cover

68844 Valve Cover Adapter, Adapts GM COPO Breathers into Moroso Billet Aluminum Valve Cover Fill Holes

93025 Valve Cover Gasket, GM LS Series

** Use Moroso **No. 68844** to adapt COPO breather to valve cover*

VALVE COVER ADAPTER, ADAPTS GM COPO BREATHERS INTO MOROSO BILLET ALUMINUM VALVE COVER FILL HOLES

- Allows 2013-up COPO Camaro valve cover breather assemblies to be screwed into a Moroso GM LS billet aluminum valve cover oil fill hole
- Adapter is machined out of billet aluminum and features an o-ring for sealing



No. 68844

PART # DESCRIPTION

68844 Valve Cover Adapter, Adapts GM COPO Breathers into Moroso Billet Aluminum Valve Cover Fill Holes

GM LS BILLET ALUMINUM VALVE COVERS, 2.5" TALL, COIL PACK MOUNTS, ACCEPTS COPO STYLE BREATHERS

- Fits GM LS SERIES stock and aftermarket cylinder heads
- Each cover features a port that a Moroso Part **No. 68857** breather or COPO breather snaps into, can then be unsnapped to use an oil fill
- 2-1/2" tall to clear most aftermarket valvetrains
- The integral coil pack mounts accept LS2, LS3, LS7 & L98 style coils
- Each valve cover is CNC machined from a billet aluminum bar
- Cylinder head mounting area has a groove that accepts Moroso Part **No. 93025** or GM#12612045 gasket
- Even though these valve covers are light in weight, they are thick enough for the engine builder to be able to add fittings at the top and ends
- The covers can be polished, chromed, powder coated or left as-is for a race look



No. 68493

PART# DESCRIPTION

68493 Valve Covers, Billet Aluminum, For COPO Breathers, GM LS Series

PART # ACCESSORIES

68857 V/C Breathers, replacement for GM COPO, 2 pack

93025 Valve Cover Gasket, GM LS Series

V/C BREATHERS, REPLACEMENT FOR GM COPO, 2 PACK

- Replaces damaged COPO Breathers, a good addition to back up engines or for new builds where the goal to is breath the engine the same way as the COPO cars
- Breather screws on to factory COPO breather covers or Moroso Part **No. 68493** valve covers that accept COPO breathers
- Breather's fitting accepts a 5/8" hose



No. 68857

PART# DESCRIPTION

68857 V/C Breathers, replacement for GM COPO, 2 pack



VALVE COVERS

GM LTI/LT4/L86 BILLET ALUMINUM VALVE COVERS WITHOUT COIL MOUNTS*Fits: GM LTI/LT4/L86 6.2L Cylinder Heads*

- 1-1/2" tall to clear most engine accessories and aftermarket valve train assemblies
- Valve covers are designed for the coils to be mounted remotely
- Each valve cover is CNC machined from a solid billet aluminum bar
- Cylinder head mounting area has an O-Ring groove that accepts GM#12619787 Valve Cover O-Ring Gasket
- Even though these valve covers are light in weight, they are thick enough for the engine builder to be able to add fittings at the top and ends
- The covers can be polished, chromed, powder coated or left as-is for a race look

**No. 68480****PART # DESCRIPTION****68480*** Valve Covers, Billet Aluminum, GM LTI/LT4/L86 without Coil Mounts**PART # ACCESSORIES****68832** Valve Cover Hardware Kit for GM LT Billet**GM LTI/LT4/L86 BILLET ALUMINUM VALVE COVERS WITH FACTORY COIL MOUNTS & OIL FILL***Fits: Bolt-On Replacement for Corvette/Camaro and other applications with LTI/LT4/L86 Cylinder Heads*

- 1-1/2" tall to clear most engine accessories and aftermarket valve train assemblies
- Each valve cover is CNC machined from a billet aluminum bar
- Have integral coil pack mounts that accept OEM & LS2, LS3, LS7 & L98 style coils
- Both valve covers have ports to tie into the factory PCV lines
- One valve cover features a oil fill with a CNC machined cap with O-ring and a mounting tab for the factory dipstick tube
- Cylinder head mounting area has an o-ring groove that accepts GM#12619787 Valve Cover O-Ring Gasket
- Even though these valve covers are light in weight, they are thick enough for the engine builder to be able to add fittings at the top and ends
- The covers can be polished, chromed, powder coated or left as-is for a race look

**No. 68494****PART# DESCRIPTION****68494** Valve Covers, Billet Aluminum, GM LTI/LT4/L86, Corvette/Camaro**PART # ACCESSORIES****73848** Wire Set, Ultra 40, Sleeved In Black, for Moroso Part **No. 68494** **NEW!****68832** Valve Cover Hardware Kit for GM LT Billet**GM LTI/LT4/L86 BILLET ALUMINUM VALVE COVERS WITH OIL FILL***Fits: GM LTI/LT4/L86 Cylinder Heads*

- 1-1/2" tall to clear most engine accessories and aftermarket valve train assemblies
- Each valve cover is CNC machined from a billet aluminum bar
- One valve cover features a oil fill with a CNC machined cap with O-Ring
- Each valve cover has mounting holes near the intake that can be used to mount Moroso **Nos. 72397** or **72398** Coil Mount Brackets
- Cylinder head mounting area has an O-Ring groove that accepts GM#12619787 Valve Cover O-Ring Gasket
- Even though these valve covers are light in weight, they are thick enough for the engine builder to be able to add fittings at the top and ends
- The covers can be polished, chromed, powder coated or left as-is for a race look

**No. 68495****PART# DESCRIPTION****68495** Valve Covers, Billet Aluminum, GM LTI/LT4/L86, with Oil Fill**PART # ACCESSORIES****68832** Valve Cover Hardware Kit for GM LT Billet**Not legal for sale or use on pollution-controlled vehicles.*

CHROME PLATED STEEL

Tall Design, with & without Baffle

Fits: BBC

3.5" Tall

- Includes two breather/filler cap grommets and one baffled and one non-baffled PCV grommet

PART # DESCRIPTION

68112* Valve Covers, Stamped Steel, Chrome Plated, Tall Design without Baffle

68113* Valve Covers, Stamped Steel, Chrome Plated, Tall Design with built-in Baffle

PART # ACCESSORIES

68770 PCV Grommet

68772 PCV Grommet with Baffle

93040 Perm Align V/C Gasket

97340 Breather/Filler Cap Grommets

 **WARNING Prop. 65**
This product contains a chemical known to the state of California to cause cancer, birth defects, or reproductive harm-

NOTE: No. 68113 will not clear stud girdles or shaft rocker arm assemblies.



No. 68112



No. 68113

CAST ALUMINUM

Fits: BBC

3.5" Tall

- Includes two breather/filler cap grommets and one baffled and one non-baffled PCV grommet

PART # DESCRIPTION

68425* Valve Covers, Die-Cast Aluminum Polished Finish without Moroso logo, Tall Design

68429* Valve Covers, Cast Aluminum, Big Block Chevy Black Wrinkle Finish

PART # ACCESSORIES

68771 PCV Grommet, .095"

68773 PCV Grommet/Baffle, .095"

68776 Breather Grommet/Baffle, .095"

68562 Valve Cover, Acorn Nuts for BBC

93040 Perm Align V/C Gasket

97341 Filler Cap Breather Grommet, .095"

PART # REPLACEMENT PARTS

68770 PCV Grommet

68772 PCV Grommet with Baffle

97340 Breather/Filler Cap Grommets



No. 68425



No. 68429

CAST ALUMINUM VALVE COVERS - FIBER DESIGN

Fits: BBC

3.5" Tall

- Extra tall design clears most stud girdles and rocker combinations
- Includes one baffled and one non-baffled PVC grommets
- Sold in pairs

PART # DESCRIPTION

68426* Cast Aluminum Valve Covers, Gray/Black Fiber Design

PART # ACCESSORIES

68562 Valve Covers, Acorn Nuts for BBC

93040 Perm Align V/C Gasket



No. 68426

**Not legal for sale or use on pollution-controlled vehicles.*



VALVE COVERS

CAST ALUMINUM RIBBED VALVE COVERS

Fits: BBC, 3.5" Tall

- Constructed out of cast aluminum with a MOROSO Logo.
- Includes two breather/filler cap grommets and one baffled and one non-baffled PCV grommet
- Includes mounting hardware

PART #	DESCRIPTION
68420*	Valve Covers, Ribbed, Cast Aluminum, Big Block Chevy with a Polished Finish
68432*	Valve Covers, Ribbed, Cast Aluminum, Big Block Chevy with a Black Powder Coat Finish

PART #	ACCESSORIES
68771	PCV Grommet, .095"
68773	PCV Grommet/Baffle, .095"
68776	Breather Grommet/Baffle, .095"
68562	Valve Cover, Acorn Nuts for BBC
93040	Perm Align V/C Gasket
97341	Filler Cap Breather Grommet, .095"

PART #	REPLACEMENT PARTS
68770	PCV Grommet
68772	PCV Grommet with Baffle
97340	Breather/Filler Cap Grommets



No. 68420



No. 68432

FABRICATED ALUMINUM, RIGID RAIL

*Fits: BBC Cylinder Heads including Bowtie Heads Part No. 10051128
3.385" Tall*

- Fabricated entirely from superior quality aluminum, ultra-lightweight
- Tall enough to clear all rocker combinations
- Fasteners are included with each set and mount through tubes welded directly to the valve covers to help maintain gasket-rail flatness and to prevent leaks
- Call our Technical Services Department for custom applications not listed below

PART #	DESCRIPTION
68333*	Valve Covers, Fabricated Aluminum, 3.5" Tall, Rigid Rail, Weight: 3.5 lbs. each



No. 68333

PART #	ACCESSORIES
68771	PCV Grommet, .095"
68773	PCV Grommet/Baffle, .095"
68776	Breather Grommet/Baffle, .095"
93040	Perm Align V/C Gasket
97341	Filler Cap Breather Grommet, .095"

PART #	REPLACEMENT PARTS
97345	Washers, Stainless with Neoprene Seal

**Not legal for sale or use on pollution-controlled vehicles.*

VALVE COVERS



**PUT OUR
EXPERIENCE
TO WORK
FOR YOU!**

CUSTOM MANUFACTURING

Our state-of-the-art equipment allows Moroso Performance customers the ability to customize the latest in innovative Valve Covers as well as many other products. Moroso's advanced machining capability and experience results in custom products... **virtually any race part that can be imagined.**

SEE PAGE 104 FOR MORE DETAILS

FABRICATED ALUMINUM, BILLET RAIL

Fits: BBC & Aftermarket Cylinder Heads with stock BBC bolt pattern, clears Jesel, T&D Rocker Shaft Assemblies 3" Tall, clears Jesel style rockers & allows for greater hood clearance

- 3/8" billet rail CNC machined
- Steel inserts pressed into all mounting holes to eliminate galling after removal and installation
- CNC machined after welding to ensure airtight sealing
- Mating of billet rail to valve cover is done with a smooth transition on exhaust side to eliminate trapped oil
- Notched at each mounting location with socket-sized clearances for quick removal and installation
- Will not clear stud girdles

PART #	DESCRIPTION
68345*	Valve Covers, Fabricated Aluminum, 3" Tall, Logo
68353*	Valve Covers, Fabricated Aluminum, 3" Tall, No Logo
68356*	Valve Covers, Fabricated Aluminum, 3" Tall, Logo, Installed with Part No. 22635 -12AN Pos Seal Fitting (included)

PART #	ACCESSORIES
68771	PCV Grommet, .095"
68773	PCV Grommet/Baffle, .095"
68776	Breather Grommet/Baffle, .095"
68831	Stud Kit, V/C, Bullet Nose, 12 Pt. Nut
93040	Perm Align V/C Gasket
97341	Filler Cap Breather Grommet, .095"



No. 68345



No. 68353



No. 68356

FABRICATED ALUMINUM, MARINE, DIRT LATE MODEL

Fits: BBC, symmetrical-port Bowtie Cylinder Heads and Stock BBC Heads, clears Jesel, T&D Rocker Shaft Assembly 3.5" Tall, clears Jesel style rockers & allows for greater hood clearance

- 3/8" billet rail CNC machined
- Steel inserts pressed into all mounting holes to eliminate galling after removal and installation
- CNC machined after welding to ensure airtight sealing
- Mating of billet rail to valve cover is done with a smooth transition on exhaust side to eliminate trapped oil
- Notched at each mounting location with socket-sized clearances for quick removal and installation
- Will not clear stud girdles

PART #	DESCRIPTION
68350*	Valve Covers, Fabricated Aluminum, Billet Rail, swept back design engineered to clear most marine wet manifolds, Dirt Late Chassis



No. 68350

PART #	ACCESSORIES
68771	PCV Grommet, .095"
68773	PCV Grommet/Baffle, .095"
68776	Breather Grommet/Baffle, .095"
68831	Stud Kit, V/C, Bullet Nose, 12 Pt. Nut
93040	Perm Align V/C Gasket
97341	Filler Cap Breather Grommet, .095"

*Not legal for sale or use on pollution-controlled vehicles.



VALVE COVERS

FABRICATED ALUMINUM, BILLET RAIL

Fits: Big Block GM and Aftermarket Cylinder Heads with stock GM bolt pattern. Clears Jesel and T&D Rocker Shaft Assemblies

- Fabricated entirely from superior quality aluminum, ultra lightweight
- One-piece billet rail is CNC machined to ensure a precision flat surface for superior sealing
- Mating of the billet rail to the valve cover is done with a smooth transition, eliminating trapped oil and spills when removing the cover

3" TALL, FOR GREATER HOOD CLEARANCE

PART # DESCRIPTION

- 68457*** Valve Covers, Fabricated Aluminum, pockets on both exhaust and intake sides, Logo
- 68479*** Valve Covers, Fabricated Aluminum, pockets on both exhaust and intake sides, No Logo
- 68458*** Valve Covers, Fabricated Aluminum, tubes on intake side and pockets on exhaust side, Logo
- 68481*** Valve Covers, Fabricated Aluminum, tubes on intake side and pockets on exhaust side, No Logo

3.875" TALL

PART # DESCRIPTION

- 68459*** Valve Covers, Fabricated Aluminum, pockets on both exhaust and intake side, Logo
- 68482*** Valve Covers, Fabricated Aluminum, pockets on both exhaust and intake side, No Logo
- 68460*** Valve Covers, Fabricated Aluminum, tubes on intake side and pockets on exhaust side, Logo
- 68486*** Valve Covers, Fabricated Aluminum, tubes on intake side and pockets on exhaust side, No Logo

PART # ACCESSORIES

- 68771** PCV Grommet, .095"
- 68773** PCV Grommet/Baffle, .095"
- 68776** Breather Grommet/Baffle, .095"
- 68831** Stud Kit, V/C, Bullet Nose, 12 Pt. Nut
- 93040** Perm Align V/C Gasket
- 97035** Nuts, 12 Pt
- 97341** Filler Cap Breather Grommet, .095"



No. 68457



No. 68479



No. 68458



No. 68481



No. 68459



No. 68482



No. 68460



No. 68486



VALVE COVERS

**Not legal for sale or use on pollution-controlled vehicles.*

ALL BILLET ALUMINUM

*Fits: BBC, symmetrical-port Bowtie Cylinder Heads and Stock BBC Heads, clears Jesel, T&D Rocker Shaft Assembly
3" Tall*

- Each valve cover is CNC machined from a solid billet aluminum bar
- The end result is that each valve cover weighs 3.9 lbs with out sacrificing strength
- Airtight sealing allows the engine to pull greater vacuum for improved ring seal and power
- 3" Tall, clears Jesel style rockers & allows for greater hood clearance
- Designed with a broad, flat surface for engine builder engraving, the covers can be polished, chromed, powder coated or left as-is for a race look



No. 68469

PART #	DESCRIPTION
68469*	Valve Covers, BBC Fits symmetrical-port Bowtie and Stock BBC heads

PART #	ACCESSORIES
68831	Stud Kit, V/C, Bullet Nose, 12 Pt. Nut
93040	Perm Align V/C Gasket

AFTERMARKET HEADS

FABRICATED ALUMINUM, BILLET RAIL

*Fits: Dart Big Chief II, 11 Degree and 14 Degree Style Cylinder Heads
3" Tall*

- Fabricated entirely from superior quality aluminum, ultra lightweight
- One-piece billet rail is CNC machined to ensure a precision, flat surface for superior sealing
- Airtight sealing allows the engine to pull greater vacuum for improved ring seal and power



No. 68463

PART #	DESCRIPTION
68463*	Valve Covers, Fabricated Aluminum, Dart Big Chief II, 11 Degree and 14 Degree Style Cylinder Heads

PART #	ACCESSORIES
68831	Stud Kit, V/C, Bullet Nose, 12 Pt. Nut
93045	Perm Align V/C Gasket

FABRICATED ALUMINUM, BILLET RAIL

Fits: BBC with Brodix PB2005, Brodix PB1200, Brodix 1202 and Sonny 14.5 Cylinder Heads 3" Tall

- Fabricated entirely from superior quality aluminum, ultra-lightweight
- One-piece billet rail is CNC machined to ensure a precision flat surface for superior sealing
- Airtight sealing allows the engine to pull greater vacuum for improved ring seal and power



No. 68455

PART #	DESCRIPTION
68455*	Valve Covers, Fabricated Aluminum, Billet Rail

PART #	ACCESSORIES
68831	Stud Kit, V/C, Bullet Nose, 12 Pt. Nut

FABRICATED ALUMINUM, BILLET RAIL

*Fits: BBC with Dart Big Chief and Brodix Big Duke Style Cylinder Heads.
Does not fit Dart Big Chief II, 11 Deg. Cylinder Heads. Clears Jesel and T&D Rocker Shaft assemblies
3" Tall*

- Fabricated entirely from superior quality aluminum, ultra-lightweight
- One-piece billet rail is CNC machined to ensure a precision flat surface for superior sealing
- Airtight sealing allows the engine to pull greater vacuum for improved ring seal and power



No. 68456

PART #	DESCRIPTION
68456*	Valve Covers, Fabricated Aluminum, pockets on intake and exhaust side

PART #	ACCESSORIES
68831	Stud Kit, V/C, Bullet Nose, 12 Pt. Nut
93045	Perm Align V/C Gasket

**Not legal for sale or use on pollution-controlled vehicles.*



VALVE COVERS

BRODIX SR20/DART PRO1 20 DEG. FAB. ALUM, BILLET RAIL VALVE COVERS

Fits: Brodix SR20/Dart Pro1 20 Deg. Cylinder Heads 3" Tall

- Fabricated entirely from superior quality aluminum, ultra lightweight
- One-piece billet rail is CNC machined to ensure a precision flat surface for superior sealing
- Mating of the billet rail to the valve cover is done with a smooth transition, eliminating trapped oil and spills when removing the cover
- Designed with a broad, flat surface for engine builder engraving, the covers can be polished, chromed, powder coated or left as-is for a race look

PART # DESCRIPTION

- 68483*** Valve Cover, Fab. Alum., Billet Rail for Brodix SR20/Dart Pro1 Cylinder Heads, tubes on intake side and pockets on exhaust side, no logo
- 68484*** Valve Cover, Fab. Alum., Billet Rail for Brodix SR20/Dart Pro1 Cylinder Heads, tapered on exhaust side to clear Dirt Late chassis, Moroso Logo
- 68487*** Valve Cover, Fab. Alum., Billet Rail for Brodix SR20/Dart Pro1 Cylinder Heads, pockets on both intake and exhaust side, no logo
- 68489** Valve Cover, Fabricated Aluminum, Billet Rail for Brodix SR20/Dart Pro1 20 Degree Cylinder Heads, Moroso Logo

PART # ACCESSORIES

- 68831** Stud Kit, V/C Bullet Nose, 12 Pt. Nut



No. 68483



No. 68484



No. 68487



No. 68489

CHRYSLER 273-360

CHROME PLATED STEEL

Fits: S.B. Chrysler, 273, 318, 340, 360 and W2 Heads 3.375" Tall

- Includes two breather/filler cap grommets

PART # DESCRIPTION

- 68161*** Valve Covers, Stamped Steel, Chrome Plated, Tall Design with Baffles

PART # ACCESSORIES

- 93050** Perm Align V/C Gasket

PART # REPLACEMENT PARTS

- 97340** Breather/Filler Cap Grommets

 **WARNING Prop. 65**
This product contains a chemical known to the state of California to cause cancer, birth defects, or reproductive harm-



No. 68161

FABRICATED ALUMINUM, BILLET RAIL

Fits: S.B. Chrysler, 273, 318, 340, 360 and W2 Heads 3.750" Tall

- Fabricated entirely from one-piece superior quality aluminum, ultra-lightweight
- One-piece billet rail is CNC machined to ensure a precision flat surface for superior sealing
- Airtight sealing allows the engine to pull greater vacuum for improved ring seal and power
- Mating of the billet rail to the valve cover is done with a smooth transition, eliminating trapped oil and spills when removing the cover
- Notched at each mounting location with socket-sized clearances for quick removal and installation
- Tall enough to clear most rocker combinations
- Fasteners Included

PART # DESCRIPTION

- 68310*** Valve Covers, Fabricated Aluminum, Billet Rail

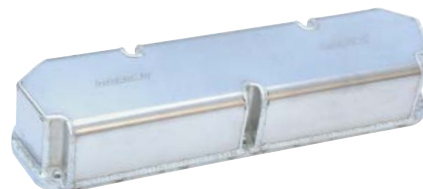

No. 68310

PART # ACCESSORIES

- 68771** PCV Grommet, .095"
- 68773** PCV Grommet/Baffle, .095"
- 68776** Breather Grommet/Baffle, .095"
- 93050** Perm Align V/C Gasket
- 97341** Filler Cap Breather Grommet, .095"

PART # REPLACEMENT PART

- 97035** Nuts, 12 Pt.

**Not legal for sale or use on pollution-controlled vehicles.*

ALL BILLET ALUMINUM

Fits: Chrysler 5.7/6.1/6.2/6.4 Hemi

2.05" Tall

- Make your Hemi engine look like it deserves the Hemi name
- Each 4 lb. valve cover is CNC machined from a 34 lb. solid billet aluminum bar
- Fits both early and late 5.7, 6.1, 6.2 and 6.4 heads
- Must use 2006-up 5.7, 6.1, 6.2 or 6.4 coil packs
- The end result is a lightweight, strong cover that has a precision flat surface for superior sealing
- Covers are designed to work with stock coil packs, gaskets and fasteners
- Taller for aftermarket valve train assemblies
- Airtight sealing allows the engine to pull greater vacuum for improved ring seal and power
- Available in two finishes; raw machined billet finish or black anodized finish with machined ribs
- Use MOPAR V/C gasket Part No. 5114179AB



No. 68467



No. 68468

PART # DESCRIPTION

68467* Valve Covers, Billet Aluminum, Raw Machined Billet Finish

68468* Valve Covers, Billet Aluminum, Anodized Black with machined ribs

CHRYSLER 361 - 440

CHROME PLATED STEEL

Fits: B.B. Chrysler, 361, 383, 400, 413, 426 wedge and 440

3.375" Tall with Baffle

- Includes two breather/filler cap grommets

PART # DESCRIPTION

68181* Valve Covers, Stamped Steel, Chrome Plated, Tall Design with Baffles

PART # ACCESSORIES

93055 Perm Align V/C Gasket

⚠ WARNING Prop. 65
This product contains a chemical known to the state of California to cause cancer, birth defects, or reproductive harm.



No. 68181

PART # REPLACEMENT PARTS

97340 Breather/Filler Cap Grommets

FORD 221, 260, 289, 302, 351W

CHROME PLATED STEEL

Fits: Ford 221-302 & 351W

3.5" Tall

- Includes two breather/filler cap grommets and one non-baffled PCV grommet

PART # DESCRIPTION

68201* Valve Covers, Stamped Steel, Chrome Plated, Tall Design with Baffles under openings, Moroso Logo

68202* Stamped Steel Valve Covers, Chrome Plated, Tall Design without Baffles, Moroso Logo

68210* Valve Covers, Stamped Steel, Chrome Plated, Tall Design with Baffles, no logo

PART # ACCESSORIES

68770 PCV Grommet

97340 Breather/Filler Cap Grommets

93060 Perm Align V/C Gasket

⚠ WARNING Prop. 65
This product contains a chemical known to the state of California to cause cancer, birth defects, or reproductive harm.



No. 68201



No. 68202



No. 68210

**Not legal for sale or use on pollution-controlled vehicles.*



VALVE COVERS

POLISHED CAST ALUMINUM

Fits: 260-351W Engines

3.5" Tall

- Brilliant hand polished finish
- Die-casting process is far more precise and results in a blemish-free surface without porosity
- Extra tall design clears most stud girdles and rocker combinations
- Inside cover is pilot notched, making it easy to cut out openings for a PCV Valve, breather, or oil filler cap; includes grommets

PART # DESCRIPTION
68450* Valve Covers, Die-Cast Aluminum
 Ford 221, 260, 289, 302 (5.0L) & 351W

PART # ACCESSORIES
68771 PCV Grommet, .095"
68773 PCV Grommet/Baffle, .095"
68776 Breather Grommet/Baffle, .095"
93060 Perm Align V/C Gasket
97341 Filler Cap Breather Grommet, .095"



No. 68450

FABRICATED ALUMINUM, BILLET RAIL

Fits: Ford 302/351W stock and Aftermarket Cylinder Heads 2.75"

Tall to clear most popular rocker combinations including Jesel & T&D Shaft rockers

- Replaces Moroso **No. 68325**
- Fabricated entirely from superior quality aluminum, ultra-lightweight
- One piece billet rail is CNC machined to ensure a precision flat surface for superior sealing
- Airtight sealing allows the engine to puller greater vacuum for improved ring seal and power
- Notched at each mounting location with socket-sized clearances for quick removal and installation
- Fasteners included

PART # DESCRIPTION
68475* Valve Covers, Fabricated Aluminum, Ford 302/351W with Billet Rail



No. 68475

PART # ACCESSORIES
93060 Perm Align V/C Gasket

ALL BILLET ALUMINUM

Fits: Ford 302/351W stock and Aftermarket Cylinder Heads 2.875"

tall to clear most popular rocker combinations including Jesel & T&D Shaft rockers

- Each valve cover is CNC machined from a solid billet aluminum bar
- Precision flat mounting rail surface for airtight sealing allowing the engine to pull greater vacuum for ring seal and power
- Even though these valve covers are light in weight, they are thick enough for the engine builder to be able to add fittings at the top and ends
- Includes oil fill cap, Moroso **No. 68485**
- The covers can be polished, chromed, powder coated or left as-is for a race look

PART # DESCRIPTION
68474* Valve Covers, Billet Aluminum, Ford 302/351W



No. 68474

PART # ACCESSORIES
68831 Stud Kit, V/C, Bullet Nose, 12 Pt. Nut
93060 Perm Align V/C Gasket

**Not legal for sale or use on pollution-controlled vehicles.*



FABRICATED ALUMINUM, BILLET RAIL

Fits: Ford 4.6 & 5.4 Three Valve Engines

3.971" Tall at Cam Cover, 3.674" Tall at the main body

- Fabricated entirely from superior quality aluminum, ultra-lightweight
- One piece billet aluminum rail is CNC machined for superior sealing
- Bright aluminum finish matches the Moroso tanks and other under hood accessories or can be polished, chrome plated, etc. for a custom look
- These valve covers are a direct bolt in for 2005 - 2010 Mustangs and feature a oil fill hole with billet aluminum cap, ports for PCV and vent lines
- Features stand offs for factory wiring, coil mounting, and provisions for factory cam timing solenoids
- Airtight sealing allows the engine to pull greater vacuum for improved ring seal and power
- 3/8" billet rail with machined to accept OEM gasket
- Includes mounting hardware, PCV and fitting

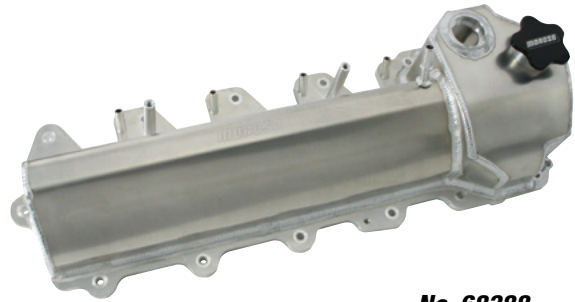

No. 68388



PART # DESCRIPTION

68388* Valve Covers, Fabricated Aluminum, Ford 4.6 & 5.4, Three Valve

FABRICATED ALUMINUM, BILLET RAIL

Fits: Ford 4.6/5.4L 11 Bolt Cylinder Heads

4.225" Tall at Cam Cover, 3.110" Tall main body

- Fabricated entirely from superior quality aluminum, ultra-lightweight
- One piece billet rail is CNC machined to ensure a precision flat surface for superior sealing
- Mating of the billet rail to the valve cover is done with a smooth transition, eliminating trapped oil and spills when removing the cover
- Tall enough to clear most popular rocker combinations
- Fasteners included
- Comes with knurled billet oil filler cap and uses stock style gaskets



No. 68389

PART #	DESCRIPTION
68389*	Valve Covers, Fabricated Aluminum, SBF Modular
PART #	ACCESSORIES
68771	PCV Grommet, .095"
68773	PCV Grommet/Baffle, .095"
68776	Breather Grommet/Baffle, .095"
97341	Filler Cap Breather Grommet, .095"

**Not legal for sale or use on pollution-controlled vehicles.*



FABRICATED ALUMINUM, BILLET RAIL

Fits: Ford FE

3.5" Tall

- Fabricated entirely from superior quality aluminum, ultra-lightweight
- One-piece billet rail is CNC machined to ensure a precision flat surface for superior sealing
- Airtight sealing allows the engine to pull greater vacuum for improved ring seal and power



No. 68461

PART # DESCRIPTION

68461* Valve Covers, Fabricated Aluminum, Billet Rail, 3.5' Tall

PART # ACCESSORIES

- 68771** PCV Grommet, .095"
- 68773** PCV Grommet/Baffle, .095"
- 68776** Breather Grommet/Baffle, .095"
- 97341** Filler Cap Breather Grommet, .095"

FORD 429-460

FABRICATED ALUMINUM, BILLET RAIL

Fits: Ford 429-460

PART # DESCRIPTION

- 68348*** Valve Covers, Fabricated Aluminum, Billet Rail, 2.5" Tall
- 68349*** Valve Covers, Fabricated Aluminum, Billet Rail, 3.5" Tall

PART # ACCESSORIES

- 68771** PCV Grommet, .095"
- 68773** PCV Grommet/Baffle, .095"
- 68776** Breather Grommet/Baffle, .095"
- 93065** Perm Align V/C Gasket
- 97341** Filler Cap Breather Grommet, .095"



No. 68348

PONTIAC V8

CHROME PLATED STEEL

Fits: Pontiac 301-455

3.5" Tall Design with Baffle

- Includes two breather/filler cap grommets and one baffled and one non-baffled PCV grommet

PART # DESCRIPTION

68281*o Valve Covers, Stamped Steel, Chrome Plated, Tall Design with Baffle

PART # REPLACEMENT PARTS

- 68770** PCV Grommet
- 68772** PCV Grommet with Baffle
- 97340** Breather/Filler Cap Grommets



No. 68281

o **WARNING Prop. 65**
This product contains a chemical known to the state of California to cause cancer, birth defects, or reproductive harm-

*Not legal for sale or use on pollution-controlled vehicles.



PERM-ALIGN VALVE COVER GASKETS

- Specially designed gaskets are manufactured from 40 durometer silicone, molded over and vulcanized to a rigid steel frame
- The extra-strength design will not leak, blow out or get sucked in like stock or inferior-quality aftermarket gaskets
- Superior quality silicone/steel gaskets outlast cork and rubber composite designs to provide years of dependable service, especially when constantly removing and reinstalling valve covers
- Full 3/16"-thick
- Two per package

PART # DESCRIPTION

93020 Perm-Align Valve Cover Gasket
Fits: SBC, Moroso Fabricated Billet Valve Covers and others of similar design, not for Stamped or Cast Valve Covers



No. 93020

93021 Perm-Align Valve Cover Gasket
Fits: 18, 16, 15, 13.5 & 12° Dart, Brodix, Edelbrock and All Pro cylinder heads



No. 93021

93040 Perm-Align Valve Cover Gasket
Fits: BBC, Moroso Valve Covers and others of similar design



No. 93040

93045 Perm-Align Valve Cover Gasket
Fits: Big Chief (does not fit Dart Big Chief II, 11° Cylinder heads)



No. 93045

93050 Perm-Align Valve Cover Gasket
Fits: SB Chrysler



No. 93050

93055 Perm-Align Valve Cover Gasket
Fits: BB Chrysler



No. 93055

93060 Perm-Align Valve Cover Gasket
Fits: Ford 221, 260, 289, 302 and 351W, Moroso Valve Covers and others of similar design



No. 93060

93065 Perm-Align Valve Cover Gasket
Fits: BB Ford



No. 93065

NOTE: Modifications required for Moroso Valve Cover Nos. 68329 and 68417

VALVE COVER GASKETS, GM LS SERIES

Fits: Both Moroso GM LS Series and O.E.M. Valve Covers

- Manufactured out of heavy duty molded rubber
- Quality design and manufacturing meets or exceeds O.E.M. quality
- Two per package

PART # DESCRIPTION

93025 Valve Cover Gasket, GM LS Series



No. 93025



VALVE COVER HOLD DOWN TABS

Fits: SBC and 90° V6 Chevy

- Specifically designed to spread the fastener load over a larger area of the valve cover flange to eliminate flange distortion and subsequent oil leakage
- Available in chrome plated steel, black, red and blue powder coated steel

PART #	DESCRIPTION
68501	Valve Cover Hold Down Tabs, Steel, Powder Coated-Black with Clear Lacquer
68505	Valve Cover Hold Down Tabs, Steel, Powder Coated-Red
68506	Valve Cover Hold Down Tabs, Steel, Powder Coated-Blue
68510	Valve Cover Hold Down Tabs, Steel, Chrome Plated



No. 68501

Other Colors Available:



WARNING Prop. 65
This product contains a chemical known to the state of California to cause cancer, birth defects, or reproductive harm-

VALVE COVER HOLD DOWN TABS

Fits: BBC

- Set fits one valve cover, includes four 3" tabs and three 4" tabs with 5/16" diameter holes

PART #	DESCRIPTION
68516	Valve Cover Hold Down Tabs, Steel, Chrome Plated
68525	Valve Cover Hold Down Tabs, Steel, Powder Coated-Red
68526	Valve Cover Hold Down Tabs, Steel, Powder Coated-Blue



No. 68516

WARNING Prop. 65
This product contains a chemical known to the state of California to cause cancer, birth defects, or reproductive harm-

VALVE COVER HOLD DOWN TABS

Fits: Chrysler 273-360

- Set fits one valve cover, includes three 4" tabs
- Use 1/4" washer face nuts for the two end holes

PART #	DESCRIPTION
68512	Valve Cover Hold Down Tabs, Steel, Chrome Plated



No. 68512

WARNING Prop. 65
This product contains a chemical known to the state of California to cause cancer, birth defects, or reproductive harm-

VALVE COVER HOLD DOWN TABS

Fits: Ford 221, 260, 289, 302, 351W

- Set fits one valve cover, includes three 3" tabs for the shallow recessed bolt holes and one 4" tab for the deep recessed bolt hole
- Use 1/4" washer face bolts for the two end holes

PART #	DESCRIPTION
68519	Valve Cover Hold Down Tabs, Steel, Chrome Plated



No. 68519

WARNING Prop. 65
This product contains a chemical known to the state of California to cause cancer, birth defects, or reproductive harm-

VALVE COVER HOLD DOWN TABS

Fits: Pontiac 301-455

- Set fits one valve cover, includes four 5" tabs with 3/8" diameter holes

PART #	DESCRIPTION
68530	Valve Cover Hold Down Tabs, Steel, Chrome Plated



No. 68530

WARNING Prop. 65
This product contains a chemical known to the state of California to cause cancer, birth defects, or reproductive harm-

NOTE: Set fits one valve cover, includes four 5" hold down tabs with 3/8" diameter holes

VALVE COVER ACORN NUTS

Fits: SBC or any Valve Cover using 1/4"-20 hold downs

- Add a decorative touch to engines in cases where long valve cover wing nuts are impractical
- Set includes eight 1-3/8" high nuts and 1/4"-20 x 1-3/8" studs

PART # DESCRIPTION
68561 ◊ Valve Cover Acorn Nuts for SBC, Chrome

PART # REPLACEMENT PARTS
97030 Studs 1/4"-20 x 1-3/8"



No. 68561

◊ **WARNING Prop. 65**
 This product contains a chemical known to the state of California to cause cancer, birth defects, or reproductive harm-

VALVE COVER HEX HEAD NUTS

- Use when space is critical or if the valve cover nuts must be snugged down tighter than wing-nut-finger-tight
- Four per package with 1/4"-20 x 1-3/8" studs included
- Install and remove with half inch socket wrench with extension or a speed handle

PART # DESCRIPTION
68550 ◊ Valve Cover Hex Head Nuts, 1/2" hex head, 4-1/4" long, Chrome Plated Steel

PART # REPLACEMENT PART
97030 Studs 1/4"-20 x 1-3/8"



No. 68550

◊ **WARNING Prop. 65**
 This product contains a chemical known to the state of California to cause cancer, birth defects, or reproductive harm-

EXTRA LONG VALVE COVER WING NUTS

- Available in chrome plated steel or powder coated aluminum colors including red, blue, black and chrome
- Includes matching studs to eliminate gasket alignment problems and to speed up installation
- Four per pack
- Extra Long Valve Cover Wing Nuts will clear 4-1/2" tall valve cover

PART # DESCRIPTION
68603 Extra Long Valve Cover Wing Nuts, 1/4"-20 with 1-3/8" long studs. Aluminum, Powder Coated-Black
68604 Extra Long Valve Cover Wing Nuts, 1/4"-20 with 1-3/8" long studs. Aluminum, Powder Coated-Blue
68605 Extra Long Valve Cover Wing Nuts, 1/4"-20 with 1-3/8" long studs. Aluminum, Powder Coated-Red
68610 ◊ Extra Long Valve Cover Wing Nuts, 1/4"-20 with 1-3/8" long studs. Steel, Chrome Plated
68621 Extra Long Valve Cover Wing Nuts, 5/16"-18 with 1-3/8" long studs. Aluminum, Powder Coated-Black to fit Pontiac 301-455 and Ford 332-428 FE Series and others
68630 ◊ Extra Long Valve Cover Wing Nuts, 5/16"-18 with 1-3/8" long studs. Steel, Chrome Plated to fit Pontiac 301-455 and Ford 332-428 FE Series and others
68640 ◊ Long Valve Cover Wing Nuts, 1/4"-20 with 1-3/8" long studs. Steel, Chrome Plated for stock height valve covers

PART # REPLACEMENT PARTS
97020 Studs, 1/4"-20 x 1-3/4", 8 per package
97030 Studs, 1/4"-20 x 1-3/8", 8 per package



Other Colors Available:



◊ **WARNING Prop. 65**
 This product contains a chemical known to the state of California to cause cancer, birth defects, or reproductive harm-

NOTE: Wing nut studs 1-3/4" long are packaged with our tall Small Block Chevy die-cast aluminum valve covers to allow for the thicker gasket flange on these covers.



VALVE COVERS

VALVE COVER STUD KIT

Fits: SBC or any Valve Cover using 1/4"-20 hold downs

- These studs were developed primarily for the oval track racer using Moroso Small Block Chevy cast aluminum valve covers where a leaking valve cover caused by a fastener shaking loose from vibration could mean disaster
- Set consists of eight 1/4"-20 x 1-3/4" slotted head studs and eight 1/4"-20 nylon insert lock nuts with washers

PART # DESCRIPTION
68820 Valve Cover Stud Kit

PART # REPLACEMENT PART
97020 8 Studs 1/4"-20 x 1-3/4", Slotted Head



No. 68820

VALVE COVER NUTS

Fits: BBC with Moroso Part Nos. 68420, 68425, 68426, 68429 and 68432 Valve Covers

- Set includes (14) Lock Nuts, (6) 1/4"-20 x 3-1/4" Studs and (8) 1/4"-20 x 1-3/4" Studs
- Lock Nuts have a clear zinc finish

PART # DESCRIPTION
68562 Valve Cover Lock Nuts for BBC

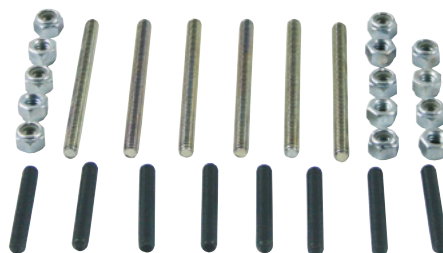

No. 68562

BULLET NOSE VALVE COVER STUD KIT

- Bullet nose tip makes it easy to start mounting nuts
- Prevents Small Block Chevy, Big Block Chevy & Small Block Chrysler cast aluminum valve covers from vibrating loose in competition
- Includes eight 1/4"-20 x 1-1/2" heat-treated studs, nylon-insert lock nuts and washers

PART # DESCRIPTION
68830 Bullet Nose Valve Cover Stud Kit
68831 Bullet Nose Valve Cover Stud Kit, 12 pt. nut

PART # REPLACEMENT PARTS
97035 Nuts, 12pt.
97040 Studs, 1/4"-20 & 28 Bullet Nose



No. 68830



No. 68831

NOTE: Will not work with Stamped Aluminum Valve Covers.

VALVE COVER BREATHER BAFFLE

- Made of 14 gauge 6061-T6 aluminum, this baffle mounts inside Moroso valve covers under the breather hole to keep oil from getting into the breather
- Use with Valve Cover Breathers **Nos. 68740, 68741, 68781, 68810, 68813** or **68817**
- Cannot be used with engines equipped with stud girdles
- One per package; includes all necessary fasteners

PART # DESCRIPTION
68790 Valve Cover Breather Baffle



No. 68790

BREATHER GROMMETS

With Integral Baffle

- Designed to work with Fabricated Sheet Metal and Cast Aluminum Valve Covers, without logo, that have a 1.220" diameter hole
- Ideal for those using aftermarket valve covers without OEM-style oil control baffles
- Ideally suited for push-in style breather systems
- Will not clear stud girdles
- Made from oil resistant rubber

PART #	DESCRIPTION
68775	Breather Grommet/Baffle, 2 per package
68776	Breather Grommet/Baffle, 2 per package (Designed for .090 - .100" material thickness)



No. 68776

PCV GROMMET

With Integral Baffle

- Designed to work with Fabricated Sheet Metal and Cast Aluminum Valve Covers, without logo, that have a 1.220" diameter hole
- Ideal for those using aftermarket valve covers without OEM-style oil control baffles
- Works with all popular GM PCV valves
- Special design keeps oil out of the PCV valve
- Will not clear stud girdles, made from oil resistant rubber

PART #	DESCRIPTION
68772	PCV Grommet/Baffle, 1 per package
68773	PCV Grommet/Baffle, 1 per package (Designed for .090 - .100" material thickness)



No. 68772

PCV GROMMETS FOR AFTERMARKET VALVE COVERS

- Designed to work with Fabricated Sheet Metal and Cast Aluminum Valve Covers, without logo, that have a 1.220" diameter hole
- Ideal for street enthusiasts using aftermarket valve covers and a positive crankcase ventilation system
- Works with all popular GM PCV valves
- Made from oil-resistant rubber

PART #	DESCRIPTION
68770	PCV Grommets, 2 per package
68771	PCV Grommets, 2 per package (Designed for .090 - .100" material thickness)



No. 68770

BREATHER/FILLER CAP GROMMETS

- Designed to work with Fabricated Sheet Metal and Cast Aluminum Valve Covers, without logo, that have a 1.220" diameter hole
- Replacement Valve Cover Grommets for breathers and oil filler caps; two per pack

PART #	DESCRIPTION
97340	Breather/Filler Cap Grommets
97341	Breather/Filler Cap Grommets (Designed for .090-.100" material thickness)



No. 97340

OIL FILL CAP

Fits: All Moroso and OEM Valve Covers with 1.22" diameter hole

- Push-in design for applications requiring a sealing-type filler plug
- Chrome plated top section

PART #	DESCRIPTION
68660	Oil Fill Cap

 **WARNING Prop. 65**
This product contains a chemical known to the state of California to cause cancer, birth defects, or reproductive harm-



No. 68660



VALVE COVERS

ONE PIECE PUSH-IN VALVE COVER BREATHERS

Fits: Moroso or any Valve Cover with 1.22" hole

- Designed to drain oil trapped in the foam back into the valve cover rather than allow it to drain out the air vents
- Two per package except **No. 68741**

PART # DESCRIPTION

- 68717*** One Piece Push-In Valve Cover Breathers, Aluminum, Powder Coated-Blue,
- 68718*** One Piece Push-In Valve Cover Breathers, Aluminum, Powder Coated-Red
- 68719*** One Piece Push-In Valve Cover Breathers, Aluminum, Powder Coated-Black
- 68740*** One Piece Push-In Valve Cover Breathers, Steel, Chrome Plated
- 68741*** One Piece Push-In Valve Cover Breathers, Steel, Chrome Plated, for street cars that require a PCV set-up. Contains one breather with valve cover grommet and one PCV valve grommet

PART # REPLACEMENT PART

- 97340** Breather/Filler Cap Grommets



No. 68717



Other Colors Available:



WARNING Prop. 65
This product contains a chemical known to the state of California to cause cancer, birth defects, or reproductive harm-



No. 68718



CRANKCASE EVACUATION SYSTEM

- Reduces crankcase pressure throughout entire rpm range for increased piston ring seal, reduced intake charge contamination, and fewer oil leaks
- Track and dyno tests prove increases in engine performance
- Includes 2 each: Oil Separators/Breathers, Breather/Filler Cap Grommets, One-Way Check Valve and Weld-In Nipple for header collector, use with 5/8" dia. hose

PART # DESCRIPTION

- 25900*** Crankcase Evacuation System

ACCESSORIES

- 68788** Breather

PART # REPLACEMENT PARTS

- 68780** Oil Separator/Breathers
- 97800** Check Valve for Header Collector
- 97810** Weld-in Nipple for Header Collector

**Cannot be used on cars with mufflers*



No. 25900

BREATHER/OIL SEPARATOR

Push-in

Fits: All Valve Covers with 1.22" holes; includes rubber grommet

- **No. 68781** is ideal for plumbing your crankcase ventilation system into the air cleaner, while **No. 68780** is a direct breather replacement for **No. 25900** Crankcase Evacuation System
 - Uses internal foam disc and baffling to prevent oil from entering air cleaner
- No. 68781**

PART # DESCRIPTION

- 68780*** Replacement Breather/Oil Separator, for **No. 25900** Crankcase Evacuation System, 5/8" Hose, Clear Zinc
- 68781*** Replacement Breather/Oil Separator, 3/4" Hose, Chrome (for street use only)

PART # REPLACEMENT PART

- 97340** Breather/Filler Cap Grommets

WARNING Prop. 65
This product contains a chemical known to the state of California to cause cancer, birth defects, or reproductive harm-



No. 68781



No. 68780



**Not legal for sale or use on pollution-controlled vehicles.*



POSITIVE LOCKING BREATHER

Stamped Style

Fits: All Valve Covers with 1.22" holes

- Meets rule requirement for cars running 7.99 E.T. and quicker
- Threaded tube with collar mounts from inside valve cover through 1.22" opening; breather screws into the tube for secure attachment
- Viton gasket resists oil, alcohol and race fuel to form airtight seal
- Jam nuts allow breather to be positioned to suit plumbing requirements
- Internal baffling keeps oil/air separated
- Clear zinc finish resists rust
- Includes all mounting hardware; one per pack



No. 68785

PART # DESCRIPTION

68785* Positive Locking Breather, with Tube for 3/4" hose

POSITIVE LOCKING BREATHER

Billet Aluminum

Fits: All Valve Covers with 1.25" holes

- Manufactured from 6061 Billet Aluminum
- Screws to valve cover for positive fit, does not push on
- Designed in two pieces with a top that unscrews to allow for oil filling and easier cleaning or replacement of oil separator filter
- Slip-on fitting for pan evac system
- O-ring Seal – no gaskets (reduces leakage)
- Meets rule requirement for cars running 7.99 E.T. and quicker



No. 68788

PART # DESCRIPTION

68788* Positive Locking Billet Aluminum Filtered Breather

PART # AVAILABLE OPTIONS

22706 1/2" NPT to -10AN Fitting
22708 1/2" NPT to -12AN Fitting

BREATHER TANK, TWO 1/2" FEMALE FITTINGS

Vent Valve Cover Breathers into this Tank by running a hose from the Breathers to the Tank using the Optional Fittings

- Use as a remote multi-inlet oil catch/breather for Crankcase Ventilation, Vacuum Pumps, Dry Sump Tanks or Rear Ends
- Can be used to collect from 2 sources
- Features Two 1/2" NPT Female Fittings that are 180 Degrees apart for ease of plumbing
- Aluminum, lightweight tank features internal baffling with mesh media for separation of air and oil
- Includes non-hooded, clamp-on filtered breather, Heavy Duty T-Clamp and a bottom petcock drain
- Dimensions: 3-1/8" diameter (without mount), 6-1/2" tank height (without filter or drain), 11-1/2" overall height

NEW!

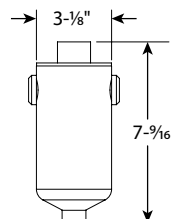

No. 85455

PART # DESCRIPTION

85455 Breather Tank, Two 1/2" NPT Fittings

PART # AVAILABLE OPTIONS

22735 Fitting, 1/2" NPT Male to 5/8" Barbed Hose, Straight
22736 Fitting, 1/2" NPT Male to 5/8" Barbed Hose, 90 Deg.



No. 22735



No. 22736

WARNING Prop. 65
 This product contains a chemical known to the state of California to cause cancer, birth defects, or reproductive harm.

*Not legal for sale or use on pollution-controlled vehicles.



VALVE COVERS

VALVE COVER ADAPTER, ADAPTS GM COPO BREATHERS INTO MOROSO BILLET ALUMINUM VALVE COVER FILL HOLES

- Allows 2013-up COPO Camaro valve cover breather assemblies to be screwed into a Moroso GM LS billet aluminum valve cover oil fill hole
- Adapter is machined out of billet aluminum and features an o-ring for sealing
- Using Moroso **No. 68844** adapters with Moroso **No. 68488** GM LS valve covers featuring an oil fill in each cover

No. 68844



PART # DESCRIPTION

68844 Valve Cover Adapter, Adapts GM COPO Breathers into Moroso Billet Aluminum Valve Cover Fill Holes

V/C BREATHERS, REPLACEMENT FOR GM COPO, 2 PACK

- Replaces damaged COPO Breathers, a good addition to back up engines or for new builds where the goal to is breath the engine the same way as the COPO cars
- Breather screws on to factory COPO breather covers or Moroso Part **No. 68493** valve covers that accept COPO breathers
- Breather's fitting accepts a 5/8" hose



No. 68857

PART# DESCRIPTION

68857 V/C Breathers, replacement for GM COPO, 2 pack

VALVE COVER FILTERED BREATHERS

- Available in half-hooded or non-hooded
- Provides maximum protection against dirt and airborne debris without restricting air flow
- Also available with completely exposed filter element and chrome plated top
- Available in two types; Push-In or Clamp-On (for existing stacks; includes clamp)
- Cleanable and re-usable; oil before use
- One per pack

 **WARNING Prop. 65**
This product contains a chemical known to the state of California to cause cancer, birth defects, or reproductive harm-

PART # DESCRIPTION

- 68811***◊ Valve Cover Filtered Breather, half-hood, clamp-on type; for Moroso Covers with welded-in stacks, 1-3/8" I.D.
- 68812***◊ Valve Cover Filtered Breather, half-hood, clamp-on type; for Moroso Covers with welded-in stacks, 1-1/2" I.D.
- 68813***◊ Valve Cover Filtered Breather, half-hood, push-in type; for Moroso Covers with 1.22" punched holes
- 68815***◊ Valve Cover Filtered Breather, non-hooded style, clamp-on type; for Moroso Covers with welded-in stacks, 1-3/8" I.D.
- 68816***◊ Valve Cover Filtered Breather, non-hooded style, clamp-on type; for Moroso Covers with welded-in stacks, 1-1/2" I.D.
- 68817***◊ Valve Cover Filtered Breather, non-hooded style, push-in type; for Moroso Covers with 1.22" punched holes
- 68818***◊ Filtered Breather, non-hooded style, clamp-on type; for Moroso Breather Tanks, 2" O.D.



No. 68813



No. 68811



No. 68817



No. 68815

CLAMP ON BREATHER

- Clamps onto a 1" outside diameter tube
- Fits Moroso Billet Aluminum Vacuum Relief Valves **Nos. 22633, 22636 and 22637**
- Provides maximum protection against dirt and airborne debris without restricting air flow
- Clamp included
- Cleanable and re-usable: oil before use

 **WARNING Prop. 65**
This product contains a chemical known to the state of California to cause cancer, birth defects, or reproductive harm-

PART # DESCRIPTION

- 68791***◊ Clamp On Breather, 1" I.D.
- 68792** Clamp On Breather has a Black Finish, fits 1" I.D. tubes



No. 68792



No. 68791

*Not legal for sale or use on pollution-controlled vehicles.



WELD-IN FILTERED BREATHER KIT

- Kit contains two aluminum 1-3/8" O.D. breather tubes with internal baffling, two half-hooded filtered breathers, and two stainless hose clamps
- Designed to be welded to Moroso valve covers and can be adapted to other aluminum covers

PART # DESCRIPTION
68800* Weld-In Filtered Breather Kit

PART # REPLACEMENT PARTS
68811* Filtered Breathers, with protective half-hood
68812* Filtered Breathers for early No. 68800 with 1-1/2" tube, half hood

 **WARNING Prop. 65**
 This product contains a chemical known to the state of California to cause cancer, birth defects, or reproductive harm-



No. 68800

PUSH-IN FILTERED BREATHER KIT

- Kit allows engine builder to install filtered breathers on Moroso steel or aluminum valve covers (or other covers with 1.22" holes) without welding
- Consists of two filtered breathers with clamps, two chrome plated adapter tubes and two valve cover grommets
- Filters must be oiled before use

PART # DESCRIPTION
68810* Push-In Filtered Breather Kit

PART # REPLACEMENT PARTS
68816* Filtered Breathers Non-Hooded
68812* Filtered Breathers Half-Hooded

 **WARNING Prop. 65**
 This product contains a chemical known to the state of California to cause cancer, birth defects, or reproductive harm-



No. 68810

SPRINT CAR BREATHER TUBE KITS

- Sprint Car racers can now mount an aluminum tube-style crossover breather kit to their aluminum valve covers and save some money in the process
- Kit comes with all mounting hardware and aluminum bungs which must be welded to the valve covers

PART # DESCRIPTION
68762* Valve Cover Breather Tube Kit, SBC Sprint Cars

PART # ACCESSORIES
68811* Filtered Breathers, Half Hood
68815* Filtered Breathers, Non-Hooded

 **WARNING Prop. 65**
 This product contains a chemical known to the state of California to cause cancer, birth defects, or reproductive harm-



No. 68762

NOTE: Can only be used with aluminum valve covers. Breathers are not included with the kit and must be purchased separately.

BREATHER KIT

For Sprint Car Engines

- Attaches to the valley pan on a sprint car engine
- Kit includes 1-3/4" dia. tubing with 8.5" long legs and a black anodized finish
- Includes a billet aluminum clamp with mounting holes
- Cleanable and re-usable filter

PART # DESCRIPTION
68850* Breather Kit for Sprint Car Engines

BULK PART # REPLACEMENT PART
68850-004* Breather

 **WARNING Prop. 65**
 This product contains a chemical known to the state of California to cause cancer, birth defects, or reproductive harm-



No. 68850

**Not legal for sale or use on pollution-controlled vehicles.*



VALVE COVERS

U-WELD VALVE COVER BREATHER KITS

Available for Aluminum and Steel Valve Covers

- Provides a way of adding a breather to a valve cover with a minimum amount of cutting and welding
- Features a billet aluminum baffled screw in adapter with a 1" breather with either a chrome or black finish
- Cleanable and re-usable filter

PART#	DESCRIPTION
68849	Steel Valve Cover Breather Kit, U-Weld, 1" Breather, Chrome Finish
68851	Steel Valve Cover Breather Kit, U-Weld, 1" Breather, Black Finish
68852	Aluminum Valve Cover Breather Kit, U-Weld, 1" Breather, Chrome Finish
68853	Aluminum Valve Cover Breather Kit, U-Weld, 1" Breather, Black Finish



No. 68849



No. 68851

WARNING Prop. 65
This product contains a chemical known to the state of California to cause cancer, birth defects, or reproductive harm-



No. 68853



No. 68852

VALVE COVER BREATHER KITS, NON-WELD

- Provides an easy way of adding a breather to a steel or aluminum valve cover without welding
- Since no welding is required then there is not the possibility of heat damage to the chrome or powder coat
- Features a billet aluminum baffled screw in adapter with a 1" breather with either a chrome or black finish
- Includes optional interior baffle and mounting hardware
- Cleanable and re-usable filter

PART#	DESCRIPTION
68854	Valve Cover Breather Kit, Non-Weld, 1" Breather, Chrome Finish
68855	Valve Cover Breather Kit, Non-Weld, 1" Breather, Black Finish

No. 68854



No. 68855

WARNING Prop. 65
This product contains a chemical known to the state of California to cause cancer, birth defects, or reproductive harm-



BREATHER KITS, GM LS MOROSO VALVE COVERS

For Moroso GM LS Valve Covers or any 1-1/4" -12 Female Threaded Bung/Opening

- Provides an easy way of adding a breather to Moroso LS valve cover with an oil fill bung
- Remove knurled cap on valve cover to screw in the Part Nos. **68848** and **68841** Breather Kits
- Features a billet aluminum baffled screw in adapter with a 1" breather
- Cleanable and re-usable filter

PART # DESCRIPTION

- 68841*** Breather Kit for Moroso GM LS Valve Cover
68848 Breather Kit for Moroso Valve Covers, Breather has a Black Finish

PART# REPLACEMENT PART

- 68791** Clamp on breather, 1" I.D.

 **WARNING Prop. 65**
 This product contains a chemical known to the state of California to cause cancer, birth defects, or reproductive harm-



No. 68848



No. 68841

BREATHER KITS, GM LS O.E.M. VALVE COVERS

- Provides an easy way of adding a breather to GM LS O.E.M. valve cover with an oil fill bung
- Remove oil fill bung on valve cover, screw in breather kit and tighten down with built-in hex
- All kits feature a baffled billet aluminum screw in adapter with a 1" breather
- Cleanable and re-usable breather

Part# DESCRIPTION

- 68839** Breather Kit for O.E.M. GM LS **Single Tab** Valve Cover
68840 Breather Kit for O.E.M. GM LS **Double Tab** Valve Cover
68846 Breather Kit With Black Finish, O.E.M. GM LS **Single Tab** Valve Covers
68847 Breather Kit With Black Finish, O.E.M. GM LS **Double Tab** Valve Covers

 **WARNING Prop. 65**
 This product contains a chemical known to the state of California to cause cancer, birth defects, or reproductive harm-

SINGLE TAB

DOUBLE TAB

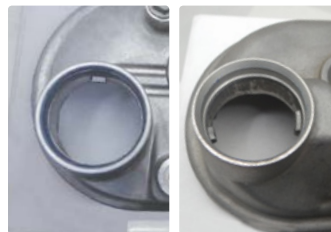

PART# REPLACEMENT PART

- 68791** Clamp on breather, 1" I.D.



No. 68840

-12AN FITTING KITS, GM LS O.E.M. VALVE COVERS

- Provides an easy way of adding a -12AN Male fitting to GM LS O.E.M. valve cover with an oil fill bung
- Remove oil fill bung on valve cover, screw in -12AN fitting kit and tighten down with built-in hex

Part# DESCRIPTION

- 68843** Fitting Kit, -12AN for O.E.M. GM LS **Double Tab** Valve Cover
68845 Fitting Kit, -12AN for O.E.M. GM LS **Single Tab** Valve Cover

DOUBLE TAB

SINGLE TAB

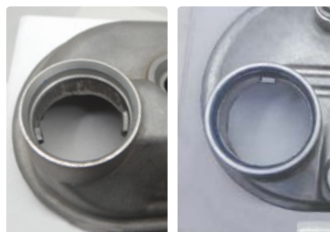

No. 68843

-12AN FITTING KIT, MOROSO GM LS VALVE COVERS

- Provides an easy way of adding a -12AN Male fitting to MOROSO GM LS valve cover with an oil fill bung, or any 1-1/4"-12 Female Threaded Bung/Opening
- Remove oil fill bung on valve cover, screw in -12AN fitting kit and tighten down with built-in hex

PART# DESCRIPTION

- 68856** Fitting Kit, -12AN for Moroso GM LS Valve Cover



No. 68856

*Not legal for sale or use on pollution-controlled vehicles.



-10AN MALE FITTING

Non-Weld

- Non-weld kit, makes it easy to add a leak proof fitting to oil pans for oil returns, valve covers etc., without having to actually weld the fitting
- Perfect for adding a fitting to steel or aluminum with up to a 1/8" max. wall thickness
- O-ring seal to prevent leaks

PART #	DESCRIPTION
22753	-10AN Male Fitting, Non-Weld



No. 22753

-12AN MALE NON-WELD, BAFFLED FITTING KIT

- Provides an easy way of adding a -12AN male fitting to a steel or aluminum flat surface without welding
- Since no welding is required then there is not the possibility of heat damage to the surface or the need to take the piece to get welded
- Billet aluminum mounting plate features an o-ring and hardware for leak free sealing
- Includes optional interior baffle and mounting hardware
- -12AN fitting screws into base plate and can be tightened down with built-in hex

PART #	DESCRIPTION
22754	Fitting Kit, -12AN Male, Non-Weld Baffled



No. 22754

FILL CAP KITS, UNIVERSAL

- Cap Kit **No. 85280** and **No. 85282** are knurled
- Cap Kit **No. 85283** is designed with contoured grip
- These universal kits, available with steel or 6061-T6 aluminum bung, can be used on valve covers and other locations to replenish fluid, or serve as an inspection port
- Bungs can be welded to any suitable tank, valve cover or plate
- Manufactured from 6061-T6 aluminum, includes O-Rings for leak-free sealing

PART #	DESCRIPTION
85280	Fill Cap Kit, Universal, Steel Bung, 1-1/4" -12UNF Threads, 1.5" OD
85282	Fill Cap Kit, Universal, Aluminum Bung, 1-1/4" -12UNF Threads, 1.5" OD
85283	Fill Cap Kit, Universal, Aluminum Bung, Black Anodized with logo, 1-3/8" -12UNF Threads, 2.6" OD



No. 85280



No. 85283

NOTE: For steel applications, use Rear End Fill Cap No. C9085

FILL CAP KITS, UNIVERSAL, NON-WELD, WELD

- Provides an easy way of adding an oil fill to a valve cover, tank, rear end and other locations
- Available in two versions:
 - Non-Weld, for aluminum or steel, since no welding is required then there is not the possibility of heat damage to chrome or powder coat
 - Weld On, for steel (Steel Bung)
- Finger Grip cap manufactured from 6061-T6 billet aluminum with a black anodized finish, Moroso logo, includes O-Ring for leak free sealing

PART #	DESCRIPTION
68485	Fill Cap Kit, Non-Weld, 1-1/4" -12UNF Threads, 1.5" O.D.
85284	Fill Cap Kit, Weld, Steel, 1-1/4" -12UNF Threads, 1.5" O.D.



No. 68485



No. 85284

VALVE COVER WELD-IN BUNGS

- Can be welded to aluminum valve covers, holding tanks, cylinder heads, oil pans, etc. or wherever an NPT fitting is needed
- Made of 6061-T6 aluminum and fit a 1" diameter hole
- Two per pack

PART #	DESCRIPTION
68900	Aluminum Weld-In Bungs, 3/8" NPT Fitting
68910	Aluminum Weld-In Bungs, 1/2" NPT Fitting



No. 68900



HOW MOROSO IGNITION WIRE IS MANUFACTURED

Adapted from *DRAG RACING ACTION Magazine*
by JOHN DiBARTOLOMEO

Spark plug wire used to be nothing more than a solid core length of wire with some type of insulation. Suppression wire was later developed to combat radio interference, otherwise known as RFI (radio frequency interference) or EMI (electro-magnetic interference). For suppression wire to work, it must contain a certain amount of electrical resistance. Because of this resistance, it was never useful in race applications, where every bit of spark energy is beneficial to lighting an adequate fire within the engine's cylinders. For that reason, racers always choose a solid core plug wire, which had no suppression capabilities, but offered very little resistance to the spark generated by modern era ignition boxes.

That changed in the mid-'80's when data loggers became standard issue on race cars. The capabilities of those early loggers were very susceptible to RFI noise, which could disrupt the timing functions of the delay/throttle stop boxes, as well as the recording ability of data loggers. Though most manufacturers installed some filtering, RFI became a big issue in the racing industry.

The engineers at Moroso realized the need for enhanced suppression plug wire that would alleviate or reduce the amount of RFI. A spark voltage that exceeds 50,000-volts through a plug wire would inevitably find its way through the outer core of the wire and into the airwaves. So, it became optimal for racers to install suppression plug wires but the requirement to have a very low resistance wire was a necessity.

Moroso Wire Technology led the development of modern ignition wire, designed with a Kevlar core, nickel copper alloy wire wrapped around the Kevlar and ferrite-impregnated outer sleeve. Moroso high performance Ignition Wire, manufactured at our facility in Philadelphia, protects against heat, chaffing, contaminants and results in a resistance of only 40-ohms per foot.



For info. on Custom Imprinted Wire Sets and other street applications, see pg. 335



The wire travels 250 feet through these long tubes on the right in order to cure and cool the wire after manufacturing.



The rubber cover material for the center conductor starts out in this ribbon-like form. It's fed into a tube that heats and feeds it through a series of collets to form it around the center conductor.



An optical laser measuring device keeps constant measurement on the completed wire as it comes to the end of the line. The machine operator must maintain the measurement within a specified amount and adjust as necessary.



The outer silicone material is fed through the machine in the same fashion as the center core cover, eventually making it's way onto the wire and completing the forming process.

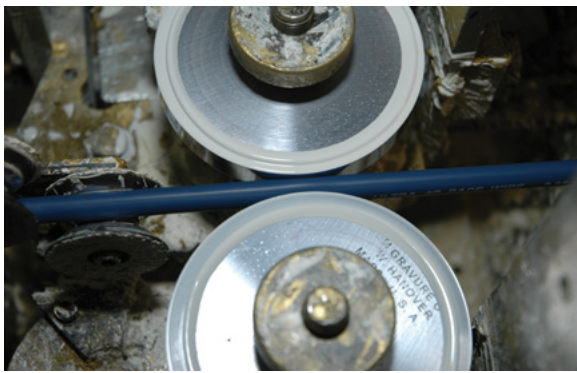

These print wheels are laser engraved with the Moroso and Ultra 40 Race Wire logos. At the end of the forming line, the wheels pick up ink and print on both sides of the wire.



In the last step in the manufacturing process, completed wire is rolled onto wooden spools. Each spool holds 5,000-feet of wire awaiting the final steps to complete a length of spark plug wire.



This automatic machine cuts the wire from the bulk spools to specified lengths and strips back the insulation on both ends prior to the terminal end crimping process.



Each wire is hand fed into a crimping machine that automatically feeds terminal ends through it, while an operator feeds the previously stripped back wire in, finally ending up with a crimped terminal on the end.



Before a plug boot is installed, each wire undergoes testing to ensure the quality of the crimp and the wire's conductivity. The plug boot is then installed, the wire is packaged and is ready for delivery.



Moroso Ultra 40 Race Wire Sets receive a fiberglass reinforced silicone outer sleeve which requires a heat shrink sleeve at the boot in order to seal off the whole assembly.



The manufacture of Ignition Wire requires several different steps: first, the center conductor (1) has EPDM (Ethylene Propylene Diene Monomer) rubber material formed around it (2). The wire is then re-fed into the machine where the outer silicone covering is formed and printed with the type of wire it is (3). The completed wire is then stripped back (4) and the terminal ends are crimped on (5). The plug boot is installed (6) and finally, for race applications, a silicone-jacketed fiberglass sleeve is slipped over the assembly and a shrink sleeve installed (7).

ULTRA 40 UNIVERSAL WIRE SETS, UNSLEEVED

The most powerful wire for any race application!

- Moroso Ultra-40 Race Wire is the standard in high performance ignition wire
- Optimized EMI/RFI resistance
- Used in the highest level of racing applications, from dual mag Top Fuel Cars thru NASCAR Sprint® Cup Series
- 7mm or 8.65mm diameter wire with 40 ohms of resistance per foot
- Incorporates a highly engineered spiral wound conductor
- Maximizes energy transfer and minimizes electro magnetic interference (EMI) and radio frequency (RF) interference noise
- Includes appropriate hardware



No. 73814

BUYER'S GUIDE FOR ULTRA 40 UNIVERSAL WIRE SETS, UNSLEEVED

APPLICATION/ DISTRIBUTOR CAP STYLE	WIRE COLOR			WIRE DIA. (mm)	SPARK PLUG WIRE LENGTHS (INCHES)								PLUG BOOT	COIL WIRE LENGTH (inches)
	BLUE	RED	BLACK		1	2	3	4	5	6	7	8		
UNIVERSAL FIT														
90° Universal	73800	73810	73814	8.65	35	35	39	39	46	50	53	53	90°	36
Straight Universal	73801	73812	73815	8.65	35	35	39	39	46	50	53	53	STR.	36
135° Universal	73802	73836	73816	8.65	35	35	39	39	46	50	53	53	135°	36
HEMI														
Mopar/Chrysler OEM Style Insulators	73840	N/A	73841	8.65	28	32	38	42	51	56	61	66	Hemi	36
BAE-AJPE/8.5" Insulators	N/A	N/A	73804	8.65	38	42	48	52	56	61	66	71	Hemi	41
Hemi, AJPE, BAE, MBE, NOONAN Style Heads, 9" Long Hemi Insulators, HEI Boots & Terminals	N/A	N/A	73805	8.65	38	42	48	52	56	61	66	71	Hemi	41
BAE-AJPE/7" Insulators	73808	N/A	N/A	8.65	28	32	38	42	51	56	61	66	Hemi	36
GM Pro Stock, Brodix PB201, CFE, Ford, Yates/ 5" Long Straight Pro Boot	73813	N/A	73839	8.65	41	41	46	46	56	56	66	66	STR.	38
GM LS SERIES														
Coil-on Plug	73811	73837	73828	7	48	48	48	48	48	48	48	48	STR.	N/A



**NOW AVAILABLE
IN BLUE, RED OR
BLACK!**

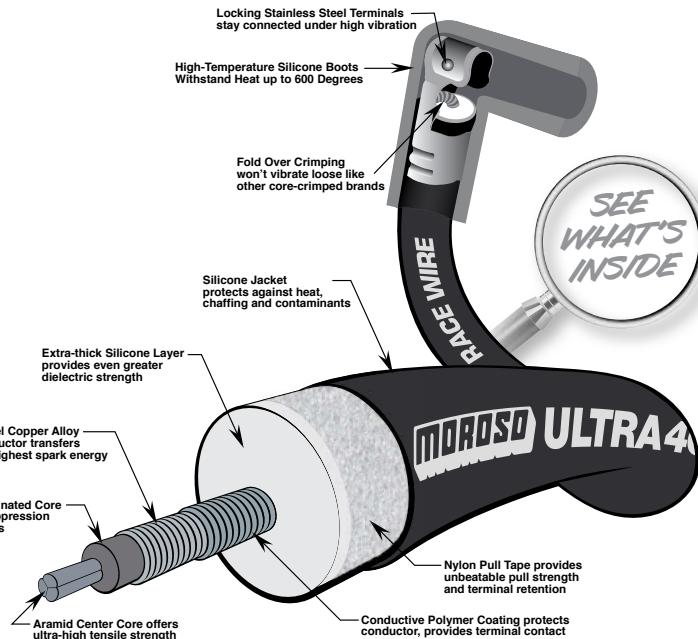

WARNING Prop. 65
This product contains a chemical known to the state of California to cause cancer, birth defects, or reproductive harm.



ULTRA 40 CUSTOM FIT WIRE SETS, UNSLEEVED

- Cost-effective version of our race proven Ultra 40 Race Wire, without heat sleeving
- 7 or 8.65mm diameter wire with 40 ohms of resistance per foot
- Complete, ready-to-install sets available for specific engines
- Wire for each cylinder is labeled

WARNING Prop. 65
 This product contains a chemical known to the state of California to cause cancer, birth defects, or reproductive harm-



BUYER'S GUIDE FOR ULTRA 40 CUSTOM FIT WIRE SETS, UNSLEEVED

APPLICATION/ DISTRIBUTOR CAP STYLE	WIRE COLOR			WIRE DIA. (MM)	SPARK PLUG WIRE LENGTHS (INCHES)										PLUG BOOT	COIL WIRE LENGTH (INCHES)
	BLUE	RED	BLACK		CYLINDER #											
	PART #				1	2	3	4	5	6	7	8	9	10		
SBC																
Over VC/Non-HEI	73663	73683	73706	8.65	29	33	35	27	25	27	25	24	N/A	N/A	90°	36
Over VC/HEI	73664	73684	73707	8.65	29	33	35	27	25	27	25	24	N/A	N/A	90°	36
Over V/C, HEI	N/A	N/A	73725	8.65	29	33	35	27	25	27	25	24	N/A	N/A	135°	36
Under Header/Non-HEI	73665	73685	73708	8.65	45	45	40	40	27.75	28	27	26.75	N/A	N/A	90°	36
Under Header/HEI	73666	73686	73709	8.65	45	45	40	40	27.75	28	27	26.75	N/A	N/A	90°	36
Under Header, HEI	N/A	N/A	73726	8.65	45	45	40	40	27.75	28	27	26.75	N/A	N/A	135°	36
Sprint Car, HEI, Rear Drive	73677	73699	73722	8.65	39	38	36	34	28.00	27	25	24.00	N/A	N/A	90°	18
Sprint Car Front Magneto Drive Kit, Non-Raised Cam	N/A	N/A	73723	8.65	26.25	20.25	28	25.50	33	30	30.50	33.50	N/A	N/A	90°	48
Sprint Car Front Magneto Drive Kit, Raised Cam	N/A	N/A	73724	8.65	26.75	20.75	28.50	26	33.50	30.50	31	34	N/A	N/A	90°	48
GM LS SERIES																
Coil-On Plug, Short	73660	73680	73703	7	8	8	8	8	8	8	8	8	N/A	N/A	STR.	N/A
Coil-On Plug, Med.	73662	73682	73705	7	9.75	9.75	9.75	9.75	9.75	9.75	9.75	9.75	N/A	N/A	STR.	N/A
Coil-On Plug, Med.	N/A	N/A	73727	7	9.75	9.75	9.75	9.75	9.75	9.75	9.75	9.75	N/A	N/A	135°	N/A
Coil-On Plug, Med., Alum. Shielded	73659	73679	73730	7	9.75	9.75	9.75	9.75	9.75	9.75	9.75	9.75	N/A	N/A	SHLD.	N/A
Coil-On Plug, Long	73661	73681	73704	7	12	12	12	12	12	12	12	12	N/A	N/A	STR.	N/A
BBC																
Over VC/Non-HEI Style Cap	73667	73687	73710	8.65	31	39	35	30	29	28	26	27	N/A	N/A	STR.	36
Over VC/HEI Style Cap	73668	73688	73711	8.65	28.75	34.75	34.25	28.75	27.25	28.50	26	25	N/A	N/A	STR.	36
Over VC/HEI Style Cap	N/A	N/A	73728	8.65	28.75	34.75	34.25	28.75	27.25	28.50	26	25	N/A	N/A	135°	36
Under Header/Non-HEI Style Cap	73670	73690	73713	8.65	39	42	37	25	29.5	31	22	29	N/A	N/A	90°	36
Under Header/HEI Style Cap	73669	73689	73712	8.65	41.5	44.5	37.5	37	31	31	26.5	31	N/A	N/A	90°	36
Under Header/HEI Style Cap	N/A	N/A	73729	8.65	41.5	44.5	37.5	37	31	31	26.5	31	N/A	N/A	135°	36
Under Header/Non-HEI Crab	73671	73691	73714	8.65	38	43	35	33	29.5	30	26	29	N/A	N/A	90°	36
Under Header, HEI Crab	73672	73692	73715	8.65	38	43	35	33	29.5	30	26	29	N/A	N/A	90°	36
DODGE/CHRYSLER																
Hemi Truck 2003-2005	73657	N/A	N/A	7	34.5	36.5	36.5	37.75	35.5	34.5	37.75	35.25	N/A	N/A	STR.	N/A
5.7 Hemi 2005 Magnum, 300, Jeep	73658	N/A	N/A	7	44	36.5	37.5	35	39	44	35	40	N/A	N/A	STR.	N/A
FORD 289-302																
Non-HEI	73676	73696	73719	8.65	27.75	28	26.5	29	24.5	25	28	28.5	N/A	N/A	135°	38
HEI	73675	73695	73718	8.65	27.75	28	26.5	29	24.5	25	28	28.5	N/A	N/A	135°	36
FORD 351W																
HEI	73673	73693	73716	8.65	29	29	32	32	28	26	34	36	N/A	N/A	135°	36
FORD 429-460																
HEI	73674	73694	73717	8.65	27	27	29	29.5	24	32.5	27	32.25	N/A	N/A	135°	36

ULTRA 40 CUSTOM FIT WIRE SETS, SLEEVED

Exterior sleeving offers improved dielectric strength for added resistance to outside pulses while protecting wire against heat, chafing and contaminants

- 7mm or 8.65mm diameter wire with 40 ohms of resistance per foot
- Sleeving adds extra dielectric strength
- Sleeving extends spark plug wire life and protects against exhaust header heat, chafing and contaminants
- Complete, ready to install sets available for specific engines

WARNING Prop. 65
This product contains a chemical known to the state of California to cause cancer, birth defects, or reproductive harm-



BUYER'S GUIDE FOR ULTRA 40 CUSTOM FIT WIRE SETS, SLEEVED

APPLICATION/ DISTRIBUTOR CAP STYLE	WIRE COLOR		WIRE DIA. (MM)	SPARK PLUG WIRE LENGTHS (INCHES)										PLUG BOOT	COIL WIRE LENGTH (INCHES)
	BLUE	BLACK		CYLINDER #											
	PART #			1	2	3	4	5	6	7	8	9	10		
SBC															
Over VC/Non HEI	73600	73824	8.65	29	33	35	27	25	27	25	24	N/A	N/A	90°	36
Over VC, HEI	73602	73817	8.65	29	33	35	27	25	27	25	24	N/A	N/A	90°	36
Under Header, Non HEI	73605	73825	8.65	45	45	40	40	27.75	28	27	26.75	N/A	N/A	90°	36
Under Header, HEI	73607	73818	8.65	45	45	40	40	27.75	28	27	26.75	N/A	N/A	90°	36
Jesel Front Drive Distributor	N/A	73842	8.65	23	23	24	24.50	36	29.50	33	37.50	N/A	N/A	90°	48
GM LS SERIES															
Coil-On Plug, Short	73535	73823	7	8	8	8	8	8	8	8	8	N/A	N/A	STR.	N/A
Coil-On Plug, Medium	73537	73827	7	9.75	9.75	9.75	9.75	9.75	9.75	9.75	9.75	N/A	N/A	STR.	N/A
Coil-On Plug, Long	73536	73826	7	12	12	12	12	12	12	12	12	N/A	N/A	STR.	N/A
Coil-on Plug, Coils on Valve Covers	N/A	73846	7	9.25	9.25	9.25	9.25	9.25	9.25	9.25	9.25	N/A	N/A	90°	N/A
Coil-On Plug, Remote coils	N/A	73845	7	15	15	15	15	15	15	15	15	N/A	N/A	90°	N/A
GM LT SERIES															
Coil-On Plug, Medium	NEW! N/A	73848	7	9.25	9.25	9.25	9.25	9.25	9.25	9.25	9.25	N/A	N/A	135°	N/A
Coil-On Plug, Long	N/A	73731	7	13	13	13	13	13	13	13	13	N/A	N/A	135°	N/A
BBC															
Over VC, Non HEI	73614	N/A	8.65	31	39	35	30	29	28	26	27	N/A	N/A	STR.	36
Over VC, HEI	73615	73819	8.65	28.75	34.75	34.25	28.75	27.25	28.5	26	25	N/A	N/A	STR.	36
Under Header, Non HEI	73617	73821	8.65	39	42	37	25	29.5	31	22	29	N/A	N/A	90°	36
Under Header, HEI	73616	73820	8.65	41.5	44.5	37.5	37	31	31	26.5	31	N/A	N/A	90°	36
Under Header, Non HEI Crab	73621	N/A	8.65	38	43	35	33	29.5	30	26	29	N/A	N/A	90°	36
Under Header, HEI Crab	73622	73832	8.65	38	43	35	33	29.5	30	26	29	N/A	N/A	90°	36
Jesel Front Drive Distributor	N/A	73843	8.65	27	26	31.75	31.75	36	34	38	43	N/A	N/A	90°	48
DODGE/CHRYSLER															
Dodge Viper '08-'17	N/A	73512	7mm	9.5	9.5	9.5	9.5	9.5	9.5	9.5	9.5	9.5	9.5	135°	N/A
FORD															
289-302															
HEI	73630	73833	8.65	27.75	28	26.5	29	24.5	25	28	28.5	N/A	N/A	135°	36
Non HEI	73631	73834	8.65	27.75	28	26.5	29	24.5	25	28	28.5	N/A	N/A	135°	38
351W															
HEI	73626	73822	8.65	29	33	32	32	28	26	34	36	N/A	N/A	135°	36
429-460															
HEI	73628	73835	8.65	27	27	29	29.5	24	32.5	27	32.25	N/A	N/A	135°	36

ULTRA 40 WIRE - SPOOL

- 100 ft. of 8.65mm Ultra 40 wire on a spool

PART #	DESCRIPTION
73830	Ultra 40 Wire Spool, 100 ft, Blue
73838	Ultra 40 Wire Spool, 100 ft, Black

WARNING Prop. 65
This product contains a chemical known to the state of California to cause cancer, birth defects, or reproductive harm-

No. 73830



IGNITION WIRE

COIL WIRE OR REPLACEMENT WIRE KIT, UNSLEEVED, ULTRA 40 WIRE KIT

Ultra 40

- Allows installation of an ignition coil in a remote location or can be used as a replacement wire in a wire set
- Kit includes:
 - 72" wire
 - 2-HEI 90 Deg. distributor boots
 - 2-HEI 90 Deg. spark plug boots
 - 4-HEI terminals, 2-Non-HEI 90 Deg. Boots
 - 4-Non-HEI terminals and 2 coil boots

PART #	DESCRIPTION
73237	Coil, Replacement Wire Kit, Ultra 40, Blue
73238	Coil, Replacement Wire Kit, Ultra 40, Black



No. 73237



No. 73238

WARNING Prop. 65
 This product contains a chemical known to the state of California to cause cancer, birth defects, or reproductive harm-

COIL WIRE OR REPLACEMENT WIRE KIT, SLEEVED, ULTRA 40 WIRE

Ultra 40

- Allows installation of an ignition coil in a remote location or can be used as a replacement wire in a wire set
- Sleeving adds extra dielectric strength, which is wire's ability to not be affected by outside electrical pulses
- Sleeving extends spark plug wire life and protects against exhaust heat, chaffing and contaminants
- Kit includes:
 - 48" wire
 - 48" high temp sleeving
 - 2-HEI 90 Deg. distributor boots
 - 2-HEI 90 Deg. spark plug boots
 - 4-HEI terminals, 2-Non-HEI 90 Deg. Boots
 - 4-Non-HEI terminals and 2 coil boots

PART #	DESCRIPTION
73240	Coil, Replacement Wire Kit, Sleeved, Ultra 40, Blue
73241	Coil, Replacement Wire Kit, Sleeved, Ultra 40, Black

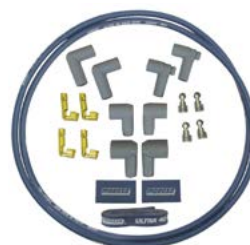

No. 73240



No. 73241

WARNING Prop. 65
 This product contains a chemical known to the state of California to cause cancer, birth defects, or reproductive harm-

ULTRA 40 SPARK PLUG BOOT & TERMINAL KITS

- Manufactured from high temperature silicone
- Ultra 40 boots are available for both spark plug and distributor ends
- Comes in sets of 8 with positive-locking spark plug or distributor terminals

PART #	DESCRIPTION
72041	Boot & Terminal Kit, Dist., HEI, Ultra 40
72061	Boot & Terminal Kit, Spark Plug Boot, Straight, Ultra 40
72071	Boot & Terminal Kit, Spark Plug Boot, 90 Degree, Ultra 40
72076	Boot & Terminal Kit, Spark Plug Boot, 135 Degree, Ultra 40
72081	Boot & Terminal Kit, Dist., Non-HEI, Ultra 40



No. 72041

No. 72061

No. 72071

No. 72076

No. 72081

WARNING Prop. 65
 This product contains a chemical known to the state of California to cause cancer, birth defects, or reproductive harm-

SPARK PLUG INSULATORS, HEMI 8.2" LONG, 8 PACK

- Fits 8mm to 8.7mm ignition wire
- Works with all popular tall tube hemi valve covers
- Accepts Moroso Part No. 72061 Straight Boot Kit
- Features 90 Deg. "Easy To Pull" handle

PART #	DESCRIPTION
72050	Spark Plug Insulators Hemi 8.2" Long, Black, 8 pack

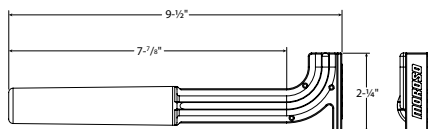

No. 72050

RACE PROVEN PERFORMANCE... FOR STREET OR STRIP!

The superiority of Blue Max 8mm 800 ohm Spiral Core Wire comes from over 35 years of refinement.

The combination of Moroso's engineering expertise and our rigorous testing program yields the finest wire available for the Street or Strip.

WHETHER YOU HAVE A FULL-TIME STREET MACHINE, HOT ROD, OR RACE CAR, MOROSO BLUE MAX 800 OHM SPIRAL CORE WIRE IS THE RIGHT CHOICE FOR YOU!

 **WARNING Prop. 65**
This product contains a chemical known to the state of California to cause cancer-
www.P65Warnings.ca.gov

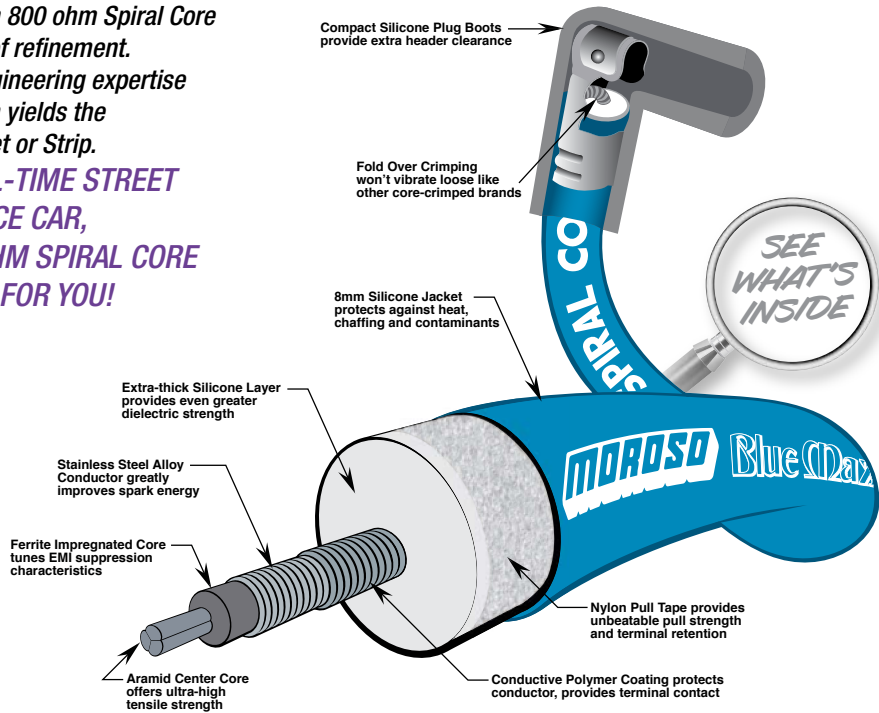

- Available in popular 8mm and extra-thick Super Max™ 11mm
- Universal and Custom Fit Sets
- Optimized combination of capacitance, inductance and resistance provides more spark energy and EMI protection than any other 8mm Spiral Core Wires in their class
- Eliminates interference with on-board electronics and provides static-free sound quality for car audio systems

INDEPENDENT TESTING CONFIRMS...BLUE MAX™ TOPS ALL OTHER WIRE!

More Spark Energy vs. Comparative Brands!

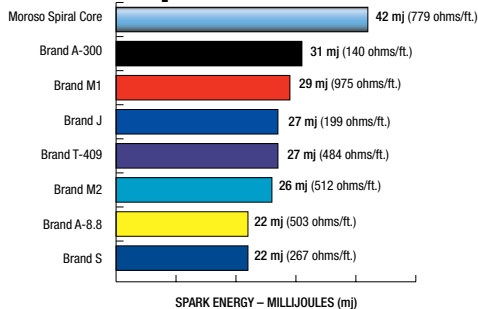

Note: No correlation between Resistance and Spark Energy

Elite Electronics Laboratories, a leading automotive electronics test facility, tested Moroso Blue Max™ against 14 other brands. Their results confirm that Blue Max™ transmitted more spark energy than any of the others.

Greater EMI/RF Suppression!

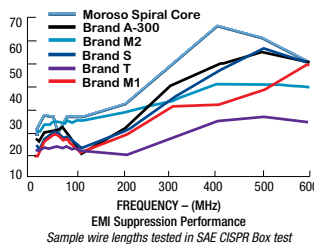

Elite Electronic Laboratories confirms, using SAE's CISPR test, that Blue Max™ suppresses more electro-magnetic interference than any other brand of "high-performance" spiral core wire.

Higher Dielectric Strength!

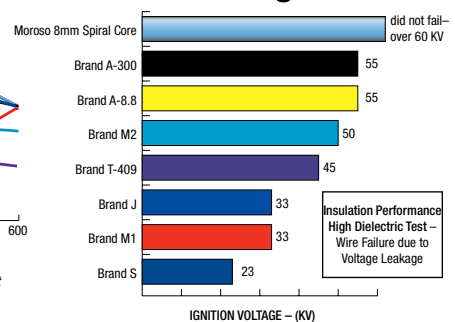

The chart illustrates the break-through voltage of sample wires tested in a water-filled tank (per SAE's approved test). Even at the maximum test output of 60,000 volts, Moroso Blue Max™ does not break down or arc through.



IGNITION WIRE

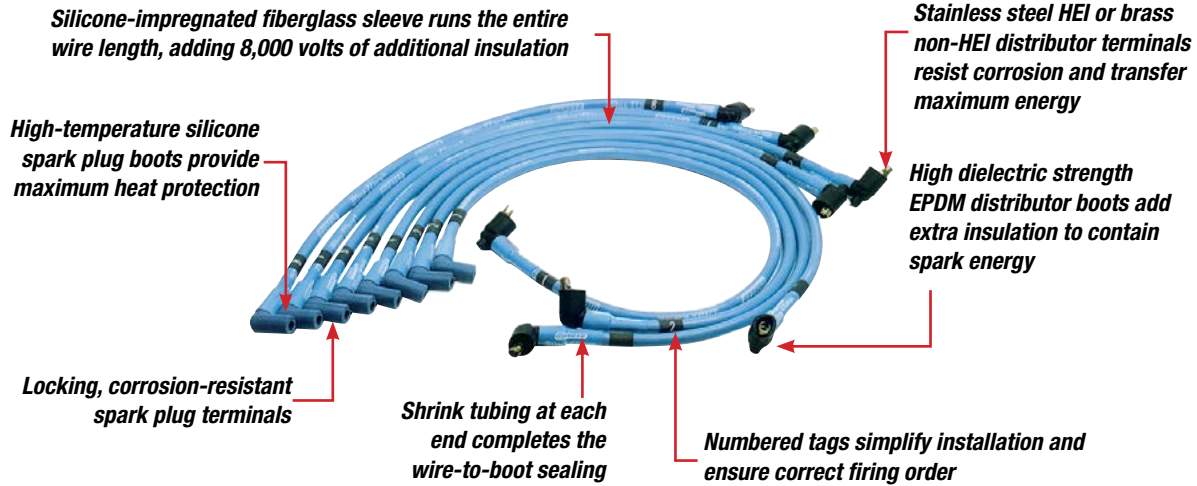

TAKE THEM OUT OF THE BOX, PLUG THEM IN, AND GO RACING!

Moroso Blue Max™ Sleeved Wire Sets come complete with our famous 8mm, 800 ohm Spiral Core Wire pre-terminated at both ends with the correct terminals and boots, insulating sleeve that runs the entire wire length, shrink tubing to seal the boots, and numbered ID tags.

- Complete, ready-to-install sets available for your specific engine application
- Each wire is individually tested for continuity and resistance after termination to ensure race-ready performance

WARNING Prop. 65
 This product contains a chemical known to the state of California to cause cancer, birth defects, or reproductive harm-

BUYER'S GUIDE for Blue Max™ Custom Fit Sleeved Wire Sets

PART #	APPLICATION	DISTRIBUTOR CAP STYLE	WIRE DIA. (mm)	SPARK PLUG WIRE LENGTHS (INCHES)								SPARK PLUG BOOT	COIL WIRE LENGTH (inches)
				CYLINDER #									
				1	2	3	4	5	6	7	8		
SMALL BLOCK CHEVY													
72402	Over Valve Covers	HEI Style	8	29	33	35	27	25	27	25	24	90°	36
72405	Under Headers	Non-HEI	8	45	45	40	40	27.75	28	27	26.75	90°	36
72407	Under Headers	HEI Style	8	45	45	40	40	27.75	28	27	26.75	90°	36
BIG BLOCK CHEVY													
72415	Over Valve Covers	HEI Style	8	28.75	34.75	34.25	28.75	27.25	28.5	26	25	STR.	36
72416	Under Headers	HEI Style	8	41.5	44.5	37.5	37	31	31	26.5	31	90°	36
FORD													
351W, V-8													
72426	Over Valve Covers	HEI Style	8	29	33	32	32	28	26	34	36	135°	36
289-302													
72430	Over Valve Covers	HEI Style	8	27.75	28	26.6	29	24.5	25	28	28.5	135°	36

BLUE MAX™ SPIRAL CORE WIRE SPOOL

PART # DESCRIPTION

73230◁ Spiral Core 8mm, 800 ohm Wire Spool, 100 ft.

⚠ **WARNING Prop. 65**
This product contains a chemical known to the state of California to cause cancer, birth defects, or reproductive harm-



No. 73230

BLUE MAX™ SPIRAL CORE COIL REPLACEMENT WIRE KIT

- 36" Long
- All the parts necessary to make a coil wire to fit virtually all popular coils and distributor cap combinations
- Kit contains three feet of Blue Max™ Spiral Core 8mm suppression wire, a wire stripping tool, and a 13-piece boot and terminal kit

PART # DESCRIPTION

73235◁ Spiral Core 8mm, 800 ohm Coil Wire Kit, Blue
73236◁ Spiral Core 8mm, 800 ohm Coil Wire Kit, Black

⚠ **WARNING Prop. 65**
This product contains a chemical known to the state of California to cause cancer, birth defects, or reproductive harm-



No. 73235

BLUE MAX™ SPIRAL CORE TWO WIRE SET

- Moroso offers a two-piece Spiral Core Wire Set to replace individual wires
- Each wire is 55" long and terminated with a straight plug terminal at one end, and a 90° plug terminal at the other
- Simply cut wire to length and use the two distributor boots and two distributor terminals supplied with the kit to complete each wire

PART # DESCRIPTION

72475◁ Blue Max™ Spiral Core 8mm, 800 ohm Two Wire Set

⚠ **WARNING Prop. 65**
This product contains a chemical known to the state of California to cause cancer, birth defects, or reproductive harm-



No. 72475

STREET DRESS-UP KITS

Complete Pre-Terminated Kits for Header-Equipped Engines

- Kits contain one set of Moroso Blue Max™ Spiral Core 8mm, 800 ohm Spark Plug Wire, four two hole wire looms, four chrome loom brackets, six spark plug wire separators, and a chrome distributor hold down
- Designed to route the plug wires over the top of the valvecover and down to the spark plug on engines equipped with exhaust headers

PART # DESCRIPTION

72751◁ Ignition Wire Dress-up Kit
Fits: SBC, pre-H.E.I. Distributor

72752◁ Ignition Wire Dress-up Kit
Fits: SBC, H.E.I. Distributor

72753◁ Ignition Wire Dress-up Kit
Fits: BBC, pre-H.E.I. Distributor

72754◁ Ignition Wire Dress-up Kit
Fits: BBC, H.E.I. Distributor

72792◁ Ignition Wire Dress-up Kit
Fits: Big Block Chrysler

⚠ **WARNING Prop. 65**
This product contains a chemical known to the state of California to cause cancer, birth defects, or reproductive harm-

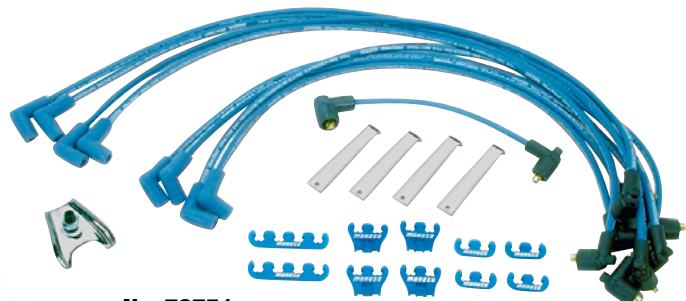

No. 72751



Terminals and boots are factory-installed on the spark plug end of the wire with straight, 90°, or 135° ends

Wires are long enough so they can be cut to fit any engine



Includes boots for both HEI and Non-HEI distributors

Moroso Wire Stripping Tool removes insulation without damaging the conductor

Each set includes enough terminals for either HEI or Non-HEI distributors

FOR UNIVERSAL IGNITION WIRE APPLICATIONS, THESE SETS ARE THE WAY TO GO!

Moroso Blue Max™ Universal Fit Wire Sets are terminated at the plug end only, and include enough wire length and terminals to fit HEI or Non-HEI distributors. A coil wire is included when required. There's even a wire stripping tool to simplify the termination. And like all Moroso Blue Max™ wire, each is individually tested for unsurpassed quality control.

- Comes complete with everything you need
- Available in 8mm, 800 ohm
- Includes Moroso Wire Stripping Tool for quick and easy installation

WARNING Prop. 65
This product contains a chemical known to the state of California to cause cancer, birth defects, or reproductive harm-

BUYER'S GUIDE for Blue Max™ Spiral Core Universal Fit Wire Sets

PART #	DISTRIBUTOR CAP STYLE	WIRE COLOR	WIRE DIA. (mm)	SPARK PLUG WIRE LENGTHS (INCHES)								SPARK PLUG BOOT	COIL WIRE LENGTH (inches)
				1	2	3	4	5	6	7	8		
4 CYLINDER ENGINES													
73229	HEI & Non-HEI	Blue	8	32	32	44	44					STR.	18
8 CYLINDER ENGINES													
73210	LT-1	Blue	8	40	40	40	40	40	40	40	40	90°	18
73214	HEI & Non-HEI	Red	8	35	35	39	39	46	50	53	53	135°	36
73215	HEI & Non-HEI	Yellow	8	35	35	39	39	46	50	53	53	135°	36
73216	HEI & Non-HEI	Yellow	8	35	35	39	39	46	50	53	53	STR.	36
73217	HEI & Non-HEI	Yellow	8	35	35	39	39	46	50	53	53	90°	36
73218	HEI & Non-HEI	Red	8	35	35	39	39	46	50	53	53	STR.	36
73219	HEI & Non-HEI	Red	8	35	35	39	39	46	50	53	53	90°	36
73220	HEI & Non-HEI	Blue	8	35	35	39	39	46	50	53	53	135°	36
73225	HEI & Non-HEI	Blue	8	35	35	39	39	46	50	53	53	90°	36
73226	HEI & Non-HEI	Blue	8	35	35	39	39	46	50	53	53	STR.	36
73231	HEI & Non-HEI	Black	8	35	35	39	39	46	50	53	53	90°	36
73232	HEI & Non-HEI	Black	8	35	35	39	39	46	50	53	53	STR.	36
73233	HEI & Non-HEI	Black	8	35	35	39	39	46	50	53	53	135°	36

We have taken our race-proven Blue Max™ 8mm, 800 ohm Spiral Core Wire and packaged it in pre-terminated sets for most popular applications. This is the very same wire used by professional racers and engine builders to deliver maximum spark energy and provide the greatest protection against electro-magnetic interference (EMI). The result is superior ignition performance and excellent sound quality from your car's audio system.

PRE-TERMINATED AND READY TO INSTALL!

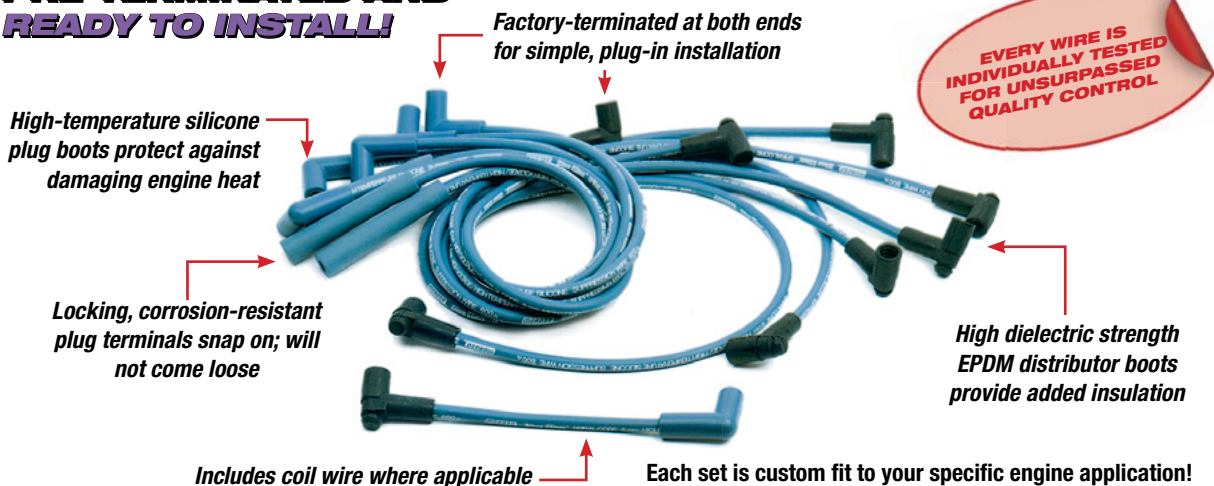

Each set is custom fit to your specific engine application!

AMERICAN MOTORS

All Models - V8 Engines

YEAR	ENGINE	PART #
1984-67	All 8 Cylinders	72550
1984-67	All 8 Cylinders	72550

BUICK

All Models - V8 Engines

YEAR	ENGINE	PART #
1982	4.4L 267 (E)	72520
1981	4.4L 267, 5.0L 305	72560
1980-78	350 (X)	72520
1977	305, 350 (L)	72521
	350 (H) (J)	72560
1976-74	350, 400 with HEI	72560
1992-83	5.0L 307 (Y) (E) (7)	72565
1982	5.0L 307	72565
1981-77	260, 307, 350 (R), 403	72565
1976-74	260	72565

CADILLAC

All Models - V8 Engines

YEAR	ENGINE	PART #
1991	5.0L (E) (7) Brougham	72538
1990-86	5.0L, 307 (Y) (9)	72565
1980-79	5.7L 350 Eldorado, Seville	72565
1978-75	350	72565

CHEVROLET

Full Size/Bel Air/Caprice/Impala - V8 Engines

YEAR	ENGINE	PART #
1996-94	5.7L 350 LT-1	72529
1992-90	5.0L 305 (E) (F), 5.7L 350 (7)	72538
1989	5.0L 305 (E) (F), 5.7L 350 (7)	72538
	5.0L 307 (Y)	72565
1988-87	5.0L 307 (Y)	72565

CHEVROLET, continued

All Models - V8 Engines

YEAR	ENGINE	PART #
1981	4.3L 265	72570
	4.4L 267, 5.0L 305, 5.7 350	72520
1979	5.0L 305, 5.7 350	72522
1978	5.0L 305, 5.7 350	72522
1977	305, 350, 400	72521
1976-74	305, 350, 400 with HEI	72521
	454 with HEI	72528
1974-71	307, 350, 400 without HEI	72510
	396, 402, 427, 454 without HEI	72550
1970-65	283, 307, 327, 350, 400	72500
	396, 402, 427, 454	72550
1964-55	265, 283, 327	72500
1992-83	5.0L 307 (Y) (E) (7)	72565
1982	4.4L 267 (E)	72520
	5.0L 307	72565
1981	4.3L 265, 5.0L 301	72570
	4.4L 267, 5.0L 305	72520
	260, 307, 350 (R), 403	72565
1980-79	301	72570
	350 (R), 403	72565
	350 (X)	72560
1978	301	72570
	305 Skylark	72522
	305 Century, Regal	72523
	350 (L)	72522
	350 (X)	72560
1977	350 (R), 403	72565
	301	72570
	350 (R), 403	72565
	305, 350 (L)	72521
	350 (H) (J)	72560
1976-74	260	72565
	350, 400 with HEI	72560

⚠ WARNING Prop. 65
This product contains a chemical known to the state of California to cause cancer, birth defects, or reproductive harm-



CHEVROLET, continued

Camaro Z28 - V8 Engines

YEAR	ENGINE	PART #
2000-98	5.7L 350 LS-1	72535◊
1997-96	5.7L 350 LT-1	72527◊
1995-93	5.7L 350 LT-1	72526◊
1992-88	5.0L 305, 5.7L 350	72538◊
1987	5.0L 305	72538◊
	5.7L 350	72525◊
1984-83	5.0L 305	72520◊
1982	5.0L 305 with 4-Bbl. Carb.	72520◊
1980	267, 305, 350 excludes California	72522◊
1979-78	305, 350	72522◊
1977-74	305, 350 with HEI	72521◊
1974-67	283, 302, 327, 350 without HEI	72510◊
1972-67	396, 402, 427, 454	72550◊

Chevelle/El Camino, Monte Carlo/Malibu - V8 Engines

1986-83	5.0L 305	72520◊
1982-81	4.4L 267, 5.0L 305	72520◊
1977-74	305, 350, 400 with HEI	72521◊
1974-73	307, 350, 400 without HEI	72510◊
1972-65	283, 307, 327, 350, 400	72510◊
	396, 402, 427, 454	72550◊
1964	283, 327	72510◊

Chevy II/Nova - V8 Engines

1979-78	305, 350	72522◊
1977-74	305, 350, 400 with HEI	72521◊
1974-71	305, 350, 400 without HEI	72510◊
1970-68	307, 327, 350	72500◊
	396, 402	72550◊
1967-64	283, 327	72510◊

Corvette - V8 Engines

2000-97	5.7L 350 LS-1	72535◊
1996-92	5.7L 350 LT-1, LT-4	72524◊
1991-85	5.7L 350	72525◊
1982-74	5.0L 305, 5.7L 350 with HEI	72561◊
1974-65	327, 350 without HEI	72510◊
	396, 427, 454 without HEI	72550◊
1964-55	265, 283, 327	72500◊

CHEVROLET/GMC TRUCK

All Series - V8 Engines

YEAR	ENGINE	PART #
1992-87	7.4L 454 (N) C/K	72542◊
1989	5.0L 305 (H) C/K, G	72540◊
	5.7L 350 (K) C/K, R/V	72542◊
	7.4L 454 (N) C/K, R/V	72542◊
1988-87	5.0L 305 (H) C/K, G	72540◊
	5.7L 350 (K) C/K, R/V	72542◊
	5.7L 350 (K) G/P	72540◊
	5.7L 350 (M) C/K, R/V	72522◊
	7.4L 454 (N) C/K, R/V, G	72542◊
1986	5.7L 350 (K) G/P	72522◊
	7.4L 454 (N) C/K, P	72530◊
1985-83	5.0L 305, 5.7L 350 C/K	72520◊
	5.0L 305, 5.7L 350 G/P	72522◊
	excludes Motor Home	72522◊
	7.4L 454 (N) C/K, P	72530◊
1982	5.0L 305, 5.7L 350 C/K 30, 35	72522◊
	5.0L 305, 5.7L 350 G/P	72522◊
	7.4L 454 (N) C/K, P	72530◊
1981	4.3L 265	72565◊

◊ WARNING Prop. 65

This product contains a chemical known to the state of California to cause cancer, birth defects, or reproductive harm-

CHEVROLET/GMC TRUCK, continued

All Series - V8 Engines

YEAR	ENGINE	PART #
	5.0L 305, 5.7L 350 G/P	72522◊
	7.4L 454 (N) C/K, P	72530◊
1980-78	305, 350	72522◊
	454	72530◊
1977	305, 350, 400	72521◊
	454	72530◊
1976-75	305, 350, 400 with HEI	72521◊
	305, 350, 400 without HEI	72500◊
	454	72528◊
1974-73	307, 350, 400	72510◊
	396, 402, 454	72550◊
1972-65	396, 402, 454	72550◊
	283, 307, 327, 350, 400	72500◊
1964-55	265, 283, 327	72500◊

CHRYSLER

All Models - V8 Engines

YEAR	ENGINE	PART #
1989-79	5.2L 318, 5.9L 360	72650◊
1978-73	318, 360	72650◊
	400, 440	72655◊
1972-71	360	72650◊
	400, 440 with Electronic Ignition	72656◊
	400, 440 excludes Electronic Ignition	72660◊
1970-59	361, 383, 413, 440	72660◊

DODGE

All Models - V8 Engines

YEAR	ENGINE	PART #
1989-79	5.2L 318, 5.9L 360	72650◊
1978-73	318, 340, 360	72650◊
	400, 440	72655◊
1972-62	273, 318, 340, 360	72650◊
	361, 383, 400, 440	72656◊
1961-60	318	72650◊

DODGE TRUCK

All Models - V8 Engines

Year	Engine	PART #
1991-79	5.2L 318, 5.9L 360	72650◊
1978-73	318, 360	72650◊
	400, 440 with Electronic Ignition	72656◊
1972-60	318, 360	72650◊

FORD

Full Size, Custom/Galaxie/LTD Crown Victoria - V8 Engines

YEAR	ENGINE	PART #
1987-86	5.8L 351W	72645◊
1985-84	5.8L 351W	72645◊
1979	5.0L 302 California only	72645◊
	5.8L 351W California only	72645◊
1974-73	351C, 400	72605◊
1972-71	302, 390	72600◊
	351, 400, 429	72605◊
1970	302	72600◊
	351, 390, 427, 428, 429	72605◊
1969-68	302, 351	72600◊
	390, 427, 428, 429	72605◊
1967-61	221, 260, 289, 292	72605◊



FORD, continued

YEAR	ENGINE	PART #
	All 8 Cylinder excludes 221, 260, 289, 292	72600 ↻
1960-58	All 8 Cylinder excludes 292	72600 ↻
Fairlane - V8 Engines		
1970-66	289, 302, 351	72600 ↻
	390, 427, 428	72605 ↻
1965-62	All 8 Cylinder	72600 ↻
Falcon - V8 Engines		
1970-63	All 8 Cylinder	72600 ↻
LTD II/Torino/Ranchero - V8 Engines		
1985-84	All 8 Cylinder	72645 ↻
1974-73	351C, 400	72605 ↻
1972-70	302	72600 ↻
	351, 429	72605 ↻
1969-68	302	72600 ↻
	390, 428	72605 ↻
Mustang - V8 Engines		
1998-96	4.6L SOHC V8	72646 ↻
1994-86	5.0L 302	72645 ↻
1985	All 8 Cylinder with EEC IV	72645 ↻
1984	5.0L 302	72645 ↻
1973	351	72605 ↻
1972-70	302	72600 ↻
	All 8 Cylinder excludes 302 cid	72605 ↻
1969-67	All 8 Cylinder	72605 ↻
1965-66	All 8 Cylinder	72600 ↻
Thunderbird - V8 Engines		
1993-91	5.0L 302	72635 ↻
1972-69	All 8 Cylinder	72605 ↻
1968-58	All 8 Cylinder excludes 429 cid 429	72600 ↻
		72605 ↻
FORD TRUCK		
Bronco - V8 Engines		
YEAR	ENGINE	PART #
1994-88	5.0L 302	72645 ↻
	5.8L 351	72635 ↻
1984-83	5.8L 351	72645 ↻
1982	5.8L 351 California only	72645 ↻
1972-66	All 8 Cylinder	72600 ↻
E Series - V8 Engines		
1994-91	5.0L 302	72645 ↻
	5.8L 351	72635 ↻
1990	5.0L 302	72645 ↻
	5.8L 351	72635 ↻
1989-88	5.0L 302 with EEC IV	72645 ↻
	5.8L 351	72635 ↻
1987	5.8L 351 with EEC IV	72645 ↻
1986	5.8L 351 with EEC IV	72645 ↻
1985	5.8L 351 with EEC IV	72645 ↻
1984	5.8L 351 with EEC IV	72645 ↻
1982	5.8L 351 with EEC IV	72645 ↻
F Series - V8 Engines		
1994-91	5.0L 302	72645 ↻
	5.8L 351	72635 ↻
1990-88	5.0L 302 with EEC IV	72645 ↻
	5.8L 351	72635 ↻
1987-86	5.0L 302 with EEC IV	72645 ↻
	5.8L 351	72645 ↻
1985	5.0L 302 with EEC IV	72645 ↻

FORD TRUCK, continued

YEAR	ENGINE	PART #
1984-83	5.8L 351	72645 ↻
1982	5.8L 351	72645 ↻
1973	360, 390 Engs	72600 ↻
F Series - V8 Engines		
1972-71	302 F-100	72600 ↻
	330 MD, 360, 390	72600 ↻
	352	72605 ↻
1970-69	302 F-100	72600 ↻
	330 MD	72600 ↻
	352, 360, 390	72605 ↻
1968-67	330 MD	72600 ↻
	352, 360, 390	72605 ↻
1966-65	352, 360, 390	72605 ↻
1964	All 8 Cylinder	72605 ↻
LINCOLN		
Continental - V8 Engines		
YEAR	ENGINE	PART #
1972-69	All	72605 ↻
1968-58	All	72600 ↻
Mark III/IV/V/VI/VII - V8 Engines		
1992	5.0L 302 LSC	72645 ↻
1984	5.0L 302 LSC	72645 ↻
1976-69	All	72605 ↻
Town Car - V8 Engines		
1988-86	302	72645 ↻
MERCURY		
Full Size Grand Marquis, Monterey/Etc. - V8 Engines		
YEAR	ENGINE	PART #
1987-86	5.8L 351	72645 ↻
1985	5.8L 351W	72645 ↻
1984	5.8L 351W	72645 ↻
1979	5.8L 351W	72645 ↻
1974-73	351, 400	72605 ↻
1972	429 Interceptor	72605 ↻
1971	400, 429	72605 ↻
1970-69	390, 400, 428, 429	72605 ↻
1968	390, 428	72605 ↻
1967-65	All 8 Cylinder	72605 ↻
1964	390, 427	72600 ↻
1963	390	72600 ↻
1962-61	All 8 Cylinder excludes 292 cid	72600 ↻
1960-58	383, 430	72600 ↻
Capri- V8 Engines		
1986-84	All 8 Cylinder	72645 ↻
Comet/Meteor - V8 Engines		
1971	302	72600 ↻
1970	302	72600 ↻
	351, 429	72605 ↻
1969-66	289, 302	72600 ↻
	390, 427, 428	72605 ↻
1965-62	All 8 Cylinder	72600 ↻
Cougar - V8 Engines		
1993-91	5.0L 302	72635 ↻
1974	351, 400	72605 ↻
1973-70	All 8 Cylinder	72605 ↻
1969-68	302	72600 ↻
	351, 390, 427, 428	72605 ↻
1967	428	72600 ↻



WARNING Prop. 65
This product contains a chemical known
to the state of California to cause cancer,
birth defects, or reproductive harm-

MERCURY, continued

Montego - V8 Engines

YEAR	ENGINE	PART #
1974-73	351, 400	72605 ↻
1972-70	302	72600 ↻
	351, 400	72605 ↻
1969-68	302	72600 ↻
	351, 390, 427, 428	72605 ↻

Marquis - V8 Engines

1985-84	5.0L 302	72645 ↻
---------	----------	----------------

OLDSMOBILE

Full Size Delta 88/98/Toronado - V8 Engines

YEAR	ENGINE	PART #
1991	5.0L (E) Custom Cruiser	72538 ↻
1990-86	5.0L 307(9)(Y) Custom Cruiser	72565 ↻
1985-84	5.0L 307(9)(Y)	72565 ↻
1983	4.3L 260, 5.0L 307(Y)	72565 ↻
1982-81	4.3L 260, 5.0L 307(Y), 5.7 350	72565 ↻
	4.4L 267	72520 ↻
1980	4.3L 260, 5.0L 307(Y), 5.7 350	72565 ↻
1979	260, 5.0L 307(Y), 5.7 350	72565 ↻
	4.9L 301	72570 ↻
1978-74	260, 350, 403 with HEI	72565 ↻
1974-65	All 8 Cylinder without HEI	72650 ↻

Cutlass F85/442 V8 Engines

1988-87	5.0L 307 (Y) (9)	72565 ↻
1986-85	5.0L 305 (H)	72520 ↻
	5.0L 307 (Y) (9)	72565 ↻
1984-83	5.0L 305 (H)	72520 ↻
	4.3L 260, 5.0L 307 (Y)	72565 ↻
1982-81	4.3L 260, 5.0L 307 (Y), 5.7 350	72565 ↻
1980-79	260, 350	72565 ↻
1978	260, 350	72565 ↻
1977	260, 350 (R), 403	72565 ↻
	301	72570 ↻
	305, 350 (L)	72521 ↻
1976-74	260, 350, 403 with HEI	72565 ↻
1974-65	330, 350, 400, 455 without HEI	72650 ↻

Omega - V8 Engines

1979-77	305, 350 (L)	72522 ↻
1976-75	260	72565 ↻
	350	72560 ↻
1974-73	350	72565 ↻

PLYMOUTH

All Models - V8 Engines

YEAR	ENGINE	PART #
1989-79	5.2L 318, 5.9L 360	72650 ↻
1978-73	318, 340, 360	72650 ↻
	400, 440	72655 ↻
1972-62	273, 318, 340, 360	72650 ↻
	361, 383, 400, 440	72656 ↻
1961-60	318	72650 ↻

PONTIAC

Bonneville/Catalina/Parisienne - V8 Engines

YEAR	ENGINE	PART #
1989-88	5.0L 307 (Y)	72565 ↻
1987	5.0L 307 (Y)	72565 ↻
1986	5.0L 305 (H), 5.7L 350 (6)	72520 ↻
	5.0L 307 (Y)	72565 ↻

PONTIAC, continued

YEAR	ENGINE	PART #
	5.0L 307	72565 ↻
1980-79	265, 301	72570 ↻
	307, 350 (R), 403	72565 ↻
	350 (X)	72560 ↻
1978-77	301, 350 (P), 400	72570 ↻
	350 (R), 403	72565 ↻
1976-74	350, 400, 455 with HEI	72570 ↻
1974-68	350, 400, 455 without HEI	72550 ↻
<i>Firebird/Trans Am - V8 Engines</i>		
2000-98	5.7L 350 LS-1	72535 ↻
1997-96	5.7L 350 LT-1	72527 ↻
1995-93	5.7L 350 LT-1	72526 ↻
1992-88	5.0L 305, 5.7L 350	72538 ↻
1987	5.0L 305	72538 ↻
	5.7L 350	72525 ↻
1984-83	5.0L 305	72520 ↻
1982	5.0L 305 with 4-Barrel Carburetor	72520 ↻
1981	4.9L 301 excludes Turbo	72570 ↻
1980-78	301, 400	72570 ↻
	305, 350 (L) excludes California	72522 ↻
	403	72565 ↻
1977	301, 350 (P), 400	72570 ↻
	350 (R), 403	72565 ↻
1976-74	350, 400, 455 with HEI	72570 ↻
1974-67	All 8 Cylinder without HEI	72550 ↻
<i>Grand Prix - V8 Engines</i>		
1982-81	4.4L 267, 5.0L 305	72520 ↻
1977	301, 350 (P), 400	72570 ↻
	350 (R), 403	72565 ↻
1976-74	350, 400, 455 with HEI	72570 ↻
1974-62	All 8 Cylinder without HEI	72550 ↻
<i>Phoenix - V8 Engines</i>		
1979-77	305, 350 (L)	72522 ↻
<i>Tempest/Lemans/GTO - V8 Engines</i>		
1981	4.4L 265, 4.9L 301	72570 ↻
1980	4.4L 265, 4.9L 301	72570 ↻
1979	301	72570 ↻
1978	301	72570 ↻
	305, 350 (L)	72523 ↻
1977-74	All 8 Cylinder with HEI	72570 ↻
1974-64	All 8 Cylinder without HEI	72550 ↻
<i>Ventura - V8 Engines</i>		
1977	301	72570 ↻
	350 (R)	72565 ↻
	305, 350 (L)	72521 ↻
1976-74	260 with HEI	72565 ↻
	350 with HEI	72570 ↻
1974-71	All 8 Cylinder without HEI	72550 ↻

ⓘ  **WARNING Prop. 65**

This product contains a chemical known to the state of California to cause cancer, birth defects, or reproductive harm-

BUYER'S GUIDE for Blue Max™ Spiral Core Custom Fit Wire Sets

PART #	SPARK PLUG WIRE LENGTHS (INCHES)								SPARK PLUG BOOTS	HEI OR NON-HEI	COIL WIRE LENGTH (INCHES)
	CYLINDER #										
	1	2	3	4	5	6	7	8			
72535↔	8	8	8	8	8	8	8	8	STR.	NA	N/A
72500↔	28	28	32	32	45	49	49	49	90°	Non-HEI	10
72510↔	26	26	28	30	34	34	38	38	90°	HEI	15
72520↔	20	28	36	36	40	40	40	44	90°	HEI	N/A
72521↔	22	22	22	26	32	32	32	40	90°	HEI	10
72522↔	22	22	22	22	26	32	32	40	90°	HEI	N/A
72523↔	20	32	36	36	40	40	40	44	90° & STR.	HEI	N/A
72524↔	25	23	25	23	33	34	33	34	90°	HEI	16
72525↔	26	26	26	28	32	40	44	44	90° & STR.	HEI	N/A
72526↔	15	19	18	21	23	27	38	32	90°	HEI	12
72527↔	16	18	18	21	23	28	36	32	90°	HEI	10
72528↔	22	22	28	28	36	36	36	36	STR.	HEI	N/A
72529↔	13	15	15	17	19	23	25	35	90°	HEI	9, 11
72530↔	26	28	28	28	28	32	36	40	STR.	HEI	N/A
72538↔	22	28	32	32	32	32	36	40	90° & STR.	HEI	8
72540↔	26	26	26	32	32	36	40	40	90°	HEI	10
72542↔	26	28	32	32	32	36	40	40	STR.	HEI	10
72550↔	26	26	28	28	32	32	34	38	STR.	Non-HEI	12
72560↔	26	27	29	30	30	32	35	37	STR.	HEI	N/A
72561↔	22	26	28	28	44	48	56	56	90°	HEI	N/A
72565↔	22	22	24	24	28	36	40	40	STR.	HEI	N/A
72570↔	18	20	22	26	28	28	36	40	135° & STR.	HEI	N/A
72600↔	28	28	28	28	28	31	31	34	STR.	Non-HEI	17-1/2
72605↔	28	28	28	28	31	31	31	34	STR.	Non-HEI	18
72635↔	18	19	22	22	24	29	30	30	135°	Non-HEI	17
72645↔	20	20	21	25	28	31	32	32	135°	Non-HEI	18, 23
72646↔	18	39	26	53	35	32	23	29	130°	Non-HEI	N/A
72650↔	22	24	24	28	28	28	30	34	STR.	Non-HEI	12
72655↔	19	26	32	38	44	48	52	55	90°	Non-HEI	9
72656↔	16	26	32	32	32	36	38	52	90°	Non-HEI	10
72660↔	22	27	33	46	56	41	51	56	90° & STR.	Non-HEI	15

BLUE MAX™ SPIRAL CORE WIRE SETS - SPORT COMPACT

- Every wire is cut to the correct length and factory terminated at each end with locking, corrosion resistant steel terminals
- Terminals are protected by high-temperature OEM style silicone boots, bonded to the wire to seal out moisture, fuel and oil
- Includes color matched high-temperature plastic wire separators where necessary to keep wires evenly spaced

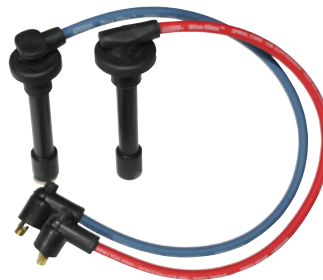

WARNING Prop. 65
 This product contains a chemical known to the state of California to cause cancer, birth defects, or reproductive harm-

BUYER'S GUIDE for Blue Max™ Spiral Core Sport Compact Wire Sets

PART #	SPARK PLUG WIRE LENGTHS CYLINDER #						SPARK PLUG BOOT	COIL WIRE LENGTH (inches)
	1	2	3	4	5	6		
72673↔	33	28	26	20	N/A	N/A	OEM style	14
72674↔	32	30	24	21	N/A	N/A	OEM style	N/A
72680↔	33	28	26	20	N/A	N/A	OEM style	14
72682↔	32	30	24	21	N/A	N/A	OEM style	N/A

ACURA

YEAR	MODEL	BLUE	RED
1998-94	Integra VTEC	72674↔	72682↔
1998-90	Integra (excl VTEC)	72673↔	72680↔

HONDA

YEAR	MODEL	BLUE	RED
1995-90	Accord DX, LX	72673↔	72680↔
1995-92	Civic CX, DX, LX	72674↔	72682↔
1991-88	Civic, CRX	72674↔	72682↔
1998-94	Civic/Del Sol VTEC	72674↔	72682↔
2000-99	Civic Si	72674↔	72682↔
1995-92	Prelude	72673↔	72680↔

SOLID CORE PERFORMANCE!

Blue Max™ Solid Core combines state-of-the-art engineering with the finest workmanship and quality control available!

Our Solid Core Sets are pre-terminated at the spark plug end and include enough wire, boots and terminals so you can complete the distributor/magneto end.

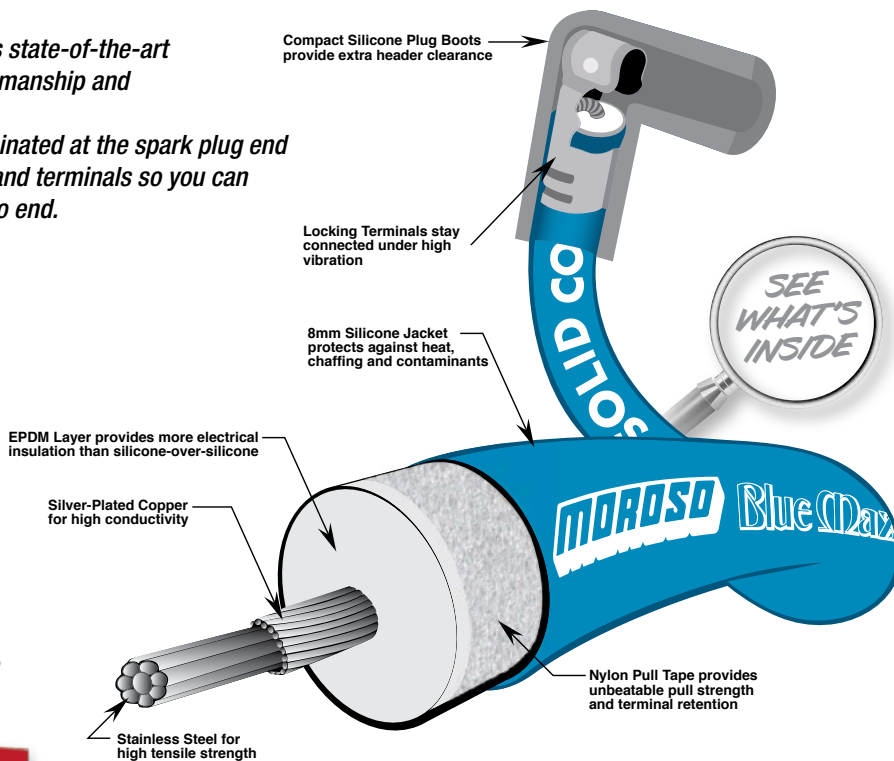

WARNING Prop. 65
This product contains a chemical known to the state of California to cause cancer, birth defects, or reproductive harm-



- Super High-Performance Wire for Racing Only
- Engineered for magneto and other ignitions that do not require electro-magnetic interference (EMI) suppression
- Combination silver-plated copper and stainless steel “solid core” provides maximum conductivity and strength
- Each wire individually tested for continuity after termination to ensure race-ready performance

ENGINEERED FOR MAXIMUM SPARK ENERGY!

High Tensile Strength!

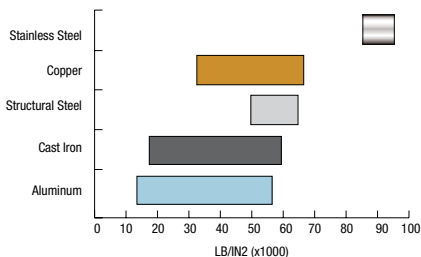

Central core of corrosion-resistant stainless steel provides high strength to eliminate wire breakage.

Highest Conductivity!

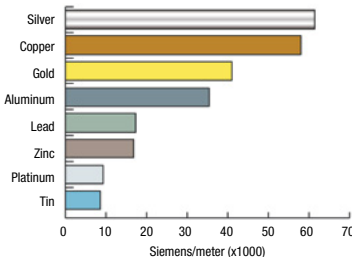

Plated, low-oxygen copper provides maximum conductivity for peak spark energy.

Highest Dielectric Strength!

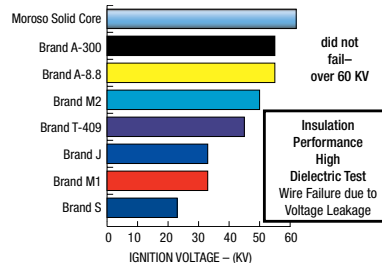

Premium silicone jacket over special EPDM (Ethylene Propylene Diene Monomer) for best insulation performance.

BLUE MAX™ SOLID CORE UNIVERSAL FIT WIRE SETS

- Pre-terminated at the plug end with either straight or 90° boots
- Sets contain both HEI and Non-HEI terminals and boots to terminate-your-own distributor/magneto wire ends
- Sets can also be used in part for 2-, 4- and 6-cylinder applications
- For a professional installation use with Moroso insulating Sleeve Nos. 72000, 72002 or 72004 Shrink Sleeve Nos. 72030 or 72031, Spark Plug looms and wire separators

◦  **WARNING Prop. 65**
This product contains a chemical known to the state of California to cause cancer, birth defects, or reproductive harm-



No. 72820

BUYER'S GUIDE for Blue Max™ Solid Core Universal Wire Sets

SPARK PLUG WIRE LENGTHS (INCHES)									SPARK PLUG BOOT	COIL WIRE LENGTH (inches)	8 CYLINDER APPLICATIONS			
PART #	1	2	3	4	5	6	7	8			PART #	PLUG TERM'S/BOOTS	DIST. TERM'S/BOOTS	WIRE COLOR
72800*◊	35	35	39	39	46	50	53	53	STR.	36	72800*◊	Straight	HEI & Non-HEI	Blue
72820*◊	35	35	39	39	46	50	53	53	90°	36	72820*◊	90°	HEI & Non-HEI	Blue

BLUE MAX™ SOLID CORE COIL WIRE KIT

8mm

- Kit contains all the parts necessary to make a coil wire fit virtually all popular coils and distributor cap combinations
- Includes 3 feet of Blue Max™ Solid Core Wire, terminals and boots

PART # DESCRIPTION
72855*◊ Solid Core Coil Wire Kit Wire Looms and Wire Separators

◦  **WARNING Prop. 65**
This product contains a chemical known to the state of California to cause cancer, birth defects, or reproductive harm-



No. 72855

BLUE MAX™ SOLID CORE WIRE SPOOL

8mm

PART # DESCRIPTION
72830*◊ Solid Core Wire Spool, 8mm, 100 ft

◦  **WARNING Prop. 65**
This product contains a chemical known to the state of California to cause cancer, birth defects, or reproductive harm-



No. 72830

*Not legal for sale or use on Street vehicles per F.C.C. regulations



BLUE MAX™ SPARK PLUG BOOT & TERMINAL KITS

- Manufactured from high temperature silicone
- Blue Max™ 8mm boots are available in straight, 90° and 135° ends
- Comes in sets of 8 with positive, locking spark plug terminals

PART #	DESCRIPTION
72060	Spark Plug Wire Boot & Terminal Kit, Straight Ends
72070	Spark Plug Wire Boot & Terminal Kit, 90° Ends
72075	Spark Plug Wire Boot & Terminal Kit, 135° Ends

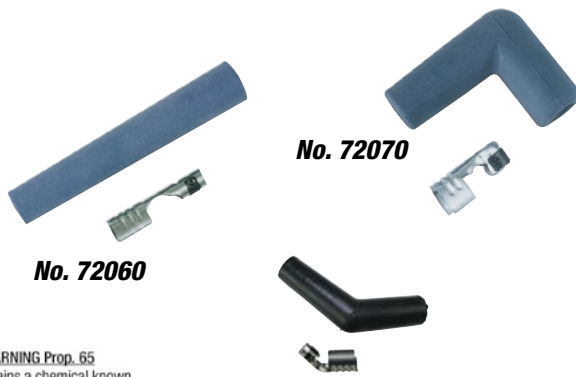

WARNING Prop. 65
 This product contains a chemical known to the state of California to cause cancer, birth defects, or reproductive harm-

No. 72075

BLUE MAX™ DISTRIBUTOR BOOT & TERMINAL KIT

Fits: Moroso, Ford, MSD Distributors and others

- High dielectric strength EPDM provides excellent insulation
- Stainless HEI terminals provide maximum corrosion resistance, high conductivity
- Positive, locking HEI terminals won't fall off under racing conditions

PART #	DESCRIPTION
72040	HEI Distributor Boot Kit, 8mm. Includes 9 Boots & Terminals



WARNING Prop. 65
 This product contains a chemical known to the state of California to cause cancer, birth defects, or reproductive harm-

No. 72040

UNIVERSAL WIRE ACCESSORIES

SELF-VULCANIZING TAPE, BLACK

- High dielectric strength, high-temperature silicone tape wraps around ignition wire, boots and connectors to provide added insulation
- Extra insulation keeps spark energy contained within the wire, preventing high-voltage leaks and resulting misfire
- Also seals out moisture, while protecting the wire from the harmful effects of oil and excessive heat
- Specially formulated silicone rubber vulcanizes automatically, providing adhesion when tape surfaces make contact
- An excellent alternative to applying shrink sleeves and insulated wire sleeving
- One-inch wide tape packaged in 12-foot rolls



No. 72038

PART #	DESCRIPTION
72038	Self-Vulcanizing Tape, Black

SPARK PLUG MARKERS

- Fits 8mm -8.65mm only
- Plastic, clip-on style
- 8 per package

PART #	DESCRIPTION
72023	Spark Plug Markers

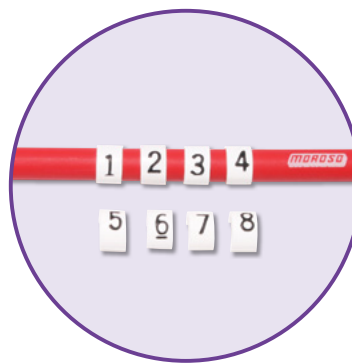

No. 72023

WIRE CRIMPING TOOLS

- Must have tools to crimp a variety of spark plug terminals and other automotive wire hardware

PART #	DESCRIPTION
62260	General Purpose Wire Crimper. Made of high carbon steel with black oxide finish and plastic hand grips
62268	Super-Duty Wire Crimping Tool. Positive ratcheting mechanism adjusted for perfect crimps. Supplied with crimping jaws for Moroso (and other) spark plug wire terminals. Hardened steel frame with Blue molded cushion grips. Also comes with additional standard wire crimping jaws for electrical insulated terminals.

 **WARNING Prop. 65**
This product contains a chemical known to the state of California to cause cancer, birth defects, or reproductive harm-



No. 62260



No. 62268

ENHANCED IGNITION WIRE STRIPPING TOOL

Made especially for stripping 8mm & 8.65mm Moroso Ignition Wire and others

- An easy way to strip wire without damage, which is more likely to occur using other methods
- Simple and efficient operation: place the end of the wire in the “mouth” of the tool, twist in a circular pattern until the cut is made around the wire, then pull off sheath
- Heavy-duty construction and quality components provide reliable operation after repeated use
- After using this Enhanced Stripping Tool, you will never go back to using manual strippers for assembling wire sets again

PART #	DESCRIPTION
62272	Enhanced Ignition Wire Stripping Tool, for 8mm & 8.65mm diameter wire



No. 62272



ADJUSTABLE WIRE STRIPPING TOOL

- Will strip the outer jacket and insulation in one easy operation giving a cleaner precise cut
- For stripping different diameters of cable, use the built in hex key adjuster screws to align the blade for desired results
- The V-Block can be reversed and the indication arrow set to recommended cable size
- The stripper distance can be changed by removing one of the stripping blades

PART #	DESCRIPTION
62271	Adjustable Wire Stripping Tool



No. 62271

WIRE STRIPPING TOOL

- Ideal for stripping 8mm Moroso ignition wire without damaging the conductor
- Damage to conductor during stripping can cause interruption of spark and misfire
- Moroso’s specially-designed tool uses a hard-edge, razor-sharp blade specially positioned in a plastic holder to cut only the insulation – not the conductor

PART #	DESCRIPTION
62270	Wire Stripping Tool, 8mm



No. 62270

INSULATED WIRE SLEEVE

- Available in Black, Blue and Red
- Closely woven fiberglass impregnated with high voltage, leak resistant silicone which adds up to 8,000 volts of extra insulation
- Extend spark plug wire life by adding insulation against exhaust header heat
- For best results, we recommend that the sleeve cover the full length of wire from spark plug boot to distributor boot and sealed with Shrink Sleeve **No. 72030** or **No. 72031**
- **Nos. 72000, 72002, 72004** fits 7 & 8mm wire;
- **Nos. 72011, 72012, 72013** fits 8.65mm Ultra 40 Wire
- Packaged in 25' lengths



No. 72000 No. 72002 No. 72004



No. 72011 No. 72012 No. 72013

PART # DESCRIPTION

- 72000** Insulated Spark Plug Wire Sleeve, Blue
- 72002** Insulated Spark Plug Wire Sleeve, Red
- 72004** Insulated Spark Plug Wire Sleeve, Black
- 72011** Ultra 40 Insulated Spark Plug Wire Sleeve, Blue
- 72012** Ultra 40 Insulated Spark Plug Wire Sleeve, Black
- 72013** Ultra 40 Insulated Spark Plug Wire Sleeve, Red

WARNING Prop. 65
This product contains a chemical known to the state of California to cause cancer-



Shown installed with **No. 72030** Moroso Shrink Sleeve (blue), sold below.

NUMBERED SHRINK SLEEVES

- Simplifies spark plug wire identification and installation
- Pre-numbered from 1 through 8; sets include two sleeves of each number to identify both ends of each spark plug wire



PART # DESCRIPTION

- 72020** Numbered Shrink Sleeves

No. 72020

NOTE: Use **No. 72030** or **72031** Shrink Sleeves to complete the seal between boots and spark plug wire at ends.

MOROSO SHRINK SLEEVES

- Insures a complete seal between spark plug, distributor boots, and spark plug wire sleeve **Nos. 72000, 72002, 72004, 72011, 72012** or **72013**
- Packaged 18 shrink sleeves to a set

PART # DESCRIPTION

- 72030** Moroso Shrink Sleeve, Blue
- 72031** Moroso Shrink Sleeve, Black



No. 72031

HIGH-TEMPERATURE BOOT SLEEVES

- Have "Dual Wall" construction, which assures protection from spark plug and ignition wire burnout
- Protects up to 1200 Deg. F.
- Wires and Boots stay cooler in exhaust area
- Porous/breathable to reduce "Oven Effect"
- Non-flammable, will not react with petroleum based products
- 1" I.D., 5-1/2" Long
- Expands and stretches over regular surfaces, will work with 135 Deg. and 90 Deg. Spark Plug Boots
- Sold in pairs



PART # DESCRIPTION

- 71992** High-Temperature Boot Sleeves, Blue
- 71993** High-Temperature Boot Sleeves, Red
- 71994** High-Temperature Boot Sleeves, Black
- 71995** High-Temperature Boot Sleeves, Natural

WARNING Prop. 65
This product contains a chemical known to the state of California to cause cancer-



UNIVERSAL LOOM KITS

- Includes four 2-hole looms, two 3-hole looms, and four chrome plated brackets which secure to valve cover bolts
- One kit per engine

PART # DESCRIPTION

- 72150**◀ Universal Loom Kit, Blue, 7-9mm
- 72151**◀ Universal Loom Kit, Red, 7-9mm
- 72153**◀ Universal Loom Kit, Black, 7-9mm

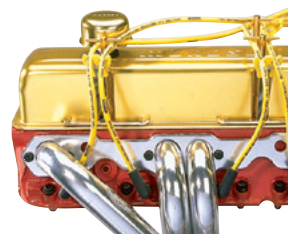

No. 72150

WARNING Prop. 65
This product contains a chemical known to the state of California to cause cancer, birth defects, or reproductive harm-

SHOW CAR LOOM KITS

- Includes eight 2-hole looms, two 4-hole separators, and four chrome plated brackets which secure to valve cover bolts
- One kit per engine

PART # DESCRIPTION

- 72170**◀ Show Car Loom Kit, Blue., 7-9mm
- 72168**◀ Show Car Loom Kit, Red, 7-9mm
- 72167**◀ Show Car Loom Kit, Black, 7-9mm

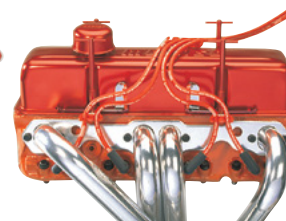

No. 72168

WARNING Prop. 65
This product contains a chemical known to the state of California to cause cancer, birth defects, or reproductive harm-

BIG BLOCK CHEVY LOOM KITS

- Includes four right-side and four left-side chrome plated brackets, two 1-hole looms, two 2-hole looms, two 3-hole looms, two 4-hole looms, two 4-hole separators, and two 2-hole separators
- One kit per engine

PART # DESCRIPTION

- 72175**◀ Big Block Chevy Loom Kit, Blue, 7-9mm
- 72176**◀ Big Block Chevy Loom Kit, Red, 7-9mm
- 72178**◀ Big Block Chevy Loom Kit, Black, 7-9mm

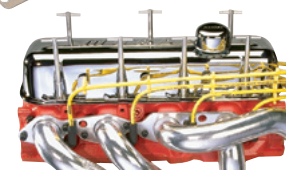

No. 72175

WARNING Prop. 65
This product contains a chemical known to the state of California to cause cancer, birth defects, or reproductive harm-

SUPER LOOM KITS

- Includes two right-side and two left-side chrome plated brackets for mounting on the valve covers, two 4-hole wire looms, six 2-hole looms, two 4-hole wire separators, and two 2-hole separators.
- One kit per engine

PART # DESCRIPTION

- 72171**◀ Super Loom Kit, Blue, 7-9mm
- 72172**◀ Super Loom Kit, Red, 7-9mm
- 72174**◀ Super Loom Kit, Black, 7-9mm

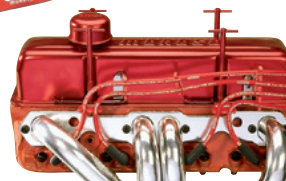

No. 72172

WARNING Prop. 65
This product contains a chemical known to the state of California to cause cancer, birth defects, or reproductive harm-

SMALL BLOCK FORD LOOM KITS

- Includes: three 4-hole wire looms, one 3-hole wire loom, one 2-hole wire loom, one 1-hole wire loom, two 4-hole wire separators, one 3-hole wire separator, one 2-hole wire separator, and six chrome plated brackets
- One kit per engine

PART # DESCRIPTION

- 72130**◀ Ford Loom Kit, Blue, 7-9mm
- 72131**◀ Ford Loom Kit, Red, 7-9mm
- 72133**◀ Ford Loom Kit, Black, 7-9mm

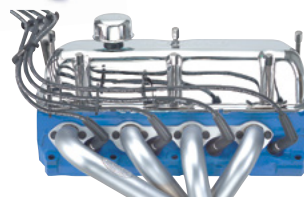

No. 72133

WARNING Prop. 65
This product contains a chemical known to the state of California to cause cancer, birth defects, or reproductive harm-

SMALL BLOCK CHEVY CENTERBOLT LOOM KITS

- Includes two right-side and two left-side chrome plated brackets that mount to engine, two 4-hole wire looms, six 2-hole looms, two 4-hole wire separators, and two 2-hole separators
- One kit per engine

PART #	DESCRIPTION
72140	Small Block Chevy Centerbolt Loom Kit, Blue, 7-9mm
72141	Small Block Chevy Centerbolt Loom Kit, Red, 7-9mm
72143	Small Block Chevy Centerbolt Loom Kit, Black, 7-9mm

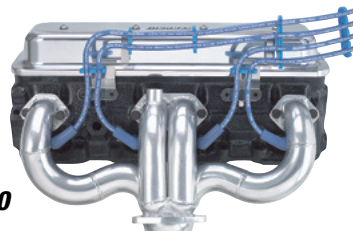
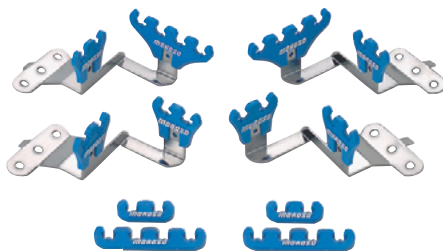

No. 72140

WARNING Prop. 65
This product contains a chemical known to the state of California to cause cancer, birth defects, or reproductive harm-

FOUR HOLE SPARK PLUG WIRE LOOM KITS

- Includes two chrome plated brackets and two 4-hole looms
- One kit per engine

PART #	DESCRIPTION
72180	Four Hole Loom Kit, Blue, 7-9mm
72181	Four Hole Loom Kit, Red, 7-9mm
72182	Four Hole Loom Kit, Yellow, 7-9mm
72183	Four Hole Loom Kit, Black, 7-9mm

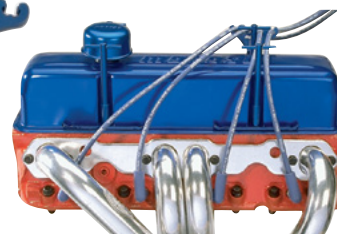

No. 72180

WARNING Prop. 65
This product contains a chemical known to the state of California to cause cancer, birth defects, or reproductive harm-

SBC HIGH-TEMP UNDER HEADER LOOM KIT

- Designed for routing wires under headers on old and new style Small Block Chevy engines
- Includes four chrome plated brackets, two 4-hole looms, two 2-hole looms, two 4-hole separators, two 3-hole separators, two 2-hole separators and mounting bolts
- One kit per engine



No. 72195

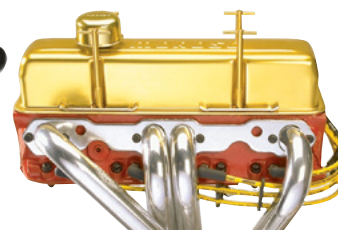

PART #	DESCRIPTION
72195	Under Header Loom Kit, Black, 7-9mm

WARNING Prop. 65
This product contains a chemical known to the state of California to cause cancer, birth defects, or reproductive harm-

REPLACEMENT WIRE LOOMS

- Direct replacement looms 7-9mm used in Moroso Loom Kits, also fits other brands' loom brackets
- High-temperature injection molded polyester for extended durability
- Not for use with Part No. 72195
- Packaged two per card

PART #	DESCRIPTION
97830	Wire Loom, 2-Hole, Blue, 7-9mm
97832	Wire Loom, 4-Hole, Blue, 7-9mm
97833	Wire Loom, 2-Hole, Red, 7-9mm
97835	Wire Loom, 4-Hole, Red, 7-9mm



No. 97830



No. 97835



LOOM KITS

Triple-process chrome plated brackets with high-temperature plastic separators keep plug wires away from exhaust manifolds, headers and other trouble spots. Prevents ignition crossfire by keeping wires evenly spaced. Available with Blue, Red, Yellow and Black looms/separators to give your engine a neat and orderly look.

SPARK PLUG WIRE SEPARATORS

- Protect against heat damage by preventing contact with hot engine components
- Prevent crossfiring by firmly holding plug wires away from one another
- Can be used for routing wires over valve covers or under headers
- Wires “snap” into place with slight pressure
- Sets include two 2-hole separators, two 3-hole separators and two 4-hole separators
- Available in Blue, Red, Yellow and Black

**No. 72163****PART # DESCRIPTION**

72160	Spark Plug Wire Separators, Blue, 7-9mm
72161	Spark Plug Wire Separators, Red, 7-9mm
72162	Spark Plug Wire Separators, Yellow, 7-9mm
72163	Spark Plug Wire Separators, Black, 7-9mm
73160	Spark Plug Wire Separators, Blue, 11mm or sleeved wire
73163	Spark Plug Wire Separators, Black, 11mm or sleeved wire

WIRE SEPARATOR KIT, 2 EACH OF 2, 3 & 4 SEPARATORS, BLACK

Fits: up to 8.65mm Non-Sleeved Ignition Wire

- Separators are constructed out of plastic and are a split design with center retaining hardware
- Kit includes an Allen Wrench
- Two kits would be needed for a typical SBC V-8 engine

PART # DESCRIPTION

72166	Wire Separator Kit, 2 each of 2, 3, & 4 hole separators including allen wrench
--------------	--

**No. 72166**

OUR BEST SPEAKS FOR ITSELF!

In most catalogs, a manufacturer will showcase their top-of-the-line product, whether sold in larger numbers or not. Unfortunately, we can't show you our **Premier Circle Track Distributors** because of proprietary agreements.

We can tell you how extraordinarily well our distributors perform—in Circle Track's top racing series—by both the leader and the majority of the top ten series cars. In addition to racing, Moroso distributors are also utilized on one of the **largest fleet of delivery vehicles in the United States.**

Even though you might not be racing 500 miles or picking up 500 packages a day, Moroso's line of distributors give our customers the same **performance, quality and reliability** that racing and industry leaders have come to depend on.



DISTRIBUTOR REPLACEMENT PARTS

Refer to chart below for specific replacement parts for your distributor model.

WARNING Prop. 65
This product contains a chemical known to the state of California to cause cancer, birth defects, or reproductive harm.

MODEL OF DISTRIBUTOR

DESCRIPTION	MODEL OF DISTRIBUTOR				
	MOROSO MULTIPHASE	MOROSO PREMIER BLUE BELL	MOROSO DURABILLET ONE-PIECE BLACK HOUSING	JESEL® FRONT DRIVES	CRANE PRO SERIES
Cap	97852	97852	97855	97855	97855
Cap, Non Wire Retainer	97850	97850	97856	97856	97856
Rotor	97848	97848	97848	97860	97849
Adapter Ring	N/A	N/A	97854	97861	97854
Wire Retainer	97853	97853	97853	97853	97853
Moroso Race Pickup 11"	97862	97862	97862	N/A	N/A

DURAFIRE DISTRIBUTORS

COMPLETE BOLT-IN REPLACEMENTS FOR HEI CHEVROLET V8 ENGINES

Now there's no need to build your own high-output distributor that you can tune for non-computerized HEI Chevy V8's. The ignition experts at Moroso have done it for you!

Moroso's **DuraFire Distributor** come equipped with everything needed to customize the ignition timing curve for your particular street/strip application. They feature several high-output components including Moroso's **ProCoil** that provides more complete combustion for easier starts, smoother idle, improved acceleration and more horsepower!

Included: High-Output Module, Mechanical Advance Curve Kit, HEI Cap & Rotor, High-Output **ProCoil** & Cover

- Improved weight and advance cam pin retention by TIG welding the pin backside to prevent them from coming loose
- Upgraded strength of the plastic wire harness plug so that the two lock tabs do not break off when unplugging the harness from the distributor cap

PART #	DESCRIPTION
72231	DuraFire Distributor, GM HEI, V8, w/out Vacuum Advance
PART #	REPLACEMENT PARTS
97857, 97858, 97859	Distributor Repl, Parts (see pg.344)
72355	ProCoil Ignition Coils (see pg. 349)



No. 72231



CHECK OUT THE FEATURES

- One-piece aluminum housing is cleanly machined for neat appearance; steel shaft and gear provide concentric operation
- HEI Distributor Cap and Rotor are precision molded from advanced polymers with solid brass contacts and low-resistance center coil brush
- Mechanical Advance Curve Kit with extra springs allow you to recurve your distributor for full advance at optimum RPM; precision stamped weights, welded pins and center plates with smooth edges eliminate erratic timing
- Moroso's ProCoil combines low oxygen, high-conductivity magnet wire, high-silicon core material, and non-porous epoxy impregnation to produce extremely high current and extended duration for increased spark energy
- High-Output Module delivers high spark output and extended reliability

WARNING Prop. 65
This product contains a chemical known to the state of California to cause cancer, birth defects, or reproductive harm-



IGNITION SYSTEM



No. 72251

DURAFIRE DISTRIBUTOR, PASSENGER CAR, TRUCK, '87 -'95

Moroso's DuraFire Distributors are now available for GM '87-'95 passenger cars, trucks with GM "H" and "K" code engines with external coils

- Heavy duty billet aluminum body, machined for durability and looks
- Hardened steel shaft and gear provide concentric operation
- Cap and rotor are precision molded from advanced polymers with solid brass contact and inserts on the cap and rotor
- High-output module delivers high spark output and extended reliability

PART # DESCRIPTION

72251 ◊ DuraFire Distributor.

PART # REPLACEMENT PARTS

27043 Ignition Module

97866 Cap

97867 ◊ Rotor

◊  **WARNING Prop. 65**
This product contains a chemical known to the state of California to cause cancer, birth defects, or reproductive harm-

DURAFIRE DISTRIBUTOR, GM VORTEC, '95 -'01

Moroso's DuraFire Distributors are now available for GM '95-'01, "R" and "M" code V-8 Vortec, "LT" Engines

- Heavy duty aluminum body is stronger than O.E.M. plastic housing
- Hardened steel shaft and gear provide concentric operation
- Caged needle roller bearings for smooth operation
- Flat cap like O.E.M.
- Cap and rotor are precision molded from advanced polymers with solid brass contacts and inserts on the cap and rotor
- This distributor does not use a module (it only has a HAL Effect Sensor)

PART # DESCRIPTION

72252 DuraFire Distributor



No. 72252

CHEVROLET V8 SUPER HEI IGNITION KIT

8mm

- Includes HEI Distributor Cap and Rotor, Coil Cover, Blue Max™ high-performance Wire Set, and Super Loom Kit
- Developed for racing, all ignition components engineered to improve ignition accuracy, fuel economy, starting, and throttle response
- HEI Distributor Cap & Rotor precision molded from advanced polymers with solid brass contacts to provide high dielectric strength & unsurpassed timing accuracy
- Custom-Fit Blue Max™ 8mm, 800 ohm Spiral Core Wire Set is factory terminated in the correct lengths with numbered I.D. tags, corrosion-resistant locking plug terminals and high-temperature silicone boots
- Wire Loom Kit with separators and show quality chrome brackets routes wires over the valve covers to keep them away from hot exhaust manifolds or headers
- Emissions legal in all 50 states

PART # DESCRIPTION

72280 ◊ Super HEI Ignition Kit

Fits: 1974 and newer Chevy V8's with HEI ignition (without centerbolt valve covers)

◊  **WARNING Prop. 65**
This product contains a chemical known to the state of California to cause cancer, birth defects, or reproductive harm-



No. 72280



REPLACEMENT IGNITION MODULE

Moroso/GM HEI Distributors

- Fits Moroso DuraFire Distributors **No. 72231** and any 4-pin GM HEI Distributor for 4, 6 and 8 cylinder engines
- High-output module delivers consistent dwell, accurate timing, extended durability and high spark output

PART #	DESCRIPTION
97857	Replacement Ignition Module. Fits: GM-style HEI Distributors



No. 97857

ADJUSTABLE VACUUM ADVANCE KIT

- Allows you to change the amount of ignition vacuum advance for maximum part-throttle performance while preventing harmful effects of spark knock (detonation)
- Dial in as much spark advance as conditions permit—add more advance under light load conditions to improve throttle response and fuel economy, or limit spark advance in high compression engines and high load conditions to eliminate knock
- Built-in stop prevents the adjustment screw from "backing out" like other designs
- Perfect companion to Moroso HEI Advance Curve Kit **No. 72300**, below



No. 72315

PART #	DESCRIPTION
72315	Adjustable Vacuum Advance Kit. Fits: 1975-'81 GM HEI Distributors

ADVANCE CURVE KITS

- "Recurve" your distributor for full spark advance at the optimum RPM
- Three sets of advance springs allow you to adjust the rate of spark advance
- Weights and centerplates precision stamped with smooth edges eliminate erratic timing
- Comes with complete installation instructions



No. 72300

PART #	DESCRIPTION
72300	HEI Advance Curve Kit, special design centerplate eliminates over-centering of the centrifugal weights. Designed by Nelson Crozier. Fits: All GM HEI Distributors
72310	Advance Curve Kit. Fits: All 1957-'75 GM/Delco Non-HEI

DISTRIBUTOR REPLACEMENT PARTS

REPLACEMENT COIL COVER

Moroso/GM HEI Distributors

- Fits Moroso DuraFire Distributors **No. 72231** and any GM HEI Distributor
- Precision molded from advanced polymers for longer life and protection

PART #	DESCRIPTION
97858	Distributor Coil Cover, GM HEI V8



No. 97858

REPLACEMENT CAP, ROTOR & BRUSH KIT

Moroso/GM HEI Distributors

- Fits Moroso DuraFire Distributors **No. 72231** and any GM HEI Distributor

PART #	DESCRIPTION
97859	Distributor Cap, Rotor & Brush Kit, GM HEI V8

WARNING Prop. 65
 This product contains a chemical known to the state of California to cause cancer, birth defects, or reproductive harm.

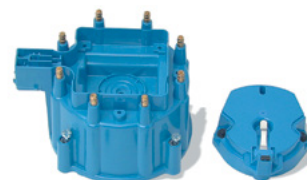

No. 97859



IGNITION SYSTEM

ROTOR, DISTRIBUTOR

Short Drive Lug

Fits: Jesel®, Mallory® and Crane® Distributors

- Designed specifically for each manufacturers' distributor for better fit, tip positioning and balance
- Made with high performance plastic for longer life and greater durability
- The brass tip and heavy duty stainless steel spring provides and maintains great electrical performance
- Features designed into the tip, plastic body and screw provide superior tip retention



No. 97849

WARNING Prop. 65
 This product contains a chemical known to the state of California to cause cancer, birth defects, or reproductive harm-

PART #	DESCRIPTION
97849	Rotor, Distributor, Short Drive Lug. <i>Fits: Crane</i>
97860	Rotor, Distributor, Short Drive Lug. <i>Fits: Jesel, Mallory</i>

DISTRIBUTOR GEAR SHIM KIT

- Allows precise adjustment of distributor shaft end play to improve timing accuracy and reduce gear wear
- Works with Moroso, GM®, Accel®, Chrysler® and other distributors with ½" diameter shaft
- Includes two .010" shims, two .020" shims and one .053" shim



No. 26140

PART #	DESCRIPTION
26140	Distributor Gear Shim Kit

DISTRIBUTOR HOUSING SHIM KIT

Fits: Small Block, Big Block, and 90° V6 Chevy engines

- Eliminates oil pump bind and spark scatter when using a distributor in an engine with resurfaced heads or decks
- Made from high impact nylon to exact GM® gasket specs
- Kit insures leak-free operation and contains one each .030", .060" and .100" shims

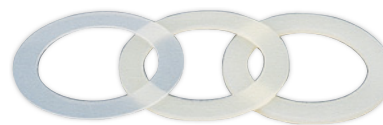

No. 26150

PART #	DESCRIPTION
26150	Distributor Housing Shim Kit, 1.290 I.D. & 1.830 O.D

SPARK PLUG INDEXING WASHERS

- Designed for use on all 14mm spark plugs with ⅝" hex
- With three thicknesses in each package, one will correct the electrode placement on any plug and simplify the time-consuming task of spark plug indexing
- The washers are precision stamped from copper for perfect sealing and heat transfer
- 30 per pack, 10 each size



No. 71900

PART #	DESCRIPTION
71900	Spark Plug Indexing Washers, Tapered Seat, .010", .021", .032"
71910	Spark Plug Indexing Washers, Flat Seat, .040", .050", .064"



IGNITION SYSTEM

DISTRIBUTOR HOLD DOWN CLAMPS

- Extra-thick and heavy-duty to ensure adequate retention of distributor housing
- Stud mounted to eliminate thread wear in intake manifold
- Slotted for quick distributor removal
- Includes stud, washer, nut

PART #	DESCRIPTION
26200	Distributor Hold Down Clamp. <i>Fits: All V8 and 90° V6 Chevrolet engines, Clear-Zinc Steel</i>
26210	Distributor Hold Down Clamp. <i>Fits: All V8 and 90° V6 Chevrolet engines, Chromed Steel</i>
26211	Distributor Hold Down Clamp. <i>Fits: All Small Block Ford engines, Chromed Steel</i>



 **WARNING Prop. 65**
This product contains a chemical known to the state of California to cause cancer, birth defects, or reproductive harm.

**ADJUSTABLE DISTRIBUTOR COLLAR**

Fits: Small Block, Big Block, and 90° V6 Chevrolet

- Precision machined steel collar can be positioned on distributor housing to adjust installed height for dead-center gear alignment
- Also aligns the distributor's lubrication grooves with oil passages in the block
- Socket-head cap screw tightens collar to housing, while two cupped-point hardened steel set screws grip housing to eliminate any movement
- Specially designed for Moroso's Billet Distributors (also fits MSD Distributors and others) 1.25" O.D. lower distributor housing
- Distributors with fixed collars can be machined smooth to accept Adjustable Collar

PART #	DESCRIPTION
26217	Adjustable Distributor Collar



No. 26217

BILLET DISTRIBUTOR HOLD DOWN

- Machined from sturdy steel billet to eliminate deflections
- Secures distributors firmly while allowing easy timing changes
- Specially designed for Moroso's Billet Distributors
- Also fits MSD and Accel distributors with a 1.850" O.D. flange or a 1.25" O.D. lower distributor housing using a Moroso **No. 26217** Adjustable Collar

PART #	DESCRIPTION
26215	Billet Distributor Hold Down. <i>Fits: Small Block, Big Block, and 90° V6 Chevrolet</i>



No. 26215

HIGH OUTPUT IGNITION COIL

- Provides high output ignition for any 12V points-equipped car or truck
- Plated with beautiful show-quality chrome for great looks and extended durability
- 40,000 volt rating

PART # DESCRIPTION
72350* High Output Ignition Coil, Chrome-Plated,
 Points-triggered Ignitions

 **WARNING Prop. 65**
 This product contains a chemical known
 to the state of California to cause cancer,
 birth defects, or reproductive harm-

No. 72350



**Not legal for sale or use on pollution-controlled vehicles.*

BALLAST RESISTOR

- Absolutely required for point-triggered ignitions equipped with coils that do not feature a built-in resistor such as Moroso Coil **No. 72350**, Accel Super Coil 140001, Super Stock High Vibration 8140HV, Racing Coils 140108, 140205 and 140305; Crane PS20 and PS40, Jacob's 380672T and MSD Blaster 2 - 8200, 8202, and 8203, Blaster 3 - 8223
- Ceramic base supports resistor to eliminate the possibility of electrical shorts and to dissipate heat
- Includes built-in mounting boss; must be mounted to firewall or other metallic surface to further dissipate heat
- 1/4" spade terminals facilitate wiring to battery side of the coil

PART # DESCRIPTION
72390* Ballast Resistor, 1.82 ohms

 **WARNING Prop. 65**
 This product contains a chemical known
 to the state of California to cause cancer,
 birth defects, or reproductive harm-

No. 72390

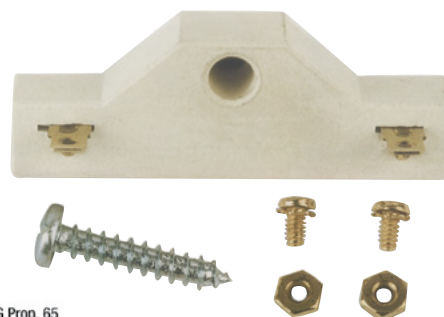

IGNITION SYSTEM

REMOTE COIL MOUNTING BRACKET KIT

Fits: LS Series

- Relocates ignition coils from valve cover
- Fits O.E.M. and larger aftermarket coils with 2-⁹/₁₆" bolt spacing
- Use with Moroso Ultra 40 Wire Sets **Nos. 73811 & 73828**
- Two Mounting Brackets per kit (for 8 coils)

PART #	DESCRIPTION
72395	Remote Coil Mounting Bracket with Spacers



No. 72395

REMOVEABLE COIL MOUNTING BRACKET

Fits: LS Series

- Hinged to provide quick access to valve cover fasteners
- Coil pack mounting bracket removes with two fasteners
- Coils nested toward back of motor to free up area on front of valve cover for breathers, vacuum pump fittings, fill caps, etc.
- Drivers' side assembly shown
- Fits O.E.M. and larger aftermarket coils with 2-⁹/₁₆" bolt spacing
- Use with Moroso Ultra 40 Wire Sets **Nos. 73661, 73681 or 73704**

PART #	DESCRIPTION
72396	Coil Mounting Bracket, Hinged, Removable



No. 72396



COIL MOUNT BRACKET KIT, GM LS SERIES FOR MOROSO 68471/68473 VALVE COVERS

- These Coil Brackets can be used to relocate LS Coils between the top of the valve cover and the intake
- Designed to be used with Moroso valve covers but can be drilled to be used with other valve covers or to remote mount coils in a different location.
- Two versions available; One for LS1/LS6 Coils & the Second for LS2, LS3, LS7, L92, L98, L99 Coils
- When used with Moroso valve covers, the valve cover can be removed and installed without disturbing the coils or brackets
- Kit includes black anodized aluminum brackets and metric hardware, one kit does one LS engine

PART #	DESCRIPTION
72397	Coil Mount Bracket, GM LS Series for Moroso Nos. 68471/68473 , LS1, LS6 Coils
72398	Coil Mount Bracket, GM LS Series for Moroso Nos. 68471/68473 , LS2, LS3, LS7, L92, L98, L99 Coils



No. 72398

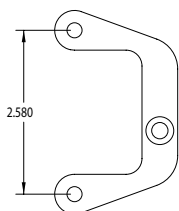

No. 72397

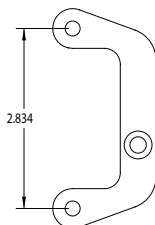

No. 72398



PLASMA PULSE IGNITION COIL

The Ultimate In Ignition Coil Technology!

- For Racing Only
- Ultra-High Spark Current
- Maximum Horsepower & Combustion Efficiency

We've taken our years of ignition experience and engineered an extremely powerful Racing Coil for both Capacitive Discharge (CD) and Inductive Discharge (breaker points, HEI, etc.) ignitions.

Moroso Plasma Pulse Coils feature a unique winding and core design that generates ultra-high spark current for maximum horsepower and combustion efficiency! In addition to delivering exceptional ignition power, Plasma Pulse Coils are loaded with durability features that include double-layer insulation, corrosion-resistant connectors and a durable alkyd case.

The blue anodized extruded aluminum housing not only gives the coil a distinctive appearance, but cooling fins dissipate damaging heat quickly. In fact, the entire coil can withstand continuous operation without overheating! A high-temperature epoxy filling allows you to mount the coil in any direction.



WARNING Prop. 65
This product contains a chemical known to the state of California to cause cancer, birth defects, or reproductive harm.

No. 72380

PART #	DESCRIPTION
72380	Plasma Pulse Ignition Coil, Inductive Discharge. For use with Chevy HEI and Ford DuraSpark ignitions

ENGINEERED FOR MAXIMUM POWER AND DURABILITY!

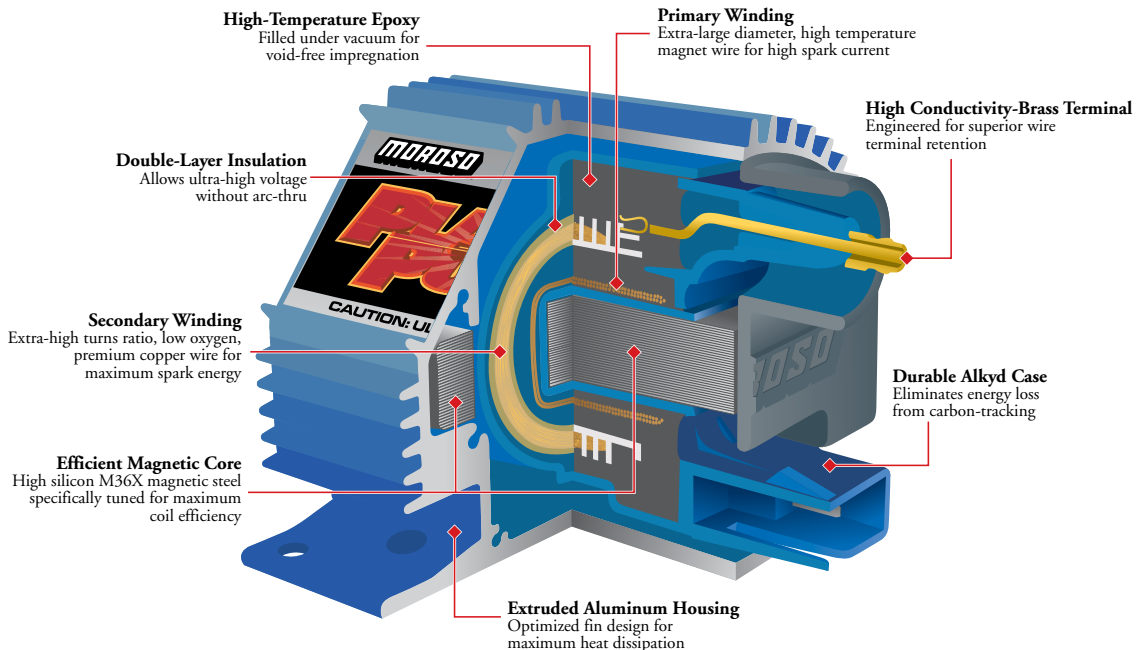

PROCOIL IGNITION COILS

Increased Spark Energy! Bolt In Replacement!

Finally, a coil design that gives your ignition system real power. Real ignition power that provides more complete combustion for easier starts, better idle, snappier acceleration, and more horsepower. Real ignition power that eliminates the "6000 RPM barrier" inherent with stock systems.

We've combined low oxygen, high-conductivity magnet wire, high-silicon core material, and non-porous epoxy impregnation to produce extremely high current and extended duration for increased spark energy. And our expert workmanship gives you the reliability needed for hard-core racing or daily street use.



No. 72355

REFER TO FOLLOWING PAGES FOR PROCOIL APPLICATION CHARTS:

PART #	DESCRIPTION	PAGE NUMBERS
72355	ProCoil HEI, 1975-93 GM	pgs. 350-353
72358	ProCoil F, 1985-96 GM	pgs. 350-353
72360	ProCoil H.O., 1982-97 Ford, DuraSpark	pgs. 352-353

WARNING Prop. 65
This product contains a chemical known to the state of California to cause cancer, birth defects, or reproductive harm.

No. 72358



No. 72360



IGNITION SYSTEM

CHECK OUT THE FEATURES THAT MAKE MOROSO'S PROCOIL SUPERIOR TO ALL OTHER BRANDS!

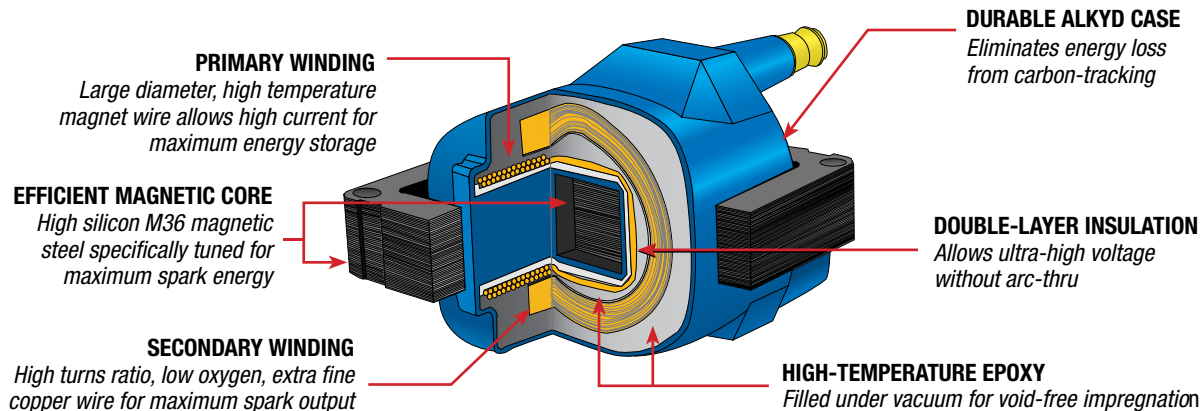

HEI PROCOIL APPLICATION CHART

BUICK

YEAR	ENGINE	PART#
1988-87	122 2.0K, 2.0M, 4 cyl. Skyhawk (with Dist. 1103710)	72358 ◊
1986	112 1.8-0, 1.8J, 4 cyl. Skyhawk	72358 ◊
1986	121 2.0P, 4 cyl. Skyhawk	72358 ◊
1986	151 2.5R, 4 cyl. Century (with Dist. 1103634)	72358 ◊
1986	151 2.5U, 4 cyl. Somerset	72358 ◊
1985	121 2.0P, 4 cyl. Skyhawk	72358 ◊
1985	151 2.5R, 4 cyl. Century, Skylark	72358 ◊
1985	151 2.5U, 4 cyl. Somerset, Regal	72358 ◊
1981-80	151 2.5L, 4 cyl. Skylark (Can. Only)	72355 ◊
1986	173 2.8X, 6 cyl. Century	72358 ◊
1985	173 2.8W, 6 cyl. Skylark	72358 ◊
1985	173 2.8X, 6 cyl. Century, Skylark	72358 ◊
1985	173 2.8X, 6 cyl. Century, Skylark (Can., Export with Dist. 1103619, 1103704)	72358 ◊
1982	173 2.8L, 6 cyl.	72355 ◊
1981-80	173 2.8L, 6 cyl. Skylark	72355 ◊
1981-80	252 4.1L, 6 cyl.	72355 ◊
1995-94	350 5.7P, 8 cyl. Roadmaster	72358 ◊
1993-92	350 5.7, 8 cyl. Roadmaster	72358 ◊
1992-91	305 5.0E, 8 cyl. Roadmaster	72358 ◊
1987-84	305 5.0L, 8 cyl. (Can. Only)	72355 ◊
1980-83	267 4.4L, 305 5.0L, 8 cyl.	72355 ◊
1979-77	305 5.0L, 350 (L) 5.7L, 8 cyl.	72355 ◊

CADILLAC

YEAR	ENGINE	PART#
1986-85	121 2.0P, 4 cyl. Cimarron	72358 ◊
1986-85	173 2.8W, 6 cyl. Cimarron	72358 ◊
1995-94	350 5.7P, 8 cyl. Brougham, Com. Chassis, (MFI Dist. 1103916)	72358 ◊
1993	350 5.7, 8 cyl. Fleetwood Brougham (with Dist.1103953)	72358 ◊

CADILLAC, continued

YEAR	ENGINE	PART #
1992	350 5.7, 8 cyl. Brougham	72358 ◊
1991-92	305 5.0E, 8 cyl. Brougham, Fleetwood	72358 ◊
1991	350 5.7, 8 cyl. Brougham, Fleetwood (with Dist.1103880)	72358 ◊
1990	350 5.7, 8 cyl. Fleetwood (with Dist. 1103749, 827)	72358 ◊
1988-90	273 (5) 4.5L, 8 cyl. Allante, Fleetwood, DeVille	72355 ◊
1987	250 (7) 4.1L, 8 cyl. Allante with Dist. 1103747	72355 ◊
1986-87	252 4.1L, 8 cyl. Fleetwood, DeVille FWD	72355 ◊
1984-85	252 4.1L, 8 cyl. Eldorado, Seville	72355 ◊
1983-82	252 4.1L, 8 cyl. Eldorado, Seville	72355 ◊
1980-85	368 6.0L, 8 cyl. DeVille, Eldorado, Fleetwood, Seville	72355 ◊
1980-85	368 6.0L, 8 cyl. Comm. Chassis, Limousine	72355 ◊
1978-79	425 7.0L, 8 cyl. Comm. Chassis, Limousine	72355 ◊
1978-79	425 7.0L, 8 cyl. DeVille, Fleetwood	72355 ◊
1977-74	500 8.2L, 8 cyl. with HEI	72355 ◊
1977-74	425 7.0L, 8 cyl. with HEI	72355 ◊

CHEVROLET

YEAR	ENGINE	PART#
1987-88	92 1.5-9, 4 cyl. Spectrum (with Dist. 1103674) Turbo	72358 ◊
1985-87	98 1.6C, 4 cyl. Chevette	72358 ◊
1985-86	121 2.0P, 4 cyl. Cavalier	72358 ◊
1985-1986	151 2.5-2, 2.5R, 4 cyl. Camaro, Celebrity	72358 ◊
1981	151 2.5L, 4 cyl. Citation (Can. Only)	72355 ◊



CHEVROLET, continued

YEAR	ENGINE	PART #
1980	151 2.5L, 4 cyl. Citation, Monza	72355◊
1979-78	151 2.5L, 4 cyl. Monza	72355◊
1993-94	189 3.1D, 6 cyl. Lumina APV	72358◊
1993	262 4.3Z, 6 cyl. Caprice	72358◊
1992-93	262 (Z) 4.3L, 6 cyl. Caprice	72355◊
1992	189 3.1D, 6 cyl. Lumina APV	72358◊
1992	189 3.1T, 6 cyl. Camaro	72358◊
1992	262 4.3Z, 6 cyl. Caprice	72358◊
1991	189 3.1D, 6 cyl. Lumina APV-A.T. (with Dist. 1103864)	72358◊
1991	189 3.1T, 6 cyl. Camaro (with Dist. 1103704, 1103900)	72358◊
1991	262 4.3Z, 6 cyl. Caprice	72358◊
1990	189 3.1D, 6 cyl. Lumina APV (with Dist. 1103644)	72358◊
1990	189 3.1T, 6 cyl. Camaro (with Dist. 1103704)	72358◊
1990	262 4.3Z, 6 cyl. Caprice	72358◊
1987-89	173 2.8S, 6 cyl. Camaro (with Dist. 1103704)	72358◊
1987-89	262 4.3Z, 6 cyl.	72358◊
1986	173 2.8X, 6 cyl. Celebrity A.T.	72358◊
1986	173 2.8S, 6 cyl. Camaro	72358◊
1986	173 2.8W, 6 cyl. Cavalier, Celebrity	72358◊
1986	262 4.3Z, 6 cyl.	72358◊
1985	173 2.8W, 6 cyl. Cavalier, Celebrity, Citation	72358◊
1985	173 2.8X, 6 cyl. Celebrity, Citation-Can., Export, Fed.	72358◊
1985	173 2.8S, 6 cyl. Camaro	72358◊
1985	262 4.3Z Eng, 6 cyl.	72358◊
1984-82	229 3.8L, 6 cyl.	72355◊
1981	173 2.8L, cyl.	72355◊
1981	229 3.8L, 6 cyl.	72355◊
1980	173 2.8L, 6 cyl.	72355◊
1979	200 3.3L, 6 cyl.	72355◊
1978	200 3.3L, 6 cyl.	72355◊
1995	265 4.3W, 8 cyl.	72358◊
1995	350 5.7P, 8 cyl. Camaro, Caprice, Corvette	72358◊
1994	265 4.3L, 8 cyl.	72358◊
1994	350 5.7P, 8 cyl. Camaro, Caprice, Corvette	72358◊
1993	305 5.0E, 8 cyl.	72358◊
1993	350 5.7, 8 cyl.	72358◊
1993	350 5.7P, 8 cyl. Camaro, Corvette	72358◊
1992	305 5.0E, 8 cyl. Caprice, Camaro	72358◊
1992	305 5.0F, 8 cyl. Camaro	72358◊
1992	350 5.7, 8 cyl. Camaro	72358◊
1992	350 5.7, 8 cyl. Caprice	72358◊
1992	350 5.7P, 8 cyl. Corvette	72358◊
1991	305 5.0F, 8 cyl. Caprice, Camaro	72358◊
1991	305 5.0E, 8 cyl. Camaro, Caprice	72358◊
1991	350 5.7, 8 cyl. Caprice	72358◊
1991	350 5.7, 8 cyl. Camaro	72358◊

CHEVROLET, continued

YEAR	ENGINE	PART #
1990	305 5.0E, 5.0F, 8 cyl. Camaro	72358◊
1990	350 5.7L, 8 cyl. Caprice (w/ Dist. 1103749) Police Car	72358◊
1990	350 5.7, 8 cyl. Camaro (with Dist. 1103838, 880)	72358◊
1989	305 5.0E, 8 cyl. Camaro	72358◊
1989	350 5.7, 8 cyl. Caprice (w/ Dist. 1103749) Police Car	72358◊
1989	350 5.7, 8 cyl. Camaro	72358◊
1988	305 5.0E, 5.0F, 5.0G, 5.0H, 8 cyl.	72358◊
1988	350 5.7, 8 cyl. Camaro.	72358◊
1988	350 5.7L, 8 cyl. Caprice (w/ Dist. 1103749) Police Car	72358◊
1987	305 5.0F, 5.0G, 5.0H, 8 cyl (with Dist. 1103698, 749)	72358◊
1987	350 5.7L, 8 cyl. Caprice Fed. (with Dist 1103698, 749) Police Car	72358◊
1987	350 5.7 8 cyl. Camaro	72358◊
1987	305 (H) 5.0L, 8 cyl. (Can. Only)	72355◊
1986	350 5.7L, 8 cyl. Caprice Fed. (with Dist 1103698, 749) Police Car	72358◊
1986	350 5.7L, 8 cyl. Caprice, Police Car (Can. Only)	72355◊
1986	305 (F), (G), (H) 5.0L, 8 cyl.	72355◊
1986	350 5.7L, 8 cyl. (Exc. Corvette)	72355◊
1985	305 (F), (G), (H) 5.0L, 8 cyl.	72355◊
1985	350 5.7L, 8 cyl. Caprice, Impala, Police Car	72355◊
1984	305 5.0L, 8 cyl.	72355◊
1984	350 5.7L 8 cyl. (Exc. Corvette)	72355◊
1983	305 5.0L, 8 cyl. (Can. Only)	72355◊
1983	350 5.7, 8 cyl. Caprice, Impala, Police Car	72355◊
1982-81	267 4.4L, 8 cyl.	72355◊
1982-81	305 5.0L, 8 cyl. (Can. Only)	72355◊
1982-81	350 5.7L, 8 cyl. (Exc. Corvette)	72355◊
1980-77	All 8 Cyl. Engs.	72355◊
1976	350 5.7L, 8 cyl. with 4 Bbl. Carb. (Cal. Only)	72355◊
1976	350 5.7L, 8 cyl. with 2 Bbl. Carb.	72355◊
1976	262 4.3L, 305 5.0L, 400 6.6L, 454 7.4L, 8 cyl.	72355◊
1975	350 5.7L, 8 cyl. Camaro with 4 Bbl. Carb.	72355◊
1975	Exc. Z-28, 8 cyl. (Cal. Only)	72355◊
1975	350 5.7L, 8 cyl. Camaro Z-28	72355◊
1975	350 5.7L, 8 cyl. with 2 Bbl. Carb.	72355◊
1975	262 4.3L, 305 5.0L, 400 6.6L, 454 7.4L, 8 cyl.	72355◊
1974	All 8 cyl. Engs. with HEI	72355◊



WARNING Prop. 65
 This product contains a chemical known to the state of California to cause cancer, birth defects, or reproductive harm-

CHEVROLET/GMC TRUCK

YEAR	ENGINE	PART#
1985-89	151 2.5E, 4 cyl. S10, S15, Astro, Safari	72358 ◊
1996	262 4.3Z, 6 cyl. G-1, 2, 3	72358 ◊
1995	262 4.3W, 6 cyl. Pick-up -A.T. with out Module Powertrain Control	72358 ◊
1994-95	262 4.3 B, W, Z , 6 cyl.	72358 ◊
1992-93	173 2.8 R, 6 cyl. Sonoma, S10, S15	72358 ◊
1992-93	262 4.3 B, W, Z, 6 cyl.	72358 ◊
1991	262 4.3 B, W, 6 cyl. Astro, Safari, S10, S15	72358 ◊
1991	262 4.3Z, 6 cyl.	72358 ◊
1986-90	292 4.8L, 6 cyl.	72355 ◊
1986-90	262 4.3Z, 6 cyl. All incl. Safari (with Dist. 1103655)	72358 ◊
1985-86	262 4.3L, 6 cyl. C-10/K-10 Pickup, Suburban, Blazer, Jimmy	72355 ◊
1985-86	262 4.3L, 6 cyl. G-10, -20, -30 Van	72355 ◊
1985-91	173 2.8B, 6 cyl. S10, S15	72358 ◊
1984	250 4.1L, 292 4.8L, 6 cyl. Caballero	72355 ◊
1980-84	229 3.8L, 6 cyl. El Camino, Caballero	72355 ◊
1979-78	200 3.3L, 6 cyl. El Camino, Caballero	72355 ◊
1978-84	250 4.1L, 6 cyl.	72355 ◊
1987-95	305 5.0H, 8 cyl.	72358 ◊
1987-95	350 5.7K, 8 cyl.	72358 ◊
1987-95	454 7.4N, 8 cyl.	72358 ◊
1989	454 (W) 7.4L, 8 cyl. P-30, R-30, V-30	72355 ◊
1989	350 (K) 5.7L, 8 cyl. P-30, R-30, V-30	72355 ◊
1988	350 (M) 5.7L, 8 cyl. G-30, P-20, P-30, R-30, V-30	72355 ◊
1987	305 (H), 8 cyl. El Camino (Can. Only)	72355 ◊
1987	350 (M) 5.7L, 8 cyl. G-30, P-20, P-30, R-30, V-30	72355 ◊
1987	454 (W) 7.4L, 8 cyl. with 4 Bbl. Carb.	72355 ◊
1975-86	All 8 Cyl. Engs. (Exc. 1978 403 cid G-30)	72355 ◊

FORD

YEAR	ENGINE	PART#
1993-95	122 2.0L, 4 cyl. Probe	72360 ◊
1986-91	153 2.5L, 4 cyl. Taurus	72360 ◊
1985-90	116 1.9L, 4 cyl. Escort, EXP	72360 ◊
1984-94	140 2.3L, 4 cyl. Tempo, Exc. LPG	72360 ◊
1984-90	140 2.3L, 4 cyl. EFI, Mustang	72360 ◊
1983-85	98 1.6L, 4 cyl. Escort with EFI	72360 ◊
1983-84	140 2.3L (Turbo), 4 cyl. EFI, Mustang, Thunderbird	72360 ◊
1982	98 1.6L, 4 cyl. Escort with Distr. Mounted Module	72360 ◊
1992-94	183 3.0L, 6 cyl. Tempo	72360 ◊

FORD, continued

YEAR	ENGINE	PART #
1987-93	232 3.8L, 6 cyl. Thunderbird Exc. S/C	72360 ◊
1986-95	183 3.0L, 232 3.8L, 6 cyl. Taurus Exc. FFV, SHO	72360 ◊
1990-92	183 3.0L, 6 cyl. Probe	72360 ◊
1984-91	302 5.0L, 351W 5.8L, 8 cyl. Crown Victoria, LTD	72360 ◊
1984-95	302 5.0L, 8 cyl. Mustang	72360 ◊
1984-93	302 5.0L, 8 cyl. Thunderbird	72360 ◊

FORD TRUCKS

YEAR	ENGINE	PART#
1988	122 2.0L, 4 cyl. Ranger	72360 ◊
1987-89	140 2.3L, 4 cyl. Aerostar, Ranger with Dist. Mounted Module	72360 ◊
1985-86	140 2.3L, 4 cyl. Aerostar, Bronco II, Ranger	72360 ◊
1986-96	171 2.8L, 183 3.0L, 6 cyl. Aerostar	72360 ◊
1986-95	177 2.9L, 183 3.0L, 6 cyl. Bronco II, Ranger	72360 ◊
1984-96	300 4.9L, 6 cyl. E, F Series, Module on Distributor	72360 ◊
1990-96	302 5.0L, 8 cyl. Bronco	72360 ◊
1990-96	302 5.0L, 8 cyl. E-150/E-250	72360 ◊
1990-96	302 5.0L, 8 cyl. F-150/F-250	72360 ◊
1990-96	351 5.8L, 8 cyl. Bronco (Exc. Calif. Remote Mtd Module) Module #E8PF-12A199-AB	72360 ◊
1990-96	351 5.8L, 8 cyl. E-150/E-250/350	72360 ◊
1990-96	351 5.8L, 8 cyl. F-150/F-250/350	72360 ◊
1990-96	460 7.5L, 8 cyl. E-250/350 Super-Duty, F-250/350 Super-Duty Module #E8PF-12A199-AB	72360 ◊
1984-89	302 5.0L, 8 cyl. EEC-IV with Bolt-On Rotor	72360 ◊
1984-89	351 5.8L, 8 cyl. EEC-IV with Bolt-On Rotor	72360 ◊
1984-89	460 7.5L, 8 cyl. EEC-IV with Bolt-On Rotor	72360 ◊

GEO

YEAR	ENGINE	PART#
1992-93	144 1.8-8, 4 cyl. Storm	72358 ◊
1990-93	98 1.6-6, 4 cyl. Storm	72358 ◊

LINCOLN

YEAR	ENGINE	PART#
1988-94	232 3.8L, 6 cyl. Continental	72360 ◊
1992	302 5.0L, 8 cyl. Mark VIII	72360 ◊
1991	302 5.0L, 8 cyl. Mark VII, Town Car	72360 ◊
1990	302 5.0L, 8 cyl. Town Car	72360 ◊
1985-89	302 5.0L, 8 cyl. All	72360 ◊
1984	302 5.0L, 8 cyl. Continental EEC-IV, Mark VII, TownCar	72360 ◊



MERCURY

YEAR	ENGINE	PART#
1986-91	153 2.5L, 4 cyl. Sable	72360◊
1985-87	116 1.9L, 4 cyl. LN7, Lynx	72360◊
1984-94	140 2.3L, 4 cyl. Topaz	72360◊
1984-86	140 2.3L, 4 cyl. EFI, Capri	72360◊
1983-85	98 1.6L, 4 cyl. LN7, Lynx with EFI	72360◊
1983-84	140 2.3L (Turbo), 4 cyl. EFI, Capri, Cougar	72360◊
1982	98 1.6L, 4 cyl. Lynx with Distr. Mounted Module	72360◊
1992-94	183 3.0L, 6 cyl. Topaz	72360◊
1987-93	232 3.8L, 6 cyl. Cougar Exc. S/C	72360◊
1986-95	183 3.0L, 232 3.8L, 6 cyl. Sable	72360◊
1984-91	302 5.0L, 351W 5.8L, 8 cyl. Grand Marquis	72360◊
1984-86	302 5.0L, 8 cyl. Capri	72360◊
1984-93	302 5.0L, 8 cyl. Cougar	72360◊

MERKUR

YEAR	ENGINE	PART#
1985-89	140 2.3L (Turbo), 4 cyl. XR4TI	72360◊
1988-89	177 2.9L, 6 cyl. Scorpio	72360◊

OLDSMOBILE

YEAR	ENGINE	PART#
1985-88	112 1.8, 121 2.0, 122 2.0, 4 cyl. Firenza	72358◊
1985-86	151 2.5R, 2.5U, 4 cyl. Calais, Ciera	72358◊
1981	151 2.5L, 4 cyl. Omega (Can. Only)	72355◊
1978-80	151 2.5L, 4 cyl. Starfire	72355◊
1990-95	189 3.1D, 6 cyl. Silhouette (with Dist. 1103644 or 1103864)	72358◊
1991-93	262 4.3Z, 6 cyl. Bravada	72358◊
1985-86	173 2.8W, 6 cyl. Ciera, Firenza	72358◊
1986	173 2.8X, 6 cyl. Ciera (with Dist. 1103643, 619)	72358◊
1985	173 2.8X, 6 cyl. Ciera Can., Export	72358◊
1980-82	173 2.8L, 181 3.0L, 6 cyl.	72355◊
1992	350 5.7, 8 cyl. Custom Cruiser	72358◊
1991	305 5.0E, 8 cyl. Custom Cruiser (with Dist. 1103852)	72358◊
1983-87	305 (H) 5.0L, 8 cyl.	72355◊
1983-86	267 4.4L, 8 cyl. (Can. Only)	72355◊
1983-86	305 (H) 5.0L, 8 cyl.	72355◊
1981	267 4.4L, 305 5.0L, 8 cyl.	72355◊
1977-80	305 5.0L, 350 (L) 5.7L, 8 cyl.	72355◊
1977-78	403 6.6L, 8 cyl. Toronado	72355◊
1975-76	455 7.5L, 8 cyl. Toronado	72355◊

PONTIAC

YEAR	ENGINE	PART#
1988-93	98 1.6, 4 cyl. LeMans (with Dist. 1103766)	72358◊

PONTIAC, continued

YEAR	ENGINE	PART#
1990	122 2.0K, 4 cyl. Sunbird, LeMans	72358◊
1989	122 2.0K, 4 cyl. LeMans (with Dist. 1103774)	72358◊
1988-91	122 2.0K, M, 4 cyl., Grand AM, Sunbird	72358◊
1987	122 2.0K, 4 cyl. J2000	72358◊
1987	122 2.0M, 4 cyl. Grand AM, J2000	72358◊
1985-86	112 1.8-0, 1.8J, 4 cyl. J2000	72358◊
1985-86	121 2.0P, 4 cyl. J2000	72358◊
1985-86	151 2.5U, 2.5-2, 4 cyl. Firebird, Grand AM	72358◊
1985-86	151 2.5R, 4 cyl.	72358◊
1985-87	98 1.6C, 4 cyl. T1000	72358◊
1985	151 2.5U, 4 cyl.	72358◊
1981	151 2.5L, 4 cyl. Phoenix (Can. Only)	72355◊
1977-80	151 2.5L, 4 cyl. Starfire with HEI	72355◊
1991-95	189 3.1D, 6 cyl. Trans Sport	72358◊
1990-92	189 3.1T, 6 cyl. Firebird	72358◊
1990	189 3.1D, 6 cyl. Trans Sport (with Dist. 1103644)	72358◊
1987-89	173 2.8S, 6 cyl. Firebird (with Dist. 1103704)	72358◊
1987-88	173 2.8-9, 6 cyl. Fiero	72358◊
1986	173 2.8S, 2.8W, 6 cyl.	72358◊
1986	173 2.8X, 6 cyl. Can., Export, Fed	72358◊
1985-86	173 2.8-9, 6 cyl. Fiero	72358◊
1985-87	262 4.3Z, 6 cyl.	72358◊
1985	173 2.8S, 2.8W, 6 cyl. U.S.	72358◊
1985	173 2.8X, 6 cyl. 6000	72358◊
1985	262 4.3Z, 6 cyl.	72358◊
1983	229 (9) 3.8L, 6 cyl. Parisienne	72355◊
1982	173 2.8L, 6 cyl. 6000, Phoenix	72355◊
1980-81	229 3.8L, 6 cyl.	72355◊
1980	173 2.8L, 6 cyl.	72355◊
1993-95	350 5.7P (H.O.) Eng. Firebird	72358◊
1988-92	305 5.0E, 5.0F	72358◊
1988-92	350 5.7-8 Eng. Firebird	72358◊
1987	305 5.0F, 5.0H Eng. Firebird, exc. Canada	72358◊
1987	305 5.0H Eng. Grand Prix, exc. Canada	72358◊
1987	350 5.7-8 Eng. Firebird (with Dist. 1103698)	72358◊
1987	305 (H) 5.0L, 8 cyl. Firebird, Grand Prix (Can. Only)	72355◊
1986	305 (F), (G), (H) 5.0L, 8 cyl.	72355◊
1983-85	305 (F), (G), (H) 5.0L, 8 cyl.	72355◊
1977-83	267 4.4L, 305 5.0L, 350 (L) 5.7L, 403 6.6L, 8 cyl.	72355◊
1975-76	350 5.7L, 400 6.6L Chevrolet, 8 cyl.	72355◊

◊  **WARNING Prop. 65**
This product contains a chemical known to the state of California to cause cancer, birth defects, or reproductive harm-



IGNITION SYSTEM

CRANK TRIGGER ULTRA SERIES KIT

Big Block Chevrolet

Fits: O.E.M., Fluidampr, ATI, Fischer, JEGS and other BBC 8.0" or smaller diameter damper cases with 4.749" mounting registers

- Crank Trigger Kit is based on the popular, flying magnet-style kits
- Compact adjuster arm for better fitment with two-piece oil pans and containment devices
- The trigger wheel and arm are constructed out of billet aluminum with black anodized finish for long lasting good looks
- Moroso has designed the trigger wheel and adjuster arm to allow for infinite timing settings, while still giving you the ability to position the sensor for the greatest range of adjustment for your combination. No more having the sensor run out of adjustment before you even start the engine up.
- The sensor mounting block is designed so that it will not stick out of the back of the arm and interfere with the oil pan or a diaper
- Moroso Crank trigger sensor comes with the most common plug to easily hook to any popular ignition box with no modifications
- Has two sensor locations for non-motorplate applications
- Includes all necessary hardware



No. 60008



No. 60012

WARNING Prop. 65
This product contains a chemical known to the state of California to cause cancer, birth defects, or reproductive harm-

PART # DESCRIPTION

- 60008***◊ Crank Trigger Ultra Series Kit for Big Block Chevrolet, Passenger
60012*◊ Crank Trigger Ultra Series Kit for Big Block Chevrolet, Mounts to driver's side of block for mechanical fuel pumps, Procharger clearance

CRANK TRIGGER ULTRA SERIES KIT

Small Block Chevrolet

Fits: O.E.M., Fluidampr, ATI, Fischer, JEGS and other SBC 7.0" or smaller diameter damper cases with 4.749" mounting registers

- Crank trigger kit is based on the popular flying magnet style kit
- Compact adjuster arm for better fitment with chassis restrictions pans and containment devices
- The trigger wheel and arm are constructed out of billet aluminum with black anodized finish for long lasting good looks
- Moroso has designed the trigger wheel and adjuster arm to allow for infinite timing settings while still giving you the ability to position the sensor for the greatest range of adjustment for your combination. No more having the sensor run out of adjustment before you even start the engine up
- The sensor mounting block is designed so that it will not stick out of the back of the arm and interfere with the oil pan
- Moroso Crank trigger sensor comes with the most common plug to easily hook to any popular ignition box with no modifications
- Kit mounts to passenger side of block only, and has two sensor locations for non-motorplate applications
- Includes all necessary hardware



No. 60009

WARNING Prop. 65
This product contains a chemical known to the state of California to cause cancer, birth defects, or reproductive harm-

PART # DESCRIPTION

- 60009***◊ Crank Trigger Ultra Series Kit, Small Block Chevy

REPLACEMENT CRANK TRIGGER TRANSDUCER

"Magnet-In Wheel" Style

- High-quality transducer with zinc-plated, cold-rolled steel body reduces unwanted signal interference and improves triggering accuracy
- Special, non-hardening epoxy impregnates pickup for shock and vibration isolation
- Built-in strain relief prevents wire from pulling out of potting compound



No. 60055

WARNING Prop. 65
This product contains a chemical known to the state of California to cause cancer, birth defects, or reproductive harm-

PART # DESCRIPTION

- 60055***◊ Replacement Crank Trigger Transducer, Magnet-in-Wheel Style

*Not legal for sale or use on Pollution-controlled vehicles.



CRANK TRIGGER ULTRA SERIES, ADJUSTABLE TIMING POINTER KIT

Small Block Ford, 302 - 351W

Fits: O.E.M., Fluidampr, ATI, Jegs and other S.B.F. 7.0" or smaller diameter by 3.35" long 4-bolt dampers

- Crank trigger kit is based on the popular flying magnet style kit
- Compact adjuster arm for better fitment with chassis restrictions pans and containment devices
- The trigger wheel and arm are constructed out of billet aluminum with black anodized finish for long lasting good looks
- Built-in adjustable timing pointer
- The trigger wheel and arm are constructed out of billet aluminum with black anodized finish for long lasting good looks
- Moroso has designed the trigger wheel and adjuster arm to allow for infinite timing settings while still giving you the ability to position the sensor for the greatest range of adjustment for your combination. No more having the sensor run out of adjustment before you even start the engine up
- The sensor mounting block is designed so that it will not stick out of the back of the arm and interfere with the oil pan
- Moroso Crank trigger sensor comes with the most common plug to easily hook to any popular ignition box with no modifications
- Kit mounts to passenger side of block or on motorplate applications
- Includes all necessary hardware



No. 60010



PART # DESCRIPTION
60010 Crank Trigger Ultra Series Kit, Small Block Ford

PART # AVAILABLE OPTION
63853 Oil Pump and Vacuum Pump Drive Kit with Pulleys, 4-Bolt
63885 Oil Pump and Vacuum Pump Drive Kit without Pulleys, 4-Bolt

WARNING Prop. 65
 This product contains a chemical known to the state of California to cause cancer, birth defects, or reproductive harm-

CRANK TRIGGER ULTRA SERIES UNIVERSAL KIT, NO WHEEL

- Moroso has designed the aduster arm to allow for infinite timing settings while still giving you the ability to position the sensor for the greatest range of adjustment for your combination. No more having the sensor run out of adjustment before you even start the engine up
- To be used with dampers that have built in crank trigger shells or EFI trigger wheels
- Crank trigger kit is based on the popular flying magnet style kit
- Compact adjuster arm for better fitment with chassis restrictions pans and containment devices
- The trigger arm is constructed out of billet aluminum with a black anodized finish for long lasting good looks
- The sensor mounting block is designed so that it will not stick out of the back of the arm and interfere with the oil pan
- Moroso crank trigger sensor comes with a more common plug to easily hook to any popular ignition box with no modifications
- Kit mounts to passenger side of block only, and has two sensor locations for non-motorplate applications
- Includes all necessary hardware



No. 60016

PART # DESCRIPTION
60016* Crank Trigger Ultra Series Kit, No Wheel

WARNING Prop. 65
 This product contains a chemical known to the state of California to cause cancer, birth defects, or reproductive harm-

REPLACEMENT CRANK TRIGGER TRANSDUCER

Older "Lug Type" Style

- High-quality, non-magnetic stainless steel body
- Precision-wound low impedance winding and rare earth magnet for consistent output signal
- Special, non-hardening epoxy impregnates pickup for shock and vibration isolation

PART # DESCRIPTION
60355* Replacement Crank Trigger Transducer, "Lug Type" Style

WARNING Prop. 65
 This product contains a chemical known to the state of California to cause cancer, birth defects, or reproductive harm-

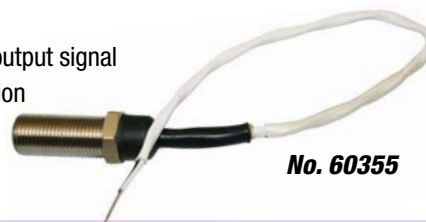

No. 60355

*Not legal for sale or use on Pollution-controlled vehicles.



DRIVE MANDREL SPACER KIT

SBC

- For use with Moroso **Nos. 63857 & 63859** drive mandrels
- Maintains register of mandrel when using a 1/4" thick crank trigger
- Comes with a 1/4" longer crankshaft bolt
- Constructed out of stress-proof steel with a black oxide finish

PART # DESCRIPTION

63861 Drive Mandrel Spacer Kit, SBC, for 1/4" Thick Crank Trigger Wheels



No. 63861

TIMING POINTERS FOR SBC AND BBC

- Designed to hug the damper so it is easier to line up the damper and the pointer for more accurate timing
- Up to 4 degrees of adjustment are possible
- Constructed of billet aluminum with a black anodized finish
- Stainless steel mounting hardware included

PART # DESCRIPTION

- 60100** Timing Pointer, SBC, 6.250"
- 60105** Timing Pointer, SBC, 6.375"
- 60110** Timing Pointer, SBC, 6.750"
- 60115** Timing Pointer, SBC, 7"
- 60120** Timing Pointer, SBC, 7.250"
- 60125** Timing Pointer, SBC, 8"
- 60130** Timing Pointer, BBC, 6.250"
- 60135** Timing Pointer, BBC, 7"
- 60140** Timing Pointer, BBC, 7.250"
- 60145** Timing Pointer, BBC, 8"



No. 60110



No. 60145

WARNING Prop. 65
 This product contains a chemical known to the state of California to cause cancer, birth defects, or reproductive harm-

TIMING POINTERS FOR FORD 289/302/351W

- Designed to hug the damper so it is easier to line up the damper and the pointer for more accurate timing
- Up to 4 degrees of adjustment are possible
- Fits 6.125" to 6.250" balancers
- Constructed out of billet aluminum with a black anodized finish
- Stainless steel mounting hardware included

PART # DESCRIPTION

- 60150** Timing Pointer, Ford 289/302/351W, 11 O'clock TDC
- 60155** Timing Pointer, Ford 289/302/351W, 10 O'clock TDC



No. 60150



No. 60155

WARNING Prop. 65
 This product contains a chemical known to the state of California to cause cancer, birth defects, or reproductive harm-



No. 74016



Jack Roush depends on the Moroso Power Charger to keep his Drag Racing Team ready for their next round of competition!

MOROSO POWER CHARGER

Includes a list of features that will make all other chargers obsolete!

With this versatile charger you have at your disposal one you can use on your race car, your towing vehicle, your street car or a battery you had to buy in an emergency at the racetrack. The **Power Charger** not only charges your everyday 12-volt battery but will also charge 16-volt batteries. Plus, it will also charge any type of battery including Gel Cell, Sealed, Lead Acid, Wet/Deep Cycle, "Reactor" batteries and even (AGM) Absorbed Glass Mat type batteries.

If you're looking for speed, you can be sure your battery is ready for the next round of competition. Featuring a near full charge recovery in about 14 minutes, it also has a maintain mode for batteries in storage. The large handle makes it easy to carry or the unit can be mounted on a wall or workbench.

- Made in USA, approved by U.L., E.T.L., C.S.A. and CE
- Dual Voltage charges both 12 and 16 volt batteries
- 30 amp rating makes for fast recharge
- Solid state LED Ammeter shows battery condition is charging at 80% or READY
- Battery Type "dip" switches can be accessed and changed to charge ANY type battery
- Hibernate mode is perfect for long storage, automatically shuts down to zero output after 24 hours, applying a maintenance charge cycle once every thirty days
- Low Start Voltage for deeply discharged batteries, will begin charging a battery that has only .02 of a volt
- Short and reverse polarity connection shutdown
- External ambient temperature compensation
- Works with (AGM) batteries without need for adjustment; calibrated not to exceed 19 volts charge when in the 16 volt mode

PART #	DESCRIPTION
74016	Moroso Power Charger, 12/16 Volts at 30 Amps

⚠ WARNING Prop. 65
This product contains a chemical known to the state of California to cause cancer, birth defects, or reproductive harm-

SEALED BATTERY BOX

- Ideal for relocating a battery to the rear of any race, street or show vehicle with or without a rear firewall
- Holds a Series 21, 24, 26, 34, 42, 54, 55, 56, 61, 62, 63, 85, 86, 96R battery with either top-post or side-post terminals
- Outside Dimensions: 13-1/8" W, 11-1/8" D, 11-1/8" T
- Inside Dimensions: 10-1/2" W, 8-1/4" D, 8-1/2" T
- Fully approved for racing by NHRA, IHRA and SCCA
- Includes grommets and all mounting hardware
- Does not include battery cable; use with Moroso Battery Cable Kit No. 74055

PART #	DESCRIPTION
74051	Sealed Battery Box, Black

⚠ WARNING Prop. 65
This product contains a chemical known to the state of California to cause cancer-

No. 74051



Competition Engineering
Battery/Weight Box on pg. 452



BATTERY CABLE KITS

- High-grade 2 gauge copper cable provides unrestricted current flow
- Rugged PVC insulation resists most car fuels, oils and under hood cleaners
- Available with and without battery terminals
- Ideal for relocating a battery to the rear for improved weight transfer



PART #	DESCRIPTION
74005	Battery Cable Kit, 20' with 4 terminals
74055	Battery Cable Kit, 20' with 4 terminals, 8' with top-post terminals and 6" 12 gauge leads with butt connectors*, rubber-lined clamps, grommets and shrink sleeving. Use with Sealed Battery Box No. 74051 .

No. 74055

WARNING Prop. 65
 This product contains a chemical known to the state of California to cause cancer, birth defects, or reproductive harm-

*Terminated at both ends. Cut in two to desired length.

BATTERY CABLE TERMINAL KITS

- Compression-style fittings with tin plated brass for added conductivity and corrosion resistance provide solid electrical connection
- Two per pack

PART #	DESCRIPTION
74170	Battery Cable Remote Fitting for 1 or 2 Ga. Wire, Compression-style, 3/8" diameter stud
74172	Battery Cable Remote Fitting for 1 or 2 Ga. Wire, Compression-style, 1/2" diameter stud
74173	Battery Cable Terminal for 1/0 Wire, Copper, Solder, 3/8" diameter stud
74174	Battery Cable Terminal for 1/0 Wire, Copper, Solder, 1/2" diameter stud
74175	Battery Post Terminal End Kit for 1 or 2 Ga. Wire



No. 74170

No. 74172

No. 74173



No. 74174



No. 74175

WARNING Prop. 65
 This product contains a chemical known to the state of California to cause cancer, birth defects, or reproductive harm-

BATTERY CABLE DISCONNECT SWITCH

- One turn of the knob disconnects the battery and saves the solid state voltage regulator and alternator when charging
- Also deters possible car thieves when parked
- Switch is rated at 100 amps for 12 or 24 DC use

PART #	DESCRIPTION
74103	Battery Terminal Disconnect Switch, Top Terminal
74104	Battery Terminal Disconnect Switch, Side Post

No. 74103



No. 74104

WARNING Prop. 65
 This product contains a chemical known to the state of California to cause cancer, birth defects, or reproductive harm-



BATTERY POST BOOTS

Meets sanctioning body requirement that terminals be covered on the battery

- Insulated Battery Post Boots meet sanctioning bodies requirement that battery posts be covered, and are a tidier looking solution than tape
- Molded to fit over most non-disconnect top terminals
- Works with 4-0 gauge and larger battery cables
- Designed to be slipped on cable before terminal is installed, or can be slit and wire-tied over cable
- When the battery needs to be charged or jumped, simply fold back the boot for access to the post; when done, just unfold and recover



No. 74114

PART #	DESCRIPTION
74114	Battery Post Boots, one each in black and red per package



REMOTE BATTERY JUMPER TERMINALS

- Allows battery to be placed anywhere in the car allowed by rules and still be completely accessible for between-rounds charging
- Connect to battery with a high amperage battery cable such as Moroso **No. 74005** or **No. 74055** or for use with Moroso Power Charger **No. 74016**
- Universal for 6-36 volt DC applications
- Two per pack with color-coded caps

PART # DESCRIPTION**74140** Remote Battery Jumper Terminals**PART # REPLACEMENT PART****97545** Terminal Cap Kit one red, one black**PART # AVAILABLE OPTION****74149** Battery Jumper Terminal Mounting Bracket**No. 74140**

WARNING Prop. 65
This product contains a chemical known to the state of California to cause cancer, birth defects, or reproductive harm-

BATTERY JUMPER TERMINAL BRACKET, FOR MOROSO PART NO. 74140

- "L" shaped bracket makes mounting and aligning Moroso Part **No. 74140** or similar battery disconnect switches easier than previous methods
- Made out of 1/8" thick steel
- Can be bolted and/or welded into place
- Finish of the bracket can be painted, polished or left as is

PART # DESCRIPTION**74149** Battery Jumper Terminal Mounting Bracket**No. 74149****QUICK-DISCONNECT FLUSH MOUNT BATTERY CABLE CONNECTORS**
Complete Pre-Terminated Kits for Header-Equipped Engines

- Ideal for heavy-duty battery cable connection through firewalls or body panels
- A quick release half-turn lock provides easy charger hook-ups
- Black and red color-coded for easy identification
- Two per pack

PART # DESCRIPTION**74155** Quick-Disconnect Flush Mount Battery Cable Connectors**PART # REPLACEMENT PARTS****97550** Male End, Black**97551** Male End, Red**97552** Female End, Black**97553** Female End, Red**No. 74155**

WARNING Prop. 65
This product contains a chemical known to the state of California to cause cancer, birth defects, or reproductive harm-

QUICK-DISCONNECT FLUSH MOUNT BATTERY CABLE CONNECTOR KIT

- Kit contains one black male and female lug, one red male and female lug
- Ideal for heavy-duty battery cable connections through firewalls or body panels
- A quick release taper lock provides easy charger hook-ups
- Features brass connections for full contact
- Accommodates 1 or 2 gauge wire

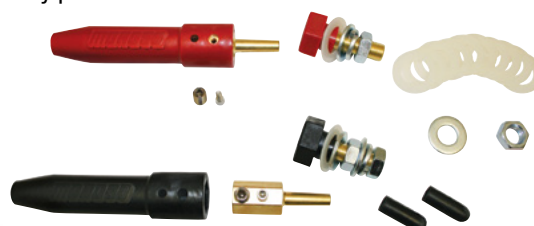
PART # DESCRIPTION**74156** Quick-Disconnect Flush Mount Battery Cable Connectors, Red & Black (Male and Female)**No. 74156**

WARNING Prop. 65
This product contains a chemical known to the state of California to cause cancer, birth defects, or reproductive harm-



BATTERY QUICK-CONNECT PLUG**Full Size**

- Instantly connects your vehicle's electrical system to an auxiliary power source, either to start the car or for fast battery charges
- Also useful on tow vehicles and 4 x 4's as a power plug for winches, jumper cable connection, or battery chargers
- Made of tough polycarbonate with spring-loaded copper contacts
- Will connect up to 175 amps using #1/0 AWG wire

**No. 74200**

PART #	DESCRIPTION
74200	Battery Quick-Connect Plug

BATTERY QUICK-CONNECT, MINI

- To save space this is a smaller version of Moroso **No. 74200**
- Will connect up to 50 amps, using #6 wire
- Instantly connects your vehicle's electrical system to an auxiliary power source, either to start the car or for fast battery charges
- Also useful on tow vehicles and 4 x 4's as a power plug for winches, jumper cable connections, or battery chargers
- Made of tough polycarbonate with spring-loaded copper contacts

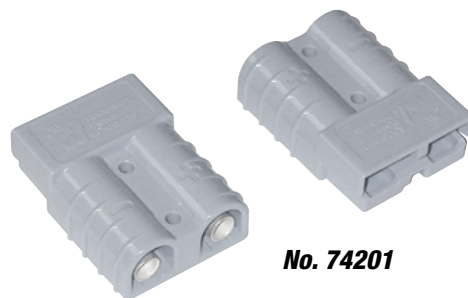
**No. 74201**

PART #	DESCRIPTION
74201	Battery Quick Connect, Mini

THRU-PANEL BATTERY CONNECTOR

- Can be used wherever a battery cable goes through a firewall or other similar panel
- Connector fits through 1-1/4" hole
- Use Battery Cable Remote Fitting End Kit **Nos. 74170** or **74172** to complete installation
- One per pack

PART #	DESCRIPTION
74144	Thru Panel Battery Connector, Red
74145	Thru Panel Battery Connector, Black

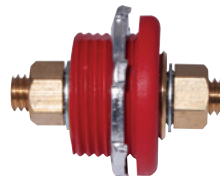
No. 74144**No. 74145**

◦  **WARNING Prop. 65**
This product contains a chemical known to the state of California to cause cancer, birth defects, or reproductive harm-



BATTERY DISCONNECT SWITCHES

- Easy to install Disconnect Switch required by many sanctioning bodies
- A quick twist of the non-slip handle or a quick push of the knob (**No. 74106**) shuts off all electrical current to the electric fuel pump, electric water pump, ignition, instruments, etc.
- For drag racing vehicles, the switch should be mounted on the vehicle's rear panel for easy accessibility
- For oval track and road racing applications, the switch should be mounted so that it can easily be reached by the driver or service personnel from outside the vehicle
- In street applications, the switch can be hidden to thwart car thieves
- Use Push/Pull Switch Kit **No. 74105** for remote installation for **Nos. 74100 & 74101**
- 2-3/8" Studs included



No. 74106

PART # DESCRIPTION

- 74100** Battery Disconnect Switch, Twist, Limited-Service, i.e. Drag Race applications without alternators. Rating: 125 amps @ 6-36 volts DC
- 74101** Battery Disconnect Switch, Twist, Heavy-Duty, Street Race Cars with alternators, multiple battery applications, etc. Rating: 175 amps @ 6-36 volts DC
- 74106** Battery Disconnect Switch, Push On/Off, Heavy-Duty, Street or Race Applications with alternators, multiple battery applications, etc. Rating: 250 amps @ 6-24 volts DC



No. 74100

BACK

⚠ **WARNING Prop. 65**
This product contains a chemical known to the state of California to cause cancer, birth defects, or reproductive harm-

BATTERY DISCONNECT SWITCH, SUPER-DUTY

- Moroso's Super-Duty switch with rating of 2,000 amps intermittent and 300 amps continuous is perfect for engines with large starter draw, RVs, Drag Cars with alternators and other applications (20 amps on small terminals)
- Two pairs of copper studs (1/2" -20 & 10 -32) make it ideal for disconnecting alternator (or other electrical device) in addition to the battery
- Sealed shaft keeps out moisture and debris
- Indexing pin aligns switch with mounting panel and prevents rotation; fits mounting panels up to 1/4" thick
- Includes switch position face plate; also includes decal to indicate switch location during emergencies
- Use with Moroso Push/Pull Kit **No. 74105** for remote installations and Moroso Battery Cable Fitting End Kit with 1/2" opening **No. 74172** and Moroso **No.74107** if using with alternator

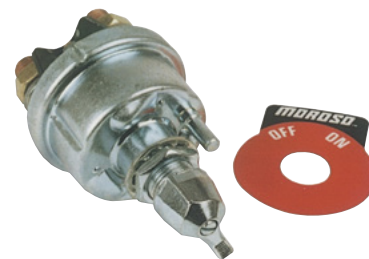

No. 74102

⚠ **WARNING Prop. 65**
This product contains a chemical known to the state of California to cause cancer, birth defects, or reproductive harm-

PART # DESCRIPTION

- 74102** Battery Disconnect Switch, Super-Duty

BATTERY & ALTERNATOR DISCONNECT SWITCH

- As race cars have gotten more complicated so has sanctioning bodies rules in making sure that a racecar's electrical power can be completely shut off
- This 4-Pole switch makes installing a "Master Disconnect" switch much simpler. A 4-Pole switch is used to disconnect both the battery and the alternator feed simultaneously without the need for relays.
- Can be mounted in the same locations as traditional On/Off switches with the added security of being able to interrupt the alternator circuit
- Four 3/8" -24 Terminals, rated at 125A continuous/ 750A intermittent, up to 36V DC max., Two Terminals marked "Terminal A" for the battery circuit and Two Terminals marked "Terminal B" for the alternator circuit
- Indexing pin aligns switch with mounting panel and prevents rotation: fits mounting panels up to 1/4" thick
- Includes switch position decal and switch location decal for the exterior of the car
- Use with Moroso Push/Pull Kit **No. 74105** for remote installations and Moroso Battery Cable Fitting End Kit with 3/8" opening **No. 74170**



No. 74108

BACK

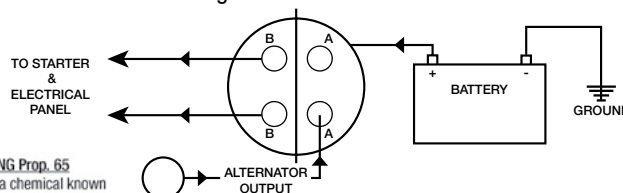

⚠ **WARNING Prop. 65**
This product contains a chemical known to the state of California to cause cancer, birth defects, or reproductive harm-

PART # DESCRIPTION

- 74108** Battery & Alternator Disconnect Switch



ALTERNATOR SHUTDOWN RELAY KIT

- Designed to stop engine run-on when electrical master disconnect is turned off by stopping electrical feedback in malfunctioning or high amperage alternators
- More and more racing sanctioning bodies are recommending that this type of device be used
- Compliments Battery Disconnect switches such as Moroso **Nos. 74100, 74101, 74102** and **74106**
- Kit includes; Heavy Duty Solenoid rated at 225 Amps, mounting hardware, wiring harness and terminal

PART # DESCRIPTION
74107 Alternator Shutdown Relay Kit

 **WARNING Prop. 65**
 This product contains a chemical known to the state of California to cause cancer, birth defects, or reproductive harm-

**No. 74107****BOOTS FOR BATTERY DISCONNECT SWITCHES**

Meets sanctioning body requirement that terminals on the master electrical cut-off switch be covered

- Perfect compliment to Moroso Part **Nos. 74100, 74101, 74102** and **74106**
- Prevents the shorting out of exposed terminals
- When installed, creates a finished "clean look" to disconnect switch wiring
- Constructed out of high quality, pliable, race environment friendly rubber
- Accommodate 2 to 4 gauge wire and 1/2" to 3/8" terminal studs
- Can be installed before or after termination of remote fitting ends

**No. 74110**

PART # DESCRIPTION
74110 Boots for Battery Disconnect Switches, Two per pack (1 ea. Black/Red)

BATTERY DISCONNECT SWITCH BRACKET

- "L" shaped bracket makes mounting and aligning Moroso Part **Nos. 74100, 74101 & 74108** or similar battery disconnect switches easier than previous methods
- Made out of 1/8" thick steel
- Can be bolted and/or welded into place

PART # DESCRIPTION
74116 Battery & Alternator Disconnect Switch Bracket

**No. 74116**

REMOTE PUSH/PULL BATTERY DISCONNECT SWITCH KIT

- “Push/Pull” Style of remote battery disconnect switch allows you to mount the Battery Disconnect Switch a roll cage tube with a weld-on bracket, then actuate it with this T-handle kit protruding through the rear panel
- Included switch Moroso Part **No. 74100** is for applications without alternators, Rating: 125 amps @ 6-36 volts DC
- Includes switch, brackets, swing arm linkage, 18” long aluminum tube actuator link, all necessary bushings, fasteners, switch position decal and switch location decal for the exterior of the car

PART #	DESCRIPTION
74109	Remote Push/Pull Battery Disconnect Switch Kit

WARNING Prop. 65
 This product contains a chemical known to the state of California to cause cancer, birth defects, or reproductive harm-

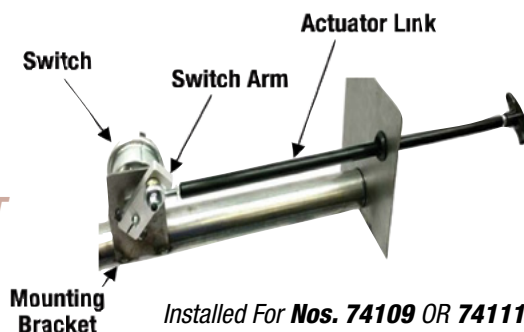

REMOTE PUSH/PULL BATTERY & ALTERNATOR DISCONNECT SWITCH KIT

- “Push/Pull” Style of remote battery disconnect switch allows you to mount the Battery Disconnect Switch a roll cage tube with a weld-on bracket, then actuate it with this T-handle kit protruding through the rear panel
- Included is Moroso Part **No. 74108** “Master Disconnect” 4-Pole switch. A 4-Pole switch is used to disconnect both the battery and the alternator feed simultaneously without the need for relays
- Includes switch, brackets, swing arm linkage, 18” long aluminum tube actuator link, all necessary bushings, fasteners, switch position decal and switch location decal for the exterior of the car

PART #	DESCRIPTION
74111	Battery & Alternator Disconnect Switch Kit

WARNING Prop. 65
 This product contains a chemical known to the state of California to cause cancer, birth defects, or reproductive harm-



PUSH/PULL BATTERY DISCONNECT MOUNTING KIT

- Allows you to mount a Battery Disconnect Switch **Nos. 74100, 74101 74102 or 74108** (not included) to a roll cage tube with a weld-on bracket, then actuate it with this T-handle kit protruding through the rear panel
- Comes with brackets, swing arm linkage, 18” long aluminum tube actuator link, all necessary bushings, fasteners and complete instructions
- Aluminum parts are black anodized

PART #	DESCRIPTION
74105	Push/Pull Battery Disconnect Mounting Kit

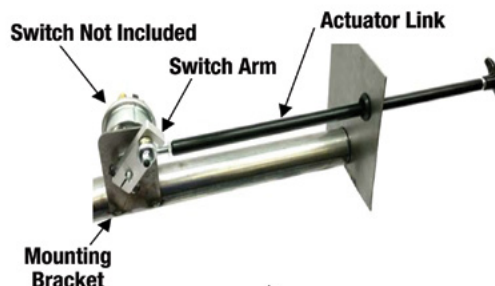

WARNING Prop. 65
 This product contains a chemical known to the state of California to cause cancer, birth defects, or reproductive harm-



**REMOTE BATTERY DISCONNECT SWITCH KIT,
MORSE CABLE ACTUATED**

- This kit allows for greater flexibility of mounting a remote battery disconnect lever
- Using a morse cable to actuate the battery disconnect switch allows more flexibility and greater distances between the switch itself and the lever that the driver, crew, or safety workers operate
- Included is Moroso Part No. 74100 Battery Disconnect switch for applications without alternators, Rating: 125 amps @ 6-36 volts DC
- Kit includes brackets, fasteners, handle, switch position decal and switch location decal for the exterior of the car

PART # DESCRIPTION

74118 Remote Battery Disconnect Switch Kit, Morse Cable Actuated

 **WARNING Prop. 65**
This product contains a chemical known to the state of California to cause cancer, birth defects, or reproductive harm-

**REMOTE BATTERY &
ALTERNATOR DISCONNECT SWITCH
KIT, MORSE CABLE ACTUATED**

- This kit allows for greater flexibility of mounting a remote battery disconnect lever
- Using a morse cable to actuate the battery disconnect switch allows more flexibility and greater distances between the switch itself and the lever that the driver, crew, or safety workers operate
- Included is Moroso Part No. 74108 "Master Disconnect" 4-Pole switch. A 4-Pole switch is used to disconnect both the battery and the alternator feed simultaneously without the need for relays
- Kit also includes brackets, fasteners, switch position decal and switch location decal for the exterior of the car

PART # DESCRIPTION

74119 Remote Battery & Alternator Disconnect Switch Kit, Morse Cable Actuated

**No. 74118**

Installed For **Nos. 74118 OR 74119**

**No. 74119****REMOTE BATTERY DISCONNECT SWITCH MOUNTING KIT,
MORSE CABLE ACTUATED**

- This kit allows for greater flexibility of mounting a remote battery disconnect lever
- Using a morse cable to actuate the battery disconnect switch allows more flexibility and greater distances between the switch itself and the lever that the driver, crew, or safety workers operate
- Kit also includes brackets, fasteners, switch position decal and switch location decal for the exterior of the car
- Use with Moroso Part Nos. 74100, 74101, 74106 & 74108 Battery Disconnect Switches or other similar switches

PART # DESCRIPTION

74117 Remote Battery Disconnect Switch Mounting Kit, Morse Cable

**No. 74117**

PUSH BUTTON STARTER SWITCH

- Waterproof and dustproof with neoprene cap for in-car or under hood mounting
- 35 amp rated @ 12 volts

PART # DESCRIPTION**74120** Push Button Starter Switch

 **WARNING Prop. 65**
This product contains a chemical known to the state of California to cause cancer, birth defects, or reproductive harm-

**No. 74120****UNIVERSAL MOMENTARY SWITCH CABLE**

- Heavy-duty spiral cable has 15 amp rating
- Ideal for transbrakes, brake line locks and nitrous systems
- The cable features two 16-gauge wires enclosed in a protective PVC outer layer
- Spiral cable stretches to 4 feet and "springs" back when relaxed
- Use with 15 amp Momentary Push Button Switch **No. 74123**

PART # DESCRIPTION**74115** Heavy-Duty Universal Cable, 15 amp DC

 **WARNING Prop. 65**
This product contains a chemical known to the state of California to cause cancer, birth defects, or reproductive harm-

**No. 74115****UNIVERSAL MOMENTARY SWITCH & CABLE**

- Precision high-quality momentary switch with a coiled flex cable
- Used on roll control devices, nitrous oxide systems, as a push-to-talk button on radios, or in any other application where an instant on/off switch is needed
- The normally open, snap action, short throw switch mounts in a 1/4" dia. hole
- Rated at 6 amps @ 28 volts DC or 125 volts AC

PART # DESCRIPTION**74122** Universal Momentary Switch and Cable

 **WARNING Prop. 65**
This product contains a chemical known to the state of California to cause cancer, birth defects, or reproductive harm-

**No. 74122****ADJUSTABLE UNIVERSAL MOMENTARY SWITCH**

- Heavy-duty switch has 15 amp rating; ideal for operating a transbrake on drag race cars
- Adjustable collar allows the plunger travel to be preset from .020" to .219", making the switch "fast" or "slow" to suit individual reaction time requirements
- Screw-on type terminals
- Can be mounted through-panel or anywhere using the two mounting holes provided
- Use with Universal Momentary Cable **No. 74115**

PART # DESCRIPTION**74123** Adjustable Universal Momentary Switch, 15 amp DC

 **WARNING Prop. 65**
This product contains a chemical known to the state of California to cause cancer, birth defects, or reproductive harm-

**No. 74123**

TOGGLE SWITCHES

- Momentary Switches ideal for starting engines
- On-Off Single Throw Switches control accessories such as lights, pump, fan, etc.
- Rated at 20 amps lamp load
- ON/OFF faceplate included

PART # DESCRIPTION

74124↔ Toggle Switch Momentary On, Long Handle, 1-1/2"

74125↔ Toggle Switch On/Off, Long Handle, 1-1/2"

74126↔ Toggle Switch On/Off, Short Handle, 1 1/16"

ⓘ **WARNING Prop. 65**
This product contains a chemical known to the state of California to cause cancer, birth defects, or reproductive harm-

**No. 74124****No. 74126****TOGGLE SWITCH COVER**

- Fits over Moroso **No. 74126** and other short handle 1 1/16" shaft-mounted toggle switches
- Features flip up lid that prevents switch from accidentally being turned on
- Protects switch from dirt
- Helps denote different toggle switches from each other

PART # DESCRIPTION

74129↔ Toggle Switch Cover

ⓘ **WARNING Prop. 65**
This product contains a chemical known to the state of California to cause cancer, birth defects, or reproductive harm-

**No. 74129****STARTER HEAT SHIELDS**

- Engineered to protect starters against damaging heat from exhaust manifolds or headers
- Ideal for extending starter life in both race and street applications, including tow vehicles and RVs
- High-temperature insulating material (Non-Asbestos) sandwiched between two sheets of aluminum

PART # DESCRIPTION

74299↔ Starter Heat Shield. **Fits:** Most passenger-side small Tilton-style starters

74300↔ Starter Heat Shield. **Fits:** SBC and BBC engines with Delco starters

ⓘ **WARNING Prop. 65**
This product contains a chemical known to the state of California to cause cancer-

**No. 74299****No. 74300**

TOGGLE SWITCH PANELS

- Make custom wiring of your vehicle much easier and professional
- Face constructed of rugged .050" thick aluminum and black anodized to prevent corrosion, Fiber Design versions available for enhanced styling
- Power indicator lights and front mounted, E-Z access fuse holders with pigtails attached, features not found on other manufacturer's switch panels (*except No. 74136*)
- Heavy-duty on/off switches are 12 volt single-pole, single-throw with screw terminals rated at 20 amps lamp load
- Heavy-duty fingertip starter controls on **Nos. 74130, 74131** and **74135** are waterproof and dustproof, and include screw terminals rated at 12 volts and 35 amps
- A selection of custom labels is included so you can customize each Switch Panel to your individual needs
- Black anodized finish prevents corrosion, Fiber Design available for enhanced styling

PART # DESCRIPTION

- 74130**⊕ Oval Track Switch Panel, 4" x 5", includes: Starter button, two on/off switches
- 74131**⊕ Drag Race Switch Panel, 4" x 7.75", includes: Starter button, five on/off switches
- 74132**⊕ Cage-Mount Switch Panel, Includes: five on/off switches without starter button, Steel bracket to be welded to roll cage, length: 5.5"
- 74133**⊕ Dash-Mount Street Switch Panel, 2" x 5.5", includes: five on/off switches, a separate 7-station fuse panel for remote mounting
- 74134**⊕ Accessory Switch Panel, 4" x 6.75", includes: five on/off switches without starter button
- 74135**⊕ Cage-Mount Switch Panel, includes: five on/off switches with starter button, Steel bracket to be welded to roll cage, length: 7"
- 74136**⊕ Econo-Switch Panel, 2.5" x 5", includes: four on/off switches to control various electrical functions, one momentary long handle switch for engine starting
- 74139**⊕ Switch Panel, Grey/Black, Fiber Design, Dash Mount, 4" x 7-3/4", Starter Button, 1/2" LED
- 74143**⊕ Switch Panel, Grey/Black, Fiber Design, Dash Mount, 2" x 5-1/2", 1/4" LED
- 74148**⊕ Switch Panel, Grey/Black, Fiber Design, 6-3/4" x 4", 1/2" LED



No. 74130



No. 74131



No. 74132



No. 74135



No. 74134



No. 74133



No. 74136

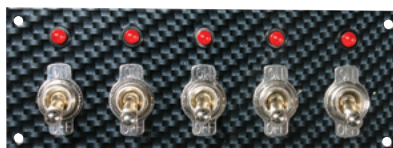

No. 74143

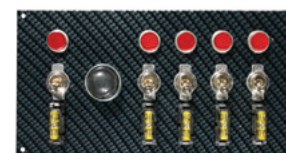

No. 74139

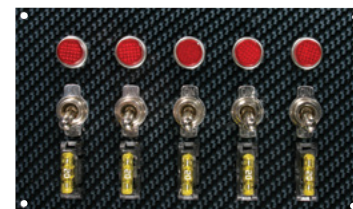

No. 74148

⊕ **WARNING Prop. 65**
This product contains a chemical known to the state of California to cause cancer, birth defects, or reproductive harm-

PART # REPLACEMENT PARTS

- 74120**⊕ Push Button Starter Switch
- 74124**⊕ Toggle Switch, Momentary On, Long Handle, 1-1/2"
- 74125**⊕ Toggle Switch, On/Off, Long Handle, 1-1/2"
- 74126**⊕ Toggle Switch, On/Off, Short Handle, 1 1/16"
- 97542** Switch Panel Replacement Label Sheets



ROCKER LED SWITCH PANELS

- High-tech rocker style switches are dust and water resistant and feature a wide-profile face for use with racing gloves
- Aluminum panel versions feature laser-etched Moroso logo are black anodized to withstand years of constant use
- Fiber Design versions available (**No. 74193**) for enhanced styling
- All switches are single pole, single throw rated at 20 amps
- Switches feature heavy-duty springs for positive engagement, orange LED indicator lamps, and ¼" spade terminals to simplify wire connections
- Five resettable 20 amp circuit breakers (except **No. 74186**) eliminate the need for fuses and make it easy to reactivate the circuit while driving
- Switches and circuit breakers simply snap into place with locking mechanism for a secure attachment
- Includes complete wiring instructions and switch decal package to indicate start, ignition, fuel, fan, lights, nitrous and other uses

PART # DESCRIPTION

- 74180** Flat Surface Mount, five on/off lighted switches with momentary start switch, 3.388" x 8", five circuit breakers, 20 amps ea.
- 74181** Flat Surface Mount, five on/off lighted switches without momentary start switch, 3.375" x 8", five circuit breakers, 20 amps ea.
- 74183** Flat Surface Mount, five on/off lighted switches, 2.488" x 6.695", separate panel for five circuit breakers 20 amps each, 1.350" x 6.695"
- 74186** Flat Surface Mount, four on/off lighted switches, with momentary start switch, no breakers, 2.488" x 6.695"
- 74190** Cage Mount, five on/off switches with momentary start switch, 3.750" x 8"
- 74193** Rocker Switch Panel, Grey/Black, Fiber Design, 8" x 3-13/32", Dash Mount

 **WARNING Prop. 65**
This product contains a chemical known to the state of California to cause cancer, birth defects, or reproductive harm.

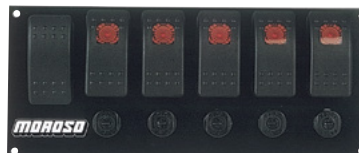

No. 74180

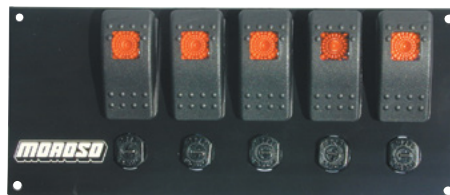

No. 74181



No. 74186



No. 74183



No. 74190

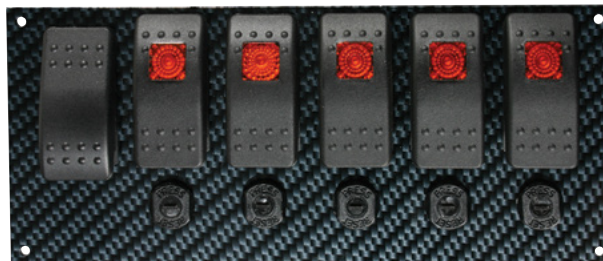

No. 74193

- PART # REPLACEMENT PARTS**
- 97535** Replacement Circuit Breaker
 - 97542** Switch Panel Replacement Label Sheets
 - 97543** ON/OFF Switch



ROCKER LED SWITCH PANEL, USB PORTS

As more racers use Action Cameras to record the in car action of a race, smart phones with timer apps. and tablets, there is a greater need to have a convenient, efficient solution to power these devices.

- High-tech LED rocker style switches are dust, weather resistant and feature a wide-profile face for use with racing gloves
- Panel face is constructed out of aluminum and are black anodized to withstand years of constant use
- LED switches are single pole, single throw rated at 20 amps, feature a heavy duty spring for positive engagement, 3 switches have orange LED indicator lamp, 1 switch has a blue LED indicator lamp which can be used for a cooling function, all of the switches have ¼" spade terminals to simplify wire connections
- Momentary Start switch with a red cover for easy identification
- Dual USB charging ports with dust cover
- Switches and USB Ports simply snap into place with locking mechanism for a secure attachment
- Includes complete wiring instructions and switch decal package to indicate start, ignition, fuel, fan, lights, nitrous and other uses



No. 74195

PART # DESCRIPTION

74195 Flat Surface Mount, five on/off lighted switches with momentary start switch, 2.488" x 7.855", USB Ports

 **WARNING Prop. 65**
This product contains a chemical known to the state of California to cause cancer, birth defects, or reproductive harm-

ROCKER LED SWITCH PANEL, CIRCUIT BREAKER, USB PORTS

As more racers use Action Cameras to record the in car action of a race, smart phones with timer apps. and tablets, there is a greater need to have a convenient, efficient solution to power these devices. This is why we designed these Switch Panels with a built in USB port.

- High-tech LED rocker style switches are dust, weather resistant and feature a wide-profile face for use with racing gloves
- Panel face is constructed out of aluminum and are black anodized to withstand years of constant use
- LED Switches are single pole, single throw rated at 20 amps, feature a heavy duty spring for positive engagement, 4 switches have orange LED indicator lamp, 1 switch has a blue LED indicator lamp which can be used for a cooling function, all of the switches have ¼" spade terminals to simplify wire connections
- Momentary Start switch with a red cover for easy identification
- Dual USB charging ports with dust cover
- 6 resetable 20 amp circuit breakers eliminate the need for fuses and make it easy to reactivate the circuit while driving
- Switches, USB Ports and circuit breakers simply snap into place with locking mechanism for a secure attachment
- Includes complete wiring instructions and switch decal package to indicate start, ignition, fuel, fan, lights, nitrous and other uses



No. 74194

PART # DESCRIPTION

74194 Flat Surface Mount, five on/off lighted switches with momentary start switch, 3.388" x 9.150", 6 circuit breakers, 20 amps ea., USB Ports

 **WARNING Prop. 65**
This product contains a chemical known to the state of California to cause cancer, birth defects, or reproductive harm-



FORD 9" DIFFERENTIAL SHIM & REPLACEMENT PARTS KITS

- Kits include hard-to-find items needed to assemble Ford 9" center sections

PART # DESCRIPTION

84750 Drag Race Kit Contains: housing gasket; pinion shaft seal; nine pinion support shims consisting of one each .005", .006", .0075", .0082", two .004", and three .0105"; eight pinion pre-load shims for use with aftermarket aluminum pinion supports consisting of one each .005", .006", .0075", .0082", .009" and three .0105"; one pinion housing O-ring; and one 3/4" -20 Ford pinion nut

84751 Oval Track Kit Contains: nine pinion retainer shims consisting of one each .005", .006", .0075", .0082", two .004", and three .0105"; twelve pinion pre-load shims consisting of one each .005", .006", .0075", .0082", .009", .020", .030", two .050" and three .010"; one pinion spacer .375" thick; and one 3/4" -20 Ford pinion nut

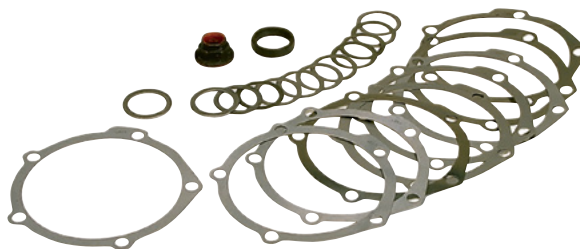

No. 84751

REAR AXLE SPRING PERCHES, 2-1/2" WIDE

Fits: Ford 9", Dana 60 and other 3" diameter axle housings

- Precision stamped for easy weld-on installation
- Two per package

PART # DESCRIPTION

85090 Rear Axle Spring Perches, 2-1/2" Wide

SEE MORE
Competition Engineering
Rear Axle Components
on pg. 401



No. 85090

DANA 60 U-BOLTS

- Moroso has an agreement with Dana Corporation to market hard-to-get replacement parts for the Dana 60, a popular rear axle in the Competition Eliminator and Super Stock classes

PART # DESCRIPTION

85080 U-Bolts, Dana 60, also *Fits: Ford 9" with 1350 series yoke*

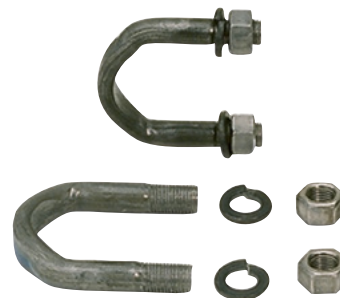

No. 85080

GM 12 BOLT REAR END COVERS

- Heavy duty steel stamping
- Hand polished chrome plated finish
- Includes chrome fasteners and gasket

PART # DESCRIPTION

85330 Rear End Cover, Chevy 12-bolt, Chrome-Plated Steel

WARNING Prop. 65
 This product contains a chemical known to the state of California to cause cancer, birth defects, or reproductive harm-



No. 85330



U-JOINT GIRDLES

- Unique design provides more bearing surface for the universal joint bearing cap, for increased strength
- Manufactured from 7075-T6 aluminum with anodized finish
- Comes complete with fasteners
- One set per package

PART #	DESCRIPTION
85800	Use with 1-1/8" dia. cap and 1.415" bolt centers, gold anodized. <i>Fits: 1955-82 Chevy with U-Bolts; Dana 60 with U-Bolts</i>
85810	Use with 1-1/8" dia. cap and 1.595" bolt centers, red anodized. <i>Fits: 1965-82 GM 12-Bolt with straps</i>
85820	Use with 1-1/8" dia. cap and 1.540" bolt centers, dark blue anodized. <i>Fits: Dana 60 with straps. Also fits Chrysler 8-3/4" ring gear with large yoke (Type 7290 driveshaft)</i>
85830	Use with 1-3/16" dia. cap and 1.668" bolt centers, black anodized. <i>Fits: 1350 Series race yokes including Mark Williams Ford 8.8, 9" Ford Series with 9" ring gear</i>
85850	Use with 1-1/16" dia. cap & 1.505" bolt centers, silver anodized. <i>Fits: Chrysler 8-3/4" ring gear w/ small yoke (Type 7260 driveshaft)</i>
85860	Use with 1-1/8" dia. cap and 1.575" bolt centers, light blue anodized. <i>Fits: Ford 9"</i>



No. 85800

WARNING Prop. 65
This product contains a chemical known to the state of California to cause cancer.

FILLER CAP KIT, STEEL APPLICATIONS, UNIVERSAL

- This kit comes with a 1-1/4" steel female bung that can be welded to steel; rear ends, tanks, valve covers, filler neck plates and other locations to replenish fluid or serve as an inspection port
- The included filler cap is knurled for easy grip removal and replacement
- Filler cap is machined from 6061-T6 aluminum and includes an O-ring for leak free sealing

PART #	DESCRIPTION
85280	Filler Cap Kit, Universal, Steel Bung, 1-1/4" -12UNF Threads, 1.5" O.D.



No. 85280

FILLER CAP KITS, ALUMINUM APPLICATIONS, UNIVERSAL

- These kits comes with an aluminum female bung that can be welded to aluminum, tanks, valve covers, filler neck plates and other locations to replenish fluid or serve as an inspection port
- Three kits are available, Knurled Filler Cap with 1.5" OD Female weld bung Contoured grip for easy removal and installation with either Moroso or Competition Engineering logo, 2.6" OD weld bung
- Filler caps are machined from 6061-T6 aluminum and include an O-ring for leak free sealing

PART #	DESCRIPTION
85282	Filler Cap Kit, Universal, Aluminum Bung, Black Anodized with Moroso logo 1-1/4" -12UNF Threads, 1.5" O.D.
85284	Fill Cap Kit, Universal, Steel Bung, Black Anodized with Moroso logo, 1-1/4" -12UNF Threads, 1.5" O.D.
85283	Filler Cap Kit, Universal, Aluminum Bung, Black Anodized with Moroso logo, 1-3/8" -12UNF Threads, 2.6" O.D.

No. 85283



No. 85284



C9085	Filler Cap Kit, Universal, Steel Bung, Black Anodized with Competition Engineering logo, 1-3/8" -12UNF Threads, 2.6" O.D.
-------	---

No. C9085



UNIVERSAL REAR SPOILER KIT

- Provides downforce to rear wheels for improved high speed stability
- Comes complete with support struts, mounting brackets, hardware and detailed instructions
- Can be trimmed to fit most applications
- Untrimmed dimensions: 57" length, 12" width and 24" struts
- Made from .050" 3003-H 14 Aluminum sheet

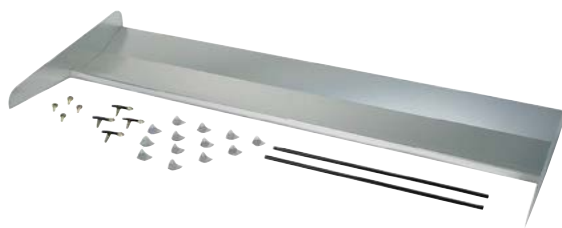
**No. 78740**

PART #	DESCRIPTION
78740	Universal Rear Spoiler Kit

ACCESS DOOR

- .050" aluminum door is hinged to frame, providing quick and easy access to fuel cells, dry sump tanks or any other component
- Comes with natural finish so customer can anodize or paint to match car color
- Door held securely closed with self-ejecting, flush-head Dzus fastener
- Includes all mounting hardware
- 6" x 6" door, 8- $\frac{1}{8}$ " x 8- $\frac{1}{8}$ " overall

**No. 85700**

PART #	DESCRIPTION
85700	Access Door

**FLOOR PAN BRACE***Bolt-On Design**Fits: Camaro 2010-'15*

- Like all high performance Pony Cars, 2010-'15 Camaro's suffer from having a flexible chassis; which affects acceleration, handling, long term rattles and traction
- The first step in fortifying a Camaro 2010-'15 chassis is to use this Floor Pan Brace, which replaces the factory stamped steel piece
- Brace stiffens the floor pan and drive shaft tunnel area
- Constructed out of 1- $\frac{1}{2}$ " x 2- $\frac{1}{2}$ " x .120 wall rectangular tubing
- Easy to install bolt-on design that uses the existing mounting points
- Use with optional Part **No. 78010**, Frame Connectors for the ultimate in tying the front and rear subframes together and triangulating the chassis side to side
- Durable gloss, black powder coat finish

**No. 78000**

PART #	DESCRIPTION
78000	Floor Pan Brace, Bolt-on, for Camaro, 2010-'15

HOOD SCOOP PLUG

- Available for "Aero" series scoops
- Specially formed to fit snugly without falling out
- Bonding technology eliminates part separation
- Open cell foam allows engine to breathe while idling, preventing airborne debris from entering hood scoop

**No. 99430**

PART #	DESCRIPTION
99430	Hood Scoop Plug, fits 3- $\frac{1}{2}$ " x 12- $\frac{1}{2}$ " to 13- $\frac{3}{4}$ " openings

STEERING JOINTS, DRAG RACE

- Available in splined & unsplined configurations to fit a variety of steering shafts
- Drag Race Applications only

PART #	DESCRIPTION
80110	Steering Universal Joint Unsplined. <i>Fits: steering columns with 3/4" O.D. shafts, 1-1/4" O.D.</i>
80120	Steering Universal Joint Unsplined. <i>Fits: steering columns with 5/8" O.D. shafts, 1-1/4" O.D.</i>
80131	Steering Universal Joint, 3/4-36 spline to 3/4" O.D. shafts, 1-1/4" O.D. <i>Fits: Ford power rack and GM manual, 1976 and up</i>



No. 80120

QUICK RELEASE HUB & ADAPTER

SFI APPROVED QUICK RELEASE STEERING WHEEL HUB AND ADAPTER

- Meets NHRA, IHRA, SCCA, NASA and other sanctioning body criteria for SFI (Safety Foundation Inc.) requirement #42.1 concerning steering wheel attachment and release
- Hub manufactured from lightweight billet aluminum with anodized finish
- 5/16" -18 threaded bolt holes for mounting
- Spring loaded quick release pin is integral with the hub and features a large diameter engagement surface for use with bulky racing gloves
- Includes steering shaft adapter manufactured from 1018 steel for extra strength and ease of welding

PART #	DESCRIPTION
80160	SFI Approved Quick Release Steering Wheel Hub and Adapter. <i>Fits: 3/4" O.D. steering shafts and steering wheels with a 3 hole, 1-3/4" diameter bolt pattern</i>



No. 80160

FIVE HOLE STEERING WHEEL ADAPTER

- Allows racers to continue to use Moroso's Quick Release Steering Wheel Hub **No. 80160** or similar aftermarket hubs with 3 hole bolt pattern when converting to steering wheels with a 5 hole bolt pattern
- Billet aluminum adapter includes all mounting hardware (steering wheel to adapter and adapter to hub)

PART #	DESCRIPTION
C5078	Five Hole Steering Wheel Adapter

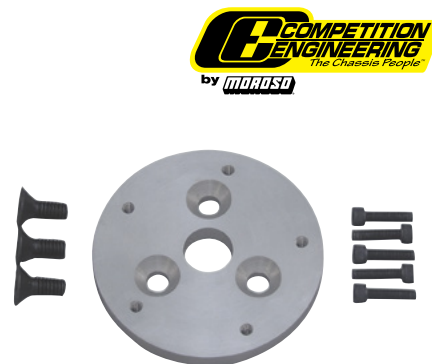

No. C5078



STEERING

DS-2™ FRONT TIRES

- Aircraft inspired tread design offers reduced weight, minimal rolling resistance and high-speed stability
- Asymmetrical tread pattern improves high-speed stability by reducing the tire's tendency to "walk" at the top end
- 4-ply nylon construction with high-strength bead provides added durability, especially during mounting and dismounting
- Ozone-resistant tire compound withstands the harmful effects of the sun and other environmental conditions
- Tested to 225 MPH with 1,000 lb. load
- Bias ply style tires



No. 17040

SPECIFICATIONS: DS-2

PART #	SIZE (INCHES)	APPROX. WEIGHT	DIA.	TREAD WIDTH	RECOMMENDED RIM WIDTH	OPERATING PRESSURE	SECTION WIDTH	CIRCUMFERENCE
17023	23.0 x 5.0 x 15	11 lbs.	23"	5"	3-1/2"-6-1/2"	30 psi.	6.2" on 5" Rim	72-7/16"
17040	24.0 x 5.0 x 15	11 lbs.	24"	5"	3-1/2"-6-1/2"	30 psi.	6.8" on 5" Rim	76-7/16"
17025	25.0 x 4.5 x 15	12 lbs.	25"	4.5"	3-1/2"-5"	30 psi.	6.4" on 5" Rim	78-1/4"
17026	26.0 x 4.5 x 15	12 lbs.	26"	4.5"	3-1/2"-5"	30 psi.	7.1" on 5" Rim	81"
17028	28.0 x 4.5 x 15	13 lbs.	28"	4.5"	3-1/2"-5"	30 psi.	7.7" on 5" Rim	86-3/8"
17029	26.2 x 5 x 17	13.5 lbs.	26.2"	5"	4-1/2" -5-1/2"	30 psi.	6.12" on 4-1/2" Rim	82-5/16"

DRAG SPECIAL FRONT TIRES

- Tubeless construction and 2-ply nylon cord helps to reduce unsprung weight
- High cord angle and unique tread design reduce rolling resistance for increased speeds
- Shallow tread depth increases stability at high speeds
- Stronger mounting bead withstands higher pressures when adjusting for roll-out
- Bias ply style tires



No. 17050

SPECIFICATIONS: DRAG SPECIAL

PART #	SIZE (INCHES)	APPROX. WEIGHT	DIA.	TREAD WIDTH	RECOMMENDED RIM WIDTH	OPERATING PRESSURE	SECTION WIDTH	CIRCUMFERENCE
17050	5.50 x 15	10 lbs.	25-1/4"	3-1/2"	3-1/2"-4"	30-35 psi.	5.7" on 4" Rim	78"
17100	7.10 x 15	11 lbs.	27-3/4"	4-1/8"	3-1/2"-5"	30-35 psi.	7.4" on 5" Rim	87-3/4"
17600	7.60 x 15	13 lbs.	29-1/4"	4-5/8"	3-1/2"-5"	30-35 psi.	8.0" on 5" Rim	90-3/4"



TIRES

DIGITAL TIRE PRESSURE BACK LIT GAUGES

Accuracy 1/2%

- Strong back lighted display is easily read in the darkest of pits
- 2-5/8" dia. gauge face
- Reads to .1 psi
- Can be adjusted to read in standard and metric units
- Auto-Off feature to increase battery life
- Battery level on gauge face
- Includes 9 volt battery
- Includes rubber gauge cover
- 16-1/4" hose with finger operated air-bleed valve allows you to release pressure quickly
- Hose has easy grip angle chuck end

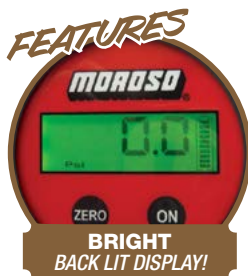

No. 89576

WARNING Prop. 65
This product contains a chemical known to the state of California to cause cancer, birth defects, or reproductive harm-

PART # DESCRIPTION

- 89574 Digital Tire Pressure Back Lit Gauge, 0-15 psi
- 89575 Digital Tire Pressure Back Lit Gauge, 0-60 psi
- 89576 Digital Tire Pressure Back Lit Gauge, 0-100 psi

PART # REPLACEMENT PART

- 97485 Tire Gauge Replacement Hose

TIRE PRESSURE GAUGES

Accuracy 2%

- 16-1/4" hose with a finger operated air-bleed valve allows you to release pressure quickly
- Individually calibrated for accuracy within 2%
- The large 2-5/8" dia. dial face in 1/2 lb. increments is easy to read, while the hardened swivel chuck rotates 360° for positive valve stem attachment

PART # DESCRIPTION

- 89550 Tire Pressure Gauge, dial type, 0-15 psi.
- 89555 Radial Tire Pressure Gauge, dial type, 0-40 psi.
- 89560 Tire Pressure Gauge, dial type, 0-60 psi.
- 89570 Tire Pressure Gauge, dial type, 0-100 psi.

PART # AVAILABLE OPTION

- 89590 Tire Pressure Gauge Cover

PART # REPLACEMENT PART

- 97480 Gauge Head for No. 89550
- 97485 Tire Gauge Replacement Hose

WARNING Prop. 65
This product contains a chemical known to the state of California to cause cancer, birth defects, or reproductive harm-

BETTER



No. 89555

PRO SERIES TIRE PRESSURE GAUGES

Accuracy 1/2%

- Long 16-1/4" hose with pressure release valve and hardened steel swivel chuck is perfect for getting into deep-dish wheels
- Premium high-quality instruments with brass internals and bourdon tube pressure element provide full-range accuracy to within 1/2%
- Extra-large 4" diameter face and knife-edge pointer eliminate human error
- Adjustable pointer can be calibrated at the race track
- Fiberglass-reinforced thermoplastic housing withstands harsh racing environments
- Rugged polyethylene plastic carrying case is lined with a medium-density, open-cell foam insert to keep gauge protected during transportation and storage
- Includes protective gauge cover

PART # DESCRIPTION

- 89552 Pro Series Tire Pressure Gauge, 0-15 psi. Major increments at 3 psi with minor increments at 0.1 psi.
- 89562 Pro Series Tire Pressure Gauge, 0-60 psi. Major increments at 10 psi with minor increments at 0.5 psi.

PART # REPLACEMENT PART

- 97485 Tire Gauge Replacement Hose

WARNING Prop. 65
This product contains a chemical known to the state of California to cause cancer, birth defects, or reproductive harm-

BEST



No. 89562

TIRE COVERS

- Moroso Tire Covers keep tire pressures consistent by blocking hot rays
- Made from a rugged 6 mil vinyl reflecting outer surface laminated to an insulating backing of polyscrim
- Completely washable and available in two different styles
- **No. 99410** fits right over the tire and is held securely in place by a 4" rear flap
- **No. 99421** uses suction cups and hangs like a curtain against the body

PART #	DESCRIPTION
99410	Tire Cover, fits over tires up to 33.5" x 17.5" x 15"
99421	Tire Cover, universal design with suction cups, 42" x 36"



No. 99410



No. 99421

WARNING Prop. 65
 This product contains a chemical known to the state of California to cause cancer, birth defects, or reproductive harm-

DIGITAL DUROMETER

Includes Case

In racing where a thousandth of a second can count, a durometer is used to check on; whether a tire has gotten too hard as it has aged, compare different tires hardness and softness against each other or how a tire responded to a chemical tire softener.

- Calibrated on a Shore type A scale, the scale used to measure the hardness of race and ultra high performance tires
- Easy to read Digital readout with 1/2" tall numbers
- Reads to .5
- Has a hold button to capture the reading on the readout
- Comes with a foam lined plastic case for storage of the unit when not in use

PART #	DESCRIPTION
89585	Digital Durometer with Case



No. 89585

WARNING Prop. 65
 This product contains a chemical known to the state of California to cause cancer, birth defects, or reproductive harm-

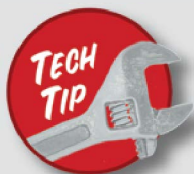

NHRA TIRE CONTINGENCY RULE



NHRA's contingency rule for the Professional Categories states that the "vehicle must be equipped with all four tires bearing the same tire manufacturer's brand name" to be eligible for contingency awards. Please note that this rule applies only to the Pro classes. All other classes can use Moroso DS-2™ or Drag Special Front Tires and still be eligible for tire contingencies posted by any rear tire manufacturer.

CE **COMPETITION** **ENGINEERING** *The Chassis People™*

by **MOROSO**



COMPETITION ENGINEERING CHASSIS COMPONENTS

DIGITAL
CATALOG

2020

APPAREL	377
PRODUCT INDEX	379
SUSPENSION BASICS	382
CHOOSING THE RIGHT EQUIPMENT	385
REAR FRAME KITS	389
FRAME RAILS	392
FRAME CONNECTORS	394
LADDER BARS	395
TRACTION DEVICES	397
4-LINKS	399
REAR AXLE	400
ANTI-ROLL BARS	409
ROD ENDS	410
DRIVESHAFT LOOPS	411
TRANSMISSION MOUNTS	413
SHOCKS	414
SPRINGS	422
WHEEL-E-BARS™	423
ROLL BARS	426
CHASSIS COMPONENTS	433
SHEET METAL	436
STEERING COMPONENTS	437
BUSHINGS	440
ENGINE MOUNTING	441
TABS & BRACKETS	447
MISCELLANEOUS	452
TIE DOWN / TOW HOOKS	453
REPLACEMENT PARTS	454
NUMERICAL PRODUCT INDEX	455-464

MOROSO PROMOTIONAL T-SHIRTS

- Limited Edition Designs

DESCRIPTION	COLOR	PART #	SIZE
A. DISTRESSED VINTAGE Vintage & antiqued Moroso arrow logo in black & red (front design only).	Natural	99551	Medium
		99552	Large
		99553	X-Large
		99554	XX-Large
		99555	XXX-Large
B. RETRO LOGO STRIPE Vintage Moroso arrow logo with silver racing stripe.	Black	99546	Medium
		99547	Large
		99548	X-Large
		99549	XX-Large
		99550	XXX-Large
		99557	4X-Large
C. SINCE '68 Limited edition design for Moroso's 40th Anniversary! Black, white & red flag logo on front & back.	Charcoal	99534	Medium
		99535	Large
		99536	X-Large
		99537	XX-Large
		99538	XXX-Large
E. GRUMPY'S TOYS Vintage Moroso arrow logo on front with vintage illustration on back, front pocket.	Off-White	99615	Medium
		99616	Large
		99617	X-Large
		99618	XX-Large
		99619	XXX-Large
F. DICK'S DRIVE-IN Vintage Moroso arrow logo on front with vintage illustration on back, front pocket.	Off-White	99610	Medium
		99611	Large
		99612	X-Large
		99613	XX-Large
		99614	XXX-Large
G. 50TH ANNIVERSARY Celebrating 50 years! Features our traditional logo with a golden/red logo on front & back with flag emblem. Thank you for your loyalty!	Gray	99520	Small
		99521	Medium
		99522	Large
		99523	X-Large
		99524	XX-Large
		99525	XXX-Large



Detail of logo's on arms



APPAREL



Detail of Competition Engineering logo on arm



MOROSO PERFORMANCE POLOS

- Richly embroidered logos on front and arm
- 100% Poly with stay-cool moisture wicking technology

DESCRIPTION	COLOR	PART #	SIZE
1. OGIO® POLO Features colorblocked rib knit panels and angled zippered pocket	Grey/Black	99581	Medium
		99582	Large
		99583	X-Large
		99584	XX-Large
2. SPORT POLO Fine poly jacquard knit with classic 3-button placket	Black	99586	Medium
		99587	Large
		99588	X-Large
		99589	XX-Large

MOROSO BUTTON DOWN CAMP SHIRT

- Richly embroidered logos on front and arm
- Classic, button down camp shirts

DESCRIPTION	COLOR	PART #	SIZE
3. BUTTON DOWN CAMP Easy care poly-rayon blend fabric with side vents	Black	99591	Medium
		99592	Large
		99593	X-Large
		99594	XX-Large



APPAREL



MOROSO JACKET



- Moroso arrow logo embroidered on chest and “original” Moroso logo patch on back
- Fitted, retro-style silhouette
- Charcoal grey, heavyweight poly/cotton twill with nylon quilted lining
- Solid brass zippered closure
- Two lower, inset on-seam pockets plus utility pocket on left sleeve

PART #	COLOR	SIZE
99620	Charcoal	Medium
99621		Large
99622		X-Large
99623		XX-Large

MOROSO AND COMPETITION ENGINEERING ADJUSTABLE CAPS

- Richly embroidered logos
- Fully adjustable for a custom fit
- Stay-cool vent holes for air circulation

PART #	DESCRIPTION
99601	MOROSO FLEX HAT
C9020	COMPETITION ENGINEERING LOGO



MOROSO SWEATSHIRTS, HOODIE

- Thick cotton blend, preshrunk pullover hoodie
- Black with Moroso logo, front and rear
- Front “Through” pockets



DESCRIPTION	COLOR	PART #	SIZE
SWEATSHIRT	Black	99625	Medium
		99626	Large
		99627	X-Large
		99628	XX-Large
		99629	XXX-Large

NUMBERED

2° Wedge Plates	402
9" Ford Axle Housing Braces	400
90/10 Drag Shocks	414-418
90/10 Drag Struts	418
8-Point Roll Bars	380, 426
10-Point Conversion Kits	428
10-Point Roll Cages	429
12-Point Roll Cages	430

A

A-Arm Bushings	440
Accelerator Pedal Kit	433
Access Door	436
Adjustable Drag Shocks	414-418
Adjustable Panhard Bar	404
Adjustable Pinion Snubber	408
Aluminum, Body Mounts	440
Aluminum Fenderwells	436
Aluminum Fuel Line (Moroso)	275
Aluminum Spring Eye Bushings	440
Angle Finder	452
Anti-Roll Bars	409
Apparel	377-378
Axle Bearing Conversion Kit	402
Axle Housing Braces	400
Axle Housing Ends	401

B

Battery Box (Moroso)	355
Battery Cable Kits (Moroso)	356
Battery/Weight Box	452
Body Mounts, Aluminum	440
Bolt-On Diagonal Link	403
Bolt-On Driveshaft Loops	411-412
Bolt-On Floating Housing Mounts	396
Bolt-On Frame Connectors	394
Bolt-On Traction Devices	397-398
Bolt-On Wheel-E-Bars™	425
Brace, Seat Back	431
Brace, Ford 9" Rear Axle	400
Brackets	419, 447-451
Bumpsteer Adjuster Kit	439
Bushings, A-Arm	440
Bushings, Control Arm	407-408, 440
Bushings, Slide-A-Link™	398
Bushings, Spring Eye	440
Bushings, Transmission Crossmember	413

C

Cage Kit, Funny Car	431
Carrier Stud Kit	402
Chassis Brackets and Tabs	447-451
Chassis Brackets, 4 –Link	449
Chassis Brackets, Ladder Bar	450-451
Choosing the Right Equipment	385-388
Clevis Brackets	447
Coil-Over Housing Brackets	419, 451
Coil-Over Mount Kits	421
Coil-Over Shock Adjusting Tool	420
Coil-Over Shock Kits	419-422
Coil-Over Shock, Lower Mounting Bracket	419, 451
Coil-Over Shock, Magnum Series	418
Coil-Over Shock Mounting Brackets	419, 451
Coil-Over Shock Mount Kits	419-422
Coil-Over Springs, Rear	422
Coil Spring Traction Bars	397
Competition Ladder Bars	395
Control Arms and Accessories	405-407
Conversion Kits, 10 Point Roll Cage	428
Crossmember, Ladder Bar	393
Crossmember 2" x 3" Dropped	393
Crossmember, Transmission Bushings	413
Crossmember, Transmission Universal	413

D

Diagonal Link	403
Door, Access	436
Door Bar Kits, 6-8 & 10-12 pt.	432
Door Handle Linkage Kit	434
Door Hinge Linkage Kit	434
Door Limiter Strap	434
Dragster Rear End Housings	400
Drag Shocks, Adjustable	414-417
Drag Struts	418
Driveshaft Loops	411-412

E

Engine Limiter Kit	441
Engine Torque Link	441

F

Fabricated Rear Axle Housings	400
Fenderwells, Aluminum and Steel	436
Firewall, Kit Rear for Mustang 2005-10	436
Floating Housing Mounts	396
Floor Pan Brace	393



F (CON'T)

Flywheel Shims	441
Forged Rear Axle Housing Ends	401
Formed Rear Frame Rails	392-393
Formed Rear Struts, 8 Point Bar	428
Four-Link, Chassis Brackets	449-450
Four-Link, Frame Kits	390-391
Four-Link, Frame Rails	392
Four-Link Kits	399
Four Link Mounting Brackets	448
Frame Brackets, Universal	448
Frame Connectors	394
Frame Kits, rear	389-391
Frame Rails & Components	392
Front Down Strut Upgrade Kit	431
Front End Travel Limiter	439
Front Motor Plates	444-446
Front Suspension Components	439
Fuel Line, Aluminum (Moroso)	275
Fuel Tank Sump Kits	436
Funny Car Cage Kit	431

G

Gas Pedal Kit	433
Gas Pedal Linkage Kit	433
Gussets, Roll Bar	432

H

Housing Brace, 9" Ford	400
Housing Brackets, Coil-Over	451
Housing Ends, Axle	401
Housing Mounts, Floating	396
Housing Vent, Rear Axle	402

L

Ladder Bars	395
Ladder Bar, Chassis Brackets	448-451
Ladder Bar, Crossmember	392
Ladder Bar Crossmember Brackets	450-451
Ladder Bar Frame Kits	389-391
Ladder Bar Frame Rails	392
Ladder Bar Housing Bracket	448-451
Ladder Bar Spring Chart	391
Ladder Bars & Accessories	395-396
Ladder Link	395
Locating Devices, Rear Axle	403-408
Lower Control Arms	405
Lower Rear Control Arm Bushings	407-408
Lower Shock Mount, Universal	419

M

Mid Mount Plates	442-443
Motor Plates	444-446
Motor Plate Mounting Kit	441
Mounting Brackets, 4-Link	447-449
Mounting Bracket, Shock	451

O

Offset Spring Hangers	422
-----------------------	-----

P

Panhard Bars	404
Panhard Bar Frame Brace	404
Parachute Anchor Mount	435
Parachute Pack Mount	435
Parachute Release Cable Clamp	435
Parachute Release Cable Kit	435
Pedal Kit, Accelerator	433
Pinion Snubber, Adjustable	408
Progressive Rate Springs, Rear	422

R

Radiator Mounting Kit	434
Rear Axle Housings & Components	400-402
Rear Axle Housing Brace	400
Rear Axle Housing Ends	401
Rear Axle Housing Fill Cap Kit	402
Rear Axle Housing Vent	402
Rear Axle Locating Devices & Components	403-405
Rear Axle Spring Perches	401
Rear Coil-Over Shock Kit	419-421
Rear Coil-Over Springs	422
Rear Control Arms & Accessories	406-408
Rear Control Arm Spherical Bearing Kit	408
Rear Fenderwells	436
Rear Firewall Kit	436
Rear Frame Kits	389-391
Rear Frame Rails, Formed	392
Rear Shocks	414-417
Rear Shock Crossmember	421
Rear Shock Mounts	419-421
Replacement Bushings	398, 407-408, 440
Replacement Brackets	447-451
Replacement Parts	423, 454
Rod Ends	410, 437
Roll Bars & Cages	380, 426-432
Roll Bar Bolt-In Conversion Kit	428
Roll Bar Door Bar Kits 6-8 & 10-12 pt.	432

R (CON'T)

Roll Bar Fill Plates	381, 427
Roll Bar Formed Struts	428
Roll Bar Gussets	432
Roll Bar Mounting Plates	380, 427
Roll Bar Padding	432
Roll Bar Rear Struts, 8 point	428
Roll Cage Upgrade Kit	429
Roll Cage Swing Out Door Kit	432
Roll Cage X-Brace Kit	430

S

Seat Back Braces	431
Seat Belt Harness Tabs	447
Sheetmetal	436
Shims, Flywheel	441
Shock Absorbers & Components	414-421
Shock Adjusting Tool, Coil-Over	420
Shocks, Coil-Over, Magnum Series	418
Shock Crossmember	421
Shock Kits, Coil-Over	419-421
Shock Mount Kits, Coil-Over	419-421
Shock Mounting Brackets, Coil-Over	451
Springs, Coil-Over Rear	422
Slide-A-Links™	398
Slide-A-Link™, Bushings	398
Slide-A-Link™ Wrenches	398
Snubber, Adjustable	408
Solid Aluminum Body Mounts	440
Solid Replacement Bushings	440
Spoiler, Rear Universal (Moroso)	372
Sport Compact Roll Bars & Cages	426
Spring Chart, Ladder Bar	391
Spring Eye Bushings, Aluminum	440
Spring Hangers, Offset	422
Spring Perches, Rear Axle	401
Springs, Progressive Rate	391, 422
Springs, Rear Coil Over	422
Stabilizer Bars, Anti-Roll	409
Stabilizer Bars, Diagonal Link	403
Stabilizer Bars, Panhard Bar	404
Steering Column Kits	437
Steering Column Mounting Kit	437
Steering Shaft Support Rod End	437
Steering Wheel Adapter	438
Steering Wheel Hub and Adpater	438
Strut Upgrade Kit, Front Down	431
Struts, Drag Race	418
Struts, Roll Bar Formed	428
Stud Kit, Carrier	402
Swing Out Door Kit	432

T

Tabs, Brackets	447-451
Throttle Linkage Rod Kit	433
Tie Down Hooks, Universal	453
Torque Box Reinforcement Plates	407
Torque Link, Engine	441
Tow Hook, Universal	453
Tow Hook, Folding, Universal	453
Traction Bars, Coil Spring & Leaf Spring	397
Traction Devices, Bolt-On	398
Transmission, Crossmember Bushings	413
Transmission Crossmember Mount Kit	413
Transmission, Universal Crossmember	413
Travel Limiter, Front End	439
Two Degree Wedge Plates	402

U

U-Bend Universal Mount	452
Understanding Suspension Basics	382-384
Universal Brackets & Tabs	447-451
Universal Crossmembers	392-393
Universal Driveshaft Loops	411-412
Universal Door Window Frame Kit	433
Universal Frame Rails	392
Universal Lower Shock Mounts	419-420
Universal, Tow Hook	453
Universal Window Frame Kit	433
Upper, Rear Control	406-408
Upper A-Arm Bushings	440
Universal Wheel-E-Bars™	423-425

W

Wedge Plates, Two Degree	402
Weight/Battery Box	452
Weld In, Frame Connectors	394
Wheel-E-Bars™, Bolt-On	425
Wheel-E-Bars™, Universal	423-425
Wheel Tubs, Aluminum and Steel	436
Window Frame Kit	433
Window Install Kit	433
Wishbone Housing Locators	403
Wrenches, Slide-A-Link™	398





Getting more power from an engine is something all racers are familiar with. Getting that power to the ground, however, is a science that few racers really understand. For those of you just starting out in drag racing, we've put together a basic overview of how chassis and suspension systems are affected by sudden acceleration. The Chassis People™ at Competition Engineering want you to understand the relationship between engine power and the chassis, suspension and driveline systems of your car. By doing so, you will be in a better position to select equipment that allows you to hook up and lower ET's!

Without the right chassis and suspension setup, all the horsepower in the world will only go up in tire smoke!

As you're trying to understand how modifications to the chassis and suspension systems improve traction, it helps to keep one thing in mind. Power produced by your engine must take a direct path to "planting" the tires and "launching" your car forward. Any power that gets absorbed by the chassis and suspension is power that can't be used to get you to the finish line as quickly as possible.

There's a basic law of physics that states "for every action there is an equal and opposite reaction." Relating this principle to a game of billiards is relatively easy.

But applying it to chassis and suspension systems on a drag race car is more complex. When trying to understand how chassis and suspension setups affect traction, keep the "action/reaction" concept in mind. It will make things much easier to understand.

While race cars are designed for racing, street cars are designed primarily for carrying passengers safely and comfortably. From the factory, passenger cars are not equipped to handle high rpm launches from a standing start. This instant release of power places great strain on stock suspension systems and usually results in unwanted wheel hop, tire spin and parts breakage. Controlling this unwanted reaction is the job of a traction device, which limits the rotation of the rear axle housing and transfers forces to the track surface.

For example, the installation of traction bars is a popular way of limiting rotation of the rear axle housing. Traction bars mount directly to each side of the axle housing and extend forward like long arms or levers. When the housing begins to rotate during initial launch, the traction bars stop this action, holding the housing in place and converting some of the applied torque to a force which pushes the rear tires into the track surface. By stabilizing the axle housing, wheel hop is virtually eliminated, acceleration is smoother and parts breakage is minimized.

HOW "WHEEL HOP" OCCURS

REAR AXLE HOUSING ROTATION WITHOUT TRACTION CONTROL

When horsepower is suddenly delivered to the differential, whether from a clutch or a torque converter, the pinion attempts to "climb" the ring gear. This sudden shock of torque causes the entire rear axle housing to rotate backwards in a counter-clockwise direction. This causes the springs to distort, resulting in severe driveshaft/U-joint misalignment.

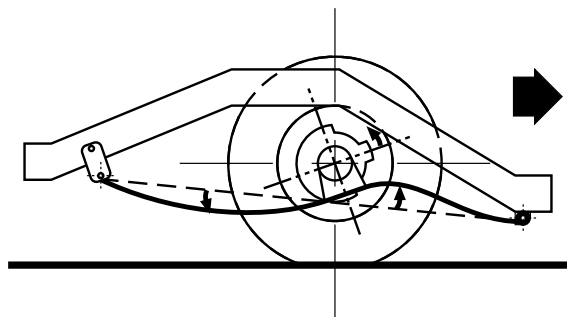

SPRING REACTION UNLOADS SUSPENSION, CAUSING "WHEEL-HOP"

The axle housing is allowed to continue its rotation until it meets resistance from the suspension/springs, which then try to "snap" the housing back to its original position. As power continues to the differential, the housing is once again allowed to rotate back against the springs. This action/reaction of the suspension, commonly known as "wheel hop," continues much like a tug-of-war. Instead of launching your car forward, you sit there bouncing around and spinning your wheels.

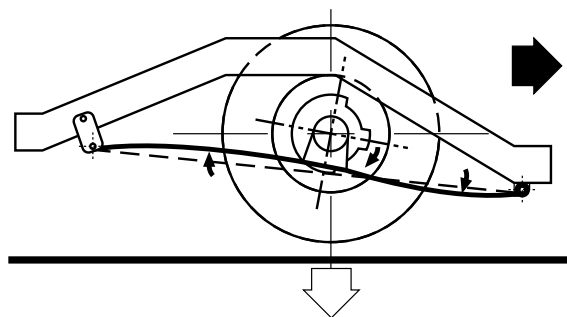

COMPETITION ENGINEERING TRACTION BAR LIMITS AXLE ROTATION

The bolt-on "Slapper Bar" is one of the most basic traction devices available. Originally pioneered by Bill "Grumpy" Jenkins in the mid-sixties, it gets its name from the way it works. One end of the Traction Bar replaces the stock spring pad and is clamped to the rear axle housing. The front end of the bar is suspended just below the spring eye. When the housing begins to rotate during launch, the bar also rotates until it contacts or "slaps" the spring. (Unlike other brands, Competition Engineering Traction Bars make contact directly below the front spring eye, preventing spring damage). When contact occurs, the Slapper Bar becomes a lever trying to push the axle housing down and planting the tires in the process.

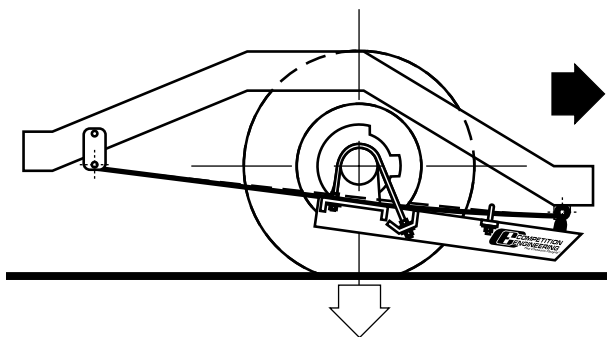

SLIDE-A-LINK™

A revolutionary, patented, completely bolt-on traction device, the Slide-A-Link™, designed for both street and strip use is track tested and competition proven to outperform conventional "Slapper" bars. A solid mounted front plate is installed inside the original front spring pocket and clamps to the leaf spring to provide a positive displacement for the torque that is transmitted from the rear axle through the telescoping bar and special durometer shock pad. These forces, along with improved instant center geometry, provide better weight transfer for increased traction. Free travel and pre-load adjustments are made on the vehicle by adjusting the jack screw at the rear of the bar.

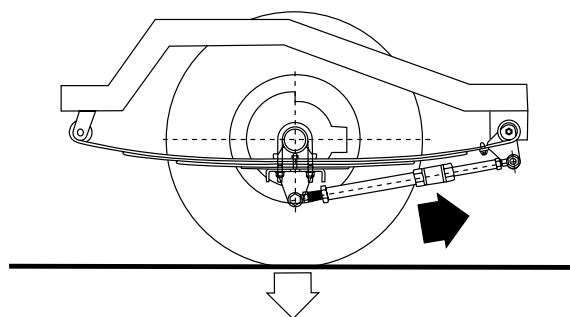

HOW LADDER BARS WORK

The Ladder Bar is a more sophisticated traction device because it serves as an extremely rigid, bridge-type truss that locates the rear axle housing directly to the chassis. With the axle housing held firmly in place, the torque applied to the differential is now transferred immediately through the Ladder Bars and into the chassis. By using the Ladder Bar to carry power to the chassis, the front end reacts by rising. As the front of the car travels upward, rapid weight transfer is created which "plants" the rear tires and propels the car forward.

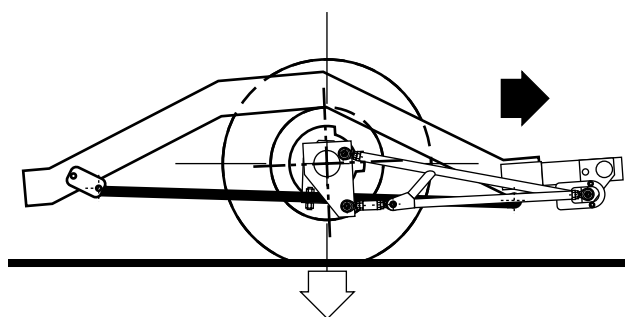

HOUSING FLOATERS ELIMINATE SUSPENSION BIND

When using Ladder Bars with a leaf spring rear suspension, the axle housing cannot be rigidly attached to the springs. If it were, severe binding of the rear suspension would occur because the Ladder Bar and the leaf spring both travel in separate competing arcs. By allowing the housing to rotate and glide on the leaf spring, the Floating Housing Mount eliminates the bind and allows the Ladder Bars to work the way they were designed.

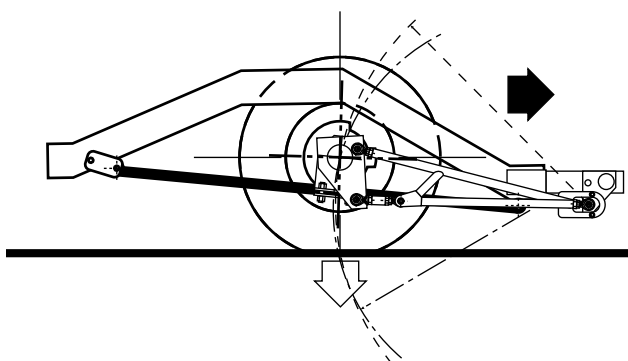



Traction devices are only half the story. When used properly to transfer the torque action created in the differential into the chassis, other aspects of the car must also be enhanced. Since the chassis is the backbone of the car, the "action" of transferring power into it must not result in the "reaction" of twisting and flexing. Therefore, the chassis must be as rigid as possible. Frame Connectors are used to connect front and rear uni-body subframes, effectively making them one piece. This eliminates unwanted flex in the chassis and prevents it from absorbing the power needed for acceleration. Solid Body Mounts, Solid Motor Mounts, Engine Torque Links and Solid Transmission Mounts contribute to forming a rigid structure and help eliminate unwanted twisting and power loss.

Large-diameter Tubular Control Arms, which are much stronger than stock units, also add rigidity, eliminate flex and help direct power to the ground. Finally, Roll Bars and Roll Cages help make the chassis and body solid while providing an extra measure of safety.

The suspension also contributes to overall performance. It serves as a flexible connection to the track, providing mechanical and hydraulic damping to control unwanted body and chassis movements. The suspension must remain flexible enough to offer a sufficient level of comfort and safety, while contributing to traction when

subjected to sudden acceleration. Installation of Competition Engineering's Adjustable Drag Shocks are one of the first steps taken to help stabilize suspension movement. In race applications, the front shocks play a dual role. When the front end lifts, they extend freely to increase weight transfer. When the front end begins to lower, these same shocks provide resistance to maximize the duration of weight transfer. Complementing the action of the shocks are Front Drag Springs, specially engineered for each application to hold a great amount of stored energy for instantaneous weight transfer. Rear Coil Springs are also available for specific vehicle weights to obtain the correct ride height, and provide full suspension travel for optimum weight transfer and traction. Stabilizer Bars are used in conjunction with both Ladder Bars and 4-Links. They center the rear axle housing within the chassis. This prevents lateral movement between the body and the suspension, which helps to provide high speed stability.

We hope that our introduction to chassis, suspension and traction systems has been helpful. From our simplified explanations you should realize that horsepower, while important, is not the only factor contributing to elapsed time results. A properly tuned chassis and suspension will help you to determine the level of equipment needed to obtain that traction.

WHEEL-E-BARS™ HELP CONTROL WEIGHT TRANSFER

Although Ladder Bars and 4-Links provide lift to the front end by transferring weight to the rear, too much lift detracts from the forward motion and reduces overall performance. Installation of Wheel-E-Bars™ helps to maintain the correct amount of lift and controls weight transfer to maximize traction.

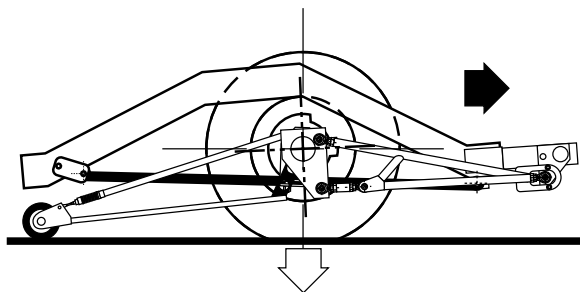

LADDER BARS VS. 4-LINKS

4-Links offer more adjustment over Ladder Bars and can handle higher torque loads. With two bars per side, one on top and one on the bottom, you basically have an open ended Ladder Bar. You can adjust the suspension for different track conditions by manipulating the mounting positions in the frame and axle housing brackets. This gives you the option of making the intersection point, or point of "instant center," as far forward or rearward to suit your particular needs. The point of instant center is the location where the upper and lower links would intersect if imaginary lines extended from the front of the 4-Link bars. Unlike a Ladder Bar where the point of instant center is always located at the bar's front mounting point, the instant center on a 4-Link changes quickly as the car is launched.

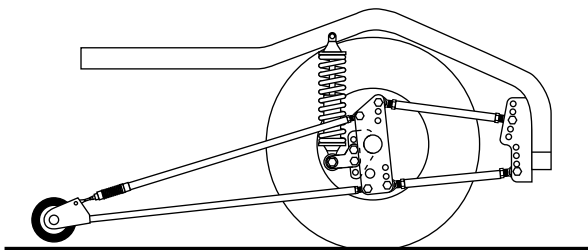

CHOOSING THE RIGHT EQUIPMENT

Selecting chassis components is something that should not be taken lightly. It's just as important as choosing the right camshaft or gear ratio. Making the right chassis setup decision wins races. Making the wrong one leaves you with a car that doesn't perform as expected and usually ends up wasting a lot of your hard earned money. Before purchasing a single chassis component, you must first make some very important decisions concerning your car and the level of competition you plan to achieve. First, determine what you want out of your car. Are you looking for better performance from your street machine; do you want a dedicated race car that will never see the street; or do you want a performance street machine that can do occasional track time? If you are going racing, become familiar with all rules and guidelines established by your sanctioning body. Determine the horsepower level you want the engine to make.

Decide if you want to use bolt-on or weld-in components. Once you have addressed all of these important issues, you will be in a better position to choose the chassis components that are correct for your car.

To help both the beginner and seasoned racer select chassis equipment, we've grouped cars in four stages beginning with street performance and mild bracket cars, and ending up with "Outlaw" Pro Street and Pro Modified type race cars. In our **Blueprint for Performance**, we've built each of the four stages around the three most important factors concerning component selection:

- 1) Intended Use
- 2) Horsepower Level
- 3) Installation Complexity

Following along stage by stage will help you select equipment that best suits your performance requirements.

STAGE ONE

Street Performance & Mild Bracket Cars

Our first stage is our entry level stage intended for those looking to get more performance from their street machine that may see some track time occasionally as a mild bracket racer. In this stage, horsepower levels are stock or slightly modified. All of the equipment can be easily installed with simple hand tools. No welding is required. All of the bolt-on equipment included in Stage One is intended to strengthen the chassis, suspension, body and drivetrain. By making the car more rigid, power is transferred directly to the wheels for improved traction.

To control wheel hop on older cars with leaf or coil springs, Competition Engineering offers **Bolt-On Traction Bars**. These bars limit rear housing rotation, thereby eliminating wheel hop and improving rear wheel traction. As a step up from the traditional Traction Bar, we now offer the **Slide-A-Link™** traction device. This revolutionary, patented bolt-on piece provides you with the ultimate bolt-on traction system for leaf spring cars.

For better handling and improved traction in rear coil spring equipped street cars, we offer **Tubular Rear Control Arms**. These rugged control arms are direct replacements for flimsy stock units, and serve to strengthen the suspension for quick launches and stable cornering.

The Mustang and GM A&G Body versions have three adjustment settings to suit changing track conditions. Additional components for this stage include Competition Engineering's **Solid Aluminum Body Mounts** that help eliminate chassis twist, and **Solid Motor Mounts** and **Transmission Mounts** to keep the engine from wasting torque by twisting in the chassis. For uni-body cars, **Bolt-On Subframe Connectors** create a rigid structure for direct transmission of power.

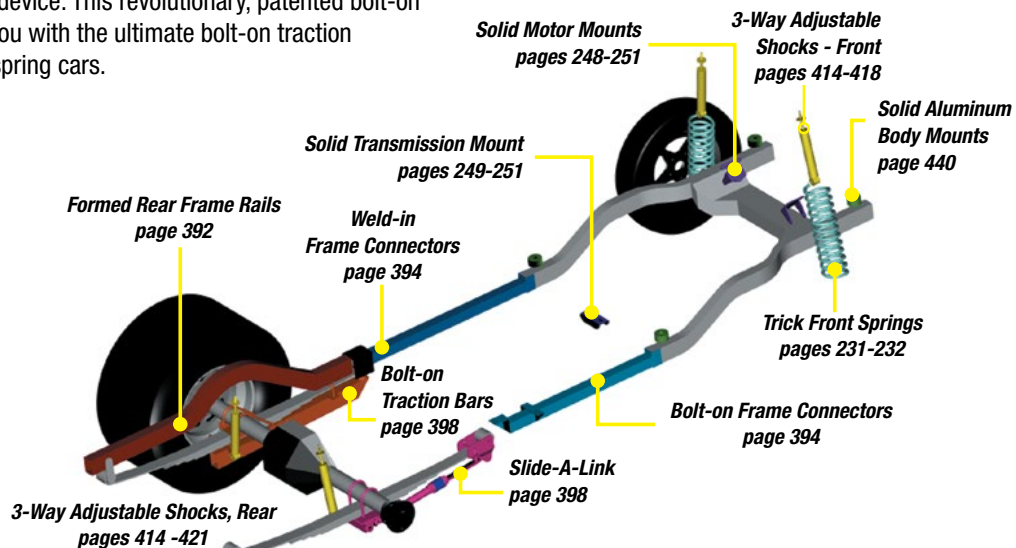

STAGE TWO

Borderline Street Legal & Bracket Racing Cars

As horsepower levels start to increase, so does the need for stronger traction control. The components that make up Stage Two, along with the other stages that follow, will require skills in both welding and fabrication. Installation of this equipment will also cause street driveability to be affected. Stage Two cars may need to be trailered to the track.

An **8-point Roll Bar** and **Bolt-On Driveshaft Loop** should be among the first components added when deciding to build more horsepower and go faster. A properly installed roll bar not only offers increased protection in the event of a crash, but also adds rigidity to the chassis which results in quicker E.T.'s.

The rear suspension also needs to be reinforced in order to handle the higher torque loads produced by the engine. The installation of **Weld-In Ladder Bars** and a **Tubular Crossmember** will help control the transfer of power to the rear wheels. If you're retaining leaf springs, you'll also need a **Housing Floater** (see page 396) to keep the springs from working against the Ladder Bars. To provide additional suspension adjustment without going through the trouble of installing a **4-Link**, Competition Engineering offers the **Ladder Link™**. This popular traction device gives you

more adjustability over standard Ladder Bars. Its 33-½" length is ideal for most applications.

More power also requires larger rear tires. To fit larger rear tires into a passenger car body, you'll need to enlarge the wheel housings and move the rear springs inboard. This can be accomplished by installing a set of our **Rear Fenderwells**, available in either steel or aluminum, and using our **Offset Spring Hangers** (see page 422) to relocate the leaf springs. You'll also need **Weld-In Subframe Connectors** to tie the front and rear subframes together in a uni-body car. For maximum strength on uni-body vehicles, our **Formed Rear Frame Rail Kits** provide a solid base for mounting a variety of traction components.

Additional components that make Stage Two complete include computer-designed **Trick Front Springs** for maximum front end lift and weight transfer, **Rear Drag Springs** that provide full suspension travel to take advantage of that weight transfer; **3-Way Adjustable Drag Shocks** to control suspension movement, and **Front End Travel Limiters** to prevent the front end from rising too high.

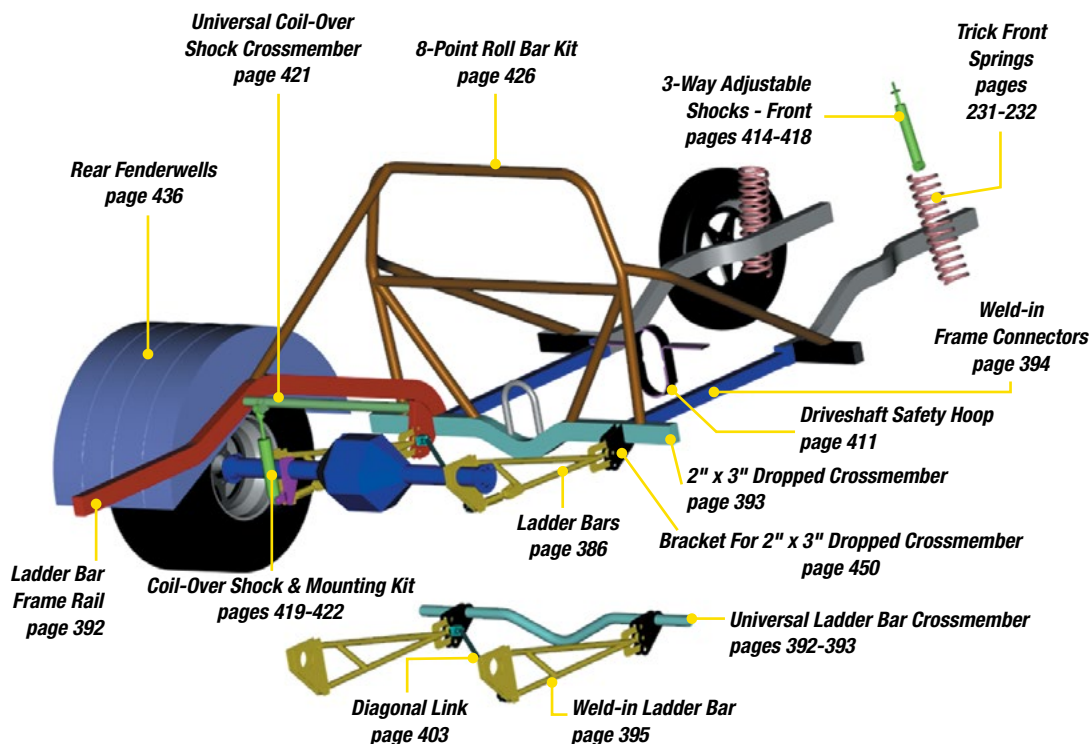

STAGE THREE

Pro-Street & Sportsman Class Cars

Stage Three includes all-out race cars that require fabrication skills to complete. Higher horsepower and larger tires also require that a dedicated racing suspension be installed. Installation of components included in this stage mandates that the car be "back-halved" to accept a fabricated rear frame and 4-Link rear suspension. The backbone of this stage is the 2" x 3" mandrel bent Rear Frame Rails and the 2" x 3" Dropped Crossmember.

This will give you a sturdy base in which to install our 4-Link Kit and Coil-Over Shock Mounts. In addition to this setup, an Axle Locating Device is required to keep the rear housing centered in the chassis. The installation of a 10-Point Roll Cage is mandatory to support the new back half, as well as to help protect the driver at increased speeds.

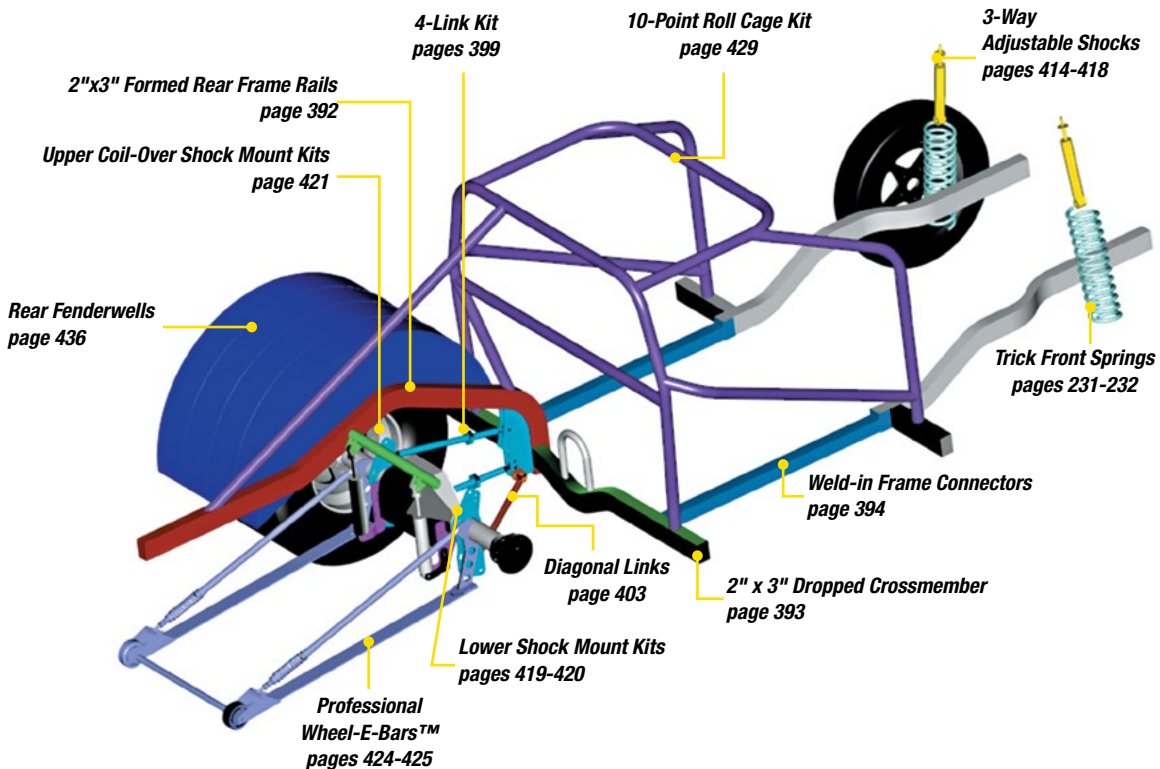

OTHER COMPONENTS THAT COMPLEMENT STAGE THREE INCLUDE:

PART #	DESCRIPTION	PAGE
C9100	Fabricated 9" Ford Rear End Housing, Chrome Moly	400
C9200	Fabricated 9" Ford Rear End Housing, Mild Steel	400
C4029	Battery/Weight Box	452
C5073/74	Steering Column Kits	437-438



No. C4029



No. C5074



No. C9100



CHOOSING EQUIPMENT

STAGE FOUR

Pro-Street & Pro-Modified Type Race Cars

We have designed this final stage for the **professional racer**. Hard core components for Stage Four include our **12-Point Roll Cage** for maximum protection and chassis rigidity and our **Magnum Series 4-Link** to handle brute force horsepower levels. Our Wishbone Rear Axle Locator improves chassis stability. To locate the engine in tube chassis cars, **Aluminum Motor Plates** and **Steel Mid-Mount Plates** are computer machined for precise

fit and alignment. **Fabricated Rear Axle Housings** and 43" and 46" **Monster Wheel Tubs** are designed exclusively for Funny Car size slicks. To keep everything on a level attitude we strongly suggest our **Universal 60" Wheel-E-Bar™** or **80" Single Wheel-E-Bar™**. Additional components include **Fabricated 9" Ford Housing**, **Steering Column Kit** and **Rack and Pinion Steering Units** for the front end.

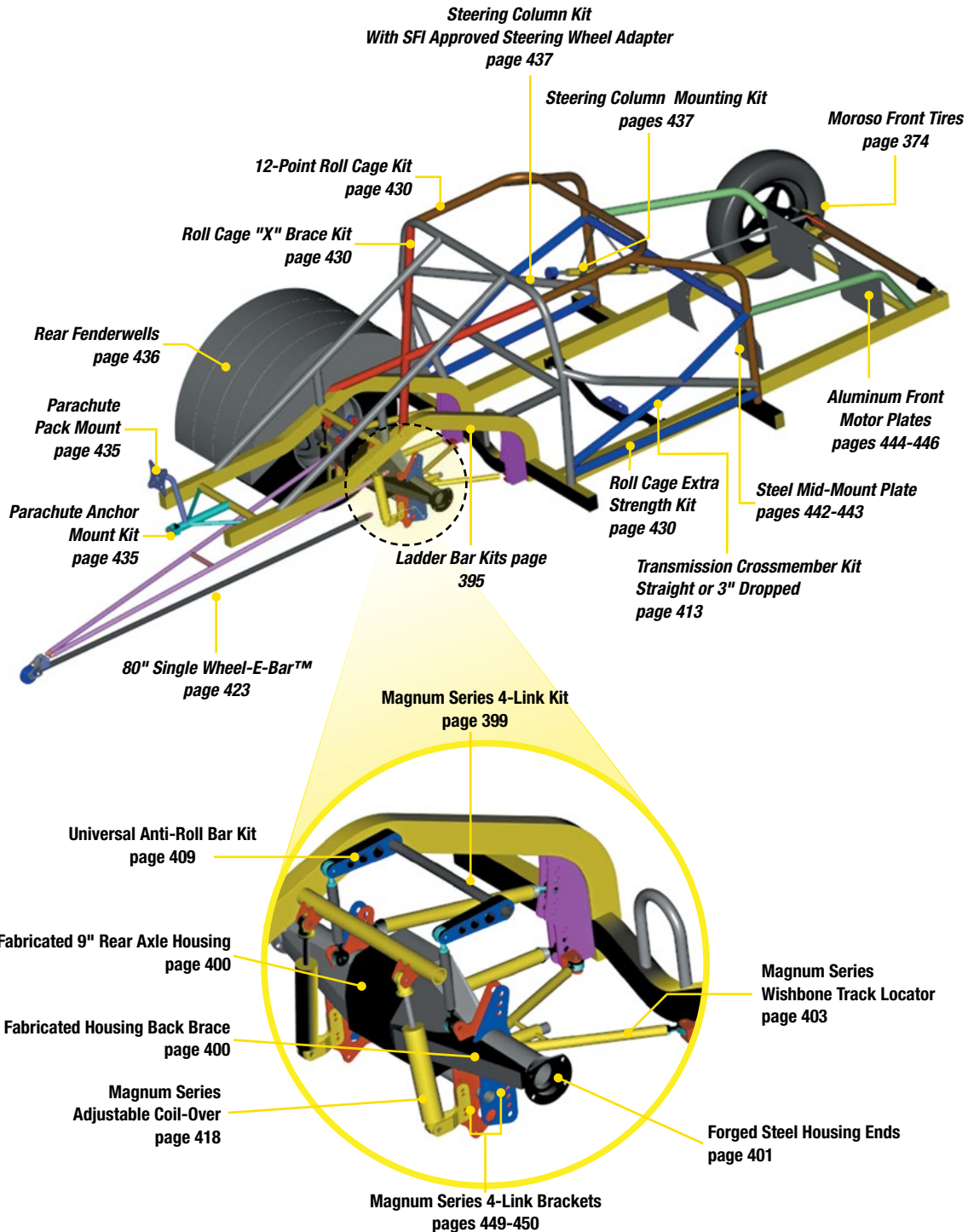

Competition Engineering complete **Rear Frame Kits** with custom suspension options will save you hours of fabrication time. Each kit is individually welded on precise jigs for unmatched accuracy...getting you hooked up and winning, right out of the box!

When you choose a Competition Engineering **Rear Frame Kit** you know it's built with quality. Each and every component is manufactured with the finest American craftsmanship and materials, ensuring a perfect fit and years of dependable service.

Best of all, our efficient manufacturing processes make these built-to-order **Rear Frame Kits** available at a great price!

We've expanded our line of **Rear Frame Kits** to better meet the needs of our customers. Now, each Frame Kit has its own part number to make it easier to find and order exactly what you are looking for!



Complete Frame Kits Application Chart
on pg. 391

DESIGN YOUR OWN REAR CLIP!

Widths - Frame Kits are offered in three widths: 24", 26" and 28".

Welded or Unwelded - Frame Kits are available in your choice of welded or unwelded. The unwelded option is available only on the 28" Kit. This allows the chassis builder to cut to their desired width.

Suspension Designs - Four different are available: *Single Adjustable Ladder Bar*, Part No. **C2006**; *Ladder Bar Double Adjustable* Part No. **C2005** (page 395); *Standard 4-Link* and *Magnum Series 4-Link* (page 399).

Shocks Options - Available with three different shock options: *3-Way Adjustable Drag Shocks* (pages 414-418), *Magnum Series Rear Coil Over Shocks* (page 418).

Spring Rate Options - Seven different spring rates are offered: 85, 100, 125, 150, and 200 lb., plus Progressive Rate Springs are available.

LADDER BAR REAR FRAME KITS

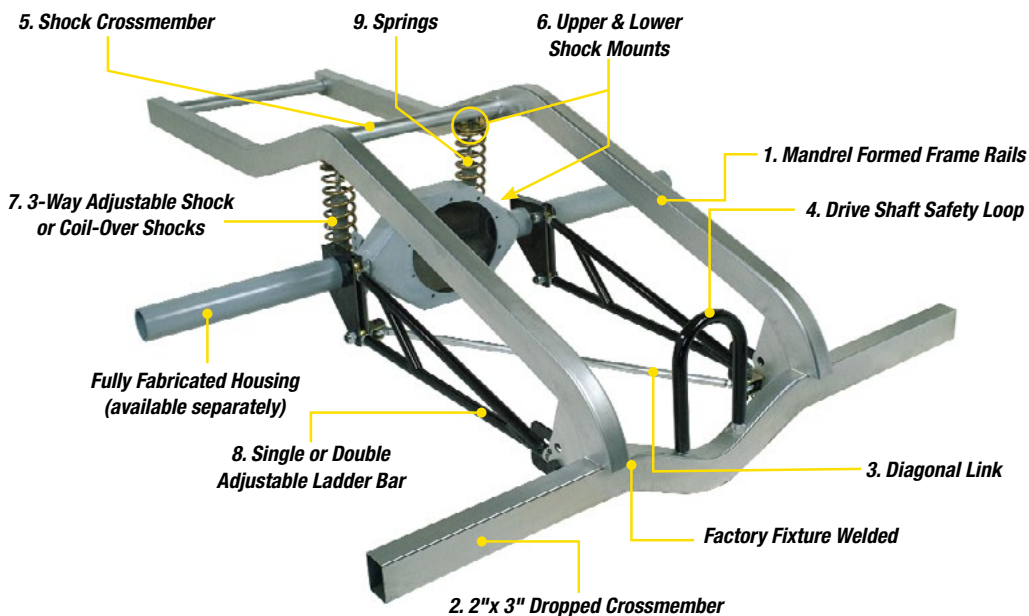

1. **Ladder Bar Frame Rails** – Specially engineered profile clears suspension and axle components, while accommodating low ride height and wide tires.
2. **2" x 3" Crossmember** – Mandrel formed for uniform profile; 3.5" drop center makes it adaptable to virtually any chassis design; 60" wide.
3. **Diagonal Link** – 3/4" O.D. DOM steel with 1/2" Spherical Rod Ends for easy, in-chassis adjustment.
4. **Driveshaft Loop** – 1-1/8" O.D. mandrel formed Round Tube contains driveshaft during U-joint failure.
5. **Shock Crossmember** – Tubular design provides high strength with light weight.
6. **Upper & Lower Shock Mounts** – Provides 6" of ride height adjustment.

7. **Available With 3-Way Adjustable Shocks or Coil-Over Shocks** – Single, externally adjustable Coil-Over Shocks with CNC machined billet aluminum body and 1" wide top/bottom bearings or economical 3-Way Adjustable Shocks with Spring Kit.
8. **Available With Competition Single Adjustable or Double Adjustable Ladder Bars.** (see page 395)
9. **Springs** – Matched to your specific rear vehicle weight. 2.5" I.D. x 12" long, premium-grade chrome silicone steel, powder coated for durability. Progressive Ladder Bar Rate Springs available.



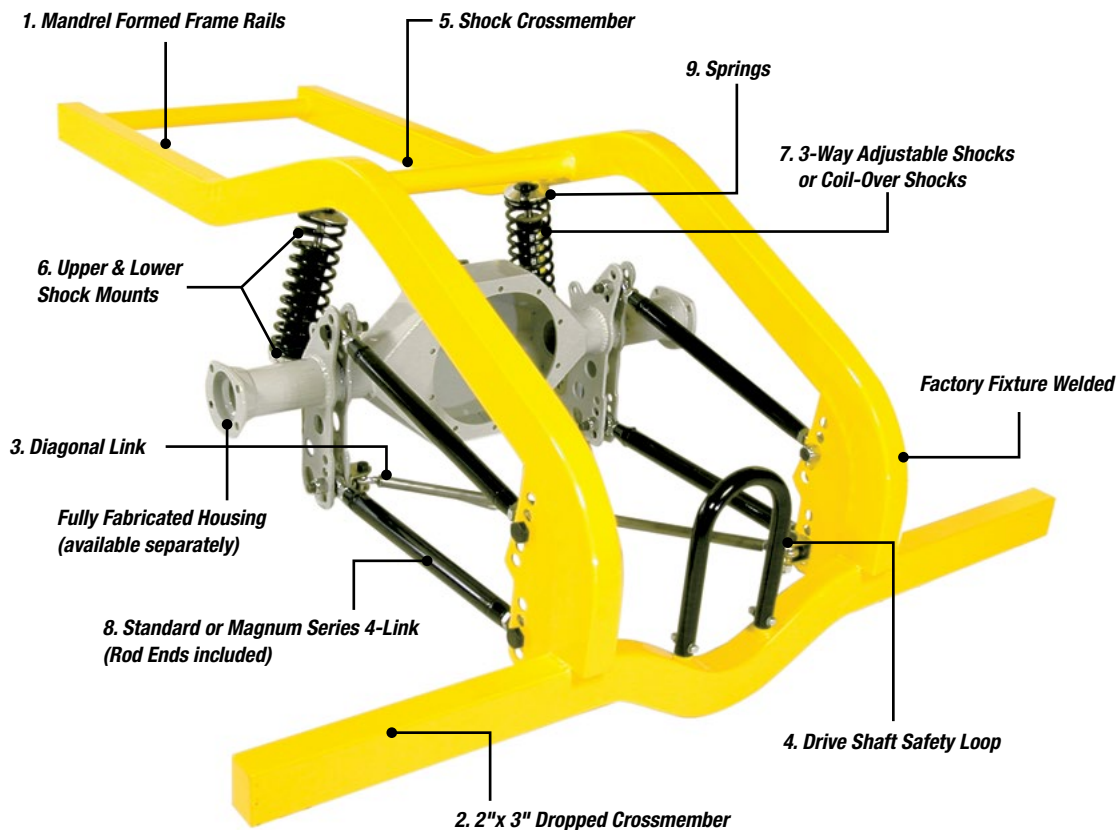

EACH 4-LINK REAR FRAME KIT INCLUDES:

- 1. 4-Link Frame Rails** – Specially engineered profile clears suspension and axle components while accommodating low ride height and wide tires; Rugged 2" x 3" construction makes them strong without adding unnecessary weight.
- 2. 2"x 3" Crossmember** – Mandrel formed for uniform profile; 3.5" drop center makes it adaptable virtually any chassis design; 60" wide.
- 3. Diagonal Link** – $\frac{3}{4}$ " O.D. DOM steel with $\frac{1}{2}$ " Spherical Rod Ends for easy, on-chassis adjustment.
- 4. Driveshaft Loop** – 1- $\frac{1}{8}$ " O.D. mandrel formed Round Tube contains driveshaft during U-joint failure.
- 5. Shock Crossmember** – Tubular design provides high strength with light weight.
- 6. Upper & Lower Shock Mounts** – Provides 6" of ride height adjustment.
- 7. Available With 3-Way Adjustable Shocks or Coil-Over Shocks** – Single, externally adjustable Coil-Over Shocks with CNC machined billet aluminum body and 1" wide top/bottom bearings or economical 3-Way Adjustable Shocks with Spring Kit.
- 8. Available With Standard or "Magnum" Series 4-Link Kits** – Rod Ends included. (see page 410)
- 9. Springs** – Matched to your specific rear vehicle weight. 2.5" I.D. x 12" long, premium-grade chrome silicone steel, powder coated for durability. Progressive Rate Springs are also available.



Complete Frame Kits Application Chart
on pg. 391

LADDER BAR FRAME KITS

SPRING RATE	85 LB	100 LB	125 LB	150 LB	200 LB	PROGRESSIVE RATE SPRING	
						1,900 LBS TO 2,900 LBS	2,901 LBS TO 3,900 LBS
24" WIDTH							
12 WAY ADJ. COIL-OVER SHOCK	C0411↻	C0412↻	C0413↻	C0414↻	C0415↻	C0416↻	C0417↻
3 WAY ADJ. SHOCK	C0421↻	C0422↻	C0423↻	C0424↻	C0425↻	C0426↻	C0427↻
26" WIDTH							
12 WAY ADJ. COIL-OVER SHOCK	C0611↻	C0612↻	C0613↻	C0614↻	C0615↻	C0616↻	C0617↻
3 WAY ADJ. SHOCK	C0621↻	C0622↻	C0623↻	C0624↻	C0625↻	C0626↻	C0627↻
28" WIDTH							
12 WAY ADJ. COIL-OVER SHOCK	C0811↻	C0812↻	C0813↻	C0814↻	C0815↻	C0816↻	C0817↻
3 WAY ADJ. SHOCK	C0821↻	C0822↻	C0823↻	C0824↻	C0825↻	C0826↻	C0827↻

LADDER LINK FRAME KITS

24" WIDTH							
12 WAY ADJ. COIL-OVER SHOCK	C2422↻	C2423↻	C2425↻	C2426↻	C2427↻	C2428↻	C2436↻
3 WAY ADJ. SHOCK	C2429↻	C2430↻	C2431↻	C2432↻	C2433↻	C2434↻	C2437↻
26" WIDTH							
12 WAY ADJ. COIL-OVER SHOCK	C2611↻	C2612↻	C2613↻	C2614↻	C2617↻	C2618↻	C2619↻
3 WAY ADJ. SHOCK	C2621↻	C2622↻	C2623↻	C2624↻	C2625↻	C2626↻	C2627↻
28" WIDTH							
12 WAY ADJ. COIL-OVER SHOCK	C2811↻	C2812↻	C2813↻	C2814↻	C2815↻	C2816↻	C2817↻
3 WAY ADJ. SHOCK	C2821↻	C2822↻	C2823↻	C2824↻	C2826↻	C2827↻	C2828↻

4-LINK FRAME KITS

24" WIDTH							
12 WAY ADJ. COIL-OVER SHOCK	C1411↻	C1412↻	C1413↻	C1414↻	C1415↻	C1416↻	C1417↻
3 WAY ADJ. SHOCK	C1421↻	C1422↻	C1423↻	C1424↻	C1425↻	C1426↻	C1427↻
26" WIDTH							
12 WAY ADJ. COIL-OVER SHOCK	C1611↻	C1612↻	C1613↻	C1614↻	C1615↻	C1616↻	C1617↻
3 WAY ADJ. SHOCK	C1621↻	C1622↻	C1623↻	C1624↻	C1625↻	C1626↻	C1627↻
28" WIDTH							
12 WAY ADJ. COIL-OVER SHOCK	C1811↻	C1812↻	C1813↻	C1814↻	C1815↻	C1816↻	C1817↻
3 WAY ADJ. SHOCK	C1821↻	C1822↻	C1823↻	C1824↻	C1825↻	C1826↻	C1827↻

MAGNUM SERIES 4-LINK FRAME KITS - (1/4" BRACKET WITH 5/8" HOLES)

24" WIDTH							
12 WAY ADJ. COIL-OVER SHOCK	C1431↻	C1432↻	C1433↻	C1434↻	C1435↻	C1436↻	C1467↻
3 WAY ADJ. SHOCK	C1437↻	C1438↻	C1439↻	C1440↻	C1441↻	C1442↻	C1468↻
26" WIDTH							
12 WAY ADJ. COIL-OVER SHOCK	C1443↻	C1444↻	C1445↻	C1446↻	C1447↻	C1448↻	C1469↻
3 WAY ADJ. SHOCK	C1449↻	C1450↻	C1451↻	C1452↻	C1453↻	C1454↻	C1470↻
28" WIDTH							
12 WAY ADJ. COIL-OVER SHOCK	C1455↻	C1456↻	C1457↻	C1458↻	C1459↻	C1460↻	C1471↻
3 WAY ADJ. SHOCK	C1461↻	C1462↻	C1463↻	C1464↻	C1465↻	C1466↻	C1473↻

 **WARNING Prop. 65**
 This product contains a chemical known to the state of California to cause cancer, birth defects, or reproductive harm-



FORMED REAR FRAME RAIL KITS

- Replaces the stock rear rails in subframe equipped cars
- Engineered to move the leaf springs and frame rails inboard to provide additional tire clearance
- Designed to fit stock floor contours with minor fabrication
- Requires use of a fuel cell, Rear Fenderwells and an Upper Shock Crossmember (see Available Options)
- Eliminates stock sheet metal rear frame rails
- Increases chassis strength for quicker vehicle reaction times
- Manufactured from mandrel formed 2" x 3" x .083" wall mild steel tube
- Two rails and tube sleeves



No. C3031

PART # DESCRIPTION

- C3031** Formed Rear Frame Rail Kits, 1967-'69 Camaro, Firebird
C3032 Formed Rear Frame Rail Kits, 1970-'81 Camaro, Firebird
C3034 Formed Rear Frame Rail Kits, 1962-'67 Chevy II, Exc. Wagon
C3035 Formed Rear Frame Rail Kits, 1968-'76 Nova, Ventura II

PART # AVAILABLE OPTIONS

- C3002-C3011** Rear Fenderwells
C3012-C3048 Weld-In Subframe Connectors
C2046 Upper Shock Crossmember
C2047 Lower Shock Mount

UNIVERSAL FRAME RAILS KITS

- Available for both 4-Link and Ladder Bar suspensions
- Narrows the rear chassis to accept extra-wide racing tires
- Universal design for any car – Pro Street to Drag Race
- Manufactured from mandrel formed 2" x 3" x .083" rectangular steel
- Use with **No. C3061** 2" x 3" crossmember for a solid mounting point for our suspension components
- Two rails and hardware per kit

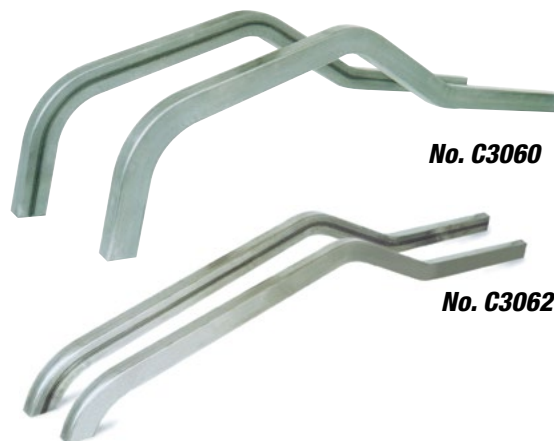

No. C3060

No. C3062

PART # DESCRIPTION

- C3060*** 4-Link Frame Rails, Universal
C3062* Ladder Bar Frame Rails, Universal

PART # AVAILABLE OPTIONS

- C3061** Universal Dropped Crossmember
C3421 Magnum Series 4-Link Bracket
C3408 Standard 4-Link Bracket
C3411 Ladder Bar Bracket

***NOTE:** Installation of this product requires stock rear floor pan be substantially modified or removed. The addition of a full roll cage is also required for proper installation.

CROSSMEMBER KIT

Ladder Bar

- Convenient kit includes components needed to install a Ladder Bar Crossmember on a Pro Street or Drag Race car
- Kit includes: 2" x 3" x .083", 60" long Dropped Crossmember, four Ladder Bar Crossmember Brackets and all hardware
- 60" length and full 3.5" drop-center profile makes this sturdy, mandrel bent Crossmember an ideal front attachment point on virtually any chassis design
- The ladder bar mounting holes are stamped on a 33" radius to allow quicker adjustments when used with Competition Engineering's Ladder Bars



No. C3059

PART # DESCRIPTION

- C3059** Crossmember Kit - Ladder Bar

2" X 3" DROPPED CROSSMEMBER

Makes fabricating a rear frame on a Pro Street or Drag Race car easier and more professional

- Sturdy 2" x 3" x .083" steel is mandrel formed on computer-controlled equipment, providing uniform wall thickness and exact profile dimensions
- 60" length and full 3.5" drop-center profile makes this crossmember an ideal front attachment point on virtually any chassis design
- Use with Competition Engineering's Formed Rear Frame Rails Nos. C3060, C3062 or any other suitable frame rail kit

PART #	DESCRIPTION
C3061	Dropped Crossmember, 2" X 3"



No. C3061

PART #	AVAILABLE OPTIONS
C3060	Universal 4-Link Frame Rails
C3062	Universal Ladder Bar Frame Rails
C3409	Ladder Bar Brackets

LADDER BAR CROSSMEMBER

- Designed to provide a sturdy mounting point for the front Ladder Bar rod end
- Manufactured from 1-3/4" x .134" wall mandrel formed steel tubing
- Capable of withstanding the abuse of a racing suspension while adding strength to the chassis
- 54" wide bar serves double duty as both a locating device for the Ladder Bars as well as a rear driveshaft loop
- Kit includes 3/16" stamped steel brackets with 360° thru-mounting holes for increased strength
- Mounting holes stamped on a 33" radius to allow quicker settings without added adjustments
- Includes mounting hardware
- Welding required

PART #	DESCRIPTION
C2019	Ladder Bar Crossmember



No. C2019

PART #	AVAILABLE OPTIONS
C2005	Ladder Link™
C2006	Competition Ladder Bar

PART #	REPLACEMENT PARTS
C3418	Ladder Bar Brackets

FLOOR PAN BRACE

Easy To Install Bolt-On Design Uses Existing Mounting Points
Fits: Camaro 2010-'15

- Even though 2010-'15 Camaros have a stiffer chassis than earlier models, they still suffer from flexibility; which affects acceleration, handling, long term rattles and traction
- Fortify your Camaro 2010-'15 chassis with this Brace, which replaces the factory stamped, steel piece to stiffen the floor pan and drive shaft tunnel area
- Durable, gloss black powder-coat finish

PART #	DESCRIPTION
C3065	Floor Pan Brace, Bolt-on Design, 1-1/2" x 2-1/2" x .120 wall rectangular tubing



No. C3065



No. C3112



No. C3012



No. C3142



FRAME CONNECTORS

FRAME CONNECTORS

Bolt-On & Weld-In

- Eliminates bending, flexing and cracking of spot-welded sheet metal panels in unibody cars
- Ties the front and rear frames together creating a solid platform for increased performance levels
- Legal for all classes of Drag Racing
- Bolt On Frame Connectors available in black powder coat finish
- Weld-in frame connectors available in Raw Steel



APPLICATION	ATTACH. METHOD	PART NUMBER	STEEL TUBE DIMENSIONS	STOCK FLOOR PAN MODIFICATION REQUIRED	INSTALLATION NOTES
Camaro, Firebird					
1967-1969	Weld-In	C3012	2" x 2" x .083" wall	Yes	Must be used w/ formed frame rails
1967-1969	Bolt-On	C3112	2" x 1-1/2" x .083" wall	Yes	
1970-1981	Weld-In	C3013	2" x 2" x .083" wall	Yes	Must be used w/ formed frame rails
1970-1975	Bolt-On	C3113	2" x 1-1/2" x .083" wall	Yes	
1976-1981	Bolt-On	C3114	2" x 1-1/2" x .083" wall	No	
1982-1992	Weld-In	C3046	2" x 2" x .083" wall	Yes	Without Ladder Bar Crossmember
1982-1992	Bolt-On	C3111	2" x 1-1/2" x .120" wall	No	Factory exhaust/catalytic converter can't be used
1982-1992	Bolt-On	C3120	2" x 1-1/2" x .083" wall	No	Fits factory exhaust/catalytic converter
1993-2002	Bolt-On	C3108	2" x 1-1/2" x .083" wall	No	Fits factory exhaust/catalytic converter
Chevy II/Nova					
1962-1967	Bolt-On	C3118	2" x 1-1/2" x .083" wall	No	
Nova, Omega, Ventura, Apollo					
1968-1979	Weld-In	C3016	2" x 2" x .083" wall	Yes	Must be used w/ formed frame rails
1968-1979	Bolt-On	C3116	2" x 1-1/2" x .083" wall	No	
Mustang					
1964-1973	Weld-In	C3040	2" x 2" x .083" wall	Yes	Must be used w/ formed frame rails
1964-1970	Bolt-On	C3140	2" x 1-1/2" x .083" wall	No	
1979-1993	Weld-In	C3048	2" x 2" x .083" wall	No	
1979-1993	Bolt-On	C3141	2" x 1-1/2" x .083" wall	No	
2005-2014	Bolt-On	C3142	2" x 1-1/2" x .083" wall	No	
Chrysler "B" Body					
1966-1974	Weld-In	C3047	2" x 2" x .083" wall	Yes	
1966-1974	Bolt-On	C3117	2" x 1-1/2" x .083" wall	No	
Duster, Demon (108" Wheel Base Only)					
1970-1976	Bolt-On	C3115	2" x 1-1/2" x .083" wall	No	
Barracuda					
1967-1969	Bolt-On	C3115	2" x 1-1/2" x .083" wall	No	
1970-1974	Weld-In	C3043	2" x 2" x .083" wall	Yes	
Challenger					
1970-1974	Weld-In	C3043	2" x 2" x .083" wall	Yes	



TECH TIP Our Weld-In Subframe Connectors require the floor pan in most cars to be channeled and

the floor to be welded to the side of the connector. Installing subframe connectors this way utilizes the shear strength of the floor pan, resisting loads in all directions. If you don't wish to cut the floor pan, you can use our bolt-on subframe connectors and weld them in for added strength.

LADDER LINK™ DOUBLE ADJUSTABLE LADDER BAR™

Competition Engineering's Ladder Link™ Double Adjustable Ladder Bar™ is designed so that the user can adjust preload and pinion angle without removal of Part No. C2005. This is accomplished by adjusting the front rod end and/or rear rod ends of the Ladder Bar itself. Includes two unique one-piece brackets which get welded to the rear end housing, cutting down on installation time and errors.

- Comes with two Ladder Bars, NHRA Approved Safety Brackets and hardware
- Adjuster allows quick on-vehicle preload adjustments for changing track conditions
- Contains two one piece 3/16" steel mounting brackets make installation easier
- 33 1/2" overall length
- 1" dia. x .156" wall DOM steel tube construction
- Black powder coat finish
- Rod ends, Front - Chrome Moly Spherical, Rear – Fully Machined Solid
- Welding required
- For use with 3" O.D. Axle Tubes

PART #	DESCRIPTION
C2005	Ladder Link™ Double Adjustable Ladder Bar

PART #	RELATED COMPONENTS
C2019	Ladder Bar Crossmember
C2030	Floating Housing Mount
C6152	Polyurethane Rod End

PART #	REPLACEMENT PARTS
C6011	Front Rod Ends
C6156	Rear Rod Ends-Right Hand Thread
C6157	Rear Rod Ends-Left Hand Thread



SINGLE ADJUSTABLE LADDER BAR

Competition Ladder Bar provides solid connection between rear axle housing and chassis, preventing rear suspension damage from wheel hop

- 33-1/2" overall length
- Contains two, one piece, 3/16" steel mounting brackets
- 1" dia. x .156" wall DOM steel tube construction
- Forged steel rear rod ends
- Welding required
- Rod end safety brackets installed
- Mounting bracket gussets included
- High quality alloy spherical front rod ends
- Black powder coat finish
- For use with 3" O.D. Axle Tubes

PART #	DESCRIPTION
C2006	Competition Ladder Bar

PART #	AVAILABLE OPTIONS
C2019	Ladder Bar Crossmember
C2030	Floating Housing Mount
C6152	Polyurethane Rod End

PART #	REPLACEMENT PARTS
C6011	Front Rod Ends
C6156	Rear Rod Ends - Right hand thread
C6157	Rear Rod Ends - Left hand thread



***NOTE:** Competition Engineering's Ladder Bars are legal for all sanctioning bodies and include the mandatory front rod end safety brace at no additional charge. Additional gusseting material is also included in the kit to allow the rear brackets to be boxed for added strength.



LADDER BARS

FLOATING HOUSING MOUNT

Bolt-On

- Eliminates the bind that occurs when Ladder Bars are installed on leaf spring equipped cars
- The Ladder Bars travel in one arc while the leaf springs travel in a separate, opposing arc
- Isolates the leaf springs from Ladder Bar system making it work properly without unwanted bind
- For use with 3" O.D. Axle Tubes

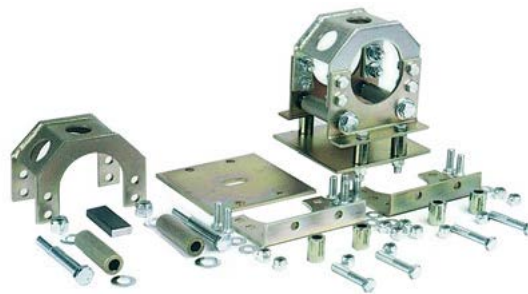

No. C2030

PART #	DESCRIPTION
C2030	Floating Housing Mount, Bolt-On

INSTALLATION IMAGES

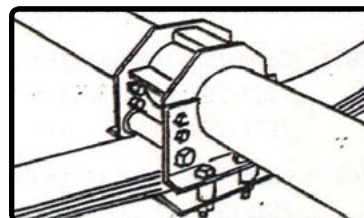
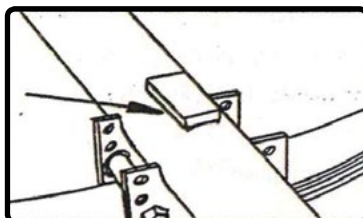
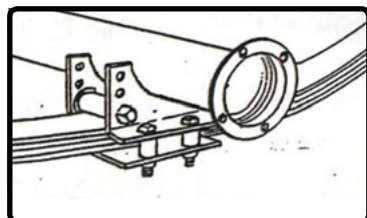
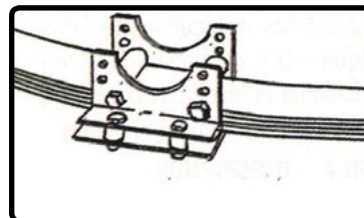
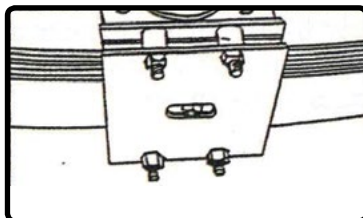
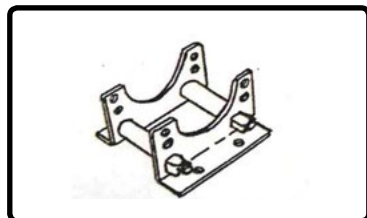

Competition Engineering offers a variety of bolt-on traction devices to meet the needs of both the street enthusiast and the entry level racer. Bolt-on traction devices allow you to handle moderate levels of horsepower without having to weld and fabricate.

Unlike some other brands, our "bolt-on" components fit perfectly for a hassle-free installation. Each part is custom designed for the specific application. Instead of rushing to production, we spend a great deal of engineering time on each product, hand-fitting prototype parts on test cars to ensure proper fit and alignment.

In addition, our bolt-on products are manufactured on sophisticated computer controlled equipment to ensure that all parts are made to extremely close tolerances. The result is a bolt-on traction device that fits perfectly out of the box. This eliminates the additional fabrication and struggling often required when installing so-called "bolt-on" products offered by others.

COMPETITION LEAF SPRING TRACTION BARS

Fits: 1967-69 Camaro, Firebird; 1962-79 Chevy II, Nova; 1973-76 Buick Apollo; 1973-79 Olds Omega; 1971-79 Pontiac Ventura II

- Designed especially for Stock Eliminator and Bracket Race Cars with leaf springs
- Eliminates wheel hop and improves traction by directing force downward where the tire meets the pavement
- Sturdy 2.5" x 1.5" x .120" wall steel tubing handles horsepower levels up to 450 hp
- Fixture welded to ensure a perfect fit for each application
- Bar length designed so that snubber locates under spring eye for maximum traction
- Complete installation hardware included, nothing else to buy
- ½" J-Bolts included in kits where required, ½" U-Bolts supplied to replace stock hardware
- Square U-Bolt bracket on front designed to keep from rotating downward during hard braking
- Available in black powder coat or triple process chrome finishes
- Legal in all sanctioning bodies

PART # DESCRIPTION

C2101 Competition Leaf Spring Bars, Black Powder-Coated. *Fits: 1967-'69 Camaro, Firebird; 1962-'79 Chevy II, Nova; 1973-'76 Buick Apollo; 1973-'79 Olds Omega; 1971-'79 Pontiac Ventura II*



C2201 Competition Leaf Spring Bars, Chrome. *Fits: 1967-'69 Camaro, Firebird; 1962-'79 Chevy II, Nova; 1973-'76 Buick Apollo; 1973-'79 Olds Omega; 1971-'79 Pontiac Ventura II*



C2103 Competition Leaf Spring Bars, Black Powder-Coated
Fits: 1970-'81 Camaro, Firebird

C2109* Competition Leaf Spring Bars, Black Powder-Coated
Fits: 1965-'73 Mustang

PART # AVAILABLE OPTION

C7025 Two Degree Wedge Plates

PART # REPLACEMENT PARTS

C7024 Rubber Bumpers. 2" diameter base. Two/card

C7030 U-bolts, 3" Radius w/ washers & lock nuts. Two/card

C7031 U-bolts, Square w/ washers & lock nuts. Two/card

C7032 J-bolt Kit. Incl. 2-½" J-bolts w/ all necessary standard lock nuts & washers. Two/card

WARNING Prop. 65
This product contains a chemical known to the state of California to cause cancer, birth defects, or reproductive harm-

***NOTE:** U-bolts instead of J-bolts

BOLT-ON TRACTION DEVICES

COMPETITION COIL SPRING TRACTION BARS

Effectively eliminates wheel hop and associated parts breakage

- Designed to provide a high performance alternative to stock factory 4-link suspensions
- Rugged 2" x 2" x .120" wall steel tubing construction withstands power levels found in racing and eliminates flex found in other bars
- Computer-controlled stamping and mandrel-formed brackets ensure a perfect fit
- Adjustable threaded link design allows for fine tuning and infinite adjustability
- Includes all hardware and brackets necessary to complete the installation



PART # DESCRIPTION

C2111 Competition Coil Spring Traction Bars, Black Powder-Coated
Fits: 1968-'77 GM Intermediate: Chevelle, GTO, Cutlass, 442, Skylark, Gran Sport, 1970 Tempest, LeMans, etc.,

WARNING Prop. 65
This product contains a chemical known to the state of California to cause cancer, birth defects, or reproductive harm-

PART # AVAILABLE OPTION

C7025 Two Degree Wedge Plates

PART # REPLACEMENT PART

C7024 Rubber Bumpers. 2" diameter base. Two/card



No. C2096



No. C2097



No. C2099



No. C2100

SLIDE-A-LINK™

- Patented (No. 6,386, 565) design for both street and strip' outperforms conventional "Slapper" bars
- Solid mounted front plate installed inside original front spring pocket and clamps to the leaf spring
- Provides a positive displacement for the torque from the rear axle through telescoping bar and special durometer shock pad
- Includes replacement lower axle mount pads, 1/2" U-bolts, aluminum front spring eye bushings, hardware and instructions
- Offers the adjustability of a 4-link, allowing you to tune for better 60-foot time
- Unlike rigid bars, adjustable link makes on-car pinion angle and preload changes quick and easy
- Mounts to factory locations with no welding required
- Special durometer polyurethane bushing stores energy for more consistent E.T.'s
- Sold in pairs

PART #	DESCRIPTION
C2093	Slide-A-Link™. Fits: 1967-'71 Chrysler B-Body
C2096	Slide-A-Link™. Fits: 1970-'81 Camaro, Firebird
C2100	Slide-A-Link™. Fits: 1967-'69 Camaro, Firebird, 1968-'79 Nova
C2099	Slide-A-Link™. Fits: 1962-'67 Chevy II w/ monoleaf rear springs
C2091	Slide-A-Link™. Fits: 1964-'76 Dodge Duster, Demon, Scamp & Valiant

PART #	DESCRIPTION
C2090	Slide-A-Link™. Fits: 1982-'00 Cheverolet S-10, GMC Sonoma Pickup Truck
C2094	Slide-A-Link™. Fits: 1964-'83 AMC, 1965-73 Ford Mustang, 1968-'74 Javelin
C2097	Slide-A-Link™. Fits: 1982-'00 Chevrolet S10/ S15 Lowered

SLIDE-A-LINK™ WRENCHES

- Two wrenches of correct size to fit Competition Engineering Slide-A-Link™ adjustment nuts
- Can fit under vehicle for easy adjustments in staging lanes
- Manufactured from billet aluminum with large grip handle
- Black anodized for corrosion resistance

PART #	DESCRIPTION
C2199	Slide-A-Link™ Wrenches



No. C2199

SLIDE-A-LINK™ REPLACEMENT BUSHING

For Use With Slide-A-Link™ Traction Devices

- Sturdy Polyurethane
- Two per package

PART #	DESCRIPTION
C9700	Bushing, Replacement for Slide-A-Link™



No. C9700



No. C2017

STANDARD SERIES 4-LINK KIT

Offers enhanced adjustability over a ladder bar suspension for increased performance

By locating the bars with the various mounting holes in the brackets, you can create an instant center that is correct for your application.

Kit Includes:

- 17- $\frac{1}{4}$ " long, 1" dia. x .156" direct threaded links
- Adjusting nuts for quick tuning
- $\frac{3}{16}$ " thick mounting brackets stamped from cold rolled steel
- Includes 4 left and 4 right hand chrome moly spherical rod ends
- $\frac{3}{4}$ " Grade 8, Fasteners and Jam Nuts Included
- Includes complete hardware and instructions
- Welding required
- For 3" Axle Tubes
- Sold in pairs

PART #	DESCRIPTION
C2017	Standard Series 4-Link Kit

PART #	AVAILABLE OPTIONS
C3408	4-Link Chassis Bracket
C2052	Diagonal Link



No. C2028

MAGNUM SERIES 4-LINK KIT

Designed for ultra-high horsepower race cars

Includes $\frac{1}{4}$ " thick housing & frame brackets (most competitors kits have $\frac{3}{16}$ " brackets) with $\frac{5}{8}$ " mounting holes on a 21" radius, with mounting holes for Wheel-E-Bars™, sway bar and shock mounting as well as 1- $\frac{1}{4}$ " holes for additional tube gusseting. We use 1- $\frac{1}{4}$ " O.D. x .095" wall top tube and a 1- $\frac{3}{8}$ " O.D. x .095" wall bottom tube to handle the shock loads without flexing.

Kit Includes:

- All hardware and mounting instructions to ensure an effortless installation
- $\frac{1}{4}$ " thick Axle Bracket w/ integral shock mounting holes saves fabrication time by eliminating separate shock brackets
- Heavy Duty chrome moly steel link tubes and threaded tube inserts for added strength
- 21" mounting radius
- Computer machined threaded tube ends
- 1- $\frac{1}{4}$ " holes provided in brackets for additional gusseting
- For 3" Axle Tubes
- Includes 4 left & 4 right-hand chrome moly spherical rod ends
- Welding required
- Sold in pairs

PART #	DESCRIPTION
C2028	Magnum Series 4-Link Kit

PART #	AVAILABLE OPTIONS
C3421	Magnum Series Front Bracket
C2031	Magnum Series Diagonal Link
C2024	Magnum Series Wishbone

ULTRA MAGNUM 4-LINK KIT

Design offers additional adjustment over standard or traditional style 4-Link Kits for ultra-high horsepower race cars

This innovative Ultra-Magnum 4-Link Suspension Kit provides increased adjustability by incorporating a system of multi-hole brackets that weld to the chassis and bolt-on chassis brackets. Substantial gains in chassis tuning can be obtained with this Ultra Magnum 4-Link Kit.

Kit Includes:

- $\frac{3}{4}$ " x $\frac{1}{2}$ " Chrome Moly rod ends
- 4130 Chrome Moly tubes (.095" wall thickness)
- $\frac{1}{2}$ " NAS quality, flare head bolts & nuts
- Housing brackets with integral anti-roll bar mounts ($\frac{1}{4}$ " plate)
- For 3" Axle Tubes
- Sold in pairs



No. C2029

PART #	DESCRIPTION
C2029	Ultra Magnum 4-Link Kit

FABRICATED REAR AXLE HOUSINGS

- Triangulated design offers increased strength over three piece stock housings
- CAD designed and CNC manufactured in-house
- Offered in 4130 Chrome Moly or Mild Steel
- Exterior welds ground smooth to eliminate stress risers
- 1/4" face plate for added strength
- Face plates accepts 3/8" press-in studs
- Includes drain plug and filler plug
- Carrier Stud Kit **No. C9006** available separately



No. C9100
(Chrome Moly)

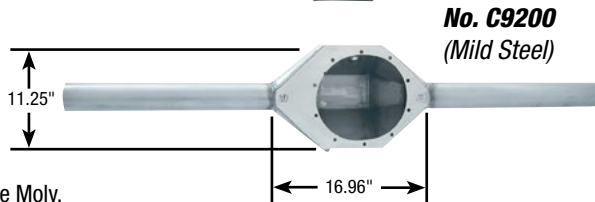

No. C9200
(Mild Steel)

PART # DESCRIPTION

- C9100** Full bodied car with cut-to length 3" dia. axle tubes, Chrome Moly, 60.75" overall length (Mild Steel tubes)
- C9200** Full bodied car with cut-to length 3" dia. axle tubes, Mild Steel, 60.75" overall length

DRAGSTER REAR AXLE HOUSINGS

- Stronger .125" thick sheet metal shell is more accurately produced than any other rear end housings on the market
- Designed with overlapping joints that provide two weld seams to greatly improve strength compared to butt-welded housing shells
- Housing comes in standard 26.00" flange to flange width
- Withstands advanced E.T. applications: internal bulkheads stiffen the shell to the face plates preventing movement and adding strength around the housing mounting brackets
- 3/8" thick face plate is CNC machined after the housing is welded to ensure proper axle alignment to center section
- Includes a -6 AN drain plug, 1/8" NPT fitting for a vent, and an aluminum o-ring filler cap
- All housings have machined symmetrical housing ends
- Carrier Stud Kit **No. C9006** available separately



Rear View



Front View

No. C9004

PART # DESCRIPTION

- C9004** Dragster Housing, Drag, Mild Steel

PART # REPLACEMENT PARTS

- C9085** Rear End Cap, Black Anodized with Logo

9" FORD AXLE HOUSING BRACES

Fits: 9" Ford Heavy-Duty Housings and Competition Engineering Fabricated Housings

9" Ford rear axles are very popular in drag racing because of their light weight and the ability to change gears easily. The only disadvantage to this design is the tendency to flex and bow under hard acceleration. As the pinion rotates, it tries to climb the ring gear. This force tends to flex the rear housing out of shape. To combat this flex, Competition Engineering has designed the 9" Ford Axle Housing Brace. This two piece brace welds directly to the rear housing, triangulating the main housing with the axle tubes to eliminate any flex. By eliminating the flex, you increase the amount of power applied to the tires and improve your ET's as well.

- Eliminates housing flex
- Two piece design makes it easier to install
- CAD designed, CNC manufactured
- Contoured to fit for easier welding
- Made from 1/8" material
- Welding required



No. C9105

PART # DESCRIPTION

- C3405** 9" Ford Axle Housing Brace, Mild Steel
- C9105** Competition Engineering Fabricated Housing Brace, Fits **CE No. C9100** Chrome Moly
- C9205** Competition Engineering Fabricated Housing Brace, Fits **CE No. C9200** Mild Steel

REAR AXLE SPRING PERCHES

When installing a spring perch in a leaf spring car or moving the leaf springs inboard, these Moroso Axle Spring Perches are a necessity.

- Precision stamped for easy weld-on installation
- Fits Ford 9", Dana 60 and other 3" diameter axle housings
- Two per package

PART #	DESCRIPTION
85090	Rear Axle Spring Perches



FORGED AXLE HOUSING, HEAVY DUTY

Whether narrowing a rear axle housing for bigger tires or just building a new housing for your race or street car, you will need housing ends to complete the project. You could re-use the old housing ends but most of the time they are either too rusty or damaged from the removal process.

Axle Housing Ends feature:

- Extra thick flange
- For 3" Axle Tubes
- Sold in pairs
- Welding required
- Forged
- Fully CNC machined

PART #	DESCRIPTION
C9505	Axle Housing Ends, Big Ford w/ .515 dia. bolt holes, Nominal 3.15" Bearing Bore
C9507	Axle Housing Ends, Ford 9" large 3.150" dia. bearing, 3/8" -24 Threaded, Spaced 3.557" W x 2.750"
C9510	Axle Housing Ends, Dana 60 Mopar 8-3/4", 3/8" -24 Threaded, Nominal 2.875" Bearing Bore



NOTE: For use with aftermarket axles and bearings.

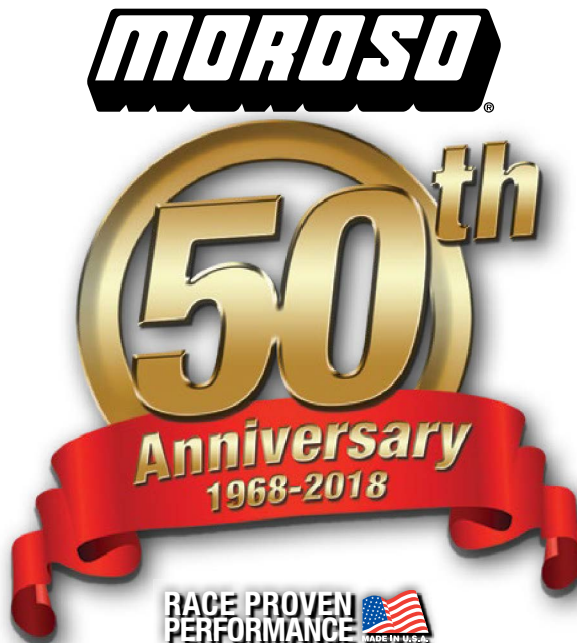

REAR END FILL CAP KIT

- Comes with steel weld bung and O-ring
- Manufactured from 6061-T6 Aluminum, with contoured grip
- Universal kit can be used on rear end housings and steel tanks to replenish fluids

PART # DESCRIPTION
C9085 Rear End Fill Cap Kit, Black Anodized, 1-3/8" -12UNF Threads, 2.6" OD



No. C9085



Rear End Fill Cap on Moroso page 371

AXLE BEARING CONVERSION KIT

Fits: Dana 60 and Chrysler 8-3/4"

- Converts original tapered roller axle bearings to precision ball bearings
- Improves reliability and eliminates the stock load adjuster
- Includes retaining ring and gasket
- One per package

PART # DESCRIPTION
C8008 Axle Bearing Conversion Kit



No. C8008

CARRIER STUD KIT FOR REAR AXLE HOUSINGS

- Designed for our Rear Axle Housings (pg. 400), similar sheet metal housings, or stock-style Ford 9" housings
- Heat treated, Grade 8 steel studs provide solid mounting points for the center section differential
- Manufactured with splined ends, the press-in studs are pulled through from inside the housing
- Includes nuts and copper sealing washers—far superior than steel to prevent seepage and leakage
- Packaged in sets of 10 studs, nuts, and washers

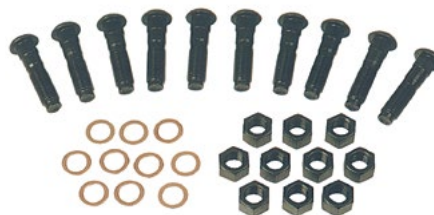

No. C9006

PART # DESCRIPTION
C9006 Carrier Stud Kit

WARNING Prop. 65
 This product contains a chemical known to the state of California to cause cancer, birth defects, or reproductive harm-

REAR AXLE HOUSING VENT

- Reduces internal housing pressure while preventing dirt from entering housing
- Superior quality vent features 1/8" NPT Nickel Plated Steel threads and sintered bronze element for years of dependable service
- Protected low-profile element is recessed, preventing it from being knocked out like stock plastic designs
- Can be used as a replacement for stock vents or adapted to any rear axle housing; ideal for use on narrowed or fabricated housings



No. C3406

PART # DESCRIPTION
C3406 Rear Axle Housing Vent

WARNING Prop. 65
 This product contains a chemical known to the state of California to cause cancer, birth defects, or reproductive harm-

2 DEGREE WEDGE PLATES

- Used to adjust pinion angle or change traction bar angle on leaf spring equipped cars and trucks
- Allows pinion angle change in 2° increments
- Made from 6063-T5 aluminum, they won't crack like cast zinc
- Interlocking ribs allow plates to be stacked without sliding and eliminate unwanted pinion angle change
- Two per package



No. C7025

PART # DESCRIPTION
C7025 2° Wedge Plates



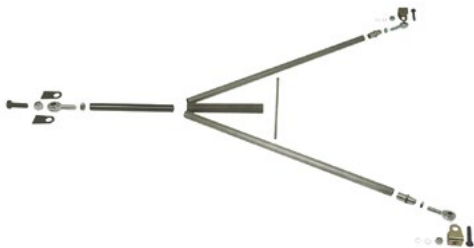

No. C2024



No. C2035

WISHBONE REAR AXLE HOUSING LOCATORS

Eliminates sway in Ladder Bar and 4-Link suspension systems

- Positively locates rear axle housing for super straight launches without binding
- Offered in two different styles: Mild Steel (No. C2035) or Magnum Series Chrome Moly (No. C2024)
- Mild Steel version manufactured from 1" O.D. x .156" wall DOM steel tubing with 3/4" forged solid steel rod ends
- Magnum Series version has overall mounting width of 25" and an overall length of 31-7/16" making it perfect for most Sportsman and Pro Street applications
- Designed with the pro chassis builder in mind, Magnum Series Kit coordinates with our No. C2028 Magnum Series 4-Link
- Magnum Series features chrome moly tubing, precision machined 4130 tube inserts, 5/8" bolt mounting brackets and a centerless ground sliding link with machined wrench flats to ensure a precise fit
- Magnum Kit also includes a high strength 3/4" spherical rod end for the front pivot and high mis-alignment rod ends for the side pivots. The sliding link is black oxide plated to eliminate corrosion and binding.
- Universal design offers you the ability to tailor the overall width and length for your specific application
- Kits include all hardware and all bracketry to complete installation
- Welding required for all kits

PART # DESCRIPTION

- C2024** Wishbone Rear Axle Housing Locator Kit, Unwelded, Magnum Series, Chrome Moly, 5/8" hole (use No. C3423 for 3/4" mounting)
- C2035** Wishbone Rear Axle Housing Locator Kit, Unwelded, Universal, 3/4" hole

DIAGONAL LINKS

Eliminates side-to-side housing movement

- Superior to the Panhard Bar for eliminating sway in Ladder Bar and 4-Link suspensions
- Are available in 4 different versions:
 - Bolt-On Diagonal Link, Part No. C2045 is constructed from 3/4" x .156" wall, 36.5" overall length, mild steel tubing with 1/2" hole mounting brackets
 - Bolt-On Diagonal Link, Part No. C2052 is constructed from 3/4" x .156" wall, 36.5" overall length, mild steel tubing with 3/4" hole mounting brackets
 - Weld-On Diagonal Link, Part No. C2031 is constructed from 1" x .065" wall 36" overall length, chrome-moly tubing with weld-in tube adapters and 5/8" hole mounting brackets
 - Weld-On Diagonal Link, Part No. C2053 is constructed from 1" x .065" wall 36" overall length, chrome-moly tubing with weld-in tube adapters and 1/2" hole mounting brackets
- Length can be shortened to accommodate a narrow chassis
- Left and right hand rod ends allow for on-car adjustments
- Kits include all rod ends and mounting hardware



No. C2031

PART # DESCRIPTION

- C2031** Diagonal link, for 5/8" rod ends, weld-on
- C2045** Diagonal link, for 1/2" rod ends, bolt-on. Works with current style C2005 & C2006
- C2052** Diagonal link, for 3/4" rod ends, bolt-on
- C2053** Diagonal link, for 1/2" rod ends, weld-on. Works with current style C2005 & C2006

PART # REPLACEMENT PARTS

- C3422** 5/8" Clevis Bracket for No. C2031
- C3423** 3/4" Clevis Bracket for No. C2052
- C3431** 1/2" Clevis Bracket for No. C2045, No. C2053



REAR AXLE



No. C2037

PANHARD BAR KIT

- Eliminates side-to-side housing movement of the rear axle housing within chassis
- Keeps your tires from rubbing the wheel openings, making sure you get down the track in a straight line
- Perfect for street driven vehicles
- Includes gusseted mounting brackets and spherical rod ends
- 30" tube length can be trimmed to fit
- Hardware and instructions included to ensure a trouble-free installation
- Welding required

PART #	DESCRIPTION
C2037	Panhard Bar Kit
PART #	AVAILABLE OPTIONS
C2017	4-Link
C2006	Ladder Bar



No. C2139

PANHARD BAR, STREET/STRIP

Fits: Mustang, 2005 - '14

- Bolt-in Panhard Bar perfect for Street/Strip vehicles
- Constructed from tubular steel for light weight and strength
- Polyurethane ends provide less deflection than stock rubber bushings
- Black powder coat finish for long-lasting looks

PART #	DESCRIPTION
C2139	Panhard Bar, Street/Strip



No. C2137

PANHARD BAR FRAME BRACE

Fits: Mustang, 2005 - '14

- Much stiffer than stock stamped piece
- Constructed of 1.25" dia. steel tubing for strength
- Black powder coat finish for long-lasting looks

PART #	DESCRIPTION
C2137	Panhard Bar Frame Brace

LOWER CONTROL ARMS

For Drag/Road Racing
Fits: Mustang, 2005-'14

- Constructed from 4130 (.120" wall) chrome moly tubing
- Adjustability for pre-load, squaring chassis and wheel base
- Eliminates the flex of the factory control arms
- 3/4" Chrome moly rod ends on both ends to increase strength and adjustability
- Comes with high grade 12.9 hardware
- Helps reduce wheel hop, improve traction, cornering and E.T. times
- Durable, glossy, black powder-coated finish
- Instructions included



No. C8010

PART #	DESCRIPTION
C8010	Lower Control Arms, Drag/Road Racing, Adjustable

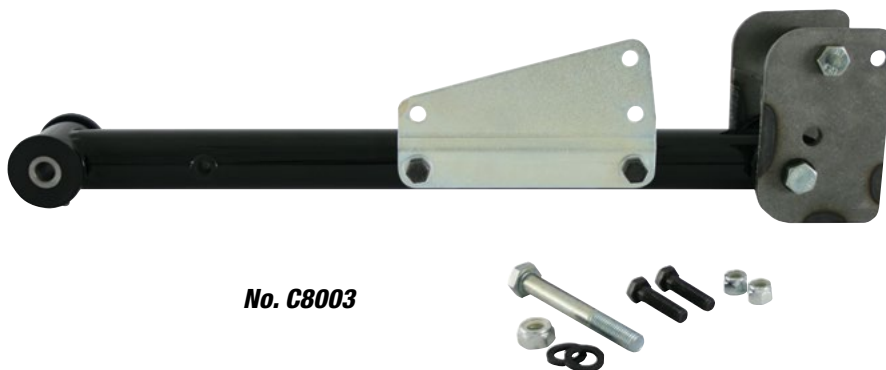

No. C8003

LOWER CONTROL ARMS, REAR

Fits: 1978-'88 G Body GM Intermediates incl. Cutlass, El Camino, Grand National, Grand Prix, Malibu, Monte Carlo, Regal

- Mounting brackets for additional strength and easy install
- Brackets included are for mounting OEM sway bar and most aftermarket sway bars
- Direct bolt-on replacement for stock units
- Controls wheel hop and improves handling
- Improves 60 foot times
- 3-Way adjustable for changing track conditions
- Computer designed and CNC stamped 3/16" thick axle brackets
- High durometer polyurethane bushings with grease fittings for quiet operation
- Finished in black powder-coat
- Sway bar brackets are zinc plated for durability
- Includes all mounting hardware
- Legal for Stock Eliminator Racing
- Welding required

PART #	DESCRIPTION
C8003	Lower Control Arms, Rear



REAR AXLE

UPPER CONTROL ARM MOUNTING PLATE

For Drag/Road Racing

Fits: Mustang, 2005-'14

- Mounting Plate Bolts in place of factory upper control arm mounting plate
- Plates are constructed from 1/4" thick steel, so does not flex like factory mounting plate
- Has two upper control arm mounting positions on each plate for instant center adjustment and pinion angle adjustment
- Durable, glossy, black powder-coated finish



No. C8016

PART #	DESCRIPTION
C8016	Upper Control Arm Mounting Plate

COMPETITION ENGINEERING PRODUCT DEVELOPED AT:

THE DRAG STRIP



AND ON THE ROAD COURSE



UPPER CONTROL ARM, NON-ADJUSTABLE

For Street Use

Fits: Mustang, 2005-'14

- Constructed from 4130 .120" wall chrome moly tubing
- Polyurethane bushings on both ends
- Grease fittings to eliminate squeaks
- Much stronger than stock components to eliminate flex
- Helps reduce wheel hop, improve traction and E.T. times
- Durable glossy black powder coated finish
- Instructions included

PART #	DESCRIPTION
C8019	Upper Control Arm



No. C8019

UPPER CONTROL ARM BUSHING KIT

Fits: Mustang, 2005 - '14

- 88 Durometer Polyurethane bushing and steel sleeves for single upper control arm
- Improves attachment of the upper control arm to the rear end
- Less energy loss by reduced distortion compared to factory soft rubber bushing
- Use with Competition Engineering Upper Upper Control Arm Kit, Street/Strip, Non-Adjustable **No. C8019**

PART #	DESCRIPTION
C8017	Upper Control Arm Bushing Kit

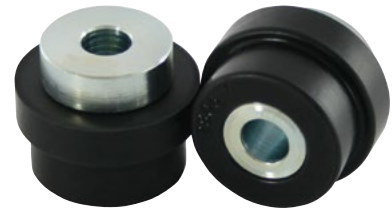

No. C8017

TORQUE BOX REINFORCEMENT PLATES, LOWER

Fits: Mustang, 1979-'04

- Designed to tie lower torque boxes together for increased strength and durability
- Kit includes two stamped steel lower torque box reinforcement plates
- Welding required

PART #	DESCRIPTION
C8015	Torque Box Reinforcement Plates, Lower



No. C8015



REAR UPPER CONTROL ARM SPHERICAL BEARING-BUSHING KIT

Fits: Mustang, 1979-'04

- Constructed from billet aluminum
- Fits Ford 8.8 axle housing
- Eliminates flex and binding, improves handling
- Provides positive location of rear axle housing

PART #	DESCRIPTION
C3168	Arm Bearing-Bushing Kit, Spherical, Rear Upper Control



No. C3168



REAR AXLE

ADJUSTABLE PINION SNUBBER

Fits: Mustang, 1979-'04

- Controls wheel hop in mildly modified 1979-'04 Mustangs and similar Fox bodied cars
- Replaces stock pinion snubber, can be adapted to earlier models without factory snubber
- Easily adjustable in 1/4" increments for different driving situations
- Zinc plated for extended durability

PART #	DESCRIPTION
C2112	Adjustable Pinion Snubber



No. C2112

MUSTANG LOWER CONTROL ARMS

Fits: Mustang 1979-'04, Drag Race/Road Race

- Reduced weight with increased strength
- Adjustable length for squaring axle to chassis
- Spherical rod ends for precise axle control while eliminating suspension bind
- Perfect for drag racing or road racing
- Rear end brackets allow 3-way adjustment for improved performance
- Bolt in installation, includes all hardware

PART #	DESCRIPTION
C8007	Mustang Lower Control Arms



No. C8007

"MAGNUM SERIES" ANTI-ROLL BAR

Universal Application

**No. C2027****Fits:** Tube Frame, Purpose Built and Modified Chassis Drag Race Cars

- Includes a formed, heavy gauge frame mounts, enabling you to install the torsion tube through the frame rails for increased strength
- Billet aluminum arms incorporate special splines to prevent arms from slipping on torsion tube
- Can be adapted to fit any type of race or street application
- Makes it possible to preload the chassis, elimination body roll during hard launches
- Allows the Drag Race car to drive straighter off the starting line, helping to improve 60-foot times
- Features ball bearing pivot point, which makes for smoother functioning and the unit can be disassembled for maintenance
- *Kit includes:* 1-4130 Chrome Moly torsion tube, 2-Adjustable splined billet aluminum arms, 2-Mounting brackets, 2-Adjustable links, 4-Rod Ends, 4-Weld in threaded adjusters, 2-Bearings flange mounted & hardware
- Welding required

PART # DESCRIPTION**C2027** "Magnum Series" Anti-Roll Bars, Universal Application, Rebuildable

MUSTANG ANTI-ROLL BAR

ANTI-ROLL BAR**No. C2021****Fits:** Mustang, 1979-'04, Drag Race

- Includes a tubular style mount enabling you to install the torsion tube through the frame rails for increased strength
- Can be adapted to fit any type of race or street application
- Makes it possible to preload the chassis, eliminating body roll during hard launches
- Allows the car to drive straighter off the starting line, helping to improve 60-foot times
- *Kit includes:* 4130 Chrome Moly torsion tube, 6061-T6 Billet Aluminum arms, threaded adjuster links, mounting tabs and hardware
- Welding required

PART # DESCRIPTION**C2021** "Magnum Series" Anti-Roll Bars, Ford Mustang, Spherical Bearings - Rebuildable

ROD ENDS

- A complete assortment of high quality rod ends to meet your specific application ranging from throttle linkages to suspension arms
- Includes one rod end and one jam nut
- Available in a number of sizes and in both right or left hand threads
- All-steel bodies are available in either carbon steel or chrome moly
- Chrome Moly is highly recommend for use exclusively in our 4-Link and Ladder Bar Suspension Kits; Polyurethane Rod Ends for street applications using Ladder Bars

No. C6011



No. C6009



No. C6150



PART #	MATERIAL DESCRIPTION	THREAD	SHANK & HOLE	STATIC RADIAL LOAD CAPACITY
C6003	Low Carbon Steel	¼" Right Hand	¼" x ¼"	2,225 lbs.
C6004	Low Carbon Steel	⅜" Right Hand	⅜" x ⅜"	5,100 lbs.
C6007	Low Carbon Steel	½" Right Hand	½" x ½"	8,386 lbs.
C6009	Low Carbon Steel	⅝" Right Hand	⅝" x ⅝"	9,813 lbs.
C6010	Low Carbon Steel	⅝" Left Hand	⅝" x ⅝"	9,813 lbs.
C6011	Low Carbon Steel	¾" Right Hand	¾" x ¾"	14,290 lbs.
C6012	Low Carbon Steel	¾" Left Hand	¾" x ¾"	14,290 lbs.
C6130	Chrome Moly Steel	¾" Right Hand	¾" x ¾"	28,090 lbs.
C6131	Chrome Moly Steel	¾" Left Hand	¾" x ¾"	28,090 lbs.
C6160	Extra-Heavy-Duty Chrome Moly	¾" Right Hand	¾" x ⅝"	40,590 lbs.
C6161	Extra-Heavy-Duty Chrome Moly	¾" Left Hand	¾" x ⅝"	40,590 lbs.
C6150*	Forged Steel	¾" Right Hand Solid	¾" x ¾"	26,000 lbs.
C6151*	Forged Steel	¾" Left Hand Solid	¾" x ¾"	26,000 lbs.
C6152	Polyurethane Bushing	¾" Poly	¾" x ¾"	18,500 lbs.
C6156*	Forged Steel	¾" Right Hand	¾" x ½"	18,500 lbs.
C6157*	Forged Steel	¾" Left Hand	¾" x ½"	18,500 lbs.



*Part Nos. C6150, C6151, C6156 and C6157 are not recommended for the front point of 3-Link, 4-Link or Ladder Bar suspension

"MAGNUM SERIES" CHROME MOLY ROD ENDS

The Best Choice for Ladder Bar and 4-Link Applications

- Self-lubricating, self-sealing Rod Ends have increased thickness for greater tensile strength
- Perfect for demanding Motorsports applications
- When loaded, creates metal to metal contact for unsurpassed strength yet when unloaded, the Rilsan® AZM30 injected liner will not rattle or squeak like standard two or three piece rod ends
- Jam nut included

PART #	DESCRIPTION	THREAD	SHANK & HOLE	LOAD CAPACITY
C6014	Chrome Moly Rod Ends	⅜" R/H	⅜" x ⅜"	9,500 lbs.
C6017	Chrome Moly Rod Ends	⅜" L/H	⅜" x ⅜"	9,500 lbs.
C6019	Chrome Moly Rod Ends	½" R/H	½" x ½"	12,696 lbs.
C6020	Chrome Moly Rod Ends	½" L/H	½" x ½"	12,696 lbs.
C6021	Chrome Moly Rod Ends	⅝" R/H	⅝" x ⅝"	14,480 lbs.
C6132	Chrome Moly Rod Ends	⅝" L/H	⅝" x ⅝"	14,480 lbs.
C6133	Chrome Moly Rod Ends	¾" R/H	¾" x ½"	23,256 lbs.
C6153	Chrome Moly Rod Ends	¾" L/H	¾" x ½"	23,256 lbs.
C6154	Chrome Moly Rod Ends	¾" R/H	¾" x ⅝"	23,256 lbs.
C6155	Chrome Moly Rod Ends	¾" L/H	¾" x ⅝"	23,256 lbs.
C6162	Chrome Moly Rod Ends	¾" R/H	¾" x ¾"	23,192 lbs.
C6163	Chrome Moly Rod Ends	¾" L/H	¾" x ¾"	23,192 lbs.



No. C6014



No. C6019

No. C6154

No. C6021

No. C6162



IS THERE A MAINTENANCE PROCEDURE FOR ROD ENDS?

Yes. Before each race, rod ends should be examined for excessive play by moving the bar back and forth and noting any excessive ball movement. Visually inspect the rod ends for any signs of wear, cracks or metal filings. Replace any rod end that exhibits any one of these characteristics.

SHOULD ROD ENDS BE CLEANED PERIODICALLY?

Yes. Routine rod end maintenance should include cleaning and re-oiling. This can be accomplished by removing the rod ends, cleaning them with a solvent (for example, mineral spirits), and allowing them to air dry. Once dry, lubricate the rod ends with good quality 30-weight motor oil. For High Heat Applications, use Synthetic Grease.

BOLT-ON DRIVESHAFT SAFETY LOOP

Universal

- Meets the requirements of all sanctioning bodies of racing
- Will help contain the driveshaft in the event of a U-joint failure, keeping it from digging into the ground and possibly overturning the vehicle
- Simple bolt-together design allows easier installation
- Mounts to the floor pan with four fasteners per side offering increased strength over competitor's loops
- Manufactured from CNC formed 1/4" thick, 2" wide mild steel
- Finished in durable clear zinc plating



No. C3028

PART #	DESCRIPTION
C3028	Bolt-on Driveshaft Safety Loop, Universal

TUBULAR DRIVESHAFT LOOP KIT



No. C3029

- Offers a lightweight, weld-in alternative to the bolt-on driveshaft safety loop
- Can be used in two locations on your vehicle to contain both the front and rear of the driveshaft—highly recommended in vehicles with fabricated sheet metal interiors
- Tubing is mandrel formed from 1.25" O.D. x .083" wall mild steel tubing that is 54" long with a 4" drop center profile
- Kit features a bolt-on loop for easier driveshaft access in cars with removable transmission tunnels
- Removable loop for easy driveshaft removal
- Welding required

PART #	DESCRIPTION
C3029	Driveshaft Loop Kit, Tubular

DRIVESHAFT LOOP KIT

Fits: 1997-'04 Ford Lightning & F-150 Trucks

- Bolt-on design allows easy installation with no modification
- Removable loop for easy driveshaft removal
- Meets the requirements of all sanctioning bodies of racing
- Fits 2-wheel drive trucks w/ steel or aluminum driveshafts
- Will help contain the driveshaft in the event of a U-joint failure, keeping it from digging into the ground and possibly overturning the vehicle
- Made from 1.25" O.D. x .083" wall DOM mild steel tubing
- Finished in durable gloss black powder coating



No. C3090

PART #	DESCRIPTION
C3090	Driveshaft Loop Kit, includes all hardware

DRIVESHAFT LOOPS

Camaro LS, LT, SS, ZL1 2010-'15

- Bolt-on design allows easy installation with no modifications required
- Removable loop for easy driveshaft removal
- Meets the requirements of all racing sanctioning bodies
- Will help contain the driveshaft in the event of a U-joint failure, keeping it from digging into the ground and possibly overturning the vehicle
- Manufactured from heavy-gauge fabricated steel
- Durable gloss black powder finish
- All hardware included



No. C3174



No. C3175

PART #	DESCRIPTION
C3174	Driveshaft Loop, Standard Transmission
C3175	Driveshaft Loop, Automatic Transmission



DRIVESHAFT LOOP*Fits: Mustang 2005-'14*

- Bolt-on design allows easy installation, driveshaft removal unnecessary
- For large diameter aftermarket and O.E.M. driveshafts
- Meets the requirements of all sanctioning bodies of racing
- Will help contain the driveshaft in the event of a front U-joint failure, keeping it from digging into the ground and possibly overturning the vehicle
- Includes quality hardware for loop halves
- Manufactured from mild steel with a long-lasting black powdercoat finish

PART # DESCRIPTION**C3160** Driveshaft Loop, Bolt-on. *Fits: Mustang 2005-'14***No. C3160****DRIVESHAFT LOOP***Fits: Chrysler LX, Automatic Transmission Only, 2005-'18*

- For Chrysler chassis cars—Challenger, Charger, Magnum and 300C
- Bolt-on design allows easy installation with no modifications required
- Removable loop for easy driveshaft removal
- Meets the requirements of all sanctioning bodies of racing
- Will help contain the driveshaft in the event of a front U-joint failure, keeping it from digging into the ground and possibly overturning the vehicle
- Manufactured from 1.25" O.D. x .095" wall DOM mild steel tubing
- Finished in durable gloss black powder coating
- All hardware included

PART # DESCRIPTION**C3161** Driveshaft Loop. *Fits: Chrysler LX, Automatic Transmission Only***No. C3161****DRIVESHAFT LOOP***Fits: Dodge Challenger SRT8®, 2009-'11, Standard Transmission*

- Bolt-on design allows easy installation with no modifications required
- Removable loop for easy driveshaft removal
- Meets the requirements of all racing sanctioning bodies
- Will help contain the driveshaft in the event of a front U-joint failure, keeping it from digging into the ground and possibly overturning the vehicle
- Manufactured from heavy-gauge fabricated steel
- Durable, gloss black powder finish
- All hardware included

PART # DESCRIPTION**C3162** Driveshaft Loop**No. C3162**

TRANSMISSION CROSSMEMBERS

- Allows quick and easy transmission installation and removal
- Includes 42" x 1-5/8" x .134 wall EWT tube, four mounting tabs (flat) and four mounting tabs (concave) with all hardware

PART #	DESCRIPTION
C3600	Transmission Crossmember, Universal, Un-welded
C3601	Transmission Crossmember, Universal, Un-welded with 3-1/2" offset



No. C3601

TRANSMISSION CROSSMEMBER BUSHINGS

Fits: Mustangs, 1979-'93

- The solid aluminum bushings act as a chassis stiffening device, helping to increase E.T. consistency
- They replace rubber bushings in factory crossmember
- No modifications or welding required

PART #	DESCRIPTION
C3610	Transmission Crossmember Bushings

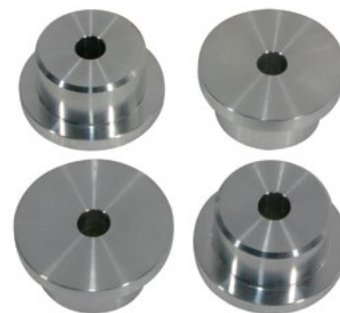

No. C3610



Competition Engineering by Moroso has developed 2005-up Mustang bolt-in components both racers and enthusiasts deserve. These direct replacement products eliminate weakness and improve performance.

So, what are you waiting for?

<p>PANHARD BARS SOLID & ADJUSTABLE</p> <p>C2137 C2138 C2139</p>	<p>LOWER CONTROL ARMS CHROME MOLY - SOLID & ADJUSTABLE</p> <p>C8009</p>	<p>DRIVESHAFT LOOP DRIVESHAFT REMOVAL UNNECESSARY!</p> <p>C3160</p>
<p>COMPETITIONENGINEERING.COM 80 Carter Drive, Guilford, CT 06437 • 203.453.5200</p>		
<p>RACE PROVEN PERFORMANCE MADE IN U.S.A.</p>		

TRANSMISSION MOUNTS

Competition Engineering's 3-Way **Adjustable Drag Shocks** are designed to allow the racer to dial-in the race car to meet changing track conditions. Shock valving plays a very important role in the way your car will perform both during initial launch and throughout the quarter mile.

The principle behind our shock absorber design is to allow the front end of the race car to rise rapidly upon initial launch, creating greater weight transfer and better traction to the rear tires. As the car travels down the track, the front end will gradually descend to its ride height without unloading the rear tires which is a major cause of wheel spin. Our rear shocks work in conjunction with our front shocks making the transition from initial launch to top end charge as smooth as possible.

Competition Engineering's **Rear Drag Shocks** can be adjusted for changing track conditions by simply compressing and turning the shock. For slick tracks, set to the 50/50 adjustment; on good tracks, set to the 70/30 for better weight transfer.

Competition Engineering's **Front Drag Shocks** are adjustable in three ratios: 90/10, 80/20 and 60/40. These ratios reflect the percentage of force required to extend and compress the shock absorber. You can quickly change the valve setting by simply compressing the shock fully and rotating the shaft until the indexing notch mates with the desired setting on the body. **It's as simple as twist and click.**

Our **Rear Drag Shocks** are also adjustable in three ratios: 70/30, 60/40 and 50/50. These ratios also represent the percentage of force required to compress and extend the shock unit. Only this time, the first number is compression and the second extension. These shocks also adjust by compressing them fully and rotating to the desired setting on the body.

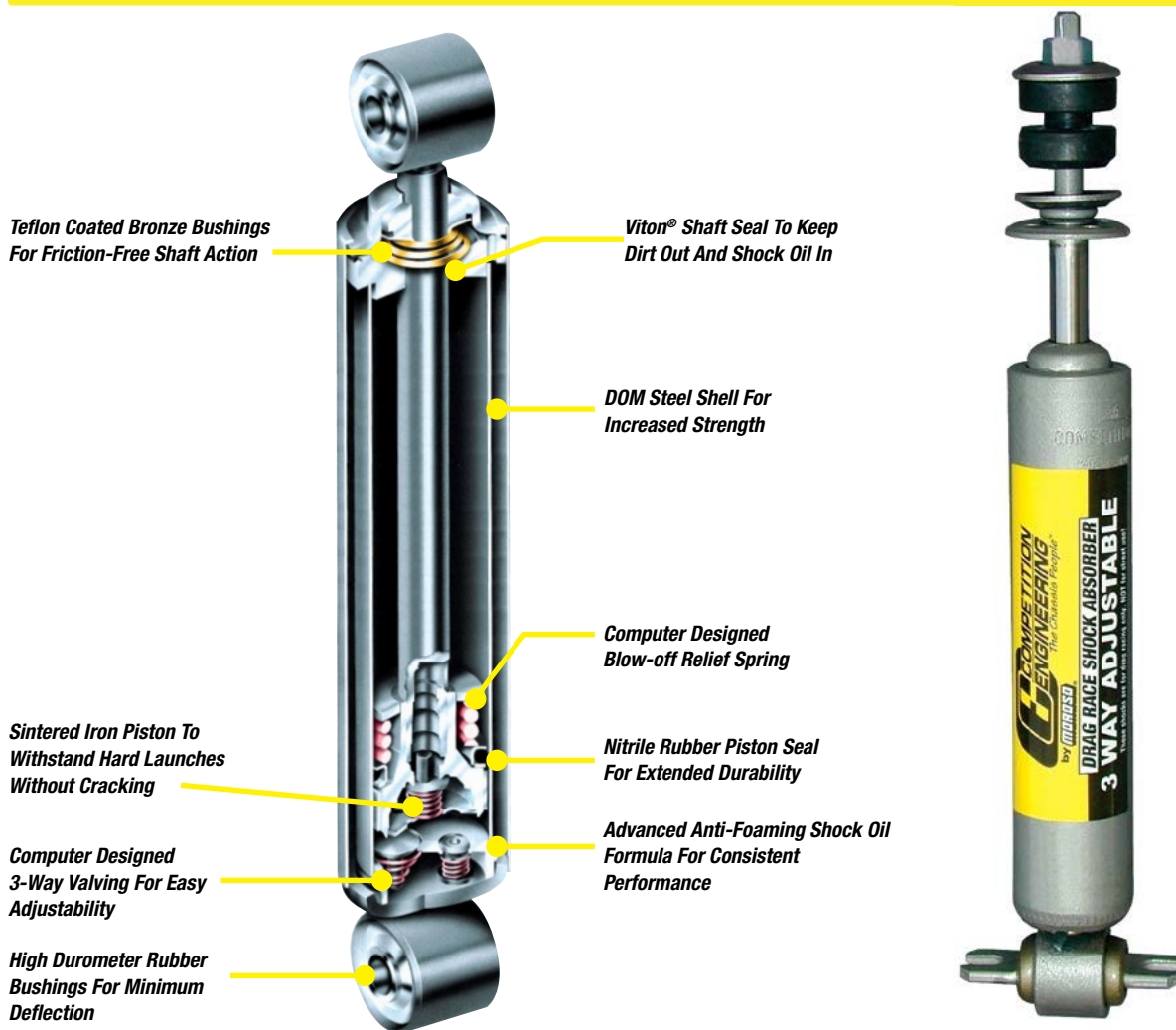

No. C2600

⚠ **WARNING Prop. 65**
This product contains a chemical known to the state of California to cause cancer, birth defects, or reproductive harm.

NOTE: These shocks are designed for DRAG RACE use only! Not for street use.

SHOCK APPLICATION CHART

MAKE & MODEL	YEAR	FRONT SHOCKS	REAR SHOCKS	MAKE & MODEL	YEAR	FRONT SHOCKS	REAR SHOCKS
AMERICAN MOTORS				FORD			
Ambassador, Classic, Matador, Rebel	1978-70 1969-62	C2640*	C2700*	Mustang II / Pinto	1978-74	C2639*	
American, Rambler	1969-64		C2700*	Ranchero	1979-72 1971-60	C2610* C2640*	C2700* C2740*
AMX	1980-78	C2640*		Ranger	2005-99 1998-90 1989-83	C2647* C2646* C2645*	
AMX, Javelin	1974-70 1969-68	C2640*	C2700* C2700*	Thunderbird	1988-87 1979-67	C2806* C2610*	C2700*
Concord, Gremlin, Hornet, Spirit	1983-70	C2640*		MERCURY			
Eagle	1988-80	C2640*	C2700*	Capri	1986-79	C2806* C2630*	C2750* C2740*
CHRYSLER/DODGE				Comet	1977-71 1969-60	C2630* C2640*	C2740*
Challenger	1974-70	C2620*	C2730*	Cougar	1982-80 1979-74 1973-71 1970-67	C2806* C2610* C2640* C2630*	C2750* C2700* C2740* C2740*
Charger, Coronet	1978-73 1972-65	C2620* C2620*	C2730*	Full Size	1986-65	C2610*	C2700*
Cordoba	1976-75		C2730*	Montego	1976-72 1971-68	C2610* C2640*	C2700* C2740*
Dakota	1992-87	C2600*		GENERAL MOTORS			
Dart, Demon, Swinger	1976-64	C2620*	C2735*	BUICK			
Dodge Truck, Ram 50	1992-79	C2600*		Apollo without H.D. Suspension	1980-74 1973	C2600* C2600*	C2720* C2720*
Full Size	1978-74 1964-57		C2730* C2730*	with H.D. Suspension	1973 1972-68	C2600* C2600*	C2720* C2720*
Lancer, Monaco	1978-62 1962-61	C2620* C2620*	C2730* C2730*	Century	1981-73	C2600*	C2720*
Magnum XE	1979-77	C2620*	C2730*	Full Size	1984-71	C2610*	
PLYMOUTH				Full Size Wagon	1986 1985-71	C2610*	C2700* C2700*
Barracuda	1974-70 1969-64	C2620* C2620*	C2730* C2735*	Regal	1987-73	C2600*	C2720*
Belvedere, Fury, Savoy	1970-62	C2620*	C2730*	Riviera	1978-71	C2600*	C2720*
Belvedere, Satellite	1974-73 1972-65	C2620* C2620*	C2730* C2730*	Skyhawk	1980-75	C2600*	
Valiant, Duster, Sport Scamp	1976-64	C2620*	C2735*	Skyhawk, Special	1979-68 1967-64	C2600* C2610*	C2720* C2720*
GTX	1970-67	C2620*	C2730*	CHEVROLET			
Road Runner	1975-68	C2620*	C2730*	S-10 Blazer 2WD, S-10 Pickup	2004-82	C2600*	C2720*
FORD				Caballero, El Camino	1987-68 1967-64	C2600* C2610*	C2720* C2720*
Elite, Fairlane, LTD II, Torino	1979-72 1971-65	C2610* C2640*	C2700* C2740*	Camaro	2002-93 1992-82 1981-70 1969-67	C2610* C2600*	C2700* C2700* C2710* C2700*
Falcon	1970-66	C2640*	C2700*	Chevelle, Malibu	1983-68 1967-64	C2600* C2610*	C2720* C2720*
Full Size	1986-65 1959-57	C2610* C2610*	C2700* C2740*	Chevette	1987-76		C2700*
Granada	1982-81 1980-75	C2806* C2640*	C2750*				
Maverick	1977-70	C2630*					
Mustang, Fairmont	2004-79 1973-71 1970-65	C2806* C2640* C2630*	C2750* C2740* C2740*				

⚠️ **WARNING Prop. 65**

This product contains a chemical known to the state of California to cause cancer, birth defects, or reproductive harm.

***90/10 Drag Strut - Not Adjustable**



HAVE YOU BEEN EXPERIENCING BAD WHEEL HOP WITH YOUR LEAF SPRING OR COIL OVER STREET/STRIP VEHICLE?

While there are many factors in determining why your car may be experiencing excessive wheel hop, we have found that weak springs and old, worn out shocks play a key role. Check your springs and shocks at least once a year for excessive wear. Worn out springs and bad shocks do not supply enough dampening to counter act the effects of spring wind up or weight transfer upon initial launch to effectively plant your tires. In turn they will cause wheel hop.



SHOCKS



SHOCKS

MAKE & MODEL	YEAR	FRONT SHOCKS	REAR SHOCKS	MAKE & MODEL	YEAR	FRONT SHOCKS	REAR SHOCKS
CHEVROLET (CON'T)				PONTIAC			
Chevy II, Nova without H.D. Suspension with H.D. Suspension with Monoleaf Rear Springs with Multileaf Rear Springs	1979-74	C2600◊	C2720◊	Astre	1977-75	C2600◊	
	1973	C2600◊		Bonneville	1986-82	C2600◊	C2700◊
	1973	C2600◊		Firebird	2002-93		C2700◊
	1972-68	C2600◊			1992-82		C2700◊
	1972-68	C2600◊			1981-70	C2610◊	C2710◊
1967-62	C2605◊	C2705◊	1969-67	C2600◊	C2700◊		
Corvette	1982-63	C2610◊	C2700◊	Full Size	1986-63	C2610◊	C2720◊
	1962-53			Grand Am	1981-68	C2600◊	C2700◊
Full Size	1986-65	C2610◊	C2720◊	Grand Prix	1987-69	C2600◊	C2720◊
	1957-55	C2610◊		1968-62	C2610◊	C2700◊	
Monte Carlo	1988-70	C2600◊	C2720◊	GTO	1973-67	C2600◊	C2720◊
Monza	1980-75	C2600◊		LeMans, Tempest-1970	1981-67	C2600◊	C2720◊
Truck, Full Size	2007-88	C2616◊		Sunbird	1992-76		
	1987-73	C2615◊					
Vega	1977-72	C2600◊					
OLDSMOBILE				Ventura II with H.D. Suspension with Multileaf Rear Springs	1977-71 1973 1972-71	C2600◊	C2720◊ C2720◊ C2720◊
Cutlass, F85 without H.D. Suspension with H.D. Suspension	1988-68	C2600◊	C2700◊	ISUZU			
	1967-64		C2720◊	Impulse	1989-83		C2700◊
1967-64	C2700◊	TOYOTA					
Full Size	1986-71	C2610◊	C2720◊	Corolla	1983-77		C2700◊
Full Size Wagon	1992-77	C2610◊	C2720◊	Corona Mark II	1976-72	C2600◊	C2700◊
	1990-65	C2610◊		Corona	1978-74	C2600◊	C2700◊
Omega	1979-73	C2600◊	C2720◊	1973-65			
Starfire	1980-75	C2600◊		1964-61		C2720◊	
Toronado	1978-71		C2720◊	Celica	1977-73		C2700◊

*90/10 Drag Strut - Not Adjustable

WARNING Prop. 65
This product contains a chemical known to the state of California to cause cancer, birth defects, or reproductive harm-
www.P65Warnings.ca.gov



HOW TO ADJUST COMPETITION ENGINEERING DRAG RACING SHOCKS

PLEASE NOTE: Before installation Competition Engineering Shocks need to have their shock ratio adjustment set.
The Shock Ratio represents the percentage of force required to compress the shock compared to the force required to extend it.
BEFORE INSTALLATION FOR THE FIRST TIME OR BEFORE ADJUSTMENT THE FOLLOWING PROCEDURE SHOULD BE FOLLOWED:

1. Upon removal of the shock from its packaging, it is important to "purge" the shock of any air that may be trapped inside during shipment. Skipping this step can make the shock feel as if it is not functioning properly. To purge the shock, simply hold it so that it points up and down and completely cycle it 12-15 times.
2. To begin making adjustment changes once the shock has been purged, you must compress the shock **completely**. On the inside of the shock, at the bottom of the adjuster is a small pawl. This pawl must make contact with the bottom of the shock body or it will not turn, and in doing so not change the settings of the shock. Keep in mind that you must have the shock pointed straight up while making adjustments to avoid aerating it.
3. With the shock still compressed and in the upright position, begin turning the shaft in the **clockwise** direction. This is where you will notice a series of clicks. Pay attention to these clicks and you will notice that one is more pronounced than the others. This is the key to properly setting the shock adjustment. This louder, more pronounced click is the beginning of the settings and should be considered the "R" or regular setting. The following series of softer clicks will be the "F" or firm setting, and finally the "XF" or extra firm setting. When turning the shaft to make adjustments, remember that you can only go clockwise. If you feel like you have missed the setting you were looking for do not worry, just keep turning the shaft until you hear the loudest click and you will be back to the default setting and can begin making shock adjustments.

As an example:

If you wanted to find the XF setting, you would go through all the steps mentioned and while listening for the clicks, you would hear a loud click and then two softer clicks.

This would be similar for the F setting, the loudest click and then one soft click.

Something else to keep in mind when making adjustments:

Trying to gauge the setting of the shock by compressing it in your hand and feeling the difference in Compression is not advised. Though you can compress the shock, you will not be able to simulate the weight of a vehicle or the speed at which it can cycle the shock. If you continually try to check adjustment by hand, it can cause the shock to aerate and feel inconsistent.

The only true way to verify adjustment of the settings is to record the vehicle at the track or to test the piece on a shock dynamometer

Adjustment Chart - Shock Ratio

SETTINGS	FRONT SHOCKS	REAR SHOCKS
R	60/40	50/50
F	80/20	40/60
XF	90/10	30/70

FRONT SHOCKS SPECIFICATIONS CHART

PART NUMBER	EXTENDED LENGTH	COLLAPSED LENGTH	DIAMETER	UPPER MOUNT	LOWER MOUNT
C2600	14.10"	9.00"	1.63"		
C2610	15.34"	9.62"	1.63"		
C2616	17.31"	12.56"	2.0"		
C2647	20.7"	15.9"	2.0"		
C2605	16.50"	11.00"	1.63"		
C2640	14.34"	9.24"	1.63"		
C2620	16.84"	10.37"	1.63"		
C2639	13.86"	10.56"	1.53"		
C2645	17.22"	12.22"	2.0"		
C2646	16.96"	12.21"	2.0"		
C2630	15.02"	9.80"	1.63"		
C2615	14.73"	9.63"	2.0"		

WARNING Prop. 65
 This product contains a chemical known to the state of California to cause cancer, birth defects, or reproductive harm.

REAR SHOCKS SPECIFICATIONS CHART

PART NUMBER	EXTENDED LENGTH	COLLAPSED LENGTH	DIAMETER	UPPER MOUNT	LOWER MOUNT
C2700	21.69"	12.84"	1.63"		
C2705	19.50"	12.35"	1.63"		
C2710	22.43"	13.21"	1.63"		
C2720	22.87"	13.65"	1.63"		
C2730	23.62"	14.15"	1.63"		
C2755	16.41"	10.44"	1.63"		
C2735	24.50"	14.50"	1.63"		
C2740	20.16"	11.81"	1.63"		
C2750	21.65"	13.29"	1.63"		



90/10 DRAG STRUTS

No. C2806

Unlike so-called "racing" struts that use stock dampening valving, Competition Engineering's Drag Struts feature a true 90/10 ratio. This race-proven dampening allows the front end to lift quickly for instant weight transfer to the rear tires. Plus, the design provides increased resistance when the front end descends, preventing the rear tires from unloading and maximizing traction.

- Gas charging reacts faster, eliminates foaming and won't fade like hydraulic designs
- Computer designed valving for consistent performance under severe racing conditions
- Micro-polished 7/8" dia. hard-chrome shaft reduces friction for faster reaction
- Bolt-In replacement for easy installation
- One per package

PART # DESCRIPTION

C2806◊ 90/10 Drag Struts
Fits: 1979-'93 Mustang, 1987-'88 Thunderbird, 1979-'86 Capri, 1980-82 Cougar, 1978-'83 Fairmont

◊ **WARNING Prop. 65**
 This product contains a chemical known to the state of California to cause cancer, birth defects, or reproductive harm-

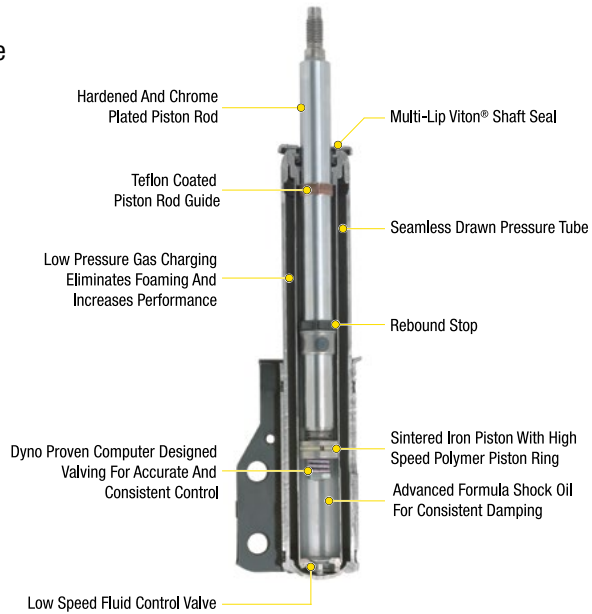

MAGNUM SERIES REAR COIL-OVER SHOCK

"MAGNUM SERIES" REAR COIL-OVER SHOCK ABSORBER

Competition Engineering's Rear Coil-Over Shocks are a part of our Magnum Series, a line of professional-grade products engineered for maximum performance and durability. They feature 12 settings, allowing you to tune the suspension from soft to firm with a simple turn of the knob.

- All-aluminum billet housing is CNC machined with a black anodized body
- Spring seats are adjustable for preload and accept 2-1/2" I.D. springs
- 5/8" hardened chrome piston rod provides superior strength
- Advanced sealing reduces drag for faster reaction
- Includes two 1" wide spherical mounting bearings with locking snap rings
- 17" extended height; 13-3/4" to 14-5/8" recommended ride height; 11-3/4" compressed height
- One per package
- Springs not included

PART # DESCRIPTION

C2770◊ "Magnum Series" Rear Coil-Over Shock Absorber

◊ **WARNING Prop. 65**
 This product contains a chemical known to the state of California to cause cancer, birth defects, or reproductive harm-

SEE MORE
For Spring Choices on page 422



No. C2770

COIL-OVER SHOCK KIT

Adjustable

- Kit includes: 3-Way Adjustable Shocks, Upper Mounts, Adjustable Lower Mounts, Threaded Sleeve, Spring Cap, Seat and Hardware
- Universal design allows installation on a variety of chassis
- 3-Way Adjustable shocks provide controlled squat at the rear for improved weight transfer and traction
- Lower shock mounts have 6" of adjustment in one-half inch increments to suit ride height requirements
- Lower shock mounts are zinc plated and the threaded sleeve, spring cap and seat are anodized for corrosion resistance
- Fits housings with 3" O.D. axle tubes
- Springs not included
- Adjustable spring seat with locking set screw allow the spring rate to be finely tuned
- Use with Competition Engineering Rear Coil-Over Springs depending on specific rear-end weight, accepts 2.5" I.D. Spring
- Sold in pairs

PART # DESCRIPTION
C2765 Coil-Over Shock Kit, Adjustable

 **WARNING Prop. 65**
 This product contains a chemical known to the state of California to cause cancer, birth defects, or reproductive harm-

SEE MORE
For Spring Choices on page 422



No. C2765

UNIVERSAL LOWER SHOCK MOUNTS

- Created for relocating non coil-over shocks when the rear frame rails have been moved inboard
- Manufactured from .25" mild steel
- Fits housings with 3" O.D. axle tubes
- 1/2" bolt hole
- Four per package
- Accepts "eye" shock mount
- Welding required
- Fits all axle tube diameters

PART # DESCRIPTION
C3170 Universal Lower Shock Mounts



No. C3170

MORE TABS & BRACKETS

Are on pages 447-452 to help you create your own shock mounting options!



Lower Coil-Over Shock Mounting Brackets
No. C3417



Coil-Over Housing Bracket
No. C3414



Shock Mounting Bracket
No. C3413



Heavy Duty Flat Chassis Brackets
No. C3434



SHOCKS

REAR COIL-OVER SHOCK KIT

- Universal design allows installation on a variety of chassis
- Complete kit includes 3-Way Adjustable Shocks, Upper Mounts and Adjustable Lower Mounts
- 3-Way Adjustable Shocks provide controlled squat at the rear for improved weight transfer and traction
- Lower Shock Mounts have 6" of adjustment in ½" increments to suit ride height requirements
- Lower Spring Perches and Shock Mounts are zinc plated for corrosion resistance
- Fits housings with 3" O.D. axle tubes
- Use with Competition Engineering Rear Coil-Over Springs depending on specific rear-end weight, accepts 2.5" I.D. Spring
- Sold in pairs; replacement shocks sold separately

PART # DESCRIPTION**C2051** Rear Coil-Over Shock Kit**PART # REPLACEMENT PARTS****C2755** Replacement Shock Absorber, each**C3420** Replacement Shock Mounts**NOTE:** Coil Springs not included.

WARNING Prop. 65
 This product contains a chemical known to the state of California to cause cancer, birth defects, or reproductive harm-

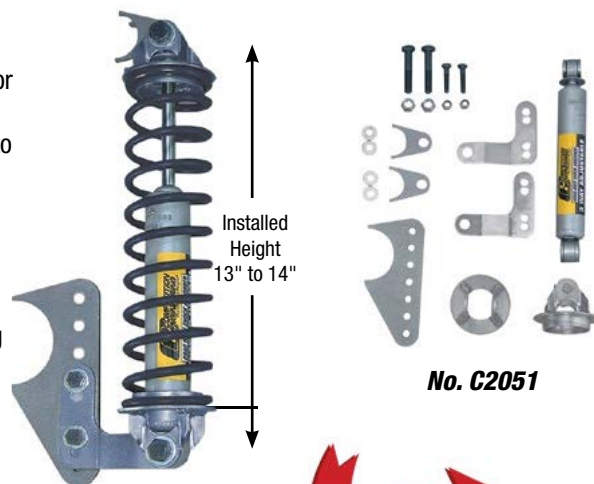
**No. C2051**

For Spring Choices
 on page 422

LOWER COIL-OVER SHOCK MOUNT KIT

- Designed to be used either by itself or in conjunction with our Upper Coil-Over Shock Mount Kit
- Provides a solid, adjustable mounting point for racing coil-over shocks
- Fits housings with 3" O.D. axle tubes
- Allows 6" of height adjustment in ½" increments
- ¼" thick housing brackets, ⅜" thick shock brackets
- Fits most popular coil-over shocks
- Includes Grade 8 hardware and spacers for mounting two shocks
- Welding required

PART # DESCRIPTION**C2047** Lower Coil-Over Shock Mount Kit**PART # REPLACEMENT PARTS****C3417** Coil-Over Shock Bracket, Right**C3419** Coil-Over Shock Bracket, Left**C3414** Coil-Over Housing Bracket**No. C2047****COIL-OVER SHOCK ADJUSTING TOOL**

- Makes adjusting coil-over shocks much easier than the commonly used hammer and screwdriver method
- Works with Moroso, Avo, Hal, Koni, Bilstein, Carrera, Monroe and most other coil-over shocks with adjusting nuts up to 3-¼" diameter
- Manufactured of cast steel with finger indents for sure grip operation

PART # DESCRIPTION**62030** Coil-Over Shock Adjusting Tool**No. 62030**

REAR COIL-OVER MOUNT KIT

Fits: 1979-'04 Mustang, Without Shocks & Springs

- Designed specifically to improve traction and handling
- Upper and lower shock mounts to fit stock rear locations
- Bolt-in design with no welding or fabricating needed
- Includes all hardware and spacers

PART #	DESCRIPTION
C2056	Rear Coil-Over Mount Kit

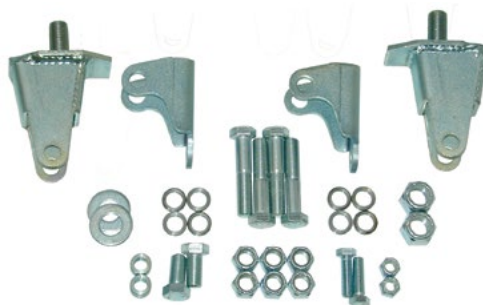

No. C2056

REAR SHOCK CROSSMEMBER

Fits: 1967-'69 Camaro, Firebird

- Required with **No. C2032** Offset Spring Hanger installation
- Ties rear subframe together for increased strength
- Relocates shocks inboard of frame
- Provides solid mounting point for rear shocks
- Welding required

PART #	DESCRIPTION
C3019	Rear Shock Crossmember



No. C3019

NOTE: Crossmember may be shortened 1" to fit 1968-72 Nova, 1971-72 Ventura and 1970-81 Camaro, Firebird.

UPPER COIL-OVER SHOCK MOUNT KIT

- Works in conjunction with our Lower Coil-Over ShockMount Kit **No. C2047** to provide a solid mounting point
- Designed to mount between the rear frame rails on any Drag Race, Pro Street or Street Rod application
- Lightweight, tubular design makes it perfect for mounting shocks when "back-halving" a vehicle
- Includes one 40" long x 1.625" dia. mounting tube, ¼" thick mounting brackets, 4 shock mount tabs, 4 shock spacers for older style coil-over shocks and all mounting hardware
- Fits most popular coil-over shocks
- Welding required

PART #	DESCRIPTION
C2046	Upper Coil-Over Shock Mount Kit



No. C2046



SHOCKS

REAR COIL-OVER SPRINGS

- Each spring is computer designed for specific rear end weights to establish the correct ride height and to allow the full range of suspension travel
- Maximizing the full potential of the springs based on vehicle weight provides optimum weight transfer, rear axle control and traction
- Manufactured on precise CNC equipment for superior accuracy and uniform spring rate from one spring to another
- Premium grade chrome silicon steel extends durability and maintains correct spring rate and ride height after repeated hard launches
- Powder coating provides an attractive finish and helps extend spring life
- Spring dimensions: 2.5" I.D. x 12" long
- Sold in pairs



No. C2550

REAR COIL-OVER SPRINGS APPLICATION CHART

PART NUMBER	SPRING RATE LBS./INCH	TOTAL WEIGHT ON REAR WHEELS
C2550	85	Under - 1050 lbs.
C2555	100	1050 - 1150 lbs.
C2560	125	1150 - 1250 lbs.
C2565	150	1250 - 1450 lbs.
C2570	200	1450 - 1800 lbs.

PROGRESSIVE WOUND REAR SPRINGS, 12", 100-200 LBS.

An excellent choice for multiple applications

- For vehicles of unspecified weight (under 3,400 lbs. total)
- Progressive design reduces rate of compression, making it less likely for vehicle to "drive up" on the tire during violent wheel stands — as the vehicle pitch rotates the weight to the rear wheels, this compresses the spring making it more conducive to lifting the front end
- Progressive springs compensate for added rear weight in Street Rods and Pro-street Cars using a back seat
- Sold in pairs

PART # DESCRIPTION

C2575 Progressive Wound Rear Springs, 12", 100-200 Lb.



No. C2575

OFFSET SPRING HANGERS

Fits: 1967-'69 Camaro, Firebird; 1962-'67 Chevy II; 1968-'74 Nova; 1971-'72 Ventura

- Created for Super Stock classes, designed to relocate the rear of the leaf springs inboard 4" for additional tire clearance
- An additional 2-1/2" of tire clearance can be had by relocating the front of the leaf springs inboard and modifying both the axle mounting pads and the inner fenderwell
- Allows you to accommodate a 13"-14" racing slick
- OEM gas tank needs to be narrowed 2", or use a fuel cell

PART # DESCRIPTION

C2032 Offset Spring Hangers, Two per package



No. C2032

NOTE: Some welding required. Not for use with weld-in frame connectors.





No. C2148

UNIVERSAL 80" SINGLE WHEEL-E-BAR™ KIT

Competition Engineering has designed a single wheel Wheel-E-Bar™ kit that is perfect for both the professional and amateur chassis builder. The lower tube and wheel pocket are fixture welded in house for perfect alignment while still allowing the builder to trim it to any desired length. The 1" O.D. x .065" wall chrome moly tube is strong yet lightweight, while the two hi-misalignment rod ends allow the bar to adjust to any rear axle housing without the need for a tubing bender. Each kit comes with all the necessary hardware and a detailed set of instructions.

- Extra Long Bar Improves Chassis Reaction Times
- Designed to Fit Any Application
- Includes All Necessary Hardware

- Strong, Lightweight Chrome Moly Construction
- Hard Plastic Wheel with Steel Bearings for Long Life
- Welding Required

PART #	DESCRIPTION
C2148	Universal 80" Single Wheel-E-Bar™ Kit

PART #	REPLACEMENT PART
C7060	Replacement Wheel

UNIVERSAL 60" WHEEL-E-BAR™ KITS

These Universal Wheel-E-Bar™ Kits allow the professional chassis builder to fabricate bars to fit a specific vehicle. Each kit is available in mild steel with a choice of sprung or unsprung versions. The 60" long tubes can be cut to the desired length to suit individual needs. As an added feature, each kit includes the necessary material to install an upper crossbrace for increased strength. Wheel-E-Bars™ are designed to mount to existing 4-Link or Weld-On Housing Brackets.

- Longer bar improves chassis reaction times
- Mild steel tubing
- Designed for 28" housing mounting width
- Hard plastic wheels with steel bearings for long life
- Material included for x-brace installation
- Welding required
- Housing Brackets sold separately **No. C7048**

PART #	DESCRIPTION
C2140	Universal 60" Wheel-E-Bar™ Kit, Unsprung, Seamless Steel Tubes
C2145	Universal 60" Wheel-E-Bar™ Kit, Sprung, Seamless Steel Tubes

PART #	AVAILABLE OPTIONS
C7048	Axle Housing Mounting Bracket, qty. 1

PART #	REPLACEMENT PARTS
C7060	Replacement Wheel
C7051	Replacement Spring
90430	Wheel-E-Bar™ Quick Release Pins



No. C2145

No. C7048

REPLACEMENT PARTS FOR DISCONTINUED WHEEL-E-BARS™

PART #	DESCRIPTION	FITS DISCONTINUED WHEEL-E-BAR™
C7051	Wheel-E-Bar™ Professional Springs. One per package	C2015, C2038
C7052	Wheel-E-Bar™ Professional Spring Adjusting Mechanism. One per package	C2015, C2038, C2039, C2155
C7058	Wheel-E-Bar™ Replacement Wheel. Natural rubber w/ ball bearing center, 1/2" hole. One per package	C2015, C2038, C2039
C7060	Wheel-E-Bar™ Replacement Wheel. Synthetic rubber w/ ball bearing center, 3/8" hole. One per package	C2042, C2130, C2140, C2150, C2155
C7066	Strut, Lower. Polished and Buffed Aluminum. One per package	C2015, C2045
90430	Wheel-E-Bar™ Quick Release Pin. Two per package	C2015, C2038, C2039

Wheelstands may look spectacular but they can actually hurt performance. Although some front end lift is beneficial to weight transfer, excessive lift can hurt. When a car wheelstands upon initial launch, it uses up power that could propel the vehicle forward. This results in slower ET's. As tire technology and horsepower levels progressed over the years, racers experimented with different ways to combat the wheelstanding problem. Most of the original designs consisted of merely bars or leaf springs that were welded directly to the rear end housing, hoping that they would prevent the front of the car from rising too high. One of the major problems with these early designs is that they caused the rear tires to unload resulting in a loss of traction.

Competition Engineering recognized this problem long ago and developed a series of Wheel-E-Bars™ designed to limit and control big wheelstands without unloading the rear tires. We accomplish this by utilizing an axle housing mounted bracket that allows the Wheel-E-Bar™ to react instantaneously with rear housing movement. As the rear housing rotates, the natural rubber wheels come in contact with the track. The shock of this contact is absorbed by both the lower aluminum struts and the coil spring upper struts which keep the tires from unloading. As the housing continues to rotate more and the front end begins to lift, the coil springs on the upper struts start to compress. The more that the springs are compressed, the more force they exert against the housing rotation, eventually overcoming the rising force of the front end and gently pushing it back down. This converts the rotational energy into forward motion, resulting in quicker ET's.



Designed to withstand the abuse of drag racing, the Competition Engineering Professional Wheel-E-Bar™ Series is the choice of more racers than any other design when quality and premium materials count.

Each bar features lower spring adjusters made from 7075-T6 aluminum to allow for ease in preload adjustment. The lower struts are made from high strength 6061-T6 aluminum, enabling them to handle the forces applied to them without fatiguing. Each kit includes all the required fasteners as well as quick release pins to allow access to the rear end housing for jacking. 44" overall length, 22-11/16" center to center mounting bracket distance.

- Fits 3" Axle Tube

PART # DESCRIPTION

- C2016** Professional Wheel-E-Bars™, Chrome plated with natural finish aluminum components
- C2036** Professional Wheel-E-Bars™, Chrome plated with black anodized aluminum components
- C2039** Professional Wheel-E-Bars™, Chrome plated with blue anodized aluminum components
- C2040** Professional Wheel-E-Bars™, Chrome plated with red anodized aluminum components

PART # REPLACEMENT PARTS

- C7046** Conversion Kit, Bolt-on. Converts weld-in Wheel-E-Bars™ to bolt-on style
- C7047** Conversion Kit, Weld-In. Converts bolt-on Wheel-E-Bars™ to weld-in style
- C7051** Replacement Springs
- C7052** Professional. Spring Adjusting Mechanism. One per package
- C7058** Replacement Wheel. Natural rubber w/ ball bearing center, 1/2" hole
- C7066** Replacement Lower Strut, Aluminum with natural finish
- 90430** Quick Release Pins. Two per package



No. C7047



No. C7046

 **WARNING Prop. 65**
This product contains a chemical known to the state of California to cause cancer, birth defects, or reproductive harm-

Competition Engineering has designed a bolt-on version of our famous Wheel-E-Bars™ specifically for street enthusiasts. Utilizing similar components as our Professional Wheel-E-Bars™ we were able to adapt them for street use by replacing the weld-in mounting brackets with bolt-on brackets.

BOLT-ON CHROME ROUND TUBE WHEEL-E-BAR™

- Bolt-On design, no welding required
- Round tube design, for 3" Axle Tubes
- Triple process, show quality, chrome plated finish
- Available in sprung and unsprung versions
- 44" overall length
- 18-5/8" center to center mounting bracket distance
- Includes all hardware and mounting instructions
- Synthetic Rubber Wheels



No. C2043

PART #	DESCRIPTION
C2043	Bolt-On Chrome Round Tube Wheel-E-Bar™, Sprung
PART #	REPLACEMENT PARTS
C7051	Professional Springs. One per package
C7052	Professional Spring Adjusting Mechanism. One per package
C7060	Replacement Wheel. Synthetic rubber w/ ball bearing center, 3/8" hole

 **WARNING Prop. 65**
 This product contains a chemical known to the state of California to cause cancer, birth defects, or reproductive harm-

INSTALLATION ON REAR AXLE HOUSING

With car on level surface, locate Bolt-on Wheel-E-Bar™ under the car with the brackets up against the housing and prop up the Wheel-E-Bar™ wheels to a height of about 6" off the ground for street use (3-1/2" for strip use). In this position, fasten the Housing Saddle Brackets over the rear end housing and attach to Rear Housing Brackets using the hardware provided. If the Rear Housing Brackets are too big for your particular housing so that they cannot be bolted securely, The Housing Bracket Saddle can be welded to the housing and the Rear Housing Bracket bolted to it, thereby allowing the Wheel-E-Bars™ to be removed.

STATE AND LOCAL ORDINANCES

May prohibit the Bolt-on Wheel-E-Bars™ from extending beyond the rear bumper. If this situation exists and you wish to shorten the Wheel-E-Bars™, the upper and lower struts can each be shortened and re-drilled. Care must be taken to insure that the Bolt-on Wheel-E-Bars™ will clear driveways, etc., without being severely loaded. If the bars are to be used for street use, it is recommended that they be loosely bolted to the housing while backing out of and pulling into a driveway (for example) until the bars "adjust" to the required height. Once this height is determined, the bars can be secured to the housing.

CAN I USE A BOLT-ON STYLE WHEEL-E-BAR™ FOR RACING?

Although our Bolt-On Wheel-E-Bars™ are intended for a Pro Street look, they contain many of the same components used in our Weld-On Wheel-E-Bars™ for racing. In fact, the only difference is the bracketry which in its bolt-on configuration is not strong enough to control the vehicle in a wheelstand. By removing the clamp bracket and welding the axle bracket directly to the housing, you have a Wheel-E-Bar™ suitable for both street and strip use.



WHEEL-E-BARS

Competition Engineering offers a variety of Roll Bars and Roll Cages to meet the different requirements of most racers. Countless hours were spent developing and perfecting these kits to offer the utmost in strength and fit without adding unnecessary weight. All tubing used in our kits exceeds the requirements of racing sanctioning bodies and is mandrel formed on computer controlled equipment for uniform wall thickness. Every Competition Engineering Kit has been designed to fit the specific application with only minor modifications necessary for installation.

- Manufactured from 1-3/4" O.D. x .134" wall mild steel or 1-3/4" O.D. x .083" wall aircraft-quality AMS-T-6736 chrome moly tubing
- Increases chassis strength
- Provides added safety
- Mandrel formed, model-specific main hoop
- NHRA and IHRA approved
- Tube ends notched for better fit and easier installation
- Strut Kits include two rear struts, two front door bars, main hoop crossbrace, two diagonal hoop supports, six weld joint gussets and eight floor plates are 6"x 6", 10 gauge (.134" thick)
- Complete instructions are included to ensure a hassle-free installation
- Welding required



8-Point Roll Bar
(Actual product may vary from image shown)

B) STRUT KITS

PART #	DESCRIPTION
C3000	8-Point Strut Kit, Mild Steel
C3100	8-Point Strut Kit, Chrome Moly
PART #	ADDITIONAL OPTIONS
C3181	Roll Cage X-Brace Kit, Mild Steel
C3191	Roll Cage X-Brace Kit, Chrome Moly

TWO PART NUMBERS are required to get a complete 8-Point Roll Bar Kit!

You must order both **A)** the appropriate 8-Point Main Hoop Kit and

B) Strut Kit No. **C3000** for Mild Steel OR Strut Kit No. **C3100** for Chrome Moly (unless otherwise noted)*

8-POINT ROLL BARS APPLICATION CHART - A) MAIN HOOPS

PART #		APPLICATION	PART #		APPLICATION
MILD STEEL	CHROME MOLY		MILD STEEL	CHROME MOLY	
AMC			GENERAL MOTORS, continued		
C3039	C3151	1970-'83 Hornet, Concord, Sprint	C3124	C3152	1964-'72 Chevelle, GTO, Tempest, Cutlass, Skylark, LeMans
CHRYSLER/DODGE			C3127	C3139	1955-'57 Chevrolet
C3129	C3159	1970-'74 Barracuda, Challenger	C3023	C3137	1966-'67 Chevy II, Sedan/Wagon
C3123	C3158	1970-'76 Duster, Demon, Sport, Scamp, 1968-'69 Dart, Barracuda, Valiant	C3122	C3149	1978-'87 Malibu, Monte Carlo, Grand Prix, Regal, Grand National, Cutlass, 442
C3128	C3157	1968-'74 Roadrunner, GTX, R/T, Satellite, Super Bee, Coronet, Belvedere	C3024	C3136	1962-'65 Nova
C3135*	C3150*	2008 - '19 Challenger, Complete Kit	C3022	C3144	1968-'79 Nova, Apollo, Omega, Ventura
FORD			C3026	C3146	1971-'77 Vega 1975-'80 Monza, Astro, Skyhawk, Starfire
C3025	C3154	1979-'93 Capri, Mustang	SPORT COMPACT		
C3124	C3152	1968-'72 Fairlane, Torino, Montego	HONDA		
C3039	C3151	1967-'73 Mustang, 1971-'77 Maverick 1977-'81 Fairmont	C9402	C9412	1992-'00 Honda Civic Coupe, Hatchback
C3126	C3153	1974-'78 Mustang II 1971-'80 Pinto, Bobcat	C9401	C9410	1988-'91 Honda CRX
C3125	C3155	1994-'04 Mustang Hardtop	MAZDA		
C3132*	C3156*	2005 - '14 Mustang, Complete Kit	C9408	C9418	1979-'85 Mazda RX-7
GENERAL MOTORS			MITSUBISHI		
C3021	C3138	1967-'69 Camaro, Firebird	C9405		1990-'94 Mitsubishi Eclipse
C3121	C3145	1970-'81 Camaro, Firebird	TRUCKS (See footnote below for appropriate Strut Kit)		
C3130	C3147	1982-'92 Camaro, Firebird	C3134**	C3133**	1982-'00 GM S-10, S-15
C3131	C3148	1993-'02 Camaro, Firebird	C3042*		1973-'87 GM Pickup
			C3044*		1988-'98 GM Pickup

*These part numbers ONLY come complete, Strut Kit included.

Strut Kits for Trucks include 2" x 3" box tubing to connect rocker panel to the frame. Order No. **C3001 Mild Steel or No. **C3101** Chrome Moly



ROLL BAR BOLT-IN CONVERSION KIT

Fits: Any Uni-Body Race Vehicle, Domestic or Import, using an 8-Point Roll Bar

- Universal application allows installation of 8-Point Roll bar (mild steel or chrome moly) to meet sanctioning body rules without welding base plates to the floor
- 6" x 6" x 1/8" steel plates get positioned under the floor and are used with the existing roll bar plates to "sandwich" the floor pan
- Includes 3/8"-16 x 1" Grade 8 bolts and Nylock nuts for mounting
- Requires drilling floor pan and forming mounting plates to match under-floor contours

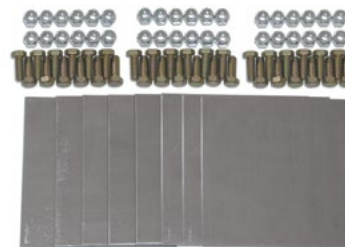

No. C3020

PART #	DESCRIPTION
C3020	Roll Bar Bolt-In Conversion Kit

ROLL BAR FILL PLATES, SLOTTED, 2 PACK

- These plates are designed to fill gaps around roll bar tubing that pass through sheet metal such as firewalls or rear parcel shelves
- They can also be used to tie roll bar tubing into rockers, A and B Pillars
- If switch panels, disconnect switches, fire system pulls or anything else is going to be mounted off the roll bar tubing these plates will simplify the process
- These steel fill plates are 5" x 10" and are constructed out of 18 gauge (.050" thick)

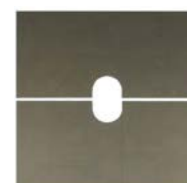

C3176

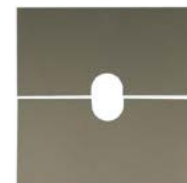

C3177

PART #	DESCRIPTION
C3176	Roll Bar Fill Plates, Slotted, 1-5/8" Diameter
C3177	Roll Bar Fill Plates, Slotted, 1-3/4" Diameter

ROLL BAR MOUNTING PLATES, 6 INCH X 6 INCH, 10 GAUGE, 4 PACK

- These are the same plates that are included in Competition Engineering 8 Point Roll Bar, 10 Point and 12 Point Roll Cage Kits
- Based on customer requests, they are now available separate as a 4 pack
- These steel mounting plates are 6" x 6", 10 gauge (.134" thick)



No. C3178

PART #	DESCRIPTION
C3178	Roll Bar Mounting Plates, 6" X 6", 10 Gauge, 4 Pack



ROLL BARS

FORMED REAR STRUTS

8-Point Roll Bar

- Designed to allow roll bar installation in most vehicles without permanently removing or modifying the rear seat
- Manufactured from 1-3/4" O.D. x .134" wall mild steel or 1-3/4" O.D. x .083" wall aircraft-quality AMS T-6736 chrome moly tubing with 50° bend
- NHRA and IHRA approved
- Welding and fabrication required
- Two per kit

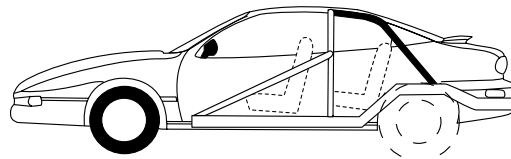

No. C3185

PART #	DESCRIPTION
C3185	Formed Rear Struts, Mild Steel
C3195	Formed Rear Struts, Chrome Moly



ROLL BARS

10-POINT CONVERSION KITS

- Eliminates the hassle of replacing your existing bar with a new cage
- Designed to convert a legal 8-point roll bar into a legal 10-point roll cage
- Kit includes top hoop and two forward downstruts that tie into your existing 8-point roll bar
- Manufactured from 1-5/8" O.D. x .134" wall mild steel or 1-5/8" O.D. x .083" wall aircraft-quality AMS T-6736 chrome moly tubing
- Mandrel formed on computer controlled equipment
- Meets NHRA requirements for cars running 10.99 or quicker
- Custom fit applications
- Welding required



No. C3325

(Actual product may vary from image shown)

10-POINT CONVERSION KIT APPLICATION CHART

MILD STEEL PART #	CHROME MOLY PART #	DESCRIPTION
FORD		
C3325	C3345	10-Point Conversion Kit, 1979-'93 Mustang, Capri
C3328	C3348	10-Point Conversion Kit, 1994-'04 Mustang
GENERAL MOTORS		
C3320	C3340	10-Point Conversion Kit, 1967-'69 Camaro, Firebird
C3323	C3343	10-Point Conversion Kit, 1970-'81 Camaro, Firebird
C3324	C3344	10-Point Conversion Kit, 1968-'72 GTO Chevelle, Cutlass, LeMans, Tempest
C3321	C3341	10-Point Conversion Kit, 1968-'79 Nova, Ventura, Omega, Apollo
C3322	C3342	10-Point Conversion Kit, 1966-'67 Nova, Chevy II

10-POINT ROLL CAGES

- Bridges the gap between an 8-Point Roll Bar and a 12-Point Roll Cage
- Meets NHRA & IHRA requirements for cars running 10.99 or quicker with modified firewalls and/or floorboards
- Provides increased driver protection in rollover
- Increases chassis rigidity for better reaction times
- Main Hoop Kit consists of one mandrel formed main hoop, one top hoop, two front downstruts, one main hoop crossbrace and two diagonal hoop supports designed specifically for your application
- Strut Kit consists of two door bars, two rear struts, ten floor plates are 6" x 6", 10 gauge (.134" thick) and twelve weld joint gussets
- Manufactured from 1 5/8" O.D. x .134" wall mild steel or 1 5/8" O.D. x .083" wall aircraft-quality AMS-T-6736 chrome moly tubing
- All bends mandrel formed on CNC equipment
- Tube ends notched for better fit and easier installation
- Complete instructions included to ensure a hassle-free installation
- Welding required



10-Point Roll Cage
(Actual product may vary from image shown)

TWO PART NUMBERS are required to get a complete 10-Point Roll Bar Kit! You must order both **A)** the appropriate 10-Point Main Hoop Kit and **B)** Strut Kit **No. C3310** for Mild Steel OR Strut Kit **No. C3250** for Chrome Moly (unless otherwise noted)

B) STRUT KITS

PART #	DESCRIPTION
C3310	10-Point Strut Kit, Mild Steel
C3250	10-Point Strut Kit, Chrome Moly
PART #	ADDITIONAL OPTIONS
C3181	Roll Cage X-Brace Kit, Mild Steel
C3191	Roll Cage X-Brace Kit, Chrome Moly
C3184	Roll Cage Upgrade Kit
C3194	Roll Cage Upgrade Kit, Chrome Moly

10-POINT ROLL CAGES APPLICATION CHART - A) MAIN HOOPS

PART #		APPLICATION	PART #		APPLICATION
MILD STEEL	CHROME MOLY		MILD STEEL	CHROME MOLY	
CHRYSLER/DODGE			GENERAL MOTORS		
C3227	C3287	1968-'69 Barracuda, 1970-'76 Duster	C3220	C3260	1967-'69 Camaro, Firebird
C3235*	C3285*	2008-'19 Challenger, Custom Fit	C3222	C3262	1970-'81 Camaro, Firebird
FORD			C3226	C3266	1982-'92 Camaro, Firebird
C3225	C3275	1979-'93 Capri, Mustang	C3231	C3267	1993-'02 Camaro, Firebird
C3229	C3279	1994-'04 Mustang	C3223	C3263	1968-'72 Chevelle, GTO, Tempest, Cutlass, Skylark, LeMans
C3240*	C3270*	2005-'14 Mustang, Complete Kit	C3221	C3261	1966-'67 Chevy II, Nova
*NOTE: These part numbers ONLY come complete, Strut Kit included.			C3224	C3264	1968-'79 Nova, Apollo, Ventura, Omega
			C3233	C3265	1978-'87 Malibu, Monte Carlo, Grand Prix, Regal, Grand National, Cutlass, 442
			TRUCKS		
			C3234	C3268	1982-'00 GM S-10, S-15

ROLL CAGE UPGRADE KIT

- Designed to upgrade your existing roll cage to meet NHRA requirements when the firewall, floor pan, or rocker panels have been modified or replaced with aluminum panels
- Manufactured from 1-5/8" O.D. x .134" wall mild steel or 1-5/8" O.D. x .083" wall aircraft-quality AMS-T-6736 chrome moly tubing
- Comes complete with one dash bar, two door diagonals, two rocker bars and six gussets
- Welding and fabrication required



No. C3184

PART #	DESCRIPTION
C3184	Roll Cage Upgrade Kit
C3194	Roll Cage Upgrade Kit, Chrome Moly

12-POINT ROLL CAGES

- Designed to provide the utmost in chassis strength and superior 360° driver protection with proper installation
- Design ties the front frame to the roll cage making it one solid unit, eliminating chassis flex and decreasing vehicle reaction time
- Hoop Kit includes one main hoop, one top hoop, two front downstruts, one main hoop crossbrace and two forward struts
- Strut Kit consists of two door struts, two rear struts, two diagonal hoop supports, one rear X-brace, ten floor plates are 6"x 6", 10 gauge (.134" thick) and twelve weld joint gussets
- Manufactured from 1 5/8" O.D. x .134" wall mild steel or 1 5/8" O.D. x .083" wall aircraft-quality AMS-T-6736 chrome moly tubing
- Pre-notched tube ends provide for a better installation
- Meets NHRA and IHRA requirements
- All tubes mandrel formed in-house on CNC equipment
- Complete instructions are included to ensure a hassle-free installation
- Welding required



12-Point Roll Cage
(Actual product may vary from image shown)

ROLL BARS

TWO PART NUMBERS are required to get a complete 12-Point Roll Bar Kit!

You must order both **A)** the appropriate 12-Point Main Hoop Kit and

B) Strut Kit No. **C3000** for Mild Steel OR Strut Kit No. **C3350** for Chrome Moly (unless otherwise noted)*

B) STRUT KITS

PART #	DESCRIPTION
C3300	12-Point Strut Kit, Mild Steel
C3350	12-Point Strut Kit, Chrome Moly
PART #	ADDITIONAL OPTIONS
C3184	Roll Cage Upgrade Kit
C3194	Roll Cage Upgrade Kit, Chrome Moly

12-POINT ROLL BARS APPLICATION CHART - A) MAIN HOOPS

PART #		APPLICATION	PART #		APPLICATION
MILD STEEL	CHROME MOLY		MILD STEEL	CHROME MOLY	
CHRYSLER/DODGE			GENERAL MOTORS, continued		
C3309	C3361	1968-'69 Barracuda 1970-'76 Duster	C3311	C3383	1968-'72 Chevelle, GTO, Tempest, Cutlass, Skylark, LeMans
C3308*	C3373*	2008 -'19 Challenger, Complete Kit	C3312	C3371	1978-'87 Malibu, Monte Carlo, Grand Prix, Regal, Grand National, Cutlass, 442
FORD			C3306	C3384	1975-'80 Monza 1971-'77 Vega, Starfire, Skyhawk
C3303	C3370	1979-'93 Mustang, Capri	C3313	C3385	1968-'79 Nova, Apollo, Omega, Ventura
GENERAL MOTORS			TRUCKS		
C3305	C3380	1967-'69 Camaro, Firebird	C3314	C3372	1982-'00 GM S-10, S-15
C3307	C3381	1970-'81 Camaro, Firebird			
C3302	C3382	1982-'92 Camaro, Firebird			

*NOTE: These part numbers ONLY come complete, Strut Kit included.

ROLL BARS, CAGES & CHASSIS ACCESSORIES

ROLL CAGE X-BRACE KIT

Available In Mild Steel or Chrome Moly Finish

- Designed to increase the strength of your chassis by eliminating side to side twist and uneven suspension loading
- Use in conjunction with the rear struts found in our Roll Bar and Roll Cage Kits to create a solid racing chassis
- Kit includes one 60" long tube and two 30" long tubes; manufactured from 1-5/8" O.D. x .134" wall mild steel or 1-5/8" O.D. x .083" wall aircraft-quality AMS T-6736 chrome moly tubing
- Welding required

No. **C3181**



PART #	DESCRIPTION
C3181	Roll Cage X-Brace Kit, Mild Steel
C3191	Roll Cage X-Brace Kit, Chrome Moly

FRONT DOWN STRUT UPGRADE KIT

- Tie the front frame to the roll cage making it one solid unit, eliminating chassis flex and decreasing vehicle reaction time
- Front Down Struts have the same specifications as the Front Struts that are included in Competition Engineering 12-Point Roll Cage Kits
- Combine with Competition Engineering Nos. C3181 or C3191 to convert 10-Point Roll Cages to 12-Point Roll Cages
- Pre-notched tube ends provide for better installation
- Meets NHRA and IHRA requirements
- All tubes mandrel formed in-house on CNC equipment
- Welding required
- Sold as a pair

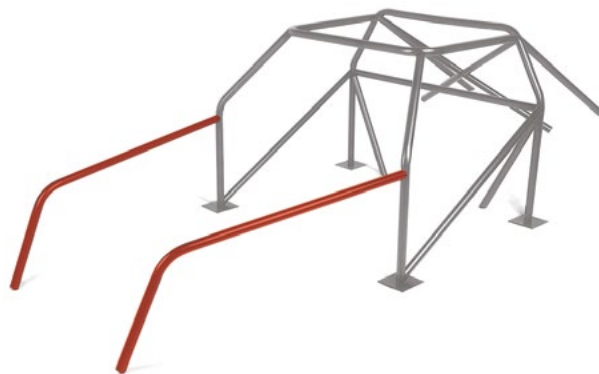

No. C3186

PART #	DESCRIPTION
C3186	Front Down Strut Kit, Mild Steel
C3196	Front Down Strut Kit, Chrome Moly

FUNNY CAR CAGE KITS

Note: Funny Car Cage Kit is the tubing highlighted in red on the image

- Available in 1-5/8" O.D. x .134" wall mild steel or 1-5/8" O.D. x .083" wall aircraft-quality AMS-T-6736 chrome moly tubing
- Upgrades 10 point or more point cage kit to have Funny Car cage protection
- Kits contain 10 pieces of pre-bent 1-5/8" O.D. x .134" wall or 1-5/8" O.D. x .083" wall tubing and 2 pieces of 1" O.D. x .118" wall mild steel or 1" O.D. x .058" wall chrome moly head/helmet guards
- Tubing is left long and un-notched so kit can be custom fitted to the application
- Meets NHRA and IHRA requirements
- All tubes mandrel formed in-house on CNC equipment
- Welding required



No. C3197

PART #	DESCRIPTION
C3187	Funny Car Cage Kit, Mild Steel
C3197	Funny Car Cage Kit, Chrome Moly

SEAT BACK BRACES

- Designed to meet different sanctioning body rules on bracing non-FIA rated seats
- Non-FIA seats can be attached to the brace's 3" x 6" plate, 18 square inches
- On FIA approved seats this brace can be used as an additional support
- Adjustable back and forth with a locking collar
- No welding is required for installation
- Available for 3 different diameters of roll bar tubing



No. C4905

PART #	DESCRIPTION
C4905	Seat Back Brace, Adjustable for 1 3/4" Dia. Tubing
C4906	Seat Back Brace, Adjustable for 1 5/8" Dia. Tubing
C4907	Seat Back Brace, Adjustable for 1 1/2" Dia. Tubing

OFFSET ROLL BAR PADDING

- Our popular Roll Bar Padding is now packaged in single 3-foot lengths for improved convenience and pricing
- 3" O.D. padding is extruded from high-density foam for maximum safety and protection
- Inside diameter of 1-5/8" is offset by 7/16" to position extra cushioning towards the driver where it's needed the most
- Available in black, red, blue and orange



PART #	DESCRIPTION
80939	Offset Roll Bar Padding, Black
80940	Offset Roll Bar Padding, Blue
80941	Offset Roll Bar Padding, Red
80942	Offset Roll Bar Padding, Orange

ROLL BAR PADDING, SFI 45.1 APPROVED

Meets the requirements of NHRA, IHRA, SCCA and other organizations

- SFI 45.1 Specified approved padding, approval marked on padding
- Comes in 36" lengths; 7/8" thickness fits 1-5/8"-2" bar diameter
- Padding backed with pressure-sensitive adhesive and can be cut to size to make installation easy
- Padding exceeds SFI 45.1 rating for dripping or melting in a fire, and is self-extinguishing
- SFI 45.1 approved Roll Bar Padding is more dense than traditional padding, and is designed to absorb the impact energy



No. 80944

PART #	DESCRIPTION
80944	Roll Bar Padding, SFI 45.1 Approved, Black

ROLL BAR GUSSETS

These lightweight, stamped plate gussets provide additional strength to welded tube joints

- Available in mild steel or chrome moly
- Measures 1-1/4" x 2-1/4"
- 25 per package
- Welding required



No. C3172



No. C3173

PART #	DESCRIPTION
C3172	Roll Bar Gussets, 1/8" Mild Steel
C3173	Roll Bar Gussets, 4130 Chrome Moly

SWING OUT DOOR BAR KITS

For 6, 8, 10 or 12 Point

- Meets NHRA Sanctioning rule for OEM full body cars 7.50 E.T. and slower
- **No. C3182** is manufactured for 1-3/4" steel tubing and **No. C3183** is manufactured for 1-5/8" steel tubing
- One kit does one door bar
- Includes release pin and hinge bracket
- Welding required

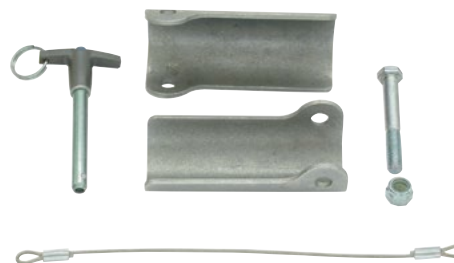

No. C3182

PART #	DESCRIPTION
C3182	8-Point Swing Out Door Bar Kit, 1-3/4" tube
C3183	10 & 12-Point Swing Out Door Bar Kit, 1-5/8" tube

UNIVERSAL DOOR WINDOW FRAME KIT

- Use on drag racing vehicles running a plastic/lexan type window
- Will complete two doors
- Includes 3/8" steel tubing (2-84" long, 2-48" long), bend to fit with supplied bending fixture, tabs and hardware
- Packaged in a tube with instructions
- Welding required



No. C4900

PART #	DESCRIPTION
C4900	Universal Door Window Frame Kit

WINDSHIELD INSTALL KITS

- Kit includes rubber seal and (50) stainless steel flathead screws and lock nuts
- Can be used on rear windows

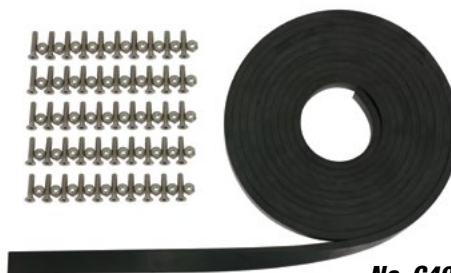

No. C4901

PART #	DESCRIPTION
C4901	Windshield Install Kit, 1/4" Thick
C4902	Windshield Install Kit, 3/8" Thick

THROTTLE LINKAGE ROD KIT

- Universal for vehicles with carburetors
- Kit includes a 23" aluminum rod, two spherical rod ends, throttle return spring tab and hardware
- Aluminum linkage rod is easy to install, bendable to simplify alignment issues and the length is easily adjusted by turning the rod ends in or out
- The rod ends will help to overcome misalignment problems
- This linkage is the preferred linkage for Oval Track claimeer racing
- Will not be affected by dirt as some cable linkages can be



No. C3465

PART #	DESCRIPTION
C3465	Throttle Linkage Rod Kit

WARNING Prop. 65
 This product contains a chemical known to the state of California to cause cancer, birth defects, or reproductive harm.

PART #	AVAILABLE OPTIONS
C3461	Accelerator Pedal Kit

ACCELERATOR PEDAL KIT

- Steel Accelerator Pedal with Steel Mounting Brackets and Hardware to mount where desired
- Installation instructions included



No. C3461

PART #	DESCRIPTION
C3461	Accelerator Pedal Kit

WARNING Prop. 65
 This product contains a chemical known to the state of California to cause cancer, birth defects, or reproductive harm.

PART #	AVAILABLE OPTION
C3465	Throttle Linkage Rod Kit

DOOR HANDLE LINKAGE KIT

- Kit includes two lightweight door handles with enough tubing, nuts, bolts and rod ends for two doors
- Easy to install in any door

PART # DESCRIPTION
C4935 Door Handle Linkage Kit

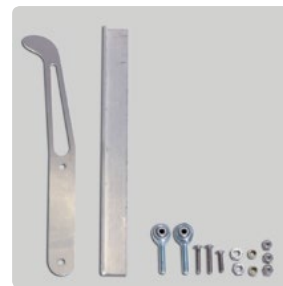

No. C4935

DOOR LIMITER STRAP

- Kit is complete with (2) Door Limiter Straps and all hardware necessary to complete one car
- Installation instructions included

PART # DESCRIPTION
C4931 Door Limiter Strap



No. C4931

DOOR HINGE KIT

- For Race vehicles with fiberglass doors
- Longer hinge pins on bottom mounts facilitates quick removal and installation of doors
- Kit includes two door hinges and mounts (enough for 1 car)
- Lightweight design
- Welding required

PART # DESCRIPTION
C4930 Door Hinge Kit



No. C4930

RADIATOR MOUNTING KIT

- Radiator Mount for Scirocco style radiators
- For race cars with tube front ends
- Facilitates quick removal and installation of radiator
- Includes radiator mounting bracket, frame mount and hardware
- Welding required

PART # DESCRIPTION
C4925 Radiator Mounting Kit

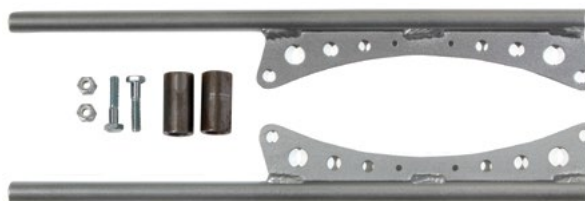

No. C4925

PARACHUTE ANCHOR MOUNT*For attaching parachute anchor strap to chassis*

- Accepted by NHRA and IHRA
- Manufactured from 1-5/8" dia. DOM tubing
- Includes mount and support tubes, anchor strap bracket and aluminum bushing
- For use with Competition Engineering's Parachute Pack Mount **No. C3451**
- Welding and fabrication required

PART # DESCRIPTION
C3450 Parachute Anchor Mount

**No. C3450****PARACHUTE PACK MOUNT***Mounts Parachute Pack to Parachute Anchor Mount*

- Includes pack mounting plate, mounting tube, weld bung and quick release pin
- Quick release mount for removal when working on car
- Manufactured from mild steel for extra strength
- For use with Competition Engineering's **No. C3450** or similar kits
- Welding and fabrication required

PART # DESCRIPTION
C3451 Parachute Pack Mount

**No. C3451****PARACHUTE RELEASE CABLE KIT**

- Kit consists of 18' of Teflon lined Felsted cable
- Mounting Bracket and Rod End on one end of the cable
- Full handle

PART # DESCRIPTION
C3452 Parachute Release Cable Kit

**No. C3452****PARACHUTE RELEASE CABLE CLAMP**

- Complies with NHRA General Regulations requiring the cable clamp to be attached within 12" of the parachute pack edge
- Works with Competition Engineering Parachute Mount **Nos. C3451, C3452** and can be used with other mounts
- Manufactured from 1/8" thick aluminum bracket with steel clamp and mounting hardware

PART # DESCRIPTION
C3453 Parachute Release Cable Clamp

**No. C3453**

FUEL TANK SUMP KITS

- Factory gas tank pickups located in the front of tanks allow fuel pumps to ingest air during acceleration causing a momentary loss of fuel pressure
- Installed in the lowest portion of the rear of the fuel tank, to guarantee consistent fuel pressure under the hardest acceleration
- Designed to fit stock steel fuel tanks
- Manufactured from 18-gauge cold rolled steel for easy welding with two pre-welded 3/8" or 1/2" NPT bungs to ensure adequate fuel flow
- I.D. 7-3/8" wide x 11" long x 3" tall
- Installation instructions include a template for baffling the tank
- Welding required

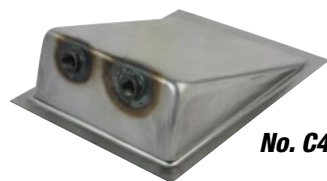

No. C4040



No. C4041

SEE MORE
Moroso Aluminum
Fuel Line on pg. 275

PART #	DESCRIPTION
C4040	Fuel Tank Sump Kit, Two 3/8" NPT weld bungs
C4041	Fuel Tank Sump Kit, Two 1/2" NPT weld bungs

ACCESS DOOR

- .050" aluminum door is hinged to frame, providing quick and easy access to fuel cells, dry sump tanks or any other component
- Comes with natural finish so customer can anodize or paint to match car color
- Door held securely closed with self-ejecting, flush-head Dzus fastener
- Includes all mounting hardware
- 6" x 6" door, 8-1/8" x 8-1/8" overall

No. 85700



PART #	DESCRIPTION
85700	Access Door

ALUMINUM & STEEL REAR FENDERWELLS

- 24-gauge steel or .032" thick aluminum
- Pittsburgh locking seam for easy assembly
- Different widths to accommodate a variety of tire sizes
- Available in six diameters
- Bead rolled reinforcing ribs for strength
- Two Fenderwell/Wheel Tubs per Kit



No. C3006

PART #		DIMENSIONS
STEEL	ALUMINUM	LENGTH X HEIGHT X WIDTH
C2998	C2999	30" (L) x 15" (H) x 23.25" (W)
C3006	C3007	36" (L) x 18" (H) x 23.25" (W)
C3008	C3009	38" (L) x 19" (H) x 23.25" (W)
C3010	C3011	40" (L) x 20" (H) x 23.25" (W)
C3002	C3004	43" (L) x 21.5" (H) x 23.25" (W)
N/A	C3005	46" (L) x 23" (H) x 23.25" (W)

REAR FIREWALL KIT, CUSTOM FIT FOR 2005-'10 MUSTANG

Makes it easy to install a firewall between the passenger compartment and trunk mounted fuel cell and/or battery
Fits: 2005-'10 Mustang

No. C4990



- Pre-cut and bent, only a small amount of trimming may be necessary
- Constructed out of .032" thick aluminum, which meets NMRA and other sanction bodies requirements
- Can be used with or without the factory rear seat

PART #	DESCRIPTION
C4990	Rear Firewall Kit, 2005-'10 Mustang



STEERING COLUMN KITS, UNIVERSAL DESIGN

Two versions available; Drag Race Only which has a strong yet light weight 3/4" x .058" wall chrome moly shaft and the NEW Circle Track, Road Race and Street version that has a 3/4" x .156" wall mild steel shaft which is stronger and heavier for the rigors of Circle Track, Road Racing and the Street.

- Can be used in new car construction or used to replace a heavy bulky OEM steering column
- Kit contains a stop collar to prevent the steering shaft from entering the driver's compartment in the event of an impact.
- Inner shaft rides in two flanged polymer bushings that mount to the column tube
- Features unique grease fittings to keep the bushings lubricated
- Includes "SFI" Approved Quick Release Steering Wheel Hub and Shaft to Hub Adapter, Moroso part **No. 80160**
- Also includes a precision needle bearing U-joint and complete installation instructions
- Welding and Fabrication required



No. C5074

PART #	DESCRIPTION
C5073	Steering Column Kit, Circle Track, Road Race, Street
C5074	Steering Column Kit, Drag Race Only

PART #	AVAILABLE OPTIONS
C5076	Steering Column Mount Kit
C9609	Steering Shaft Support Rod End

STEERING COLUMN MOUNTING KIT

- Mounts Steering Column Kit **Nos. C5073 or No. C5074** into tube chassis vehicle
- Compact design allows column to be mounted rigidly to the chassis while keeping weight to a minimum
- Includes two split clamps that secure 1-1/2" O.D. steering tube firmly in place and two lengths of tubing to mount column to chassis
- Split clamp mounting system makes it easy for the column tube to be removed or repositioned without cutting or re-welding
- Can be adapted to other steering column kits that use a 1-1/2" dia. column tube
- Kit includes complete installation instructions
- Welding & fabrication required



No. C5076

PART #	DESCRIPTION
C5076	Steering Column Mounting Kit

STEERING SHAFT SUPPORT ROD END

- Rod end serves as both bearing and support for steering shaft
- Inside diameter of .757" is specially sized to allow steering shaft to pass through and rotate with a precise fit
- 3/4"-16 right hand threaded shank mounts to steering support bracket
- Includes two jam nuts for securing rod end in place
- Static radial load capacity of 11,518 lbs.
- One per package



No. C9609

PART #	DESCRIPTION
C9609	Steering Shaft Support Rod End

FIVE HOLE STEERING WHEEL ADAPTER

- Allows racers to continue to use Moroso's Quick Release Steering Wheel Hub **No. 80160** or similar aftermarket hubs with 3 hole 1-3/4" diameter bolt pattern when converting to steering wheels with a 5 hole bolt pattern
- Billet aluminum adapter includes all mounting hardware (steering wheel to adapter and adapter to hub)



No. C5078

PART #	DESCRIPTION
C5078	Five Hole Steering Wheel Adapter

SFI APPROVED QUICK RELEASE STEERING WHEEL HUB AND ADAPTER

Fits: 3/4" O.D. steering shafts and steering wheels with a 3 hole, 1-3/4" diameter bolt pattern

- Meets NHRA, IHRA and other sanctioning body criteria for meeting SFI (Safety Foundation Inc.) requirement #42.1 concerning steering wheel attachment and release
- Hub is manufactured from lightweight billet aluminum with anodized finish
- 5/16" -18 thread bolt holes
- Spring loaded quick release pin is integral with the hub and features a large diameter engagement surface for use with bulky racing gloves
- Includes steering shaft adapter manufactured from 1018 steel for extra strength and ease of welding



No. 80160



PART #	DESCRIPTION
80160	SFI Approved Quick Release Steering Wheel Hub and Adapter. <i>Fits: 3/4" O.D. steering shafts and steering wheels with a 3 hole, 1-3/4" diameter bolt pattern</i>

POWER STEERING TANKS

POWER STEERING TANKS

Fits: Universal Panel Mount

- Fabricated of aluminum for strength – can be polished, chromed, powder coated or left as-is for a race look
- Built in bracket allows convenient mounting on a panel
- -6 AN inlet and -10AN outlet with an internal baffle
- Includes a heavy duty vented screw on cap

PART #	DESCRIPTION
63506	Power Steering Tank, Universal Panel Mount, Inlet left side
63507	Power Steering Tank, Universal Panel Mount, Inlet right side



No. 63506

No. 63507



Power Steering Tanks
on Moroso pgs. 192, 196,
197, 199 & 204

Competition Engineering has the components to make your front suspension work properly. Poor front suspension tuning can affect the way your race car reacts. OEM-style front suspension components can saddle your race car with excess weight. All Competition Engineering front suspension components are designed to be both lightweight and strong to provide you with the utmost in reliability and quicker ET's.

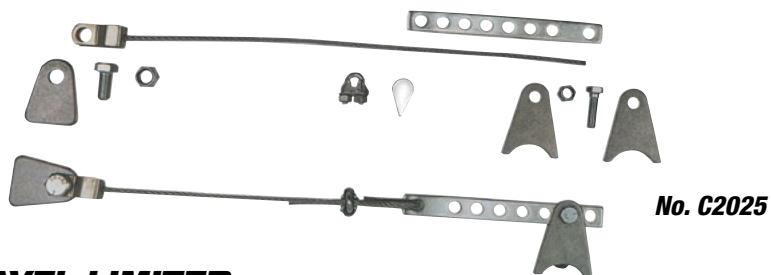

FRONT END TRAVEL LIMITER

Cable Style

- Designed to fit both A-arm and strut front suspensions
- 7-position adjuster for fast, between round changes
- Adjuster enables you to fine tune front-end separation, improving 60 foot times as well as vehicle reaction time
- Kit includes weld-on mounting tabs, cable assemblies, mounting hardware and detailed instructions
- Limits front suspension separation on launch
- Welding required

PART #	DESCRIPTION
C2025	Front End Travel Limited

FRONT END TRAVEL LIMITER

Bolt-On

- Designed for race cars with factory upper A-arm suspensions
- Installs easily by removing the factory upper snubber and threading the adjuster bolt through the stock hole
- Threaded design allows you to quickly dial-in the right amount of front end lift without wasting power on high wheelstands
- Replaces rubber snubber in factory control arms
- Bolt-On, no welding requires
- Increases weight transfer



PART #	DESCRIPTION
C2026	Front End Travel Limiter

PART #	REPLACEMENT PART
C7024	Rubber Bumpers. 2" diameter base. Two/card

MUSTANG BUMPSTEER ADJUSTER KITS

- Corrects "Bumpsteer" that occurs when the Mustang's front end is lowered or raised from stock
- Fully adjustable kit replaces non-adjustable stock components with precision, aircraft-quality components that bolt into place with common hand tools
- Does not require the front spindles to be modified or drilled out
- Can also be used for easy, on-car toe adjustments
- Includes 6061-T6 billet aluminum adjuster tubes with anodized finish to resist corrosion, 5/8" rod ends and an assortment of adjustment shims

PART #	DESCRIPTION
C2408	Bumpsteer Adjuster Kit, Mustang '79-'93
C2409	Bumpsteer Adjuster Kit, Mustang '94-'04



Competition Engineering offers solid aluminum replacement bushings for stock factory bushings that improve chassis/suspension control. By swapping solid bushings for the stock pieces, you increase vehicle reaction in both acceleration and cornering, as well as improve overall feel. Ride quality will be sacrificed due to the elimination of the factory bushing deflection.

SOLID ALUMINUM BODY MOUNTS

Fits: 1967-'81 Camaro, Firebird, 1968-'79 Nova; 1971-'77 Ventura, Apollo, Omega

- Replacement for the factory subframe bushings
- Eliminates deflection and twisting commonly found on GM unibody equipped vehicles
- CNC machined from 6061-T6 aluminum for a perfect fit and black anodized to eliminate corrosion
- Complete set of six for one car with complete instructions



No. C3027

PART #	DESCRIPTION
C3027	Body Mounts, Solid Aluminum

GM A&G BODY REAR CONTROL ARM BUSHINGS

Fits: 1982-'02 Camaro, Firebird; 1964-'88 Chevelle, Malibu; 1964-'77 Skylark, Gran Sport; 1964-'77 LeMans, GTO, Tempest; 1966-'77 Cutlass 442; 1966-'70 Pontiac full-size; 1964-'70 Olds full-size

- Eliminates the twist and play found in the factory rear control arms
- CNC machined from 6061-T6 aluminum and black anodized for corrosion resistance
- Designed to replace the stock bushings on the lower control arms only
- Four to a package



No. C3165

PART #	DESCRIPTION
C3165	Arm Bushings, GM A&G Body Rear Control

ALUMINUM SPRING EYE BUSHINGS

Fits: 1967-'81 Camaro, 1968-'79 Nova

- Solid Aluminum Bushings replace stock bushings and provide positive housing positioning, eliminating wheel-hop and excessive pinion angle
- Eliminates the deflection of stock bushings
- Packaged in pairs

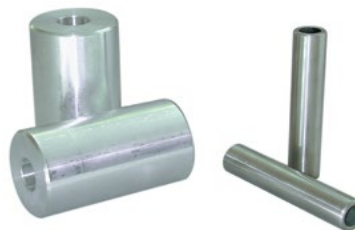

No. C2022

PART #	DESCRIPTION
C2022	Spring Eye Bushings, Aluminum, Front, 2" O.D. x 3-5/8" long for 1/2" bolt
C2023	Spring Eye Bushings, Aluminum, Rear, 1-5/8" O.D. x 3-1/4" long for 3/16" bolt

UPPER A-ARM BUSHINGS

Fits: 1965-'70 Chevrolet Full Size, 1967-'69 Camaro, Firebird; 1968-'79 Nova; 1963-'82 Corvette; 1964-'72 Chevelle, Tempest, LeMans, GTO; 1973-'74 Omega, Apollo, Skylark; 1971-'74 Ventura; 1971-'72 Monte Carlo; 1965-'72 F-85, Cutlass, 442

The stock upper control arm bushings found on most cars have a rubber bushing material that is bonded to the inner sleeve and the outer housing. Bonding the rubber bushings makes them resistant to rotation and suppresses front end lift and hinders weight transfer.

Competition Engineering's **Upper A-Arm Bushings** are a non-bonded design, which lets the bushing material rotate. This allows the A-Arm to pivot freely on the cross shaft, resulting in rapid front end lift and increased weight transfer. The superior polyurethane material comprising our Bushings doesn't flex or break down like stock conventional rubber bushings with exposure to oils, chemicals and ozone.

- Quicker front end rise produces quicker ETs
- Superior polyurethane bushing material is better performing and last longer



No. C3166

PART #	DESCRIPTION
C3166	Upper A-Arm Bushings

PART #	AVAILABLE OPTIONS
C2026	Front End Travel Limiter

ENGINE LIMITER KIT

- Mounts diagonally between the engine block and the frame rail preventing the forward and rearward movement of the engine/transmission assembly during launch and braking conditions
- Without this kit, the movement of the engine within the chassis would cause the front and rear motor plates to flex and eventually crack
- The use of two kits positioned on either side of the engine is highly recommend for high horsepower race cars
- Includes a 3/4" dia. DOM steel tube, two chassis tabs, a 1/2" high misalignment rod end, an engine mounting tube and complete instructions
- Improves reaction times
- Fabrication & welding required



No. C4034

PART #	DESCRIPTION
C4034	Engine Limiter Kit

ENGINE TORQUE LINK, MUSTANG

- The benefits of a solid motor mount for racing with the comfortable ride of a stock motor mount for street use
- Removable Torque Link is installed with supplied pins and clips, limiting engine movement for racing use
- Torque Link can then be removed for street use
- Includes two zinc plated brackets, all hardware and complete installation instructions

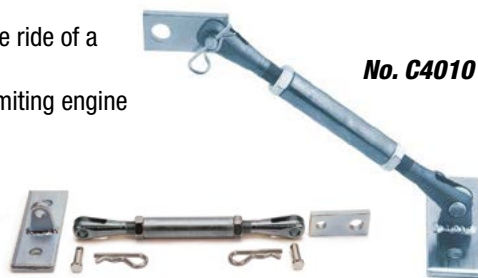

No. C4010

PART #	DESCRIPTION
C4010	Engine Torque Link. <i>Fits: Mustang 1979-'95 5.0L</i>

MID-MOUNT PLATE REPLACEMENT MOUNTING KIT

- Recommended when more than one mounting kit is required
- Manufactured from 1/8" mild steel with four triangular gussets
- Includes mounting hardware
- Welding required



No. C4032

PART #	DESCRIPTION
C4032	Mid-Mount Plate Replacement Mounting Kit

SHIM KITS, FLYWHEEL

- Replacement flywheel shims for Competition Engineering and other mid-mount motor plates
- Can be used anytime that the spacing of the torque converter to the transmission pump needs adjustment
- Manufactured from .090" Steel
- 3 per pack

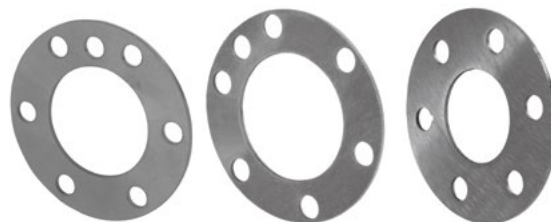

No. C4047

No. C4048

No. C4049

PART #	DESCRIPTION
C4047	Shim Kit. <i>Fits: GM LS Series</i>
C4048	Shim Kit. <i>Fits: Chevy V-8, 2 piece seal & 90 Deg. V-6</i>
C4049	Shim Kit. <i>Fits: Ford 289-302</i>
C4050	Shim Kit. <i>Fits: Ford 351M, 400, 429, 460</i>
C4051	Shim Kit. <i>Fits: Mopar 426 or others with an 8 bolt aftermarket crankshaft</i>
C4052	Shim Kit. <i>Fits: Mopar 273-440 with a 6 bolt crankshaft</i>

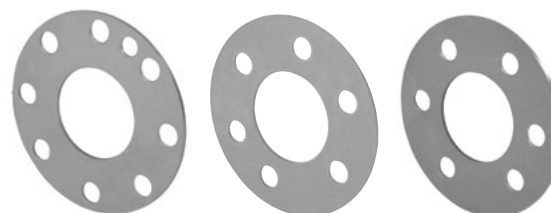

No. C4050

No. C4051

No. C4052

MID MOUNT PLATES

Available In Steel and Aluminum

- Provides a solid connection between the transmission and the chassis
- Eliminates torsional chassis stress, block twisting and broken transmission cases
- Steel versions include flywheel shims to ensure accurate torque converter to front pump engagement, (except No. C4024)
- Allows easier transmission swaps and aids clutch operation
- Universal frame mounts included
- Designed on CAD equipment for a precise fit and easy installation
- Universal Frame Mounts Included, welding required



MID MOUNT PLATES APPLICATION CHART

PART #	APPLICATION	MATERIAL DESCRIPTION	DIMENSIONS
UNIVERSAL FIT			
C4033*	Universal Fit	6061-T6 Aluminum	30" x 20" x .188" thick
GENERAL MOTORS			
OLDSMOBILE/PONTIAC			
C4025*	301-345 Engines	6061-T6 Aluminum	24" x 14-5/8" x .188" thick
CHEVROLET			
C4027*	LS Series	6061-T6 Aluminum	29-1/4" x 14-13/16" x .188" thick
C4028	LS Series	Steel	29-1/4" x 14-13/16" x .090" thick
C4030*	SBC, BBC, V8 & 90° V6 Engines	6061-T6 Aluminum	29-1/4" x 13-1/2" x .188" thick
C4031	SBC, BBC, V8 & 90° V6 Engines	Steel	29-1/4" x 13-1/2" x .090" thick
FORD			
C4022*	Ford FE 352 - 428	6061-T6 Aluminum	27" x 13 1/2" x .188" thick
C4024	Modular 4.6, 5.4 & 6.8L	Steel	34" x 12 3/16" x .090" thick
C4035	289-302, 351C, 351W Engines	Steel	30" x 9-1/4" x .090" thick
C4053*	289-302, 351C, 351W Engines	6061-T6 Aluminum	30" x 9-1/4" x .188" thick
C4037	351M, 400, 429, 460 Engines	Steel	30" x 10-13/16" x .090" thick
C4054*	351M, 400, 429, 460 Engines	6061-T6 Aluminum	30" x 10-13/16" x .188" thick
CHRYSLER			
C4036	383-440 Engines	Steel	30" x 11-15/16" x .090" thick
C4055*	383-440 Engines	6061-T6 Aluminum	30" x 11-15/16" x .188" thick
C4038	273-360 Engines with 727 & A904 Transmissions	Steel	30" x 15" x .090" thick
C4056*	273-360 Engines with 727 & A904 Transmissions	6061-T6 Aluminum	30" x 15" x .188" thick

* Flywheel shims not included, see optional flywheel shims on page 441

PART # REPLACEMENT PARTS
C4032 Mid-Mount Plate Replacement Mounting Kit

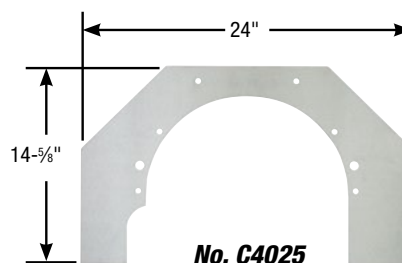
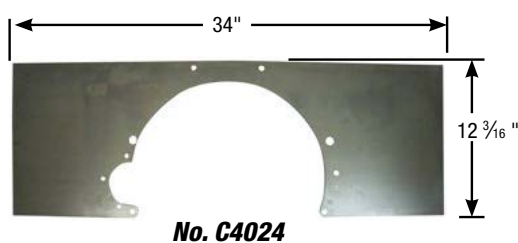
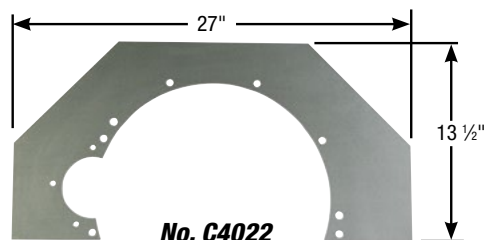

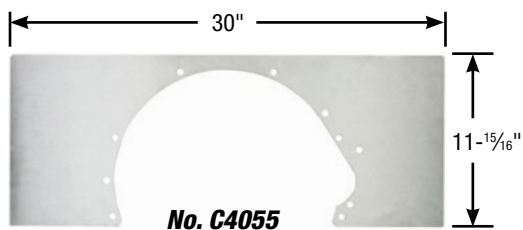
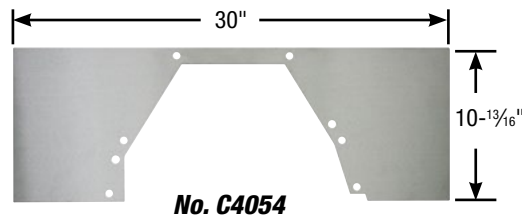
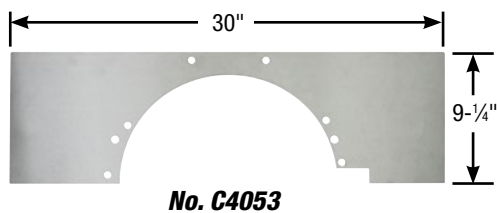
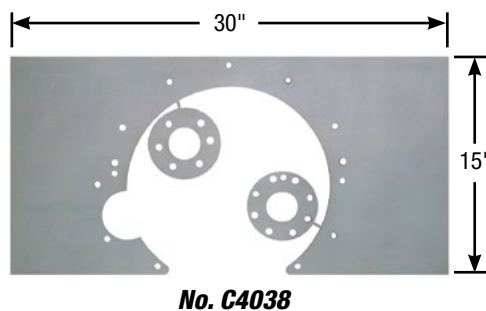
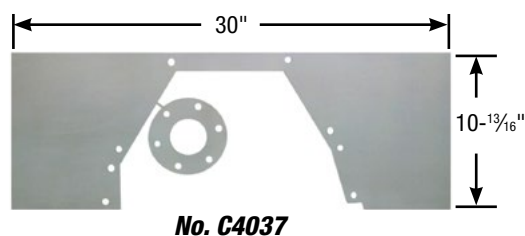
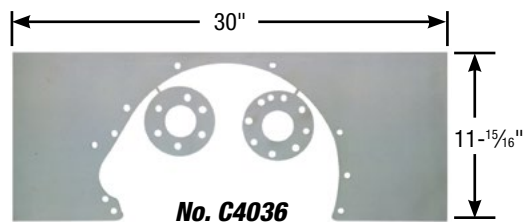
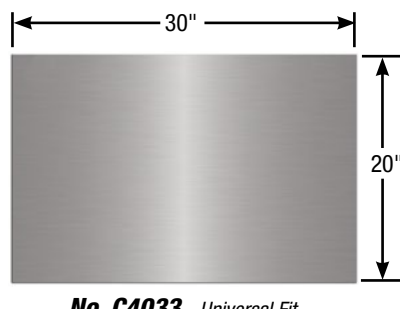
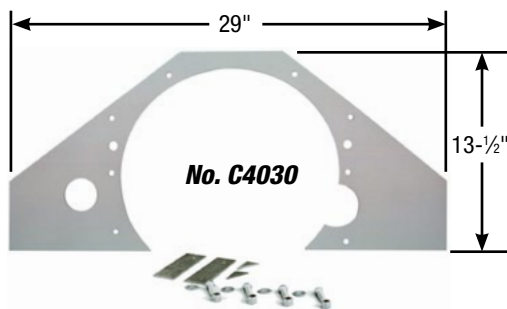
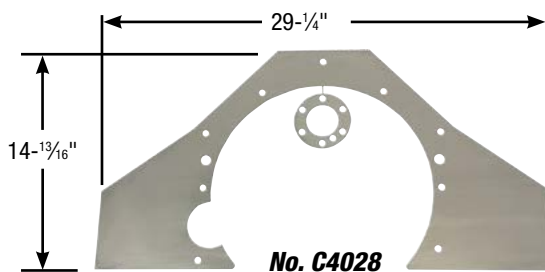

FRONT MOTOR PLATES

Make sure your motor stays in place!

- Provides a solid connection between the engine and the chassis
- Improves reaction and 60-foot times
- Eliminates twisting of the chassis caused by engine torque and ensures that the power gets to the rear wheels
- Computer designed and machined for accuracy
- Used by leading chassis builders as a positive method of locating the engine in the chassis
- Perfect for performing engine swaps or setting motor back in chassis for increased weight transfer

FRONT MOTOR PLATES APPLICATION CHART

PART #	APPLICATION	MATERIAL DESCRIPTION	DIMENSIONS
UNIVERSAL FIT			
C4014	Universal Fit	6061-T6 Aluminum	36" x 12" x .25" thick
GENERAL MOTORS			
SMALL BLOCK CHEVROLET			
C3995	LS Series, 2-piece	6061-T6 Aluminum	15" x 12" x .25" thick
C4003	SBC and 90°, V6 2 Piece Seal Engines, Pre-trimmed	6061-T6 Aluminum	27-½" x 13" x .25" thick
C4004	SBC and 90°, V6 2 Piece Seal Engines	6061-T6 Aluminum	36" x 10-½" x .25" thick
C4006	SBC and 90°, V6 Piece Seal Engines, 2-piece	6061-T6 Aluminum	10-½" x 8-½" x .25" thick
BIG BLOCK CHEVROLET			
C3997*	Gen. V & Gen. VI Engines	6061-T6 Aluminum	36" x 11" x .25" thick
C4005	BBC, 1-piece	6061-T6 Aluminum	36" x 10-⅝" x .25" thick
C4007	BBC, 2-piece	6061-T6 Aluminum	9" x 8-¼" x .25" thick
FORD			
C3990	351C Engines	6061-T6 Aluminum	36" x 11" x .25" thick
C3991	2 & 3-Valve Modular, 4.6L Engines, 2-piece	6061-T6 Aluminum	15-½" x 7-¾" x .25" thick
C3992	4-Valve Modular, V8, 4.6L Engines, 2-piece	6061-T6 Aluminum	15-½" x 7-¾" x .25" thick
C3993	4-Valve Modular, V8, 5.4L Engines, 2-piece	6061-T6 Aluminum	15-½" x 7-¾" x .25" thick
C4001	289-302, 351W Engines, 1970-93	6061-T6 Aluminum	36" x 10-½" x .25" thick
C4002	429-460 Engines	6061-T6 Aluminum	36-½" x 9-½" x .25" thick
C4011	Ford, FE 352-428	6061-T6 Aluminum	See diagram on pg. 436 x .25" thick
C4015	Ford, 289-302, 351W Engines, 1979-93	6061-T6 Aluminum	See diagram on pg. 436 x .25" thick
CHRYSLER			
C4000	318-360 Engines	6061-T6 Aluminum	36" x 9-½" x .25" thick
C4008	383-440, 426 Hemi Engines, 2-piece	6061-T6 Aluminum	11-¾" x 13-¾" x .25" thick
C4009	383-440, 426 Hemi Engines	6061-T6 Aluminum	36" x 10" x .25" thick
C4012	5.7 / 6.1/6.4 Engines	6061-T6 Aluminum	See diagram on pg. 436 x .25" thick

* **NOTE:** Chevrolet Gen. V & Gen VI will need modifications.

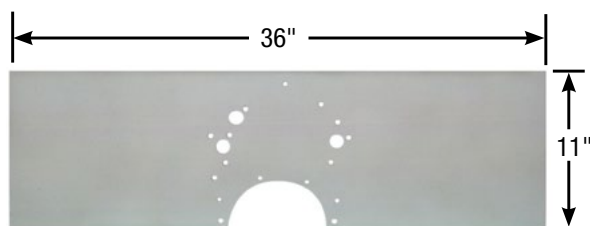

No. C3990

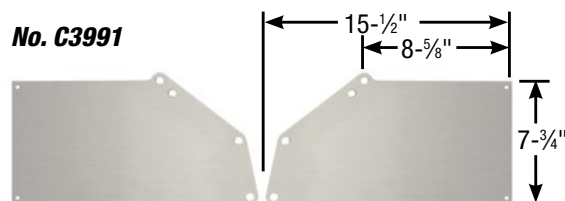

No. C3991

FRONT MOTOR PLATES

No. C3993

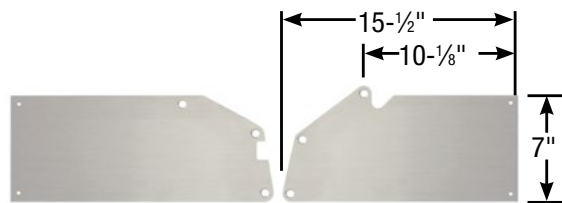
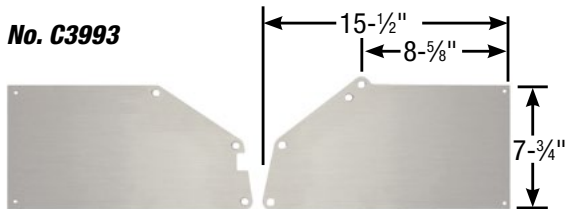

No. C3992

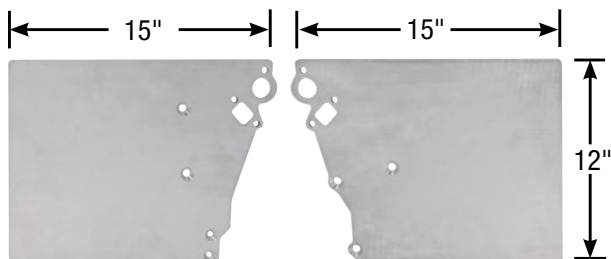

No. C3995

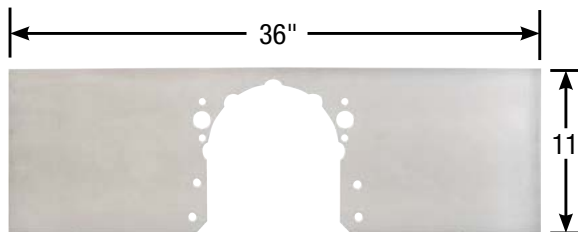

No. C3997

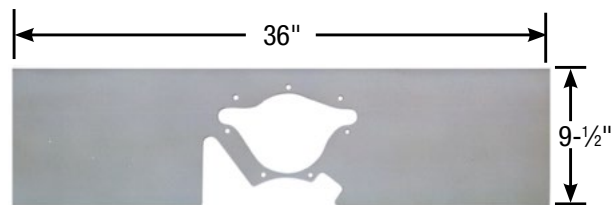

No. C4000

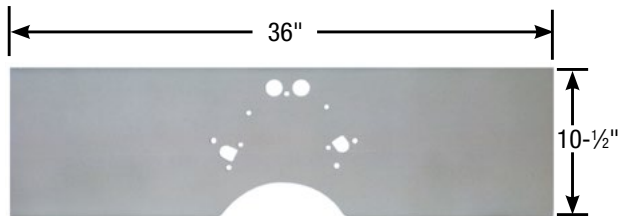

No. C4001

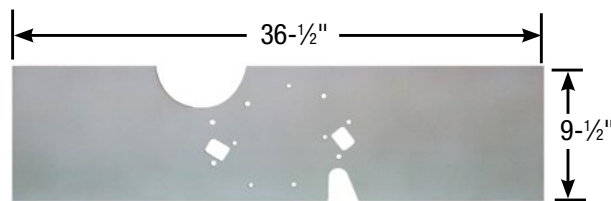

No. C4002

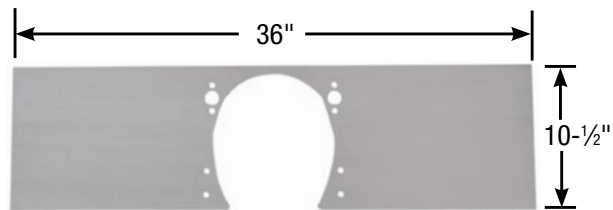

No. C4004

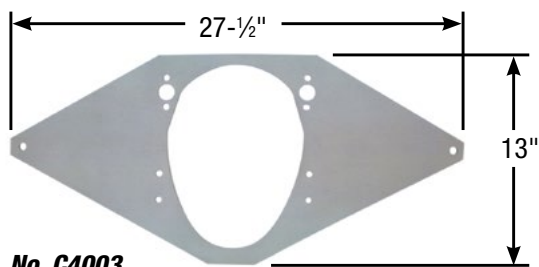

No. C4003



ENGINE MOUNTING

FRONT MOTOR PLATES

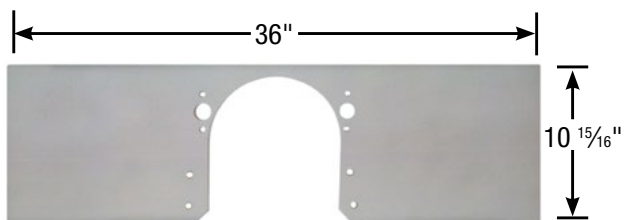

No. C4005

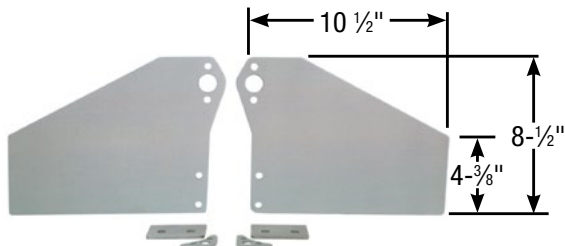

No. C4006

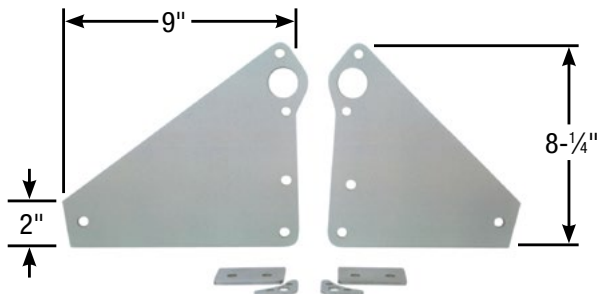

No. C4007

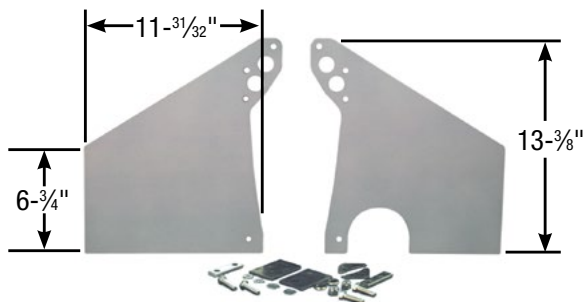

No. C4008

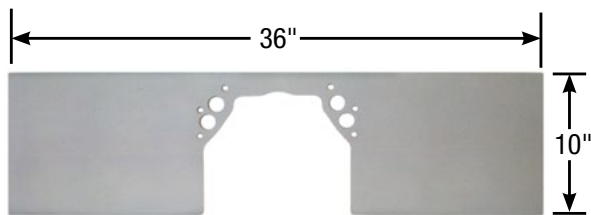

No. C4009

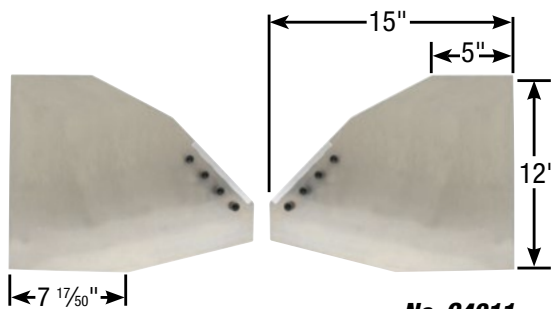

No. C4011

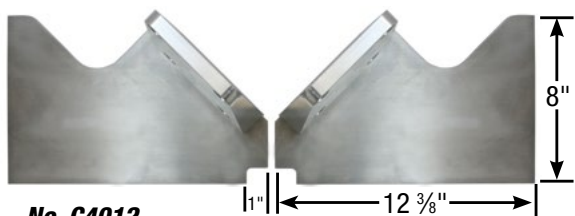

No. C4012

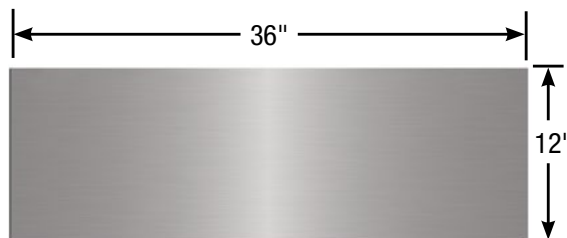

No. C4014 - Universal Fit

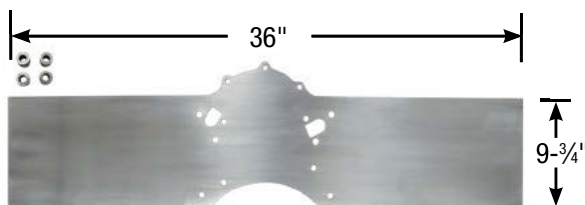

No. C4015



Competition Engineering offers several different types of brackets and tabs to help make it easier for you to mount and install accessories to your chassis. We also offer mounting brackets for our Ladder Bars and 4-Links that enable you to replace bent and damaged brackets or when updating your rear end housing.

REPLACEMENT CLEVIS BRACKETS

- Replaces Clevis Brackets found in **Nos. C2031, C2045, C2052 & C2053** Diagonal Links
- Also allows **No. C2024** Magnum Series Wishbone Locator or other locating devices to be converted to 3/4" mounting as needed
- Stamped from 3/16" mild steel
- 1/2" rod end mounting holes
- Inside dimension 1.160"
- One per package

PART #	DESCRIPTION
C3422	Replacement Clevis Bracket, 5/8"
C3423	Replacement Clevis Bracket, 3/4"
C3431	Replacement Clevis Bracket, 1/2"

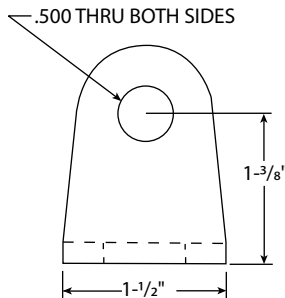

No. C3422



No. C3423

UNIVERSAL LARGE CHASSIS BRACKETS

- 13/16" radius accepts 1-5/8" tube
- 1/2" mounting hole
- Stamped from 1/8" cold rolled steel
- Four per package

PART #	DESCRIPTION
C3424	Universal Large Chassis Bracket

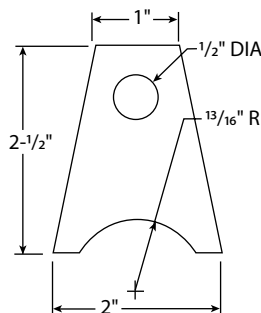

No. C3424

SEAT BELT HARNESS TABS

- Provides a professional and simple way of installing a 5-Point Safety Harness
- Rugged 1/4"-thick steel mounting tabs can be welded to roll bars, seat anchors or other locations to provide secure attachment points
- Includes 1/2" center holes for attaching harness
- Five tabs per package; enough to install a complete harness
- Welding required

PART #	DESCRIPTION
C3425	Seat Belt Harness Tabs

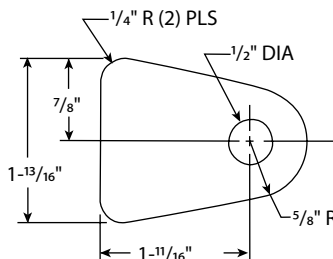

No. C3425



UNIVERSAL FRAME BRACKETS

- Can be drilled for any size hole
- $1\frac{3}{16}$ " radius accepts 1- $\frac{5}{8}$ " tube
- Gusseted for strength
- Stamped from $\frac{1}{8}$ " cold rolled steel
- Four per package

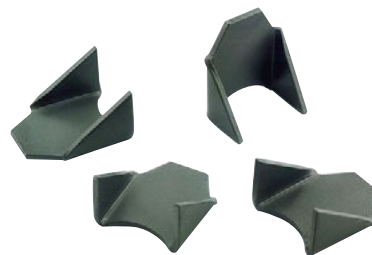
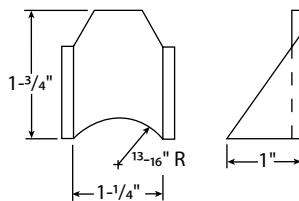

No. C3428

PART #	DESCRIPTION
C3428	Universal Frame Brackets

UNIVERSAL BELLCRANK TABS

- Provides convenient mount for linkages
- Gusseted for strength
- Stamped from $\frac{1}{8}$ " cold rolled steel
- $\frac{3}{8}$ " mounting hole
- Four per package

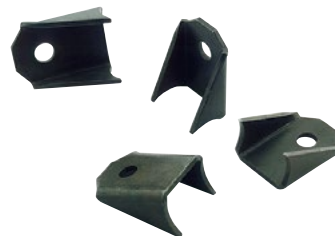
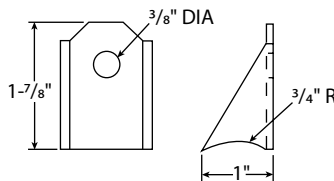

No. C3430

PART #	DESCRIPTION
C3430	Universal Bellcrank Tabs

UNIVERSAL GUSSETED CHASSIS TABS

- $1\frac{3}{16}$ " radius accepts 1- $\frac{5}{8}$ " tube
- Gusseted for strength
- $\frac{3}{8}$ " mounting hole
- Stamped from $\frac{1}{8}$ " hot rolled steel
- Two per package

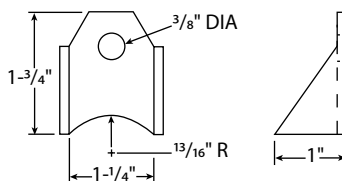

No. C3432

PART #	DESCRIPTION
C3432	Universal Gusseted Chassis Tabs

HEAVY-DUTY FLAT CHASSIS BRACKETS

- Great for mounting suspension components
- Stamped from $\frac{3}{16}$ " cold rolled steel
- $\frac{3}{4}$ " mounting hole
- Available with straight or radiused bottom
- Four per package

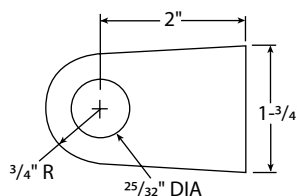

No. C3434

PART #	DESCRIPTION
C3434	Heavy-Duty Flat Chassis Brackets, Straight

UNIVERSAL 4-LINK CHASSIS BRACKETS

- Replaces chassis brackets found in No. C2017 4-Link Kit
- Stamped from $\frac{3}{16}$ " cold rolled steel
- $\frac{3}{4}$ " rod end mounting holes
- Two per package; four Brackets required per car

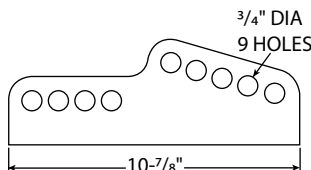

No. C3410

PART #	DESCRIPTION
C3410	Universal 4-Link Chassis Brackets



4-LINK REAR END BRACKETS

- Replaces chassis brackets found in **No. C2017** 4-Link Kit
- Stamped from 1/4" cold rolled steel
- 3" dia axle mounting hole
- 3/4" rod end mounting holes
- Two per package; four Brackets required per car

PART # DESCRIPTION
C3412 4-Link Rear End Brackets

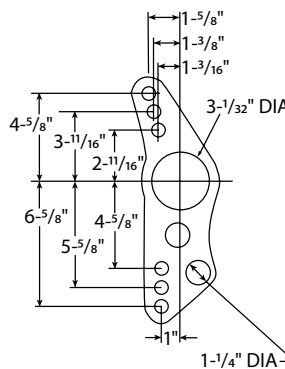

No. C3412

MAGNUM SERIES 4-LINK BRACKET

- Radiused bracket replaces the universal, square-end brackets found in our Magnum Series 4-Link to mate perfectly with our 4-Link Frame Rails
- Radiused profile simplifies welding and saves hours of fabrication time
- Rugged 1/4"-thick steel construction eliminates bending in ultra high horsepower cars
- Entire profile is stamped from hot rolled steel in one operation to eliminate distortion and to ensure exact dimensions
- Nine mounting holes provide a wide range of chassis adjustments; accepts 5/8" hole, 3/4" shank rod ends
- One per package; four brackets required per car

PART # DESCRIPTION
C3421 Heavy-Duty Flat Chassis Brackets, Straight



No. C3421

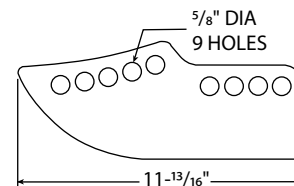

4-LINK CHASSIS BRACKET

- Bracket radius is shaped to provide an exact fit when welding to our 4-Link Formed Frame Rails
- Entire profile, including the nine rod end mounting holes, is stamped from 3/16" hot rolled steel in one operation to eliminate distortion and to ensure exact dimensions
- 3/4" rod end mounting holes
- Can also be used as replacements for the chassis brackets found in our 4-Link Rear Frame Kits
- One per package; four brackets required per car

PART # DESCRIPTION
C3408 4-Link Chassis Bracket



No. C3408

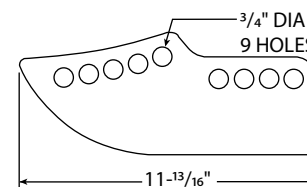

MAGNUM SERIES 4-LINK BRACKET

Without Integral Shock Mounting Holes

- Designed for use on 3" dia. Axle Tubes
- Radiused profile simplifies welding and saves hours of fabrication time
- 5/8" dia. rod end holes
- Rugged 1/4"-thick steel construction eliminates bending in ultra high horsepower cars
- Entire profile is stamped from hot rolled steel in one operation to eliminate distortion and to ensure exact dimensions
- One per package; four brackets required per car
- Use with two Competition Engineering Magnum Series 4-Link Brackets

No. C3427

PART # DESCRIPTION
C3429 Magnum Series 4-Link Bracket

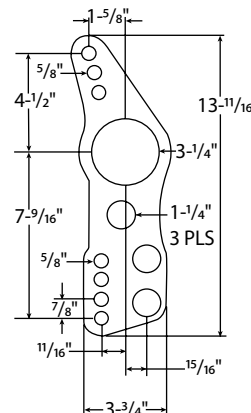

No. C3429



"MAGNUM SERIES" 4-LINK BRACKET

With Integral Shock Mounting Holes

- Designed for 3" diameter Axle Tubes
- Radiused profile simplifies welding and saves hours of fabrication time
- Rugged 1/4" thick steel construction eliminates bending in ultra high horsepower cars
- 5/8" dia. rod end holes
- Mounting holes for Wheel-E-Bars™, Sway Bar and Shock Mounting
- Entire profile is stamped from hot rolled steel in one operation to eliminate distortion and to ensure exact dimensions
- One per package; four brackets required per car
- Use with two Competition Engineering Magnum Series 4-Link Brackets No. C3429

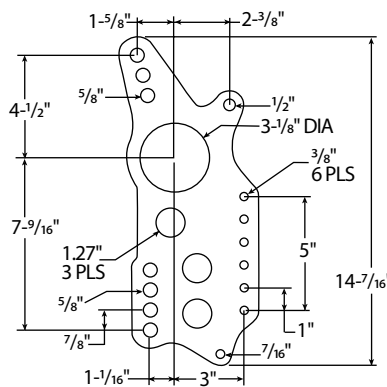

No. C3427

PART #	DESCRIPTION
C3427	"Magnum Series" 4-Link Bracket

LADDER BAR 2" X 3" CROSSMEMBER BRACKET

- Pre-notched to simplify welding and provide a neat installation
- Stamped from 3/16" mild steel
- Three 3/4" mounting holes in a 33.5" radius for chassis adjustments
- One per package; four Brackets required per car

PART #	DESCRIPTION
C3409	Ladder Bar 2" X 3" Crossmember Bracket

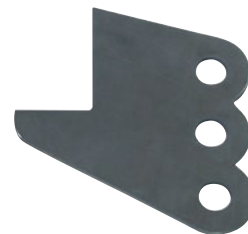
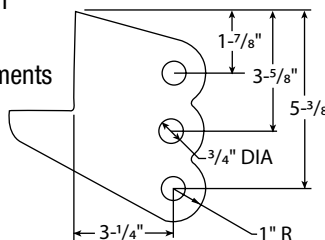

No. C3409

SHOCK MOUNTING BRACKET

For Use With Housing Back Brace

- Designed to work with Housing Brace Nos. C3405, C9105, C9205 and other 2" tall back braces
- Stamped from 1/4" steel
- Eight 3/8" dia. mounting holes, spaced 1" apart
- Welding required
- One per package, two brackets required per car
- Designed for use with Shock Bracket Nos. C3417 and C3419

PART #	DESCRIPTION
C3413	Shock Mounting Bracket

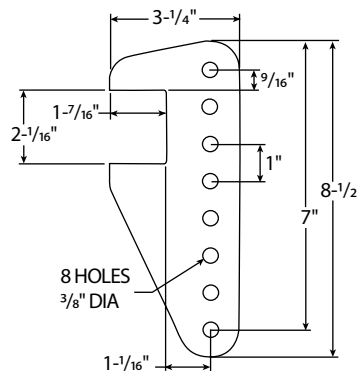

No. C3413

LADDER BAR CHASSIS BRACKET

- Bracket is radiused to mate perfectly with our Ladder Bar Frame Rails to simplify welding
- Provides a front mounting location for Ladder Bars with 3/4" rod ends
- Entire profile, including the three rod end mounting holes, is stamped from 3/16" hot rolled steel in one operation to eliminate distortion and to ensure exact dimensions
- Can also be used as replacement for the brackets found in our Ladder Bar Rear Frame Kits
- One per package; four brackets required per car

PART #	DESCRIPTION
C3411	Ladder Bar Chassis Bracket

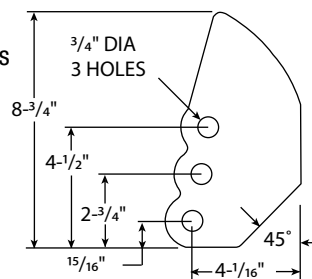

No. C3411

COIL-OVER HOUSING BRACKET

- Replaces weld-in axle brackets found in **Nos. C2047 & C2051**
Lower Coil-Over Shock Mount Kit
- 1-1/2" radius accepts 3" dia axle tube
- 3/8" shock bracket mounting holes
- Stamped from 1/4" hot rolled steel
- One per package; two brackets required per car

PART # DESCRIPTION

C3414 Coil-Over Housing Bracket

PART # AVAILABLE OPTIONS

C3417 Lower Coil-Over Shock Mounting Bracket, Right

C3419 Lower Coil-Over Shock Mounting Bracket, Left

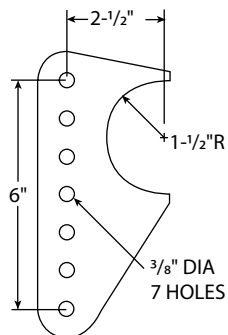

No. C3414

LOWER COIL-OVER SHOCK MOUNTING BRACKETS

- Replacement bracket, also used in **Nos. C2047 & C2051**
Lower Coil-Over Shock Mount Kit
- Stamped from 3/16" cold rolled steel
- 3/8" bracket mounting holes
- 1/2" shock mounting hole
- One per package; two of each bracket required per car

PART # DESCRIPTION

C3417 Lower Coil-Over Shock Mounting Bracket, Right

C3419 Lower Coil-Over Shock Mounting Bracket, Left

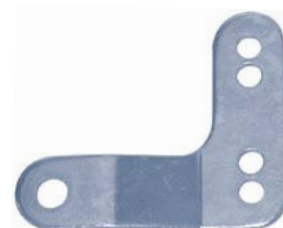
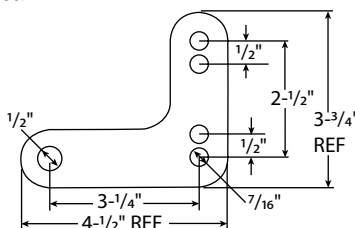

No. C3417

LADDER BAR CROSSMEMBER BRACKETS

- Replaces brackets found in **No. C2019** Ladder Bar Crossmember
- Stamped from 3/16" hot rolled steel
- 1-25/32" bar mounting hole
- 25/32" rod end mounting holes
- Two per package; four brackets required per car

PART # DESCRIPTION

C3418 Ladder Bar Crossmember Brackets

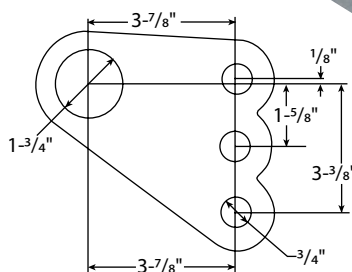

No. C3418



WELDING TABS AND BRACKETS

Before welding any tabs and brackets permanently, tack weld them in place first to check the final alignment. It's much easier to realign a tab or bracket with a temporary tack weld.

"MAGNUM SERIES" LADDER BAR HOUSING BRACKET KIT

Universal

- Innovative, four-piece housing bracket design allows for easy axle upgrades
- Creates a 360° housing bracket that can be tack welded in half the time of older systems – no more safety straps and individual plates!
- Kit allows you to adjust preload and pinion angle without bind
- Complete with two large, formed 180° housing brackets; two small, formed 180° housing brackets and four gussets
- For 3" axle tubes



No. C7212

PART # DESCRIPTION

C7212 "Magnum Series" Ladder Bar Housing Bracket Kit

U-BEND UNIVERSAL MOUNT

- This kit can be used in different applications; battery mount, shifter mount, drive shaft loop, etc.
- Comes complete with weld tube for mounting and safety pins to make removing it a snap
- U-Bend is 1-1/8" x .045" wall



No. C3030

PART # DESCRIPTION

C3030 U-Bend Universal Mount

ALIGNMENT & LEVEL TOOL

PROFESSIONAL ANGLE FINDER & LEVEL

- Handy, easy-to-read gauge face
- Perfect for setting pinion angle or determining level
- Accurate to 1/2 of 1°
- Angle and grade chart on back of gauge
- Made from ABS plastic with convenient grooved base to sit flat

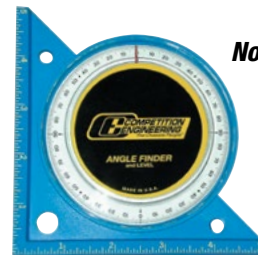

No. C5020

PART # DESCRIPTION

C5020 Professional Angle Finder & Level

ELECTRICAL COMPONENTS

BATTERY/WEIGHT BOX

- Bolts together for easy installation
- Bottom flange for secure attachment
- Holes provided for battery cables
- Constructed from 1/8" thick mild steel
- Includes 3/8" hold down rod and grommets
- Fits "Series 24" batteries
- Meets sanctioning body requirements for weight box and battery containment in cars with rear firewall
- Inside dimensions: 12-3/8" long x 9-3/4" wide x 10" high
- Weighs approximately 28 pounds



No. C4029

PART # DESCRIPTION

C4029* Battery/Weight Box

***NOTE:** Check your rule book for specific mounting requirements

TIE DOWN HOOKS, UNIVERSAL

- Are available in three angles and come as a pair
- Constructed out of 1/4" thick steel with a zinc finish
- 1.5" opening accepts standard race car tie-down straps, such as Moroso Nos. 80740, 80750
- The hooks mounting hole measures 1 1/16" or 17.5mm which accommodates most factory shock and suspension bolts or the hooks can be welded on

PART #	DESCRIPTION
C3437	Tie Down Hook, Universal, Pair, Flat
C3438	Tie Down Hook, Universal, Pair, 45 Degree
C3439	Tie Down Hook, Universal, Pair, 90 Degree



No. C3438

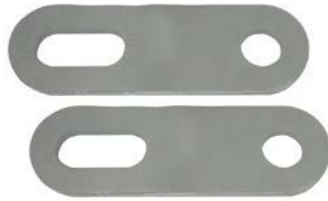

No. C3437



No. C3439

TOW HOOK, FOLDING, UNIVERSAL

- 2" opening meets sanctioning bodies rules about Tow Hooks
- Constructed out of 1/4" thick steel with a zinc finish
- Grade 8 hinge hardware
- Bolt-on or weld-on

PART #	DESCRIPTION
C3435	Tow Hook, Universal, Folding



No. C3435



TOW HOOK, UNIVERSAL

- Steel, zinc plated
- 3/16" Universal with 2" opening
- Bolt-on or weld-on
- Can be used for trailer tie-down points

PART #	DESCRIPTION
C3440	Tow Hook, Universal



No. C3440



TIE DOWNS / TOW HOOKS

**MOROSO PERFORMANCE
REPLACEMENT PARTS**

**COMPETITION ENGINEERING
REPLACEMENT PARTS**

For a list and descriptions of replacement parts for discontinued Wheel-E-Bars™, please refer to page 423

PART #	PAGE #	PART #	PAGE #
97000	107	97530	145
97001	107	97535	368
97002	107	97542	367-368
97003	107	97543	368
97005	108	97545	359
97006	107, 208	97550	359
97010	108	97551	359
97011	108	97552	359
97015	151	97553	359
97020	309-310	97570	454
97030	309	97571	185-186
97035	291, 310	97580	189
97036	218	97590	154
97037	218	97641	154-155
97040	310	97644	158
97050	150	97690	454
97062	276	97730	229
97070	284	97731	229
97080	280-281	97732	229
97081	280-281	97751	185-186
97085	283	97800	151, 312
97090	281	97810	151, 312
97170	170, 173, 177, 179	97817	265
97172	177	97830	340
97180	158	97832	340
97181	158	97833	340
97200	180, 182, 187-190	97835	340
97210	255	97848	342
97220	255	97849	342, 345
97230	255	97850	342
97250	255	97852	342
97252	255	97853	342
97255	255	97854	342
97257	255	97855	342
97275	252	97856	342
97290	211	97857	342, 344
97291	211	97858	342, 344
97319	66	97859	342, 344
97321	138-139	97860	342, 345
97322	138	97861	342
97323	138	97862	342
97324	138	97866	343
97325	138	97867	343
97330	280-281		
97331	283		
97340	311-312		
97341	311		
97345	298		
97346	291		
97450	256		
97485	245-246, 375		
97500	236		
97510	282		
97520	282		

PART #	PAGE #
C2755	420
C3414	451
C3417	451
C3418	451
C3419	451
C3420	451
C3422	447
C3423	447
C6011	410
C6150	410
C6151	410
C7024	397
C7030	397
C7031	397
C7032	397
C7046	424
C7047	424
C7048	454
C7051	423
C7052	423
C7058	423
C7059	423
C7060	423
C7066	423
C9700	398
90430	423



PART#	PAGE	PART#	PAGE	PART#	PAGE	PART#	PAGE	PART#	PAGE	PART#	PAGE
17023	374	20201	27	20535	74	20967	98	21553	36	22162	120
17025	374	20205	26	20536	78	20968	100	21554	36	22163	37, 53-65, 115
17026	374	20206	27	20546	83	20969	98	21555	36	22164	37, 53-65, 115
17028	374	20211	28	20548	83	20970	103	21556	36	22167	61, 115
17029	374	20212	28	20549	82	20971	103	21581	62	22171	25-30, 114
17040	374	20230	29	20554	82	20975	99	21592	66	22175	53-65, 116
17050	374	20372	65	20555	83	20976	99	21597	66	22185	53-65, 116
17100	374	20376	61	20557	81	21015	8, 29	21598	9, 66	22186	53-65, 116
17600	374	20385	59	20558	81	21017	29,	21600	61	22187	57-58, 117
20032	60	20401	54	20569	84	21019	37	21631	92	22195	52, 116
20043	70	20403	54	20570	84	21047	57	21811	32	22241	135
20044	70	20405	57	20571	85	21048	58	21812	32	22243	135
20045	70	20406	56	20572	85	21049	58	21813	31	22244	135
20049	71	20408	53	20573	84	21149	9, 42	21814	31	22245	135
20054	72	20409	64	20574	86	21150	41	21815	31	22251	135
20055	71	20411	63	20575	10, 85	21151	43	21816	32	22253	135
20105	8, 39	20412	55	20576	10, 85	21152	48	22000	153	22254	135
20138	45	20413	63	20577	10, 86	21153	44	22010	153	22255	135
20139	42	20416	55	20606	87	21154	51	22016	153	22300	147
20140	39	20420	62	20607	88	21155	49	22017	153	22305	147
20141	40	20421	65	20608	88	21156	49	22018	153	22074	125
20142	46	20431	56	20609	87	21157	44	22045	153	22077	125
20143	47	20433	64	20612	91	21158	43	22050	153	22080	125
20144	50	20449	52	20614	90	21159	48	22070	125	22082	125
20145	41	20451	52	20616	90	21161	68	22072	125	22090	125
20146	45	20460	53	20620	89	21166	10, 68	22074	125	22099	119
20147	40	20480	92	20625	89	21234	30	22077	125	22101	120
20148	46	20485	59	20710	67	21240	30	22080	125	22109	119
20149	47	20486	60	20730	67	21247	38	22082	125	22111	120
20150	40	20490	93	20760	69	21248	38	22090	125	22120	120
20151	50	20492	93	20766	69	21308	32	22099	119	22124	25-30, 116
20155	51	20500	93	20901	94	21312	35	22101	120	22134	25-30, 116
20160	26	20501	78	20910	94	21314	35	22109	119	22139	25-29, 117
20165	26	20502	73	20911	94	21315	35	22111	120	22144	25, 116
20170	25	20503	73	20912	95	21316	33	22112	120	22146	25-29, 117
20171	25	20506	74	20915	96	21317	33	22124	25-30, 116	22147	34-35, 117
20172	25	20507	77	20916	9, 95	21318	34	22134	25-30, 116	22149	119
20179	31	20511	75	20917	95	21319	34	22139	25-29, 117	22150	120
20180	25	20520	79	20919	96	21320	33	22144	25, 116	22159	119
20181	25	20521	75	20930	101	21322	33	22146	25-29, 117	22160	120
20182	25	20522	81	20935	101	21323	33	22147	34-35, 117		
20185	31	20523	79	20936	102	21324	33	22149	119		
20190	26	20527	76	20937	102	21325	34	22150	120		
20191	27	20528	76	20940	97	21326	34	22159	119		
20193	37	20529	80	20942	97	21327	34	22160	120		
20195	27	20530	82	20960	98	21330	36				
20196	28	20533	77	20965	100	21551	38				
20200	26	20534	80	20966	100	21552	38				



NOTE: Part Nos. in RED are New Products

PART#	PAGE	PART#	PAGE	PART#	PAGE	PART#	PAGE	PART#	PAGE	PART#	PAGE
22367	14, 133	22636	161	22724	156	23036	110	23695	140	24010	94, 124
22400	147	22637	161	22725	156	23040	112	23698	140	24011	94, 124
22405	14, 133	22640	158	22726	156	23045	113	23699	140	24012	95, 124
22411	12, 128	22641	158	22727	156	23143	70	23700	142	24050	39-42, 46-48, 121
22412	12, 128	22642	159	22728	156	23144	70	23701	139	24052	45, 121
22413	12, 128	22643	159	22729	156	23210	113	23703	140	24100	118
22414	14, 133	22644	159	22730	285	23520	173, 175, 179	23705	16, 140	24101	34-36, 119
22415	14, 133	22645	158	22731	285	23523	173, 175, 179	23710	142	24103	34-36, 119
22421	136	22646	158	22732	285	23528	170, 177	23711	141	24104	34-36, 119
22423	136	22649	163	22733	285	23532	170, 177, 179	23712	141	24120	28, 118
22424	136	22651	163	22734	285	23533	178	23750	142	24122	28, 118
22425	136	22652	15, 134, 160	22735	17, 188, 313	23534	178	23760	142	24144	25, 50, 121
22435	134	22654	15, 134, 160	22736	17, 188, 313	23535	178	23763	143	24150	26, 118
22441	127	22674	187	22737	156	23534	178	23764	143	24153	43, 121
22443	131	22677	186	22738	108	23540	178	23766	143	24161	68, 122
22444	131	22678	186	22739	16, 187	23541	178	23767	142	24162	68, 122
22445	131	22679	187	22741	129, 132-136	23542	178	23770	138	24166	11, 68, 122
22446	131	22681	185	22742	129, 132-136	23543	178	23775	138	24170	25-30, 38, 118
22459	148	22682	185	22743	129, 132-136	23544	178	23782	138	24171	37, 118
22460	148	22683	185	22744	129, 132-136	23545	178	23790	138	24181	25-30, 38, 118
22461	148	22684	185	22749	154	23546	178	23820	139	24185	25, 31, 118-119
22462	148	22686	185	22753	108, 162, 316	23547	178	23840	139	24212	25, 31, 118-119
22463	51, 148	22687	185	22754	156	23548	178	23845	150	24213	25, 31, 118-119
22470	148	22688	185	22755	108, 162, 316	23556	178	23850	150	24308	32, 118
22515	13, 129	22689	185	22774	156	23558	178	23860	150	24314	34-35, 119
22517	13, 129	22691	186	22780	156	23560	173	23870	150	24315	34-35, 119
22518	13, 129	22697	16, 186	22784	158	23561	173	23875	146	24316	33, 119
22521	136	22698	16, 186	22842	159	23562	173	23900	145	24317	33, 119
22523	136	22699	187	22843	159	23675	139	23901	145	24318	34-35, 119
22524	136	22701	16, 187	22850	111, 153	23676	139	23902	145	24320	25-29, 38, 118
22525	136	22703	155	22912	109	23677	139	23903	145	24325	36, 119
22604	16, 155	22704	155	22928	112	23678	139	23905	146	24330	118,
22605	155	22706	155	22930	111	23679	139	23907	146	24340	26, 118
22606	155	22708	155	22933	112	23681	141	23908	146	24350	25-30, 38, 118
22610	156	22709	155	22934	109	23682	140	23920	145	24351	37, 118
22620	155	22710	151	22935	111	23683	140	23921	145		
22622	155, 253	22711	156	22936	15, 86, 112	23684	140	23960	156		
22624	16, 162	22712	156	22939	111	23685	140	23961	156		
22625	155	22713	156	22940	112	23686	140	23962	156		
22626	155, 158, 162	22714	156	22941	110	23687	141	23963	156		
22627	16, 162	22715	156	22943	111	23688	141	23965	150		
22629	161	22716	156	23000	110	23689	142	23970	108		
22630	161	22717	156	23010	110	23690	139	23980	154		
22631	161	22718	156	23020	110	23691	140	23990	154		
22632	162	22719	156	23030	110	23692	140	23991	154		
22633	161	22720	156	23035	110	23693	140	23995	154		
22634	162	22722	156			23694	140	23996	154		
22635	162							23997	154		

NOTE: Part Nos. in RED are New Products

PART#	PAGE	PART#	PAGE	PART#	PAGE	PART#	PAGE	PART#	PAGE	PART#	PAGE
24360	25-29, 118	24579	11, 85-86, 123	26215	346	38415	109	42025	207-209	47195	231-232
24430	52, 56, 121	24601	68, 122	26217	346	38420	219	42030	207-209	47200	231-232
24440	53-65, 121	24602	68, 122	27043	343	38541	217	42031	207-209	47205	231-232
24441	53-65, 121	24608	88, 123	27264	92	38542	217	42040	208	47210	231-232
24446	60, 121	24609	87, 123	27293	106	38550	218	42050	208	47215	231-232
24448	52, 121	24700	67, 122	27336	91	38551	219	42060	208	47220	231-232
24450	53, 121	24750	69, 122	27601	68	38555	218	42080	208	47230	231-232
24460	92, 122	24766	69, 122	27862	72	38560	218	42090	208	47500	232
24463	92, 122	24800	69, 122	34800	212	38590	219	44050	227	47510	232
24480	93, 122	24811	32,	35000	212	38710	219	44052	227	47520	232
24482	93, 122	24813	25, 31, 118-119	35500	213	38755	220	44056	227	49500	151
24501	123	24814	32, 119	35520	213	38760	220	46140	229	60008	354
24504	91, 123	24817	32, 119	35560	212	38764	211, 219	46150	228	60009	354
24505	90, 123	24819	32, 119	35570	213	38765	211, 219	46151	228	60010	355
24507	77-78, 123	24840	124	35571	213	38770	220	46160	228	60012	354
24508	89, 123	24841	124	35581	213	38772	220	46180	228	60016	22, 355
24509	89, 123	24862	124	37800	214	38775	220	46185	228	60055	354
24511	90, 123	24866	124	37810	214	39000	220	46190	228	60100	356
24515	81, 123	24890	49	37812	214	39005	221	46200	229	60105	356
24516	75-76, 122	24936	102, 124	37900	214	39010	221	46220	228	60110	356
24517	74, 122	24964	125	37920	214	39015	221	46240	228	60115	356
24518	74, 122	24965	124-125	37930	214	39016	221	46241	228	60120	356
24520	73, 122	24976	99, 124	37932	215	39020	221	46245	228	60125	356
24522	90, 123	25000	150	37934	215	39021	221	46247	19, 228	60130	356
24523	73-74, 122	25001	150	37936	215	39022	221	46300	230	60135	356
24527	76-77, 122	25025	152	37938	215	39023	221	46310	230	60140	356
24528	76-77, 122	25026	150	37950	216	39025	221	46320	228	60145	356
24530	82, 123	25050	152	37955	216	39050	220	46330	228	60150	356
24532	79-80, 123	25100	152	37960	216	39152	214	46340	228	60155	356
24534	80, 123	25150	152	37961	216	39153	214	46345	228	60200	137
24547	82, 123	25177	152	38150	215	39154	214	46420	228	60201	137
24548	82, 123	25178	152	38191	216	41060	211	46440	228	60205	137
24558	81, 123	25179	237	38192	216	41090	163, 279	46445	228	60206	137
24570	54, 123	25180	237	38193	216	41091	163, 279	46450	228	60355	355
24573	84, 123	25180	237	38194	216	41100	210	46460	228	60460	226
24574	86, 123	25800	109	38300	215	41200	211	46480	228	60461	226
24576	11, 84-85, 123	25830	109	38310	215	41201	211	46485	228	60462	226
24577	11, 84-85, 123	25900	151, 312	38315	109	41205	211	46490	228	60464	226
24578	11, 85, 123	25970	106	38350	217	41221	191	47130	231-232	61740	233
		25971	107	38356	217	41300	210	47135	231-232	61741	233
		25973	107	38360	217	41301	210	47140	231-232	61742	233
		26140	345	38361	218	41302	210	47150	231-232	61743	233
		26150	345	38366	217	41303	210	47160	231-232	61744	233
		26200	346	38385	218	41305	210	47165	231-232	61745	233
		26210	346	38387	218	42000	207-209	47170	231-232	61746	233
		26211	346	38390	218	42001	207-209	47175	231-232	61755	234
				38400	219	42010	207-209	47180	231-232	61756	234
				38410	219	42020	207-209	47190	231-232	61757	234



NUMERICAL INDEX

PART#	PAGE	PART#	PAGE	PART#	PAGE	PART#	PAGE	PART#	PAGE	PART#	PAGE
61760	234	62515	248	63465	259	63542	253	63783	199	63843	169
61770	234	62520	250	63466	259	63543	253	63784	206	63844	170
61790	234	62530	248	63467	260	63544	253	63785	205	63845	170
61805	234	62535	248	63468	259	63546	255	63786	199	63846	170
61820	235	62540	250	63469	263	63547	252	63787	196	63847	171
61840	235	62544	251	63471	262	63555	255	63788	196	63848	170
61870	235	62545	251	63473	259	63557	252	63791	203	63849	171
61880	235	62550	249	63474	259	63565	252	63793	203	63852	18, 198
62010	230, 244	62555	250	63475	259	63566	252	63795	206	63853	171
62026	243	62600	249	63476	259	63570	253	63796	197	63854	196
62027	243	62602	251	63477	259	63571	253	63797	203	63856	196
62030	243	62610	249	63485	260	63575	252	63800	198	63857	171
62050	236	62630	249	63486	260	63585	252	63801	198	63858	171
62070	239	62635	249	63488	260	63595	252	63802	198	63859	171
62071	239	62640	250	63490	199	63610	256	63803	198	63860	171
62080	236	62641	250	63491	199	63611	256	63804	201	63861	171, 356
62160	241	62670	237	63492	200	63615	254	63805	201	63865	166
62190	234	62672	237	63493	200	63616	254	63806	199	63866	166
62191	234	62673	237	63494	200	63645	257	63808	196	63867	166
62192	234	62674	237	63495	200	63650	193	63809	197	63870	165
62200	237	63000	21, 263	63496	200	63651	193	63810	168	63871	18, 205
62205	237	63001	21, 263	63497	197	63655	193	63811	203	63880	172
62208	136	63307	258	63498	197	63656	193	63812	197	63881	172
62210	237	63309	258	63499	197	63657	192	63813	195	63882	172
62220	237	63313	258	63500	256	63660	192	63814	205	63883	172
62250	237	63316	258	63501	199	63700	258	63815	168	63884	172
62255	235	63320	258	63502	200	63730	258	63817	166	63885	172
62256	235	63324	258	63503	195	63731	258	63818	166	63886	172
62260	242, 337	63328	258	63506	192	63740	258	63819	166	63887	17, 173
62268	242, 337	63332	258	63507	192	63741	258	63820	201	63890	171
62270	242, 337	63401	191	63508	200	63745	258	63821	167	63895	169
62271	242, 337	63402	191	63509	200	63746	258	63822	167	63897	169
62272	242, 337	63403	191	63510	256	63750	255	63823	167	63909	164
62280	247	63420	260	63511	256	63760	258	63824	167	63910	164
62284	286	63421	261	63512	254	63765	257	63825	168	63911	164
62293	240	63422	261	63513	254	63766	193	63827	165	63916	164
62295	240	63423	261	63514	254	63767	199	63828	165	63917	164
62370	238	63424	261	63515	254	63768	199	63829	165	63918	164
62371	238	63425	264	63516	254	63769	194	63832	165	63921	164
62372	238	63426	264	63519	253	63771	194	63833	165	63922	164
62380	238	63427	264	63521	253	63772	194	63834	165	63923	164
62385	241	63430	262	63522	253	63773	193	63836	166	63924	164
62388	239	63431	262	63523	253	63777	204	63837	166	63950	196
62389	239	63432	262	63525	253	63778	204	63838	166	64030	174
62390	238	63433	21, 263	63530	201	63779	204	63839	165	64031	173
62391	239	63440	257	63531	195	63780	204	63840	169	64035	173
62500	248	63455	259	63539	255	63781	204	63841	169	64050	174
62510	248	63461	259	63541	253	63782	199	63842	169	64051	175

PART#	PAGE	PART#	PAGE	PART#	PAGE	PART#	PAGE	PART#	PAGE	PART#	PAGE
64060	174	64985	269	65374	277	65912	282	68332	22, 292	68482	300
64070	174	64991	269	65375	275	65913	282	68333	298	68483	302
64100	174	64996	269	65380	275	65915	280	68335	291	68484	302
64110	174	65000	269	65381	182, 275	65920	283	68345	299	68485	317
64111	175	65015	270	65382	182, 275	65928	281	68348	306	68486	300
64120	174	65016	270	65385	277	65945	281	68349	306	68487	302
64200	174	65017	270	65388	182, 275	65946	281	68350	299	68488	295
64201	175	65018	270	65389	182, 275	65947	283	68353	299	68489	302
64210	174	65030	271	65390	275	65951	284	68356	299	68493	295
64211	175	65042	268	65391	278	65960	284	68365	290	68494	296
64550	174	65045	266	65392	278	65961	284	68370	290	68495	296
64551	175	65047	265	65393	278	66210	282	68371	290	68501	308
64700	174	65050	266	65394	278	66303	282	68374	290	68505	308
64800	174	65052	265	65395	278	66304	282	68380	290	68506	308
64860	175	65062	265	65396	278	66305	282	68381	290	68510	308
64870	176	65064	265	65397	163, 278	66310	282	68385	290	68512	308
64885	176	65070	266	65398	163, 278	66390	284	68388	305	68516	308
64886	177	65075	266	65401	274	67100	287	68389	305	68519	308
64887	176	65090	279	65408	274	67160	287	68392	288	68525	308
64888	177	65127	20, 265	65411	274	67170	287	68401	289	68526	308
64917	267-268	65130	275	65412	274	67250	287	68405	289	68530	308
64918	267	65131	182, 275	65413	274	67300	287	68411	289	68550	309
64919	267	65140	275	65414	272	67320	287	68420	298	68561	309
64920	268	65141	275	65425	272	67650	286	68425	297	68562	215, 297, 310
64922	266	65144	275	65426	273	67700	153, 287	68426	297	68603	309
64923	367	65145	276	65432	273	68003	289	68429	297	68604	309
64925	266	65146	275	65440	271	68005	289	68432	298	68605	309
64926	266	65160	276	65441	271	68006	289	68450	304	68610	309
64927	267	65170	276	65442	272	68025	293	68455	301	68621	309
64928	266	65222	274	65443	272	68026	293	68456	301	68630	309
64929	268	65223	274	65444	272	68028	293	68457	300	68640	309
64930	270	65224	274	65531	272	68050	293	68458	300	68660	317
64935	268	65225	271	65532	273	68051	292	68459	300	68717	312
64940	270	65226	271	65534	273	68102	288	68460	300	68718	312
64941	270	65227	271	65750	279	68103	288	68461	306	68719	312
64943	270	65228	273	65752	279	68112	297	68463	301	68740	312
64945	270	65230	276	65770	279	68113	297	68467	303	68741	312
64947	270	65231	276	65800	240	68161	302	68468	303	68762	315
64950	269	65234	276	65801	240	68181	303	68469	301	68770	311
64951	269	65300	276	65802	240	68201	303	68470	294	68771	311
64952	270	65310	276	65803	240	68202	303	68471	294	68772	311
64960	269	65315	276	65805	240	68210	303	68472	294	68773	311
64964	269	65330	275	65820	284	68281	306	68473	294	68775	311
64965	269	65340	275	65904	280	68310	302	68474	304	68776	311
64966	269	65345	275	65905	280	68326	291	68475	304	68780	151, 312
64970	269	65360	276	65906	280	68328	291	68479	300	68781	312
64980	269	65370	277	65910	280	68329	292	68480	296	68785	313
64981	269	65372	277	65911	281	68330	293	68481	300	68788	151, 313





PART#	PAGE	PART#	PAGE	PART#	PAGE	PART#	PAGE	PART#	PAGE	PART#	PAGE
68790	311	71279	222	71376	223	71910	345	72180	340	72561	329-333
68791	160, 314	71280	222	71377	223	71992	338	72181	340	72565	329-333
68792	314	71290	222	71378	223	71993	338	72182	340	72570	329-333
68800	315	71291	222	71379	223	71994	338	72183	340	72600	329-333
68810	315	71293	222	71380	223	71995	338	72195	340	72605	329-333
68811	314	71294	222	71381	223	72000	338	72231	342	72635	329-333
68812	314	71295	222	71382	223	72002	338	72251	343	72645	329-333
68813	314	71296	222	71383	223	72004	338	72252	343	72646	329-333
68815	314	71297	222	71400	223	72011	338	72280	343	72650	329-333
68816	314	71298	222	71410	223	72012	338	72300	344	72655	329-333
68817	314	71299	222	71420	223	72013	338	72310	344	72656	329-333
68818	187, 314	71300	222	71425	223	72020	338	72315	344	72660	329-333
68820	310	71301	222	71430	223	72023	336	72350	347	72673	333
68825	292	71302	222	71440	223	72030	338	72355	342, 349-353	72674	333
68830	310	71310	222	71441	223	72031	338	72358	349-353	72680	333
68831	310	71311	222	71450	223	72038	336	72360	349-353	72682	333
68832	18, 217	71312	222	71451	223	72040	336	72380	349	72751	327
68839	316	71325	222	71460	223	72041	324	72390	347	72752	327
68840	316	71327	222	71470	223	72050	324	72395	348	72753	327
68841	316	71329	222	71490	224	72060	336	72396	348	72754	327
68843	316	71330	222	71495	224	72061	324	72396	348	72792	327
68844	295, 315	71331	222	71500	223	72070	336	72397	294, 348	72800	335
68845	316	71332	222	71501	223	72071	324	72398	294, 348	72820	335
68846	316	71333	222	71502	223	72075	336	72402	326	72830	335
68847	316	71340	222	71505	223	72076	324	72405	326	72855	335
68848	316	71341	222	71506	223	72081	324	72407	326	73160	341
68849	318	71345	222	71507	223	72130	339	72415	326	73163	341
68850	314	71346	222	71510	223	72131	339	72416	326	73210	328
68851	318	71349	222	71530	223	72133	339	72426	326	73214	328
68852	318	71350	222	71531	223	72140	340	72430	326	73215	328
68853	318	71351	222	71532	223	72141	340	72475	327	73216	328
68854	318	71352	222	71540	223	72143	340	72500	329-333	73217	328
68855	318	71353	222	71550	224	72150	339	72510	329-333	73218	328
68856	317	71354	222	71551	224	72151	339	72520	329-333	73219	328
68857	295, 313	71355	222	71552	224	72153	339	72521	329-333	73220	328
68900	317	71356	222	71553	224	72160	341	72522	329-333	73225	328
68910	317	71358	222	71554	224	72161	341	72524	329-333	73226	328
68995	294	71359	222	71555	224	72162	341	72525	329-333	73229	328
71161	67	71360	222	71556	224	72163	341	72526	329-333	73230	327
71162	49	71361	222	71557	224	72166	341	72527	329-333	73231	328
71260	222	71362	222	71559	224	72167	339	72528	329-333	73232	328
71270	222	71363	222	71600	225, 244	72168	339	72529	329-333	73233	328
71271	222	71364	222	71601	225, 243	72170	339	72530	329-333	73235	327
71272	222	71365	222	71602	225, 243	72171	339	72535	329-333	73236	327
71274	222	71370	223	71605	225, 243	72172	339	72538	329-333	73237	324
71275	222	71371	223	71606	225, 244	72174	339	72540	329-333	73238	324
71276	222	71372	223	71607	225, 244	72175	339	72542	329-333	73240	324
71277	222	71373	223	71610	225	72176	339	72550	329-333	73241	324
71278	222	71375	223	71900	345	72178	339	72560	329-333	73512	323

NOTE: Part Nos. in RED are New Products

MOROSO NUMERICAL INDEX

PART#	PAGE	PART#	PAGE	PART#	PAGE	PART#	PAGE	PART#	PAGE	PART#	PAGE		
73535	323	73690	322	73818	323	74119	364	74240	196	85461	190	85521	183
73536	323	73691	322	73819	323	74120	365	74241	196	85462	190	85522	184
73537	323	73692	322	73820	323	74122	365	74246	195	85463	190	85523	184
73600	323	73693	322	73821	323	74123	365	74247	195	85464	190	85524	183
73602	323	73694	322	73822	323	74124	366	74248	195	85465	187	85530	183
73605	323	73695	322	73823	323	74125	366	74253	202	85466	189	85531	180, 184
73607	323	73696	322	73824	323	74126	366	74254	202	85467	188	85532	183
73614	323	73699	322	73825	323	74129	366	74255	202	85468	188	85600	184
73615	323	73703	322	73826	323	74130	367	74256	202	85469	188	85601	184
73616	323	73704	322	73827	323	74131	367	74258	195	85470	187	85602	183
73617	323	73705	322	73828	321	74132	367	74299	366	85471	180, 190	85603	183
73621	323	73706	322	73830	323	74133	367	74300	366	85472	183	85604	184
73622	323	73707	322	73832	323	74134	367	78740	372	85473	188	85605	184
73626	323	73708	322	73833	323	74135	367	78000	372	85474	180, 184	85606	184
73628	323	73709	322	73834	323	74136	367	80110	373	85475	187	85607	184
73630	323	73710	322	73835	323	74139	367	80120	373	85477	184	85608	184
73631	323	73711	322	73836	321	74140	359	80131	373	85478	183	85609	184
73657	322	73712	322	73837	321	74143	367	80160	373	85479	183	85610	184
73658	322	73713	322	73838	323	74144	360	80700	247	85481	183-184	85611	184
73659	322	73714	322	73839	321	74145	360	80740	247	85482	184	85612	183
73660	322	73715	322	73840	321	74148	367	80750	247	85483	184	85613	183
73661	322	73716	322	73841	321	74149	359	80805	286	85484	184	85616	184
73662	322	73717	322	73842	323	74155	359	80807	286	85485	184	85617	184
73663	322	73718	322	73843	323	74156	359	80808	286	85486	184	85626	184
73664	322	73719	322	73845	294, 323	74170	358	80809	286	85487	183	85627	184
73665	322	73722	322	73846	294, 323	74172	358	80939	247	85488	184	85628	184
73666	322	73723	322	73848	22, 296, 323	74173	358	80940	247	85489	184	85629	184
73667	322	73724	322	74005	358	74174	358	80941	247	85491	184	85632	183
73668	322	73725	322	74016	357	74175	358	80942	247	85492	184	85633	183
73669	322	73726	322	74051	357	74180	368	80944	247	85493	183	85634	183
73670	322	73727	322	74055	358	74181	368	84750	370	85494	184	85635	183
73671	322	73728	322	74100	361	74183	368	84751	370	85495	180, 184, 190	85636	184
73672	322	73729	322	74101	361	74186	368	85080	370	85496	181, 184	85637	184
73673	322	73730	322	74102	361	74190	368	85090	370	85497	181, 184	85638	184
73674	322	73731	323	74103	358	74193	368	85280	317, 371	85498	184	85639	184
73675	322	73800	321	74104	358	74194	369	85282	317, 371	85498	184	85640	183
73676	322	73801	321	74105	363	74195	369	85283	317, 371	85499	183	85641	183
73677	322	73802	321	74106	361	74200	360	85284	317, 371	85500	188	85642	183
73679	322	73804	321	74107	362	74201	360	85330	370	85505	192	85643	183
73680	322	73805	321	74108	361	74220	202	85390	17, 189	85510	184	85644	184
73681	322	73808	321	74109	363	74221	202	85400	187	85511	184	85645	184
73682	322	73810	321	74110	362	74222	202	85402	187	85513	184	85646	184
73683	322	73811	321	74111	363	74224	202	85404	187	85514	184	85647	184
73684	322	73812	321	74114	358	74225	202	85406	187	85515	184	85648	183
73685	322	73813	321	74115	365	74226	198	85450	189	85516	183	85649	183
73686	322	73814	321	74116	362	74228	202	85455	17, 188	85517	184	85650	184
73687	322	73815	321	74117	364	74229	202	85456	187	85518	184	85651	184
73688	322	73816	321	74118	364	74230	202	85458	187	85519	184	85652	183
73689	322	73817	323			74231	206	85459	187	85520	184	85653	183

NOTE: Part Nos. in RED are New Products



NUMERICAL INDEX

PART#	PAGE	PART#	PAGE	PART#	PAGE	PART#	PAGE	PART#	PAGE	PART#	PAGE
85654	184	89576	245, 375	93150	106	97010	108	97200	180, 182, 187-190	97641	154, 155, 158, 162, 264
85655	184	89585	244, 376	93151	106	97011	108	97210	255	97642	158
85660	184	89590	246, 375	93152	106	97015	151	97220	255	97644	158
85661	184	89592	245	93153	106	97020	309-310	97230	255	97690	454
85664	183	89593	245	93154	106	97030	309	97250	255	97730	229
85665	183	89594	245	93156	106	97035	291, 310	97252	255	97731	229
85666	184	89595	245	93160	106	97036	218	97255	255	97732	229
85667	184	89600	236	93161	106	97037	218	97257	255	97751	185-186
85668	184	89602	236	93162	106	97040	310	97275	252	97800	151, 312
85669	184	89603	236	93163	106	97050	150	97290	211	97810	151, 312
85670	184	89610	160, 277	93164	106	97062	276	97291	211	97817	265
85671	184	89611	151, 160, 277	93166	106	97070	284	97300	182	97830	340
85672	184	89650	241	93167	106	97080	280-281	97301	181, 182	97832	340
85673	184	90100	230	93174	106	97081	280-281	97319	66, 454	97833	340
85674	184	90110	230	93175	106	97085	283	97321	138-139	97835	340
85675	184	90366	226	93200	106	97090	281	97322	138	97848	342
85676	184	90367	226	93230	20, 256	97092	21, 198	97323	138	97849	342, 345
85677	184	90368	226	93231	20, 256	97105	179	97324	138	97850	342
85678	183	90369	226	93232	20, 256	97110	173, 179	97325	138	97852	342
85679	183	90370	226	93233	20, 256	97113	179	97330	280-281	97853	342
85680	184	90371	226	93234	20, 257	97120	173, 179	97331	283	97854	342
85681	184	90372	226	93235	20, 257	97123	179	97340	311-312	97855	342
85682	181	90373	226	93236	20, 257	97125	179	97341	311	97856	342
85683	181	90374	226	93237	20, 257	97130	173, 179	97345	298	97857	342, 344
85684	184	90375	226	93238	20, 257	97133	179	97346	291	97858	342, 344
85685	184	90376	226	93239	20, 257	97135	179	97450	454	97859	342, 344
85686	183	90377	226	93240	20, 257	97136	179	97480	246, 375	97860	342, 345
85687	183	90378	226	93241	20, 257	97138	179	97481	19, 245	97861	342
85696	183	90379	227	93300	266, 270, 279	97140	173, 179	97485	245-246, 375	97862	342
85697	183	90770	227	93301	270, 279	97141	179	97500	236	97866	343
85699	181	93020	307	93310	270, 279	97142	179	97510	282	97867	343
85700	372	93021	307	93320	21, 278	97143	179	97520	282	99400	235
85702	183	93025	307	93321	21, 278	97144	179	97530	145	99401	235
85703	183	93040	307	93322	21, 278	97146	179	97535	368	99406	239
85800	371	93045	307	93323	21, 278	97147	179	97542	367-368	99410	376
85810	371	93050	307	94050	285	97149	179	97543	368	99421	376
85820	371	93055	307	94051	285	97151	179	97545	359	99430	372
85830	371	93060	307	94052	285	97152	179	97550	359	99520	377
85850	371	93065	307	94054	285	97154	179	97551	359	99521	377
85860	371	93100	208-209	94055	285	97157	179	97552	359	99522	377
89550	246, 375	93102	208-209	94056	285	97159	179	97553	359	99523	377
89552	246, 375	93103	208-209	97000	107	97164	179	97570	454	99524	377
89555	246, 375	93104	208-209	97001	107	97170	170, 173, 177, 179	97571	185-186	99525	377
89560	246, 375	93105	209	97002	107	97171	177	97580	189	99534	377
89562	246, 375	93106	209	97003	107	97172	177	97590	154	99535	377
89570	246, 375	93107	208-209	97005	108	97180	158			99536	377
89574	245, 375	93108	209	97006	107, 208	97181	158			99537	377
89575	245, 375	93110	208-209								

NOTE: Part Nos. in RED are New Products

COMPETITION ENGINEERING NUMERICAL INDEX

PART#	PAGE	PART#	PAGE	PART#	PAGE	PART#	PAGE	PART#	PAGE	PART#	PAGE		
C0411	391	C1417	391	C1471	391	C2036	424	C2550	422	C2815	391	C3046	394
C0412	391	C1421	391	C1473	391	C2037	404	C2555	422	C2816	391	C3047	394
C0413	391	C1422	391	C1611	391	C2039	424	C2560	422	C2817	391	C3048	394
C0414	391	C1423	391	C1612	391	C2040	424	C2565	422	C2821	391	C3059	392
C0415	391	C1424	391	C1613	391	C2043	425	C2570	422	C2822	391	C3060	392
C0416	391	C1425	391	C1614	391	C2045	403	C2575	422	C2823	391	C3061	393
C0417	391	C1426	391	C1615	391	C2046	421	C2600	414-417	C2824	391	C3062	392
C0421	391	C1427	391	C1616	391	C2047	420	C2605	414-417	C2826	391	C3065	393
C0422	391	C1431	391	C1617	391	C2051	420	C2610	414-417	C2827	391	C3090	411
C0423	391	C1432	391	C1621	391	C2052	403	C2611	391	C2828	391	C3100	426
C0424	391	C1433	391	C1622	391	C2053	403	C2612	391	C2998	436	C3101	426
C0425	391	C1434	391	C1623	391	C2056	421	C2613	391	C2999	436	C3108	394
C0426	391	C1435	391	C1624	391	C2090	398	C2614	391	C3000	426	C3111	394
C0427	391	C1436	391	C1625	391	C2091	398	C2615	414-417	C3001	426	C3112	394
C0611	391	C1437	391	C1626	391	C2093	398	C2616	414-417	C3002	436	C3113	394
C0612	391	C1438	391	C1627	391	C2094	398	C2617	391	C3004	436	C3114	394
C0613	391	C1439	391	C1811	391	C2096	398	C2618	391	C3005	436	C3115	394
C0614	391	C1440	391	C1812	391	C2097	398	C2619	391	C3006	437	C3116	394
C0615	391	C1441	391	C1813	391	C2099	398	C2620	414-417	C3007	436	C3117	394
C0616	391	C1442	391	C1814	391	C2100	398	C2621	391	C3008	436	C3118	394
C0617	391	C1443	391	C1815	391	C2101	397	C2622	391	C3009	436	C3120	394
C0621	391	C1444	391	C1816	391	C2103	397	C2623	391	C3010	436	C3121	426
C0622	391	C1445	391	C1817	391	C2109	397	C2624	391	C3011	436	C3122	426
C0623	391	C1446	391	C1821	391	C2111	397	C2625	391	C3012	394	C3123	426
C0624	391	C1447	391	C1822	391	C2112	408	C2626	391	C3013	394	C3124	426
C0625	391	C1448	391	C1823	391	C2137	404	C2627	391	C3014	394	C3125	426
C0626	391	C1449	391	C1824	391	C2139	404	C2630	414-417	C3016	394	C3126	426
C0627	391	C1450	391	C1825	391	C2140	423	C2639	414-417	C3019	421	C3127	426
C0811	391	C1451	391	C1826	391	C2145	423	C2640	414-417	C3020	427	C3128	426
C0812	391	C1452	391	C1827	391	C2148	423	C2645	414-417	C3021	426	C3129	426
C0813	391	C1453	391	C2005	395	C2199	398	C2646	414-417	C3022	426	C3130	426
C0814	391	C1454	391	C2006	395	C2201	397	C2647	414-417	C3023	426	C3131	426
C0815	391	C1455	391	C2016	424	C2408	439	C2700	414-417	C3024	426	C3132	426
C0816	391	C1456	391	C2017	399	C2409	439	C2705	414-417	C3025	426	C3133	426
C0817	391	C1457	391	C2019	393	C2422	391	C2710	414-417	C3026	426	C3134	426
C0821	391	C1458	391	C2021	409	C2423	391	C2720	414-417	C3027	440	C3135	426
C0822	391	C1459	391	C2022	440	C2425	391	C2730	414-417	C3028	411	C3136	426
C0823	391	C1460	391	C2023	440	C2426	391	C2735	414-417	C3029	411	C3137	426
C0824	391	C1461	391	C2024	403	C2427	391	C2740	414-417	C3030	452	C3138	426
C0825	391	C1462	391	C2025	439	C2428	391	C2750	414-417	C3031	392	C3139	426
C0826	391	C1463	391	C2026	439	C2429	391	C2755	420	C3032	392	C3140	394
C0827	391	C1464	391	C2027	409	C2430	391	C2765	419	C3034	392	C3141	394
C1411	391	C1465	391	C2028	399	C2431	391	C2770	418	C3035	392	C3142	394
C1412	391	C1466	391	C2029	399	C2432	391	C2806	418	C3039	426	C3144	426
C1413	391	C1467	391	C2030	396	C2433	391	C2811	391	C3040	394	C3145	426
C1414	391	C1468	391	C2031	403	C2434	391	C2812	391	C3042	380, 426	C3146	426
C1415	391	C1469	391	C2032	422	C2436	391	C2813	391	C3043	394	C3147	426
C1416	391	C1470	391	C2035	403	C2437	391	C2814	391	C3044	380, 426	C3148	426



PART#	PAGE	PART#	PAGE	PART#	PAGE	PART#	PAGE	PART#	PAGE	PART#	PAGE
C3149	426	C3233	429	C3361	430	C3600	413	C4052	441	C6162	410
C3150	426	C3234	429	C3370	430	C3601	413	C4053	442-443	C6163	410
C3151	426	C3235	429	C3371	430	C3610	413	C4054	442-443	C7024	397
C3152	426	C3240	429	C3372	430	C3990	444-446	C4055	442-443	C7025	402
C3153	426	C3250	429	C3373	430	C3991	444-446	C4056	442-443	C7030	397
C3154	426	C3260	429	C3380	430	C3992	444-446	C4900	433	C7031	397
C3155	426	C3261	429	C3381	430	C3993	444-446	C4901	433	C7032	397
C3156	426	C3262	429	C3382	430	C3995	444-446	C4902	433	C7046	424
C3157	426	C3263	429	C3383	430	C3997	444-446	C4905	431	C7047	424
C3158	426	C3264	429	C3384	430	C4000	444-446	C4906	431	C7048	454
C3159	426	C3265	429	C3385	430	C4001	444-446	C4907	431	C7051	423
C3160	412	C3266	429	C3405	400	C4002	444-446	C4925	434	C7052	423
C3161	412	C3267	429	C3406	402	C4003	444-446	C4930	434	C7058	423
C3162	412	C3268	429	C3408	449	C4004	444-446	C4931	434	C7060	423
C3165	440	C3270	429	C3409	450	C4005	444-446	C4935	434	C7066	423
C3166	440	C3275	429	C3410	448	C4006	444-446	C4990	436	C7212	452
C3168	408	C3279	429	C3411	450	C4007	444-446	C5020	452	C8003	405
C3170	419	C3285	429	C3412	449	C4008	444-446	C5073	437	C8007	408
C3172	432	C3287	429	C3413	419, 450	C4009	444-446	C5074	437	C8008	402
C3173	432	C3300	430	C3414	419, 451	C4010	441	C5076	437	C8010	405
C3174	411	C3302	430	C3417	419, 451	C4011	445-446	C5078	373, 438	C8015	407
C3175	411	C3303	430	C3418	451	C4012	444-446	C6003	410	C8016	406
C3176	381, 427	C3305	430	C3419	451	C4014	444-446	C6004	410	C8017	407
C3177	381, 427	C3306	430	C3420	420	C4015	444-446	C6007	410	C8019	407
C3178	381, 427	C3307	430	C3421	449	C4022	442-443	C6009	410	C9004	400
C3181	430	C3308	430	C3422	447	C4023	442-443	C6010	410	C9006	402
C3182	432	C3309	430	C3423	447	C4024	442-443	C6011	410	C9020	375
C3183	432	C3310	429	C3424	447	C4025	442-443	C6012	410	C9085	371, 402
C3184	429	C3311	430	C3425	447	C4027	442-443	C6014	410	C9100	400
C3185	428	C3312	430	C3427	450	C4028	442-443	C6017	410	C9105	400
C3186	431	C3313	430	C3428	448	C4029	452	C6019	410	C9200	400
C3187	431	C3314	430	C3429	449	C4030	442-443	C6020	410	C9205	400
C3191	430	C3320	428	C3430	448	C4031	442-443	C6021	410	C9401	426
C3194	429	C3321	428	C3431	447	C4032	441	C6130	410	C9402	426
C3195	428	C3322	428	C3432	448	C4033	442-443	C6131	410	C9405	426
C3196	431	C3323	428	C3434	419, 448	C4034	441	C6132	410	C9408	426
C3197	431	C3324	428	C3435	381, 453	C4035	442-443	C6133	410	C9410	426
C3220	429	C3325	428	C3437	381, 453	C4036	442-443	C6150	410	C9412	426
C3221	429	C3328	428	C3438	381, 453	C4037	442-443	C6151	410	C9415	426
C3222	429	C3340	428	C3439	381, 453	C4038	442-443	C6152	410	C9418	426
C3223	429	C3341	428	C3440	453	C4040	436	C6153	410	C9505	401
C3224	429	C3342	428	C3450	435	C4041	436	C6154	410	C9507	401
C3225	429	C3343	428	C3451	435	C4047	441	C6155	410	C9510	401
C3226	429	C3344	428	C3452	435	C4048	441	C6156	410	C9609	437
C3227	429	C3345	428	C3453	435	C4049	441	C6157	410	C9700	398
C3229	429	C3348	428	C3461	433	C4050	441	C6160	410		
C3231	429	C3350	430	C3465	433	C4051	441	C6161	410		