

# **MALONE**<sup>®</sup>

**CHANGING THE WAY YOU GET THERE**



## **2019**

**CAR RACK ACCESSORIES  
SPORT TRAILERS**

# MALONE

CHANGING THE WAY YOU GET THERE

Here at Malone, we like to think we are doing more than selling a product. We are providing the very best long term solution with ongoing support for your transport, storage and boat loading needs.

This ideology begins with an array of simple to use rack & carriers, storage systems, accessories and sport trailers with easily understood **Award Winning Instructions** and demonstration videos.

It continues with our **Lifetime Warranty**. If there is a workmanship problem with your lifetime guaranteed Malone product, we will replace it. Just one call is all it takes.

And finally, it is enhanced with **World Class Customer Service** that works to satisfy each individual installation and provides ongoing support for the life of the product.



Offering the largest choice of **Sports Trailers** with bundled packages in the industry. See pages 46 - 62.

## AFFORDABLE TO BUY - EASY TO ASSEMBLE - SIMPLE TO USE



Ten different models of **Kayak, Canoe & SUP Carts** with capacity ratings of 150, 200 and 250 lb. See pages 35 - 38.



Over twenty **Storage Systems** for ceiling, wall or floor installation. See pages 39 - 45.



**Canoe or Kayak Carrier Systems** for nearly any boat or vehicle. Over 30 options available. See pages 8 - 21.



**Bike Racks** for hitch, top-of-car, trunk mount and spare tire. See pages 28 - 34.

## Roof Racks

. SteelTop™ Square Cross Bars	04
. AirFlow2™ Aero-Style Cross Bars	05
. VersaRail™ Bare Roof Cross Bars	06
. HandiRack™ Inflatable Roof Racks	07

## Watersport Carriers (Rooftop)

. SeaWing™ V-Style	08
. SaddleUp™ Pro	09
. DownLoader™ Folding J-Style	10
. Stax™ Pro2 Stacker-Style	11
. J-Pro™ J-Style	12
. J-Pro2™ J-Style	12
. J-Loader™ J-Style	13
. Paddle Carrier	13
. BigFoot™ Pro Canoe	14

## Watersport Carriers (Truck Rack)

. SaddleUp™ Pro	15
. DownLoader™ Folding J-Style	15
. Stax™ Pro2 Stacker-Style	15
. J-Pro™ J-Style	15
. BigFoot™ Pro Canoe	15
. 14" Kayak Foam	15
. Jumbo Rack Pads	15

## Installation Hardware

. Jawz2™ Kits	16
. Mounting Bolts	16
. T-Slot Truck Racks	16

## Load Assists

. SeaWing™ / Stinger™ Combo	17
. Stinger™ Module	17
. Telos™XL Module	18
. K-Rack™	19

## Watersport Carriers (Foam)

. Deluxe Kayak Kit	20
. Standard Kayak Kit	20
. Standard Canoe Kit	20
. Kayak Stacker Block Kit	20
. Deluxe PaddleBoard Kit	20
. Kayak Block, 4 X 4.75 X 18	20
. Canoe Block, 4 X 4.75 X 6	20
. Kayak Block, 4 X 4.75 X 12	20
. Kayak Block, 8 X 4	20
. Kayak/SUP Block, 4 X 4.75 X 24	20
. Spacer Block, 1.5 X 4.75 X 22	20

## Rack Pads

. SUP30™ Rack Pad Kit	21
. 18" Rack Pads	21
. 25" Rack Pads	21
. 30" Rack Pads	21
. Aero18™ Aero-Style	21
. Aero25™ Aero-Style	21
. Aero30™ Aero-Style	21

## Safety Tie-Downs

. Sentry™ Ratchet-Style	22
. SpeedLine™ Mini Ratchet	22
. Bow & Stern	22
. Hood Loop Straps	22

## Safety Tie-Downs (Continued)

. QuickLash™ T-Style	22
----------------------	----

## Load Straps

. 9' Load Strap, 2PK	22
. 9' Load Strap, Single	22
. 12' Load Strap, 2PK	22
. 12' Load Strap, Single	22
. 15' Load Strap, 2PK	22
. 15' Load Strap, Single	22
. 18' Load Strap, 2PK	22
. 18' Load Strap, Single	22

## Security

. LockUp™ 6' Cable Lock	23
. LockUp™ 8' Cable Lock	23
. LockUp™ 10' Cable Lock	23
. Lariat™ Universal Canoe/Kayak	23

## Cargo Boxes

. Cargo12™	25
. Cargo16™	25
. Profile18S™	26
. Profile18B™	26

## Cargo Carriers (Hitch & Rooftop)

. Katahdin™ Rooftop Basket	27
. Axis™	27
. Cargo Net	27

## Bike Racks

. Pilot™ TC ST	28
. Pilot™ HM2	29
. Co Pilot™	29
. Pilot™ HM2 Solo	30
. Pilot™ BC2	30
. Hanger™ HM4	31
. Hanger™ BC3 OS	31
. Hanger™ HM3	31
. Hanger™ Spare T3 OS	32
. RunWay™ HM2 Platform	32
. Runway™ HM3 OS	32
. Runway™ BC3	33
. Runway™ Spare T3	33

## Bike Racks Accessories

. Fork Block QR	34
. Top Tube Adapter	34
. Loop lock 1"	34
. Loop lock 1.25"	34
. Locking Hitch Pin	34

## Ground Transport

. Clipper™	35
. Nomad™	35
. Xpress™	35
. SoloCart™	35
. WideTrak™ w/ All-Terrain Wheels	36
. WideTrak™ w/ Beach Wheels	36
. Clipper™ / Xpress™ Beach Wheels	36
. SuperiorSling™	36
. Clipper™ w/ Beach Wheels	37
. Xpress™ w/ Beach Wheels	37

## Ground Transport (Continued)

. YakHauler™	38
. YakHauler™ Wheels	38
. BeachHauler™	38
. BeachHauler™ Wheels	38

## Storage

. JDock™	39
. HangTime™	39
. Kayak Hammock™	39
. FoamHome™	39
. Elevate™	39
. HighRise™	40
. BoardRoom™	40
. J-Hoops™	40
. SUP~Port™	40
. SlingOne™	41
. SlingTwo™	41
. SlingThree™	41
. YAK~Swing™	41
. SUP~Swing™	41
. FS Rack™ 3 Kayak	42
. FS Rack™ 6 Kayak	42
. FS Rack™ 3 Bike, 2 SUP, 1 Kayak	43
. FS Rack™ 2 Kayak, 2 SUP, 6 Ski	43
. FS Rack™ 3 Bike, 2 Kayak, 6 Ski	43
. FS Rack™ 2 Kayak, 2+ SUP	44
. FS Rack™ 6+ SUP	44
. FS Rack™ Base Rack	44
. FS Rack™ Accessories	45

## Sports Trailers (XtraLight™)

. XtraLight™ Base Trailer	46
. XtraLight™ Accessories	46
. XtraLight™ Trailer Packages	47

## Sports Trailers (MicroSport™)

. MicroSport™ Base Trailer	48
. MicroSport™ XT Base Trailer	48
. MicroSport™ Trailer Upgrades	49
. MicroSport™ Trailer Accessories	49
. MicroSport™ Trailer Accessories	50
. MicroSport™ Trailer Packages	51
. MicroSport™ Trailer Packages	52
. MicroSport™ Trailer Packages	53

## Sports Trailers (MegaSport™)

. MegaSport™ Base Trailer	54
. MegaSport™ Trailer Upgrades	55
. MegaSport™ Trailer Accessories	55
. MegaSport™ Trailer Accessories	56
. MegaSport™ Trailer Accessories	57
. MegaSport™ Trailer Packages	58
. MegaSport™ Trailer Packages	59
. MegaSport™ Trailer Packages	60

## Sports Trailers (Miscellaneous)

. MegaSport™ Outfitter	61
. MicroSport™ Jon Boat Pkg	62
. Trailer Accessories	62
. Trailer Accessories	63

# SteelTop™ "Square Bar" Racks

SteelTop™ cross rail systems are designed to attach to factory installed raised side rails. These medium-duty racks are an affordable alternative for transporting bikes, kayaks, ski carriers and roof boxes. Available in three lengths and delivered ready to install.

Roof Racks



STEELTOP™  
ROOFTOP CROSS BAR SYSTEM

## Security Key Locks Included

### Features

- Corrosion resistant coating for longer life
- Spacer blocks to fit smaller bar profiles
- Key locking security attachment towers
- Rectangular shape fits most rack accessories
- Delivered complete and ready to install
- Simple (No Tools Required) Installation
- Removable shield design fits more vehicles
- Lifetime Warranty



### Available in Three Popular Lengths

- MPG201 (50" length)
- MPG202 (58" length)
- MPG203 (65" length)



## AirFlow2™ "Aero Style" Racks

The AirFlow2™ features enhanced strength, great fit capability and upgraded aerodynamics. Includes integrated towers, pre-installed locks and double walled aluminum rails for a quiet and confident transport. Optional T-slot installation hardware available.

### Roof Racks



MPG215 (50" length)  
MPG216 (58" length)  
MPG217 (65" length)

#### Features

- Non-corrosive aluminum double wall construction
- Integrated T-slots for easy accessory attachment
- Cam assist bolts ensure a tight fit on small side rails
- Key locking security attachment towers
- Aerodynamic profile to reduce wind noise
- Delivered complete and ready to install
- Simple and quick installation - No tools required
- 165 lb load capacity for confident transport
- Lifetime Warranty

T-Slot Mounting Kits for Accessories  
Available Separately  
See Page 16

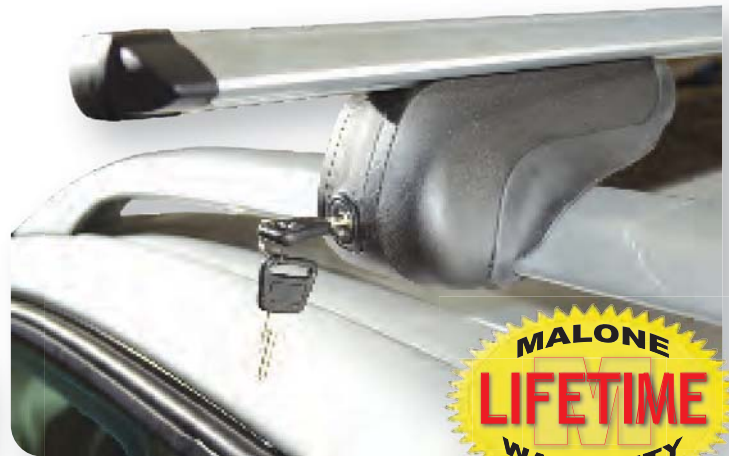

# VersaRail™ Universal Fit Racks

The VersaRail™ instantly transforms a bare roof into a functional platform for transporting bikes, kayaks, canoes or cargo boxes. Available in 50" and 58" lengths, these racks come assembled and ready to install. Includes twin cup vacuum towers, 1.5" attachment straps and Five Year Warranty.

Roof Racks



MPG224  
Single VersaRail™  
Also Available

**VERSA RAIL™**  
UNIVERSAL FIT - BARE ROOF CROSS BARS

## Features

- . No additional tools required (wrench provided)
- . Coated corrosion resistant load bar construction
- . Rectangular shape fits most rack accessories
- . 75 lb pull strength vacuum tower bases
- . 1.5" wide safety attachment straps
- . Delivered complete and ready to install
- . 135 lb load capacity



Kayak Carriers  
and  
Kayak not Included



Available in Two Lengths

MPG220 (50" length)  
MPG221 (58" length)

Simple Installation - Fits Most Four Door Vehicles



# HandiRack™ Inflatable Roof Racks

The HandiRack™ offers all the benefits of a traditional roof rack with none of the disadvantages. These high capacity roof racks are rugged enough for a wide selection of loads and are easily mounted to the vehicle's roof in a matter of minutes.

Roof Racks



## HandiRack™

MPG452



### Features

- . Three ply nylon construction
- . Double action air pump
- . 10' cam style load straps
- . Bow & stern safety tie-downs
- . Transport loads up to 180 lb
- . Fuel efficient low profile design
- . Quick and easy deployment
- . Five D-ring anchor points
- . 37" x 9" x 4" high
- . Two Year Warranty



Conveniently stores in the trunk when not in use.



With it's twin pressure tube design, the HandiRack™ can easily handle large loads such as kayaks, canoes and assorted miscellaneous gear. Great for rental cars or quick trips to the hardware store.



# SeaWing™ Kayak Carriers

The SeaWing™ features a non-corrosive molded frame that was engineered to assure a rust free life cycle. These carriers continue to be one of our best sellers because of their ease of use when loading and unloading boats. Includes everything needed to transport one kayak.

Water Sport Carriers



SEAWING™  
V-STYLE KAYAK CARRIER

MPG107MD



### Features

- . Universal fit Jawz2 mounting hardware
- . 50mm and 60mm coated mounting bolts
- . Cam style load straps with buckle protectors
- . Low profile design for garage clearance
- . Corrosion resistant nylon construction
- . Simple "no tools" installation
- . Bow & stern safety tie-downs
- . 27.5" x 6" x 4.5" high
- . Maximum boat weight 75 lb
- . Lifetime Warranty





# SaddleUp™ Kayak Carriers

The SaddleUp™ is a great way to transport large sit-on-top and fishing kayaks. The MPG110MD features four high-grip self-ad using saddles. Each set includes two rear saddle covers that allow the boat to easily slide into place. Comes complete with hardware, straps and safety tie-downs for one kayak.

## Water Sport Carriers



MPG110MD



Front High Grip Saddles

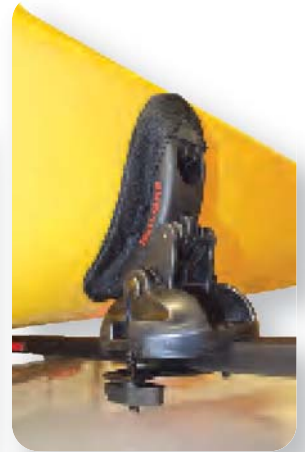

Rear Saddles With "Easy Load" Sleeves

### Features Include

- Four self-ad using high-grip saddles
- Jawz2™ universal fit mounting hardware
- Two "easy load" rear saddle covers
- Corrosion resistant construction
- Two mounting bolt lengths provided
- Two 11' cam style polyester load straps
- Safety bow & stern lines for one kayak
- Detailed install and usage instructions
- 5" x 5" x 9" high
- Maximum boat weight 90 lb
- Lifetime Warranty



# Downloader™ Kayak Carrier

The Downloader™ is our premium J-Style carrier with features for low clearance, ease of loading and universal fit for most load bars. These carriers also include aluminum corrosion proof frames, molded strap bales and replaceable base pads and frame pad sleeves.

Water Sport Carriers



MPG114MD

**DOWNLOADER™**  
FOLDING J-STYLE KAYAK CARRIER

## Features

- . Fold-down aluminum frame
- . Jawz2 universal hardware
- . Replaceable frame pad sleeves
- . Corrosion resistant construction
- . Built-in kayak boarding ramp
- . 11' cam style load straps
- . 10' safety tie-downs
- . Assembled in the USA
- . Lifetime Warranty
- . Maximum boat weight 75 lb
- . 17" x 6" x 19.5" high



Lowered When Not in Use



# Stax™ Pro2 Kayak Carrier

The Stax™ Pro2 is the combination of intelligent design, excellent workmanship, superior strength and affordable pricing. This two boat transport system delivers a safe and secure trip to the water and back and assures a great paddling experience.

Water Sport Carriers



MPG115MD

STAX™ PRO2  
TWO KAYAK VERTICAL FOLD-DOWN CARRIER



**Features** "Open gate" head design easily and securely captures load straps - Universal fit hardware  
Cam style load straps and 10' safety tie-downs - Fold-down design for low clearance needs  
Foam stacker blocks to protect the kayaks - Octagonal aluminum post construction  
Corrosion resistant molded components - Made in the USA - Lifetime Warranty - 5" x 5" x 20" high



Deployed for Kayak Transport



Retracted When Not In Use

Maximum Boat Weight 75 lb per boat

Transport One or Two Boats

# J-Pro™ and J-Pro2™ Kayak Carriers

The J-Pro™ and J-Pro2™ are traditionally designed J-Cradles built to handle most sit-inside and sit-on-top kayaks. These very affordable and well built carriers have multiple layers of corrosion resistant coating and a **Lifetime Warranty** for guaranteed satisfaction.

Water Sport Carriers



**J-PRO™**  
J-STYLE KAYAK CARRIER



MPG116MD

**Features**

- . Adjustable rear foam pads
- . Jawz2 universal mounting hardware for most racks
- . Synthetic base pads
- . Black coated corrosion resistant finish
- . Load straps and safety tie-downs
- . Assembled in the USA
- . Maximum boat weight 75 lb
- . 16" x 6" x 16.5" high

**J-PRO2™**  
J-STYLE KAYAK CARRIER



MPG117MD

**Features**

- . Jawz2 universal mounting hardware for most racks
- . Full length nylon covered foam pads (replaceable)
- . 11' cam style straps and safety tie-downs
- . Silver coated corrosion resistant protective finish
- . Lifetime Warranty
- . Assembled in the USA
- . Maximum boat weight 75 lb
- . 16" x 6" x 16.5" high



**UNIVERSAL FIT**  
SQUARE ROUND OVAL  
ALL LOAD BAR SHAPES



MPG116MD



MPG117MD

# J-Loader™ Kayak Carriers and Paddle Carriers

The J-Loader™ is a premium high strength steel kayak carrier featuring our exclusive boarding ramp that makes loading simple. The Ratchet Style Paddle & Mast Carrier comes complete with universal mounting hardware and is fully padded to protect and avoid road abrasion.

Water Sport Carriers



MPG118MD

**J-LOADER™**  
J-STYLE KAYAK CARRIER



MPG118MD

### Features

- Heavy duty steel corrosion proof frames
- Universal fit mounting hardware
- Oversize foam padding with replaceable sleeves
- 11' heavy duty cam style polyester load straps
- Cushioned base pads to protect the kayak's finish
- Integrated boarding ramp to simplify kayak loading
- Assembled in the USA
- Lifetime Warranty
- Maximum boat weight 75 lb
- 20" x 6" x 16.5"

### Ratchet Style Paddle & Mast Carrier

Transporting long SUP paddles, 1pc kayak paddles and sailboard masts can be difficult. These Ratchet Style Paddle Carriers attach to round, square or aero style cross bars and provide a safe secure transport.



MPG121



# BigFoot™ Canoe Carriers

The BigFoot™, with it's wide padded base to secure large canoes and small footprint to fit most factory cross rails is the perfect carrier choice. Corrosion resistant nylon ensures years of service. Includes straps, hardware and safety tie-downs for one canoe.

Water Sport Carriers



**BigFoot™**  
GUNNEL-STYLE CANOE CARRIER



### Features

- Corrosion resistant nylon construction
- Universal fit Jawz2 mounting hardware
- 50mm and 60mm mounting bolts
- Cam style load straps with buckle protectors
- Fully padded frames
- Safety bow & stern lines
- Fits T-slot aluminum car & truck racks
- Optional T-slot hardware available separately
- Lifetime Warranty
- Maximum boat weight 90 lb
- 5.25" x 5.50" x 4.25" high



**UNIVERSAL FIT**  
SQUARE ROUND OVAL  
ALL LOAD BAR SHAPES

# Aluminum Truck Rack Carriers

Most after-market extruded aluminum truck racks are designed with a topside T-slot for accessory attachment. Malone offers a T-slot mounting kit for these racks which allow installation of our more popular rooftop water sports carriers. Foam Blocks & Rack Pads also available.

## Water Sport Carriers



MPG1012

Includes MPG112 BigFoot™ with MPG1498 fit kit, load straps and tie-downs for one canoe.



MPG1014

Includes MPG114 DownLoader™ with MPG8287 fit kit, load straps and tie-downs for one kayak.



MPG1001

Includes MPG110 SaddleUp™ with MPG1498 fit kit, load straps and tie-downs for one kayak.



MPG1015

Includes MPG115 Stax™ Pro2 with MPG1498 fit kit, load straps and tie-downs for two kayaks.



MPG1016

Includes MPG116 J-Pro™ with MPG8287 fit kit, load straps and tie-downs for one kayak.



MPG159

EVA Foam Kayak Blocks. Sold in singles. 5.75" x 4" x 14" long.



MPG436

36" Jumbo Rack Pads. Sold in sets of 2. Fade proof construction. For racks 1.00"- 4.00" thick and 3.00"- 4.50" wide.



Image Shown  
MPG436  
36" Jumbo Rack Pads  
(Load Bars Not Included)

# Carrier Installation Hardware

Providing the best possible fit is paramount for a successful installation. We offer a large cross section of hardware to securely and dependably attach Malone carrier systems to nearly any type of vehicle or trailer load bar set-up.

Installation Hardware



MAKING THE BEST FIT

## Mounting Kits

The MPG303 and MPG304 both feature the V-shaped Jawz2 that fit factory oval and Malone aero and square style bars. Adapters that mount to after-market round bars are available upon request.



### Features Include

- Jawz2 v-style adapters, M8 T-knobs
- inc plated anti-corrosive mounting bolts
- MPG303 (with 50mm & 60mm bolts)

### Features Include

- Jawz2 v-style adapters, M8 T-knobs
- inc plated anti-corrosive mounting bolts
- MPG304 (with 60mm & 70mm bolts)

## Mounting Bolts

Because the cross bar thickness can vary between manufacturers, there is a requirements for different lengths for a correct attachment. All bolt kits are provided in M8, 4 pack sets.



MPG361 (50mm)

MPG362 (60mm)

MPG363 (70mm)

MPG364 (80mm)

MPG366 (90mm)

## Specialty Mounting Systems

Malone offers a wide selection of custom mounts for all types of carrier systems. The MPG5576-6 is available in sets of six. Single units available upon request.



## T-Slot Mounting Kits

These kits replace the standard MPG300 series Mounting Kits and utilize the T-slot in aluminum load bars to create an integrated mount for a variety of Malone carriers. See below for kit description and carrier fit.



MPG915 for Aero Style  
(MPG110, MPG112, MPG115, MPG119)



MPG1498 for Truck Rack  
(MPG110, MPG112, MPG115)



MPG6604 for Aero Style  
(MPG114, MPG116, MPG117, MPG118)



MPG8287 for Truck Rack  
(MPG114, MPG116, MPG117, MPG118)



## V-Style Kayak Carrier Load Assist

Simplify the kayak transport process with this integrated carrier / loader system. The SS Combo™ combines our MPG107 wing style saddles with a modular loader that extends nearly 22". Protects the vehicle and safely loads the kayak.

Kayak Load Assist



Extend the Loading Frame. Set the front of the kayak into the V-Block. Slide the kayak up and into the carriers.



Retract the Loading Frame. Dress the load straps and safety tie-downs. The kayak is now secure and ready for transport.



MPG113MD

SS COMBO™  
V-STYLE KAYAK CARRIER WITH LOAD ASSIST

### Features

- MPG107MD SeaWing™ Carriers
- Retractable loading frame (extends over 21")
- Integrated V-block to align the kayak
- Fully padded to protect the kayak and vehicle
- Corrosion resistant polycarbon construction
- 70mm mounting bolts (fits most vehicles)
- Simple "no tools" installation
- Maximum boat weight 75 lb
- Lifetime Warranty

MPG350 Stinger™  
Load Assist Module  
Available Separately

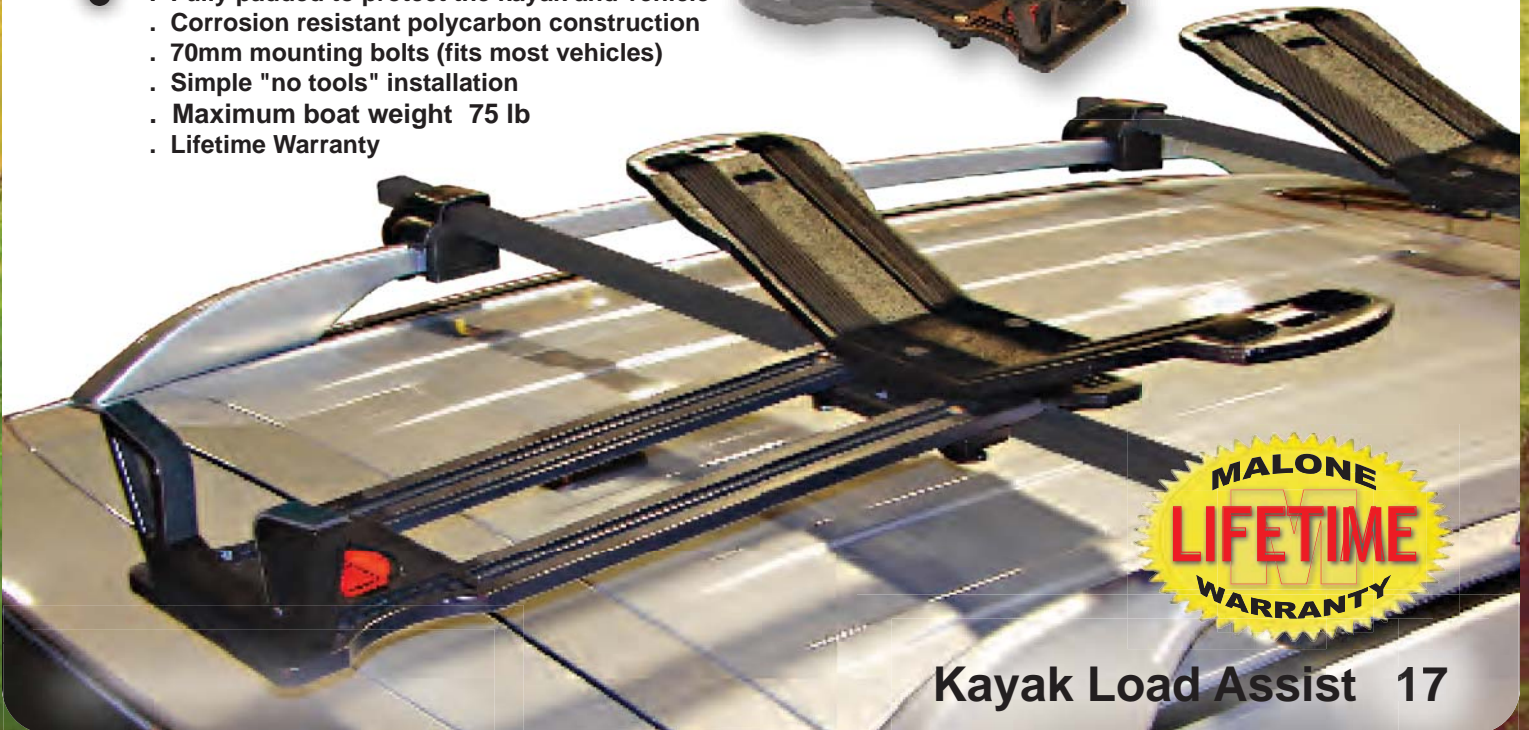

MALONE  
LIFETIME  
WARRANTY

# J-Style / V-Style Kayak Carrier Load Assist

The Telo<sup>SM</sup>XL Load Assist provides a safe and simple way to load a kayak into J-style and V-Style carriers. Using quick release attachments and the ad ustable extensions, this system can be installed in seconds. Works with the MPG107, MPG114 and MPG118 kayak carriers.

Kayak Load Assist



Telo<sup>SM</sup>XL installed on a MPG118 J-Loader™



Telo<sup>SM</sup>XL installed on a MPG107 SeaWing™



Place the cradles in their lowest position and load the kayak.



Slowly raise each cradle independently using a side to side motion.



Continue to raise the cradles up to their highest position.



MPG351XL

## Features & Specifications

- . Self-locking vertical ratchet for ensured safety
- . Ad ustable bottom extensions
- . Fully padded steel cradles
- . Quick release detachment system
- . Conveniently stores in the trunk
- . Made in the USA
- . Lifetime Warranty
- . Length (Extended) 98.25"
- . Length (Retracted) 58.75"
- . Weight 19 lb



Slide the kayak up and over the boarding ramps and into the carriers.

# K-Rack™ Universal Load Assist

Finally, a loading system that installs in seconds and anyone can use. Fits nearly any type of canoe or kayak and works great on sedans, hatchbacks, SUV's and vans. Protects your vehicle and boats. The MPG353 K-Rack™ is sold in singles and features a Lifetime Warranty.

Kayak Load Assist



Provides safe solo" loading for touring and recreational kayaks



Unique Molded Cradle



With its unique cradle shape that centers and holds the boat's keel, the K-Rack™ provides a self-aligning universal fit platform that works perfectly with nearly all canoes and kayaks.



High Grip Vacuum Cups



The K-Rack™ quickly locks into place with a flip of the two vacuum control levers and provides a rock solid abrasion resistant bond anywhere on the vehicle's rear glass or sheet metal.



Installs in Seconds  
Stores in the Vehicle

MPG353



Kayak Load Assist 19

# Foam Block Carriers

Malone car top foam kits and single replacement blocks offer an affordable transport system for your canoe, kayak, surf or stand up paddle board. Universal profile fits round, square and oval load bars. Made in the USA with only the finest EVA closed cell foam.

Foam Block Carriers



**MPG154 Standard Kayak Kit**  
12" blocks, 15' load strap and tie-downs.



**MPG152 Deluxe Kayak Kit**  
18" blocks, block straps, 15' load straps and tie-downs.



**MPG156 Standard Canoe Kit**  
6" blocks, 15' load straps and tie-downs.

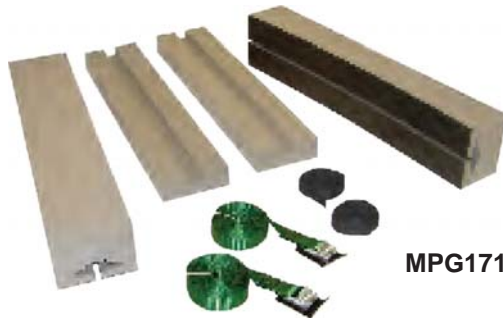

**MPG171**



**MPG171, Deluxe SUP Kit** Works with a bare roof, or, rooftop cross bars. The MPG171 is an entry level system that utilizes 24" oversized EVA foam blocks with 15' heavy duty load straps to provide maximum rooftop support. Each set includes 22" foam spacer pads that allow a second board to be safely stacked.



**MPG162, 12" Kayak Foam Block**  
Sold in singles. Transport requires two each. Non-skid bottom. 12" x 4.75" x 3.75"



**MPG159, 14" Kayak Foam Block for Truck Racks**  
Fits Bar Size, 4" x 1 5/8". Sold in singles. Transport requires two each. 14" x 5.50" x 4"



**MPG160, 6" Canoe Foam Block**  
Sold in singles. Transport requires four each. Non-skid bottom. 6" x 4.75" x 3.75"

**MPG172, 24" StandUp Paddle Board Foam Block**  
Sold in singles. Transport requires two each. Non-skid bottom. 24" x 4.75" x 3.75"



**MPG173, 22" SUP and Surfboard Spacer Block.** Sold in singles. Transport requires two each. Plain bottom, 22" x 4.75" x 2"



Vehicle shown with MPG156 Standard Canoe Kit



**MPG168, 8" Kayak Stacker Block**  
Sold in singles. Transport requires two each. Plain bottom. 8" x 4" x 3.25"



**MPG158, 18" Kayak Foam Block**  
Sold in singles. Transport requires two each. Non-skid bottom. 18" x 4.75" x 3.75"



**MPG169 Stacker Kit**  
8" blocks, load straps and tie-downs

## Rack Pads (SUP30™ Kit & 2pc Sets)

Rack pads are a simple, safe and effective way to transport surf and SUP boards when rooftop load bars are in-place. We offer two designs and three lengths of pad sets. A bundled kit that includes everything needed for board transport is also available.

Rack Pads



**Standard Rack Pads** Produced from heavy weave UV resistant polyester and featuring two different closure systems (hook and loop fastener). Fits round, square and smaller factory oval bars. One Year Warranty.



**MPG313, 18" Rack Pads** For surfboards. Sold in sets of 2.



**MPG314, 25" Rack Pads** For kayaks. Sold in sets of 2.



**MPG315, 30" Rack Pads** For SUPs. Sold in sets of 2.



MPG312



**MPG312, SUP30™ Rack Pad Kit** Carry one or more SUPs with this easy to use, hassle free rack pad system. The SUP30™ works with round, square and most factory cross rails. Features include two fade-resistant nylon weave 30" rack pads, cam style load straps and a ratchet tie-down with grab loop for safe transport.

**Premium Rack Pads** These high performance pads are designed for both after-market and factory oval wing-style™ load bars. Featuring acrylic fabric with UV resistant coating and a hook and loop fastening system that firmly holds each pad in place. One Year Warranty.



**AERO18™**  
Premium Rack Pads

**MPG380-18, 18" Rack Pads**  
For surfboards. Sold in sets of two.

**AERO25™**  
Premium Rack Pads

**MPG380-25, 25" Rack Pads**  
For kayaks. Sold in sets of two.

**AERO30™**  
Premium Rack Pads

**MPG380-30, 30" Rack Pads** For StandUp paddle boards. Sold in sets of two.

# Safety Tie-Downs & Load Straps

Tie-downs and load straps are a basic safety requirement for all transports. We offer the largest selection of safety line anchors, ratchet systems and straps in the industry. Our systems meet the needs of a wide range of budgets and installation requirements.

Tie-Downs & Straps

**Sentry™ Ratchet-Style Safety Tie-Down** Our premier tie-down system offers unparalleled performance to keep watercraft safely anchored and secure. Installs in seconds and simple to deploy. One Year Warranty.



- Features**
- Ratchet style pulleys (2)
  - Stainless steel S-hooks (2)
  - 10' - 1/4" polypropylene rope (2)
  - 2' black grab loops (2)
  - One Year Warranty

MPG316



**Additional Tie-Downs & Anchors** The MPG306 Tie-Down is our economy priced rope & hook. The MPG309 SpeedLine™ delivers excellent performance with ratchet-style pulleys using 1/8" poly-cord with carabineers. The MPG322 Hood Loops are strictly for under the hood application and provide secure anchor points.



MPG306 Tie-Downs



MPG309 SpeedLine™ Ratchet



MPG322 Hood Loops

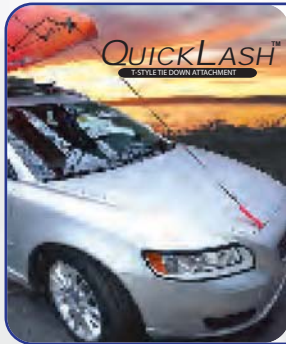

MPG308 QuickLash T-Style Hood Loops

T-style anchors designed to work under the hood or with the deepest rear hatches. Eliminates the need for finding vehicle frame tie-down points. Polypropylene and in action molded T-body construction with end caps. Two per set.



**Premium Load Straps** One inch wide 1200 lb pull strength polyester load straps featuring corrosion resistant cam style buckles. Each strap features a heavy duty molded rubber buckle protector along with an outer neoprene sleeve that ensures maximum protection for the vehicle and boat. Available in singles or two piece packs. One Year Warranty.



MPG307-9 (2 Pack)  
MPG307-9B (Single)

MPG307-12 (2 Pack)  
MPG307-12B (Single)

MPG307-15 (2 Pack)  
MPG307-15B (Single)

MPG307-18 (2 Pack)  
MPG307-18B (Single)

# Lariat™ and LockUp™ Security Cable Systems

Opportunity theft happens all the time. Expensive gear can be lost in a matter of seconds. Malone offers several styles and sizes of reinforced key-lock theft deterrent cable sets to protect kayaks and bikes. All security cables include a One Year Warranty.

## Cable Locks

SECURITY

**Lariat™ Universal Cable Locks** A single design that installs on touring, recreational and tandem kayaks and provides a theft resistant layer of protection. Also works with most canoes. Includes key lock mechanism and two keys. hook and loop straps keep the cables rolled up when not in use.



MPG398



### Features

Double cable assembly  
Fits all styles of kayaks/canoes  
.375" stranded anti-theft cable  
Key lock attachment system  
hook and loop storage straps  
**One Year Warranty**

**Bike Security Cable Locks** Protect your investment with our **LockUp™** cable locks. These systems have state-of-the-art technology in anti-drill, anti-saw and anti-pick design. These heavy duty 12mm thick multi-coaxial cables are available in 6', 8' and 10' lengths.

**MPG355**, LockUp™ 12mm x 6' long cable lock

**MPG356**, LockUp™ 12mm x 8' long cable lock

**MPG357**, LockUp™ 12mm x 10' long cable lock

(Sold in singles only)



# Rooftop Cargo Boxes

A perfect selection of premium rooftop boxes for vacations, the slopes or general transport needs. Dual side opening lids, quick attachment hardware and gas filled struts for effortless opening and closing. Molded from UV resistant ABS plastic for years of service. Assembled in the USA. Lifetime Warranty.

## Cargo Carriers



MPG902

Attachment Wrench



Interior Load Straps to Secure Contents



Quick Attach Mounting System  
Fits Round, Square and Oval / Aero Cross Rails

### Features

- . Two Tone High Gloss ABS Construction
- . Gas Spring Struts
- . High Tensile Reinforced Base
- . Aerodynamic High Volume Design
- . Three Locking Points



Dual Opening Lid Included with the MPG902, MPG910 & MPG911. Simplifies Installation.

MPG911





# Cargo™ Series of Rooftop Boxes

The Cargo™ series includes two premium level boxes uniquely designed for daily use or a long planned road trip. Each unit features a high gloss outer coating for a great look and is ensured with a Lifetime Warranty. Proudly assembled and packaged in the USA.

## Cargo Carriers



MPG901

The **Cargo12™** is designed for high functionality. Great for smaller vehicles or when high load capacity isn't required. A clean aerodynamic profile with central locking system.

Available in high gloss grey. Lifetime Warranty.

### Specifications

- . Volume 12.0 cf
- . Length 55.1"
- . Width 31.5"
- . Height 17.3"
- . Capacity 165 lb
- . Mounting System Quick Attach
- . Box Opening Single Side
- . Locking Points 2
- . Material Polyester (Gloss Grey)
- . Cross Bar Spread 25" - 27"



MPG902

The **Cargo16™**, our full-sized and most popular rooftop box is perfect for a family vacation or transporting skis and boards to the mountain. Fits five to six skis (max length 192cm) or three to four snowboards or gear for three to four passengers.

Includes all the features for simple installation and effortless opening and closing. Each unit is coated with a high gloss for a great look and ensured with our Lifetime Warranty.

### Specifications

- . Volume 16.25 cf
- . Length 76.4"
- . Width 27.9"
- . Height 18.9"
- . Capacity 165 lb
- . Mounting System Quick Attach
- . Box Opening Dual Side
- . Locking Points 3
- . Material ABS (Gloss Silver)
- . Cross Bar Spread 25" - 40"



# Profile18™ Rooftop Boxes

The Profile18™ is offered in two color choices and features a low profile design that is perfect when headed to the slopes. These boxes have a patented quick attach mounting system, abrasion and UV resistant ABS construction, centralized locking system and dual opening lid.

Cargo Carriers



**PROFILE™**  
ROOFTOP CARGO BOX 18B

The Profile18B™ comes with a rich high gloss onyx black lid and matte black reinforced bottom. This sophisticated design, when coupled with it's technical features, successfully delivers a rock solid gear transport system.

MPG911

Volume 18.0 cf - Length 78.75" - Width 32.3" - Height 15.75" - Capacity 165 lb - Mounting System Quick Attach  
Box Opening Dual Side - Locking Points 3 - Material ABS (Gloss Black or Silver) - Cross Bar Spread 25" - 36"



**PROFILE™**  
ROOFTOP CARGO BOX 18S

The Profile18S™ is offered in a pearl silver that compliments nearly all vehicle colors. This "low and wide" profile is the perfect mountain-bound choice for multiple skis and boards. Assembled in the USA with a Lifetime Warranty.

MPG910



# Axis™ and Katahdin™ Cargo Carriers

The Axis™ can be vertically or horizontally deployed for differing loads and is produced from high grade steel tubing and powder coated to resist corrosion. The Katahdin™ delivers great style and large volume capacity. The MPG311 includes cargo net and Lifetime Warranty.

## Cargo Carriers



**Features** 8 height settings (56" - 63") - 10 width settings (32" - 48") - Side arm load containment 2" receiver with pin - Powder coat finish - Dimensions 63" x 48" - Capacity 500 lb - Weight 33 lb

### MPG925 Heavy Duty Cargo Net

Secure your gear with this durable shock cord mesh net. Stretches to conform to the cargo. Works great with the MPG311 Katahdin™. Includes impact resistant hooks. **One Year Warranty.**

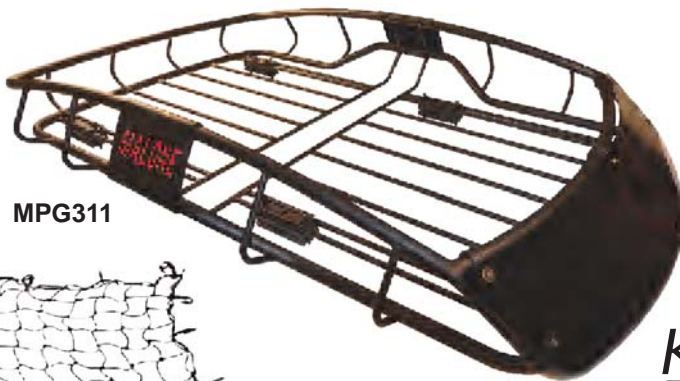

### Features

- Two piece design assembles in minutes
- Powder coated steel construction
- Safely transport loads up to 165 lb
- Universal mounting hardware
- Custom fairing for less wind noise
- Requires a minimum 25" cross bar span
- Lifetime Warranty
- 61" x 38" x 10" high

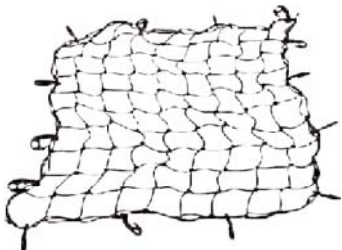

Includes MPG925 Cargo Net

**KATAHDIN™**  
CARGO BASKET



# Pilot™ TC ST (Top of Car)

Malone proudly offers a world class line of rooftop, hitch, back of car and spare tire transport systems. The Pilot™ TC ST ratchet arm bike rack features a 51" tray which is great for rooftop transport. A 65" long version (MPG2100) is also available for trailers. See page 53 for details



Shown MPG2130. See Page 32 for details.

## PILOT

The Pilot™ series of rooftop, hitch and back of car carriers represents our flagship line and deliver the best in options materials, tooling and overall performance design.

## HANGER

Look for moderate pricing, yet world class engineering in our Hanger™ line of bike transports. These hitch and trunk systems combine great value without sacrificing quality.

## RUNWAY

For those on a budget, but still require a high level of performance, the RunWay™ line of hitch, back of car and spare tire carriers are the best choice.

### Features

- Single bike capacity
- Ratchet SafeHook™ secures the front tire with no frame contact
- Available in two tray lengths (51" and 65")
- Compatible with disk brake, thru-axles axles and most frames
- Ad unstable extra wide wheel holders fit most tires
- Universal fit mounting hardware fits Malone racks, factory oval, round and most aero-style load bars

### Specifications

- Load capacity 33 lb
- Aluminum & steel powder coated construction
- Fits 20" to 29" wheels and up to 5" fat tires
- Dimensions 51" x 12" x 6"
- Weight 10 lb

**Note** Not compatible with tandem and recumbent bikes. Rear hatch spoilers may inhibit installation.



PILOT™  
ROOFTOP TRAY STYLE BIKE CARRIER  
TC ST

Some Assembly Required

MPG2103

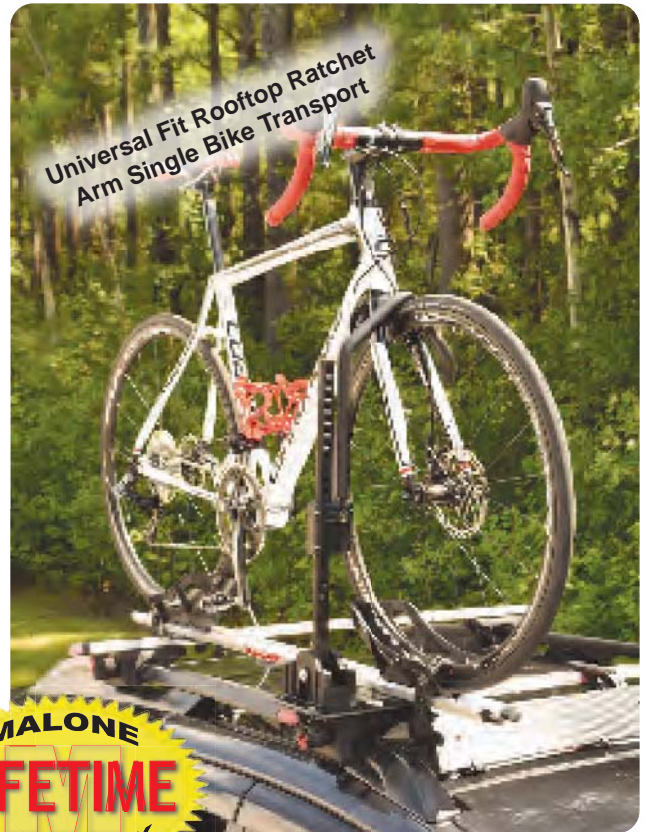

Universal Fit Rooftop Ratchet  
Arm Single Bike Transport



MPG2100 Pilot™ TC LT  
(65" Long Tray - See Page 53, Trailer Accessories)

# Pilot™ HM2, Co-Pilot™ 2 (Hitch Platform)

The Pilot™ HM2 is a two bike, hitch style platform carrier for 2" receivers only. This system can be integrated with the separately available MPG2115 Co-Pilot™ 2 which converts overall capacity from a two bike carrier to a four bike carrier.

## Bike Racks



### Features

- Two bike capacity (four bike with MPG2115)
- Tilt-down frame for access to rear hatch or trunk
- Pivoting ratchet arm secures bike's front wheel
- Arm & wheel holders eliminate bike to bike contact
- Fits 20" - 29" wheels and up to 5" fat tires
- Includes anti-wobble locking hitch pin
- Semi-retracting key lock security cable

### Specifications

- Load Capacity 33 lb per bike x (2 or 4) bikes
- Aluminum & steel powder coated construction
- Fits 2" receiver mounts & MPG2115 Module
- Dimensions 31" x 39" x 15"
- Weight 30 lb

**Note** Not compatible with tandem, electric or recumbent bikes.

PILOT™  
HITCH MOUNT PLATFORM STYLE BIKE CARRIER  
HM2



Co-PILOT™ 2  
MODULAR PLATFORM BIKE CARRIER  
HM2



Add the Co-Pilot™ 2 Expansion Module to Your Existing MPG2112 Pilot™ HM2 to Transport Four Bikes

### Features

- Integrates with the MPG2112 Pilot™ HM2
- Two bike capacity (four bikes with MPG2112)

### Specifications

- Load Capacity 33 lb per bike x 2 bikes
- Dimensions 20" x 39" x 7"
- Weight 22 lb

**Note** Purchase of MPG2112 Pilot™ HM2 required.



# Pilot™ Solo (Platform), Pilot™ BC2 (Back of Car)

The Pilot™ Solo HM2 is a stand alone hitch mount two bike carrier. It mounts to 1.25" or 2" receivers and provides simplified loading with minimal bike lifting. The Pilot™ BC2 attaches to all vehicle styles and eliminates bike to bike contact.

## Bike Racks

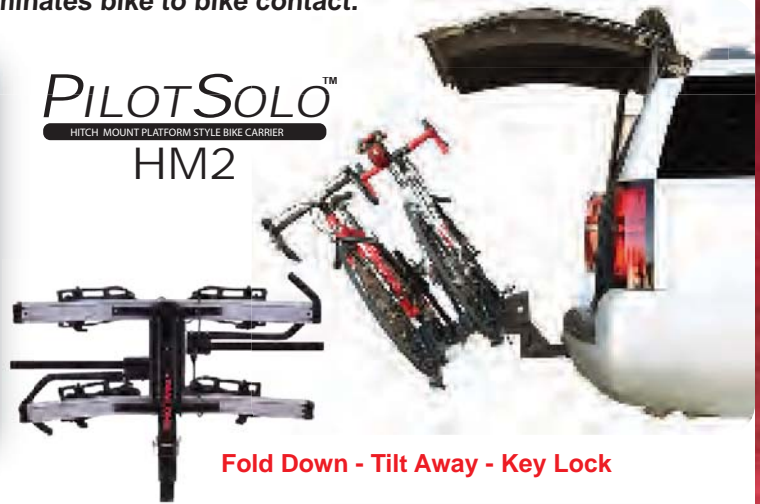

**PILOT SOLO™**  
HITCH MOUNT PLATFORM STYLE BIKE CARRIER  
**HM2**

**Fold Down - Tilt Away - Key Lock**

### Features

- . Two bike capacity
- . Tilt-down frame to access rear hatch or trunk
- . Pivoting ratchet arm secures bike's front wheel
- . Wheel holders eliminate bike to bike contact
- . Fits 20" - 29" wheels and up to 5" fat tires
- . Includes anti-wobble locking hitch pin
- . Semi-retracting key lock security cable
- . Fits both 1.25" and 2" receiver mounts

### Specifications

- . Load Capacity 33 lb per bike x 2 bikes
- . Aluminum & steel powder coated construction
- . Dimensions 31" x 39" x 15"
- . Weight 30 lb



**MPG2109**

**Fits 1.25" and 2" Receivers**

**Note** Not compatible with tandem or recumbent bikes. Not compatible with MPG2115 Co-Pilot.™



**S**ock **s**oring  
**S**trap **S**ystem  
**e**lps **P**rotect **t**e  
**C**arrier & **B**ikes



**PILOT™**  
BACK OF CAR BIKE CARRIER  
**BC2**  
**MPG2133**



**Plat**orm **S**tyle  
**e**sign

### Features

- . 2 bike capacity
- . Platform design eliminates bike to bike contact
- . Folds flat for easy storage
- . Padded key lock fully adjustable frame cradles
- . Adjustable ratchet style wheel holders
- . Lock cylinders & keys included

### Specifications

- . Load Capacity 33 lb per bike x 2 bikes
- . Fits tire sizes up to 2.50"
- . Powder coated steel construction
- . Dimensions 22" x 45" x 35" - Weight 17 lb

**Note** Not compatible with tandem or recumbent bikes. May not be compatible with spoilers on rear hatch.

# Hanger™ Series (Hitch & Back of Car)

The Hanger™ HM3 and HM4 are hitch style carriers that offer convenience, flexibility and security for three and four bike transport. The Hanger™ BC3-OS has the flexibility of fitting nearly any vehicle and provides bike stability using anti-sway technology.

## Bike Racks



### Features

- Four bike capacity
- Arms fold down when not in use
- Tilt-away mast with foot pedal & pin control
- Soft fully padded anti-sway frame cradles
- Integrated security cable with key locks
- Anti-wobble security key locking hitch pin
- Padded mast for additional bike protection
- Cradle ratchet straps & webbing strap

### Specifications

- Load Capacity 33 lb per bike x 4 bikes
- Powder coated construction
- Fits 1.25" and 2" receivers
- Dimensions 29" x 14" x 34"
- Weight 22 lb

**Note** Not compatible with tandem or recumbent bikes.



### Features

- Three bike capacity
- Oversize steel tubing for strength and stability
- Integrated cable lock secures bikes to rack
- Four quick release hubs for quick adjustment
- Six point webbing strap system
- Anti-sway cages help maintain the load
- Webbing stabilizing strap included
- Arms fold when not in use

### Specifications

- Load Capacity 33 lb per bike x 3 bikes
- Oversize steel construction
- Dimensions 32" x 22" x 30"
- Weight 15 lb

**Note** Not compatible with tandem, recumbent or electric bikes. May not be compatible with rear roof top spoilers.

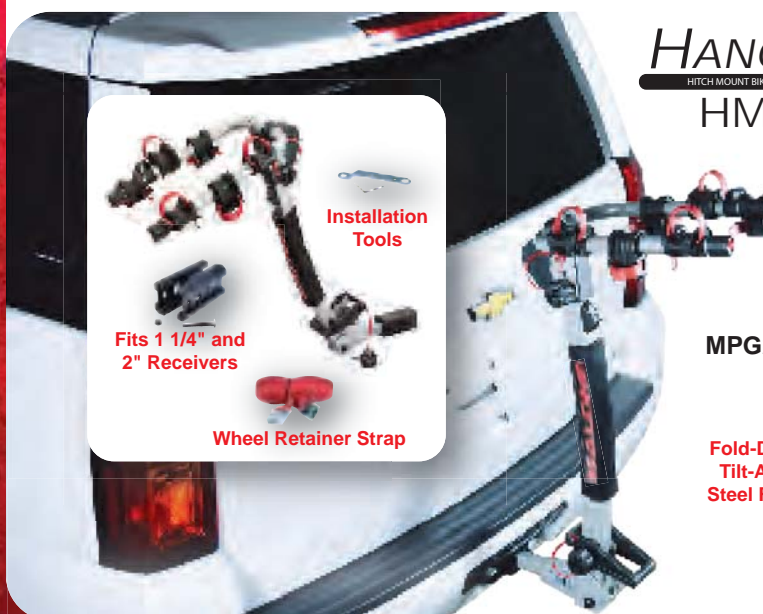

### Features

- Three bike capacity
- 16" arms fold down when not in use
- Tilt-away mast with foot pedal / pin control
- Soft fully padded anti-sway cradles
- Integrated security cable with key locks
- Anti-wobble security key locking hitch pin
- Padded mast for additional bike protection
- Cradle ratchet straps & webbing strap included

### Specifications

- Load Capacity 33 lb per bike x 3 bikes
- Aluminum & steel powder coated construction
- Fits 1.25" and 2" receivers
- Dimensions 24" x 14" x 34"
- Weight 20 lb

**Note** Not compatible with tandem or recumbent bikes.

# Hanger™ (Spare Tire), RunWay™ (Hitch)

The Hanger™ T3 OS delivers our best price and design quality for 3 bike spare tire transport.

The RunWay™ HM3-OS is a traditional 3 bike system that features anti-sway technology.

The RunWay™ HM2 is a platform style carrier that eliminates bike to bike contact.

## Bike Racks



### Features

- Three bike capacity
- Oversize steel tube construction
- Two cam buckle anchor straps
- Quick release and unstable hubs
- Three tire settings (8"-10.5")
- Right or left wheel offset
- Three anti-sway cages
- Padded frame cradles
- Safety reflectors

### Specifications

- Load Capacity 33 lb per bike x 3 bikes
- Dimensions 33" x 25" x 7"
- Weight 12.5 lb
- Lifetime Warranty

## HANGER™ SPARE T3 OS

SPARE TIRE MOUNT BIKE CARRIER

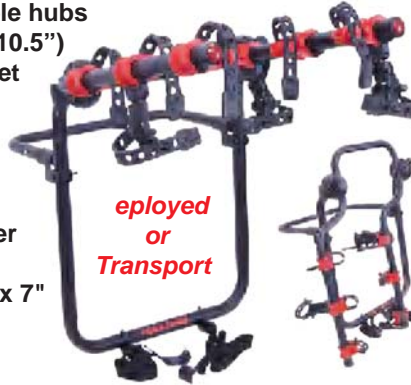

employed  
or  
Transport

olds  
on  
en  
ot  
In Use

MPG2147



## RUNWAY™ HM3-OS

HITCH MOUNT BIKE CARRIER



**Note** Not compatible with tandem, electric or recumbent bikes.

### Features

- 3 bike capacity - Fits both 1.25" and 2" receivers - Integrated cable lock
- Cradle arms fold down when not in use - Tilting mast for rear access
- Non-locking anti-wobble hitch bolt - Anti-sway padded frame cradles

### Specifications

- Load Capacity 33 lb per bike x 3 bikes
- Oversize steel construction
- Dimensions 38" x 12" x 36" - Weight 21 lb



Key Lock  
Security Cable



Anti-Sway  
Stability  
Cages



Wheel  
Retainer  
Strap



MPG2130

Fold-Down / Tilt-Away Steel Frame



To Bike Transport  
it Key lock  
Security

### Features

- 2 bike capacity
- Tilt-down frame for access
- Center arms secure bike's top tube
- Key lock fully padded top arm
- Wheel holders prevent bike to bike contact
- Includes anti-wobble hitch pin

### Specifications

- Load Capacity 33 lb per bike x 2 bikes
- Fits 20"- 29" wheels - tires up to 3.50"
- Fits 1.25" and 2" receiver mounts
- Dimensions 25" x 33" x 8"
- Weight 23 lb

**Note** Not compatible with tandem, electric or recumbent bikes.

## RUNWAY™ HM2

HITCH MOUNT BIKE CARRIER

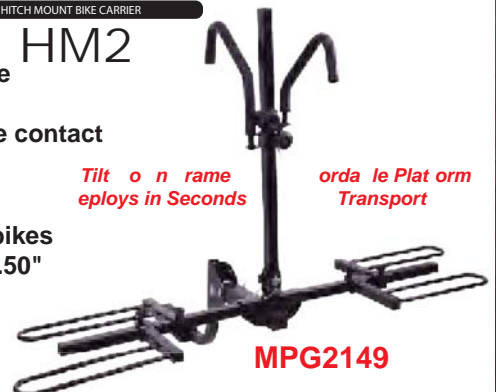

Tilt on frame  
employs in Seconds

order the Platform  
Transport

MPG2149



# RunWay™ (Back of Car & Spare Tire)

The RunWay™ BC3 is our most affordable three bike carrier fits most vehicles and is simple to install and use. The RunWay™ Spare attaches to a vehicle's exposed spare tire using a choice of three width settings and provides safe transport for up to three bikes.

## Bike Racks



### Features

- . Three bike capacity
- . Six point strap system
- . Folds flat for storage
- . Two quick-release hubs for cradle arm adjustment

### Specifications

- . Load Capacity 33 lb per bike x 3 bikes
- . Coated steel construction
- . Dimensions 28" x 22" x 26"
- . Weight 9 lb
- . Lifetime Warranty

**Note** Not compatible with tandem, recumbent or electric bikes. May not be compatible with all rear vehicle spoilers.

## RUNWAY™ BC3

BACK OF CAR BIKE CARRIER

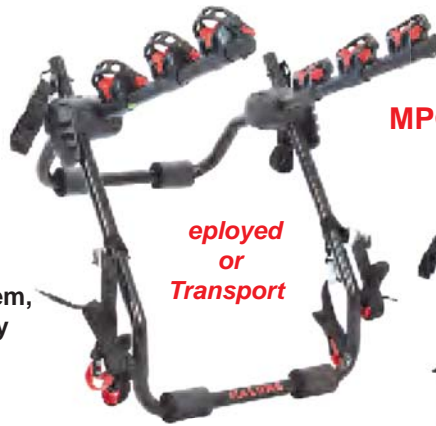

*employed  
or  
Transport*

MPG2142



*Retracted  
or Storage*



### Features

- . Three bike capacity
- . Steel construction
- . Two webbing straps anchor to spare
- . Right or left wheel offset
- . Folds flat for storage
- . Three way adjustment for tire width

### Specifications

- . Load Capacity 33 lb per bike x 3 bikes
- . Steel construction
- . Dimensions 22" x 45" x 35"
- . Weight 14 lb
- . Lifetime Warranty

**Note** Not compatible with tandem, electric or recumbent bikes.

## RUNWAY™ SPARE T3

SPARE TIRE MOUNT BIKE CARRIER

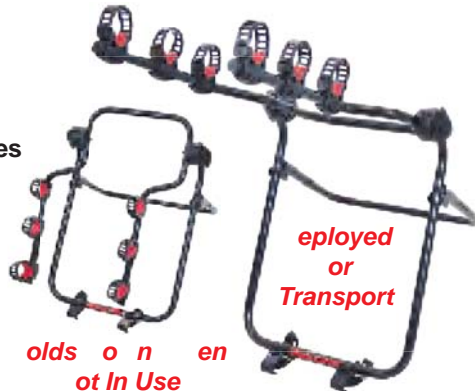

*employed  
or  
Transport*

*olds o n en  
ot In Use*



MPG2148

*d usta le      Position Tire  
Padded Cradles      idt Setting*

Installs in Minutes - No Tools Required



# Bike Transport & Security Accessories

Along with offering a complete line of car top, hitch, back of car and spare tire bike carriers, Malone also offers a cross section of accessories designed to improve and simplify the aspects of bike transport and security.

## Bike Racks



### MPG2151 - Fork Block QR

Create your own bike carrier with these simple and versatile block mounts. Installs on any flat surface and secures the bike's fork for a confident transport.

#### Features

- Capacity One bike
- 9mm quick release skewer holds bike to block
- 100mm spacing fits most bikes
- Pass-through holes for inserting security cables
- Powder coated aluminum construction
- Dimensions 2" x 7" x 2"
- Lifetime Warranty



### MPG2165 - Top Tube Adapter

For use when the bike is required to hang from a carrier's horizontal arms. The Top Tube Adapter provides a removable temporary frame piece on bikes with step-through or other unconventional frame designs.

Easy one button operation opens locking gates that snap shut around the seat post and stem.

#### Features

- Coated gates protect the bike's finish
- Simple one button operation
- Oversize telescoping (23" - 30") shaft
- Non-rotating shaft to maintain transport stability
- Steel construction
- Dimensions 24" x 3" x 2"



### MPG2168 - MPG2171 LoopLocks™

A fast and economical way to add a layer of security when transporting bikes. Dress the cable loop around the frame of the rack back through the bike and then insert into the keyed bracket attached to the carrier.

Locking brackets can be attached to any 1" (MPG2168) or 1.25" (MPG2171) diameter tubing.

#### Features

- 46" long coated 1/4" diameter security cable
- Mounting bolts shielded by locking end of cable
- Two models offered (1" and 1.25" diameter tubing)
- Mounting tool included

**Note** Not a high security locking system. Designed to stop the opportunistic thief.



### MPG2174 - Locking Hitch Pin

These locking hitch pins are used with most Malone receiver hitch carriers. They are threaded to provide anti-wobble to the carrier and security locking capacity at the hitch.

Can be used with or without the locking head when the hairpin cotter (included) is deployed.

#### Features Include

- Fits 2" trailer hitches
- 10,000 lb towing capacity
- Corrosion resistant coating
- Cotter pin & two keys included



# Standard Ground Transport

Malone canoe, kayak and SUP carts were developed with the idea that portage from the vehicle to the water should be as effortless as possible. All four carts share the features of marine grade aluminum frames, airless tires and stainless steel hardware.

Ground Transport



### Features

- . Large capacity for canoes & kayaks
- . Corrosion resistant construction
- . Stainless steel hardware
- . **Never Go Flat**™ airless tires
- . 200 lb maximum load capacity
- . 11' Cam buckle load strap
- . Lifetime Warranty
- . 14" x 27" x 15" high

MPG502

**CLIPPER**™  
DELUXE CANOE & KAYAK CART



### Features

- . Medium capacity for kayaks only
- . 10" x 3" **Never Go Flat**™ airless tires
- . 150 lb maximum load capacity
- . Corrosion proof aluminum tubing
- . Full size kick-stand
- . 11' Cam buckle load strap
- . Lifetime Warranty
- . 12" x 24" x 14" high

MPG503

**NOMAD**™  
STANDARD KAYAK CART



### Features

- . New coated metal T-fittings
- . Ad ustable width (7.75"-19")
- . Removable foam block
- . Anodized aluminum frame
- . Two variable length cross bars
- . **Never Go Flat**™ airless tires
- . Lifetime Warranty
- . 10" x 18" x 22" high

MPG504

**XPRESS**™  
SCUPPER STYLE KAYAK CART



### Features

- . Ad ustable inside width (14"- 21")
- . Anodized aluminum frame
- . Fully padded to protect the SUP
- . Integrated 32" strap captures fin
- . 10" x 3" **Never Go Flat**™ airless tires
- . Lifetime Warranty
- . 10" x 28" x 17" high

MPG510

**SOLO**™  
STANDUP PADDLE BOARD CART



Recommended  
for SUP  
use only.



# Extra Wide Carts and Transport Accessories

Most canoes, sit-on-top and fishing kayaks have wide hulls for stability. These boats require a cart with additional width and higher load capacity. The new **WideTrak™** series of carts offer the perfect solution for confident transport in both all-terrain and sand conditions.

Ground Transport

## WIDETRAK™ AT

LARGE KAYAK/CANOE CART



Two sets of 2pc cam style load straps firmly secure the boat.

MPG519

### Features

- Extra wide frame for wide hull boats
- Stainless steel hardware - **12" x 3" x 16"** tires
- Two, 2pc cam buckle load straps
- 200 lb maximum load capacity
- Lifetime Warranty - 14" x 33" x 16" high



MPG519

Distinctive two color frame with adjustable padding and double kickstand.



Large 12" x 3" airless all terrain wheels.



Oversized design featuring 25mm frame tubing and 20mm axle tube.

## WIDETRAK™ S

LARGE KAYAK/CANOE CART W/ BEACH WHEELS

### Features

- Extra wide frame for most canoes, sit-on-top & fishing kayaks
- Corrosion resistant construction
- Stainless steel hardware
- MPG516 - 12" x 7" beach wheels
- 200 lb maximum load capacity
- Two, 2pc cam buckle load straps
- Low pressure air pump
- Lifetime Warranty
- 14" x 37" x 16" high



MPG519-S



Includes air pump.

Easily access sand beaches and soft terrain put-ins.

## SUPERIOR SLING™

STANDUP PADDLE BOARD SHOULDER HARNESS

Shoulder Harness to Easily Transport Large Standup Paddle Boards

Oversized Shoulder Pads - 1.5" Webbing  
80" Loops - Waterproof Carry Bag

MPG359

## 12" x 7" Beach (Sand) Wheels

Sold in Sets of Two

### Features

- Low air pressure (2-4 p.s.i.)
- Fits MPG502, MPG504 and MPG519 carts
- No axle conversion kit required
- Provides cart stability in sand
- Lifetime Warranty
- 12" high x 7" wide



MPG516

# Soft Terrain Kayak Carts

A soft shoreline can be challenging for portage. Adding low pressure sand wheels to the Clipper™ and Xpress™ frames create affordable "beach ready" transport systems. Both carts includes a hand air pump and are ensured with a Lifetime Warranty.

Ground Transport



*Effortless on Soft Sand*

### Features & Specifications

- . Corrosion resistant construction
- . Stainless steel hardware
- . Large capacity for canoes & kayaks
- . Low pressure air pump
- . 12" diameter x 7" wide sand wheels
- . 200 lb maximum load capacity
- . 11' Cam buckle load strap
- . Lifetime Warranty

**Dimensions** 14" x 35" x 18" high



## CLIPPER™

DELUXE CART WITH BEACH WHEELS

200 lb  
Large Capacity  
Frame

Fits Most  
Recreational  
Kayaks



MPG502-S

### Features & Specifications

- . Frame adjusts 7.75" - 19" wide
- . Removable foam block
- . Anodized aluminum frame
- . Low pressure air pump
- . 12" diameter x 7" wide sand wheels
- . Two variable length cross bars
- . 150 lb maximum load capacity
- . Lifetime Warranty

**Dimensions** 10" x 29" x 24" high



## XPRESS™

SCUPPER CART WITH BEACH WHEELS



Adjustable Width Control  
for Nearly All Kayaks  
with Scupper Holes.



MPG504-S

# Ground Transport for Large Boats

Large fishing kayaks require a cart that can support high capacity loads and navigate challenging terrain. The **YakHauler™** & **BeachHauler™**, featuring all-terrain or soft-terrain wheels, 250 lb capacity frames and twin 1.5" wide load straps.

Ground Transport



**BEACHHAULER™**  
SOFT TERRAIN LARGE BOAT CART

MPG507

**Features** Folding black powder coated aluminum frame - Stainless steel hardware  
Two snap-buckle 1.5" wide load straps - Twin kick stand design for loading stability  
Quick release sand wheels - Hand Air Pump - Padded bunks to accommodate non-traditional hulls

**Specifications** Wheels 12" diameter x 7" wide - Cart Weight 20.5 lb - Capacity 250 lb  
Dimensions 16" x 39" x 15" high - Padding Oversized 3.5" diameter - Frame 22mm aluminum



**YAKHAULER™**  
ALL TERRAIN LARGE BOAT CART

MPG508

**Features** Folding black powder coated aluminum frame - Stainless steel hardware  
Two snap-buckle 1.5" wide load straps - Twin kick stand design for loading stability  
Custom molded quick release wheels - Padded bunks to accommodate non-traditional hulls

**Specifications** Wheels 15" x 6" "Never Go Flat" all-terrain - Cart Weight 20.5 lb - Capacity 250 lb  
Dimensions 16" x 39" x 15" high - Padding Oversized 3.5" diameter - Frame 22mm aluminum

**Soft Terrain BeachHauler™ Wheels**  
Sold in Sets of Two



MPG513

**All Terrain YakHauler™ Wheels**  
Sold in Sets of Two



MPG515

# Specialty Storage Systems

For ceiling, wall or floor mount, we offer the complete spectrum for keeping your gear safe when put away". The J-Dock™ is a great buy for storing two boats. The HangTime™ provides safe storage for one bike. The Kayak Hammock™ is a must for most garages.

## Storage Systems



**J-DOCK™**  
TWO BOAT WALL STORAGE



MPG317

200 lb Capacity

**Features** Two kayak storage capacity - 3" lag bolt mounting hardware - Heavy duty 12' cam style load straps  
Approved for inside or outside installation - Lifetime Warranty - 16" x 5" x 10" high



**HANGTIME™**  
SINGLE BIKE WALL STORAGE

MPG348

**Lifetime Warranty**  
12" wide x 18" high  
(when retracted)



**Features** Poly coated grab hooks - Stainless steel hardware  
Rust resistant powder coat - Retracts when not in use



**KAYAK HAMMOCK™**  
PREMIUM HOIST SYSTEM



120 lb Capacity

MPG346

**Features** Simple no hassle mounting - Independent lift control system - Padded hooks for bike storage  
Rope tie-down bracket - Lift straps for kayaks & canoes - Corrosion resistant construction

**ELEVATE™**  
LARGE BOAT STANDS

**Features**

- 23" tall when deployed
- 14" x 20" retracted size
- Powder coated frame
- Marine aluminum tubing
- 175 lb capacity
- Lifetime Warranty



MPG349

**FOAMHOME™**  
FOAM STORAGE BLOCKS

**Features**

- Fits all boat profiles
- Use inside or outside
- One boat capacity
- Reusable tote bag
- Set of two
- 24" x 4" x 4" high

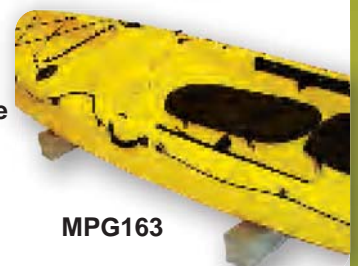

MPG163

# Kayak & SUP Wall Mount (Fixed Position)

We offer the largest cross section of storage systems in the industry. Each product has been carefully engineered to meet the exact requirements for the installation. Regardless of the kayak, canoe or board to be stored, we have the right rack to keep it safe.

Storage Systems

250 lb Capacity



MPG323

Fixed Position

**MPG323, J-Style Wall Rack** A high capacity wall system designed to hold large kayaks where weight is a factor. Constructed of 1.25" steel tubing and coated for inside / outside installation. Fully padded. Stainless steel hardware.

150 lb Capacity



MPG344

Fixed Position

**MPG344, Single Kayak Wall Rack** This medium capacity wall storage system safely holds sit-inside and sit-on-top kayaks. 1.00" round powder coated steel tubing covered with a thick layer of foam. Lifetime Warranty. Includes hardware.

250 lb Capacity



MPG327

Fixed Position

**MPG327, SUP-Style Wall Rack** A rock solid wall mount rack for multiple surfboards and stand-up paddle boards. 27" long powder coated and fully padded steel frame with stainless steel mounting bolts that resists corrosion.



MPG347

150 lb Capacity

**MPG347, Single Board Wall Rack** Safe storage for one SUP. 26" high x 11" deep frame. Easily installs in minutes.

## Wall Mount Ski Storage Rack



- . Rubber coating 7" long hangers
- . Includes six hanger assemblies
- . Includes mounting hardware
- . Reinforced steel frame
- . Load capacity (per hanger) 20 lb
- . Load capacity (total) 120 lb



MPG385

**MPG385, Ski Wall Rack** Safely store six sets of skis. Dimensions 49" x 7" x 3.5". Lifetime Warranty.



# Kayak & SUP Wall & Ceiling Mount (Folding & Strap)

The **Yak~Swing™** and **SUP~Swing™** each feature a convenient "fold away" design when not in use. The **SlingOne™**, **SlingTwo™** and **SlingThree™** utilize a quick-release carabineer system that offers an improved process for loading or unloading kayakers.

## Storage Systems



**YAK~SWING™**  
KAYAK FOLDING WALL STORAGE SYSTEM

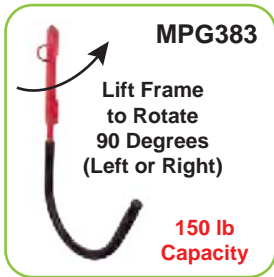

**MPG383 Kayak Wall Storage (Folding)** A medium capacity wall storage system that conveniently folds back against the wall when not in use. Safely holds sit-inside, and, sit-on-top kayakers. Includes a welded cable ring that allows a cable lock to be installed for theft prevention. Includes all mounting hardware. Lifetime Warranty.



**SUP~SWING™**  
SUP FOLDING WALL STORAGE SYSTEM



**MPG384**



**150 lb Capacity**

**MPG384 SUP Wall Storage (Folding)** A fully padded single SUP or surfboard storage system that rotates 90 degrees when not in use. Includes a welded security cable ring, nine point fastening system and mounting hardware.

**SLINGONE™**  
KAYAK STORAGE SYSTEM

**135 lb Capacity**

**MPG340**



**S / S, Kayak Storage Systems** Three storage units that feature 1200 lb, 1.5" wide quick release carabineer straps. Mounts to the wall or ceiling. Includes coated eye-hook mounting bolts. One Year Warranty.

**SLINGTWO™**  
KAYAK STORAGE SYSTEM

**135 lb Capacity**

**MPG341**



**SLINGTHREE™**  
KAYAK STORAGE SYSTEM

**MPG342**

**135 lb Capacity**



# Free Standing Kayak Storage Packages

Built with powder coated high load steel, these FS Rack™ storage packages are easy to assemble and will last for years. Fully padded J-style Holders gently protect the kayaks from abrasion and hull distortion. Available in three kayak and six kayak storage bundles.

Storage Systems



**FS RACK™**  
THREE BOAT FREE STANDING STORAGE

**250 lb**  
Capacity  
37" x 48" x 83"



**MPG318**

### FS Rack™ 3 Kayak Features

- Heavy duty 1.25" square tube construction
- Powder coated for inside or outside installation
- Six independent adjustable frame levelers
- One set of MPG339 Kayak Blocks (lower frame)
- Two sets of MPG320 J-Style Holders
- Zinc coated hardware and assembly tool included
- Easy to assemble design - **Lifetime Warranty**



**FS RACK™**  
SIX BOAT FREE STANDING STORAGE

**500 lb**  
Capacity  
54" x 48" x 83"

**MPG331**

### FS Rack™ 6 Kayak Features

- Heavy duty 1.25" square tube construction
- Powder coated for inside or outside installation
- Eight independent adjustable frame levelers
- Two sets of MPG339 Kayak Blocks (lower frame)
- Four sets of MPG320 J-Style Holders
- One MPG326 Leg Extension Kit
- Four MPG179 Upright Pads
- Easy to build design - **Lifetime Warranty**

# Free Standing Boat/Bike/Ski Storage Packages

Most outdoor enthusiasts own and use a cross selection of kayaks, canoes, bikes and skis. The need to safely store different and multiple types of gear is required. Malone offers three storage packages that meet and exceed that requirement.

Storage Systems



## FS RACK™

3 BIKE - 2 SUP - 1 KAYAK FREE STANDING STORAGE

### FS Rack™ 3 Bike, 2 SUP, 1 Kayak Features

- . 1.25" square tube construction
- . Corrosion resistant powder coating
- . Six adjustable frame levelers
- . One set of MPG325 SUP-Style Holders
- . One set of MPG339 Kayak Blocks
- . One set of MPG391 Bike Holders
- . Coated hardware included
- . Assembly tool included
- . Easy to assemble design
- . **Lifetime Warranty**

250 lb  
Capacity



MPG386



MPG387

## FS RACK™

2 KAYAK - 2 SUP - 6 SKI FREE STANDING STORAGE

### FS Rack™ 2 Kayak, 2 SUP, 6 Ski Features

- . 1.25" square tube construction
- . Corrosion resistant powder coating
- . Install inside or outside
- . Six adjustable frame levelers
- . One set of MPG325 SUP-Style Holders
- . One set of MPG339 Kayak Blocks
- . One set of MPG320 J-Style Holders
- . One MPG390 Ski Holder
- . Inc coated hardware
- . Assembly tool included
- . Easy to assemble design
- . **Lifetime Warranty**

250 lb  
Capacity



## FS RACK™

3 BIKE - 2 KAYAK - 6 SKI FREE STANDING STORAGE

### FS Rack™ 3 Bike, 2 Kayak, 6 Ski Features

- . Heavy duty 1.25" square tube construction
- . Corrosion resistant powder coating
- . Six independent adjustable frame levelers
- . One set of MPG339 Kayak Blocks
- . One set of MPG391 Bike Holders
- . Two sets of MPG320 J-Style Holders
- . One MPG390 Ski Holder
- . Coated hardware included
- . Assembly tool included
- . Easy to assemble design
- . **Lifetime Warranty**

250 lb  
Capacity



MPG388

# SUP & Kayak Packages / Frame & Accessories

The MPG334 and MPG338 are two additional packages for storing SUP's and kayaks. The FS Rack™ Storage Systems are also available in individual components. This "a la carte" approach can create the exact storage solution for all your boats, bikes, paddle boards, surfboards and cargo boxes.

Storage Systems

## FS RACK™

2 KAYAK - 2 SUP FREE STANDING STORAGE

### FS Rack™ 2 Kayak, 2 SUP Features

- . 1.25" square tube construction
- . Corrosion resistant powder coating
- . Six adjustable frame levelers
- . One set of MPG339 Kayak Blocks
- . One set of MPG320 J-Style Holders
- . One set of MPG325 SUP-Style Holders
- . Corrosion resistant hardware included
- . Assembly tool included
- . Easy to assemble design
- . 250 lb capacity
- . Lifetime Warranty
- . 37" x 48" x 83"



MPG334



## FS RACK™

6 SUP FREE STANDING STORAGE

### FS Rack™ 6 SUP Features

- . Three sets of MPG325 SUP-Style Holders
- . Corrosion resistant powder coating
- . 1.25" square tube construction
- . Six adjustable frame levelers
- . Coated hardware included
- . Assembly tool included
- . Easy to assemble design
- . 250 lb capacity
- . Lifetime Warranty
- . 37" x 48" x 83"



MPG338



## FS Rack™ Frame & Accessories (A-la-Carte)

### Base Frame (Single)

#### Features

- . 12 Gauge construction
- . Powder coated frame
- . Zinc coated steel hardware
- . Adjustable frame levelers
- . Assembly instructions
- . Assembly tools
- . Lifetime Warranty
- . 37" x 48" x 83"



MPG332

### Leg Extension Kit (Set of Two)

#### Features

- . 1.25" steel construction - Powder coated surface
- . Protective end caps - Adjustable frame levelers
- . Lifetime Warranty - 1.25" x 1.25" x 16.5"



MPG326

# FS Rack™ Accessories (A-la-Carte)

The FS Rack™ system includes a wide selection of holder designs and accessory options for safe and convenient gear storage. These systems are specifically designed to store kayaks, bikes, canoes, surfboards, SUPs, skis, paddles, PFDs and related sports equipment.

## Storage Systems



### FS Rack™ J-Style Holders



- . 120 lb load capacity
- . Padded frames
- . Includes hardware
- . Sold in sets of two
- . Lifetime Warranty
- . 1.25" x 7.5" x 20.5"

Fits Nearly All Kayak Styles

MPG320

### FS Rack™ SUP-Style Holders



- . 100 lb load capacity
- . Padded frames
- . Includes hardware
- . Sold in sets of two
- . Lifetime Warranty
- . 1.25" x 7.5" x 27.5"

Great for Surfboard and Cargo Box Storage

MPG325

### FS Rack™ Paddle Holders



- . Coated steel rod (1/4")
- . Sold in sets of two
- . Lifetime Warranty
- . 6" high x 6" wide

MPG389

### FS Rack™ Dealer SUP-Style Holders



- . 100 lb load capacity
- . Custom end caps
- . Padded frames

1.25" x 7.5" x 20.5"

MPG329

### FS Rack™ SUP Spacer Blocks

- . EVA foam construction
- . Great when stacking SUPs
- . Dimensions 22" x 4.75" x 2"
- . Sold in sets of two
- . One Year Warranty



MPG176

### MPG339

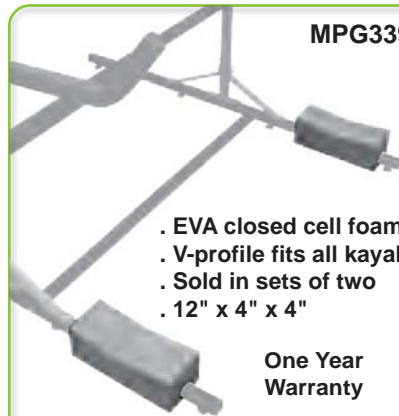

- . EVA closed cell foam
- . V-profile fits all kayaks
- . Sold in sets of two
- . 12" x 4" x 4"

One Year Warranty

FS Rack™ Foam Kayak Blocks

### FS Rack™ Caster Wheel Kit



- . 50 lb load capacity per unit
- . Multi-directional tracking
- . Push-down wheel locks
- . Height adjustable
- . Sold in sets of four
- . Lifetime Warranty

MPG333

### FS Rack™ Ski Holder



- . Rubber coating ski hangers
- . Includes 6 hanger assemblies
- . Mounting hardware included
- . Reinforced steel frame
- . Stores 1-6 sets of skis
- . Load capacity (per hanger) 20 lb
- . Load capacity (total) 120 lb
- . Lifetime Warranty

MPG390

### FS Rack™ Bike Holder

- . Mounting hardware included
- . Ribbed rubber outer coating
- . 1" diameter steel frame
- . Stores 1-3 bikes
- . Load capacity 100 lb
- . Sold in sets of two
- . Lifetime Warranty



MPG391

# XtraLight™ Base Trailer

Slightly downsized and loaded with features is the best way to describe the XtraLight™. Designed for recreational and fishing kayak transport, this trailer can handle any boat up to 14 ft long. Extremely well built, affordable, made in the USA and covered by our exclusive 5 Year Warranty.

Sport Trailers

## XTRALIGHT™

MPG525 BASE TRAILER



### Features

- Marine grade galvanized frame
- DOT & Transport Canada approved
- L.E.D. "plug & play" lights
- In action molded fenders
- 58" 14 gauge steel load bars with D-ring tie-downs
- 2pc reinforced tongue
- Tongue lift handle
- 2" Class II receiver
- Five Year Warranty

### Specifications

- Weight 159 lb
- Length 11' 2"
- Width 58"
- Wheels 8" diameter - 5 lug
- Tire Pressure 35-40 PSI
- Maximum speed rating 65 MPH
- Load Capacity 400 lb

For Boats Up to  
14' in Length



2" Receiver with Lift Handle and Four Pin Connector



Easy to Assemble "T-Box" Style Galvanized Frame



Tows Perfectly with Solid Axle and Leaf Spring Suspension

## OPTIONAL ACCESSORIES



MPG481 Storage Trunk with Mounting Brackets



MPG207 MegaWing Reinforced Carriers (For Large Kayaks)

Keeps the Trailer Visible at All Times.



Helps when Backing Up.

MPG488 Safety Mast with Mounting Hardware



65" x 12" x 6" - 13 lb  
See Page 53 for Specifications

MPG2100 Pilot TC/LT Bike Carrier for Trailers



MPG467 Jack Stand (With Caster Wheel)



MPG565 Spare Tire with Locking Attachment

# XtraLight™ Trailer Packages

The XtraLight™ is available in popular bundled packages for transporting one, two or four kayakers  
 The choice of carriers includes traditional saddles, side load J-Style, bottom down V-Style, or upright Stackers (L-Style).

Sport Trailers

## MPG526-S

SINGLE KAYAK TRANSPORT



Excellent Kayak Fishing Package

Boat Not Included

**MPG526-S Features Include** MPG525G Base Trailer - MPG110 carriers. **Best Application** Large single fishing kayak.

## MPG526-V

TWO KAYAK TRANSPORT



Affordable Multi-Boat Transport

Boats Not Included

- MPG526-J Includes**
- MPG525G Base Trailer
  - V-Style carriers (2 sets)
  - Carrier mounting hardware
  - Cam Style Load Straps

**Best Application**  
Four medium to large sized recreational kayakers.

## MPG526-L

FOUR KAYAK TRANSPORT



- MPG526-J Includes**
- MPG525G Base Trailer
  - L-Style carriers (1 set)
  - MPG168 stacker blocks (8)
  - Carrier mounting hardware
  - Cam Style Load Straps

Boats Not Included

**Best Application**  
Four medium sized recreational kayakers.

Tows Perfectly w/ Four Kayaks

## MPG526-J

TWO KAYAK TRANSPORT



2pc Reinforced Tongue

Boats Not Included

- MPG526-J Includes**
- MPG525G Base Trailer
  - J-Style carriers (2 sets)
  - Carrier mounting hardware
  - Cam Style Load Straps

**Best Application** Two medium sized recreational kayakers.

# MicroSport™ Base Trailer

The MicroSport™ is a premium sports trailer built in the USA and is offered in two packages. The MPG460G is the base platform and comes with extended tongue, 78" load bars and 12" wheels. The MPG460XT is the upgraded model and features some of our best selling options.

Sport Trailers

## MICROSPORT™

MPG460 BASE TRAILER

### Features

- Marine grade galvanized frame
- DOT & Transport Canada approved
- L.E.D. plug & play" lights
- In action molded fenders
- 78" 14 gauge steel load bars with D-ring tie-downs
- Extended reinforced tongue
- Tongue lift handle
- 2" Class II receiver
- Five Year Warranty



MPG460G



New Double Leaf Spring  
Upgrades Load Capacity to 800 lb



New LED Plug & Play" Lights  
Simplify the Assembly Process

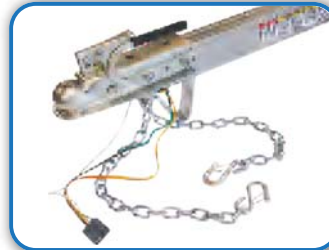

Class II 2" Receiver with Lift  
Handle and Four Pin Connector



Conveniently Ship UPS or FedEx  
Ground in Four Cartons

### Specifications

- Weight 197 lb
- Length 13' 3"
- Width 78"
- Wheels 12" diameter - 5 lug
- Tire Pressure 40 PSI
- Maximum speed rating 75 MPH
- Load Capacity 800 lb



## MICROSPORT™ XT

MPG460XT UPGRADED BASE TRAILER



Featuring Aluminum Wheels  
and Diamond Plate Fenders



Boats & Cargo Box  
Not Included  
MPG474 Second  
Tier and MPG114 Kayak  
Carriers available  
separately

Heavy Duty Frame with 78" Load Bars Safely Transport  
Large Kayaks & Gear

Retractable Tongue  
Eliminates Storage  
Space Issues



Includes Rear Bumpers  
for Vertical Storage



MPG460XT

### MPG460XT Features

- MPG460G Base Trailer
- MPG494 retractable tongue kit
- MPG496 aluminum wheel / diamond plate fender upgrade



# MicroSport™ Upgrades & Accessories

The MicroSport™ is also available with a wide array of accessories for creating an individual custom look or upgrading to satisfy additional transport requirements. All components of this trailers series are protected with a five year warranty to ensure total satisfaction.

Sport Trailers

## MicroSport™ Upgrades (Upgrade at the time of trailer purchase)

MPG496

**Aluminum Wheel & Diamond Plate Aluminum Fender Upgrade**



Replaces standard galvanized wheels and fenders. Sold in sets of two each.

## MicroSport™ Accessories (Retrofit your existing trailer)

MPG467

**Retractable Kick Stand**



Elevates the tongue for easy handling. Rotates and locks in the "Up" or "Down" position.

MPG474

**Second Tier Kit with 50" Load Bars**



Boats & Cargo Box Not Included  
MPG114 Kayak Carriers available separately



Retrofits to all MicroSport™ Trailers.

Great for a cargo box, extra boat or additional gear space.

MPG465

**12" Spare Tire with Lock**



12" galvanized wheel with trailer wheel lock.

MPG475

**78" Cross Rails with Supports & Brackets**

A complete 78" load bar system including cross supports and installation hardware.



MPG494

**Retractable Tongue Kit**



Store your trailer upright against a wall. Reduces overall length from 159" to 98".

Retrofits to all existing MPG460 MicroSport trailers.

Includes rear rubber bumpers, hitch pins and all wiring needs.

17.5" x 6.5" x 2.75"

WARRANTY  
FIVE 5 YEAR  
WARRANTY

Vertical Storage Option



MPG207

**MegaWing™ Reinforced V-Style Carriers**

Specifically designed to transport heavy sit-on-top fishing kayaks. Includes 15' cam style load straps and all required mounting hardware.



# MicroSport™ Accessories

Additional accessories include an assortment of cross rail designs and mounting options. We offer several choices of alternative transport systems as well as the MPG2100 bike carrier specifically developed to work with our trailer product line.

Sport Trailers



**MPG4001**  
**78" HD 1.25" Galvanized Cross Bars**



Retrofits to existing MicroSport trailers and provides additional bar length.

**MPG553**  
**SUP Transport Pads for Trailers**



Sold in sets of 2.

Transport SUP's under the load bars using these UV resistant fully cushioned frame pads.

**MPG2100**  
**Pilot™ TC/LT Bike Carrier for Trailers**



65" x 12" x 6" - 13 lb  
See Page 53 for Specifications

Extra long tray designed for trailer mount bike transport.

**MPG488**  
**Trailer Safety Mast**



Includes mounting hardware kit.

Helps when backing up.

Keeps the trailer visible at all times.

**MPG561**  
**MPG561 Large Kayak Bunk Kit™**



84" x 4" x 2"

Sold in sets of 2.

Transport one kayak - Includes bunks and hardware.  
Made in USA - Five Year Warranty

**MPG4002**  
**Tongue Mount Cross Rail**



Bar Dimensions  
78" x 1.25" x 1.25"

Increase bar spread for longer boats. Includes single bar, support & hardware.



**MPG481**  
**Hard Shell Storage Trunk**

The MPG481 offers 3.7 cubic feet of storage space. The lid is removable from the trunk and can be locked for added security (locks not included). Includes galvanized mounting brackets and fits perfectly in the trailer's framework.

# MicroSport™ Trailer Packages

The MicroSport™ is also available in outfitted trailer packages that make it simple to create a total kayak transport system. All of these two and four carrier packages include a spare tire with locking attachment and are perfect for multiple sea and recreational kayaks.

## Sport Trailers



**MPG461GS**  
TWO KAYAK TRANSPORT

**Features**  
MPG460G Base Trailer - MPG107 Carriers (2)  
MPG465 Spare Tire & Lock

**Best Application**  
Two sit-inside kayaks or two medium sized sit-on-top kayaks.

Kayaks Not Included



**MPG461GU**  
TWO KAYAK TRANSPORT

**Features**  
MPG460G Base Trailer - MPG110 Carriers (2)  
MPG465 Spare Tire & Lock

**Best Application**  
Two large sized sit-on-top kayaks.

Kayaks Not Included



**MPG461G2**  
TWO KAYAK TRANSPORT

**Features**  
MPG460G Base Trailer - MPG117 Carriers (2)  
MPG465 Spare Tire & Lock

**Best Application**  
Two sit-inside or two sit-on-top kayaks with additional room for bikes or a cargo box.

Kayaks Not Included



**MPG462G2**  
FOUR KAYAK TRANSPORT

**Features**  
MPG460G Base Trailer - MPG117 Carriers (4)  
MPG465 Spare Tire & Lock - MPG476 78" Cross Rails

**Best Application**  
Four sit-inside or four medium sized sit-on-top kayaks.

Kayaks Not Included



**MPG462G1**  
FOUR KAYAK TRANSPORT

**Features**  
MPG460G Base Trailer  
MPG115 Carrier  
MPG465 Spare Tire & Lock

**Best Application**  
Four sit-inside or four medium sized sit-on-top kayaks.

Kayaks Not Included

# MicroSport™ Fishing Kayak Packages

A packaged line of MicroSport™ trailers that are set up for large fishing kayaks. The MPG461B1 and MPG461B2 both feature bunk style carriers that fit most hull designs. The MPG461SU and MPG461SS have standard kayak carriers. All four trailers come with Spare Tire & Lock.

Sport Trailers



**MPG461B1**  
SINGLE KAYAK BUNK STYLE TRAILER

**Features**  
MPG460G Base Trailer  
MPG561 Trailer Bunk Kit  
MPG465 Spare Tire & Lock

**Best Application**  
Single large fishing kayak.



**MPG461B2**  
TWO KAYAK BUNK STYLE TRAILER

**Features**  
MPG460G Base Trailer  
MPG561 Trailer Bunk Kit (2)  
MPG465 Spare Tire & Lock

**Best Application**  
Two medium to large fishing kayaks.



**MPG461SU**  
SINGLE KAYAK TRANSPORT

**Features**  
MPG460G Base Trailer  
MPG110 Carriers  
MPG465 Spare Tire & Lock

800 lb Maximum Capacity

**Best Application**  
Single large sized kayak.



**MPG461SS**  
SINGLE KAYAK TRANSPORT

**Features**  
MPG460G Base Trailer  
MPG207 Carriers  
MPG465 Spare Tire & Lock

**Best Application**  
Single large sized kayak.

# MicroSport™ Trailer Bike & Kayak Packages

These packages include two bike / two kayak, and, four bike carrier bundles. Both of these packages feature Malone MPG2100 Pilot™ TC LT Upright Bike Racks. These tray style carriers are 65" long and accommodate the wider bar spacing found with trailer transport.

Sport Trailers



**MPG461KB**  
TWO KAYAK - TWO BIKE TRANSPORT

**Features**  
MPG460G Base Trailer  
MPG117 Kayak Carriers (2)  
MPG2100 Bike Carriers (2)  
MPG465 Spare Tire & Lock.

**Best Application**  
Two sit-inside kayaks or two medium sized sit-on-top kayaks and two bikes (most styles).



**MPG462B4**  
FOUR BIKE TRANSPORT

**Features**  
MPG460G Base Trailer  
MPG2100 Bike Carriers (4)  
MPG465 Spare Tire & Lock.

**Best Application** Four bikes (most styles). Note Not compatible with tandem, recumbent or electric bikes.



**PILOT™**  
TRAY STYLE BIKE CARRIER FOR TRAILERS  
**TC LT**

**MPG2100**

**Features**

- Single bike capacity
- Ratchet SafeHook™ secures the front tire
- Compatible with most frames
- Ad ustable extra wide wheel holders fit most tires
- Mounting hardware fits Malone trailer racks

**Specifications**

- Load capacity 33 lb
- Aluminum & steel powder coated construction
- Fits 20" to 29" wheels and up to 5" fat tires
- Dimensions 65" x 12" x 6"
- Weight 13 lb

**Note** Not compatible with tandem and recumbent bikes.

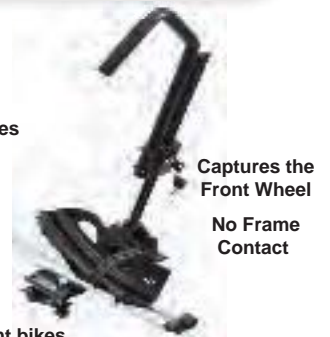

- MPG355, LockUp™ 12mm x 6' long cable lock**
- MPG356, LockUp™ 12mm x 8' long cable lock**
- MPG357, LockUp™ 12mm x 10' long cable lock**



(Sold in singles only)

**Bike Security Cable Locks** With today's prices for bikes, security and theft are ma or issues. Protect your investment with LockUp™ cable locks. These systems have state-of-the-art technology in anti-drill, anti-saw and anti-pick. These heavy duty 12mm thick multi-coaxial cables are available in 6', 8' and 10' lengths.

# MegaSport™ Base Trailer

The MegaSport™ was designed to meet the needs of the serious kayak angler. Made in the USA, this premium marine grade trailer can be customized with options that provide wet or dry gear management, overhead storage, lighting options and electronics recharging.

Sport Trailers



### Specifications

- . Weight 325 lb
- . Length 14'
- . Width 86"
- . Wheels 10" diameter - 5 lug
- . Tire Pressure 40 PSI
- . Maximum speed 70 MPH
- . Load Capacity 1000 lb

**MEGASPORT™**  
MPG535 BASE TRAILER



Proudly Made In The USA

### Features

- . Marine grade galvanized frame
- . DOT & Transport Canada approved
- . L.E.D. plug & play™ lights
- . Crank assist ack stand & wheel
- . 86" long, 14 gauge steel load bars
- . D-ring lash downs
- . Extended reinforced tongue
- . Tongue lift handle
- . 2" Class II receiver
- . Five Year Warranty



86" Steel Load Bars with 3.5" x 1.5" C-Channel Construction



2" Class II Hitch

Includes Lift Handle and Jack Stand

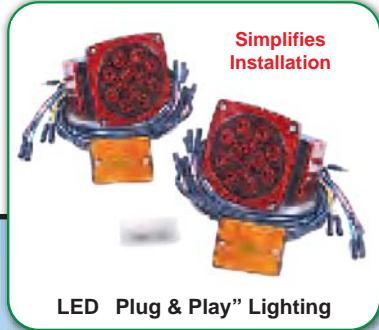

Simplifies Installation

LED Plug & Play™ Lighting



1000 lb Triple Leaf Suspension

Trailer Shown with Multiple Optional Accessories (See Pages 55-57)



# MegaSport™ Trailer Upgrade & Accessories

The MPG549 Upgrade allows the standard galvanized wheels & fenders to be swapped out for custom aluminum designs. Several choices for secure and convenient in-chassis storage are available. Electronic options include a magnetic flood light and charging station.

Sport Trailers



**Aluminum Wheel Upgrade**  
Replaces standard galvanized wheels.



MPG549



**Aluminum Fender Upgrade**  
Replaces standard galvanized fenders.

## MPG549 MegaSport™ Wheel & Fender Upgrade

Available only at the time of the original purchase of a MegaSport™ trailer, this upgrade allows the standard galvanized wheels and fenders to be exchanged for aluminum wheels and diamond tread aluminum fenders. See page 56 for updating an existing trailer.



MPG547

## MPG547 Wire Storage Basket

This ruggedly built wire basket fits perfectly in the MegaSport™ chassis and provides storage space for wet gear, bait buckets and landing nets.

### Features Include

- Powder coated steel welded construction
- 8 cubic feet of storage space (48" x 16" x 18")
- Removable wire lid with cam buckle retention strap
- Includes all mounting hardware

MPG536



## MPG536 Plastic Storage Trunk

An alternative to the wire basket and fitting in the same chassis area, the MPG536 adds a level of security and overall water resistance.

### Features Include

- High strength molded plastic construction
- 8 cubic feet of dry storage space (44" x 19" x 17.75")
- Hinged lid with security latches (locks not included)
- Includes all required mounting hardware



## MPG543 Electric Charging Station

Waterproof permanent mount station for charging LED lighting, fish finders, GPS, phones & camera.

### Features Include

- One 5V 1 amp illuminated USB receptacle
- One 5V 2.1 amp illuminated USB receptacle
- One 12V standard accessory receptacle
- Galvanized mounting plate with hardware



MPG543



MPG542

## MPG542 LED Flood Light (Magnetic Mount)

With it's 10' power cord, this magnetic base LED flood light can be mounted anywhere on the trailer. The 2000 lumen twin beam bulbs provide ample light for late night / early morning set ups.

### Features Include

- Aluminum waterproof housing - 10' coiled power cord
- Standard 12V accessory plug with switch - May require MPG543

# MegaSport™ Trailer Accessories

The MPG537 Storage Drawer provides easy access to gear. The MegaWing™, with it's enhanced strength, can handle kayaks weighing over 75 lb. Other options include a Spare Tire kit Fishing Rod Storage Tube and custom aluminum wheels and fenders.

Sport Trailers



MPG537

Unique Slide-Out Storage for Quick Gear Access

Can Be Retrofitted to any Existing MegaSport™

## MPG537 Plastic Storage Drawer with Rollers

A dry storage drawer (with cover) that conveniently slides out from under loaded boats for easy access to stored gear. Great for batteries, fish finders and tackle boxes. Oversized rollers integrate with the trailer frame to create a conveyor platform for ease of use.

### Features Include

- Molded plastic construction for high durability - 5.5 cubic feet of storage space - Removable plastic lid with water seal gasket
- Includes all mounting hardware, steel rollers and guide wheels. Please note Locks not included.



MPG207

MPG207 MegaWing™ High Capacity Kayak Carriers with 15' Straps and Universal Hardware



MPG540

MPG540 MegaSport™ Spare Tire with Locking Attachment  
Locks not included.

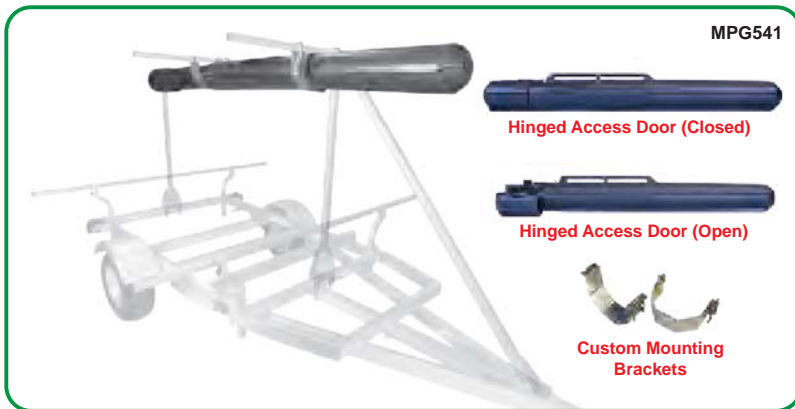

MPG541

Hinged Access Door (Closed)

Hinged Access Door (Open)

Custom Mounting Brackets

## MPG541 Fishing Rod Storage Tube

This telescoping rod transport system delivers a reliable and secure transit for your expensive "gone fishing" gear. Custom made brackets firmly secure this system to load bars and overhead vertical supports.

Designed for easy access with a hinged door. Holds up to six saltwater (extra long) rods. A fully molded and nearly indestructible frame with padded ends for years of service.

### Features

- Custom mounting brackets for a confident attachment
- Telescoping 6" diameter frame (73" to 102" in length)
- Lockable hinged access for convenience and security
- High volume capacity holds up to six oversized rods
- Five Year Warranty



Aluminum Spoke Wheels

MPG560

Diamond Plate Fenders

## MPG560 MegaSport™ Aluminum Wheel & Fender (two sets of 2)

Add a custom look to your trailer with aluminum 10" x 8" spoke wheels and diamond plate aluminum fenders. Replaces the standard galvanized wheels & fenders on an existing Malone MegaSport trailer. Lugs nuts, fender hardware and wheel caps not included.



# MegaSport™ Trailer Accessories

The MPG539 Flood Light attaches to the trailer's load bars and provides convenient overhead lighting. Add a second tier to your trailer with the MPG545 and take advantage of the extra space with the MPG546 Milk Crate Cage. The MegaSport™ Trailer Bunk Kit can easily handle one large kayak.

Sport Trailers

## MPG539 Flood Light (Bracket Mount)

This powerful and waterproof 2000 lumen LED flood light comes with mounting bracket and attachment hardware. Can be easily mounted to the MegaSport™ 2nd Tier Load Bar System in multiple locations. Provides exceptional light for rigging gear and loading accessories in the dark.

### Features

- . Sealed housing with twin beam with 2000 lumen LED lights
- . Waterproof toggle switch
- . 12' wiring harness
- . Coated mounting bracket
- . Aluminum waterproof housing
- . Five Year Warranty

**Permanently Installs  
Into the Trailer's  
Wiring Harness**



## MPG545 2nd Tier Load Bar System

Increase load capacity to your MegaSport™ with this all steel upper level load bar system. Installation is quick and simple using the retro-fit design that easily integrates to a prior assembled trailer.

Ideal for adding extra gear without sacrificing convenient waist-level lower space. The ad ustable rear load bar allows perfect placement for differing load requirements.

### Features

- . Modular galvanized steel design for a quick installation
- . 50" long x 1.25" square heavy duty galvanized load bars
- . 150 lb load bar capacity
- . Dimensions 5' 10" long x 50" wide
- . Five Year Warranty



## MPG546 Milk Crate Cage

Loading and controlling your small item gear is one of the biggest challenges to kayak fishing and the milk crate has become the standard solution within the industry.

The MPG546 Milk Crate Cage holds five standard sized crates up and out of the way. Great for keeping your gear safe and organized. Note Milk crates and tie-downs not included.

### Features

- . 11 gauge galvanized construction
- . No drilling required - Installs directly to the MPG545
- . Deep trough design to firmly capture the crates
- . Large capacity frame holds five standard sized crates
- . Made in the USA
- . Five Year Warranty

Transport one large kayak. Fits nearly any hull configuration.

## MPG561 Large Kayak Bunk Kit™

### Features

- . 84" x 4" x 2" covered bunks (2)
- . Marine grade weather resistant bunk covering
- . Installation hardware for two bunks
- . Made in the USA - Five Year Warranty



# MegaSport™ Trailer Packages

The MegaSport™ was designed to be accessorized and these three trailer packages target the serious angler who wants the best possible transport. Each of these packages feature our MPG561 Large Kayak Bunk carriers and a cross section of our best options.

Sport Trailers



**MPG550-AH**

MEGASPORT TRAILER PACKAGE

**Best Application**

Two large fishing kayakers and a need for overhead storage, milk crate cage, rod holders and lower wet / dry storage.



**Features**

- MegaSport™2 Boat Ultimate Angler Package - Bunks
  - MPG535 Base Trailer
  - MPG561 Large Kayak Bunk Kit (2)
  - MPG537 Storage Drawer - MPG547 Wire Basket
  - MPG545 2nd Tier Kit - MPG541 Fishing Rod Tube
  - MPG546 Milk Crate Cage - MPG540 Spare Tire
- (See individual product descriptions)



**MPG550-H**

MEGASPORT TRAILER PACKAGE

**Best Application**

Two large fishing kayakers and a need for lower wet / dry storage.



**Features**

- MegaSport™2 Boat w/ Storage - Bunks
  - MPG535 Base Trailer - MPG561 Large Kayak Bunk Kit (2)
  - MPG537 Storage Drawer - MPG547 Wire Basket
  - MPG540 Spare Tire & Lock
- (See individual product descriptions)



**MPG550-TH**

MEGASPORT TRAILER PACKAGE

**Best Application**

Two large fishing kayakers and a need for overhead storage and lower wet / dry storage.



**Features**

- MegaSport™2 Boat w/ Storage & 2nd Tier - Bunks
  - MPG535 Base Trailer - MPG561 Large Kayak Bunk Kit (2)
  - MPG537 Storage Drawer - MPG547 Wire Basket
  - MPG545 2nd Tier Kit - MPG540 Spare Tire & Lock
- (See individual product descriptions)

# MegaSport™ Trailer Packages

The MPG207 MegaWing™ and SaddleUp™ carriers work well with more traditionally designed hulls. We created three excellent packages using these carriers along with a wide selection of affordable options to make every fishing experience a great one.

Sport Trailers



### Best Application

Two medium to large fishing or recreational kayaks with standard hull design and a need for increased overhead storage, rod holders, milk crate containment and lower wet / dry storage.



## MPG550-AM

MEGASPORT TRAILER PACKAGE

### Features

MegaSport™ 2 Boat Ultimate Angler Package - MegaWing™  
 MPG535 Base Trailer - MPG207 Carriers (2)  
 MPG537 Storage Drawer - MPG547 Wire Basket  
 MPG545 2nd Tier Kit - MPG541 Fishing Rod Tube  
 MPG546 Milk Crate Cage - MPG540 Spare Tire  
 (See individual product descriptions)



### Best Application

Two medium to large fishing or recreational kayaks. A need for increased overhead storage, rod holders, milk crate containment and lower wet / dry storage.



## MPG550-AU

MEGASPORT TRAILER PACKAGE

### Features

MegaSport™ 2 Boat Ultimate Angler Package - SaddleUp™ Pro  
 MPG535 Base Trailer - MPG110 Carriers (2)  
 MPG537 Storage Drawer - MPG547 Wire Basket  
 MPG545 2nd Tier Kit - MPG541 Fishing Rod Tube  
 MPG546 Milk Crate Cage - MPG540 Spare Tire  
 (See individual product descriptions)



### Best Application

Two medium to large fishing or recreational kayaks with standard hull design. A need for lower wet / dry storage.

## MPG550-M

MEGASPORT TRAILER PACKAGE

### Features

MegaSport™ 2 Boat w/ Storage - MegaWing™  
 MPG535 Base Trailer - MPG207 Carriers (2)  
 MPG537 Storage Drawer - MPG547 Wire Basket  
 MPG540 Spare Tire & Locking Attachment  
 (See individual product descriptions)

# MegaSport™ Trailer Packages

Rounding out our offering of MegaSport™ packages are three designs developed for anglers with both recreational or larger fishing kayaks. Each product has been carefully assembled to meet both budget requirements and specific optional needs.

Sport Trailers



**Best Application**

Two medium or large fishing or recreational kayakers with traditional hull designs and a need for increased overhead storage and lower wet / dry storage.



**MPG550-TM**  
MEGASPORT TRAILER PACKAGE

**Features**

- MegaSport™ 2 Boat w/ Storage & 2nd Tier - MegaWing™
  - MPG535 Base Trailer - MPG207 Carriers (2)
  - MPG537 Storage Drawer - MPG547 Wire Basket
  - MPG545 2nd Tier Kit - MPG540 Spare Tire
- (See individual product descriptions)



**Best Application**

Two medium or large fishing or recreational kayakers and a need for increased overhead storage and lower wet / dry storage.



**MPG550-TU**  
MEGASPORT TRAILER PACKAGE

**Features**

- MegaSport™ 2 Boat w/ Storage & 2nd Tier - SaddleUp™ Pro
  - MPG535 Base Trailer - MPG110 Carriers (2)
  - MPG537 Storage Drawer - MPG547 Wire Basket
  - MPG545 2nd Tier Kit - MPG540 Spare Tire
- (See individual product descriptions)



**Best Application**

Two medium or large fishing or recreational kayakers and a need for lower wet / dry storage.



**MPG550-U**  
MEGASPORT TRAILER PACKAGE

**Features**

- MegaSport™ 2 Boat w/ Storage - SaddleUp™ Pro
  - MPG535 Base Trailer - MPG110 Carriers (2)
  - MPG537 Storage Drawer - MPG547 Wire Basket
  - MPG540 Spare Tire with Locking Attachment
- (See individual product descriptions)

# MegaSport™ Outfitter™ Three Tier Trailer

A trailer designed for commercial and large scale kayak & canoe transport. The MegaSport™ Outfitter™ meets the tough requirements for high load capacity, heavy duty construction, extended warranty and affordable cost containment.

Sport Trailers



Proudly Made  
In The USA

## Features

- . Marine grade galvanized frame
- . DOT & Transport Canada approved
- . L.E.D. plug & play™ lights
- . Crank assist jack stand & wheel
- . MPG540 Spare Tire w/ lock attachment
- . Three tier load bar design with D-Rings  
Lower / Middle Bars 86" wide  
Top Bar 55" wide
- . Extended reinforced tongue
- . Tongue lift handle
- . 2" Class II receiver
- . Five Year Warranty



**MEGASPORT™**  
MULTI-LEVEL HIGH CAPACITY TRAILER  
**OUTFITTER™**



DOT and  
Transport Canada  
Approved



## Specifications

- . Weight 446 lb
- . Length 14' 6"
- . Width 86"
- . Height 84"
- . Suspension Triple leaf spring
- . Wheels 10" diameter
- . Tire Pressure 40 PSI
- . Maximum speed 70 MPH
- . Load Capacity 1000 lb

**MPG550-O**



1000 lb Capacity  
Crank Style Jack  
Allows the Trailer  
to be Easily  
Moved & Positioned

Pivots for Transport

2" Class Two Hitch with  
Lift Handle and Jack Stand

86", 86" and 55" Long Three-Tier  
Steel Load Bars with D-Ring Lash-downs

# MicroSport™ Jon Boat Trailer Package - Trailer Accessories

The MPG461JB is a modified MicroSport™ trailer with high capacity leaf springs, 1000 lb winch and bunk style carriers designed to transport Jon boats. The TopTier™ is an extremely popular option for adding upper load bars to a utility trailer.

Sport Trailers



### Features

- MicroSport™ Trailer - Jon Boat Package
- MPG460 Base Trailer w/o Load Bars
- 6' x 4" x 2" Trailer Bunk Kit
- 1000 lb Winch with Bow Stop & Mast
- MPG467 Kick Stand - MPG465 Spare Tire
- (See individual product descriptions)



### Specifications

- Capacity 800 lb
- Weight 210 lb
- Length 164"

Boat & Rear Retaining Strap Not Included



Includes 1000 lb Capacity Winch with Bow Stop and 26" Mast

### Best Application

One Jon boat with a maximum length of 16' and maximum width of 70"

## TopTier™ Utility Trailer Cross Bar System

Dramatically increase utility trailer payload capacity with the TopTier™ Trailer Cross Bar Kit. Easily installs to most utility trailers with raised side rails. Great for transporting canoes and kayaks. The perfect solution for contractors needing extra overhead cargo space or paddlers looking to retrofit an existing trailer.



Trailer, Boats & ATV Not Included

Made in the USA



### Features

- 53" Galvanized Steel Uprights
- 65" Steel Cross Bars
- Upright Stabilizers
- Proudly Made In The USA
- Five Year Warranty



## Miscellaneous Trailer Accessories

Offering a popular cross section of trailer accessories to improve overall trailer transport satisfaction. Each item has been carefully selected for convenience, quality and overall workmanship and covered by Malone's Five Year Warranty.

Sport Trailers

### Ball Mount Kits - Trailer Cross Bar Conversion Kit

We offer two popular Ball Mount Receiver kits. Add a Cross Bar Conversion Kit to your trailer in minutes.

MPG477		1.25" x 7" Ball Mount 2" Chrome Ball 1/2" Hitch Pin	MPG475
MPG454		2" x 10" Ball Mount 2" Chrome Ball 5/8" Hitch Pin	
			Complete Trailer 78" Cross Bar Conversion Kit

### MPG544 Double Hitch Receiver

Double your towing capacity with this Class II, 2" Double Hitch Receiver. Add a Malone bike or cargo carrier to your trailer hitch set-up. Features an anti-wobble design that holds the carrier in position.



### Harness Adapter - Safety Flag - Hitch Anti-Wobble Bracket

The Trailer Harness Adapter (7 to flat 4) works with all Malone trailer wiring systems. A Safety Flag is a must for day time safe transport of canoes & kayaks. Stop hitch accessory rattle with the MPG908 Anti-Wobble Bracket.



2019



*PILOT*<sup>™</sup>

BACK OF CAR BIKE CARRIER

BC2

Rely only on high-grade roof racks & cargo carriers offered on our virtual shelves.