

MALONE[®]

CHANGING THE WAY YOU GET THERE



2020

**CAR RACK ACCESSORIES
SPORT TRAILERS**

Intro To Sports Trailers



Malone[®] offers the largest cross section of Sports Trailers in the industry. These “Made in the USA” trailers are available in six separate models with 37 total packages and 25 option choices.

Individually designed to transport kayaks, canoes, bikes, cargo boxes, storage holders and accessory systems.

EcoLIGHT[™] MPG585 BASE TRAILER



See Pages 46-47

Base
MPG585
Low Clearance
25" Load Bar Height

Specifications:

- . Wheels: 8" dia - 5 lug
- . Maximum Speed: 65 MPH
- . Load Capacity: 400 lb
- . Weight: 145 lb
- . Length: 10' 6"
- . Width: 58"

Packages Available: 4 Options Available: 7



Package MPG586XJ

XTRALIGHT[™] MPG595 BASE TRAILER LowMAX[™]



See Pages 48-49

Base
MPG595
Low Clearance
26" Load Bar Height

Specifications:

- . Wheels: 8" dia - Pontoon
- . Maximum Speed: 65 MPH
- . Load Capacity: 600 lb
- . Weight: 206 lb
- . Length: 11' 3"
- . Width: 78"

Packages Available: 6 Options Available: 9



Package MPG596XKB

MICROSPORT[™] MPG460 BASE TRAILER



See Pages 50-52

Base
MPG460G

Specifications:

- . Wheels: 12" dia - 5 lug
- . Maximum Speed: 75 MPH
- . Load Capacity: 800 lb
- . Weight: 197 lb
- . Length: 13' 3"
- . Width: 78"

Packages Available: 8 Options Available: 12



Package MPG462G2

MICROSPORT[™] MPG464 BASE TRAILER LowBED[™]



See Pages 53-55

Base
MPG464-LB
Low Clearance
22" Load Bar Height

Specifications:

- . Wheels: 12" dia - 5 lug
- . Maximum Speed: 75 MPH
- . Load Capacity: 800 lb
- . Weight: 197 lb
- . Length: 13' 3"
- . Width: 78"

Packages Available: 7 Options Available: 10



Package MPG464-LBT

MEGASPORT[™] MPG535 BASE TRAILER

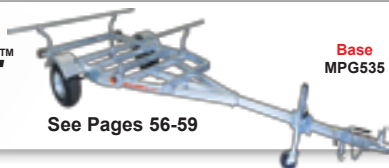

See Pages 56-59

Base
MPG535

Specifications:

- . Wheels: 10" dia - 5 lug
- . Maximum Speed: 70 MPH
- . Load Capacity: 1000 lb
- . Weight: 325 lb
- . Length: 14'
- . Width: 86"

Packages Available: 9 Options Available: 13

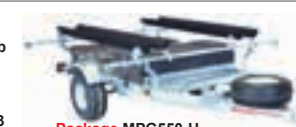

Package MPG550-H

MEGASPORT[™] MPG550-LB LOW BED BASE TRAILER LowBED[™]



See Pages 60-61

Base
MPG550-LB
Low Clearance
25" Load Bar Height

Specifications:

- . Wheels: 10" dia - 5 lug
- . Maximum Speed: 70 MPH
- . Load Capacity: 1000 lb
- . Weight: 325 lb
- . Length: 14'
- . Width: 86"

Packages Available: 3 Options Available: 13



Package MPG550-LBB

SteelTop™ "Square Bar" Racks

SteelTop™ cross rails are designed to attach to factory installed raised side rails. Available in three lengths, these heavy-duty racks are an affordable choice for transporting bikes, kayaks, ski carriers and roof boxes. The MPG225 allows rack installation for vehicles with flush mount rails.



STEELTOP™
ROOFTOP CROSS BAR SYSTEM



Features:

- . Corrosion resistant coating for longer life
- . Spacer blocks to fit smaller bar profiles
- . Key locking security attachment towers
- . Rectangular shape fits most rack accessories
- . Delivered complete and ready to install
- . Simple (no extra tools required) installation
- . Includes installation wrench
- . Lifetime Limited Warranty



Position the Racks



Includes Spacers, Installation Wrench and Security Keys



Secure the Towers

Available in Three Popular Lengths

- MPG201 (50" length)
- MPG202 (58" length)
- MPG203 (65" length)



Lock the Shields

MPG225 Flush Rail Adapter



Works with SteelTop™ and AirFlow2™ Roof Racks



MPG201
MPG202
MPG203

165 lb Load Capacity

Features:

- . Works with popular models - See Online Fit Guide
- . Dimensions: 1" x 3" x 8" - Weight: 3.2 lb
- . Lifetime Limited Warranty - Sold in sets of four

AirFlow2™ "Aero Style" Racks

The AirFlow2™ features enhanced strength, great fit capability and upgraded aerodynamics. Includes integrated towers, pre-installed locks and double walled aluminum rails for a quiet and confident transport. Optional T-slot installation hardware available.



MPG215 (50" length)
MPG216 (58" length)
MPG217 (65" length)



Fits Most Vehicles
with Raised Side Rails

Features:

- . Non-corrosive aluminum double wall construction
- . Integrated T-slots for easy accessory attachment
- . Cam assist bolts ensure a tight fit on small side rails
- . Key locking security attachment towers
- . Aerodynamic profile to reduce wind noise
- . Delivered complete and ready to install
- . Simple and quick installation - No tools required
- . 165 lb load capacity for confident transport
- . Limited Lifetime Warranty

T-Slot Mounting Kits for Accessories
Available Separately
See Page 16



VersaRail™ Universal Fit Racks

The VersaRail™ instantly transforms a bare roof into a functional platform for transporting bikes, kayaks, canoes or cargo boxes. Available in 50" and 58" lengths, these racks come assembled and ready to install. Includes twin cup vacuum towers, 1.5" attachment straps and Five Year Limited Warranty.



MPG224
Single VersaRail™
Also Available



Features:

- . No additional tools required (wrench provided)
- . Coated corrosion resistant load bar construction
- . Rectangular shape fits most rack accessories
- . 75 lb pull strength vacuum tower bases
- . Non-marking vacuum base pads
- . 1.5" wide safety attachment straps
- . Delivered complete and ready to install
- . 150 lb load capacity



*Kayak Carriers
and
Kayak Not Included*

Available in Two Lengths

- MPG220 (50" length)
- MPG221 (58" length)



Simple Installation - Fits Most Four Door Vehicles



HandiRack™ Inflatable Roof Racks

The HandiRack™ offers all the benefits of a traditional roof rack with none of the disadvantages. These high capacity roof racks are rugged enough for a wide selection of loads and are easily mounted to the vehicle's roof in a matter of minutes.



HandiRack™

Features:

- . Three ply nylon construction - Double action air pump
- . 10' cam style load straps - Bow & stern safety tie-downs
- . Transport loads up to 180 lb - Fuel efficient design
- . Quick and easy deployment - Five D-ring anchor points
- . 37" x 9" x 4" high - Two Year Limited Warranty

Description:

With it's twin pressure tube design, the HandiRack™ can easily handle kayaks, canoes and assorted miscellaneous gear. Great for rental cars or quick trips to the hardware store.



Conveniently stores in the trunk when not in use.



SeaWing™ Kayak Carriers

The SeaWing™ features a non-corrosive molded frame that was engineered to assure a rust free life cycle. These carriers continue to be one of our best sellers because of their ease of use when loading and unloading boats. Includes everything needed to transport one kayak.



SEA WING™
V-STYLE KAYAK CARRIER

MPG107MD



Features:

- Universal fit Jawz2 mounting hardware
- 50mm and 60mm coated mounting bolts
- Cam style load straps with buckle guards
- Corrosion resistant nylon construction
- Simple "no tools" installation
- Bow & stern safety tie-downs
- 27.5" x 6" x 4.5" high
- Maximum boat weight: 75 lb
- Limited Lifetime Warranty

UNIVERSAL FIT
SQUARE ROUND OVAL
ALL LOAD BAR SHAPES



SaddleUp™ Kayak Carriers

The SaddleUp™ is a great way to transport large sit-on-top and fishing kayaks. The MPG110MD features four high-grip self-adjusting saddles. Each set includes two rear saddle covers that allow the boat to easily slide into place. Comes complete with hardware, straps and safety tie-downs for one kayak.



MPG110MD

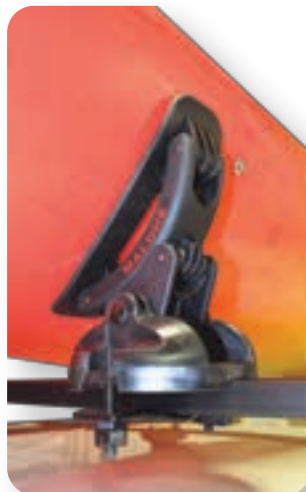

Front High Grip Saddles

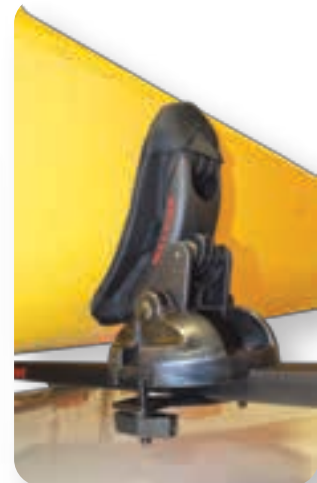

Rear Saddles With "Easy Load" Sleeves

Features:

- . Four self-adjusting high-grip saddles
- . JawZ2 universal fit mounting hardware
- . Two "easy load" rear saddle covers
- . Corrosion resistant construction
- . Two mounting bolt lengths provided
- . Two 11' cam style polyester load straps
- . Safety bow & stern lines for one kayak
- . Detailed install and usage instructions
- . 5" x 5" x 9" high
- . Maximum boat weight: 90 lb
- . Limited Lifetime Warranty



Downloader™ Kayak Carrier

The Downloader™ is our premium J-Style carrier with features for low clearance, ease of loading and universal fit for most load bars. These carriers also include corrosion proof frames, molded strap bales, replaceable base pads, replaceable upper sleeves and a new fold-down release design.

DOWNLOADER™ FOLDING J-STYLE KAYAK CARRIER



Kayak & Load Bars
Not Included

Features:

- Fold-down heavy duty aluminum frame
- Jawz2™ universal hardware for most racks
- Replaceable fade-resistant pad sleeves
- Corrosion resistant material selection
- Built-in kayak boarding ramp
- Single-throw multi-hub release handle
- 11' cam style load straps with protectors
- 10' safety tie-downs with "S" hooks
- Integrates with MPG351XL Load Assist
- Designed & Assembled in the USA
- Lifetime Limited Warranty
- Maximum boat weight: 75 lb
- 17" x 6" x 19.5" high



Integrates
with the
MPG351XL
Telos™
Kayak
Load Assist.

See Page
19 for
Details.



New dual-hub release system makes
raising & lowering the upper
frame quick & easy

FoldAway-5™ MultiRack & FoldAway-J™ Carriers

The FoldAway-5™ can side-load a single recreational kayak, stack two kayaks, carry a canoe or large sit-on-top kayak, or transport any size SUP. Featuring universal load bar fit hardware and a Lifetime Limited Warranty. The MPG132 is exclusively a single kayak J-style carrier.

FOLDaway-5™ MULTIRACK WATERSPORT CARRIER MULTIRACK

MPG125

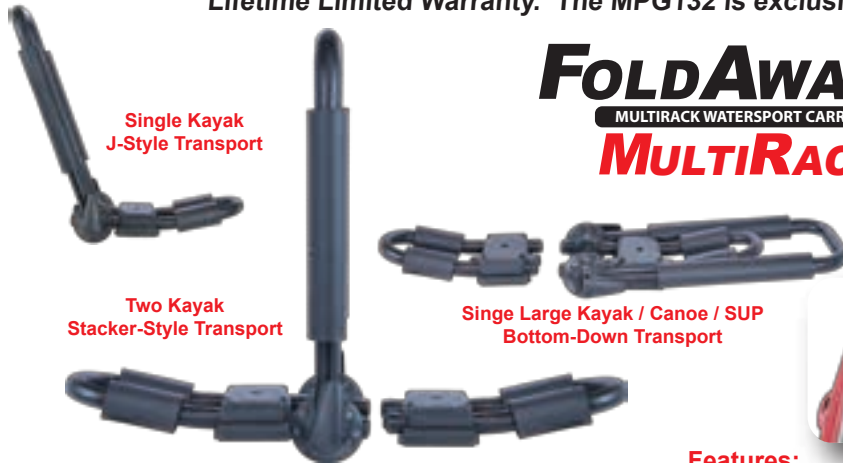

Single Kayak J-Style Transport

Two Kayak Stacker-Style Transport

Single Large Kayak / Canoe / SUP Bottom-Down Transport



Features:

- Quick-release fold-down corrosion resistant frames - Additional 2-boat module (12" x 6" x 4")
- Universal fit mounting hardware - Foam padding - Four 12' cam style load straps
- Maximum load weight: 75 lb x 2 boats - Dimensions (folded): 19.5" x 8.5" x 3.5"
- Dimensions (deployed): 14" x 8.5" x 19.5" - Weight: 14.5 lb - Lifetime Limited Warranty



FOLDaway-J™ J-STYLE KAYAK CARRIER

Features:

- Fold-down corrosion proof frames
- Universal fit mounting hardware
- Lever actuated quick-release hubs
- Two 12' heavy duty cam style load straps
- Maximum boat weight: 75 lb
- Dimensions (folded): 19.5" x 8.5" x 3.5"
- Dimensions (deployed): 14" x 8.5" x 19.5"
- Weight: 10 lb
- Lifetime Limited Warranty



MPG132



Stax™ Pro2 Kayak Carrier

The Stax™ Pro2 is the combination of intelligent design, excellent workmanship, superior strength and affordable pricing. This two boat transport system delivers a safe and secure trip to the water and back and assures a great paddling experience.



- Features:** "Open gate" head design easily and securely captures load straps - Universal fit hardware
 Cam style load straps and 10' safety tie-downs - Fold-down design for low clearance needs
 Foam stacker blocks to protect the kayaks - Octagonal aluminum post construction
 Corrosion resistant molded components - Made in the USA - Lifetime Limited Warranty - 5" x 5" x 20" high



Deployed for Kayak Transport



Retracted When Not In Use

Maximum Boat Weight: 75 lb per boat

Transport One or Two Boats



J-Style Kayak Carriers

We offer three traditionally designed J-Cradles built to handle most sit-inside and sit-on-top kayaks. These affordable and well built carriers are offered with different components and price points. Each carrier features corrosion resistant coating and a **Lifetime Limited Warranty**.

J-PRO™

J-STYLE KAYAK CARRIER



MPG116MD

J-PRO2™

J-STYLE KAYAK CARRIER



MPG117MD

J-LOADER™

J-STYLE KAYAK CARRIER



MPG118MD

Features:

- . Adjustable rear foam pads
- . Jawz2 universal fit hardware
- . Synthetic base pads
- . Black corrosion resistant finish
- . Load straps and safety tie-downs
- . Assembled in the USA
- . Maximum boat weight: 75 lb
- . 16" x 6" x 16.5" high

Features:

- . Jawz2 universal fit hardware
- . Full length foam pads (replaceable)
- . 11' cam style load straps
- . Silver corrosion resistant finish
- . Waterproof safety tie-downs
- . Assembled in the USA
- . Maximum boat weight: 75 lb
- . 16" x 6" x 16.5" high

Features:

- . Jawz2 universal fit hardware
- . Full length foam pads (replaceable)
- . 11' cam style load straps
- . Silver corrosion resistant finish
- . Kayak boarding ramp (fits MPG351XL)
- . Assembled in the USA
- . Maximum boat weight: 75 lb
- . 20" x 6" x 16.5" high

UNIVERSAL FIT
 SQUARE ROUND OVAL
 ALL LOAD BAR SHAPES

MALONE
LIFETIME
 WARRANTY



MPG116MD



MPG117MD



MPG118MD

BigFoot™ Canoe Carriers

The BigFoot™, with its wide padded base to secure large canoes and small footprint to fit most factory cross rails is the perfect carrier choice. Corrosion resistant nylon ensures years of service. Includes straps, hardware and safety tie-downs for one canoe.



BigFoot™
GUNNEL-STYLE CANOE CARRIER



UNIVERSAL FIT
SQUARE ROUND OVAL
ALL LOAD BAR SHAPES



MPG112MD

Features:

- . Corrosion resistant nylon construction
- . Universal fit Jawz2 mounting hardware
- . 50mm and 60mm mounting bolts
- . Cam style polyester load straps
- . Replaceable base & upright frame pads
- . Safety bow & stern lines
- . Fits T-slot aluminum car & truck racks
- . Optional T-slot hardware available (pg 16)
- . Lifetime Limited Warranty
- . Maximum boat weight: 90 lb
- . 5.25" x 5.50" x 4.25" high



Striper-4™ Fishing Rod and Paddle Carriers

The MPG126 Striper-4™ safely carries up to four large spinning rod & reels and conveniently mounts to most roof racks. The Ratchet Style Paddle & Mast Carrier comes complete with universal fit hardware and is fully padded to protect and avoid road abrasion.



STRIPER-4™
FISHING ROD CARRIER



MPG126

Includes Mounting Hardware & Two Keys



Padded Tip Clamp

Key-Locks for Security

Features:

- . Holds four spinning style rods & reels
- . Universal fit for most round, square, oval and most factory cross bars
- . Corrosion resistant construction and stainless steel hardware
- . Key-lockable cushioned tip clamp
- . Lifetime Limited Warranty
- . Clamp Dimensions: 18" x 5" x 4"
- . Tube Dimensions: 14" x 11" x 4"
- . Weight: 4 lb

Ratchet Style Paddle & Mast Carrier

Transporting long SUP paddles, 1pc kayak paddles and sailboard masts can be difficult. These Ratchet Style Paddle Carriers attach to round, square or aero style cross bars and provide a safe secure transport.



MPG121



Aluminum Truck Rack Carriers

Most after-market extruded aluminum truck racks are designed with a topside T-slot for accessory attachment. Malone[®] offers a T-slot mounting kit for these racks which allow installation of our more popular rooftop water sports carriers. Foam Blocks & Rack Pads also available.



MPG1012

Includes MPG112 BigFoot™ with MPG1498 fit kit, load straps and tie-downs for one canoe.



MPG1014

Includes MPG114 DownLoader™ with MPG8287 fit kit, load straps and tie-downs for one kayak.



MPG1001

Includes MPG110 SaddleUp™ with MPG1498 fit kit, load straps and tie-downs for one kayak.



MPG1015

Includes MPG115 Stax™ Pro2 with MPG1498 fit kit, load straps and tie-downs for two kayaks.



MPG1016

Includes MPG116 J-Pro™ with MPG8287 fit kit, load straps and tie-downs for one kayak.



MPG159

EVA Foam Kayak Blocks.
Sold in singles.
5.75" x 4" x 14" long.



MPG436

36" Jumbo Rack Pads. Sold in sets of 2.
Fade proof construction. For racks
1.00" - 4.00" thick and 3.00" - 4.50" wide.

Image Shown:
MPG436
36" Jumbo Rack Pads
(Load Bars Not Included)

Carrier Installation Hardware

Providing the best possible fit is paramount for a successful installation. We offer a large cross section of hardware to securely and dependably attach Malone® carrier systems to nearly any type of vehicle or trailer load bar set-up.

Mounting Kits

The MPG303 and MPG304 both feature the V-shaped Jawz2 that fit factory oval and Malone® aero and square style bars. Adapters that mount to after-market round bars are available upon request.



Features Include:

- . Jawz2 v-style adapters, M8 T-knobs
- . Zinc plated anti-corrosive mounting bolts
- . MPG303 (with 50mm & 60mm bolts)



Features Include:

- . Jawz2 v-style adapters, M8 T-knobs
- . Zinc plated anti-corrosive mounting bolts
- . MPG304 (with 60mm & 70mm bolts)

Mounting Bolts

Because the cross bar thickness can vary between manufacturers, there are requirements for different bolt lengths for a correct attachment. All bolt kits are provided in M8, 4 pack sets.



MPG361 (50mm)



MPG362 (60mm)



MPG363 (70mm)



MPG364 (80mm)



MPG365 (90mm)

Specialty Mounting Systems

Malone® offers a wide selection of custom mounts for all types of carrier systems. These include load bar shim systems, specialty carrier adapters and rooftop flush rail attachment assemblies.

MPG208 Aero Bar Shim Kit

Before After

Corrects leaning issue on most factory racks. Includes four each 1/4" thick rubber shims and two extended 80mm length bolts.

MPG5576-6 Specialty Cradle Adapters

Secure Attachment Hardware for Specialty Carriers

Sold in Sets of Six

MPG225 Flush Rail Adapter

See Page 3 For Details

Works with SteelTop™ and AirFlow2™ Roof Racks

T-Slot Mounting Kits

These kits replace the standard MPG300 series Mounting Kits and utilize the T-slot in aluminum load bars to create an integrated mount for a variety of Malone® carriers. See below for kit description and carrier fit.



MPG915 for Aero Style (MPG110, MPG112, MPG115)



MPG1498 for Truck Rack (MPG110, MPG112, MPG115)



MPG6604 for Aero Style (MPG114, MPG116, MPG117, MPG118)



MPG8287 for Truck Rack (MPG114, MPG116, MPG117, MPG118)

V-Style Kayak Carrier Load Assist

Simplify the kayak transport process with this integrated carrier / loader system. The SS Combo™ combines our MPG107 wing style saddles with a modular loader that extends nearly 22". Protects the vehicle and safely loads the kayak.



Extend the Loading Frame. Set the front of the kayak into the V-Block. Slide the kayak up and into the carriers.



Retract the Loading Frame. Dress the load straps and safety tie-downs. The kayak is now secure and ready for transport.



MPG113MD

SS COMBO™
V-STYLE KAYAK CARRIER WITH LOAD ASSIST

Features:

- . MPG107MD SeaWing™ Carriers
- . Retractable loading frame (extends over 21")
- . Integrated V-block to align the kayak
- . Padded carriers protect the kayak and vehicle
- . Corrosion resistant nylon construction
- . 70mm mounting bolts (fits most vehicles)
- . Simple "no tools" installation
- . Maximum boat weight: 75 lb
- . Lifetime Limited Warranty

MPG350 Stinger™
Load Assist Module
Available Separately

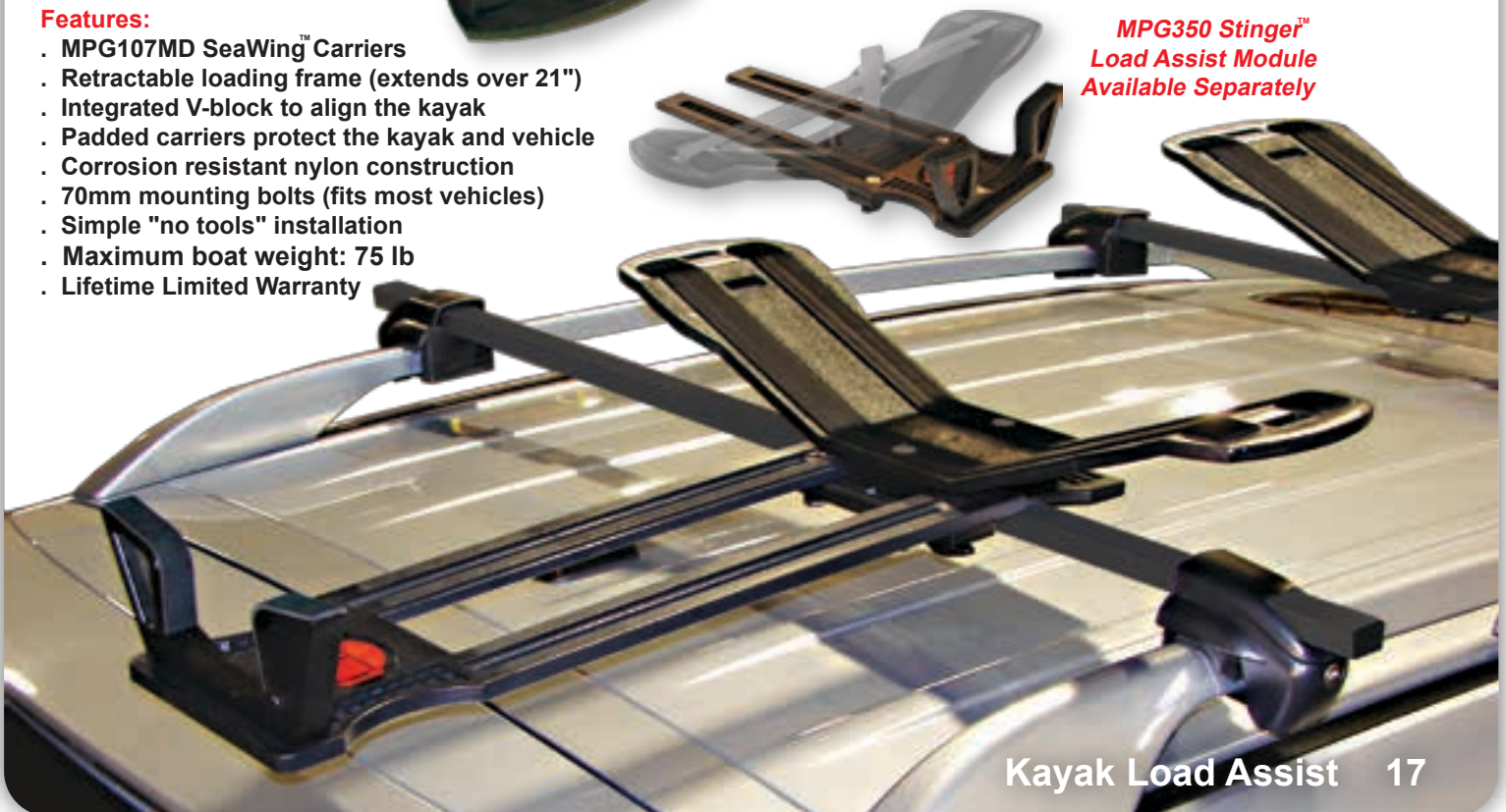

V-Style Kayak Carrier Load Assist

A loading system that installs in seconds and anyone can use. Fits most kayaks and works great on sedans, hatchbacks, SUV's and vans. Protects your vehicle and boats from loading & unloading abrasion. The MPG367 Channel Loader™ is sold in singles and features a Lifetime Limited Warranty.

SUV's, Vans & Hatchbacks



Mount a single Channel Loader™ to the upper rear of the vehicle. Place kayak bow onto the roller. Lift kayak stern and push forward. Secure kayak in carriers. Remove and store Channel Loader™.

Sedans



Mount two Channel Loaders™ to the upper and lower rear of the vehicle. Place kayak onto the lower roller. Lift kayak stern and push forward. Secure kayak in carriers. Remove and store Channel Loaders™.



Three Position Setting

CHANNELLOADER™
KAYAK LOAD ASSIST



75 LB. Load Limit

MPG367

Features:

- . V-shaped roller works with most kayaks
- . Padded non-marking vacuum cups
- . Fits most SUV's, sedans and hatchbacks
- . Three position loading adjustment
- . Stores in the vehicle when not in use
- . Easily installs in seconds
- . Maximum kayak weight: 75 lb



Protects the Vehicle and Kayak

Sold in Single Units

Two Units Recommended for Sedans

J-Style / V-Style Kayak Carrier Load Assists

The Telo^{XL} provides a safe way to side-load a kayak into Malone[®] J-style or V-Style carriers. Using quick-release attachment and adjustable extensions, this system installs in seconds. The MPG368 is an adapter system that allows the Telo^{XL} to be used with most racks & after-market carriers.

TELOSTM XL

J-STYLE CARRIER LOAD ASSIST



Place the cradles in their lowest position and load the kayak.



Continue to raise the cradles up to their highest position.



Slowly raise each cradle independently using a side to side motion.



Slide the kayak up and over the boarding ramps and into the carriers.



"Quick Release" attachment for a simple installation.



Telo^{XL} installed on a MPG107 SeaWing[™]



Telo^{XL} installed on a MPG118 J-Loader[™]



MPG351XL



MPG351-XL Features & Specifications:

- . Self-locking vertical ratchet for ensured safety
- . Adjustable bottom extensions
- . Fits MPG107, MPG114 & MPG118
- . Fully padded steel cradles
- . Quick release detachment system
- . Conveniently stores in the trunk
- . Made in the USA
- . Lifetime Limited Warranty
- . Length (Extended): 98.25"
- . Length (Retracted): 58.75"
- . Weight: 19 lb

MPG368 Telo^{XL} Multi-Rack Adapter



Description: Sold in sets of two. Universal attachment for most roof racks. Allows the MPG351-XL to be mounted and used with most J-Style carriers.

Dimensions: 9" x 5.5" x 4" - **Weight:** 10 lb
Load Capacity: 75 lb



Rack Pads (SUP30™ Kit & 2pc Sets)

Rack pads are a simple, safe and effective way to transport surf and SUP boards when rooftop load bars are in-place. We offer two designs and three lengths of pad sets. A bundled kit that includes everything needed for board transport is also available.



Standard Rack Pads: Produced from heavy weave UV resistant polyester and featuring two different closure systems (hook and loop fastener and shock cord). Fits round, square and most factory oval bars. One Year Limited Warranty.



MPG313, 18" Rack Pads: For surfboards. Sold in sets of 2.

MPG314, 25" Rack Pads: For kayaks. Sold in sets of 2.

MPG315, 30" Rack Pads: For SUPs. Sold in sets of 2.



MPG312



MPG312, SUP30™ Rack Pad Kit: Carry one or more SUPs with this easy to use, hassle free rack pad system. The SUP30 works with round, square and most factory cross rails. Features include two fade-resistant nylon weave 30" rack pads, cam style load straps and a ratchet tie-down with grab loop for safe transport.

Premium Rack Pads: These high performance pads are designed for both after-market and factory oval "wing-style" load bars. Featuring acrylic fabric with UV resistant coating and a hook and loop fastener fastening system that firmly holds each pad in place. One Year Limited Warranty.



AERO18™
Premium Rack Pads

MPG380-18, 18" Rack Pads:
For surfboards. Sold in sets of two.

AERO25™
Premium Rack Pads

MPG380-25, 25" Rack Pads:
For kayaks. Sold in sets of two.

AERO30™
Premium Rack Pads

MPG380-30, 30" Rack Pads: For StandUp paddle boards. Sold in sets of two.

Foam Block Carriers

Malone® car top foam kits and single replacement blocks offer an affordable transport system for your canoe, kayak, surf or stand up paddle board. Universal profile fits round, square and oval load bars. Made in the USA with only the finest EVA closed cell foam.

PREPACKAGED KITS



MPG152
Deluxe Kayak Kit
With Reusable Tote

MPG186
Deluxe Kayak Kit
With Mesh Bag

Both Kits Include: 18" Blocks, Block Straps,
15' Load Straps and Tie-Downs.



**MPG154 Standard Kayak Kit
With Reusable Tote**
12" Blocks, 15' Load Strap
and Tie-Downs.



MPG156
Standard Canoe Kit
With Reusable Tote

MPG187
Standard Canoe Kit
With Mesh Bag

Both Kits Include: 6" Blocks,
15' Load Straps and Tie-Downs.



MPG169 Stacker Kit
8" Blocks, Load Straps
and Tie-Downs.

MPG171 Deluxe SUP Kit
24" Blocks, 22" Pads
15' Load Straps
and Tie-Downs.



**MPG185 Foam
Canoe Blocks**
6" Blocks.



MPG174 Standard SUP Kit
24" Blocks and
15' Load Straps.



**MPG184 Foam
Kayak Blocks**
16" Blocks.

SINGLE KAYAK, CANOE & SUP BLOCKS



MPG172, 24" StandUp Paddle Board Foam Block
Sold in singles. Transport requires two each.
Non-skid bottom. 24" x 4.75" x 3.75"



**MPG173, 22" SUP and Surfboard
Spacer Block.** Sold in singles.
Transport requires two each.
Plain bottom, 22" x 4.75" x 2"



MPG162, 12" Kayak Foam Block
Sold in singles. Transport requires two
each. Non-skid bottom. 12" x 4.75" x 3.75"

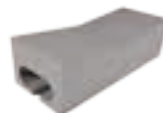

MPG159, 14" Kayak Foam Block for Truck Racks
Fits Bar Size, 4" x 1 5/8". Sold in singles.
Transport requires two each. 14" x 5.50" x 4"



MPG160, 6" Canoe Foam Block
Sold in singles. Transport requires
four each. Non-skid bottom.
6" x 4.75" x 3.75"



MPG168, 8" Kayak Stacker Block
Sold in singles. Transport requires two
each. Plain bottom. 8" x 4" x 3.25"



MPG158, 18" Kayak Foam Block
Sold in singles. Transport requires two each.
Non-skid bottom. 18" x 4.75" x 3.75"



Safety Tie-Downs & Load Straps

Safety tie-downs and cam-style load straps are a basic safety requirement for most transports. Malone® offers one of the largest selections of safety line anchors, ratchet systems and load straps in the industry. Our systems meet the needs for a wide range of budgets and installation requirements.

Sentry™ Ratchet-Style Safety Tie-Down: Our premier tie-down system offers unparalleled performance to keep watercraft safely anchored and secure. Installs in seconds and simple to deploy. One Year Limited Warranty.



- Features:**
- Ratchet style pulleys (2)
 - Stainless steel S-hooks (2)
 - 10' - 1/4" polypropylene rope (2)
 - 2' black grab loops (2)
 - One Year Limited Warranty

MPG316



Additional Tie-Downs & Anchors: The MPG306 Tie-Down is our economy priced rope & hook. The MPG309 SpeedLine™ delivers excellent performance with ratchet-style pulleys using 1/8" poly-cord with carabiners. The MPG322 Hood Loops are strictly for under the hood application and provide secure anchor points.



MPG306 Tie-Downs

MPG309 SpeedLine™ Ratchet



MPG322 Hood Loops

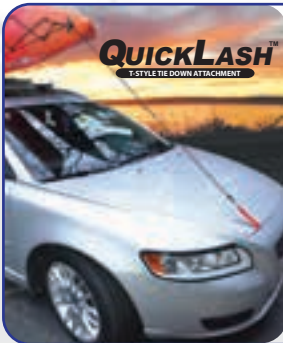

MPG308 QuickLash™ T-Style Hood Loops

T-style anchors designed to work under the hood or with the deepest rear hatches. Eliminates the need for finding vehicle frame tie-down points. Polypropylene and injection molded T-body construction with end caps. Two per set.



Premium Load Straps: One inch wide 1200 lb. pull strength polyester load straps featuring corrosion resistant cam style buckles. Each strap features a heavy duty molded rubber buckle protector along with an outer neoprene sleeve that ensures great protection for vehicle and boat. Available in singles or two piece packs. One Year Limited Warranty.



Lariat™ and LockUp™ Security Cable Systems

Opportunity theft happens all the time. Expensive gear can be lost in a matter of seconds. We offer several styles and sizes of reinforced key-lock theft deterrent cable sets to protect kayaks and bikes. All security cables include a One Year Limited Warranty.

Lariat™ Universal Cable Locks: A single design that installs on touring, recreational and tandem kayaks and provides a theft resistant layer of protection. Also works with most canoes. Includes key lock mechanism and two keys. Hook and loop fastener straps keep the cables rolled up when not in use.

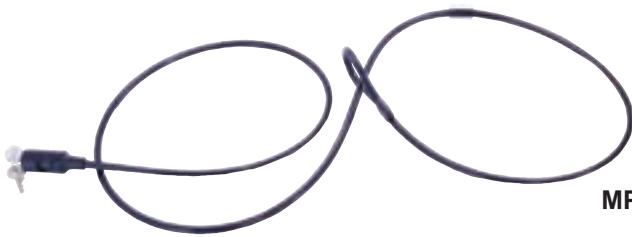

MPG398



Features:

- Double cable assembly
- Fits all styles of kayaks/canoes
- Stranded .375" steel cables
- Key lock attachment system
- hook and loop fastener storage straps

Bike Security Cable Locks: Protect your investment with our LockUp™ cable locks. These systems include state-of-the-art technology in anti-drill, anti-saw and anti-pick design. Heavy duty thick multi-coaxial cables are available in 6', 8' and 10' lengths.

MPG355, LockUp™ - 6' long cable lock

MPG356, LockUp™ - 8' long cable lock

MPG357, LockUp™ - 10' long cable lock

(Sold in singles only)



Rooftop Cargo Boxes

A perfect selection of premium rooftop boxes for vacations, the slopes or general transport needs. Dual side opening lids, quick attachment hardware and gas filled struts for effortless opening and closing. Molded from UV resistant ABS plastic for years of service. Assembled in the USA. Lifetime Limited Warranty.



MPG902



Attachment Wrench

Interior Load Straps to Secure Contents



Quick Attach Mounting System
Fits Round, Square and Oval / Aero Cross Rails

- Features:**
- . Two Tone High Gloss ABS Construction
 - . Gas Spring Struts
 - . High Tensile Reinforced Base
 - . Aerodynamic High Volume Design
 - . Three Locking Points

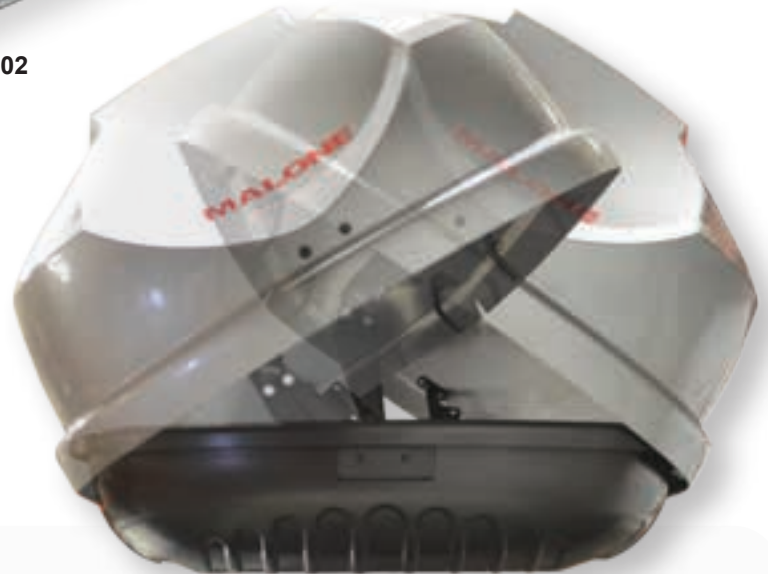

Dual Opening Lid Included with the MPG902, MPG910 & MPG911. Simplifies Installation.

MPG911



Cargo™ Series of Rooftop Boxes

The Cargo™ series includes two premium level boxes uniquely designed for daily use or a long planned road trip. Each unit features a high gloss outer coating for a great look and is ensured with a Lifetime Limited Warranty. Proudly assembled and packaged in the USA.



MPG901

The Cargo12™ is designed for high functionality. Great for smaller vehicles or when high load capacity isn't required. A clean aerodynamic profile with central locking system. Available in high gloss grey. Lifetime Limited Warranty.

CARGO12™ ROOFTOP CARGO BOX

Specifications:

- . Volume: 12.0 cf
- . Length: 55.1"
- . Width: 31.5"
- . Height: 17.3"
- . Capacity: 165 lb
- . Mounting System: Quick Attach
- . Box Opening: Single Side
- . Locking Points: 2
- . Material: Polyester (Gloss Grey)
- . Cross Bar Spread: 25" - 27"



MPG902

The Cargo16™, our full-sized and most popular rooftop box is perfect for the family vacation or transporting skis and boards to the mountain. Fits five to six sets of skis (max length 192cm) or three to four snowboards or additional gear space for three to four passengers.

CARGO16™ ROOFTOP CARGO BOX

Specifications:

- . Volume: 16.25 cf
- . Length: 76.4"
- . Width: 27.9"
- . Height: 18.9"
- . Capacity: 165 lb
- . Mounting System: Quick Attach
- . Box Opening: Dual Side
- . Locking Points: 3
- . Material: ABS (Gloss Silver)
- . Cross Bar Spread: 25" - 40"

Includes all the features for simple installation and effortless opening and closing. Each unit is coated with a high gloss for a great look and ensured with our Lifetime Limited Warranty.



ProfileTM18 Rooftop Boxes

The ProfileTM18 is offered in two color choices and features a low profile design that is perfect when headed to the slopes. These boxes have a patented quick-attach mounting system, abrasion and UV resistant ABS construction, centralized locking system and dual opening lid.



PROFILETM
ROOFTOP CARGO BOX **18B**

The ProfileTM18B comes with a rich high gloss onyx black lid and matte black reinforced bottom. This sophisticated design, when coupled with its technical features, successfully delivers a rock solid gear transport system.

MPG911

Volume: 18.0 cf - Length: 78.75" - Width: 32.3" - Height: 15.75" - Capacity: 165 lb - Mounting System: Quick Attach
Box Opening: Dual Side - Locking Points: 3 - Material: ABS (Gloss Black or Silver) - Cross Bar Spread: 25" - 36"



PROFILETM
ROOFTOP CARGO BOX **18S**

The ProfileTM18S is offered in pearl silver that compliments nearly all vehicle colors. This "low & wide" profile is a perfect mountain-bound choice for multiple skis and boards. Assembled in the USA with a Lifetime Limited Warranty.

MPG910



Axis™ Cargo Carriers & Attachments

The MPG907 Axis™ Truck Bed Extender can be vertically or horizontally deployed and includes an anti-wobble bracket for stability. The LoadRoller™ attaches to the MPG907 and makes loading easier with less boat abrasion. The MPG912 creates a complete above-bed cargo transport system.



MPG907



Includes Anti-Wobble Bracket

Features: 8 height settings (56" - 63") - 10 width settings (32" - 48") - Side arm load containment - 2" receiver with pin - Powder coat finish - Includes anti-wobble bracket - Dimensions: 63" x 48" - Capacity: 500 lb - Weight: 33 lb



Shown Installed to MPG907 Bed Extender

Axis™ TRUCK BED EXTENDER ROLLER LOADROLLER

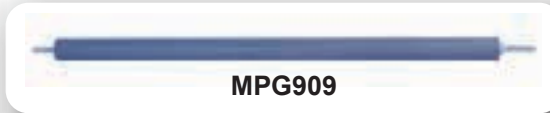

MPG909



Shown Installed to MPG907 Bed Extender



Shown Installed to MPG907 Bed Extender

Features:

- . Attaches to the MPG907
- . Makes loading easier
- . No tools required installation
- . Lifetime Limited Warranty

Features:

- . PVC sleeve w/ steel core
- . Dimensions: 42" long x 2" dia
- . Weight: 8 lb
- . Capacity: 250 lb

Axis™ LOAD EXTENDER WITH VERSARAIL™ W/SINGLE VERSARAIL™



MPG912



Features:

- . MPG907 Axis™ Truck Bed Extender
- . MPG224 58" VersaRail™ (single)
- . Capacity: 250 lb
- . Lifetime Limited Warranty

Introduction & Overview

MALONE[®]
BIKE RACKS



Shown: MPG2130 RunWay™ HM3 OS.
See Page 34 for details.

Malone proudly offers a value class lineup of rooftop, hitch-style, back of car and spare tire bike transport systems.

These carriers are designed to carry a maximum of one, two or four bikes based on the design.

A **Lifetime Limited Warranty** that covers workmanship or component failure is included with each rack.

To satisfy customer requirements for cost and product performance, we created three different product categories. See pages 29-35 for details.



PILOT[™]

The Pilot™ series of rooftop and hitch carriers presents our flagship line and delivers the best in options materials, tooling and overall performance design.



MPG2103



MPG2109



MPG2115



MPG2112 + MPG2115

HANGER[™]

Look for moderate pricing and great engineering in our Hanger™ line of bike transports. These hitch and trunk systems combine great value without sacrificing quality.



MPG2124



MPG2147



MPG2139



MPG2127

RUNWAY[™]

For those on a budget, but still require a high level of performance, the RunWay™ line of hitch, back of car and spare tire carriers is the best choice.



MPG2148



MPG2142



MPG2149



MPG2130



MPG2137

Pilot™ HM2, Co-Pilot™ 2 (Platform)

The Pilot™ HM2 is a two bike, hitch style platform carrier for 2" receivers only. This system can be integrated with the separately available MPG2115 Co-Pilot™ 2 which converts overall capacity from a two bike carrier to a four bike carrier.

Features:

- Two bike capacity (four bike with MPG2115)
- Tilt-down frame for access to rear hatch or trunk
- Pivoting ratchet arm secures bike's front wheel
- Arm & wheel holders eliminate bike to bike contact
- Fits 20" - 29" wheels and up to 5" fat tires
- Includes anti-wobble locking hitch pin
- Semi-retracting key lock security cable

Specifications:

- Load Capacity: 33 lb per bike x (2 or 4) bikes
- Aluminum & steel powder coated construction
- Fits 2" receiver mounts & MPG2115 Module
- Dimensions: 31" x 39" x 15"
- Weight: 30 lb

Note: Not compatible with tandem, electric or recumbent bikes.



PILOT™ HM2

HITCH MOUNT PLATFORM STYLE BIKE CARRIER



MPG2112

2
Bikes

Custom Engineered
Wheel Holders

Key Lock
Security Cable

Adjustable Padded
Ratchet Arms



Removable End Cap Allows Installation
of the MPG2115 Co-Pilot™ 2 Module
(Available Separately)

Co-PILOT™ 2 MODULAR PLATFORM BIKE CARRIER HM2



MPG2115

MPG2115 + MPG2112

4
Bikes

MPG2115 Co-Pilot™ 2 - Two Bike Carrier
Expansion Module

Shown with MPG2115 Co-Pilot™ 2
attached to the MPG2112 Pilot™ HM2

Add the Co-Pilot™ 2 Expansion Module to Your Existing MPG2112 Pilot™ HM2 to Transport Four Bikes

Features:

- Integrates with the MPG2112 Pilot™ HM2
- Two bike capacity (four bikes with MPG2112)

Specifications:

- Load Capacity: 33 lb per bike x 2 bikes
- Dimensions: 20" x 39" x 7"
- Weight: 22 lb

Note: Purchase of MPG2112 Pilot™ HM2 required.

Pilot™ TC ST (Top of Car), Pilot™ Solo (Platform)

The Pilot™ TC ST ratchet arm bike rack features a 51" tray which is great for most standard bike frame & tire combinations. The Pilot™ Solo HM2 is a stand alone hitch mount two bike platform style carrier that prevents bike to bike contact and fits both 1.25" and 2" receivers.

Features:

- Single bike capacity
- Ratchet SafeHook™ secures the front tire with no frame contact
- Compatible with disk brake, thru-axles axles and most frames
- Adjustable extra wide wheel holders fit most tires
- Universal fit mounting hardware fits Malone® racks, factory oval, round and most aero-style load bars

Specifications:

- Load capacity: 33 lb
- Aluminum & steel powder coated construction
- Fits 20" to 29" wheels and up to 5" fat tires
- Dimensions: 51" x 12" x 6"
- Weight: 10 lb

Note: Not compatible with tandem and recumbent bikes. Rear hatch spoilers may inhibit installation.



Features:

- Two bike capacity
- Tilt-down frame to access rear hatch or trunk
- Pivoting ratchet arm secures bike's front wheel
- Wheel holders eliminate bike to bike contact
- Fits 20" - 29" wheels and up to 5" fat tires
- Includes anti-wobble locking hitch pin
- Semi-retracting key lock security cable
- Fits both 1.25" and 2" receiver mounts

Specifications:

- Load Capacity: 33 lb per bike x 2 bikes
- Aluminum & steel powder coated construction
- Dimensions: 31" x 39" x 15"
- Weight: 30 lb

Note: Not compatible with tandem or recumbent bikes. Not compatible with MPG2115 Co-Pilot.™



Hanger™ Series (Hitch & Spare Tire)

The Hanger™ HM4 is a hitch style carrier that offers the convenience, strength and security to safely carry up to four full size bikes. The Hanger™ T3 OS delivers our best design quality for three bike spare tire transport.



HANGER™ HITCH MOUNT BIKE CARRIER HM4

Fold-Down
Tilt-Away Mast



4
Bikes

Safely Transport
Up To Four Bikes

Fits 1.25" and 2"
Hitch Receivers

MPG2124

Features:

- . Four bike capacity
- . Arms fold down when not in use
- . Tilt-away mast with foot pedal & pin control
- . Soft fully padded anti-sway frame cradles
- . Integrated security cable with key locks
- . Anti-wobble security key locking hitch pin
- . Padded mast for additional bike protection
- . Cradle ratchet straps & webbing strap

Specifications:

- . Load Capacity: 33 lb per bike x 4 bikes
- . Powder coated construction
- . Fits 1.25" and 2" receivers
- . Dimensions: 29" x 14" x 34"
- . Weight: 22 lb

Note: Not compatible with tandem or recumbent bikes.



HANGER™ SPARE SPARE TIRE MOUNT BIKE CARRIER T3 OS

Deployed
for
Transport

3
Bikes

MPG2147



3
Bikes

Folds
Down
When
Not
In Use



Frame Retainer Straps

Features:

- . Three bike capacity
- . Oversize powder coated steel tube construction
- . Two high strength cam buckle anchor straps
- . Quick release adjustable hubs
- . Frame adjusts to three tire settings (8"-10.5")
- . Three anti-sway cages to control bike movement
- . Padded frame cradles to avoid abrasion & wear
- . Arm mounted safety reflectors for night transport

Specifications:

- . Load Capacity: 33 lb per bike x 3 bikes
- . Dimensions: 33" x 25" x 7"
- . Weight: 12.5 lb
- . Lifetime Limited Warranty

Note: Not compatible with electric, tandem or recumbent bikes. May not be compatible with rear roof top spoilers.

Hanger™ Series (Hitch & Back of Car)

The Hanger™ HM3 provides dependable three bike transport using either 1.25" or 2" receivers. The Hanger™ BC3-OS is designed to fit nearly any vehicle and provides bike stability using anti-sway technology.



MPG2127



Features:

- . Three bike capacity
- . 16" arms fold down when not in use
- . Tilt-away mast with foot pedal / pin control
- . Soft fully padded anti-sway cradles
- . Integrated security cable with key locks
- . Anti-wobble security key locking hitch pin
- . Padded mast for additional bike protection
- . Cradle ratchet straps & webbing strap included

Specifications:

- . Load Capacity: 33 lb per bike x 3 bikes
- . Powder coated construction
- . Fits 1.25" and 2" receivers
- . Dimensions: 24" x 14" x 34"
- . Weight: 20 lb

Note: Not compatible with tandem or recumbent bikes.

HANGER™ BACK OF CAR BIKE CARRIER BC3-OS

Arms Fold-Down
When Not In Use



Coated Steel Frame
Installs in Minutes - No Tools Required



MPG2139

Features:

- . Three bike capacity
- . Oversize steel tubing for strength and stability
- . Integrated cable lock secures bikes to rack
- . Four quick-release hubs for fine adjustment
- . Six point webbing strap system
- . Anti-sway cages help control the load
- . Webbing stabilizing strap included
- . Arms fold when not in use

Specifications:

- . Load Capacity: 33 lb per bike x 3 bikes
- . Oversize steel construction
- . Dimensions: 32" x 22" x 30"
- . Weight: 15 lb

Note: Not compatible with electric, tandem or recumbent bikes. May not be compatible with rear roof top spoilers.

RunWay™ (Back of Car & Spare Tire)

The RunWay™ BC3 is our most affordable three bike carrier; fits most vehicles and is simple to install and use. The RunWay™ Spare attaches to a vehicle's exposed spare tire using a choice of three width settings and provides safe transport for up to three bikes.



Features:

- Three bike capacity
- Six point strap system
- Folds flat for storage
- Two quick-release hubs for cradle arm adjustment

Specifications:

- Load Capacity: 33 lb per bike x 3 bikes
- Dimensions: 28" x 22" x 26"
- Weight: 9 lb
- Lifetime Limited Warranty

Note: Not compatible with tandem, recumbent or electric bikes. May not be compatible with all rear vehicle spoilers.

RUNWAY™ BACK OF CAR BIKE CARRIER BC3

MPG2142



Deployed
for
Transport



3
Bikes

Retracted
for Storage

Features:

- Three bike capacity
- Coated steel construction
- Two webbing straps anchor to spare
- Right or left wheel offset
- Folds flat for storage
- Three way adjustment for tire width

Specifications:

- Load Capacity: 33 lb per bike x 3 bikes
- Dimensions: 22" x 45" x 35"
- Weight: 14 lb
- Lifetime Limited Warranty

Note: Not compatible with tandem, electric or recumbent bikes.

RUNWAY™ SPARE SPARE TIRE MOUNT BIKE CARRIER T3

3
Bikes

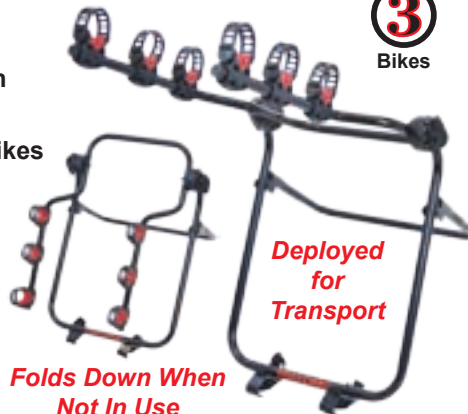

Deployed
for
Transport

Folds Down When
Not In Use



MPG2148

Adjustable 3 Position Tire
Padded Cradles Width Setting

Installs in Minutes - No Tools Required



RunWay™ (Hitch)

The RunWay™HM2 is an affordable platform style carrier that eliminates bike to bike contact using wheel & frame capture systems. The RunWay™HM3-OS is a traditional three bike hitch based carrier that features anti-sway technology.

2
Bikes

*Tilt-Down Frame
Tilt-Away Mast*

*Easily Deploys
in Seconds*

MPG2149

*Two Bike Transport
with Key Lock
Security*

RunWay™
HITCH MOUNT BIKE CARRIER
HM2





Features:

- . Two bike capacity
- . Tilt-down frame for access
- . Center arms secure bike's top tube
- . Key lock fully padded top arm
- . Wheel holders prevent bike to bike contact
- . Includes anti-wobble hitch pin

Specifications:

- . Load Capacity: 33 lb per bike x 2 bikes
- . Fits 20"- 29" wheels - tires up to 3.50"
- . Fits 1.25" and 2" receiver mounts
- . Dimensions: 25" x 33" x 8"
- . Weight: 23 lb

Note: Not compatible with tandem, electric or recumbent bikes.

RunWay™
HITCH MOUNT BIKE CARRIER
HM3-OS

*Fold-Down / Tilt-Away
Steel Frame*



3
Bikes



*Key Lock
Security
Cable*



*Wheel
Retainer
Strap*



*Anti-Sway
Stability
Cages*

MPG2130

Features:

- . Three bike capacity
- . Fits both 1.25" and 2" receivers
- . Integrated cable lock secures bikes to rack
- . Cradle arms fold down when not in use
- . Tilting mast for rear access
- . Non-locking anti-wobble hitch bolt
- . Anti-sway fully padded frame cradles

Specifications:

- . Load Capacity: 33 lb per bike x 3 bikes
- . Dimensions: 38" x 12" x 36"
- . Weight: 21 lb

Note: Not compatible with electric, tandem or recumbent bikes. May not be compatible with rear roof top spoilers.

RunWay™ (Hitch) & Bike Accessories

The RunWay™ HM4 is a reinforced steel carrier designed to carry up to four bikes. Great for get-aways with the whole family. Malone® also offers accessories designed to improve the aspects of bike transport and security.

4
Bikes

*Padded Arms
Protect the
Bikes from
Abrasion*

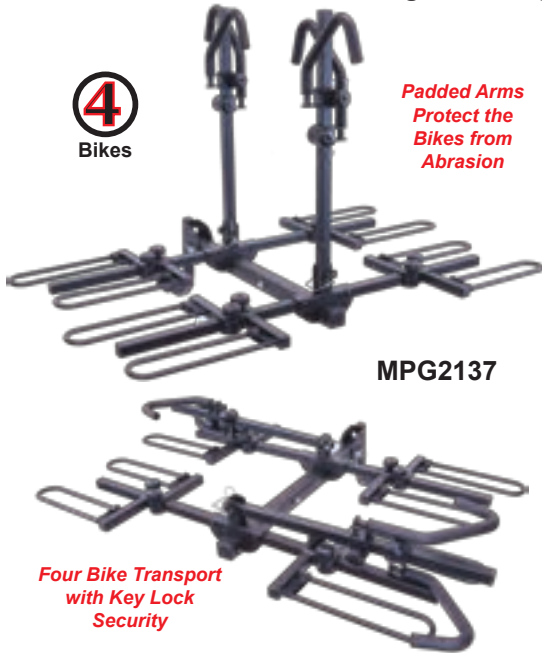

MPG2137

*Four Bike Transport
with Key Lock
Security*



*Tilt-Down Frame Powder Coated
Tilt-Away Mast Welded Steel Frame*

Features:

- . Four bike capacity
- . Tilt-down frame for access
- . Center arms secure bike's top tube
- . Key lock fully padded top arms
- . Wheel holders prevent bike to bike contact
- . Includes anti-wobble hitch pin
- . Hook & loop straps for wheel attachment

Specifications:

- . Load Capacity: 33 lb per bike x 4 bikes
- . Fits 20" - 29" wheels - tires up to 3.50"
- . Fits 2" receiver mounts (only)
- . Dimensions (deployed): 57" x 74" x 41"
- . Weight: 60 lb

Note: Fits bikes with 28" to 58" wheel bases. Not compatible with tandem, electric or recumbent bikes.

MPG2165 - Top Tube Adapter

For use when the bike is required to hang from a carrier's horizontal arms. The Top Tube Adapter provides a removable temporary frame piece on bikes with step-through or other unconventional frame designs.

Easy one button operation opens locking gates that snap shut around the seat post and stem.

Features:

- . Coated gates protect the bike's finish
- . Simple one button operation
- . Oversize telescoping (23" - 30") shaft
- . Non-rotating shaft to maintain transport stability
- . Steel construction
- . Dimensions: 24" x 3" x 2"



For Bikes with Step-Through Frames

MPG2165
Sold in
Singles

MPG2174 - Locking Hitch Pin

These locking hitch pins are used with most Malone receiver hitch carriers. They are threaded to provide anti-wobble to the carrier and security locking capacity at the hitch.

Can be used with or without the locking head when the hairpin cotter (included) is deployed.

Features Include:

- . Fits 2" trailer hitches
- . 10,000 lb towing capacity
- . Corrosion resistant coating
- . Cotter pin & two keys included



MPG2174

*Provides Anti-Rattle
and Hitch Security*

Standard & Light Duty Carts

We design our ground transport products with the idea that portage from the vehicle to the water should be as effortless as possible. Now presenting three upgraded carts that feature TRX wheels with push button release, on-board straps and marine grade aluminum tubing.

CLIPPER^{TRX}

ALL TERRAIN CANOE & KAYAK CART

Features:

- . Works best with V-style bottom canoes & kayaks
- . Marine grade aluminum tubing
- . Corrosion resistant hardware
- . Push button wheel release
- . TRX *Never-Go-Flat* tires with high grip rubber tread
- . Dual on-board cam style load straps
- . 200 lb max. load capacity
- . Net weight: 6.5 lb
- . Dimensions: 27" x 15" x 16" high
- . Dimensions (folded): 27" x 14" x 3" high



MPG522



For boats with traditional center beam hulls



Wheels also available separately

NOMAD^{TRX}

STANDARD DUTY KAYAK CART

Features:

- . Works best with V-style bottom kayaks
- . Marine grade aluminum tubing
- . Corrosion resistant hardware
- . Push button wheel release
- . TRX *Never-Go-Flat* tires with high grip rubber tread
- . On-board cam style load strap
- . 150 lb max. load capacity
- . Net weight: 5.2 lb
- . Dimensions: 26" x 12" x 15" high
- . Dimensions (folded): 26" x 14" x 4" high



MPG523



Easily stows away in most hatches



Wheels also available separately

Features:

- . Works with most scupper style kayaks
- . Marine grade aluminum construction
- . Convenient fold-away kick-stand
- . Corrosion resistant hardware
- . Push button wheel release
- . TRX *Never-Go-Flat* tires with high grip rubber tread
- . Padded "scuff-free" base pads
- . Adjustable width (5.5"-20.5")
- . 150 lb max. load capacity
- . Net weight: 6.0 lb
- . Dimensions: 26" x 14" x 28" high
- . Dimensions (folded): 26" x 24" x 2" high

XPRESS^{TRX}



MPG524



Fits most scupper hole dimensions



Wheels also available separately

Standard & Light Duty Carts with Beach Wheels

A soft shoreline can be challenging for portage. Adding low pressure sand wheels to the ClipperTRX™ and XpressTRX™ frames create affordable “beach ready” transport systems. Both carts includes a hand air pump and are ensured with a Lifetime Limited Warranty.



Fits Most
V-Bottom
Kayaks

200 lb Capacity
Frame



MPG522-S

MPG522-S Features:

- Works best with V-style bottom canoes & kayaks
- Marine grade aluminum tubing
- MPG516 - 12" diameter x 7" wide low pressure beach wheels
- Corrosion resistant hardware
- Includes low pressure air pump
- Dual on-board cam-style load straps
- 200 lb max. load capacity
- Net weight: 11.2 lb
- Dimensions: 36" x 15" x 16" high
- Dimensions (folded): 27" x 14" x 3"

CLIPPERTRX-S

DELUXE CANOE & KAYAK CART WITH BEACH WHEELS

Effortless on Soft Sand



MPG524-S

XPRESSTRX-S

SCUPPER STYLE KAYAK CART WITH BEACH WHEELS

MALONE
LIFETIME
WARRANTY



Includes
Low Pressure
Air Pump

150 lb
Capacity
Frame

MPG524-S Features:

- Works with scupper style kayaks
- Includes low pressure air pump
- Convenient fold-away kick-stand
- MPG516 - 12" diameter x 7" wide low pressure sand wheels
- Padded “scuff-free” base pads
- Adjustable width (5.5"-20.5")
- 150 lb max. load capacity
- Net weight: 10.2 lb
- Dimensions: 35" x 14" x 28" high
- Dimensions (folded): 26" x 24" x 2"

12" x 7" Beach (Sand) Wheels
Sold in Sets of Two

Features:

- Low air pressure (2-4 p.s.i.)
- Fits MPG522 and MPG524 carts
- Provides cart stability in sand
- Lifetime Limited Warranty
- 12" high x 7" wide



MPG516

Ground Transport 37

Soft / Hard Terrain Heavy Duty Carts

Most canoes, sit-on-top and fishing kayaks have wide hulls for stability. These boats require a cart with additional width and higher load capacity. The **WideTrak**™ series of carts offer the perfect solution for confident transport in both all-terrain and sand conditions.



MPG521-S



250 lb Capacity
Frame Easily Transports
Heavy Kayaks over
Soft Sand Conditions

MPG521-S Features:

- . Extra wide frame for most canoes, sit-on-tops & fishing kayaks
- . Adjustable 24" padded bunks
- . Marine grade aluminum tubing
- . MPG516 - 12" diameter x 7" wide low pressure beach wheels
- . Corrosion resistant hardware
- . Low pressure hand air pump
- . Two 2pc cam buckle load straps
- . 250 lb max. load capacity
- . Net weight: 15 lb
- . Dimensions: 38" x 20" x 21" high
- . Dimensions (folded): 33" x 14" x 5"

WIDETRAK™ SB

LARGE KAYAK/CANOE CART W/ BEACH WHEELS

Fits Nearly Any
Hull Configuration



Multi-Position Adjustable Bunks



WIDETRAK™ ATB

LARGE KAYAK/CANOE CART



MPG521



MPG521 Features:

- . Extra wide frame for most canoes, sit-on-tops & fishing kayaks
- . Adjustable 24" padded bunks
- . MPG518 - 12" diameter x 3" wide all terrain airless tires
- . Corrosion resistant hardware
- . Two 2pc cam buckle load straps
- . 250 lb max. load capacity
- . Net weight: 12 lb
- . Dimensions: 33" x 20" x 21" high
- . Dimensions (folded): 33" x 14" x 5"

12" x 3" All Terrain Tires
Sold in Sets of Two

Features:

- . Airless Never-Go-Flat Tires
- . 20mm axle tube
- . Fits MPG521 carts
- . Provides cart stability in rough uneven terrain
- . Lifetime Limited Warranty
- . 12" high x 3" wide



MPG518

Specialty Storage Systems

For ceiling, wall or floor mount, we offer the complete spectrum for keeping your gear safe when "put away". The J-Dock™ is a great buy for storing two boats. The HangTime™ provides safe storage for one bike. The Kayak Hammock™ is a must for most garages.



J-Dock™
TWO BOAT WALL STORAGE



MPG317

200 lb
Capacity

Features: Two kayak storage capacity - 3" lag bolt mounting hardware - Heavy duty 12' cam style load straps
Approved for inside or outside installation - Lifetime Limited Warranty - 16" x 5" x 10" high



HANGTIME™
SINGLE BIKE WALL STORAGE

MPG348

Lifetime Limited Warranty
12" wide x 18" high
(when retracted)



Features: Poly coated grab hooks - Stainless steel hardware
Rust resistant powder coat - Retracts when not in use



**KAYAK
HAMMOCK™**
PREMIUM HOIST SYSTEM



120 lb
Capacity

MPG346

Features: Simple no hassle mounting - Independent lift control system - Padded hooks for bike storage
Rope tie-down bracket - Lift straps for kayaks & canoes - Corrosion resistant construction

ELEVATE™
LARGE BOAT STANDS

- Features:**
- 23" tall when deployed
 - 14" x 20" retracted size
 - Anodized frame
 - Marine aluminum tubing
 - Sold in sets of two
 - 175 lb capacity
 - Lifetime Limited Warranty



MPG349

FOAMHOME™
FOAM STORAGE BLOCKS

- Features:**
- Fits all boat profiles
 - Use inside or outside
 - One boat capacity
 - Reusable tote bag
 - Sold in sets of two
 - 24" x 4" x 4" high
 - One Year Limited Warranty

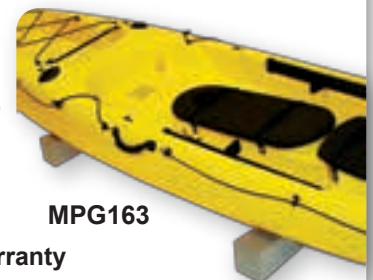

MPG163

Kayak & SUP Wall Mount (Fixed Position)

We offer the largest cross section of storage systems in the industry. Each product has been carefully engineered to meet the exact requirements for the installation. Regardless of the kayak, canoe or board to be stored, we have the right rack to keep it safe.

250 lb
Capacity



HIGHRISE™
J-STYLE WALL STORAGE

MPG323

Fixed Position

MPG323, J-Style Wall Rack: A high capacity wall system designed to hold large kayaks where weight is a factor. Constructed of 1.25" steel tubing and coated for inside / outside installation. Fully padded. Corrosion resistant mounting hardware.

150 lb
Capacity

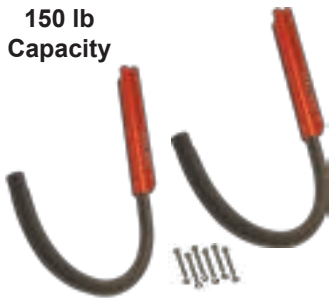

J-Hoops™
KAYAK WALL STORAGE

MPG344

Fixed Position

MPG344, Single Kayak Wall Rack: This medium capacity wall storage system safely holds sit-inside and sit-on-top kayaks. 1.00" round powder coated steel tubing covered with a thick layer of foam. Lifetime Limited Warranty. Includes mounting hardware.

250 lb
Capacity



BOARDROOM™
SUP-STYLE WALL STORAGE

MPG327

Fixed Position

MPG327, SUP-Style Wall Rack: A rock solid wall mount rack for multiple surfboards and stand-up paddle boards. 27" long powder coated and fully padded steel frame with coated mounting bolts that resists corrosion.



SUP~PORT™
SUP WALL STORAGE SYSTEM

150 lb
Capacity



MPG347

MPG347, Single Board Wall Rack: Safe storage for one SUP. 26" high x 11" deep frame. Easily installs in minutes.

Wall Mount Ski Storage Rack



- . Rubber coating 7" long hangers
- . Includes six hanger assemblies
- . Includes mounting hardware
- . Reinforced steel frame
- . Load capacity (per hanger): 20 lb
- . Load capacity (total): 120 lb



MPG385

MPG385, Ski Wall Rack: Safely store six sets of skis. Dimensions: 49" x 7" x 3.5". Lifetime Limited Warranty.

Kayak & SUP Wall & Ceiling Mount (Folding & Strap)

The **Yak~Swing™** and **SUP~Swing™** each feature a convenient “fold away” design when not in use. The **SlingOne™**, **SlingTwo™** and **SlingThree™** utilize a quick-release carabiner system that offers an improved process for loading or unloading kayakers.



MPG383 Kayak Wall Storage (Folding): A medium capacity wall storage system that conveniently folds back against the wall when not in use. Safely holds sit-inside, and, sit-on-top kayakers. Includes a welded cable ring that allows a cable lock to be installed for theft prevention. Includes all mounting hardware. Lifetime Limited Warranty.



MPG384 SUP Wall Storage (Folding): A fully padded single SUP or surfboard storage system that rotates 90 degrees when not in use. Includes a welded security cable ring, nine point fastening system and mounting hardware.



SLINGS, Kayak Storage Systems: Three storage units that feature 1200 lb, 1.5" wide quick-release carabiner straps. Mounts to a wall or the ceiling. Includes coated eye-hook mounting bolts. One Year Limited Warranty.



Free Standing Kayak Storage Packages

Built with powder coated high load steel, these FS Rack™ storage packages are easy to assemble and will last for years. Fully padded J-style Holders gently protect the kayaks from abrasion and hull distortion. Available in three kayak and six kayak storage bundles.



FS Rack™ 3 Kayak Features:

- Heavy duty 1.25" square tube construction
- Powder coated for inside or outside installation
- Six independent adjustable frame levelers
- One set of MPG339 Kayak Blocks (lower frame)
- Two sets of MPG320 J-Style Holders
- Zinc coated hardware and assembly tool included
- Easy to assemble design - **Lifetime Limited Warranty**

MPG318



FS Rack™ 6 Kayak Features:

- Heavy duty 1.25" square tube construction
- Powder coated for inside or outside installation
- Eight independent adjustable frame levelers
- Two sets of MPG339 Kayak Blocks (lower frame)
- Four sets of MPG320 J-Style Holders
- One MPG326 Leg Extension Kit
- Four MPG179 Upright Pads
- Easy to build design - **Lifetime Limited Warranty**

MPG331

Free Standing Boat/Bike/Ski Storage Packages

Most outdoor enthusiasts own and use a cross selection of kayaks, canoes, bikes and skis. The need to safely store different and multiple types of gear is required. Malone® offers three storage packages that meet and exceed that requirement.

FS RACK™

3 BIKE - 2 SUP - 1 KAYAK FREE STANDING STORAGE

FS Rack™ 3 Bike, 2 SUP, 1 Kayak Features:

- . 1.25" square tube construction
- . Corrosion resistant powder coating
- . Six adjustable frame levelers
- . One set of MPG325 SUP-Style Holders
- . One set of MPG339 Kayak Blocks
- . One set of MPG391 Bike Holders
- . Coated hardware included
- . Assembly tool included
- . Easy to assemble design
- . Lifetime Limited Warranty

250 lb
Capacity



MPG386

FS RACK™

2 KAYAK - 2 SUP - 6 SKI FREE STANDING STORAGE

FS Rack™ 2 Kayak, 2 SUP, 6 Ski Features:

- . 1.25" square tube construction
- . Corrosion resistant powder coating
- . Install inside or outside
- . Six adjustable frame levelers
- . One set of MPG325 SUP-Style Holders
- . One set of MPG339 Kayak Blocks
- . One set of MPG320 J-Style Holders
- . One MPG390 Ski Holder
- . Zinc coated hardware
- . Assembly tool included
- . Easy to assemble design
- . Lifetime Limited Warranty

250 lb
Capacity



MPG387

FS RACK™

3 BIKE - 2 KAYAK - 6 SKI FREE STANDING STORAGE

FS Rack™ 3 Bike, 2 Kayak, 6 Ski Features:

- . Heavy duty 1.25" square tube construction
- . Corrosion resistant powder coating
- . Six independent adjustable frame levelers
- . One set of MPG339 Kayak Blocks
- . One set of MPG391 Bike Holders
- . One set of MPG320 J-Style Holders
- . One MPG390 Ski Holder
- . Coated hardware included
- . Assembly tool included
- . Easy to assemble design
- . Lifetime Limited Warranty

250 lb
Capacity



MPG388



SUP & Kayak Packages / Frame & Accessories

The MPG334 and MPG338 are two additional packages for storing SUP's and kayaks. The FS Rack™ Storage Systems are also available in individual components. This "a la carte" approach can create the exact storage solution for all your boats, bikes, paddle boards, surfboards and cargo boxes.



Boards & Boats Not Included

MPG334

FS RACK™

2 KAYAK - 2 SUP FREE STANDING STORAGE

FS Rack™ 2 Kayak, 2 SUP Features:

- . 1.25" square tube construction
- . Corrosion resistant powder coating
- . Six adjustable frame levelers
- . One set of MPG339 Kayak Blocks
- . One set of MPG320 J-Style Holders
- . One set of MPG325 SUP-Style Holders
- . Corrosion resistant hardware included
- . Assembly tool included
- . Easy to assemble design
- . 250 lb capacity
- . Lifetime Limited Warranty
- . 37" x 48" x 83"



FS RACK™

6 SUP FREE STANDING STORAGE

FS Rack™ 6 SUP Features:

- . Three sets of MPG325 SUP-Style Holders
- . Corrosion resistant powder coating
- . 1.25" square tube construction
- . Six adjustable frame levelers
- . Coated hardware included
- . Assembly tool included
- . Easy to assemble design
- . 250 lb capacity
- . Lifetime Limited Warranty
- . 37" x 48" x 83"



MPG338

Boards Not Included

FS Rack™ Frame & Accessories (A-la-Carte)

Base Frame (Single)

Features:

- . 12 Gauge construction
- . Powder coated frame
- . Zinc coated steel hardware
- . Adjustable frame levelers
- . Assembly instructions
- . Assembly tools
- . Lifetime Limited Warranty
- . 37" x 48" x 83"

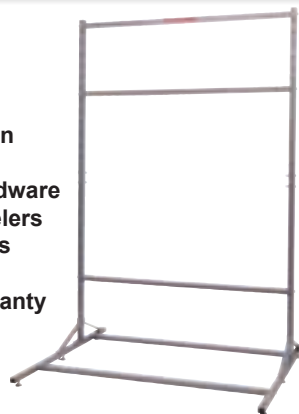

MPG332

Leg Extension Kit (Set of Two)

Features:

- . 1.25" steel construction - Powder coated surface
- . Protective end caps - Adjustable frame levelers
- . Lifetime Limited Warranty - 1.25" x 1.25" x 16.5"



MPG326

FS Rack™ Accessories (A-la-Carte)

The FS Rack™ system includes a wide selection of holder designs and accessory options for safe and convenient gear storage. These systems are specifically designed to store kayaks, bikes, canoes, surfboards, SUPs, skis, paddles, PFDs and related sports equipment.

FS Rack™ J-Style Holders



- . 120 lb load capacity
- . Padded frames
- . Includes hardware
- . Sold in sets of two
- . Lifetime Limited Warranty
- . 1.25" x 7.5" x 20.5"

Fits Nearly All Kayak Styles

MPG320

FS Rack™ SUP-Style Holders



- . 100 lb load capacity
- . Padded frames
- . Includes hardware
- . Sold in sets of two
- . 1.25" x 7.5" x 27.5"

Great for
Surfboard and Cargo Box Storage

MPG325

FS Rack™ Paddle Holders



- . Coated steel rod (1/4")
- . Sold in sets of two
- . Lifetime Limited Warranty
- . 6" high x 6" wide

MPG389

FS Rack™ Dealer SUP-Style Holders



- . 100 lb load capacity
- . Custom end caps
- . Padded frames

1.25" x 7.5" x 20.5"

MPG329

FS Rack™ SUP Spacer Blocks

- . EVA foam construction
- . Great when stacking SUPs
- . Dimensions: 22" x 4.75" x 2"
- . Sold in sets of two
- . One Year Limited Warranty



MPG176

MPG339

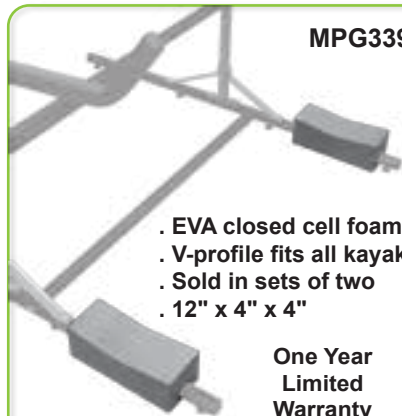

- . EVA closed cell foam
- . V-profile fits all kayaks
- . Sold in sets of two
- . 12" x 4" x 4"

One Year
Limited
Warranty

FS Rack™ Foam Kayak Blocks

FS Rack™ Caster Wheel Kit



- . 50 lb load capacity per unit
- . Multi-directional tracking
- . Push-down wheel locks
- . Height adjustable
- . Sold in sets of four
- . Lifetime Limited Warranty

MPG333

FS Rack™ Ski Holder



- . Rubber coated ski hangers
- . Includes 6 hanger assemblies
- . Mounting hardware included
- . Reinforced steel frame
- . Stores 1-6 sets of skis
- . Load capacity (per hanger): 20 lb
- . Load capacity (total): 120 lb
- . Lifetime Limited Warranty

MPG390

FS Rack™ Bike Holder

- . Mounting hardware included
- . Ribbed rubber outer coating
- . 1" diameter steel frame
- . Stores 1-3 bikes
- . Load capacity: 100 lb
- . Sold in sets of two
- . Lifetime Limited Warranty



MPG391

EcoLight™ Base Trailer & 2 Kayak Package

The EcoLight™ is our most affordable line of kayak trailers. Each unit is produced in the USA with high grade galvanized steel; can travel at most posted speed limits and is covered by a Five Year Limited Warranty. The MPG586XJ is bundled with our J-Style carriers for two kayaks.



8" High Speed Tires with Powder Coated Wheels and Molded Fenders

EcoLight™

MPG585 BASE TRAILER



58" Wide 14 Gauge Steel Load Bars



2" Receiver with Lift Handle, Four Pin Connector & Skid Plate



MPG585

Specifications:

- . Weight: 145 lb
- . Length: 10' 6"
- . Width: 58"
- . Wheels: 8" diameter - 5 lug
- . Tire Pressure: 35-40 PSI
- . Maximum Speed: 65 MPH
- . Load Capacity: 400 lb
- . DOT & Transport Canada approved



400 lb Capacity Leaf Spring Suspension



Optional EcoLight™ Spare Tire with Lock Attachment



DOT Approved Incandescent Lights

EcoLight™

PACKAGES



Best Application:
Two medium sized touring or recreational kayaks with traditional V-shaped hull designs

MPG586XJ

ECOLIGHT TRAILER PACKAGE

Boats Not Included



Features:
EcoLight™ 2 Kayak Package (2 J-Racks)
MPG585 Base Trailer - J-Style Carriers (2)
Carrier Mounting Hardware
Cam Style Load Straps (4)

EcoLight™ Trailer Packages

The combination of the EcoLight™ Base with a selection of our dedicated trailer based carriers has created a family of low cost transport systems for one, two and four kayaks. Easy to assemble. Made in the USA. Five Year Limited Warranty.



Boat Not Included

Best Application:
One medium to large sized recreational or fishing kayak with traditional or non-traditional hull design

MPG586XB

ECOLIGHT TRAILER PACKAGE



Features:
EcoLight™ Single Kayak Package
(1 set of Bunks)
MPG585 Base Trailer
MPG561 Large Kayak Bunk Kit

MPG586XL

ECOLIGHT TRAILER PACKAGE



Boats Not Included



Features:
EcoLight™ 4 Kayak Package
(1 Stacker & 4 Blocks)
MPG585 Base Trailer
Stacker-Style Carriers (1)
Mounting Hardware & Straps
Foam Kayak Blocks (4)

Best Application:
Four sit-inside or four sit-on-top recreational kayaks



Boats Not Included

MPG586XV

ECOLIGHT TRAILER PACKAGE

Features:
EcoLight™ 2 Kayak Package
(2 V-Racks)
MPG585 Base Trailer - V-Style Carriers (2)
Carrier Mounting Hardware
Cam Style Load Straps (4)

Best Application:
Two sit-inside or two sit-on-top recreational kayaks

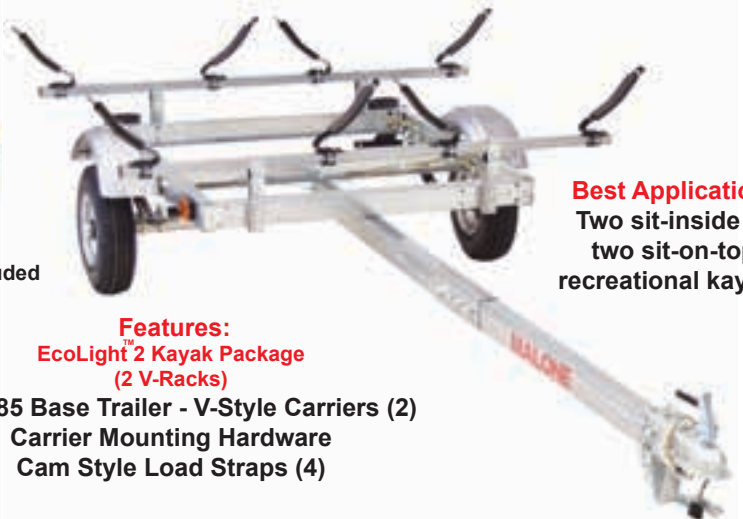

XtraLight™ LowMax™ Base Trailer & 2 Kayak Package

The XtraLight™ LowMax™ has a 600 lb capacity suspension and 78" load bars that are only 26" from the ground. Produced in the USA from high grade galvanized steel and featuring a Five Year Limited Warranty. The MPG596XJ2 is bundled with J-Style carriers for two kayaks.



XTRALIGHT™
MPG595 BASE TRAILER
LowMax™



MPG595

Features:

- Marine grade galvanized frame
- DOT & Transport Canada approved
- L.E.D. "plug & play" lights
- Galvanized steel fenders
- 78" 14 gauge steel load bars with D-ring tie-downs
- Detachable tongue to lower storage space requirements
- Tongue lift handle (2)
- Rubber bumpers for vertical storage
- 2" hitch receiver
- Five Year Limited Warranty

Specifications:

- Weight: 206 lb
- Length: 11' 3"
- Width: 78"
- Wheels: 8" dia. pontoon-style - 5 lug
- Tire Pressure: 40 PSI
- Maximum speed rating: 70 MPH
- Load Capacity: 600 lb



2" Receiver with Lift Handle and Four Pin Connector



Trailer includes **Rear Rubber Bumpers** for vertical storage with tongue detached.

Detachable Tongue to Lower Storage Space Requirements



LED "Plug & Play" Lights Simplify the Assembly Process



Optional
XtraLight™ LowMax™ Spare Tire with Lock Attachment

XTRALIGHT™ LowMax™ PACKAGES

MPG596XJ2
XTRALIGHT LOWMAX TRAILER PACKAGE



Boats Not Included

Features:

- XtraLight LowMax™ 2 Kayak Package (2 J-Racks)
- MPG595 Base Trailer
- J-Style Carriers (2)
- Carrier Mounting Hardware
- Cam Style Load Straps (4)

Best Application:

Two medium to large sized touring or recreational kayaks with traditional V-shaped hull designs

XtraLight™ LowMax™ Kayak Packages

The elevated load capacity of the XtraLight™ LowMax™ makes it the perfect multi-boat transport system. Each of these outfitted packages have been carefully selected to optimize this trailer to carry nearly all makes and styles of kayaks (and bikes).

MPG596XB2

XTRALIGHT LOWMAX TRAILER PACKAGE

Features:

XtraLight™ LowMax™
Two Kayak Package
(2 sets of Bunks)

MPG595 Base Trailer
MPG561 Large Kayak
Bunk Kit (2)



84" x 4" x 2"
Padded Bunks with
weather resistant
covering



Kayaks
Not Included

Best Application:

Two medium to large sized recreational or fishing kayaks with traditional (V-bottom) or non-traditional (pontoon style) hull designs

MPG596XJ4

XTRALIGHT LOWMAX TRAILER PACKAGE

Features:

XtraLight™ LowMax™
Four Kayak Package
(4 J-Racks)

MPG595 Base Trailer
J-Style Carriers (4)
Carrier Mounting Hardware
Cam Style Load Straps



J-Racks are produced
with coated heavy gauge
steel & padded to
protect the kayaks

Best Application:
Two medium sized
touring or recreational kayaks
with traditional V-bottom
hull designs



Kayaks Not Included

MPG596XKB

XTRALIGHT LOWMAX TRAILER PACKAGE

Features:

XtraLight™ LowMax™
Two Kayak - Two Bike Package
(2 J-Racks - 2 Bike Racks)

MPG595 Base Trailer
J-Style Carriers (2)
MPG2100 Pilot™ TC LT
Bike Racks (2)



Best Application:
Two medium sized
touring or recreational kayaks
with traditional V-bottom
hull designs and
two bikes (most styles)



Kayaks & Bikes
Not Included

MPG596XSRP

XTRALIGHT LOWMAX TRAILER PACKAGE

Features:

XtraLight™ LowMax™
Four Kayak Package
(2 Stackers - 4 sets of Rack Pads)

MPG595 Base Trailer
Stacker-Style Carriers (2)
Mounting Hardware & Straps
MPG313 Rack Pads (4)



Best Application:
Four medium to large sized
touring or recreational kayaks with
traditional or non-traditional
hull designs



Kayaks Not
Included

MPG596XV2

XTRALIGHT LOWMAX TRAILER PACKAGE

Features:

XtraLight™ LowMax™
Two Kayak Package
(2 V-Racks))

MPG595 Base Trailer
V-Style Carriers (2)
Mounting Hardware
Cam Style Load Straps (4)



Best Application:
Two medium to large sized
recreational or fishing kayaks with
traditional hull designs



Kayaks Not Included

MicroSport™ Base Trailer

The MicroSport™ is a premium grade sports trailer built in the USA and offered in two packages.

The MPG460G is the base platform and comes with extended tongue, 78" load bars and 12" wheels. The MPG460XT is the upgraded model and features some of our best selling options.

MICROSPORT™

MPG460 BASE TRAILER

Features:

- . Marine grade galvanized frame
- . DOT & Transport Canada approved
- . L.E.D. "plug & play" lights
- . Galvanized steel fenders
- . 78" 14 gauge steel load bars with D-ring tie-downs
- . Extended reinforced tongue
- . Tongue lift handle
- . 2" receiver
- . Five Year Limited Warranty

MPG460G



Specifications:

- . Weight: 197 lb
- . Length: 13' 3"
- . Width: 78"
- . Wheels: 12" diameter - 5 lug
- . Tire Pressure: 40 PSI
- . Maximum speed rating: 70 MPH
- . Load Capacity: 800 lb



Double Leaf Spring for Load Capacity to 800 lb



LED "Plug & Play" Lights Simplify the Assembly Process



2" Receiver with Lift Handle and Four Pin Connector



Conveniently Ship UPS or FedEx Ground in Four Cartons



Featuring Aluminum Wheels and Diamond Plate Fenders

MICROSPORT™ XT

MPG460XT UPGRADED BASE TRAILER



Boats & Cargo Box Not Included
MPG474 Second Tier and MPG114 Kayak Carriers available separately

Heavy Duty Frame with 78" Load Bars Safely Transport Large Kayaks & Gear



Retractable Tongue Eliminates Storage Space Issues

Includes Rear Bumpers for Vertical Storage

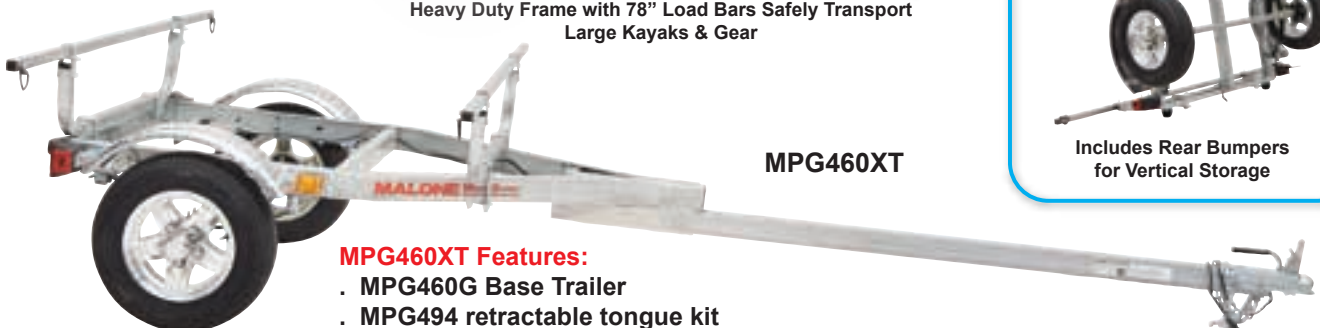

MPG460XT

MPG460XT Features:

- . MPG460G Base Trailer
- . MPG494 retractable tongue kit
- . MPG496 aluminum wheel / diamond plate fender upgrade

MicroSport™ Upgrade & Trailer Packages

The MPG496 upgrades the Base Trailer from standard galvanized to aluminum fenders & wheels. This upgrade must be ordered at the time of the new trailer purchase. All MicroSport™ Trailer Packages are offered with Spare Tire, Carriers and have a Five Year Limited Warranty.



MicroSport™ Trailer Packages (Includes Bunks or Carriers & Spare Tire Kit)



MicroSport™ Trailer Packages

MicroSport™ Trailer Packages offer multiple setups for safely transporting both kayaks and bikes. Each individual package is designed with different features that satisfy nearly all gear transport requirements.



MPG461GU

TWO KAYAK TRANSPORT

Kayaks Not Included

Features:
MPG460G Base Trailer - MPG110 Carriers (2)
MPG465 Spare Tire & Lock Attachment



Best Application:
Two large sized sit-on-top kayakers.



MPG461KB

TWO KAYAK - TWO BIKE TRANSPORT

Kayaks and Bikes Not Included

Features:
MPG460G Base Trailer
MPG117 Kayak Carriers (2)
MPG2100 Bike Carriers (2)
MPG465 Spare Tire & Lock Attachment

Best Application:
Two sit-inside kayakers or two medium sized sit-on-top kayakers and two bikes (most styles).



MPG462G2

FOUR KAYAK TRANSPORT

Features:
MPG460G Base Trailer - MPG117 Carriers (4)
MPG465 Spare Tire & Lock Attachment

Best Application:
Four sit-inside or four medium sized sit-on-top kayakers.



Kayaks Not Included



Kayaks Not Included

Features:
MPG460G Base Trailer
Stacker Style Kayak Carriers (2)
18" Rack Pads (4)
MPG465 Spare Tire & Lock Attachment

Best Application:
Four sit-inside or four medium sized sit-on-top kayakers.

MPG461SRP

FOUR KAYAK TRANSPORT



MicroSport™ LowBed™ Trailers

The **MPG464-LB** is a modified MPG460G Base Trailer. New load bar supports have been developed to extensively lower the bar height. Now just 22" from the ground, loading and unloading heavy kayaks is simplified. The **MPG464-LBT** includes the 2nd Tier Kit for added capacity.

Features:

- Marine grade galvanized frame
- 22" low-clearance load bar supports
- DOT & Transport Canada approved
- L.E.D. "plug & play" lighting system
- Galvanized steel fenders
- 78" long rectangular steel load bars with D-ring tie-downs
- Extended reinforced tongue
- Tongue lift handle & skid plate
- 2" receiver
- Five Year Limited Warranty

Specifications:

- Weight: 197 lb
- Length: 13' 3"
- Width: 78"
- Wheels: 12" diameter - 5 lug
- Tire Pressure: 40 PSI
- Maximum speed rating: 70 MPH
- Load Capacity: 800 lb



MICROSPORT™
MPG464 BASE TRAILER
LOWBED™

MPG464-LB



Kayaks and Carriers
Not Included



LED "Plug & Play" Lights
Simplify the Assembly Process



Double Leaf Spring for
Load Capacity to 800 lb



2" Receiver with Lift
Handle and Four Pin Connector



Conveniently Ship UPS or FedEx
Ground in Four Cartons



MPG464-LBT

MICROSPORT™
MPG464 BASE TRAILER W/ 2ND TIER
LOWBED™ 2ND TIER

Kayaks, Carriers
and Cargo Box
Not Included



Features: MPG464-LB Base Trailer - MPG474 2nd Tier Kit w/ 50" Load Bars

MicroSport™ LowBed™ Trailer Packages

Three LowBed™ Packages designed to transport large heavy kayaks with traditional or non-traditional hulls. These marine grade trailers can safely be backed down a boat ramp for kayak launch directly into the water. Includes submersible LED lighting, kayak carriers and Spare Tire.

MPG464-LBB

TWO KAYAK BUNK STYLE TRAILER

Features:

- MPG464-LB LowBed™ Base Trailer
- MPG561 Large Kayak Bunk Kit (2)
- MPG465 Spare Tire & Lock Attachment

Best Application:
Two large sit-on-top or two large fishing kayaks.
(Works with most hull types)



Kayaks Not Included

MPG464-LBM

TWO KAYAK TRAILER

Features:

- MPG464-LB LowBed™ Base Trailer
- MPG207 MegaWing™ Kayak Carriers (2)
- MPG465 Spare Tire & Lock Attachment

Best Application:
Two large sit-on-top or two large fishing kayaks.
(Great for traditional hull types)



Kayaks Not Included

800 lb
Load Capacity

MPG464-LBS

TWO KAYAK TRAILER

Features:

- MPG464-LB LowBed™ Base Trailer
- MPG110 SaddleUp™ Pro Kayak Carriers (2)
- MPG465 Spare Tire & Lock Attachment

Best Application:
Two medium to large sit-on-top or fishing kayaks.
(For traditional and some non-traditional hull types)



Kayaks Not Included

MicroSport™ LowBed™ Trailer Packages

These kayak fishing packages combine large boat transport capability with storage for fishing rods and cargo box for extra gear. With the kayak carriers and Spare Tire Kit included, these trailers are a great choice for the serious angler.

MPG464-LBTB

TWO KAYAK LOWBED TRAILER - 2ND TIER - CARGO BOX - ROD TUBE

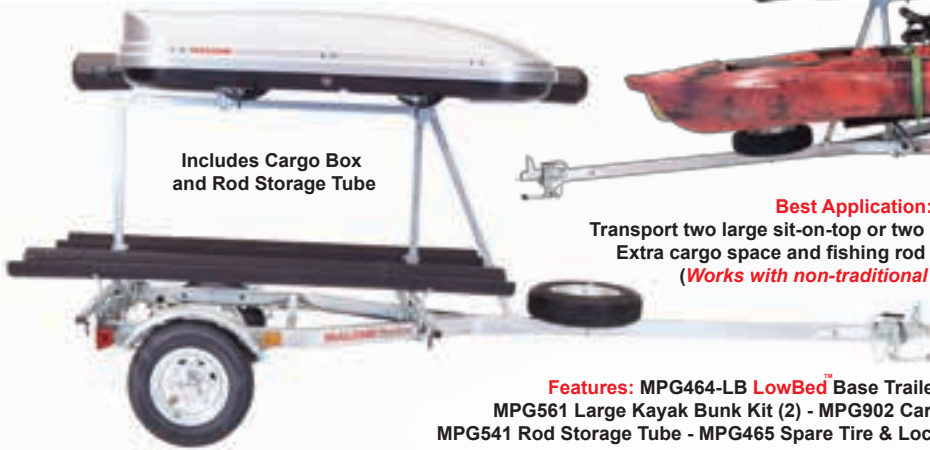

Includes Cargo Box and Rod Storage Tube

Best Application:
Transport two large sit-on-top or two large fishing kayaks. Extra cargo space and fishing rod storage available.
(Works with non-traditional hull types)

Features: MPG464-LB LowBed™ Base Trailer
MPG561 Large Kayak Bunk Kit (2) - MPG902 Cargo Box
MPG541 Rod Storage Tube - MPG465 Spare Tire & Lock Attachment



Kayaks Not Included

800 lb
Load Capacity

MPG464-LBTM

TWO KAYAK LOWBED TRAILER - 2ND TIER - CARGO BOX - ROD TUBE



Includes Cargo Box and Rod Storage Tube

Best Application:
Two large sit-on-top or fishing kayaks with extra cargo space and fishing rod storage.
(Works best with traditional hull types)

Features: MPG464-LB LowBed™ Base Trailer
MPG207 MegaWing™ Kayak Carriers (2) - MPG902 Cargo Box
MPG541 Rod Storage Tube - MPG465 Spare Tire & Lock Attachment



Kayaks Not Included

800 lb
Load Capacity

MPG464-LBTS

TWO KAYAK LOWBED TRAILER - 2ND TIER - CARGO BOX - ROD TUBE

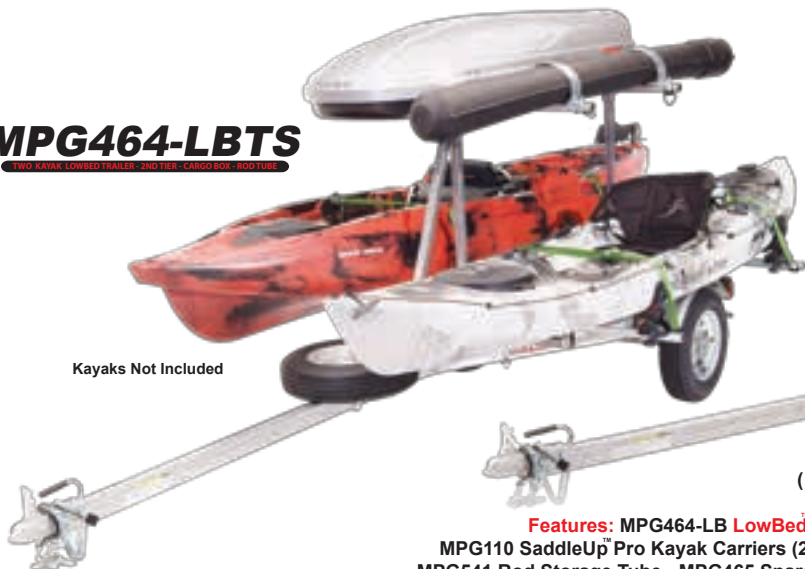

Kayaks Not Included

Best Application:
Two large sit-on-top or fishing kayaks. Extra cargo space and fishing rod storage.
(Works with traditional and most non-traditional hull types)

Features: MPG464-LB LowBed™ Base Trailer
MPG110 SaddleUp™ Pro Kayak Carriers (2) - MPG902 Cargo Box
MPG541 Rod Storage Tube - MPG465 Spare Tire & Lock Attachment



Includes Cargo Box and Rod Storage Tube

MegaSport™ Base Trailer

The MegaSport™ was designed to meet the needs of the kayak angler requiring more pay load than the MicroSport™. This premium marine grade trailer can be fitted with options that include wet or dry gear management, overhead storage, lighting and electronic recharging.



MPG535

MEGASPORT™
MPG535 BASE TRAILER

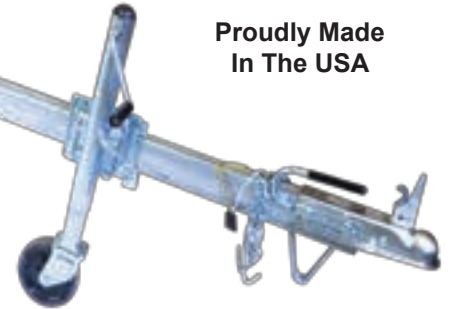

Proudly Made
In The USA

Features:

- . Marine grade galvanized frame
- . DOT & Transport Canada approved
- . L.E.D. "plug & play" lights
- . Crank assist jack stand & wheel
- . 86" long, 14 gauge steel load bars with D-ring lash downs
- . Extended reinforced tongue
- . Tongue lift handle & skid plate
- . 2" receiver
- . Five Year Limited Warranty

Specifications:

- . Weight: 325 lb
- . Length: 14'
- . Width: 86"
- . Wheels: 10" diameter - 5 lug
- . Tire Pressure: 40 PSI
- . Maximum speed: 70 MPH
- . Load Capacity: 1000 lb

Trailer Shown with
Multiple Optional
Accessories
(See Pages 63-68)

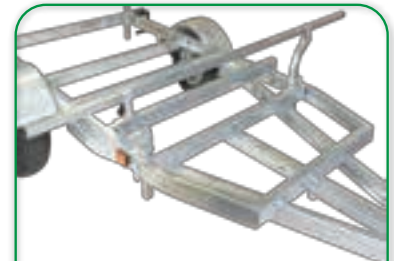

86" Steel Load Bars with
3.5" x 1.5" C-Channel Construction



1000 lb Triple Leaf Suspension

MPG540



Optional MegaSport™ Spare Tire with
Lock Attachment

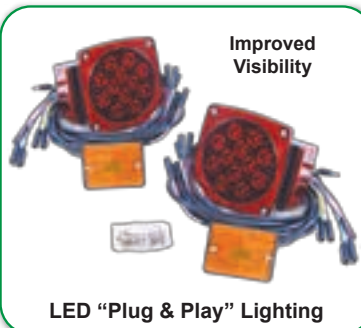

LED "Plug & Play" Lighting



2" Hitch Receiver

Includes Lift Handle
and Jack Stand

MegaSport™ Trailer Packages

The MegaSport™ was designed to be accessorized and these three trailer packages target the serious angler who wants the best possible transport. Each of these packages feature our MPG561 Large Kayak Bunk carriers and a cross section of our best options.



MPG550-AH
MEGASPORT TRAILER PACKAGE

Best Application:

Two large fishing kayakers and a need for overhead storage, milk crate cage, rod holders and lower wet / dry storage.



Features:

- MegaSport™ 2 Boat
 - Ultimate Angler Package - Bunks
 - MPG535 Base Trailer
 - MPG561 Large Kayak Bunk Kit (2)
 - MPG537 Storage Drawer - MPG547 Wire Basket
 - MPG545 2nd Tier Kit
 - MPG541 Fishing Rod Tube
 - MPG546 Milk Crate Cage - MPG540 Spare Tire
- (See individual product descriptions)



MPG550-H
MEGASPORT TRAILER PACKAGE

Best Application:

Two large fishing kayakers and a need for lower wet / dry storage.



Features:

- MegaSport™ 2 Boat w/ Storage - Bunks
 - MPG535 Base Trailer
 - MPG561 Large Kayak Bunk Kit (2)
 - MPG537 Storage Drawer - MPG547 Wire Basket
 - MPG540 Spare Tire & Lock
- (See individual product descriptions)



MPG550-TH
MEGASPORT TRAILER PACKAGE

Best Application:

Two large fishing kayakers and a need for overhead storage and lower wet / dry storage.



Features:

- MegaSport™ 2 Boat w/ Storage & 2nd Tier - Bunks
 - MPG535 Base Trailer
 - MPG561 Large Kayak Bunk Kit (2)
 - MPG537 Storage Drawer
 - MPG547 Wire Basket
 - MPG545 2nd Tier Kit
 - MPG540 Spare Tire & Lock
- (See individual product descriptions)

MegaSport™ Trailer Packages

The MPG207 MegaWing™ and SaddleUp™ carriers work well with more traditionally designed hulls. We created three excellent packages using these carriers along with a wide selection of affordable options to make every fishing experience a great one.



Best Application:

Two medium to large fishing or recreational kayakers with standard hull design and a need for increased overhead storage, rod holders, milk crate containment and lower wet / dry storage.



MPG550-AM
MEGASPORT TRAILER PACKAGE

Features:

MegaSport™ 2 Boat Ultimate Angler Package - MegaWing™
MPG535 Base Trailer - MPG207 Carriers (2)
MPG537 Storage Drawer - MPG547 Wire Basket
MPG545 2nd Tier Kit - MPG541 Fishing Rod Tube
MPG546 Milk Crate Cage - MPG540 Spare Tire
(See individual product descriptions)



Best Application:

Two medium to large fishing or recreational kayakers. A need for increased overhead storage, rod holders, milk crate containment and lower wet / dry storage.



MPG550-AU
MEGASPORT TRAILER PACKAGE

Features:

MegaSport™ 2 Boat Ultimate Angler Package - SaddleUp™ Pro
MPG535 Base Trailer - MPG110 Carriers (2)
MPG537 Storage Drawer - MPG547 Wire Basket
MPG545 2nd Tier Kit - MPG541 Fishing Rod Tube
MPG546 Milk Crate Cage - MPG540 Spare Tire
(See individual product descriptions)



Best Application:

Two medium to large fishing or recreational kayakers with standard hull design. A need for lower wet / dry storage.



MPG550-M
MEGASPORT TRAILER PACKAGE

Features:

MegaSport™ 2 Boat w/ Storage - MegaWing™
MPG535 Base Trailer - MPG207 Carriers (2)
MPG537 Storage Drawer - MPG547 Wire Basket
MPG540 Spare Tire & Locking Attachment
(See individual product descriptions)

MegaSport™ Trailer Packages

Rounding out our offering of MegaSport™ packages are three designs developed for anglers with both recreational or larger fishing kayaks. Each product has been carefully assembled to meet both budget requirements and specific optional needs.



Best Application:
Two medium or large fishing or recreational kayakers with traditional hull designs and a need for increased overhead storage and lower wet / dry storage.



MPG550-TM

MEGASPORT TRAILER PACKAGE

Features:
MegaSport™ 2 Boat w/ Storage & 2nd Tier - MegaWing™
MPG535 Base Trailer - MPG207 Carriers (2)
MPG537 Storage Drawer - MPG547 Wire Basket
MPG545 2nd Tier Kit - MPG540 Spare Tire
(See individual product descriptions)



Best Application:
Two medium or large fishing or recreational kayakers and a need for increased overhead storage and lower wet / dry storage.



MPG550-TU

MEGASPORT TRAILER PACKAGE

Features:
MegaSport™ 2 Boat w/ Storage & 2nd Tier - SaddleUp™ Pro
MPG535 Base Trailer - MPG110 Carriers (2)
MPG537 Storage Drawer - MPG547 Wire Basket
MPG545 2nd Tier Kit - MPG540 Spare Tire
(See individual product descriptions)



Best Application:
Two medium or large fishing or recreational kayakers and a need for lower wet / dry storage.



MPG550-U

MEGASPORT TRAILER PACKAGE

Features:
MegaSport™ 2 Boat w/ Storage - SaddleUp™ Pro
MPG535 Base Trailer - MPG110 Carriers (2)
MPG537 Storage Drawer - MPG547 Wire Basket
MPG540 Spare Tire with Locking Attachment
(See individual product descriptions)

MegaSport™ LowBed™ Base Trailer

The **MPG550-LB** is a MegaSport™ Base Trailer refitted with new lower bar supports and bundled with a custom 2nd Tier Kit. The kayaks are just 25" off the ground and can be loaded much safer. This lower height allows the trailer to be backed down a boat ramp for kayak launch into the water.

Features:

- Marine grade galvanized frame
- 25" low-clearance load bar supports
- Custom 2nd tier load bar system
- DOT & Transport Canada approved
- L.E.D. "plug & play" lights
- Crank assist jack stand & wheel
- 86" long, 14 gauge steel load bars with D-ring lash downs
- Extended reinforced tongue
- 2" trailer coupler
- Tongue lift handle & skid plate
- Five Year Limited Warranty

Specifications:

- Weight: 325 lb
- Length: 14'
- Width: 86"
- Wheels: 10" diameter - 5 lug
- Tire Pressure: 40 PSI
- Maximum speed: 70 MPH
- Load Capacity: 1000 lb



Proudly Made
In The USA

MPG550-LB

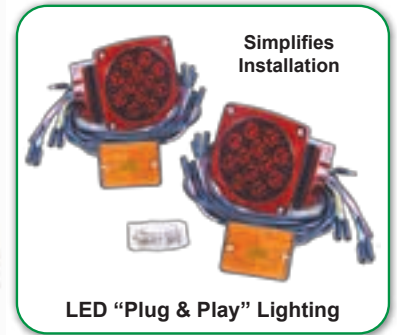

MegaSport™ LowBed™ Trailer Packages

Three LowBed™ Trailers that include a 2nd Tier Load Bar System, Cargo Box, Rod Tubes, Spare Tire and several choices for kayak carriers. These packages are part of our Pro Level offering for transport of multiple large kayakers with nearly any hull configuration.



MPG550-LBB

Best Application:
Two large sit-on-top or two large fishing kayakers.
(Works with most hull types)

MPG550-LBB

MEGASPORT LOWBED TRAILER PACKAGE



Kayakers Not Included

MegaSport LowBed™ w/ 2nd Tier, Spare Tire
2 sets Kayak Bunks
Cargo Box, 2 Rod Tubes

Features:

MPG550-LB LowBed™ Base Trailer - Custom 2nd Tier Load Bar System
MPG902 Rooftop Cargo Box - MPG541 Fishing Rod Storage Tube (2)
MPG561 Large Kayak Bunk Kit (2) - MPG540 Spare Tire & Lock Attachment
(See individual product descriptions)

MPG550-LBM

MEGASPORT LOWBED TRAILER PACKAGE



Kayakers Not Included

MegaSport LowBed™ w/ 2nd Tier, Spare Tire
2 sets MegaWings™
Cargo Box, 2 Rod Tubes

Features:

MPG550-LB LowBed™ Base Trailer - Custom 2nd Tier Load Bar System
MPG902 Rooftop Cargo Box - MPG541 Fishing Rod Storage Tube (2)
MPG207 MegaWing™ Carriers (2) - MPG540 Spare Tire & Lock Attachment
(See individual product descriptions)



MPG550-LBM

Best Application:
Two large sit-on-top or two large fishing kayakers.
(Great for traditional hull types)

MPG550-LBS

MEGASPORT LOWBED TRAILER PACKAGE



MPG550-LBS

Best Application:
Two medium to large sit-on-top recreational or fishing kayakers.
(For traditional and some non-traditional hull types)



MegaSport LowBed™ w/ 2nd Tier, Spare Tire
2 sets SaddleUp™
Cargo Box, 2 Rod Tubes

Kayakers Not Included

Features:

MPG550-LB LowBed™ Base Trailer - Custom 2nd Tier Load Bar System
MPG902 Rooftop Cargo Box - MPG541 Fishing Rod Storage Tube (2)
MPG110 SaddleUp™ Carriers (2) - MPG540 Spare Tire & Lock Attachment
(See individual product descriptions)

MegaSport™ Outfitter™ Three Tier Trailer

A trailer designed for commercial and large scale kayak & canoe transport. The MegaSport™ Outfitter™ meets the tough requirements for high load capacity, heavy duty construction, extended warranty and affordable cost containment.

MEGASPORT™ MULTI-LEVEL HIGH CAPACITY TRAILER OUTFITTER™

Proudly Made
In The USA

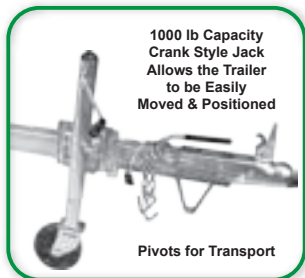

1000 lb Capacity
Crank Style Jack
Allows the Trailer
to be Easily
Moved & Positioned

MPG550-O

Pivots for Transport

Features:

- . Marine grade galvanized frame
- . DOT & Transport Canada approved
- . L.E.D. "plug & play" lights
- . Crank assist jack stand & wheel
- . MPG540 Spare Tire w/ lock attachment
- . Three tier load bar design with D-Rings
Lower / Middle Bars: 86" wide
Top Bar: 55" wide
- . Extended reinforced tongue
- . Tongue lift handle
- . 2" receiver
- . Five Year Limited Warranty

Specifications:

- . Weight: 446 lb
- . Length: 14' 6"
- . Width: 86"
- . Height: 84"
- . Suspension: Triple leaf spring
- . Wheels: 10" diameter
- . Tire Pressure: 40 PSI
- . Maximum speed: 70 MPH
- . Load Capacity: 1000 lb



Kayaks & Canoe
Not
Included

Trailer Accessory Fit Guide

Malone® has grown its line of trailers to six models, each with different pricing, specifications and components (standard and bundled). To improve optional accessory selection, we now offer an icon system (see below) to confirm that the selected accessory correctly fits the trailer.

Accessory Icons (Each trailer accessory (pages 65-70) includes icons to confirm correct trailer fit & compatibility.)

**MPG460G
MicroSport™**

**MPG464-LB
MicroSport™
LowBed™**

**MPG535
MegaSport™**

**MPG550-LB
MegaSport™
LowBed™**

**MPG585
EcoLight™**

**MPG595
XtraLight™
LowMax™**

**MPG460G
MicroSport™**

This icon includes the following trailers: MPG460G, MPG460XT, MPG461B2, MPG461G2, MPG461GS, MPG461GU, MPG461KB, MPG461SRP and MPG462G2.

**MPG464-LB
MicroSport™
LowBed™**

This icon includes the following trailers: MPG464-LB, MPG464-LBT, MPG464-LBB, MPG464-LBM, MPG464-LBS, MPG464-LBTB, MPG464-LBTM And MPG464-LBTS.

**MPG535
MegaSport™**

This icon includes the following trailers: MPG535, MPG550-H, MPG550-TH, MPG550-AH, MPG550-M, MPG550-AM, MPG550-AU, MPG550-U, MPG550-TM, MPG550-TU and MPG550-O.

**MPG550-LB
MegaSport™
LowBed™**

This icon includes the following trailers: MPG550-LB, MPG550-LBB, MPG550-LBM and MPG550-LBS.

**MPG585
EcoLight™**

This icon includes the following trailers: MPG585, MPG586XJ, MPG586XV, MPG586XL and MPG586XB.

**MPG595
XtraLight™
LowMax™**

This icon includes the following trailers: MPG595, MPG596XJ2, MPG596XV2, MPG596XB2, MPG596XSRP, MPG596XJ4 and MPG596XKB.

Trailer Accessories

All Malone[®] trailers are offered with a wide array of optional accessories for creating an individual custom look or upgrading to satisfy additional transport requirements. All of these products are covered by our **Five Year Limited Warranty** to ensure total satisfaction.

MPG465

MicroSport™ Spare Tire with Lock Attachment



MPG460G
MicroSport™

MPG464-LB
MicroSport™
LowBed™

12" galvanized wheel.
Lock not included.

MPG540

MegaSport™ Spare Tire with Lock Attachment



MPG535
MegaSport™

MPG550-LB
MegaSport™
LowBed™

10" galvanized wheel.
Lock not included.

MPG582

EcoLight™ Spare Tire with Lock Attachment



MPG585
EcoLight™

8" powder coated wheel.
Lock not included.

MPG592

**XtraLight™ LowMax™
Pontoon-Style Spare Tire with Lock Attachment**



MPG595
XtraLight™
LowMax™

8" powder coated wheel.
Lock not included.

MPG474

Second Tier Kit with 50" Load Bars



MPG460G
MicroSport™

MPG464-LB
MicroSport™
LowBed™

Great for a cargo box, extra boat or additional gear space.

Retrofits to all MicroSport Trailers.

MPG467

Retractable Kick Stand



MPG460G
MicroSport™

MPG585
EcoLight™

MPG595
XtraLight™
LowMax™

Elevates the tongue for easy handling.

MPG207

MegaWing™ Reinforced V-Style Carriers

MPG460G
MicroSport™

MPG550-LB
MegaSport™
LowBed™

MPG464-LB
MicroSport™
LowBed™

MPG585
EcoLight™

MPG535
MegaSport™

MPG595
XtraLight™
LowMax™

These injected molded carriers are built with the increased strength & firmness required to transport heavy sit-on-top kayaks. Includes 15' cam style load straps and all required mounting hardware.

We recommend use with traditional bottom keel hull designs.



MPG481 Hard Shell Storage Trunk

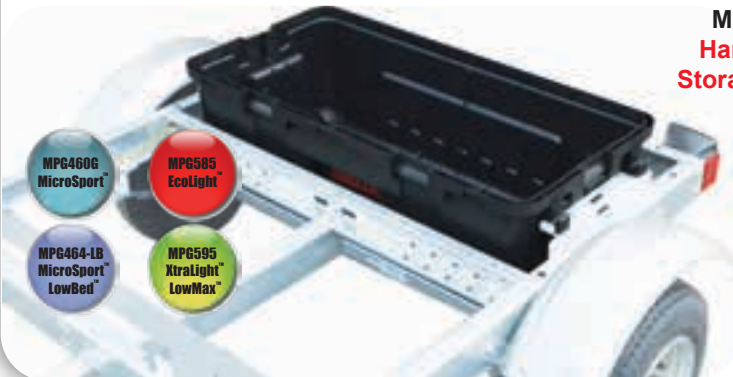

MPG460G
MicroSport™

MPG585
EcoLight™

MPG464-LB
MicroSport™
LowBed™

MPG595
XtraLight™
LowMax™



Removable Lid
Galvanized Mounting Brackets
Fits Perfectly in Trailer Frame

3.7 cubic feet of storage space.

Trailer Accessories

The MPG494 allows the MicroSport™ tongue to be retracted back into the frame for improved storage. The Trailer Safety Mast ensures that the trailer is visible at all times. The MPG536 and MPG537 are unique in-frame storage systems for the MegaSport™.

MPG494

MicroSport™ Retractable Tongue Kit



17.5" x 6.5" x 2.75"

Store your trailer upright against a wall. Reduces overall length from 159" to 98".

Retrofits to all existing MicroSport™ trailers.

Includes rear rubber bumpers, hitch pins and all wiring needs.



MPG460G
MicroSport™

MPG464-LB
MicroSport™
LowBed™

Vertical
Storage
Option

MPG488

Trailer Safety Mast

MPG460G
MicroSport™

MPG464-LB
MicroSport™
LowBed™

MPG535
MegaSport™

MPG550-LB
MegaSport™
LowBed™

MPG585
EcoLight™

MPG595
XtraLight™
LowMax™

Includes
Mounting
Hardware Kit.

Helps When
Backing Up.

Keeps the
Trailer's Position
Visible at
All Times.

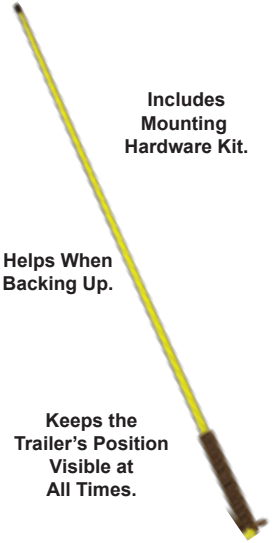

MPG536

MegaSport™ Plastic Storage Trunk



MPG535
MegaSport™



An alternative to the MPG547 Wire Basket and fitting in the same chassis area, the MPG536 adds a level of added security and moisture resistance.

Features:

- High strength molded plastic construction
- 8 cubic feet of dry storage space (44" x 19" x 17.75")
- Hinged lid with security latches (locks not included)
- Includes all required mounting hardware

MPG537

MegaSport™ Storage Drawer w/ Rollers & Wheels

Can Be Retrofitted
to Any Existing
MegaSport™

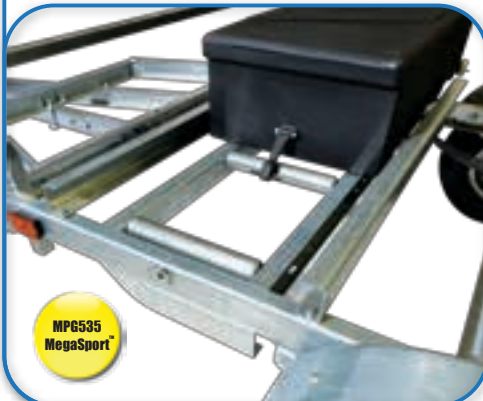

MPG535
MegaSport™

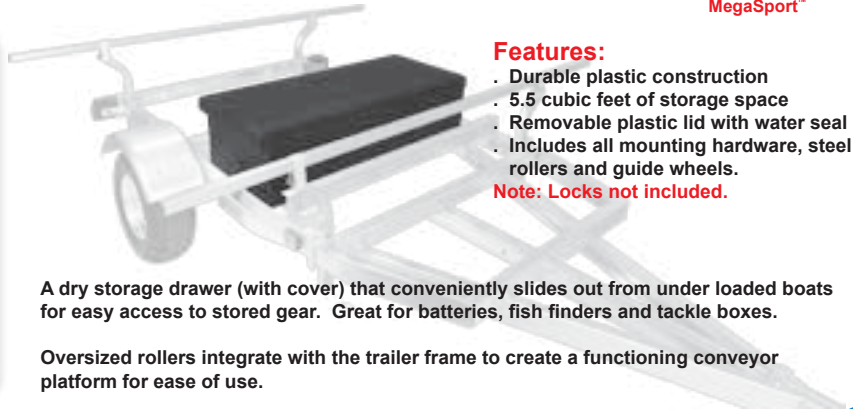

Features:

- Durable plastic construction
- 5.5 cubic feet of storage space
- Removable plastic lid with water seal
- Includes all mounting hardware, steel rollers and guide wheels.

Note: Locks not included.

A dry storage drawer (with cover) that conveniently slides out from under loaded boats for easy access to stored gear. Great for batteries, fish finders and tackle boxes.

Oversized rollers integrate with the trailer frame to create a functioning conveyor platform for ease of use.

Trailer Accessories

The MPG539 provides a permanent light source for the MegaSport™ trailer. Safely carry up to six fishing rods with the MPG541 Rod Storage Tube. The MPG543 provides permanent charging power to the trailer. Mount the magnetic MPG542 LED light source anywhere on a trailer.

MPG539 MegaSport™ Flood Light (Bracket Mount)

This powerful and waterproof 2000 lumen LED flood light comes with mounting bracket and attachment hardware. Can be easily mounted to the MegaSport™ 2nd Tier Load Bar System in multiple locations. Provides exceptional light for rigging gear and loading accessories in the dark.

Features:

- Sealed housing with twin beam with 2000 lumen LED lights
- Waterproof toggle switch
- 12' wiring harness
- Coated mounting bracket
- Aluminum waterproof housing
- Five Year Limited Warranty

Permanently Installs Into the Trailer's Wiring Harness



MPG541 Fishing Rod Storage Tube

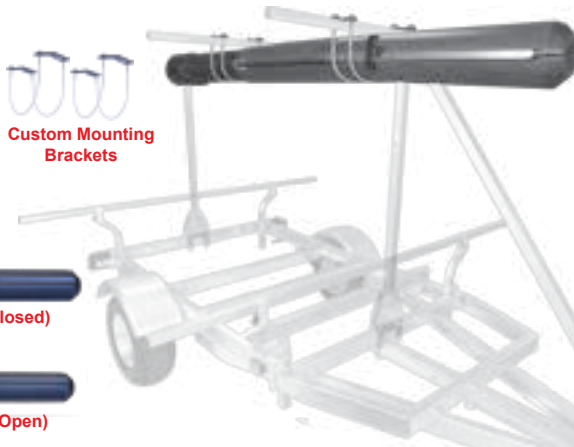

This telescoping rod transport system delivers a reliable and secure transit for your expensive "gone fishing" gear. Custom made brackets firmly secure this system to load bars and overhead vertical supports.

Designed for easy access with a hinged door. Holds up to six saltwater (extra long) rods. A fully molded and nearly indestructible frame with padded ends for years of service.

Features:

- Custom mounting brackets for a confident attachment
- Telescoping 6" diameter frame (73" to 102" in length)
- Lockable hinged access for convenience and security
- High volume capacity holds up to six oversized rods
- Five Year Limited Warranty



MPG543 Electric Charging Station

Waterproof permanent mount station for charging LED lighting, fish finders, GPS, phones & camera.

Features Include:

- One 5V 1 amp illuminated USB receptacle
- One 5V 2.1 amp illuminated USB receptacle
- One 12V standard accessory receptacle
- Galvanized mounting plate with hardware

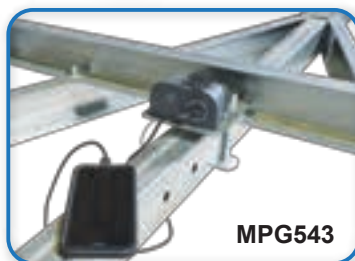

MPG542 LED Flood Light (Magnetic Mount)



MPG542 LED Flood Light (Magnetic Mount)

With it's 10' power cord, this magnetic base LED flood light can be mounted anywhere on the trailer. The 2000 lumen twin beam bulbs provide ample light for late night / early morning set-ups.

Features Include:

- Aluminum waterproof housing - 10' coiled power cord
- Standard 12V accessory plug with switch - May require MPG543

Trailer Accessories

Store your wet gear in the MegaSport™ Wire Storage Basket. The MPG553 SUP Transport Pads fit the MicroSport™ and provide a safe abrasion resistant transport for paddle boards. The MPG545 furnishes the MegaSport™ with an extra tier to fit accessories like the MPG546 Milk Crate Cage.

MPG547 MegaSport™ Wire Storage Basket

This ruggedly built wire basket fits perfectly in the MegaSport™ chassis and provides storage space for wet gear, bait buckets and landing nets.

Features Include:

- Powder coated steel welded construction
- 8 cubic feet of storage space (48" x 16" x 18")
- Removable wire lid with cam buckle retention strap
- Includes all required mounting hardware



MPG553 MicroSport™ SUP Transport Pads



Sold in
Sets of Two



One Year Limited Warranty

Installs under the load bars and attaches directly to the MicroSport trailer frame. These 36" long pads protect and transport StandUp paddle boards which can require extra caution to avoid abrasions and scratches.

MPG545 MegaSport™ 2nd Tier Kit w/ Load Bars



Excellent for a
Cargo Box or
Additional Boat

Increase load capacity to your MegaSport™ with this all steel upper level load bar system. Installation is quick and simple using the retro-fit design that easily integrates to a prior assembled trailer. **Please Note: This part does not fit the MegaSport™ LowBed™ version trailers.**

Ideal for adding extra gear without sacrificing convenient waist-level lower space. The adjustable rear load bar allows perfect placement for differing load requirements.

Features:

- Modular galvanized steel design for a quick installation
- 50" long x 1.25" square heavy duty galvanized load bars
- 150 lb load bar capacity
- Made in the USA
- Dimensions: 5' 10" long x 50" wide
- Five Year Limited Warranty

MPG546 MegaSport™ Milk Crate Cage w/ Mounting Hardware

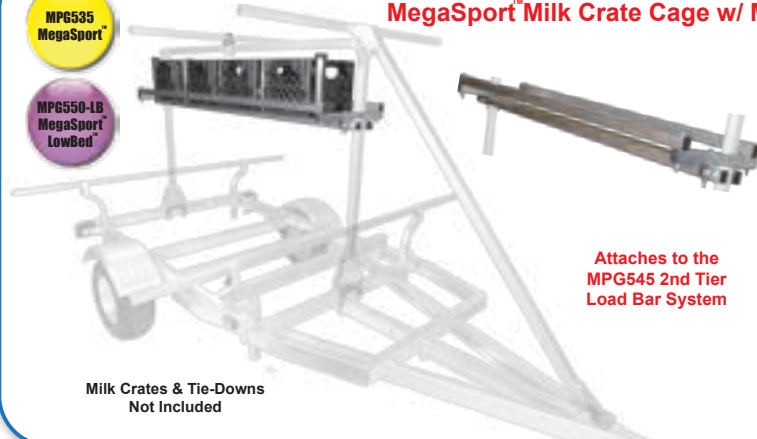

Attaches to the
MPG545 2nd Tier
Load Bar System

Loading and controlling your small item gear is one of the biggest challenges to kayak fishing and the milk crate has become the standard solution within the industry.

The MPG546 Milk Crate Cage holds five standard sized crates up and out of the way. Great for keeping your gear safe and organized. **Note: Milk crates and tie-downs not included.**

Features:

- 11 gauge galvanized construction
- No drilling required - Installs directly to the 2nd Tier
- Deep trough design to firmly capture the crates
- Large capacity frame holds five standard sized crates
- Made in the USA
- Five Year Limited Warranty

Milk Crates & Tie-Downs
Not Included

Trailer Accessories

The MPG561 Large kayak Bunk Kit can safely carry nearly any kayak regardless of the hull configuration. The Pilot™ TC LT was designed specifically for trailer based bike transport. The MPG126 mounts to the trailer's load bars and can transport up to four fishing rods.



MPG561
MPG561 Large Kayak Bunk Kit

Sold in
Sets of Two

Features:

- 84" x 4" x 2" covered bunks (set of 2)
- 15' green cam style load straps (set of 2)
- Marine grade weather resistant bunk covering
- Installation hardware for two individual bunks
- Made in the USA - Five Year Limited Warranty









MPG561

Transport One Kayak.
Fits Nearly Any Hull Configuration.



PILOT™

TRAY STYLE BIKE CARRIER FOR TRAILERS

TC LT

Features:

- Single bike capacity
- Ratchet SafeHook™ secures the front tire
- Compatible with most frames
- Adjustable wide wheel holders fit most tires
- Mounting hardware fits Malone® trailer racks

Specifications:

- Load capacity: 33 lb
- Powder coated construction
- Fits 20" to 29" wheels and up to 5" fat tires
- Dimensions: 65" x 12" x 6"
- Weight: 13 lb

Note: Not compatible with tandem and recumbent bikes.













The MPG2100 Tray Style Bike Carrier provides safe transport for one bicycle on all Malone® trailers. Features an extra-long tray to fit a wider bar spread. Key locking to prevent opportunistic theft. Captures the front wheel with no frame contact. Five Year Limited Warranty. Please note that for the MegaSport™, the second tier is required.



MPG126
Striper™ Fishing Rod Holder

Features:

- Four rod capacity
- Universal fit for most load bars
- Corrosion resistant construction
- Key-lock theft deterrent design

See Page 14 for Full Specifications









Trailer Accessories

For additional load support, the MPG4002 Cross Rail System can be installed on a fixed MicroSport™ tongue. The MPG5576-6 Adapters work well for mounting specialty style carriers. The TopTier™ is part of our General Accessory lineup and great for adding a second tier to a utility trailer.



Made in the USA

MPG4002
MicroSport™ 78" Tongue Mount Cross Rail System



Note: Not compatible with MPG460XT Trailer.

Note: Not compatible with MPG494 Retractable Tongue Kit.

Bar Dimensions:
78" x 1.25" x 1.25"

Provides a mid-point cross bar attachment system for extra long boats. For those wanting less rear boat overhang, the MPG4002 allows the boat to be moved forward on the trailer. Great for extra gear. Includes 78" load bar and all attachment hardware. Five Year Limited Warranty.







MPG5576-6
Hobie™ Style Cradle Adapter

Specialty Style Carrier
Installation Hardware



MPG5576-6

Secure attachment hardware
for specialty carriers





TopTier™ Utility Trailer Cross Bar System

Dramatically increase utility trailer payload capacity with the TopTier™ Trailer Cross Bar Kit. Easily installs to most utility trailers with raised side rails. Great for transporting canoes and kayaks. The perfect solution for contractors needing extra overhead cargo space or paddlers looking to retrofit an existing trailer.



- Features:**
- 53" Galvanized Steel Uprights
 - 65" Steel Cross Bars
 - Upright Stabilizers
 - Proudly Made In The USA
 - Five Year Limited Warranty



General Trailer Accessories

Offering a popular cross section of trailer accessories to improve overall trailer transport satisfaction. Each item has been carefully selected for convenience, quality and overall workmanship and is covered by a Five Year Limited Warranty.

Trailer Cross Bar Conversion Kit

Add a Cross Bar Conversion Kit to your utility trailer in minutes. Comes complete with 78" bars, bar upright supports and all required installation hardware.



MPG475

Convert a standard utility trailer into a canoe, kayak, bike or cargo box hauler. The Trailer Cross Bar Conversion Kit provides an easy solution for upgrading your trailer.

Featuring a set of 78" long load bars with cross supports, brackets and mounting hardware to create a confident and professional set-up.

Made in USA. Five Year Limited Warranty.

Double Hitch Receiver

Double your towing capacity with this 2" Double Hitch Receiver. Add a Malone[®] bike or cargo carrier to your trailer hitch set-up. Features an anti-wobble design that holds the carrier in position.



MPG544



Safety Flag - Hitch Anti-Wobble Bracket

A Safety Flag is a must for daytime safe transport of canoes & kayaks. Stop hitch accessory rattle with the MPG908 Anti-Wobble Bracket.



MPG551

Clearly display the back of your canoe or kayak with this DOT approved Safety Flag when towing.



MPG908

Hitch
Anti-Wobble
Bracket

Stops Rattling

Stabilizes Hitch
Accessories

Roof Racks

. SteelTop™ Square Cross Bars	03
. AirFlow2™ Aero-Style Cross Bars	04
. VersaRail™ Bare Roof Cross Bars	05
. HandiRack™ Inflatable Roof Racks	06

Watersport Carriers (Rooftop)

. SeaWing™ V-Style	07
. SaddleUp™ Pro	08
. DownLoader™ Folding J-Style	09
. FoldAway-5™ MultiRack	10
. FoldAway-J	10
. Stax™ Pro2 Stacker-Style	11
. J-Pro™ J-Style	12
. J-Pro2™ J-Style	12
. J-Loader™ J-Style	12
. BigFoot™ Pro Canoe	13
. Striper-4 Fishing Rod Carrier	14
. Paddle Carrier	14

Watersport Carriers (Truck Rack)

. SaddleUp™ Pro	15
. DownLoader™ Folding J-Style	15
. Stax™ Pro2 Stacker-Style	15
. J-Pro™ J-Style	15
. BigFoot™ Pro Canoe	15
. 14" Kayak Foam	15
. Jumbo Rack Pads	15

Installation Hardware

. Jawz2™ Kits	16
. Mounting Bolts	16
. T-Slot Truck Racks	16
. Aero Bar Shim Kit	16
. Flush Rail Adapter Kit	16

Load Assists

. SeaWing™ / Stinger™ Combo	17
. Stinger™ Module	17
. Channel Loader™	18
. Telos™ XL Module	19
. Telos™ XL MultRack Adapter	19

Rack Pads

. SUP30™ Rack Pad Kit	20
. 18" Rack Pads	20
. 25" Rack Pads	20
. 30" Rack Pads	20
. Aero18™ Aero-Style	20
. Aero25™ Aero-Style	20
. Aero30™ Aero-Style	20

Watersport Carriers (Foam)

. Deluxe Kayak Kit (2)	21
. Standard Kayak Kit	21
. Standard Canoe Kit (2)	21
. Kayak Stacker Block Kit	21
. Deluxe PaddleBoard Kit	21
. 16" Kayak Blocks (Set of 2)	21
. 6" Canoe Blocks (Set of 2)	21
. Kayak Block, 4 X 4.75 X 18	21
. Canoe Block, 4 X 4.75 X 6	21
. Kayak Block, 4 X 4.75 X 12	21
. Kayak Block, 8 X 4	21

Watersport Carriers (Foam)

. Kayak/SUP Block, 4 X 4.75 X 24	21
. Spacer Block, 1.5 X 4.75 X 22	21

Safety Tie-Downs

. QuickLash™ T-Style	22
. Sentry™ Ratchet-Style	22
. SpeedLine™ Mini Ratchet	22
. Bow & Stern	22
. Hood Loop Straps	22

Load Straps

. 9' Load Strap, 2PK	22
. 9' Load Strap, Single	22
. 12' Load Strap, 2PK	22
. 12' Load Strap, Single	22
. 15' Load Strap, 2PK	22
. 15' Load Strap, Single	22
. 18' Load Strap, 2PK	22
. 18' Load Strap, Single	22

Security

. LockUp™ 6' Cable Lock	23
. LockUp™ 8' Cable Lock	23
. LockUp™ 10' Cable Lock	23
. Lariat™ Universal Canoe/Kayak	23

Cargo Boxes

. Cargo Box Intro	24
. Cargo12™	25
. Cargo16™	25
. Profile18S™	26
. Profile18B™	26

Cargo Carriers (Hitch & Rooftop)

. Axis™ Truck Bed Extender	27
. Axis™ LoadRoller	27
. Axis™ Extender w/ 58" VersaRail™	27

Bike Racks

. Pilot™ HM2	29
. Co Pilot™	29
. Pilot™ TC ST	30
. Pilot™ HM2 Solo	30
. Hanger™ HM4	31
. Hanger™ Spare T3 OS	31
. Hanger™ BC3 OS	32
. Hanger™ HM3	32
. Runway™ BC3	33
. Runway™ Spare T3	33
. Runway™ HM3 OS	34
. RunWay™ HM2 Platform	34
. RunWay™ HM4	35

Bike Racks Accessories

. Top Tube Adapter	35
. Locking Hitch Pin	35

Ground Transport

. Clipper™ TRX	36
. Nomad™ TRX	36
. Xpress™ TRX	36
. Clipper™ TRX-S w/ Beach Wheels	37
. Xpress™ TRX-S w/ Beach Wheels	37

Ground Transport

. WideTrak™ ATB	38
. WideTrak™ ATB	38

Storage

. JDock™	39
. HangTime™	39
. Kayak Hammock™	39
. FoamHome™	39
. Elevate™	39
. HighRise™	40
. BoardRoom™	40
. J-Hoops™	40
. SUP~Port™	40
. Wall Mount Ski Storage Rack	40
. SlingOne™	41
. SlingTwo™	41
. SlingThree™	41
. YAK~Swing™	41
. SUP~Swing™	41
. FS Rack™ 3 Kayak	42
. FS Rack™ 6 Kayak	42
. FS Rack™ 3 Bike, 2 SUP, 1 Kayak	43
. FS Rack™ 2 Kayak, 2 SUP, 6 Ski	43
. FS Rack™ 3 Bike, 2 Kayak, 6 Ski	43
. FS Rack™ 2 Kayak, 2+ SUP	44
. FS Rack™ 6+ SUP	44
. FS Rack™ Base Rack	44
. FS Rack™ Accessories	45

Sports Trailers (EcoLight™)

. EcoLight™ Base Trailer	46
. EcoLight™ Trailer Packages	46
. EcoLight™ Trailer Packages	47

Sports Trailers (XtraLight™ LowMax)

. XtraLight™ LM Base Trailer	48
. XtraLight™ LM Trailer Packages	49

Sports Trailers (MicroSport™)

. MicroSport™ Base Trailer	50
. MicroSport™ XT Base Trailer	50
. MicroSport™ Trailer Upgrade	51
. MicroSport™ Trailer Packages	51
. MicroSport™ Trailer Packages	52

Sports Trailers (MicroSport™ Lowbed)

. MicroSport™ LB Base Trailers	53
. MicroSport™ LB Trailer Packages	54
. MicroSport™ LB Trailer Packages	55

Sports Trailers (MegaSport™)

. MegaSport™ Base Trailer	56
. MegaSport™ Trailer Packages	57
. MegaSport™ Trailer Packages	58
. MegaSport™ Trailer Packages	59

Sports Trailers (MegaSport™ LowBed)

. MegaSport™ LB Base Trailer	60
. MegaSport™ LB Trailer Packages	61

Sports Trailers (Miscellaneous)

. MegaSport™ Outfitter	62
. Trailer Accessories	63 - 70