

MagnaFuel

2019 PARTS CATALOG

**FUEL DELIVERY SYSTEMS
FOR CARBURETED AND
FUEL INJECTED ENGINES**



RACE-PROVEN DURABILITY



HISTORY

SINCE 1995, MAGNAFUEL HAS DESIGNED AND MANUFACTURED PREMIUM, LONG-LASTING, DURABLE, HIGH-PERFORMANCE FUEL SYSTEMS. MAGNAFUEL PRODUCTS CONTINUE TO BE DEVELOPED IN CLOSE ASSOCIATION WITH PROFESSIONAL RACERS. WHEN YOU PURCHASE A MAGNAFUEL FUEL SYSTEM, YOU REAP THE BENEFITS FROM THE WORK OF THOSE SUCH AS WARREN JOHNSON, KURT JOHNSON, GREG ANDERSON, JASON LINE, GREG STANFIELD, RICK JONES, V. GAINES, CHRIS MCGAHA, TANNER GRAY AND MANY OTHERS.

WHEN KURT JOHNSON BECAME THE FIRST NHRA DRIVER TO ENTER THE SIX-SECOND CLUB, HE DID IT WITH A MAGNAFUEL RACING FUEL SYSTEM. AS A MATTER OF FACT, A MAGNAFUEL FUEL SYSTEM WAS ONBOARD FOR EVERY 200 MPH PASS WARREN AND KURT JOHNSON EVER MADE. NOW, MAGNAFUEL RACING FUEL SYSTEMS ARE INSTALLED ON EVERYTHING FROM SPEEDBOATS TO HILL-CLIMB TRUCKS.

MAGNAFUEL IS ABLE TO DELIVER HIGH-END FEATURES AND RACE-PROVEN DURABILITY IN A SYSTEM THAT'S AFFORDABLE TO ALL RACERS, STREET TO PRO. MAGNAFUEL TESTS EVERY PUMP AND REGULATOR FOR PRESSURE AND VOLUME. ALL MAGNAFUEL PUMPS AND REGULATORS ARE SERIALIZED AND MARKED WITH THE LOGO AND NAME. IF IT DOESN'T SAY MAGNAFUEL, IT ISN'T A MAGNAFUEL PRODUCT.

WHEN YOU BUY A MAGNAFUEL FUEL SYSTEM, YOU GET A LOT MORE PERFORMANCE FOR YOUR RACING INVESTMENT.

PHOTO BY SRA PHOTO



GREG ANDERSON- MULTI PRO STOCK CHAMPION

MagnaFuel

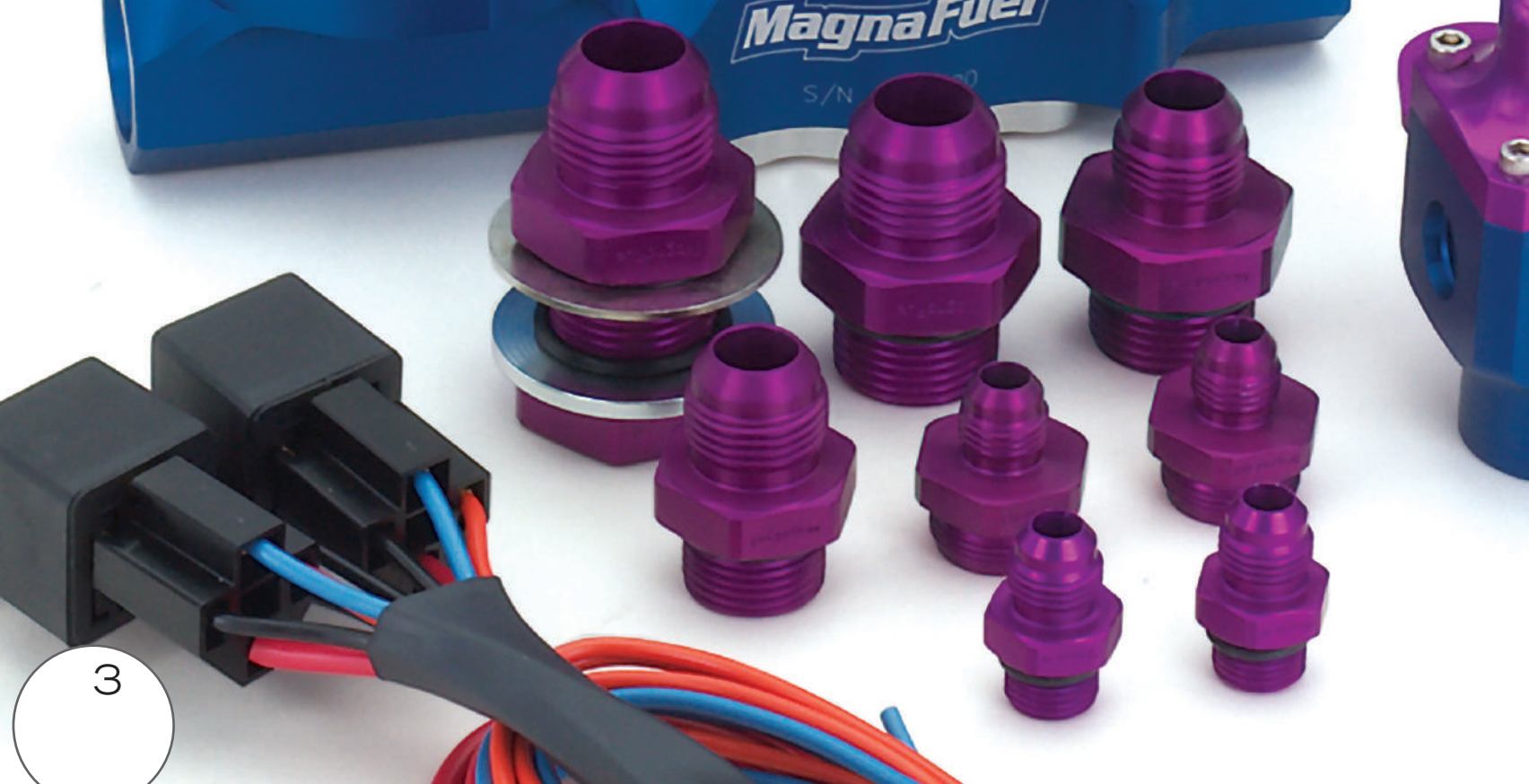

TABLE OF CONTENTS

EFI FUEL SYSTEM COMPONENTS

EFI PUMPS	5
BYPASSING REGULATORS	10

CARBURETED FUEL SYSTEM COMPONENTS

FUEL PUMPS AND FILTER COMBINATIONS	13
JR DRAGSTER DIAPHRAGM PUMP	15
CARBURETED REGULATORS	17

KITS

COMPLETE FUEL PUMP AND REGULATOR KITS WITH APPLICATION DIAGRAMS	19
NITROUS FUEL REGULATOR KITS AND AIR-BLEED SYSTEMS WITH APPLICATION DIAGRAMS	25
WIRING KITS	27
FITTING KITS	2

PARTS AND ACCESSORIES

Y-FITTINGS	29
ADAPTERS AND ACCESSORIES	31
FUEL LOGS	33
IN-LINE FILTERS	35
FUEL CELL FILTERS	36
ANTI-REVERSION PLATES	37
HOSES AND HOSE ENDS	39

TECHNICAL INFORMATION

NOTES	40
APPAREL TEAM M	41
TECH NOTES & PERFORMANCE TIPS	43
QUESTIONS AND ANSWERS	45



FUEL INJECTION

SWIVELING ELECTRIC GEAR PUMPS

NEW BLACK FINISH

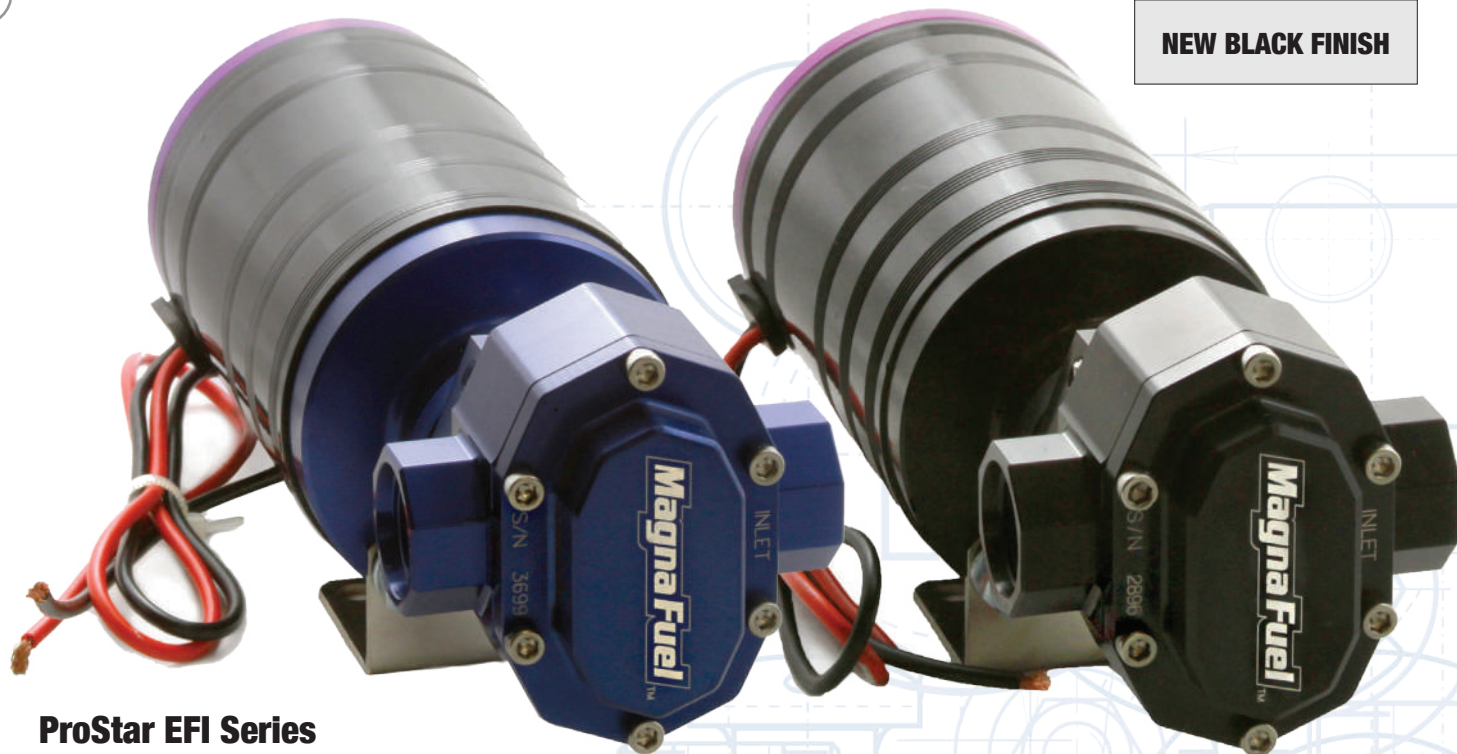

ProStar EFI Series

Engine Horsepower: up to 2,500+¹

*First electric gear pump on the market.
Swivel adapter allows more mounting options.*

- Swivel pump head allows more mounting freedom
- First electric motor gear pump to supply 2,500+ HP
- Provides highest volume at highest pressure... Period
- Great performance for the high volume and pressure demands of supercharged and turbo-charged applications
- Never requires voltage reduction devices due to high quality motor construction
- Powered by the same motor as the race proven MagnaFuel ProStar 500
- Compatible with alcohol and gasoline racing fuels
- Hand assembled to the highest quality standards
- Pump bodies computer machined out of high quality 6061-T6 Billet Aluminum
- Flow tested to ensure maximum performance
- All MagnaFuel pumps are totally rebuildable to "As New" factory specifications
- Durable hardened steel wear plates for smooth, quiet operation
- Designed for 12 or 16-volt applications



Swivel flange allows you to loosen pinch bolt and swivel the head 360° after the pump is mounted to optimize the fuel line routing. ²Fittings not included.

Model	Part No.	Horsepower ¹	Pressure	Amps @ 12.5V	Ports ²	Dimensions	Weight
ProStar EFI 750	MP-4703 MP-4703-BLK	2,500+	20 to 120 psi	17A @ 45psi	#10 AN (inlets and outlets)	9.5"L x 3"W x 3"H	6.5 lbs
ProStar EFI 625	MP-4701 MP-4701-BLK	2,000+	20 to 120 psi	15A @ 45psi	#10 AN (inlets and outlets)	9.5"L x 3"W x 3"H	6.5 lbs
ProStar EFI 525	MP-4702 MP-4702-BLK	1,500+	20 to 120 psi	12A @ 45psi	#10 AN (inlets and outlets)	9.5"L x 3"W x 3"H	6.5 lbs

¹ Power ratings are for naturally aspirated engines running gasoline. ²Fittings not included. Some products legal for racing only; never to be used on public roads or emission-controlled vehicles.

FUEL INJECTION

ELECTRIC GEAR PUMPS

ProStar EFI SQ Series

Engine Horsepower: up to 2,500+¹

One-piece design is more compact and lightweight.

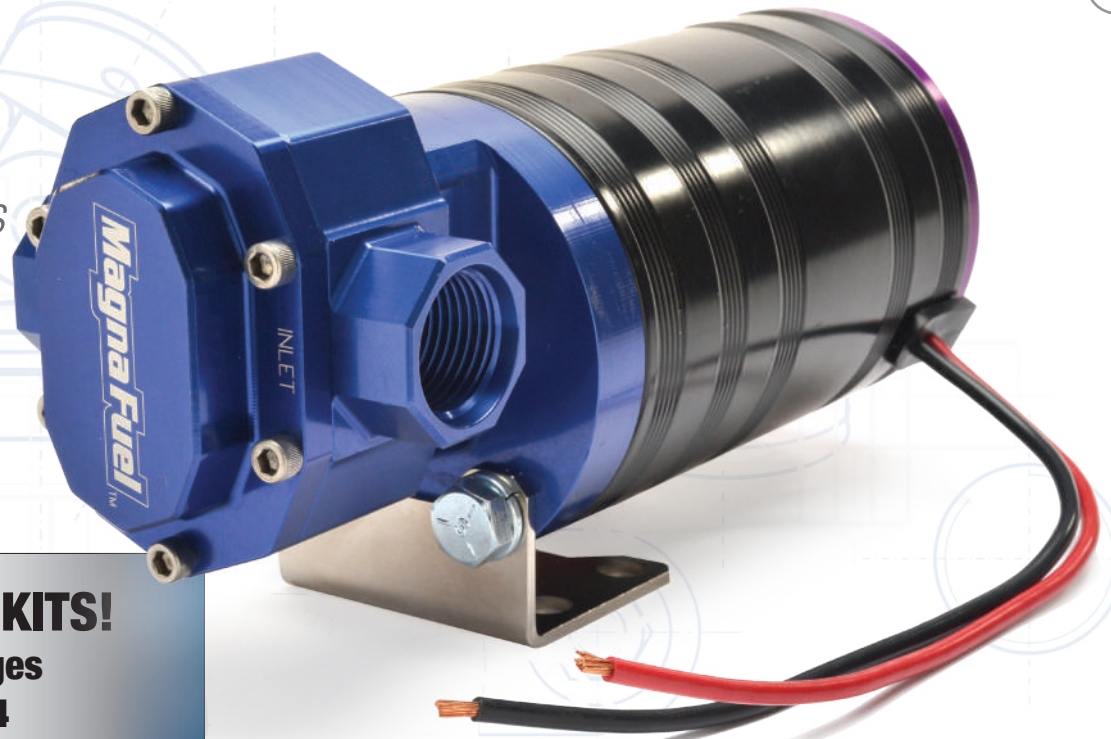

SAVE ON KITS!
See pages
19-24

- Compact design fits in smaller spaces
- First electric motor gear pump to supply 2,500+ HP
- Provides highest volume at highest pressure. Period
- Great performance for the high volume and pressure demands of supercharged and turbo-charged applications
- Never requires voltage reduction devices due to high quality motor construction
- Powered by the same motor as the race proven MagnaFuel ProStar 500
- Compatible with alcohol and gasoline racing fuels
- Hand assembled to the highest quality standards
- Pump bodies computer machined out of high quality 6061-T6 Billet Aluminum
- Flow tested to ensure maximum performance
- All MagnaFuel pumps are rebuildable to "as-new" factory specifications
- Durable hardened steel wear plates for smooth, quiet operation
- Designed for 12 or 16-volt applications.



ProStar Swivel

ProStar SQ Fixed

Fixed-head pump (right) is much more compact to fit in tighter spaces. ²Fittings not included.

Model	Part No.	Horsepower ¹	Pressure	Amps @ 12.5V	Ports ²	Dimensions	Weight
ProStar EFI SQ 750	MP-4103 MP-4103-BLK	2,500+	20 to 120 psi	17A @ 45psi	#10 AN (inlets and outlets)	8"L x 3"Dia.	5.5 lbs.
ProStar EFI SQ 625	MP-4101 MP-4101-BLK	2,000+	20 to 120 psi	15A @ 45psi	#10 AN (inlets and outlets)	8"L x 3"Dia.	5.5 lbs.
ProStar EFI SQ 525	MP-4102 MP-4102-BLK	1,500+	20 to 120 psi	12A @ 45psi	#10 AN (inlets and outlets)	8"L x 3"Dia.	5.5 lbs.

¹ Power ratings are for naturally aspirated engines running gasoline. ²Fittings not included.
Some products legal for racing only; never to be used on public roads or emission-controlled vehicles.

FUEL INJECTION

IN-LINE PUMPS

AVAILABLE IN BLACK FINISH

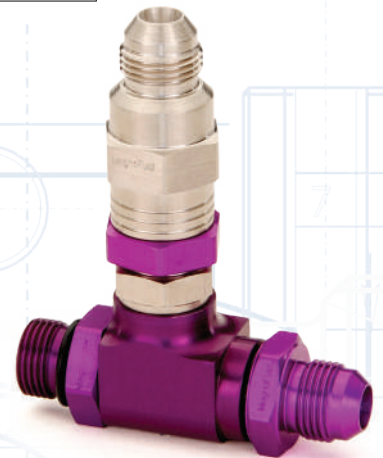
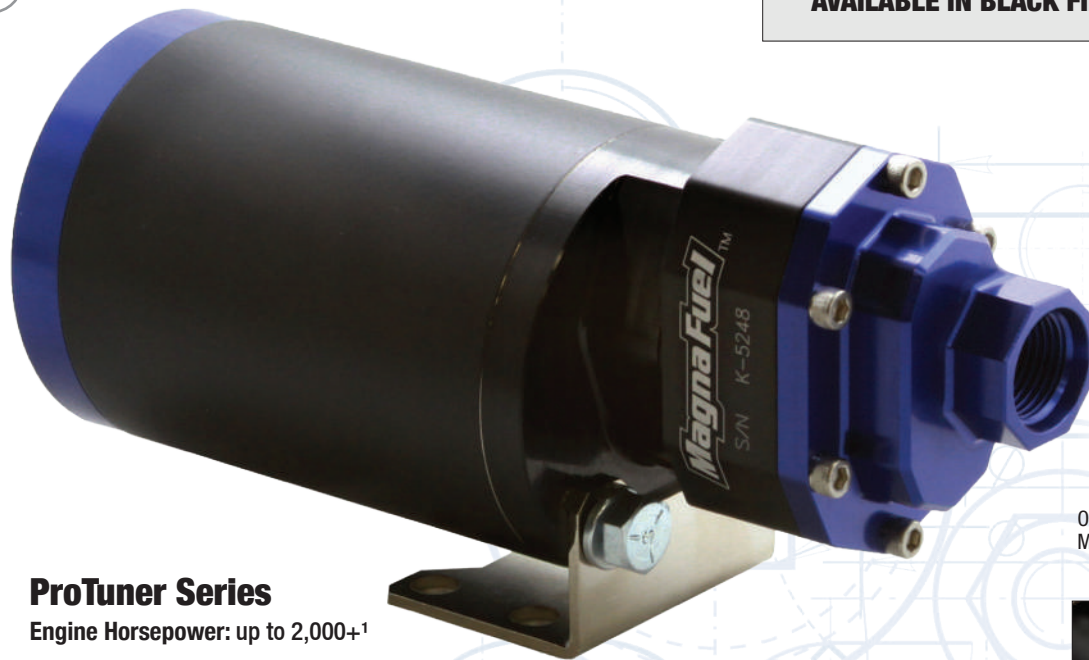

Optional bypass for Carbureted Applications MP-8026. Outlet fitting not included.

ProTuner Series

Engine Horsepower: up to 2,000+¹

MagnaFuel is the first pump manufacturer to bring the efficiency, reliability and durability of a gear pump to in-line pumps.

- Ideal for street muscle cars
- Quiet operation
- Self priming
- Continuous duty
- No pump shaft seals, no leaks
- Pump body CNC machined aircraft aluminum
- High-torque custom motor with very low current draw. Never requires step-down
- More efficient than other motors
- Double support bearings
- Rebuildable to as-new condition
- Compact design to fit in tight spaces
- Smaller than competitive pumps, lower current draw, more powerful
- Hard anodized, long lasting finish
- Mounting bracket included
- Vertical or horizontal mount
- Durable hardened steel wear plates for smooth, quiet operation
- Optional bypass available for carbureted applications



Jam-nut design allows you to position the bypass at any angle. Bypass connects to output port on the top of the pump.



²Fittings not included.

Model	Part No.	Horsepower ¹	Pressure	Amps @ 12.5V	Ports ²	Dimensions	Weight
ProTuner 750	MP-4303	2,000+	20 to 120 psi	14A @ 45psi	#8 AN (inlets and outlets)	7"L x 3"Dia.	4.5 lbs
ProTuner 625	MP-4301	1,500+	20 to 120 psi	12A @ 45psi	#8 AN (inlets and outlets)	7"L x 3"Dia.	4.5 lbs
ProTuner 525	MP-4302	1,000+	20 to 120 psi	10A @ 45psi	#8 AN (inlets and outlets)	7"L x 3"Dia.	4.5 lbs

¹ Power ratings are for naturally aspirated engines running gasoline. ²Fittings not included. Some products legal for racing only; never to be used on public roads or emission-controlled vehicles.

FUEL INJECTION IN-TANK PUMPS

AVAILABLE IN BLACK FINISH

ProTuner Series Engine Horsepower: up to 2,000+¹ *In-Tank Pumps*

- Available in Blue or Black
- Same quality and reliability our ProTuners are known for
- Capable of supporting 2000+ HP
- Proven in NHRA Pro Stock
- No pump shaft seals, no leaks
- Drop-in replacement for COPO, Drag Pak and Cobra Jet Race Cars and other In-Tank applications
- Complete systems for custom tank fabricators
- Stainless 74 Micron Filter Sock with Adapter (MP-FL450300-Element Only)
- Three models to choose from

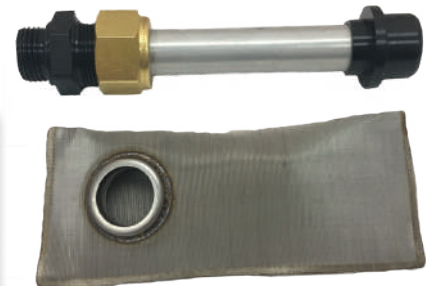
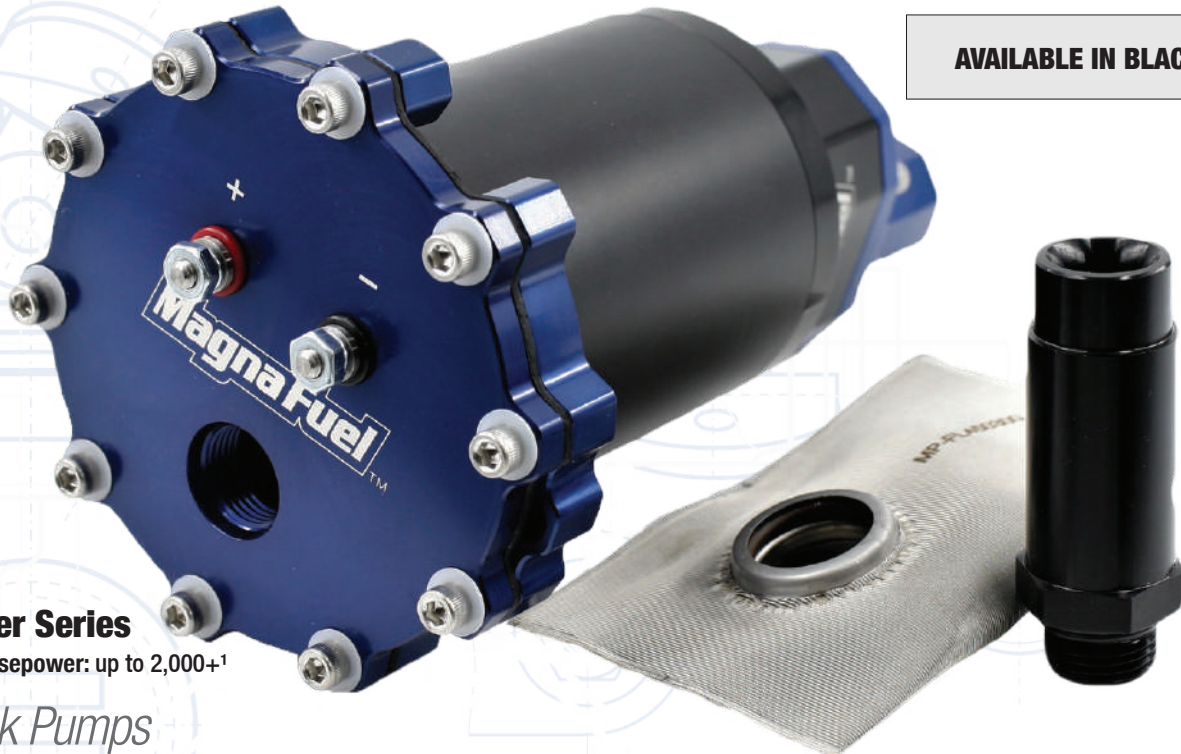

MP-FL7072
Adjustable Pick-up Tube Assembly with element -8
*Fittings and Filter can be purchased separately

Model	Part No.	Horsepower ¹	Pressure	Amps @ 12.5V	Ports	Dimensions	Weight	Tank Depth
ProTuner 750	MP-4312	2,000+	20 to 120 psi	14A @ 45psi	#8 AN (inlets and outlets)	7"L x 3"Dia.	4.5 lbs	10" Tank
	MP-4312-BLK	2,000+	20 to 120 psi	14A @ 45psi	#8 AN (inlets and outlets)	7"L x 3"Dia.	4.5 lbs	10" Tank
	MP-4315	2,000+	20 to 120 psi	14A @ 45psi	#8 AN (inlets and outlets)	7"L x 3"Dia.	4.5 lbs	Universal Pump Kit w/ Adjustable Pickup
	MP-4315-BLK	2,000+	20 to 120 psi	14A @ 45psi	#8 AN (inlets and outlets)	7"L x 3"Dia.	4.5 lbs	Universal Pump Kit w/ Adjustable Pickup
	MP-4318	2,000+	20 to 120 psi	14A @ 45psi	#8 AN (inlets and outlets)	7"L x 3"Dia.	4.5 lbs	JAZ Pro Stock Cell or 8.5" Tank
	MP-4318-BLK	2,000+	20 to 120 psi	14A @ 45psi	#8 AN (inlets and outlets)	7"L x 3"Dia.	4.5 lbs	JAZ Pro Stock Cell or 8.5" Tank
ProTuner 625	MP-4311	1,500+	20 to 120 psi	12A @ 45psi	#8 AN (inlets and outlets)	7"L x 3"Dia.	4.5 lbs	10" Tank
	MP-4311-BLK	1,500+	20 to 120 psi	12A @ 45psi	#8 AN (inlets and outlets)	7"L x 3"Dia.	4.5 lbs	10" Tank
	MP-4314	1,500+	20 to 120 psi	12A @ 45psi	#8 AN (inlets and outlets)	7"L x 3"Dia.	4.5 lbs	Universal Pump Kit w/ Adjustable Pickup
	MP-4314-BLK	1,500+	20 to 120 psi	12A @ 45psi	#8 AN (inlets and outlets)	7"L x 3"Dia.	4.5 lbs	Universal Pump Kit w/ Adjustable Pickup
	MP-4317	1,500+	20 to 120 psi	12A @ 45psi	#8 AN (inlets and outlets)	7"L x 3"Dia.	4.5 lbs	JAZ Pro Stock Cell or 8.5" Tank
	MP-4317-BLK	1,500+	20 to 120 psi	12A @ 45psi	#8 AN (inlets and outlets)	7"L x 3"Dia.	4.5 lbs	JAZ Pro Stock Cell or 8.5" Tank
ProTuner 525	MP-4310	1,000+	20 to 120 psi	10A @ 45psi	#8 AN (inlets and outlets)	7"L x 3"Dia.	4.5 lbs	10" Tank
	MP-4310-BLK	1,000+	20 to 120 psi	10A @ 45psi	#8 AN (inlets and outlets)	7"L x 3"Dia.	4.5 lbs	10" Tank
	MP-4313	1,000+	20 to 120 psi	10A @ 45psi	#8 AN (inlets and outlets)	7"L x 3"Dia.	4.5 lbs	Universal Pump Kit w/ Adjustable Pickup
	MP-4313-BLK	1,000+	20 to 120 psi	10A @ 45psi	#8 AN (inlets and outlets)	7"L x 3"Dia.	4.5 lbs	Universal Pump Kit w/ Adjustable Pickup
	MP-4316	1,000+	20 to 120 psi	10A @ 45psi	#8 AN (inlets and outlets)	7"L x 3"Dia.	4.5 lbs	JAZ Pro Stock Cell or 8.5" Tank

FUEL INJECTION

BELT-DRIVEN PUMPS



ProOutlaw
MP-4205



ProOutlaw
MP-4205-BLK

NEW BLACK FINISH

Pro Outlaw Series

Engine Horsepower: up to 3,000+¹

Belt drive with industry standard coupling for instant switch to high performance.

- Tighter tolerances for easy priming, quick and reliable starts
- Flow rates up to 10.5 gpm at 100psi for engines with high-volume fuel demands, such as alcohol
- Compact, ultralight design
- Standard 3/8" Hex drive for use with existing devices (belt, cam or oil pump)
- High-performance gear pump is more durable and requires less maintenance than other designs
- CNC machined body, with hard-anodized finish is compatible with gas, methanol and ethanol
- Double-support bearings, ground-steel shafts, precision lapped gears
- Durable hardened steel wear plates for smooth, quiet operation
- Field serviceable with available rebuild kits
- Absolutely eliminates fuel starvation
- Increases fuel volume delivery as engine RPM increases
- Each pump is flow tested to ensure optimum performance and shipped ready-to-run
- Requires bypassing regulator for EFI applications
- Bracket and cog pulley not included



Outlaw
MP-4203



Outlaw
MP-4201



Outlaw
MP-4202

Model	Part No.	Rail Pressure	Flow	Ports ²
ProOutlaw 1000	MP-4205 MP-4205-BLK	Up to 150 psi	10.5 gpm @ 4,000 RPM	#10 AN (inlets and outlets)
ProOutlaw 750	MP-4204 MP-4204-BLK	Up to 150 psi	8 gpm @ 4,000 RPM	#10 AN (inlets and outlets)
Outlaw 750	MP-4203 MP-4203-BLK	Up to 150 psi	7 gpm @ 4,000 RPM	#10 AN (inlets and outlets)
Outlaw 625	MP-4201 MP-4201-BLK	Up to 150 psi	6 gpm @ 4,000 RPM	#10 AN (inlets and outlets)
Outlaw 525	MP-4202 MP-4202-BLK	Up to 150 psi	5 gpm @ 4,000 RPM	#10 AN (inlets and outlets)

Industry-standard belt-drive coupling



¹ Power ratings are for naturally aspirated engines running gasoline. ²Fittings not included. Some products legal for racing only; never to be used on public roads or emission-controlled vehicles.

²Fittings not included.



ProStar and QuickStar Series EFI Regulators

Engine Horsepower: ProStar: up to 2,000+¹, QuickStar: up to 700¹

Guided-metering valve provides precise control, requires less maintenance.

- Unique guided-metering valve assembly provides accurate metering of fuel flow
- MagnaFuel EFI Regulators provide the most stable platform for fuel delivery in the performance industry
- Maintains steady fuel flow during times of sudden changes in fuel demands, such as initial launch, gear change and nitrous oxide application
- Designed for use with the MagnaFuel EFI gear pumps
- Regulators available in two different body sizes and two different spring combinations to suit your fuel flow at pressure specifications
- Each Regulator has 1/8" NPT gauge port, standard filtered vent fitting or boost reference fitting (1:1 compensation ratio)
- Special fittings and adapters available for most applications
- All MagnaFuel Regulators are hand assembled to the highest quality standards
- MagnaFuel Regulators are compatible with racing gasoline and alcohol fuels
- Billet body precision CNC-machined from aircraft-quality aluminum and hard anodized for extra long service life
- Completely user-serviceable, with ready to order replacement parts

FUEL INJECTION

EFI REGULATORS



ProStar EFI
MP-9950-B-BLK



ProStar 4 EFI
MP-9940



ProStar EFI
MP-9950-BLK



QuickStar EFI
MP-9925-BLK



QuickStar EFI
MP-9925



QuickStar EFI and ProStar EFI mounting brackets

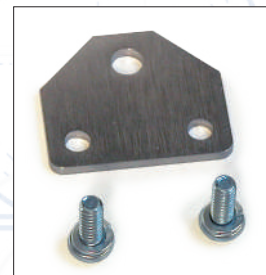

Mounting bracket
MP-9950-16



Boost fitting



Filter fitting

Model	Part No.	Description	Horsepower	Pressure	Ports ¹
ProStar 4 EFI	MP-9940 MP-9940-BLK	Four-port EFI Regulator	2,000	35–85 psi	4 x #8 AN, 1 x #8 AN return
ProStar 4 EFI	MP-9940-B MP-9940-B-BLK	Four-port EFI Regulator w/ 1:1 Boost Reference	2,000+	35–85 psi	4 x #8 AN, 1 x #8 AN return
ProStar EFI	MP-9950 MP-9950-BLK	Large Two-port EFI Regulator	2,000	35–85 psi	2 x #8 AN, 1 x #8 AN return
ProStar EFI	MP-9950-B MP-9950-B-BLK	Large Two-port EFI Regulator w/ 1:1 Boost Reference	2,000	35–85 psi	2 x #8 AN, 1 x #8 AN return
ProStar EFI	MP-9950-C MP-9950-C-BLK	Large Two-port EFI Bypassing Regulator	2,000	18–50 psi	2 x #8 AN, 1 x #8 AN return
QuickStar EFI	MP-9925 MP-9925-BLK	Two-port EFI Regulator	700	35–85 psi	2 x #8 AN, 1 x #6 AN return
QuickStar EFI	MP-9925-B MP-9925-B-BLK	Two-port EFI Regulator w/ 1:1 Boost Reference	700	35–85 psi	2 x #8 AN, 1 x #6 AN return
QuickStar EFI	MP-9925-C MP-9925-C-BLK	Two-port EFI Bypassing Regulator	700	18–50 psi	2 x #8 AN, 1 x #6 AN return

¹Fittings not included.
Some products legal for racing only; never to be used on public roads or emission-controlled vehicles.

FUEL INJECTION EXPLODED VIEW

Pressure-Adjustment
Screw with Locknut

The Regulator's
top is designed to
prevent damage to
diaphragm due to
over-clamping.

All internals
compatible with
alcohol and exotic
fuel additives.

Diaphragm,
made of MagnaFuel's proven
nitrile-impregnated fabric

Regulator Body with
1/8" NPT Pressure Port

Inlet

Outlet

Boost Reference Fitting

Filtered Vent Fitting

Double reverse-wound springs
for super stability.

Guided-Valve/Seat Assembly

Stainless Steel Seat

O-ring

Flow-shaped Fittings
with AN O-ring Seals

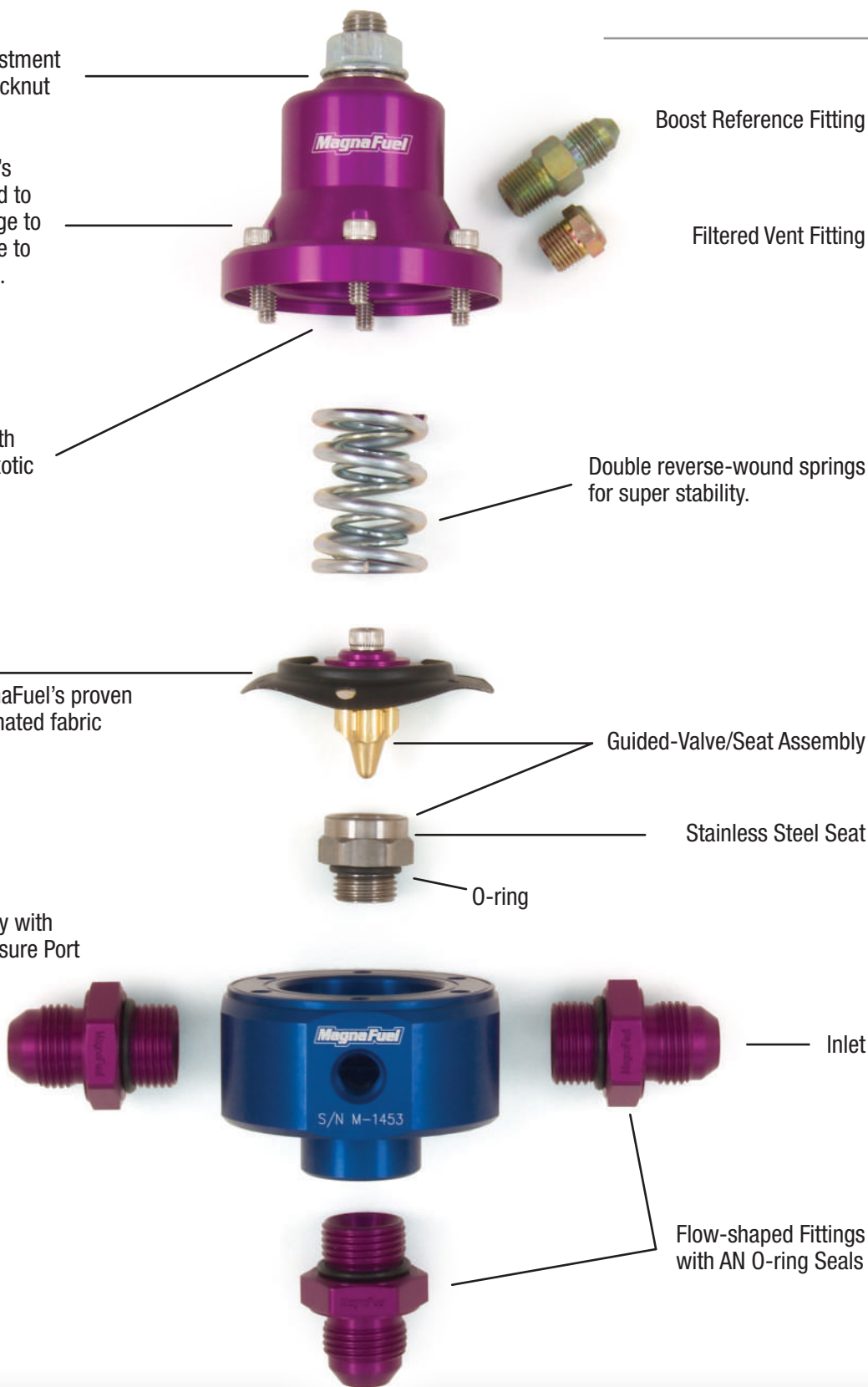

CARBURETOR

CARBURETED PUMPS



Pump with Filter
MP-4450



Pump with Filter
MP-4450-BLK

SAVE ON KITS!

See pages
19 - 24



Standard Pump
MP-4401

Standard Pump
MP-4401-BLK



ProStar 500

Engine Horsepower: 2,000+¹ at 28 psi

The classic: high volume at rated pressure.

- High performance when rated at flow vs. pressure
- External by-pass to eliminate pump cavitations
- Instantaneous compensation for sudden changes in fuel demand
- Consistent, reliable fuel supply for optimum carburetor performance
- Compatible with both alcohol and gasoline racing fuels
- Light weight
- Hand assembled to the highest quality standards
- Pump bodies computer machined out of high quality 6061 Aluminum
- Custom built low amperage motors – the best in the industry
- Compatible with 12- and 16-V electrical systems
- No metal to metal contact for reduced wear and greater reliability
- Blades self-compensating for wear
- Flow tested to ensure maximum performance
- All MagnaFuel pumps are rebuildable to “as-new” factory specifications
- Designed for 12 or 16-volt applications

CARBURETED PUMPS

QuickStar 300

Engine Horsepower: up to 950¹ at 25 psi.

For the requirements of turbo, supercharged or nitrous assist systems, where the high volume of the ProStar is not required.

- Designed for 12 or 16-volt applications.



Pump with Filter
MP-4650

Standard Pump
MP-4601

QuickStar 275

Engine horsepower: up to 750¹ at 18 psi.

A pump that provides the same quality and precision as the ProStar pump.

- Designed for 12 or 16-volt applications.



Pump with Filter
MP-4550

Standard Pump
MP-4501

Model No.	Part No.	Horsepower ¹	Pressure	Amps @ 12.5V	Ports ²	Dimensions	Weight
ProStar 500 with Filter	MP-4450	2,000	25–36 psi	13A @ 28 psi	2 x #12 in and out, #8 bypass	8¼ x 3 x 7"	8 lbs.
ProStar 500	MP-4401	2,000	25–36 psi	13A @ 28 psi	2 x #12 in and out, #8 bypass	5¾ x 3 x 7"	7 lbs.
QuickStar 300 with Filter	MP-4650	950	25–36 psi	10A @ 25 psi	2 x #10 in and out, #8 bypass	8 x 3 x 6¾"	8 lbs.
QuickStar 300	MP-4601	950	25–36 psi	10A @ 25 psi	2 x #10 in and out, #8 bypass	5 x 3 x 6¾"	7 lbs.
QuickStar 275 with Filter	MP-4550	750	18 psi	8A @ 18 psi	2 x #10 in and out, #8 bypass	8 x 3½ x 6½"	7 lbs.
QuickStar 275	MP-4501	750	18 psi	8A @ 18 psi	2 x #10 in and out, #8 bypass	5 x 3½ x 6½"	5.5 lbs.

¹ Power ratings are for naturally aspirated engines running gasoline. ²Fittings not included. Some products legal for racing only; never to be used on public roads or emission-controlled vehicles.

JR DRAGSTER DIAPHRAGM PUMP

- Maximum flow rating exceeds 17 GPH. Flow is based on engine vacuum signal
- Internal design prevents fuel aeration and provides instantaneous compensation for sudden changes in fuel demand based on engine's pressure signal
- Compatible with both alcohol and gasoline racing fuels
- All pumps are hand assembled to the highest quality standards providing superior reliability
- Light weight pump bodies are computer machined out of 6061 Aluminum and include integrated mounting ears
- Includes three #4 to 8mm barb fittings

Diaphragm Pump
MP-4000 and MP-4001
Includes #4-to-8mm barb fittings.

4000 Series Diaphragm Pump

*High performance diaphragm pump
for Jr. Dragsters*

Diaphragm Pump
MP-4000

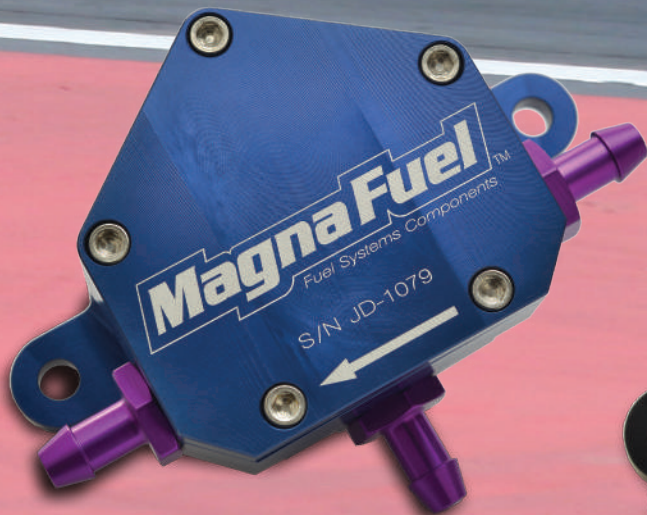

Diaphragm Pump
MP-4000-BLK

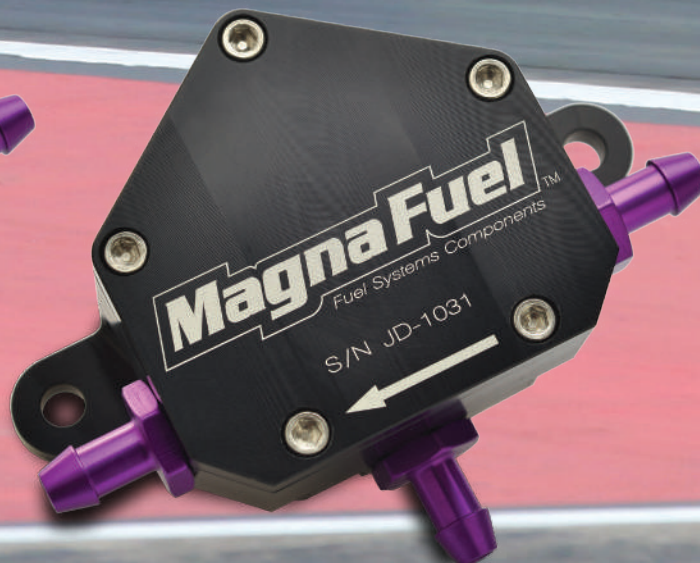



CARTER WARD- NHRA JR DRAGSTER DRIVER

PHOTO BY SRA PHOTO

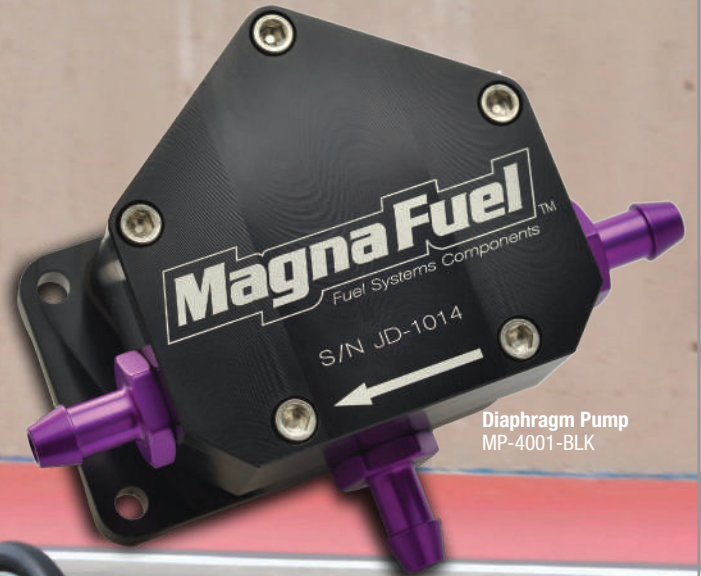

Diaphragm Pump
MP-4001-BLK



Diaphragm Pump
MP-4001



4000 Series Mikuni Mount



4001 Series Walbro Mount

CARBURETOR

CARBURETED REGULATORS



Carbureted Regulators

Engine Horsepower: up to 2,000+¹

Fast response, low maintenance.

- MagnaFuel unique cartridge design provides the most stable platform for fuel delivery in the performance industry
- Durable metal to metal seat for instantaneous response and low maintenance
- Two and four-port configurations available
- 1/8" NPT gauge ports on all models
- Boost-reference models provide a 1:1 compensation ratio
- Suitable for drag racing, circle track, road racing, mud bog, power boat, tractor pulling
- Adjustable base pressure
- Machined from billet aircraft aluminum and anodized for long lasting finish
- Precise pressure control

All Regulators available in standard blue/purple or black.

Part No.	Description	Horsepower	Pressure	Ports ¹
MP-9945 MP-9945-BLK	Bypass Carbureted Regulator	2,000+	3-12 psi	5 x #8 in/out, 1 x #10 return
MP-9433 MP-9433-BLK	4-port Regulator	1,600+	4-12 psi	1 x #10 in, 4 x #6 out
MP-9433-B MP-9433-B-BLK	4-port Boost Reference Regulator	1,600+	4-12 psi	1 x #10 in, 4 x #6 out
MP-9450 MP-9450-BLK	4-port Flow-Thru Regulator	1,600+	4-12 psi	1 x #10 in, 4 x #6 out
MP-9633 MP-9633-BLK	2-port Regulator	750+	4-12 psi	1 x #10 in, 2 x #6 out
MP-9650 MP-9650-BLK	2-port Nitrous Regulator	750+	4-12 psi	1 x #10 in, 2 x #6 out
MP-9690 MP-9690-BLK	2-port Boost Reference Regulator	750+	4-12 psi	1 x #10 in, 2 x #6 out
MP-9833 MP-9833-BLK	Large 2-port Regulator	1,600+	4-12 psi	1 x #10 in, 2 x #8 out
MP-9833-B MP-9833-B-BLK	Large 2-port Boost Reference Regulator	1,600+	4-12 psi	1 x #10 in, 2 x #8 out
MP-9850 MP-9850-BLK	Large 2-port Flow-Thru Regulator	1,600+	4-12 psi	1 x #10 in, 2 x #8 out

¹Fittings not included.

Some products legal for racing only; never to be used on public roads or emission-controlled vehicles.

Large Two-port Regulator
MP-9833-BLK



Two-port Regulator
MP-9633-BLK



Five - port Bypass
Carbureted Regulator
MP-9945-BLK



Two-port Nitrous Regulator
MP-9650



Two-port Boost Reference
Regulator
MP-9690



4-port Flow-Thru Regulator
MP-9450-BLK



Large 2-port
Flow-Thru Regulator
MP-9850-BLK

CARBURETOR EXPLODED VIEW



Original Cartridge Design:

The high-performance MagnaFuel cartridge design is easy to adjust, maintain and repair. Just remove the fasteners and you can check or replace the internal cartridge without removing the regulator body from hoses and mounting bracket.

The top and body are made of computer-machined aluminum. The internal cartridge is custom-machined stainless steel.

Adjustment Screw with Locknut



The Regulator's top is designed to prevent damage to diaphragm due to over-clamping



Special-wound heat-treated stainless steel adjustment spring

Special Design, Lightweight Spring Cup



Diaphragm, made of the highest quality nitrile-impregnated fabric.



Setting Pressure

All pressure adjustments should be made while Regulator is in a flowing condition (motor running at 1,800–2,000 RPM).

MagnaFuel's unique cartridge design simplifies maintenance by eliminating alignment problems.

Regulator Body with 1/8" NPT Pressure Port



Outlet



Outlet



Optional boost reference fitting provides a 1:1 pressure compensation ratio.

Flow-shaped fittings with AN O-ring seals



Inlet



MagnaFuel's flow-shaped fittings reduce restrictions in the fuel flow.



All carbureted regulators include CNC-machined, hard-anodized mounting bracket that attaches to the rear of the regulator.

KITS

FUEL PUMP AND REGULATOR KITS

Dual Four-barrel Carburetor up to 1,600 hp



Qty.	Part No.	Description
1	MP-4450	Pro Star 500 w/Filter
1	MP-9433	4 Port Regulator
1	MP-1050	Dual Relay Harness
1	MP-3006	#12 Bulkhead
1	MP-3009	#12AN x #12 Straight
1	MP-3019	#10AN x #12 Straight
1	MP-3007	#10AN x #10 Straight
4	MP-3012	#6AN x #6 Straight
4	MP-3501	#6AN x Holley

MP-4810-B Boost Reference Applications

Single Four-barrel Carburetor up to 750 hp



Qty.	Part No.	Description
1	MP-4450	Pro Star 500 w/Filter
1	MP-9633	2 Port Regulator
1	MP-1050	Dual Relay Harness
1	MP-3006	#12 Bulkhead
1	MP-3009	#12AN x #12 Straight
1	MP-3019	#10AN x #12 Straight
1	MP-3007	#10AN x #10 Straight
2	MP-3012	#6AN x #6 Straight
2	MP-3501	#6AN x Holley

FUEL PUMP AND REGULATOR KITS

Single Four-barrel Carburetor up to 1,600 hp

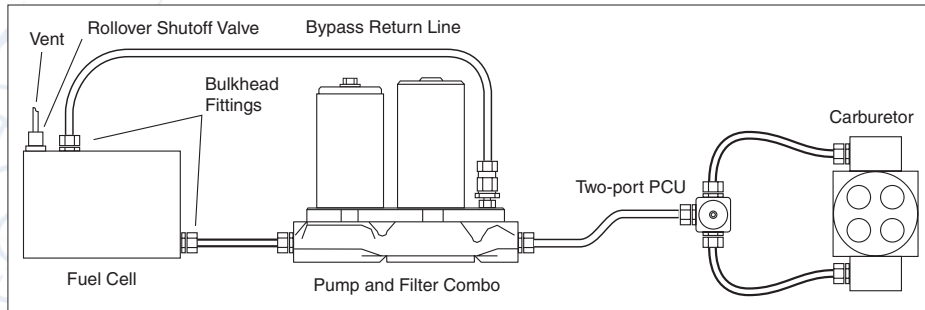

MP-4812 Pro Star 500 Large 4-barrel Kit

Qty.	Part No.	Description
1	MP-4450	Pro Star 500 w/Filter
1	MP-9833	Large 2 Port Regulator
1	MP-1050	Dual Relay Harness
1	MP-3006	#12 Bulkhead
1	MP-3009	#12AN x #12 Straight
1	MP-3019	#10AN x #12 Straight
1	MP-3007	#10AN x #10 Straight
2	MP-3022	#6AN x #8 Straight
2	MP-3501	#6AN x Holley

MP-4812-B Boost Reference Applications

EFI Pump and Regulator for ProStock Carburetor

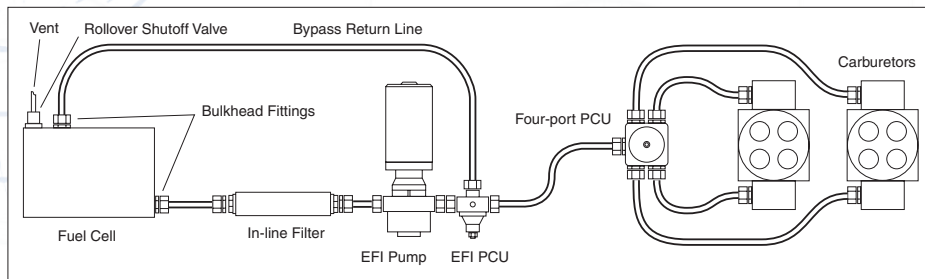

MP-4819 EFI 625 Kit

Qty	Part No.	Description
1	MP-4701	EFI Fuel Pump 625
1	MP-9950-C	Large 2 Port EFI Regulator
1	MP-3006	#12 Bulkhead
3	MP-3005	#12F X #10S
1	MP-3007	#10F X #10S
1	MP-7009	Medium In-Line PreFilter 74 Micron
1	MP-3028	#10 X #8 Coupler
1	MP-3013	#8F X #8S
1	MP-3016	#10F X #8S
1	MP-9433	.33" 4 Port Regulator
4	MP-3012	#6F X #6S
4	MP-3501	#6F x Holley

FUEL PUMP AND REGULATOR KITS

Fuel-injection with Swivel Pump Head for 1,000+ hp

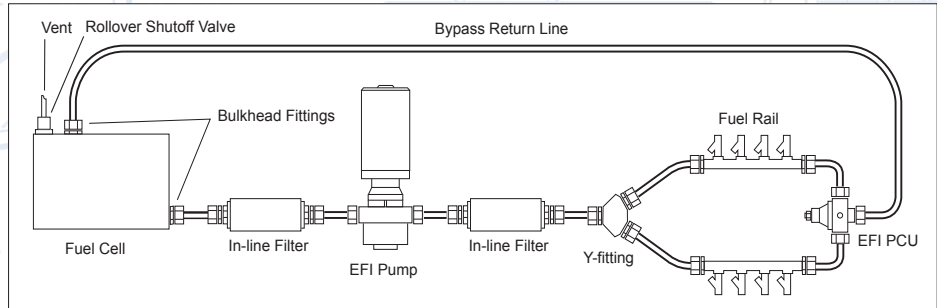

MP-4813 EFI 625 Kit with Swivel Head

Qty.	Part No.	Description
1	MP-4701	EFI Fuel Pump 625
1	MP-9950	ProStar Large 2 Port EFI Regulator
1	MP-3006	#12 Bulkhead
3	MP-3005	#12F X #10S
3	MP-3007	#10F X #10S
1	MP-7009	Medium In-Line PreFilter 74 Micron
1	MP-7008	Medium In-Line AfterFilter 25 Micron
2	MP-3022	#6F X #8S
1	MP-3013	#8F X #8S
1	MP-6208	Y-Fitting - 1 #10AN by 2 #8AN
1	MP-1050	Dual Relay Harness

MP-4813-B Boost Reference Applications

Fuel-injection with Fixed Pump Head for 1,000+ hp



MP-4814 EFI 625 Kit with Fixed Head

Qty.	Part No.	Description
1	MP-4101	EFI Fuel Pump 625
1	MP-9950	ProStar Large 2 Port EFI Regulator
1	MP-3006	#12 Bulkhead
3	MP-3005	#12F X #10S
3	MP-3007	#10F X #10S
1	MP-7009	Medium In-Line PreFilter 74 Micron
1	MP-7008	Medium In-Line AfterFilter 25 Micron
2	MP-3022	#6F X #8S
1	MP-3013	#8F X #8S
1	MP-6208	Y-Fitting - 1 #10AN by 2 #8AN
1	MP-1050	Dual Relay Harness

MP-4814-B Boost Reference Applications

FUEL PUMP AND REGULATOR KITS

Single Four-barrel Carburetor for 950 hp

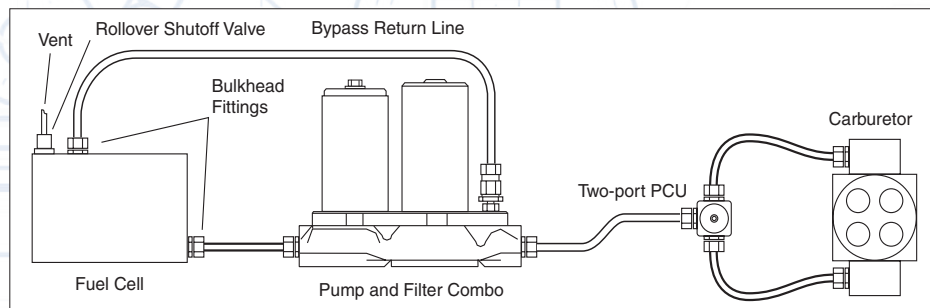

MP-4817 Quick Star 300 Kit

Qty	Part No.	Description
1	MP-4650	Quick Star 300 w/ Filter
1	MP-9833	Hi-Flo 2 Port Regulator
1	MP-3008	#10 Bulkhead
3	MP-3007	#10F X #10S
2	MP-3022	#6F X #8S
1	MP-1050	Dual Relay Harness
2	MP-3501	#6F X Holley

Single Four-barrel Carburetor for 750 hp

MP-4818 Quick Star 275 Kit

Qty	Part No.	Description
1	MP-4550	Pump and Filter Combo
1	MP-9633	.33" 2 Port Regulator
1	MP-3008	#10 Bulkhead
1	MP-3007	#10F X #10S
2	MP-3017	#8F X #10S
2	MP-3012	#6F X #6S
1	MP-1050	Dual Relay Harness
2	MP-3501	#6F X Holley



FUEL PUMP AND REGULATOR KITS

In-line Pump for Fuel Injection 800 hp or more

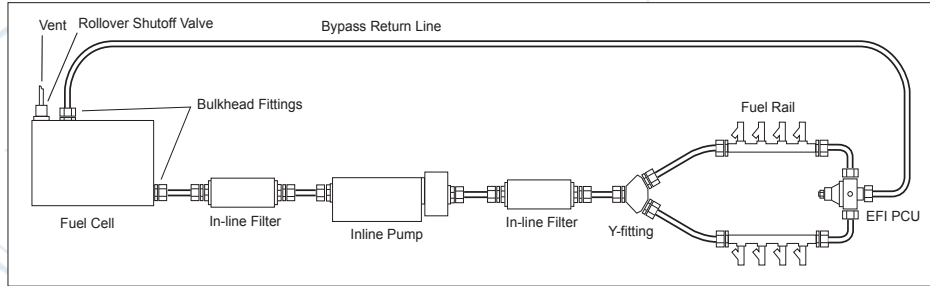

MP-4815 In-Line Pump Kit (800 HP or more)

Qty.	Part No.	Description
1	MP-4301	625 In-Line Pump
1	MP-3006	#12 Bulkhead
2	MP-3005	#12F X #10S
2	MP-3007	#10F X #10S
1	MP-7008	Medium In-Line AfterFilter 25 Micron
1	MP-7009	Medium In-Line PreFilter 74 Micron
1	MP-3016	#10F X #8S
2	MP-3022	#6F X #8S
1	MP-3023	#12F X #8S
1	MP-6208	Y-Fitting - 1 #10AN by 2 #8AN
1	MP-9950	Pro Star EFI Regulator
1	MP-3013	#8F X #8S
1	MP-1050	Dual Relay Harness

MP-4815-B Boost Reference Applications

In-line Pump for Fuel Injection up to 800 hp



MP-4816 In-Line Pump Kit (800 HP or less)

Qty.	Part No.	Description
1	MP-4302	525 In-Line Pump
1	MP-3008	#10 Bulkhead
2	MP-3007	#10F X #10S
1	MP-7010	Small In-Line AfterFilter 25 Micron
1	MP-7009	Medium In-Line PreFilter 74 Micron
1	MP-3016	#10F X #8S
3	MP-3013	#8F X #8S
1	MP-6288	Y-Fitting - 1 #8AN by 2 #8AN
1	MP-9925	EFI Regulator
2	MP-3022	#6F X #8S
1	MP-1050	Dual Relay Harness
1	MP-3012	#6F X #6S

MP-4816-B Boost Reference Applications

FUEL PUMP AND REGULATOR KITS

Belt Drive Diagrams

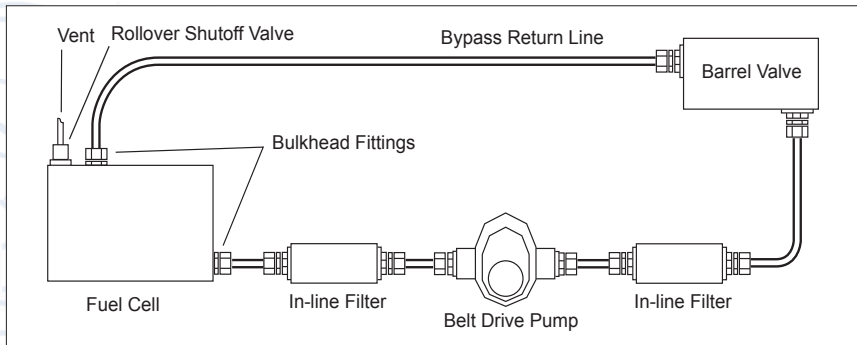

MFI-Belt Drive

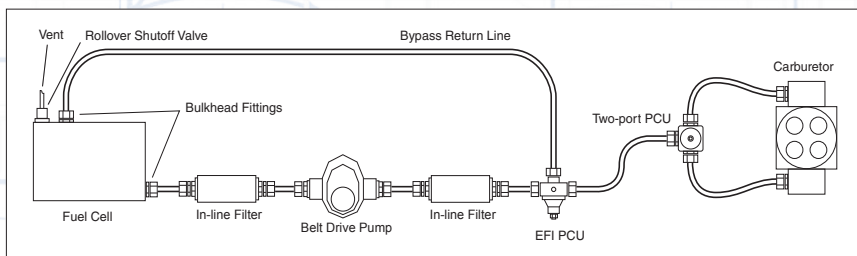

Belt Drive Single Carburetor

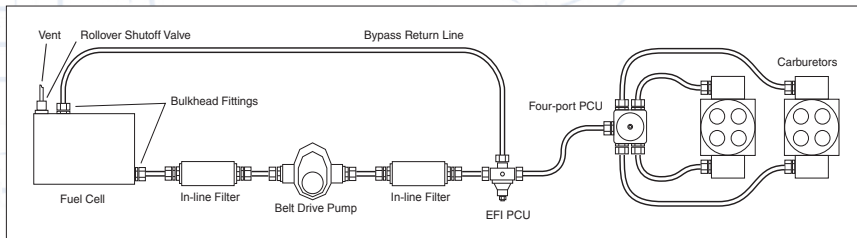

Belt Drive Duel Carburetor

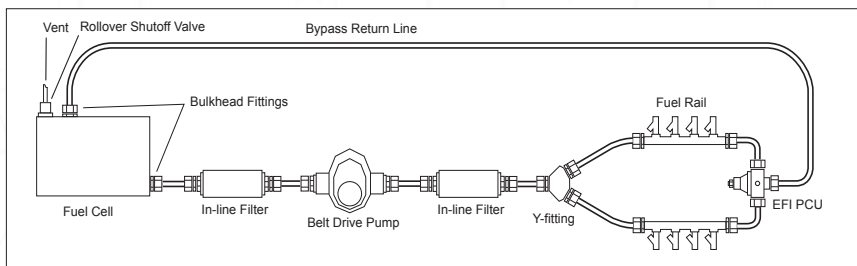

Belt Drive EFI

InLine Pump in Carburetor Application

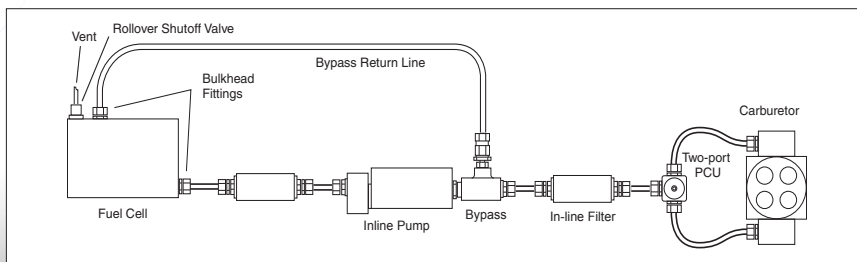

Carburetor Swivel Pump

NITROUS OXIDE REGULATOR KITS

Pump/Filter Combo for Single 4-bbl Carburetor with Single Stage Nitrous Fuel Enrichment Circuit with Solenoid Air Bleed

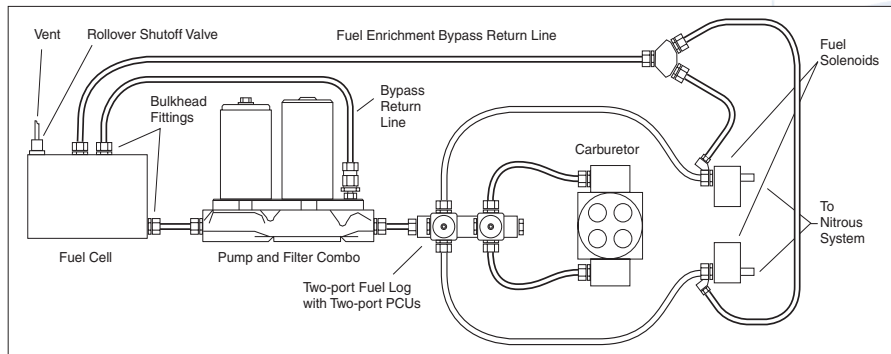

Single Four-barrel Carburetor with One-stage Nitrous (MP-9520) or Two-stage Nitrous Regulator (MP-9540)*

Qty.	Part No.	Description
2	MP-9633	Two-port regulator
2	MP-3011	#10 X #10 coupler
1	MP-7600-2	Double fuel log
1	MP-3007	#10 AN X #10 straight fitting (fuel log inlet)
1	MP-3002	#10 port plug

Single Four-barrel Carburetor with Two-stage Nitrous Under 700hp (MP-9525)*

Qty.	Part No.	Description
3	MP-9633	Two-port Regulator
3	MP-3011	#10 X #10 coupler
1	MP-7600-3	Triple fuel log
1	MP-3007	#10 AN X #10 straight fitting (fuel log inlet)
1	MP-3002	#10 port plug

Dual Four-barrel Carburetor with One-stage Nitrous (MP-9530)*

Qty.	Part No.	Description
1	MP-9433	Four-port Regulator
1	MP-9633	Two-port Regulator
2	MP-3011	#10 X #10 coupler
1	MP-7600-2	Double fuel log
1	MP-3007	#10 AN X #10 straight fitting (fuel log inlet)
1	MP-3002	#10 port plug



MP-9540-BLK
Regulator outlet fittings not included.

MP-9575
Optional bypass

*Also available in the new black finish. When ordering you part, make sure to designate BLK to your order.

AIR-BLEED SYSTEMS



Air Bleed Systems

We strongly recommend using an air bleed with all nitrous Regulators to eliminate air from the fuel system and allow for easy adjustment of the Regulator at a flowing condition.

Part No.	Description
MP-9575	Dual air-bleed system (shown)
MP-9580	Triple air-bleed system
MP-9585	Nitrous fuel solenoid air bleed



Air Bleed Adapter Fitting

Part No.	Description
MP-3110	#3 x 1/8" pipe x 1/8" pipe with pill

NITROUS OXIDE REGULATOR KITS

Pump/Filter Combo for Dual 4-bbl Carburetor with Single Stage Nitrous Fuel Enrichment Circuit with Dual Air Bleed

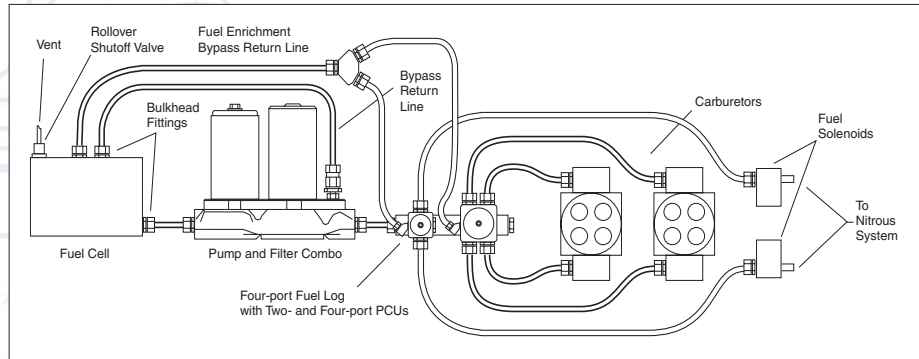

Dual Four-barrel Carburetor with Two-stage Nitrous (MP-9535)*

Qty.	Part No.	Description
1	MP-9433	Four-port Regulator
2	MP-9633	Two-port Regulator
3	MP-3011	#10 X #10 coupler
1	MP-7600-3	Triple fuel log
1	MP-3007	#10 AN X #10 straight fitting (fuel log inlet)
1	MP-3002	#10 port plug

Three-stage Nitrous Regulator (MP-9545)*

Qty.	Part No.	Description
3	MP-9633	Two-port Regulator
3	MP-3011	#10 X #10 coupler
1	MP-7600-3	Triple fuel log
1	MP-3007	#10 AN X #10 straight fitting (fuel log inlet)
1	MP-3002	#10 port plug

Single Four-barrel Carburetor with One stage of nitrous 700+ Engine HP (MP-9550)*

Qty.	Part No.	Description
1	MP-9833	Hi-Flo 2 Port Regulator
1	MP-9633	Two-port Regulator
2	MP-3011	#10 X #10 coupler
1	MP-7600-2	Double fuel log
1	MP-3007	#10 AN X #10 straight fitting (fuel log inlet)
1	MP-3002	#10 port plug

Single Four-barrel Carburetor with Two stages of nitrous 700+ Engine HP (MP-9555)*

Qty.	Part No.	Description
1	MP-9833	Hi-Flo 2 Port Regulator
2	MP-9633	Two-port Regulator
3	MP-3011	#10 X #10 coupler
1	MP-7600-3	Triple fuel log
1	MP-3007	#10 AN X #10 straight fitting (fuel log inlet)
1	MP-3002	#10 port plug



MP-9535
Regulator outlet fittings not included.

*Also available in the new black finish.
When ordering you part, make sure to designate BLK to your order.

WIRING KITS

RELAY HARNESSSES

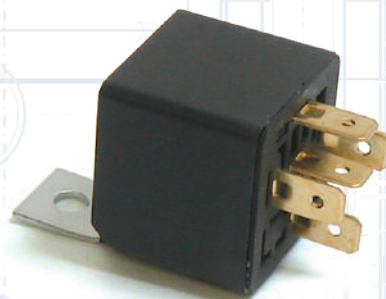
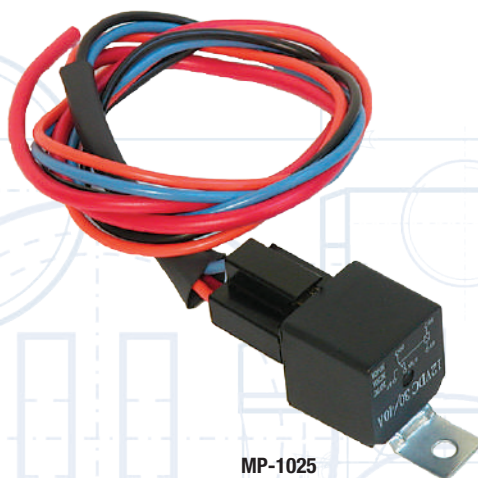
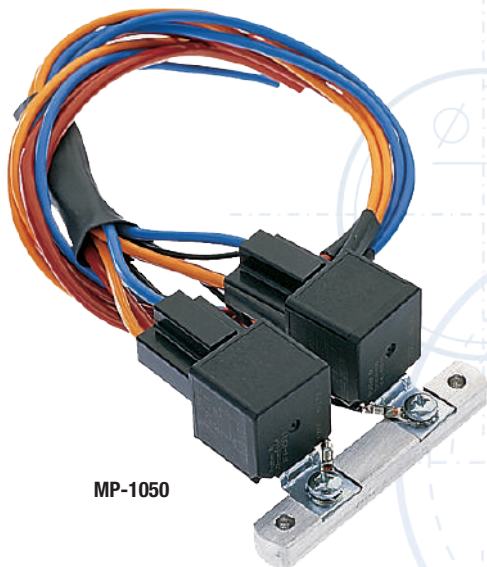

Eliminate long wire runs that cause voltage drops. 12 VDC, 40/30A.

Part No.	Description
MP-1010	Electric relay
MP-1025	Single electric relay harness
MP-1050	Dual electric relay harness

- Use with electric fans, water pumps, nitrous/fuel solenoids, fuel pumps, lighting systems, etc.
- MagnaFuel always recommends the Dual Relay Harness for redundancy

MP-1025 Single Relay harness wiring

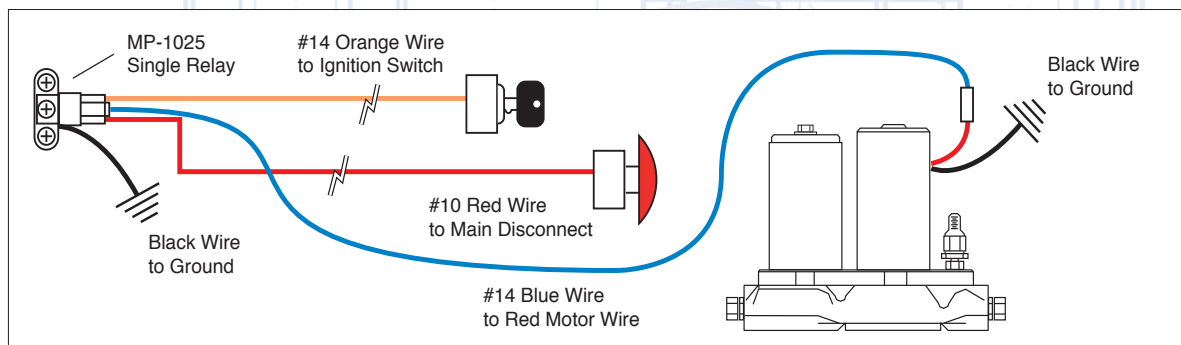

MP-1050 Dual Relay harness wiring

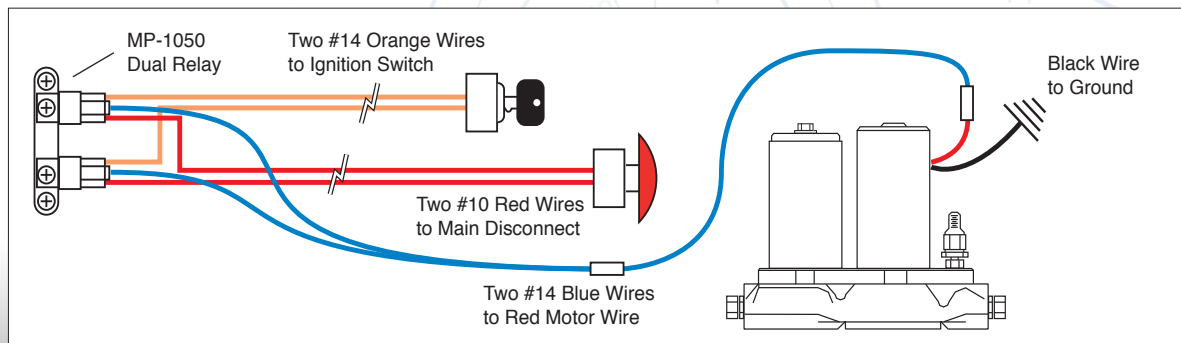

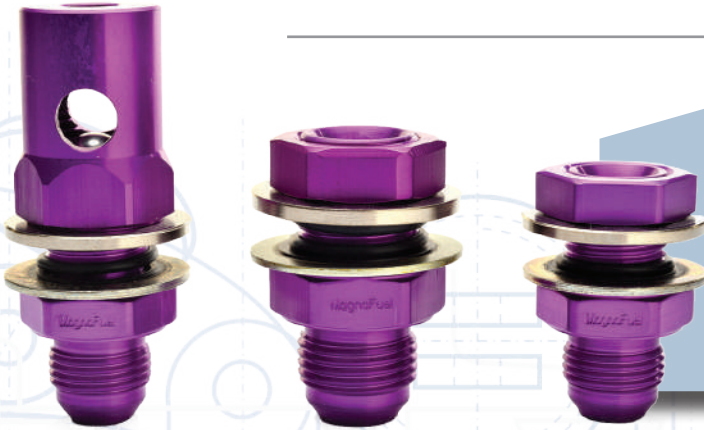

Fuel Cell Kit*

Use these fittings to connect vent, inlet and outlet lines to your racing fuel cell. Kit includes (1) Rollover Valve/Vent, (2) Bulkhead Outlet and (3) Bulkhead Bypass Return. All fittings include O-rings and washers. See page 32 for replacement Bulkhead O-ring and washer kits.

Part No.	Description
MP-3623	#10 outlet, #8 return, #8 vent
MP-3624	#12 outlet, #8 return, #8 vent

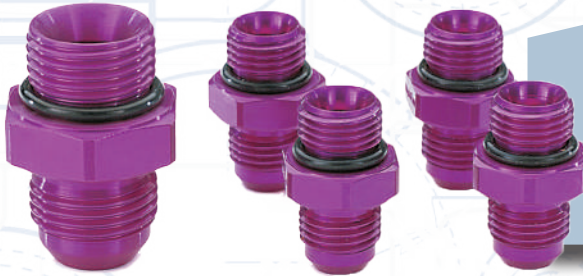

Four-port Regulator Kit

Use this fitting kit on your four-port Regulator. All fittings include O-rings.

MP-9433 Regulator Kits*

Part No.	Description
MP-3604	#10 in & (4) #6 out
MP-3605	#10 in & (4) #8 out



Pump Fitting Kit

Fittings for inlet and outlet of pump. All fittings include O-rings.

PS-500 Pump, Std or Combo*

Part No.	Description
MP-3614	#12 in & #10 out
MP-3613	#10 in & #10 out

PS-600 EFI*

Part No.	Description
MP-3617	#12 in & #8 out
MP-3618	#10 in & #8 out
MP-3619	#12 in & #10 out
MP-3620	#10 in & #10 out

ProTuner*

Part No.	Description
MP-3633	#12 in #10 out
MP-3634	#10 in #8 out

QS-300, 275, EFI and EFI DXL Pumps, Std or Combo*.

Part No.	Description
MP-3612	#10 in & #10 out
MP-3611	#10 in & #8 out

EFI Pump, 4700 and 4100 Series*

Part No.	Description
MP-3631	#12 in #10 out
MP-3632	#10 in #10 out



Two-port Regulator Kit (carb & EFI)

Use this fitting kit on your two-port Regulator. All fittings include O-rings.

MP-9633 Regulator Kits*

Part No.	Description
MP-3600	#8 in & (2) #6 out
MP-3601	#8 in & (2) #8 out
MP-3602	#10 in & (2) #6 out
MP-3603	#10 in & (2) #8 out

MP-9925 EFI Regulator Kits*

Part No.	Description
MP-3626	(2) #6 in & #6 out
MP-3627	(2) #6 in & #8 out
MP-3628	(2) #8 in & #8 out

MP-9833 Regulator Kits*

Part No.	Description
MP-3606	#8 in & (2) #6 out
MP-3607	#8 in & (2) #8 out
MP-3608	#10 in & (2) #6 out
MP-3609	#10 in & (2) #8 out

MP-9950 EFI Regulator Kits*

Part No.	Description
MP-3629	(2) #6 in & #8 out
MP-3630	(2) #8 in & #8 out

*Also available in the new black finish. When ordering your part, make sure to designate BLK to your order.

PARTS AND ACCESSORIES

'Y' FITTINGS

*The only true one-piece 'Y' fitting design.
They will not fail.*



- Great for any liquid or gas application where a high-flow splitter is needed.
- MagnaFuel's sleek new Y-fitting design replaces a seven-piece assembly when compared to Y-block with fittings and O-rings
- Smoother flow path
- One-piece design is compact and lightweight. This eliminates leaks due to poor solder joints or leaky O-rings.
- CNC-machined from one-piece 6061-T6 billet
- Hard-anodized coating is compatible with alcohol, exotic fuel-additives, water and oil
- Laser-etched logo and AN fitting sizes
- High flow capacity
- Sizes available to accommodate most plumbing needs

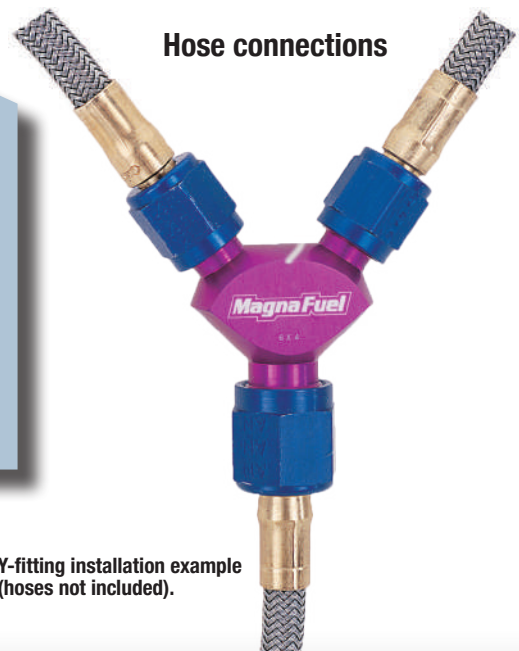

Hose connections

Y-fitting installation example
(hoses not included).

PARTS AND ACCESSORIES

'Y' FITTINGS



Cutaway view



AN Sizes

Part No.	Single	Double
MP-6200	#10	#10
MP-6208	#10	#8
MP-6220	#12	#10
MP-6222	#12	#12
MP-6228	#12	#8
MP-6231	1/8" NPT	#3
MP-6233	#3	#3
MP-6244	#4	#4
MP-6263	#6	#3
MP-6264	#6	#4
MP-6266	#6	#6
MP-6283	#8	#3
MP-6286	#8	#6
MP-6288	#8	#8
Part No.	Single	Triple
MP-6363	#6	#3
MP-6364	#6	#4
MP-6366	#6	#6
MP-6383	#8	#3

AN Sizes

Part No.	Single	Double
MP-6200-BLK	#10	#10
MP-6208-BLK	#10	#8
MP-6220-BLK	#12	#10
MP-6222-BLK	#12	#12
MP-6228-BLK	#12	#8
MP-6231-BLK	1/8" NPT	#3
MP-6233-BLK	#3	#3
MP-6244-BLK	#4	#4
MP-6263-BLK	#6	#3
MP-6264-BLK	#6	#4
MP-6266-BLK	#6	#6
MP-6283-BLK	#8	#3
MP-6286-BLK	#8	#6
MP-6288-BLK	#8	#8
Part No.	Single	Triple
MP-6363-BLK	#6	#3
MP-6364-BLK	#6	#4
MP-6366-BLK	#6	#6
MP-6383-BLK	#8	#3

PARTS AND ACCESSORIES



MP-6120



MP-6150



MP-6160

Y-block

Join or split fuel lines for a neat installation with minimal flow loss.

Part No. Description

MP-6120 One #12 port and two #10 ports

MP-6150 One #8 port and three #6 ports with mounting holes

MP-6160 One #8 port and two #6 ports

Quad-Y-Block

Part No. MP-6110-BLK

Takes one #8AN and splits it to four 1/16 NPT fittings.



Replacement Filter

Part No. MP-7050

Polyethylene filter is cleanable and reusable. Alcohol compatible. Fits all "Pump with Filter" filter housings. O-ring used in 500 series pumps only.



Seal Kit

Keep a seal kit in your tool box just in case. These kits are composed of the exact same seals that go in your pump when it's new. They are the highest quality available.

Part No.

MP-4401-SK PS-500 Pump w/o Filter

MP-4450-SK PS-500 Pump w/ Filter

MP-4501-SK QS-275 and 300 Pump w/o Filter

MP-4550-SK QS-275 and 300 Pump w/Filter

MP-4301-SK ProTuner Pumps

MP-4701-SK ProStar EFI, SQ, Pro Outlaw, and Outlaw Pumps



Regulator Diaphragm Kits

Part No.

MP-9400-03 Four Port and Large Two Port Regulators

MP-9600-03 Standard Two Port Regulators

MP-9950-03 ProStar EFI and Carb Bypass Regulators

MP-9925-03 QuickStar EFI Regulators

Bulkhead O-Ring & Washer Kit

Factory replacement seals for the MP-3006, MP-3008, and MP-3014 bulkhead fittings.

Part No. AN Size

MP-3301 #8

MP-3302 #10

MP-3303 #12



Mounting Brackets

Regulator to Carburetor Bracket

MP-964150 Carb bracket for 4150/4160 and MP-9633 Regulator

MP-964500 Carb bracket for 4500 and MP-9633 Regulator

MP-944150 Carb bracket for 4150/4160 and MP-9433/MP-9833 Regulators

MP-944500 Carb bracket for 4500 and MP-9433/MP-9833 Regulators



MP-9400-16

Carbureted Regulator Bracket

MP-9950-16

EFI Regulator Bracket



Standard Mounting Bracket

All pumps come with standard clear zinc-plated steel mounting bracket and pump-side hardware.

Part No. Description

MP-4401-16 Pump Mounting Bracket with bolts and washers

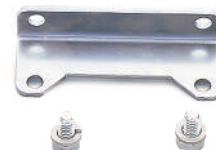

Fuel Pump Mounting Kit

Give your pump a quieter, more stable mount. Can be used with both the 500 and 300 Series pumps. Used with the stock mounting bracket and a cushioned clamp to give extra stability to the motor.

Part No. Description

MP-4900 Band clamp



Jet Plate

Keep jets organized and free from damage. Jets screw in and out. For Holley®-style carburetor jets.

Part No. Description

MP-2000 Billet aluminum jet plate



Pressure Gauges

Accurate pressure readings are critical for proper calibration. MagnaFuel supplies 1½" diameter gauges. These are the right tools for the job. All come with easy-to-read black faces.

Part No. Description

MP-0101 MagnaFuel logo gauge (0-15 psi).

MP-0102 MagnaFuel logo gauge (0-60 psi).

MP-0103 MagnaFuel logo gauge (0-100 psi).

MP-0104 MagnaFuel logo gauge (0-30 psi).



MP-0101



MP-0102



MP-0103



MP-0104

PARTS AND ACCESSORIES

FUEL FITTINGS

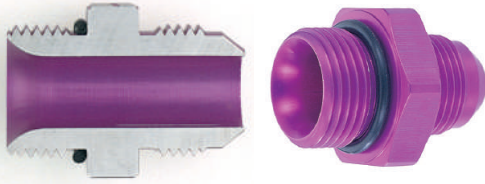

Many MagnaFuel fittings are flow-shaped; computer-machined to provide the best possible flow by eliminating sharp edges and angles that cause flow losses and aeration.

Barbed Fittings*

Part No.	Description
MP-3092	8mm Barb x #6S
MP-3093	3/16 Barb x 1/8 NPT
MP-3094	1/8" Barb to 10-32 Thread
MP-3097	1/4" Barb to #8
MP-3098	8mm Barb to #4
MP-3099	8mm Barb to #8



Coupler Fitting



Flow shaped

Part No.	Str. Size
MP-3010-BLK	#12 x #12
MP-3011-BLK	#10 x #10
MP-3004-BLK	#8 x #8
MP-3028-BLK	#10 x #8
MP-3029-BLK	#10 x 3/8 NPT
MP-3030-BLK	#10 x 3/8 npt w/ Jam Nut
MP-3031-BLK	#10 x #12



O-ring Port Plug

Part No.	Str. Size
MP-3000-BLK	#6
MP-3001-BLK	#8
MP-3002-BLK	#10
MP-3003-BLK	#12

Bulkhead Fittings

Part No.	Str. Size
MP-3014-BLK	#8
MP-3008-BLK	#10
MP-3006-BLK	#12

Flow shaped



Plugs with 1/8" NPT in Center*

Part No.	Str. Size
MP-3071	#6
MP-3072	#8
MP-3073	#10
MP-3074	#12



Part No.	AN Size
MP-3083	#10

Rollover Shut-off Valve For Fuel Cell*

Part No.	Description
MP-3125	#8AN vent valve

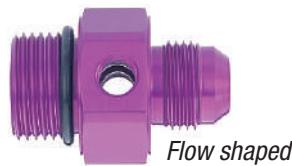

Flow shaped

1/8" NPT Fuel Gauge Port Adapter*

Part No.	An Size	Str. Size
MP-3062	#8	#10*
MP-3063	#10	#10
MP-3064	#10	#12

Part No.	An Size	Pipe
MP-3065	#6	1/8" NPT male

*with only one gauge port

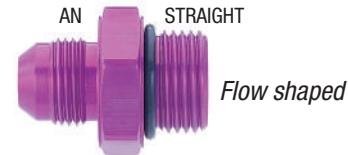

Flow shaped

AN Flare-to-Straight Adapters*

Part No.	AN Size	Str. Size
MP-3024	#3	#6
MP-3020	#4	#10
MP-3012	#6	#6
MP-3022	#6	#8
MP-3021	#6	#10
MP-3015	#8	#6
MP-3013	#8	#8
MP-3017	#8	#10
MP-3018	#8	#12
MP-3025	#10	#6
MP-3027	#16	#12
MP-3016	#10	#8
MP-3007	#10	#10
MP-3019	#10	#12
MP-3023	#12	#8
MP-3005	#12	#10
MP-3009	#12	#12

*Also available in the new black finish.
When ordering you part, make sure to designate BLK to your order.

PARTS AND ACCESSORIES

FUEL LOGS



MP-7600-04-BLK

MP-7600-03-BLK

MP-7600-02-BLK

MP-7600-01-BLK

Fuel Logs

Designed to configure multiple Regulators with less restriction and even fuel distribution. All ports are #10 AN.

Part No.	Description
MP-7600-01	Single fuel log
MP-7600-01-BLK	Single fuel log
MP-7600-02	Double fuel log
MP-7600-02-BLK	Double fuel log
MP-7600-03	Triple fuel log
MP-7600-03-BLK	Triple fuel log
MP-7600-04	Quad fuel log
MP-7600-04-BLK	Quad fuel log



MP-7600-03



MP-7600-02

PHOTO BY GRAY MOTORSPORTS



Holley® Fuel Logs

Designed to configure multiple Holley® Regulators with less restriction and even fuel distribution. End Ports #10, Top Ports #8.

Part No.	Description
MP-7610-03	Three Port Log for Holley 12-803 Regulators
MP-7610-03-BLK	Three Port Log for Holley 12-803 Regulators
MP-7610-04	Four Port Log for Holley 12-803 Regulators
MP-7610-04-BLK	Four Port Log for Holley 12-803 Regulators
MP-7610-05	Five Port Log for Holley 12-803 Regulators
MP-7610-05-BLK	Five Port Log for Holley 12-803 Regulators

MP-7610-05-BLK

MP-7610-04-BLK

MP-7610-03-BLK



TANNER GRAY - 2018 NHRA PRO STOCK CHAMPION

PARTS AND ACCESSORIES

IN-LINE FUEL FILTERS



Protect expensive components with an in-line filter

MagnaFuel's custom-machined In-line Fuel Filters keep your carburetor and engine free of harmful debris.

These handsome filters protect your investment for many years. All MagnaFuel filters have top-quality reusable elements. The medium filters are available with two different elements with different porosities.

Exploded View



Inlet
Very Coarse
(150 micron)

Inlet Coarse
(74 micron)

Outlet Fine
(25 micron)

Outlet
Super Fine
Cellulose
(10 micron)

- Bodies, end caps made from anodized aircraft aluminum for superior strength and corrosion-resistance
- End caps equipped with o-rings for leak-proof operation
- Choose 10, 25, 74 or 150 micron filters (MagnaFuel recommends 74 for inlet, 25 for outlet before the carburetor/regulators)
- Stainless steel reinforced basket-shaped filter element (7009, 7008, 7010)
- Works great for both gasoline and alcohol
- Easy to disassemble, clean and reassemble
- High-flow, cleanable and replaceable elements
- Light, compact
- Virtually no loss of flow volume or pressure
- Hard anodized coating
- Cleanable, reusable and replaceable filter elements
- Gas and methanol/ethanol/oil compatible
- Female AN ports for a variety of fitting options

Model	Part No.	Filter Size	Ports	Dimensions	Replacement Elements
PreFilter	MP-7006 MP-7006-BLK	150 micron	#12 in/out	6½ x 2½" dia	MP-7055
AfterFilter	MP-7007 MP-7007-BLK	10 micron	#10 in/out	4¼ x 2" dia	MP-7060-10
AfterFilter	MP-7008 MP-7008-BLK	25 micron	#10 in/out	4¼ x 2" dia	MP-7060-25
PreFilter	MP-7009 MP-7009-BLK	74 micron	#10 in/out	4¼ x 2" dia	MP-7060-74
AfterFilter	MP-7010 MP-7010-BLK	25 micron	#8 in/out	4½ x 1½" dia	MP-7065
AfterFilter	MP-7011 MP-7011-BLK	10 micron	#8 in/out	4½ x 1½" dia	MP-7065-10

FUEL CELLS

Fuel Cell Bulkhead Filter Kit



Bulkhead Filter Kits

- MP-7025 Bulkhead Filter Kit 10 Micron Cellulose
- MP-7025-BLK Bulkhead Filter Kit 10 Micron Cellulose
- MP-7026 Bulkhead Filter Kit 74 Micron Stainless
- MP-7026-BLK Bulkhead Filter Kit 74 Micron Stainless

Replacement Elements

- MP-7026-74 Stainless 74 Micron Element for 7026
- MP-7025-10 Cellulose 10 Micron Element for 7025

These install in the fuel cell for applications with minimal space. They are radius flow shaped for maximum uninterrupted flow. For a #12 connection.



MP-7026
Fuel Cell Bulkhead Filter Kit

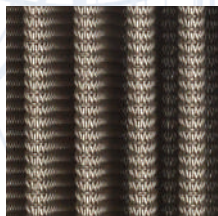

MP-7026-74
Replacement Element for MP-7026
Stainless 74 Micron



MP-7025-BLK
Fuel Cell Bulkhead Filter Kit

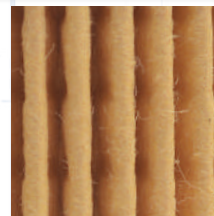

Outlet
Super Fine Cellulose
(10 micron)

ANTI-REVERSION PLATES

*Increase airflow by extending carburetor bore.
Gasketed plates isolate vibration and help prevent fuel cavitation.*

MagnaFuel's custom-machined Anti-Reversion Plates (shear plates) keep your carburetor flowing at or beyond its CFM rating by reducing intake reversion at high RPM. These plates help prevent airflow reversion by redirecting the hot gasses that can rise into the intake manifold as the intake valve opens and the exhaust valve is still closing. These re-directed gasses can then help release and atomize fuel droplets that sometimes stick and drip down the carburetor bores.

If you run aggressive cam overlap, without MagnaFuel's Anti-Reversion Plate, these hot gasses disrupt the cool intake charge, reducing flow, dampening the carburetor booster signal and creating unwanted turbulence.

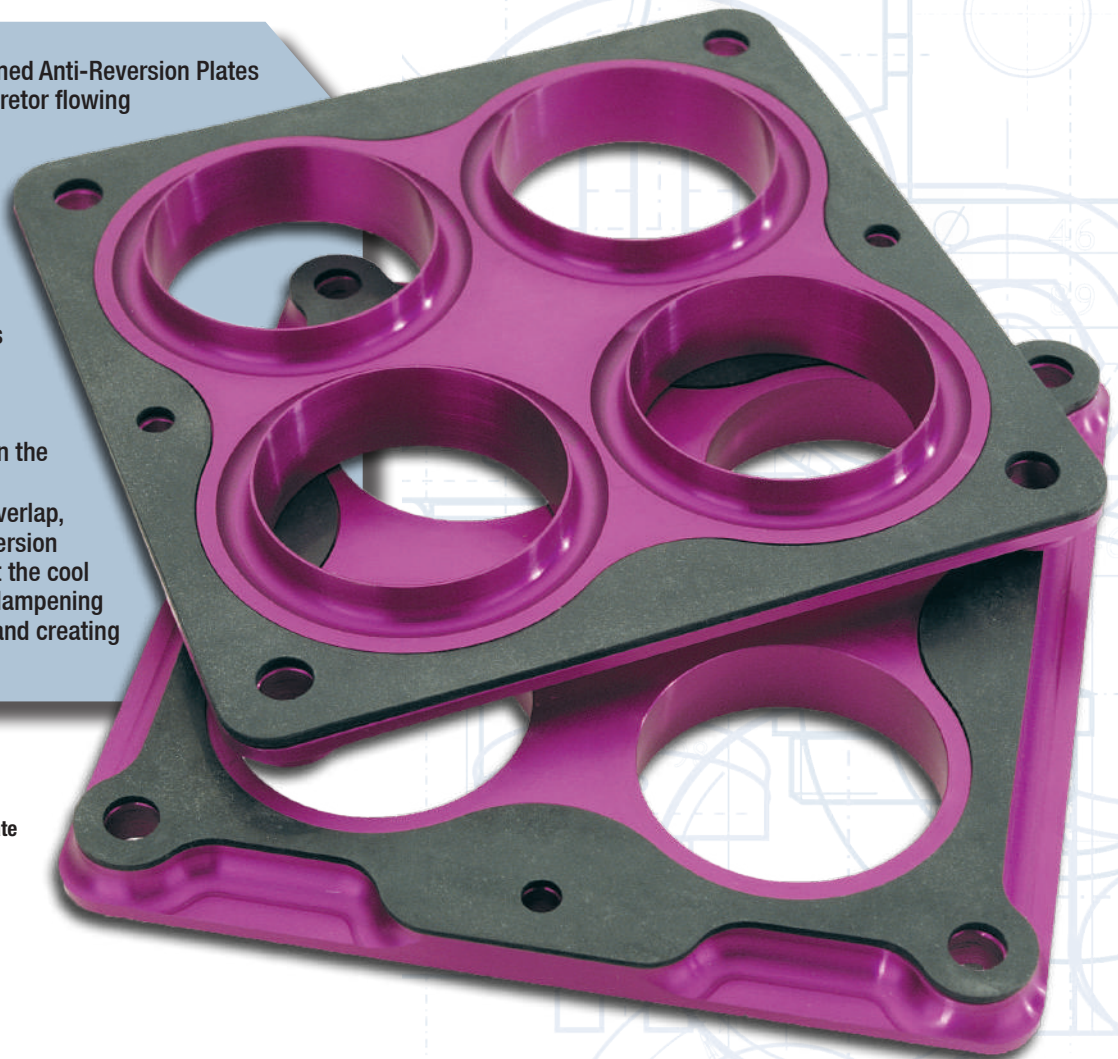

Dominator
Anti-reversion Plate
MP-5010

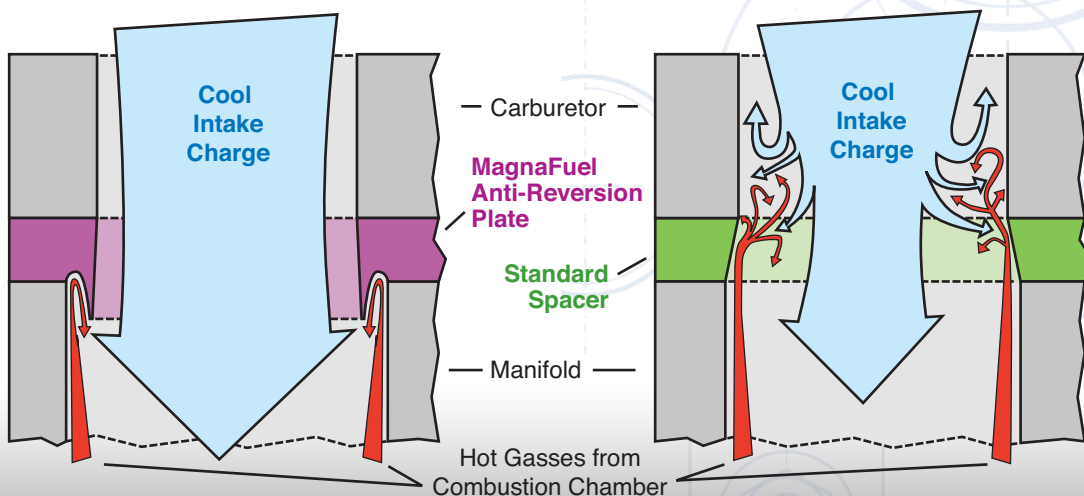

ANTI-REVERSION PLATES

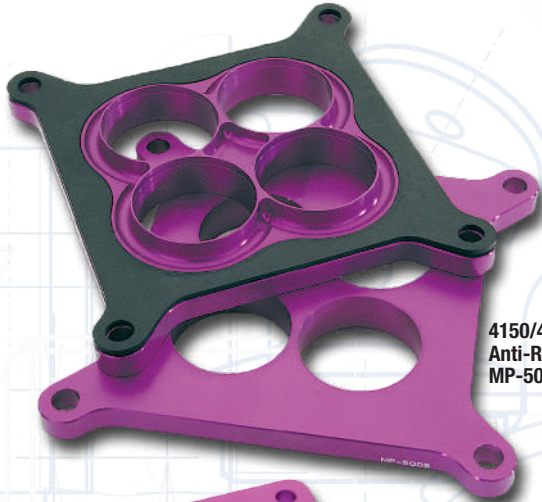

4150/4160 Holley®
Anti-Reversion Plate
MP-5005/MP-5006

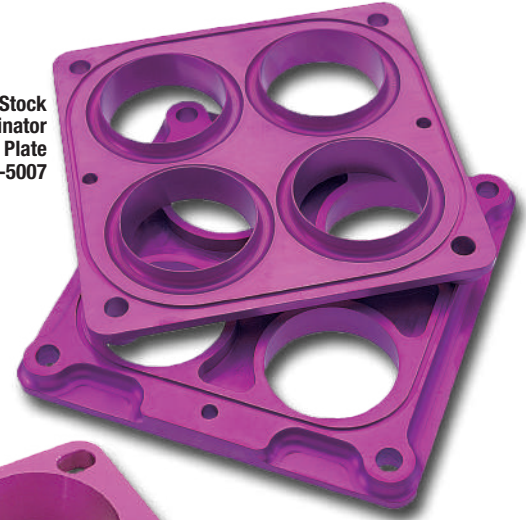

Special Pro-Stock
Drag 4500 Dominator
Anti-Reversion Plate
MP-5007

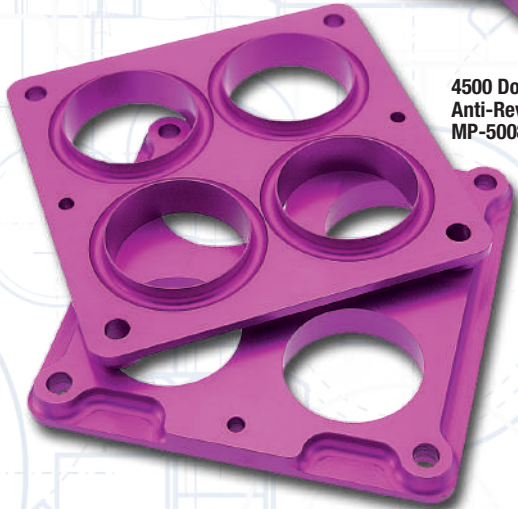

4500 Dominator
Anti-Reversion Plate
MP-5008



Split Dominator
Anti-Reversion Plate
MP-5009

Comparison of Carburetor Flow
With and Without
MagnaFuel Anti-reversion Plate

■ With ■ Without

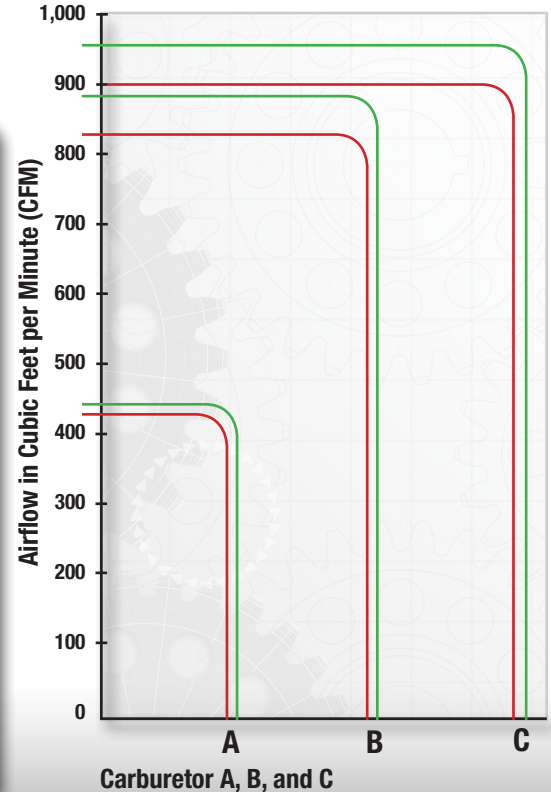

Part No.	Bore Size	Description
MP-5005	1-11/16"	4150/4160 Holley w/ rubber gaskets
MP-5006	1-3/4"	4150/4160 Holley w/ rubber gaskets
MP-5007-00	2.000	ProRev Plate w/ two O-rings
MP-5007-01	2.030	ProRev Plate w/ two O-rings
MP-5007-02	2.060	ProRev Plate w/ two O-rings
MP-5007-03	2.090	ProRev Plate w/ two O-rings
MP-5007-04	2.120	ProRev Plate w/ two O-rings
MP-5008-00	2.000	ProRev Plate 4500 Dominator
MP-5008-01	2.030	ProRev Plate 4500 Dominator
MP-5008-02	2.060	ProRev Plate 4500 Dominator
MP-5008-03	2.090	ProRev Plate 4500 Dominator
MP-5008-04	2.120	ProRev Plate 4500 Dominator
MP-5009-01	2.015	Split Dominator Set of 4
MP-5009-02	2.115	Split Dominator Set of 4
MP-5009-03	2.215	Split Dominator Set of 4
MP-5010-00	2.000	Dominator w/ rubber gaskets
MP-5010-01	2.030	Dominator w/ rubber gaskets
MP-5010-02	2.060	Dominator w/ rubber gaskets
MP-5010-03	2.090	Dominator w/ rubber gaskets
MP-5010-04	2.120	Dominator w/ rubber gaskets

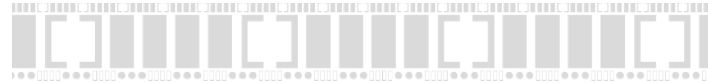

HOSES AND HOSE ENDS



Startlite Black Hose



AQP Stainless Braid Hose



Part No.	Hose Size	Description
MP-FBA0600	-6	-6 AQP Stainless Braid Hose Per Foot
MP-FBA0800	-8	-8 AQP Stainless Braid Hose Per Foot
MP-FBA1000	-10	-10 AQP Stainless Braid Hose Per Foot
MP-FBA1200	-12	-12 AQP Stainless Braid Hose Per Foot
MP-FBU0600	-6	-6 Startlite Black Hose Per Foot
MP-FBU0800	-8	-8 Startlite Black Hose Per Foot
MP-FBU1000	-10	-10 Startlite Black Hose Per Foot
MP-FBU1200	-12	-12 Startlite Black Hose Per Foot
MP-FBU1600	-16	-16 Startlite Black Hose Per Foot
MP-FCM4412	-6 Straight	-6 Straight Hose End Black
MP-FCM4413	-8 Straight	-8 Straight Hose End Black
MP-FCM4414	-10 Straight	-10 Straight Hose End Black
MP-FCM4415	-12 Straight	-12 Straight Hose End Black
MP-FCM4416	-16 Straight	-16 Straight Hose End Black
MP-FCM4422	-6 45 Degree	-6 45 Degree Hose End Black
MP-FCM4423	-8 45 Degree	-8 45 Degree Hose End Black
MP-FCM4424	-10 45 Degree	-10 45 Degree Hose End Black
MP-FCM4425	-12 45 Degree	-12 45 Degree Hose End Black
MP-FCM4426	-16 45 Degree	-16 45 Degree Hose End Black
MP-FCM4432	-6 90 Degree	-6 90 Degree Hose End Black
MP-FCM4433	-8 90 Degree	-8 90 Degree Hose End Black
MP-FCM4434	-10 90 Degree	-10 90 Degree Hose End Black
MP-FCM4435	-12 90 Degree	-12 90 Degree Hose End Black
MP-FCM4436	-16 90 Degree	-16 90 Degree Hose End Black

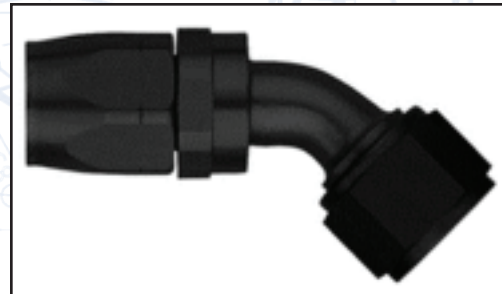

**Crimping Services
Are Also Available**

NOTES

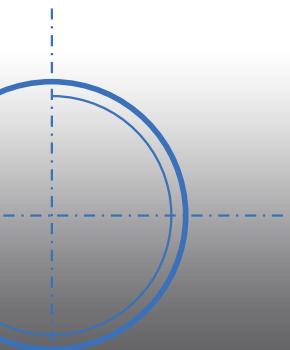

MagnaFuel

APPAREL

WOMAN'S

AVAILABLE
SIZES
XS SM M LG XL



MEN'S

AVAILABLE
SIZES
XS SM M LG XL XXL



CAPS

FLEX FIT
S-M LG-XL
*Also Available
in Flat Bill





JOIN THE GROWING LIST OF WINNING RACERS THAT RELY ON MAGNAFUEL PRODUCTS TO ACHIEVE THEIR GOALS.

- RYAN WARTER - NHRA COMPETITION ELIMINATOR
- DERRICK BROWN - PDRA ELITE TOP SPORTSMAN
- BRADLEY JOHNSON - NHRA SUPER GAS/SUPER COMP
- PAUL DALLENBACH - PIKES PEAK HILL CLIMB
- LEONARD VAHSOLTZ - PIKES PEAK HILL CLIMB
- MARK PORTER - LUCAS OFF ROAD
- CARTER WARD - NHRA JR. DRAG
- DON HARLESS - NHRA JR. DRAG
- GREG ANDERSON, JASON LINE, WARREN JOHNSON, KURT JOHNSON, DERIC KRAMER, BO BUTNER TANNER GRAY - NHRA PRO STOCK
- DOC, VARLEY, CHUCK, FARMTRUCK, KELLY BLUEBAUGH- DISCOVERY CHANNEL "STREET OUTLAWS"/ "NO PREP KINGS"

MAGNAFUEL PAYS OUT MORE CONTINGENCY THROUGH MORE ORGANIZATIONS THAN ANY OTHER FUEL SYSTEM COMPANY IN 2018.

Display your decal to be part of TEAM MAGNAFUEL, win contingency!



INFORMATION

TIPS

Why do you need a high-output, high-pressure fuel system?

Today's race cars need more fuel system than ever before because of improvements in torque, RPM and horsepower. As carburetors, manifolds and cylinder heads improved in airflow capacity, the need for more efficient racing fuel systems grew substantially. More efficient chassis and tires created the need for more fuel in order to maintain the maximum output power of the engine. Simply put, the harder the race car launches, the higher the system pressure must be to overcome the effects of gravity that cause restriction to flow. Firemen plan for this restriction to flow by adding 5 psi to the fire hose pressure per floor above street level. Pilots flying in high-performance fighters must control their blood supply with exercises and special flight suits when in high g-factor maneuvers or they suffer "redouts" or "blackouts" because they can't control their blood pressure. Aircraft launched with catapults from aircraft carriers must take off with fuel systems in high boost or the engine will starve for fuel. High g-factor launches coupled with wheel stands increase the demands on fuel systems whether the application is for Pro Street, Stock, Bracket or Pro Stock.

How much fuel flow is enough?

The correct volume of fuel is that which is required to support the amount of horsepower that the engine can produce. Most engines that are using gasoline burn approximately .5 pounds per horsepower-hour. This is sometimes called BSFC (Brake Specific Fuel Consumption). What this means is that for each horsepower produced, it takes ½ pound of fuel. This is a general statement and sometimes engines can be a little more efficient than .5lb/hp-hr., but it is a good practice to plan and measure fuel system operation using this number. Carburetors must have a stable supply of fuel in order to maintain the correct liquid fuel height. This is most difficult with drag racing vehicles that sometimes have forward acceleration and wheel stand at the same time. Each time that a nitrous system is engaged, additional fuel supply demands must be met or melted parts may result from "system lean-out." The fuel required is in excess of the .5 lb/hp-hr. for normally aspirated conditions. The additional fuel requirements for nitrous system planning is about .7 lb/hp-hr.

How much fuel pressure is necessary?

First, the fuel system pressure (provided by the fuel pump) must be enough to oppose the effects of gravity during the launch and during the run for drag racers. The system pressure of at least 8 to 10 psi per g is generally adequate. MagnaFuel ProStar 500 Series pumps are factory set to 28 to 30 psi. They are field adjustable from 24 to 36 psi. The MagnaFuel QuickStar 300 Series pumps are factory set to 25 psi and field adjustable from 25 to 36 psi. The QuickStar 275 series pumps are factory preset to 18 psi (these units are not field adjustable). MagnaFuel regulators need to be adjusted to 6.5 to 7.5 psi WITH FUEL FLOWING at a rate of about ½ cc per second (that's about 10 drops per second). Higher fuel pressure will generate more foam in the float bowl.

How can you plan your racing fuel system?

Use a handheld calculator and plan on .5 lbs/hp-hr. (gasoline). Methanol alcohol requires about 1.0 lbs/hp-hr. Use .7 lbs/hp-hr when planning a gasoline system for nitrous assist.

EXAMPLE: You have a 650 hp engine. $650\text{hp} \times .5 = 325 \text{ lbs/hr. (gasoline)}$. Although you need to know how much your fuel weighs, assume for this example that it weighs 6.2 lbs/gal. $325 \text{ lbs/hr.} \div 6.2 = 52.42 \text{ gal/hr.}$ Dividing by 60 (minutes per hour) yields .847 gal/min (GPM).

Check the graph and specification information for a pump selection for your application. Note that this flow number is what your engine needs at the float bowls. So you also need to check out the graphs and specs for a MagnaFuel regulator.

Is it necessary to plumb your system for a return line to the fuel tank?

Yes, because all MagnaFuel pumps are equipped with external bypass system. We don't think that any well-engineered racing fuel system should use internal bypasses because all they do is heat up and add foam (bubbles) to the fuel. It is a little more difficult to plumb, but it provides a better and more efficient system. See the drawings on pages 14-21 for proper placement of the return line in the tank.

Should you use a fuel filter?

All fuel systems are dirty and need to use a filter in the system. The filter should be located on the suction side (between tank and pump) of the pump. The filter cartridge is washable. Replacements are available.



How important is the size of the tank vent?

Attention to this detail may make the difference between winning and losing. It should be equipped with a filter so that trash and dirt cannot enter the fuel system. Absolute minimum size vent is -6 AN, but -8 AN is preferred for any application over 600 hp. Some specialty applications actually need a -10 AN. MagnaFuel rollover/vent (MP-3125) is -8 AN and provides some safety benefits if the vehicle flips over.

How can you check a system for flow and pressure?

Free-flow ratings of racing fuel systems are a joke, so MagnaFuel stresses that the only way to test a system is AT RATED PRESSURE. MagnaFuel rates all its systems at FLOW vs. PRESSURE.

Have a fire extinguisher handy. Observe safe practices when dealing with fuel. NO Smoking. You will need an accurately scaled jug (semi-clear polypropylene is ideal) of at least one gallon capacity. One gallon = 128 fluid ounces. One gallon = 4 quarts. One gallon = 231 cubic inches. You need to test the complete fuel supply system, so this measurement will be after regulated control. You will need a stop watch or a watch with a second counter. You will need to provide a variable orifice (brass draincock or petcock works well) for attachment to the end of the fuel line.

Run the test at various fuel pressures (regulated flow) and you will learn what your system can do.

Use the previous example under fuel system planning.

This is particularly important for nitrous enrichment fuel applications so that you will know the result of changing the fuel pressure ¼ psi at a time.

General Notes:

Proper Electrical Supply: The DC electric motors in electric fuel delivery systems are dependent on consistent electric supply. They require good battery voltage, solid connections, proper wire gauge, good ground and a properly operating alternator.

Debris in System: Fuel delivery systems are composed of valves, seals, diaphragms and orifices. Dirt and other debris can disrupt the proper operation of these components. A clean system is imperative. Clean or change your filters often, and periodically check the system for debris. If you are about to install a new system, make sure you clean all installation trash out of the fuel lines. Pay close attention to stainless steel lines.

Voltage Step-down Devices: Never use step-down devices (voltage reduction boxes) on MagnaFuel fuel pumps. Never operate any electric motor on lower voltage than the motor was designed for. Low voltage can cause motor fluctuation and excessive amp draw. MagnaFuel recommends 12.5V and higher

Gauges: Gauges are tuning tools only, and should be removed from vehicle during racing conditions.

Air in System: Any air going into fuel pump on the intake side causes the fuel to foam. Foam will create fluctuation in regulated pressure, oscillation in the pump motor and lean air/fuel mixture. Poor seals on the inlet side fittings, poor placement of the fuel pickup and/or return lines can cause this problem. Return line to fuel cell should be as far as possible from the pick up line fitting.

Fuel Cell Vent Size: If the fuel cell vent is too small, it can cause excessive load and heat in the pump. You should run a minimum of a #8 vent for all applications.

TONY STARK-
2016 MADCAP RACING ENG FAST 16 CHAMPION
2017 MADCAP RACING ENG FAST 16 CHAMPION
2018 MADCAP RACING ENG FAST 16 CHAMPION



PHOTO BY SRA PHOTO

INFORMATION

TIPS

Questions and Answers

Q. Why does my fuel pressure vary from one pass to the next?

A. Faulty fuel pressure gauge can cause fuel pressure fluctuation. If your gauge is a few years old, test it. Under-hood heat can affect gauge accuracy. Dirty regulator. Clean it or send it in. You should always set the regulator in a flowing condition. The engine should be running at about 1,700 to 2,000 RPM. Battery low. Check voltage. Low pump pressure. Look for inlet line obstructions such as fuel-cell foam.

Q. Why is my fuel pressure too low, or I have no pump pressure?

A. Check the voltage to the pump, relay switch. Could be faulty. They can be bad without going out. Weak relay reduces voltage. Replace them. Check wiring, look for an improper ground. Check the battery voltage. Check the filter and inlet line for obstructions. Look for leaks on inlet side. Adjust bypass. Is there debris in pump bypass (poppet). The bypass valve could be stuck open. Clean filter. Replace deteriorated fuel-cell foam. If no pressure, the pump may be operating in reverse. Check the wiring diagram. No fuel in fuel cell, or fuel cell improperly vented.

Q. Why does my pump seem excessively hot?

A. Note that normal operating temperature can reach 137 degrees Fahrenheit. Anything below this is OK. If the pump is warmer than this, look for low voltage. If there is excessive pressure, there could be debris in pumping mechanism causing too much load. Check to see if the bypass is obstructed. Check instructions for proper pressure setting.

Q. Why won't my pump run at all?

A. This is most likely a low- or no-voltage problem. Check battery condition. Check for a bad fuse or bad relay. Look for improper ground. Check diagram, make sure you have wired everything correctly. Check any in-line switches for proper operation and voltage rating.

Q. Why is my fuel pressure too high?

A. The return line could be too small. The voltage could be too high. If you need to run the pump at a pressure lower than it is designed for, call us and we'll send you a special spring. Improperly adjusted bypass. See pump instruction sheet for proper setting.

DERIC KRAMER- NHRA PRO STOCK EVENT WINNER

PHOTO BY SRA PHOTO



Questions and Answers

Q. Why does my regulated pressure seem to creep higher and higher or go to full pump pressure?

A. Debris in fuel system has contaminated the valve-to-seat seal. Disassemble per regulator exploded view. Wash with brake cleaner or similar cleaner and reassemble. Be sure you reassemble correctly. CAUTION: Do not over-tighten cartridge. Check fuel filter. Make sure to flush lines before using a newly installed fuel system. A common problem of new systems when there is debris left over from cutting fuel lines and other installation trash.

Q. What could cause my pump to operate noisier than usual?

A. Aeration, or air in the system, can cause excessive noise. Check for poor inlet side sealing, check O-rings, fittings, damaged sealing angles on fittings. We recommend rubber isolator between pump and frame mounting surfaces. Mounting the pump solid to the frame of the vehicle can accentuate the noise. If the fluid level in the tank/cell is too low, the pump can suck a vortex and induce air into the system. Check pump mounting brackets for tightness. If the fuel cell return line dumps fuel near the suction line, it can cause air to enter the system also. Keep this return line's fuel input as far away from the supply line as possible.

Q. Why is my regulator noisy when I first start the engine?

A. Vibration or chatter is common when the engine is first started due to air in system. This is amplified due to the metal-to-metal valve/seat assembly. Should go away in less than a minute. Regulators used for Nitrous are "dead-headed" to the solenoid. MagnaFuel suggests you use an air-bleed system to purge trapped air from the system.

Q. What can I do about a leaky pump?

A. Leaks are almost always caused by a worn or damaged pump seal. You need a new one. Return to factory. Seal should be replaced every two years under heavy use or if it sets unused for a long time. Return pump to factory for service. If pump leaks from vent hole, you need a new seal. Return pump to factory for service and bench flow testing.

Q. Why does my car seem to slow halfway through a quarter-mile run?

A. Not enough fuel volume. If it falls off in high gear, it is a pump volume issue; pump may be too small. If it falls down during launch, it is a fuel-pressure issue.

Q. Why does my fuel system pressure seem to drop throughout the day?

A. Heat can effect liquid-filled gauges. Voltage drop can also cause this problem (battery, ground, connections, and incorrect wire gauge. Avoid mounting fuel system close to heat sources.

Q. Why does my regulator's pressure fluctuate?

A. MagnaFuel considers excessive fluctuation to be over 1-1/2 pounds of pressure. Vibration, aeration, faulty gauges, or sharp changes in supply/pump pressure usually cause this. You should isolate the regulator with rubber mounting to tame vibration.

Q. Why am I getting pressure spikes?

A. Poor gauges, too high or too low pump pressure, or sharp drops in system pressure could cause large pressure spikes at the regulator.

TERMS AND CONDITIONS

Terms: We accept Visa and MasterCard. Verification on accounts may be needed before order is shipped.

Shipment: F.O.B. We use FedEx unless otherwise specified.

Foreign Shipments: We will ship to foreign customers unless restricted by law. Credit card or cash (in US currency), name of freight carrier and required import/export documents must be included with order.

Claims: Open or concealed freight damage claims must be made to the freight carrier.

Returns: Please obtain permission before returning merchandise. Shipping charges on returned items must be prepaid. *A 15% Restocking Fee will be added to returned merchandise that needs to be repackaged

Ordering: Your order is processed in-house. To expedite order handling please use catalog part numbers.

Prices: Prices are subject to change without notice.

Specifications: Non-critical specifications are subject to change without notice.

The logo for MagnaFuel is rendered in a stylized, italicized font. The letters are white with a thick black outline. The text is set against a background that is a gradient of blue and purple, with a jagged, flame-like border around the letters. The overall appearance is dynamic and energetic.