



Installation Instructions

For Part Number: .

LPP401-239-1

2011-14 Ford F-150 3.5L, 3.7L and 5.0L

2010-14 Ford SVT Raptor 6.2L

2011-15 Ford F-250/ 350 Superduty 6.2L

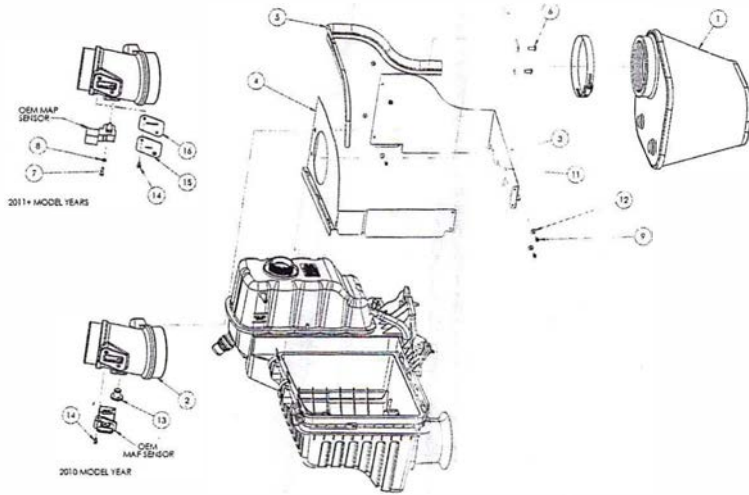

Component Identification

1	Premium Filter	1
1	Intake Tube	1
1	Rear Panel	1
1	Front Panel	1
1	Weather Strip, 22"	1
1	1/4-20 Button Head Screw	2
1	8-32 x 3/4" Button Head Screw	1
1	#8 Flat Washer	1
1	6-32 x 5/16" Phillips Head Screw	4
1	1/4" Flat Washer	2
1	6-32 Kep Nut	4
1	#6 Flat Washer	4
1	MAP Plug	1
1	1/2" Button Head Screw	2
1	MAF Cap	1
1	MAF Cap Gasket	1
17	Torx Bit	1
18	Airaid Decal	1

NOTE: These instructions depict an installation being performed on a 5.0L F-150 and is meant to be a guide for all other makes and models listed. While some details may vary from vehicle to vehicle, the general install procedure remains the same.

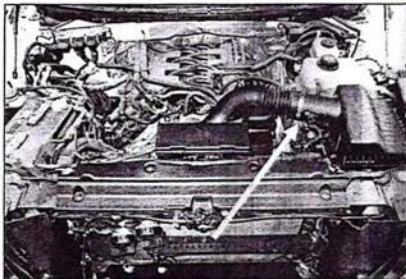

Disconnect The Negative Battery Terminal!

1. Loosen the hose clamp on the airbox side of the factory [air intake tube](#).

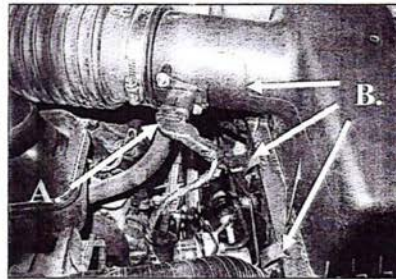

2. A. Disconnect the Air meter in the factory airbox top.
B. Unfasten the Three clips on the left side of the airbox.

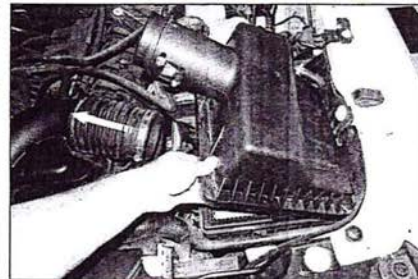

3. Slide the factory intake away from the airbox. Lift up and slide the airbox tabs out of the slots in the lower half and set aside.

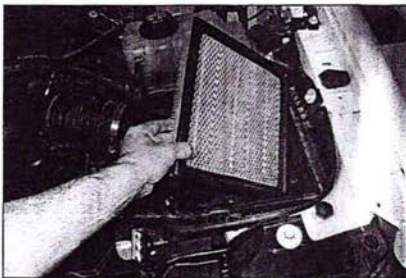

4. Remove the Factory air filter.

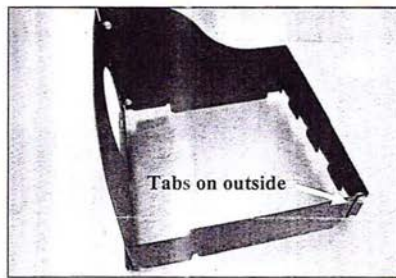

5. Assemble the Front and Rear Panels as shown with the tabs on the outside of the assembly. Use the four 6-32 Button Head Screws #6 Flat Washers, and #6 Kep Nuts to secure the assembly.

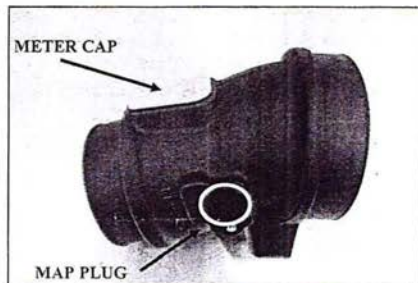

6. Depending on the sensor configuration of your factory intake system, you will use one of the two sensor receptacles in the Windstorm intake tube. There is a Mass Airflow sensor receptacle on the tube and a MAP sensor receptacle on the tube.

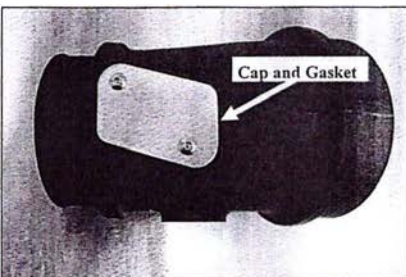

7. If your vehicles intake utilizes a MAP sensor: Install the Meter Cap and Gasket onto the Intake tube as shown, using the two 8-32 1/2" Button Head Screws.

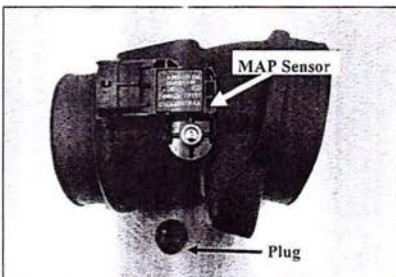

8. Transfer the MAP Sensor into the intake tube as shown. Secure the sensor using the Long 8-32 Button Head Screw and the Washer. Discard the Plug. It will not be used.

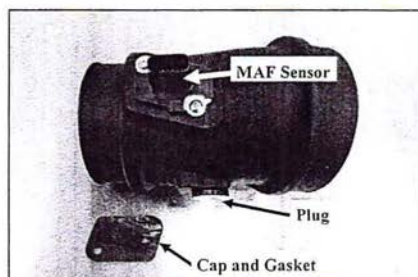

9. If your vehicles intake utilizes a Mass Airflow, or MAF sensor: Transfer the sensor into the intake tube as shown and secure using the two 1/2" Button Head Screws. Complete the Tube assembly by inserting the MAP Plug. Discard the Meter Cap and Gasket. They will not be used.

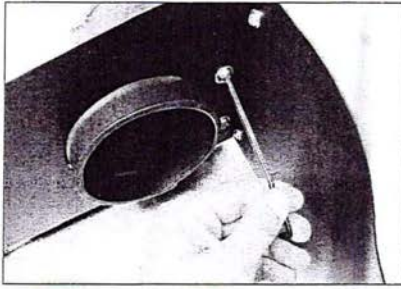

10. Install the Air Meter Tube into the Panel Assembly and secure using the two 1/4-20 Button Head Screws and 1/4" Flat Washers.

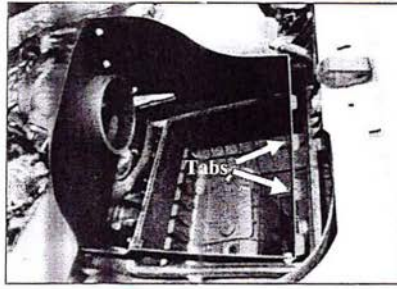

11. Install the Windstorm intake assembly onto the factory airbox bottom. Insert the Panel tabs into the slots first, then lower the tube side down and fasten the three clips.

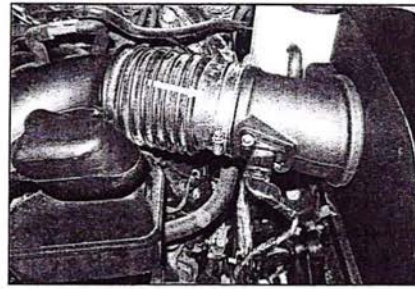

12. Slide the factory intake tube onto the Windstorm Tube and tighten the clamp. Reconnect the Mass Air Flow sensor.

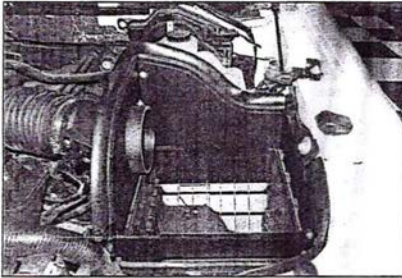

13. Install the Weather Strip to the Panel assembly as shown, with the contour rolling away from the filter area.

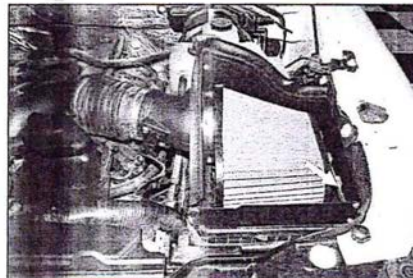

14. Install the Windstorm Premium Filter on to the Air Meter Tube and tighten the clamp.

14. Double check your work!

Make sure there is no foreign material in the intake path. Make sure all clamps, hoses, bolts, and screws are tight. Double check the hood clearance!

Reconnect the negative battery cable!