



# KNAACK®

NEW SECURITY ENHANCING UPGRADES •  
**NEW!**  
3-Point Latch System  
PowerPass™  
Electrical Pass-through  
Reinforced  
Lock Housing  
(see pages 4-7)  
• TO STORAGEMASTER® & JOBMASTER® CHESTS •

KNAACK® SECURE JOBSITE STORAGE

# WORKS HARD. WORKS SMART.



# KNAACK WORKS.

**KNAACK® Jobsite Storage Solutions have the strongest work ethic around – and the smartest.**

**Not only does every box, chest and cabinet cause tool thieves to strongly reconsider, but KNAACK Jobsite Storage Solutions also provide easier access, better organization, more mobility and versatility.**





# TOUGH AS NAILS EASY TO USE.

KNAACK® jobsite storage equipment is synonymous with ultra-secure protection of tools, equipment and supplies. From durable, all-steel construction to tamper-resistant, innovative features, we don't mess around. Our durability and security are legendary. But, we also know how to multitask. After nearly 50 years of experience, we know how crews work. Every one of our boxes is built with organization and efficiency in mind and geared toward keeping equipment and work surfaces readily accessible.



**STORAGEMASTER® Chests** are the workhorses on any jobsite, ideal for every trade – mechanical, plumbing, HVAC, electrical, rough and finish carpentry. They're caster-ready and include full-width shelves for organization of small to large tools and supplies. Model 91 even features a drop-down ramp for loading large, heavy items.



**Rolling Work Benches** are secure storage on wheels. The heavy-duty top is great as a work surface and for mounting pipe threaders or vices.



A **field station** serves as your jobsite office. Use it to securely store tools, supplies, documents and more.

## KNAACK SECURITY? It's a lock.

All KNAACK products are designed for use with the Commercial Master Lock® No. 5 or equivalent sized lock.

- The Commercial Master Lock® No. 5 has a hardened steel plate bottom with an hourglass keyhole opening that provides drill resistance for added security.
- The WATCHMAN® IV Lock System, with recessed housing, prevents bolt-cutter break-ins.
- One-time lock installation means no downtime replacing locks.



**JOBMASTER® Chests**, available in multiple models, are for jack-of-all trade applications. They're versatile and portable – especially with accessory casters – and hold anything from hand to power tools and supplies.



**JOBMASTER® Cabinets** are incredibly secure and configurable for any need. They act as a remote tool crib and offer "glance and grab" organization.



# CHESTS

STORAGEMASTER®

Nothing works harder or smarter than STORAGEMASTER® Chests when it comes to secure jobsite storage, durability and ease of use. Consider these key features when you're looking for an ultra-rugged piano box.

- A WATCHMAN® IV Lock System with 3-point latching** and recessed lock housing for the ultimate protection against pry-ins. One-time lock installation means no downtime replacing locks.
- B Power Pass™** electrical pass-through grommet for easy weatherproof power cord access.
- C Reinforced lock housing** provides unbeatable strength.
- D Heavy-duty hinges** are staked and welded to stand up to any amount of prying.



## STORAGEMASTER Chests also feature:

- Recessed handles for positive gripping even with a gloved hand
- Baked-on enamel finish for weather resistance and durability
- Protected gas springs to prevent damage from shifting loads
- Caster-ready 12-gauge steel skids to accommodate optional casters (see page 9)
- Heavy-duty 16-gauge steel construction with fully arc-welded seams

## STORAGEMASTER® CHESTS

### MODEL 91

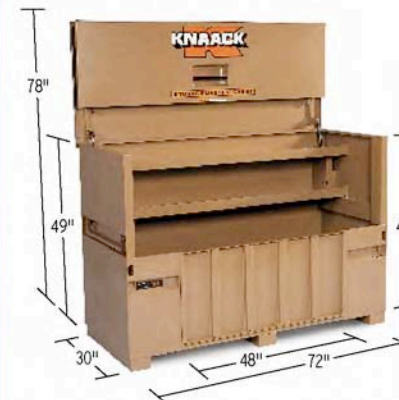

Features a built-in, 12-gauge steel ramp to make loading large, bulky items easy.

Capacity: 57.5 Cu. Ft.  
Ship Wt: 409 lbs.



### MODEL 90



Capacity: 57.5 Cu. Ft.  
Ship Wt: 380 lbs.

### MODEL 89



Capacity: 47.8 Cu. Ft.  
Ship Wt: 337 lbs.

### MODEL 79



Capacity: 38.2 Cu. Ft.  
Ship Wt: 287 lbs.

### MODEL 69



When cover is closed, Model 69 chest can be used as a work table.

Capacity: 35.3 Cu. Ft.  
Ship Wt: 282 lbs.



## ACCESSORY SHELF DOORS



Model	Fits	Ship Wt.
479	79	20 lbs.
489	89	26 lbs.
491	90, 91	30 lbs.

Accessory shelf doors allow you to have the best of both worlds. Keyed doors create a secure area while allowing the chest to remain open during the work day.



# CHESTS

JOBMASTER®

Security and durability to go. JOBMASTER® Chests are tool storage solutions that are as easy to handle as they are tough. They're compact enough to be lifted and moved around the jobsite or into a work vehicle with minimal effort. Yet, JOBMASTER Chests include all the same security features as STORAGEMASTER® Chests.

- A WATCHMAN® IV Lock System with 3-point latching** and recessed lock housing for the ultimate protection against pry-ins. One-time lock installation means no downtime replacing locks.
- B Power Pass™ electrical pass-through grommet** for easy weatherproof power cord access.
- C Reinforced lock housing** provides unbeatable strength.
- D Heavy-duty hinges** are staked and welded to stand up to any amount of prying.



## JOBMASTER Chests also feature:

- Recessed handles for positive gripping even with a gloved hand
- Baked-on enamel finish for weather resistance and durability
- Caster-ready 12-gauge steel skids to accommodate optional casters (see page 9)
- Heavy-duty 16-gauge steel construction with fully arc-welded seams

## JOBMASTER® CHESTS

### MODEL 4830



Capacity: 25.25 Cu. Ft.  
Ship Wt: 194 lbs.  
Closed Height: 34 1/4"

### MODEL 2472



Capacity: 24.5 Cu. Ft.  
Ship Wt: 216 lbs.  
Closed Height: 28 1/4"

### MODEL 60



Capacity: 20.25 Cu. Ft.  
Ship Wt: 190 lbs.  
Closed Height: 28 1/4"

### MODEL 4824



Capacity: 16 Cu. Ft.  
Ship Wt: 158 lbs.  
Closed Height: 28 1/4"

### MODEL 42



Capacity: 9 Cu. Ft.  
Ship Wt: 114 lbs.  
Closed Height: 23 1/2"

### MODEL 36



• Does not have 3-point latch or Power Pass™  
Capacity: 7 Cu. Ft.  
Ship Wt: 97 lbs.  
Closed Height: 21 1/2"

### MODEL 32



• Does not have 3-point latch or Power Pass™  
Capacity: 5 Cu. Ft.  
Ship Wt: 84 lbs.  
Closed Height: 18 1/2"



# CHESTS

## WELDERS BOX MODEL 30



- Designed to hold welders gloves, goggles, tools and rods
  - Spot-welded construction
  - 16-gauge steel
  - Baked-on enamel finish
- Capacity: 3.3 Cu. Ft.  
Ship Wt: 38 lbs.

## STORAGE BOX MODEL 28

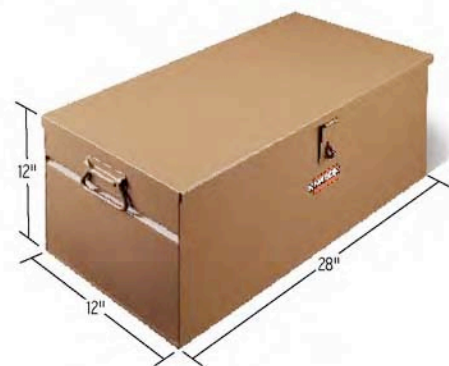

- Fully arc-welded for extreme strength
  - Optional tool tray Model 51 available below
  - 16-gauge steel
  - Baked-on enamel finish
- Capacity: 2.3 Cu. Ft.  
Ship Wt: 32 lbs.

## ACCESSORY TRAYS

These handy lift-out trays keep tools organized and ready to go. No more digging around the bottom for what you need.

### TOOL TRAY MODEL 51

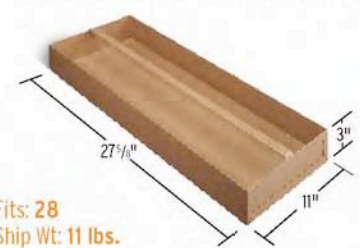

Fits: 28  
Ship Wt: 11 lbs.

### TOOL TRAY MODEL 31

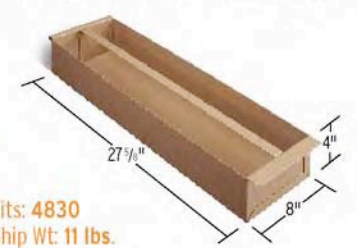

Fits: 4830  
Ship Wt: 11 lbs.

### TOOL TRAY MODEL 21

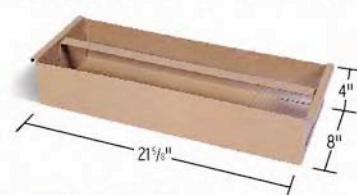

Fits: 2472, 4824, 60  
Ship Wt: 9 lbs.

### TOOL TRAY MODEL 41

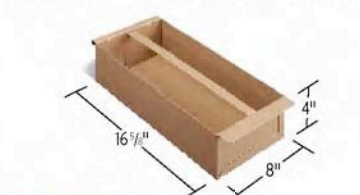

Fits: 32, 36, 42  
Ship Wt: 7 lbs.

### TOTE TRAY MODEL 10/11

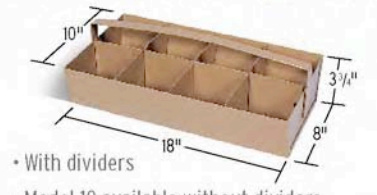

- With dividers
  - Model 10 available without dividers
- Ship Wt: 11 lbs.

## ACCESSORY CASTER SETS

Load ratings are for all four wheels combined. Rating includes weight of KNAACK® product and its contents. Each caster set includes two rigid and two swivel casters with mounting bolts. Caster sets with brakes have the brake unit located on the swivel casters. KNAACK casters are recommended for use with KNAACK products.

**CAUTION:** Caster brakes are not suitable for keeping the units in place when transporting. Secure by another method. Do not use casters on rough or uneven surfaces. Do not tow caster-mounted boxes.

### 4" CASTERS



Model: 404 (without brakes)  
Set of 4 Casters

Total Load Rating: 1060 lbs.  
Use With: 32, 36, 42, 60, 2032, 2048, 2060, 2472, 3068, 4824, 4830  
Ship Wt: 11 lbs.



Model: 405 (with brakes)  
Set of 4 Casters

Total Load Rating: 1060 lbs.  
Use With: 32, 36, 42, 60, 2032, 2048, 2060, 2472, 3068, 4824, 4830  
Ship Wt: 12 lbs.

DO NOT USE 4" caster sets with Models 69, 79, 89, 90, 91, 99, 109, 111, 112, 119, 129 and 139.

### 6" CASTERS



Model: 606 (without brakes)  
Set of 4 Casters

Total Load Rating: 1360 lbs.  
Use With: All Models  
Ship Wt: 15 lbs.



Model: 607 (with brakes)  
Set of 4 Casters

Total Load Rating: 1360 lbs.  
Use With: All Models  
Ship Wt: 16 lbs.



Model: 516 (with brakes and non-marking polyurethane wheels)  
Set of 4 Casters

Total Load Rating: 2240 lbs.  
Use With: 32, 36, 42, 60, 2032, 2048, 2060, 2472, 3068, 4824, 4830  
Ship Wt: 18 lbs.

### 5" CASTERS



Model: 505 (without brakes)  
Set of 4 Casters

Total Load Rating: 1240 lbs.  
For Use With: 32, 36, 42, 60, 69, 79, 89, 90, 91, 2032, 2048, 2060, 2472, 3068, 4824, 4830  
Ship Wt: 14 lbs.

DO NOT USE 5" caster sets with Models 99, 109, 111, 112, 119, 129, and 139.



Model: 600 (heavy duty with brakes)  
Set of 4 Casters

Total Load Rating: 3280 lbs.  
For Use With: All Models  
Ship Wt: 25 lbs.



# CABINETS

JOBMASTER®

No matter how big the job, roomy JOBMASTER® Cabinets work. They provide at-a-glance, easy-access shelving storage for small, big and in-between tools, equipment and supplies. Optional accessories like casters and door shelves create custom solutions that work even harder.

- A WATCHMAN® IV Lock System with 3-point latching** and recessed lock housing for the ultimate protection against pry-ins. One-time lock installation means no downtime replacing locks.
- B Convenient foot latch** opens the doors when you step on it, allowing hands-free operation.
- C Deep door design** for maximum pry-bar resistance and better tool organization.



## JOBMASTER Cabinets also feature:

- Recessed handles for positive gripping even with a gloved hand
- Baked-on enamel finish for weather resistance and durability
- Caster-ready 12-gauge steel skids to accommodate optional casters (see page 9)
- Heavy-duty 16-gauge steel construction with fully arc-welded seams
- Optional door shelves allow for greater organization

## HALF-WIDTH SHELF CABINETS

### MODEL 112



- Includes: Three 2 1/2" deep drawers with 50 lb. load capacity, four 6" drawers with 75 lb. load capacity
- Powder-coated drawers roll on ball bearing slides
- Full top shelf for more storage
- Shelf spacing from top down: 13", 12 1/2", 9 1/2", 19 3/4"
- Ability to add accessory door shelves

Capacity: 54.9 Cu. Ft.  
Ship Wt: 670 lbs.

### MODEL 111



- More open space for large items
- Half-width shelves on left side only
- Top shelf is 13" from top of cabinet, second shelf is 12 1/2" from top shelf, bottom shelf is 9 1/2" from second shelf
- Ability to add accessory door shelves

Capacity: 47.5 Cu. Ft.  
Ship Wt: 385 lbs.

## FULL-WIDTH SHELF CABINETS

### MODEL 139

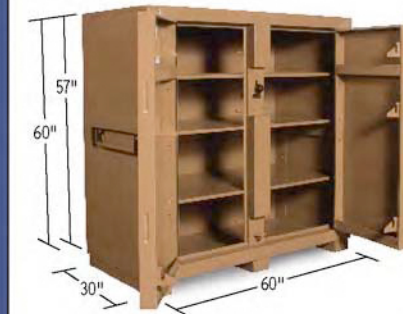

- Full-length shelves allow you to organize longer items
- Top shelf is 14" from top of cabinet, second shelf measures 10" from bottom of top shelf
- Adjustable bottom shelf
- Ability to add accessory door shelves

Capacity: 59.4 Cu. Ft.  
Ship Wt: 445 lbs.

### MODEL 109



- Full-length shelves allow you to organize longer items
- Top shelf is 14" from top of cabinet, second shelf measures 10" from bottom of top shelf
- Adjustable bottom shelf
- Ability to add accessory door shelves

Capacity: 47.5 Cu. Ft.  
Ship Wt: 394 lbs.



### BIN STORAGE CABINET MODEL 129



- Perfect for storage of fittings and bulk parts
- Each shelf has a 2" hemmed lip to keep parts from spilling out
- Full-length top shelf allows you to organize longer items
- 18 separate bins
- Doors on front only

Capacity: **48 Cu. Ft.**  
Ship Wt: **452 lbs.**

### DOUBLE-SIDED SHELF CABINET MODEL 99



- Double doors on front and back
- Fully open top shelf
- Top shelf is 14" from top of cabinet, second shelf measures 10" from bottom of top shelf, bottom shelf is adjustable for easy storage of bulky items
- Ability to add accessory door shelves

Capacity: **59.4 Cu. Ft.**  
Ship Wt: **519 lbs.**

### ROLLING CABINET MODEL 100



- Included casters allow one person to maneuver the closed cabinet through a jobsite
- Shelves are 14" deep with a 1" hemmed lip, and welded in place with a 12 7/8" minimum spacing between shelves
- 16-gauge fully arc-welded steel construction
- Load capacity: 1200 lbs. evenly distributed
- Vertical storage area features a bracket for hanging extension cords or tool belts

Capacity: **60.9 Cu. Ft.**  
Ship Wt: **470 lbs.**

### SHELF MODEL 493



- Accessory shelf for the left inside door provides additional storage and organization
- Fits models 99, 109, 111, 112, 139

Ship Wt: **3 lbs.**

### SHELF MODEL 494

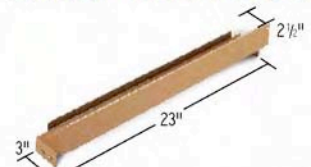

- Accessory shelf for the right inside door provides additional storage and organization
- Fits models 99, 109, 111, 112, 139

Ship Wt: **3 lbs.**

## FIELD STATION MODEL 119



Think of it as command central. It's first to the jobsite and last to leave and holds everything that's needed day-to-day – from tools and equipment to essential supplies, drawings and documents. When the work day is over, the field station locks up tight as a drum for secure overnight storage.

- A WATCHMAN® IV Lock System** with recessed lock housing for the ultimate protection against pry-ins. One-time lock installation means no downtime replacing locks.
- B Recessed handles and latch levers** offer protection during transport.
- C Hinged desk top** allows 9 cu. ft. of storage space underneath.
- D Large swing-up door** features an easy-to-use rotary latch, an easy-to-grip recessed handle, a gas spring to assist with opening and closing and a prop arm that locks in place to hold the door open.
- E 16-gauge steel body** with fully arc-welded seams for the ultimate in strength and weather protection.



Storage Capacity: **115.2 Cu. Ft.**  
Ship Wt: **624 lbs.**



# ROLLING WORK BENCH

STORAGEMASTER®

Sturdy. Mobile. Secure. STORAGEMASTER® Rolling Work Benches carry the load in more ways than one. They're not only load-rated for a half-ton, but they're efficiency centers on the jobsite, providing handy work surfaces and organized storage that go wherever work needs to be done.

- A WATCHMAN® IV Lock System** with recessed lock housing for the ultimate protection against pry-ins. One-time lock installation means no downtime replacing locks.
- B Heavy-duty steel construction** with fully arc-welded seams.
- C Full-length staked piano hinges** resist pry-ins.
- D Baked-on enamel finish** for weather resistance and durability.



## CAUTION:

Caster brakes are not suitable for keeping the units in place when transporting. Secure by another method. Do not use casters on rough or uneven surfaces. Do not tow caster-mounted boxes.

## STORAGEMASTER® ROLLING WORK BENCH

### MODEL 49



Load Capacity: 1000 lbs.  
Ship Wt: 352 lbs.

- (3) Model 471-3, 1" deep drawers
- (4) Model 472-3, 2 1/2" deep drawers
- (1) Model 476-3, 6" deep drawers
- (1) Model 477-3 shelf
- (1) 6" caster set

### MODEL 45



Load Capacity: 1000 lbs.  
Ship Wt: 296 lbs.

- (4) Model 474-3, 4 1/2" deep drawers
- (1) 6" caster set

### MODEL 47



- Basic unit
  - No drawers
  - Use this model to design your own Rolling Work Bench (see p. 17)
- Load Capacity: 1125 lbs.  
Ship Wt: 229 lbs.

(1) 6" caster set

### MECHANIC'S CHEST MODEL 63



- 6" non-marking polyurethane caster set is included
- Red baked-enamel finish

Load Capacity: 1000 lbs.  
Ship Wt: 352 lbs.

- (3) Model 471-3, 1" deep drawers
- (4) Model 472-3, 2 1/2" deep drawers
- (1) Model 476-3, 6" deep drawer
- (1) Model 477-3, 1" deep shelf
- (1) 6" caster set
- (1) Rubber mat



# ROLLING WORK BENCH

## STORAGEMASTER® HD ROLLING WORK BENCHES

Our heavy-duty work benches are ready to take on extra-large loads – up to 2,700 pounds – and move where they're needed while providing almost 10 square feet of work space.

- WATCHMAN® IV Single Lock System
- 7-gauge steel work top and cabinet bottom
- Permanently welded 12-gauge steel shelves
- Heavy-duty 6" caster sets are included (caster model 600)
- Standard drawer capacity is 100 lbs., heavy-duty drawer capacity is 200 lbs.

### MODEL 57



- No drawers
- One half-width shelf
- Includes 6" caster set

Load Capacity: 2850 lbs.  
Ship Wt: 434 lbs.

### MODEL 59



- (3) Model 471-3, 1" Std. Duty Drawers
- (4) Model 483-3, 2 1/2" HD Drawers
- (1) Model 486-3, 6" HD Drawer
- (1) 6" caster set

Load Capacity: 2650 lbs.  
Ship Wt: 641 lbs.

### MODEL 58



- (3) Model 471-3, 1" Std. Duty Drawers
- (1) Model 483-3, 2 1/2" HD Drawer
- (1) Model 486-3, 6" HD Drawer
- (1) Model 490-3, 9 1/2" HD Drawer
- (1) 6" caster set

Load Capacity: 2650 lbs.  
Ship Wt: 591 lbs.

## WAR WAGON® ROLLING WORK BENCH

### MODEL 62

Got a challenge? This big boy is up for it, with an ability to accommodate over 2.5 tons of whatever you want to load into it. Its large, 13 square-foot work area and lower working height more conveniently positions your equipment when you attach a vise or pipe threader.

- WATCHMAN® IV Single Lock System
- Three doors in front and three in back for the ultimate accessibility
- 12-gauge steel body, fully arc-welded
- 7-gauge steel work top and bottom panel
- Standard drawer capacity is 100 lbs., heavy-duty drawer capacity is 200 lbs.



Load Capacity: 3400 lbs.  
Ship Wt: 597 lbs.

- (2) Model 471-3, 1" Std. Duty Drawers
- (1) Model 486-3, 6" Heavy Duty Drawer
- (1) Model 490-3, 9 1/2" Heavy Duty Drawer
- (1) 6" caster set

## DESIGN YOUR OWN PACKAGE

It's easy to make **STORAGEMASTER®** Rolling Work Benches accommodate various jobsite situations with shelves, standard or heavy-duty accessory drawers or a combination of both.

### START WITH MODEL 47



- Fifteen notches are in the cabinet door space for mounting drawers
- You can put together any combination of standard drawers as long as the sum of the notches doesn't exceed 15

### START WITH MODEL 57



- Nine notches are located in the cabinet door space for mounting drawers
- Top three notches use a combination of 1", 2 1/2" or 4 1/2"-deep standard drawers. The bottom six notches use a combination of 2 1/2", 6" or 9 1/2"-deep heavy-duty drawers
- Choose any combination of heavy-duty drawers for the bottom six notches, as long as the sum of the notches doesn't exceed nine

All drawers come with attached glides.

### STANDARD DRAWERS FOR MODELS 47 & 57

Load capacity is 100 lbs. each



### STANDARD DRAWERS FOR MODEL 47

Load capacity is 100 lbs. each



### HEAVY-DUTY DRAWERS FOR MODEL 57

Load capacity is 200 lbs. each



\* Place larger drawers to the bottom of the cabinet to avoid tipping.



# CLASSIC STORAGE

CLASSIC STORAGE



KNAACK® CLASSIC Storage Chests and Rolling Work Benches provide great value, versatility, secure storage and efficiency on jobsites, as well as at home. Models 2048 and 2060 can also take to the road in any full-size pickup truck.

## CLASSIC STORAGE Chests feature:

- Recessed handles for positive gripping even with a gloved hand
- Baked-on enamel finish for weather resistance and durability
- Caster-ready 12-gauge steel skids to accommodate optional casters (see page 9)
- Heavy-duty 16-gauge steel construction with fully arc-welded seams

## CLASSIC STORAGE CHESTS

### MODEL 3068



- Double lock system
- Slanted top allows easy access to contents
- Permanently welded built-in tray measures 11"W x 60"L x 2 1/2"D

Storage Capacity: **31 Cu. Ft.**  
Ship Wt: **225 lbs.**

### MODEL 2060



- Double lock system
- Inset skids allow chest to fit into 8' bed pickups
- Permanently welded built-in tray measures 5 1/2"W x 60"L x 3 5/8"D

Storage Capacity: **20 Cu. Ft.**  
Ship Wt: **180 lbs.**  
Closed Height: **28"**

### MODEL 2048



- Double lock system
- Fits perfectly into full-size pickups
- Permanently welded built-in tray measures 5 1/4"W x 48"L x 3 5/8"D

Storage Capacity: **16 Cu. Ft.**  
Ship Wt: **145 lbs.**  
Closed Height: **28"**

### MODEL 2032



- Double lock system
- Built-in tray not included
- Optional model 41 tool tray available (see p. 8)

Storage Capacity: **5 Cu. Ft.**  
Ship Wt: **77 lbs.**  
Closed Height: **18 1/4"**

## CLASSIC ROLLING WORK BENCHES

- WATCHMAN® IV Single Lock System, a KNAACK® exclusive, saves you time and money with a one-time install
- Recessed padlock housing deters bolt cutters, pry bars and hack saws
- Heavy-duty drawers are rated for 50 lbs. and operate on ball-bearing slides
- Two 4" swivel casters and two 4" rigid casters are included with each bench
- Shelf is welded in place for maximum strength

### MODEL 44



- Includes four drawers and a half-width shelf
- Shelf clearance measures 14" from bottom of cabinet to bottom edge of shelf and 16" from top of shelf to top of cabinet

Load Capacity: **800 lbs.**  
Ship Wt: **240 lbs.**

### MODEL 40



- Includes two drawers and a full-width shelf
- Shelf clearance is 14" from bottom of cabinet to bottom edge of shelf and 8" from top of shelf to bottom of drawer

Load Capacity: **800 lbs.**  
Ship Wt: **210 lbs.**



# EXTRAS THAT WORK.

**26" HAND HELD  
TOOL BOX  
MODEL 743**



- 18-gauge steel
- Removable steel tool tray included
- Chrome-plated handle and latches

Storage Capacity: 1 1/2 Cu. Ft.  
Ship Wt: 27 lbs.

**22" HAND HELD  
TOOL BOX  
MODEL 742**



- 18-gauge steel
- Removable steel tool tray included
- Chrome-plated handle and latches

Storage Capacity: 1 Cu. Ft.  
Ship Wt: 22 lbs.

**20" HAND HELD  
TOOL BOX  
MODEL 741**



- 18-gauge steel
- Removable steel tool tray included
- Chrome-plated handle and latches

Storage Capacity: 3/4 Cu. Ft.  
Ship Wt: 17 lbs.

**WALL CABINET MODEL 33**

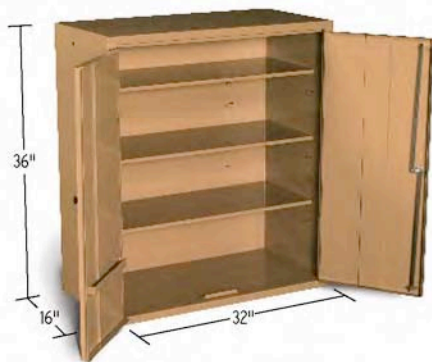

- Ideal for locking up small parts, tools and supplies, and can be used almost anywhere in the shop or on the job
- Holes are pre-punched in the back (on 16" and 24" centers) for easy mounting to walls
- A key lock combination with 2-point latching helps prevent unauthorized access

Storage Capacity: 10 3/4 Cu. Ft.  
Ship Wt: 81 lbs.

**WORK TABLE MODEL R-72**



- Ideal for the shop or special fabrication areas on the jobsite
- 10-gauge steel work top
- 14-gauge steel legs
- Foldable legs for easy transport

Load Capacity: 750 lbs. evenly distributed  
Ship Wt: 136 lbs.

WHAT MAKES KNAACK® THE UNDISPUTED LEADER IN DURABLE AND SECURE JOBSITE STORAGE? NEARLY 50 YEARS OF EXPERIENCE. WE APPLY KNAACK KNOW-HOW TO EVERY ASPECT OF EVERY PRODUCT TO ENSURE MAXIMUM SECURITY, FUNCTIONALITY AND PRODUCTIVITY. THIS FOCUS AND EXPERIENCE HAVE MADE US THE NUMBER-ONE CHOICE IN JOBSITE STORAGE.

