

2018



JONES

Racing Products

WHAT DRIVES YOU!®

Crankshaft Hubs & Pulleys	4-19
Drive Mandrels and Drive Hubs	5-8
Split-V Drive Hubs & Drive Hub Spacers & Accessories	9
Drive Hub Hardware	11
Radius Tooth HTD Crankshaft Pulleys	13-14
Square Tooth Gilmer Crankshaft Pulleys	15
Serpentine Poly-V (Micro-V) Crankshaft Pulleys	17
V-Belt Crankshaft Pulleys	18-19
Alternators & Accessories	20-25
Lightweight Aluminum Alternators	21
Radius Tooth Alternator Pulleys	22
Gilmer, Serpentine, & V-Belt Alternator Pulleys	23
SBC Alternator Brackets	24
SBF, SB Chrysler, MP, & LS Alternator Brackets	25
Power Steering Pumps & Accessories	26-30
Aluminum Power Steering Pumps, Reservoirs & PS Fluid	27
Power Steering Pump Pulleys	28
SB & BBC Power Steering Pump Brackets	29
SBF, SB Chrysler, MP & LS PS Pump Brackets	30
Fuel & Tandem Pump, Pump Pulleys & Brackets	31-33
Fuel & Tandem Pumps, Brackets, & Accessories	32
FP & TP Pulleys & Guides	33
Vacuum Pumps, Pulleys, Brackets & Accessories	34-36
Vacuum Pumps & Accessories	35
Vacuum Pump Pulleys & Guides	36
Dry Sump Oil Pumps & Accessories	37-39
Dry Sump Oil Pumps, Brackets & Accessories	38
Dry Sump Oil Pump Pulleys & Guides	39
Water Pumps & Components	40-45
Water Pumps, Spacers, & Restrictors	41
WP Fans, Fan Spacers, Pulley Bushing, Spacers, Shims & Bolts ..	42
Expansion Tanks, Expansion Tank Hose Kit & WP Bleeder Kit	43
Radius Tooth, Square Tooth & Serpentine WP Pulleys	44
V-Belt Water Pump Pulleys	45
Accessories	46-48
Belt Guides	46
AN Wrenches, Temp Guns, Exhaust Covers, & Spark Plug Tools ..	47
AN Fittings, AN Line, and Support Coil	48

Index

CRATE/OPEN

Stand-Alone Water Pump Belt Drives 49-53
 LS Serpentine Stand-Alone Water Pump Drive & LS WP PS & Alt Kit 49
 SB Chevy, Ford & Chrysler Stand-Alone Water Pump Serpentine Drives .. 50
 602 & 604 SBC Crate Engine Drives 51
 Radius Tooth HTD Crate Engine Drives 52
 604 SBC Crate Water Pump & Tandem Pump Drive 53

Serpentine Water Pump & Power Steering Belt Drives 54-57
 SB Chevy Serpentine Water Pump & Power Steering Drive 54
 SB Ford Serpentine Water Pump & Power Steering Drive 55
 SB Chrysler Serpentine Water Pump & Power Steering Drive 56
 Hemi, Late Model, Gen iii Belt Drive 57

Radius Tooth HTD Drive Kits 58-59
 SB Chevy, or Ford Water Pump Drive 58
 SB Chevy, Water Pump & Oil Pump Drive 58
Bell Housing Mounted Oil, PS, Tandem Pump & Alternator Drives 59

OPEN w/ OP

Water Pump, Power Steering, Oil Pump & Alternator Drive System 60-63
 SBC Serpentine Crank to WP, WP to PS, Radius Tooth OP & Alt Drive 60
 BBC Serpentine Crank to WP, WP to PS, Radius Tooth OP & Alt Drive 61
 SBF Serpentine Crank to WP, WP to PS, Radius Tooth OP & Alt Drive 62

SBC Belt Driven Cam Drive, Runs in Oil Under Stock Cover 63

Radius Tooth HTD Drive Kits w/ Oil Pump 64-65
 SBC Asphalt Late Model Radius Tooth WP, PS, Alt & OP 64
 SBC NASCAR Modified Radius Tooth WP, PS, Alt & OP 65

ALT KITS

Complete Alternator Kits 66-72
 SBC & LS Complete Alternator Kits 66-68
 SB Ford Complete Alternator Kits 69
 SB Chrysler Complete Alternator Kits 70
 BBC Complete Alternator Kits 71
 Motorplate & Rear Mount Alternator Kits 72

STREET

Street Belt Drive Systems 73-76
 BBC Street Belt Drive 73
 SBC Street Belt Drive 74
 SBF Street Belt Drive 75

Belts 76-77

Kit Finder

Accessory → Kit# & Page# Engine Type ↓	WP Drive	WP & PS	WP & PS & AL	WP, PS, OP & AL	Fuel Pump	Oil Pump	Alternator	Street
SB Chevy	1020-S ...50 1035-S ...51 2010-RA ..58	1020-PS..... 50 1004-AR-CE..54	2441-AR-CE..52 1441-AR-CE..54 1065-AR-SB..74	1056-S 60 4-4698-R .. 64 4-4698-MP 65	1035-S-TP 53 2001-RA ...53 2001-CS ...53	2015-RA ..58 2002-RA ..58	See Pages 66, 67 & 68	See Pages 54, 74
SB Ford	1026-S ...50 2010-F ...58	1005-S-CE ..55	1565-AR-CE..55	1057-S 62	2001-F53	2002-F58	See Page 69	See Pages 55 & 75
SB Chry	1028-S ...50	1008-S-CE ..56	1875-65 ...56		2001-CR ...53		See Page 70	See Page 56
BB Chevy	1020-S ...50 2010-RA-BB ..58	1065-S73	1065-S73	1055-S ...61	2001-BB ...53	2002-BB ..58	See Page 71	See Page 73
Bell Housing		PS Only 2004-PS59		2004-OP-AL ...Pg 59	2001-BH ...53	2004-RA ..59	2004-AL ..59	
LS (CT525)	1020-LS ..49	1006-LS ..49	1646-LS ..49		2003-LS ..49	2002-LS-R 56 2002-LS-L 56	2046-LS ..66 2069-LS...66	

WHAT DRIVES YOU



Billet Aluminum Drive Hubs

Aluminum:

The manufacturing of each drive hub starts with the highest quality domestic billet aluminum bar stock, precision machined using our state-of-the-art CNC machinery.



Concentricity:

Our drive hubs are engineered for each engine and damper application to provide a true and concentric drive system. The correct register is the key to ensure fitment and concentricity. Whether it be the two piece design of the 1.0" outside diameter mandrels or the stronger 1-1/8" diameter, all mandrels incorporate the standard 1/8" keyway.

Durability:

The lightweight design and strength of each drive hub promotes reliability and performance in even the most extreme RPM conditions. Our one piece drive hubs feature internal threads at their base for the mandrel's pulley retaining bolt, allowing the use of the correct standard length crank bolt and heavy duty washer to secure the damper, independent of the drive hub.



SBC Billet Aluminum Drive Hubs 05

Billet aluminum SBC drive hub.

The base registers inside your SB balancer and has a built-in nut to turnover engine.

The "A" has a built-in spacer to align with "C" offset WP pulleys. 2.5, 3.5, & 4" is the length from the front face of the 1/2" thick nut forward.



DH-8101-NE-A-2.5"
Uses Bolt & End cap kit: BEC-2109-D

H-8101-NE-B-2.4" (Bolt & End cap kit: BEC-2109-D)
H-8101-NE-B-2.9" (Bolt & End cap kit: BEC-2109-D)
H-8101-NE-B-3.5" (Bolt & End cap kit: BEC-2109-D)
H-8101-NE-B-4.0" (Bolt & End cap kit: BEC-2109-D)



SB CHEVY 3-BOLT HUB

Bolts to the face of your SBC balancer, independent of the balancer bolt!

H-8101-WC-SB

Uses a self contained end bolt, bolt kit# **BEC-2109-HC**

DH-8101-ADP-SB
SBC Register

H-8101-ADP-CT
SBC Register for Crank Trigger



SB CHEVY DUAL DOWEL HUB

Aluminum SB *Dual Dowel* pin drive hub
Bolts to balancer face via **SK-2109-DK**.
Uses thru bolt to retain balancer.

H-8101-C-DP

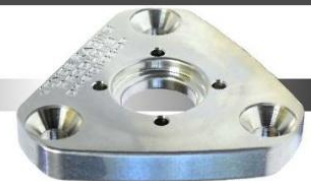

SBC SLIDE-IN HUB

Aluminum SB thread-in mandrel hub, fits inside of the balancer & Uses a thru bolt to retain it & the balancer.



DH-8101-A

SBC BOLT-ON HUB

Aluminum SB thread-in hub. Bolts to balancer via **SK-2109-DK** & uses a thru bolt to retain it & the balancer.



DH-8101-C

THREAD-IN MANDRELS

- DHM-8101-A 1.06" x 1-1/8"
- DHM-8101-B 3.5" x 1-1/8"
- DHM-8101-C 4.0" x 1-1/8"
- DHM-8101-D 4.5" x 1-1/8"
- DHM-8101-E 5.0" x 1-1/8"
- DHM-8101-F 5.5" x 1-1/8"
- DHM-8101-G 4.0" x 1" O.D.



06 BBC Billet Aluminum Drive Hubs



BB CHEVY 3-BOLT HUB

Bolts to the face of your BBC balancer, independent of the balancer bolt!

DH-8101-WC-BB
DH-8101-09-BB (Low Profile)

Uses a self contained end bolt, bolt kit# BEC-2109-HC



BB CHEVY 3-BOLT HUB

Bolts to the face of your BBC balancer, independent of the balancer bolt! Features built-in spacer and has both a BBC & SBF 3-Bolt Pattern. Available in three lengths.

(3.25" long from balancer to end)
(3.917" long from balancer to end)
(4.168" long from balancer to end)



BB CHEVY DUAL DOWEL (Low Profile)



Low profile, 3/8" thick **Dual Dowel** drive hub. Has a self contained retaining bolt, allowing it to mount independent of the balancer bolt. Accepts "-WC" components

DH-8101-DP-BB

BB CHEVY DUAL DOWEL

Aluminum BB **Dual Dowel** pin drive hub
Bolts to balancer face via SK-2109-DK.
Uses thru bolt to retain balancer.

DH-8101-DP-BB



BB CHEVY SLIDE-IN HUB

Aluminum BB thread-in mandrel hub Slips inside of the balancer & uses two roll pins.



DH-8101-B

BB CHEVY BOLT-ON HUB

Aluminum BB thread-in mandrel hub, bolts to balancer via SK-2109-DK.



DH-8101-C-BB

THREAD-IN MANDRELS

DHM-8101-A 1.06" x 1-1/8"
DHM-8101-B 3.5" x 1-1/8"
DHM-8101-C 4.0" x 1-1/8"
DHM-8101-D 4.5" x 1-1/8"
DHM-8101-E 5.0" x 1-1/8"
DHM-8101-F 5.5" x 1-1/8"
DHM-8101-G 4.0" x 1" O.D.



SB & BB Ford Billet Aluminum Drive Hubs 07



SB FORD 3-BOLT

Bolts to the face of your SBF 3-bolt balancer, independent of the balancer bolt!

Uses a self contained end bolt, bolt kit# **BEC-2109-HC**



SB FORD/BBC 3-BOLT

Bolts to the face of your SBF, independent of the balancer bolt! Built-in spacer design & has both a BBC & SBF 3-Bolt Pattern.

DH-8101-WC-DE
(3.375" long from balancer to end)

DH-8101-WC-SR
(3.937" long from balancer to end)

DH-8101-WC-SR-A
(4.187" long from balancer to end)

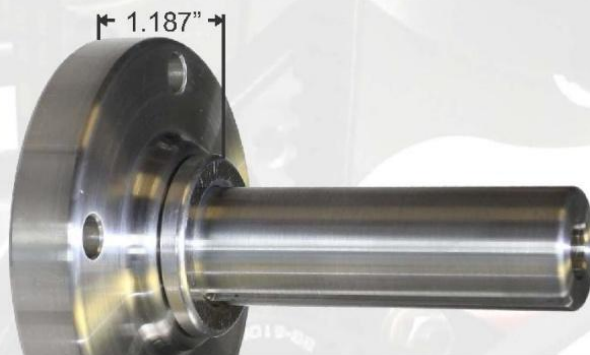

SB FORD 4-BOLT

Bolts to the face of your SBF 4-bolt balancer, independent of the balancer bolt!

DH-8101-351W-F4

Uses a self contained end bolt, bolt kit# **BEC-2109-HC**

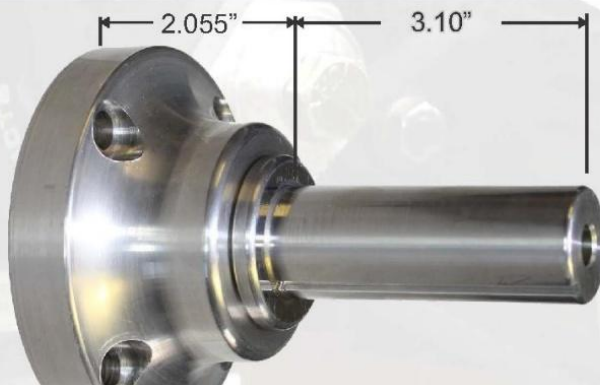

BB FORD 4-BOLT

Bolts to the face of your BBF 4-bolt balancer, independent of the balancer bolt!

DH-8101-WC-F4-460

Uses a self contained end bolt, bolt kit# **BEC-2109-F4**



08 Billet Aluminum Drive Hubs



CHRYSLER/MOPAR

Chrysler 6-bolt drive hub with both 3/8 & 5/16 6-bolt patterns. Mounts independent of the balancer bolt!

DH-8101-WC-C

Uses a self contained end bolt, bolt kit# BEC-2109-HC

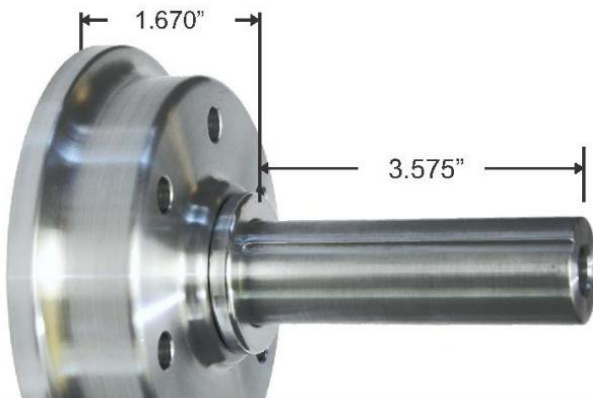

DURAMAX DIESEL

Billet aluminum drive hub for ATI Duramax Super Dampers. Available for both balancers with or without counterweight.

DH-8101-WC-DD

(Balancer with Counterweight, Right →)

DH-8101-WC-DD2

(← Left, Balancer without Counterweight)



LS DRIVE MANDREL

Bolts to the face of your ATI LS 3-bolt balancer, independent of the balancer bolt!

DH-8101-WC-LS

DH-8101-09-LS (Low Profile)



LS DUAL DOWEL HUB

Low profile, 3/8" thick *Dual Dowel* drive hub. Has a self contained retaining bolt, allowing it to mount independent of the balancer bolt. Accepts "-WC" components.

DH-8101-DP-LS





SPLIT-V DRIVE HUBS

Mounts "CS-3102-WC" V-Belt pulleys
 BBC bolt pattern and register
 Use **DH-8101-ADP-SB** for SBC
 Use **DH-8101-F3-ADP** for SBF
 Use w/ **DHS-3102-SK-BC** Shim Kit

DH-3102-A for 1 Split-Vs
 DH-3102-B for 2 Split-Vs
 DH-3102-D for 3 Split-Vs
 DH-3102-C for 4 Split-Vs



DH-3102 SPLIT-V SPACER

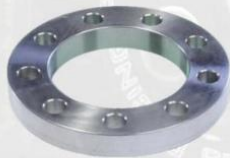

DHS-3102-1/4"
 DHS-3102-3/8"
 DHS-3102-1/2"
 DHS-3102-3/4"

DHS-3102-SK-B

6- .020 Shim

DHS-3102-SK-C

1- .060 Shim

DHS-3102-SK-BC

2- .060 Shim & 6 - .030 Shims



DRIVE HUB SPACERS

SBC REGISTER

SP-3102-SB-1/4"
 SP-3102-SB-3/8"
 SP-3102-SB-1/2"
 SP-3102-SB-3/4"

BBC REGISTER

SP-3102-BB-1/4"
 SP-3102-BB-3/8"
 SP-3102-BB-1/2"
 SP-3102-BB-3/4"

DRIVE MANDREL PULLEY SPACERS

an "A" signifies an 1-1/8" Inside Diameter

a "B" signifies an 1" Inside Diameter

SP-6103-G- (A or B) 1/16" Thick

SP-6103-A- (A or B) 1/4" Thick

SP-6103-B- (A or B) 3/8" Thick

SP-6103-C- (A or B) 1/2" Thick

SP-6103-D- (A or B) 3/4" Thick

SP-6103-E- (A or B) 1.0" Thick

SP-6103-F- (A or B) 1-1/4" Thick

SP-6103-K- (A or B) Spacer Assortment



DUAL DOWEL PULLEY SPACERS

Dual-Dowel Pin

SP-6103-WC-A Dual Dowel 1/4" Thick

SP-6103-WC-B Dual Dowel 3/8" Thick

SP-6103-WC-C Dual Dowel 1/2" Thick

SP-6103-WC-D Dual Dowel 3/4" Thick

SP-6103-WC-E Dual Dowel 1.0" Thick

SP-6103-WC-F Dual Dowel 1-1/4" Thick

SP-6103-WC-K Dual Dowel Spacer Assortment



BBC DH to SBC



BBC DH to SBC w. CT

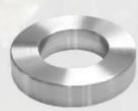

SBC DH to BBC Balancer



Chevy to Ford 3-Bolt

ADAPTERS

DH-8101-ADP-SB (BBC DH to SBC Bal. Adapter)

DH-8101-ADP-CT (DH to SBC Bal. w/ Crank Trigger)

DH-3102-ADP (SBC to BBC Bal. Adapter)

DH-3102-F3-ADP (3-Bolt BBC to 3-Bolt Ford Bal.)

10 Billet Alum. Drive Hub Accessories

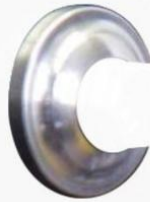

DRIVE HUB END CAPS

Standard End Caps

EC-6111-A (7/16 ID for 1-1/8" Mandrel)

EC-6111-B (1/2 ID for 1-1/8" Mandrel)

EC-6111-C (7/16 ID for 1" Mandrel)

EC-6111-D (1/2 ID for 1" Mandrel)



DUAL DOWEL END CAPS

Dual Dowel Pin assembly retaining caps. Use EC-6111-WC-N series end caps to incorporate an engine turn over nut into your stack up, or you can use EC-6111-WC end caps to create a lower profile assembly.



End cap with built-in nut to turn over engine. For use with dual dowel pin assemblies

EC-6111-WC-N-1/2" (1/2 I.D.)

EC-6111-WC-N-7/16" (7/16 I.D.)



End Cap for Dual Dowel Pin Assemblies

EC-6111-WC-1/2" (1/2 I.D.)

EC-6111-WC-7/16" (7/16 I.D.)



MANDREL NUT

(To turn over engine)

GSN-6103-A (1-1/8" mandrel)

GSN-6103-B (1" mandrel)



ENGINE TURNOVER WRENCH

WR-8101-A (Open End Wrench)

WR-8101-B (Closed End Wrench)

KEYS & PINS

SBC, "DH-8101-NE" Series Woodruff Key

3/16" Woodruff key

WK-2109-A (1/2 Moon Woodruff Key)



Dowel Pins for "WC" Series Components

DP-2109-A

(2: 3/4" Long, 3/16" Dowel Pins)



BBC, "DH-8101-B" Drive Hub Roll Pins

RP-2109-C

(2: 1" Long, 3/16" Roll Pins)



Crankshaft Pulley Mandrel Keyways

1/8" Keyways for CS Pulleys

KS-2109-B (1" Long, 1/8" Keyway)

KS-2109-C (0.83" Long, 1/8" Keyway)

KS-2109-D (1/2" Long, 1/8" Keyway)



Oil Pump and Fuel Pump Pulley Keyway

3/16" Keyways for OP Pulleys

KS-2109-A (1" Long, 3/16" Keyway)



Drive Hub Hardware 11

DRIVE HUB BOLT KITS

SBC Thru-Bolt Kits

7/16 Through Bolts (Fine, SAE):

BEC-2109-2.5	2.5" Long
BEC-2109-A	4.0" Long
BEC-2109-B	4.5" Long
BEC-2109-C	5.0" Long
BEC-2109-D	5.5" Long
BEC-2109-E	6.0" Long
BEC-2109-F	6.5" Long
BEC-2109-G	7.0" Long

BBC Thru-Bolt Kits

1/2 Through Bolts (Fine, SAE):

BEC-2109-H	4.0" Long
BEC-2109-I	4.5" Long
BEC-2109-J	5.0" Long
BEC-2109-K	5.5" Long
BEC-2109-L	6.0" Long
BEC-2109-M	6.5" Long
BEC-2109-N	7.0" Long

Drive Hubs Self-Contained End Bolts

1/2 Bolts for 1-pc Mandrels, USS

BEC-2109-HC	4.0" Long
BEC-2109-IC	3.0" Long
BEC-2109-JC	2.5" Long
BEC-2109-KC	2.5" Long
BEC-2109-LC	2.0" Long



DRIVE HUB BOLT KITS

Flat Head Allen Bolts:

USS Coarse Thread

SK-2109-A	3/8"x0.75" USS
SK-2109-C	3/8"x1.00" USS
SK-2109-D	3/8"x1.25" USS
SK-2109-E	3/8"x1.50" USS
SK-2109-F	3/8"x1.75" USS
SK-2109-G	3/8"x2.00" USS
SK-2109-G2	3/8"x2.25" USS
SK-2109-H	3/8"x2.50" USS
SK-2109-Q	3/8"x2.75" USS
SK-2109-I	3/8"x3.00" USS
SK-2109-P	3/8"x3.50" USS



Socket Head Allen Bolts:

USS Coarse Thread

SK-2109-A	3/8"x0.75" USS
SK-2109-C	3/8"x1.00" USS
SK-2109-D	3/8"x1.25" USS
SK-2109-E	3/8"x1.50" USS
SK-2109-F	3/8"x1.75" USS
SK-2109-G	3/8"x2.00" USS
SK-2109-G2	3/8"x2.25" USS
SK-2109-H	3/8"x2.50" USS
SK-2109-Q	3/8"x2.75" USS
SK-2109-I	3/8"x3.00" USS
SK-2109-P	3/8"x3.50" USS



USF Fine Thread

SK-2109-J	3/8" x 1" USF
SK-2109-K	3/8x1.25" USF
SK-2109-L	3/8x1.5" USF
SK-2109-F-USF	3/8x1.75" USF
SK-2109-G-USF	3/8x2" USF
SK-2109-M	3/8x2.25" USF
SK-2109-Q-USF	3/8x2.25" USF
SK-2109-N	3/8x3.00" USF



USF Fine Thread

SK-2109-J	3/8" x 1" USF
SK-2109-K	3/8x1.25" USF
SK-2109-L	3/8x1.5" USF
SK-2109-F-USF	3/8x1.75" USF
SK-2109-G-USF	3/8x2" USF
SK-2109-M	3/8x2.25" USF
SK-2109-Q-USF	3/8x2.25" USF
SK-2109-N	3/8x3.00" USF



CUSTOM DRIVE HUBS

Give us a call with your custom needs!



Radius Tooth HTD & Gilmer Crank Pulleys

**Billet
Aluminum:**

Precision CNC machining from the highest quality domestic billet aluminum yields industry leading Jones radius and square tooth pulleys. The proprietary black hardcoat is applied to maximize wear resistance and overall performance.

**Unmatched
Efficiency:**

The design characteristics of our radius tooth drive pulleys are unparalleled. Reduced belt tension along with the smooth-running rounded tooth design minimizes drag and wear. We offer a comprehensive selection of pulleys that will guarantee the proper sizing for complete ratio control. Total optimization of the belt drive system provides horsepower savings with no compromise in reliability.

**Industry
Leading:**

Our company has been at the forefront of innovation, the first to produce radius tooth pulley systems for the high-performance industry. Leading the way in implementation and evolution, we have offered designs which are unmatched in longevity, performance and strength. In our selection, five different pulley widths accommodate the same five choices of belt width options. The choice of either the 1.0" or 1-1/8" inside diameter both with an 1/8" keyway slot or the dual dowel pin style of pulleys offer numerous fitment options.



Radius Tooth HTD Crank Pulleys 13

1" WIDE (25MM) WIDER DESIGN FOR EASE OF BELT ALIGNMENT

1" Wide, 1 1/8" I.D. with 1/8 Keyway

- CS-6102-A-17 (17 teeth)
- CS-6102-A-18 (18 teeth)
- CS-6102-A-19 (19 teeth)
- CS-6102-A-20 (20 teeth)
- CS-6102-A-21 (21 teeth)
- CS-6102-A-22 (22 teeth)
- CS-6102-A-23 (23 teeth)
- CS-6102-A-24 (24 teeth)
- CS-6102-A-25 (25 teeth)
- CS-6102-A-26 (26 teeth)
- CS-6102-A-27 (27 teeth)
- CS-6102-A-28 (28 teeth)
- (See .830 wide for 29 teeth)
- CS-6102-A-30 (30 teeth)
- CS-6102-A-31 (31 teeth)
- (See .830 wide for 32-36 teeth)
- CS-6102-A-37 (37 teeth)
- CS-6102-A-38 (38 teeth)
- (See .830 wide for 40 teeth & up)



1" Wide, 1" I.D. with 1/8 Keyway

- CS-6102-B-17 (17 teeth)
- CS-6102-B-18 (18 teeth)
- CS-6102-B-19 (19 teeth)
- CS-6102-B-20 (20 teeth)
- CS-6102-B-21 (21 teeth)
- CS-6102-B-22 (22 teeth)
- CS-6102-B-23 (23 teeth)
- CS-6102-B-24 (24 teeth)
- CS-6102-B-25 (25 teeth)
- CS-6102-B-26 (26 teeth)
- CS-6102-B-27 (27 teeth)



0.830" WIDE, (NARROW DESIGN TO CREATE A SHORTER, MORE COMPACT, STACK UP)

.830" Wide, 1 1/8" I.D. with 1/8 Keyway

- CS-6102-AS-17 (17 teeth)
- CS-6102-AS-18 (18 teeth)
- CS-6102-AS-19 (19 teeth)
- CS-6102-AS-20 (20 teeth)
- CS-6102-AS-21 (21 teeth)
- CS-6102-AS-22 (22 teeth)
- CS-6102-AS-23 (23 teeth)
- CS-6102-AS-24 (24 teeth)
- CS-6102-AS-25 (25 teeth)
- (See 1" wide for 26 teeth)
- CS-6102-AS-27 (27 teeth)
- (See 1" wide for 28 teeth)
- CS-6102-AS-29 (29 teeth)
- CS-6102-AS-30 (30 teeth)
- CS-6102-AS-31 (31 teeth)
- CS-6102-AS-32 (32 teeth)
- CS-6102-AS-33 (33 teeth)
- CS-6102-AS-34 (34 teeth)
- CS-6102-AS-35 (35 teeth)
- CS-6102-AS-36 (36 teeth)
- CS-6102-AS-37 (37 teeth)
- CS-6102-AS-38 (38 teeth)
- CS-6102-AS-40 (40 teeth)
- CS-6102-AS-44 (44 teeth)
- CS-6102-AS-45 (45 teeth)



CS-6102-BS-38
shown with: BG-6108-38S

.830" Wide, 1" I.D. with 1/8 Keyway

- CS-6102-BS-17 (17 teeth)
- CS-6102-BS-18 (18 teeth)
- CS-6102-BS-19 (19 teeth)
- CS-6102-BS-20 (20 teeth)
- CS-6102-BS-21 (21 teeth)
- CS-6102-BS-22 (22 teeth)
- CS-6102-BS-23 (23 teeth)
- CS-6102-BS-24 (24 teeth)
- CS-6102-BS-30 (30 teeth)
- CS-6102-BS-31 (31 teeth)
- CS-6102-BS-32 (32 teeth)
- CS-6102-BS-30 (30 teeth)
- CS-6102-BS-33 (33 teeth)
- CS-6102-BS-34 (34 teeth)
- CS-6102-BS-36 (36 teeth)
- CS-6102-BS-38 (38 teeth)



0.830" WIDE, (NARROW DESIGN TO CREATE A SHORTER, MORE COMPACT, STACK UP)

.830" Wide, 3/16" Dual Dowel Pin Design

- CS-6102-WC-22 (22 teeth)
- CS-6102-WC-23 (23 teeth)
- CS-6102-WC-24 (24 teeth)
- CS-6102-WC-25 (25 teeth)
- CS-6102-WC-26 (26 teeth)
- CS-6102-WC-36 (36 teeth)



3/16" Dowel for Dual Dowel Pin Assemblies

DP-2109-A (Set of Two Dowel Pins)



14 Radius Tooth HTD Crank Pulleys

1/2" WIDE RADIUS TOOTH HTD CRANKSHAFT PULLEYS

1/2" Wide, 1 1/8" I.D. with 1/8 Keyway

- CS-6102-AC-17 (17 teeth)
- CS-6102-AC-18 (18 teeth)
- CS-6102-AC-19 (19 teeth)
- CS-6102-AC-20 (20 teeth)
- CS-6102-AC-21 (21 teeth)
- CS-6102-AC-22 (22 teeth)
- CS-6102-AC-23 (23 teeth)
- CS-6102-AC-24 (24 teeth)
- CS-6102-AC-25 (25 teeth)
- CS-6102-AC-32 (32 teeth)
- CS-6102-AC-35 (35 teeth)
- CS-6102-AC-36 (36 teeth)
- CS-6102-AC-37 (37 teeth)
- CS-6102-AC-38 (38 teeth)
- CS-6102-AC-40 (40 teeth)
- CS-6102-AC-45 (45 teeth)



1/2" Wide, 1" I.D. with 1/8 Keyway

- CS-6102-BC-17 (17 teeth)
- CS-6102-BC-18 (18 teeth)
- CS-6102-BC-19 (19 teeth)
- CS-6102-BC-20 (20 teeth)
- CS-6102-BC-21 (21 teeth)
- CS-6102-BC-22 (22 teeth)
- CS-6102-BC-23 (23 teeth)
- CS-6102-BC-24 (24 teeth)
- CS-6102-BC-25 (25 teeth)
- CS-6102-BC-33 (33 teeth)
- CS-6102-BC-34 (34 teeth)
- CS-6102-BC-35 (35 teeth)



1/2 Wide, RADIUS TOOTH HTD DUAL DOWEL PIN CRANKSHAFT PULLEYS

1/2 Wide, 3/16" Dual Dowel Pin Design

- CS-6102-WC-C-22 (22 teeth)
- CS-6102-WC-C-23 (23 teeth)
- CS-6102-WC-C-24 (24 teeth)



3/16" Dowel for Dual Dowel Pin Assemblies

DP-2109-A (Set of Two Dowel Pins)



CRANKSHAFT PULLEY BELT GUIDES



1/16" Belt Guides

- BG-6108-F (1 1/8" ID, for 17-22 tooth Pulleys)
- BG-6108-G (1" ID, for 17-22 tooth Pulleys)
- BG-6108-A (1 1/8" ID, for 17-25 tooth Pulleys)
- BG-6108-B (1" ID, for 17-25 tooth Pulleys)
- BG-6108-C (1 1/8" ID, for 26-35 tooth Pulleys)
- BG-6108-D (1" ID, for 26-35 tooth Pulleys)
- BG-6108-E (1 1/8" ID, for 35-40 tooth Pulleys)
- BG-6108-H (1" ID, for 35-40 tooth Pulleys)



- BG-6108-WC
22-24 tooth Pulleys
- BG-6108-WC-3
25-30 tooth Pulleys
- BG-6108-WC-C
30-36 tooth Pulleys



Gilmer Pulleys Crankshaft Pulleys 15

1-1/16" WIDE SQUARE TOOTH GILMER CRANKSHAFT PULLEYS

1 1/16" Wide, 1 1/8" I.D. with 1/8 Keyway

- CS-4102-A-12 (12 teeth)
- CS-4102-A-14 (14 teeth)
- CS-4102-A-15 (15 teeth)
- CS-4102-A-16 (16 teeth)
- CS-4102-A-17 (17 teeth)
- CS-4102-A-18 (18 teeth)
- CS-4102-A-19 (19 teeth)
- CS-4102-A-20 (20 teeth)
- CS-4102-A-21 (21 teeth)
- CS-4102-A-22 (22 teeth)
- CS-4102-A-26 (26 teeth)



1 1/16" Wide, 1" I.D. with 1/8 Keyway

- CS-4102-B-12 (12 teeth)
- CS-4102-B-14 (14 teeth)
- CS-4102-B-15 (15 teeth)
- CS-4102-B-16 (16 teeth)
- CS-4102-B-17 (17 teeth)
- CS-4102-B-18 (18 teeth)
- CS-4102-B-19 (19 teeth)
- CS-4102-B-20 (20 teeth)
- CS-4102-B-21 (21 teeth)
- CS-4102-B-26 (26 teeth)



1 1/16" Wide, 3/16" Dual Dowel Pin Design

- CS-4102-WC-16 (16 teeth)
- CS-4102-WC-18 (18 teeth)
- CS-4102-WC-19 (19 teeth)
- CS-4102-WC-20 (20 teeth)



3/16" Dowel for Dual Dowel Pin Assemblies

DP-2109-A (Set of Two Dowel Pins)



SQUARE TOOTH GILMER CRANKSHAFT PULLEYS (9/16" WIDE)

9/16" Wide, 1 1/8" I.D. with 1/8 Keyway

- CS-4102-AC-14 (14 teeth)
- CS-4102-AC-15 (15 teeth)
- CS-4102-AC-16 (16 teeth)
- CS-4102-AC-17 (17 teeth)
- CS-4102-AC-18 (18 teeth)
- CS-4102-AC-19 (19 teeth)
- CS-4102-AC-20 (20 teeth)



9/16" Wide, 1" I.D. with 1/8 Keyway

- CS-4102-BC-12 (12 teeth)
- CS-4102-BC-14 (14 teeth)
- CS-4102-BC-15 (15 teeth)
- CS-4102-BC-16 (16 teeth)
- CS-4102-BC-17 (17 teeth)
- CS-4102-BC-18 (18 teeth)
- CS-4102-BC-19 (19 teeth)
- CS-4102-BC-20 (20 teeth)



9/16" Wide, 3/16" Dual Dowel Pin

- CS-4102-WC-C-16 (16 teeth)
- CS-4102-WC-C-18 (18 teeth)
- CS-4102-WC-C-19 (19 teeth)
- CS-4102-WC-C-20 (20 teeth)



3/16" Dowel for Dual Dowel Pin Assemblies

DP-2109-A (Set of Two Dowel Pins)



CRANKSHAFT PULLEY BELT GUIDES



1/16" Wide Belt Guides

- BG-6108-F (1 1/8" ID, for 12-20 Square Pulleys)
- BG-6108-G (1" ID, for 12-21 Square Pulleys)
- BG-6108-A (1 1/8" ID, for 12-20 Square Pulleys)
- BG-6108-B (1" ID, for 12-21 Square Pulleys)
- BG-6108-C (1 1/8" ID, for 22-30 Square Pulleys)
- BG-6108-D (1" ID, for 22-30 Square Pulleys)



1/16" Dual Dowel Belt Guide

BG-6108-WC
(Dual Dowel Design
16-20 Square Tooth
Pulleys)

Serpentine Crank Pulleys

Manufacturing:

The design and engineering process for serpentine pulleys and belts has been a top priority of Jones Racing Products since our inception in 1981. The ability to have complete control over not only the manufacturing of the pulleys but the belts as well ensures our serpentine drives will work seamlessly together. Our manufacturing process starts with domestic aluminum bar stock which is CNC machined in-house at our Pennsylvania facility. Pulleys are then matched with their Jones counterpart, race specific serpentine belts. We are proud to manufacture our complete serpentine drives in the USA.

Exacting Tolerances:

Our serpentine drive pulleys are CNC machined to exacting tolerances, promoting optimal engagement into our race specific engineered belts. This combination will drive the engine's accessories without the worry of belt slip and premature wear, all while saving horsepower due to decreased belt tensions.

Performance Driven:

The high demands racing puts on each driven engine accessory is intense. The proper design of pulley and belt along with a tailored pulley ratio for the engine RPM's will generate the most reliable and efficient belt drive system. Many variables need to be considered when choosing the correct components for your application. Jones Racing Products has the extensive knowledge from our 35+ years of experience to ensure our customers' drives run flawlessly.



Serpentine Poly-V Crank Pulleys 17

1-1/8" I.D. KEYED SERPENTINE POLY-V CRANKSHAFT PULLEYS (5 OR 6PK)

6-Groove, 1" wide, 1 1/8" I.D. with an 1/8 key
1 extra groove for ease of belt alignment or for use with a 6PK belt in extreme applications

CS-5102-AA	2.00" Diameter
CS-5102-A	2.50" Diameter
CS-5102-B	2.80" Diameter
CS-5102-C	3.00" Diameter
CS-5102-D	3.25" Diameter
CS-5102-E	3.50" Diameter
CS-5102-F	3.75" Diameter
CS-5102-G	4.00" Diameter
CS-5102-H	4.25" Diameter
CS-5102-I	4.50" Diameter
CS-5102-J	5.00" Diameter
CS-5102-K	5.50" Diameter
CS-5102-M	6.00" Diameter



1" I.D. DUAL DOWEL SERPENTINE POLY-V CRANKSHAFT PULLEYS (5 OR 6PK)

6-Groove, 1" wide, 1" I.D., Dual Dowel Design (Can be customized to use w/ a 1" mandrel)
1 extra groove for ease of belt alignment or for use with a 6PK belt in extreme applications

CS-5102-WC-A	2.50" Diameter
CS-5102-WC-B	2.80" Diameter
CS-5102-WC-C	3.00" Diameter
CS-5102-WC-D	3.25" Diameter
CS-5102-WC-E	3.50" Diameter
CS-5102-WC-F	3.75" Diameter
CS-5102-WC-G	4.00" Diameter
CS-5102-WC-H	4.25" Diameter
CS-5102-WC-I	4.50" Diameter
CS-5102-WC-J	5.00" Diameter
CS-5102-WC-K	5.50" Diameter
CS-5102-WC-M	6.00" Diameter



DP-2109-A (Set of Two)
3/16" Dowels for
Dual Dowel
Pin Assemblies 

DIRECT BOLT-ON SERPENTINE POLY-V CRANKSHAFT PULLEYS (5 OR 6PK)

6-Groove, Direct Bolt-on Crank Pulleys, SBC Register & 3-Bolt Pattern
1 extra groove for ease of belt alignment or for use with a 6PK belt for extreme applications

DH-5102-G 4.000"
3-Bolt, with BB & SBC
Register. See Kit 1020
Stand-alone WP Drive.



DH-5102-H 4.250"
3-Bolt w. SBC Register
See Kit 1035-S, Stand-
alone Crate WP Drive.



CT-525 4.000"
3-Bolt, with CT525 O.D.
Register, for LS CT525
Stand-alone WP Drive.



ID-5107 (Pulley) &
IDM-9100 (Mount)
Idler Pulley Assembly



T-5100
Spring-Loaded
Belt Tensioner

V-Belt Crank Pulleys

Billet Aluminum:

The same pride is taken in the manufacturing of our Deep Grip V-Belt pulleys as the rest of our extensive Jones Racing Products pulley line. CNC machining in its entirety produces an accurate end product and using the proven black hardcoat finish maximizes performance. Our billet aluminum Deep Grip V-Belt pulleys feature wear resistance, supreme accuracy and a lightweight design without compromising strength.

Deep Grip-V:

Our precisely machined Deep Grip V-Belt groove design allows our pulleys to properly seat the belt even at high race RPM's. This feature maximizes belt contact for traction. With our design, the reliability is significantly increased by reducing the risk of belt unseating.

Selection:

Whether you are using the Deep Grip V-Belt pulleys for alternators, water pumps, power steering or vacuum pumps our comprehensive selection of pulleys will guarantee the proper sizing of both the crank drive pulley and the driven pulley, resulting in the optimal ratio for your application.



V-BELT CRANKSHAFT PULLEYS FOR MANDRELS

3" Diameter

- CS-3102-A (3" O.D., 1 1/8" I.D., 1/8" Keyway)
- CS-3102-B (3" O.D., 1" I.D., 1/8" Keyway)
- CS-3102-WC (3" O.D., Dual Dowel Pin Design)

4" Diameter

- CS-3102-D-A (4" O.D., 1 1/8" I.D., 1/8" Keyway)
- CS-3102-D-B (4" O.D., 1" I.D., 1/8" Keyway)

5" Diameter

- CS-3102-C-A (5" O.D., 1 1/8" I.D., 1/8" Keyway)
- CS-3102-C-B (5" O.D., 1" I.D., 1/8" Keyway)



V-BELT DIRECT BOLT-ON CRANKSHAFT PULLEYS

Double V-Belt, with Center Threads

to accept DHM Mandrel or Dual Dowel Assem.
3-Bolt Pattern SBC Register

- CS-3102-WC-A 6" Diameter
- CS-3102-WC-B 5.5" Diameter

Single V-Belt

3-Bolt Pattern SB & BBC Register
DH-3102-C-5 5" Diameter, SBC
DH-3102-C-5-BB 5" Diameter, BBC



SPLIT-V CRANKSHAFT PULLEYS

- CS-3102-WC-D (5.20" O.D. Split-V CS Pulley)
- CS-3102-WC-E (5.50" O.D. Split-V CS Pulley)
- CS-3102-WC-F (5.75" O.D. Split-V CS Pulley)
- CS-3102-WC-G (6.00" O.D. Split-V CS Pulley)
- CS-3102-WC-I (6.50" O.D. Split-V CS Pulley)
- CS-3102-WC-J (7.00" O.D. Split-V CS Pulley)



SPLIT-V SHIMS

- DHS-3102-SK-B (3, .020" Shims)
- DHS-3102-SK-C (1, .060" Shims)
- DHS-3102-SK-BC (2, .060" Shims & 3, .020" Shims)

SPLIT-V SPACERS

- DHS-3102-1/4" (1/4" Spacer, Use w/ Split-V Hubs)
- DHS-3102-3/8" (3/8" Spacer, Use w/ Split-V Hubs)
- DHS-3102-1/2" (1/2" Spacer, Use w/ Split-V Hubs)
- DHS-3102-3/4" (3/4" Spacer, Use w/ Split-V Hubs)
- DHS-3102-1" (1" Spacer, Use w/ Split-V Hubs)



(See Page 9 for Split-V Drive Hubs)

Alternators & Alternator Components

Lightweight:

The combination of performance driven reliability and our lightweight design produces a true racing alternator to meet our customer's high demands. One of the advantages of the dual internal fans is to allow for a cooler operating temperature which promotes the units to produce the output needed to keep a full charge.

High Output:

Our alternators are engineered to provide the maximum amount of voltage output from a small sturdy platform. With a large range of output sizes offered, we can provide a unit that will satisfy the electrical demands all while saving horsepower. The correct alternator will allow the correct voltage output from the smallest, lightest unit without sacrificing efficiency or reliability

High Efficiency:

Our alternators are designed to create a high output at a low operating RPM. This allows our units to spin much slower, reducing drag and saving valuable horsepower. The correct alternator for the application will have a ratio between 1:1 and 1.5:1. The options to have either 12 volt or 16 volt battery charging outputs are available in any of our alternators. The one-wire electrical hookup for the alternator, along with numerous bracket mounting options, keeps installation easy.



35 AMPS AT LOW RPM, 55 MAX, MINI ALTERNATOR, 5 LBS

AL-9101-A-NS

(1-Wire, Self Exciting, 12v, 40+ amps)

AL-9101-A-A (Adjustable Voltage)

(1-Wire, Self Exciting, adjustable 12v-19v, 40+ amps)



45 AMPS AT LOW RPM, 70 MAX, MINI ALTERNATOR, 6 LBS.

AL-9101-B-NS

(1-Wire, Self Exciting, 12v, 70+ amps)

AL-9101-B-A (Adjustable Voltage)

(1-Wire, Self Exciting, adjustable 12v-19v, 70 amps)



80 AMPS AT LOW RPM, 140 MAX HD ALTERNATOR, 11 LBS.

AL-9101-E-NS

(1-Wire, Self Exciting, 12v, 140+ amps)

AL-9101-E-A (Adjustable Voltage)

(1-Wire, Self Exciting, adjustable 12v-19v, 135+ amps)



135 AMPS AT LOW RPM, 170 MAX, MINI ALTERNATOR, 12 LBS.

AL-9101-E-170

(1-Wire, Self Exciting, 12v, 170+ amps)

AL-9101-E-240

(1-Wire, Self Exciting, 12v, 240+ amps)

AL-9101-E-240

(1-Wire, Self Exciting, 12v, 240+ amps)



120 AMPS AT LOW RPM, 160 MAX HD ALTERNATOR, 14 LBS.

AL-9101-D-NS

(1-Wire, Self Exciting, 12v, 90 Idle, 160+ amps)

AL-9101-D-200

(1-Wire, Self Exciting, 12v, max 200 amps)

AL-9101-D-A (Adjustable Voltage)

(1-Wire, Self Exciting, adjustable 12v-19v, 150+ amps)



22 Radius Tooth Alternator Pulleys

1/2" WIDE RADIUS TOOTH HTD ALTERNATOR PULLEYS

15mm (.590") I.D.

AL-9105-24-A (24 Tooth, .590, 15mm I.D., .5" Wide, w/ Guides)
 AL-9105-32-A (32 Tooth, .590, 15mm I.D., .5" Wide, w/ Guides)

17mm (.669") I.D.

AL-9105-24-B (24 Tooth, .669, 17mm I.D., .5" Wide, w/ Guides)
 AL-9105-32-B (32 Tooth, .669, 17mm I.D., .5" Wide, w/ Guides)



AL-9105-24

AL-9105-32

1" WIDE RADIUS TOOTH HTD ALTERNATOR PULLEYS

15mm (.590") I.D.

AL-6105-18-A (18 Tooth, .590, 15mm I.D., 1" Wide)
 AL-6105-22-A (22 Tooth, .590, 15mm I.D., 1" Wide)

17mm (.669") I.D.

AL-6105-18-B (18 Tooth, .669, 17mm I.D., 1" Wide)
 AL-6105-22-B (22 Tooth, .669, 17mm I.D., 1" Wide)



AL-6105-18

AL-6105-22

RADIUS TOOTH HTD ALTERNATOR PULLEY BELT GUIDES

BG-9108-A (Bolt-On Belt Guides for 24 Tooth Alternator Pulley)
 BG-9108-C (Bolt-On Belt Guides for 32 Tooth Alternator Pulley)

BG-6108-18-CAP (Billet Belt Guide for 18 Tooth Alternator Pulley)
 BG-6108-22-CAP (Billet Belt Guide for 22 Tooth Alternator Pulley)



BG-9108-A & C

BG-6108-18 & 22-CAP

ALTERNATOR DRIVE PULLEYS (MOUNTS IN FRONT OF THE WP PULLEY)

WP-9104-32 (32 Tooth, Bolt-On, 0.50" Wide Alternator Drive Pulley)
 WP-9104-28 (28 Tooth, Bolt-On, 0.83" Wide Alternator Drive Pulley)
 WP-6104-40x1.25 (40 Tooth, Bolt-On, 1.25" Wide Alternator Drive Pulley)
 WP-6104-40x0.50 (40 Tooth, Bolt-On, 0.50" Wide Alternator Drive Pulley)



WP-9104-32

WP-9104-28

WP-6104-40

ALTERNATOR DRIVE PULLEYS GUIDES & GM BILLET FAN

BG-9108-W (3.5", 28 & 32 Tooth Belt Guide, 1/16" Thick)
 BG-9108-E (4.0", 40 Tooth Belt Guide, 1/16" Thick)

F-9105-GM (Replacement, Billet Alum. GM External Fan)



BG-9108-W

F-9105-GM

SQUARE TOOTH GILMER ALTERNATOR PULLEYS

- AL-9105-20-A (20 Tooth, .590 (15mm) I.D. w/ Guides, ½" Wide)
- AL-9105-20-B (20 Tooth, .669 (17mm) I.D. w/ Guides, ½" Wide)
- AL-9105-27-A (27 Tooth, .590 (15mm) I.D. w/ Guides, ½" Wide)
- AL-9105-27-B (27 Tooth, .669 (17mm) I.D. w/ Guides, ½" Wide)

GILMER ALTERNATOR PULLEY BELT GUIDES

- BG-9108-B (Bolt-On Belt Guides for 20 Tooth Alternator Pulley)
- BG-9108-D (Bolt-On Belt Guides for 27 Tooth Alternator Pulley)



SERPENTINE POLY-V ALTERNATOR PULLEYS

15mm (.590") LD.

- AL-5105-A-A (2.5" O.D., .590 (15mm) I.D. 6-Groove)
- AL-5105-A-B (3.0" O.D., .590 (15mm) I.D. 6-Groove)
- AL-5105-A-C (4.0" O.D., .590 (15mm) I.D. 6-Groove)

17mm (.669") LD.

- AL-5105-B-A (2.5" O.D., .669 (17mm) I.D. 6-Groove)
- AL-5105-B-B (3.0" O.D., .669 (17mm) I.D. 6-Groove)
- AL-5105-B-C (4.0" O.D., .669 (17mm) I.D. 6-Groove)



SERPENTINE & V-BELT ALT DRIVE PULLEYS

Serpentine

- AL-5104-3.25" (3.25" O.D., 4-Groove Serp.)
- WP-5104-D-4" (4.00" O.D., 6-Groove Serp.)

V-Belt

- WP-3104-A-3.50" (3.50" O.D., V-Belt)



V-BELT ALTERNATOR PULLEYS

15mm (.590") LD.

- AL-3105-A-A (2.375" Dia.)
- AL-3105-A-B (2.500" Dia.)
- AL-3105-A-C (3.000" Dia.)
- AL-3105-A-D (4.500" Dia.)
- AL-3105-A-E (5.000" Dia.)
- AL-3105-A-F (5.500" Dia.)
- AL-3105-A-G (6.000" Dia.)

17mm (.669") LD.

- AL-3105-B-A (2.375" Dia.)
- AL-3105-B-B (2.500" Dia.)
- AL-3105-B-C (3.000" Dia.)
- AL-3105-B-D (4.500" Dia.)
- AL-3105-B-E (5.000" Dia.)
- AL-3105-B-F (5.500" Dia.)
- AL-3105-B-G (6.000" Dia.)



24 Chevy Alternator Brackets

SB CHEVY MID-MOUNT ALTERNATOR BRACKETS

Mounts from Short-Water Pump, Mounts on Left or Specify Right-Side if Required

Front Bracket

- AL-9100-CL-B (AL-9101-B alt.)
- AL-9100-CL-C (AL-9101-E alt.)
- AL-9100-CL-GM (GM alt.)

Rear Support Arm

- AL-9100-CL-HM (Head Rear Support)
- AL-9100-CL-BM (Block Rear Support)

Mounting Kit

- AL-9100-CL-BK (Mounting kit)
- AL-9100-CL-GM-BK (GM Mounting kit)



(universal)



WPM-9101-C

(universal)



WPM-9101-A

BB CHEVY MID-MOUNT ALTERNATOR BRACKETS

Mounts from Short-Water Pump, Mounts on Left or Specify Right-Side if Required

Front Bracket:

- AL-9100-CL-B-BB (AL-9101-B alt.)
- AL-9100-CL-C-BB (AL-9101-E alt.)
- AL-9100-CL-D-BB (AL-9101-D alt.)
- AL-9100-CL-GM (GM alt.)

Rear Support:

- AL-9100-CL-BM-BB (Rear Support)

Mounting Kit:

- AL-9100-CL-BK-BB (Mounting kit)
- AL-9100-CL-GM-MK (GM Mounting kit)



(120 amp alt.)



AL-9100-CL-D-BB

(universal)



WPM-9101-C

SB & BB CHEVY LOW-MOUNT ALTERNATOR BRACKETS

Ideal for use with an Electric WP, *Requires 10.5" from the center of the crank straight out to the frame

SBC & BBC Universal Mid-Mount Passenger Side



EBM-9100-A & MP-9101-C

BBC Universal Lower Driver Side



AL-9101-BB-LM

SBC Universal Lower Driver Side



AL-9101-SB-LM

LS ALTERNATOR BRACKETS

LS High-Mount, Driver Side for AL-9101-B-NS



AL-9100-LS-B

LS High-Mount, Driver Side for AL-9101-E-NS



AL-9100-LS-E

LS Low-Mount, Driver Side for AL-9101-D-NS



AL-9100-LSL-D

Alternator Brackets, Continued 25

Ford, Chrysler, Motor Plate and Bell Housing

SB FORD ALTERNATOR BRACKETS



Front Bracket:
AL-9100-CL-F-B (AL-9101-B alt.)
AL-9100-CL-F-C (AL-9101-E alt.)
AL-9100-CL-F-D (AL-9101-D alt.)

Rear Support:
AL-9100-CL-HM-F

Mounting kit:
AL-9100-CL-BK-F

Universal Mid Mount



AL-9101-F3

Universal Head Mount



AL-9101-HM

SB CHRYSLER ALTERNATOR BRACKETS



Front Bracket:
AL-9100-CL-CR-B (AL-9101-B alt.)
AL-9100-CL-CR-C (AL-9101-E alt.)
AL-9100-CL-CR-D3 (AL-9101-D alt.)

Rear Support Arm:
AL-9100-CL-BM-CR

Chrysler Mounting kit:
AL-9100-CL-BK-CR



CH-9101-A(Universal)
 Use with ADR-9100-5.0"

MOTOR PLATE ALTERNATOR BRACKETS



MP-9101-C (universal)
 Use with ADR-9100-3.5"

AL-9100-CL-B (SBC, AL-9101-B alt)
AL-9100-CL-C (SBC, AL-9101-E alt)

AL-9100-CL-B-BB (BBC, AL-9101-B alt)
AL-9100-CL-C-BB (BBC, AL-9101-E alt)



BELL HOUSING MOUNTED ALTERNATOR BRACKETS

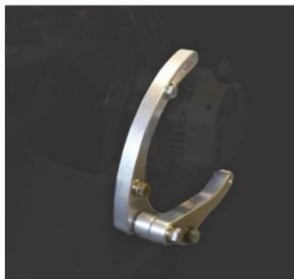

Bell Housing Mount to drive the alternator from the coupler pulley, uses alt. "AL-9101-B-NS"

AL-9100-BH

Bell Housing Mount to work in conjunction with an oil pump, tandem pump, or power steering pump uses AL-9101-B-NS

AL-9100-RA-BH



Power Steering Pumps & Components

Reservoir Options:

We offer steering pumps with the standard -10 AN return fitting along with different remote tank options or with the fabricated aluminum integrated reservoir. Using the integrated reservoir insures the pump will not starve for fluid regardless of track conditions, plus offers the added benefit of an easier installation due to the elimination of the “-10 AN return fittings and hose” while still keeping plenty of fluid in reserve in the high capacity tank. Internal baffling will keep the fluid calm and airless even at high RPM's. The integrated reservoir also offers numerous routing options for the -6 AN return line via the choice of using the included straight 45° or 90° fitting in either the side of the reservoir or the bottom making for easy clearance for other chassis components. The integrated reservoir is topped off with a vented a billet cap.

Performance Built:

Every one of our Jones Racing Products power steering pumps is purpose built from the ground up for performance. The CNC machined housings provide accurate tolerances for the race proven internals along with enhanced flow characteristics. These pumps are built to withstand the demands of any application whether you choose a remote mounted fluid reservoir pump with the -10 AN return fitting or an integrated reservoir pump.

Wide Selection

Each and every pump Jones Racing Products offers undergoes complete testing on our custom dyno to ensure maximum efficiency and performance. Pumps can be flow and pressure tuned, replicating the demands that the driver desires from his steering. With a large range of pulley size options available, tuning the pump speed is easily achievable. Using these options will benefit a substantial increase in efficiency and reliability for the pump, fluid and pulleys along with the rest of the steering system.



Power Steering Pumps 27

PS-9008-AL-AR
Lightweight Alum Pump
with Integrated 18oz
Alum. Tank

Features HD Billet
Tank-to-pump
Mounting Ears
& Billet Cap.



PS-9008-AR2
18oz Aluminum Tank
with **Billet Mounting
Ears** to Attach the Tank
to the Pump

Uses Tank to Pump
Mounting Kit:
PSR-9008-MK



PS-9008-AL-R
Lightweight Aluminum
Pump with Integrated
16oz tank.

This Tank's Compact
Design is Ideal for
Tighter Engine
Compartments!



PS-9008-R
16oz Built-in Tank,
Attaches to Pumps
Made to Accept
Integrated
Reservoirs.

Uses Tank to Pump
Mounting Kit:
PSR-9008-MK



PS-8101-A
Remote Reservoir
For Tubular Frame



PS-9008-AL
Lightweight Alum
Pump, Uses Remote Tank



PS-8101-B
Remote Reservoir
For Flat Surface



Fully Synthetic Clear
Formula. It's clear
design makes it easy
to see impurities
throughout the life of
the fluid

PS-8009-16S
PS-8009-32S
PS-8009-1G

PSR-7005-A
Tool to remove and
install press on power
steering pulleys



28 Power Steering Pulleys

SERPENTINE POWER STEERING PUMP PULLEYS

- PS-5106-B-4.000" Press Fit, 6-Groove Serpentine PS Pulley
- PS-5106-B-4.250" Press Fit, 6-Groove Serpentine PS Pulley
- PS-5106-B-4.500" Press Fit, 6-Groove Serpentine PS Pulley
- PS-5106-B-5.000" Press Fit, 6-Groove Serpentine PS Pulley
- PS-5106-B-5.500" Press Fit, 6-Groove Serpentine PS Pulley
- PS-5106-B-6.000" Press Fit, 6-Groove Serpentine PS Pulley



V-BELT POWER STEERING PUMP PULLEYS

- PS-3106-B-4.500" 4.5" Press Fit, 3/8 or 1/2 V-Belt, PS Pulley
- PS-3106-B-5.000" 5.0" Press Fit, 3/8 or 1/2 V-Belt, PS Pulley
- PS-3106-B-5.500" 5.5" Press Fit, 3/8 or 1/2 V-Belt, PS Pulley
- PS-3106-B-6.000" 6.0" Press Fit, 3/8 or 1/2 V-Belt, PS Pulley
- PS-3106-B-6.500" 6.5" Press Fit, 3/8 or 1/2 V-Belt, PS Pulley
- PS-3106-B-7.000" 7.0" Press Fit, 3/8 or 1/2 V-Belt, PS Pulley
- PS-3106-B-6x0.4 6.0" Press Fit, 3/8 or 1/2 V-Belt, -0.400" Offset



RADIUS TOOTH POWER STEERING PUMP PULLEYS

- PS-6106-B-33 Press Fit, 33 Tooth, Radius Tooth PS Pulley
- PS-6106-B-40 Press Fit, 40 Tooth, Radius Tooth PS Pulley
- PS-6106-B-45 Press Fit, 45 Tooth, Radius Tooth PS Pulley

- BG-6108-33S Set of 33 Tooth Belt Guide for PS-6106-B-33
- BG-6108-40S Set of 40 Tooth Belt Guide for PS-6106-B-40
- BG-6108-45S Set of 45 Tooth Belt Guide for PS-6106-B-45



GILMER POWER STEERING PUMP PULLEYS

- PS-4106-B-28 Press Fit, 28 Tooth, Gilmer PS Pulley
- PS-4106-B-30 Press Fit, 30 Tooth, Gilmer PS Pulley
- PS-4106-B-32 Press Fit, 32 Tooth, Gilmer PS Pulley



Power Steering SB & BB Chevy Brackets 29

SB CHEVY POWER STEERING BRACKETS

MOUNTS TO BLOCK & HEAD

Low-mount with horizontal adjustment for built-in reservoirs



PS-8001-SB-R

MOUNTS TO BLOCK & HEAD

Mid Mount Clears Dry-Sump



PS-8001-SB-DS

MOUNTS TO HEAD

Driver or Passenger-side head mount



Reversible

PSH-8001-C

MOUNTS TO HEAD



PSH-8001-SB-R

MOUNTS TO HEAD



PSH-8001-SB-R2

MOUNTS TO HEAD



PSH-8001-C-R

BB CHEVY POWER STEERING BRACKETS

Horizontal adjustment for pumps with a built-in reservoir.



Low mount design to maximize belt wrap.



PSL-8001-BB-R
Mounts to Lower Block

PSL-8001-BB-R2 is designed to mount the pump as close to the balancer as possible.

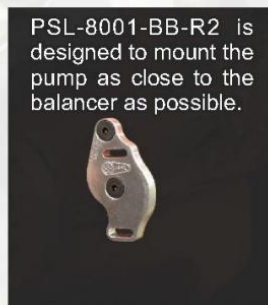

PSL-8001-BB-R2
Mounts to Lower Block

PSL-8001-BB-R3 is designed to get the pump pulley as close as 1/2" off the balancer

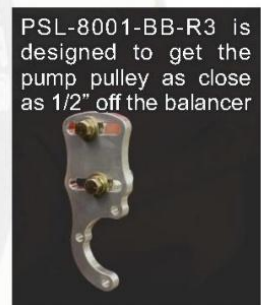

PSL-8001-BB-R3
Mounts to Lower Block

Mid-mount for pump with remote reservoir.

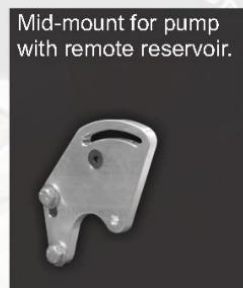

PSL-8001-BB
Mounts to Block



VP-9100-BM
Mounts to Lower Block

Mounts pump from the driver or passenger-side head



PSH-8001-BB
Mounts to Head



PSH-8001-BB-R
Mounts to Head

30 Power Steering Brackets, Continued

SB FORD POWER STEERING BRACKETS



PSH-8001-F-R
Head Mount PS Bracket
Shown with Mounting Kit
PSH-8001-FR-MK

Horizontal Adjustment
for Pumps with Built-in
Reservoir



PSH-8001-F-R2
(High Mount Version)
Head Mount PS Bracket
Shown with Mounting Kit
PSH-8001-FR-MK

Horizontal Adjustment
for Pumps with Built-in
Reservoir



PSH-8001-F
Head Mount PS Bracket
Shown with Mounting Kit
PSH-8001-F-MK



PSH-8001-Y
Head Mount PS Bracket
Shown with Mounting Kit
PSH-8001-FR-MK

Designed for Yates C3 &
Cleveland Heads.
Use # PSH-8001-Y-R for
Integrated Tank

CHRYSLER PS BRACKETS



PSL-8001-C
Mounts to Block
& Head

PS-8001-CR-R
Horizontal Adjustment
for Pumps w. Built-in
Reservoirs. Low mount
Design to Maximize
Belt Wrap.



MOTORPLATE PS BRACKET



PST-8001-E
Motorplate Bracket

LS POWER STEERING BRACKETS

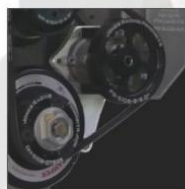

PS-8001-LS-R
Horizontal Adjustment
for Pumps w. Built-in
reservoirs. Low Mount
Design to Maximize
Belt Wrap.

PST-8001-LS-R
Horizontal Adjustment
for Pumps w. Built-in
Reservoirs. High Mount
Design for Additional
Clearance



Fuel Pumps & Components

Precision
Made:

Premium
Components:

Linear
Output:

Belt driven fuel pumps increase performance and offer an output consistent with the demands of the engine. Our fuel pumps are backed by the ability to have the correct pulley ratio driving the pump and hundreds of pulley and belt combinations that will suit any racers' need for pump RPM control. Pump mounting options are endless with the available brackets. Providing racers with the flexibility to properly run and mount the pumps will ensure a correct system with no interference of other belt driven accessories.

Jones Racing Products offers a complete array of components to complete your fuel system including fuel regulators, fuel logs, fuel filters, shut offs, fittings, hose, pulleys and brackets.

We offer a full range of billet belt driven fuel pumps for use with gas or alcohol engines, standalone and combination fuel and power steering pumps. Overall operating temperatures are greatly reduced when using a belt driven pump when compared to the heat transferred thru a conventional block pump. Keeping the fuel entering the carburetor at a much cooler temperature combined with an adjustable yet, steady positive flow, all adds up to a more efficient, reliable fuel delivery system.

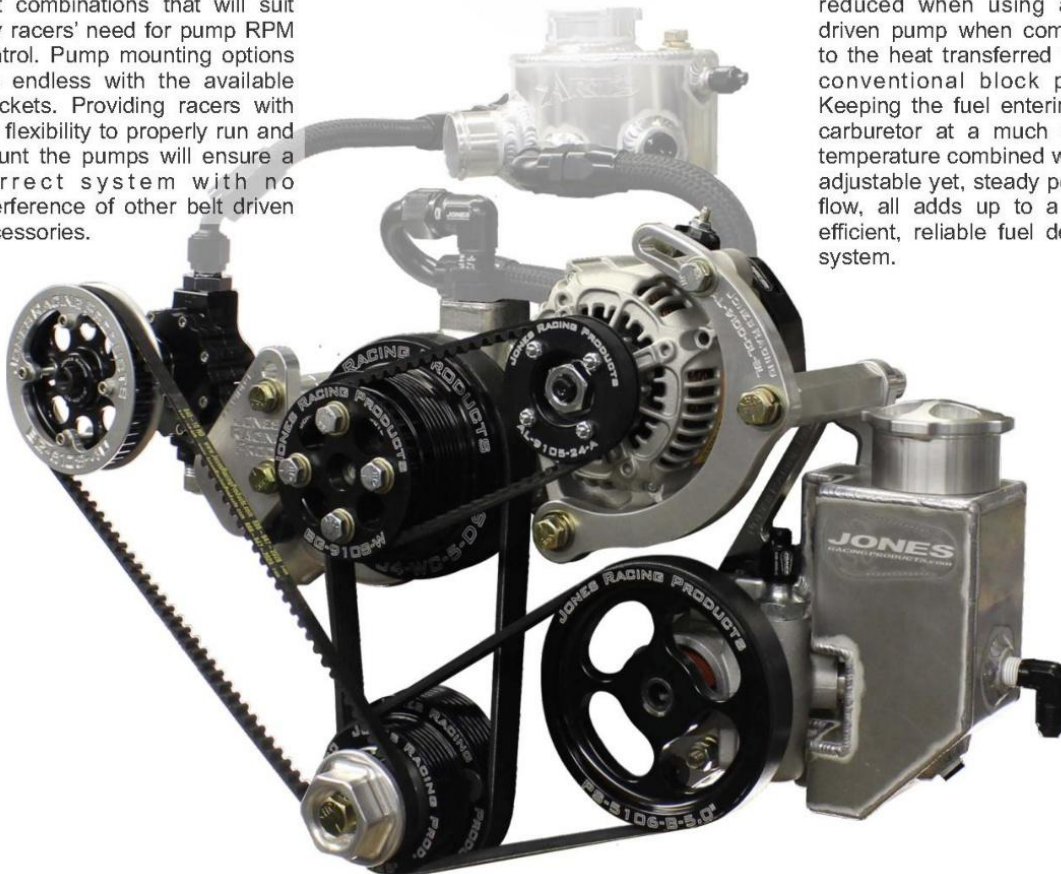

32 Fuel Pumps & Accessories

KSE TANDEM PUMP



KSE-8009-C
Combination PS & Fuel Pump

SWEET TANDEM PUMP



SWE-305-85841
Combination PS & Fuel Pump

BELT DRIVEN FUEL PUMP



FP-8009-A
Belt Driven Fuel Pump

FUEL PUMP ACCESSORIES

Billet Aluminum
Telescoping
Fuel Log



FP-7100-LB
-8 Braswell
FP-8009-LH
-8 Holley



FP-8009-R
Billet Return Bypass Fuel Regulator

FUEL FILTERS

- FP-7100-6** -6 in-line Fuel Filter, 100 Micron Filter
- FP-7100-8** -8 in-line Fuel Filter, 100 Micron Filter
- FP-7100-10** -10 in-line Fuel Filter, 100 Micron Filter
- FP-7100-12** -12 in-line Fuel Filter, 100 Micron Filter



FUEL PUMP BRACKETS

SBC TP Bracket



FP-9100-C

SBF TP Bracket



FP-9100-A

Chrysler TP Brkt



FP-9100-F

LS FP Bracket



FP-9100-LS

SB/BB FP Bracket



FP-9100-E

Bell Housing
Mount



FP-9100-BH

FUEL PUMP KITS



2001-CS
Up Front Tandem Pump
Drive, Drives from Crank



2001-RA
Up Front Tandem Pump
Drive, Drives from WP



2001-CS-FP
Up Front Fuel Pump
Drive, Drives from WP



2003-FP
Up Front Fuel Pump
Drive, Drives from WP

RADIUS TOOTH HTD FUEL PUMP PULLEYS, 1" WIDE

FP-6106-40-1" 5/8" I.D., 3/16" Key, 1" Wide, 40 Teeth
FP-6106-42-1" 5/8" I.D., 3/16" Key, 1" Wide, 42 Teeth
FP-6106-44-1" 5/8" I.D., 3/16" Key, 1" Wide, 44 Teeth
FP-6106-45-1" 5/8" I.D., 3/16" Key, 1" Wide, 44 Teeth
FP-6106-48-1" 5/8" I.D., 3/16" Key, 1" Wide, 48 Teeth



RADIUS TOOTH HTD FUEL PUMP PULLEYS, 5/8" WIDE

FP-6106-36-5/8" 5/8" I.D., 3/16" Key, 5/8" Wide, 36 Teeth
FP-6106-38-5/8" 5/8" I.D., 3/16" Key, 5/8" Wide, 38 Teeth
FP-6106-40-5/8" 5/8" I.D., 3/16" Key, 5/8" Wide, 40 Teeth
FP-6106-44-5/8" 5/8" I.D., 3/16" Key, 5/8" Wide, 44 Teeth



FUEL PUMP PULLEY BELT GUIDES

BILLET, BOLT-ON BELT GUIDES

BG-6108-33S 33 Tooth Pulleys	BG-6108-40S 40 Tooth Pulleys
BG-6108-34S 34 Tooth Pulleys	BG-6108-42S 42 Tooth Pulleys
BG-6108-35S 35 Tooth Pulleys	BG-6108-44S 44 Tooth Pulleys
BG-6108-36S 36 Tooth Pulleys	BG-6108-45S 45 Tooth Pulleys
BG-6108-38S 38 Tooth Pulleys	BG-6108-48S 48 Tooth Pulleys



Vacuum Pumps & Components

Design

Our vacuum pumps are manufactured from billet aluminum and feature a housing which includes built-in heat sinks, integrated -12 AN inlet and exhaust fittings. Mounting of the pump is simple with our built-in brackets that are designed to bolt directly to the front of the block or universally on a motor plate and pumps are available in either a right or left side configuration. Pulley alignment is made easy with the use of the 5/8" pump shaft which allows the pulley to be slid forward or backward and locked into place using the set screws and 3/16" key. While our pump boasts these great features, it's lightweight design measures just under 3.3".

Longevity

Our vacuum pump is a gear style pump, enabling it to handle both long runs for circle track racing and high performance street/strip applications. A significant advantage of our gear style pump is that it allows the passage of oil, fuel, or moisture without damaging the pump.

High Efficiency:

Additional mounting brackets are available to optimize the desired placement of the pump along with the needed pulley options for ratio control. Our vacuum pump product line also covers the racers who use a conventional style pumps with the offering of the 3-bolt style vacuum pump pulleys. We have the parts needed to complete your pump install including vacuum regulators, bracketry, hose and fittings.



VACUUM PUMPS

BILLET ALUMINUM PUMPS, WITH BUILT-IN BRACKETS AND MACHINED IN AN FITTINGS

2 Stage, Gear Style Vacuum Pump



VP-9100-B
Left Side Vacuum Pump

2 Stage, Gear Style Vacuum Pump



VP-9100-B
Right Side Vacuum Pump

2 Stage, Gear Style Vacuum Pump with a 1 Stage External Wet Sump



VP-9100-WS
Right Side Vacuum Pump

VACUUM PUMP ACCESSORIES

Internal Support Coil, prevents vacuum line from sucking shut. Offers added support necessary for maximum efficiency.



AN-1200-SC
-12 Internal Support Coil
AN-1600-SC
-16 Internal Support Coil

Adjustable Vacuum regulator, Mounts to valve cover.



AN-0800-R2
AN-0800-F (Air Filter)



Vacuum Pump Breather Tank. 2 Inlets, one for vacuum pump exhaust, one for the regulator. With petcock to drain.



VP-9106-A

36 Vacuum Pump Pulleys & Guides

VACUUM PUMP BRACKETS



SBC Head Mount,
Left or Right Side
PSH-8001-C

SB & BBC Mount,
Left or Right Side
VP-9100-BM



BBC Head Mount,
Left Side
VP-9100-TM

SB & BBC Right
Side Low Mount
VP-9100-L-BM



RADIUS TOOTH HTD VACUUM PUMP PULLEYS, 5/8" WIDE

FP-6106-36-5/8" 5/8" I.D., 3/16" Key, 5/8" Wide, 36 Teeth
 FP-6106-38-5/8" 5/8" I.D., 3/16" Key, 5/8" Wide, 38 Teeth
 FP-6106-40-5/8" 5/8" I.D., 3/16" Key, 5/8" Wide, 40 Teeth
 FP-6106-44-5/8" 5/8" I.D., 3/16" Key, 5/8" Wide, 44 Teeth



VACUUM PUMP PULLEYS

FOR 3-BOLT HUB DESIGN

VP-6106-36-M
1/2" Wide, 36 Teeth

VP-6106-40-M
1/2" Wide, 40 Teeth



BELT GUIDES

(RE-USABLE, BOLT ON BILLET GUIDES)

- BG-6108-36S**
36 Teeth Guides
- BG-6108-38S**
38 Teeth Guides
- BG-6108-40S**
40 Teeth Guides
- BG-6108-44S**
44 Teeth Guides



Oil Pumps & Components

Diversity:

Jones Racing Products has built long-lasting relationships with the best companies in the industry. We proudly offer a full selection of oil pumps from:

- ARE Dry Sump Systems
- Aviaid
- Barnes Dry Sump Oil Systems
- Dailey Engineering
- Johnson's HTP
- Peterson Fluid Systems

High Efficiency:

We manufacture a wide range of pulleys and components to maximize your dry sump system. Low drag pulley configurations are available in a wide range of ratios along with hundreds of belts to work with any crank to oil pump center line. With today's race engines reaching higher RPMs, the use of our radius tooth pulleys is a benefit the racer needs to insure a smooth operating system with lower drag placed on the pump's shaft and bearings. Each oil pump drive system is tailored to each application. Focus on belt and pulley style, the correct belt length for any center line measurement; whether for a fixed pump location or adjustable, all while keeping the pump ratio correct to the engine RPM. To help with the ease of installation, we feature a full line of AN fittings, lightweight braided hose, remote oil filter mounts and even an oil pump primer which is available in square tooth or radius tooth configurations.

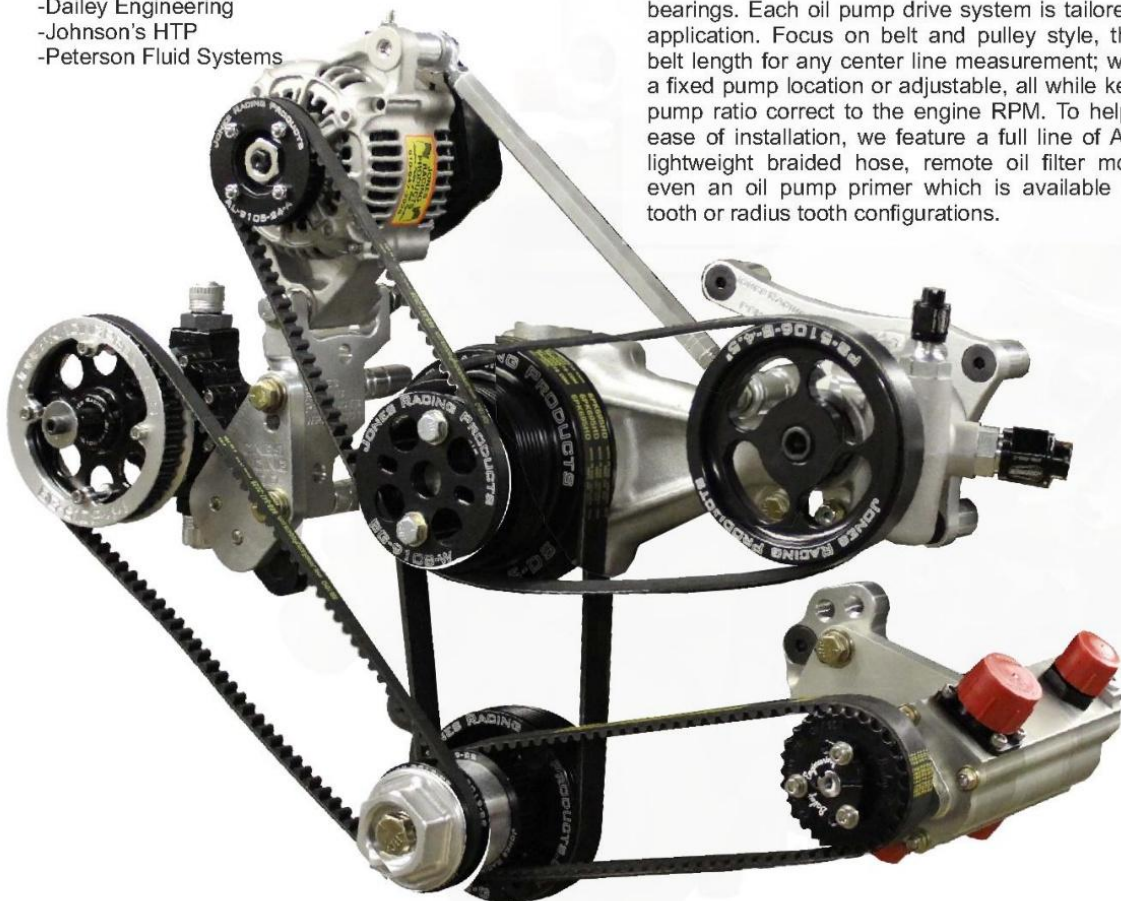

38 Oil Pumps & Accessories

DRY SUMP OIL PUMPS

- OP-8103-1** External Wet Sump Oil Pump
Left Side Mount, SB/BB Chevy
- OP-8103-3** 3 Stage Dry Sump Oil Pump
Left Side Mount, SB/BB Chevy
- OP-8103-4** 4 Stage Dry Sump Oil Pump
Left Side Mount, SB/BB Chevy
- OP-8103-5** 5 Stage Dry Sump Oil Pump
Left Side Mount, SB/BB Chevy



We are proud to work with the best in the business

ARE DRY SUMP SYSTEMS
WWW.DRYSUMPS.COM

AVIAD
DRY SUMP OIL SYSTEMS

BARNES
DRY SUMP OIL SYSTEMS

Daily Engineering

JOHNSON'S
HIGH TECH PERFORMANCE

3/4" THICK BILLET ALUMINUM OIL PUMP BRACKETS

SB Chevy, Mounts next to the Balancer, Offers 3 Different Mounting Positions

OP-9101-A

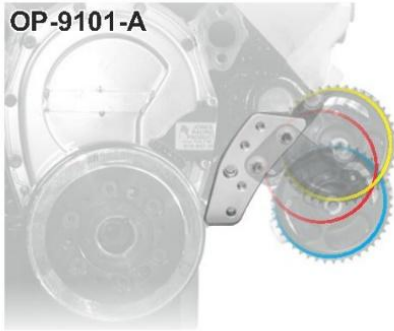

SBC, Mounts next to the Balancer, Raises the Oil Pump up and out for Frame Clearance

OP-9101-A2



SB Ford, Mounts on the Lower Passenger Side from the Timing Cover

OP-9101-B



Oil Pump Accessories

Internal Support Coil offers added support necessary for maximum efficiency from your scavenge and vacuum lines.



- AN-1000-SC**
-10 Internal Support Coil
- AN-1200-SC**
-12 Internal Support Coil
- AN-1600-SC**
-16 Internal Support Coil

Remote breather oil separator with 1/2 NPT ports. Comes a -12 & -8 AN Adapter fittings, filter & bracket.

VP-9106-A



OP-8103-12F
OP-8103-16F



-12 or -16 Oil Line Filter



Remote Oil Filter Mount

OP-8103-F

OIL PUMP PRIMER

OP-6103-PP
(Radius Tooth HTD)

OP-4103-PP
(Square Tooth Gilmer)



LOCKING COLLET

- OP-.437** 7/16" I.D. Locking Collet
- OP-.500** 1/2" I.D. Locking Collet
- OP-.590** 15mm I.D. Locking Collet
- OP-.625** 5/8" I.D. Locking Collet
- Call for Custom Sizes



RADIUS TOOTH HTD OIL PUMP PULLEYS

LIGHTWEIGHT, BILLET ALUMINUM, 5/8" LD., 3/16" KEYWAY WITH 5 SET SCREWS

OP-6103-28-1	1 1/4"	1 1/4" Wide, 28 Teeth
OP-6103-30-1	1 1/4"	1 1/4" Wide, 30 Teeth
OP-6103-32-1	1 1/4"	1 1/4" Wide, 32 Teeth
OP-6103-33-1	1 1/4"	1 1/4" Wide, 33 Teeth
OP-6103-34-1	1 1/4"	1 1/4" Wide, 34 Teeth
OP-6103-35-1	1 1/4"	1 1/4" Wide, 35 Teeth
OP-6103-36-1	1 1/4"	1 1/4" Wide, 36 Teeth
OP-6103-37-1	1 1/4"	1 1/4" Wide, 37 Teeth
OP-6103-38-1	1 1/4"	1 1/4" Wide, 38 Teeth
OP-6103-40-1	1 1/4"	1 1/4" Wide, 40 Teeth
FP-6106-42-1"	1"	1" Wide, 42 Teeth
OP-6103-44-1	1 1/4"	1 1/4" Wide, 44 Teeth
OP-6103-45-1	1 1/4"	1 1/4" Wide, 45 Teeth
OP-6103-46-1	1 1/4"	1 1/4" Wide, 46 Teeth
OP-6103-47-1	1 1/4"	1 1/4" Wide, 47 Teeth
OP-6103-48-1	1 1/4"	1 1/4" Wide, 48 Teeth
OP-6103-56-1	1 1/4"	1 1/4" Wide, 56 Teeth



SQUARE TOOTH GILMER OIL PUMP PULLEYS

LIGHTWEIGHT, BILLET ALUMINUM, 5/8" LD., 3/16" KEYWAY WITH 5 SET SCREWS

OP-4103-26-SQ	1 1/4"	1 1/4" Wide, 26 Teeth
OP-4103-28-SQ	1 1/4"	1 1/4" Wide, 28 Teeth
OP-4103-30-SQ	1 1/4"	1 1/4" Wide, 30 Teeth
OP-4103-32-SQ	1 1/4"	1 1/4" Wide, 32 Teeth
OP-4103-34-SQ	1 1/4"	1 1/4" Wide, 34 Teeth



REUSABLE, BOLT-ON BELT GUIDES

SUPPLIED WITH 4 ALLEN BOLTS AND AN ALLEN WRENCH

BG-6108-33S	Billet, Bolt-On Belt Guides for 33 Tooth Pulleys
BG-6108-34S	Billet, Bolt-On Belt Guides for 34 Tooth Pulleys
BG-6108-35S	Billet, Bolt-On Belt Guides for 35 Tooth Pulleys
BG-6108-36S	Billet, Bolt-On Belt Guides for 36 Tooth Pulleys
BG-6108-37S	Billet, Bolt-On Belt Guides for 37 Tooth Pulleys
BG-6108-38S	Billet, Bolt-On Belt Guides for 38 Tooth Pulleys
BG-6108-40S	Billet, Bolt-On Belt Guides for 40 Tooth Pulleys
BG-6108-42S	Billet, Bolt-On Belt Guides for 42 Tooth Pulleys
BG-6108-44S	Billet, Bolt-On Belt Guides for 44 Tooth Pulleys
BG-6108-45S	Billet, Bolt-On Belt Guides for 45 Tooth Pulleys
BG-6108-48S	Billet, Bolt-On Belt Guides for 48 Tooth Pulleys



Water Pumps & Components

Edelbrock:

Jones Racing Products carries a full line of Edelbrock water pumps that are available in lightweight and low drag designs with options for auxiliary coolant lines.

Ratio Control:

We offer a wide range of pulleys in various styles. Choosing the correct ratio will increase the efficiency of your cooling system and selecting the correct pulley style will greatly benefit the system, whether it is a low-drag radius tooth setup or a serpentine system to handle the demands of a heavy fan.

High Efficiency:

We offer all components needed to complete the water system including numerous pulley and belt combinations for any type of performance application. Whether you need water pump spacers (available in three different thicknesses), water restrictors for aid in cooling, lightweight fans, fan spacers, water pump pulley spacers, expansion tanks and/or related hose kits, Jones Racing Products has you covered.

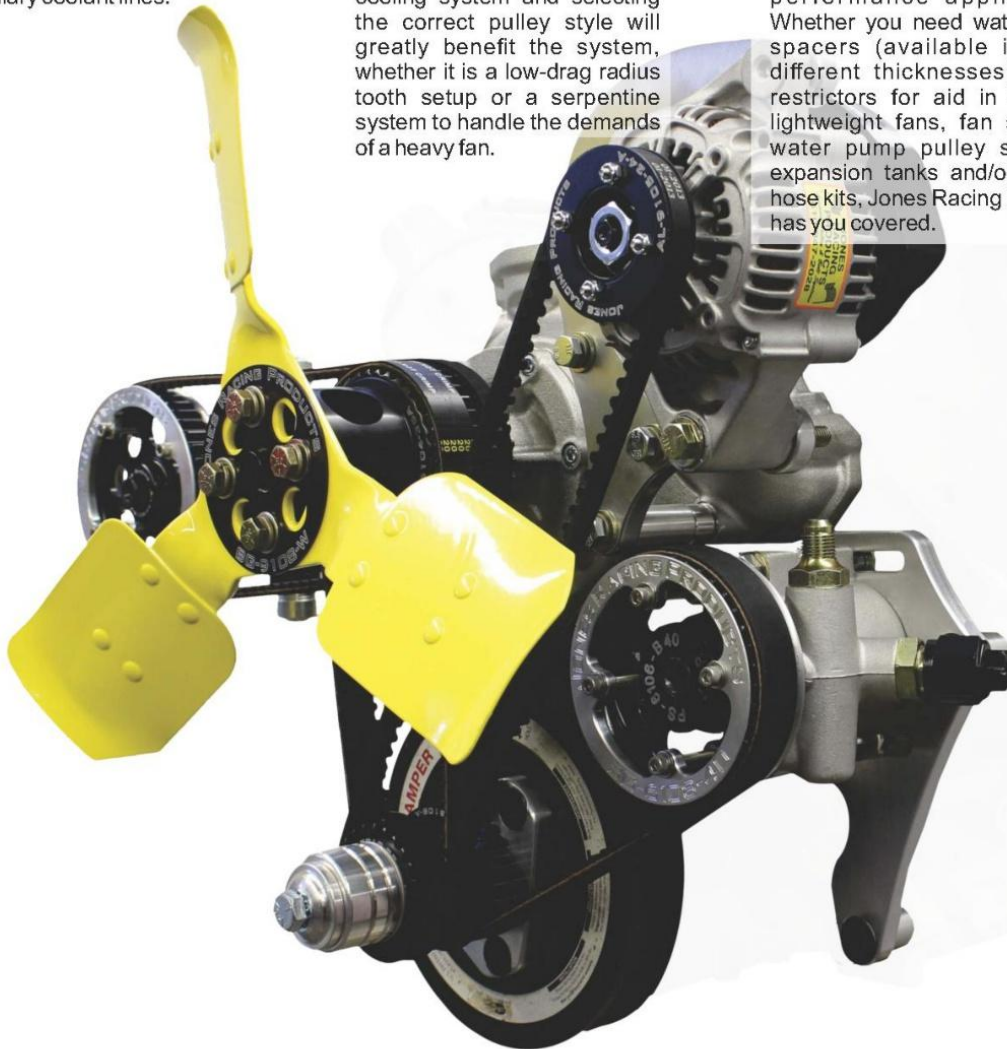

Water Pumps & Accessories 41

SMALL BLOCK CHEVY WATER PUMPS

Aluminum, SBC Short Style



Steel, SBC Short Style



Edelbrock Victor Series Short Style, 2-Aux Fittings



BIG BLOCK CHEVY WATER PUMPS

Edelbrock Victor Series Short Style Water Pump



Edelbrock Short Style Black Coated Water Pump



SB FORD WP

Edelbrock Victor Series Aluminum Water Pump



SB CHRYSLER WP

Aluminum Water Pump



WATER PUMP SPACERS



WP-9104-1/4"-SB or WP-9104-1/4"-BB 1/4" Thick WP Spacers
 WP-9104-3/8"-SB or WP-9104-3/8"-BB 3/8" Thick WP Spacers
 WP-9104-1/2"-SB or WP-9104-3/8"-BB 1/2" Thick WP Spacers



WATER RESTRICTOR



RR-9104-A

Billet Aluminum water restrictor. Place our restrictor in the water outlet of the radiator to aid in cooling your engine. We guarantee our unique restrictor will lower your water temperature. Do not combine with any other restrictors.

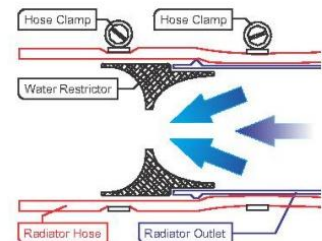

42 WP Fans, Fan & Pulley Spacers, & Bolts

LIGHTWEIGHT 3-BLADE FAN

WP-9104-15-H3 :15" Fan
 WP-9104-17-H3 :17" Fan
 WP-9104-19-H3 :19" Fan

HUSTLER
 3-Blade Fan
 3" Blade L&D



FAN SPACERS

WP-9104-FS-1 1" Fan Spacer
 WP-9104-FS-1.5 1-1/2" Spacer
 WP-9104-FS-2 2" Fan Spacer
 WP-9104-FS-3 3" Fan Spacer
 WP-9104-FS-4 4" Fan Spacer



WP PULLEY ACCESSORIES

5/8 to 3/4 WP
 Shaft Adapter



WP-6104-B

Fan Register



WP-6104-C

WP Pulley Spacer



WP-9104-1/2
 WP-9104-5/8
 WP-9104-3/4

Set of 3 - 1/16" WP Pulleys
 Shims

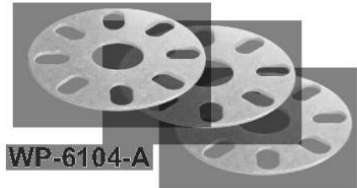

WP-6104-A

5/16-24 Flat Head
 Bolts for Serp. & V
 WP Pulley



WP-2109-A

5/16-24 Flat Head
 Bolts for Serp. & V
 WP Pulley with
 1/2" Spacer



WP-2109-D

5/16-24 Flat Head
 Bolts for Serp. & V
 WP Pulley with
 3/4" Spacer



WP-2109-D2

5/16-24
 Button Head
 Bolts for HTD
 WP Pulleys



WP-6104-B

MODIFIED EXPANSION TANK



EXT-9104-SK
 Alum. Construction
 2 Auxiliary Fittings
 -4 Overflow Fitting

 Mounts to Intake
 (2 Barrel Intake)

EXT-9104-TM
 Alum. Construction
 2 Auxiliary Fittings
 -4 Overflow Fitting
 and Bleeder

 Mounts to Intake
 (4 Barrel Intake)

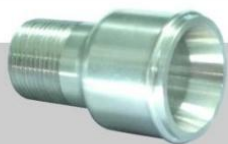

EXT-1 1/2"
 Billet Alum. 1 1/2"
 Upper Hose Adapter

EXT-1 3/4"
 Billet Alum. 1 3/4"
 Upper Hose Adapter

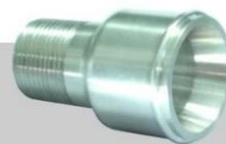

EXT-16
 Billet Alum. -16
 Upper Hose Adapter

EXT-20
 Billet Alum. -20
 Upper Hose Adapter



DIRT MODIFIED EXPANSION TANK



EXT-58037-CBB
 Aluminum
 Construction
 Auxiliary Fitting &
 -4 Overflow Fitting

 Mounts to Intake
 Passenger-Side
 1-1/2" Inlet

EXT-58037-L
 Aluminum
 Construction
 2 Auxiliary Fittings
 -4 Overflow Fitting
 and Bleeder

 Mounts to Intake
 Passenger-Side
 1-1/2" Inlet



EXPANSION TANK ACCESSORIES

WP-3414-B
 3/4"-NPT Air Bleeder Fitting



WP-1014-B
 AN -10 O-Ring Air Bleeder Fitting

Mounts on top of water pump
 to aid in bleeding the cooling
 system



EXT-9104-10
 -10 Braided Line and
 Fittings to run from
 the water pump to
 your expansion tank

Radius Tooth HTD & Gilmer and Serpentine Water Pump Pulleys

RADIUS TOOTH HTD WATER PUMP PULLEYS

Teeth from 0-1.9" Deep
WP-6104-35A
 35 Teeth
WP-6104-36A
 36 Teeth
WP-6104-37A
 37 Teeth



Teeth from 0.15-2.05" Deep
WP-6104-35S
 35 Teeth
WP-6104-36S
 36 Teeth
WP-6104-37S
 37 Teeth
WP-6104-40S
 40 Teeth



Teeth from 0.84-2.74" Deep
WP-6104-37-F1
 37 Teeth



Teeth from 0-1.250" Deep
WP-6104-40
 40 Teeth



GILMER WATER PUMP PULLEYS

Teeth from 0-1.9" Deep
WP-4104-28A
 28 Teeth
WP-4104-32A
 32 Teeth



Teeth from 1.62-2.05" Deep
WP-4104-28S
 28 Teeth
WP-4104-32S
 32 Teeth



SERPENTINE, REVERSE ROTATION

WP-5104-FS-4
 1.780" Offset
 4" Diameter



WP-5104-FS-5.5
 1.450" Offset
 5.5" Dia.



6-GROOVE SERPENTINE WATER PUMP PULLEYS



.750" Offset



WP-5104-D 4" Diameter

1.25" Offset



WP-5104-C-4" Diameter
WP-5104-C-4.5" Diameter
WP-5104-C-5" Diameter

1.900" Offset



WP-5104-F 4" Diameter
WP-5104-UC-5 5" Diameter

2.395" Offset



WP-5104-WC-4.5" 4.5" Dia.

2.395" Offset



WP-5104-WC-4.5-V
 4.5" Dia. Rear Serp,
 3 7/8" Front-V

2.395" Offset



WP-5104-WC-5" 5" Dia.

2.115" Offset



WP-5104-WC-5-DS
 5" Dia. Rear, 3 7/8" Front Serp.
WP-5104-JC-5" : 5" Dia. Rear
 "JC" Does not have a front Serp.

V-Belt Water Pump Pulleys 45



SINGLE-V WATER PUMP PULLEYS

WP-3104-A-6"
2.170" Offset
6" O.D.



WP-3104-A-7"
2.170" Offset
7" O.D.



DOUBLE-V WATER PUMP PULLEYS, (3/8 TO 17/32 WIDE BELT)

WP-3104-J-4.75"
2.400" & 1.800" Offset
4.75" O.D.



WP-3104-B-6"
2.170" & 1.390" Offset
6" O.D.



WP-3104-E-7"
2.170" & 1.390" Offset
7" O.D.



TRIPLE-V WATER PUMP PULLEYS, (3/8 TO 17/32 WIDE BELT)

WP-3104-G
5.875" O.D. @ 2.397" & 1.682"
4.5" O.D. @ .967" Offset



WP-3104-H
7" O.D. @ 2.397" & 1.682"
4.5" O.D. @ .967" Offset



WP-3104-F-7-TV"
7" O.D. @ 2.397", 1.682"
& 1.028" Offset



46 Belt Guides

Lightweight Aluminum

All of Jones Racing Products' belt guides are made from aluminum. We manufacture them to be as light as possible, contouring, pocketing and drilling to further reduce inertia. We also offer a large selection of sizes so you can pick the smallest one to fit your needs.

1/16" THICK CRANKSHAFT PULLEY BELT GUIDES



1-1/8" LD.

	Radius Tooth	Square Tooth
BG-6108-F 2.500" O.D.	fits 17-22	fits 12-20
BG-6108-A 2.625" O.D.	fits 17-25	fits 12-22
BG-6108-C 3.500" O.D.	fits 26-35	fits 23-28
BG-6108-E 4.000" O.D.	fits 36-40	fits 28-32

1" LD.

	Radius Tooth	Square Tooth
BG-6108-G 2.375" O.D.	fits 17-22	fits 12-19
BG-6108-B 2.625" O.D.	fits 17-25	fits 12-22
BG-6108-D 3.500" O.D.	fits 26-35	fits 23-28
BG-6108-H 4.000" O.D.	fits 36-40	fits 28-32

DUAL DOWEL PIN CRANKSHAFT PULLEY BELT GUIDES



BG-6108-WC 2.6" O.D.	fits all Dual Dowel Pulleys
BG-6108-WC-3 3.0" O.D.	fits all Dual Dowel Pulleys
BG-6108-WC-C 3.5" O.D.	fits all Dual Dowel Pulleys
BG-6108-WC-H 4.0" O.D.	fits all Dual Dowel Pulleys

Aluminum removable & reusable belt guide for Dual Dowel, 'WC' crankshaft pulleys. Mounts utilizing the existing two dowel pins connecting the drive assembly. Easy to install & designed to be durable yet lightweight!

OIL PUMP, FUEL PUMP & VACUUM PUMP BOLT-ON BELT GUIDES



BG-6108-33S	Fits 33 Tooth, Radius Tooth Pulleys
BG-6108-34S	Fits 34 Tooth, Radius Tooth Pulleys
BG-6108-35S	Fits 35 Tooth, Radius Tooth Pulleys
BG-6108-36S	Fits 36 Tooth, Radius Tooth Pulleys
BG-6108-37S	Fits 37 Tooth, Radius Tooth Pulleys
BG-6108-38S	Fits 38 Tooth, Radius Tooth Pulleys
BG-6108-40S	Fits 40 Tooth, Radius Tooth Pulleys

BG-6108-42S	Fits 42 Tooth, Radius Tooth Pulleys
BG-6108-44S	Fits 44 Tooth, Radius Tooth Pulleys
BG-6108-45S	Fits 45 Tooth, Radius Tooth Pulleys
BG-6108-48S	Fits 48 Tooth, Radius Tooth Pulleys
BG-6108-30SQ	Fits 30 Tooth, Square Tooth Pulleys
BG-6108-32SQ	Fits 32 Tooth, Square Tooth Pulleys
BG-6108-34SQ	Fits 34 Tooth, Square Tooth Pulleys

ALTERNATOR PULLEY BELT GUIDES

24 Tooth Alternator Pulley Belt Guides



BG-9108-A

32 Tooth Alternator Pulley Belt Guides



BG-9108-C

18 & 22 Tooth Alt. Pulley Guide



BG-6108-18-CAP
BG-6108-22-CAP

Water Pump Pulley Belt Guide



BG-9108-W (28-35 Teeth)
BG-9108-E (35+ Teeth)

1/2" THICK BILLET ALUMINUM AN WRENCHES

- WR-9100-3 -3 An Wrench
- WR-9100-4 -4 An Wrench
- WR-9100-6 -6 An Wrench
- WR-9100-8 -8 An Wrench
- WR-9100-10 -10 An Wrench
- WR-9100-12 -12 An Wrench
- WR-9100-16 -16 An Wrench
- WR-9100-20 -20 An Wrench
- WR-9100-PV-6 -6, Power Valve and Needle & Seat
- WR-9100-PV-8 -6, Power Valve and Needle & Seat



LASER-GUIDED TEMPERATURE GAUGES

Heavy-Duty High Temp Gun



TL-8101-L-HT
0-1000° F

Temp Gun



TL-8101-L
0-525° F

Pocket Temp Gauge



TL-8101-L-HH
0-518° F

SBC EXHAUST COVER SET

EX-9101-A



SPARK PLUG TOOLS

Spark Plug Indexer



SP-8101-V8-C

Spark Plug Indexer with Rotatable Inserts



SP-8101-V8-B



SP-8101-V8-A

Indexer with Rotatable Inserts & a 9th hole for easy setup

Spark Plug Inspection Tool









SP-8101-IL

Billet aluminum spark plug indexers, available with inserts that rotate to synchronize the threads between the head and tool. Available in an 8-hole or 9-hole design. Use the 9th hole to make indexing your plugs quicker. See our Spark Plug Indexing info sheet for complete directions & the advantages of indexing your spark plugs.

48 AN Fittings & Hose

AN HOSE ENDS (SWIVELING HIGH-FLOW DESIGN WITH BLACK FINISH)

<p>0°</p>  <table border="0"> <tr> <th>AN Size</th> <th>Part #</th> </tr> <tr> <td>-6</td> <td>ANB-0600-0</td> </tr> <tr> <td>-8</td> <td>ANB-0800-0</td> </tr> <tr> <td>-10</td> <td>ANB-1000-0</td> </tr> <tr> <td>-12</td> <td>ANB-1200-0</td> </tr> <tr> <td>-16</td> <td>ANB-1600-0</td> </tr> </table>	AN Size	Part #	-6	ANB-0600-0	-8	ANB-0800-0	-10	ANB-1000-0	-12	ANB-1200-0	-16	ANB-1600-0	<p>45°</p>  <table border="0"> <tr> <th>AN Size</th> <th>Part #</th> </tr> <tr> <td>-6</td> <td>ANB-0600-45</td> </tr> <tr> <td>-8</td> <td>ANB-0800-45</td> </tr> <tr> <td>-10</td> <td>ANB-1000-45</td> </tr> <tr> <td>-12</td> <td>ANB-1200-45</td> </tr> <tr> <td>-16</td> <td>ANB-1600-45</td> </tr> </table>	AN Size	Part #	-6	ANB-0600-45	-8	ANB-0800-45	-10	ANB-1000-45	-12	ANB-1200-45	-16	ANB-1600-45																										
AN Size	Part #																																																		
-6	ANB-0600-0																																																		
-8	ANB-0800-0																																																		
-10	ANB-1000-0																																																		
-12	ANB-1200-0																																																		
-16	ANB-1600-0																																																		
AN Size	Part #																																																		
-6	ANB-0600-45																																																		
-8	ANB-0800-45																																																		
-10	ANB-1000-45																																																		
-12	ANB-1200-45																																																		
-16	ANB-1600-45																																																		
<p>90°</p>  <table border="0"> <tr> <th>AN Size</th> <th>Part #</th> </tr> <tr> <td>-6</td> <td>ANB-0600-90</td> </tr> <tr> <td>-8</td> <td>ANB-0800-90</td> </tr> <tr> <td>-10</td> <td>ANB-1000-90</td> </tr> <tr> <td>-12</td> <td>ANB-1200-90</td> </tr> <tr> <td>-16</td> <td>ANB-1600-90</td> </tr> </table>	AN Size	Part #	-6	ANB-0600-90	-8	ANB-0800-90	-10	ANB-1000-90	-12	ANB-1200-90	-16	ANB-1600-90	<p>120°</p>  <table border="0"> <tr> <th>AN Size</th> <th>Part #</th> </tr> <tr> <td>-6</td> <td>ANB-0600-120</td> </tr> <tr> <td>-8</td> <td>ANB-0800-120</td> </tr> <tr> <td>-10</td> <td>ANB-1000-120</td> </tr> <tr> <td>-12</td> <td>ANB-1200-120</td> </tr> <tr> <td>-16</td> <td>ANB-1600-120</td> </tr> </table>	AN Size	Part #	-6	ANB-0600-120	-8	ANB-0800-120	-10	ANB-1000-120	-12	ANB-1200-120	-16	ANB-1600-120	<p>150°</p>  <table border="0"> <tr> <th>AN Size</th> <th>Part #</th> </tr> <tr> <td>-6</td> <td>ANB-0600-150</td> </tr> <tr> <td>-8</td> <td>ANB-0800-150</td> </tr> <tr> <td>-10</td> <td>ANB-1000-150</td> </tr> <tr> <td>-12</td> <td>ANB-1200-150</td> </tr> <tr> <td>-16</td> <td>ANB-1600-150</td> </tr> </table>	AN Size	Part #	-6	ANB-0600-150	-8	ANB-0800-150	-10	ANB-1000-150	-12	ANB-1200-150	-16	ANB-1600-150	<p>180°</p>  <table border="0"> <tr> <th>AN Size</th> <th>Part #</th> </tr> <tr> <td>-6</td> <td>ANB-0600-180</td> </tr> <tr> <td>-8</td> <td>ANB-0800-180</td> </tr> <tr> <td>-10</td> <td>ANB-1000-180</td> </tr> <tr> <td>-12</td> <td>ANB-1200-180</td> </tr> <tr> <td>-16</td> <td>ANB-1600-180</td> </tr> </table>	AN Size	Part #	-6	ANB-0600-180	-8	ANB-0800-180	-10	ANB-1000-180	-12	ANB-1200-180	-16	ANB-1600-180
AN Size	Part #																																																		
-6	ANB-0600-90																																																		
-8	ANB-0800-90																																																		
-10	ANB-1000-90																																																		
-12	ANB-1200-90																																																		
-16	ANB-1600-90																																																		
AN Size	Part #																																																		
-6	ANB-0600-120																																																		
-8	ANB-0800-120																																																		
-10	ANB-1000-120																																																		
-12	ANB-1200-120																																																		
-16	ANB-1600-120																																																		
AN Size	Part #																																																		
-6	ANB-0600-150																																																		
-8	ANB-0800-150																																																		
-10	ANB-1000-150																																																		
-12	ANB-1200-150																																																		
-16	ANB-1600-150																																																		
AN Size	Part #																																																		
-6	ANB-0600-180																																																		
-8	ANB-0800-180																																																		
-10	ANB-1000-180																																																		
-12	ANB-1200-180																																																		
-16	ANB-1600-180																																																		

NPT ADAPTERS

NPT Size	to: -6 x 0°	to: -6 x 90°	to: -8 x 0°	to: -8 x 90°	to: -10 x 0°	to: -10 x 90°	to: -12 x 0°	to: -12 x 90°
1/8"	ANB-0612-0	ANB-0612-90	N/A	N/A	N/A	N/A	N/A	N/A
1/4"	ANB-0625-0	ANB-0625-90	ANB-0825-0	ANB-0825-90	N/A	N/A	N/A	N/A
3/8"	ANB-0637-0	ANB-0637-90	ANB-0837-0	ANB-0837-90	ANB-1037-0	ANB-1037-90	N/A	N/A
1/2"	N/A	N/A	ANB-0850-0	ANB-0850-90	ANB-1050-0	ANB-1050-90	ANB-1250-0	ANB-1250-90
3/4"	N/A	N/A	N/A	N/A	ANB-1075-0	ANB-1075-90	ANB-1275-0	ANB-1275-90

LIGHTWEIGHT BRAIDED HOSE

- ANB-0600-BL : -06 Braided Hose
- ANB-0800-BL : -08 Braided Hose
- ANB-1000-BL : -10 Braided Hose
- ANB-1200-BL : -12 Braided Hose
- ANB-1600-BL : -16 Braided Hose
- ANB-2000-BL : -20 Braided Hose

Lightweight Stainless Steel impregnated **Synthetic rubber** hose with a lightweight **black nylon** outer cover.

350-500 PSI Continuous
1400-2000 PSI Burst



INTERNAL SUPPORT COIL

- AN-1200-SC
-12 Internal Support Coil
- AN-1600-SC
-16 Internal Support Coil

Internal Support Coil, prevents vacuum line from sucking shut. Offers added support necessary for maximum efficiency.



LS Belt Drives 49

1020-LS LS SERPENTINE WATER PUMP DRIVE



DH-CT525 Crank Pulley
SK-2109-I CS Pulley Bolts
DP-2109-A Dowel Pin Set
EC-6111-WC-Nx1/2" End Cap w/ Integrated Billet Nut

WP-5104-C-4.5" Water Pump Pulley
WP-5104-MK WP Pulley Mounting Kit
WP-9104-LS HP LS Water Pump
5PK-698 HD Heavy Duty Belt

Kit 1020-LS shown with kits:
 2046 (Alternator) &
 2002-LS (Tandem PS & Fuel Pump)



1006-LS LS WATER PUMP & POWER STEERING SERPENTINE BELT DRIVE SYSTEM

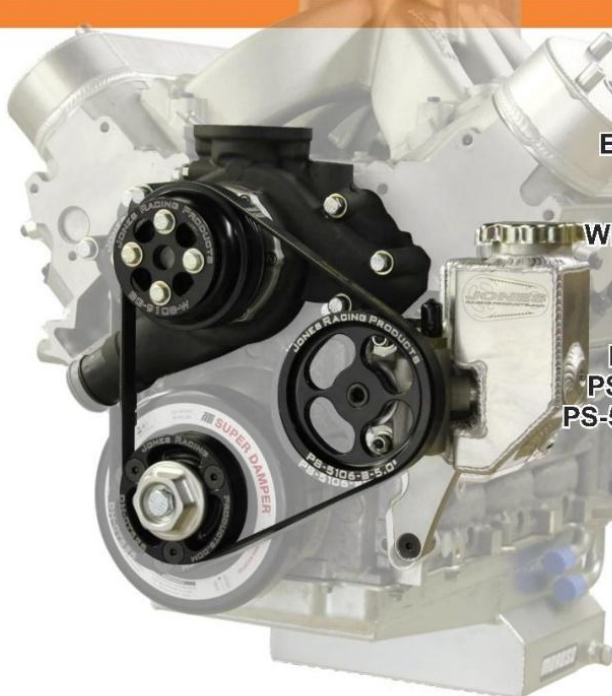

DH-CT525 Crank Pulley
SK-2109-I CS Pulley Bolts
DP-2109-A Dowel Pin set
EC-6111-WC-N End Cap w/ Integrated Billet Nut

WP-5104-C-4.5" Water Pump Pulley
WP-5104-MK Pulley Mounting Kit
WP-9104-LS HP LS Water Pump

PS-8001-LS-R PS Bracket
PS-9008-AL-AR PS Pump w. Tank
PS-5106-B-5.000" PS Pulley
5PK-890 HD Heavy Duty Belt

Kit 1006 shown with kits:
 2046 (Alternator) &
 2003-LS (Fuel Pump)



50 Serpentine WP Belt Drives

1020-S SMALL BLOCK & BIG BLOCK CHEVY SERPENTINE WATER PUMP DRIVE

Features a one-piece lower pulley further reducing weight while adding strength. This design also features a reversible registering ring making one kit compatible with BB or SB crank snouts.

CHEVY



WP-5104-WC-5" Water Pump Pulley
WP-5104-MK Mounting Kit

5PK-695HD Heavy Duty Belt

DH-5102-G Crank Pulley, bolts directly to the balancer.

SK-2109-M2 Flat head Mounting Bolts

DH-5102-R SB or BB Pulley Register

EC-6111-WC-N End Cap w/ Integrated Billet Nut & Crank Bolt

1020-PS ADD-ON POWER STEERING KIT



1026-S SMALL BLOCK FORD SERPENTINE WATER PUMP DRIVE

FORD



WP-5104-WC-5" Water Pump Pulley
WP-5104-MK Mounting Kit

5PK-690HD Heavy Duty Belt

DH-8101-WC-DE Drive Hub

DH-2109-BC Bolt Kit

CS-5102-G Crank Pulley

BEC-2109-JC End Cap & Crank Bolt



EDE-8833

Edelbrock Victor Series
Circle Track Pump

1028-S

SMALL BLOCK CHRYSLER
SERPENTINE WATER PUMP DRIVE

SBC Crate Engine Kits 51

1035-S-CE SB CHEVY CRATE ENGINE WATER PUMP DRIVE

- | | |
|-----------------|-------------------|
| DH-5102-H | Crank Pulley |
| DH-2109-BC | Bolt Kit |
| BEC-2109-A | End Cap & Bolt |
| WP-5104-WC-4.5" | Water Pump Pulley |
| WP-5104-MK | Mounting Kit |
| 5PK-690HD | Heavy Duty Belt |

3441-AR-CE SBC 602/604 CRATE ENGINE V-BELT DRIVE SYSTEM

Kit Includes Brand New, Aluminum Short Style Water Pump; Alum. Power Steering Pump with Built-In Tank; & our Mini, Lightweight Aluminum, 1-wire 45-idle / 70-max amp Alternator. Kit also features all Billet Aluminum Pulleys & Brackets, which are supplied with all the necessary Belts, Spare Belts, Mounting Hardware and Spacers.

POPULAR KIT VARIATIONS

- | | |
|------------|-------------------------|
| 3441-AR-CE | Complete System |
| 3004-AR-CE | CS, WP & PS Only |
| 3004-AL-CE | PS for Remote Reservoir |
| 3001-CE | Water Pump Drive Only |

52 Radius Tooth HTD Belt Drives

2442-AR-CE SMALLBC, RADIUS TOOTH WP, PS & ALTERNATOR BELT DRIVE

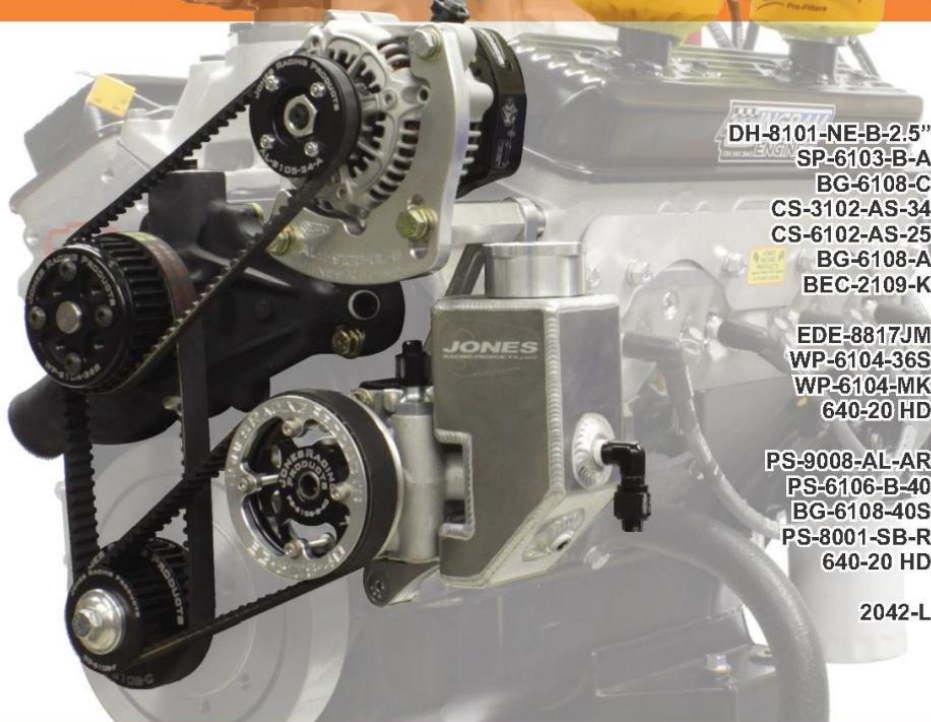

- DH-8101-NE-B-2.5"** SBC Drive Mandrel
- SP-6103-B-A** Crank Pulley Spacer
- BG-6108-C** Belt Guides (2)
- CS-3102-AS-34** Radius Tooth CS Pulley
- CS-6102-AS-25** Radius Tooth CS Pulley
- BG-6108-A** Belt Guides (1)
- BEC-2109-K** Bolt & End Cap Kit

- EDE-8817JM** HP Water Pump
- WP-6104-36S** Radius Tooth WP Pulley
- WP-6104-MK** Pulley Mounting Kit
- 640-20 HD** hEAVY Duty Belt

- PS-9008-AL-AR** PS Pump w/ Alum. Tank
- PS-6106-B-40** Radius Tooth PS Pulley
- BG-6108-40S** Belt Guides
- PS-8001-SB-R** PS Bracket w/ Hardware
- 640-20 HD** Radius Tooth Belt

- 2042-L** Radius Tooth Alt. Kit

2441-AR-CE SBC CRATE ENGINE RADIUS TOOTH WATER PUMP, POWER STEERING & ALTERNATOR DRIVE

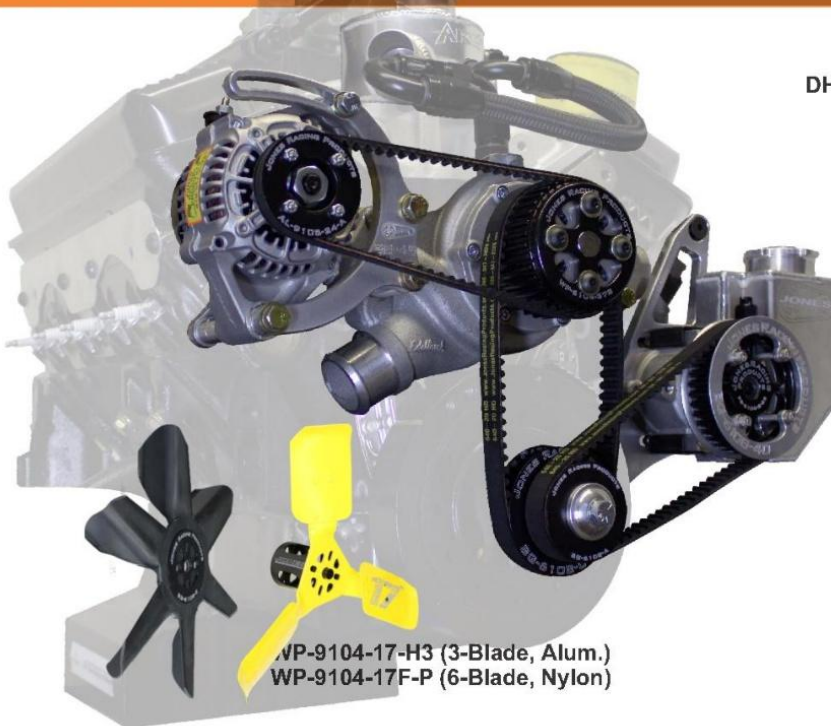

- DH-8101-NE-B-2.5"** SBC Drive Mandrel
- SP-6103-B-A** Crank Pulley Spacer
- BG-6108-C** Belt Guides (2)
- CS-3102-AS-33** Radius Tooth CS Pulley
- CS-6102-AS-25** Radius Tooth CS Pulley
- BG-6108-A** Belt Guides (2)
- BEC-2109-K** Bolt & End Cap Kit

- EDE-8827** HP Water Pump
- WP-6104-37S** Radius Tooth WP Pulley
- WP-6104-MK** Pulley Mounting Kit
- 640-20 XHD** Extreme Duty Belt
- WP-9104-17F-P** Polymer L/W Fan
- BG-9108-E** Fan Shield

- PS-9008-AL-AR** PS Pump w/ Alum. Tank
- PS-6106-B-40** Radius Tooth PS Pulley
- BG-6108-40S** Belt Guides
- PS-8001-SB-R** PS Bracket w/ Hardware
- 640-20 HD** Radius Tooth Belt

- 2041-44698R** Radius Tooth Alt. Kit

WP-9104-17-H3 (3-Blade, Alum.)
WP-9104-17F-P (6-Blade, Nylon)

SBC Water Pump & Tandem or FP Drive Kit 53

1035-S-1P SBC SWP SERPENTINE DRIVE
W. RADIUS TOOTH TANDEM PUMP DRIVE PULLEY

- DH-8101-NE-B Drive Mandrel
- CS-5102-H Serp. Crank Pulley
- SP-6103-D2 TP Pulley Spacer
- BG-6108-A Belt Guides
- CS-6102-A-20 TP Drive Pulley
- BEC-2109-E Bolt & End Cap Kit

- WP-5104-WC-4.5" Serp. WP Pulley
- WP-5104-MK WP Pulley Mounting Kit
- 5PK-690 HD Serp. Belt



SB CHEVY WATER PUMP



EDE-8819 (10 O-ring Aux. Ports)
EDE-8817 (3/8 NPT Aux. Ports)
WP-9104-SBC-AL (House Pump)

OPTIONAL FUEL PUMP BRACKETS

SB/BBC



Bracket # **FP-9100-E**
Kit# **2001-BB**

Ford



Bracket # **FP-9100-A**
Kit# **2001-F**

Chrysler



Bracket # **FP-9100-F**
Kit# **2001-CR**

Bell Housing



Bracket # **FP-9100-BH**
Kit # **2001-BH**

OPTIONAL FUEL PUMPS



KSE-8009-C
Combination PS & Fuel Pump



FP-8009-A
Belt Driven Fuel Pump



SWE-305-85841
Combination PS & Fuel Pump

54 Serpentine WP Belt Drives

1004-AR-CE SB CHEVY SERPENTINE WATER PUMP & PS DRIVE SYSTEM



See our stand alone water pump drives on pages 28 & 29

- DH-8101-NE-A-2" Drive Hub
- CS-5102-F Crank Pulley
- BEC-2109-C End Cap & Bolt
- WP-9104-SBC-AL Alum. HP Water Pump
- WP-5104-C Water Pump Pulley
- WP-5104-MK Shims & Bushings
- PS-8001-SB-R PS Bracket
- PS-9008-AL-AR PS Pump with Tank
- PS-5106-B-4.5" PS Pulley
- 5PK-850HD Heavy Duty Belt

Kits for your Specific RPM Range

- 1004-AR-CE 6200 RPM Engine
- 1004-AR-7200 7200 RPM Engine
- 1004-AR-7500 7500 RPM Engine
- 1004-AR-8000 8000+ RPM Engine

1441-AR-CE COMPLETE SBC BELT DRIVE SYSTEM



Kit Includes Brand New, Aluminum Short Style Water Pump; Alum. Power Steering Pump with Built-In Tank; & a Mini, Lightweight Aluminum, 1-wire 45-idle / 70-max amp Alternator. Kit also features all Billet Aluminum Pulleys & Brackets, which are supplied with all the necessary Belts, Spare Belts, Mounting Hardware and Spacers.

Kits for your Specific RPM Range

- 1441-AR-CE 6200 RPM Engine
- 1441-AR-72 7200 RPM Engine
- 1441-AR-75 7500 RPM Engine
- 1441-AR-80 8000+ RPM Engine

1004-AL-CE REMOTE-TANK PS PUMP



1004-S-CE PULLEYS & BRACKET ONLY



SBF WP & PS Drive Kits 55

1005-AL-CE SBF SERPENTINE WATER PUMP & PS DRIVE SYSTEM



- DH-8101-SR-A Drive Hub
- DH-2109-BC Hub Bolt Kit
- SP-6103-KP Spacer Kit
- CS-5102-F Crank Pulley
- BEC-2109-JC End Cap & Bolt
- WP-5104-C Water Pump Pulley
- WP-5104-MK Shims & Bushings
- PS-8001-F-R PS Brackets
- PS-8001-FR-MK Hex Stand-Offs
- PS-5106-B-4.5" PS Pulley
- 5PK-890HD Heavy Duty Belt

1565-AR-CE COMPLETE SB FORD BELT DRIVE SYSTEM:



Kit Includes Alum. Power Steering Pump with Built-In Tank; & a Mini, Lightweight Aluminum, 1-wire 45-idle / 70-max amp alternator. Kit also features all Billet Alum. Pulleys & Brackets, which are supplied w. all the necessary Mounting Hardware, Belts, Spare Belts, and Spacers. Shown with optional EDE-8833 Water Pump.

Kits for your Specific RPM Range

- 1565-AR-CE 6200 RPM Engine
- 1565-AR-72 7200 RPM Engine
- 1565-AR-75 7500 RPM Engine
- 1565-AR-80 8000+ RPM Engine

1005-S-CE PULLEYS & BRACKET ONLY



1005-AR-CE KIT W. BUILT-IN PS TANK



Kits for your Specific RPM Range

- 1005-S-CE No Pumps, Just Pulleys
- 1005-AR-CE 6200 RPM Engine w/ PS Pump
- 1005-AR-72 7200 RPM Engine w/ PS Pump
- 1005-AR-75 7500 RPM Engine w/ PS Pump
- 1005-AR-80 8000 RPM Engine w/ PS Pump

OPTIONS WATER PUMP



EDE-8833

Alternator Options



AL-9101-B-NS
45 idle/70 amps max
Mini 1-Wire Alternator



AL-9101-E-NS
80 idle/140 amps max
1-Wire Alternator



AL-9101-E-170
135 idle/170 amps max
1-Wire Alternator

56 SB Chrysler WP & PS Belt Drives

1008-S-CE SB CHRYSLER SERPENTINE WATER PUMP & PS DRIVE SYSTEM

See our stand alone water pump drive on page 50



- DH-8101-WC-C Drive Hub
- DH-2109-BC Hub Bolt Kit
- CS-5102-F Crank Pulley
- BEC-2109-HC End Cap & Bolt
- WP-5104-F Water Pump Pulley
- WP-5104-MK Shims & Bushings
- PS-8001-CR-R PS Bracket
- PS-5106-B-4.5" PS Pulley
- 5PK-825HD Heavy Duty Belt

Kits for your Specific RPM Range

- 1008-AR-CE 6200 RPM Engine
- 1008-AR-72 7200 RPM Engine
- 1008-AR-75 7500 RPM Engine
- 1008-AR-80 8000 RPM Engine

1875-AR-CE COMPLETE SB CHRYSLER BELT DRIVE SYSTEM



Kit Includes an Alum. Power Steering Pump with Built-In Tank; & a Mini, Lightweight Aluminum, 1-wire 45-idle / 70-max amp Alternator. Kit also features all Billet Aluminum Pulleys & Brackets, which are supplied with all the necessary Belts, Spare Belts, Mounting Hardware and Spacers. Shown with Optional EDE-8877 Water Pump.

Kits for your Specific RPM Range

- 1875-AR-CE 6200 RPM Engine
- 1875-AR-72 7200 RPM Engine
- 1875-AR-75 7500 RPM Engine
- 1875-AR-80 8000+ RPM Engine

Power Steering Options



PS-9008-AL



PS-9008-AL-R



PS-9008-AL-AR



PS-8101-A



PS-8101-B



PS-8009-32

Late Model Hemi Belt Drives 57

1776-AC-SS GEN III HEMI SERPENTINE WP, PS, AL & AC DRIVE

- | | |
|-----------------|----------------------------|
| AL-9101-E-NS | 80/140 1-Wire Alternator |
| AL-9100-CL-H62 | Alternator Bracket |
| IDL-5102-H62-AL | Alternator Idler Pulley |
| PS-9008-AL-AR | PS Pump w. Integrated Tank |
| PSH-8001-H62 | Power Steering Bracket |
| IDL-5102-H62-PS | PS Idler Pulley Assembly |
| AC-9101-C | Compact A/C Compressor |
| AC-8001-H62 | A/C Bracket |
| 6PK-2170 | Heavy Duty Belt |

Optional Upgraded Alternator



- | | |
|---------------|-----------------------|
| AL-9101-E-170 | 135 idle/170 amps max |
| AL-9101-E-240 | 145 idle/245 amps max |



1776-AR-SS GEN III HEMI SERPENTINE WP, PS, AL & AC DRIVE

- | | |
|-----------------|----------------------------|
| AL-9101-E-NS | 80/140 1-Wire Alternator |
| AL-9100-CL-H62 | Alternator Bracket |
| IDL-5102-H62-AL | Alternator Idler Pulley |
| PS-9008-AL-AR | PS Pump w. Integrated Tank |
| PSH-8001-H62 | Power Steering Bracket |
| IDL-5102-H62-PS | PS Idler Pulley Assembly |
| AC-9101-C | Compact A/C Compressor |
| AC-8001-H62 | A/C Bracket |
| 6PK-2005 | Heavy Duty Belt |

Optional Remote Reservoir PS Pump



PS-9008-AL



PS-8101-B



58 SB Chevy Radius Tooth WP Drive

2010-RA SB CHEVY RADIUS TOOTH WATER PUMP DRIVE SYSTEM



- DH-8101-NE-A-2" Drive Mandrel/Hub
- CS-6102-AS-25 Radius Tooth Crank Pulley
- BG-6108-A CS Pulley Belt Guides
- SP-6103-A-A-1/4" Spacer
- BEC-2109-D End Cap & Bolt Kit

- WP-6104-35A Radius Tooth WP Pulley
- WP-6104-MK WP Bushings & Hardware
- 600-20 HD HD Radius Tooth WP Belt

Kits for your Specific RPM Range

- 2010-RA-7 7% Reduction
- 2010-RA-10 10% Reduction
- 2010-RA-23 23% Reduction
- 2010-RA 29% Reduction
- 2010-RA-F Ford Setup

2015-RA SB CHEVY RADIUS TOOTH WP & OIL PUMP DRIVE SYSTEM



- DH-8101-NE-C-4" Drive Mandrel/Hub
- CS-6102-AS-25 Radius Tooth Crank Pulley
- BG-6108-A CS Pulley Belt Guides
- CS-6102-AS-18 Radius Tooth Crank Pulley
- SP-6103-KP Mandrel Spacer Kit
- BEC-2109-F End Cap & Bolt Kit

- WP-6104-35A Radius Tooth WP Pulley
- WP-6104-MK WP Bushings & Hardware
- 600-20 HD HD Radius Tooth WP Belt

- OP-6103-32-1 1/4" Oil Pump Pulley
- 560-20 HD HD Radius Tooth OP Belt

WATER PUMP OPTIONS

High Flow, SBC, SWP w/
2 Auxiliary Fittings



EDE-8819 or EDE-8817

OIL PUMP OPTIONS



See Page 38
for Oil Pumps

Remote Mount
for Oil Filter



OP-8103-F



VP-9106-A

Remote breather/
oil separator with
1/2 NPT Fittings.
Comes w. -12 &
-8 AN Adapters,
filter and bracket.

Bell Housing Kits 59

2004-RA BELL HOUSING MOUNTED OIL PUMP DRIVE SYSTEM

OP-6103-38-1 1/4"	Oil Pump Pulley
BG-6108-38S	OP Pulley Belt Guides
RDH-6102-22	Coupler with Built-In Pulley
640-30 HD	HD Radius Tooth Belts



2004-PS BELL HOUSING MOUNTED PS DRIVE SYSTEM

PS-9008-AL	Alum. PS Pump
PS-6106-B-33	PS Pulley
BG-6108-33S	PS Pulley Guides
PS-8001-BH	Bell Housing PS Bracket
RDH-6102-22	Coupler with Built-In Pulley
560-20 HD	HD Radius Tooth Belts



2004-OP-AL BELL HOUSING MOUNTED ALT DRIVE SYSTEM, WORK WITH OP

AL-9101-B-NS	1-Wire Mini Alternator
AL-9100-OP-BH	Bell Housing Alt Bracket
AL-6105-18-A	Alt Pulley
BG-6108-18-CAP	Alt Pulley Guides
RDH-6102-22	Coupler with Built-In Pulley
592-20 HD	HD Radius Tooth Belts



2004-AL BELL HOUSING MOUNTED ALTERNATOR DRIVE SYSTEM

AL-9101-B-NS	1-Wire Mini Alternator
AL-9100-BH	Bell Housing Alt Bracket
AL-6105-18-A	Alt Pulley
BG-6108-18-CAP	Alt Pulley Guides
RDH-6102-22	Coupler with Built-In Pulley
592-20 HD	HD Radius Tooth Belts



60 SBC WP, PS & OP Drive

1056-S SBC SERPENTINE WP & PS W. HTD OIL PUMP DRIVE SYSTEM



Shown with Optional:
 Alternator kit 2041-RA
 Water Pump EDE-8817
 & Dry Sump OP-8103-5

SB CHEVY WATER PUMP



EDE-8819 (10 Oring Aux. Ports)
 EDE-8817 (3/8 NPT Aux. Ports)

EXPANSION TANKS



EXT-9104-DML



EXT-9104-DMR



EXT-58037-L
 (Low Profile)

- DHS-3102-1/4" 1/4" Crank Spacer
- DH-5102-R Register & Balancer Bolt
- DH-5102-G Crank Pulley
- DHS-3102-1/4" Billet Alum. SB-Offset Spcr
- SK-2109-H Bolt Kit
- SP-6103-WC-C-1/2" Crank Pulley Spacer
- BG-6108-WC Belt Guide
- CS-6102-WC-22 HTD OP Drive Pulley
- EC-6111-WC-Nx7/16" End Cap with Large Nut
- WP-5104-WC-5-DS Water Pump Pulley
- WP-5104-MK Shims & Bushings
- 6PK-695 HD Serpentine WP Belt
- PSH-8001-C PS Bracket
- PS-9008-AL PS Pump
- PS-5106-B-4.500" PS Pulley
- 5PK-735 HD Serpentine PS Belt
- OP-6103-38-1 1/4" HTD Oil Pump Pulley
- 600-20 HD HTD Oil Pump Belt
- (Optional) 2041-RA SBC HTD Alternator Kit

Power Steering Options



PS-9008-AL



PS-9008-AL-R



PS-9008-AL-AR



PS-8101-A



PS-8101-B



PS-8009-32

BBC WP, PS, Alt, & Dry Sump 61

1055-S BBC SERPENTINE WP & PS W/
HTD OIL PUMP DRIVE SYSTEM



- DH-5102-R CS Pulley Register
- DH-5102-G Crank Pulley
- SK-2109-H Bolt Kit
- SP-6103-WC-C-1/2" 2 Crank Pulley Spacers
- BG-6108-WC Belt Guide
- CS-6102-WC-22 HTD OP Drive Pulley
- EC-6111-WC-Nx1/2" End Cap with Large Nut

- WP-5104-WC-5-DS Water Pump Pulley
- WP-5104-MK Shims & Bushings
- 6PK-695 HD Serpentine WP Belt

- PSH-8001-BB PS Bracket
- PS-9008-AL PS Pump
- PS-5106-B-4.500" PS Pulley
- 5PK-690 HD Serpentine PS Belt

- OP-6103-38-1 1/4" HTD Oil Pump Pulley
- 640-20 HD HTD Oil Pump Belt
- *Sold Separately
- *2031-RA BBC HTD Alternator Kit

BB CHEVY WATER PUMP



EDE-8852

EXPANSION TANKS



EXT-9104-DML



EXT-9104-DMR



EXT-58037-L
(Low Profile)

Alternator Options



AL-9101-B-NS
45 idle/70 amps max
Mini 1-Wire Alternator



AL-9101-E-NS
80 idle/140 amps max
Mini 1-Wire Alternator



AL-9101-D-NS
100 idle/140 amps max
Mini 1-Wire Alternator



AL-9101-E-170
135 idle/170 amps max
1-Wire Alternator

62 SBF WP, PS & OP Drive

1057-S SBF SERPENTINE WP & PS W. HTD OIL PUMP DRIVE SYSTEM



Shown with Optional:
Alternator kit 2065-80
& Dry Sump OP-8103-WS

- DH-8101-WC-SR-A Drive Hug
- CS-5102-F Crank Pulley
- CS-6102-AS-19 HTD OP Drive Pulley
- BG-6108-F Belt Guides (2)
- SP-6103-A-A Crank Pulley Spacer
- BEC-2109-JC End Cap & Bolt Kit
- WP-5104-WC-5-DS Water Pump Pulley
- WP-5104-MK Shims & Bushings
- 6PK-690 HD HD Serpentine WP Belt
- PSH-8001-F-R PS Bracket
- PSH-8001-FR-MK PS Bracket Mounting Kit
- PS-9008-AL-AR PS Pump
- PS-5106-B-4.500" PS Pulley
- 5PK-735 HD HD Serpentine PS Belt
- OP-6103-33-1 1/4" HTD Oil Pump Pulley
- 640-20 HD HTD Oil Pump Belt
- (Optional) 2065-RA SBF HTD Alternator Kit

OPTIONS WATER PUMP



EDE-8833

Power Steering Options



PS-9008-AL



PS-9008-AL-R



PS-9008-AL-AR



PS-8101-A



PS-8101-B



PS-8009-32

SBC Cam Drive 63

CDA-8001-1 1/8" SBC BELT DRIVEN CAM DRIVE
RUNS IN OIL UNDER STOCK COVER



- CP-8001-A Cam Pulley
- CS-8001-A Crank Pulley (SB Snout)
- CB-8001-A Cam Button
- CB-8001-B Bearings for Cam Pulley
- CB-8001-C Bolts for Cam Pulley
- CS-8001-1 1/8"-HD Heavy-Duty Cam Drive Belt

OPTIONS

- CS Pulley (BB Snout)
- Normal Duty Belt

64 SBC Radius Tooth WP, PS & OP Drive

4-4698-R SBC RADIUS TOOTH DRIVE SYSTEM WP & PS OIL PUMP & ALTERNATOR

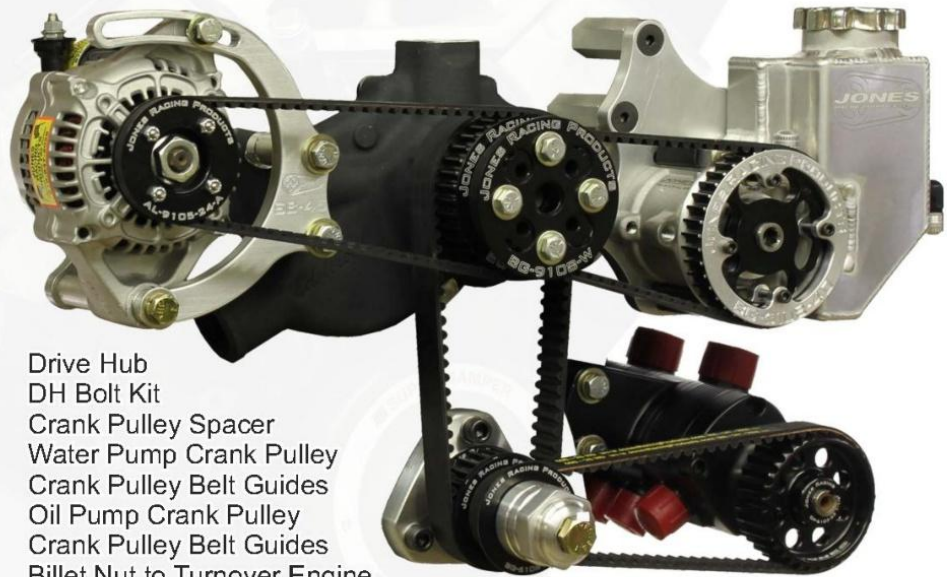

- DH-8101-WC-BB** Drive Hub
- DH-2109-BC** DH Bolt Kit
- SP-6103-K** Crank Pulley Spacer
- CS-6102-A-26** Water Pump Crank Pulley
- BG-6108-A (Qty 2)** Crank Pulley Belt Guides
- CS-6102-AS-18** Oil Pump Crank Pulley
- BG-6108-F (Qty 2)** Crank Pulley Belt Guides
- CSN-6103-A** Billet Nut to Turnover Engine
- BEC-2109-HC** Bolt & End Cap Kit

- WP-6104-36A** Water Pump Pulley
- WP-6104-MK** Shims & Bushings
- 608-25 HD (Qty 2)** HD Radius Tooth WP Belt

- PSH-8001-SB-R** PS Bracket
- PS-9008-AL-AR** PS Pump
- PS-6106-B-40-15** Radius Tooth PS Pulley
- BG-6108-40S** PS Pulley Belt Guides
- 576-15 HD (Qty 2)** HD Radius Tooth PS Belt

- OP-6103-32-1 1/4"** Radius Tooth Oil Pump Pulley
- 560-20 HD (Qty 2)** HD Radius Tooth OP Belt

2041-4698 SBC Radius Tooth Alternator Kit

(Optional) EDE-8819 Edelbrock WP w. -10 Aux. Ports



Lightweight HD Mini 1-Wire Alternator

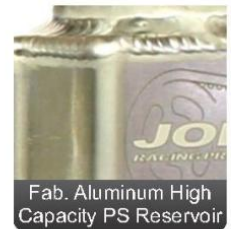

Fab. Aluminum High Capacity PS Reservoir



Radius Tooth Belt & Billet Alum. Pulleys



Billet Alum. Brackets & Mounting Hardware

Alternator Options



AL-9101-B-NS
45 idle/70 amps max
Mini 1-Wire Alternator



AL-9101-E-NS
80 idle/140 amps max
Mini 1-Wire Alternator



AL-9101-D-NS
100 idle/140 amps max
Mini 1-Wire Alternator



AL-9101-E-170
135 idle/170 amps max
1-Wire Alternator

SBC w. MP Radius Tooth WP, PS & OP Drive 65

4-4698-RMP SBC RADIUS TOOTH DRIVE SYSTEM WP & PS OIL PUMP & ALTERNATOR

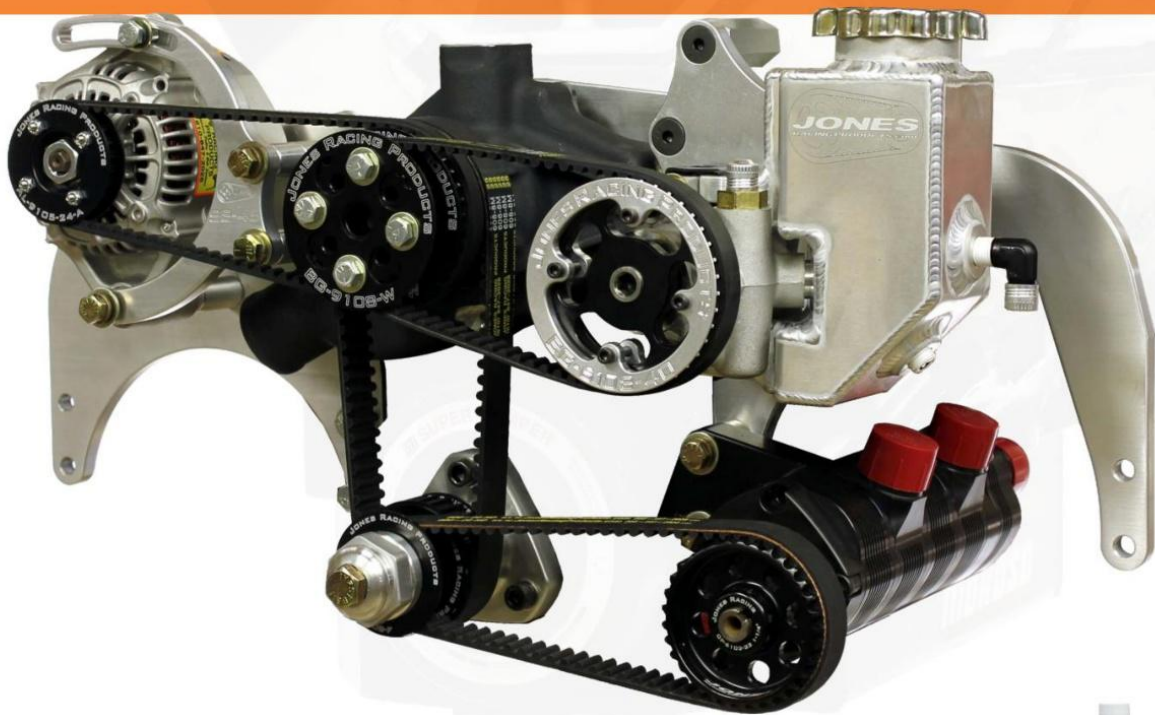

- DH-8101-WC-BB** Drive Hub
- DH-2109-BC** DH Bolt Kit
- SP-6103-K** Crank Pulley Spacer
- CS-6102-A-26** Water Pump Crank Pulley
- BG-6108-A (Qty 2)** Crank Pulley Belt Guides
- CS-6102-AS-18** Oil Pump Crank Pulley
- BG-6108-F (Qty 2)** Crank Pulley Belt Guides
- CSN-6103-A** Billet Nut to Turnover Engine
- BEC-2109-HC** Bolt & End Cap Kit

- WP-6104-36A** Water Pump Pulley
- WP-6104-MK** Shims & Bushings
- 608-25 HD (Qty 2)** HD Radius Tooth WP Belt

- PSH-8001-SB-R** PS Bracket
- PS-9008-AL-AR** PS Pump
- PS-6106-B-40-15** Radius Tooth PS Pulley
- BG-6108-40S** PS Pulley Belt Guides
- 576-15 HD (Qty 2)** HD Radius Tooth PS Belt

- OP-6103-32-1 1/4"** Radius Tooth Oil Pump Pulley
- 560-20 HD (Qty 2)** HD Radius Tooth OP Belt

- 2041-RA** SBC Radius Tooth Alt Kit



Remote-Tank Aluminum PS Pump also Available



Synthetic PS Fluid PS-8009-16 & 32

-6 AN & -10 AN fittings



PS Reservoir PS-8101-A

-6 AN & -10 AN fittings



PS Reservoir PS-8101-B



Expansion Tank EXT-9104-TM



Expansion Tank EXT-9104-SK

66 SBC Alternator Kits

2040 SBC V-BELT ALTERNATOR KIT

AL-9101-B-NS 70 amp, 1-Wire Alternator
 AL-3105-A-B-2.500" 2.5" V-Belt Alt. Pulley
 WP-3104-A-3.500" 3.5" Alt. Drive Pulley
 2700-375 27" V-Belt
 AL-9100-CL-B Alternator Bracket
 AL-9100-CL-HM Rear Alt. Support
 AL-9100-CL-BK Mounting Kit
 SW-9100-A Switch



Block Mount Rear Support
 arm for 2040 & 2041-RA
 AL-9100-CL-BM (shown)



Head Mount Rear
 Support arm for
 2040 & 2041-RA
 AL-9100-CL-HM



See Pages 66 & 67 for more
 SBC Alternator Options

2041-RA SBC RADIUS TOOTH ALTERNATOR KIT

AL-9101-B-NS 70 amp, 1-Wire Alternator
 AL-9105-24-A 24 Tooth Alt. Pulley
 WP-9104-32 32 Tooth Drive Pulley
 BG-9108-W Belt Guide
 672-10 HD Radius Tooth Belt
 AL-9100-CL-B Alternator Bracket
 AL-9100-CL-HM Rear Alt. Support
 AL-9100-CL-BK Mounting Kit
 SW-9100-A Switch



Popular Kit Variations:



- 2041-ADJ Adjustable Voltage
- 2041-80 80/140 amp E-Alt
- 2041-L Left Side Kit
- 2041-L-80 Left Side, 80/140
- 2041-CS Driven from Crank
- 2041-CS-80 80/140, Driven from Crank

See Pages 24 for more
 Bracket Details

Alternator Options



AL-9101-B-NS
 45 idle/70 amps max
 Mini 1-Wire Alternator



AL-9101-E-NS
 80 idle/140 amps max
 Mini 1-Wire Alternator



AL-9101-D-NS
 100 idle/140 amps max
 Mini 1-Wire Alternator



AL-9101-E-170
 135 idle/170 amps max
 1-Wire Alternator

SBC Alternator Kits 67

2050-RA SBC UNIVERSAL, BLOCK-MOUNT, ALTERNATOR KIT

- AL-9105-24-A 24 Tooth Alt. Pulley
- WP-9104-32 32 Tooth Drive Pulley
- BG-9108-W Belt Guide
- 656-10 HD Radius Tooth Belt
- AL-9100-CL-SB Alternator Bracket
- ADR-9100-3.5" Adjusting Rod
- SW-9100-A Switch



See Pages 64 & 66 for more SBC Alternator Options

2051-RA SBC RADIUS TOOTH, BLOCK-MOUNT ALTERNATOR KIT

- AL-9101-B-NS 70+ Amp, 1-wire Alternator
- AL-9105-24-A 24 Tooth Alt. Pulley
- WP-9104-32 32 Tooth Drive Pulley
- BG-9108-W Belt Guide
- 656-10 HD Radius Tooth Belt
- AL-9100-CL-SB Alternator Bracket
- ADR-9100-3.5" Adjusting Rod
- SW-9100-A Switch



2067-RA SBC LOW MOUNT RADIUS TOOTH ALTERNATOR KIT

requires a minimum of 10.75" from the center of the crank to the frame rail.

- DH-8101-C Drive Hub
- SK-2109-D-3/8x1.25" Bolt Kit
- DHM-8101-A Drive Mandrel
- BEC-2109-B End Cap & Bolt
- AL-9101-E-NS 80/140 Amp, 1-wire Alt.
- AL-9105-24-A 24 Tooth Alt. Pulley
- CS-6102-AC-35 35 Tooth Crank Pulley
- BG-6108-C Belt Guides
- 680-10 HD Radius Tooth Belt
- AL-9101-SB-LM Alternator Bracket
- AL-9100-CL-HM-F Adjusting Arm
- SW-9100-A Switch



Alternator Options



AL-9101-B-NS
45 idle/70 amps max



AL-9101-E-NS
80 idle/140 amps max



AL-9101-D-NS
100 idle/140 amps max



AL-9101-E-170
135 idle/170 amps max

68 SBC & LS Alternator Kits

2053-RA SBC RADIUS TOOTH ALTERNATOR KIT

AL-9101-B-NS	70+ Amp, 1-wire Alternator
AL-9105-24-A	24 Tooth Alt. Pulley
WP-9104-32	32 Tooth Drive Pulley
BG-9108-W	Belt Guide
480-10 HD	Radius Tooth Belt
WPM-9101-A	Alternator Bracket
ADR-9100-6"	Adjusting Rod
SW-9100-A	Switch



See Pages 64 & 65 for more SBC Alternator Options

2046-LS LS HIGH-MOUNT RADIUS TOOTH ALTERNATOR KIT

AL-9101-B-NS	70+ Amp, 1-wire Alternator
AL-9105-24-A	24 Tooth Alt. Pulley
WP-9104-32	32 Tooth Drive Pulley
BG-9108-W	Belt Guide
608-10 HD	Radius Tooth Belt
AL-9100-LS-B	Alternator Bracket
WP-6104-C	Fan Register
SW-9100-A	Switch

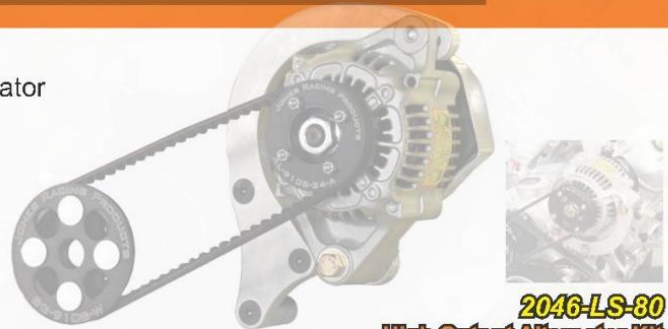

2046-LS-80
High Output Alternator Kit

2069-LS LS LOW-MOUNT RADIUS TOOTH ALTERNATOR KIT

DH-8101-DP-LS	Low Profile Drive Dub
SK-2109-DK	Mounting Bolts
DP-2109-A	Dowel Pin Set
CS-6102-WC-36	Crank Pulley
BG-6108-WC-H	Crank Pulley Belt Guide
EC-6111-WC-Nx1/2"	End Cap w/ Built-in Turnover Nut
AL-9100-LSL-D	Alternator Bracket
AL-9101-D-NS	160 Amp, 1-wire Alternator
AL-6105-22-B	22 Tooth Alt. Pulley
BG-6108-22-CAP	Belt Guide
720-20 HD	Radius Tooth Belt



Alternator Options



AL-9101-B-NS
45 idle/70 amps max



AL-9101-E-NS
80 idle/140 amps max



AL-9101-D-NS
100 idle/140 amps max



AL-9101-E-170
135 idle/170 amps max

SBF Alternator Kits 69

2057-RA SB FORD RADIUS TOOTH ALTERNATOR KIT

AL-9101-B-NS	70 Amp, 1-wire Alternator
AL-9105-24-A	24 Tooth Alt. Pulley
WP-9104-32	32 Tooth Drive Pulley
BG-9108-W	Belt Guide
640-10 HD	Radius Tooth Belt
AL-9101-F3	Alternator Bracket
ADR-9100-5"	Adjusting Rod
SW-9100-A	Switch



2065-RA SB FORD RADIUS TOOTH ALTERNATOR KIT

AL-9101-B-NS	70 Amp, 1-wire Alternator
AL-9105-24-A	24 Tooth Alt. Pulley
WP-9104-32	32 Tooth Drive Pulley
BG-9108-W	Belt Guide
656-10 HD	Radius Tooth Belt
AL-9100-CL-F-B	Alternator Bracket
AL-9100-CL-BK-F	Alt. Mounting Kit
AL-9100-CL-HM-F	Alt. Rear Support
SW-9100-A	Switch



Popular Kits Variations:

2065-80	80/140 Amp E-Alt
2065-D3	100/160 Amp D3-Alt
2065-ADJ	Adjustable Voltage

2070-RA SB FORD HEAD MOUNT RADIUS TOOTH ALTERNATOR KIT

DH-8101-WC-F3-3.5"	Drive Hub
SP-6103-K	Spacer Kit
BEC-2109-HC	End Cap & Bolt
CS-6102-AS-35	35 Tooth Crank Pulley
BG-6108-35	Crank Pulley Belt Guides
656-20	HdD Radius Tooth Belt
AL-6105-22-B	22 Tooth Alt. Pulley
BG-6108-22-CAP	Alt. Pulley Belt Guide
AL-9101-D-NS	120+ Amp, 1-Wire Alt.
AL-9101-ADP	Pivot Arm Adjust
AL-9100-RH-B	Back Alt. Bracket
AL-9100-RH-F	Front Alt. Bracket
AL-9100-MK	Mounting Kit
ADR-9100-2.5"	Adjusting Rod



70 SB Chrysler Alternator Kits

2075-RA SB CHRYSLER RADIUS TOOTH ALTERNATOR KIT

AL-9101-B-NS	45 Amp, 1-Wire Alternator
AL-9105-24-A	24 Tooth Alt. Pulley
WP-9104-32	32 Tooth Drive Pulley
BG-9108-W	Belt Guide
680-10 HD	Radius Tooth Belt
AL-9100-CL-CR-B	Alternator Bracket
AL-9100-CL-BK-R	Mounting Kit
AL-9100-CL-BM-CR	Rear Support Arm
SW-9100-A	Switch



Popular Kits Variations:

2075-80	80/140 Amp E-Alt
2075-D3	100/160 Amp D3-Alt
2075-ADJ	Adjustable Voltage

2058-RA SB CHRYSLER RADIUS TOOTH ALTERNATOR KIT

AL-9101-B-NS	45 Amp, 1-Wire Alternator
AL-9105-24-A	24 Tooth Alt. Pulley
WP-9104-32	32 Tooth Drive Pulley
BG-9108-W	Belt Guide
536-10 HD	Radius Tooth Belt
CH-9101-A	Alternator Bracket
ADR-9100-3.5"	Adjusting Rod
SW-9100-A	Switch



Alternator Options



AL-9101-B-NS
45 idle/70 amps max
Mini 1-Wire Alternator



AL-9101-E-NS
80 idle/140 amps max
Mini 1-Wire Alternator



AL-9101-D-NS
100 idle/140 amps max
Mini 1-Wire Alternator



AL-9101-E-170
135 idle/170 amps max
1-Wire Alternator

BBC Alternator Kits 71

2031-RA BB CHEVY RADIUS TOOTH ALTERNATOR KIT

AL-9101-B-NS	70 amp, 1-Wire Alternator
AL-9105-24-A	24 Tooth Alt. Pulley
WP-9104-32	32 Tooth Drive Pulley
BG-9108-W	Belt Guide
680-10 HD	Radius Tooth Belt
AL-9100-CL-B-BB	Alternator Bracket
AL-9100-CL-BM-BB	Rear Support Bracket
AL-9100-CL-BK-BB	Mounting Kit
SW-9100-A	Switch



Use kit # 2030 for V-Belt Setup

AL-9101-C-NS	65/90 amp, 1-Wire Alternator
AL-9105-24-A	24 Tooth Alt. Pulley
WP-9104-32	32 Tooth Drive Pulley
BG-9108-W	Belt Guide
656-10 HD	Radius Tooth Belt
EBM-9100-A	Block Mount
MP-9101-C	Alternator Bracket
ADR-9100-3.5"	Adjusting Rod
SW-9100-A	Switch



2068-RA BB CHEVY LOW MOUNT RADIUS TOOTH ALTERNATOR KIT

DH-8101-C	Drive Hub
SK-2109-D-3/8x1.25"	Bolt Kit
DHM-8101-A	Drive Mandrel
SP-6103-A-A-1/4"	1/4" Spacer
CS-6102-AC-35	35 Tooth Crank Pulley
BG-6108-C	Belt Guides
BEC-2109-I	End Cap & Crank Bolt
AL-9101-E-NS	65/90 amp, 1-Wire Alt.
AL-9105-24-A	24 Tooth Alt. Pulley
680-10	Radius Tooth Belt
AL-9101-BB-LM	Alternator Bracket
AL-9100-CL-HM-F	Adjusting Rod
SW-9100-A	Switch



requires a minimum of 10.75" from the center of the crank to the frame rail.

72 Specialty Alternator Kits

2055-RA MOTORPLATE ALTERNATOR KIT

- AL-9101-B-NS 70 amp, 1-Wire Alternator
- AL-9105-24-A 24 Tooth Alt. Pulley
- WP-9104-32 32 Tooth Drive Pulley
- BG-9108-W Belt Guide
- 720-10 HD Radius Tooth Belt
- MP-9101-C Alternator Bracket
- ADR-9100-3.5" Adjusting Rod
- SW-9100-A Switch



2059 V-BELT, QUICK CHANGE REAR ALTERNATOR KIT

- AL-9101-E-NS 80/140 amp, 1-Wire Alt.
- AL-3105-A-D-4.500" 4.5" V-Belt Alt. Pulley
- QCM-9101-A Quick-Change-Rear Alt. Mount
- BEV-300-1/2 V-Belt
- FY-9101-V Yoke w/ V-Pulley
- SW-9100-A Switch

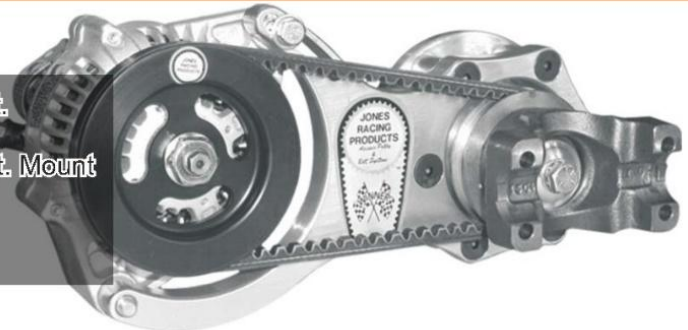

2059-F V-BELT, FORD 9-BOLT REAR ALTERNATOR KIT



- AL-9101-E-NS 80/140 Amp, 1-wire Alternator
- AL-3105-B-D-4.500" 4.5" V-belt Alt. Pulley
- F9-9101-A Ford-9 Bolt-rear Alt. Mount
- BEV-300-1/2 V-belt
- FY-9101-V Yoke W/ V-pulley
- SW-9100-A Switch

Alternator Options



AL-9101-B-NS
45 idle/70 amps max
Mini 1-Wire Alternator



AL-9101-E-NS
80 idle/140 amps max
Mini 1-Wire Alternator



AL-9101-E-170
135 idle/170 amps max
1-Wire Alternator

BBC WP, PS & Alternator Drive 73

1065-AR-ST BIG BLOCK CHEVY SERPENTINE WP, PS & ALT. DRIVE SYSTEM

DH-8101-DP-BB	Drive Hub
SK-2109-DK	DH Bolt Kit
CS-5102-WC-K	Crank Pulley
EC-6111-WC-N	Billet Cap
WP-9104-1/2"-BB	WP Spacers
EDE-8852JM	Water Pump
WP-5104-WC-5-DS	WP Pulley
WP-5104-MK	Shims & Bushings
PSL-8001-BB-R	PS Bracket
PS-9008-AL-AR	PS Pump
PS-5106-B-4.500"	PS Pulley
6PK-940	HD Serpentine Belt
AL-9101-E-NS	HD 1-Wire Alternator
AL-5105-B-B	Alternator Pulley
AL-9100-CL-C-BB	Alternator Bracket
AL-9100-CL-BM-BB	Alternator Support
AL-9100-CL-BK-BB	Alternator Mounting Kit
6PK-695	HD Alternator Belt

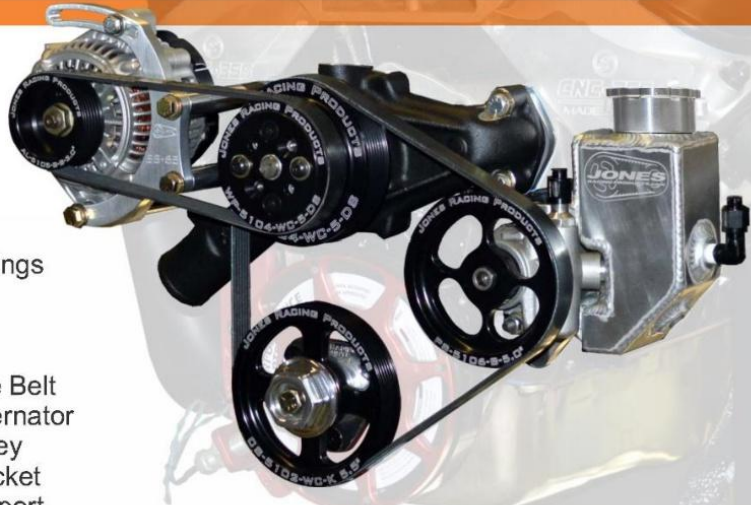

1065-RA-AC BBC WP, PS, ALT, & AC BELT DRIVE SYSTEM

This system is available in a Radius Tooth design as shown, or a Serpentine belt setup.

BBC WP, PS, Alt, & AC Drive
(Also available without PS)

Kit includes everything needed: PS Pump w. integrated or remote style reservoir, 1-Wire alternator with an output of 80 amps at idle and 140 amps at cruising RPM, Sanden AC unit, WP, Pulleys, Belts, Spares Belts, Brackets, & all of the necessary Mounting Hardware and spacers.



1065-AR-ST-B

"AR" features an integrated PS Tank & the "B" option adds the Blackout Components

BB CHEVY WATER PUMP



EDE-8862



EDE-88503 (Black)
EDE-8852JM (Silver)

74 SBC High Performance Street Kits

1064-AR-SB SBC WP, PS & ALTERNATOR DRIVE SYSTEM

DH-8101-C-DP	Drive Hub
SK-2109-DK	DH Bolt Kit
SP-6103-WC-B	Pulley Spacer
CS-5102-WC-K	Crank Pulley
EC-6111-WC-N	Billet Cap
EDE-8812	Water Pump
WP-5104-WC-5-DS	WP Pulley
WP-5104-MK	Shims & Bushings
PS-8001-SB-R	PS Bracket
PS-9008-AL-AR	PS Pump
PS-5106-B-5.000"	PS Pulley
6PK-957	HD Serpentine Belt
AL-9101-E-NS	HD 1-Wire Alternator
AL-5105-B-A	Alternator Pulley
AL-9100-CL-C	Alternator Bracket
AL-9100-CL-HM	Alternator Support
AL-9100-CL-BK	Alternator Mounting Kit
6PK-660	HD Alternator Belt



1064-RA-AC SBC WP, PS, ALT, & AC BELT DRIVE SYSTEM

This system is available in a Radius Tooth design as shown, or a Serpentine belt setup.

SBC WP, PS, Alt, & AC Drive
(Also available without PS)

Kit includes everything needed: PS Pump w. integrated or remote style reservoir, 1-Wire alternator with an output of 80 amps at idle and 140 amps at cruising RPM, Sanden AC unit, WP, Pulleys, Belts, Spares Belts, Brackets, & all of the necessary Mounting Hardware and spacers.

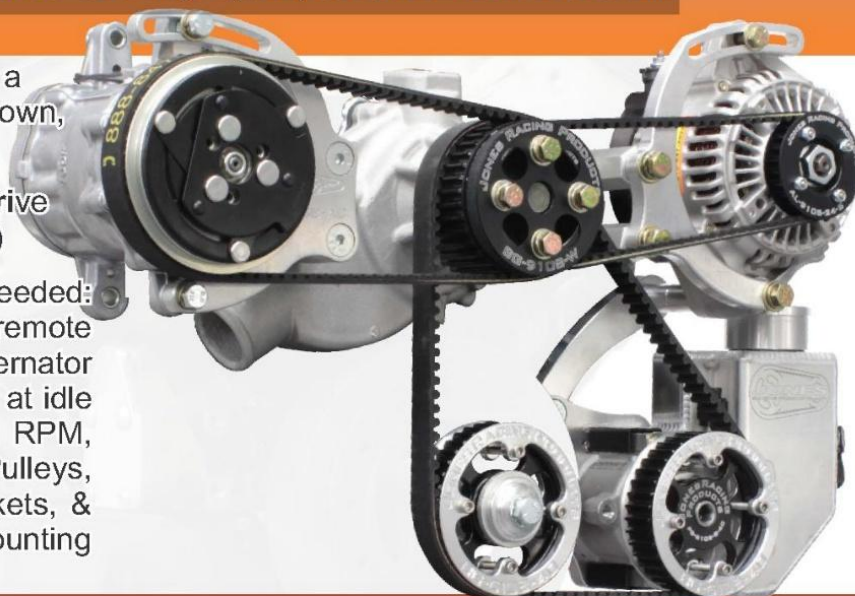

POWER STEERING & ALTERNATOR OPTIONS



PS-9008-AL



PS-8101-A



PS-8101-B



PS-9008-AL-AR



PS-9008-AL-R

SBF High Performance Street Kits 75

1565-AR-AC SBF WP, PS, ALTERNATOR & AC DRIVE SYSTEM

SBF WP, PS, Alt, & AC Belt Drive

Kit includes everything needed: PS Pump w. an integrated or remote style reservoir, 1-Wire alternator with an output of 80 amps at idle and 140 amps at cruising RPM, Sanden AC unit, Pulleys, Belts, Spares Belts, Brackets, & all of the necessary Spacers & Mounting Hardware .



2565-AR-ST SBF WP, PS & ALTERNATOR BELT DRIVE SYSTEM

SBF WP, PS, & Alternator Belt Drive System

This system is available in a range of configurations for different applications and RPM. It is available in Radius Tooth HTD Design as shown or a Serpentine setup.

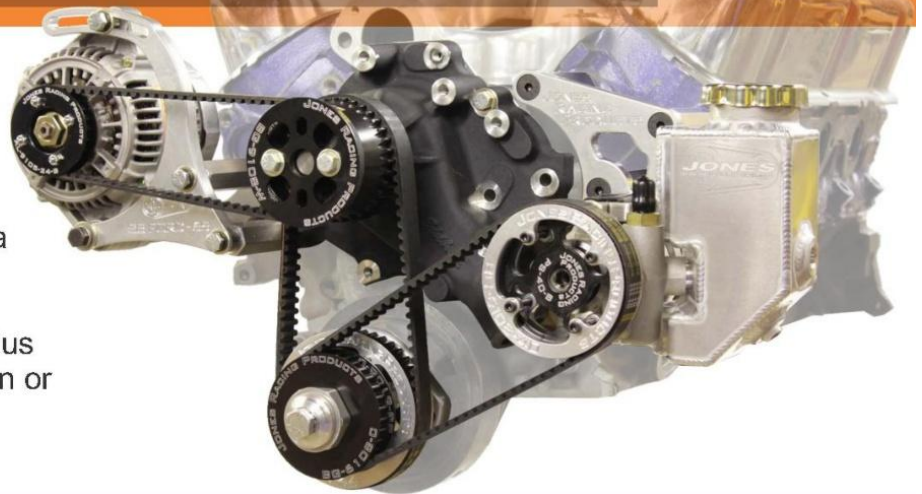

OPTIONS WATER PUMP



EDE-8833

Alternator Options



AL-9101-B-NS
45 idle/70 amps max
Mini 1-Wire Alternator



AL-9101-E-NS
80 idle/140 amps max
1-Wire Alternator



AL-9101-E-170
135 idle/170 amps max
1-Wire Alternator

76 Radius Tooth HTD Belts

Radius Tooth HTD 10mm Wide, 8mm Pitch

480-10 HD	18.898" Long
536-10 HD	21.102" Long
544-10 HD	21.417" Long*
552-10 HD	21.732" Long
560-10 HD	22.047" Long
576-10 HD	22.677" Long
584-10 HD	22.992" Long
592-10 HD	23.307" Long
600-10 HD	23.622" Long
608-10 HD	23.937" Long
624-10 HD	24.567" Long
632-10 HD	24.882" Long
640-10 HD	25.197" Long
648-10 HK	25.512" Long
656-10 HD	25.827" Long
672-10 HD	26.457" Long
680-10 HD	26.772" Long
688-10 HD	27.086" Long*
696-10 HD	27.402" Long
712-10 HK	28.032" Long
720-10 HD	28.346" Long
736-10 HD	28.976" Long
744-10 HD	29.291" Long
760-10 HD	29.921" Long
776-10 HD	30.551" Long
784-10 HD	30.866" Long
800-10 HD	31.496" Long
816-10 HD	32.126" Long
824-10 HD	32.441" Long
840-10 HD	33.071" Long
856-10 HD	33.701" Long
864-10 HK	34.016" Long
880-10 HD	34.646" Long
896-10 HK	35.276" Long
912-10 HD	35.906" Long
920-10 HD	36.220" Long
936-10 HD	36.850" Long*
960-10 HD	37.795" Long
1040-10 HD	40.945" Long

* Special Order

Radius Tooth HTD 20mm Wide, 8mm Pitch

480-20 HD	18.898" Long
536-20 HD	21.102" Long
544-20 HD	21.417" Long*
552-20 HD	21.732" Long
560-20 HD	22.047" Long
576-20 HD	22.677" Long
584-20 HD	22.992" Long
592-20 HD	23.307" Long
600-20 HD	23.622" Long
608-20 HD	23.937" Long
616-20 HD	24.252" Long
624-20 HD	24.567" Long
632-20 HD	24.882" Long
640-20 HD	25.197" Long
648-20 HK	25.512" Long
656-20 HD	25.827" Long
664-20 HD	26.142" Long
672-20 HD	26.457" Long
680-20 HD	26.772" Long
688-20 HD	27.086" Long*
696-20 HD	27.402" Long
712-20 HK	28.032" Long
720-20 HD	28.346" Long
736-20 HD	28.976" Long
744-20 HD	29.291" Long
760-20 HD	29.921" Long
776-20 HD	30.551" Long
784-20 HD	30.866" Long
800-20 HD	31.496" Long
816-20 HD	32.126" Long
824-20 HD	32.441" Long
840-20 HD	33.071" Long
856-20 HD	33.701" Long
864-20 HK	34.016" Long
880-20 HD	34.646" Long
896-20 HK	35.276" Long
912-20 HD	35.906" Long
920-20 HD	36.220" Long
936-20 HD	36.850" Long*
960-20 HD	37.795" Long
1040-20 HD	40.945" Long

* Special Order

Radius Tooth HTD 30mm Wide, 8mm Pitch

560-30HD	22.047" Long
600-30HD	23.622" Long
608-30HD	23.937" Long
624-30HD	24.567" Long
632-30HD	24.882" Long
640-30HD	25.197" Long
656-30HD	25.827" Long
680-30HD	26.772" Long

Radius Tooth HTD 50mm Wide, 8mm Pitch Blower Belts

1600-50	62.992" Long
1608-50	63.307" Long
1616-50	63.622" Long
1624-50	63.937" Long
1640-50	64.567" Long
1648-50	64.882" Long
1656-50	65.199" Long
1680-50	66.142" Long
1696-50	66.772" Long

Gilmer & Serpentine Belts 77

Square Tooth Gilmer 1" Wide, 3/8 Pitch

187-L-100	18.750" Long
202-L-100	20.250" Long
210-L-100	21.000" Long
233-L-100	23.250" Long
236-L-100	23.625" Long
240-L-100	24.000" Long
244-L-100	24.375" Long
248-L-100	24.750" Long
255-L-100	25.500" Long
263-L-100	26.250" Long
270-L-100	27.000" Long
277-L-100	27.750" Long
285-L-100	28.500" Long
300-L-100	30.000" Long
315-L-100	31.500" Long
320-L-100	31.875" Long
322-L-100	32.250" Long
334-L-100	33.375" Long
345-L-100	34.500" Long
367-L-100	36.750" Long
390-L-100	39.000" Long

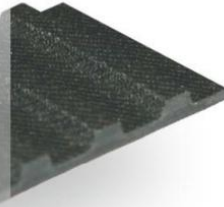

Serpentine 5 & 6 Groove Belts

*6PK-660	25.984" Long, 6-Groove
5PK-690	27.165" Long, 5-Groove
*6PK-690	27.165" Long, 6-Groove
5PK-695	27.362" Long, 5-Groove
*6PK-695	27.362" Long, 6-Groove
5PK-698	27.480" Long, 5-Groove
5PK-735	28.937" Long, 5-Groove
5PK-750	29.527" Long, 5-Groove
5PK-770	30.315" Long, 5-Groove
5PK-825	32.480" Long, 5-Groove
5PK-850	33.465" Long, 5-Groove
5PK-890	35.039" Long, 5-Groove
5PK-915	36.024" Long, 5-Groove
5PK-940	37.008" Long, 5-Groove
*6PK-940	37.008" Long, 6-Groove
5PK-970	38.189" Long, 5-Groove
5PK-985	38.780" Long, 5-Groove
5PK-1000	39.370" Long, 5-Groove
5PK-1040	40.945" Long, 5-Groove
5PK-1065	41.929" Long, 5-Groove

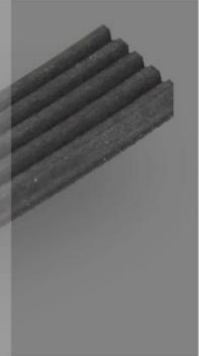

* signifies 6 Grooves

Square Tooth Gilmer 1/2" Wide, 3/8 Pitch

187-L-050	18.750" Long
202-L-050	20.250" Long
210-L-050	21.000" Long
233-L-050	23.250" Long
236-L-050	23.625" Long
240-L-050	24.000" Long
244-L-050	24.375" Long
248-L-050	24.750" Long
255-L-050	25.500" Long
263-L-050	26.375" Long

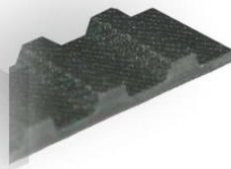

Square Tooth Gilmer (Continued) 1/2" Wide, 3/8 Pitch

270-L-050	27.000" Long
277-L-050	27.750" Long
285-L-050	28.500" Long
300-L-050	30.000" Long
315-L-050	31.500" Long
320-L-050	31.875" Long
322-L-050	32.250" Long
345-L-050	34.500" Long
367-L-050	36.750" Long
390-L-050	39.000" Long

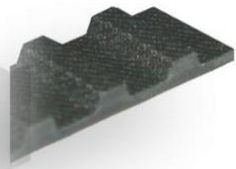

Square Tooth Gilmer 3/4" Wide, 3/8 Pitch

255-L-075	25.500" Long
263-L-075	26.375" Long
270-L-075	27.000" Long
285-L-075	28.500" Long
300-L-075	30.000" Long
315-L-075	31.500" Long
345-L-075	34.500" Long
367-L-075	36.750" Long

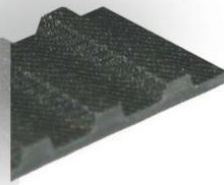

CUSTOM

Don't see the belt you need or
need help finding the right one?
Give us a call!



Alternators

Belts



Brackets

Dry Sump Pumps



Fuel Pumps

Power Steering Pumps

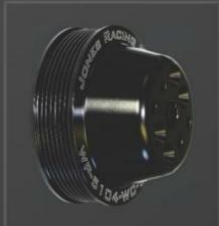

Pulleys

Vacuum Pumps



Water Pumps



& Related Accessories

