

**Read all instructions BEFORE assembly and USE of product.
KEEP INSTRUCTIONS FOR FUTURE USE.**



**Pack 'n Play[®] Playard
Reversible Napper & Changer[™]**

Owner's Manual



WARNING

Failure to follow these warnings and the instructions could result in serious injury or death.

Setting Up the Playard

- THIS PRODUCT REQUIRES ADULT ASSEMBLY.
- Keep fingers clear of top corners during setup. Be sure playard is completely set up before use. Check that the four top rails are completely latched, the center of the floor is pushed down, the mattress/pad is flat, the straps are securely fastened to the bottom of the unit and the four corners are tucked under the stiffeners. Always follow the instructions in the owner's manual to set up the playard.

Using the playard

- The playard is for playing or sleeping. When used for playing, never leave child unattended and always keep child in view. When used for sleeping, you must still provide the supervision necessary for the continued safety of your child.
- Always keep the playard away from hazards in the area that may injure your child.
- When child is able to pull to standing position, remove large toys and other objects that could serve as steps for climbing out.
- Stop using this product when your child reaches 35 inches (89 cm) in height, weighs more than 30 lb (14 kg), or is able to climb out.
- Do not modify playard or add any attachments that are not listed in the owner's manual, including an add-on bassinets.
- Child can become entrapped and die when improvised netting or covers are placed on top of a playard. Never add such items to confine child in playard.
- NEVER leave child in product with side lowered. Be sure side is in raised and locked position whenever child is in product.

! WARNING

- If refinishing, use a nontoxic finish specified for children's products.

Avoiding Suffocation Hazards

- Unlike cribs that have rigid sides, the playard has flexible sides.
As a result, the playard mattress/pad is specially designed to prevent suffocation. The playard mattress/pad has a solid base, a certain length and width, and is less than one inch thick in order to meet safety standards. Using a thicker or a different sized mattress/pad may allow a child's head to get between mattress/pad and the side of the playard causing suffocation.

- **Infants can suffocate**

- In gaps between a mattress too small or too thick and products sides
- On soft bedding, NEVER add a mattress, pillow, comforter or padding. Use ONLY mattress pad provided by Graco.

- To reduce the risk of SIDS, pediatricians recommend healthy infants be placed on their backs to sleep, unless otherwise advised by your physician.
- Never use plastic shipping bags or other plastic film as mattress covers not sold and intended for that purpose. They can cause suffocation.
- NEVER use a water mattress with the playard.

Avoiding Strangulation Hazards

- Strings and cords can cause strangulation. Keep strings and cords away from child.
- NEVER place the playard near a window where cords from blinds or drapes can strangle a child.
- NEVER hang strings on or over the playard.
- NEVER place items with a string around a child's neck, such as hood strings, pacifier cords, etc.
- NEVER attach strings to toys.
- **This product is not intended for commercial use.**

2-A Parts list

This model may not include some features shown below. **Check** that you have all the parts for this model **BEFORE** assembling your product. If any parts are missing, call Customer Service.

No tools required.

ALL MODELS

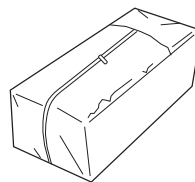
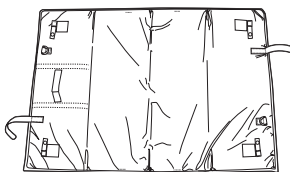

FEATURES ON CERTAIN MODELS

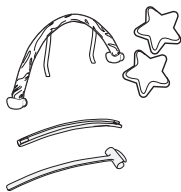
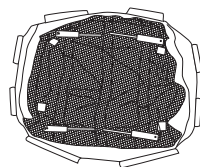
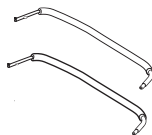

2X

OR

Toy styles vary

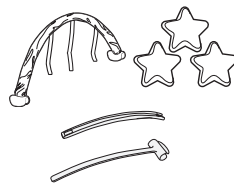

2X

3-A Playard Setup

1. Disconnect straps holding mattress around playard.

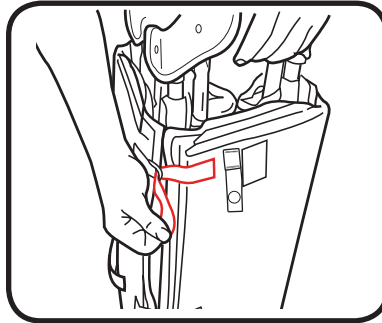

2. Remove mattress from around playard.

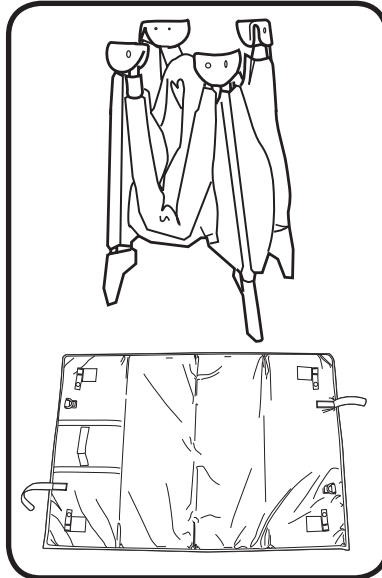

3. Pull up on side rails in middle above push button until all four sides are locked. **DO NOT** push center down yet.

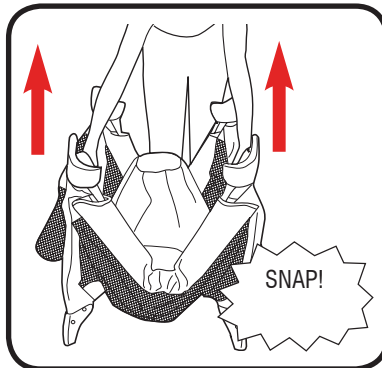

3 Assembly

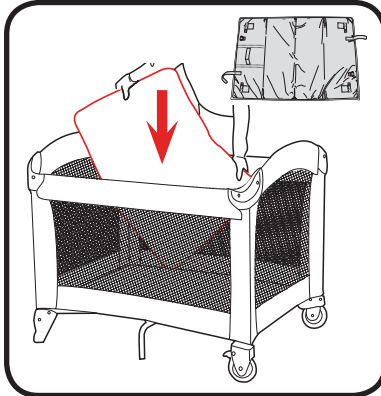
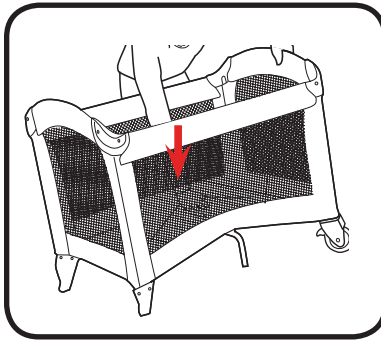
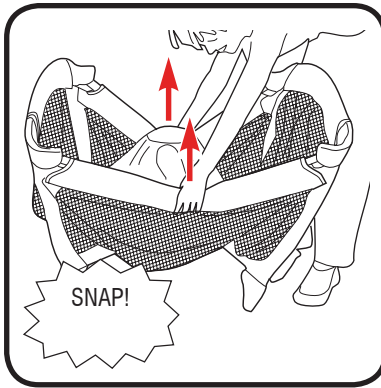

4. **When setting up, lock rails BEFORE lowering center.** Be sure top rails have become rigid. If not, pull up again until they are rigid. If top rails do not latch, lift the center of the floor higher. **CHECK** that fabric covers corners.

5. Hold one end of the unit up and push the center of the floor down until locked securely into place.

6. Always use mattress/pad soft side up.

7. Pull the two hook and loop tabs under mattress/pad through the slotted holes and attach to hook and loop patch on bottom of playard.

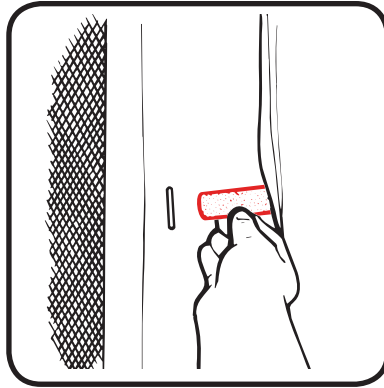

8. Pull the four snap straps on corners of playard mattress through bottom of playard. Wrap around the tube and fasten snap onto the tube. Repeat on all corners.

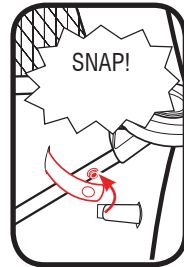
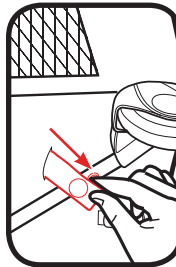
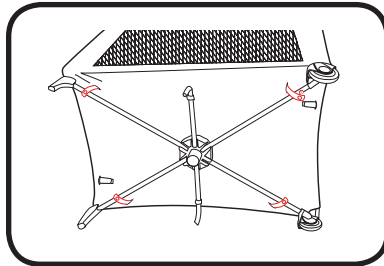

9. Tuck four corners of mattress/pad under corner stiffeners.

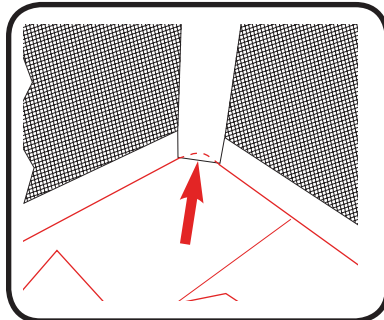

3-B Bassinet Set Up

⚠ WARNING

SUFFOCATION HAZARD Infants have suffocated:

- In gaps between extra padding and side of the bassinet, and
- On soft bedding.

Use **ONLY** mattress/pad provided by Graco. **NEVER** add a pillow, comforter or another mattress for padding.

- **FALL HAZARD:** To help prevent falls, do not use this product when the infant begins to push up on hands and knees or weighs over 15 lb (6.8 kg), whichever comes first.
- Use bassinet with only one child at a time.
- Never place a child under the bassinet.
- The bassinet must be fully assembled and installed, including four metal tubes, eight clips and mattress/pad, before using. Do not modify bassinet or add any attachments that are not listed in the owner's manual.
- **DO NOT** store the bassinet in the playard while in use.
- To help prevent heat build-up inside the playard and to avoid overheating your child, when using the bassinet **DO NOT** use an outdoor canopy.
- To reduce the risk of SIDS, pediatricians recommend healthy infants be placed on their backs to sleep, unless otherwise advised by your physician.
- If a sheet is used with the pad use only the one provided by Graco or one specifically designed to fit the dimensions of the bassinet.
- Never place child in bassinet while napper/changer is attached.

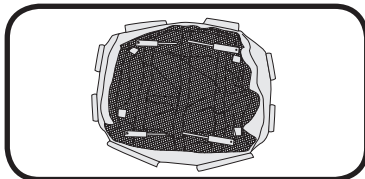

3 Assembly

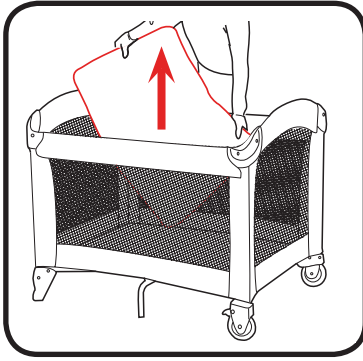

1. You will need to remove the mattress/pad from the bottom of the playard to use inside your bassinet.

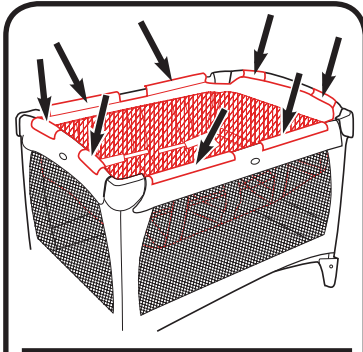

2. Make sure to fasten the bassinet clips to the playard. Always press down on the left side of the clip, then the right as shown. Repeat on all eight clips.

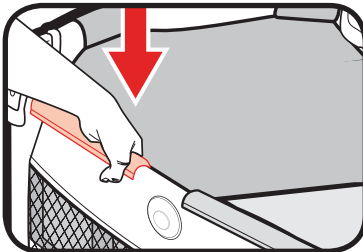
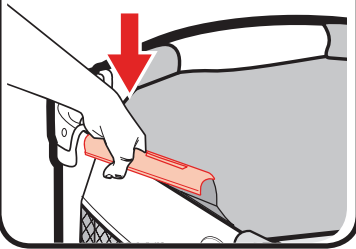

3. Insert tapered end of bar into end of other bar with hole in it. Repeat with other set of bars.

CHECK: Tubes **MUST** be assembled before placing mattress/pad in bassinet.

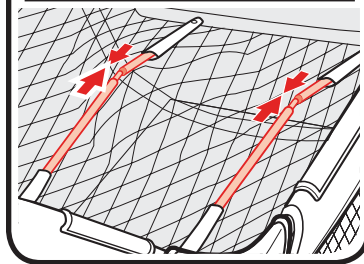
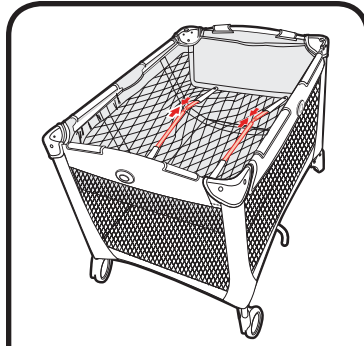

4. Insert the mattress/pad soft side up into the playard, making sure the hook and loop patches on bottom of mattress attaches to matching hook and loop patches on the bassinet.

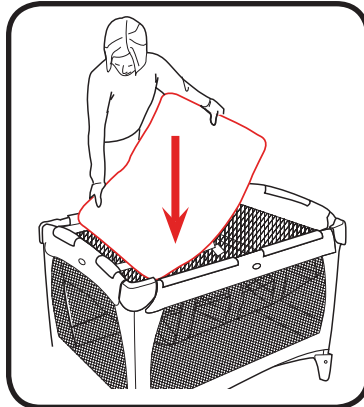

4-A To Fold

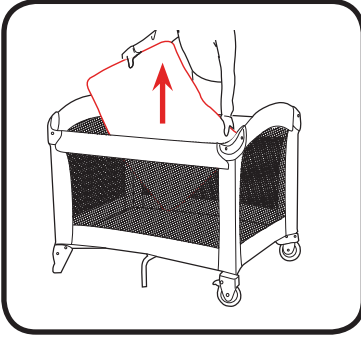

1. Release snap straps and hook and loop straps on bottom of playard. Pull mattress fully out of playard.

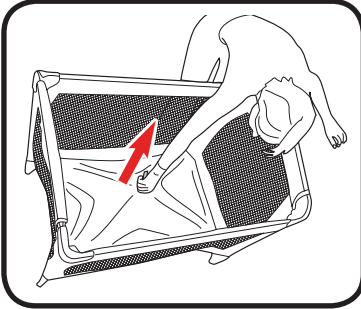

2. **DO NOT** unlock top rails yet. Pull the center of the playard floor up with the tab in the middle of the playard. Center of floor must be halfway up before top rails will unlock.

3. **Center of floor must be up.**

- a. Lift up slightly on the top rail.
- b. Push in on the button located on the side of the top rail to release the two tubes.
- c. Push down.
- d. Repeat on all four rails until all tubes are released.

- If top rails do not unlatch, **DO NOT FORCE**. Lift the center of the floor higher.
- **Both** tubes must be released for the top rail to fold.

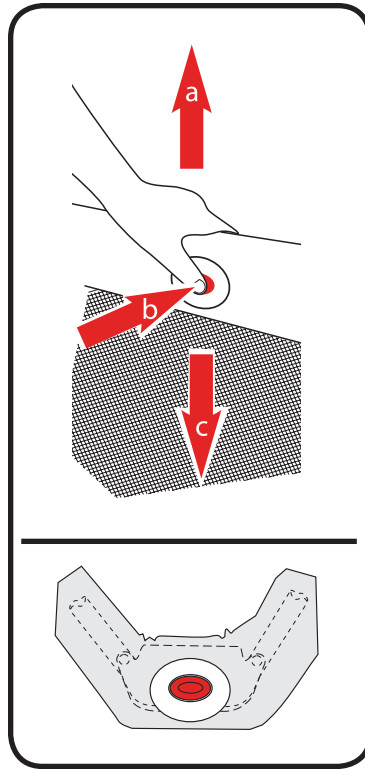

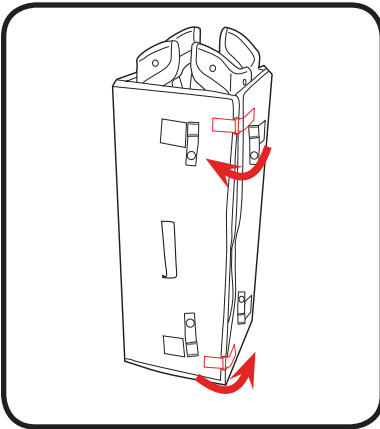
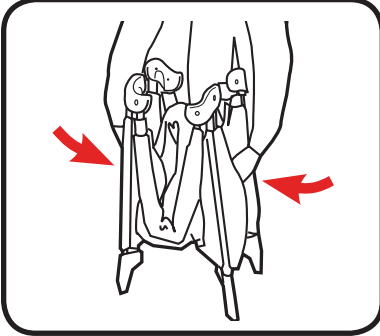
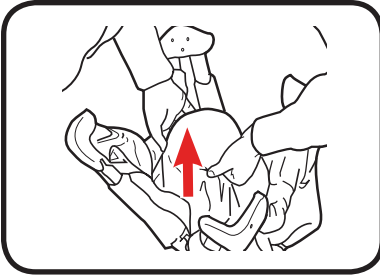

4. **Do not force.** If unit will not fold, look for a partially latched top rail. Squeeze the latch button to release the rail.

4-B To Cover

1. Cover unit with handle out.



2. Zip together.

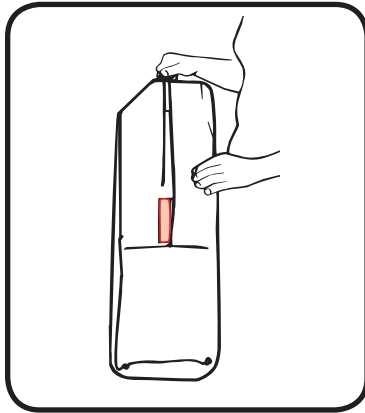

This model may not include some features shown

5-A Reversible Napper/Changer

WARNING

Prevent serious injury or death: follow these warnings and the instructions.

NAPPER MODE

- You are responsible to provide adult supervision when using your napper.
- Napper must be properly attached to bassinet before use.

FALL HAZARD: To prevent falls, stop using the product when infant:

- Begins to wiggle out of position or turn over in the product or
- Head touches the upper edge of the product or
- Weights more than 15 lb (6.8 kg) (approximately 3 months of age).

SUFFOCATION HAZARD: Infants have suffocated

- On added pillows, blankets and extra padding. **ONLY** use the pad provided by the manufacturer. **NEVER** place extra padding under or beside infant.
- When trapped between product and adjacent surfaces. Only use in bassinet when it is securely attached. **NEVER** use napper in different product.
- To reduce the risk of SIDS, pediatricians recommend healthy infants be placed on their backs to sleep, unless otherwise advised by your physician.
- Never place baby face down in napper.
- Never place any objects in napper while child is in it.
- Use napper with only one child at a time.

STRANGULATION HAZARD: • Strings can cause strangulation! Do not place items with a string around a child's neck, such as hood strings or pacifier cords. Do not suspend strings over product or attach strings to toys.

CHANGING TABLE MODE:

FALL HAZARD- To prevent death or serious injury,

- Always stay within arm's reach of your child when using the changing table. Never leave child unattended.
- Use changing table only on this playard model. Check that it is supported by the playard by pushing down into center of changing table.
- Do not use on the floor, bed, counter or other surfaces.
- Do not use changing table as a sleeping or play area.
- Weight limit for the changing table is 15lb (6.8kg). Do not use the changing table as extra storage.
- Strangulation Hazard: Child can lift changing table and get neck trapped between changing table and playard frame. Always remove the changing table when your child is in the playard.
- Never place child in bassinet while napper/changer is attached.
- Never place baby face down on the changing table.

⚠️ WARNING

To prevent serious injury or death, **DO NOT REMOVE FOAM.**

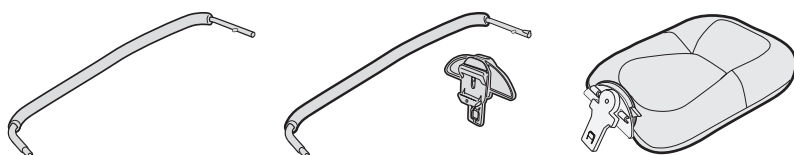

NOTE: Napper/changer should always be attached opposite the wheels.

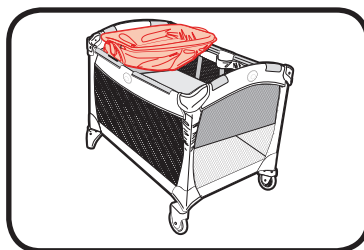

Changing Table Mode

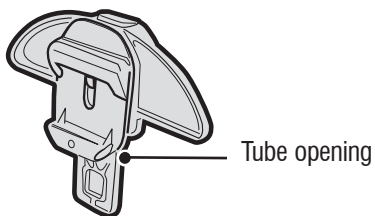

NOTE: Start assembly with the button housing in this orientation. If not in this orientation, follow steps 1-3.

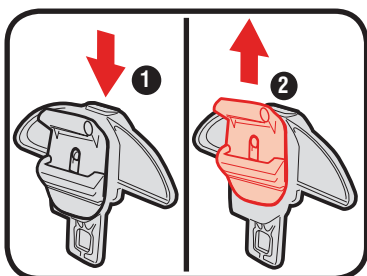

1. Press button ❶ and pull up ❷ to unlock and rotate as shown.

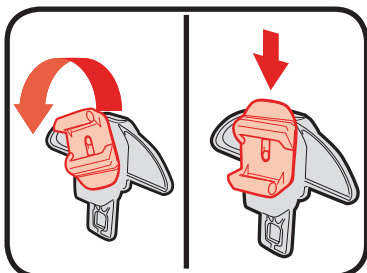

2. Rotate until tube opening is on the bottom, then press down to lock it in place.

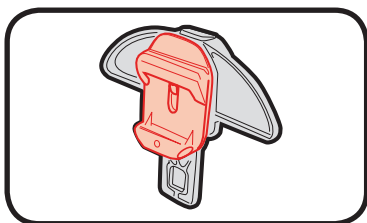

3. CORRECT.

4. Insert the long end of the tube into the button housing as shown.

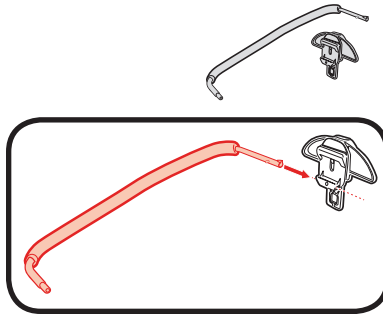

5. The metal button should be facing out when snapped in place as shown.

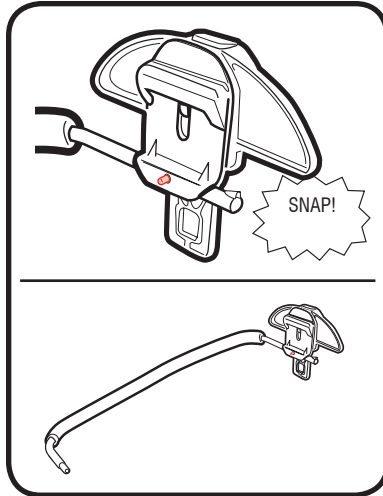

6. With the napper side up, insert the button housing tube as shown.

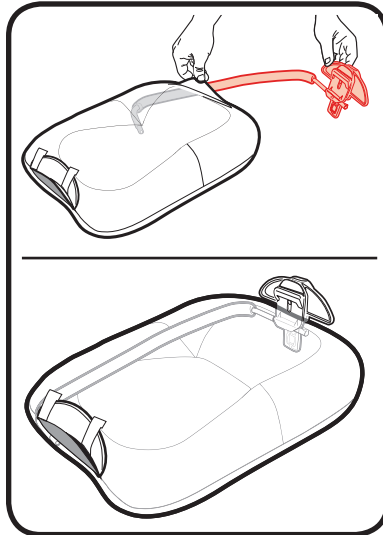

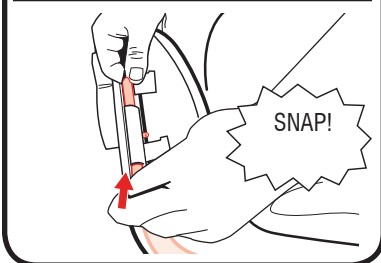
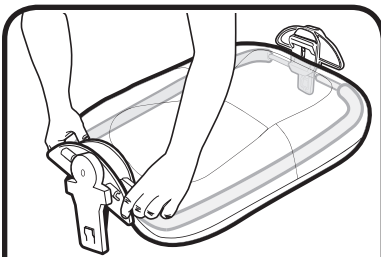
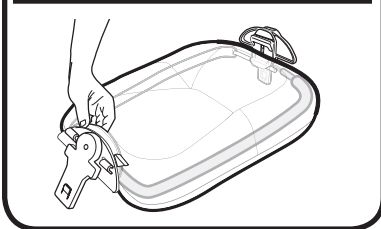
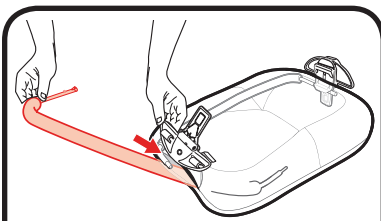
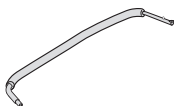

7. Pull up on the flap with the 2 straps and insert the tube into the opposite side of the napper/ changer.

8. Insert the button housing tube as shown. The metal button should be facing out when snapped in place as shown.

9. Secure the tubes on both ends of the napper/changer as shown.

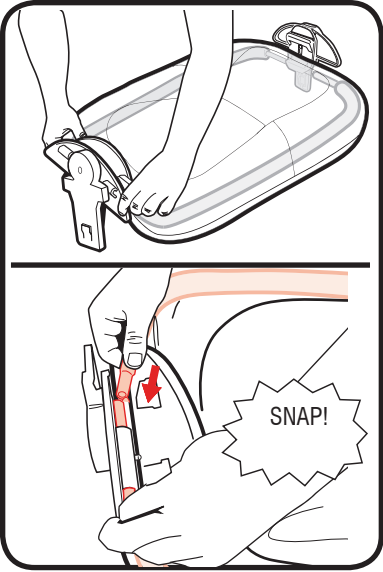

10. Secure the tubes on both ends of the napper/changer as shown.

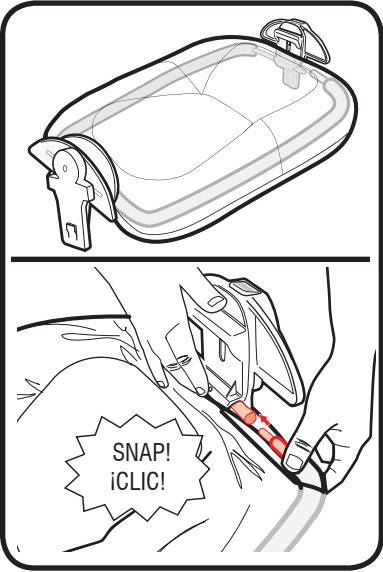

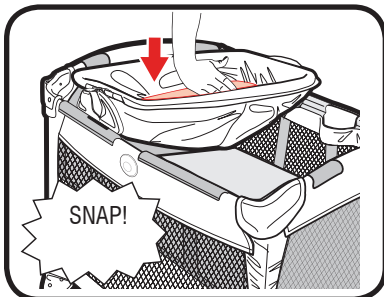
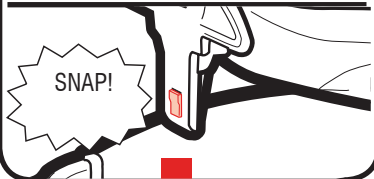
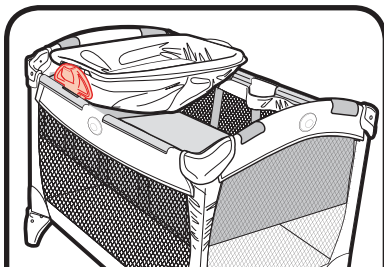
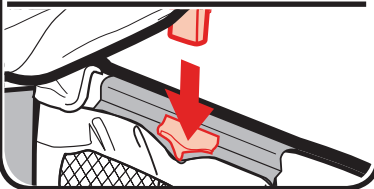
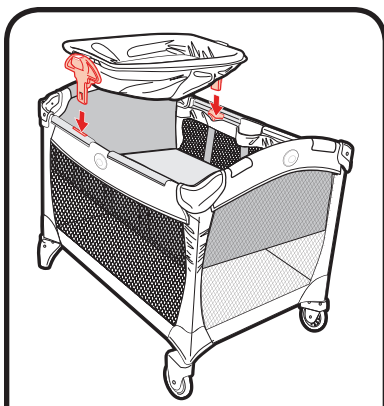

11. Attach napper/changer to the sides of the bassinet as shown.

Napper/changer should always be attached opposite the wheels.

12. The tabs on the sides of the napper will snap in place as shown.

13. Push down on the inside of napper/changer until it clicks into place. Check that napper/changer is securely attached by pulling up on it.

Napper Mode

1. Press button ❶ and pull up ❷ to unlock and rotate to the napper side.

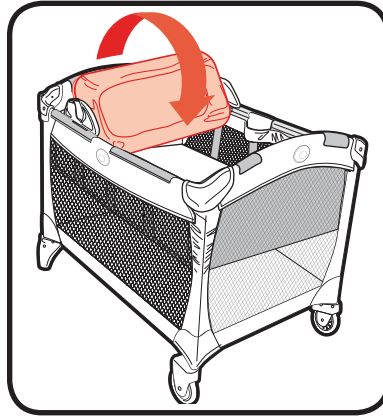
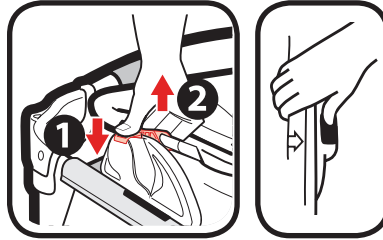
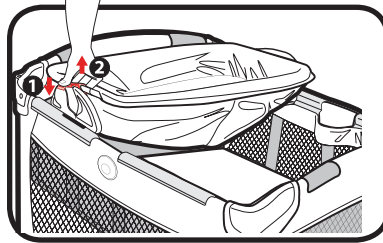

2. Push down on the inside of napper until it clicks into place.
Check that napper is securely attached by pulling up on it.

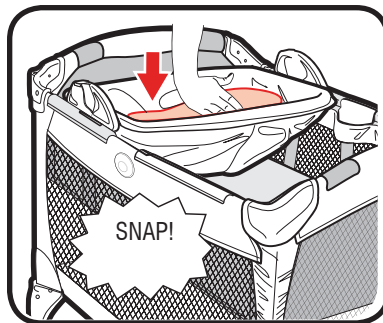

Changer Mode



⚠️ WARNING

Never place baby face down on the changing table.

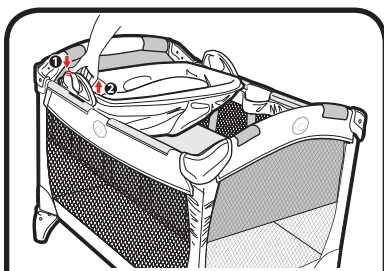

1. Press button on housing **1** and pull up **2** to unlock and rotate to the changer side.

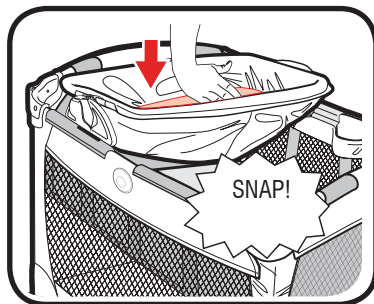
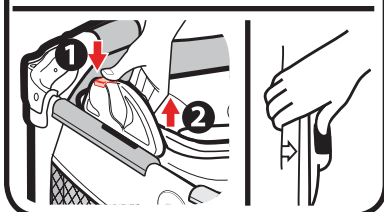

2. Push down on the inside of changer until it clicks into place. **Check** that changer is securely attached by pulling up on it.

To Remove Reversible Napper/Changer

1. Pull up on bassinet clip to detach it from the playard.

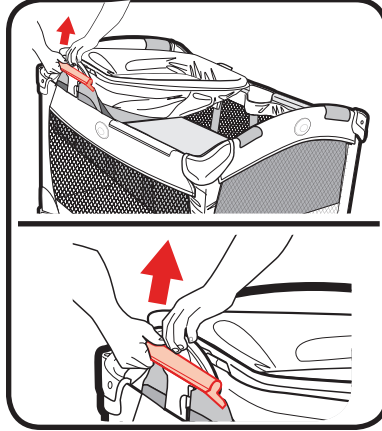

2. Press button and pull up on napper/changer to release. Repeat steps 1- 2 on the opposite side.

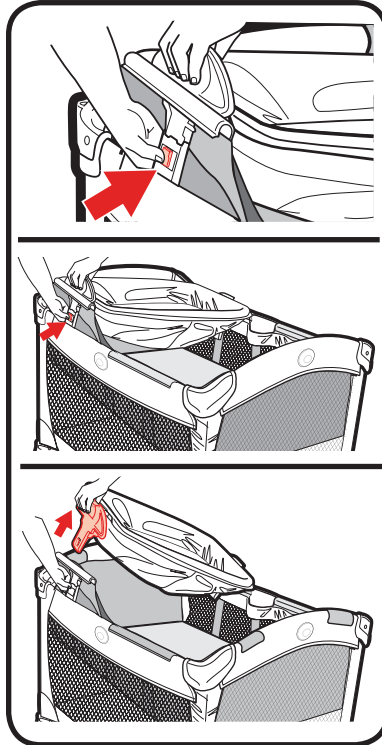

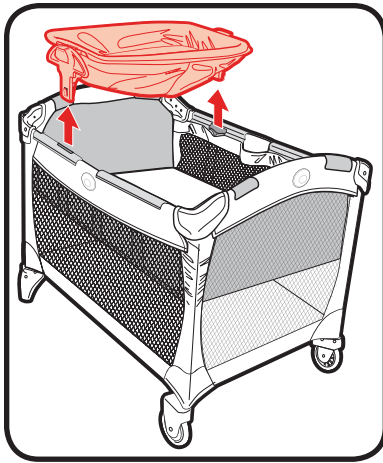

3. Remove the napper/changer.

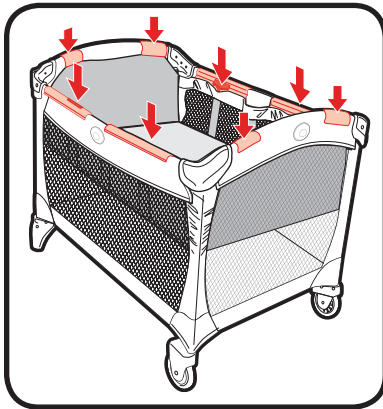

4. Make sure to fasten the bassinet clips to the playard as shown.

5-B Toybar

⚠️ WARNING

- Possible entanglement or strangulation injury. Remove toy bar when baby begins to push up on hands and knees. Recommended use from birth to 5 months.
- Toys are not intended to be mouthed by the baby and should be positioned clearly out of reach of the baby's face and mouth.
- Always attach all provided fasteners (strings, straps, clamps, etc.) tightly to playard according to these instructions. Check frequently.
- Do not add additional strings or straps to attach to any other crib or playpen.

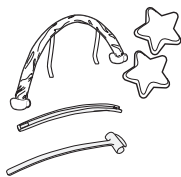

2X

OR

Toy styles vary

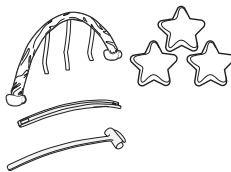

2X

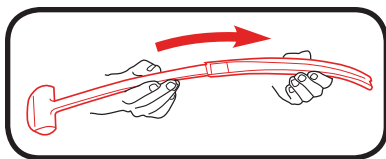

1. Attach one end of toybar into center connector.

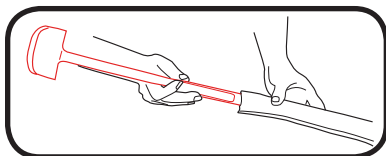

2. Insert assembled toybar parts into toybar fabric.

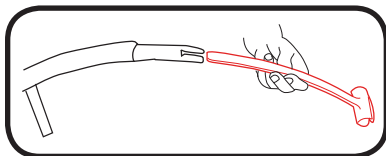

3. Attach other end of toybar to center connector.

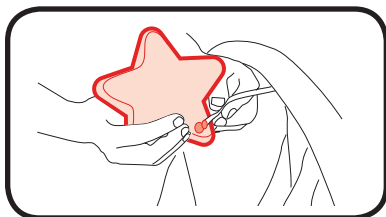

4. Attach toy to toybar with hook and loop tape.

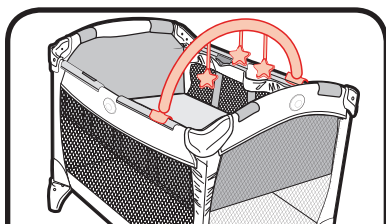

5. Attach toybar to playard as shown.

OR

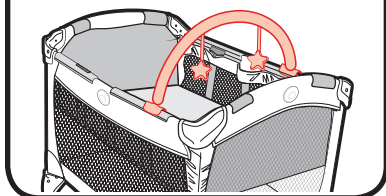

5-C Diaper stacker

⚠️ WARNING

- Always keep objects out of child's reach.
- Remove when child is able to pull himself up in the playard.
- NEVER use on inside of unit. Child may use as a step to climb out of unit or reach items in bag.

1. Attach diaper stacker to playard with snaps.

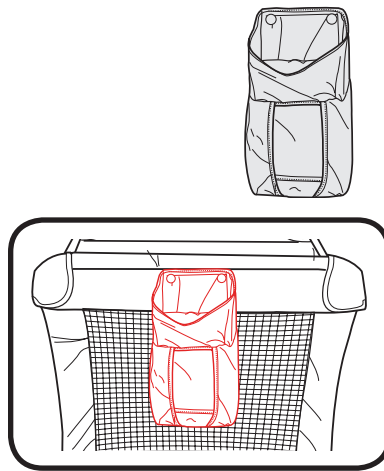

6-A Care and Maintenance

FROM TIME TO TIME CHECK YOUR PLAYARD for worn parts, torn material or stitching. Replace or repair the parts as needed. Use only Graco® replacement parts.

IF PLAYARD IS USED AT THE BEACH, you **MUST** clean sand off your playard, including the feet, before packing it into cover. Sand in top rail lock may damage it.

TO CLEAN PLAYARD, use only household soap or detergent and warm water.

TO WASH CARRY BAG, machine wash in cold water on delicate cycle and drip-dry. **NO BLEACH.**

TO WASH BASSINET: Hand wash with warm water and household soap. Drip dry.

TO WASH NAPPER/CHANGER: Wipe clean with damp cloth.