

**Read all instructions BEFORE assembly and USE of product.
KEEP INSTRUCTIONS FOR FUTURE USE.**

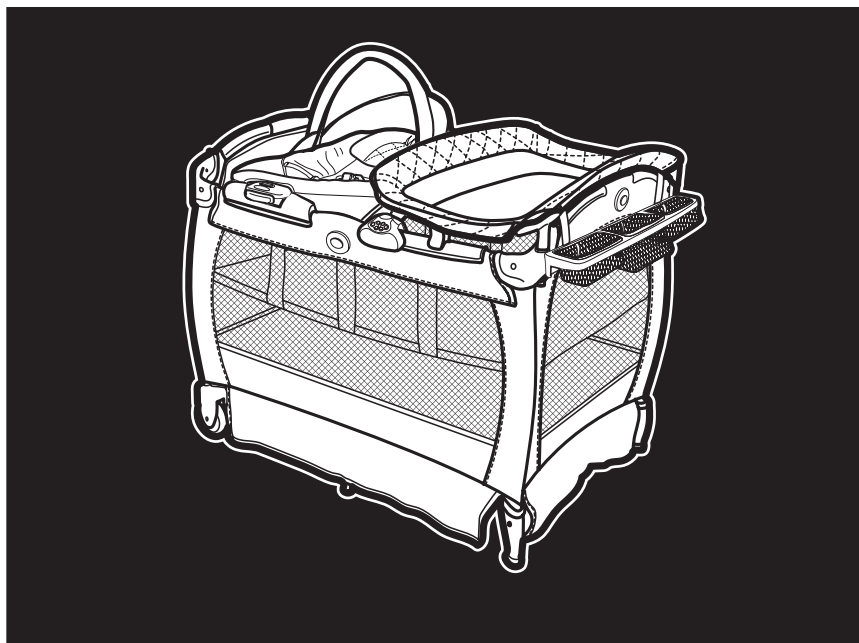

**Pack 'n Play[®] Playard
Snuggly Suite[™] LX**

Owner's Manual



WARNING

Failure to follow these warnings and the instructions could result in serious injury or death.

Setting Up the Playard

- This product requires adult assembly.
- Keep fingers clear of top corners during setup. Be sure playard is completely set up before use. Check that the four top rails are completely latched, the center of the floor is pushed down, the mattress/pad is flat, the straps are securely fastened to the bottom of the unit and the four corners are tucked under the stiffeners. Always follow the instructions in the owner's manual to set up the playard.

Using the playard

- The playard is for playing or sleeping. When used for playing, never leave child unattended and always keep child in view. When used for sleeping, you must still provide the supervision necessary for the continued safety of your child.
- Always keep the playard away from hazards in the area that may injure your child.
- When child is able to pull to standing position, remove large toys and other objects that could serve as steps for climbing out.
- Stop using this product when your child reaches 35 inches (89 cm) in height, weighs more than 30 lb (14 kg), or is able to climb out.
- Do not modify playard or add any attachments that are not listed in the owner's manual, including an add-on bassinet.
- Child can become entrapped and die when improvised netting or covers are placed on top of a playard. Never add such items to confine child in playard.

WARNING

- NEVER leave child in product with side lowered. Be sure side is in raised and locked position whenever child is in product.
- If refinishing, use a nontoxic finish specified for children's products.
- To reduce the risk of SIDS, pediatricians recommend healthy infants be placed on their backs to sleep, unless otherwise advised by your physician.
- Never use plastic shipping bags or other plastic film as mattress covers not sold and intended for that purpose. They can cause suffocation.

Avoiding Suffocation Hazards

- Unlike cribs that have rigid sides, the playard has flexible sides. As a result, the playard mattress/pad is specially designed to prevent suffocation. The playard mattress/pad has a solid base, a certain length and width, and is less than one inch thick in order to meet safety standards. Using a thicker or a different sized mattress/pad may allow a child's head to get between mattress/pad and the side of the playard causing suffocation.
- Infants can suffocate
 - In gaps between a mattress too small or too thick and products sides
 - On soft bedding.

NEVER add a mattress, pillow, comforter or padding. Use ONLY mattress pad provided by Graco.

Avoiding Strangulation Hazards

- Strings and cords can cause strangulation. Keep strings and cords away from child.
 - NEVER place the playard near a window where cords from blinds or drapes can strangle a child.
 - NEVER hang strings on or over the playard.
 - NEVER place items with a string around a child's neck, such as hood strings, pacifier cords, etc.
- NEVER attach strings to toys.

This product is not intended for commercial use.

WARNING

FOR SAFE BATTERY USE

Keep the batteries out of children's reach.

Any battery may leak battery acid if mixed with a different battery type, if inserted incorrectly (put in backwards) or if all batteries are not replaced or recharged at the same time. Do not mix old and new batteries. Do not mix alkaline, standard (carbon-zinc) or rechargeable (nickel-cadmium) batteries.

Any battery may leak battery acid or explode if disposed of in fire or an attempt is made to charge a battery not intended to be recharged. Never recharge a cell of one type in a recharger made for a cell of another type.

Discard leaky batteries immediately. Leaky batteries can cause skin burns or other personal injury. When discarding batteries, be sure to dispose of them in the proper manner, according to your state and local regulations.

Always remove batteries if the product is not going to be used for a month or more. Batteries left in the unit may leak and cause damage.

Recommended type batteries—alkaline disposables. NEVER mix battery types. Change batteries when product ceases to operate satisfactorily.

Troubleshooting: If your device is not functioning properly, check for the following problems:

1. No batteries in electronics module.
2. Batteries dead.
3. Batteries in backwards—check “+” and “-”.
4. Corrosion on battery terminals. Rotate batteries in place against terminals, or clean with sandpaper or steel wool if corrosion is severe.
5. Batteries too weak.

WARNING

Changes or modifications not expressly approved by the party responsible for compliance could void the user's authority to operate the equipment.

This device complies with part 15 of the FCC Rules. Operation is subject to the following two conditions: (1) This device may not cause harmful interference, and (2) this device must accept any interference received, including interference that may cause undesired operation.

NOTE: This equipment has been tested and found to comply with the limits for a Class B digital device, pursuant to Part 15 of the FCC Rules. These limits are designed to provide reasonable protection against harmful interference in a residential installation. This equipment generates, uses and can radiate radio frequency energy and, if not installed and used in accordance with the instructions, may cause harmful interference to radio communications.

However, there is no guarantee that interference will not occur in a particular installation. If this equipment does cause harmful interference to radio or television reception, which can be determined by turning the equipment off and on, the user is encouraged to try to correct the interference by one or more of the following measures:

- Reorient or relocate the receiving antenna.
- Increase the separation between the equipment and receiver.
- Connect the equipment into an outlet on a circuit different from that to which the receiver is needed.
- Consult the dealer or an experienced radio/TV technician for help.

2-A Parts list

This model may not include some features shown below. **Check** that you have all the parts for this model **BEFORE** assembling your product.

If any parts are missing, call Customer Service.

Tools required:

Philips Screwdriver

ALL MODELS

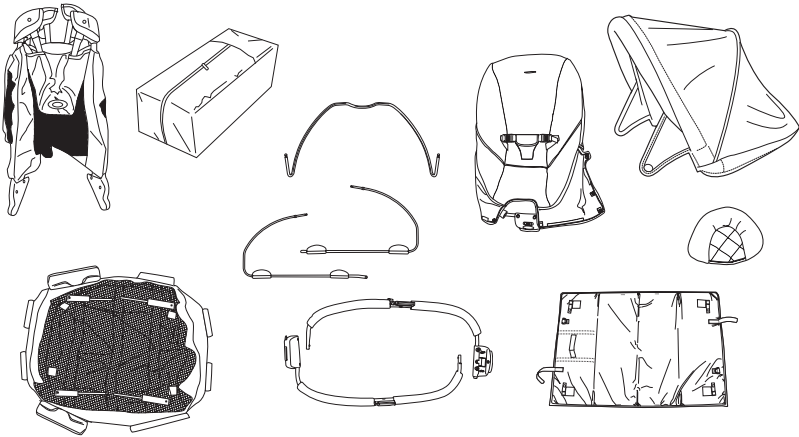

FEATURES ON CERTAIN MODELS

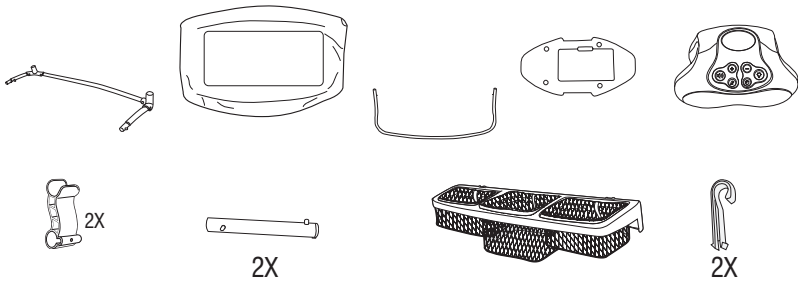

3-A Playard Set Up

1. Disconnect straps holding mattress around playard.

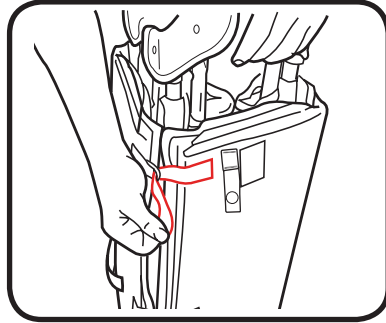

2. Remove mattress from around playard.

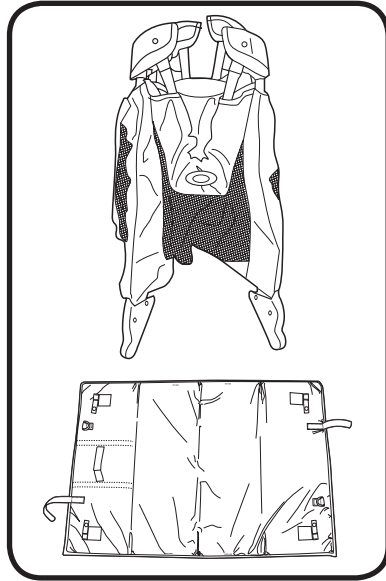

3. Pull up on side rails in middle above push button until all four sides are locked. **DO NOT** push center down yet.

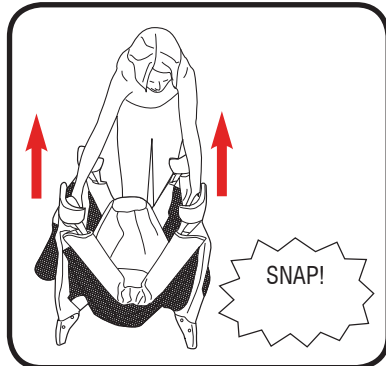

3 Assembly

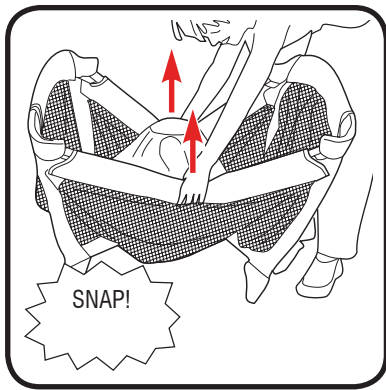

4. **When setting up, lock rails before lowering center.**

Be sure top rails have become rigid. If not, pull up again until they are rigid. If top rails do not latch, lift the center of the floor higher.

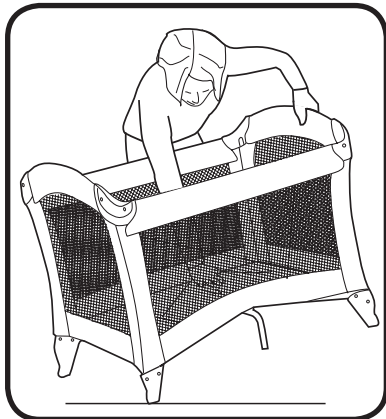

5. Hold one end of the unit up and push the center of the floor down.

6. Always use mattress/pad soft side up.

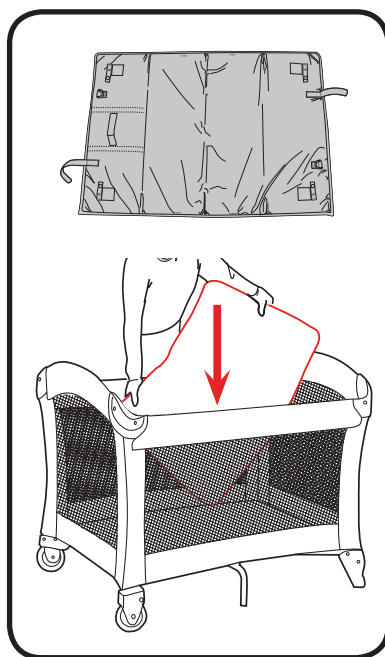

2 Features

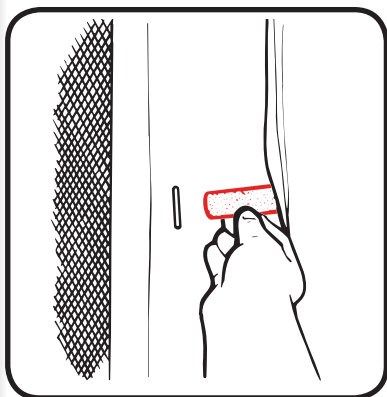

7. Put two tabs under mattress/pad through button holes and fasten securely on bottom of unit.

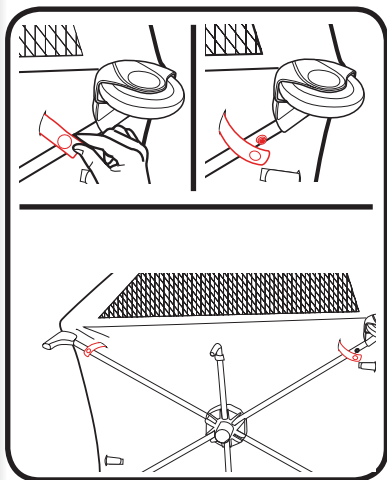

8. Pull strap through bottom of playard and wrap around tube and refasten snap. Repeat on other corners.

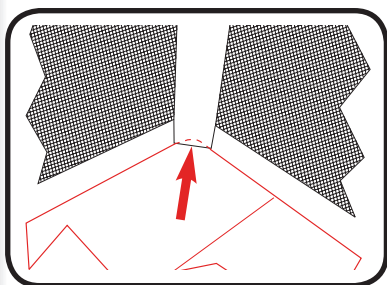

9. Tuck four corners of mattress/pad under corner stiffeners.

3-B Bassinet Set Up

! WARNING

SUFFOCATION HAZARD Infants have suffocated:

- In gaps between extra padding and side of the bassinet, and
- On soft bedding.

Use ONLY mattress/pad provided by Graco. NEVER add a pillow, comforter or another mattress for padding.

- **FALL HAZARD:** To help prevent falls, do not use this product when the infant begins to push up on hands and knees or weighs over 15 lbs (6.8 kg), whichever comes first.
- Use bassinet with only one child at a time.
- Never place a child under the bassinet.
- The bassinet must be fully assembled and installed, including four metal tubes, eight clips and mattress/pad, before using. Do not modify bassinet or add any attachments that are not listed in the owner's manual.
- **DO NOT** store the bassinet in the playard while in use.
- To help prevent heat build-up inside the playard and to avoid overheating your child, when using the bassinet **DO NOT** use an outdoor canopy.
- To reduce the risk of SIDS, pediatricians recommend healthy infants be placed on their backs to sleep, unless otherwise advised by your physician.
- If a sheet is used with the pad use only the one provided by Graco or one specifically designed to fit the dimensions of the bassinet.
- Never place child in bassinet while seat is attached.

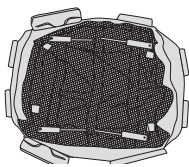

1. You will need to remove the mattress/pad from the bottom of the playard to use inside your bassinet.

1. Necesitará sacar el colchón / almohadilla del fondo del corralito para usarlo adentro del moisés.

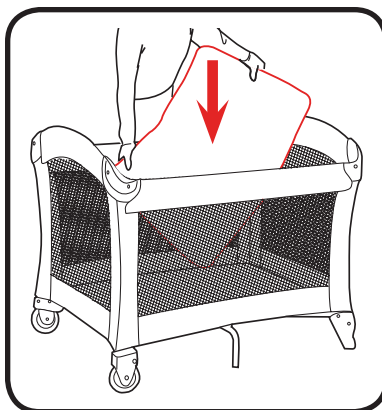

2. Make sure to fasten the bassinet clips to the playard. Attach 8 clips on bassinet clips to playard.
NOTE: Bassinet mounts should always be attached on the end with the wheels as shown.

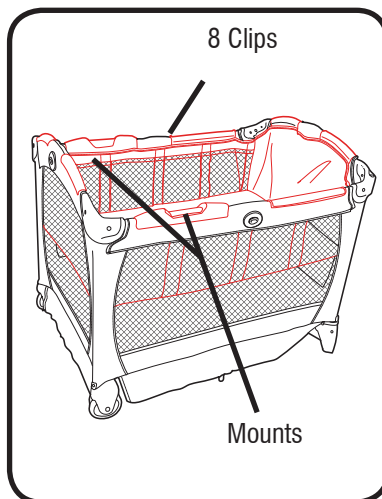

3 Assembly

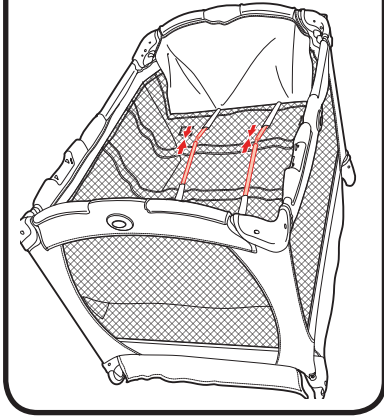
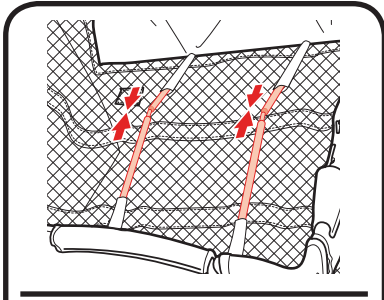

3. Insert tapered end of bar into end of other bar with hole in it. Repeat with other set of bars.

Check: Tubes **MUST** be assembled before placing mattress/pad in bassinet.

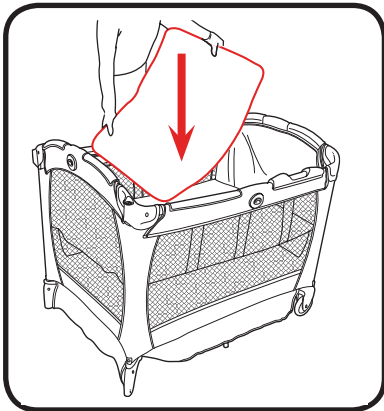

4. Insert the mattress/pad soft side up into the playard, making sure the hook and loop patches on bottom of mattress attaches to matching hook and loop patches on the bassinet.

4-A To Fold

1. Release snap straps and hook and loop straps on bottom of playard. Pull mattress fully out of playard.

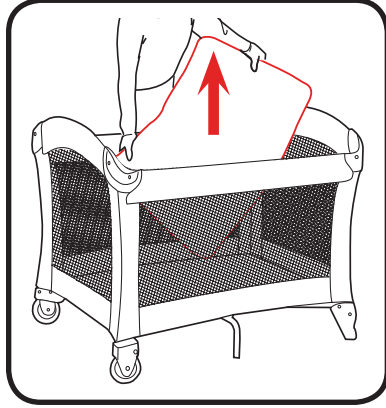

2. **DO NOT** unlock top rails yet. Pull the center of the playard floor up with the tab in the middle of the playard. Center of floor must be halfway up before top rails will unlock.

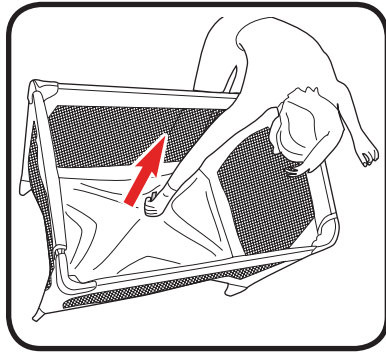

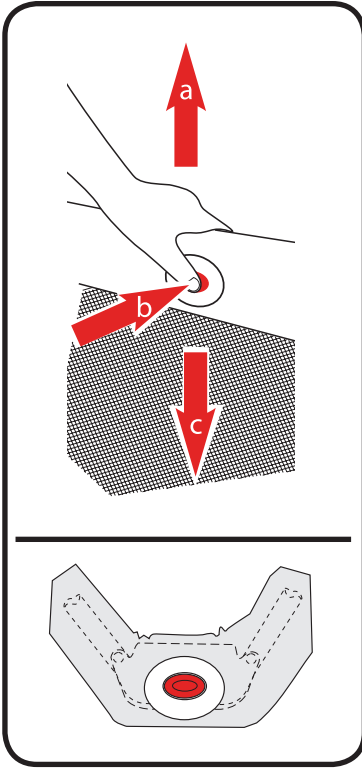

3. **Center of floor must be up.**

- a. Lift up slightly on the top rail.
 - b. Push in on the button located on the side of the top rail to release the two tubes.
 - c. Push down.
 - d. Repeat on all four rails until all tubes are released.
- If top rails do not unlatch, **DO NOT FORCE**. Lift the center of the floor higher.
 - **Both** tubes must be released for the top rail to fold.

5. **Do not force.** If unit will not fold, look for a partially latched top rail. Squeeze the latch button to release the rail.

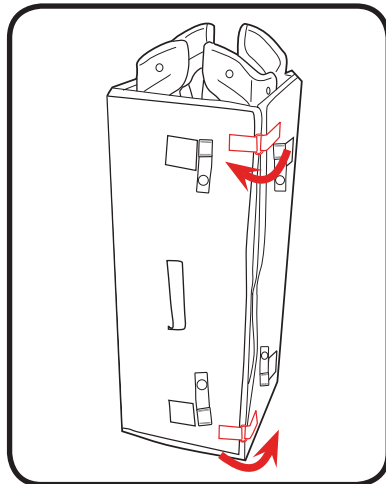
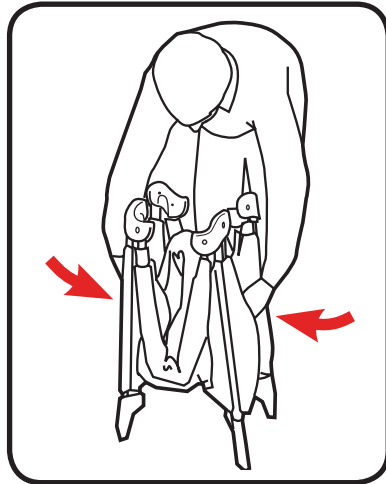
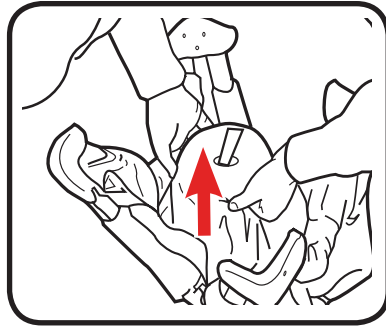

4-B To Cover



1. Cover unit with handle out.

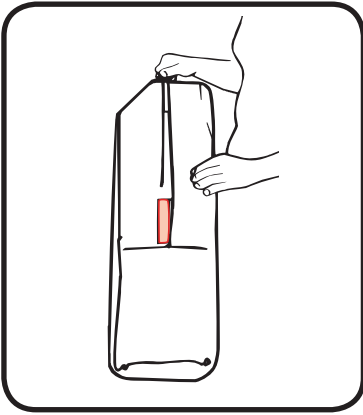

2. Zip together.

5-A Using Electronics Module

⚠ WARNING

You must remove the module from the unit when your child can pull up to a standing position.

1. Remove 2 screws from back of electronics module.

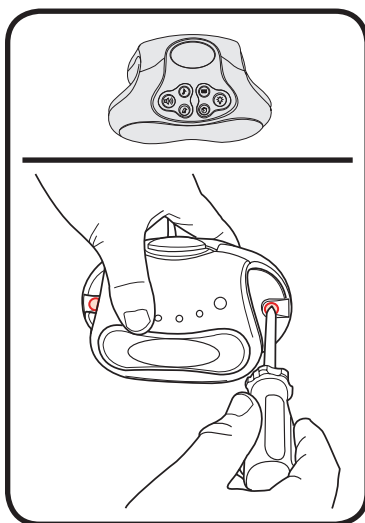

2. Remove battery door and insert 3 AA (LR06) batteries (not included). Replace door and screws.



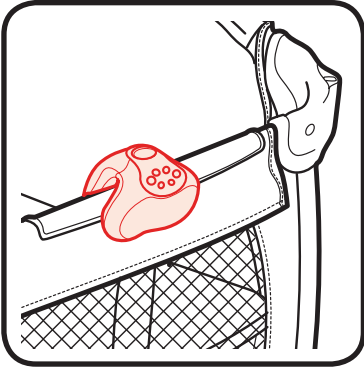

3. Attach electronic module to playard as shown.

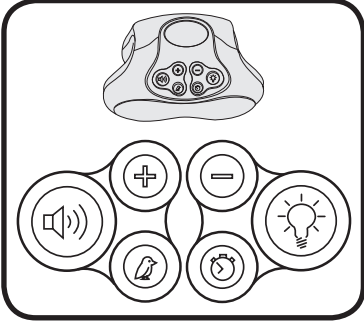

4. **TO TURN OFF ANY FUNCTION**—
Press and hold the button for 2 seconds.

LIGHTS— Press once to turn top light **(A)** on, press twice to turn both lights on, press three times to turn bottom light **(B)** on, and four times to turn lights off.

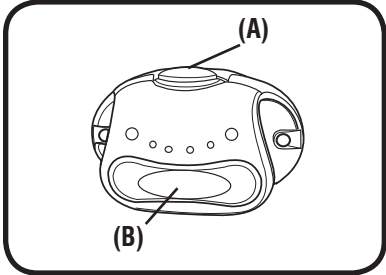
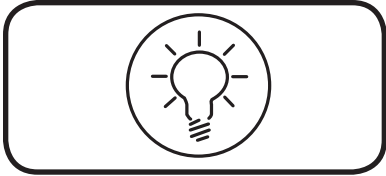

MUSIC— Each press will start the next music function in sequence, after the 5th song is selected, the next press will turn music off.



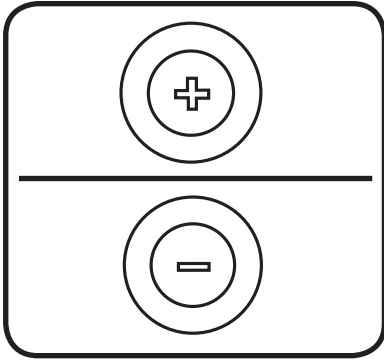

VOLUME— Press the plus (+) to raise the volume and the minus (-) to lower the volume.

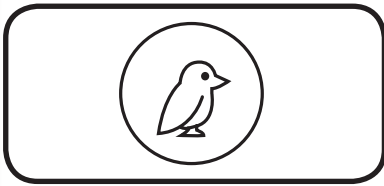

NATURE SOUNDS— Each press will change to the next nature sound. After the 5th sound is selected, the next press will turn sound off.

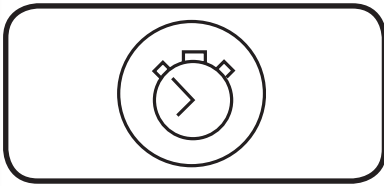

TIMER— Press once to set timer to 5 minutes, Press twice for 10 minutes, Press 3 times for 15 minutes.

5-B Changing Table

WARNING

FALL HAZARD- To prevent death or serious injury,

- Always stay within arm's reach of your child when using the changing table. Never leave child unattended.
- The changing table is designed for use only with this Graco playard. Do not use on the floor, bed, counter or other surfaces. Before each use make sure the changing table is properly secured to the playard by pushing down firmly in the middle of the changing table.
- Do not use changing table as a sleeping or play area.
- Weight limit for the changing table is 30 lbs (13.6 kg). Do not use the changing table as extra storage.
- Use only the pad provided by Graco.
- Do not use changing table if it is damaged or broken.
- Strangulation Hazard: Child can lift changing table and get neck trapped between changing table and playard frame. Always remove the changing table when your child is in the playard.
- Never use changing table on the same side as seat.

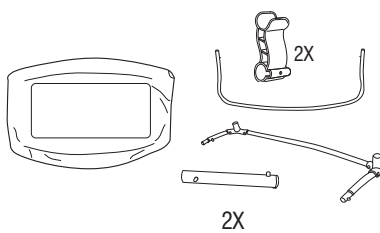
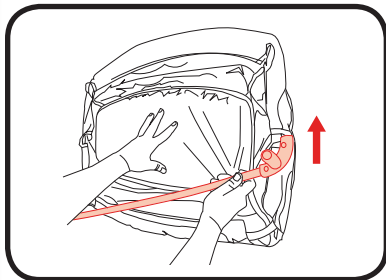
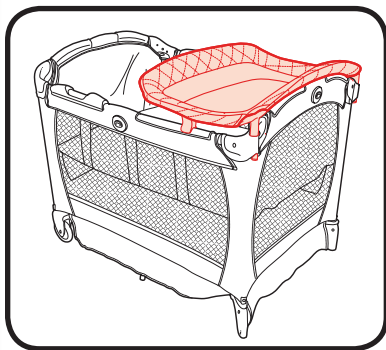

Slide tube through fabric as shown.
Repeat with other tube.

2. Tubes should appear exactly as shown.

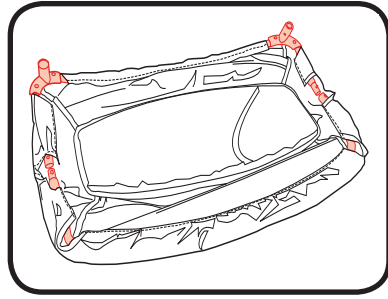

3. Snap leg tubes together as shown.

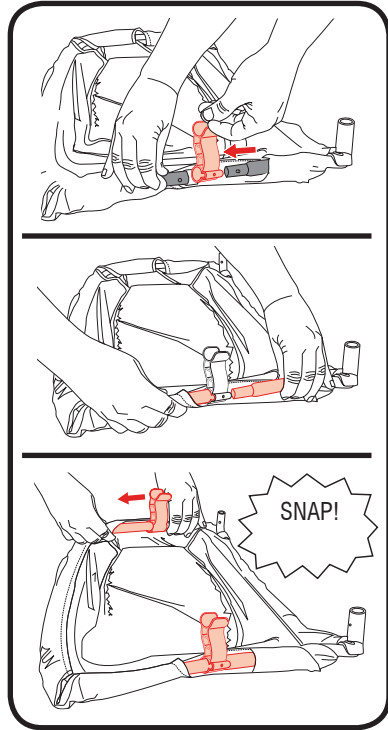

4. Attach short tubes into changing table mounts.

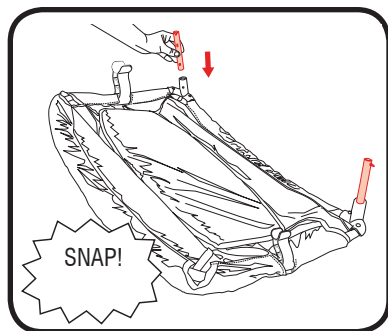

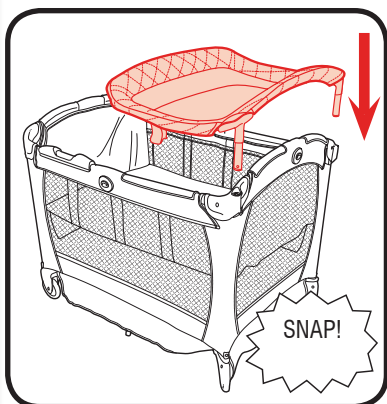

5. Insert changer connector tubes into openings in corners of playard. Ensure both kickstands are securely attached to the sides of the playard.

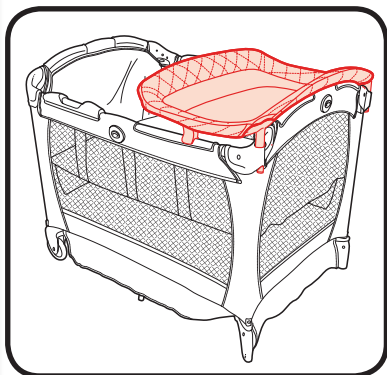

6. To remove, push in button while pulling up on corner of changing table. Repeat for other side.

5-C Portable Newborn Seat

WARNING

Prevent serious injury or death: Failure to follow these warnings and the instructions could result in serious injury or death.

FALL HAZARD: Babies have suffered skull fractures falling while in and from bouncer.

- Use bouncer **ONLY** on floor.
- **ALWAYS** use restraints. Adjust to fit snugly.

FALL HAZARD: To prevent falls, stop using the product when infant:

- Begins to wiggle out of position or turn over in the product or
- Head touches the upper edge of the product or
- **WHEN IN BASSINET:** Weighs more than 15 lb (6.8kg) (approximately 3 months of age).
- **BOUNCER MODE OUTSIDE BASSINET:** Maximum recommended weight is 18lb (8.2 kg).
- Child's movement can slide seat. • Never place product near edges of counter tops, tables or other elevated surfaces.
- NEVER attach seat on the same side as the changing table.
- NEVER use this product as a means to transport an infant in a motor vehicle.

SUFFOCATION HAZARD: Infants have suffocated:

- When product was placed on a soft surface and tipped over. NEVER place product on beds, sofas, cushions or other soft surfaces.
- Never leave child unattended.
- **ALWAYS** use restraints. Adjust to fit snugly.
 - Never use for a child able to sit up unassisted.
- On added pillows, blankets and extra padding.
- **ONLY** use the pad provided by the manufacturer. NEVER place extra padding under or beside infant.
- When trapped between product and adjacent surfaces. Only use in bassinet when it is securely attached. NEVER use seat in different product.

- NEVER use in contained areas (e.g. crib, playard) or next to vertical surfaces (e.g. walls and dressers).
- ALWAYS place child on back to sleep.
- Use seat with only one child at a time.
- NEVER place a child under the seat.
- The seat must be fully assembled before using.
Do not modify seat or add any attachments that are not listed in the owner's manual.
- Always check to make sure seat is securely attached to bassinet.
- NEVER place child in bassinet while seat is attached.
- To avoid suffocation, never use seat inside bassinet unless it's attached to the mounts on the bassinet. Never place seat in the bottom of playard.

STRANGULATION HAZARD:

- Children have STRANGLED in loose or partially buckled harness straps. Fully restrain the child at all times.
- Do not use this product if it is damaged or broken.
- Strings and cords can cause strangulation. Keep strings and cords away from child.
- NEVER place the seat near a window where cords from blinds or drapes can strangle a child.
- NEVER hang strings on or over the seat.
- NEVER place items with a string around a child's neck, such as hood strings, pacifier cords, etc.
- NEVER attach strings to toys.
- Make sure canopy is securely attached when in use.
- Canopy for indoor use only.
- DO NOT store the seat in the playard while in use.
- To reduce the risk of SIDS, pediatricians recommend healthy infants be placed on their backs to sleep, unless otherwise advised by your physician.
- Never place any objects in seat while child is in it.
- Never use this seat on any other product.
- To prevent serious injury or death, DO NOT REMOVE FOAM.
- Head support for use only with this product.

⚠️ WARNING

- To prevent serious injury or death, DO NOT REMOVE FOAM.
- Remove and IMMEDIATELY discard the zip tie.

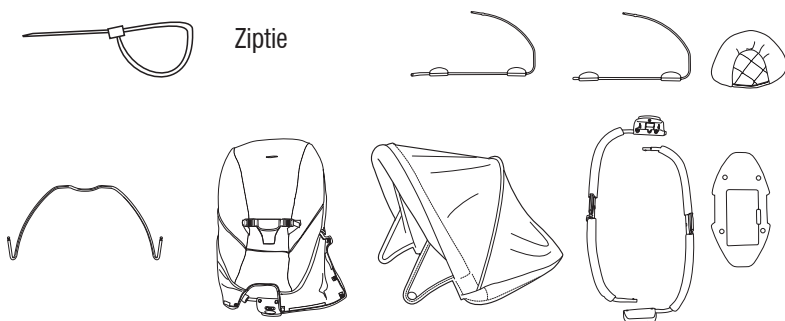

1. Insert the head support strap through the slot in the napper. **MAKE** sure strap is not twisted.

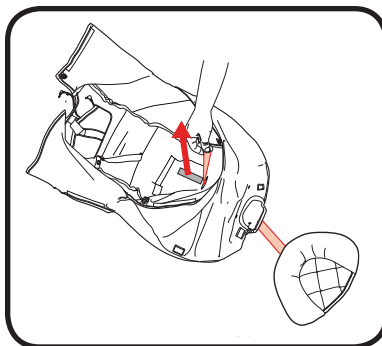

2. Secure hook and loop tape as shown.

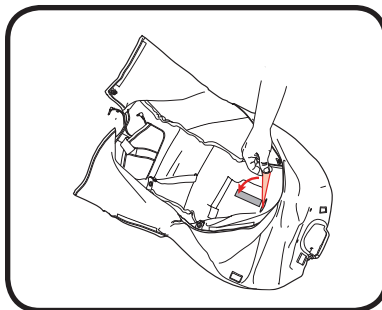

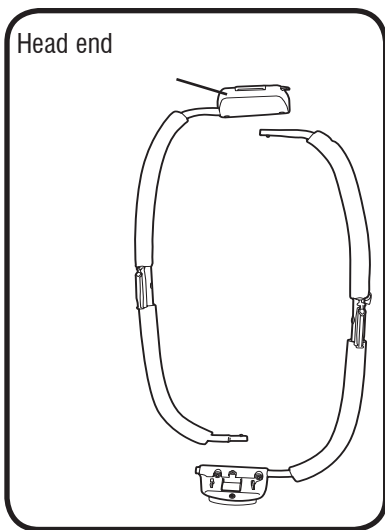

3. Place seat tubes as shown.

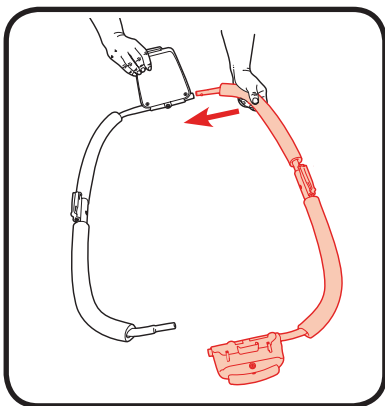

4. Insert tube into head end housing as shown.
The metal button should be facing out when snapped in place as shown.

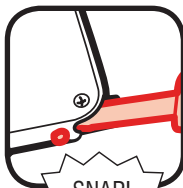
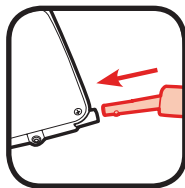

SNAP!

5. Insert tube into foot end housing as shown. The metal button should be facing out when snapped in place as shown.

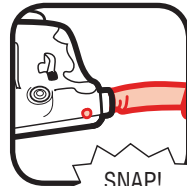
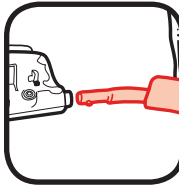
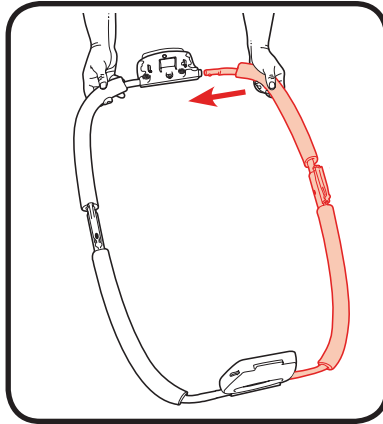

SNAP!

6. Wrap seat pad over head end of seat tubes as shown.

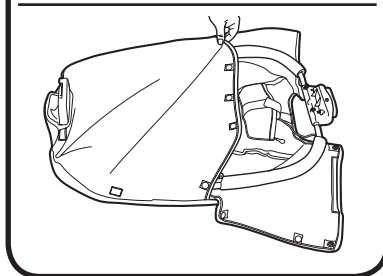
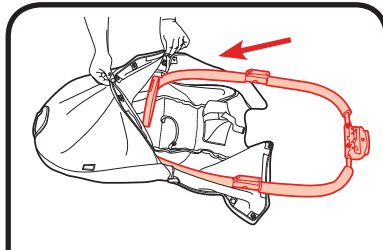

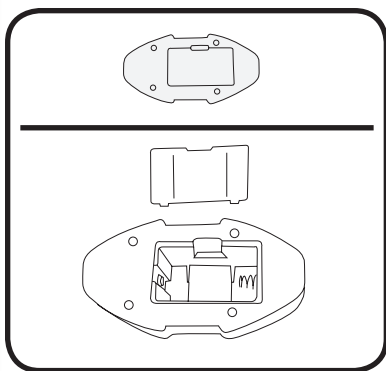

7. Open the battery compartment lid by inserting a screwdriver in the slot. Insert one D (LR20) cell battery (not included). Replace lid.

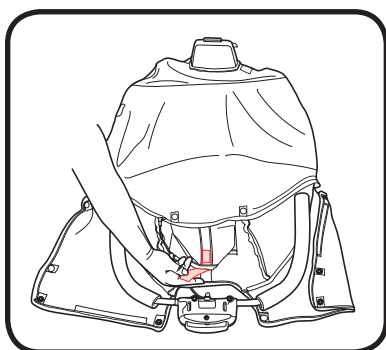

8. Open pocket by pulling on the hook and loop tape as shown.

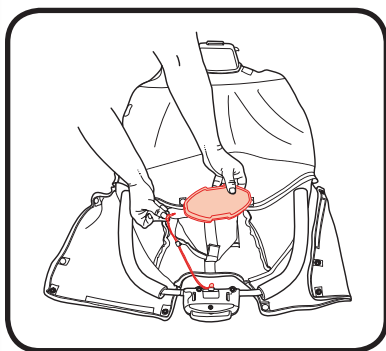

9. Plug-in one end of the short cord into the side of the vibration unit as shown.

10. Insert vibration unit into pocket.

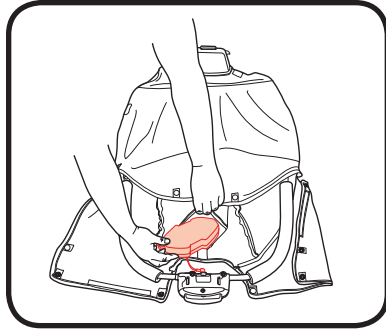

11. Plug-in the other end of the short cord into the back of the electronic switch as shown.

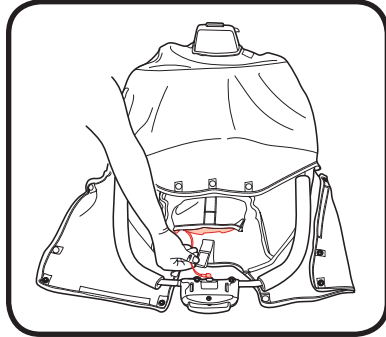

12. Close pocket by re-attaching hook and loop tape as shown.

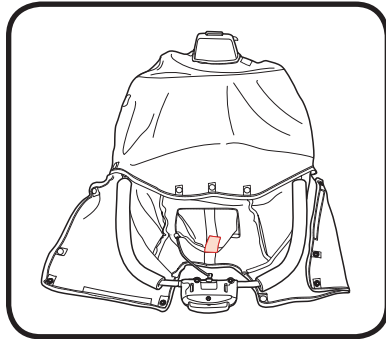

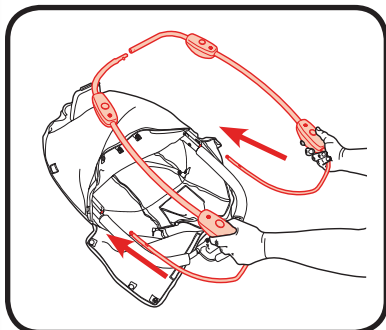
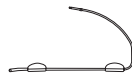
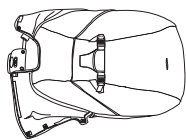

13. Insert bouncer legs into seat as shown.

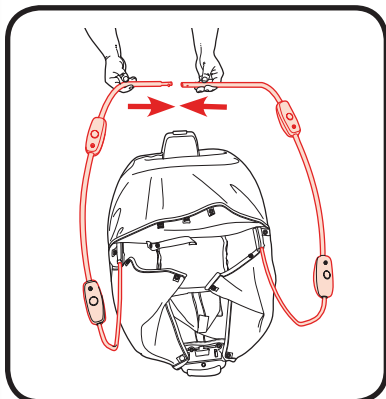

14. Attach bouncer legs together as shown.

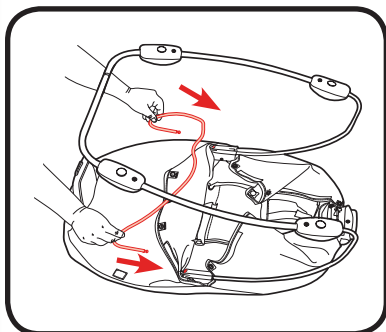

15. Insert bouncer wire as shown.

16. Wrap strap around bouncer wire.

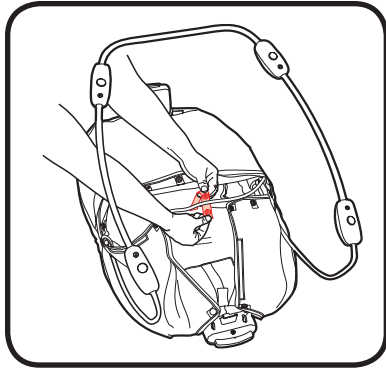

17. Wrap bouncer fabric around wire and fasten snaps and hook and loop tape.

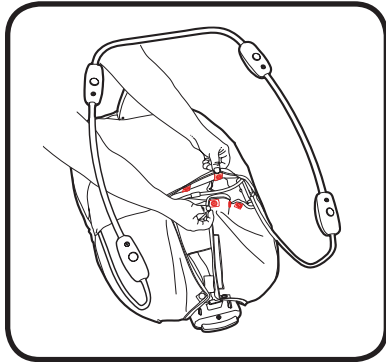

18. Fasten snaps and hook and loop tape.

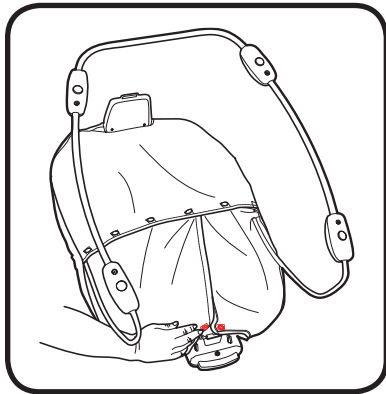

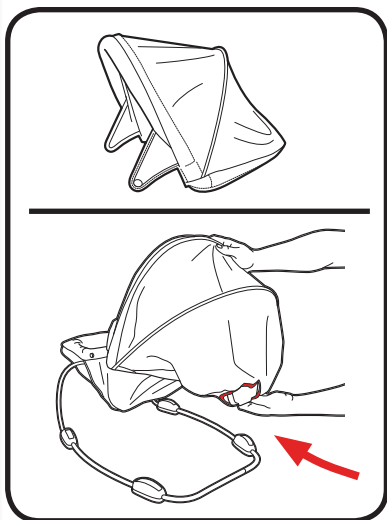

19. Secure the back of the canopy to the rear seat handle.

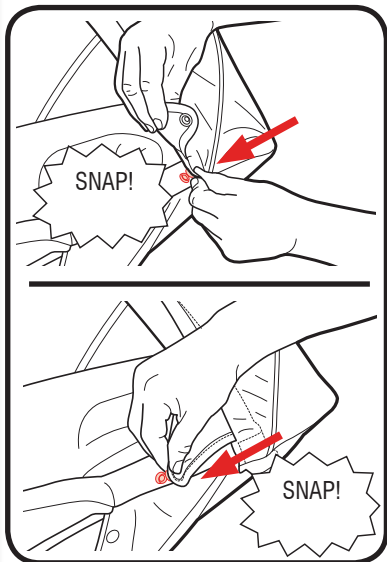

20. Attach the first snap, then the second snap.

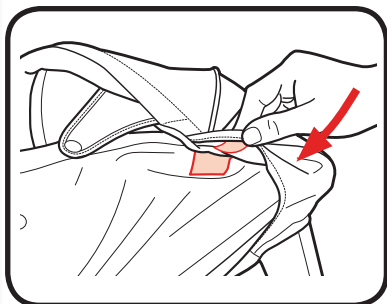

21. Secure the fastening strips and repeat for the other side.

22. **NOTE:** Seat should always be attached opposite the changing table.

Latch the seat onto the bassinet mounts on both sides of the bassinet as shown.

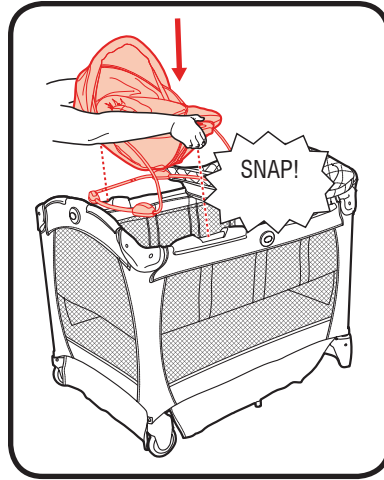

23. Make sure both sides of the seat are securely latched to the bassinet mounts by pulling up

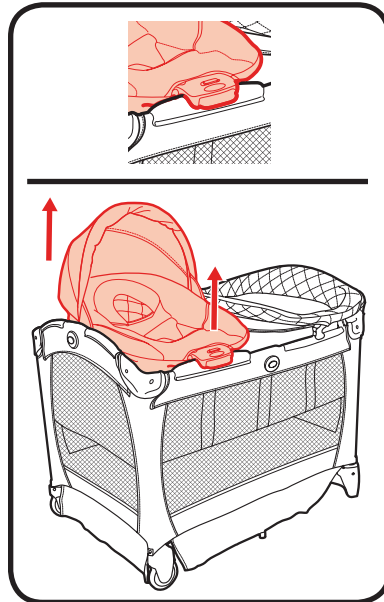

Head support

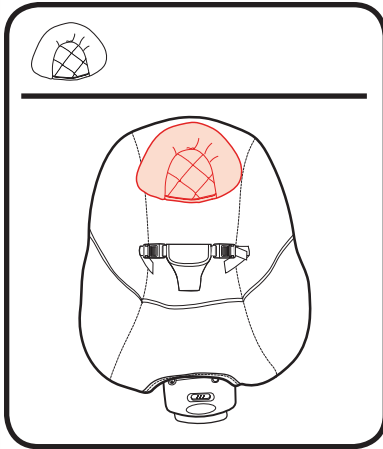

Only use this head support on this swing. Never use this head support on any other product.

To Use Electronic Switch

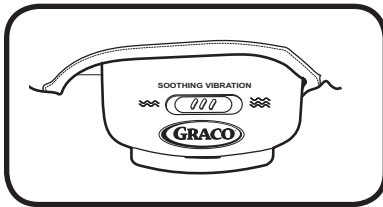

To use integrated electronic switch, slide button to left or right for hi or lo speed.

To Secure Child

25. Use slide adjuster at waist for tighter adjustment.

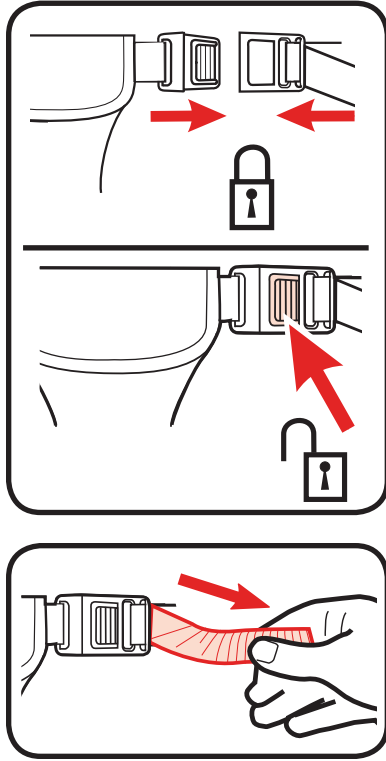

To Remove Seat

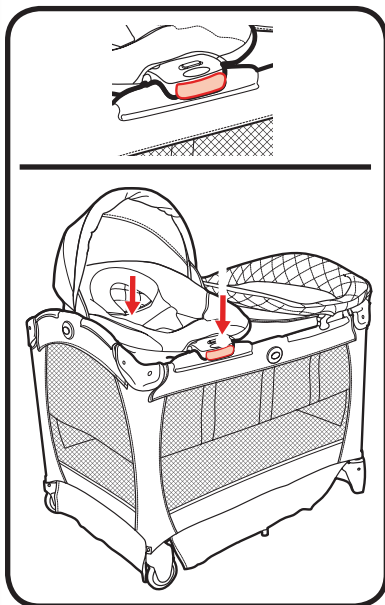

1. To remove, press buttons on both sides of the seat handles and pull up as shown.

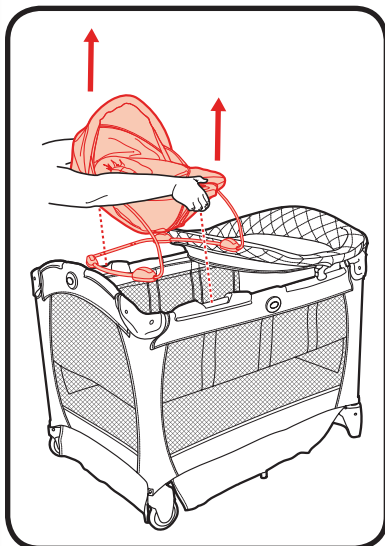

2. Lift seat up and out as shown.

5-D Parent Organizer

⚠️ WARNING

Always keep objects out of child's reach. Remove this accessory when child is able to pull himself up in the playard.

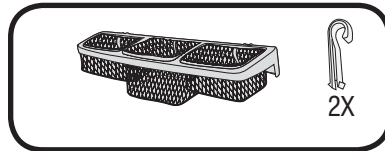

1. Insert hooks into openings in parent organizer.

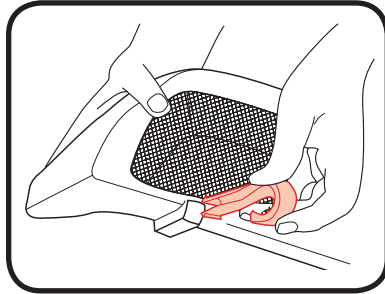

2. Attach to end of playard.

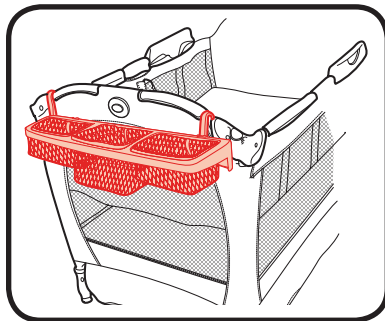

6-A Care and Maintenance

FROM TIME TO TIME CHECK YOUR PLAYARD for worn parts, torn material or stitching. Replace or repair the parts as needed. Use only Graco® replacement parts.

IF PLAYARD IS USED AT THE BEACH, you **MUST** clean sand off your playard, including the feet, before packing it into cover. Sand in top rail lock may damage it.

TO CLEAN PLAYARD, use only household soap or detergent and warm water.

TO WASH CARRY BAG, machine wash in cold water on delicate cycle and drip-dry. **NO BLEACH.**

TO WASH BASSINET: Remove electronics module and vibration unit. **NEVER** remove cord from bassinet. Hand wash with warm water and household soap. Drip dry.

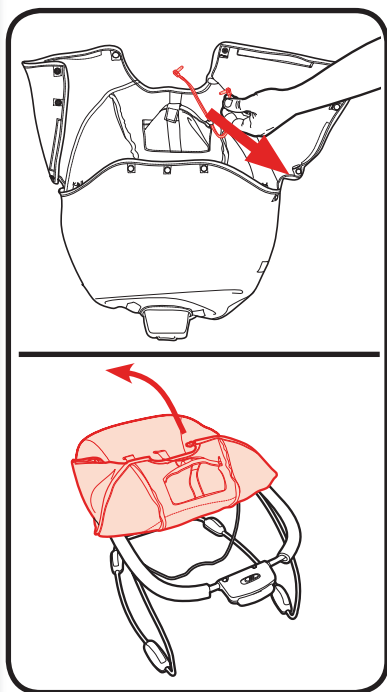

TO WASH SEAT:

1. Remove seat pad from frame as shown below.
2. Remove vibration unit.
3. Remove small cord as shown below.

Machine wash in cold water on delicate cycle and drip-dry. **NO BLEACH.** Refer to your care tag on your seat pad for washing instructions.