



Chrome Modular StepGuard

**-1992-1997 FORD P/U BRONCO-
PART NO. 3315C**

PARTS LIST

2	1/4" SOCKET SCREWS	4	1126MT MOUNTING TABS
4	3/8" x 1 1/4" HEX BOLTS	8	1/2" x 1 1/2" HEX BOLTS
4	3/8" x 1" BUTTON HEAD BOLTS	8	1/2" NYLON LOCK NUTS
4	3/8" LOCK WASHERS	1	075P PASSENGER SIDE SUPPORT BRACKET
4	3/8" HEX NUTS	1	075D DRIVER SIDE SUPPORT BRACKET
		2	FLANGED WASHERS

INSTALLATION INSTRUCTIONS

1. REMOVE HEX NUTS FROM MOUNTING STUDS WHICH ATTACH BUMPER PLATES TO FRAME BRACKETS.
NOTE: STEPS 1-4 ARE FOR DRIVER SIDE ONLY.
2. PUSH BUMPER OUTWARD AND REMOVE ASSEMBLY CLIPS FROM MOUNTING STUDS.
3. REMOVE MOUNTING STUD ASSEMBLY AND LET BUMPER RETURN TO ITS ORIGINAL POSITION.
4. PLACE 075D DRIVER SIDE SUPPORT BRACKET INSIDE BUMPER AND ATTACH TO FRAME PLATE WITH MOUNTING STUD ASSEMBLY PER DIAGRAM. SECURE WITH HEX NUTS REMOVED IN STEP #1.
5. REPEAT STEPS 1-4 FOR PASSENGER SIDE.
6. ASSEMBLE GRILLE AND BRUSH GUARD ASSEMBLY AS FOLLOWS PER DIAGRAM.
7. PLACE CENTER GUARD SIDE PLATES ON A FLAT SURFACE FACE DOWN.
8. ATTACH BOTTOM STEP TUBE INSIDE OF GRILLE GUARD SIDE PLATES USING 3/8" x 1" BUTTON HEAD BOLTS. (NOTE: DO NOT SECURE).
9. ASSEMBLE BRUSH GUARDS LEFT AND RIGHT BY SLIDING THROUGH SIDE PLATES, FLANGED WASHERS THEN INTO TOP TUBE. (NOTE: LUBRICATE BRUSH GUARD TUBES TO EASE ASSEMBLY).
10. ATTACH EURO TUBE TO BRUSH GUARDS USING 5/16" x 1 3/4" FLAT HEAD SCREWS AS SHOWN IN DIAGRAM. DO NOT SECURE.

GO RHINO® 

11. POSITION CENTER PLATE BETWEEN SIDE PLATES. ATTACH CENTER PLATE TO SIDE PLATES AND BRUSH GUARDS USING 3/8" x 1 1/4" HEX BOLTS, LOCK WASHERS AND HEX NUTS. (NOTE: THREADS MUST FACE OUTWARDS ON BOLTS).
12. ATTACH HEAD LIGHT PROTECTORS FIRST TO BRUSH GUARDS USING 1/4" x 3/4" BUTTON HEAD BOLTS THEN TO GRILLE GUARD USING 5/16" x 1" BUTTON HEAD BOLTS AND LOCK NUTS.
13. ALIGN GRILLE AND BRUSH GUARD ASSEMBLY AND SECURE ALL NUTS AND BOLTS. (NOTE: ROTATE TOP TUBE TOWARDS GRILLE TO CONCEAL SOCKET SCREWS).
14. ATTACH 1126MT MOUNTING TABS TO INSIDE OF GRILLE GUARD SIDE PLATES USING 1/2" x 1 1/2" HEX BOLTS AND NYLON LOCK NUTS NOTE: SHORT LEG OF MOUNTING TABS ATTACH TO GRILLE GUARD.
15. ALIGN GRILLE GUARD ASSEMBLY ON FRONT OF VEHICLE AND SCRIBE MOUNTING HOLES THROUGH TAB HOLES ON TOP AND BOTTOM OF BUMPER.
16. DRILL 1/2" HOLES IN BUMPER TOP BOTTOM AND THROUGH SUPPORT BRACKETS.
17. ATTACH GRILLE GUARD ASSEMBLY TO TOP AND BOTTOM OF BUMPER USING 1/2" x 1 1/2" HEX BOLTS AND NYLON LOCK NUTS SUPPLIED.

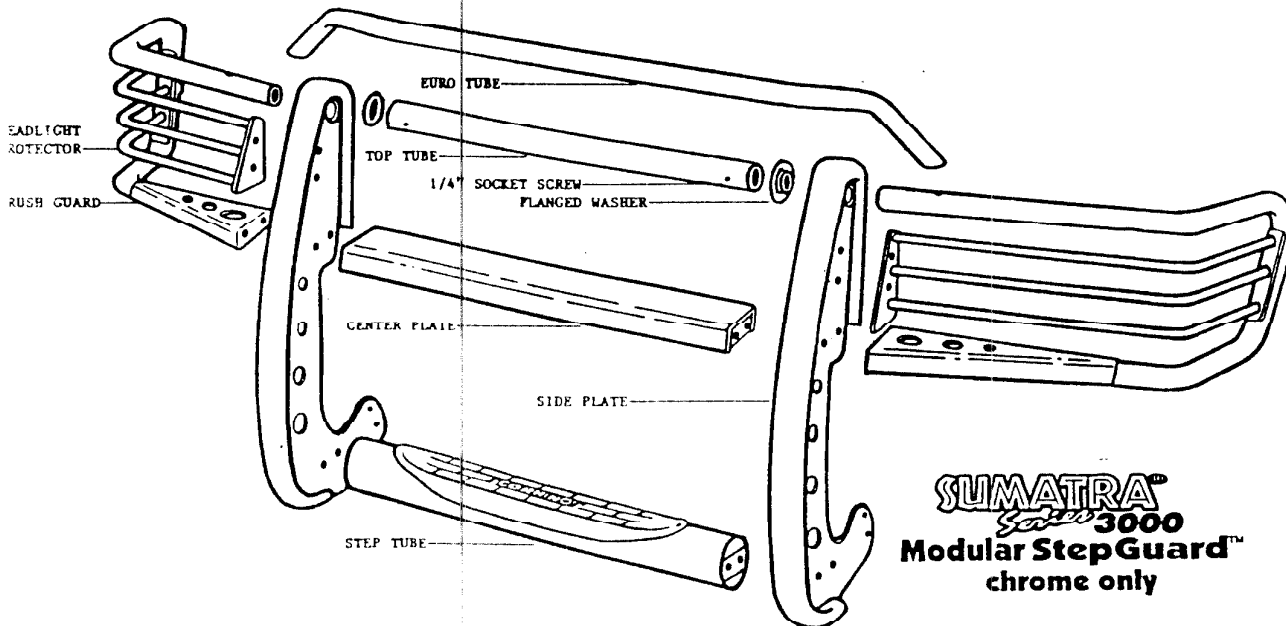

**-1992-1997 FORD P/U BRONCO-
PART NO. 3315C**

