



Clutch Release Bearing 2014

GMB will continue to distribute our mark-engraved products to the world, as we also strive to improve innovative ideas and actions in answer to the needs of our various international customers.

GMB
Your success is our Future.

Contents

PART 1 Clutch Release Bearing Presentation

1. About Vehicle Application
2. Functions of the Clutch System
3. System Layout
4. System Operation
5. Self Centering

PART 2 OE & GMB No. Reference Table

PART3 Clutch Release Bearing Presentation Application

- | | |
|--------------|--------------|
| • AUDI | • OPEL |
| • CITROEN | • PEUGEOT |
| • DAIHATSU | • PORSCHE |
| • FORD | • PROTON |
| • DAEWOO | • ROVER |
| • HONDA | • SAAB |
| • HYUNDAI | • SUBARU |
| • ISUZU | • SUZUKI |
| • KIA | • TALBOT |
| • MAZDA | • TOYOTA |
| • MITSUBISHI | • VAUXHALL |
| • NISSAN | • VOLKSWAGEN |

PART4 Item Reference Table

PART5 Item Picture & Basic Dimension





GMB Group

Global Management Business

GMB KOREA CORP.



**QINGDAO GMB
MACHINERY PRODUCE CO.,LTD.**



GMB NORTH AMERICA INC.(New Jersey)



THAI GMB IND CO.,LTD.



GMB CORPORATION(HQ)



GMB NORTH AMERICA INC.(California)



QINGDAO GMB AUTOMOTIVE CO.,LTD.

PART 1

Clutch Release Bearing Presentation

1. About Vehicle Application
2. Functions of the Clutch System
3. System Layout
4. System Operation
5. Self Centering

GMB

1. About Vehicle Application

●Power Train System

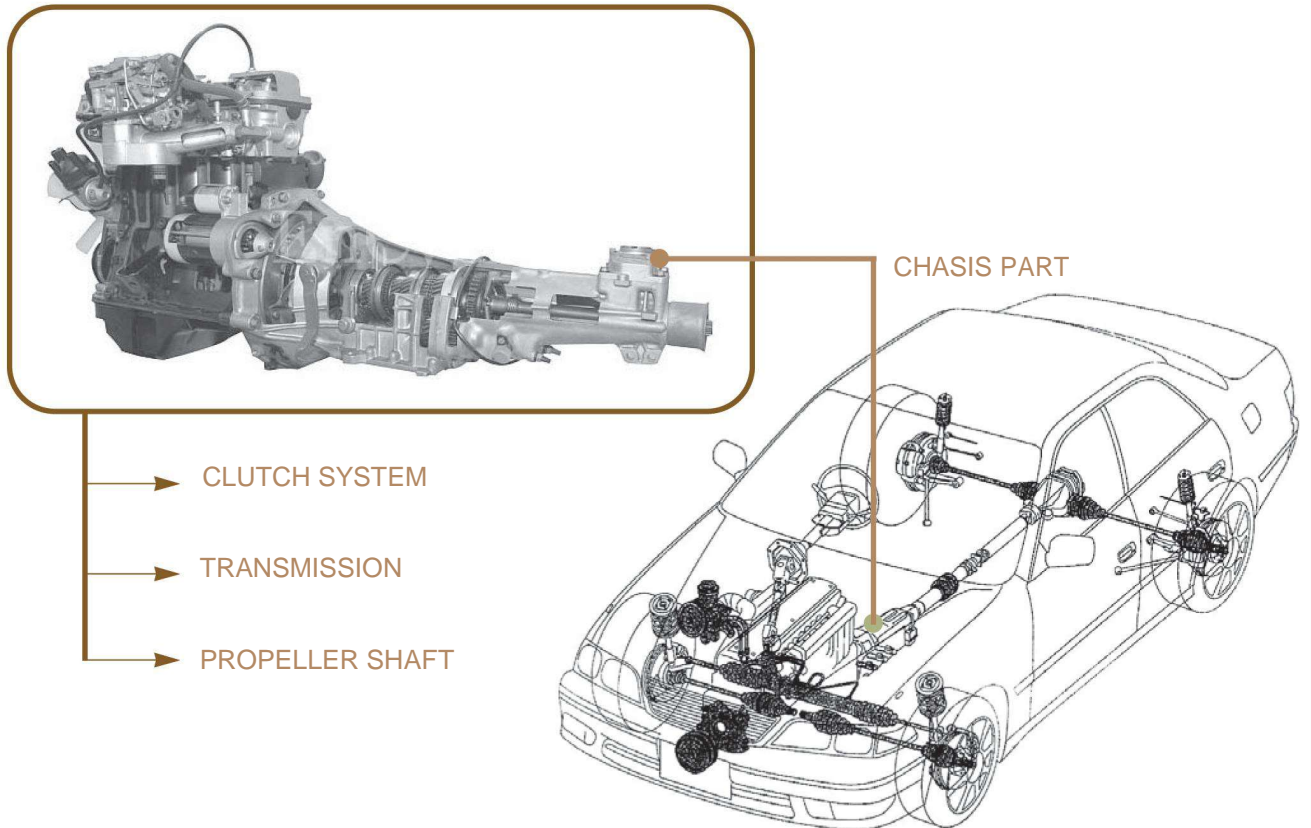

2. Functions of the Clutch System

- Component cutting off the engine power from driving shaft when starting an engine or frequently shifting gears.
- It allows a slide when the power is conveyed by clutch so that the power can be dynamically controlled in slow/high speed, on a slope or on a downhill, facilitating smooth driving.
- In addition, the clutch system helps a vehicle start smoothly and advantageously reduce various noises and vibration occurred in power-train.

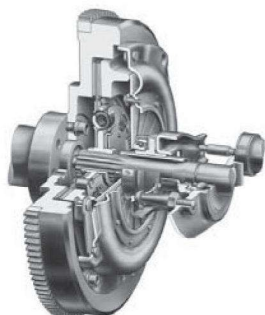

3. System Layout

● Structure of the Clutch Control System

➔ The clutch control system to operate clutch system consists of the following parts.

- CLUTCH PEDAL
- CLUTCH CABLE or CLUTCH RELEASE CYLINDER
- RELEASE FORK, and
- COMPENSATION SPRING.

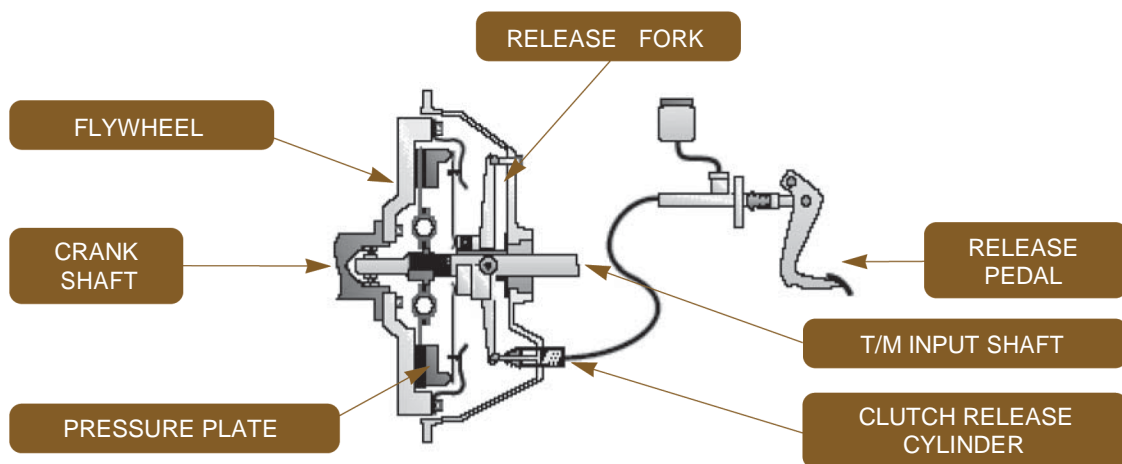

● Peripheral Parts of Clutch Release Bearing

- Sleeve

As the parts with sleeve to be assembled onto the input shaft, it is designed to adjust release bearing and automatic self centering bearing; there are two types; steel tub and plastic sleeve type.

- Back Plate

Backplate on which the release bearing operation part of release fork are attached. In case of large commercial vehicles such as truck or bus, a type that fork is directly applicable to cast iron sleeve is also prepared.

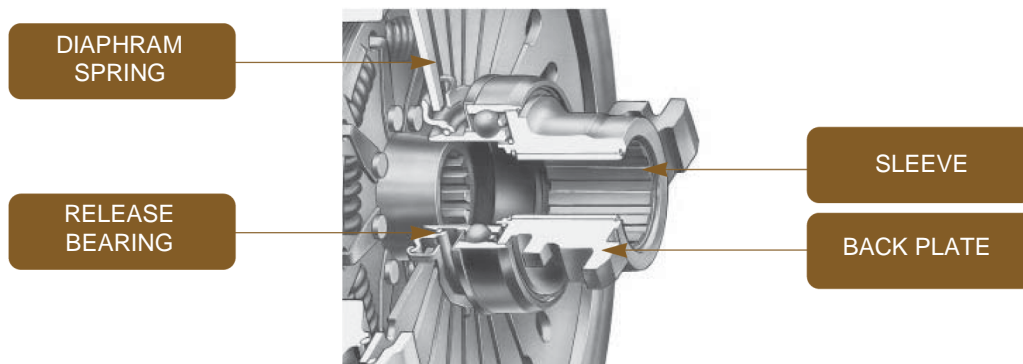

4. System Operation

●Clutch Control System's Operation Mechanism [PUSH TYPE]

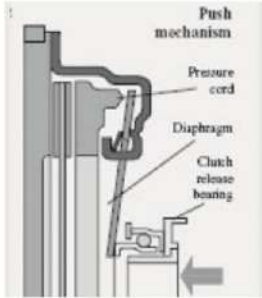

- Pedal operation → Hydraulic pump operation
- Pressure conveyed via hydraulic hose →
- Cylinder operation → Release Fork operation →
- RELEASE BEARING Movement →
- DIAPHRAGM transformation →
- PRESSURE PLATE non-contact →
- Power cut-off between engine and transmission

BEFORE OPERATION

AFTER OPERATION

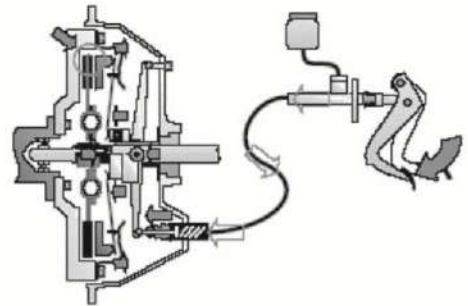
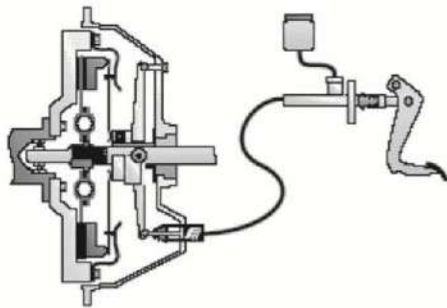

●Clutch Control System's Operation Mechanism [PULL TYPE]

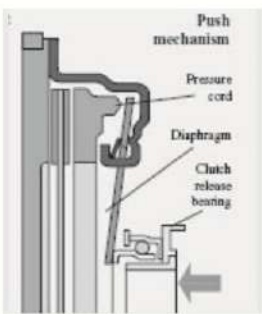

- Pedal operation → Hydraulic pump operation →
- Pressure conveyed via hydraulic hose →
- Cylinder operation → Release Fork operation →
- RELEASE BEARING movement → DIAPHRAGM
- transformation → PRESSURE PLATE non-contact →
- Power cut-off between engine and transmission

BEFORE OPERATION

AFTER OPERATION

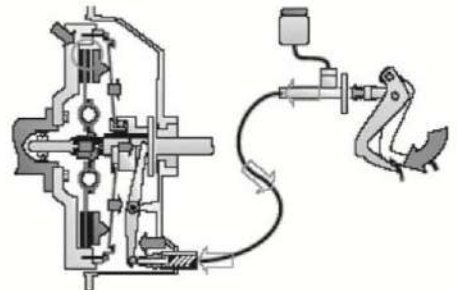
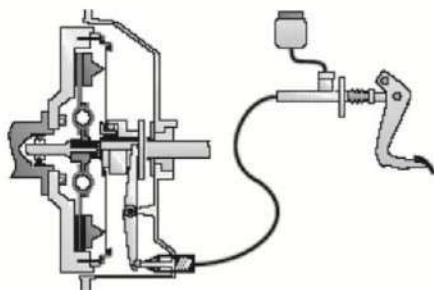

5. Self Centering

● Characteristics of the clutch release bearing

⊕ Self Centering

- Engine flywheel and sleeve are subject to eccentricity by the manufacturing tolerance.

When release bearing pushes D/Spring Finger Lever to control the coupling of the clutch, the eccentricity may generate a friction to bearing and finger part, probably causing excessive wear.

The self centering system of release bearing automatically adjusts the eccentricity when the clutch operates, avoiding the excessive wear on the clutch and bearing and improving the life span.

⊕ Self Centering Force

- Bearing for passenger car : 3 ~ 10 Kgf
- Bearing for commercial vehicle : 12inch (Φ330) : 10 ~18 Kgf
17inch (Φ430) : 20 ~35 Kgf

⊕ Auto Centering Force (F)

- $F = \mu \times P$ (Kg) [μ : friction coefficient, P : Spring force]

PART 2

OE & GMB No. Reference Table

- ALFA ROMEO
- AUDI
- BMW
- CITROEN
- DAEWOO
- DAIHATSU
- FIAT
- FORD
- HONDA
- HYUNDAI
- INNOCENTI
- ISUZU
- KIA
- LADA

- LANCIA
- MAZDA
- MITSUBISHI
- NISSAN
- RENAULT
- ROVER
- SEAT
- SKODA
- SUBARU
- SUZUKI
- TOYOTA
- VAUXHALL
- VOLVO
- VOLKSWAGEN

GMB

GMB CLUTCH RELEASE BEARING

OE & GMB No. Reference Table

ALFA ROMEO

GC96110	46821336
GC96110	60805112
GC86110	60806065
GC96110	60811561
GC63110	95462693

AUDI

GC96010	012 141 165 D
GC96010	012 141 165 E
GC03010	019 141 165
GC96010	01E 141 165
GC96010	01E 141 165B
GC96010	01E 161 165 B
GC28010	02A 141 165 A
GC28010	02A 141 165 G
GC36110	085 141 165 H
GC03010	088 141 165 B
GC03010	091 141 165 D
GC03010	113 141 165 B

BMW

GC34110	21 51 1 223 366
GC34110	21 51 1 225 203

CITROEN

GC68110	2041.47
GC63110	95492693
GC63110	95496167

DAEWOO

GC80010	90251210
GC80010	9006475
GC80010	06 68 651
GC80010	90251702
GC80010	90278884
GC80010	8732232
GC59110	96181631

DAIHATSU

GC90080	31230-87202
GC90080	31230-87202-000
GC51010	31230-87204
GC51010	31230-87280
GC88010	31230-87504
GC34010	31230-87309
GC34010	31230-87604
GC10010	31230-88702
GC10010	31230-88703
GC10010	31230-87702
GC10010	31230-87703
GC10010	31230-87704
GC10010	31230-87705
GC10010	554 621 203
GC90080	90043-63002
GC91080	90043-67004
GC91080	90363-40061
GC91080	90363-40063
GC80080	90363-33002
GC80080	90363-33004
GC01080	90363-4500

GC01080	90363-45002
GC01080	ME600198
GC21080	90363-45009
GC21080	90363-45013
GC72080	9-00095-038-1
GC72080	90363-45079

FIAT

GC96110	4409361
GC16110	46466726
GC96110	46539189
GC96110	46821336
GC26010	5954175
GC96110	5967728
GC96110	60805112
GC86110	30806065
GC96110	60811561
GC16110	73501249
GC96110	7588805
GC16110	7625958
GC86110	7628856
GC96110	7681283
GC96110	7799778
GC63110	95492693

FORD

GC51080	0222-16-222
GC13110	1554189
GC13110	1555006
GC96010	4412070
GC13110	6091026

GMB CLUTCH RELEASE BEARING

OE & GMB No. Reference Table

GC13110	6124270
GC96010	6164967
GC96010	88BB 7548 AA
GC13110	83BB 7548 AA
GC13110	ECB 113
GC96010	ECB 135
GC61010	FE62-16-510

HONDA

GC32110	22810-P20-003
GC32110	22810-P20-005
GC72010	22810-PB6-921
GC72010	22810-PB6-922
GC72010	22810-PB6-923
GC72010	22810-PC8-921
GC72010	22810-PC8-922
GC72010	22810-PC8-923
GC22110	22810-PL3-003
GC22110	22810-PL3-005

HYUNDAI

GC55110	41421-02000
GC20020	41421-28020
GC40010	41410-11000
GC40010	41421-21000
GC40010	41421-21300
GC40010	41421-21400
GC40010	41421-26000
GC40010	41421-36000
GC20020	41421-39000
GC81010	41421-43000

GC81010	41421-43010
GC81010	41421-43020
GC81010	41421-43030
GC81010	MD 719469

INNOCENTI

GC96110	7681283
---------	---------

ISUZU

GC71080	1-09820-008-0
GC71080	1-09820-008-1
GC71080	1-31312-002-1
GC71080	9-00095-0300
GC84010	1-09820-078-0
GC84010	5-09800-078-0
GC41080	5-09803-004-0
GC41080	5-09803-005-0
GC41080	90043-67014
GC41080	0222-16-220
GC41080	0222-16-222
GC41080	MD 702241
GC41080	D27Z-7548-A
GC41080	MD 702241
GC41080	D27Z-7548-A
GC41080	5-09800-072-0
GC51080	5-09800-072-0
GC51080	5-09803-004-0
GC90010	5-31314-001
GC90010	5-31314-001-1
GC90010	5-31314-011-0
GC90010	1000-9290-5

GC90010	8-94127-773
GC90010	8-94158-408
GC01010	8-94101-243-0
GC82010	8-94106-658-0
GC82010	8-94109-658-0
GC82010	8-94109-658-1
GC82010	8-94389-367-0
GC31010	8-94377-417-1
GC31010	8-94379-416
GC31010	8-94379-449
GC31010	8-94379-499-0
GC31010	8-94453-348-0
GC31010	8-94453-349
GC43010	8-97023-074-0

KIA

GC61010	OFE62-16-510A
GC11010	KB301-16-510
GC61010	OK011-16-510
GC61080	30502-90006
GC30080	30502-90007
GC12010	30502-96E20
GC41010	30502-M8000
GC41010	30502-M8005
GC41010	30502-M8060
GC52080	30502-V6200
GC92010	30502-W1700
GC92010	30502-W1701
GC71080	30502-Z5000
GC71080	30502-Z5001
GC11010	OK2A116510A

GMB CLUTCH RELEASE BEARING

OE & GMB No. Reference Table

LADA

GC68010	211001601180
---------	--------------

LANCIA

GC16110	7625958
---------	---------

GC86110	7628856
---------	---------

MAZDA

GC72080	0086-16-222
---------	-------------

GC72080	0086-16-222A
---------	--------------

GC72080	0107-16-222
---------	-------------

GC72080	0603-16-222
---------	-------------

GC72080	0672-16-220
---------	-------------

GC72080	MD 800241
---------	-----------

GC31080	0727-16-512
---------	-------------

GC31080	0727-16-512A
---------	--------------

GC31080	1304-16-510
---------	-------------

GC31080	1304-16-510A
---------	--------------

GC31080	1304-16-510B
---------	--------------

GC21010	8450-16-510
---------	-------------

GC21010	8450-16-510B
---------	--------------

GC21010	8540-16-510
---------	-------------

GC21010	8540-16-510B
---------	--------------

GC21010	33 96 878
---------	-----------

GC21010	03 396 878
---------	------------

GC55010	B301-16-510
---------	-------------

GC11010	B301-16-510A
---------	--------------

GC11010	KB301-16-510
---------	--------------

GC22010	E8BZ-7548-A
---------	-------------

GC22010	B301-15-510A
---------	--------------

GC22010	B301-16-510
---------	-------------

GC22010	B301-16-510A
---------	--------------

GC22010	B311-16-510
---------	-------------

GC22010	B315-16-510
---------	-------------

GC80110	B622-16-510
---------	-------------

GC61010	BP02-16-510
---------	-------------

GC61010	SE03-16-510
---------	-------------

GC91010	E301-16-510
---------	-------------

GC55010	E301-16-510A
---------	--------------

GC61010	FE82-16-510A
---------	--------------

GC61010	OFE62-16-510A
---------	---------------

GC61010	OK011-16-510
---------	--------------

GC21010	G560-16-510B
---------	--------------

GC21010	H606-16-510A
---------	--------------

GC21010	SE03-16-510
---------	-------------

MITSUBISHI

GC71080	03452-69000
---------	-------------

GC40010	41421-36000
---------	-------------

GC51080	MD 702241
---------	-----------

GC32010	MD 703270
---------	-----------

GC40010	MD 706180
---------	-----------

GC40010	MD 719925
---------	-----------

GC40010	MD 722744
---------	-----------

GC40010	MD 749998
---------	-----------

GC22080	ME 600000
---------	-----------

GC30010	ME 600340
---------	-----------

GC30010	ME 600341
---------	-----------

GC30010	ME 600576
---------	-----------

GC30010	ME 602710
---------	-----------

GC30010	ME 605584
---------	-----------

GC71080	ME 620330
---------	-----------

GC12080	ME 627580
---------	-----------

GC81080	JM60330
---------	---------

GC81080	MJM 60330
---------	-----------

GC81080	90363-38013
---------	-------------

GC10020	MR 145619
---------	-----------

GC81010	MR 195689
---------	-----------

GC90080	MT 209224
---------	-----------

GC90080	MT 209225
---------	-----------

NISSAN

GC02110	30502-01B00
---------	-------------

GC12010	30502-03E20
---------	-------------

GC12010	30502-03E21
---------	-------------

GC02010	30502-03E24
---------	-------------

GC02080	90043-67015
---------	-------------

GC02080	21123-05010
---------	-------------

GC02080	21123-0504P
---------	-------------

GC02080	30502-13200
---------	-------------

GC02080	30502-32200
---------	-------------

GC02080	30502-86401
---------	-------------

GC60080	30502-21000
---------	-------------

GC02010	30502-28E14
---------	-------------

GC12110	30502-28E18
---------	-------------

GC12110	30502-28E19
---------	-------------

GC12010	30502-28E20
---------	-------------

GC12010	30502-28E21
---------	-------------

GC12010	30502-96E20
---------	-------------

GC02010	30502-28E24
---------	-------------

GC92010	30502-30P00
---------	-------------

GC92010	30502-45P00
---------	-------------

GC93010	30502-52A00
---------	-------------

GMB CLUTCH RELEASE BEARING

OE & GMB No. Reference Table

GC93010	30502-52A60
GC93010	30502-53J00
GC93010	30502-53J01
GC93010	30502-53J05
GC93010	30502-54A00
GC12110	30502-56A00
GC41010	30502-81N00
GC41010	30502-81N05
GC65010	30502-D3522
GC65010	30502-D3518
GC65010	30502-D3560
GC65010	30502-D3561
GC41010	30502-M8000
GC41010	30502-M8005
GC41010	30502-M8060
GC52080	30502-V6200
GC92010	30502-W1700

RENAULT

GC07010	77 00 519 170
GC63110	77 00 576 298
GC63110	77 00 589 253
GC07010	77 00 638 870
GC07010	77 00 676 150
GC08010	77 00 692 431
GC64010	77 00 725 237
GC64010	77 00 869 415
GC07010	77 01 348 231
GC63110	77 01 348 537
GC08010	77 01 349 113
GC07010	77 01 616 841

GC08010	77 04 001 363
GC64010	77 04 001 430

ROVER

GC37010	GRB 240
GC37010	GRB 241

SEAT

GC37010	020 141 165 G
GC28010	02A 141 165 E
GC28010	02A 141 165 G
GC36110	085 141 165 E
GC36110	085 141 165 H
GC26010	4316750
GC96110	SE 022125316 A

SKODA

GC96010	012 141 165 E
GC37010	020 141 165 H
GC28010	02A 141 165 E
GC28010	02A 141 165 G

SUBARU

GC10020	30502-12U00
GC03110	30502-AA051
GC10020	30502-AA080
GC90080	30502-KA000
GC90080	30502-KA001

SUZUKI

GC23010	09269-28004
GC23010	09269-28005
GC23010	09269-53004
GC50010	09269-28006
GC20010	09269-33001
GC20010	09269-33002
GC20010	09269-33004
GC90080	83151-4700
GC90080	09269-33003
GC90080	09269-35005
GC90080	09269-53003
GC90080	09269-35003
GC20010	09269-35004
GC50010	23265-65G00
GC20010	23265-70C00
GC20010	23265-77D00

TOYOTA

GC70010	31230-05010
GC70010	31230-05011
GC70010	31230-05012
GC04010	31230-12040
GC04010	31230-12100
GC04010	31230-12110
GC04010	31230-12130
GC04010	31230-12140
GC70010	31230-12170
GC70010	31230-12180
GC70010	31230-18180
GC04010	31230-16060

GMB CLUTCH RELEASE BEARING

OE & GMB No. Reference Table

GC04010	31230-16071
GC70010	31230-20140
GC06110	31230-20160
GC06110	31230-20170
GC53010	31230-22080
GC53010	31230-22081
GC53010	31230-22090
GC33010	31230-32010
GC33010	31230-32011
GC33010	31230-32020
GC33010	31230-32040
GC83010	31230-32060
GC63010	31230-35050
GC63010	31230-35060
GC63010	30508-KA001
GC63010	30508-KA040
GC71010	31230-35070
GC71010	31230-35080
GC71010	03452-69000
GC71010	30502-Z5000
GC71010	30502-Z5001
GC60010	31230-35090
GC60010	31230-32011
GC60010	31230-32020
GC60010	31230-14042
GC60010	31230-30150
GC60010	31230-35101
GC60010	31230-35102
GC60010	J31 230 350 90
GC94010	31230-36150
GC62010	31230-36160

GC42010	31230-36170
GC05010	31230-60120
GC52010	31230-60130
GC52010	31230-36200
GC44010	31230-60150
GC44010	31230-60160
GC44010	31230-60170
GC51010	31230-87280
GC80080	90363-33002
GC80080	90363-33004
GC10080	90363-40001
GC10080	90363-40002
GC10080	90363-40008
GC10080	90363-40009
GC10080	90363-40006
GC10080	90363-40015
GC10080	90363-40016
GC10080	90363-40019
GC10080	90363-40022
GC11080	90363-520086
GC11080	90363-52001

VAUXHALL

GC01010	4293862
GC01010	ME600198
GC31010	668659
GC01010	94101243
GC31010	94379499

VOLVO

GC64010	3467165
GC64010	3411119-5

VOLKSWAGEN

GC03010	019 141 165
GC37010	020 141 165 G
GC37010	020 141 165 H
GC28010	02A 141 165 A
GC28010	02A 141 165 E
GC28010	02A 141 165 G
GC36110	085 141 165 E
GC36110	085 141 165 H
GC03010	088 141 165 B
GC03010	091 141 165 D
GC03010	113 141 165 B
GC71010	ME620330
GC71010	J31 230 350 70

PART 3

Clutch Release Bearing Application

- AUDI
- CITROEN
- DAIHATSU
- FORD
- DAEWOO
- HONDA
- HYUNDAI
- ISUZU
- KIA
- MAZDA
- MITSUBISHI
- NISSAN

- OPEL
- PEUGEOT
- PORSCHE
- PROTON
- ROVER
- SAAB
- SUBARU
- SUZUKI
- TALBOT
- TOYOTA
- VAUXHALL
- VOLKSWAGEN

GMB



GMB CLUTCH RELEASE BEARING





OE Maker		Clutch	Vehicle Model	Engine Type
AUDI	80 Avant	GC03010	80 (Ch.3-9, A-> 81-H-299000)	
	80 Quattro	GC03010	80 (Ch.81/85-F-000 0001->81/85-H-299999)	
	90 Avant	GC03010	90 (Ch.3-9, A->81-H-299000)	
	90 Quattro	GC03010	90 (Ch.81/85-F-000 0001->81/85-H-299999)	
	100	GC03010	100 Avant/Quattro (-> Ch.44-J-200099)	
	200	GC03010	200 Avant/Quattro	
	Coupe	GC03010	Coupe/Quattro (Ch.B-J)	
CITROEN	BX	GC84010	BX 1.6, 1.9	
		GC84010	BX 1.7 Diesel, 1.9 Diesel	
	Visa	GC84010	Visa 1.6	
		GC84010	Visa 1.7 Diesel	
	C15	GC84010	C15 1.1	"E" - 1118cc
		GC84010	C15 1.3	1294cc
GC84010	C15 1.8 Diesel	1769cc		
DAIHATSU	4 x 4	GC7008	4 x 4 F20	1600cc
		GC10080	4 x 4 F80, F85, F87	2000cc
		GC34010	4 x 4 F70, F25, F77	Diesel
		GC10010	Applause A101	1600cc
	Charade	GC10010	Charade G11, G30, E-G11, E-G11V, N-G30, N-G30V	1000cc
		GC10010	Charade E-G100SS, E-G112S	1000cc, 1300cc 4WD Gasoline
		GC10010	Charade G100, G101, G102, G112	1000cc, 1300cc
		GC10010	Charade G200, G201, G202, G203	1000cc, 1300cc, 1500cc, 1600cc
		GC90080	Charade G101, G100, G102	Diesel
		GC90080	Charade G20, G10	850cc, 1000cc
		GC20080	Charmant A10, 10V	1200cc / GBX:5
	Charmant	GC20080	Charmant A20, 20V	1400cc
		GC10080	Charmant A20, 20V	1400cc
		GC10080	Charmant A40, A45, A60, A65	1600cc
		GC20080	Consorte EP42, 47, 51	1200cc / GBX:5
	Consorte	GC20080	Consorte EP42, 47, 51	1200cc / GBX:5
	Feroza	GC90080	Fellow Max, Max Coure L38, 38V	360cc
Leeza		GC90080	Leeza E-L100S	550cc
		GC90080	Leeza L100S, L100V	550cc
		GC90080	Leeza E-L70S	550cc
		GC90080	Leeza L111S	660cc

				
OE Maker	Clutch	Vehicle Model		Engine Type
DAIHATSU	Max Cuore	GC90080	Max Cuore L40	550cc
	Mira Cuore	GC90080	Mira Cuore L55,55V,40,40V,45,45V	550cc
		GC90080	Mira Cuore E-L55, E-L60	550cc, 600cc
		GC90080	Mira Cuore M-L56V, M-L55V	550cc
		GC90080	Mira Cuore L70S, L70V, L71V	550cc
		GC90080	Mira Cuore E-L70S, L100S, M-L70V	550cc
		GC90080	Mira Cuore L60 (DK type clutch)	600cc
		GC90080	Mira Cuore L200/210S, L200/210V	660cc
		GC90080	Mira Cuore L80, L200, L201	850cc
		Taft/Rocky	GC34010	Rocky 4x4 F7#, F8#, F9#
	GC34010		Rugger F70, 75, 80, 81, 82	4WD 2800cc Diesel
	GC70080		Taft F20, 25	1600cc 4WD
	GC34010		Taft F50, 55, N-F60V	2500cc 4WD
	GC10080		Taft, Rocky F80, 85	2000cc 4WD
	GC34010		Taft, Rocky F60, 60V, 70, 71, 75, 76	2800cc 4WD
	Delta	GC34010	Delta N-V54P, N-V58, N-V59	1.75t
		GC01080	Delta N-V10D, N-V47D, N-V48	1.75t, 3000cc
		GC10080	Delta V30, V20, V69	2000cc, 2500cc
		GC01080	Delta V69, V109	2000cc, 2200cc
		GC10080	Delta V109	2200cc
		GC01080	Delta N-V78, 79, 98, 99	2000cc
		GC01080	Delta V76, V78, V78D, V79	3400cc
		GC01080	Delta P-V75, P-V76	3000cc
		GC01080	Delta N-V76, N-V78D, N-V79	3000cc, 2000cc
		GC01080	Delta V10	Diesel
		GC34010	Delta V57, V58, V59	Diesel
		GC01080	Delta V78, 79, 89, 98, 99	Diesel
		GC21080	Delta V118	Diesel
		GC91080	Delta 1500 SV17	1600cc
		GC02080	Delta 1500 SV17	1600cc
		GC91080	Delta 1500 SV23, DV23	2000cc
		GC10080	Delta 1500 V34, V36	2000cc
	GC41080	Delta 1500 SV18	2500cc	
GC34010	Delta 1500 V24, 26	2500cc		
GC34010	Delta 2000 V57, 58, 59	1.75 ton Diesel		

GMB CLUTCH RELEASE BEARING

				
OE Maker		Clutch	Vehicle Model	Engine Type
DAIHATSU	Delta	GC10080	Delta 2000 V30, 32, 33, 35	2000cc
		GC34010	Delta 2000 V20, 23, 24, 25	2500cc Diesel
		GC41080	Delta 2000 SV26, DV26	2500cc Diesel
		GC34010	Delta 2000 V57	2800cc Diesel
		GC01080	Delta 2000 V10, 11, 12	3000cc Diesel
		GC01080	Delta 2000 V75, 76, 78, 79, 98, 99	3000cc, 3500cc - Diesel
		GC20080	Delta 2000 750	1200cc
		GC70080	Delta 2000 750	1200cc, 1300cc
		GC10080	Delta 2000 750	1300cc
		GC10080	Delta Tipper V30	2000cc
		GC34010	Delta Tipper V20	2500cc Diesel
		GC01080	Delta Tipper V10	3000cc Diesel
		GC70080	Delta Wide KB10, 11	1200cc, 1300cc
		GC10080	Delta Wide KB12	1300cc
		GC10080	Delta Wide KB 26V, YB26V, YB20G	1300cc, 1600cc, 1800cc
		GC70080	Delta Wide TB10, 11	1600cc
		GC10080	Delta Wide TB15	1800cc
		GC10080	Delta Wide CB21G, 26V, YB21G	1800cc, 2000cc
	Hi-Jet	GC90080	Hi-Jet 55 Cab S40, S60	550cc
		GC90080	Hi-Jet Cab S38, 38V, 40T, 40V	360cc, 550cc
Light /Micro Bus	GC10080	Light Bus V32, 34	2000cc	
	GC34010	Light Bus V22, 24	2500cc Diesel	
	GC72080	Light Bus DV28N	3000cc Diesel	
	GC01080	Light Bus V12	3000cc Diesel	
	GC91080	Micro Bus SV16N, 17N, 25N, 27N, 151N	1500cc, 1600cc, 1900cc	
FORD	Probe	GC21010	Probe 2.0	
		GC21010	Probe 2.5	
	Econovan	GC21010	Econovan 2.0 Diesel	
	Courier	GC41080	Courier	1600cc, 1800cc
		GC21010	Courier	2000cc
	J80	GC21010	J80	2000cc, 2200cc
	Laser	GC91010	Laser	1300cc
		GC91010	Laser	1500cc
GC21010		Laser	1500cc Turbo	
GC61010		Laser	1500cc, 1600cc	

				
OE Maker	Clutch	Vehicle Model	Engine Type	
FORD	Laser	GC91010	Laser	
	Spectro	GC21010	Spectron	1800cc, 2000cc
	Telstar/Virgo	GC21010	Telstar/Virgo	1600cc, 1800cc, 2000cc
DAEWOO	Lemans	GC80010	Lemans	
	Labo/Damas	GC20010	Labo/Damas	
	Tico/Matiz	GC23010	Tico/Matiz	800cc
	Cielo	GC80010	Cielo	1500cc
	Espero	GC80010	Espero	1500cc, 1600cc, 1800cc, 2000cc
HONDA	Accord	GC72010	Accord SY	1600cc
		GC72010	Accord CA4, CA5	1600cc, 2000cc & 2000cc PGM-FI
		GC72010	Accord SY, SZ	1600cc, 1800cc
		GC72010	Accord AC, AD, CA1, CA2	1600cc, 1800cc
		GC72010	Accord E-AC100, E-AD100	1600cc, 1800cc
		GC72010	Accord E-SY110, E-SZ100, E-SY100, E-SZ120	1800cc
		GC72010	Accord E-CA1-100, E-CA1-106, E-CA1-120, E-CA2-100, E-CA2-106	1800cc
	Ballade	GC72010	Ballade E-AS100, E-AS110, E-AS120	1600cc
	Civic	GC20010	Civic EG1, EG2, EH6	1500cc, 1600cc
		GC72010	Civic E-AT, E-AU-110/120	1600cc
	CRX	GC72010	CRX ED9	1600cc DOHC PGM-FI
	Prelude	GC72010	Prelude E-AB 100/110/120	1800cc
		GC72010	Prelude AB, SN	1800cc
	Quint	GC72010	Quint E-SU100, E-SU110	1600cc
		GC72010	Quint E-DA1-100, E-DA2-100	1500cc, 1600cc
		GC72010	Quint/Quint Integra SU, AV	1600cc
	Vigor/Accura	GC72010	Vigour E-AC100, E-AD100	1600cc, 1800cc
		GC72010	Vigour E-CA1-100, E-CA1-106, E-CA1/E-CA2-100, E-CA2-106/120	1800cc
		GC72010	Vigour/Accura AC, AD, SZ, CA1/2/3	1800cc, 2000cc

GMB CLUTCH RELEASE BEARING



OE Maker		Clutch	Vehicle Model	Engine Type
HYUNDAI	Accent	GC18010	Accent	1500cc
	Scoupe	GC40010	Scoupe	
	Pony	GC40010	Pony 1	
		GC32010	Pony 2	1400cc, 1500cc
	Elantra	GC40010	Elantra	1500cc, 1600cc
	Lantra	GC40010	Lantra	1500cc, 1600cc
	Grace	GC81010	Grace	
	Grandeur	GC40010	Grandeur	
	Stellar/Sonata	GC40010	Sonata	2000cc, 2400cc, 3000cc
		GC40010	Y-11	
	H100/Porter - 1 ton Truck	GC81010	H100	
		GC81010	Porter - 1 ton Truck	
Atoz	GC55110	Atoz		
ISUZU	117	GC20080	117 Coupe PA, PAD	1800cc, 2000cc, 2200cc
	Florian	GC20080	Florian PA, PAD	1600cc, 1800cc, 2000cc
	Gemini	GC20080	Gemini PF50, PF60, PFD60	1600cc, 1800cc & Diesel
	Piazza	GC20080	Piazza E-JR120, 130	2000cc
		GC20080	Piazza JR30	2000cc - XF, XJ, XG, XN
		GC01010	Piazza, XS JR30	2000cc - XS
	Trooper	GC31010	Trooper UBS	
		GC20080	Trooper UBS13, UBS52	2000cc, 2200cc, 2300cc Diesel
		GC20080	Trooper UB16	2300cc 4WD
		GC20080	Trooper UBS SERIES	2300cc & Diesel
	ELF	GC90010	ELF P-NHR55, P-NKR57, 58	1.0-1.25t, 2.0-2.75t
		GC90010	ELF P-NHR54, P-NKR57	1.0, 1.25t, 2.0t
		GC31010	ELF NHS	1.5t
		GC82010	ELF P-NPR57, P-NPR59	2.0 - 3.5t
		GC41080	ELF P-TLD26, 56, 66	2.0t
GC90010		ELF NPR57GVN	2.0t	
GC90010		ELF NPR57GVN	2.0t	

				
OE Maker		Clutch	Vehicle Model	Engine Type
ISUZU	ELF	GC41080	ELF TLD	Diesel
		GC82010	ELF NPR58	MSA5P, MAS5G TYPE - Diesel
		GC20080	ELF 150 KAD, KAG	1600cc, 2000cc
		GC41080	ELF 150 KAD	2400cc
		GC90010	ELF 150 NHR	2500cc
		GC90010	ELF 150 NHR54	Diesel
		GC72080	ELF 250 TLG, TLD	2000cc, 2400cc, 2800cc
		GC41080	ELF 250 TLD, KT	2400cc, 2800cc, 3300cc
		GC90010	ELF 250 NKR	2800cc, 3300cc
		GC90010	ELF 250 NKR55, NKR57	Diesel
		GC72080	ELF 350 KS11, 21, 31, 41	3600cc
		GC51080	ELF 350 KS12, 22, 32, 42	3900cc Diesel
		GC90010	ELF 350 NPR57, NPR59	Diesel
		GC84010	ELF 350 (Manual Transmission) NPR57, 59	MSA5P, MSA5S TYPE - Diesel
		GC90010	ELF 350 (Manual Transmission) NPR57, 59	MSB5M TYPE - Diesel
		GC82010	ELF 350 (MSA Transmission) NPR	3300cc, 3900cc
		GC90010	ELF 350 (MSB Transmission) NPR	3600cc, 3900cc
	Fargo	GC20080	Fargo L-WFR10, 11, 51	1600cc, 1800cc & Diesel
		GC20080	Fargo WFR SERIES	1800cc, 2000cc & Diesel
		GC01010	Fargo WFR SERIES	1800cc, 2000cc & Diesel
		GC20080	Fargo N-WFS51, N-WFS53, N-WFR53	2000cc
		GC20080	Fargo WFR12DV, 12FV, 12FVH	2000cc
		GC31010	Fargo WFR, NFR, WFS, NFS62	2400cc
	Faster	GC20080	Faster TFR, TFS SERIES	1600cc & Diesel
		GC20080	Faster KB SERIES	1600cc, 1800cc & Diesel
		GC20080	Faster KBG, KBD SERIES	1600cc, 1800cc, 2000cc & Diesel
		GC20080	Faster N-KBD22, 42	1.0t
		GC20080	Faster KB SERIES	2300cc, 1600cc, 2000cc & Diesel
		GC01010	Faster KB SERIES	2300cc & Diesel
		GC01010	Faster TFR, TFS SERIES	2300cc & Diesel
	light Bus /Trucks	GC20080	Big Horn N-UBS52	2000cc
		GC31010	Big Horn UBS55	2800cc, 3100cc, 3200cc
		GC31010	Big Horn UBS69, UBS25	2800cc, 3100cc, 3200cc
		GC01010	Chevrolet Luv	2300cc & Diesel

GMB CLUTCH RELEASE BEARING



OE Maker		Clutch	Vehicle Model	Engine Type
ISUZU	light Bus /Trucks	GC20080	KB/LUV Pick ups (Chevrolet LUV) KB, KBG, KBD	1600cc, 1800cc, 2000cc, 2200cc
		GC72080	Light Bus BLG22-24, BLD23-24, 30N	2000cc, 2400cc, 2800cc
		GC41080	Light Bus BLD23-24, BL34, BLD35-36, BL35	2000cc,2400cc,2800cc,3300cc
		GC90010	Light Bus BL36-46	3300cc
		GC72080	Light Bus BE20	3600cc
		GC51080	Light Bus BE22	3900cc
		GC20080	Microbus WFR	1800cc, 2000cc
		GC31010	MU UCS	2500cc
	Rodeo/Faster	GC31010	Rodeo TFS52	2200cc
		GC01010	Rodeo/Faster S-TFS52, U-TFS52	2200cc, 2200cc 4WD Diesel
		GC31010	Rodeo/Faster TFS55, TFR55	2700cc, 2800cc
	WFR	GC20080	Van/Truck WFR10, 11, 50, 51V, 51W, 121, 122	1600cc, 1800cc, 2000cc, 2200cc
		GC01010	WFR/WFS series - Van/Truck	2000cc, 2200cc
	KIA	Avella/Pride	GC11010	Avella B3/Pride
Concord		GC61010	Concord F8	1800cc, 2000cc
Capital		GC61010	Capital B5	1500cc, 1800cc
Sephia		GC61010	Sephia	1800cc, 2000cc
Potentia		GC61010	Potentia	2000cc, 2200cc, 3000cc
Morning		GC55110	Morning	
Sportage		GC61010	Sportage	2000cc, 2200cc
Bongo/Frontier		GC61010	Bongo/Frontier	
MAZDA	121/Cosmo	GC11010	121 DA13, BF10	1100cc, 1300cc
		GC11010	121 DB, DC series	1300cc
		GC41080	121, 121L/Cosmo CD2VC	1800cc
		GC21010	121, 121L/Cosmo CD2VC	1800cc
		GC21010	121, 121L/Cosmo HBPH8	1800cc
		GC41080	121, 121L/Cosmo CD3MC	2000cc
		GC21010	121, 121L/Cosmo CD3MC	2000cc
		GC21010	121, 121L/Cosmo HBPHE, HBSHE, HBEP, EBES	2000cc
	323	GC91010	323	1100cc, 1300cc, 1500cc
		GC22010	323 BG	1300cc, 1600cc, 1700cc, 1800cc
		GC22010	323 B3, B6, BP	1300cc, 1600cc, 1800cc & 1800cc DOHC, Diesel
		GC22010	323 BW	1500cc, 1600cc, 1700cc 2WD Gasoline, Diesel

				
OE Maker		Clutch	Vehicle Model	Engine Type
MAZDA	323	GC91010	323 B6	1600cc
		GC61010	323 B6	1600cc DOHC Turbo 2WD ECE
		G61010	323 BP, BG	1800cc, 1800cc DOHC Turbo 4WD
		GC22010	323 BG	2WD Diesel 1300cc, 1600cc, 1700cc, 1800cc
		GC22010	323 BW	2WD Gasoline 1500cc, 1600cc, 1700cc
		GC22010	323 BG	2WD Gasoline 1300cc, 1600cc, 1700cc, 1800cc
		GC22010	323 BG	DOHC Gasoline 1300cc, 1600cc, 1700cc, 1800cc
		GC61010	323 (GLC) Turbo/Familia BFMR (DOHC)	1600cc 4WD
		GC91010	323(GLC)/Familia FA3PS, 4PS, 5PS, 4TS, 4TV, 5TV, 6TM, 6TS	1000cc, 1300cc, 1400cc
		GC61010	323 (GLC)/Familia BF5R, BF5R	1500cc 4WD
		GC91010	323 (GLC)/Familia BF5P	1500cc EGI engine
		GC91010	323 (GLC)/Familia BD1051, BF5P, BF5P; BD1011, 1031:BF3P, 3V; BF5P (OHC)	1500cc, 1100cc, 1300cc
		GC61010	323 (GLC)/Familia BFMP (DOHC)	1600cc
		GC91010	323 (GLC)/Familia BFMP (OHC)	1600cc
		GC61010	323 (GLC)/Familia BFMR (OHC)	1600cc 4WD
		GC21010	323 (GLC)/Familia E-BFMR, BFMR	1600cc 4WD Gasoline
		GC91010	323 (GLC)/Familia BF7P, BF7V	1700cc
	GC91010	323 (GLC)/Familia Station Wagon BF5W	1500cc EGI	
	GC61010	323 (GLC)/Familia Turbo BFMP (DOHC)	1600cc	
	GC41080	616, 626/Capella SN, SU2A, SNA, BSNA	1500cc, 1600cc	
	GC21010	616, 626/Capella GC6P	1600cc FWD	
	GC61010	616, 626/Capella GC6P	1600cc FWD	
	GC41080	616, 626/Capella SV2A, CB1VS	1800cc	
	GC61010	616, 626/Capella GC8P(EFI)	1800cc FWD	
	GC61010	616, 626/Capella GC8P	1800cc FWD /GBX:4	
	GC21010	616, 626/Capella GC8P	1800cc FWD /GBX:5	
	GC21010	616, 626/Capella CB2MS, CB2MH	2000cc	
		616, 626 /Capella		



GMB CLUTCH RELEASE BEARING





OE Maker	Clutch	Vehicle Model	Engine Type	
MAZDA	616, 626 /Capella	GC21010	616, 626/Capella GCEP	2000cc FWD
		GC61010	616, 626/Capella GCEP	2000cc FWD Turbo
		GC21010	626 F6, F8, FE	1600cc, 1800cc, 2000cc
		GC61010	626 F6, F8, FE	1600cc, 1800cc, 2000cc
		GC21010	626 GD, GD1	1600cc, 1800cc, 2000cc, 2200cc
		GC21010	626 F6, F8, FE	1600cc, 1800cc, 2000cc, 2200cc & Diesel
		GC21010	626 F6, F8, FE, F2, RF	1600cc, 1800cc, 2000cc, 2200cc & Diesel
		GC21010	626 RF	Diesel
		GC61010	626 RF	Diesel
		GC21010	626/Capella GD1	1600cc, 1800cc, 2000cc, 2200cc
	808, 818 /Grand Familia	GC70080	808, 818/Grand Familia STC, STCV	1300cc
		GC41080	808, 818/Grand Familia SN3, SN4	1600cc
	929	GC21010	929 MA	2000cc
		GC21010	929 FE	2000cc
		GC61010	929 FE, F2	2000cc, 2200
		GC21010	929L MA	2000cc
		GC41080	929, 929L/Luce SVA, SVAV:LA2VS, 3VS	1500cc, 1800cc
		GC21010	929, 929L/Luce 2VV	1800cc
		GC841080	929, 929L/Luce 2VV	1800cc
		GC41080	929, 929L/Luce LA4VS, VV:LA4MS, MV	1800cc, 2000cc
		GC210 10	929, 929L/Luce LA4VS, VV:LA4MS, MC, LA7MV, HBPH8, HBPHE	1800cc, 2000cc
GC21010		929, 929L/Luce HBEP, HBES	2000cc	
GC61010		929, 929L/Luce HCEP	2000cc	
GC21010		929, 929L/Luce LA4SS	2200cc	
GC21010		929, 929L/Luce HBPS2	2200cc	
Capella	GC21010	Capella GD6P	1600cc	
	GC21010	Capella E-GV6V, E-GD8S, E-GD8P, GD8PF, E-GDES	1600cc, 1800cc, 2000cc	
	GC21010	Capella GD8A, GD8B	1800cc	
	GC21010	Capella GDEA, GDEB	2000cc	
	GC21010	Capella Telstar E-GDEP, GDEPF	2000cc	
Cosmo	GC21010	Cosmo E-HBES, E-HBEP	2000cc	
	GC21010	Cosmo N-HBPS2	2200cc	

					
OE Maker	Clutch	Vehicle Model		Engine Type	
MAZDA	D1500	GC72080	D1500/Craft DUC9	1500cc	
	Etude	GC70080	F1000 FPAV, FPAH	1000cc	
	Familia	GC22010	Familia BG5P, BG5S; BG3P, BG3S		1300cc, 1500cc
		GC91010	Familia E-BD1031, E-BD1051		1300cc, 1500cc
		GC21010	Familia E-BFMR, E-BFMRF		1600cc
		GC21010	Familia E-BFMR, BFMRF		1600cc 4WD Gasoline
		GC61010	Familia BG6R, BG6Z; BG8R, BG8Z		1600cc, 1800cc
		GC22010	Familia BW7W		1700cc
		Festival/Laser /Luce/MX5	GC22010	Festival E-DA1PF, E-DA3PF, E-DAJPF	
	GC22010		Laser BG3PF		1300cc
	GC91010		Laser E-BE5PF		1500cc
	GC21010		Laser E-BFMR, E-BFMRF		1600cc
	GC61010		Laser BG8RF		1800cc
	GC21010		Luce E-HBES, E-HBEP, L-LA4MV; N-HBPS2		2000cc
	GC61010		Luce E-HCEP		2000cc
	Parkway	GC72080	Parkway/26 AEVB43:EVB43:TA3H4F		2000cc, 2700cc, 3000cc
		GC41080	Parkway/26 TA3H4F		3000cc
		GC21010	Parkway/26 WVLSF, WWF4B		3000cc
		GC61010	Parkway/26 WWL4B		3500cc
	RX/Savanna	GC41080	RX 2, RX 3, RX 4, RX 5/Savanna/Cosmo S102A		1150cc, 1300cc
		GC21010	RX 4, RX 7 LA42S, LA52S, SA22C		1150cc
		GC21010	RX 5/Cosmo HBSN2		1150cc
		GC41080	RX 5/Cosmo CD23C, CD73C, CD83C		1300cc
		GC21010	RX 5/Cosmo CD23C, CD73C, CD83C		1300cc
		GC21010	RX 7/Savanna SA22C		1150cc
		GC61010	RX 7/Savanna FC3S		1300cc
		GC61010	RX 7/Savanna FC3C, FC3S		654cc x 2
		GC61010	RX 7/Savanna FC42, FC56		654cc x 2
		GC21010	Savanna E-SA22C		573cc x 2
		GC21010	Savanna E-FC3S		654cc x 2
	B Series Pick Up /Proceed /Courier	GC41080	B Series Pick Up/Proceed/Courier BNA61, BTA67		1300cc, 1600cc
		GC21010	B Series Pick Up/Proceed/Courier PE2N, PE2V		1600cc, 1800cc, 2000cc
GC21010		B Series Pick Up/Proceed/Courier JM2UC, UD		2000cc, 2200cc	
GC21010		B1600 UDX061, UDY061		1600cc	
GC41080		B1600, B1800 NA, NC		1600cc, 1800cc	

GMB CLUTCH RELEASE BEARING

				
OE Maker		Clutch	Vehicle Model	Engine Type
MAZDA	B Series Pick Up /Proceed /Courier	GC21010	B1600, B1800 NA, NC	1600cc, 1800cc
		GC21010	B1600, B1800, B2000, B2200 NA, VC, MA, S2	1600cc, 1800cc, 2000cc, 2200cc&Diesel
		GC21010	B1600, B1800, B2000 UDX, UDY, UDY0E1, UD1Y,UDX, UDY	1800cc, 2000cc, Diesel
		GC21010	B1600, B2000 UF	1600cc, 2000cc (EKCBept EGI)
		GC61010	B2600 AM	2600cc
	Bongo	GC21010	Bongo E-SS88W	1800cc
		GC21010	Bongo E-SS88R	1800cc
		GC21010	Bongo N-SRF9W	2000cc
		GC21010	Bongo SSE8R, SSF8R	2000cc
		GC21010	Bongo E-SRE9W, M-SREAV, N-SR29V, N-SR2AV	2000cc, 2200cc
		GC21010	Bongo SD29M	2200cc
		GC21010	Bongo SE28M	2200cc
	GC61010	Bongo Brawny E-SRE9W	2000cc	
	E Series /Boxer/Bongo /Titan	GC21010	E Series/Boxer/Bongo/Titan E-SS88R	1800cc 4WD Gasoline
		GC21010	E Series/Boxer/Bongo/Titan SD89T	1800cc (Single wheel)
		GC21010	E Series/Boxer/Bongo/Titan SS88W, SR89V	1800cc, 2000cc, 2200cc (Single wheel)
		GC72080	E Series/Boxer/Bongo/Titan EVB12, 13, 43	2000cc
		GC21010	E Series/Boxer/Bongo/Titan BA2S8, BA2S9	2000cc
		GC21010	E Series/Boxer/Bongo/Titan SRE9W, SREAM, SEF8T, SSF8V, SRF9W	2000cc
		GC61010	E Series/Boxer/Bongo/Titan E-SRE9W	2000cc
		GC61010	E Series/Boxer/Bongo/Titan SSE8W	2000cc
		GC21010	E Series/Boxer/Bongo/Titan N-SSE8R;Q-SS28M/R, N-SSF8T/V/W,E-SE/SS88	2000cc, 1800cc 4WD Gasoline
		GC21010	E Series/Boxer/Bongo/Titan SREAV, SDEAT	2000cc (Single wheel)
		GC21010	E Series/Boxer/Bongo/Titan SR2AV, 29V	2200cc
		GC61010	E Series/Boxer/Bongo/Titan N-WE5AT; N-WEF4C, WEF4T	2500cc, 3000cc
		GC72080	E Series/Boxer/Bongo/Titan EKCB12, 13, 43	2700cc, 3000cc
		GC41080	E Series/Boxer/Bongo/Titan TA3H1, H4	3000cc
		GC610 10	E Series/Boxer/Bongo/Titan P-WEL4C, WEL4T, WEL7T, WELAE, WELAT	3500cc EKCBept Turbo

				
OE Maker		Clutch	Vehicle Model	Engine Type
MAZDA	E Series /Boxer/Bongo /Titan	GC31080	E Series/Boxer/Bongo/Titan EZA14, 45, 75	4100cc
		GC61010	E1800 F8	1800cc
		GC21010	E1800 F8	1800cc Van & Wagon
		GC72080	E2000 VA	2000cc
		GC41080	E2000 VA	2000cc
		GC61010	E2000 FE	2000cc/GBX:4
		GC21010	E2000 FE	2000cc/GBX:5
		GC21010	E2000, E2200 FE, R2	2000cc & Diesel
		GC21010	E2200 SE28M	2200cc
		GC21010	E2200 S2	Diesel
		GC21010	E2200 R2	Diesel
		GC72080	E2700, E3000 XB, HA	Diesel
		GC41080	E2700, E3000 XB, HA	Diesel
		Persona /Pickup /Presto	GC21010	Persona E-MA8P, E-MAEP
	GC70080		Pickup/Familia Truck BPB55:BPC55:BTA55, 65:fa2t55, 65	1000cc, 1200cc, 1300cc
	GC70080		Presto FA3	1000cc, 1300cc
	T Series	GC21010	T Series WEW051, WEWOF1 & 2:D:WEXOF1 & 2:WEYOF1& 2	2500cc, 3000cc
		GC61010	T Series WE5AT, WEFAT:WEF4C/4T:WELAT WEL4T, 4H	2500cc, 3000cc, 3500cc
		GC31080	T Series WEX011:WEY011:WEZ011	4100cc
		GC21010	T2000 VA	2000cc
		GC21010	T2000 WEEAT, WEE4T	2000cc
		GC61010	T2500, T3000, T3500 XA, HA, SL	Diesel
		GC61010	T2600 AM	2600cc
		GC21010	T3000 HA	Diesel
		GC31080	T3500 SL	Diesel Turbo
		GC31080	T4100 ZB	Diesel
		GC61010	Titan N-WE5AT	1.5t
		GC61010	Titan N-WEF4T, AT, AF, AY, AD	2.0 - 3.0t
		GC61010	Titan P-WEL4C, 4T, AF, AD, AT	2.0 - 3.0t
		GC61010	Titan N-WEFAT, N-WE5AT	2.0t, 1.5t
		GC61010	Titan WGFAD; WGLAD, WGL4H; WG5AT	3000cc, 3500cc, 2500cc
		GC31080	Titan N-WE17T, N-WE11D	3.5 - 4.0t
		GC31080	Titan P-WEL7T	4.0t

GMB CLUTCH RELEASE BEARING

					
OE Maker	Clutch	Vehicle Model	Engine Type		
MITSUBISHI	Chariot /Space Wagon	GC40010	Chariot E-D09W, E-D05W, E-D08W	1800cc, 2000cc	
		GC40010	Space Wagon/Chariot D02/03/14/05/08/09W	1600cc,1800cc,2000cc,4WD	
		GC40010	Space Wagon N31W, N33W	1800cc, 2000cc	
	Colt	GC40010	Colt C11A, 12A, 13A, 14A, 15A	1200cc, 1300cc, 1500cc, 1600cc, Turbo & Diesel	
		GC40010	Colt A151, A155, A152, A156	1200cc, 1400cc	
		GC40010	Colt C51A, 51V, 52A, 53A, 54A, C58A	1300cc, 1500cc, 1600cc, 1800cc DOHC & Diesel	
		GC81080	Colt/Delica T120	1600cc	
		GC81080	Colt/Mirage T	1400cc	
		GC40010	Colt/Mirage/Mirage II A. . . C. . .	1200cc,1300cc,1400cc,1500cc 1600cc, 1800cc	
		GC40010	Colt/Lancer C51, 52, 53, 54/58/61, 62, 63, 64, 65, 66, 67, 68, 69/76/77	1200cc,1300cc,1400cc,1500cc 1600cc, 1800cc	
		Cordia	GC40010	Cordia E-A211A, E-A212A, E-A213A	1400cc, 1600cc, 1800cc
			GC40010	Cordia A212A	1600cc
	GC40010		Cordia/Tredia A;NF24S, 41	1400cc, 1600cc, 1800cc	
	Eclipse	GC40010	Eclipse D32A, D33A	2000cc	
		GC40010	Eclipse D21A, D22A, D27A	1800cc, 2000cc 4WD	
	Eterna /Diamante	GC40010	Diamante F11A, 13A	2000cc, 2500cc	
		GC40010	Eterna E32A, 35A, E39A	1800cc, 2000cc	
		GC40010	Eterna Sigma E-E12/13/14/15/17A	1800cc, 2000cc	
		GC32010	Eterna Sigma/Lambda E-A162A, E-A164A	1800cc, 2000cc	
	Forte	GC32010	Forte L-L026G	2000cc	
	Galant	GC20080	Galant A51...,52...,53...,54...,55, 61, 62, 63, 112	1300cc,1400cc,1500cc,1600cc	
		GC20080	Galant A121	1600cc	
		GC40010	Galant E11A,E12A,E15A,E14A,E31A,E32A, E33A,E34	1600cc, 1800cc, 2000cc & Diesel Turbo	
		GC41080	Galant A114, 115, 57C	1600cc, 1850cc, 2000cc	
		GC40010	Galant E32AR, E32/37/52/54/55/57/64/75/88A	1800cc, 2000cc, 2500cc	
		GC41080	Galant A123	2000cc	
		GC32010	Galant A163	2000cc	
		GC40010	Galant E16A	2400cc	
		GC40010	Galant E38A, E39A, R39A	2000cc 4WD	
		GC40010	Galant E38A, E39A	2000cc 4WD	

				
OE Maker		Clutch	Vehicle Model	Engine Type
MITSUBISHI	Galant	GC20080	Galant Sigma A121	1600cc
		GC40010	Galant Sigma F16A	3000cc
		GC40010	Galant Sigma E-E11/12/13/14A/14AR, N-E14A	1600cc, 1800cc
		GC41080	Galant Sigma A123	2000cc
		GC40010	Galant Sigma E-E15A, E-E17A	2000cc
		GC32010	Galant Sigma/Lambda E-A162A, E-A164A	1800cc, 2000cc
		GC40010	Galant Sigma/Lambda/Eterna Sigma/Sapporo E11/12/14/15/17A, E31/32/34A	1600cc, 1800cc, 2000cc FWD
		GC20080	Galant Sigma/Lambda/Eterna Sigma/Sapporo A121/131	1600cc
		GC32010	Galant Sigma/Lambda/Eterna Sigma/Sapporo A162	1800cc Turbo
		GC41080	Galant Sigma/Lambda/Eterna Sigma/Sapporo A122/3/132/133	1850cc, 2000cc
		GC32010	Galant Sigma/Lambda/Eterna Sigma/Sapporo A163/4/7	2000cc, 2300cc, 2600cc
		GC32010	Sapporo A163, A164, A167A	2000cc, 2300cc, 2600cc
	Jeep	GC81080	Jeep J3, 30, 32	2000cc, 2300cc, 2400cc, 2600cc, 2700cc
		GC701080	Jeep J24, 36, 44, 54	2000cc, 2300cc, 2400cc, 2600cc, 2700cc
		GC22080	Jeep J20, 22, 25, 26, 28, 34, 42, 52, 58	2000cc, 2300cc, 2400cc, 2600cc, 2700cc
		GC81080	Jeep J36, 38, 54, 55	2000cc, 2300cc, 2400cc, 2600cc, 2700cc
		GC22080	Jeep J24, 36, 38, 44, 46, 54, 55, 56	2000cc, 2300cc, 2400cc, 2600cc, 2700cc
		GC81080	Jeep J26, 58	2000cc, 2300cc, 2400cc, 2600cc, 2700cc
		GC01080	Jeep J24, 24H, 26, 36, 38, 44, 46, 54, 56, 58	2000cc, 2300cc, 2400cc, 2600cc, 2700cc
		GC22080	Jeep J27, 36R, 37, 47, 54B2, 59	2000cc, 2300cc, 2400cc, 2600cc, 2700cc
GC22080		Jeep L-J59, L-J57	2000cc, 2600cc	
GC22080		Jeep N-J54	2700cc	
Lancer	GC40010	Lancer C15A, C11A, C12A, C13A, C14A	1200cc, 1300cc, 1500cc, 1600cc	

GMB CLUTCH RELEASE BEARING

				
OE Maker		Clutch	Vehicle Model	Engine Type
MITSUBISHI	Lancer	GC20080	Lancer A75	
		GC20080	Lancer A72	1200cc, 1400cc
		GC40010	Lancer C61/62/63/64/65/66/67/68/76/77A	1200cc,1300cc,1500cc,1600cc 1800cc, 2000cc
		GC40010	Lancer C61A, 62A	1300cc, 1500cc
		GC40010	Lancer C12V, C14V	1500cc & Diesel Station Wagon
		GC40010	Lancer C77A	1800cc 4WD
		GC40010	Lancer C37V	1800cc 4WD
		GC40010	Lancer C64A	DOHC Diesel
		GC40010	Lancer C37V	Station Wagon
		GC40010	Lancer Flore All Models	1200cc,1300cc,1400cc,1500cc, 1800cc
		GC40010	Lancer Flore C11V	1300cc
		GC40010	Lancer Flore C12V, 12W	1500cc
		GC40010	Lancer Flore N-C14A	1800cc
		GC40010	Lancer Flore C14V, 14W	1800cc
		GC40010	Lancer-F A155, A156, A158	1200cc, 1400cc
		GC40010	Lancer-S/Wagon C37V	1800cc 4WD
		GC20080	Lancer/Lancer Celeste A71, 75, 141, 142, 72VE, 72VJ, 143	1200cc, 1400cc
		GC20080	Lancer/Lancer Celeste A174A	1400cc/GBX:4
		GC20080	Lancer/Lancer Celeste A172A	1400cc/GBX:4
		GC20080	Lancer/Lancer Celeste A73, A77, A144A	1600cc
	GC32010	Lancer/Lancer Celeste A175A	1600cc Turbo	
	GC41080	Lancer/Lancer Celeste A78M	2000cc	
	GC32010	Lancer/Lancer Celeste A146A, A176A	2000cc	
	Minica	GC90080	Minica A	360cc, 500cc, 550cc - RWD
		GC90080	Minica E-A107A, E-A107V, M-A107V	550cc
		GC90080	Minica Van, Cab, Pick Up	360cc, 500cc, 550cc
	Mirage	GC40010	Mirage C51-3/61-3A, C11/2/14V/W, C34/37W, E-C11/2/4A, CA2/5A, CB2/5A	1300cc,1500cc,1600cc, 800cc
	Pajero /Montero /Shogun	GC30010	Pajero/Montero L146GW	3000cc
		GC32010	Pajero E-L041GW, E-L046GW, L-L041GW	2000cc, 2300cc
		GC81010	Pajero L049GV, L044G	2500cc
		GC30010	Pajero L141G, 141GW, 146GW	3000cc

				
OE Maker	Clutch	Vehicle Model	Engine Type	
MITSUBISHI	Pajero /Montero /Shogun	GC20080	Pajero	V6 4x4 leisure
		GC30010	Pajero/Montero L146GW	3000cc
		GC32010	Pajero/Montero L034G,L043GV/48GV/GW, L042G/GV, L047GV/GW	Diesel, 2600cc
		GC81010	Pajero/Montero L044G/GV,L049GV/GW,L042G/GV, L047GV/GW	Diesel, 2600cc
		GC32010	Pajero/Montero/Shogun L041/42GN/GW, L043G/GW, LO47, LO48G	2000cc, 2300cc, 2600cc
		GC81010	Pajero/Montero/ShogunL041G,L044G,L046G,L049G	2000cc, 2500cc
		GC81010	Pajero V24G, V24W, V44W	2500cc
		GC30010	Pajero V23C, V23W, V43W	3000cc
		GC32010	Pajero V21, V41	2400cc
	Starion	GC32010	Starion A	2000cc
		GC81010	Starion A187A	2600cc
		GC32010	Starion A183A	2000cc
	Space Runner	GC40010	Space Runner N11W, N18W, N21W	1800cc, 2000cc
	Tredia	GC40010	Tredia E-A211/2A, A211/3/4/5A, A215/7G/A	1400cc,1600cc,1800cc,Turbo, 1500cc, 2000cc
	Canter	GC20080	Canter	3300cc Diesel Truck
		GC30010	Canter N-FB120BW, N-FB120B, N-FB100B	1.0, 1.5t
		GC30010	Canter N-FB300	1.5 Ton
		GC30010	Canter P-FG335, 435	2 - 3 Ton - 4WD Diesel
		GC72080	Canter T91, 95, 204, 214	2000cc
		GC22080	Canter T96, 98, 200, 205, 206, 207, 210, 215, 215ZH, 216, 217, 220	2000cc,2300cc,2400cc,2700cc
		GC22080	Canter FC201, 211	2400cc
		GC30010	Canter FE100, 120, FB100, 120	2700cc
		GC30010	Canter FB300A, 300B, FE300B, 300BP	2700cc
		GC30010	Canter FE100, 101, 111, 114, 120, 121, 124, 131, 134, 214	2700cc, 3300cc
		GC30010	Canter FE221, 223, 224, 234, FB100, 120, FE211	2700cc, 3300cc
		GC30010	Canter P-FG335, P-FG435	2.0 - 3.0t
		GC30010	Canter P-FE1/2/3/4 series	2.0 -3.0t, 1.5t
		GC30010	Canter FE301B, 301BD	3300cc
		GC30010	Canter FE434C, 434E	3300cc
	GC30010	Canter FE315BD, FB308A, FB308B	3300cc, 2800cc	

GMB CLUTCH RELEASE BEARING

				
OE Maker		Clutch	Vehicle Model	Engine Type
MITSUBISHI	Canter	GC30010	Canter FE301B,301BD ;FE305B,305BD,FE315BD,315BN	3300cc, 3600cc
		GC30010	Canter FE434C,434E,FE437E,437EV,437F,447C,447E,447EV	3300cc, 4200cc
		GC30010	Canter F3325BV,325E,325EV,435C,435E,435ED	3600cc
		GC30010	Canter FE305B, 305BD, FE315BD, 315BN	3600cc
		GC30010	Canter F3325BV, 325E, 325EV, 435C, 435E, 435ED; FB300A, 300B, FE300B, 300BP	3600cc, 2700cc
		GC74010	Canter FE439E, 439EV, 439F, 449C, 449E, 449F	900cc
		GC30010	Canter P-FE214FZ,P-FE214EZ,P-FE214EZZ	3.0t, 3.5t
		GC30010	Canter FE437E, 437EV, 437F, 447E, 447EV	4200cc
		GC30010	Canter FE317BD, 317BN	4200cc
		GC30010	Canter Cargo FC432,FC312,332,432,FC332,FC312	2600cc
		GC30010	Canter Cargo FC312, 332, 432; FB300, 433, 436, FE421, 431, 424, 434, 444	32600cc, Diesel
		GC01080	Canter Cargo FE211	Diesel
		GC30010	Canter Cargo FE211	Diesel
		GC30010	Canter Cargo FE421, 431, 4424, 434, 444	Diesel
		GC30010	Canter Cargo FB300, 433, 436	Diesel
	GC30010	Canter Cargo FE301, 304, 311, 314, 331, 334, 421, 424, 431, 434, 436, 444	Diesel	
	GC32010	Delica E-L035PW	1800cc	
	GC32010	Delica P03W	2000cc	
	GC32010	Delica N-L038GV, 38P/GW/PV/PW,68PV/PW/68P, L-L037GV, E-LO37GW	2000cc, 2300cc	
	GC32010	Delica P24W	2400cc	
	GC81010	Delica L039P, P25W	2500cc	
	GC20080	L200 L021P	1600cc	
	GC32010	L200 L022P, L022G	2000cc	
	GC32010	L200 K02T, K12T, K22T, K32T, K15T, K35T	2000cc, 2400cc	
	GC32010	L200 L026P, L026G, L028P, L028G	2000cc & Diesel	
	GC32010	L200 L..P, L..G	2000cc, 2300cc	
	GC81010	L200 K03T, K24T, K34T	Diesel 4WD	
	GC32010	L200 K04T	Diesel LHD	
GC81010	L200 K04T	Diesel LHD		
GC81010	L200 K13T, K14T, K24T	2500cc,2600cc,Diesel 4WD LHD		

				
OE Maker		Clutch	Vehicle Model	Engine Type
MITSUBISHI	L200/L300 /Delica	GC32010	L200 K14T, K24T	Diesel Pick-up LHD, Diesel(4WD)LHD
		GC81010	L200 K04T, K24T, K14T, K34T	Diesel RHD(4WD), EKCBept Pick-up LHD
		GC32010	L300 P03W, P23W	2000cc
		GC32010	L300 L037G	2000cc 4WD
		GC81010	L300 P05V, P05W, P15V, P15W, P25V, P25W, P45V	2500cc Diesel
		GC81080	L300 Minibus/Colt Minibus T120	1400cc
		GC20080	L300 Minibus/Colt Minibus L031PW, L032PW	1400cc, 1600cc
		GC32010	L300 Minibus/Colt Minibus L038PW, L068PW	1800cc, 2300cc
		GC20080	L300/Delica L031P	1400cc
		GC32010	L300/Delica L036P	1400cc
		GC32010	L300/Delica LO32P, LO34P, LO33PWE, O33WUNU	1400cc, 1600cc
		GC32010	L300/Delica LO37G, LO38G, P03W, P23V, P23W, LO38P, L068P, L068PW	2000cc, 2300cc
	GC81010	L300/Delica LO39P, P05V, P15V, P15W, P05W, P25V, P25W	2300cc, 2500cc	
	Mini Cab	GC90080	Mini Cab M-L015PV, M-L015P	550cc
	Rosa Bus	GC30010	Rosa BE434F, 435F	3300cc, 3600cc
		GC22080	Rosa Bus B207	2400cc
		GC32010	Rosa Bus BC212	2600cc
		GC22080	Rosa Bus B200, 210, 215	2700cc
		GC30010	Rosa Bus BE201D, 211D	3300cc
		GC01080	Rosa Bus BE201, 201D, 211, 211D	3300cc
GC30010		Rosa Bus BE211, BH214F	3300cc	
GC22080		Rosa Bus B360	4000cc	
GC71080		Rosa Bus BH212, 212F	4000cc	
NISSAN	GC60080	120Y, 130Y, 140Y, 150Y All Models	1200cc, 1300cc, 1400cc, 1500cc	
	GC60080	140B, 160B, 180B, 200B All Models	1400cc, 1600cc, 1800cc, 2000cc	
	GC60080	160K, 180K C, BC, HC, KC, PC, VC, KBC, KHC, KPC, VBC, VPC, WPC 110, 111, 210, 211	1600cc, 1800cc	
	GC60080	180K, 240KGT C210	1800cc, 2400cc	
	GC60080	180SX, 200SX S, HS, KS, PS, US, KHS, KPS	1800cc, 2000cc	
	GC60080	300ZX, SX Z31, S13	3000cc	
	GC92010	2000 SX	DOHC 16V	

GMB CLUTCH RELEASE BEARING

				
OE Maker	Clutch	Vehicle Model	Engine Type	
NISSAN		GC60080	2000 DR Turbo All Models	2000cc
		GC60080	200C - all models eKCBept STD	2000cc
		GC802080	200C - STD model ONLY	2000cc
		GC60080	200C, 260C 230	2000cc, 2600cc
		GC60080	200K, 240K, 280K All Models	2000cc, 2400cc, 2800cc
		GC60080	200L C230	2000cc
		GC60080	200L, 240L, 280L All Models	2000cc, 2400cc, 2800cc
		GC60080	220C - all models eKCBept STD & Q series Taxi	2200cc
		GC02080	220C - STD model & Q series Taxi only	2200cc
		GC60080	220C, 240C, 260C, 280C 330	2400cc,2600cc,2800cc&Diesel
		GC60080	240C, 260C, 280C All Models	2400cc, 2600cc, 2800cc
		GC60080	240L C230	2400cc
		GC60080	240Z,260Z,280Z,280ZX,300ZX/Fairlady Z All Models	
		GC02080	710 140J, 160J	1400cc/GBX:3
		GC60080	710 140J, 160J	1400cc, 1600cc
	GC60080	810 160B, 180B	1600cc, 1800cc	
	GC60080	A10 140J, 160J	1400cc, 1600cc	
	Ad Van	GC41010	Ad Van VB11, VHB11	1300cc, 1500cc
		GC93010	Ad Van VSB11, VHB11	1500cc, 1700cc
		GC41010	Ad Van VSB11	1700cc
	Altima	GC92010	Altima A31	2000cc LHD
		GC60080	Altima A31	2000cc RHD, 2400
	Auster/Stanza	GC60080	Auster/Stanza PA11	1600cc
		GC41010	Auster/Stanza T11, KT11, FT11, T12, FT12	1600cc
		GC60080	Auster/Stanza GPA10:FPA, FRA, GPA, GRA11	1600cc, 1800cc
		GC41010	Auster/Stanza E-T11, PT11, KPT11	1600cc, 1800cc
		GC41010	Auster/Stanza PT11, KPT11, FPT11	1800cc
		GC193010	Auster/Stanza PT12, FPT12	1800cc
		GC41010	Auster/Stanza FHLT11, KHLT11	2000cc
		GC60080	B110	1200cc
	Bluebird	GC60080	B210	1200cc
		GC60080	B310	1200cc, 1400cc, 1500cc
		GC41010	Bluebird RU11, VRU11, E-RU11, E-V12	1500cc, 1600cc, 1600cc FWD
		GC60080	Bluebird WRJ, WTJ, WMJ, WPJ, WUJ 910	1600cc, 1800cc
		GC60080	Bluebird J, P, U, RJ, TJ, KJ, KP, KM, KU, MJ, PJ,	1600cc, 1800cc

				
OE Maker		Clutch	Vehicle Model	Engine Type
NISSAN	Bluebird		UJ, VJ, KPJ, KUJ, VTJ	
		GC60080	Bluebird 910	1600cc, 1800cc
		GC93010	Bluebird U11, T12	1600cc, 1800cc
		GC41010	Bluebird U11	1600cc, 1800cc, 2000cc
		GC93010	Bluebird WU11	1800cc
		GC93010	Bluebird U12	1800cc
		GC93010	Bluebird U11, KU11, WU11	1800cc FWD
		GC60080	Bluebird Y, KY, JY, JKY 910	2000cc
		GC92010	Bluebird EJ, VEJ, WEJ 910	2000cc
		GC12010	Bluebird N-VEU11	2000cc Turbo
		GC02010	Bluebird U12	GBX:5 Trans KA24E Engine
		GC92010	Bluebird 910	Diesel
		GC12010	Bluebird Maxima YU, KYU, WYU11	2000cc
		GC02080	Bluebird/Bluebird Estate Wagon 410/11 PA410, WPA410/1	1000cc, 1200cc, 1300cc
		GC60080	C20 Series All Models	1200cc, 1400cc
	GC60080	C341 Truck DC, YC, MC341	2000cc, 3000cc, 3300cc	
	GC92010	Cedric MY30, NJY31, TNJY31, CMJY31, MYJ31	2000cc	
	GC60080	Cedric E-KY30, Y30, WY30, PY30, Y31, 430, N-UY30	2000cc, 2400cc, 2800cc, 3000cc & Diesel	
	GC60080	Cedric UY31, TY31, VY30, TUJY31, UYJ31	2000cc, 2800cc	
	GC60080	Cedric N-VHY30, HY30, KHY30, WHY30; E-KPY30	2800cc, 2000cc, 3000cc	
	GC02010	Cedric Y31	Diesel	
	GC60080	Cedric/Gloria All Models	2000cc, 2300cc, 2800cc, 3000cc	
	GC60080	Cefiro E-A31, E-CA31	2000cc	
	GC92010	Cefiro A31	2000cc LHD	
	GC60080	Cefiro A31	2000cc RHD, 2400cc	
	GC60080	Cherry Vanette All Models	1200cc, 1500cc, 2000cc	
	GC60080	Fairlady Z All Model eKCBept CZ/CGZ/Z/GZ 32	2000cc, 2400cc, 2800cc, 3000cc	
	GC92010	Fairlady Z CZ/CGZ/Z/GZ 32	3000cc	
	GC60080	Gazelle E-BS12, RBS12, US12, RUS12, JS12, RJS12, S12, RS12	1800cc	
	GC60080	Gazelle (R)S, JS, US12:S110:(K)S, PS 110Y	1800cc, 2000cc	
GC92010	Gloria MY30, NJY31, TNJY31	2000cc		
GC60080	Gloria VY30	2000cc		

GMB CLUTCH RELEASE BEARING





OE Maker	Clutch	Vehicle Model	Engine Type	
NISSAN	Gloria	GC92010	Gloria CMJY31, MJY31	2000cc
		GC60080	Gloria E-KY30, Y30, WY30, KPY30, PY30	2000cc, 3000cc
		GC60080	Gloria TY31, TUJY31, UJY31, UY31	2000cc, 2800cc
		GC60080	Gloria N-VHY30, HY30, KHY30, WHY30	2800cc
		GC60080	Gloria N-UY30, N-KUY30	2800cc
		GC60080	Gloria VUY30, WUY30	2800cc
	Junior	GC02080	Junior 41, N41	1600cc, 2000cc
		GC02080	Junior 140	2000cc, 2400cc & Diesel
		GC60080	Junior 140	2000cc, 2400cc & Diesel
		GC60080	Junior Pickup All Models	1600cc,2000cc,2200cc,2500cc
	Langley	GC41010	Langley E-PN12 Langley N-SN12, RSN12, E-RPN12, E-KHN12	1300cc
		GC41010	RHN12, HN12	1300cc, 1500cc, 1700cc
		GC41010	Langley HN12, M12	1500cc
		GC93010	Langley BFN13, BHN13	1500cc
		GC41010	Langley SN12	1700cc
		GC93010	Langley BSN13	1700cc
	Laurel	GC92010	Langley FC33	1800cc
		GC92010	Laurel E-FJC32	1800cc Gasoline
		GC60080	Laurel All Models	1800cc,2000cc,2400cc,2800cc
		GC60080	Laurel E-KUJC31, HJC31, UJC31, KHC31	2000cc
		GC60080	Laurel E-HJC32	2000cc
		GC60080	Laurel E-KGC32, KHC32	2000cc
		GC92010	Laurel C32	2000cc
		GC92010	Laurel A31	2000cc LHD
		GC60080	Laurel A31	2000cc RHD, 2400cc
		GC60080	Laurel C31	2000cc, 2400cc & Diesel
		GC60080	Laurel HCC33, HC33, SC33	2000cc, 2800cc
		GC60080	Laurel C32	2400cc, 3000cc
		GC60080	Laurel N-EJC32	2800cc
		GC60080	Laurel N-SJC32	2800cc
		GC60080	Laurel SJC32, TSJC32	2800cc
		GC92010	Laurel Altima, Cefiro A31	2000cc (LHD)
GC60080	Laurel Altima, Cefiro A31	2000cc (RHD), 2400cc		
GC41010	Laurel Spirit HB, EHB11	1500cc		

				
OE Maker		Clutch	Vehicle Model	Engine Type
NISSAN	Laurel	GC93010	Laurel Spirit FB12	1500cc
		GC93010	Laurel Spirit E-FNB12, Q-SB12	1500cc 4WD, 1700cc
		GC41010	Laurel Spirit E-HB11, KHB11, WHB11, RHB11, E-B11, N-SB11, WSB11	1300cc, 1500cc, 1700cc
		GC93010	Laurel Spirit SB12, EB12	1600cc, 1700cc
		GC41010	Laurel Spirit SB11	1700cc
		GC93010	Laurel Spirit-only RS5F30A trans. E-EB12, E-FB12	1500cc, 1600cc
	Leopard	GC60080	Leopard E-JF30	1800cc
		GC60080	Leopard HF, JF, PF 30:L28, L20E-T	1800cc, 2000cc
		GC60080	Leopard E-GF30	2000cc
		GC60080	Leopard E-GF31	2000cc
		GC60080	Leopard E-HF30	2000cc, 2800cc, 3000cc
		GC60080	Leopard E-PF30	2000cc, 2800cc, 3000cc
		GC60080	Leopard E-NF30	2000cc, 2800cc, 3000cc
	LG/Liberta	GC62080	LG Series LG54V, P-LG54V	11.0 Ton
		GC41010	Liberta Ville E-PN12	1300cc
		GC41010	Liberta Ville N-SN12, RSN12; E-RPN12	1300cc, 1700cc
		GC41010	Liberta Ville E-KHN12, RHN12, HN12	1500cc
		GC41010	Liberta Ville BFNN13, BHNN13	1500cc
		GC93010	Liberta Ville BSN13	1700cc
		GC41010	Liberta, Liberta Ville HN . . . T11:PT11	1500cc, 1600cc, 1800cc
		GC41010	Liberta/Liberta Ville E-HN12, SN12	1700cc
		GC30080	LW Series p-LW46	11.25 Ton
	March/Micra	GC41010	March	1000cc Turbo
	Maxima/N10	GC12010	Maxima A32	3000cc
		GC12010	Maxima J30	3000cc
		GC93010	NX Coupe FB13, EB13	1500cc, 1600cc
	Navara /Pathfinder	GC60080	Navara D21	1600cc, 2000cc, 2400cc Diesel
		GC02010	Navara D21	Diesel
		GC12010	Navara D21	Diesel
		GC60080	Pathfinder WD21	2400cc
GC12010		Pathfinder WD21	Diesel	
Patrol	GC60080	Patrol All Models	2800cc, 3000cc, 4000cc	
	GC61080	Patrol All Models	4000cc	
	GC60080	Patrol Y60	4200cc, Diesel	

GMB CLUTCH RELEASE BEARING



OE Maker	Clutch	Vehicle Model	Engine Type		
NISSAN	Patrol	GC52080	Patrol Y60	4200cc, Diesel Turbo	
	Prairie	GC93010	Prairie BM10	1500cc	
		GC41010	Prairie BM10, VBM10	1500cc FWD	
		GC93010	Prairie BM10, VBM10	1500cc FWD	
		GC41010	PrairieE-BM10, VBM10, PM10	1500cc, 1800cc	
		GC41010	Prairie M10	1500cc, 1800cc	
		GC93010	Prairie M10	1500cc, 1800cc	
		GC41010	Prairie PM10	1800cc FWD	
		GC02010	Prairie M11	2WD/GBX:5	
		Presea	GC93010	Presea R10	1500cc
	Pulsar	GC41010	Pulsar MN/UN/KUN/TUN/KMN10, HN/KHN/RHN12, BN/RBN13		
		GC41010	Pulsar N12/13/14, FNN14E-PN12, E-HNN13, L-VHB11	1000cc, 1300cc, 1400cc, 1500cc, 1600cc 4WD	
		GC41010	Pulsar MN/UN/KUN/TUN/KMN10, HN/KHN/RHN12, BN/RBN13	1300cc, 1500cc	
		GC41010	Pulsar E-RPN12:E-HN12,RHN12,KHN12;N-SN12,RSN12	1300cc, 1500cc, 1700cc	
		GC93010	Pulsar HN13, RHN13	1500cc	
		GC41010	Pulsar FNN13	1500cc	
		GC93010	Pulsar N13	1500cc, 1600cc 2WD	
		GC93010	Pulsar E-HN13, RHN13, FHN13; N-SN13, FSN13	1500cc, 1700cc	
		GC1039	Pulsar N13	1600cc 2WD	
		GC41010	Pulsar N13	1600cc 4WD	
		GC41010	Pulsar E-EN13, E-REN13; N-VSB11; E-BN13, RBN13, L-VB11	1300cc, 1600cc, 1700cc	
		GC41010	Pulsar RSN12	1700cc	
		GC41010	Pulsar HN12, PN12	1700cc	
		GC93010	Pulsar SN13, FSN13	1700cc	
		GC12010	Pulsar RNN14	2000cc	
		GC41010	Pulsar N12	Diesel	
		GC93010	Pulsar N13	Diesel	
		GC93010	Pulsar Ad Van	1500cc	
		Safari	GC60080	Safari All Models eKCBept Y60	3300cc, 4WD Diesel
			GC52080	Safari Y60	TB42/42S Engine
	Sentra	GC93010	Sentra	2000cc	

				
OE Maker		Clutch	Vehicle Model	Engine Type
NISSAN	Sentra	GC41010	Sentra B12	1000cc, 1300cc, 1500cc
		GC93010	Sentra B12	1500cc, 1600cc 2WD
		GC41010	Sentra B12	1600cc 4WD
		GC41010	Sentra B11	Diesel
		GC93010	Sentra B12	Diesel
		GC93010	Sentra B13	1600cc
	Silvia	GC60080	Silvia S, JS, RS, BS, RJS, RBS 12	1800cc
		GC60080	Silvia E-S12, RS12, JS12, RJS12	1800cc
		GC60080	Silvia E-US12, RUS12	1800cc
		GC60080	Silvia E-BS12, RBS12	1800cc
		GC41010	Silvia PJS, RPJS 12	2000cc
		GC60080	Silvia E-RUS12, US12	2000cc
		GC60080	Silvia US, RUS12	2000cc
	Skyline	GC60080	Skyline CJR, FJR, KFJR, RCJR, RFJR, VCJR, VPJR 30	1800cc
		GC60080	Skyline R30	1800cc
		GC60080	Skyline E-FJR30, L-VPJR30	1800cc
		GC92010	Skyline FJ, KFJ 30	1800cc
		GC60080	Skyline VPJR30	1800cc
		GC92010	Skyline FJR31	1800cc
		GC92010	Skyline E-FJR31	1800cc
		GC92010	Skyline FR32	1800cc
		GC60080	Skyline R, DR, HR, KR, BJR, KDR, KHR, RHR, UJR, KBJR, KUJR, VBJR	2000cc
		GC60080	Skyline VSJR 30:HR, KHR 31	2000cc
		GC60080	Skyline E-DR30,KHR30,KDR30,HR30,RHR30,N-VSJR3	2000cc
		GC60080	Skyline HR31, YHR31	2000cc
		GC92010	Skyline R31	2000cc
		GC60080	Skyline HR32, YHR32, BNR32	2000cc, 2600cc
		GC60080	Skyline R30, MR, RMR, KMR 30	2000cc, 2400cc
		GC60080	Skyline MR, RMR, KMR, S, ER, KS, RER30	2400cc, 2800cc
		GC60080	Skyline N-ER30	2800cc
		GC92010	Skyline ER, RER 30	2800cc
		GC92010	Skyline N-KSR31	2800cc
		GC60080	Skyline N-SR, KSR; E-HR, KHR; N-SR, N-KSR, E-FJR, WFJR31, R30	1800cc,2000cc,2800cc,3000cc

GMB CLUTCH RELEASE BEARING



OE Maker		Clutch	Vehicle Model	Engine Type
NISSAN	Skyline	GC02080	Skyline - 3 Speed, 4 Speed	1500cc
		GC02080	Skyline - GT - 4 Speed	2000cc
	Stanza	GC41010	Stanza E-T12	1600cc
		GC93010	Stanza E-T12	1600cc
		GC60080	Stanza PA11, RA11	1600cc, 1800cc
		GC41010	Stanza E-T11	1600cc, 1800cc
		GC41010	Stanza PT11, KPT11	1600cc, 1800cc
		GC41010	Sunny B12	1000cc, 1300cc
	Sunny	GC41010	Sunny N13	1000cc, 1300cc
		GC41010	Sunny B13	1000cc, 1300cc, 1400cc
		GC41010	Sunny KB11, WB11, HB11, KHB11, WHB11, B12, RB12, WB12, HNB12	1300cc, 1500cc
		GC41010	Sunny B11	1300cc, 1500cc
		GC41010	Sunny N13	1400cc, 1600cc 4WD
		GC93010	Sunny HB12, RHB12, KHB12, WHB12	1500cc
		GC41010	Sunny HNB12	1500cc
		GC93010	Sunny FB12, WFB12	1500cc
		GC41010	Sunny FNB13	1500cc
		GC41010	Sunny HB12, RHB12	1500cc Turbo
		GC93010	Sunny B12, N13	1500cc, 1600cc 2WD
		GC41010	Sunny B12, N13	1500cc, 1600cc 4WD
		GC41010	Sunny E-HB/RHB/KHB/HNB12,L-VHB11,L-VB/N-VSB11;E-HNB12	1300cc, 1500cc, 1700cc(4WD)Gasoline
		GC93010	Sunny N13	1600cc 2WD
		GC41010	Sunny E-HB11,KHB11,WHB11,RHB11,E-B11,N-SB11,WSB11	1300cc, 1700cc
		GC93010	Sunny B12	1600cc 2WD
		GC41010	Sunny B12	1600cc 4WD
		GC93010	Sunny B13	1600cc Diesel
		GC41010	Sunny SB11, WSB11, VSB11	1700cc
		GC93010	Sunny N-SB12, N-WSB12	1700cc
	GC41010	Sunny N12	Diesel	
	GC41010	Sunny B11	Diesel	
	GC93010	Sunny B12, N13	Diesel	
	GC41010	Sunny Ad Van VB11	1300cc	



				
OE Maker	Clutch	Vehicle Model	Engine Type	
NISSAN	Sunny	GC41010	Sunny California E-B, E-HB, KHB, WHB, RHB N-SB11	1300cc, 1500cc, 1700cc
		GC60080	Sunny Truck B122, GB122	1200cc
		GC60080	Sunny Vanette (All Models)	1200cc, 1500cc, 1800cc, 2000cc
	Terrano	GC12010	Terrano N-VBYD21	3000cc 4WD B Gasoline
	Atlas	GC60080	Atlas BF22, PF22	1600cc, 2000cc
		GC60080	Atlas WF22, WGF22	2000cc
		GC60080	Atlas AF22, AGF22	2700cc
		GC60080	Atlas N-SBH40, DSH40, SGH40	2.0-3.0t
		GC60080	Atlas N-DMH40, MGH40, MBH40, KAH40	2.0t
		GC60080	Atlas DJH40, JGH40	3000cc
		GC60080	Atlas MH40, TMH40	3300cc
		GC60080	Atlas RH40	3500cc
		GC60080	Atlas/Condor All Models	2000cc, 2300cc
		Caball	GC02080	Caball All Models
	GC60080		Caball/Civilian C340, QC340	2000cc & Diesel
	GC60080		Caball/Clipper All Models	2000cc
	GC60080		Caball/Clipper/Bison All Models	2200cc, 3000cc, 3300cc
	Cabstar	GC60080	Cabstar F22	1600cc, 2000cc & Diesel, 1 - 1.5 Ton Truck
		GC60080	Cabstar All Models	1600cc, 2000cc, 2200cc, 2300cc, 2500cc, 3300cc
		GC60080	Cabstar H40	Diesel, 2 - 3 Ton Truck, 2800cc, 2200cc
		GC02010	Cabstar F22	TD23 Engine
	Caravan	GC60080	Caravan All Models eKCBept VYEVYGE/VRE/VRGE 24	1800cc, 2000cc, 2300cc
		GC12010	Caravan VYE/VTGVRE/VRGE 24	2300cc, 2700cc
	Civilian	GC02080	Civilian All Models	2000cc
		GC60080	Civilian All Models	2000cc, 2200cc, 3000cc, 3300cc
		GC60080	Civilian W40	2200cc, 2800cc, Diesel
		GC60080	Civilian N-MW40, MGW40	3300cc
		GC60080	Civilian FGW40, FW40	3300cc
		GC92010	Civilian BGW40, BW40	3500cc
		GC60080	Civilian RGW40, RW40, RYW40	4200cc
Datsun Truck /Vanette	GC41010	Datsun L-VB11, VHB11, N-VSB11	1300cc, 1500cc, 1700cc	
	GC41010	Datsun Ad Van VB11	1300cc	

GMB CLUTCH RELEASE BEARING



OE Maker		Clutch	Vehicle Model	Engine Type
NISSAN	Datsun Truck /Vanette	GC60080	Datsun Truck All Models	1600cc,1800cc, 2200cc,0.75t, 1.0t
		GC02010	Datsun Truck PD21, PGD21	2300cc
		GC60080	Datsun Vanette All Models	1200cc,1500cc,1800cc,2000cc
		GC60080	E20 Series All Models	1500cc,1600cc,2000cc, 2200cc, 2300cc
	Homer/Homy	GC60080	Homer Truck - Van All Models	1500cc,1600cc, 2000cc,2200cc
		GC60080	Homer L-VNE23; M-CHGE23, VHGE23, N-KSE23	1800cc, 2000cc
		GC60080	Homer CHGE24, DHGE24, CTGE24, DTGE24	2000cc
		GC12010	Homer CYGE24, DYGE24	2300cc
		GC12010	Homer VRE24, VRGE24	2700cc
		GC60080	Homer/Caravan All Models	1500cc,1600cc,2000cc, 2200cc, 2300cc
		GC12010	Homer/Caravan N-VYE24, N-VYGE24	1.0 Ton
	Pickup	GC60080	Pick Up - Truck All Models	1200cc
		GC60080	Pick Up - Truck All Models	All Models
		GC60080	Pickup B120	1200cc
		GC60080	Pickup 620, N620 Pickup 720, D21	1300cc, 1500cc 1600cc, 1800cc, 2200cc
	Urban/Urvan / Microbus	GC60080	Urban All Models	1600cc,1800cc,2000cc, 2200cc, 2300cc
		GC12010	Urban All Models	2300cc
		GC60080	Urvan E23, E24, GC22	1600cc, 1800cc, 2000cc, 2400cc Diesel, 1500cc
		GC12010	Urvan	Diesel
		GC60080	Microbus All Models	2000cc, 2200cc
	Vanette /Violet	GC60080	Vanette/Largo All Models	1200cc,1400cc, 1500cc,2000cc
		GC60080	Violet/140J, 160J, 180J (K,V)A10, 11:J(K)710, 711:VJ710, (K,J,JK)P710:8(K)PA	1400cc, 1600cc
		GC02080	Violet/140J, 160J, 180J JP710P	1600cc
		GC41010	Violet/140J, 160J, 180JT11, PT11	1600cc, 1800cc
		GC02080	Violet/140J, 160J, 180J JR710, JR711	1800cc
		GC60080	Violet/140J, 160J, 180J (K)RA11	1800cc



					
OE Maker		Clutch	Vehicle Model	Engine Type	
OPEL	Ascona	GC80010	Ascona 1.6		
		GC80010	Ascona 1.8		
		GC80010	Ascona 2.0		
		GC80010	Ascona 1.6 Diesel	16DA-1586cc Mot 14498631	
	Astra	GC80010	Astra 1.6		1.6LZ2
		GC80010	Astra 1.8		C1.8NZ/GBX:F16, F18
		GC80010	Astra 1.8		C1.8SEL
		GC80010	Astra 1.8 16V		C1.8XE, X1.8XE, C1.8XEL
		GC80010	Astra 2.0		C2.0NE
		GC80010	Astra 2.0 1.6V		X2.0XE
		GC80010	Astra 1.7 Turbo Diesel		1.7TD, X1.7DTL
	Calibra	GC80010	Calibra 2.0		C2.0NE, C2.0XE
		GC80010	Calibra 2.0 16V		X2.0XE
		GC80010	Calibra 2.0 Turbo		C2.0LET
		GC80010	Calibra 2.5 16V		C2.5XE
	Campo	GC01010	Campo 2.3		2.3
		GC20080	Campo 2.2 Diesel		2.2D
		GC01010	Campo 2.5 Diesel		2.5D
	Frontera	GC31010	Frontera 2.8 Turbo Diesel		2.8TD
	Kadett	GC80010	Kadett 1.8		GBX:F16
		GC80010	Kadett 2.0		
		GC80010	Kadett 1.5 Turbo Diesel		1.5TD
		GC80010	Kadett 1.6 Diesel		
		GC80010	Kadett 1.7 Diesel		1.7DR/GBX:F16
		GC80010	Kadett 1.7 Turbo Diesel		1.7TD
	Monterey	GC31010	Monterey 3.1 Turbo Diesel		
	Vectra	GC80010	Vectra 1.8		
		GC80010	Vectra 2.0; 2.0 16V		
		GC80010	Vectra 2.5		
		GC80010	Vectra 1.7 Turbo Diesel		
PORSCHE	924	GC03010	924 2.0	478	

GMB CLUTCH RELEASE BEARING

					
OE Maker		Clutch	Vehicle Model	Engine Type	
PROTON		GC40010	Saga C21A, C22A	1300cc, 1500cc	
		GC40010	Satria C96, 97, 98	1300cc, 1500cc, 1600cc	
		GC40010	Perdana E55A	2000cc	
		GC40010	Wira C96, 97, 98, 99	1300cc, 1500cc, 1600cc, 1800cc	
		GC40010	Persona C96, 97, 98, 99	1300cc, 1500cc, 1600cc, 1800cc	
SAAB	900	GC80010	900 2.0		
		GC80010	900 2.3, 2.5		
SUBARU	E/J/L Series /Justy	GC90080	E Series EF10, EF12	1000cc, 1200cc - 2WD	
		GC90080	FFI A14, 15, 43, 44	1100cc, 1300cc	
		GC90080	J Series EF10, EF12	1000cc, 1200cc	
		GC90080	J Series J10, J12	1000cc, 1200cc	
		GC90080	Justy E-KA6, E-KA5, E-KA8, E-KA7	1000cc, 1200cc	
		GC90080	Justy/J10 KA5, 6, 8	1000cc, 1200cc	
		GC90080	L Series EA65, EA71, EA81	300cc, 1600cc 2WD, 1800cc 2WD	
		Leone	GC90080	Leone E-AF1, E-AF2	1300cc, 1600cc
			GC90080	Leone L-AM1, L-AM2	1300cc, 1600cc
			GC90080	Leone EA65, EA71, EA81	1300cc, 1600cc 2WD, 1800cc, 2WD
			GC70080	Leone EA65, EA71, EA81	1300cc, 1600cc 4WD, 1800cc, 4WD
			GC90080	Leone E-AA3	1600cc
			GC90080	Leone E-AP2, AA2	1600cc
			GC90080	Leone E-AB2, AB3, AB4, AB5, AF3, AF5, AJ5	1600cc, 1800cc
			GC90080	Leone E-AA2, E-AA4	1600cc, 1800cc
			GC90080	Leone E-AA4	1800cc
			GC90080	Leone Car, Van & Wagon AB1, AF1:A 21, 22, 24, 25, 32, 61, 62, 64, 65:AM1	1100cc, 1200cc, 1300cc, 1400cc
	GC90080		Leone Car, Van & Wagon A 26, 27, 33, 34, 66, 67: AB, AW, AF, AM2, AB, AF, AM3	1600cc	
	GC90080	Leone Car, Van & Wagon AB4, AB5	1600cc, 1800cc		

					
OE Maker		Clutch	Vehicle Model	Engine Type	
SUBARU	Leone	GC90080	LeoneCar, Van&WagonAB, AM4A:AB, AF, AM, AJ5A	1600cc, 1800cc	
		GC70080	Leone Car, Van & Wagon AB4, AB5	1600cc, 1800cc	
		GC90080	Leone Car, Van & Wagon AA2, AP2, AA, AG, AL 4	1600cc, 1800cc	
		GC70080	Leone Car, Van & Wagon Europe only	1800cc	
		GC20080	R-2 K12, 41	360cc	
	Rex	GC90080	Rex E-KF1	550cc	
		GC90080	Rex M-KM1	550cc	
		GC90080	Rex KG1, KN1, KN2	550cc	
		GC90080	Rex KG2	550cc	
		GC90080	Rex KH1, KP1	550cc	
		GC90080	Rex E-KM2, E-KM1, M-KM2	550cc, 550cc 4WD Gasoline	
	Domingo	GC90080	Rex KF1:KM 1, 2C, 2D, 2E	600cc, 700cc FWD	
		GC90080	Domingo E-KJ5	1000cc	
		GC90080	Domingo E-KJ8	1000cc, 1200cc-4WD Gasoline	
	Sambar - Pickup /Van	GC80090	Domingo/E10 EKJ6	1000cc	
		GC90080	Sambar-Pickup/Van K55, 59, 64, 71, 72, 81	360cc	
		GC90080	Sambar-Pickup/Van KR2, KT2	550cc	
		GC90080	Sambar-Pickup/Van M-KR1, M-KT1, M-KR2, M-KT2	550cc	
	SUZUKI	Alto	GC90080	Sambar-Pickup/Van KT2, KR2	600cc, 700cc
			GC20080	LJ50, 50-2, 51, 50V-2, 80, 81	550cc, 800cc - 4WD
GC20080			LJ80	800cc 4WD	
GC20080			SK408	800cc	
GC20080			SK410	1000cc	
GC20080			LJ50	550cc 4WD	
GC20080			450	450cc	
GC20080			ST80	800cc	
GC20080			ST90	800cc	
GC23010			Alto M-CC71V	550cc	
GC23010	Alto M-CC71V, 72V	550cc 4WD			

GMB CLUTCH RELEASE BEARING

				
OE Maker		Clutch	Vehicle Model	Engine Type
SUZUKI	Alto	GC23010	Alto M-CC72V	550cc
		GC90080	Alto M-SS40V, M-SS30	550cc
		GC90080	Alto M-SS80, M-SB308	800cc
		GC90080	Alto SB305, SB308	550cc, 800cc
	Cervo	GC23010	Cervo CN21S, CN31S	660cc
		GC23010	Cervo CP31S	660cc
		GC20080	Cervo E-SS20	550cc
	Cultus	GC23010	Cultus AA33S, AB33S	1300cc
		GC50010	Cultus AA34S, AA44S, AB44S, AB34S	1000cc, 1300cc
		GC50010	Cultus AA53S, AB53S	1300cc
		GC20010	Cultus AJ14S, AF34S, AH14S	1300cc
		GC23010	Cultus E-AA33S, E-AB33S, E-AA53S, E-AB53S, E-AB51S, E-AA43S	1000cc, 1300cc
		GC32010	Cultus E-AA41S, E-AB41S	1000cc
		GC50010	Cultus E-AA43V, E-AB43S	1000cc
		GC23010	Cultus E-AB51S	1300cc
		GC23010	Cultus/Swift E-AA41S, AA41ST, AB41S, SA310, SA413	1000cc, 1300cc
		GC23010	E-AA43S, AB43S, L-AA43V	1000cc
		GC23010	E-AB51S, AA33S, AB33S, AA53S, AB53S	1300cc
		GC20010	Escudo TA01R, TA01V, TA01W	1600cc
		Fronte	GC23010	Fronte E-CP11S
	GC23010		Fronte E-CP11S, M-CM11V	550cc 4WD Gasoline
	GC20080		Fronte E-SS20	550cc
	GC90080		Fronte E-SS30	550cc
	GC90080		Fronte LC10, LC10WR	360cc
	GC20080		Fronte LC20..	360cc
	GC90080		Fronte SS80F	800cc
	GC20080		Fronte Van & Hatchback SH10	550cc
	Jimny	GC20010	Jimny E-JA51	1300cc 4WD Gasoline
		GC20010	Jimny JA51C, JA51V, JA51W	1300cc
		GC20010	Jimny JA71C, JA71V	550cc

				
OE Maker		Clutch	Vehicle Model	Engine Type
SUZUKI	Jimny	GC20080	Jimny L-SJ40, L-SJ40V, L-SJ40T	1000cc
		GC20080	Jimny L-SJ410..	1000cc
		GC20080	Jimny SJ10, SJ20	550cc, 800cc
		GC20010	Jimny SJ413	1300cc
	Swift	GC23010	Swift SA310	1000cc
		GC23010	Swift SA310-3	1000cc
		GC23010	Swift SA413	1300cc
		GC20010	Swift SF413	1300cc 4WD
		GC50010	Swift SF413	1300cc, 1300cc DOHC(2WD)
		GC20080	Swift SJ410	1000cc 4WD
	Vitara	GC20010	Swift SJ413	1300cc 4WD
		GC20010	Vitara SE416	1600cc
	Carry	GC20080	Carry/Every	550cc
		GC20080	Carry/L, ST Series	550cc
		GC20010	Carry/L, ST Series	550cc
		GC90080	Carry/L, ST Series	550cc
Every	GC20080	Every (All Models)	550cc	
TOYOTA	4 Runner /Blizzard	GC01010	4 Runner RN10#, 110#, 13#, VZN10#, 110#, 13#;RN80, 90, 121, VZN85, 90, 95	4WD, 2WD
		GC10080	Blizzard LD10	2200cc
		GC43010	Blizzard N-LD10V	2200cc
		GC10080	Blizzard LD20, N-LD20, 21G	2400cc, 2400cc 4WD Diesel
	Camry	GC33010	Camry SV10, 20, CV10	1800cc
		GC33010	Camry N-CV10	800cc
		GC33010	Camry SV22	800cc
		GC33010	Camry E-SV10, E-SV11, E-SV12	1800cc, 2000cc
		GC33010	Camry E-SV21, E-SV20, N-CV20	1800cc, 2000cc
		GC33010	Camry E-SV20, E-SV21	800cc, 2000cc
		GC83010	Camry E-SV30, E-SV32, E-SV33, E-CV30	800cc, 2000cc
		GC33010	Camry N-CV11, E-SV20, E-SV11, E-SV21	2000cc
		GC10080	Camry E-SV12	2000cc
		GC33010	Camry N-CV11	2000cc
		GC33010	Camry N-CV10, N-CV11	Diesel Turbo

GMB CLUTCH RELEASE BEARING



				
OE Maker		Clutch	Vehicle Model	Engine Type
TOYOTA	Carina	GC10080	Carina E-AL25G	500cc
		GC70080	Carina TA	400cc
		GC20080	Carina TA1	1400cc
		GC10080	Carina L-KT147V, E-AA60, E-AT140, L-KA67V	1500cc
		GC04010	Carina E-AT170, E-AT170G	1500cc
		GC10080	Carina AA60..., KA67V, AA63:TA60, 61, 67V	1500cc, 1600cc
		GC04010	Carina E-AT150, E-AT151, E-AT160	1500cc, 1600cc FWD
		GC10080	Carina N-CA67V, E-AA63, L-KA67V, E-AA60, E-SA60, E-SA60G	1500cc, 1600cc, 1800cc
		GC20080	Carina TA12	1600cc
		GC10080	Carina TA60A	1600cc
		GC04010	Carina E-AT151	1600cc
		GC33010	Carina E-AT160	1600cc
		GC04010	Carina E-AT150, E-AT151	1600cc, 1800cc
		GC10080	Carina TA40,41,42,45,46,47,49, RA40,45,46,47	1600cc, 1800cc, 2000cc
		GC33010	Carina E-AT160, E-ST160, E-ST162, N-CT150	1600cc, 1800cc, 2000cc
		GC10080	Carina CA67V, SA60, SA60G	1800cc
		GC33010	Carina E-ST150/160, E-ST163	1800cc
		GC10080	Carina N-CT147V, N-CA67V, E-ST140, SA60	1800cc
		GC33010	Carina E-ST170, E-ST170G	1800cc
		GC70080	Carina RA10, 11, 13, 14, 15, 16, 17, 30, 31	1800cc, 2000cc
GC10080	Carina RA40, RA47	1800cc, 2000cc		
GC10080	Carina RA45, RA46	1800cc, 2000cc		
GC33010	Carina ST150, ST160, ST162, CT150	1800cc, 2000cc - FWD, Diesel		
GC10080	Carina TA62, 63, 67:SA60..., CA60, CA67V, RA63	1800cc, 2000cc - RWD		

					
OE Maker		Clutch	Vehicle Model	Engine Type	
TOYOTA	Carina	GC33010	Carina CT150, CT170, CT170G, CT176V	2000cc	
		GC20080	Celica TA20	1400cc	
		GC10080	Celica E-AA60, AA63, E-SA60, E-SA60G	1500cc, 1600cc, 1800cc	
		GC10080	Celica TA40B	1600cc	
		GC10080	Celica AA63	1600cc	
		GC04010	Celica AT160	1600cc	
		GC33010	Celica AT160, ST160	1600cc, 1800cc	
		GC33010	Celica E-AT160, E-ST160, ST162, E-ST160, E-ST162, E-AT160	1600cc, 1800cc, 2000cc	
		GC10080	Celica TA60B, RA60B	1600cc, 2000cc	
		GC83010	Celica ST180, 181, ST182, 183	1800cc, 2000cc	
		GC10080	Celica E-GA61, E-MA61, 63, E-TA63	1800cc, 2000cc, 2800cc	
		GC10080	Celica RA40B	2000cc	
		GC10080	Celica RA61B	2000cc	
		GC33010	Celica ST162, ST162C	2000cc	
	Celica	GC33010	Celica ST182, ST183	2000cc	
		GC83010	Celica ST182	2000cc DOHC	
		GC04010	Celica GT AT160	1600cc	
		GC10080	Celica GT TA42, 46, 47	1800cc	
		GC10080	Celica GT TA63..., 64, SA60, 61	1800cc	
		GC10080	Celica GT, GTR, GTV, SE, ST, XT RA40/5/6/55/60/61/3	2000cc	
		GC10080	Celica GT, GTV, GTR TA40, 41, 45, 60, 61	1600cc	
		GC20080	Celica GT, GTV, LT, ST TA22, 23, 25, 27, 28, 35	1600cc	
		GC70080	Celica GT, GTV, LT, ST RA21, 23, 25, 28, 35	2000cc	
		GC33010	Celica ST, SV, SX ST160	1800cc	
		GC10080	Celica/Supra MA45, GA61, 70	2000cc	
		GC33010	Celica/Supra ST162	2000cc	
		GC10080	Celica/Supra MA45, MA46	2000cc, 2600cc	
		GC10080	Celica/Supra E-GA61, E-MA61, 63, E-TA63	2000cc, 2800cc	
		GC10080	Celica/Supra MA50, 55, 56, 61, 63 MA46, MA61B	2800cc	
		Chaser	GC10080	Chaser TX60, YX70	1800cc
			GC10080	Chaser TX40	1800cc
			GC10080	Chaser E-SX70	1800cc
			GC10080	Chaser E-SX70Y	1800cc
	GC71010		Chaser E-SX80, E-SX80Y	1800cc	

GMB CLUTCH RELEASE BEARING





OE Maker	Clutch	Vehicle Model	Engine Type		
TOYOTA	Chaser	GC10080	Chaser TX30, 40, RX30, 31, 40, 41:MX30, 40, 41	1800cc, 2000cc	
		GC10080	Chaser GX60,61,71:RX40,41,60,63:LX60,LX70:MX40,41,61	2000cc	
		GC10080	Chaser E-GX61, E-MX61	2000cc	
		GC10080	Chaser GX71	2000cc	
		GC10080	Chaser YX72Y	2000cc	
		GC60010	Chaser GX81	2000cc	
		GC10080	Chaser E-GX60G, GX71, E-MX71; N-LX70	2000cc, 2400cc	
		GC10080	Chaser E-GX60, N-LX60, E-SX60	1800cc, 2000cc, 2400cc	
		GC10080	Chaser N-LX60	2200cc	
		GC10080	Chaser N-LX65	2400cc	
		GC10080	Chaser LX70, LX70Y	2400cc	
		GC71010	Chaser LX80, LX80Y	2400cc	
		Corolla	GC20080	Corolla KE16VM KE20, 25,3., 4., 50, 60	1200cc/GBX:5
			GC04010	Corolla AE80E, E-EE80, E-EE80E, EL30, R-EE96V	1300cc
	GC10080		Corolla AL20.21	1300cc, 1500cc	
	GC10080		Corolla E-AL20, E-AL21	1300cc, 1500cc	
	GC04010		Corolla E-EL30; E-EL31, N-NL31	1300cc, 1500cc	
	GC04010		Corolla EE96V, EE97G; EE98V	1300cc, 1500cc	
	GC04010		Corolla EE110, EE111	1500cc, 1600cc	
	GC70010		Corolla AE110, AE111	1300cc	
	GC04010		Corolla EL41; EL43, EL45, NL40	1300cc, 1500cc	
	GC04010		Corolla E-AE80, E-AE81	1300cc, 1500cc, 1600cc	
	GC04010		Corolla EE90, AE92, AE97	1300cc, 1600cc	
	GC20080		Corolla TE2., 3., 4., 5., 6	1400cc	
	GC10080		Corolla TE5., 6., TE36V	1400cc	
	GC10080		Corolla L-KE74V	1500cc	
	GC10080		Corolla KE74V	1500cc	
	GC04010		Corolla E-AE80	1500cc	
	GC04010		Corolla EL31, NL30	1500cc	
	GC04010		Corolla AE91, AE91G	1500cc	
	GC04010	Corolla E-AE81, E-AE82	1500cc, 1600cc		
	GC20080	Corolla TE37, 47, 51, 61	1600cc		
GC10080	Corolla TE51, 55, 61, 65, 71	1600cc			
GC10080	Corolla TE71E	1600cc			
GC10080	Corolla E-AE86, E-AE86E	1600cc			

				
OE Maker		Clutch	Vehicle Model	Engine Type
TOYOTA	Corolla	GC04010	Corolla AE82E	1600cc
		GC10080	Corolla N-CE71V, N-CE72G	1800cc
		GC33010	Corolla N-CE80	1800cc
		GC33010	Corolla N-CE90	1800cc
		GC83010	Corolla N-CE90, N-CE96V, N-CE97G	1800cc
		GC10080	Corolla N-CE72G, L-KE74V	1300cc, 1500cc, 1800cc
		GC33010	Corolla N-CE96V, N-CE97G	1800cc
		GC33010	Corolla N-CE80E	Diesel
		GC10080	Corolla Levin E-AE86	1600cc
		GC04010	Corolla/Sprinter EE80	1300cc
		GC04010	Corolla/Sprinter AE80, AE81, AE82	1300cc, 1500cc, 1600cc
		GC10080	Corolla/Sprinter KE47V, 47E, 74	1500cc
		GC04010	Corolla/Sprinter E-AE91	1500cc
		GC10080	Corolla/Sprinter TE73V, 74V	1600cc
		GC10080	Corolla/Sprinter TE71	1600cc
		GC10080	Corolla/Sprinter TE70, 72	1800cc
		GC10080	Corolla/Sprinter CE70, 71	1800cc
		GC33010	Corolla/Sprinter CE80	1800cc
		GC10080	Corolla/Sprinter N-CE72, N-CE71V	1800cc
		GC70010	Corolla/Sprinter 4DS LX, SEL E-AE100, E-AE101	
	GC10080	Corolla/Sprinter (Levin & Trueno) E-AE86	1600cc	
	GC70080	Corona RT80, 90	1500cc	
	GC10080	Corona L-KT147V, AT140	1500cc	
	GC04010	Corona AT150	1500cc	
	GC10080	Corona E-AA60, E-AT140, L-KA67V	1500cc	
	GC04010	Corona AT150	1500cc FWD	
	GC04010	Corona E-AT150, E-AT151, AT150	1500cc, 1600cc FWD	
	GC70080	Corona RT100,106,110,116,87VK:TT100,106...,110	1600cc	
	GC70080	Corona RT120:TT120	1600cc	
	GC10080	Corona RT120:TT120, 125	1600cc	
	GC10080	Corona RT130,AT141:TT130,133,137,138,140,147V	1600cc	
	GC04010	Corona E-AT177	1600cc	
GC04010	Corona AT151, 160	1600cc FWD		
GC10080	Corona TT133, TT132	1600cc, 1800cc		
GC10080	Corona TT133, TT132	1600cc, 1800cc		
	Corona			

GMB CLUTCH RELEASE BEARING

				
OE Maker		Clutch	Vehicle Model	Engine Type
TOYOTA	Corona	GC04010	Corona E-AT150, E-AT151	1600cc, 1800cc
		GC70080	Corona RT100, RT102, RT104	1600cc, 1800cc, 2000cc
		GC10080	Corona RT100, RT102, RT104	1600cc, 1800cc, 2000cc
		GC10080	Corona TT140, TT141, CT140	1600cc, 1800cc, Diesel
		GC10080	Corona RT122, RT106:TT106..., RT104, 114, 118	1600cc, 2000cc
		GC10080	Corona RT130, TT130, 133, 137, 138, 140, RT131, 132, 133, 141	1600cc, 2000cc
		GC10080	Corona RT130, RT132	1600cc, 2000cc
		GC04010	Corona AT171, ST171, AT177	1600cc, 2000cc
		GC33010	Corona E-AT160, E-ST160, E-ST162, N-CT150	1600cc, 1800cc, 2000cc
		GC70080	Corona RT84, 94K	1700cc
		GC70080	Corona RT102, 112, 117, 137:TT120	1800cc
		GC10080	Corona TT120, 121, 126, 131, 132:RT137	1800cc
		GC10080	Corona TT131, 132, 141, 142:ST140:CT140, 147:RT137	1800cc
		GC10080	Corona N-CT147V, ST140	1800cc
		GC10080	Corona E-TA63G, N-CT147V, E-TT142	1800cc
		GC33010	Corona E-CT150, E-ST150	1800cc
		GC10080	Corona L-YT140	1800cc
		GC10080	Corona E-ST140, E-SA60	1800cc
		GC10080	Corona N-CA67V	1800cc
		GC33010	Corona ST150, 160	1800cc FWD
		GC10080	Corona N-CT141, L-YT140, E-ST140, SA60	1800cc, 2000cc
		GC83010	Corona E-ST170, 171, CT170, CT176V	1800cc, 2000cc
		GC70080	Corona RT122	2000cc
		GC10080	Corona RT131, 132, 133, 141	2000cc
		GC10080	Corona N-CT141	2000cc
		GC33010	Corona E-ST151	2000cc
		GC33010	Corona N-CT170	2000cc
		GC33010	Corona N-CT150, ST151	2000cc FWD
		GC33010	Corona E-ST162	2000cc FWD
		GC33010	Corona E-ST162	2000cc FWD
		GC33010	Corona N-CT176V, ST170	1800cc, 2000cc
		GC33010	Corona N-CT170, CT177	Diesel
GC10080	Corona MK.II/Cressida	1800cc		
GC10080	Corona MK.II/Cressida E-SX70, YX76V, SX60/70	1800cc		



				
OE Maker		Clutch	Vehicle Model	Engine Type
TOYOTA	Corona	GC71010	Corona MK.II/Cressida E-SX80, SX80Y	1800cc
		GC70080	Corona MKII/Cressida RX10, 11, 17, 21, 27, RX12, 15, 22, 28:MX10, 20, 27	1800cc, 2000cc
		GC10080	Corona MKII/Cressida E-SXE-GX60, E-GX61, E-MX61, N-LX65/60	1800cc, 2000cc, 2400cc
		GC10080	Corona MKII/Cressida SX70, SX70Y; GX71	1800cc, 2000cc, 2400cc
		GC10080	Corona MKII/Cressida L-TX67V, N-LX67V	1800cc, 2200cc
		GC71010	Corona MKII/Cressida E-SX80, S-LX76V	1800cc, 2400cc
		GC10080	Corona MKII/Cressida RX37:TX30,40,47, MX33,43	1800cc, 2600cc
		GC10080	Corona MKII/Cressida RX30,31,35,40,41,45	2000cc
		GC10080	Corona MK.II/Cressida GX71, E-GX70G, L-YX76V, YX72Y	2000cc
		GC60010	Corona MK.II/Cressida YX80, YX80Y, E-GX70G	2000cc
		GC10080	Corona MK.II/Cressida GX70, LX70, 76	2000cc, 2400cc
		GC10080	Corona MK.II/Cressida	2000cc, 2200cc
		GC10080	Corona MK.II/Cressida	2000cc, 2400cc
		GC10080	Corona MK.II/Cressida LX40, MX12, 22, 28, 33, 43, 63, N-LX70/76V	2200cc, 2300cc, 2400cc, 2600cc, 2800cc
		GC04010	Corona, Carina II AT151	1600cc
	GC33010	Corona, Carina II N-CT150, ST150	1800cc Diesel	
	Corsa	GC04010	Corsa EL30, EL31	1300cc
		GC10080	Corsa E-AL20, E-AL21, E-AL25	1300cc, 1500cc
		GC04010	Corsa E-EL 30, E-EL31, E-NL31	1300cc, 1500cc
		GC04010	Corsa E-EL41, E-EL43, E-EL45, E-NL40	1300cc, 1500cc
		GC10080	Corsa E-AL10, E-AL12	1500cc
		GC04010	Corsa E-NL30, E-EL31	1500cc
	Cressida	GC10080	Cressida RX30, RX60X, GX60X, RX70, RX71	2000cc
		GC60010	Cressida GX81, MX81	2000cc, 2800cc
		GC10080	Cressida RX72, RX73	2400cc
		GC71010	Cressida RX80, RX81, LX80	2400cc, Diesel
		GC10080	Cressida LX70, MX73, GX71	2000cc, 2800cc Diesel
	Cresta	GC10080	Cresta E-SX70, E-SX70Y, E-GX71	1800cc, 2000cc
		GC10080	Cresta GX50, 51, 61, 71:LX60,70: SX70, TX50	1800cc, 2000cc, 2200cc, 2400cc
		GC10080	Cresta E-SX60, E-GX61, E-MX61, N-LX65, N-LX60, E-GX60	1800cc, 2000cc, 2400cc

GMB CLUTCH RELEASE BEARING

58

GMB Korea Corporation

					
OE Maker		Clutch	Vehicle Model	Engine Type	
TOYOTA	Cresta	GC71010	Cresta SX80, SX80Y;LX80, LX80Y	1800cc, 2400cc	
		GC60010	Cresta GX81	2000cc	
		GC10080	Cresta E-GX60G, E-GX71, E-MX71, E-SX70, E/N-LX70	1800cc, 2000cc, 2400cc	
	Crown	GC60010	Crown GS131, MS132, MS133, YS13		
		GC70080	Crown RS60:MS60, 62, 66, 70	2000cc	
		GC70080	Crown RS80, 100:MS80, 82, 87, 90	2000cc	
		GC10080	Crown RS90,105,110:MS100,102,105,107,110,117	2000cc	
		GC10080	Crown MS110, MS117, MS110, MS120:GS110, 117, 120, 121, RS110, YS120	2000cc 2000cc	
		GC10080	Crown E-GS120/G, 121, 126V, E-MS120, MS/YS130		
		GC10080	Crown L-GS126V, E-GS120G	2000cc	
		GC60010	Crown E-GS130, 130G, 131, 131H, 136V, LS130G	2000cc	
		GC10080	Crown E-MS120, E-GS120, E-GS120G, L-GS126V; N-LS120, N-LS126V	2000cc, 2400cc	
		GC70080	Crown RS80, MS85	2000cc, 2600cc	
		GC10080	Crown RS110, MS111, MS112, LS110, RS80, MS85	2000cc,2600cc,2800cc&Diesel	
		GC10080	Crown YS120, MS122, MS123, LS120	2000cc,2400cc,2800cc&Diesel	
		GC10080	Crown LS100, 110., 117..	2200cc	
		GC20080	Crown MS64	2300cc	
		GC10080	Crown LS111, 120, 120G, N-LS120/G/126V	2400cc	
		GC71010	Crown LS130, LS136V	2400cc	
		GC53010	Crown LS131	2400cc	
		GC71010	Crown S-LS236V	2400cc Diesel	
		GC70080	Crown E-MS63, 65, 68, 75, 83, 85, 88, 95, 101, 106	2600cc	
		GC10080	Crown E-MS83, 85, 88, 95, 101, 106	2600cc	
		GC10080	Crown E-MS111/112, MS122/123/125	2600cc, 2800cc, 3000cc	
		GC71010	Crown LS130	Diesel	
		Landcruiser	GC44010	Landcruiser fzj80	
			GC10080	Landcruiser N-LJ71G, Q-LJ71G	2400cc
	GC10080		Landcruiser RJ70, LJ70	2400cc & Diesel	
	GC71010		Landcruiser RJ70, LJ70	2400cc & Diesel	
	GC72080		Landcruiser P-BJ40, 43, 45	3000cc	
	GC01080		Landcruiser P-BJ40,42,43,45,46,60,61,61V,73V,75	3400cc	
	GC01080		Landcruiser P-BJ70, BJ70V	3400cc	

				
OE Maker		Clutch	Vehicle Model	Engine Type
TOYOTA	Landcruiser	GC01080	Landcruiser N-BJ46V, N-HJ60V	3400cc
		GC01080	Landcruiser P-BJ73, P-BJ61	3400cc
		GC21080	Landcruiser P-BJ71, P-BJ74	3400cc
		GC21080	Landcruiser P-BJ71V	3400cc
		GC72080	Landcruiser HJ45	3600cc
		GC72080	Landcruiser FJ40, 43, 45, 55V	3900cc
		GC11080	Landcruiser FJ40, 43, 45, 55V	3900cc
		GC11080	Landcruiser P-HJ60, P-HJ61	4000cc
		GC11080	Landcruiser FJ62	4000cc
		GC11080	Landcruiser P-HJ60V, P-HJ61V	4000cc
		GC11080	Landcruiser FJ62; FJ70, 73, 75, HJ75	4000cc Diesel
		GC21080	Landcruiser FJ70, 73, 75, HJ75	4000cc Diesel
		GC11080	Landcruiser 40, 60, 75, FJ40, 43, 45, 55, 56, 60, 61, 62V, 65, 70, 73, 75; HJ40, 43, 45	4000cc, 4200cc
		GC11080	Landcruiser N-BJ46V, N-HJ60V; M-FJ61V	4000cc, 4230cc
		GC05010	Landcruiser HZJ80	4200cc
		GC05010	Landcruiser HD380	4200cc Turbo Diesel
		GC05010	Landcruiser HZJ18V	4200cc
		GC11080	Landcruiser FJ40, 43, 45, 55	4200cc
		GC11080	Landcruiser FJ40, 45, 60, HJ47, 60	4200cc & Diesel
		GC11080	Landcruiser FJ56, 56V	4300cc
		GC11080	Landcruiser FJ60, 60V	4300cc
		GC01080	Landcruiser BJ40, 42, 45, 60	Diesel
		GC01080	Landcruiser BJ70, 73, 75	Diesel
	GC11080	Landcruiser BJ73	Diesel	
	GC21080	Landcruiser BJ71	Diesel Turbo	
	MR2	GC04010	MR2 AW10, AW11	1500cc, 1600cc
		GC33010	MR2 SW20	2000cc
	Paseo	GC04010	Paseo EL44, EL54	1300cc, 1500cc
	Previa	GC60010	Previa	2500cc
	Publica/Soarer	GC60010	Soarer GZ20	2000cc
		GC10080	Soarer E-GZ10, E-GZ20, E-MZ10/11, E-MZ11/12/20	2000cc, 2800cc, 3000cc
	Sprinter	GC04010	Sprinter E-EE80	1300cc, 1500cc
		GC04010	Sprinter E-EE90	1300cc
GC04010		Sprinter E-EE96V, E-EE98V	1300cc, 1500cc	

GMB CLUTCH RELEASE BEARING



OE Maker	Clutch	Vehicle Model	Engine Type	
TOYOTA	Sprinter	GC04010	Sprinter E-AE80	1500cc
		GC04010	Sprinter E-AE91	1500cc
		GC04010	Sprinter E-AE81	1500cc, 1600cc
		GC04010	Sprinter E-AE82	1500cc, 1600cc
		GC10080	Sprinter E-AE86	1600cc
		GC33010	Sprinter N-CE80	1800cc
		GC33010	Sprinter N-CE90	1800cc
		GC33010	Sprinter N-CE96V	1800cc
		GC10080	Sprinter Carib	1500cc
		GC10080	Sprinter Trueno	1600cc
	Starlet	GC04010	Starlet EP70	1000cc
		GC04010	Starlet EP80, WP80, EP81	1000cc, Diesel, 1300cc
		GC20080	Starlet KP42, 47, 51	1200cc/GBX:5 RWD
		GC04010	Starlet EP71, EP76V	1300cc
		GC04010	Starlet EP85	1300cc
		GC04010	Starlet EP71, 71(EFI), 76V	1300cc FWD
		GC04010	Starlet EP82, NP80	1300cc, 1500cc
		GC04010	Starlet N-NP70, N-NP76V	1500cc
	Supra	GC60010	Supra GA70, GA70H	2000cc
		GC10080	Supra MA70	2000cc DOHC
		GC10080	Supra E-GA70, E-MA70	2000cc, 3000cc
	Tercel	GC04010	Tercel E-EL30, E-EL31	1300cc
		GC10080	Tercel E-AL11, E-AL25Z	1300cc, 1500cc
		GC10080	Tercel E-AL20, E-AL21	1300cc, 1500cc
		GC04010	Tercel E-EL30, N-EL31, N-NL31	1300cc, 1500cc
		GC04010	Tercel E-EL41, E-EL43, E-EL45, N-NL40	1300cc, 1500cc
		GC10080	Tercel E-AL25G	1500cc
		GC10080	Tercel E-AL25	1500cc
		GC10080	Tercel E-AL21	1500cc
		GC04010	Tercel N-NL30	1500cc
	Vista	GC33010	Vista N-CV10	1800cc
		GC33010	Vista E-SV22	1800cc
		GC33010	Vista E-SV10, 11, 12, SV21, N-CV20, N-CV11	1800cc, 2000cc
		GC33010	Vista N-CV20	2000cc
		GC83010	Vista N-CV30, E-SV30	2000cc

					
OE Maker	Clutch	Vehicle Model	Engine Type		
TOYOTA	BUV/Tamaro /Kijang	GC70080	BUV/Tamaro/Kijang Pick Up KF10	1200cc	
		GC10080	BUV/Tamaro/Kijang Pick Up KF20, RF30, LF20, 30	1300cc, 1600cc, 2200cc	
	Coaster	GC11080	Coaster N-HB30, N-HB36V		
		GC21080	Coaster N-HB30, N-HB36V		
		GC01080	Coaster N-BB21, N-26V, N-36V		
		GC21080	Coaster N-HB31		
		GC52010	Coaster HZB50		
		GC81080	Coaster RU18	2000cc	
		GC21080	Coaster RU18	2000cc	
		GC91080	Coaster RU19	2000cc	
		GC10080	Coaster RB10, 11, 12	2000cc, 2200cc	
		GC10080	Coaster RB13, 20	2400cc	
		GC10080	Coaster RB26V	2400cc	
		GC72080	Coaster BU19	3000cc	
		GC01080	Coaster BB10, 11, 20, 21, 30, 31:BU32	3200cc, 3400cc	
		GC01080	Coaster BB31, BB36V	3400cc	
		GC94010	Coaster BB23, 24	3700cc	
		GC11080	Coaster HB30	4000cc	
		GC21080	Coaster HB30, 31, 32, HB36V	4000cc	
		GC21080	Coaster HB36V, HB30, 31, 32	4000cc - /GBX:5	
		GC21080	Coaster FB30, HB30	4000cc & Diesel	
		GC01080	Coaster BB10, BB20	Diesel	
		Dyna	GC10080	Dyna YY50, YH80	1600cc
			GC10080	Dyna M-YY50, M-YY52/61, N-LY50, N-LY60; YU60, 61, 70, 80; M-YU61	1.25, 1, 5t; 1800cc; 2.0t
			GC91080	Dyna RU10, 12, 15	2000cc
			GC10080	Dyna RU20, RU25, RU30, RU35	2000cc
			GC10080	Dyna YU60	2000cc
	GC10080		Dyna RU22,32,2,YU60,61,70,80:YY52,61:LY50,60	2000cc, 2400cc	
	GC81080		Dyna RU10, 12, 15; JU10, 12, 15	2000cc, 2500cc	
	GC10080		Dyna YU62, 63, 71, 81	2200cc	
	GC71010		Dyna LY50, YY61	2200cc, 2400cc	
	GC72080		Dyna JU10, 12, 15	2500cc	
GC70080	Dyna JU10, 12, 15, 20		2500cc		
GC72080	Dyna LY51		2800cc		

GMB CLUTCH RELEASE BEARING

				
OE Maker		Clutch	Vehicle Model	Engine Type
TOYOTA	Dyna	GC94010	Dyna BU60, BU70V, BU70VH, BU80, BU61, BU81, BU83, BU84	3000cc
		GC01080	Dyna N-BU22, N-BU60/61/70/23, P-BU62/64/85	2.0 - 3.0t
		GC10080	Dyna M-YU60, N-YU70, M-RU22	2.0t
		GC72080	Dyna BU10, BU12, BU15	3000cc
		GC01080	Dyna BU20, BU25, BU30, BU35	3000cc
		GC21080	Dyna BU83, BU84	3000cc
		GC01080	Dyna BU2., 3., 4., 5., 6., 7., 8.:BU31	3000cc, 3200cc
		GC01080	Dyna BU60, BU61; BU62, BU62D	3000cc, 3400cc
		GC01080	Dyna BU2., 3., 4., 5., 6., 7., 8.:BU62, 64, 70, 82, 93	3400cc
		GC01080	Dyna BU85	3400cc
		GC21080	Dyna BU85, 90, 95	3400cc Turbo
		GC61080	Dyna HU15, 30	3600cc
		GC94010	Dyna BU66D, BU66H, BU67D, BU78, BU87V, BU88, BU91, BU96, NU94	3700cc
		GC21080	Dyna BU78,87,87V,91,96,BU66,66D,78,87,87V,91	3700cc
		GC21080	Dyna N-BU90, 95, 93, 98	3.0 -3.5t
		GC11080	Dyna P-WU75, 90, 95	3.0 -3.5t
		GC11080	Dyna P-WU75D	3.5t
		GC21080	Dyna P-BU95	3.5t
		GC11080	Dyna P-WU26D, P-WU50	3.5, 3.75t
		GC11080	Dyna WU26, 40, 50, 70, 75, 90, 95	4000cc
		GC61080	Dyna HU30	Diesel
		GC01080	Dyna BU20, 30	Diesel
		GC01080	Dyna BU31	Diesel
		GC01080	Dyna BU32	Diesel
		GC11080	Dyna HU40, 50	Diesel
		GC01080	Dyna BU60, BU61, BU63, BU80, BU81	Diesel
		GC10080	Dyna 100 YH80	1600cc
		GC60010	Dyna 100 YH81	1800cc
		GC10080	Dyna 100 LH81, YH81	1800cc Diesel
		GC71010	Dyna 100 LH80	1800cc Diesel
		GC10080	Dyna 150 YY51, YY60	1800cc
		GC10080	Dyna 150 YY52, YY61, LY60	2000cc Diesel
GC71010	Dyna 150 YY52, YY61, LY60	2000cc Diesel		

				
OE Maker		Clutch	Vehicle Model	Engine Type
TOYOTA	Dyna	GC10080	Dyna 150 LY60, YY61, YU62, 81, 82, RU85	2000cc,2200cc,2400ccDiesel
		GC71010	Dyna 150 LY61	Diesel
		GC01080	Dyna 200 BU83, 84	Diesel
		GC21080	Dyna 200 BU60, 61, 80, 81, 83, 84, 85, 88, 91, 96	Diesel
	Hiace	GC81080	Hiace RH10, 11, 16	1350cc, 1600cc
		GC91080	Hiace RH10	1350cc, 1600cc
		GC91080	Hiace RH11, 16	1600cc
		GC91080	Hiace RH11	1600cc
		GC70080	Hiace RH11, 13, 16, 20, 24, 30, 34, 40	1600cc
		GC10080	Hiace YH80	1600cc
		GC70080	Hiace RH11, 13, 16, 20, 24, 30, 34, 40	1600cc, 2000cc & Diesel
		GC70080	Hiace RH11, 20, 30, 22, 32, 42, LH11, 20, 30	1600cc, 2000cc & Diesel
		GC10080	Hiace RH11, 13, 16, 20, 22, 24, 30, 34, 40	1600cc, 2000cc & Diesel
		GC70080	Hiace RH12, 14, 17, 21, 31, 41	1800cc
		GC10080	Hiace YH50V, 60V	1800cc
		GC60010	Hiace YH50V	1800cc
		GC60010	Hiace YH81	1800cc
		GC10080	Hiace M-YH51G, M-YH61G, M-YH50V, YH50, YH60	1800cc, 2000cc
		GC70080	Hiace RH22, 25, 32, 42:RG23G, 33G	2000cc
		GC10080	Hiace RH35, 45:RG23G, 33G:YH51G, 52V, 61G, 62V, 71V, 2000	2000cc
		GC10080	Hiace E-YH51G, E-YH51V, M-YH71V	2000cc
		GC60010	Hiace E-YH52V	2000cc
		GC60010	Hiace RZH100G, 102V, 110G	2000cc
		GC10080	Hiace YH51, YR61, YR63	2000cc, 2200cc
		GC60010	Hiace YH51, YR61, YR63	2000cc, 2200cc
		GC10080	Hiace M-YH61V, N-LH60G, N-LH60V	2000cc, 2400cc
		GC60010	Hiace RZH102, 103, 109, 112, 113, 119	2000cc, 2400cc
		GC70080	Hiace LH11, 20, 24, 30, 40	2200cc
		GC10080	Hiace N-LH24, N-LH24HV, LH50, LH60, E-YH51G, N-LH50G	2200cc1.0t Diesel, 2000cc, 2400cc
		GC10080	Hiace LH11,20,24,30,40,50G,50V,51,60G,60V,70V; RH24	1600cc, 2000cc
GC10080	Hiace N-LH61G, 71B, 51V, 51G, 61V, N-LH50G	2200cc, 2400cc		
GC10080	Hiace LH51G, 61G, 61V, 71G, 71V, 80, 80VH, 151	2400cc		

GMB CLUTCH RELEASE BEARING



OE Maker	Clutch	Vehicle Model	Engine Type			
TOYOTA	Hiace	GC10080	Hiace N-LH51, N-LH61G, N-LH71, N-LH61V, N-LH80	2400cc		
		GC71010	Hiace LH80, LH80VH	2400cc		
		GC10080	Hiace N-LH56, N-LH66	2400cc		
		GC71010	Hiace LH100G, LH102V, LH85, U-LH80VH, U-LH85	2400cc 4WD(Diesel)		
		GC10080	Hiace LH50, LH60, LH51, LH61	Diesel		
		GC71010	Hiace LH51, LH61	Diesel		
		GC71010	Hiace LH102, 108, 112, 118	Diesel		
		GC91080	Hiace Bus RH11B, 16B	1600cc		
		GC70080	Hiace Bus RH11B, 16B, 20B, 30B, 40B	1600cc		
		GC80010	Hiace Bus YH60B, YH50	1800cc		
		GC70080	Hiace Bus RH22B, 32B, 42B	2000cc		
		GC10080	Hiace Bus RH22B, 32B, 42B	2000cc		
		GC10080	Hiace Bus YH71B:LH60B, 61B, 70B, 71B	2000cc, 2200cc, 2400cc		
		TOYOTA	Hilux	GC91080	Hilux RN20, RN25	1600cc
				GC91080	Hilux RN13, RN16	1600cc
GC70080	Hilux RN20, 25, 30, 33, 34, 40, 43			1600cc		
GC70080	Hilux RN20, RN25			1600cc		
GC10080	Hilux RN30, 40, LN30, 40			1600cc & Diesel		
GC70080	Hilux RN30, 40, LN30, 40; RN36, RN46			1600cc & Diesel, 2000cc 4WD		
GC10080	Hilux RN33, 34, 35, 40, 44, 45:YN50, 51, 55, 56, 61			1600cc, 1800cc		
GC10080	Hilux YN50, 52, 55, 57, LN50, 51, 55, 56			1600cc, 2000cc & Diesel		
GC10080	Hilux L-YN51, L-YN56; N-LN55, 50, 56			1800cc 1.0t, 2200cc 1.0t		
GC10080	Hilux YH81, LH80			1800cc Diesel		
GC60010	Hilux YN80, 81, 85, 86, 87, 92			1800cc,2000cc,2200cc,2WD		
GC70080	Hilux RN22			2000cc		
GC70080	Hilux RN31, 36, 39, 41, 46			2000cc		
GC10080	Hilux RN31, RN41			2000cc		
GC10080	Hilux RN31, 36, 39, 41, 46:YN57, 61, 61G, 65			2000cc		
GC10080	Hilux YN60			2000cc		
GC10080	Hilux E-YN60, E-YN65, E-YN61G.V			2000cc		
GC10080	Hilux YN61G, YN61V, YN65			2000cc		
GC10080	Hilux YN60, YN65			2000cc 4WD		
GC10080	Hilux RN36, RN46; RN30, 40, LN30, 40			1600cc&Diesel,2000cc4WD		
GC10080	Hilux L-RN39; K-LN36, K-LN46			2000cc, 2200cc		
GC10080	Hilux N-LN41, 51, 56, N-YN51, 56, N-LN61			2000cc, 2400cc		

					
OE Maker		Clutch	Vehicle Model	Engine Type	
TOYOTA	Hilux	GC10080	Hilux L-YN65, L-YN60V; LN60, 65	2000cc, Diesel 4WD	
		GC70080	Hilux LN30, 40	2200cc	
		GC10080	Hilux N-LN40; L-RN35, L-RN45	1600cc, 2200cc	
		GC10080	Hilux YN67	2200cc 4WD	
		GC10080	Hilux LN30, 40, 60., 65	2200cc, 2400cc, 2500cc	
		GC10080	Hilux N-LN60, N-LN65	2400cc	
		GC71010	Hilux RN80, 85 LN80, 85, 90	2400cc & Diesel 2WD	
		GC10080	Hilux LN41, LN51, LN56; RN35, RN45	1600cc, 2400cc	
		GC63010	Hilux LN105, 106, 108, 110, 111	2800cc	
		GC60010	Hilux LN100, LN106, LN80, YN85, 90, 106, 110	2400cc, 2800cc	
		GC10080	Hilux LN36, LN46	Diesel	
		LiteAce	GC20080	LiteAce KM10	1200cc
			GC70080	LiteAce KM10	1200cc
			GC70080	LiteAce KM11	1200cc, 1300cc
			GC10080	LiteAce KM20	1300cc
			GC10080	LiteAce KM35V	1300cc
			GC10080	LiteAce KM50	1300cc
			GC10080	LiteAce L-YM20V;L-KM21,L-KM21V;E-YM21G	1300cc, 1600cc, 1800cc
			GC10080	LiteAce KM11,20,21,30G,31V,35V,36V,37G;YM20,25	1300cc, 1500cc, 1600cc
			GC10080	LiteAce E-KM21, E-YM25	1300cc, 1600cc
			GC10080	LiteAce E-KM30G, E-KM36V	1500cc
			GC10080	LiteAce E-KM31V	1500cc
			GC10080	LiteAce KM36, KM37M, YM31	1500cc, 1800cc
			GC60010	LiteAce KM30G, CM36V	1500cc, 2000cc
			GC10080	LiteAce CM30G, KM36V, CM31V	1500cc, 2000cc
			GC70080	LiteAce KM11	1800cc
			GC10080	LiteAce TMG20	1800cc
			GC10080	LiteAce E-YM30G	1800cc
			GC60010	LiteAce YM30G	1800cc
			GC10080	LiteAce YM30	1800cc
			GC60010	LiteAce CM50	1800cc
			GC10080	LiteAce YM60, YM65	1800cc
	GC60010	LiteAce YM31V	1800cc		
	GC10080	LiteAce L-CM25	1800cc		
	GC10080	LiteAce TM20 YM21G,30G,31V;CM20,30G,35V	1800cc, 2000cc		

GMB CLUTCH RELEASE BEARING



OE Maker	Clutch	Vehicle Model	Engine Type	
TOYOTA	LiteAce	GC10080	LiteAce L-YM60, E-YM40G, N-CM20, N-CM26	1800cc, 2000cc
		GC10080	LiteAce N-CM30G, N-CM60	2000cc
		GC10080	LiteAce N-CM40G	2000cc
		GC10080	LiteAce N-CM40G, 60	2000cc 4WD Diesel
		GC60010	LiteAce CM51, CM55, CM60; KM51; YM55	1500cc, 1800cc, 2000cc
		GC10080	LiteAce CM20	Diesel
		GC10080	LiteAce CM35	Diesel
		GC60010	LiteAce YM30, CM36	Diesel, 1800cc
	Master-Ace /Mini-Ace /Model F	GC60010	Master-Ace E-YR20G, E-YR28G	1800cc
		GC10080	Master-Ace E-YR20G, E-YR21G	1800cc, 2000cc
		GC10080	Master-Ace E-YR28G, E-YR30G, E-YR38G, N-CR30G, N-CR36V	1800cc, 2000cc
		GC60010	Master-Ace E-CR21G, E-CR28G, E-YR21G	2000cc
		GC10080	Master-Ace N-CR21G, N-CR28G	2000cc
		GC60010	Master-Ace E-CR37G	2000cc
		GC10080	Model-F YR20, YR21, YR31	1800cc, 2000cc, 2200cc
		GC60010	Model-F YR21, YR22, YR31	2000cc, 2200cc
	Stout	GC10080	Model-F YR31, CR21	2200cc 4WD Diesel
		GC91080	Stout RK101	2000cc
		GC70080	Stout RK110	2000cc
		GC10080	Stout RK111	2000cc
		GC10080	Stout RK110	2000cc
		GC81080	Stout RK101	2000cc
		GC10080	Stout YK110	2000cc
	TownAce	GC71010	Stout YK110	2200cc
		GC10080	TownAce L-KM21	1300cc
		GC60010	TownAce L-KM50	1300cc
		GC60010	TownAce L-KM51; YM55, YM60; CM60, CM65	1500cc, 1800cc, 2000cc
		GC10080	TownAce YR26V	1600cc
		GC10080	TownAce L-YM25, L-YR26V, N-CR26V, N-CM25	1600cc, 1800cc, 2000cc
		GC60010	TownAce E-YR20G	1800cc
		GC60010	TownAce CM50	1800cc
		GC10080	TownAce E-YR21G	1800cc, 2000cc
	GC10080	TownAce N-CR27V	1800cc, 2000cc	
GC10080	TownAce N-CM20, N-CM26	1800cc, 2000cc		

				
OE Maker		Clutch	Vehicle Model	Engine Type
TOYOTA	TownAce	GC60010	TownAce E-YR28G, N-CR21G, E-YR25V, N-CR27V	1800cc, 2000cc
		GC10080	TownAce E-YR21G, N-CR21G, N-CR28G	2000cc
		GC60010	TownAce YR30G, YR36G	2000cc
		GC10080	TownAce CR30G, CR36V	2000cc
		GC60010	TownAce CR28G, CR37G, CM51	2000cc
		GC10080	TownAce E-YR30G, E-YR38G, N-CR30G, N-CR36V; E-KM21, E-YM25	1300cc, 1600cc, 2000cc
		GC70080	TownAce/Model F KR10, KR11, KR12	1200cc, 1300cc
		GC10080	TownAce/Model F KR12	1300cc
		GC70080	TownAce/Model F RR11, 20, 21:TR10, 11	1600cc
		GC10080	TownAce/Model F RR11, 21, TR11, TR15	1600cc
	ToyoAce	GC10080	ToyoAce PY10	1350cc
		GC81080H	ToyoAce RY10, 12, 14	1600cc
		GC91080	ToyoAce RY10, 12, 14	1600cc
		GC70080	ToyoAce RY10, 12, 14, 20, 30	1600cc
		GC10080	ToyoAce RY20, 30	1600cc
		GC10080	ToyoAce RY21, YY50	1600cc
		GC70080	ToyoAce RY20, 30, 31, LY20, JY30	1600cc,2000cc&Diesel,2500cc
		GC10080	ToyoAce RY20, 30, 31, LY20, JY30	1600cc,2000cc&Diesel,2500cc
		GC10080	ToyoAce M-RY32, M-RY21, N-LY20, N-LY30	1600cc,2000cc,2200cc,2400cc
		GC10080	ToyoAce M-YY50,M-YY52,M-YY/YU61,N-LY50, N-LY/M-YU60/70	1800cc
		GC71010	ToyoAce M-YY51	1800cc
		GC72080	ToyoAce RY16	2000cc
		GC70080	ToyoAce RY16, 31	2000cc
		GC10080	ToyoAce RY31, 32	2000cc
		GC10080	ToyoAce YU60	2000cc
		GC10080	ToyoAce YY52, 61	2000cc
		GC70080	ToyoAce LY20, 30	2200cc
		GC10080	ToyoAce LY20, 30	2200cc
		GC10080	ToyoAce N-LY31, LY21, 31, 60, LY50	2200cc, 2400cc
		GC72080	ToyoAce JY16	2500cc
GC70080	ToyoAce JY16, 30	2500cc		
GC10080	ToyoAce JY30	2500cc		

GMB CLUTCH RELEASE BEARING



OE Maker	Clutch	Vehicle Model	Engine Type	
TOYOTA	ToyoAce	GC01080	ToyoAce N-BU60, 61, 70, P-BU62, 64	2500cc
		GC01080	ToyoAce BY30, 31, 3	3000cc
		GC01080	ToyoAce BU60, BU60VH	3000cc
		GC94010	ToyoAce BU60, BU61, BU83, BU84	3000cc
		GC01080	ToyoAce N-BY31, BU62, BU64, BU64D	3000cc, 3400cc
		GC21080	ToyoAce BU90, BU93, BU68DH, BU78	3400cc, 3700cc
		GC94010	ToyoAce BU66	3700cc
		GC94010	ToyoAce BU67, BU78, BU87, BU88, BU91, BU94, BU96	3700cc
		GC21080	ToyoAce BU66, BU66D	3700cc
		GC21080	ToyoAce N-BU90, 95, 93, 98	3.0 - 3.5t
		GC11080	ToyoAce P-WU75, 90, 95	3.0 - 3.5t
		GC21008	ToyoAce WU90, WU95	4000cc
		GC42010	ToyoAce WU85	4000cc
		GC62010	ToyoAce WU75D	4000cc
		GC71010	ToyoAce U-LY51, 61, M-YY52, 61	Diesel/Gasoline
VAUXHALL		GC80010	Astra 1.8	GBX:F16
		GC80010	Astra 2.0	GBX:F16
		GC80010	Astra Diesel	
	Belmont	GC80010	Belmont 1.8	GBX:F16
		GC80010	Belmont 2.0	GBX:F16
		GC80010	Belmont 1.6 Diesel	
	Calibra	GC80010	Calibra	
	Cavalier	GC80010	Cavalier 1.6	GBX:F16
		GC80010	Cavalier 1.8	GBX:F16, F18
		GC80010	Cavalier 2.0	
		GC80010	Cavalier 2.0 16V	
		GC80010	Cavalier 2.5 V6	
		GC80010	Cavalier 1.6 Diesel	16DA-1586cc Mot 14498631
		GC80010	Cavalier 1.7 Turbo Diesel	
	Frontera	GC31010	Frontera 2.8 Turbo Diesel	
	Vectra	GC80010	Vectra 1.8	
		GC80010	Vectra 2.0; 2.0 16V	
		GC80010	Vectra 2.5	
		GC80010	Vectra 1.7 Turbo Diesel	
VOLKSWAGEN	Passat	GC03010	Passat 1.3	

PART 4

Item Reference Table

GMB

GMB CLUTCH RELEASE BEARING

Item Reference Table

GMB	SKF	KOYO	NSK	NTN	NACHI	BCA	SACHS	VALEO
GC00110	VKC2181						3151 199 001 3151 015 301	
GC00210								
GC01010	VKC3554	RCR37SA1	48TKA3214	FCR50-10/2E		613078	1863 805 002	
GC01080	VKC3523	RCTS45 RCT4500	45TKD07U3 TK45-15U3	SF0940/2E	BC6S	616106		
GC01110							3151 119 001	
GC01210	VKC2238						3151 809 002	
GC02010	VKC3610			FCR62-11/2E FCR62-29/2E FCR62-29-5/2E FCR62-29-7/2E		614157	3151 863 001	
GC02080	VKC3519	40TMK20-1S 40TNK20	40TMK20B 40TMK20B1U3 40TNK20AK2	40TMK20 40TNK20	40TNK20 40TMK20	614038		
GC02110	VKC3551	RCT33SA4	38TKA2801A	FCR38-1/2E		614510	3151 828 001	
GC02210		CBU442822G+C	44TKB2805BR	FCR44-25-4/2E		614110	3151 884 001	
GC03010	VKC2091						3151 193 041	355538 358273
GC03080								
GC03110	VKC3613			FCR62-42-4/2E		614159	3151 861 002	
GC03210							3400 005 035	
GC04010	VKC3556	RCT337SA3 RCTS335SA4	50TKA3305R 50TKA3305RU3 50TKB3301BR	FCR50-20	50SCRN28P-5	614043	3151 851 001	
GC04080								
GC04110						614060		
GC05080								
GC06010								
GC06080								
GC06110	VKC3584		60TKB3502AR			614084	3151 876 001	
GC07010	VKC2080		WF24=1			614012	3151 151 241	
GC07110								
GC08010	VKC2189						3151 846 001	
GC08110	VKC3600			FCR54-13/2E FCR54-19/2E FCR54-47-2/2E FCR54-48/2E FCR54-48-3/2E		614079		
GC09010			44TKZ2801BR					
GC09110	VKC2191						3151 847 001	
GC10000	VKC3502							
GC10010	VKC3578	CBU442822G+C	44TKB2805BR	FCR44-25-4/2E		614110		
GC10020	VKC3620							
GC10080	VKC3502	RCT40 RCTS4067A2RS RCTS4067A2RR5	40TKD03U3 40TKD05U3 40TKD07U3 TK40-16AU3	SF0845/2E SF0859/2E	40TRK30W1SB 40TRBC07-7SB	613010	1863 836 001	
GC10110	VKC2260						3151 066 032	
GC10210	VKC5006							
GC11010	VKC3609	CBU472921C		FCR47-8-3/2E	47SCRN35-P6	614128		PRB-10
GC11080	VKC3575	RCT52S	TK52Z-1C	50TMK804/2E	052TRBC09-7SB	613008		

Item Reference Table

GMB	SKF	KOYO	NSK	NTN	NACHI	BCA	SACHS	VALEO
GC11110							1850 282 127	
GC11210	VKC5052H							
GC12010	VKC3581			FCR62-13/2E FCR62-32-10/2E FCR62-32-11/2E FCR62-32-12/2E FCR62-32-1/2E FCR62-32-2E		614049	3151 854 001	
GC12080	VKC3661	62TMK20-1						
GC12110	VKC3598	RCTS33SA4	62TKA3311	FCR62-33-4/2E		614048	3151 829 001	
GC13080								
GC13110	VKC2144		WF34=1				3151 803 001	
GC13210								
GC14080								
GC14110	VKC3654		47TKB3101B		47SCRN40P	614122	3151 906 001	
GC15010		48RCT3301						
GC15080								
GC15110								
GC16010								
GC16080								
GC16110	VKC2183						3151 895 001 3151 895 002	
GC18010	VKC3666						3151 994 601	
GC18110								
GC19010								
GC20010	VKC3564	RCTS338SA1 RCTS338SA2	50TKB3304 50TKE3301	FCR50-30-2 FCR50-20/2E		614056	3151 818 001	PRB-07
GC20020	VKC3674						3151 994 501	
GC20020	VKC3674						3151 994 501	
GC20080	VKC3505	RCT38SL1	24TK308B2U3	SF0816/2E	BC12S4SB	1496	1850 282 709 1863 805 001	359217
GC20110	VKC5215						3151 044 031	
GC20210	VKC3556	RCT337SA3-1	50TKB3301BR	FCR50-20	50SCRN28P-5			
GC21010	VKC3507	RCT363SA RCT363SA-1	54TKAE3602 54TKB3604	FCR54-10/2E FCR-54-33-1/2E FCR54-2/2E FCR54-46-2/2E FCR54-58/2E	54SCRN42P	614067	3151 600 515 3151 807 001	
GC21080	VKC3548	RCTS45A	45TKD10U3	45TRBC07-13SB	45TRBC07-13SB			
GC21110	VKC2185						3151 033 031	
GC21210	VKC2161						3151 073 031	
GC22010	VKC3602	CBU472921		FCR47-8-3/2E FCR47-8-4/2E	47SCRN35-P2 47SCRN34K-6	614127	3151 858 001	
GC22080	VKC3545	45TNK20	45TNK20AAK2	45TNK20/4E 45TNK20/XG	45TNK20	615100		
GC22110	VKC3617		47TKB3101A			614077	3151 867 001	
GC23010	VKC3567	RCT283SA		FCR44-9/2E		614050	3151 819 002	PRB-06
GC23080								
GC23110								
GC23210								
GC24080		RCT5188						
GC24110				FCR50-41-3/2E			3151 996 602	

GMB CLUTCH RELEASE BEARING

Item Reference Table

GMB	SKF	KOYO	NSK	NTN	NACHI	BCA	SACHS	VALEO
GC25010		48RCT3303						
GC25080								
GC25110								
GC26010	VKC2064						1850 282 127	
GC26080								
GC26110	VKC2538		WF35=2				3151 835 001 3151 997 001	
GC27010								
GC28010	VKC2241						3151 180 131 3151 180 231	
GC29010								
GC30010	VKC3559	RCT371SA	58TKA3702U3 58TKA3703 58TKA3703B	FCR47-8-3/2E			3151 877 001	
GC30020								
GC30080	VKC3541	CT70B CT70BL1	TK70-1A1U3	SF1412/2E	70TNK-1=70TKN-1	613016		
GC30110			106TKC7001					
GC30210	VKC2523						3151 994 301	
GC31010	VKC3606	RCT422SA1	60TKC4202			613012	1863 860 001	
GC31080	VKC3540	RCT55B	TK55-1BU3	55TRK30A/2E	55TRK30W1			
GC31110	VKC2131						3151 027 131 3151 027 031	
GC31210					55SRN34-5			
GC32010	VKC3592		55TKA3201	FCR55-1-4/2E		614016	3151 831 001	
GC32080	VKC3566	CT5586ARSE		SF1135/2E				
GC32110	VKC3654		47TKB3101B		47SCRN40P	614122	3151 906 001	
GC33010	VKC3516	RCTS351SA4	60TKA3502U3		60SCRN033-3=31T	614147	3151 834 001	
GC33080								
GC33110								
GC34010	VKC3524	RCTS355SA		FCR54-15/2E		615104	3151 880 001	
GC34080								
GC34110	VKC2120						3151 231 031	
GC35010			61TKB3001					
GC35080								
GC35110								
GC36010	VKC2146						1850 282 607	
GC36080								
GC36110	VKC2220						3151 816 001	
GC37010							3151 802 003	
GC37110	VKC2242						3151 212 905	
GC38110			54RCT3437FO					
GC39010								
GC39110								
GC40010	VKC3515		48TKA3201U3 48TKB3202	FCR48-11/2E	48SCRN32K	614126		PRB-01
GC40020								
GC40080		CT1310ARSE						
GC40110	VKC3672		58TKB3505RA				3151 997 801	
GC40210		RCTS324SA	55TRK3201	FCR55-1-4/2EU64				

Item Reference Table

GMB	SKF	KOYO	NSK	NTN	NACHI	BCA	SACHS	VALEO
GC41010	VKC3560	RCTS33SA-1	62TKA3309U3 62TKA3310 62TKB3301 62TKB3304	FCR62-26/2E FCR62-26-5/2E FCR62-5/2E FCR62-9/2E		614022	3151 811 001	
GC41080	VKC3537		TK45-4BU3	SF0914		613008		
GC41210								
GC42010	VKC3650				68SCRN43A			
GC42080	VKC3525	CT5582RU	55TNK29	55TNK29	55TMK-1	615110		
GC42110								
GC42210								
GC43010	VKC3621	RCT473SA						
GC43080								
GC43110								
GC44010	VKC3649				68SCRN48P		3151 997 802	
GC44080								
GC44110								
GC45010	VKC3564	RCTS338SA4	50TKE3301 50TKB3304	FCR50-30-7/5K FCR50-30-13/5X		614056	3151 818 001	
GC45080								
GC46010	VKC2202						3151 069 032 3151 122 031 3151 122 331	
GC46080		CT55BL1	TK55-1A1U3	55TMK804/4E	55TMK804			
GC47110								
GC48010			48TKB3204R					
GC48110	VKC3672		58TKB3505RA				3151 997 801	
GC49010								
GC49110								
GC50010	VKC3623	RCTS28SA		FCR50-35-6/5K	BC6S	614082	3151 819 002	
GC50020							3151 213 031	
GC50080		CT1310						
GC50110	VKC2091H						3151 193 041	
GC50210								
GC51010	VKC3668	RCT285SA		FCR44-3/2E	44SCRN28P-4			
GC51080	VKC3511	RCT45-1S	TK45-4EU3	SF0914/2E	45TMK-1	FC-1723-C	1863 801 001	
GC51110	VKC2111						1850 282 193	
GC51210								
GC52010	VKC3627				68SCRN58P-2		3151 902 001	
GC52080	VKC3612	RCT4068A2RSE					1863 859 001	
GC52110			78TKL4801R					
GC52210								
GC53010	VKC3626	RCT356SA8			50SCRN37P-4	614086	3151 998 001	
GC53080								
GC53110								
GC54080								
GC54110							3151 000 121	
GC55010	VKC3607	RCT331SA1		FCR50-17-8/2E		614026		
GC55080								
GC55110	VKC3673						3151 994 301	
GC56010								
GC56080	VKC3504	RCT3360A2RS RCT3360A2RRS	33TKD03U3	SF0743/2E	33TRBC-4SB	TO-1711	1863 820 001	

GMB CLUTCH RELEASE BEARING

Item Reference Table

GMB	SKF	KOYO	NSK	NTN	NACHI	BCA	SACHS	VALEO
GC56110								
GC57010								
GC57110			54TKZ3501					
GC58010								
GC58110	VKC3515	RCT322SA	48TKB3202 48TKT3202	FCR48-11/2E	48SCRN32K		3151 808 001 3151 808 002 3151 878 001	
GC59010			47TKB3001A					
GC59110	VKC2238						3151 809 002	
GC60010	VKC3616	RCT356SA9 RCT356SA9-1	50TKB3504BR 50TKB3504BRA		50SCRN44S-2	614088	3151 875 001	
GC60020							3151 998 501	
GC60080	VKC3500	RCT4075-1S	TK40-4AU3	SF0820/2E SF0820/4E	40TRK-1	1576	1863 810 001	
GC60110								
GC60210							3151 000 121	
GC61010	VKC3600			FCR54-13/2E FCR54-19/2E FCR54-47-2/2E FCR54-48/2E FCR54-48-3/2E		614079		
GC61080	VKC3538	CT52A-1	TK52Z-1B TK52Z-1B(U3)	52TMK804	BC11S3=S2	613008		
GC61110	VKC3605		55TKB3502A			614104	3151 862 001	
GC61210				FCR62-30-6/2E				
GC62010	VKC3644				68SCRN46P			
GC62080	VKC3527	65TNK20	65TNK20	65TNK20/2E	65TNK20			
GC62110								
GC62210			44TKB2805R	FCR44-25-3/2E				
GC63010	VKC3628		50TKB3501BR		50SCRN34P-4		3151 907 001	
GC63080								
GC63110	VKC2115						1850 282 602 3151 275 601	
GC64010	VKC2191						3151 847 001	
GC64080	VKC3512	80TNK20	TK80-1A	SF1607/2E	80TNK20-1			
GC64110								
GC65010	VKC3611			FCR48-24/2E		614130	3151 865 001	
GC65080								
GC65110								
GC66010	VKC5071							
GC66080								
GC66110								
GC67010								
GC67110	VKC3564	RCTS338SA1 RCTS338SA2	50TKB3304 50TKE3301	FCR50-30-2 FCR50-20/2E		614056	3151 818 001	
GC68010	VKC2536							
GC68110	VKC2239						3151 874 002	
GC69010								
GC69110	VKC3552	RCT323SA	48TKA3210	FCR65-1/2E		614044	3151 830 001	
GC70000	VKC3541							
GC70010	VKC3622	RCT335SA4	50TKB3307R		50SCRN31P-1	614512	3151 899 001	
GC70020								

Item Reference Table

GMB	SKF	KOYO	NSK	NTN	NACHI	BCA	SACHS	VALEO
GC70080	VKC3506	RCT4064S RCT4064SL1	40TKD01U3 TK40-14AU3	SF0815/2E SF0815/4E	40TRK39-1	614000 614081		
GC70110								
GC70210								
GC71010	VKC3615	RCT356SA6	50TKB3505BR		50SCRN40P-4	614086	3151 881 001	
GC71080	VKC3514	CT55BL1	TK55-1A1U3	55TMK804X/2E	55TMK804	613009		
GC71110			50TKB3508R			614612		
GC71210	VKC2045						3151 133 331 3151 133 031 3151 104 001 3151 038 031	
GC72010	VKC3508	RCTS31SA	55TKA3102 55TKA3202A 55TKA3102U3	X10-FCR55-5/2E		614031/614146	3151 817 001	
GC72080	VKC3513	CT45-1S T45E	TK45-2 TK45-4U3	45TMK804X	45TMK-1A	1773		
GC72110								
GC72210							3400 005 036	
GC73010	VKC2520							
GC73080								
GC74010	VKC3587	RCT47SA1 RCT4700SA				614141		
GC74080								
GC74110							3151 997 501	
GC75010	VKC5045							
GC75080								
GC76010								
GC76110	VKC5168A		WF28.5=1			FI-1710-C	3151 130 241 3151 130 141	
GC77110	VKC3516	RCTS351SA4	60TKA3502U3		60SCRN033-3=31T	614147	3151 834 001	
GC78010							3151 000 014	
GC78110	VKC2186						3151 089 001	
GC79010								
GC79110	VKC2433						3151 998 701 3151 814 001	
GC80000	VKC3527							
GC80010	VKC3695		50TKA3805					PRB-08
GC80020							3000 743 001	
GC80080	VKC3504	RCT3360A2RS RCT3360A2RRS	33TKD03U3	SF0743/2E	33TRBC-4SB	TO-1711	1863 820 001	
GC80110	VKC3619			FCR44-32-2/2E		614120	3151 901 001	
GC80210	VKC2216						3151 826 001	
GC81010	VKC3579	RCTS325SA		FCR55-17-11/2E FCR55-10/2E FCR55-17/2E		614053		PRB-02
GC81080	VKC3543	CT38-1L1	24TK308E1U3	24TK308/Y	BC12C	615135		
GC81110						614161		
GC81210	VKC2045							
GC82010	VKC3574	RCT432SA				614076		
GC82080								
GC82210							3400 700 312	

GMB CLUTCH RELEASE BEARING

Item Reference Table

GMB	SKF	KOYO	NSK	NTN	NACHI	BCA	SACHS	VALEO
GC83010	VKC3625		60TKB3500R 60TKB3506R		60SCRN31P-6	6140910	3151 900 001	
GC83080	VKC3546	60TMK20U3		60TMK20	60TMK20	613017		
GC83110			93TKC6301					
GC84010	VKC3631	CT541SA	78TKC5401			613014		
GC84080								
GC84110								
GC85010	VKC3669		78TKL4001AR					
GC85080								
GC85110								
GC86110	VKC2501						3151 837 002 1850 282 666	
GC87010								
GC87110	VKC2045						3151 038 031 3151 133 331 3151 254 041	
GC88010	VKC3588	RCT282SA	44TKB2805R	FCR44-25-3/2E		614145	3151 879 001	
GC89010			60TKT3901					
GC89110	VKC2241						3151 180 231	
GC90000	VKC3500							
GC90010	VKC3558	RCT401SA	54TKA3501					
GC90020	VKC5226						3151 273 431 3151 169 332 3151 000 034	
GC90080	VKC3509	RCT35-1 RCT3558ARUS RCT2558ARUSL1 CT35S	35TMK29B2U3 35TMK29B2U5 35TMK29C1U3	SF0721/2E SF0725/2E	35TRK39 35TRK-1	613001	1863 841 001 3151 994 701	
GC90110							3151 270 503 3151 272 905	
GC90210								
GC91010	VKC3568	RTC331SA RTC336SA	54TKE3601	FCR50-10/2E FCR50-10-1/2E FCR50-1/2E	50SCRN40K	614026	3151 813 001	
GC91080		40TMK28	40TMK291BU3	40TMK29	40TMK29-1			
GC91110						614121		
GC91210	VKC2184						3151 122 031	
GC92010	VKC3565	RCT40SA RCT40SA2 RCT40SA3	62TKA3303U3 62TKC4001			613015	3151 855 001	
GC92080								
GC92110	VKC5062						3151 997 201	
GC92210	VKC2025							
GC93010	VKC3555	RCTS33A3	48TKA3301 48TKB3301 48TKB3302A	FCR48-12/2E FCR48-23/2E FCR48-23-4/2E		614047		
GC93080								
GC93110								
GC94010	VKC3643		68TKB3506AR					
GC94080								
GC94110			68TKB3803RA					
GC95010	VKKC5052							

Item Reference Table

GMB	SKF	KOYO	NSK	NTN	NACHI	BCA	SACHS	VALEO
GC95080								
GC95110	VKC2216						3151 826 001	
GC96010	VKC2601						3151 271 937 3151 843 001	
GC96110	VKC2168		WF28.5=1			FI-1710-C	3151 130 241 3151 130 141	
GC97110								
GC98010			60TKZ3502AR					
GC98110								
GC99010							3151 182 233	
GC99110		RCTS70SA-5						

PART 5

Item Picture & Basic Dimension

GMB

GMB Item Picture & Basic Dimension

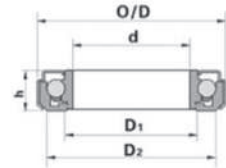
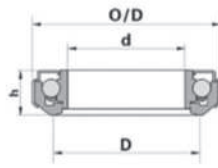
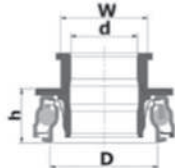
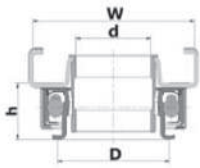

GC00110



GC00210



GC01010

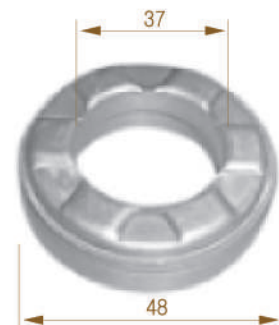

GC01080

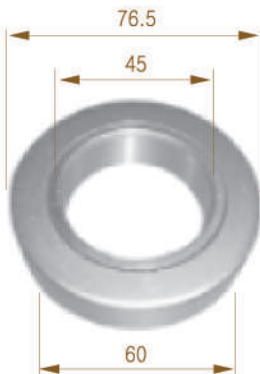

GC01110



GC01210



GC02010

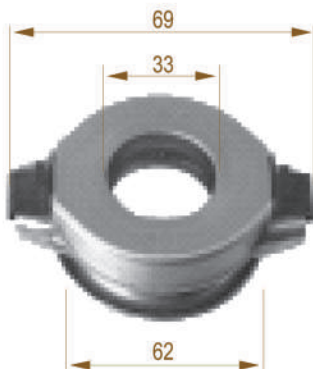

GC02080

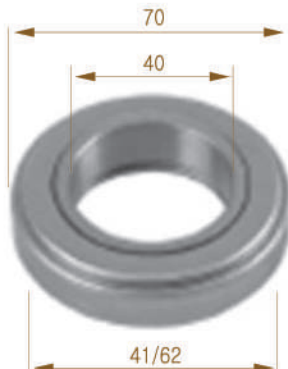

GC02110

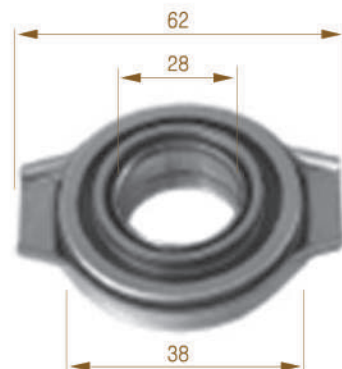

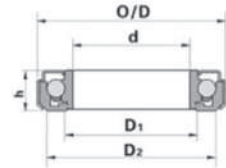
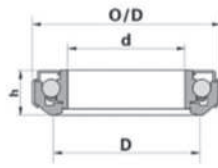
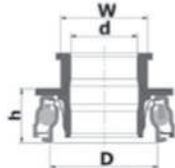
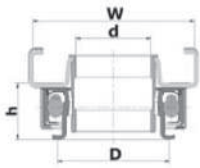

GC02210



GC03010

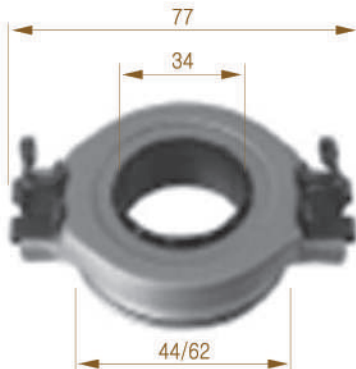

GC03080



GC03110

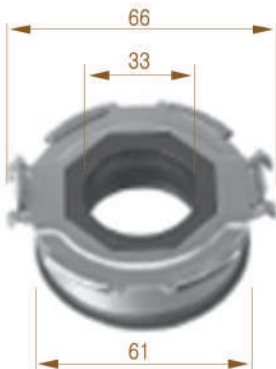

GC04010

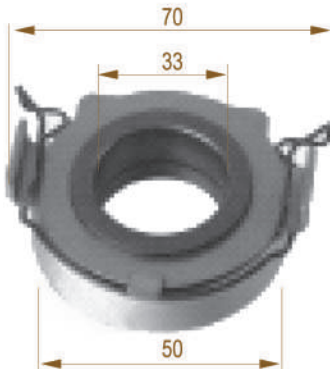

GC04080



GC04110



GC05010



GC05080



GMB Item Picture & Basic Dimension

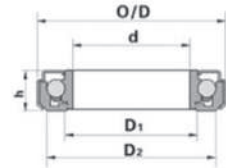
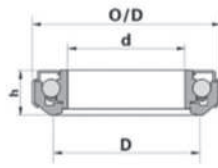
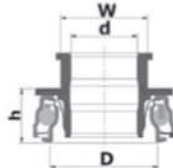
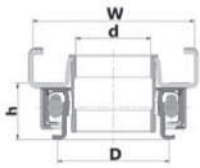

GC06010

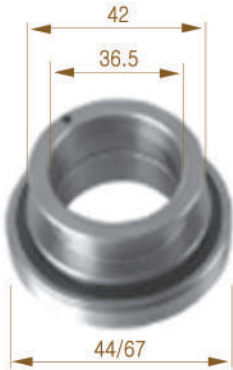

GC06080



GC06110



GC07010



GC07110

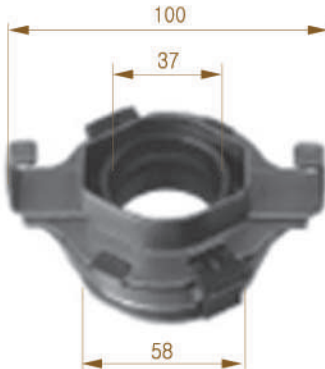

GC08010



GC08110



GC09010



GC09110



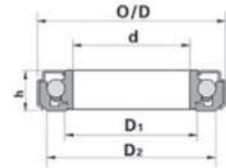
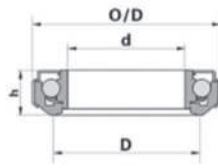
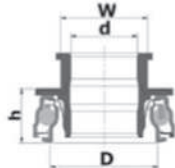
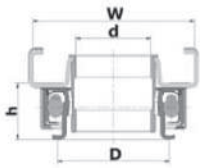

GC10010



GC10020



GC10081

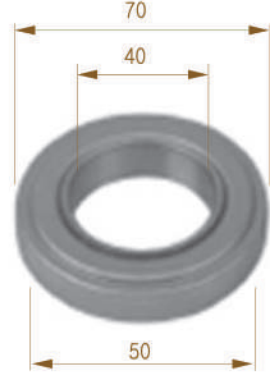

GC10110



GC10210



GC11010

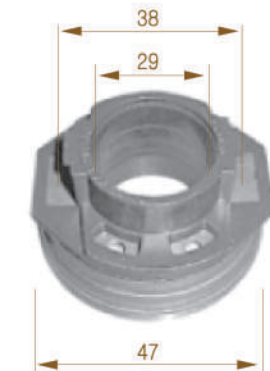

GC11081

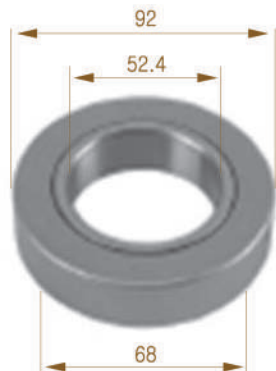

GC11110



GC11210



GMB Item Picture & Basic Dimension

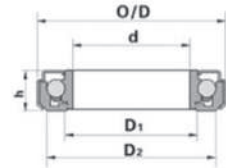
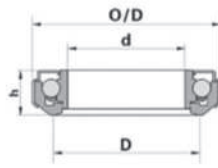
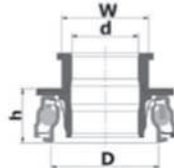
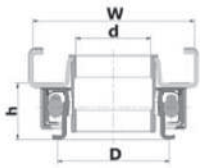

GC12010

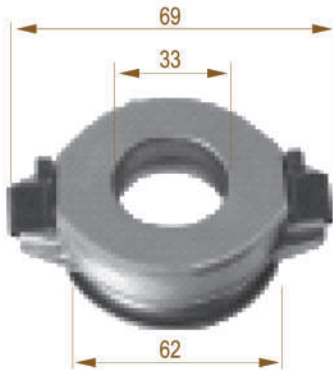

GC12080



GC12110



GC13011



GC13080



GC13110



GC14080



GC14110



GC15010



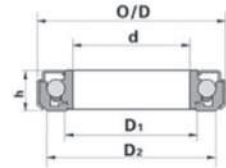
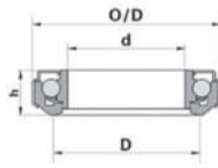
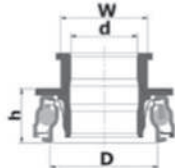
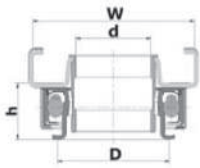

GC15080



GC15110



GC16010



GC16080

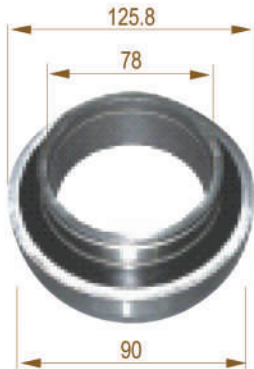

GC16110



GC17011

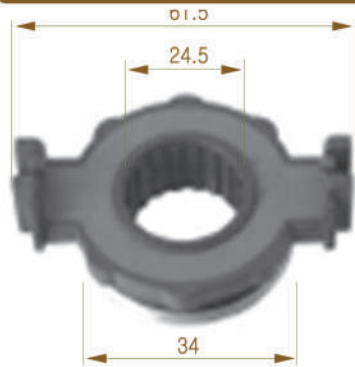

GC18010



GC18110



GC19010



GMB Item Picture & Basic Dimension

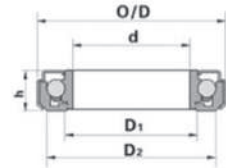
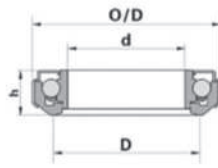
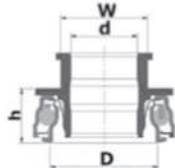
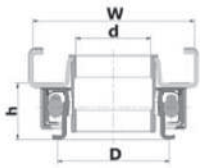

GC20010



GC20020



GC20080



GC20110

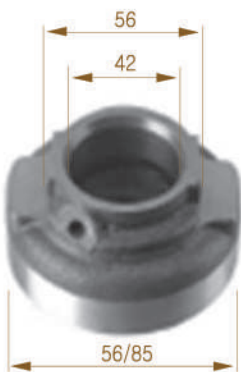

GC20210



GC21010



GC21080

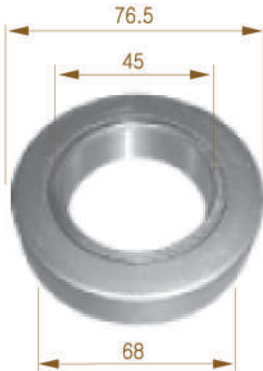

GC21110



GC21210



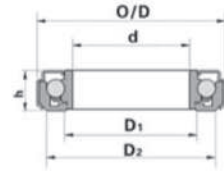
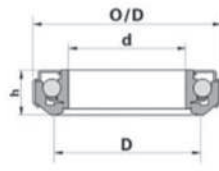
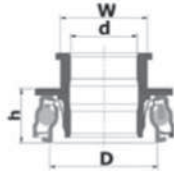
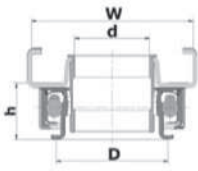

GC22010

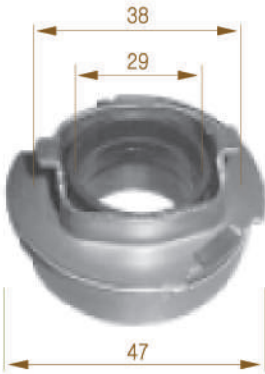

GC22080



GC22110



GC23010



GC23080



GC23110



GC24011

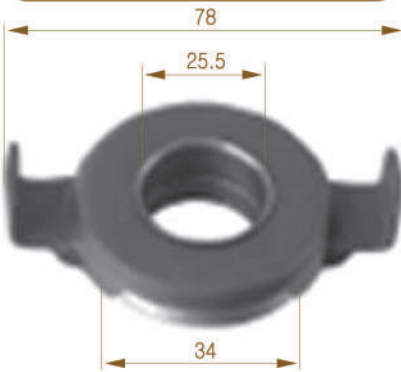

GC24080



GC24110



GMB Item Picture & Basic Dimension

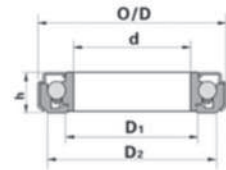
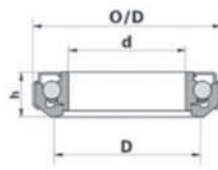
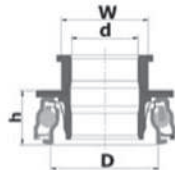
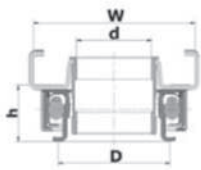

GC25010

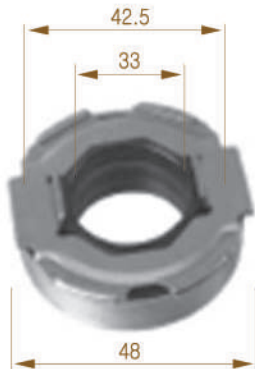

GC25080



GC25110



GC26010

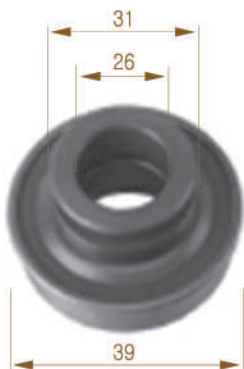

GC26110



GC27010

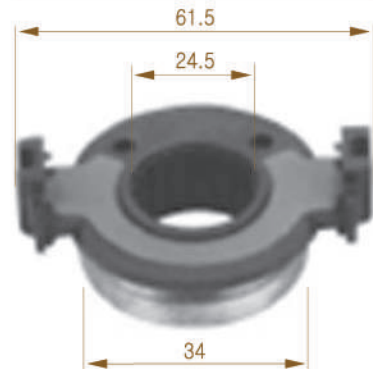

GC28010



GC29010



GC30010



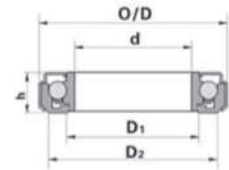
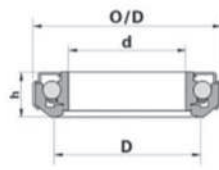
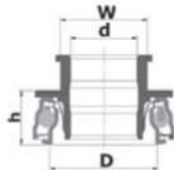
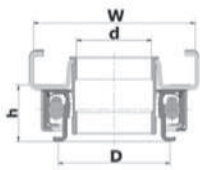

GC30020



GC30110

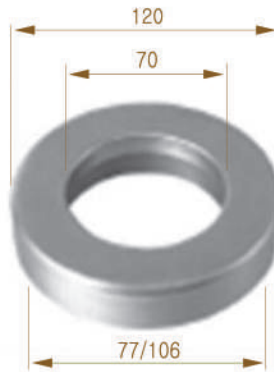

GC30210



GC31010



GC31080



GC31110



GC31210



GC32010

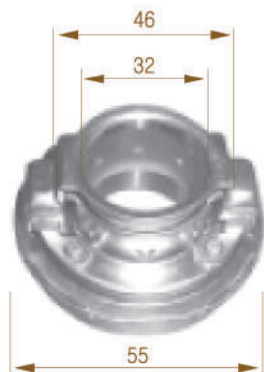

GC32080



GMB Item Picture & Basic Dimension

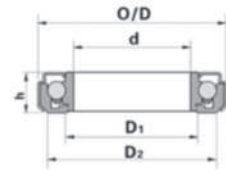
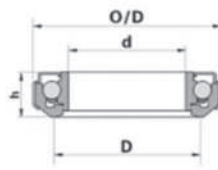
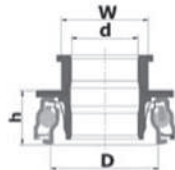
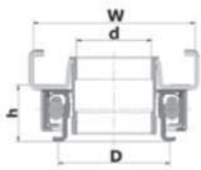

GC32110



GC33010



GC33080



GC33110



GC34010

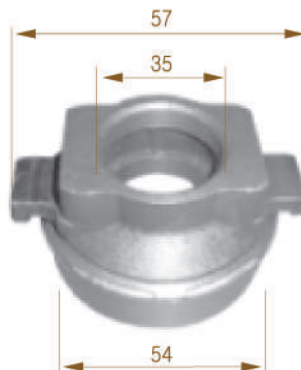

GC34080

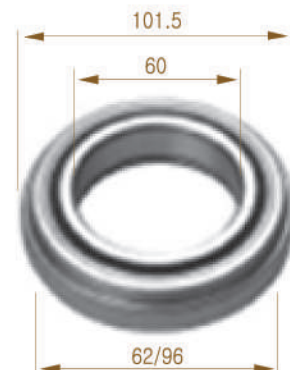

GC34110



GC35010

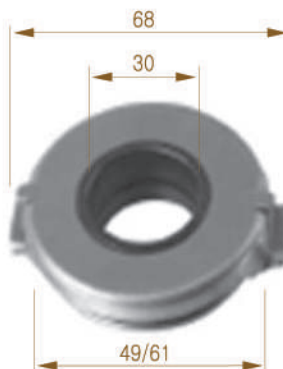

GC35080



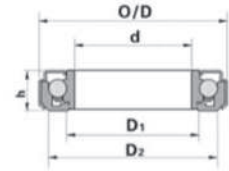
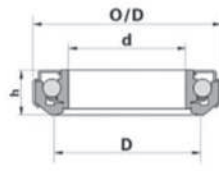
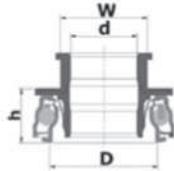
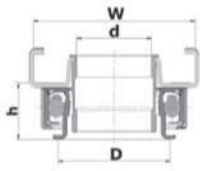

GC35110



GC36010



GC36110



GC37010



GC37110



GC38110



GC39010



GC39110



GC40010

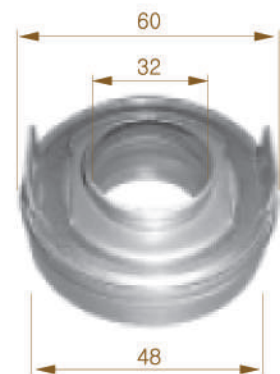

GMB Item Picture & Basic Dimension

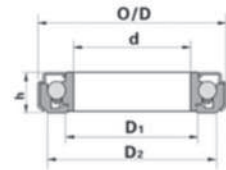
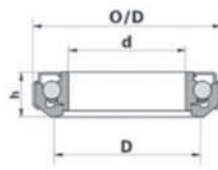
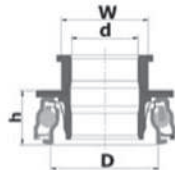
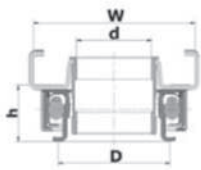

GC40011



GC40020



GC40080



GC40110

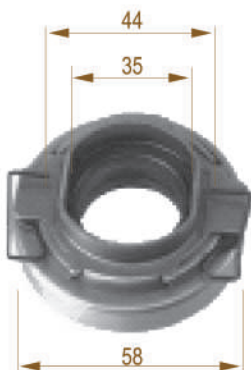

GC40210



GC41080



GC41210



GC42010

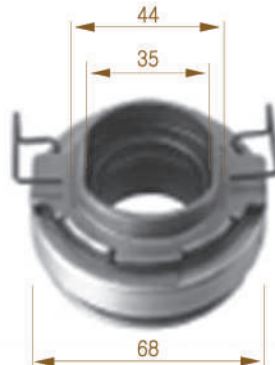

GC42080



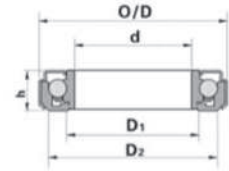
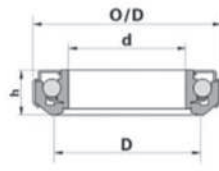
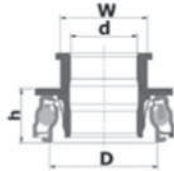
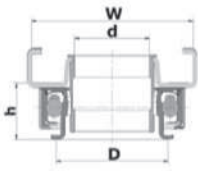

GC42110



GC43010



GC43080



GC44010

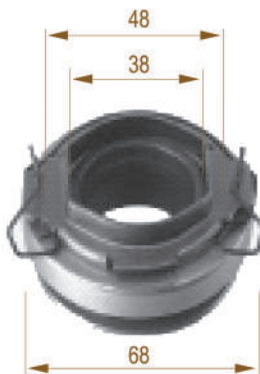

GC44080



GC44110



GC45010



GC45080



GC46010



GMB Item Picture & Basic Dimension

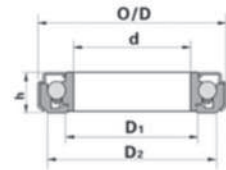
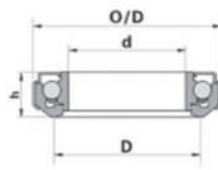
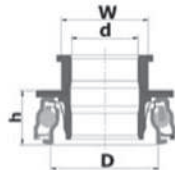
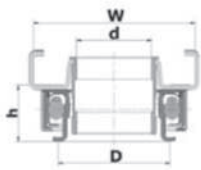

GC47110



GC48010



GC48110

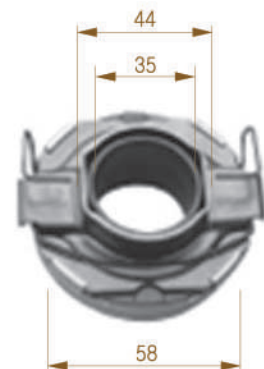

GC49010



GC49110

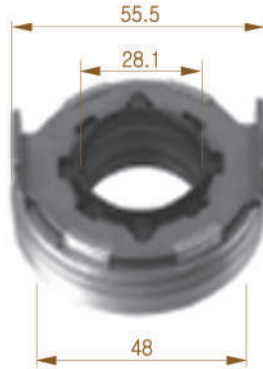

GC50010

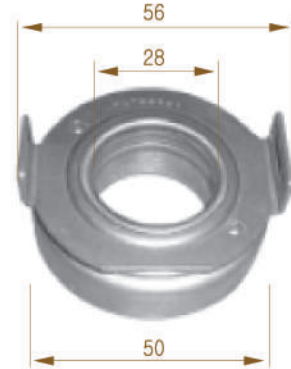

GC50020



GC50080



GC50110

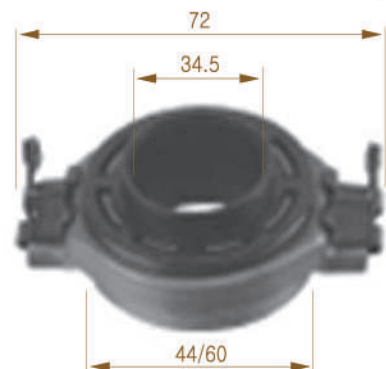

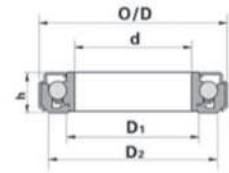
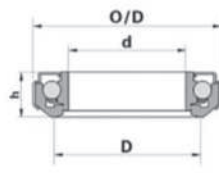
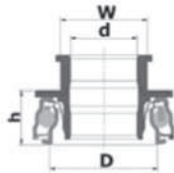
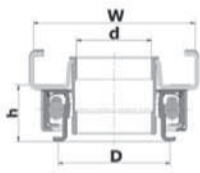

GC50210



GC51010

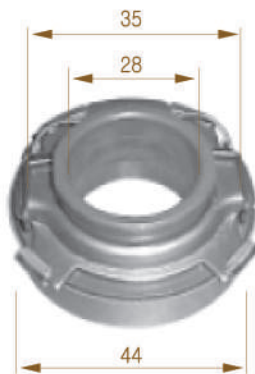

GC51080



GC51110



GC51210



GC52010



GC52110

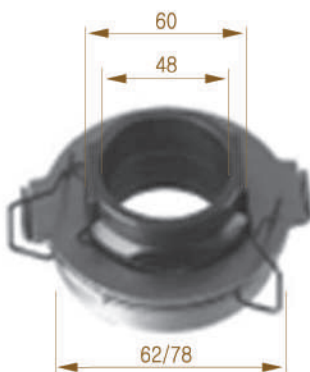

GC53010



GC53080



GMB Item Picture & Basic Dimension

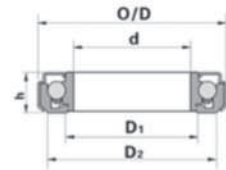
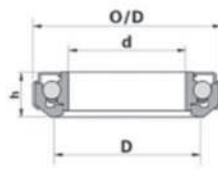
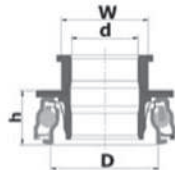
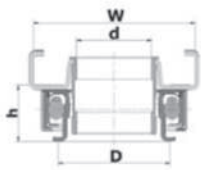

GC53110



GC54080



GC54110

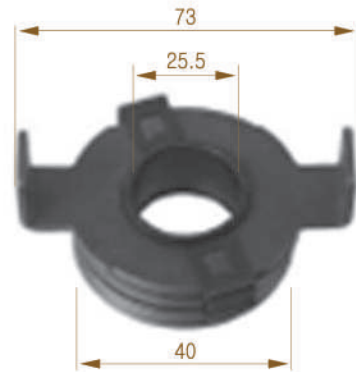

GC55010



GC55080



GC55110

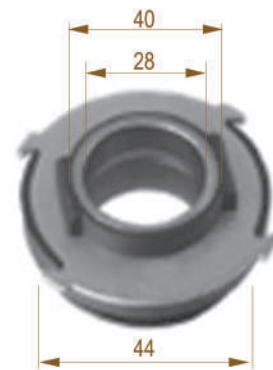

GC56010



GC56110



GC57010

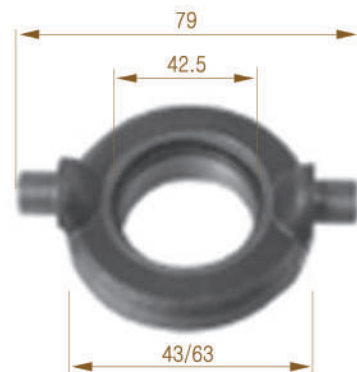

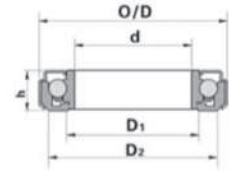
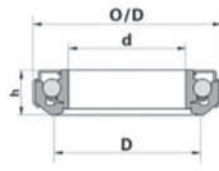
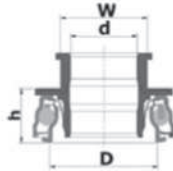
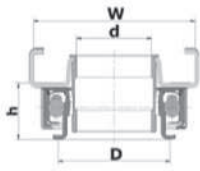

GC57110



GC58010



GC58110

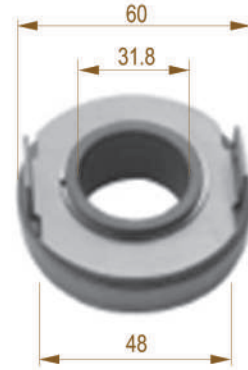

GC59010



GC59110

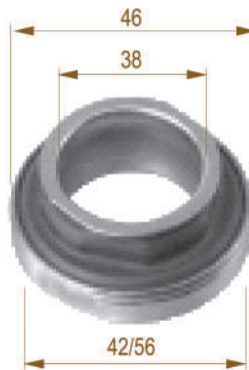

GC60010



GC60020



GC60110



GC60210



GMB Item Picture & Basic Dimension

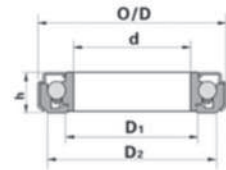
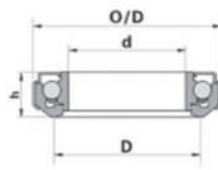
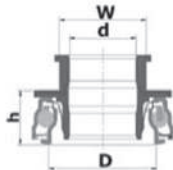
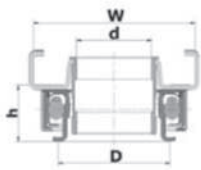

GC61010



GC61080

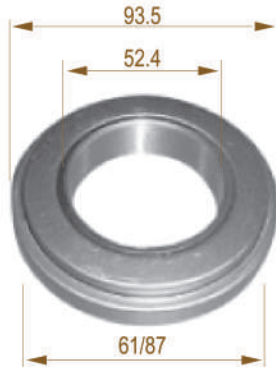

GC61110



GC61210

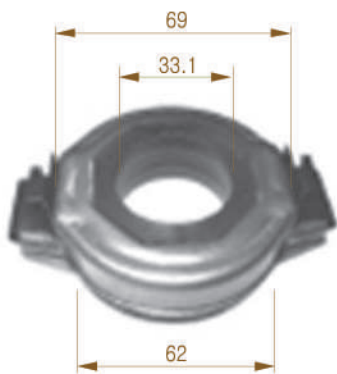

GC62010

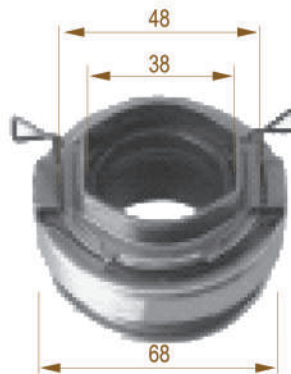

GC62010

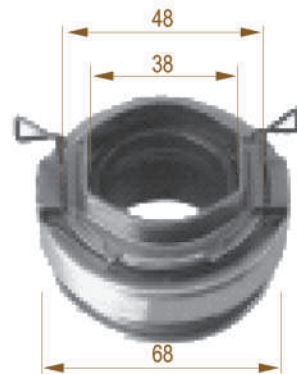

GC62110



GC63010



GC63080



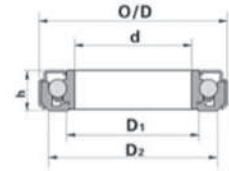
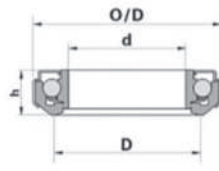
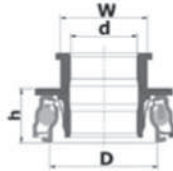
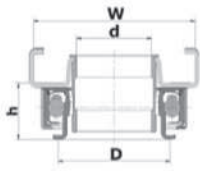

GC63110



GC64010



GC64080



GC64110



GC65010

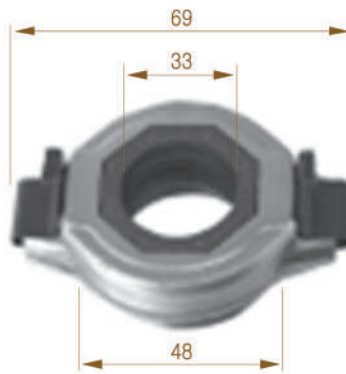

GC65080



GC65110



GC66010



GC66110



GMB Item Picture & Basic Dimension

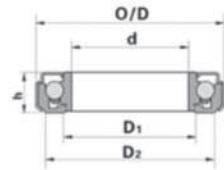
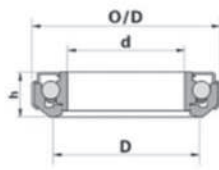
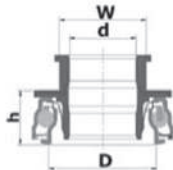
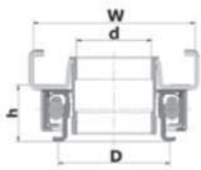

GC67010



GC67110



GC68010



GC68110



GC69010



GC69110



GC70010

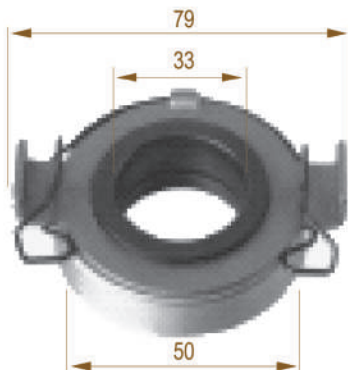

GC70020



GC70110



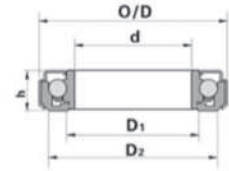
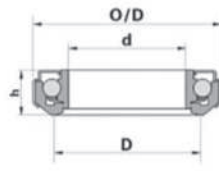
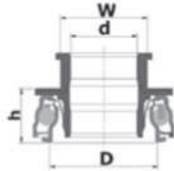
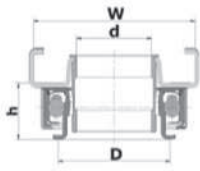

GC70210



GC71010



GC71080



GC71110



GC71210



GC72010

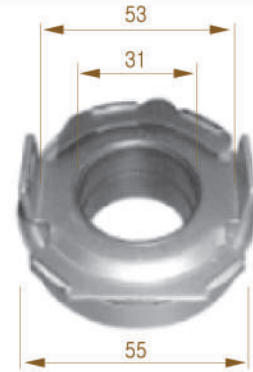

GC72080



GC72110



GC73010

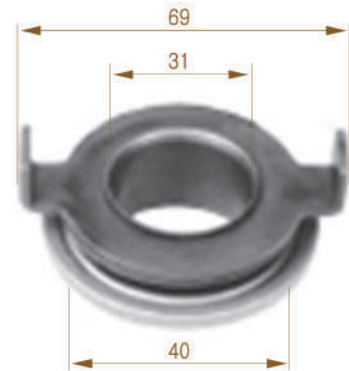

GMB Item Picture & Basic Dimension

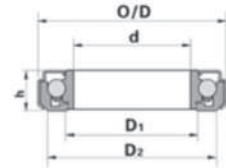
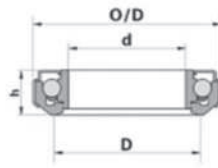
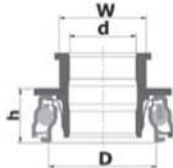
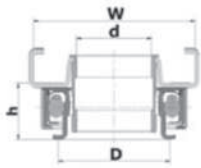

GC73080



GC74010

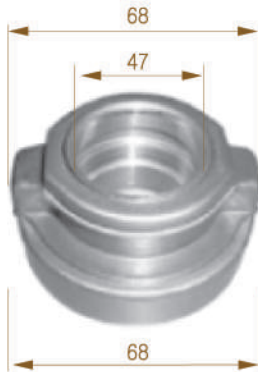

GC74080



GC74110



GC75010



GC75080



GC76010



GC76110



GC77110



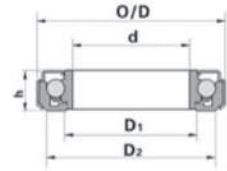
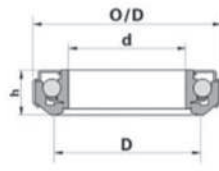
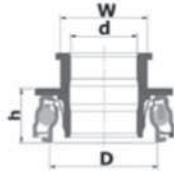
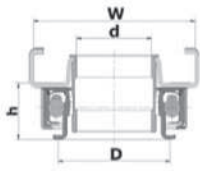

GC78010

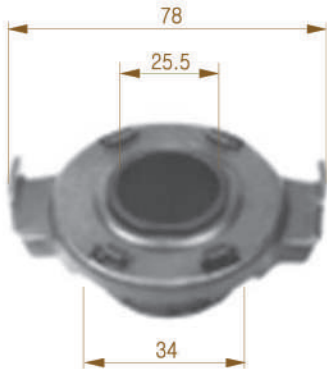

GC78110



GC79010



GC79110



GC80010



GC80020



GC80080

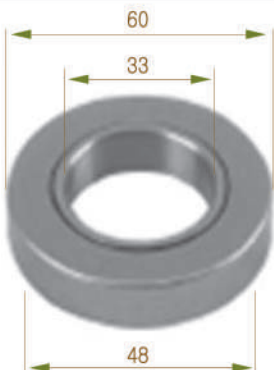

GC80110



GC80210

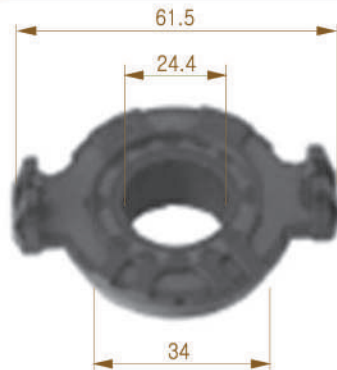

GMB Item Picture & Basic Dimension

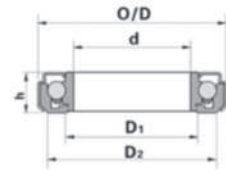
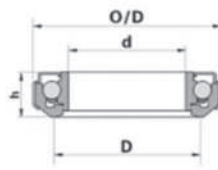
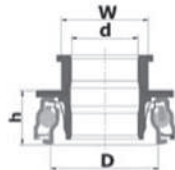
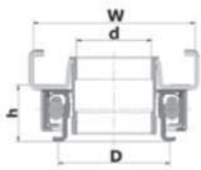

GC81012



GC81012



GC81080



GC81110

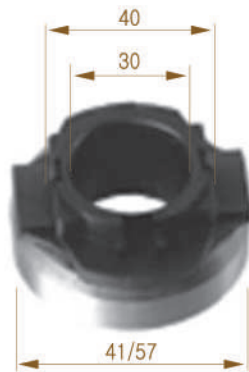

GC81210

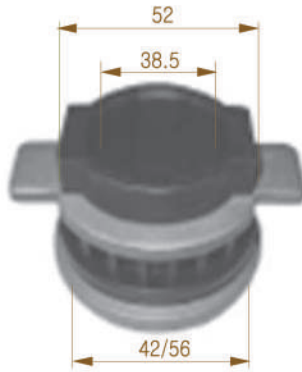

GC82010



GC82080



GC83010

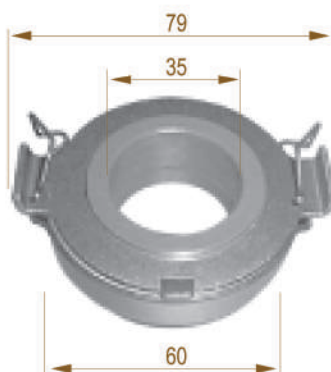

GC83010

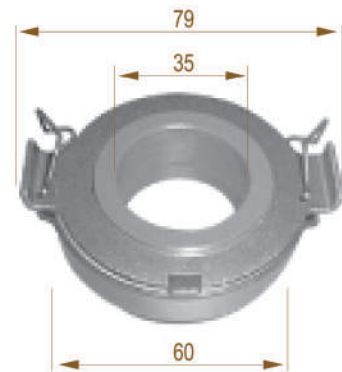

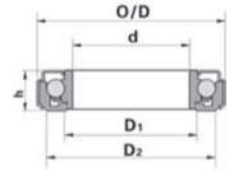
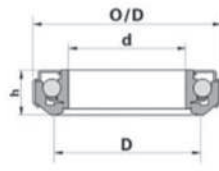
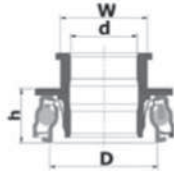
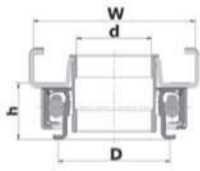

GC83080



GC83110



GC84010



GC84080



GC84110

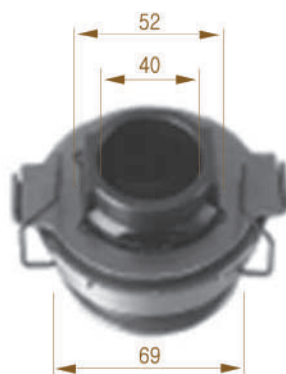

GC85010



GC85080



GC85110

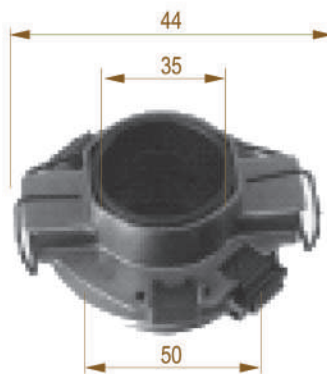

GC86110

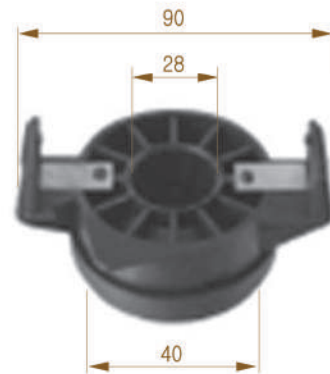

GMB Item Picture & Basic Dimension

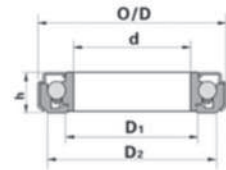
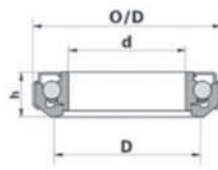
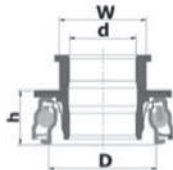
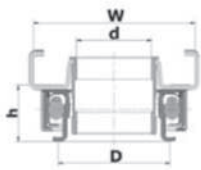

GC87010



GC87110



GC88010



GC89010



GC89110



GC90010



GC90020



GC90110



GC90210

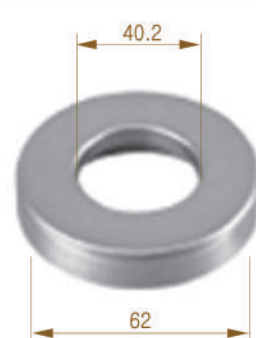

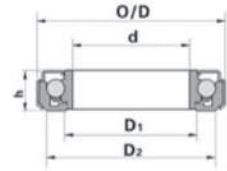
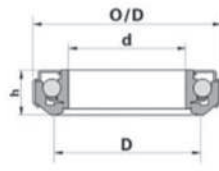
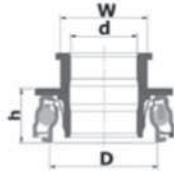
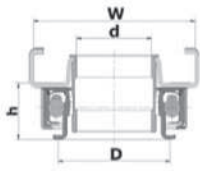

GC91010

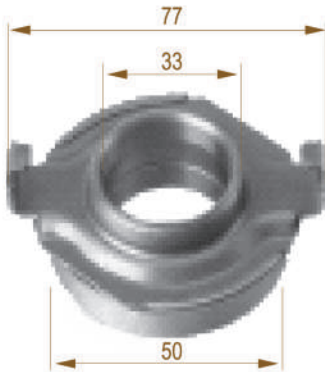

GC91080

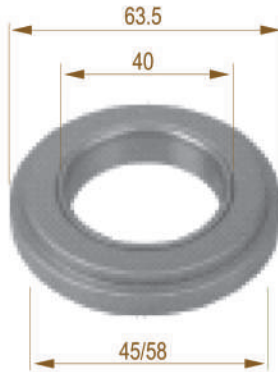

GC91110



GC91210



GC92010

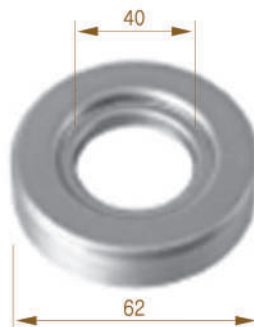

GC92080



GC92110



GC93080



GC93110

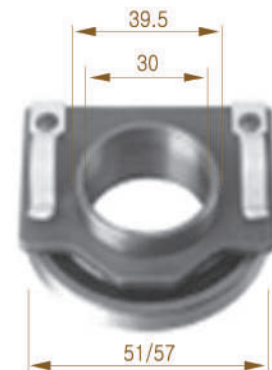

GMB Item Picture & Basic Dimension

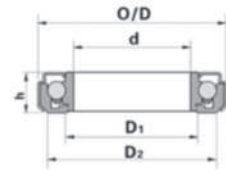
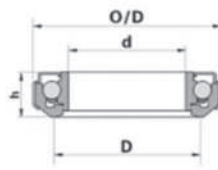
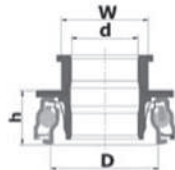
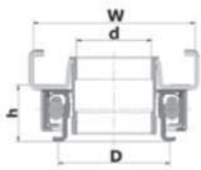

GC94010



GC94080

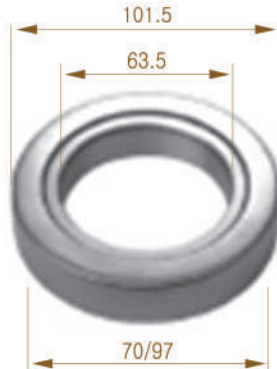

GC94110



GC95010



GC95080



GC95110

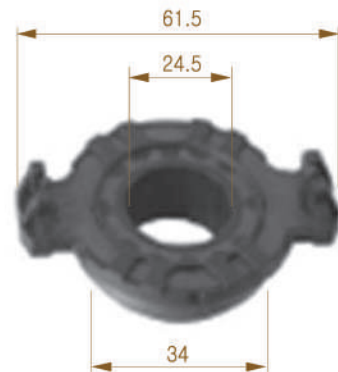

GC96010



GC96110



GC97110



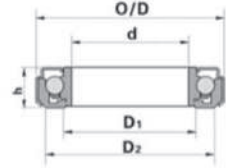
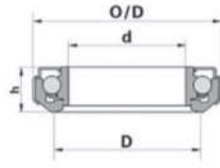
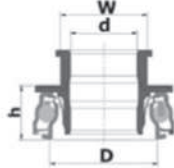
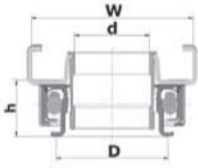

GC98010

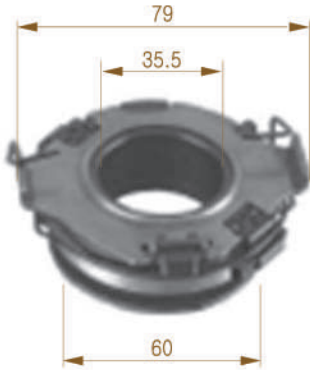

GC98110



GC99010



GC99110

