



# VGA CAT-5 1:8 Distribution S

---

# VGA CAT-5 Distribution R

**EXT-VGA-CAT5-148S**  
**EXT-VGA-CAT5-148R**  
**User Manual**



# INTRODUCTION

---

Congratulations on your purchase of the VGA CAT-5 1:8 Distribution S. Your complete satisfaction is very important to us.

## **Gefen**

Gefen delivers innovative, progressive computer and electronics add-on solutions that harness integration, extension, distribution and conversion technologies. Gefen's reliable, plug-and-play products supplement cross-platform computer systems, professional audio/video environments and HDTV systems of all sizes with hard-working solutions that are easy to implement and simple to operate.

## **The Gefen VGA CAT-5 1:8 Distribution S**

The VGA CAT-5 1:8 Distribution S is the perfect solution for sending high-definition video from a single VGA source to as many as eight remotely located VGA displays. The system is capable of delivering resolutions up to 1920x1200 as far as 330 feet away from the source over industry standard CAT-5 cabling.

## **How It Works**

Connect the VGA video source to the input of the VGA CAT-5 1:8 Distribution S with the included VGA cable. The Sender and each Receiver (not included with Sender unit) are then connected by individual runs of CAT-5 of up to 330 feet in length. The Receiver units (sold separately) receive the video signal and DC power from the Sender over the CAT-5, and are connected to the displays with user supplied VGA cables. Power up the Sender with the included power supply, and you now have crisp, high-resolution video at your remote displays. Please note that all of the VGA displays used must have the same native resolution in order to get a picture.

## OPERATION NOTES

---

- Gefen VGA CAT-5 Distribution R (Receiver units) are **not** included with the Sender unit. Receiver units (Gefen part no. EXT-VGA-CAT5-148R) can be purchased separately.

# FEATURES

---

## Features

- Distributes a single VGA source to eight displays simultaneously
- Extends video signals up to 330 feet (100 meters) over CAT-5e
- Supports resolutions up to 1920 x 1200
- Supports component video signals

## Package Includes

- (1) VGA CAT-5 1:8 Distribution S
- (1) 6 ft. VGA Cable (M-F)
- (1) 5V DC Power Supply
- (1) AC Power Cord
- (1) Quick-Start Guide

# SENDER UNIT LAYOUT

## Sender unit

Front



Back

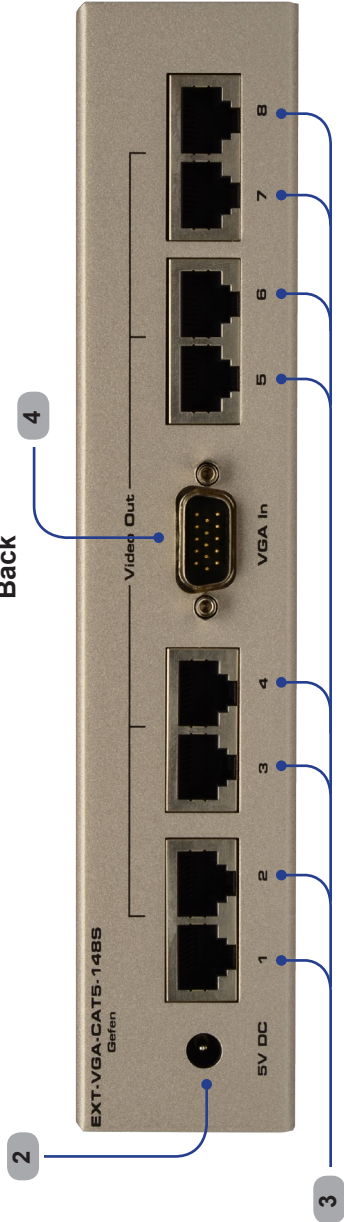

## SENDER UNIT DESCRIPTIONS

---

### **1 Power**

This LED indicator will glow bright red once the included 5V DC power supply has been properly connected to the unit and the power supply has been connected to an available electrical outlet.

### **2 5V DC**

Connect the included 5V DC power supply to this receptacle.

### **3 Video Out (1 - 8)**

Connect a CAT-5e cable, up to 330 feet (100 meters) between each RJ-45 port and a Receiver unit (Gefen part no. EXT-VGA-CAT5-148R).

### **4 VGA In**

Connect a VGA / component source to this HD-15 connector.

## RECEIVER UNIT LAYOUT



**NOTE:** Gefen VGA CAT-5 Distribution R (Receiver units) are not included with the Sender unit. Receiver units (Gefen part no. EXT-VGA-CAT5-148R) can be purchased separately.

Front

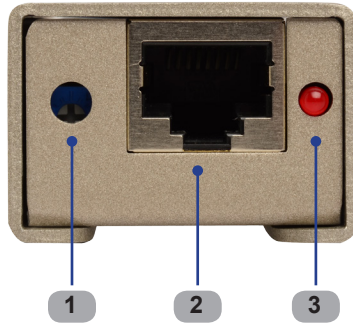

Back

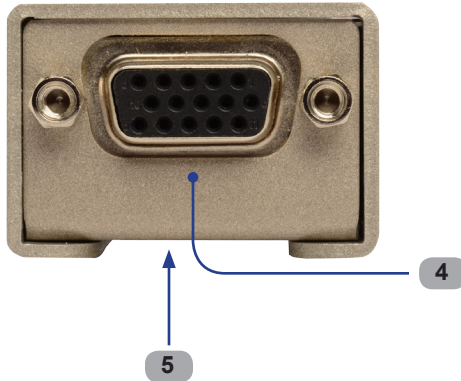

## RECEIVER UNIT DESCRIPTIONS

---

**1 *Brightness Trim***

Use a small-head Phillips screwdriver to adjust the brightness level of the picture.

**2 *RJ-45***

Connect the CAT-5e cable from the Sender unit to this RJ-45 jack.

**3 *Power Indicator***

This LED indicator will glow bright red when the

**4 *VGA In***

Connect a VGA / component source to this HD-15 connector.

**5 *DIP Switches (not shown)***

The bottom of the Receiver unit has three banks of four DIP switches on the bottom of the unit. Remove the piece of tape to expose the DIP switches. See page 9 for more information on using the DIP switches.



# CONNECTING THE VGA CAT-5 1:8 DISTRIBUTION S

## How to Connect the VGA CAT-5 1:8 Distribution S

1. Connect the included VGA cable between the VGA/component source and the VGA In connector on the *VGA CAT-5 1:8 Distribution S*.
2. Connect a CAT-5e cable, up to 330 feet (100 meters) between each RJ-45 port and a Receiver unit (Gefen part no. EXT-VGA-CAT5-148R).
3. Connect a VGA cable from each display to the VGA Out connector on each Receiver unit (not included).
4. Connect the 5V DC power supply to the *VGA CAT-5 1:8 Distribution S* and *VGA CAT-5 1:8 Distribution R* units and connect both power supplies to available electrical outlets.

## Wiring Diagram for the VGA CAT-5 1:8 Distribution S / VGA CAT-5 Distribution R

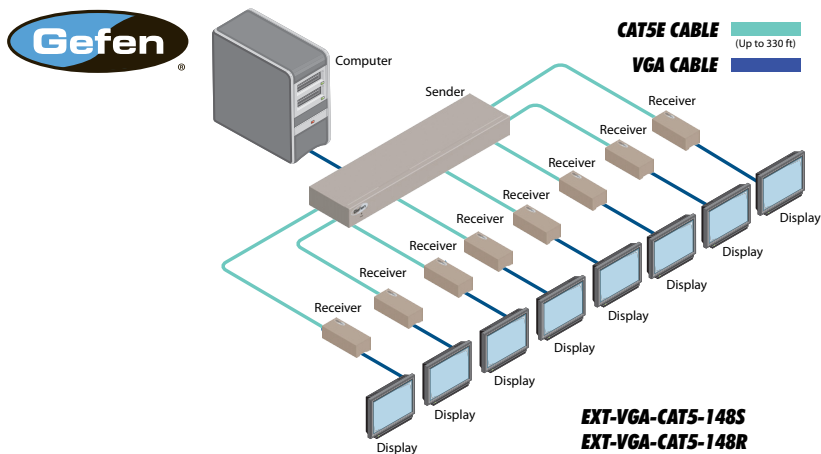

# DIP SWITCH CONFIGURATION

## Using DIP Switches to Compensate for Video Issues

The first step in adjusting the video quality is to display text and a graphic on your monitor (i.e. desktop icons). Then set your computer to the resolution that you will be using most frequently. Set the DIP (Dual Inline Package) switches to the settings that are recommended for the different lengths of CAT5 cable (see chart below). Verify that the picture quality is to your satisfaction. If the recommended setting does not produce a great quality picture, try using a different DIP switch setting.

The three DIP switch banks affect the primary colors Red, Green and Blue directly and are thus labelled accordingly. Should you find a problem with too much or too little or a certain color present in the output video, begin adjustments in the DIP switch bank corresponding to the color that is present/absent too much.

The settings shown below are our recommendations for best performance.

0-25 Feet	All DIP switches are set to OFF for all colors.
26-100 Feet	Set DIP switch #1 ON for all colors. 2,3,4 remain OFF.
101-200 Feet	Set DIP switch #2 ON for all colors. 1,3,4 remain OFF.
201-300 Feet	Set DIP switch #3 ON for all colors. 1,2,4 remain OFF.
301 Feet and Up	Set DIP switch #4 ON for all colors. 1,2,3,remain OFF.

**NOTE:** A DIP switch is set to the OFF position when the switch is closest to the number printed immediately below it. The word "ON" will be printed at the top of the DIP switch bank, usually in the lefthand upper corner.

**NOTE:** The default position of the DIP switches is that of the 26-100 feet setting above with DIP Switch #1 ON for all colors and switches 2,3,4 OFF.

## Underside of Receiver unit

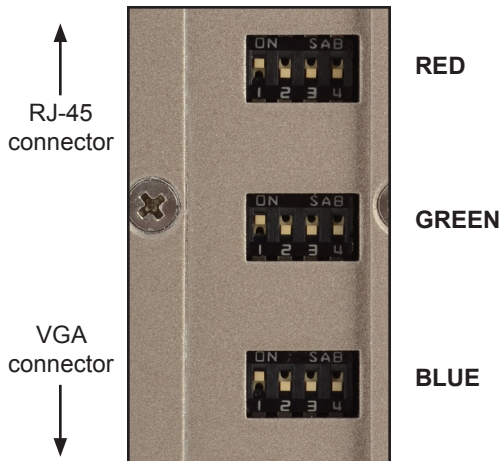

## NETWORK CABLE WIRING DIAGRAM

---

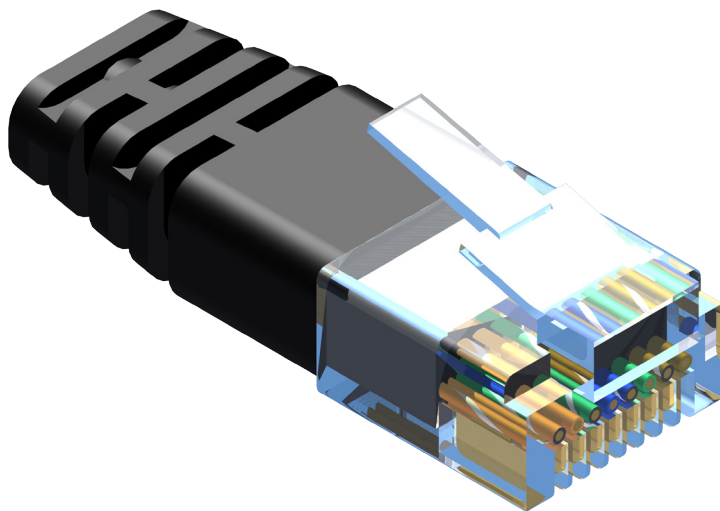

Gefen has specifically engineered their products to work with the TIA/EIA-568-B specification. Please adhere to the table below when field terminating cable for use with Gefen products. Failure to do so may produce unexpected results and reduced performance.

Pin	Color
1	Orange / White
2	Orange
3	Green / White
4	Blue
5	Blue / White
6	Green
7	Brown / White
8	Brown

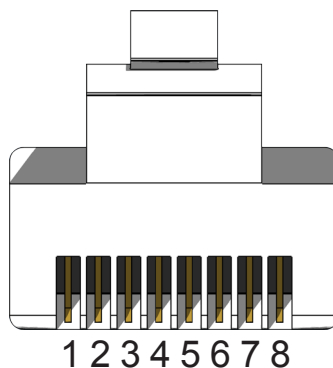

Category 5 cabling comes in stranded and solid core types. Gefen recommends using solid core cabling.

## SPECIFICATIONS

---

Video Amplifier Bandwidth.....	350 MHz
Horizontal Frequency Range.....	15 - 70 KHz
Vertical Frequency Range.....	30 - 170 Hz
Video Input Connector (Sender unit).....	VGA, HD-15, male
Video Output Connector (Receiver unit).....	VGA, HD-15, female
Link Connector.....	RJ-45, shielded
Power Supply.....	5V / 8A DC
Power Consumption.....	30W (max.)
Dimensions (W x H x D) (Sender unit).....	8.5" x 1.75" x 4.5" (216mm x 44mm x 114mm)
Dimensions (W x H x D) (Receiver unit).....	1" x 1" x 4" (25mm x 25mm x 102mm)
Shipping Weight: .....	4 lbs. (1.8 kg)

## WARRANTY

---

Gefen warrants the equipment it manufactures to be free from defects in material and workmanship.

If equipment fails because of such defects and Gefen is notified within two (2) years from the date of shipment, Gefen will, at its option, repair or replace the equipment, provided that the equipment has not been subjected to mechanical, electrical, or other abuse or modifications. Equipment that fails under conditions other than those covered will be repaired at the current price of parts and labor in effect at the time of repair. Such repairs are warranted for ninety (90) days from the day of reshipment to the Buyer.

This warranty is in lieu of all other warranties expressed or implied, including without limitation, any implied warranty or merchantability or fitness for any particular purpose, all of which are expressly disclaimed.

1. Proof of sale may be required in order to claim warranty.
2. Customers outside the US are responsible for shipping charges to and from Gefen.
3. Copper cables are limited to a 30 day warranty and cables must be in their original condition.

The information in this manual has been carefully checked and is believed to be accurate. However, Gefen assumes no responsibility for any inaccuracies that may be contained in this manual. In no event will Gefen be liable for direct, indirect, special, incidental, or consequential damages resulting from any defect or omission in this manual, even if advised of the possibility of such damages. The technical information contained herein regarding the features and specifications is subject to change without notice.