



TRUCK  
TRAILER  
AND BUS  
**SHOCKS**

20  
**20**



## Table of Contents

New Part Numbers / Part Numbers Superseded .....	2
<b>Application and Numerical Listings</b>	
Specialty Shocks .....	3
Medium Duty & Heavy Duty Trucks, Trailers & Buses Application Listing .....	5
Medium Duty & Heavy Duty Trucks, Trailers & Buses Numerical Listing.....	225
Fleetline / GasSLX Interchange .....	237
Competitive and OEM Interchange .....	238
How to Determine the Correct Shock for Your Truck.....	288
Specifications by End Mount .....	297
Specifications by Part Number.....	318
Mounting Accessory Packages and Component Parts .....	339
Mounting Accessory Packages - Buyer's Guide .....	346

## NEW PART NUMBERS IN THIS CATALOG

83081  
89503  
85642  
85648  
85649  
85650  
89502

## PART NUMBERS DROPPED FROM THIS CATALOG

83052	85011	85347	85907	85980	83046
83060	85083	85378	85912	85984	83634
83061	85085	85379	85913	86201	83636
83100	85092	85380	85930	86202	85701
83115	85097	85706	85966	86203	85719
83145	85099	85707	85968	87016	85730
83155	85313	85710	85969	87019	89416
83161	85324	85715	85971	89412	
83171	85342	85731	85974	89441	
83174	85346	85905	85975	83014	

## 9 YEAR SUPERSEDURE LIST

DELETE	THEN USE
83032	83025HD
83146	83364
83200	89402
83353	85740
83362	83215
83404	83159
85050	83221
85312	85733
85330	85379
85714	85715
85717	85715
85718	85732
89403	89401

## APPLICATION GUIDE - SPECIALITY

Year Año Année	Model Modelo Modèle	OEM #	Fleetline #
<b>ADVANCE MIXER</b>			
	Rear Discharge Mixers with Self - Steering Axle Shock	12111 ADV	646155
<b>CHALLENGE</b>			
	Cement Mixer	632147 632155	632147 646177
<b>GRANNING SUSPENSION</b>			
	Model L120 Self Steer Axle	701071-01	646155
<b>HENDRICKSON TRAILER SUSPENSION SYSTEMS</b>			
<b>Auxiliary Liftable Steerable System (HL)</b>			
	HLP Paralift	A-14496	646155
	HLU Paralift Ultra	A-14496	646155
<b>HENDRICKSON TRUCK SUSPENSION SYSTEMS</b>			
<b>Dual Tire Steer Lift Axle</b>			
	Tough Lift LK Series	A-14496	646155
<b>INGERSALL MACHINE</b>			
	700060-0 Axle Assy.	665472	665472
	Models with O.E.M. Number	665904	665472
<b>KIMBLE MIXER CO</b>			
	Rear Discharge Mixers with Self - Steering Axle Shock	OE10455	646155
<b>LINK/HIGH-STEER</b>			
	6000 Steering Stabilizer	632155	646177
	9000 Steering Stabilizer	1210-0007 1210-0009	665937 665937
	Models with O.E.M. Number	1210-0001 1210-0002 1210-0010 1210-0012 646168	646155 632147 646155 646155 646155
<b>LONDON MIXER</b>			
	Rear Discharge Mixers with Self - Steering Axle Shock	MB-37737-30	646155
<b>MC NEILUS TRUCK &amp; MAN.</b>			
	Booster Axles	1170719 600-115994B	632147 632147
	Bridgemaster V models with Self - Steering Axle Shocks	600-188206	646155
	Models with O.E.M. Number	1473224 2034140 MTM 600-11599M	646155 646155 632147
	Pusher Axles	600-115994B	632147
<b>OSHKOSH MOTORS</b>			
	Models with O.E.M. Number	2034140	646177
<b>PIERCE MANUFACTURING INC.</b>			
	Models with O.E.M. Number	2034140	646177
<b>REX MIXER</b>			
	Rear Discharge Mixers with Self - Steering Axle Shock	102-13441-10	646155
<b>REYCO SUSPENSION</b>			
	L132 Steering Stabilizer	701071-01	665937
<b>RIDEWELL CORPORATION</b>			
	RLT-230	1310002	665937
	RSS-232	1317570B001	646155
	RSS-236/R	1310002 1310004	665937 665937

**APPLICATION GUIDE - SPECIALITY**

Year Año Année	Model Modelo Modèle	OEM #	Fleetline #
----------------------	---------------------------	-------	-------------

**SAF HOLLAND**

	Self - Steering Axle Shocks	646201 90045331	646177 646155
--	-----------------------------	--------------------	------------------

**Neway V-Steer II**

	Self - Steering Axle Shocks	632155	646177
--	-----------------------------	--------	--------

**SPRING VALLEY**

	SS120 Steering Stabilizer	632155	646177
	SS130L Steering Stabilizer	632155	646177

**SUSPENSIONS INC.**

	LP11 Steerable Lift Axle	200188	646155
--	--------------------------	--------	--------

**TEREX CORPORATION**

	Rear Discharge Mixers with Self - Steering Axle Shock	12111	646155
--	---	-------	--------

**TUTHILL TECHNOLOGIES**

	Models with O.E.M. Number	66502	646155
--	---------------------------	-------	--------

**VARIOUS**

**Steering Stabilizer**

	Various Class 8 Trucks with Front Axle Rating of 10,000 lb to 20,000 lb	SC-2920	83176
--	---	---------	-------

**WATSON & CHALIN MFG. INC.**









**Self - Steering Axle Suspension Systems**

	LW5L-1100 SR	11418	646155
	Models with O.E.M. Number	17069	632147
	SL-2089 Steerable Lift Axle Suspension	11418	646155
	WCAL-1000 SST	11418	646155
	WCAL-1100 LR	11418	646155
	WCAL-1100 SR	11418	646155
	WCAL-1100 SRLP	11418	646155
	WCAL-1100 SSR	11418	646155
	WCHL-1100 FL	11418	646155
	WCHL-1100 HI-LIFT	11418	646155

**WESTPORT AXLE CORP**

	Self - Steering Axle Shocks	143699-0185 646124	646177 646177
--	-----------------------------	-----------------------	------------------

## APPLICATION GUIDE - TRUCKS, TRAILERS, AND BUSES

Year Año Année	Model Modelo Modèle	OEM #	Front		Rear	
						
						
			Fleetline	GasSLX	Fleetline	GasSLX

### ABC BUS

Drive Axle	12J-5-10		...	...	01-	85733	...
T2100 Van Hool Buses with O.E.M. Number (Front & Tag Axle)	10685703	- -	695406	...		...	...
	624314570	- -	695406	...		...	...
	90-2291	- -	695406	...		...	...
Models with O.E.M. Number	050134513	0 0	85732	...		...	...
	12L-5-88		...	...	01-	85729	...
	6243-13790	- -	85708	...		...	...
	6243-14040	- -	85708	...		...	...
Additional O.E.M. Interchanges	12B-5-1		85735	...	0 0	85735	...
	12L-5-114		...	...	- -	85727	...
	12L-5-72	- -	85709				
	3166657	0 0	85700				
	680323	0 0	85700				

### ACF BRILL BUS

37R Models	.....	0 0	85736	...		...	...
C-27 and C-31 City Bus	.....	0 0	85736	...	0 0	85702	...
C-36 City Bus Serial #1051 and on	.....	0 0	85736	...	0 0	85702	...
C-37M Models	.....	0 0	85736	...	0 0	85702	...
C-44 City Bus and T-44 Trolley Bus	.....		85308	...	0 0	85308	89422
IC-41 Intercity Bus Serial #1088 and on	.....		85308	...	0 0	85308	89422
IC-41 Intercity Bus to Serial #1088	.....	0 0	85736	...	0 0	85702	...
Additional O.E.M. Interchanges	610513	0 0	85307				
	631237	0 0	85308 or 89422				
	641521	0 0	85308 or 89422				
	649648	0 0	85308 or 89422				
	659129	0 0	85303	89422		...	...
	661732	0 0	83215				
	661733	0 0	83225				
995891	0 0	85307					

### ADVANCE MIXER

Advance Mixer part number	13424 ADV		...	...	0 0	83207	89407
	14626 ADV		...	...	0 0	83209	89414
	23458 ADV		...	...	01-	83112	...
Models with 20,000 lb Front Axle	13883	0 0	85334	...		...	...
	13883 ADV	0 0	85334	...		...	...
	680087	0 0	85334	...		...	...
	85334	0 0	85334	...		...	...
Rear Discharge Mixers with Self - Steering Axle Shock	12111 ADV		646155				





### ALLCO TRAILER

Dump Trailers with Watson & Chalin TA-5000-DB-19 Air Suspension	727602		...	...	0 0	83122	89406
---	--------	--	-----	-----	-----	-------	-------

### AM GENERAL

Small Bus	5979484		...	...	0 0	85302	89420
Additional O.E.M. Interchanges	3166657	0 0	85700				
	4975501	0 0	85700				
	5565748	0 0	85700				
	5957136	0 0	85700				
	5969438	0 0	85700				
	5978712	0 0	85700				
	5979574	0 0	85700				
	5982537	0 0	85700				









**APPLICATION GUIDE - TRUCKS, TRAILERS, AND BUSES**

Year Año Année	Model Modelo Modèle	OEM #	Front		Rear	
						
			Fleetline	GasSLX	Fleetline	GasSLX

**ARVIN MERITOR**

	Blue Bird Motor Home with IFS (37 Foot)	7805-N-1002 7805-S-1007	010	<b>85329</b>	...		...	...
			010	<b>85329</b>	...		...	...
	Models with Manufacturing Number	085009	-10	<b>85009</b>	...		...	...
		085014		...	...	010	<b>85014</b>	...
		085321		...	...	010	<b>85321</b>	...
		654907		...	...	010	<b>85000</b>	<b>89436</b>
		654958	010	<b>83164</b>	...		...	...
		665044		...	...	010	<b>83209</b>	<b>89414</b>
		665724		...	...	010	<b>85000</b>	<b>89436</b>
		665746		...	...	010	<b>85000</b>	<b>89436</b>
		665760		...	...	010	<b>85045</b>	...
		665769		...	...	010	<b>85052</b>	...
		665804		...	...	010	<b>85939</b>	...
		671091		...	...	-1-	<b>85069</b>	<b>89455</b>
		671092	010	<b>85012</b>	<b>89413</b>		...	...
		671507		...	...	010	<b>87015</b>	...
		671707		...	...	010	<b>85323</b>	<b>89436</b>
		680102	010	<b>85712</b>				
		680322		...	...	010	<b>85704</b>	...
		680331		...	...	010	<b>85702</b>	...
		680337		...	...	-1-	<b>85708</b>	...
		680347	010	<b>85732</b>	...		...	...
		680464	010	<b>85005 or 89430</b>				
		680518	010	<b>85700</b>				
		680584		...	...	010	<b>85938</b>	...
		680671		...	...	-1-	<b>85708</b>	...
		695180	-1-	<b>85705</b>	...		...	...
		695214		...	...	-1-	<b>85722</b>	...
		695348		...	...	010	<b>87018</b>	...
		695406	-1-	<b>695406</b>				
		727600	010	<b>89402</b>				
		727607	010	<b>83207 or 89407</b>				
		727609	010	<b>83209 or 89414</b>				
		727614	010	<b>83214</b>				
		727615	010	<b>83215</b>				
		727616	010	<b>83216</b>				
		727619	010	<b>83219</b>				
		727625	010	<b>83225</b>				
		727628		...	...	-10	<b>83301</b>	...
		727630	010	<b>83303</b>	...		...	...
		727631	010	<b>83304</b>	...		...	...
		727635	010	<b>83308</b>				
		727636	010	<b>83309</b>	...		...	...
		727639	010	<b>83312</b>	<b>89409</b>		...	...
		727641	010	<b>83314</b>	...		...	...
		727645	-10	<b>83318</b>	...		...	...
		727671	-1-	<b>83613</b>				
		727672	010	<b>83242</b>				
		728601	010	<b>85001 or 89410</b>				
		728603		...	...	010	<b>85003</b>	<b>89411</b>
		728604	010	<b>85300</b>				
		728606	010	<b>85302 or 89420</b>				
		728608	010	<b>85304</b>				
		728609	010	<b>85305</b>				
		728611	010	<b>85307</b>				

## APPLICATION GUIDE - TRUCKS, TRAILERS, AND BUSES

Year Año Année	Model Modelo Modèle	OEM #	Front		Rear	
						
						
			Fleetline	GasSLX	Fleetline	GasSLX

### ARVIN MERITOR(Cont'd.)

	Models with Manufacturing Number	728612		85308	...	010	85308	89422		
		728614		...	...	-1-	85310	89423		
		728615		...	...	-10	85311	89424		
		728616		...	...	010	85004	...		
		728617		85005 or 89430						
		728618		85006						
		728619		...	...	010	85007	...		
		728621		-10	85009	...		...	...	
		728622		...	...	010	85010	...		
		728624		85012 or 89413						
		728625		85013 or 89414						
		728626		...	...	01-	85733	...		
		728628		...	...	010	85314	89425		
		728631		85029	...	010	85029	...		
		728632		85030	...	010	85030	89440		
		728635		...	...	-1-	85318	...		
		728639		01-	85026	89417		...	...	
		728640		-1-	85027	89418		...	...	
		728800		-10	85711					
		728806		010	85736					
		728812		-1-	85705	...		...	...	

### AUTOCAR

#### XPEDITOR









08 - 19	4 X 2 Models with Hendrickson Primaax EX 232 Air Suspensions Standard with 8 1/2" to 10" Ride Height	60657-003		...	...	010	85072	...
		60657-003L		...	...	010	85072	...
08 - 20	6 X 4 Models with Hendrickson HMX 400/460 Haulmax with 16.5" Saddle	60680-004		...	...	01-	83143	...
		60680-004L		...	...	01-	83143	...
08 - 20	6 X 4 Models with Hendrickson HMX 400/460 Haulmax with 17.5" & 18.5" Saddle	60680-005		...	...	01-	83142	...
		60680-005L		...	...	01-	83142	...
08 - 19	6 X 4 Models with Hendrickson HN - 522	60680-003		...	...	01-	83112	...
		60680-003L		...	...	01-	83112	...
08 - 19	6 X 4 Models with Hendrickson Primaax EX 462 Air Suspensions Standard with 12 1/2" - 14 3/8" - 15 1/2" Ride Height Standard with 8 1/2" to 10" Ride Height	60665-011		...	...	010	85967	...
		60657-003		...	...	010	85072	...
		60657-003L		...	...	010	85072	...
		800670		...	...	010	85060	...
08 - 19	8 X 4 Models with Chalmers 800 Series - 46K Tandem Truck Suspensions ( HD Shock Kit with High Mounts)	800781		...	...	010	85314	89425
08 - 19	8 X 4 Models with Hendrickson Primaax EX 462 Air Suspensions Standard with 12 1/2" - 14 3/8" - 15 1/2" Ride Height Standard with 8 1/2" to 10" Ride Height	60665-011		...	...	010	85967	...
		60657-003		...	...	010	85072	...
		60657-003L		...	...	010	85072	...
		09 - 12	Models with 20,000 lb Front Axle	3946210		-1-	83103	...
2016 -	Models with 20,000 lb Front Axle	A3730008-001		010	85086	...	...	

#### XPERT

	4 X 2 Models (CLASS 7 & 8) with Hendrickson HAS-210 or HAS-230 Air Suspensions With O.E.M. Number	60670-005		...	...	010	83137	...
		60675-003		...	...	010	85976	...
		60675-003L		...	...	010	85976	...
		...		...	...	010	85976	...



## APPLICATION GUIDE - TRUCKS, TRAILERS, AND BUSES

Year Año Année	Model Modelo Modèle	OEM #	Front		Rear	
						
						
			Fleetline	GasSLX	Fleetline	GasSLX

### AUTOCAR(Cont'd.)

#### XPERT(Cont'd.)

12 - 19	4 X 2 Models (CLASS 8) with Hendrickson EX-262 Air Suspensions	60665-013		...	...	010	<b>85965</b>	...
12 - 20	6 X 4 Models with Hendrickson HMX 400 Haulmax with 16.5" Saddle	60680-004		...	...	01-	<b>83143</b>	...
		60680-004L		...	...	01-	<b>83143</b>	...
12 - 20	6 X 4 Models with Hendrickson HMX 400 Haulmax with 17.5" & 18.5" Saddle	60680-005		...	...	01-	<b>83142</b>	...
		60680-005L		...	...	01-	<b>83142</b>	...
12 - 19	6 X 4 Models with Hendrickson Primaax EX 462 Air Suspensions Standard with 12 1/2" - 14 3/8" - 15 1/2" Ride Height Standard with 8 1/2" to 10" Ride Height	60665-011		...	...	010	<b>85967</b>	...
		60657-003		...	...	010	<b>85072</b>	...
		60657-003L		...	...	010	<b>85072</b>	...

#### XSPOTTER

10 - 18	6 X 4 Off-Road Terminal Tractors with Hendrickson HN - 462	60680-003		...	...	01-	<b>83112</b>	...
		60680-003L		...	...	01-	<b>83112</b>	...





#### Additional Applications

	A42B, A42F, A64B A64F Models From Feb. 1971 Thru Jan. 1971	03-1106460	010	<b>85005</b>	<b>89430</b>		...	...
		28R010		<b>83216</b>	...		...	...
	ACM, ACL Models	35901-3201		...	...	010	<b>85024</b>	...
		37301-3201		<b>85027</b>	<b>89418</b>		...	...
	C65T, C70T, C70TS, C90, C75, C90T, DC74, DC75, DC102, DC104 Models	.....	010	<b>83216</b>	...		...	...
	DC87T, DC9364 From Feb. 1971	.....	010	<b>83122</b>	<b>89406</b>		...	...
	Models with Air Suspension and O.E.M. Number	8026658		...	...	010	<b>85046</b>	<b>89434</b>
		8071524		...	...	010	<b>85024</b>	...
	Models with Hendrickson HTS 210, HTS 230 and HTS 260 Suspensions	60665-025		...	...	010	<b>85036</b>	<b>89405</b>
		60665-025L		...	...	010	<b>85036</b>	<b>89405</b>
	Models with O.E.M. Number	1011839	010	<b>83216</b>	...		...	...
		28CFG-910	010	<b>83216</b>	...		...	...
		28CFG-910Z	010	<b>83216</b>	...		...	...
		37301-3202	01-	<b>85026</b>	<b>89417</b>		...	...
		660186	010	<b>83216</b>	...		...	...
	849246	010	<b>83216</b>	...		...	...	

#### BATCO

	Models with O.E.M. Number	1083203	010				<b>83203</b>	
		1083204	010				<b>83204</b>	
		1083207	010				<b>83207</b>	
		1083209	010				<b>83209</b>	
		1083225	010				<b>83225</b>	
		1083310	010				<b>83221</b>	
		1083317	-10				<b>83317</b>	
		1085003	010				<b>85003</b>	
		1085005	010				<b>85005</b>	
		1085007	010				<b>85007</b>	
		1085300	010				<b>85300</b>	
		1085301	010				<b>85301</b>	
		1085305	010				<b>85305</b>	
		1085308	010				<b>85308</b>	
		1085311	-10				<b>85311</b>	
		1087001	010				<b>85734</b>	
		1087004	010				<b>85735</b>	
1087006	010				<b>85736</b>			

## APPLICATION GUIDE - TRUCKS, TRAILERS, AND BUSES

Year Año Année	Model Modelo Modèle	OEM #	Front		Rear	
						
			Fleetline	GasSLX	Fleetline	GasSLX

### BECK BUS

	Deck and 1/2 Bus - Spring Suspension	.....		<b>85307</b>	...	010	<b>85307</b>	...
	Deck and 1/2 Bus - Trailing Wheel	.....		...	...	010	<b>85301</b>	...
	Deck and 1/2 Bus with Air Suspension	.....		<b>85304</b>	...	010	<b>85304</b>	...
	Luxury Liner Bus - Spring Suspension	.....		<b>85307</b>	...	010	<b>85307</b>	...
	Mainliner with Air Suspension	.....		<b>85304</b>	...	010	<b>85304</b>	...
	Models with O.E.M. Number	14QK-140	010	<b>85304</b>	...		...	...
		14QK-2102		...	...	010	<b>85304</b>	...

### BENSON TRUCK BODIES INC.

	Models with Hendrickson Intrax Air Suspension	A-20002		...	...	010	<b>85000</b>	<b>89436</b>
	Models with Neway Air Suspension	90044089		...	...	010	<b>83124</b>	<b>89407</b>

### BERING TRUCK CORP.

	HD80TT Models with Hendrickson HAS-400 Air Suspension	47902-24		...	...	010	<b>83137</b>	...
	Models with Hendrickson HAS-230 Air Suspension	47902-24		...	...	010	<b>83137</b>	...

### BERKSHIRE COACH









<b>- 2020</b>	Ultra 28 Coaches with Ford E450 Chassis	ASH-1136		...	...	-10	<b>83178</b>	...
		ASH-1154	-10	<b>83177</b>	...		...	...

### BLUEBIRD SCHOOL BUS

#### All American Series (FE & RE Models)

	Buses with 13,200 lb, 2-Leaf Parabolic Springs	AMS65109	010	<b>85058</b>	<b>89431</b>		...	...
	Buses with 19,000 lb - 21,000 lb - 2 Stage Leaf Springs	AMS65110		...	...	010	<b>85005</b>	<b>89430</b>
<b>06 - 19</b>	Buses with Comfort Air Suspensions	00085991		...	...	010	<b>85006</b>	...
		471700000428		...	...	010	<b>85006</b>	...
		60998-001		...	...	010	<b>85006</b>	...
		60998-003		...	...	010	<b>85006</b>	...
<b>06 - 19</b>	Buses with Hendrickson Airtex Front Air Suspension (10,000 lb Capacity)	58913-009	010	<b>85959</b>	...		...	...
		58913-009L	010	<b>85959</b>	...		...	...
<b>- 2019</b>	Buses with Hendrickson Airtex Front Air Suspension (13, 200 to 14,600 lb Capacity)	58913-011	010	<b>85959</b>	...		...	...
		58913-011L	010	<b>85959</b>	...		...	...
<b>98 - 15</b>	Buses with Hendrickson Parasteer Suspensions	0015222	010	<b>85919</b>	...		...	...
		0040015	010	<b>85919</b>	...		...	...
		481700131438	010	<b>85919</b>	...		...	...
		59483-000	010	<b>85919</b>	...		...	...
		60665-005	010	<b>85919</b>	...		...	...
		60665-005L	010	<b>85919</b>	...		...	...
		60998-002	010	<b>85919</b>	...		...	...
		60998-002L	010	<b>85919</b>	...		...	...
<b>- 2019</b>	Buses with Hendrickson Softek Suspension (13,200 lb - 14,600 lb Capacity)	0106303	010	<b>85106</b>	...		...	...
		471700002919	010	<b>85106</b>	...		...	...
		58913-010	010	<b>85106</b>	...		...	...
		58913-010L	010	<b>85106</b>	...		...	...
<b>06 - 19</b>	Buses with Hendrickson Softek Suspension (8,500 lb - 10,000 lb Capacity)	58913-009	010	<b>85959</b>	...		...	...
		58913-009L	010	<b>85959</b>	...		...	...
<b>05 - 16</b>	Buses with Leaf Spring Rear Suspension	0088035		...	...	010	<b>85090</b>	...
		471700000464		...	...	010	<b>85090</b>	...
	Buses with O.E.M. Number	0110808	010	<b>83124</b>	<b>89407</b>		...	...
		0823054	010	<b>85304</b>	...		...	...
	FE Models School Bus (Front Engine)	0014605		...	...	010	<b>85036</b>	<b>89405</b>
		0014985		...	...	010	<b>83137</b>	...
		59057-001		...	...	010	<b>83137</b>	...

## APPLICATION GUIDE - TRUCKS, TRAILERS, AND BUSES

Year Año Année	Model Modelo Modèle	OEM #	Front		Rear	
						
						
			Fleetline	GasSLX	Fleetline	GasSLX

### BLUEBIRD SCHOOL BUS(Cont'd.)

#### All American Series (FE & RE Models)(Cont'd.)

FE Models School Bus (Front Engine)	59057-002		...	...	010	85036	89405
RE (Rear Engine) Models with Ridewell RAS - 227 Steer Axle Air Suspension	1260008		...	...	010	87017	...
	90-2610 SP1		...	...	010	87017	...
RE Models School Bus (Rear Engine) with 1 " Mounting Pins	300-0614966	010	85307	...		...	...
	300-0614974		...	...	010	85304	...
	609180		...	...	010	85304	...
	614958	010	85307	...		...	...

#### D3 Series (FE & RE Models)

10 - 13	Buses with Comfort Air Suspensions	00085991	...	...	010	85006	...
		471700000428	...	...	010	85006	...
		60998-001	...	...	010	85006	...
		60998-003	...	...	010	85006	...
10 - 13	Buses with Hendrickson Airtek Front Air Suspension	0110808	010	83124	89407	...	...
10 - 13	Buses with Hendrickson Airtek Front Air Suspension (13, 200 to 14,600 lb Capacity)	58913-011	010	85959	...	...	...
		58913-011L	010	85959	...	...	...
10 - 13	Buses with Hendrickson Softek Suspension (13,200 lb - 14,600 lb Capacity)	0106303	010	85106	...	...	...
		471700002919	010	85106	...	...	...
		58913-010	010	85106	...	...	...
		58913-010L	010	85106	...	...	...
10 - 13	Buses with Leaf Spring Rear Suspension	0088035		...	...	010	85090
		471700000464		...	...	010	85090

#### TC 2000 Bus, TC/2000 FE Series

	Buses with Ridewell Front Suspension Option #4540	1004167	010	85712	...	...	...
		1317767	010	85029	...	...	...
		1667831	010	85029	...	...	...
		300-1317767	010	85029	...	...	...
		AMS65119	010	85029	...	...	...
	Buses with Ridewell Rear Suspension Option #4540	1316546		...	...	010	85006
		1658533		...	...	010	85010
		305-0961284		...	...	010	85734
	Buses with Standard Flat Leaf Rear Springs	1746163		...	...	010	85006





#### Type A School Bus

92 - 20	MicroBird Type A School bus with Ford E350 Chassis	8C24-18045-DA	-10	83177	...	...	...	
		8C2Z-18124-D	-10	83177	...	...	...	
		ASH-1154	-10	83177	...	...	...	
		AT-163G	-10	83177	...	...	...	
		8C24-18080-DB		...	...	-10	83178	...
		8C2Z-18125-D		...	...	-10	83178	...
		ASH-1136		...	...	-10	83178	...
		AT-164G		...	...	-10	83178	...
00 - 20	MicroBird Type A School bus with Ford E450 Chassis	8C24-18045-DA	-10	83177	...	...	...	
		8C2Z-18124-D	-10	83177	...	...	...	
		ASH-1154	-10	83177	...	...	...	
		AT-163G	-10	83177	...	...	...	
		8C24-18080-DB		...	...	-10	83178	...
		8C2Z-18125-D		...	...	-10	83178	...
		ASH-1136		...	...	-10	83178	...
		AT-164G		...	...	-10	83178	...

#### Vision Series

06 - 19	Buses with Comfort Air Suspensions	00085991		...	...	010	85006
		471700000428		...	...	010	85006
		471700131545		...	...	010	85006

**APPLICATION GUIDE - TRUCKS, TRAILERS, AND BUSES**

Year Año Année	Model Modelo Modèle	OEM #	Front		Rear	
						
			Fleetline	GasSLX	Fleetline	GasSLX

**BLUEBIRD SCHOOL BUS(Cont'd.)**









**Vision Series(Cont'd.)**

06 - 19	Buses with Comfort Air Suspensions	60998-001		...	...	010	85006	...
		60998-003		...	...	010	85006	...
	Buses with Hendrickson Airtek Front Air Suspension	00119797	010	85959	...		...	...
		65992-003	010	85959	...		...	...
06 - 19	Buses with Hendrickson Airtek Front Air Suspension (10,000 lb Capacity)	0055017	010	85959	...		...	...
		0085990	010	85959	...		...	...
		47170000456	010	85959	...		...	...
		58913-008	010	85959	...		...	...
		58913-008L	010	85959	...		...	...
		58913-009	010	85959	...		...	...
12 - 19	Buses with Hendrickson Airtek Front Air Suspension (13, 200 to 14,600 lb Capacity)	58913-011	010	85959	...		...	...
		58913-011L	010	85959	...		...	...
- 2019	Buses with Hendrickson Softek Suspension (13,200 lb - 14,600 lb Capacity)	0106303	010	85106	...		...	...
		471700002919	010	85106	...		...	...
		58913-010	010	85106	...		...	...
		58913-010L	010	85106	...		...	...
06 - 19	Buses with Hendrickson Softek Suspension (8,500 lb - 10,000 lb Capacity)	0055008	010	85959	...		...	...
		0085990	010	85959	...		...	...
		47170000456	010	85959	...		...	...
		58913-007	010	85959	...		...	...
		58913-007L	010	85959	...		...	...
		58913-009	010	85959	...		...	...
05 - 16	Buses with Leaf Spring Rear Suspension	0088035		...	...	010	85090	...
		47170000464		...	...	010	85090	...

**Additional Applications**

	Buses with 3/4" Mounting Pins	2021459		85012	...	010	85012	89413
	Buses with 35" Chassis	303-1350628	010	85712	...		...	...
		90-1968	010	85712	...		...	...
	Buses with Flat Leaf Rear Spring Suspensions (8,200 lb to 10,400 lb)	1707405		...	...	010	85005	89430
	Buses with Neway Air Suspensions with O.E.M. Number	1526417		...	...	010	85052	...
		90044448		...	...	010	85051	...
		90044915		...	...	010	83127	...
		90045083		...	...	010	85910	...
	Buses with Reyco Air Suspension	1668722	010	85030	89440		...	...
		1668730		...	...	010	85013	89414
		1722222		...	...	010	85013	89414
	City Bird Buses with 1 " Mounting Pins	300-0614966	010	85307	...		...	...
		300-0614974		...	...	010	85304	...
		609180		...	...	010	85304	...
		614958	010	85307	...		...	...
		614966	010	85307	...		...	...
	Low Floor Bus Models with O.E.M. Number	0075916	010	85086	...		...	...
		4759272		...	...	- -	...	89447
		4760958	010	85086	...		...	...
		680667		...	...	- -	...	89447
	Motor Home with IFS (37 Foot)	7805-N-1002	010	85329	...		...	...
		7805-S-1007	010	85329	...		...	...
	WanderLodge Drive Axle	1750793		...	...	010	85712	...

## APPLICATION GUIDE - TRUCKS, TRAILERS, AND BUSES

Year Año Année	Model Modelo Modèle	OEM #	Front		Rear	
						
						
			Fleetline	GasSLX	Fleetline	GasSLX

### BLUEBIRD SCHOOL BUS(Cont'd.)

#### Additional Applications(Cont'd.)

	Front with Reyco Air Suspension	90-1968-SP1 1722214	OIO	85712	...	...	...	
				...	...	OIO	85030	89440
	WanderLodge LX, LXI - Models Front Rear	90-2497-SP1		.....	...	...	...	
		90-1951-SP1		...	...	OIO	85734	...
	Models with O.E.M. Number	00119798	OIO	85106	...	...	...	
		0020326		...	...	OIO	85976	...
		300-1316546		...	...	OIO	85006	...
		614974	OIO	85304	...	...	...	...
		65992-004	OIO	85106	...	...	...	...
		680783	OIO	85304	...	...	...	...

#### Additional O.E.M. Interchanges

	Additional O.E.M. Interchanges	0523047	OIO	85736				
		1217934	OIO	85304				
		1962422	OIO	85304				
		1962430	OIO	83207 or 89407				
		300-0823047	OIO	85736				
		300-0823054	OIO	85304				
		300-09612284	OIO	85734				
		671933	OIO	85919				
		680102	OIO	85712				
		680155	OIO	85712				
		70317	OIO	89402				
		70397	OIO	85006				
		7805-M-1001	OIO	85919				
		87001-01A		...	...	OIO	85734	...
		90-1813		...	...	OIO	85712	...
A-4890		...	...	OIO	85712	...		

### BOYDSTUN EQUIPMENT MANUFACTURING

	Trailers with Ridewell RAR-210 Suspensions	1253069B000		...	...	OIO	85005	89430
	Trailers with Ridewell RAR-221AS-11-USW, RAR-221AS-11-1-USW Suspensions	1253069B000		...	...	OIO	85005	89430









### BREDA BUS

	Models with O.E.M. Number	500-403-4		...	...		.....	...
--	---------------------------	-----------	--	-----	-----	--	-------	-----

### BROCKWAY SCHOOL BUS

	257T, 260S, 260T Models	.....	OIO	83207	89407		...	...
	300, 400, 500 Models With 1" Mounting Pins With 3/4" Mounting Pins	.....	OIO	85307	...		...	...
		.....	OIO	85012	89413		...	...
	55 and 61 Passenger School Bus With 1" Rear Mounting Pins With 3/4" Rear Mounting Pins	.....	OIO	83216	...	OIO	85305	...
		.....	OIO	83216	...		...	...
	88WH, 128W, 154W Models	.....	OIO	83216	...		...	...
	Less than 55 Passenger School Bus	.....	OIO	83216	...		...	...
	Models with O.E.M. Number	14QK-281P10	OIO	85305	...		...	...
		14QK-282P1	OIO	83216	...		...	...
		14QK-282P3	OIO	83216	...		...	...
		152398	OIO	85304	...		...	...
		152412	OIO	83215	...		...	...
		508657	OIO	85307	...		...	...
		515231	OIO	85303	89422		...	...
		530873	OIO	83207	89407		...	...

## APPLICATION GUIDE - TRUCKS, TRAILERS, AND BUSES

Year Año Année	Model Modelo Modèle	OEM #	Front		Rear	
						
						
			Fleetline	GasSLX	Fleetline	GasSLX

### BROCKWAY SCHOOL BUS(Cont'd.)

Models with O.E.M. Number	532397	○ ○	<b>85307</b>	...	...	...
---------------------------	--------	-----	--------------	-----	-----	-----

### BUILT RITE

Models with Air Suspension	318-06-100	○ ○	...	...	○ ○	<b>85006</b>	...
Additional O.E.M. Interchanges	70039	○ ○	<b>85303</b>	...	○ ○	<b>85303</b>	<b>89422</b>
	70041	○ ○	<b>85305</b>	...	○ ○	<b>85305</b>	...

### BUS & TRUCK CO.

Silver Eagle	680091	○ ○	<b>85303</b>	...	○ ○	<b>85303</b>	<b>89422</b>
	70039	○ ○	<b>85303</b>	...	○ ○	<b>85303</b>	<b>89422</b>
	70041	○ ○	<b>85305</b>	...	○ ○	<b>85305</b>	...

### CARPENTER BUS

Models with O.E.M. Number	0272-SS5	○ ○	<b>85712</b>	...	○ ○	...	...
	63-0001	○ ○	...	...	○ ○	<b>85713</b>	...

### CASCADE TRAILER

Models with Air Suspension	120-1	○ ○	...	...	○ ○	<b>83125</b>	...
----------------------------	-------	-----	-----	-----	-----	--------------	-----

### CATERPILLAR

12 - 17	CT660 Models with Hendrickson HMX 460 Haulmax with 16.5" Saddle	60680-004	○ ○	...	...	○ ○	<b>83143</b>	...
		60680-004L	○ ○	...	...	○ ○	<b>83143</b>	...
12 - 17	CT660 Models with Hendrickson HMX 460 Haulmax with 17.5" & 18.5" Saddle	60680-005	○ ○	...	...	○ ○	<b>83142</b>	...
		60680-005L	○ ○	...	...	○ ○	<b>83142</b>	...

### CHALLENGE COOK

#### Cement Truck

Cement Trucks with 1/2" Bearing mount	632147	○ ○		○ ○		<b>632147</b>	
Cement Trucks with 3/4" Bushing & Sleeve mount	1540212	○ ○		○ ○		<b>646155</b>	
	1540459	○ ○		○ ○		<b>646155</b>	
	632155	○ ○		○ ○		<b>646177</b>	

### CHALMERS SUSPENSION

	800 Series - 46K Tandem Truck Suspensins ( HD Shock Kit with High Mounts)	665174	○ ○	...	...	○ ○	<b>85060</b>	...
		K800199 Model Shock Kit (Stanard)	○ ○	...	...	○ ○	<b>85060</b>	...
	K880233 Model Shock Kit (Standard 50K Suspension)	665174	○ ○	...	...	○ ○	<b>85060</b>	...
		K880233	○ ○	...	...	○ ○	<b>85060</b>	...
	K880247 Model Shock Kit	665174	○ ○	...	...	○ ○	<b>85060</b>	...
		K880247	○ ○	...	...	○ ○	<b>85060</b>	...
	K880248 Model Shock Kit	K880248	○ ○	...	...	○ ○	<b>85314</b>	<b>89425</b>
	K880642 Model Shock Kit (Used on Western Star only)	665174	○ ○	...	...	○ ○	<b>85060</b>	...
		K880642	○ ○	...	...	○ ○	<b>85060</b>	...
	Single Axle Truck Suspension (1023-23K, 1030 -30K, 1040-40K)	665174	○ ○	...	...	○ ○	<b>85060</b>	...
	800 Series - 46K Tandem Truck Suspensins ( HD Shock Kit with High Mounts)	800670	○ ○	...	...	○ ○	<b>85060</b>	...
	800 Series - 46K Tandem Truck Suspensins ( HD Shock Kit with Low Mounts)	800781	○ ○	...	...	○ ○	<b>85314</b>	<b>89425</b>
	Models with O.E.M. Number	21335	○ ○	...	...	○ ○	<b>G63355</b>	...

### CHAMPION BUS INC

- 2020	American Coach Series Shuttle buses with Ford E350 and E450 Chassis	ASH-1136	○ ○	...	...	- ○	<b>83178</b>	...
		ASH-1154	- ○	<b>83177</b>	...	○ ○	...	...

## APPLICATION GUIDE - TRUCKS, TRAILERS, AND BUSES

Year Año Année	Model Modelo Modèle	OEM #	Front			Rear		
			Fleetline	GasSLX		Fleetline	GasSLX	

### CHAMPION BUS INC(Cont'd.)

- 2020	American Crusader Series Shuttle buses with Ford E350 Chassis	ASH-1136		...	...	- 0	<b>83178</b>	...
		ASH-1154	- 0	<b>83177</b>	...		...	...
- 2020	Challenger Series Shuttle buses with Ford E350 and E450 Chassis	ASH-1136		...	...	- 0	<b>83178</b>	...
		ASH-1154	- 0	<b>83177</b>	...		...	...
- 2020	Crusader Series Shuttle buses with Ford E350 Chassis	ASH-1136		...	...	- 0	<b>83178</b>	...
		ASH-1154	- 0	<b>83177</b>	...		...	...
- 2020	FL Transport Series Shuttle buses with Ford E450 Chassis	ASH-1136		...	...	- 0	<b>83178</b>	...
		ASH-1154	- 0	<b>83177</b>	...		...	...
	GMC P6000 Chassis	22064230	- -	<b>83136</b>	...		...	...
	Models with Ford F650 and F750 Chassis - See Ford section for proper year and model information	.....					.....	
	Models with Freightliner M2 Chassis - See Freightliner section for proper year and model information	.....					.....	

### CHANCE COACH

	Buses with 3/4" Mounting Pins	2021459		<b>85012</b>	...	0 0	<b>85012</b>	<b>89413</b>	
	Models with O.E.M. Number	59039		<b>83207</b>	...	0 0	<b>83207</b>	<b>89407</b>	
		665017		...	...	0 0	<b>85014</b>	...	
		6892		<b>83207</b>	...	0 0	<b>83207</b>	<b>89407</b>	
		6893		0 0	<b>83203</b>	<b>89436</b>		...	...
		728600			<b>83203</b>	...	0 0	<b>83203</b>	<b>89436</b>
		AS789B			<b>85014</b>	...	0 0	<b>85014</b>	...
	Additional O.E.M. Interchanges	270-6708	0 0				<b>85014</b>		

### CHEVROLET TRUCK (ALSO SEE GMC TRUCK)





#### 4, 40, 4000 & 4500 Series

69 - 72	All - Exc. Tilt Cab	22012096		<b>83221</b>	...	0 0	<b>83221</b>	...
		3192892		<b>83221</b>	...	0 0	<b>83221</b>	...
60 - 68	C-40 , P-40, SS-40 Models	.....	0 0	<b>85005</b>	<b>89430</b>		...	...
1968	Cowl - Exc. School Bus	22012096	0 0	<b>83221</b>	...		...	...
		3192892	0 0	<b>83221</b>	...		...	...
69 - 70	D-D Forward Control with 9000 & 11000 lb Axles - Exc. Tilt Cab	22012096	0 0	<b>83221</b>	...		...	...
		3192892	0 0	<b>83221</b>	...		...	...
69 - 70	D-D Forward Control with Tilt Cab	22012095	0 0	<b>83126</b>	<b>89430</b>		...	...
		4940606	0 0	<b>83126</b>	<b>89430</b>		...	...
67 - 72	S-40 School Bus	22012096		<b>83221</b>	...	0 0	<b>83221</b>	...
		3192892		<b>83221</b>	...	0 0	<b>83221</b>	...
67 - 68	TDM 4 Cycle Detroit Diesel with Tandem Axle - Exc. Tilt Cab	22012096		...	...	0 0	<b>83221</b>	...
		3192892		...	...	0 0	<b>83221</b>	...

#### 5, 50, 5000 & 5500 Series

69 - 72	All - Exc. Tilt Cab	22012096		<b>83221</b>	...	0 0	<b>83221</b>	...
		3192892		<b>83221</b>	...	0 0	<b>83221</b>	...
76 - 89	C Chassis - Conventional Cab	22012196		...	...	0 0	<b>83221</b>	...
73 - 80	C, M, S Chassis - Conventional Cab	22007750	0 0	<b>83207</b>	<b>89407</b>		...	...
		4975467	0 0	<b>83207</b>	<b>89407</b>		...	...
		4975494	0 0	<b>83207</b>	<b>89407</b>		...	...
75 - 80	C, M, S Chassis - Conventional Cab	4975510	0 0	<b>83221</b>	...		...	...
76 - 89	C, M, S Chassis - Conventional Cab	22002294	0 0	<b>83304</b>	...		...	...
		22007752	0 0	<b>83304</b>	...		...	...
		22012096		...	...	0 0	<b>83221</b>	...
		22012169		...	...	0 0	<b>83221</b>	...
73 - 80	C, S Chassis - Conventional Cab and School Bus	22012096		...	...	0 0	<b>83221</b>	...
		3192892		...	...	0 0	<b>83221</b>	...
73 - 89	C, S Chassis - Conventional Cab and School Bus	22012095		...	...	0 0	<b>83126</b>	<b>89430</b>
		22012166		...	...	0 0	<b>83126</b>	<b>89430</b>

## APPLICATION GUIDE - TRUCKS, TRAILERS, AND BUSES

Year Año Année	Model Modelo Modèle	OEM #	Front		Rear	
						
						
			Fleetline	GasSLX	Fleetline	GasSLX

### CHEVROLET TRUCK (ALSO SEE GMC TRUCK)(Cont'd.)

#### 5, 50, 5000 & 5500 Series(Cont'd.)





63 - 69	C-50, M-50, S-50, SE-50, T-50 Models	.....		010	85005	89430		010	83221	...
1968	Cowl - Exc. School Bus	22012096		010	83221	...			...	...
		3192892		010	83221	...			...	...
69 - 70	D-D Forward Control with 9000 & 11000 lb Axles - Exc. Tilt Cab	22012096		010	83221	...			...	...
		3192892		010	83221	...			...	...
69 - 70	D-D Forward Control with Tilt Cab	22012095		010	83126	89430			...	...
		4940606		010	83126	89430			...	...
69 - 72	S-50 School Bus	3192892			83221	...	010		83221	...
73 - 78	S-50 School Bus	22012166			...	...	010		83126	89430
		3192892			...	...	010		83221	...
67 - 68	TDM 4 Cycle Detroit Diesel with Tandem Axle - Exc. Tilt Cab	22012096			...	...	010		83221	...
		3192892			...	...	010		83221	...
71 - 72	TDM 4 Cycle Detroit Diesel with Tandem Axle - Exc. Tilt Cab	22012095			...	...	010		83126	89430
		4940606			...	...	010		83126	89430

#### 6, 60, 6000 & 6500 Series

69 - 72	All - Exc. Tilt Cab	22012096			83221	...	010		83221	...
		3192892			83221	...	010		83221	...
68 - 69	All with 9000 & 11000 lb Axles - Exc. Tilt Cab	22012095	010		83126	89430			...	...
		4940606	010		83126	89430			...	...
79 - 89	B6P042 School Bus (Axle codes F070, F070D)	22002294	010		83304	...			...	...
		22007752	010		83304	...			...	...
79 - 89	B6P042 School Bus (Axle codes F090, F120D)	22002295	010		83303	...			...	...
		22007753	010		83303	...			...	...
		22017531	010		83303	...			...	...
79 - 89	B6P042 School Bus w/15000 lb or 17000 lb Rear Springs	22012096			...	...	010		83221	...
		22012169			...	...	010		83221	...
79 - 89	B6P042 School Bus w/18500 or 20800 lb Rear Springs	22012095			...	...	010		83126	89430
		22012166			...	...	010		83126	89430
76 - 89	C, M Chassis - Conventional Cab	22002294	010		83304	...			...	...
		22007752	010		83304	...			...	...
75 - 80	C, M, S Chassis - Conventional Cab and School Bus	4975510	010		83221	...			...	...
73 - 75	C, M, S Chassis - Conventional Cab and School Bus with 5000 & 7000 lb Axle	22007750	010		83207	89407			...	...
		4975467	010		83207	89407			...	...
		4975494	010		83207	89407			...	...
73 - 89	C, S Chassis - Conventional Cab and School Bus - Exc. with 20800 & 23000 lb Rear Axle	22012096			...	...	010		83221	...
		22012169			...	...	010		83221	...
		3192892			...	...	010		83221	...
73 - 89	C, S Chassis - Conventional Cab and School Bus with 20800 & 23000 lb Rear Axles	22012095			...	...	010		83126	89430
		22012166			...	...	010		83126	89430
		4940606			...	...	010		83126	89430
79 - 89	C, S Chassis - Conventional Cab and School Bus	22002295	010		83303	...			...	...
		22007753	010		83303	...			...	...
		22017530	010		83303	...			...	...
		22017531	010		83303	...			...	...
73 - 80	C, S, T Chassis - Conventional & Tilt Cab and School Bus with 5000 & 7000 lb Axle	22002293	010		83126	89430			...	...
		22007701	010		83126	89430			...	...
		22007751	010		83303	...			...	...
		22012095	010		83126	89430			...	...
		3192890	010		83126	89430			...	...
		4940606	010		83126	89430			...	...
		4940662	010		83126	89430			...	...
4975497	010		83126	89430			...	...		



**APPLICATION GUIDE - TRUCKS, TRAILERS, AND BUSES**

Year Año Année	Model Modelo Modèle	OEM #	Front		Rear	
			 Fleetline	 GasSLX	 Fleetline	 GasSLX

**CHEVROLET TRUCK (ALSO SEE GMC TRUCK)(Cont'd.)**



**6, 60, 6000 & 6500 Series(Cont'd.)**

71 - 72	Conventional Cab & Tilt Cab with 9000 & 11000 lb Axles	22012095		...	...	010	83126	89430
		4940606		...	...	010	83126	89430
1968	Cowl - Exc. School Bus	22012096	010	83221	...		...	...
		3192892	010	83221	...		...	...
69 - 70	D - D Forward Control with 9000 & 11000 lb Axles - Exc. Tilt Cab	22012096	010	83221	...		...	...
		3192892	010	83221	...		...	...
76 - 89	S Chassis - School Bus	22002294	010	83304	...		...	...
		22007702	010	83304	...		...	...
		22007752	010	83304	...		...	...
69 - 78	S-60	3192892		83221	...	010	83221	...
		4975510		83221	...	010	83221	...
73 - 78	S-60 w/Air Brakes	22007701	010	...	...	010	83126	89430
		22007751		83303	...		...	...
		22012095		...	...	010	83126	89430
		22012166		...	...	010	83126	89430
		3171069		...	...	010	85304	...
		4940606		...	...	010	83126	89430
73 - 75	SE, SS-60 thru Serial # 134487 (1975 1st Design)	22007700	010	83207	89407		...	...
		22007750	010	83207	89407		...	...
		4975467	010	83207	89407		...	...
		4975494	010	83207	89407		...	...
76 - 78	SE-60 From Serial # 120000 (1976 2nd Design)	22002294	010	83304	...		...	...
		22007752	010	83304	...		...	...
76 - 78	SE-60 w/Hydraulic Brakes from Serial # 120000 (1975 2nd Design)	22012169		...	...	010	83221	...
		3192892		...	...	010	83221	...
73 - 74	SG, SM-60	3192890	010	83126	89430		...	...
73 - 74	SG, SM-61	4940606	010	83126	89430		...	...
73 - 74	SG, SM-62	22002293	010	83126	89430		...	...
73 - 74	SG, SM-63	22007701	010	83126	89430		...	...
73 - 74	SG, SM-64	22007751	010	83303	...		...	...
60 - 62	Standard and Heavy Duty Truck and School Bus (2 Ton)	.....		...	...	010	83221	...
71 - 72	TDM 4 Cycle Detroit Diesel with Tandem Axle	22012095		...	...	010	83126	89430
		4940606		...	...	010	83126	89430
67 - 68	TDM 4 Cycle Detroit Diesel with Tandem Axle - Exc. Tilt Cab	22012096		...	...	010	83221	...
		3192892		...	...	010	83221	...
79 - 80	W Chassis - 72" BBC Steel Tilt Cab	22002293	010	83126	89430		...	...
		22007751	010	83303	...		...	...

**7, 70 & 7000 Series**

66 - 72	72" BBC Steel Tilt Cab with V-6 2 Cycle Diesel Engine	22012095	010	83126	89430		...	...
		3171462	010	83126	89430		...	...
		3192890	010	83126	89430		...	...
66 - 72	72" BBC Steel Tilt Cab with V-6 2 Cycle Diesel Engine with 17201 and 17221 Axle	22012096		...	...	010	83221	...
		3192892		...	...	010	83221	...
66 - 72	72" BBC Steel Tilt Cab with V-6 2 Cycle Diesel Engine with 19101 and 19201 Axle	4940600		...	...	010	83209	89414
66 - 72	92" BBC Conventional Cab	3192657	010	83216	...		...	...
		4940614	010	83216	...		...	...
		4963854	010	83216	...		...	...
79 - 89	C, M Chassis - 97" BBC Conventional Cab	22002294	010	83304	...		...	...
		22002295	010	83303	...		...	...
		22007752	010	83304	...		...	...
		22007753	010	83303	...		...	...
		22012095		...	...	010	83126	89430

**APPLICATION GUIDE - TRUCKS, TRAILERS, AND BUSES**

Year Año Année	Model Modelo Modèle	OEM #	Front		Rear	
						
			Fleetline	GasSLX	Fleetline	GasSLX

**CHEVROLET TRUCK (ALSO SEE GMC TRUCK)(Cont'd.)**





**7, 70 & 7000 Series(Cont'd.)**

79 - 89	C, M Chassis - 97" BBC Conventional Cab	22012166		...	...	010	83126	89430
		22017530	010	83303	...		...	...
		22017531	010	83303	...		...	...
66 - 72	Conventional Cab with Tapered 2-Leaf Softride 11000 lb Rating and F120 Axle (12000 lb)	22046483	010	85304	...		...	...
		22052336	010	85304	...		...	...
		3171069	010	85304	...		...	...
66 - 72	Conventional Cab With Tapered 2-Leaf Softride 7000 & 9000 lb Rating and F070, F090, F120 Axle (7000, 9000 & 12000 lb)	3171068	010	83216	...		...	...
		3192657	010	83216	...		...	...
		4940614	010	83216	...		...	...
		4963853	010	83216	...		...	...
		4963854	010	83216	...		...	...
77 - 80	H, J Chassis - 92" BBC Conventional Cab	4963854	010	83216	...		...	...
		4984526	010	83216	...		...	...
73 - 80	H, J Chassis - 92" BBC Conventional Cab with V-6, V8 Diesel Engines	4940614	010	83216	...		...	...
		4963854	010	83216	...		...	...
73 - 80	H, J, M Chassis - 92" & 114" BBC Conventional Cab	2204683	010	85304	...		...	...
		3171069	010	85304	...		...	...
73 - 80	R Chassis - Rear Engine Bus	22012090	010	85308	89422		...	...
		5552451	010	85308	89422		...	...
		5552456		...	...	010	85307	...
		5552552		...	...	010	85303	89422
83 - 84	S7T042 Forward Control Chassis w/17000, 18500, 21000, 23000 lb Rear Axle	22012095		...	...	010	83126	89430
		22012166		...	...	010	83126	89430
83 - 84	STT042 Forward Control Chassis	22012065	010	85304	...		...	...
		3171069	010	85304	...		...	...
73 - 80	T, W Chassis - 72" BBC Steel Tilt Cab (4 x 2) with V-6 Diesel Engine	22007751	010	83303	...		...	...
		22012095	010	83126	89430		...	...
		4940606	010	83126	89430		...	...
		4975497	010	83126	89430		...	...
73 - 80	T, W Chassis - 72" BBC Steel Tilt Cab with V-6 Gas Engine	22012091	010	85303	89422		...	...
		5552452	010	85303	89422		...	...

**8, 80 & 8000 Series**

66 - 69	72" BBC Steel Tilt Cab	5544060	010	85302	89420		...	...
66 - 72	92" BBC Conventional Cab	3171068	010	83216	...		...	...
		3192657	010	83216	...		...	...
		4940614	010	83216	...		...	...
		4963853	010	83216	...		...	...
		4963854	010	83216	...		...	...
66 - 72	92" BBC Conventional Cab with 7000 & 9000 lb Axles - Exc. 2-Leaf Softride	22046483	010	85304	...		...	...
		22052336	010	85304	...		...	...
		3171069	010	85304	...		...	...
79 - 82	H, J Chassis - 92" BBC Conventional Cab 4 x 2 with Air Suspension	22012065		...	...	010	85304	...
		22046483		...	...	010	85304	...
		22052336		...	...	010	85304	...
		3171069		...	...	010	85304	...
73 - 81	H, J Chassis - 92" BBC Conventional Cab	4940614	010	83216	...		...	...
		4963854	010	83216	...		...	...
		4984526	010	83216	...		...	...
73 - 86	H, J, M Chassis - 92" & 114" BBC Conventional Cab	22046483	010	85304	...		...	...
		22052336	010	85304	...		...	...

**APPLICATION GUIDE - TRUCKS, TRAILERS, AND BUSES**

Year Año Année	Model Modelo Modèle	OEM #	Front		Rear	
						
			Fleetline	GasSLX	Fleetline	GasSLX

**CHEVROLET TRUCK (ALSO SEE GMC TRUCK)(Cont'd.)**

**8, 80 & 8000 Series(Cont'd.)**

73 - 86	H, J, M Chassis - 92" & 114" BBC Conventional Cab	3171069	010	85304	...	...	...	
73 - 80	R Chassis - Rear Engine Bus	22012090	010	85308	89422	...	...	
		22012091		...	...	010	85303	89422
		5552451	010	85308	89422	...	...	
		5552452		...	...	010	85303	89422
70 - 80	T, W Chassis - 72" BBC Steel Tilt Cab with V-6 Gas Engine	22012091	010	85303	89422	...	...	
		5552452	010	85303	89422	...	...	

**9000 Series**

70 - 72	54" BBC Aluminum Tilt Cab 6 x 4	22046483		85304	...	010	85304	...
		22052336		85304	...	010	85304	...
		3171069		85304	...	010	85304	...
70 - 72	92" & 114" BBC Conventional Cab - Exc. 6 x 4	4940614	010	83216	...	...	...	
		4963854	010	83216	...	...	...	
70 - 72	92" & 114" BBC Conventional Cab 6 x 4	22046483		85304	...	010	85304	...
		22052336		85304	...	010	85304	...
		3171069		85304	...	010	85304	...
70 - 86	D, F Chassis - 54" BBC Aluminum Tilt Cab with Rear GM Air Ride Suspension (4 Req'd)	22012065		85304	...	010	85304	...
		22046483		85304	...	010	85304	...
		22052336		85304	...	010	85304	...
		3171069		85304	...	010	85304	...
70 - 86	H, J Chassis - 92" BBC Conventional Cab	22046483	010	85304	...	...	...	
		22052336	010	85304	...	...	...	
		3171069	010	85304	...	...	...	
77 - 86	M, N Chassis - 114" BBC Conventional & 108" BBC Aluminum Conventional Cab with Rear GM Air-Ride Suspension (4 Req'd)	22012065		85304	...	010	85304	...
		22046483		85304	...	010	85304	...
		22052336		85304	...	010	85304	...
		3171069		85304	...	010	85304	...
70 - 80	T, W Chassis - 72" BBC Steel Tilt Cab	22012091	010	85303	89422	...	...	
		5552452	010	85303	89422	...	...	



**B - Series - School Bus**

90 - 07	B6, B7 Model School Bus Chassis With 15000, 19000, 21000 lb Multileaf Springs	15174902		...	...	- -	85071	...
		22064232		...	...	- -	85071	...
	Models with O.E.M. Number	15123676	- -	83136	...	...	...	
		15588554	- -	83136	...	...	...	
		22064230	- -	83136	...	...	...	
		88982682	- -	83136	...	...	...	

**C - Series (C4500, C5500) Kodiak**

90 - 09	C Chassis - Conventional Cab Front Shock with O.E.M. Number	15123676	- -	83136	...	...	...	
		15588554	- -	83136	...	...	...	
		15887728	- -	83136	...	...	...	
		19152843	- -	83136	...	...	...	
	With 15000, 19000, 21000 lb Multileaf Springs	22064230	- -	83136	...	...	...	
		88982682	- -	83136	...	...	...	
		15174902		...	...	- -	85071	...
		22064232		...	...	- -	85071	...
90 - 06	C Chassis - Conventional Cab w/16900 or 17850 lb Taperleaf Springs	21998392		...	...	- -	85336	...
		22064489		...	...	- -	85336	...
		88963409		...	...	- -	85336	...

**APPLICATION GUIDE - TRUCKS, TRAILERS, AND BUSES**

Year Año Année	Model Modelo Modèle	OEM #	Front		Rear	
						
			Fleetline	GasSLX	Fleetline	GasSLX

**CHEVROLET TRUCK (ALSO SEE GMC TRUCK)(Cont'd.)**

**C - Series (C4500, C5500) Kodiak(Cont'd.)**

1990 -	C Chassis - Conventional Cab w/19000, 21000, 23000 lb Taperleaf Springs (EXC Low Profile Vehicle)	22064233		...	...	- -	83136	...
83 - 99	C Chassis - Conventional Cab with 9100 to 17500 lb Rear Axle	22064432		...	...	0 0	83221	...
03 - 09	C Chassis - Conventional Cab with Taperleaf Rear Suspension	15185643		...	...	0 0	83153	...
	Models with O.E.M. Number	88982684	- -	83136	...		...	...
		88982688		...	...	- -	85336	...

**C - Series (C6500, C7500, C8500) Kodiak**

90 - 09	Conventional Cab w/ Front Shock with O.E.M. Number	15123676	- -	83136	...		...	...
		15174898	- -	83136	...		...	...
		15588554	- -	83136	...		...	...
		15887728	- -	83136	...		...	...
		19152843	- -	83136	...		...	...
		22064230	- -	83136	...		...	...
		88982682	- -	83136	...		...	...
90 - 09	Conventional Cab w/15000, 19000, 21000 lb Multileaf Springs	15174902		...	...	- -	85071	...
		22064232		...	...	- -	85071	...
		88982686		...	...	- -	85071	...
90 - 06	Conventional Cab w/16900 or 17850 lb Taperleaf Springs	21998392		...	...	- -	85336	...
		22064489		...	...	- -	85336	...
		88963409		...	...	- -	85336	...
1990 -	Conventional Cab w/19000, 21000, 23000 lb Taperleaf Springs (EXC Low Profile Vehicle)	22064233		...	...	- -	83136	...
83 - 99	Conventional Cab with 9100 to 17500 lb Rear Axle	22064432		...	...	0 0	83221	...
95 - 02	Models with Hendrickson Air Suspension (Stamping number 47902-13)	12474915		...	...	0 0	83122	89406
		15963161		...	...	0 0	83122	89406
96 - 02	Models with Hendrickson Air Suspension (Stamping number 47902-29)	12474917		...	...	0 0	83137	...
		15740554		...	...	0 0	83137	...
		Models with O.E.M. Number	88982684	- -	83136	...		...
		88982688		...	...	- -	85336	...

**P - Series**

92 - 96	Motorhome Chassis	22064233		...	...	- -	83136	...
---------	-------------------	----------	--	-----	-----	-----	-------	-----









**T - Series (T5500, T6500, T7500, T8500)**

1997 -	FL1 Tilt Cab with 8100 lb Axle	22064804	- -	83136	...		...	...
		22064805	- -	83136	...		...	...
		22165187	- -	83136	...		...	...
		22165188	- -	83136	...		...	...
1997 -	FL2 Tilt Cab with 5000 to 11000 lb Axle	22064807	- -	83136	...		...	...
		22166442	- -	83136	...		...	...
1997 -	FL3 Tilt Cab with 14575 lb Axle	22064806	- -	83136	...		...	...
		22165189	- -	83136	...		...	...
1999	Models with Hendrickson Air Suspension (Stamping number 47902-13)	12474915		...	...	0 0	83122	89406
		15963161		...	...	0 0	83122	89406
90 - 06	Tilt Cab w/15000, 19000, 21000 lb Multileaf Springs	15174902		...	...	- -	85071	...
		22064232		...	...	- -	85071	...
92 - 06	Tilt Cab w/16900 lb Taperleaf Springs	21998392		...	...	- -	85336	...
		22064489		...	...	- -	85336	...
		88963409		...	...	- -	85336	...
92 - 99	Tilt Cab w/19000, 21000, 23000 lb Taperleaf Springs (EXC Low Profile Veh.)	22064233		...	...	- -	83136	...

**W - Series (Isuzu)**

83 - 95	W4 Models	9-51630-666-0		...	...	0 0	85012	89413
		9-51630-666-2		...	...	0 0	85012	89413
86 - 90	W4 Models	8-94454-986-0	- 0	83515	...		...	...

## APPLICATION GUIDE - TRUCKS, TRAILERS, AND BUSES

Year Año Année	Model Modelo Modèle	OEM #	Front		Rear	
						
						
			Fleetline	GasSLX	Fleetline	GasSLX

### CHEVROLET TRUCK (ALSO SEE GMC TRUCK)(Cont'd.)





#### W - Series (Isuzu)(Cont'd.)

86 - 90	W4 Models	8-94454-987-0 9-51630-647-1	-10	83515	...	...	...	...
			-10	83515	...	...	...	...
89 - 90	W4 Models Flatlow	9-51630-647-1	-10	83515	...	...	...	...
89 - 92	W4 Models Flatlow	9-51630-666-0 9-51630-666-2		...	...	010	85012	89413
				...	...	010	85012	89413
86 - 95	W4 Models with 11000 lb Suspension	97083027	-10	83515	...	...	...	...
87 - 95	W4 Models with 13000 lb Suspension	94454987 97083029	-10	83515	...	...	...	...
			-10	83515	...	...	...	...
88 - 97	W5 Models	1-51630-217-0 1-51630-217-1 1-51630-219-1	-10	83114	...	...	...	...
			-10	83114	...	...	...	...
			-10	83114	...	...	...	...
86 - 91	W6 Models	1-51630-168-1 1-51630-217-0 1-51630-217-1	-10	83515	...	...	...	...
			-10	83114	...	...	...	...
			-10	83114	...	...	...	...
	Models with O.E.M. Number	8-94057-593-0 8-97201-960-0 94033786 94051090 94057593 97201960	-10	83114	...	...	...	...
			-10	83515	...	...	...	...
			-10	83114	...	...	...	...
			-10	83114	...	...	...	...
			-10	83114	...	...	...	...
			-10	83515	...	...	...	...

#### Additional O.E.M. Interchanges

	Models with O.E.M. Number	15642943 22046489 22065218 22065251 22099889 507-24 508-86 508-88		...	...	-1-	83136	...
			010	85303	89422		...	...
			010	G63347	...		...	...
			010	85030	89440		...	...
				...	...	-1-	85336	...
				...	...	-1-	85336	...
				...	...	-1-	83136	...
				...	...	010	83153	...
	Additional O.E.M. Interchanges	22007703 22012067 22012082 22012083 22012114 22012131 22045526 22046481 22052014 3171696 3172948 3175509 3178157 3178233 3178507 3178995 3188626 3188729 4939852 4939967 4940601 4940627 4940640 4940650 4940654	010	83303	...		...	...
				85700	...	010	85700	...
			010	85702				
			-10	85711				
				85700	...	010	85700	...
			-10	85711				
				...	...	010	85702	...
			010	85702				
				...	...	010	85702	...
			010	85307				
			010	85303 or 89422				
			010	85735				
			010	85700				
			010	85734				
			010	85700				
			010	85700				
			010	85300 or 89419				
			010	85303 or 89422				
			010	85308 or 89422				
				...	...	010	85308	89422
010	83216							
010	83203 or 89436							
010	83216							
010	83207 or 89407							
010	83216							

**APPLICATION GUIDE - TRUCKS, TRAILERS, AND BUSES**





Year Año Année	Model Modelo Modèle	OEM #	Front		Rear	
						
			Fleetline	GasSLX	Fleetline	GasSLX

**CHEVROLET TRUCK (ALSO SEE GMC TRUCK)(Cont'd.)**

**Additional O.E.M. Interchanges(Cont'd.)**

Additional O.E.M. Interchanges	4940660	010	83207 or 89407			
	4963844	010	85307			
	4964853	010	83217			
	4974401	010	85700			
	4975429	010	85300 or 89419			
	4975479	-1-	83400	...		...
	4975480	-1-	83400	...		...
	4975516	010	85702			
	4975518		...	...	010	85704
	4975538	010	85700			
	4975549	010	83216	...		...
	4975550	010	85702			
	507-3	010	85307			
	5171068	010	83216			
	5316784	010	85700			
	5316791	010	83219			
	5316792	010	85305			
	5316793	010	85305			
	5321920	010	85307			
	5321929	010	85307			
	5348631	010	83203 or 89436			
	5352858	010	85305			
	5353054	010	85303	89422		...
	5355798	010	85307			
	5357955	010	85300 or 89419			
	5357956	010	85734			
	5357959	010	85300 or 89419			
	5361994	010	85734			
	5374779	010	85308 or 89422			
	5374999	010	85307			
	5385939	010	85307			
	5392387	010	85303	89422		...
	5394448	010	85305			
	5394467	010	85305			
	5394468	010	85735			
	5455798	010	85307			
	5513489	010	83216			
	5513716	010	85304			
	5516459	010	85305			
	5522781	010	85735			
	5522794	010	85308 or 89422			
	5522818	010	85305			
	5527001	010	85300 or 89419			
	5527271	010	85700			
	5527272	010	85700			
	5527606	010	85305			
	5531027	010	85301			
5531435	010	85307				
5531436	010	85307				
5531437	010	85307				
5532026		85304	...	010	85304	
5532425	010	83207 or 89407				
5532433	010	83207 or 89407				
5532675		...	...	010	85307	
5534430	010	85303 or 89422				

## APPLICATION GUIDE - TRUCKS, TRAILERS, AND BUSES

Year Año Année	Model Modelo Modèle	OEM #	Front		Rear	
						
			Fleetline	GasSLX	Fleetline	GasSLX

### CHEVROLET TRUCK (ALSO SEE GMC TRUCK)(Cont'd.)

#### Additional O.E.M. Interchanges(Cont'd.)

Additional O.E.M. Interchanges	5534439	010	85304			
	5534447	010	85303 or 89422			
	5544112	010	83216			
	5544581	010	85302 or 89420			
	5544716	010	85304			
	5544717	010	85304			
	5544812	010	83308			
	5544818	010	85735			
	5549899	010	83207 or 89407			
	5549924	010	85700			
	5549925	010	85304	...	...	...
	5552111	010	85304			
	5552112	010	85307			
	5552114	010	83216			
	5552205	010	83217			
	5552206	010	83214			
	5552207	010	83217			
	5552208	010	83217			
	5552209	010	83215			
	5552210	010	85308 or 89422			
	5552244	010	85308 or 89422			
	5552285	010	83214			
	5552286	010	83217			
	5552287	010	83217			
	5552288	010	83217			
	5552453	010	85301			
	5552527	010	85735			
	5554184	010	85302 or 89420			
	5554589	010	85307			
	5554596	010	...	...	010	85303    89422
	5554814	010	85302 or 89420			
	5554959	010	83401	...	...	...
5554995	010	85305				
5559363	010	83203 or 89436				
5585939	010	85307				
684280	010	83209 or 89414				
97-2210-00164	-1-	85708				
97-2210-00170	-1-	85733	...	01-	85733    ...	

### CHEVROLET TRUCK CAB SHOCKS

	Bruin Tractors with J9 Cabs with Link Cabmate Model GMC92J9	1202-0012	010	83023		
1990 -	Kodiak Truck Cabs with Link Cabmate Model GMC104TK	1202-0054	010	83021		
- 1989	Kodiak Truck Cabs with Link Cabmate Model GMC92TK	1202-0012	010	83023		
	Titan Cabover (Sleeper & Non-Sleeper Trucks) with Link Cabmate Model GMC-2P-A	1202-0032	010	83016		

### CHRYSLER









#### Motorhome Chassis

73 - 81	M & R-300, 400, 500 Motorhome Chassis	3638112				010	G63183	...
63 - 72	M-300, M-375 & R-375 Motorhome Chassis	2961043				010	G63183	...
		3633744				010	G63183	...

### CLARK EQUIPMENT

	Model 130885 (Air Suspension)	5532675				010	85307	...
--	-------------------------------	---------	--	--	--	-----	-------	-----

## APPLICATION GUIDE - TRUCKS, TRAILERS, AND BUSES

Year Año Année	Model Modelo Modèle	OEM #	Front		Rear	
						
						
			Fleetline	GasSLX	Fleetline	GasSLX

### CLARK EQUIPMENT(Cont'd.)

	Ross Carrier	355778		85315	...	OIO	85315	...
			680042	85301	...	OIO	85301	...

### CNH GLOBAL N V

	Models with O.E.M. Number	87019546	OIO	83022	
			87268250	OIO	83021

### COACH HOUSE RV

#### Class C MotorHomes

04 - 20	Platinum Series MotorHomes with Ford E450 Chassis	ASH-1136		...	...	-IO	83178	...
			ASH-1154	-IO	83177	...		...





### COACHMEN RV

#### Class A MotorHomes

01 - 09	Aurora Series MotorHomes with Ford F53 Chassis with 16,000 lb GVW to 22,000 lb GVW	1C34-18045-AA	OIO	83209	89414		...	...		
			1C34-18045-JA	OIO	83209	89414		...	...	
			9U94-18045-AA	OIO	83209	89414		...	...	
			9U94-18080-AA	OIO	...	...	OIO	83122	89406	
			9U9Z-18124-A	OIO	83209	89414		...	...	
			9U9Z-18125-A	OIO	...	...	OIO	83122	89406	
			ASH-1022	OIO	83209	89414		...	...	
			ASH-1023	OIO	...	...	OIO	83122	89406	
			ASH-1205	OIO	83209	89414		...	...	
			ASH-1206	OIO	...	...	OIO	83122	89406	
			ASH-1228	OIO	83209	89414		...	...	
			ASH-1229	OIO	83209	89414		...	...	
			ASH-1230	OIO	...	...	OIO	83122	89406	
			ASH-137	OIO	...	...	OIO	83122	89406	
			ASH-25822	OIO	83209	89414		...	...	
			ASH-25823	OIO	83209	89414		...	...	
			ASH-25824	OIO	...	...	OIO	83122	89406	
			ASH-294	OIO	83209	89414		...	...	
AT-620	OIO	83209	89414		...	...				
AT-621	OIO	...	...	OIO	83122	89406				
AT-766	OIO	83209	89414		...	...				
03 - 05	Cross Country Elite & SE Series MotorHomes with Freightliner XC Chassis			...	...	OIO	85029	...		
			ADL200 Suspension w/ 20K Rear	16-16873-000	OIO	83160	...		...	...
			AS120 Front Suspension	141700131810	OIO	83160	...		...	...
			Rear Shock with O.E.M. Number	16-16874-000	OIO	83160	...		...	...
			ZF - IFS Front Suspension with 23,000 lb GVW or Greater	141700131809	OIO	...	...	OIO	85029	...
			16-16736-000	OIO	...	...	OIO	85029	...	
2006	Cross Country Series MotorHomes with Freightliner XC Chassis			...	...	OIO	85029	...		
			ADL200 Suspension w/ 20K Rear	16-16873-000	OIO	83160	...		...	...
			AS120 Front Suspension	141700131810	OIO	83160	...		...	...
			Rear Shock with O.E.M. Number	16-16874-000	OIO	83160	...		...	...
			ZF - IFS Front Suspension with 23,000 lb GVW or Greater	141700131809	OIO	...	...	OIO	85029	...
			16-16736-000	OIO	...	...	OIO	85029	...	
16-18103-000	-I-	85900	...		...	...				
481700000493	-I-	85900	...		...	...				



## APPLICATION GUIDE - TRUCKS, TRAILERS, AND BUSES

Year Año Année	Model Modelo Modèle	OEM #	Front		Rear	
						
			Wrench	Wrench	Wrench	Wrench
			Fleetline	GasSLX	Fleetline	GasSLX

### COACHMEN RV(Cont'd.)











#### Class A MotorHomes(Cont'd.)

11 - 15	Encounter Series MotorHomes with Ford F53 Chassis with 16,000 lb GVW to 22,000 lb GVW	ASH-1229	010	83209	89414		...	...
			010	83209	89414		...	...
			010	83209	89414		...	...
				...	...	010	83122	89406
99 - 20	Mirada Series MotorHomes with Ford F53 Chassis with 16,000 lb GVW to 22,000 lb GVW	1C34-18045-AA	010	83209	89414		...	...
		1C34-18045-JA	010	83209	89414		...	...
		9U94-18045-AA	010	83209	89414		...	...
		9U94-18080-AA		...	...	010	83122	89406
		9U9Z-18124-A	010	83209	89414		...	...
		9U9Z-18125-A		...	...	010	83122	89406
		ASH-1022	010	83209	89414		...	...
		ASH-1023		...	...	010	83122	89406
		ASH-1205	010	83209	89414		...	...
		ASH-1206		...	...	010	83122	89406
		ASH-1228	010	83209	89414		...	...
		ASH-1229	010	83209	89414		...	...
		ASH-1230		...	...	010	83122	89406
		ASH-137		...	...	010	83122	89406
		ASH-25822	010	83209	89414		...	...
		ASH-25823	010	83209	89414		...	...
		ASH-25824		...	...	010	83122	89406
		ASH-294	010	83209	89414		...	...
		AT-620	010	83209	89414		...	...
		AT-621		...	...	010	83122	89406
AT-766	010	83209	89414		...	...		
	Models with Workhorse UFO Chassis with Hendrickson Softek Front Suspension	66153-002	010	83124	89407		...	...
		F4-BE5-C832-MO	010	83124	89407		...	...
04 - 20	Pursuit Series MotorHomes with Ford F53 Chassis with 16,000 lb GVW to 22,000 lb GVW	1C34-18045-AA	010	83209	89414		...	...
		1C34-18045-JA	010	83209	89414		...	...
		9U94-18045-AA	010	83209	89414		...	...
		9U94-18080-AA		...	...	010	83122	89406
		9U9Z-18124-A	010	83209	89414		...	...
		9U9Z-18125-A		...	...	010	83122	89406
		ASH-1022	010	83209	89414		...	...
		ASH-1023		...	...	010	83122	89406
		ASH-1205	010	83209	89414		...	...
		ASH-1206		...	...	010	83122	89406
		ASH-1228	010	83209	89414		...	...
		ASH-1229	010	83209	89414		...	...
		ASH-1230		...	...	010	83122	89406
		ASH-137		...	...	010	83122	89406
		ASH-25822	010	83209	89414		...	...
		ASH-25823	010	83209	89414		...	...
		ASH-25824		...	...	010	83122	89406
		ASH-294	010	83209	89414		...	...
		AT-620	010	83209	89414		...	...
		AT-621		...	...	010	83122	89406
AT-766	010	83209	89414		...	...		

#### Class C MotorHomes

	Catalina Series MotorHomes with Ford E350 & E450 Chassis	ASH-1136		...	...	-10	83178	...
			-10	83177	...		...	...
04 - 20	Concord Series MotorHomes with Ford E350 & E450 Chassis	ASH-1136		...	...	-10	83178	...

## APPLICATION GUIDE - TRUCKS, TRAILERS, AND BUSES

Year Año Année	Model Modelo Modèle	OEM #	Front				Rear			
										
										
Fleetline		GasSLX		Fleetline		GasSLX				

### COACHMEN RV(Cont'd.)

#### Class C MotorHomes(Cont'd.)

04 - 20	Concord Series MotorHomes with Ford E350 & E450 Chassis	ASH-1154	- O	83177	...		...	...
08 - 09	Freedom Express Series MotorHomes with Ford E350 & E450 Chassis	ASH-1136		...	...	- O	83178	...
		ASH-1154	- O	83177	...		...	...
03 - 20	Freelander Series MotorHomes with Ford E350 & E450 Chassis	ASH-1136		...	...	- O	83178	...
		ASH-1154	- O	83177	...		...	...
03 - 20	Leprechaun Series MotorHomes with Ford E350 & E450 Chassis	ASH-1136		...	...	- O	83178	...
		ASH-1154	- O	83177	...		...	...
00 - 03	Pathfinder Sport Series MotorHomes with Ford E350 & E450 Chassis	ASH-1136		...	...	- O	83178	...
		ASH-1154	- O	83177	...		...	...
99 - 06	Santara Series MotorHomes with Ford E350 & E450 Chassis	ASH-1136		...	...	- O	83178	...
		ASH-1154	- O	83177	...		...	...

### COLLINS BUS CORP

- 2020	Type A School Bus models with Ford E350 & E450 Chassis	ASH-1136		...	...	- O	83178	...
19 - 20	Type A School Bus models with Ford E350 & E450 Chassis	ASH-1154	- O	83177	...		...	...

### CONTINENTAL TRAILWAYS-EAGLE INT'L

	Buses with O.E.M. Number	01-0100-020		85307	...	O O	85307	...
		5532026		85304	...	O O	85304	...
		6-05-5		85307	...	O O	85307	...
	Silver Eagle	01-0100-905		85303	...	O O	85303	89422
		5394467		85305	...	O O	85305	...
		680091		85303	...	O O	85303	89422
		70039		85303	...	O O	85303	89422
		70041		85305	...	O O	85305	...

### COUNTRY COACH

	Models with O.E.M. Number	89406	O O	...	89406		...	...
		89414		...	...	O O	...	89414









### CRANE CARRIER

	Models with Hendrickson HMX 400 Haulmax (with 16.5" Saddle)	60680-004		...	...	O -	83143	...
		60680-004L		...	...	O -	83143	...
		64178-001		...	...	O -	83143	...
	Models with Ridewell RDS-209 Tandem Air Drive Suspension	1310002		...	...	O O	665937	...
	Models with Ridewell Truck Air-Ride Suspension with O.E.M. Number	1265157B000		...	...	O O	85712	...
	Models with O.E.M. Number	227A-14	O O	85716	...		...	...
		277A-1	O O	85307	...		...	...
		277A-13	O O	85302	89420		...	...
		277A-14	O O	85304	...		...	...
		277A-8	O O	85303	89422		...	...
		277A-9	O O	85307	...		...	...
	Additional O.E.M. Interchanges	680091	O O	85303	89422		...	...
		277A-12	O O	85304				...
		680088		...	...	O O	85713	...

### CROWN COACH

	All with Steel Spring Suspension	3188729	O O	85303	89422		...	...
		5532026		85304	...	O O	85304	...
	Models with O.E.M. Number	5532036		85734	...	O O	85734	...

## APPLICATION GUIDE - TRUCKS, TRAILERS, AND BUSES

Year Año Année	Model Modelo Modèle	OEM #	Front		Rear	
						
						
			Fleetline	GasSLX	Fleetline	GasSLX

### CUNHA PRODUCTS OHD

Truck Dollies	CP-5222			...	...	010	85315	...
---------------	---------	--	--	-----	-----	-----	-------	-----

### CUSH CORPORATION

Models with O.E.M. Number	C0227			...	...	010	85014	...
	C0228			...	...	010	85005	89430

#### Trailer Suspensions - Low Mount

25k UnderMount Econo 6/9	C0078			...	...	010	85000	89436
CompacTrac 4.5/7 RH	C0078			...	...	010	85000	89436
CP Competitor Series (U-Bolted) 25K & 30K	C0226			...	...	010	85064	...
DiscMATE LowMount 25K Disc Brake	C0062-D			...	...	010	85000	89436
Performance Yoke-8in 25K Undermount	C0062-D			...	...	010	85000	89436
RideBest 25KHD 6	C0062-D			...	...	010	85000	89436
RideBest 25KHD 8	C0062-D			...	...	010	85000	89436
RideBest Yoke 25KHD 9	C0062-D			...	...	010	85000	89436
RoughNeck Series, Cush Integrated, LowMount 30k	C0226			...	...	010	85064	...
RoughNeck, Cush Integrated, LowMount 25K	C0062-D			...	...	010	85000	89436

#### Trailer Suspensions - Top Mount









CLT-25 CushLITE BigFOOT (245 Style)	C0078			...	...	010	85000	89436
CLX25-317 CushLITE BigFOOT (317 style)	C0078			...	...	010	85000	89436
CP Performance Top Mount	C0226			...	...	010	85064	...
CT250TB Top Mount High Travel (U-Bolted)	C0226			...	...	010	85064	...
DiscMATE 25K Roughneck Topmount	C0226			...	...	010	85064	...
RideBest 25K TopMount	C0226			...	...	010	85064	...
RideBest 25KHD TopMount 14-19	C0226			...	...	010	85064	...
RoughNeck Series, Cush Integrated, TopMount 25K	C04045			...	...	010	85045	...
RoughNeck Series, Cush Integrated, TopMount 30K	C0226			...	...	010	85064	...

### DAMON MOTOR COACH

#### Class A MotorHomes

01 - 15	Challenger Series MotorHomes with Ford F53 Chassis with 16,000 lb GVW to 22,000 lb GVW	ASH-1229	010	83209	89414	...	...
		ASH-25822	010	83209	89414	...	...
		ASH-25823	010	83209	89414	...	...
		ASH-25824	010	...	...	83122	89406
99 - 13	Daybreak Series MotorHomes with Ford F53 Chassis with 16,000 lb GVW to 22,000 lb GVW	ASH-1229	010	83209	89414	...	...
		ASH-25822	010	83209	89414	...	...
		ASH-25823	010	83209	89414	...	...
		ASH-25824	010	...	...	83122	89406
99 - 06	Intruder Series MotorHomes with Ford F53 Chassis with 16,000 lb GVW to 22,000 lb GVW	ASH-1229	010	83209	89414	...	...
		ASH-25822	010	83209	89414	...	...
		ASH-25823	010	83209	89414	...	...
		ASH-25824	010	...	...	83122	89406
05 - 14	Models with Workhorse W20 , W22, & W24 MotorHome Chassis with O.E.M. Number	24-153256		...	...	- -	85124
		F4-BE5-F325-HO		...	...	- -	85124
		W0005663		...	...	- -	85124
98 - 04	Models with Workhorse W20 , W22, & W24 MotorHome Chassis with O.E.M. Number	24-186537		...	...	01-	85126
		F4-BE5-A011-HO		...	...	01-	85126
98 - 14	Models with Workhorse W20 , W22, & W24 MotorHome Chassis with O.E.M. Number	24-153249	010	85125	...	...	...
		24-186629	010	85125	...	...	...
		F4-BE5-A832-MO	010	85125	...	...	...
		F4-BE5-B492-HO	010	85125	...	...	...
		F4-BE5-F324-HO	010	85125	...	...	...

**APPLICATION GUIDE - TRUCKS, TRAILERS, AND BUSES**

Year Año Année	Model Modelo Modèle	OEM #	Front		Rear	
						
						
			Fleetline	GasSLX	Fleetline	GasSLX

**DAMON MOTOR COACH(Cont'd.)**

**Class A MotorHomes(Cont'd.)**

98 - 14	Models with Workhorse W20 , W22, & W24 MotorHome Chassis with O.E.M. Number	W0005662	010	85125	...		...	...
		W0006254	010	85125	...		...	...
07 - 14	Outlaw Series MotorHomes with Ford F53 Chassis with 16,000 lb GVW to 22,000 lb GVW	ASH-1229	010	83209	89414		...	...
		ASH-25822	010	83209	89414		...	...
		ASH-25823	010	83209	89414		...	...
		ASH-25824		...	...	010	83122	89406

**DANA**

	Dana Smart Ride - RF and RS Models - 20,000 lb and 23,000 lb	SR1VJ100		...	...	010	85078	...
--	--	----------	--	-----	-----	-----	-------	-----

**DEXTER AXLE**

**Trailer**

	86 AR / RS 1015, 1035, 3015, 3035 Slider Air Suspension	18165-01		...	...	010	85006	...
--	---	----------	--	-----	-----	-----	-------	-----

**DIAMOND COACH**

- 2020	All Shuttle buses with Ford E350 and E450 Chassis	ASH-1136		...	...	-10	83178	...
19 - 20	All Shuttle buses with Ford E350 and E450 Chassis	ASH-1154	-10	83177	...		...	...

**DIAMOND T**

	Models with O.E.M. Number	5549925	010	85304	...		...	...
--	---------------------------	---------	-----	-------	-----	--	-----	-----

**DIAMOND-REO**

	All w/Velvet Ride Suspension	.....		...	...	010	85307	...
	C054, C088 w/FH or FL Axle	.....	010	85307	...		...	...
	C054, C088, C114, C116 w/FF Axle	220-55-1	010	83214	...		...	...
		220-55-6	010	83214	...		...	...
	C090, C090D, C101	220-55-2	010	85304	...		...	...
		220-55-7	010	85304	...		...	...
	C114, C116 w/FH or FL Axle	220-55-2	010	85304	...		...	...
		220-55-7	010	85304	...		...	...
	CF Models	220-55-8	010	83217	...		...	...
	DC101	220-55-2	010	85304	...		...	...
		220-55-7	010	85304	...		...	...
	Additional O.E.M. Interchanges	220-S5-10		...	...	010	85712	...

**DODGE TRUCK**

**D Series- Conventional Cab 4 x 2**

74 - 78	D-500, D-600, D-700, D-800	3633643		...	...	010	G63183	...
1973	D-500, D-600, D-800	2516009		...	...	010	G63183	...

**LN & LNT - Conventional Cab**

64 - 72	LN, LV Models	2516009		...	...	010	G63183	...
---------	---------------	---------	--	-----	-----	-----	--------	-----

**LNT, LVT, NLT, VLT- Tilt Cab 6 x 4**

64 - 73	LNT, LVT Models	2516009		...	...	010	G63183	...
---------	-----------------	---------	--	-----	-----	-----	--------	-----

**LS & LT-Steel Tilt Cab**

73 - 75	LS-1000, LT-1000	2516009		...	...	010	G63183	...
---------	------------------	---------	--	-----	-----	-----	--------	-----

**Motorhome Chassis**

73 - 81	M & R-300, 400, 500 Motorhome Chassis	3638112		...	...	010	G63183	...
		3638631	010	G63605	...		...	...
63 - 72	M-300, M-375 & R-375 Motorhome Chassis	2961043		...	...	010	G63183	...
		3633744		...	...	010	G63183	...
77 - 81	M-6 Motorhome Chassis	3638112		...	...	010	G63183	...
		4036892	010	G63605	...		...	...

## APPLICATION GUIDE - TRUCKS, TRAILERS, AND BUSES

Year Año Année	Model Modelo Modèle	OEM #	Front			Rear		
			Fleetline	GasSLX				

### DODGE TRUCK(Cont'd.)

#### P Series - Forward Control(Cont'd.)

72 - 82	P-300	.....		...	...	OIO	G63183	...
63 - 78	P-400	.....		...	...	OIO	G63183	...
63 - 71	PC-500 and PC-600, PD-500 and PD-600	.....		...	...	OIO	G63183	...

#### School Buses

61 - 71	S-400, S-500, S-600	.....		...	...	OIO	G63183	...
72 - 73	S-500, S-600	2516009		...	...	OIO	G63183	...
74 - 78	S-600, S-700	3633643		...	...	OIO	G63183	...

#### W-Series And Power Wagons

61 - 72	W-500, WT-500 Models	.....		...	...	OIO	G63183	...
1973	W-600 Models	2516009		...	...	OIO	G63183	...
				2960707	OIO	G63183	...	...
74 - 78	W-600 Models	3633643		...	...	OIO	G63183	...

### DUPLEX TRUCK

	Models with O.E.M. Number	59024		83204	...	OIO	83204	...
		7604-3371		83204	...	OIO	83204	...

### DURA SUSPENSION

	Models with O.E.M. Number	1080099		...	...	OIO	83203	89436
		12866		...	...	OIO	83207	89407
		59024		...	...	OIO	83204	...
		59030		...	...	OIO	83203	89436
		665133		...	...	OIO	83203	89436
		665267		...	...	OIO	85029	...
		7604-3371		...	...	OIO	83204	...
		A-2212		...	...	OIO	85029	...

### DUTCHMEN RV

#### Class C MotorHomes









92 - 09	All Type C Motorhomes with Ford E350 & E450 Chassis	8C24-18045-DA	-IO	83177	...		...	...
		8C2Z-18124-D	-IO	83177	...		...	...
		ASH-1154	-IO	83177	...		...	...
		AT-163G	-IO	83177	...		...	...
		8C24-18080-DB		...	...	-IO	83178	...
		8C2Z-18125-D		...	...	-IO	83178	...
		ASH-1136		...	...	-IO	83178	...
		AT-164G		...	...	-IO	83178	...

### DYNAMAX CORP (COUNTRY COACH)

#### Class C MotorHomes

- 2019	All Models with Freightliner FAS II Rear Air Suspension	16-18708-000		...	...	OIO	85724	89443
		471700002809		...	...	OIO	85724	89443
14 - 19	DX3 Series Motorhomes with M2-106 Chassis	10-13760-000	OIO	85959	89503		...	...
		471700002991	OIO	85959	89503		...	...
		SDA471700002991	OIO	85959	89503		...	...
06 - 08	Dyna Quest XL Series Motorhomes with M2-112 Chassis	10-13634-000	OIO	85918	89449		...	...
		471700000449	OIO	85918	89449		...	...
09 - 19	Dyna Quest XL Series Motorhomes with M2-112 Chassis	10-13809-000	OIO	85958	...		...	...
		471700003920	OIO	85958	...		...	...
15 - 19	Force Series Motorhomes with M2-106 Chassis	10-13760-000	OIO	85959	89503		...	...
		471700002991	OIO	85959	89503		...	...
		SDA471700002991	OIO	85959	89503		...	...
99 - 20	Isata 4 Series Motorhomes with Ford E350 & E450 Chassis	8C24-18045-DA	-IO	83177	...		...	...
		8C2Z-18124-D	-IO	83177	...		...	...

## APPLICATION GUIDE - TRUCKS, TRAILERS, AND BUSES

Year Año Année	Model Modelo Modèle	OEM #	Front		Rear	
						
						
			Fleetline	GasSLX	Fleetline	GasSLX

### DYNAMAX CORP (COUNTRY COACH)(Cont'd.)

#### Class C MotorHomes(Cont'd.)

99 - 20	Isata 4 Series Motorhomes with Ford E350 & E450 Chassis	ASH-1154 AT-163G	-10	83177	...	...	...	
			-10	83177	...	...	...	
92 - 20	Isata 4 Series Motorhomes with Ford E350 & E450 Chassis	8C24-18080-DB 8C2Z-18125-D ASH-1136 AT-164G		...	...	-10	83178	...
				...	...	-10	83178	...
				...	...	-10	83178	...
				...	...	-10	83178	...

### EAGLE MOTOR COACH

	Buses with Rubber Torsion Suspension	6-05-5		...	...	010	85307	...
	Buses with Steel Spring Suspension	5532026		85304	...	010	85304	...
	Models with O.E.M. Number	01-0100-020		85307	...	010	85307	...
		01-0100-905		85303	...	010	85303	89422
		014-0100-905	010	85308	89422		...	...
		101364		85305	...	010	85305	...
		154-0100-514	010	85314	89425		...	...
		5394467		85305	...	010	85305	...
		680091		85303	...	010	85303	89422
		70039		85303	...	010	85303	89422
	Additional O.E.M. Interchanges	0140100-905	010	85308	89422		...	...
		12B-5-1		85735	...	010	85735	...
		12J-5-10		...	...	01-	85733	...
		690060		...	...	010	85713	...





### EAST MANUFACTURING CORP.

Identification of the trailer suspension is necessary to determine what section of the catalog to refer to. Some possible options can be Chalmers, Hendrickson, Neway, Ridewell, Reyco.								
	Shocks with stamping number	A-20002 A-20126		...	...	010	85000	89436
	Trailers with East Trailer part number	517-05001-18		...	...	010	87015	...
		517-05001-23		...	...	010	85005	89430
		517-05006-20		...	...	010	85030	89440
		517-05009-14		...	...	010	83125	...
		517-05010-07		...	...	010	83214	...
		517-05022-07		...	...	010	83217	...
		517-05110-20		...	...	010	85000	89436
		517-05511-14		...	...	010	83128	89436
		517-05805-20		...	...	010	85000	89436
		517-05806-20		...	...	010	85029	...
		517-05808-20		...	...	010	85738	...
		517-05809-20		...	...	010	...	89437
		517-05916-14		...	...	010	83124	89407

### ELDORADO NATIONAL

02 - 13	40 Foot Low Floor Buses with O.E.M	13208701 13208801		...	...	-1-	85746	...
			-1-	85745	...	...	...	
- 2020	Advantage Series Shuttle buses with Ford E350 & E450 Chassis	ASH-1136		...	...	-10	83178	...
		ASH-1154	-10	83177	...	...	...	
- 2020	Aerolite Series Shuttle buses with Ford E350 Chassis	ASH-1136		...	...	-10	83178	...
		ASH-1154	-10	83177	...	...	...	
- 2020	Aerotech Series Shuttle buses with Ford E350 & E450 Chassis	ASH-1136		...	...	-10	83178	...
		ASH-1154	-10	83177	...	...	...	

## APPLICATION GUIDE - TRUCKS, TRAILERS, AND BUSES

Year Año Année	Model Modelo Modèle	OEM #	Front		Rear	
						
			Fleetline	GasSLX	Fleetline	GasSLX

### ELKHART COACH

- 2020	Coaches with Ford E350 and E450 Chassis	ASH-1136		...	...	- O	<b>83178</b>	...
			- O	<b>83177</b>	...	...	...	...

### ENTEGRA COACH

#### Class A MotorHomes

19 - 20	Emblem Series MotorHomes with Ford F53 Chassis with 16,000 lb GVW to 22,000 lb GVW	ASH-1229	O O	<b>83209</b>	<b>89414</b>		...	...
			O O	<b>83209</b>	<b>89414</b>	...	...	
			O O	<b>83209</b>	<b>89414</b>	...	...	
			O O	...	...	O O	<b>83122</b>	<b>89406</b>
19 - 20	Vision Series MotorHomes with Ford F53 Chassis with 16,000 lb GVW to 22,000 lb GVW	ASH-1229	O O	<b>83209</b>	<b>89414</b>	...	...	
			O O	<b>83209</b>	<b>89414</b>	...	...	
			O O	<b>83209</b>	<b>89414</b>	...	...	
			O O	...	...	O O	<b>83122</b>	<b>89406</b>

#### Class C MotorHomes

17 - 20	Esteem Series MotorHomes with Ford E350 & E450 Chassis	ASH-1136		...	...	- O	<b>83178</b>	...
			- O	<b>83177</b>	...	...	...	...
17 - 20	Odyssey Series MotorHomes with Ford E350 & E450 Chassis	ASH-1136	- O	...	...	- O	<b>83178</b>	...
			- O	<b>83177</b>	...	...	...	...

### FEDERAL COACH









- 2019	Shuttle buses with Freightliner M2-106 Chassis	16-18708-000 471700002809		...	...	O O	<b>85724</b>	<b>89443</b>
			O O	...	...	O O	<b>85724</b>	<b>89443</b>
02 - 08	Shuttle buses with Freightliner M2-106 Chassis	10-12388-000 10-12390-000	O O	<b>85920</b>	<b>89503</b>	...	...	
			O O	<b>85920</b>	<b>89503</b>	...	...	
09 - 19	Shuttle buses with Freightliner M2-106 Chassis	10-13760-000 471700002991 SDA471700002991	O O	<b>85959</b>	<b>89503</b>	...	...	
			O O	<b>85959</b>	<b>89503</b>	...	...	
			O O	<b>85959</b>	<b>89503</b>	...	...	
- 2020	Spirit Series Shuttle buses with Ford E450 Chassis	ASH-1136 ASH-1154	- O	...	...	- O	<b>83178</b>	...
			- O	<b>83177</b>	...	...	...	...

### FLEETWOOD RV

#### Class A MotorHomes

18 - 20	Axon Series MotorHomes with Ford F53 Chassis with 16,000 lb GVW to 22,000 lb GVW	ASH-25824		...	...	O O	<b>83122</b>	<b>89406</b>
2018	Axon Series MotorHomes with Ford F53 Chassis with 16,000 lb GVW to 22,000 lb GVW	ASH-1229	O O	<b>83209</b>	<b>89414</b>	...	...	
			O O	<b>83209</b>	<b>89414</b>	...	...	
			O O	<b>83209</b>	<b>89414</b>	...	...	
02 - 06	Bounder / Discovery & Expedition MotorHomes with Freightliner XC Chassis  ADL200 Suspension w/ 20K Rear AS120 Front Suspension  Rear Shock with O.E.M. Number  ZF - IFS Front Suspension with 23,000 lb GVW or Greater	16-16873-000 141700131810 16-16737-000 16-16874-000 141700131809 16-16736-000 16-18103-000 481700000493	O O	...	...	O O	<b>85029</b>	...
			O O	<b>83160</b>	...	...	...	...
			O O	<b>83160</b>	...	...	...	...
			O O	<b>83160</b>	...	...	...	...
			O O	...	...	O O	<b>85029</b>	...
			O O	...	...	O O	<b>85029</b>	...
			- -	<b>85900</b>	...	...	...	...
			- -	<b>85900</b>	...	...	...	...
01 - 20	Bounder Series MotorHomes with Ford F53 Chassis with 16,000 lb GVW to 22,000 lb GVW	1C34-18045-AA  1C34-18045-JA 9U94-18045-AA 9U94-18080-AA 9U9Z-18124-A 9U9Z-18125-A	O O	<b>83209</b>	<b>89414</b>	...	...	
			O O	<b>83209</b>	<b>89414</b>	...	...	
			O O	<b>83209</b>	<b>89414</b>	...	...	
			O O	...	...	O O	<b>83122</b>	<b>89406</b>
			O O	<b>83209</b>	<b>89414</b>	...	...	
			O O	...	...	O O	<b>83122</b>	<b>89406</b>

**APPLICATION GUIDE - TRUCKS, TRAILERS, AND BUSES**

Year Año Année	Model Modelo Modèle	OEM #	Front		Rear	
						
						
			Fleetline	GasSLX	Fleetline	GasSLX





**FLEETWOOD RV(Cont'd.)**

**Class A MotorHomes(Cont'd.)**

01 - 20	Boulder Series MotorHomes with Ford F53 Chassis with 16,000 lb GVW to 22,000 lb GVW	ASH-1022	010	83209	89414		...	...
		ASH-1023		...	...	010	83122	89406
		ASH-1205	010	83209	89414		...	...
		ASH-1206		...	...	010	83122	89406
		ASH-1228	010	83209	89414		...	...
		ASH-1229	010	83209	89414		...	...
		ASH-1230		...	...	010	83122	89406
		ASH-137		...	...	010	83122	89406
		ASH-25822	010	83209	89414		...	...
		ASH-25823	010	83209	89414		...	...
		ASH-25824		...	...	010	83122	89406
		ASH-294	010	83209	89414		...	...
		AT-620	010	83209	89414		...	...
		AT-621		...	...	010	83122	89406
		AT-766	010	83209	89414		...	...
03 - 06	Excursion & Providence MotorHomes with Freightliner XC Chassis  ADL200 Suspension w/ 20K Rear AS120 Front Suspension  Rear Shock with O.E.M. Number  ZF - IFS Front Suspension with 23,000 lb GVW or Greater	16-16873-000		...	...	010	85029	...
		141700131810	010	83160	...		...	...
		16-16737-000	010	83160	...		...	...
		16-16874-000	010	83160	...		...	...
		141700131809		...	...	010	85029	...
		16-16736-000		...	...	010	85029	...
		16-18103-000	-1-	85900	...		...	...
481700000493	-1-	85900	...		...	...		
06 - 20	Flair Series MotorHomes with Ford F53 Chassis with 16,000 lb GVW to 22,000 lb GVW	ASH-1229	010	83209	89414		...	...
		ASH-25822	010	83209	89414		...	...
		ASH-25823	010	83209	89414		...	...
		ASH-25824		...	...	010	83122	89406
05 - 14	Models with Workhorse W20 , W22, & W24 MotorHome Chassis with O.E.M. Number	24-153256		...	...	-1-	85124	...
		F4-BE5-F325-HO		...	...	-1-	85124	...
		W0005663		...	...	-1-	85124	...
98 - 04	Models with Workhorse W20 , W22, & W24 MotorHome Chassis with O.E.M. Number	24-186537		...	...	01-	85126	...
		F4-BE5-A011-HO		...	...	01-	85126	...
98 - 14	Models with Workhorse W20 , W22, & W24 MotorHome Chassis with O.E.M. Number	24-153249	010	85125	...		...	...
		24-186629	010	85125	...		...	...
		F4-BE5-A832-MO	010	85125	...		...	...
		F4-BE5-B492-HO	010	85125	...		...	...
		F4-BE5-F324-HO	010	85125	...		...	...
		W0005662	010	85125	...		...	...
		W0006254	010	85125	...		...	...
99 - 20	SouthWind Series MotorHomes with Ford F53 Chassis with 16,000 lb GVW to 22,000 lb GVW	1C34-18045-AA	010	83209	89414		...	...
		1C34-18045-JA	010	83209	89414		...	...
		9U94-18045-AA	010	83209	89414		...	...
		9U94-18080-AA		...	...	010	83122	89406
		9U9Z-18124-A	010	83209	89414		...	...
		9U9Z-18125-A		...	...	010	83122	89406
		ASH-1022	010	83209	89414		...	...
		ASH-1023		...	...	010	83122	89406
		ASH-1205	010	83209	89414		...	...
		ASH-1206		...	...	010	83122	89406



## APPLICATION GUIDE - TRUCKS, TRAILERS, AND BUSES

Year Año Année	Model Modelo Modèle	OEM #	Front		Rear	
						
			Wrench	Wrench	Wrench	Wrench
			Fleetline	GasSLX	Fleetline	GasSLX

### FLEETWOOD RV(Cont'd.)

#### Class A MotorHomes(Cont'd.)

99 - 20	SouthWind Series MotorHomes with Ford F53 Chassis with 16,000 lb GVW to 22,000 lb GVW	ASH-1228	OIO	83209	89414	...	...	
		ASH-1229	OIO	83209	89414	...	...	
		ASH-1230		...	...	OIO	83122	89406
		ASH-137		...	...	OIO	83122	89406
		ASH-25822	OIO	83209	89414	...	...	
		ASH-25823	OIO	83209	89414	...	...	
		ASH-25824		...	...	OIO	83122	89406
		ASH-294	OIO	83209	89414	...	...	
		AT-620	OIO	83209	89414	...	...	
		AT-621		...	...	OIO	83122	89406
	AT-766	OIO	83209	89414	...	...		
05 - 20	Storm Series MotorHomes with Ford F53 Chassis with 16,000 lb GVW to 22,000 lb GVW	ASH-1229	OIO	83209	89414	...	...	
		ASH-25822	OIO	83209	89414	...	...	
		ASH-25823	OIO	83209	89414	...	...	
		ASH-25824		...	...	OIO	83122	89406

#### Class C MotorHomes

99 - 20	Jamboree Series MotorHomes with Ford E350 & E450 Chassis	ASH-1136	-IO	...	...	83178	...
		ASH-1154	-IO	83177	...	...	...
18 - 20	Surge Series MotorHomes with Ford E350 & E450 Chassis	ASH-1136		...	...	-IO	83178
		ASH-1154	-IO	83177	...	...	...
99 - 16	Tioga Series MotorHomes with Ford E350 & E450 Chassis	ASH-1136		...	...	-IO	83178
		ASH-1154	-IO	83177	...	...	...





### FLUIDRIVE

Models T950-1200, -1400, -1700	2697	...	...	OIO	85712	...
--------------------------------	------	-----	-----	-----	-------	-----

### FLXIBLE BUS

29 Passenger & Vista Coach	.....	OIO	83217	...	OIO	83217	...
2-Level Intercity Bus	.....		85736	...	OIO	85736	...
City Bus - 51 Passenger	6-05-1	OIO	85736	...		...	...
	6-05-2	OIO	85736	...		...	...
	6-05-3	OIO	85736	...		...	...
	6-05-4	OIO	85736	...		...	...
	6-05-5	OIO	85307	...		...	...
	6-05-6	OIO	85736	...		...	...
	6-05-7	OIO	85736	...		...	...
	6-05-8	OIO	85736	...		...	...
City Bus - 51 Passenger with Rubber Torsion Suspension	6-05-1		85736	...	OIO	85736	...
	6-05-2		...	...	OIO	85736	...
	6-05-3		...	...	OIO	85736	...
	6-05-4		...	...	OIO	85736	...
	6-05-5		...	...	OIO	85307	...
	6-05-6		...	...	OIO	85736	...
	6-05-7		...	...	OIO	85736	...
	6-05-8		...	...	OIO	85736	...
CNG Bus (Natural Gas)	87-2520-00002		...	...	OIO	...	...
	87-2520-00004		...	...	OIO	...	...
	97-2210-00010		...	...	OIO	...	...
Model 870 Flex Bus, Metro	22024506	-IO	85703	...		...	...
	22025066	-IO	85703	...		...	...
	4975518		...	...	OIO	85704	...
	680320	-IO	85703	...		...	...
	74412		...	...	OIO	85704	...





**APPLICATION GUIDE - TRUCKS, TRAILERS, AND BUSES**

Year Año Année	Model Modelo Modèle	OEM #	Front		Rear	
						
			Fleetline	GasSLX	Fleetline	GasSLX

**FLXIBLE BUS(Cont'd.)**

Model 870 Flex Bus, Metro	87-2519-00001	-10	85703	...		...	...	
	87-2519-00003	-10	85703	...		...	...	
	87-2520-00001		...	...	010	85704	...	
	87-2520-00003		...	...	010	85704	...	
	97-2201-00003	-10	85703	...		...	...	
	97-2201-00005	-10	85703	...		...	...	
	97-2201-00006	-10	85703	...		...	...	
	97-2201-00007	-10	85703	...		...	...	
	97-2201-00009	-10	85703	...		...	...	
	97-2210-00001		...	...	010	85704	...	
	97-2210-00002		...	...	010	85704	...	
	97-2210-00003		...	...	010	85704	...	
	97-2210-00004		...	...	010	85704	...	
	97-2210-00005		...	...	010	85704	...	
	97-2210-00006		...	...	010	85704	...	
	97-2210-00009		...	...	010	85704	...	
	97-2210-00011		...	...	010	85704	...	
	Models with O.E.M. Number	22012067		85700	...	010	85700	...
		22012114		85700	...	010	85700	...
		22024061		...	...	010	85704	...
22025067			...	...	010	85704	...	
22025305			...	...	010	85704	...	
3166657			85700	...	010	85700	...	
3192333			85700	...	010	85700	...	
6-05-13			...	...	010	85304	...	
6-05-9		010	85304	...		...	...	
6-367-12			85700	...	010	85700	...	
6-367-14			85700	...	010	85700	...	
6-367-16			85700	...	010	85700	...	
6-367-8			85700	...	010	85700	...	
695125			...	...	010	85704	...	
97-2201-00001		-10	85703	...		...	...	
97-2201-00002		-10	85703	...		...	...	
97-2201-00004		-10	85703	...		...	...	
97-2201-00151			85700	...	010	85700	...	
97-2210-00170			85733	...	01-	85733	...	
Additional O.E.M. Interchanges		015813		...	...	-1-	85708	...
	06-0367-00151	010				85700		
	06-0367-00156	010				85702		
	48-1-239	010				85736		
	48-1-241	010				85712		
	6-05-10	010				85734		
	6-367-1	-10				85711		
	6-367-11	-10				85711		
	6-367-17	010				85700		
	6-367-2	010				85736		
	6-367-3	010				85304		
	6-367-4	010				83217		
	6-367-6	-10				85711		
	6-367-7	010				85305		
	6-367-9	-10				85711		
	680029	010				85301		
	680155	010				85712		
	97-2210-00156	010				85702		
	97-2210-00157	-1-				85708		

**APPLICATION GUIDE - TRUCKS, TRAILERS, AND BUSES**

Year Año Année	Model Modelo Modèle	OEM #	Front		Rear	
						
			Fleetline	GasSLX	Fleetline	GasSLX

**FLXIBLE BUS(Cont'd.)**

Additional O.E.M. Interchanges	97-2210-00160	- -	<b>85705 or 89447</b>				
	97-2210-00164	- -	<b>85708</b>				
	97-9999-00807	0 0	<b>85307</b>				
	97-9999-02514	0 0	<b>85700</b>				
	97-9999-02515	0 0	<b>85702</b>				
	97-9999-02632	- 0	<b>85711</b>				
	97-9999-02633		...	...	- 0	<b>85311</b>	<b>89424</b>
	97-9999-02634	0 -	<b>85733</b>				
	97-9999-02635	0 0	<b>85732</b>				
	97-9999-02636	0 0	<b>85716</b>				

**FLYER INDUSTRIES**





	Coaches with Low Floor	15813		...	...	- -	<b>85708</b>	...
<b>1991 -</b>	Coaches with Low Floor	009863	- -	<b>85722</b>	...		...	...
Additional O.E.M. Interchanges	015915	- 0	<b>85711</b>					
	22012067		<b>85700</b>	...	0 0	<b>85700</b>	...	
	22012114		<b>85700</b>	...	0 0	<b>85700</b>	...	
	3166657	0 0	<b>85700</b>					
	3192333	0 0	<b>85700</b>					
	4975501	0 0	<b>85700</b>					
	4975552		<b>85711</b>	...	- 0	<b>85711</b>	...	
	592-6568	0 0	<b>85700</b>					
	5979574	0 0	<b>85700</b>					

**FORD**

**AeroMax (A, AT, AAT, 8500, 9500) Series**

<b>1996</b>	8000 Models with 12000 or 13000 lb Axles	F6HT-18045-LA	0 0	<b>85376</b>	...		...	...
<b>1996</b>	8000 Models with 16000 lb. Multileaf Spring	F6HT-18045-AA	0 0	<b>85054</b>	...		...	...
<b>96 - 97</b>	9500 (113" & 122" BBC) Models with 10000 lb Axle and 54" Multileaf Spring	F6HT-18045-KA	0 0	...	<b>89402</b>		...	...
<b>1996 -</b>	9500 (113" & 122" BBC) Models with 12000 or 13200 lb Axle and 54" Multileaf Spring	F6HT-18045-BC	0 0	<b>85047</b>	<b>89435</b>		...	...
<b>96 - 97</b>	9500 (113" & 122" BBC) Models with 8500 or 9000 lb Axle and 54" Taperleaf Spring	F6HT-18045-HC	0 0	<b>85054</b>	...		...	...
<b>1996 -</b>	All Models with 10000 lb or 12000 lb Axle and 54" Taperleaf Spring	F6HT-18045-AC	0 0	<b>85054</b>	...		...	...
		F6HZ-18124-A	0 0	<b>85054</b>	...		...	...
		F6HZ-18124-G	0 0	<b>85054</b>	...		...	...
<b>1996 -</b>	All with 12000 lb, 13000 lb or 14600 lb Axle and 60" Taperleaf Spring	F6HT-18045-EB	0 0	<b>85055</b>	<b>89439</b>		...	...
		F6HT-18045-EC	0 0	<b>85055</b>	<b>89439</b>		...	...
		F6HZ-18124-D	0 0	<b>85055</b>	<b>89439</b>		...	...
		F6HZ-18124-E	0 0	<b>85055</b>	<b>89439</b>		...	...
		F6HZ-18124-F	0 0	<b>85055</b>	<b>89439</b>		...	...
<b>1996 -</b>	All with 13200 lb or 14600 lb Axle and 54" Taperleaf Spring	F6HT-18045-GB	0 0	<b>85030</b>	<b>89440</b>		...	...
		F6HT-18045-GC	0 0	<b>85030</b>	<b>89440</b>		...	...
<b>1996 -</b>	All with 21000 lb or 23000 lb Axle and 46" Taperleaf spring	F5HZ-18125-B		...	...	0 0	<b>85001</b>	<b>89410</b>
<b>1996 -</b>	All with 23000 lb Axle and 52" Taperleaf spring	F5HZ-18125-A		...	...	0 0	<b>85314</b>	<b>89425</b>
<b>96 - 97</b>	All with Hendrickson 40LH Model Tandem Axle	57241-2		...	...	0 -	<b>83109</b>	...
		F6HT-18080-B		...	...	0 -	<b>83109</b>	...
		F6HT-18080-DA		...	...	0 -	<b>83109</b>	...
		F6HZ-18125-B		...	...	0 -	<b>83109</b>	...
				...	...	0 0	<b>85013</b>	<b>89414</b>
<b>96 - 97</b>	All with Hendrickson HAS-400, HA-210 or HA-230 Air Suspension	47902-28		...	...	0 0	<b>85013</b>	<b>89414</b>
		F6HZ-18080-FC		...	...	0 0	<b>85013</b>	<b>89414</b>
		F6HZ-18125-D		...	...	0 0	<b>85013</b>	<b>89414</b>
<b>96 - 97</b>	All with Neway AD-246 Air Suspension	90045099		...	...	0 0	<b>85906</b>	<b>89407</b>

## APPLICATION GUIDE - TRUCKS, TRAILERS, AND BUSES

Year Año Année	Model Modelo Modèle	OEM #	Front		Rear	
						
			Fleetline	GasSLX	Fleetline	GasSLX

### FORD(Cont'd.)

#### AeroMax (A, AT, AAT, 8500, 9500) Series(Cont'd.)

96 - 97	All with Neway AD-246 Air Suspension	90045132				010	<b>85909</b>		
<b>B - Series - Bus Cowl Chassis</b>									
61 - 79	B - 500, B - 600, B - 700, B - 750 Models	D2TF-18080-HA		...	...	010	<b>83225</b>	...	
		D7HT-18080-BA		...	...	010	<b>83225</b>	...	
70 - 79	B - 500, B - 600, B - 700, B - 750 Models	D2TF-18045-GA	010	<b>83308</b>	...		...	...	
		D7HT-18045-GA	010	<b>83308</b>	...		...	...	
61 - 69	B - 500, B - 600, B - 700, B - 750 with 4000, 4700 and 5000 lb Axle	.....	-1-	<b>83400</b>	...		...	...	
61 - 69	B - 500, B - 600, B - 700, B - 750 with 6000 & 7000 lb Axle	C2TA-18045-A	010	<b>83216</b>	...		...	...	
77 - 96	B - 600, B - 700, B - 750, B - 800, B - 7000 with 18500 lb Axle	ASH-24446		...	...	010	<b>83215</b>	...	
		AX-310		...	...	010	<b>83215</b>	...	
		D7HT-18080-AA		...	...	010	<b>83215</b>	...	
		D7HT-18080-DA		...	...	010	<b>83215</b>	...	
		D7HT-18080-DA		...	...	010	<b>83215</b>	...	
		E0HT-18080-AA		...	...	010	<b>83215</b>	...	
80 - 96	B - 600, B - 700, B - 800, B - 7000 Models	E0HT-18045-AA	010	<b>83309</b>	...		...	...	
		E0HT-18045-AB	010	<b>83309</b>	...		...	...	
		F1HT-18045-AA	010	<b>83309</b>	...		...	...	
94 - 97	B - 700, B - 800 with 14600 lb Multileaf Spring	F4HT-18045-EA	010	<b>83125</b>	...		...	...	
94 - 97	B - 700, B - 800 with 15000, 17500, 19000 lb Taperleaf Springs	F4HT-18080-AA		...	...	010	<b>85314</b>	<b>89425</b>	
		F4HT-18080-AB		...	...	010	<b>85314</b>	<b>89425</b>	
94 - 97	B - 700, B - 800 with 21000 lb Taperleaf Springs	F4HT-18080-BA		...	...	010	<b>85001</b>	<b>89410</b>	
94 - 97	B - 700, B - 800 with 52" Multileaf Spring	F4HT-18045-CB	010	<b>83107</b>	...		...	...	

#### C & CT Series - Tilt Cab

71 - 73	C-500, C-550, C-600, C-650, C-700, C-750 with 6000 & 7000 lb Axle	D1TF-18045-LA	010	<b>83312</b>	<b>89409</b>		...	...
64 - 67	C-550, C-600 with 6000 lb Axle - and Power Steering	C2TA-18045-A	010	<b>83216</b>	...		...	...
64 - 67	C-550, C-600 with 6000 lb Axle - Exc. with Power Steering	C6PF-18077-A	010	<b>G63306</b>	...		...	...
64 - 67	C-550, C-600, C-650, C-700, C-750 Models	C6PF-18077-F		...	...	010	<b>83225</b>	...
67 - 69	C-600, C-650, C-700, C-750, C-800, C-850, C-1000 with 7000, 9000, 11000, 12000, 15000 lb Axles - Exc. with 175" Wheel Base	D2HF-18045-CA	010	<b>83308</b>	...		...	...
67 - 71	C-600, C-650, C-700, C-750, C-800, C-850, C-1000 with 7000, 9000, 11000, 12000, 15000 lb Axles and 175" Wheel Base	C8HA-18045-A	010	<b>83312</b>	<b>89409</b>		...	...
80 - 90	C-600, C-700, C-7000, C-800, C-8000, CT-800, CT-8000 with 3100 lb Spring and 7000 lb Axle	D7HT-18045-JA	010	<b>83308</b>	...		...	...
76 - 79	C-600, C-700, C-750, C-800, C-900, CT-800, CT-900 Models	D2EF-18045-AA	010	<b>83312</b>	<b>89409</b>		...	...
		D7KF-18045-EA	010	<b>83312</b>	<b>89409</b>		...	...
80 - 90	C-600, C-700, C-800, C-7000, CT-800, CT-8000 with 4040, 5040 lb Springs and 7000, 9000, 12000 lb Axles	D2EF-18045-AA	010	<b>83312</b>	<b>89409</b>		...	...
64 - 66	C700/1100, CT-700/1100 with 7000, 9000, 11000, 15000 lb Axles	D2HF-18045-CA	010	<b>83308</b>	...		...	...
69 - 79	C-750, C-800, C-850, C-900, CT-750, CT-800, CT-850, CT-900, CT-950 with 9000 lb to 15000 lb Axles	C8HA-18045-A	010	<b>83312</b>	<b>89409</b>		...	...
		D1TF-18045-LA	010	<b>83312</b>	<b>89409</b>		...	...
		D2KF-18045-AA	010	<b>83312</b>	<b>89409</b>		...	...

#### CF Series (Brazilian Built)

86 - 89	CF - 600, CF - 700 Models	E5HT-18045-AA	010	<b>85301</b>	...		...	...
		E5HT-18080-DA		...	...	010	<b>85315</b>	...
		E5HT-18080-EA		...	...	010	<b>85315</b>	...
96 - 97	CF-7000, CF-8000 or CFT-8000 Models with 16000 lb. Multileaf Spring	F6HT-18045-AA	010	<b>85054</b>	...		...	...
92 - 97	CF-7000, CF-8000 or CFT-8000 Models with 9000 lb Axle	F2HT-18045-BA	010	<b>85376</b>	...		...	...
		F2HT-18045-CA	010	<b>85376</b>	...		...	...
		F2HZ-18124-A	010	<b>85376</b>	...		...	...
		F6HT-18045-LA	010	<b>85376</b>	...		...	...
86 - 97	CF-7000, CF-8000 with 12000 lb or 13000 lb Axle	.....		...	...	010	<b>85302</b>	<b>89420</b>
		87HU-18045-AA	010	<b>85301</b>	...		...	...

## APPLICATION GUIDE - TRUCKS, TRAILERS, AND BUSES

Year Año Année	Model Modelo Modèle	OEM #	Front			Rear		
			Fleetline	GasSLX				

### FORD(Cont'd.)

#### CF Series (Brazilian Built)(Cont'd.)

86 - 97	CF-7000, CF-8000 with 12000 lb or 13000 lb Axle	E5HT-18045-AA	○ ○	<b>85301</b>	...		...	...
			○ ○	<b>85301</b>	...		...	...
			○ ○	<b>85301</b>	...		...	...

#### CL & CLT Series - Highway Tractor Tilt Cab

78 - 89	CL-9000, CLT-9000 Models	D7HT-18045-NA	○ ○	<b>85301</b>	...		...	...
90 - 91	CL-9000, CLT-9000 with Multileaf Spring	F1HT-18045-NA	○ ○	<b>85040</b>	...		...	...
78 - 89	CL-9000, CLT-9000 with Rear Tandem Axle with Neway Suspension	D7HA-18080-AA		...	...	○ ○	<b>83123</b>	<b>89405</b>
78 - 89	CL-9000, CLT-9000 with Single Rear Axle Suspension	D4HA-18080-AA		...	...	○ ○	<b>83209</b>	<b>89414</b>
	Models with Hendrickson Rear Air Suspension	47902-13		...	...	○ ○	<b>83122</b>	<b>89406</b>





#### E Series - E350, E450 Models

92 - 20	Type A School bus with Ford E350 & E450 Chassis	8C24-18045-DA	- ○	<b>83177</b>	...		...	...
			- ○	<b>83177</b>	...		...	...
			- ○	<b>83177</b>	...		...	...
			- ○	<b>83177</b>	...		...	...
				...	...	- ○	<b>83178</b>	...
				...	...	- ○	<b>83178</b>	...
				...	...	- ○	<b>83178</b>	...
				...	...	- ○	<b>83178</b>	...
92 - 20	Type C Motorhomes with Ford E350 & E450 Chassis	8C24-18045-DA	- ○	<b>83177</b>	...		...	...
			- ○	<b>83177</b>	...		...	...
			- ○	<b>83177</b>	...		...	...
			- ○	<b>83177</b>	...		...	...
				...	...	- ○	<b>83178</b>	...
				...	...	- ○	<b>83178</b>	...
				...	...	- ○	<b>83178</b>	...
				...	...	- ○	<b>83178</b>	...

#### F Series - Conventional Cab

64 - 66	F-1000 Models with 11000 lb to 15000 lb Axles	C1TT-18045-D	○ ○	<b>G63406</b>	...		...	...
64 - 79	F-500, F-600 (2 x 4), F-650, F-700, F-750	C7PF-18077-A		...	...	○ ○	<b>83225</b>	...
				...	...	○ ○	<b>83225</b>	...
67 - 69	F-500, F-600, F-650, F-700, F-750 with 5500, 6000, 7000 & 9000 lb Axles	C8TA-18045-AA	- ○	<b>G63386</b>	...		...	...
70 - 79	F-500, F-600, F-650, F-700, F-750 with 5500, 6000, 7000 & 9000 lb Axles	D2HT-18045-GA	○ ○	<b>83308</b>	...		...	...
70 - 79	F-500, F-600, F-650, F-700, F-750, F-800 with 5500, 6000, 7000 & 9000 lb Axles	D2TF-18045-GA	○ ○	<b>83308</b>	...		...	...
64 - 69	F-500, F-600, F-700, F-750 with 6000 & 7000 Axle	C2TA-18045-A	○ ○	<b>83216</b>	...		...	...
86 - 90	F-600	E6HT-18080-AA		...	...	○ ○	<b>83215</b>	...
				...	...	○ ○	<b>83215</b>	...
80 - 94	F-600, F-6000, F-700, F-7000, F-800, F-8000, FT-700, FT-800, FT-8000 - Exc. 9000 lb Axle with H.D. Suspension & 12000 lb Axle	E0HT-18045-AA	○ ○	<b>83309</b>	...		...	...
			○ ○	<b>83309</b>	...		...	...
83 - 89	F-600, F-6000, F-700, F-7000, F-800, F-8000, FT-700, FT-800, FT-8000 with 9000 lb Axle with H.D. Suspension & 12000 lb Axle	D2HF-18045-AA	○ ○	<b>83314</b>	...		...	...
			○ ○	<b>83314</b>	...		...	...
64 - 90	F-600, F-650, F-700, F-750, F-800 with 13000 & 15000 lb Rear Axle	D7HT-18080-BA		...	...	○ ○	<b>83225</b>	...
86 - 90	F-600, F-700, F-800	ASH-24446		...	...	○ ○	<b>83215</b>	...
				...	...	○ ○	<b>83215</b>	...
80 - 90	F-600, F-700, F-800 with 17000 & 18000 lb Rear Axle	D7HF-18080-AA		...	...	○ ○	<b>83215</b>	...
				...	...	○ ○	<b>83215</b>	...
1990	F-600, F-700, F-800, FT-800, FT-900, with Multileaf Spring	F1HT-18045-AA	○ ○	<b>83309</b>	...		...	...
89 - 94	F-600, F-700, LPO (Low Profile Vehicle)	E9HS-18045-AA	○ ○	<b>83309</b>	...		...	...
				...	...	○ ○	<b>85716</b>	...
70 - 72	F-700 (Diesel), F-750 with 9000 lb Axle	D2HF-18045-CA	○ ○	<b>83308</b>	...		...	...

**APPLICATION GUIDE - TRUCKS, TRAILERS, AND BUSES**

Year Año Année	Model Modelo Modèle	OEM #	Front		Rear	
						
					Fleetline	GasSLX

**FORD(Cont'd.)**









**F Series - Conventional Cab(Cont'd.)**

73 - 79	F-700 (Diesel), F-750, F-800 with 9000 lb Axle	D2EF-18045-AA	010	83312	89409		...	...
		D2TF-18045-AA	010	83312	89409		...	...
		D7HT-18045-BA	010	83312	89409		...	...
86 - 97	F-700, F-800	ASH-24446		...	...	010	83215	...
		AX-310		...	...	010	83215	...
		E6HT-18080-AA		...	...	010	83215	...
		E6HZ-18125-D		...	...	010	83215	...
94 - 98	F-700, F-800 with 15000, 17500, 19000 lb Taperleaf Springs	F4HT-18080-AA		...	...	010	85314	89425
		F4HT-18080-AB		...	...	010	85314	89425
		F5HZ-18125-A		...	...	010	85314	89425
94 - 97	F-700, F-800 with 21000 lb Taperleaf Springs	F4HT-18080-BA		...	...	010	85001	89410
94 - 97	F-700, F-800 with 52" or 54" Taperleaf Springs and with 10000 or 12000 lb Axle	F4HT-18045-DA	010	85063	...		...	...
		F5HZ-18124-C	010	85063	...		...	...
94 - 97	F-700, F-800 with Multileaf Spring and 14600 lb Axle	F4HT-18045-EA	010	83125	...		...	...
		F5HZ-18124-D	010	83125	...		...	...
94 - 97	F-700, F-800 with Multileaf Spring and with 10000, 12000 or 13200 lb Axle	F4HT-18045-CB	010	83107	...		...	...
		F5HZ-18124-B	010	83107	...		...	...
94 - 98	F-700, F-800 with Taperleaf Springs and with 6000, 7000, 8500, 9000 lb Axle	F4HT-18045-AB	010	83314	...		...	...
		F4HT-18045-AC	010	83314	...		...	...
		F5HZ-18124-A	010	83314	...		...	...
76 - 79	F-800	D2HT-18080-HA		...	...	010	83225	...
		D7HT-18045-GA	010	83308	...		...	...
64 - 66	F-800, F-850-,F-900, F-950, F-1000 - Exc. Diesel with 11000 CP Axle	C1TT-18045-D	010	G63406	...		...	...
64 - 69	F-800, F-850-,F-900, F-950, F-1000 with 6000, 7000, 9000, 11000, 12000, 15000, 18000 lb Axles (Exc. Diesel with 6000 and 7000 lb Axles)	C1TT-18045-C	010	83312	89409		...	...
		C6PF-18077-DL	010	83312	89409		...	...
64 - 69	F-950, F-1000, F-1100 Diesel with 7000 lb Axle	C6PF-18077-DN	010	83314	...		...	...

**F Series - F450, F550, F650, F750 Models**

99 - 04	F-450 , F-550 Superduty with single or dual rear wheels with 165" or 201" wheel base	ASH-23486		...	...	010	G63461	...
		ASH-247		...	...	010	G63461	...
		AT-610		...	...	010	G63461	...
		AT-611		...	...	010	G63461	...
		F81A-18080-DCA		...	...	010	G63461	...
		F81Z-18125-DC		...	...	010	G63461	...
00 - 15	F-650 with 10,000 lb Front Suspension	3584116C1	010	83175	...		...	...
		3584116C2	010	83175	...		...	...
		4C4Z-18124-QA	010	83175	...		...	...
		AA-616	010	83175	...		...	...
00 - 15	F-650 with 12,000 & 13,200 lb Front Springs	3584118C2	010	85928	...		...	...
		4C4Z-18124-JB	010	85928	...		...	...
		4C4Z-18124-RA	010	85928	...		...	...
		AA-617	010	85928	...		...	...
		AT-812	010	85928	...		...	...
July/2015 - 20	F-650 with 13,500, 15,500 & 19,000 lb Multi-leaf Rear Springs	471700011531		...	...	010	85180	...
		ASH-24660		...	...	010	85180	...
		FC44-18080-AB		...	...	010	85180	...
		FC4Z-18125-A		...	...	010	85180	...
July/2015 - 20	F-650 with 19.5" or 22.5" Wheels (22,000 lb GVW)	471700011530	010	85181	...		...	...
		ASH-24658	010	85181	...		...	...
		ASH-24659	010	85181	...		...	...

## APPLICATION GUIDE - TRUCKS, TRAILERS, AND BUSES









Year Año Année	Model Modelo Modèle	OEM #	Front		Rear	
						
						
			Fleetline	GasSLX	Fleetline	GasSLX

### FORD(Cont'd.)

#### F Series - F450, F550, F650, F750 Models(Cont'd.)

July/2015 - 20	F-650 with 19.5" or 22.5" Wheels (22,000 lb GVW)	FC44-18045-BB	OIO	<b>85181</b>	...		...	...
			OIO	<b>85181</b>	...		...	...
			OIO	<b>85181</b>	...		...	...
- 2015	F-650 with 21,000 lb Rear Air Suspension	3578858C1 3578858C2 4C4Z-18125-DA		...	...	OIO	<b>85926</b>	...
				...	...	OIO	<b>85926</b>	...
				...	...	OIO	<b>85926</b>	...
04 - 11	F-650 with 22,000 lb Multi-leaf Rear Springs	4C4Z-18125-B 501906C92		...	...	-IO	<b>83317</b>	...
				...	...	-IO	<b>83317</b>	...
00 - 03	F-650 with 23,000 lb Multi-leaf Rear Springs	ASH-2447 AT-696 F81A-18080-ZC F81Z-18125-ZA		...	...	OIO	<b>83140</b>	...
				...	...	OIO	<b>83140</b>	...
				...	...	OIO	<b>83140</b>	...
				...	...	OIO	<b>83140</b>	...
00 - 15	F-650 with 8,500 lb Front Suspension	3584117C2 4C4Z-18124-HB 4C4Z-18124-P AA-615 AT-811 FC4Z-18124-HB	OIO	<b>83135</b>	...		...	...
			OIO	<b>83135</b>	...		...	...
			OIO	<b>83135</b>	...		...	...
			OIO	<b>83135</b>	...		...	...
			OIO	<b>83135</b>	...		...	...
			OIO	<b>83135</b>	...		...	...
00 - 01/23/02	F-650 with 8500 or 9000 lb Front Axle	3U2Z-18124-MAA AA-494 ASH-397 XC35-18045-AB XC35-18045-AD XC35-18045-JA XC3Z-18124-JA	OIO	<b>83131</b>	...		...	...
			OIO	<b>83131</b>	...		...	...
			OIO	<b>83131</b>	...		...	...
			OIO	<b>83131</b>	...		...	...
			OIO	<b>83131</b>	...		...	...
			OIO	<b>83131</b>	...		...	...
			OIO	<b>83131</b>	...		...	...
00 - 03	F-650 with Hendrickson HAS - 190 Rear Air Suspension	1C44-18080-AA 60670-008 60670-008L		...	...	OIO	<b>83123</b>	<b>89405</b>
				...	...	OIO	<b>83123</b>	<b>89405</b>
				...	...	OIO	<b>83123</b>	<b>89405</b>
04 - 09	F-650 with Hendrickson HAS - 230 Rear Air Suspension	4C4Z-18125-CA 60675-003 60675-003L ASH-1105 ASH-722		...	...	OIO	<b>85976</b>	...
				...	...	OIO	<b>85976</b>	...
				...	...	OIO	<b>85976</b>	...
				...	...	OIO	<b>85976</b>	...
				...	...	OIO	<b>85976</b>	...
05 - 07	F-650 with O.E.M. Number	3553628C1 3553628C2		...	...	OIO	<b>85927</b>	...
				...	...	OIO	<b>85927</b>	...
00 - 15	F-750 with 10,000 lb Front Suspension	3584116C1 3584116C2 4C4Z-18124-QA AA-616	OIO	<b>83175</b>	...		...	...
			OIO	<b>83175</b>	...		...	...
			OIO	<b>83175</b>	...		...	...
			OIO	<b>83175</b>	...		...	...
00 - 15	F-750 with 12,000 & 13,200 lb Front Springs	3584118C2 4C4Z-18124-JB 4C4Z-18124-RA AA-617 AT-812	OIO	<b>85928</b>	...		...	...
			OIO	<b>85928</b>	...		...	...
			OIO	<b>85928</b>	...		...	...
			OIO	<b>85928</b>	...		...	...
			OIO	<b>85928</b>	...		...	...
July/2015 - 20	F-750 with 13,500, 15,500 & 19,000 lb Multi-leaf Rear Springs	471700011531 ASH-24660 FC44-18080-AB FC4Z-18125-A		...	...	OIO	<b>85180</b>	...
				...	...	OIO	<b>85180</b>	...
				...	...	OIO	<b>85180</b>	...
				...	...	OIO	<b>85180</b>	...
July/2015 - 20	F-750 with 19.5" or 22.5" Wheels (22,000 lb GVW)	471700011530 ASH-24658 ASH-24659 FC44-18045-BB	OIO	<b>85181</b>	...		...	...
			OIO	<b>85181</b>	...		...	...
			OIO	<b>85181</b>	...		...	...
			OIO	<b>85181</b>	...		...	...

**APPLICATION GUIDE - TRUCKS, TRAILERS, AND BUSES**

Year Año Année	Model Modelo Modèle	OEM #	Front		Rear	
						
						
			Fleetline	GasSLX	Fleetline	GasSLX

**FORD(Cont'd.)**

**F Series - F450, F550, F650, F750 Models(Cont'd.)**





July/2015 - 20	F-750 with 19.5" or 22.5" Wheels (22,000 lb GVW)	FC4Z-18124-A	010	85181	...		...	...
		FC4Z-18124-B	010	85181	...		...	...
- 2015	F-750 with 21,000 lb Rear Air Suspension	3578858C1		...	...	010	85926	...
		3578858C2		...	...	010	85926	...
		4C4Z-18125-DA		...	...	010	85926	...
04 - 11	F-750 with 22,000 lb Rear Spring Suspension	4C4Z-18125-B		...	...	-10	83317	...
		501906C92		...	...	-10	83317	...
00 - 03	F-750 with 23000 lb Multi-leaf Rear Springs	ASH-2447		...	...	010	83140	...
		AT-696		...	...	010	83140	...
		F81A-18080-ZC		...	...	010	83140	...
		F81Z-18125-ZA		...	...	010	83140	...
00 - 15	F-750 with 8,500 lb Front Suspension	3584117C2	010	83135	...		...	...
		4C4Z-18124-HB	010	83135	...		...	...
		4C4Z-18124-P	010	83135	...		...	...
		AA-615	010	83135	...		...	...
		AT-811	010	83135	...		...	...
		FC4Z-18124-HB	010	83135	...		...	...
00 - 01/23/02	F-750 with 8500 or 9000 lb Front Axle	3U2Z-18124-MAA	010	83131	...		...	...
		AA-494	010	83131	...		...	...
		ASH-397	010	83131	...		...	...
		XC35-18045-AB	010	83131	...		...	...
		XC35-18045-AD	010	83131	...		...	...
		XC35-18045-JA	010	83131	...		...	...
		XC3Z-18124-JA	010	83131	...		...	...
00 - 03	F-750 with Hendrickson HAS - 190 Rear Air Suspension	1C44-18080-AA		...	...	010	83123	89405
		60670-008		...	...	010	83123	89405
		60670-008L		...	...	010	83123	89405
04 - 09	F-750 with Hendrickson HAS - 230 Rear Air Suspension	4C4Z-18125-CA		...	...	010	85976	...
		60675-003		...	...	010	85976	...
		60675-003L		...	...	010	85976	...
		ASH-1105		...	...	010	85976	...
		ASH-722		...	...	010	85976	...
05 - 07	F-750 with O.E.M. Number	3553628C1		...	...	010	85927	...
		3553628C2		...	...	010	85927	...

**FT Series - Conventional Cab**

90 - 92	FT-900 (Low Profile Vehicle)	E9HS-18080-AA		...	...	010	85716	...
90 - 94	FT-900 (Low Profile Vehicle)	E9HZ-18124-A	010	83309	...		...	...
94 - 97	FT-900 with 46" Taperleaf Spring and 15000, 17500 or 19000 lb Axle	F4HT-18080-AA		...	...	010	85314	89425
		F4HT-18080-AB		...	...	010	85314	89425
		F5HZ-18125-DA		...	...	010	85314	89425
94 - 97	FT-900 with 46" Taperleaf Springs and 21000 lb Axle	F4HT-18080-BA		...	...	010	85001	89410
94 - 97	FT-900 with 52 or 54" Taperleaf Springs and with 10000 or 12000 lb Axle	F4HT-18045-DA	010	85063	...		...	...
		F5HZ-18124-C	010	85063	...		...	...
90 - 94	FT-900 with 9000 lb Axle with H.D. Suspension or 10000, 11000, or 12000 lb Axles	C4HZ-18124-E	010	83309	...		...	...
		F1HT-18045-AA	010	83309	...		...	...
		F1HZ-18124-A	010	83309	...		...	...
94 - 97	FT-900 with Multileaf Spring and 14600 lb Axle	F4HT-18045-EA	010	83125	...		...	...
		F5HZ-18124-D	010	83125	...		...	...
94 - 97	FT-900 with Multileaf Spring and with 10000, 12000 or 13200 lb Axle	F4HT-18045-CB	010	83107	...		...	...
		F5HZ-18124-B	010	83107	...		...	...
90 - 97	FT-900 with shock located forward of rear axle	ASH-24446		...	...	010	83215	...



**APPLICATION GUIDE - TRUCKS, TRAILERS, AND BUSES**

Year Año Année	Model Modelo Modèle	OEM #	Front		Rear		
							
				Fleetline	GasSLX	Fleetline	GasSLX

**FORD(Cont'd.)**

**FT Series - Conventional Cab(Cont'd.)**

90 - 97	FT-900 with shock located forward of rear axle	AX-310		...	...	010	83215	...
		E6HT-18080-AA	010	...	...	010	83215	...
		E6HZ-18125-D		...	...	010	83215	...
90 - 94	FT-900, FT-900LP with 9000 lb Axle with H.D. Suspension or 10000, 11000, or 12000 lb Axles	E9HS-18045-AA	010	83309	...		...	...
94 - 97	FT-900, with Taperleaf Springs and with 6000, 7000, 8500 or 9000 lb Axles	F4HT-18045-AB	010	83314	...		...	...
		F5HZ-18124-A	010	83314	...		...	...

**H and HT Series - Hi Tilt Cab**

61 - 63	HT-950 with 11000 lb Axle	....	010	83314	...		...	...
61 - 66	HT-950 with 12000 & 15000 lb Axle	....	010	83314	...		...	...

**L, LT & LTS - Conventional Cab**

73 - 90	L-800, L8000, L-900, L-9000, LT-800, LT-880, LT8000, LT-900, LT-9000 with 7000, 9000, 12000 lb Axles	D2EF-18045-AA	010	83312	89409		...	...
		D2KF-18045-AA	010	83312	89409		...	...
		D7HF-18045-FA	010	83312	89409		...	...
		D7HT-18045-BA	010	83312	89409		...	...
73 - 85	L-800, L8000, L-900,L-9000, LT-800, LT-880, LT8000, LT-900, LT-9000, LTS-8000, LTS-900, LTS-9000 with 7000, 9000, 12000, 16000 lb Axles	D2HF-18045-AA	010	83314	...		...	...
		D2HT-18045-CA	010	83314	...		...	...
73 - 90	L-800, L850, L-900,L-9000, LT-800, LT-850, LT880, LT-900, LT-9000, LTS-800, LTS-850, LTS-900 with 7000, 9000, 12000, 16000 lb Axles	D2HF-18045-BA	010	83309	...		...	...
		D7HT-18045-DA	010	83309	...		...	...
94 - 97	L-8000, L-9000, LT-8000 or LT-9000 Models with 21000 or 23000 lb. with 46" Taperleaf Spring	F4HT-18080-BA		...	...	010	85001	89410
90 - 97	L-8000, L-9000, LT-8000, LT-9000 with 52" Taperleaf Spring	F1HT-18045-GA	010	85006	...		...	...
		F1HT-18045-GB	010	85006	...		...	...
90 - 97	L-8000, L-9000, LT-8000, LT-9000 with 58" Parabolic Taperleaf Spring	F1HT-18045-RA	010	...	89402		...	...
		F1HT-18045-RB	010	...	89402		...	...
	L-8000, L-9000, LT-8000, LT-9000 with Hendrickson Rear Air Suspension	47902-13		...	...	010	83122	89406
91 - 97	L-8000, L-9000, LT-8000, LT-9000 with Multleaf Spring	F1HT-18045-DA	010	83312	89409		...	...
91 - 97	L-8000, L-9000, LT-8000, LT-9000 with 4000, 4500, 5400, 6000, 7200 lb Multileaf Springs and with 9000, 10000, 12000 or 16000 lb Axles	F1HT-18045-CB	010	83216	...		...	...
91 - 97	L-8000, L-9000, LT-8000, LT-9000 with 4500, 5400, 6000, 7200, 10000 lb Multileaf Springs and with 10000, 12000, 13200, 16000 lb Axles	F1HT-18045-DB	010	83308	...		...	...
73 - 89	LTS-800, LTS-850, LTS-900, LTS-9000 with 16000 lb Axle	D0HA-18045-E	010	83312	89409		...	...
		D2HF-18045-DA	010	83312	89409		...	...
		D7HT-18045-EA	010	83312	89409		...	...





**LA, LS & LST - Conventional Cab**

1996	LA-8000 Models with 12000 or 13000 lb Axles	F6HT-18045-LA	010	85376	...		...	...
1996	LA-8000 Models with 16000 lb. Multileaf Spring	F6HT-18045-AA	010	85054	...		...	...
91 - 96	LA-8000, LA-9000 Models with 4000, 4500, 5400, 6000, or 7200 lb. Multileaf Spring	F1HT-18045-CB	010	83216	...		...	...
91 - 96	LA-8000, LA-9000 Models with Hendrickson Rear Air Suspension	47902-28		...	...	010	85013	89414
90 - 97	LA-8000, LA-9000, LS-8000, LST-8000 with 4500 lb to 10000 lb Multileaf Spring	F1HT-18045-CA	010	83308	...		...	...
90 - 97	LA-8000, LS-8000, LST-8000 with 52" Taperleaf Spring	F1HT-18045-EA	010	...	89402		...	...
91 - 96	LA-8000, LS-8000, LST-8000 with 58" Taperleaf Spring	F1HT-18045-EB	010	...	89402		...	...

**LL, LLA, LTA, LTL, LTLA - Conventional Cab**

91 - 95	LL-9000 with 4500, 5000, 6000 lb Springs and with 10000, 11000, 12000 lb Axles	F1HT-18045-DB	010	83308	...		...	...
91 - 96	LL-9000, LLA-9000, LTA-9000, LTLA-9000, with 4000, 4500, 5400, 6000 or 7200 lb Multileaf Springs and with 9000, 10000, 12000 or 16000 lb Axles	F1HT-18045-CB	010	83216	...		...	...

**APPLICATION GUIDE - TRUCKS, TRAILERS, AND BUSES**

Year Año Année	Model Modelo Modèle	OEM #	Front		Rear	
						
			Fleetline	GasSLX	Fleetline	GasSLX

**FORD(Cont'd.)**

**LL, LLA, LTA, LTL, LTLA - Conventional Cab(Cont'd.)**

91 - 96	LLA-9000, LTLA-9000 with 4500, 5400, 6500 lb 58" Parabolic Taperleaf Spring	F0HT-18045-CA F1HT-18045-HB	O1O O1O	85006	...		...	...
				85006	...		...	...
91 - 96	LTA-9000, LLA-9000 or LTLA-9000 Models With 4500, 5400, 6000, 7200 or 10000 lb. Multileaf Spring With Hendrickson Rear Air Suspension	F1HT-18045-CA 47902-28	O1O	83308	...		...	...
				...	...	O1O	85013	89414
80 - 85	LTL-900, LTL-9000 with 7000, 9000, 12000 lb Axle	D2HF-18045-AA	O1O	83314	...		...	...









**LN & LNT - Conventional Cab**

1972	LN-500, LN-550 with 11000, 13000, 15000, 17000 lb Axles	D2TF-18080-HA		...	...	O1O	83225	...
70 - 72	LN-500, LN-550 with 5000, 5500, 6000 & 7000 lb Axles	D2TF-18045-GA	O1O	83308	...		...	...
72 - 79	LN-600, LN-650, LN-700, LN-750 with 11000, 13000, 15000, 17000 lb Axles	D2TF-18080-HA		...	...	O1O	83225	...
70 - 89	LN-600, LN-650, LN-700, LN-750, LN-7000, LN-800, LN-8000, LNT-800, LNT-8000 with 3000, 3300 lb Springs and 5000, 5500, 6000, 7000 lb Axles	D7HT-18045-GA	O1O	83308	...		...	...
76 - 79	LN-600, LN-650, LN-700, LN-800	D7HT-18045-BA	O1O	83312	89409		...	...
70 - 89	LN-600, LN-700, LN-7000, LN-800, LN-8000, LNT-800, LNT-8000 with 4400 lb Spring and 7000, 9000 lb Axles	D2EF-18045-AA	O1O	83312	89409		...	...
80 - 89	LN-600, LN-700, LN-750 with 11000, 13000, 15000, 17000 lb Axles	D7HT-18080-BA		...	...	O1O	83225	...
70 - 75	LN-700, LN-750 Diesel with 9000 lb Axle	C1TT-18045-C	O1O	83312	89409		...	...
94 - 97	LN-7000, LN-8000, LN-9000, LNT-8000 or LNT-9000 Models with 21000 or 23000 lb. with 46" Taperleaf Spring	F4HT-18080-BA		...	...	O1O	85001	89410
91 - 97	LN-7000, LN-8000, LN-9000, LNT-8000 or LNT-9000 Models with 4000, 4500, 5400, 6000 or 7200 lb. Multileaf Springs and with 9000, 10000, 12000 or 16000 lb. Axles	F1HT-18045-CB	O1O	83216	...		...	...
90 - 97	LN-7000, LN-8000, LN-9000, LNT-8000, LNT-9000 with 52" Taperleaf Spring	F1HT-18045-GA F1HT-18045-GB	O1O O1O	85006	...		...	...
				85006	...		...	...
90 - 97	LN-7000, LN-8000, LN-9000, LNT-8000, LNT-9000 with 58" Parabolic Taperleaf Spring	F1HT-18045-RA F1HT-18045-RB	O1O O1O	...	89402		...	...
				...	89402		...	...
	LN-7000, LN-8000, LN-9000, LNT-8000, LNT-9000 with Hendrickson Rear Air Suspension	47902-13 F0HT-18080-AA F0HZ-18125-A		...	...	O1O	83122	89406
				...	...	O1O	83122	89406
				...	...	O1O	83122	89406
90 - 97	LN-7000, LN-8000, LN-9000, LNT-8000, LNT-9000 with Multileaf Spring	F1HT-18045-DA	O1O	83312	89409		...	...
91 - 97	LN-7000, LN-8000, LN-9000, LNT-8000, LNT-9000 with 4500, 5400, 6000, 7200, 10000 lb Springs and with 10000, 12000, 13200, 16000 lb Axles	F1HT-18045-DB	O1O	83308	...		...	...
76 - 77	LN-800, LN-8000, LN-900, LN-9000, LNT-800, LNT-8000, LNT-900, LNT-9000	D2KF-18045-AA	O1O	83312	89409		...	...
76 - 81	LN-800, LN-8000, LN-900, LN-9000, LNT-800, LNT-8000, LNT-900, LNT-9000	D2HF-18045-AA D7HT-18045-CA	O1O O1O	83314	...		...	...
				83314	...		...	...
70 - 71	LN-800, LN-850, LNT-900, with 7000, 9000, 12000 lb Axles	D2TF-18045-GA	O1O	83308	...		...	...
70 - 89	LN-800, LN-850, LN-8000, LN-900, LN-9000, LNT-800, LNT-850, LNT-880, LNT-8000, LNT-900, LNT-9000 with 6000, 7000, 9000, 12000, 16000 lb Axles	D2HF-18045-BA D7HT-18045-DA	O1O O1O	83309	...		...	...
				83309	...		...	...

**Louisville Series - Conventional Cab**

96 - 97	All Models with 10000 lb or 12000 lb Axle and 54" Taperleaf Spring	F6HT-18045-AC F6HZ-18124-A F6HZ-18124-G	O1O O1O O1O	85054	...		...	...
				85054	...		...	...
				85054	...		...	...
96 - 97	All with 12000 lb, 13000 lb or 14600 lb Axle and 60" Taperleaf Spring	F6HT-18045-EB F6HT-18045-EC F6HZ-18124-D F6HZ-18124-E F6HZ-18124-F	O1O O1O O1O O1O O1O	85055	89439		...	...
				85055	89439		...	...
				85055	89439		...	...
				85055	89439		...	...
				85055	89439		...	...

## APPLICATION GUIDE - TRUCKS, TRAILERS, AND BUSES

Year Año Année	Model Modelo Modèle	OEM #	Front		Rear	
						
						
			Fleetline	GasSLX	Fleetline	GasSLX

### FORD(Cont'd.)

#### Louisville Series - Conventional Cab(Cont'd.)

1996 -	All with 13200 lb or 14600 lb Axle and 54" Taperleaf Spring	F6HT-18045-GB F6HT-18045-GC	010	<b>85030</b>	<b>89440</b>		...	...
			010	<b>85030</b>	<b>89440</b>		...	...
1996 -	All with 54" Multi-leaf Spring and 14600 or 16000 lb Axle	F6HT-18045-CC F6HZ-18124-C	010	<b>85055</b>	<b>89439</b>		...	...
			010	<b>85055</b>	<b>89439</b>		...	...
	All with 54" Multileaf Spring and with 12000 or 13200 lb Axle	F6HT-18045-BC	010	<b>85047</b>	<b>89435</b>		...	...
96 - 97	All with 54" Multileaf Spring and with 8500 or 9000 lb Axle	F6HT-18045-JB F6HT-18045-JC F6HZ-18124-J	010	...	<b>89402</b>		...	...
			010	...	<b>89402</b>		...	...
			010	...	<b>89402</b>		...	...
96 - 97	All with 8500 lb or 9000 lb Axle with 54" Taperleaf Spring	F6HT-18045-HB F6HT-18045-HC F6HZ-18124-H	010	<b>85054</b>	...		...	...
			010	<b>85054</b>	...		...	...
			010	<b>85054</b>	...		...	...
	All with Hendrickson HAS-400 Air Suspension	47902-28 F6HZ-18080-FC F6HZ-18125-D		...	...	010	<b>85013</b>	<b>89414</b>
				...	...	010	<b>85013</b>	<b>89414</b>
				...	...	010	<b>85013</b>	<b>89414</b>
	All with Neway AD-246 Air Suspension	90045099 90045132		...	...	010	<b>85906</b>	<b>89407</b>
				...	...	010	<b>85909</b>	...

#### Motorhome Chassis

99 - 20	F53 Motorhome Chassis with 16,000 lb GVW to 22,000 lb GVW	1C34-18045-AA 1C34-18045-JA 9U94-18045-AA 9U9Z-18124-A ASH-1022 ASH-1205 ASH-1228 ASH-1229 ASH-25822 ASH-25823 ASH-294 AT-620 AT-766	010	<b>83209</b>	<b>89414</b>		...	...
			010	<b>83209</b>	<b>89414</b>		...	...
			010	<b>83209</b>	<b>89414</b>		...	...
			010	<b>83209</b>	<b>89414</b>		...	...
			010	<b>83209</b>	<b>89414</b>		...	...
			010	<b>83209</b>	<b>89414</b>		...	...
			010	<b>83209</b>	<b>89414</b>		...	...
			010	<b>83209</b>	<b>89414</b>		...	...
			010	<b>83209</b>	<b>89414</b>		...	...
			010	<b>83209</b>	<b>89414</b>		...	...
			010	<b>83209</b>	<b>89414</b>		...	...
			010	<b>83209</b>	<b>89414</b>		...	...
			99 - 20	F53 Motorhome Chassis with 20,500 lb GVW to 22,000 lb GVW	9U94-18080-AA 9U9Z-18125-A ASH-1023 ASH-1206 ASH-1230 ASH-137 ASH-25824 AT-621		...	...
	...	...				010	<b>83122</b>	<b>89406</b>
	...	...				010	<b>83122</b>	<b>89406</b>
	...	...				010	<b>83122</b>	<b>89406</b>
	...	...				010	<b>83122</b>	<b>89406</b>
	...	...				010	<b>83122</b>	<b>89406</b>
	...	...				010	<b>83122</b>	<b>89406</b>
73 - 76	M-400 & M-500 Motorhome Chassis	.....	010	<b>85012</b>	<b>89413</b>	010	<b>83225</b>	...
57 - 76	P-400 & 4000 Motorhome Chassis with H.D. Springs	.....	010	<b>85012</b>	<b>89413</b>		...	...









#### N and NT 89" BBC Conventional Cab

64 - 69	M-750, N-800, N-850, N-900, N-950 with 6000, 7000, 9000, 11000, 12000 lb Axles	C1TT-18045-C	010	<b>83312</b>	<b>89409</b>		...	...
64 - 69	N-1100 with 11000 thru 15000 lb Axles	C6PF-18077-DN	010	<b>83314</b>	...		...	...
64 - 69	N-500, N-550, N-600, N-650, N-700 with 5000, 6000, 7000 & 9000 lb Axles	D2TF-18045-GA	010	<b>83308</b>	...		...	...
64 - 69	N-500, N-550, N-600, N-650, N-700, N-750	C7PF-18077-A D2TF-18080-HA		...	...	010	<b>83225</b>	...
				...	...	010	<b>83225</b>	...
64 - 69	N-600, N-650, N-700, N-750, N-800, N-850, N-900, N-950 with 6000, 7000, 9000, 11000, 12000 lb Axles	C6PF-18077-DL	010	<b>83312</b>	<b>89409</b>		...	...
67 - 69	N-850, N-900, N-950, N-1000, NT-850, NT-900, NT-950, NT-1000 with 6000, 7000, 9000, 11000, 12000, 15000, 18000 lb Axles	C1TT-18045-D	010	<b>G63406</b>	...		...	...

#### P-Series - Parcel Delivery

57 - 76	P-400 & 4000 w/ H. D. Springs	.....	010	<b>85012</b>	<b>89413</b>		...	...
57 - 76	P500, P-5000	.....	010	<b>85012</b>	<b>89413</b>	010	<b>83225</b>	...

## APPLICATION GUIDE - TRUCKS, TRAILERS, AND BUSES

Year Año Année	Model Modelo Modèle	OEM #	Front		Rear	
						
						
			Fleetline	GasSLX	Fleetline	GasSLX

### FORD(Cont'd.)

#### P-Series - Parcel Delivery(Cont'd.)

78 - 79	P-600	D7HT-18045-HA D7HT-18080-CA	OIO	85012	89413	...	...
				...	...	OIO	83225

#### T-Series - Conventional Tandem

64 - 69	T-750, T-800, T-850, T-900, T-950 with 6000, 7000, 9000, 11000, 12000, 15000, 18000 lb Axles	C1TT-18045-D	OIO	G63406	...	...	...
				...	...	...	...
64 - 69	T-750, T-800, T-850, T-900, T-950 with 9000 thru 15000 lb Axles	C1TT-18045-E C6PF-18077-DN	OIO	83314	...	...	...
				83314	...	...	...



#### W and WT Series - Hi Tilt Cab Highway Tractor

66 - 71	W-900, W-950,W-1000, WT-900, WT-950, WT-1000 with 11000 lb Axle	D2HA-18045-E1A D2HA-18045-E1B D2HA-18045-E2A D2HA-18045-E2B	OIO	85304	...	...	...	
				85304	...	...	...	
				85304	...	...	...	
				85304	...	...	...	
66 - 77	W-900, W-950,W-1000, WT-900, WT-950, WT-1000 with 12000 & 15000 lb Axle	C6TA-18045-Y C6TA-18045-Z	OIO	85301	...	...	...	
				85301	...	...	...	
73 - 77	W-900, WT-900 with Air Suspension	D2HZ-18080-A D4HA-18080-AA	OIO	...	...	OIO	83209	89414
				...	...	OIO	83209	89414

#### Additional O.E.M. Interchanges

	HN-80 with 21000 lb or 23000 lb Axle & 52" Taper leaf Rear Suspension	F6HT-18080-JA		...	...	OIO	85305	...
	Models with O.E.M. Number	2C4Z-18124-BA	OIO	83175	...		...	...
		2C7Z-18125-AA		...	...	OIO	G63837	...
		2C7Z-18125-CA		...	...	OIO	G63607	...
		3U2Z-18124-BAA	OIO	G63809	...		...	...
		3U2Z-18124-BV	-IO	G63614	...		...	...
		3U2Z-18124-BW	-IO	G63614	...		...	...
		3U2Z-18124-EA	-IO	G63772	...		...	...
		3U2Z-18124-FA	-IO	G63608	...		...	...
		3U2Z-18124-FAA	-IO	G63809	...		...	...
		3U2Z-18124-JAA	-IO	G63614	...		...	...
		3U2Z-18124-YAA	OIO	G63809	...		...	...
		3U2Z-18125-AD		...	...	-IO	69575	...
		3U2Z-18125-CA		...	...	OIO	G63607	...
		3U2Z-18125-DA		...	...	OIO	G63525	...
		3U2Z-18125-EA		...	...	OIO	G63524	...
		3U2Z-18125-RA		...	...	-IO	G63623	...
		47902-8		...	...	OIO	83122	89406
		4C4O-18045-AA	OIO	83163	...		...	...
		4C4O-18045-BB	OIO	83135	...		...	...
		4C4O-18045-CA	OIO	85957	...		...	...
		4C4O-18045-DB	OIO	85927	...		...	...
		4C4O-18045-EA	OIO	85926	...		...	...
		4C4O-18045-GA	OIO	83175	...		...	...
		4C4O-18045-HA	OIO	83135	...		...	...
		4C4O-18045-JA	OIO	85928	...		...	...
		4C4O-18045-KA	OIO	85976	...		...	...
		4C4O-18045-LA	OIO	85976	...		...	...
		4C4O-18045-MA	OIO	85926	...		...	...
		4C4O-18080-AA		...	...	OIO	83101	...
		4C4O-18080-BA		...	...	-IO	83317	...
4C4Z-18124-AB	OIO	83163	...		...	...		
4C4Z-18124-BB	OIO	83135	...		...	...		
4C4Z-18124-CB	OIO	85957	...		...	...		
4C4Z-18124-DC	OIO	85927	...		...	...		

**APPLICATION GUIDE - TRUCKS, TRAILERS, AND BUSES**





Year Año Année	Model Modelo Modèle	OEM #	Front		Rear	
						
			Fleetline	GasSLX	Fleetline	GasSLX

**FORD(Cont'd.)**

**Additional O.E.M. Interchanges(Cont'd.)**

Models with O.E.M. Number						
4C4Z-18124-EA	010	85926	...		...	...
4C4Z-18124-GB	010	83175	...		...	...
4C4Z-18124-KA	010	85976	...		...	...
4C4Z-18124-LA	010	85976	...		...	...
4C4Z-18124-M	010	85926	...		...	...
4C4Z-18125-AB		...	...	010	83101	...
4U2Z-18V124-AA	-10	G63678	...		...	...
57365-111	010	85006	...		...	...
5C3Z-18124-JA	-10	G63969	...		...	...
5C3Z-18125-CF		...	...	010	77969	...
5C3Z-18125-DA		...	...	010	77968	...
5U2Z-18V124-AA	-10	G63714	...		...	...
5U2Z-18V124-AHA	01-	G63622	...		...	...
5U2Z-18V124-AU	-10	G63772	...		...	...
5U2Z-18V124-BA	-10	G63716	...		...	...
5U2Z-18V124-CAA	010	G63809	...		...	...
5U2Z-18V124-DB	010	G63455	...		...	...
5U2Z-18V124-GA	-10	G63809	...		...	...
5U2Z-18V124-LA	-10	G63929	...		...	...
5U2Z-18V125-AE		...	...	010	G63808	...
5U2Z-18V125-AF		...	...	010	G63810	...
5U2Z-18V125-BDA		...	...	-10	G63623	...
5U2Z-18V125-BGA		...	...	-10	G63778	...
5U2Z-18V125-BS		...	...	010	G63607	...
5U2Z-18V125-BT		...	...	010	G63525	...
5U2Z-18V125-BU		...	...	010	G63524	...
5U2Z-18V125-F		...	...	010	G63676	...
5U2Z-18V125-G		...	...	010	G63837	...
5U2Z-18V125-H		...	...	010	G63406	...
6C2Z-18124-B	-10	G63929	...		...	...
6E7O-18B038-AA		...	...	010	83364	...
6E7Z-18124-AB	010	83364	...		...	...
6ETZ-18125-A		...	...	010	83364	...
6U2Z18V125A		...	...	010	G63837	...
6U2Z-18V125-B		...	...	010	G63607	...
70127	010	85006	...		...	...
70128	010	85006	...		...	...
7C34-18045-HB	-10	G63969	...		...	...
7C34-18080-DCB		...	...	010	77968	...
7W7Z-18125-B		...	...	-10	69574	...
90044769		...	...	010	83207	89407
90044770		...	...	010	83207	89407
AT-504G		...	...	010	G63679	...
AX131A		...	...	010	83217	...
AX-267A	010	83309	...		...	...
AX85A	010	83219	...		...	...
B3Q-18124-A	010	83219	...		...	...
B3Q-18125-A		...	...	010	83217	...
B3TZ-18125-A		...	...	010	83217	...
B6TZ-18124-A	010	83219	...		...	...
B7C-18125-A		...	...	010	83217	...
B7T-18124-C	010	83225	...		...	...
B7TZ-18124-B	010	83216	...		...	...
B7TZ-18124-C	010	83216	...		...	...
B7TZ-18124-D	010	83219	...		...	...

**APPLICATION GUIDE - TRUCKS, TRAILERS, AND BUSES**









Year Año Année	Model Modelo Modèle	OEM #	Front		Rear	
						
			Fleetline	GasSLX	Fleetline	GasSLX

**FORD(Cont'd.)**

**Additional O.E.M. Interchanges(Cont'd.)**

Models with O.E.M. Number							
B7TZ-18124-E	010	83217	...		...	...	
B7TZ-18125-C		...	...	010	83217	...	
B8Q-18125-A		...	...	010	85307	...	
B8QZ-18124-A	010	83312	89409		...	...	
B8TZ-18124-A	010	83219	...		...	...	
B9TT-18045-C	010	83219	...		...	...	
B9TT-18045-D	010	83219	...		...	...	
C0TT-18045-A	010	83219	...		...	...	
C0TT-18045-D	010	83216	...		...	...	
C0TZ-18124-A	010	83216	...		...	...	
C1TT-18045-G	010	83216	...		...	...	
C1TT-18080-B		...	...	010	83217	...	
C1TZ-18045-C	010	83312	89409		...	...	
C1TZ-18124-A	010	83217	...		...	...	
C1TZ-18124-B	010	83216	...		...	...	
C1TZ-18124-C	010	83312	89409		...	...	
C1TZ-18124-D	010	83309	...		...	...	
C1TZ-18124-E	010	83312	89409		...	...	
C1TZ-18124-F	010	83312	89409		...	...	
C1TZ-18124-N	010	83314	...		...	...	
C1TZ-18124-P	010	83312	89409		...	...	
C1TZ-18125-B		...	...	010	83217	...	
C1VT-18080-B		...	...	010	83217	...	
C2TA-18045-B	010	83308	...		...	...	
C2TZ-18124-A	010	83308	...		...	...	
C3TA-18045-A	010	83216	...		...	...	
C3TZ-18124-A	010	83308	...		...	...	
C4HZ-18124-A	010	83312	89409		...	...	
C4HZ-18124-B	010	83309	...		...	...	
C4HZ-18124-C	010	83314	...		...	...	
C4HZ-18124-D	010	83312	89409		...	...	
C4HZ-18124-F	010	83308	...		...	...	
C4PF-18045-H	010	83216	...		...	...	
C4TZ-18124-AA	010	83308	...		...	...	
C4TZ-18124-AB	010	83308	...		...	...	
C4TZ-18124-B	010	83308	...		...	...	
C5TZ-18124-A	010	83308	...		...	...	
C6TA-18045-U	010	85301	...		...	...	
C6TA-18045-V	010	85301	...		...	...	
C6TS-18080-A		...	...	010	83217	...	
C6TZ-18124-D	010	85301	...		...	...	
C6TZ-18124-E	010	85301	...		...	...	
C6TZ-18124-H	010	85301	...		...	...	
C6TZ-18124-J	010	85301	...		...	...	
C7HZ-18124-A	010	83312	89409		...	...	
C7TA-18045-R	010	83216	...		...	...	
C7TA-18045-Z	010	85301	...		...	...	
C8PF-18045-CM	010	83216	...		...	...	
D0HA-18045-D	010	83309	...		...	...	
D0HZ-18124-A	010	83309	...		...	...	
D0HZ-18124-B	010	83312	89409		...	...	
D0HZ-18124-C	010	83314	...		...	...	
D1TZ-18124-D	010	83308	...		...	...	
D1TZ-18124-E	010	83216	...		...	...	
D1TZ-18124-F	010	83312	89409		...	...	

## APPLICATION GUIDE - TRUCKS, TRAILERS, AND BUSES





Year Año Année	Model Modelo Modèle	OEM #	Front		Rear	
						
						
			Fleetline	GasSLX	Fleetline	GasSLX

### FORD(Cont'd.)

#### Additional O.E.M. Interchanges(Cont'd.)

	Models with O.E.M. Number					
	D1TZ-18125-E		...	...	OIO	83217
OIO	D2EF-18124-AA		83312	89409		...
OIO	D2HA-18045-EB		85301	...		...
OIO	D2HA-18045-F1A		85301	...		...
OIO	D2HA-18045-F1B		85301	...		...
OIO	D2HA-18045-F2A		85301	...		...
OIO	D2HA-18045-F2B		85301	...		...
OIO	D2HF-18045-A		83314	...		...
OIO	D2HF-18124-AA		83314	...		...
OIO	D2HT-18045-EA		83312	89409		...
	D2HZ-18125-A		...	...	OIO	83209
	D2HZ-18125-B		...	...	OIO	83209
OIO	D2KF-18124-AA		83312	89409		...
OIO	D2TA-18045-AAA		83219	...		...
OIO	D2TA-18045-ZA		83219	...		...
OIO	D2TF-18045-FA		83312	89409		...
	D2TF-18080-NA		...	...	OIO	83217
OIO	D2TF-18124-F		83309	...		...
OIO	D2TZ-18124-A		83308	...		...
OIO	D2TZ-18124-E		83312	89409		...
OIO	D2TZ-18124-F		83309	...		...
OIO	D2TZ-18124-G		83314	...		...
OIO	D2TZ-18124-H		83308	...		...
OIO	D2TZ-18124-J		83312	89409		...
OIO	D3TA-18045-BA		83219	...		...
OIO	D3TZ-18124-B		83219	...		...
	D3TZ-18125-C		...	...	OIO	83217
	D3TZ-18125-D		...	...	OIO	83217
	D4HA-18080-A		...	...	OIO	83209
OIO	D4TF-18045-AA		83312	89409		...
OIO	D4TZ-18124-J		83308	...		...
OIO	D5TZ-18124-B		83308	...		...
OIO	D5TZ-18124-C		83312	89409		...
	D7HF-18125-AA		...	...	OIO	83215
OIO	D7HT-18124-BA		83312	89409		...
OIO	D7HT-18124-CA		83314	...		...
OIO	D7HT-18124-DA		83309	...		...
OIO	D7HT-18124-EA		83312	89409		...
OIO	D7HT-18124-FA		83312	89409		...
OIO	D7HT-18124-GA		83308	...		...
OIO	D7HT-18124-HA		83219	...		...
OIO	D7HT-18124-JA		83308	...		...
OIO	D7HT-18124-KA		85301	...		...
	D7HT-18125-BA		...	...	OIO	83217
	D7HT-18125-CA		...	...	OIO	83217
	D7HT-18125-DA		...	...	OIO	83215
	D7HT-18125-FA		...	...	OIO	83123
	D7HZ-18125-A		...	...	OIO	83215
OIO	D7TA-18124-GA		83314	...		...
	D7TZ-18125-C		...	...	OIO	83217
OIO	D8HZ-18124-A		85301	...		...
	D8HZ-18125-A		...	...	OIO	83209
	D8HZ-18125-B		...	...	OIO	83123
OIO	E0HZ-18124-A		83309	...		...
OIO	E1TA-18045-AA		83309	...		...

**APPLICATION GUIDE - TRUCKS, TRAILERS, AND BUSES**

Year Año Année	Model Modelo Modèle	OEM #	Front		Rear	
						
			Fleetline	GasSLX	Fleetline	GasSLX





**FORD(Cont'd.)**

**Additional O.E.M. Interchanges(Cont'd.)**

Models with O.E.M. Number							
E1TD-18045-AA	010	83309	...		...	...	
E5HT-18045-DA	010	85301	...		...	...	
E5HT-18045-EA	010	85301	...		...	...	
E6HZ-18124-D	010	85301	...		...	...	
E6HZ-18125-E		...	...	010	85315	...	
E6HZ-18125-F		...	...	010	85315	...	
E7XZ-18124-A	-10	G63386	...		...	...	
E7XZ-18124-B	-10	G63500	...		...	...	
E7XZ-18124-C	-10	G63511	...		...	...	
E7XZ-18124-D	-10	G63396	...		...	...	
E7XZ-18124-F	-10	G63398	...		...	...	
E7XZ-18124-G	-10	G63398	...		...	...	
E7XZ-18125-A		...	...	-10	G63350	...	
E7XZ-18125-B		...	...	-10	G63387	...	
E7XZ-18125-C		...	...	010	G63409	...	
E7XZ-18125-D		...	...	010	G63406	...	
E7XZ-18125-E		...	...	010	G63406	...	
E7XZ-18125-G		...	...	010	G63811	...	
E7XZ-18125-J		...	...	010	G63299	...	
E9HZ-18125-A		...	...	010	85716	...	
E9HZ-18125-AA		...	...	010	85716	...	
F0HS-18045-AA	010	85006	...		...	...	
F0HT-18045-AA	010	85006	...		...	...	
F0HZ-18124-A	010	85006	...		...	...	
F0HZ-18124-B	010	85006	...		...	...	
F1HT-18045-KB	010	85006	...		...	...	
F1HT-18045-LB	010	85006	...		...	...	
F1HZ-18124-AA	010	83309	...		...	...	
F1HZ-18124-B	010	83308	...		...	...	
F1HZ-18124-C	010	...	89402		...	...	
F1HZ-18124-D	010	85006	...		...	...	
F1HZ-18124-E	010	85006	...		...	...	
F1HZ-18124-F	010	85006	...		...	...	
F1HZ-18124-G	010	85006	...		...	...	
F1HZ-18124-H	010	85040	...		...	...	
F1HZ-18124-J	010	83308	...		...	...	
F1HZ-18124-K	010	...	89402		...	...	
F2HT-18045-DA	010	85006	...		...	...	
F2HT-18080-DA		...	...	010	85712	...	
F2HZ-18124-B	010	85301	...		...	...	
F2HZ-18124-C	010	85006	...		...	...	
F2HZ-18124-CA	010	85006	...		...	...	
F2HZ-18125-A		...	...	010	85712	...	
F2HZ-18125-AA		...	...	010	85712	...	
F4TA-18045-TA	010	G63455	...		...	...	
F4TA-18080-PA		...	...	010	G63461	...	
F4TZ-18124-D	-10	G63414	...		...	...	
F4TZ-18124-K	010	G63455	...		...	...	
F4TZ-18125-E		...	...	010	G63461	...	
F4TZ-18125-L		...	...	010	G63406	...	
F57Z-18125-AC		...	...	010	G63679	...	
F57Z-18125-BB		...	...	010	G63679	...	
F5HZ-18124-AA	010	83314	...		...	...	
F5HZ-18124-C	010	85063	...		...	...	
F5HZ-18124-DA	010	83125	...		...	...	



## APPLICATION GUIDE - TRUCKS, TRAILERS, AND BUSES

Year Año Année	Model Modelo Modèle	OEM #	Front		Rear	
						
			Fleetline	GasSLX	Fleetline	GasSLX

### FORD(Cont'd.)

#### Additional O.E.M. Interchanges(Cont'd.)

	Models with O.E.M. Number					
	F5HZ-18125-A		...	...	010	85314 89425
	F5HZ-18125-AA		...	...	010	85314 89425
	F5HZ-18125-B		...	...	010	85001 89410
	F5HZ-18125-BA		...	...	010	85001 89410
	F5TZ-18124-B	-10	G63608	...		...
	F5TZ-18125-BC		...	...	010	G63607 ...
	F5UZ-18124-A	01-	G63622	...		...
	F5UZ-18124-B	01-	G63622	...		...
	F5UZ-18125-A		...	...	-10	G63623 ...
	F5UZ-18125-C		...	...	-10	G63624 ...
	F6HT-18045-KA	010	...	89402		...
	F6HT-18045-MA	010	85006	...		...
	F6HT-18080-CA		...	...	010	85314 89425
	F6HT-18080-EA		...	...	010	85906 89407
	F6HT-18080-FC		...	...	010	85013 89414
	F6HZ-18124-B	010	83308	...		...
	F6HZ-18124-KA	010	...	89402		...
	F6HZ-18124-MA	010	85006	...		...
	F6HZ-18125-A		...	...	010	85314 89425
	F6HZ-18125-JA		...	...	010	85305 ...
	F77A-18045-AA	-10	G63608	...		...
	F77A-18080-AA		...	...	010	G63679 ...
	F77A-18080-BA		...	...	010	G63607 ...
	F77D-18080-BA		...	...	010	G63679 ...
	F7C2Z-18124-BR	-10	G63929	...		...
	F7TA-18045-AA	-10	G63608	...		...
	F7TA-18080-BA		...	...	010	G63607 ...
	F81D-18045-CD		...	...	010	83209 89414
	F81D-18080-CD		...	...	010	83122 89406
	F81Z-18124-AL	01-	G63622	...		...
	F81Z-18124-BK	010	G63809	...		...
	F81Z-18124-CA		...	...	010	83209 89414
	F81Z-18124-PA	010	85928	...		...
	F81Z-18125-FA		...	...	010	83122 89406
	F87A-18045-AH	-10	G63772	...		...
	F87A-18045-CC	-10	G63678	...		...
	F87A-18045-JA	-10	G63678	...		...
	F87A-18080-AC		...	...	010	G63773 ...
	F87A-18080-BC		...	...	010	G63773 ...
	F87Z-18124-AA	-10	G63772	...		...
	F87Z-18124-CA	-10	G63678	...		...
	F87Z-18124-JA	-10	G63678	...		...
	F87Z-18125-AA		...	...	010	G63773 ...
	F87Z-18125-BA		...	...	010	G63773 ...
	F87Z-18125-CA		...	...	010	G63773 ...
	F87Z-18125-RA		...	...	010	G63775 ...
	TACAA-18045-A	010	83216	...		...
	TANNA-18045-A	010	83312	89409		...
	TBDA-18080-A		...	...	010	83217 ...
	TBDA-18080-B		...	...	010	83217 ...
	TDAA-18080-B		...	...	010	83217 ...
	TDBA-18045-A	010	83219	...		...
	TDBA-18045-B	010	83219	...		...
	TDBA-18080-A		...	...	010	83217 ...
	TDBA-18080-B		...	...	010	83217 ...

## APPLICATION GUIDE - TRUCKS, TRAILERS, AND BUSES

Year Año Année	Model Modelo Modèle	OEM #	Front		Rear	
			Fleetline	GasSLX	Fleetline	GasSLX

### FORD(Cont'd.)

#### Additional O.E.M. Interchanges(Cont'd.)

Models with O.E.M. Number	TDBA-18080-C			...	...	010	83217	...
	TDBE-18045-A	010		83219	...		...	...
	TFAA-18045-B	010		83219	...		...	...
	TFAA-18045-C	010		83219	...		...	...
	TFAA-18080-A			...	...	010	85307	...
	THAB-18045-A	010		83219	...		...	...
	THAB-18045-B	010		83219	...		...	...
	TQSH-18045-A	010		83309	...		...	...
	XC45-18045-AA	010		83216	...		...	...
	XL24-18045-BA	-10		G63678	...		...	...
	XL24-18045-EA	-10		G63678	...		...	...
	XL24-18045-JA	-10		G63678	...		...	...
	XL24-18080-BA			...	...	010	G63679	...
	XL24-18080-CA			...	...	010	G63679	...
	XL24-18080-EA			...	...	010	G63679	...
	XL2Z-18124-BA	-10		G63678	...		...	...
	XL2Z-18124-EA	-10		G63678	...		...	...
	XL2Z-18124-JA	-10		G63678	...		...	...
	XL2Z-18125-BA			...	...	010	G63679	...
	XL2Z-18125-CA			...	...	010	G63679	...
	XL2Z-18125-EA			...	...	010	G63679	...
	XL58-18080-AC			...	...	010	G63773	...
	XL5Z-18125-AA			...	...	010	G63773	...
	YL5Z-18124-AA	-10		G63772	...		...	...
	Additional O.E.M. Interchanges	680029	010				85301	
C6PF-18077-DD		010				83216		
C6PF-18077-DE		010				83219		
C7PF-18077-Z		010				83217		

### FORD CAB SHOCKS

#### 8500 Series

Models with 101", 113" & 122" BBC Conventional Tractors with Link Cabmate Models FH101, FH1322 & FH1322-A	1201-1043		010	83025
	1202-1043		010	83025

#### 9500 Series

Models with 101", 113" & 122" BBC Conventional Tractors with Link Cabmate Models FH101, FH1322 & FH1322-A	1201-1043		010	83025
	1202-1043		010	83025
Models with O.E.M. Number	F6HZ-5K407-AB	010		83034
	F6HZ-5K407-BA	010		83033
	F8HT-5K407-AA	010		83033





#### Additional Applications

CL9000 & CLT9000 Cabover Tractors (Sleeper & Non-Sleeper) with Link Cabmate Model FCL110-2P	1202-0032		010	83016
Models with Link Cab Suspension	1202-0042		010	83025

#### L-Series Conventional

All with 60" Able Body Sleepers with Link Bunkmate Models FAS60-A & FAS60-AS	1201-1044		010	83025
	1202-1044		010	83025
L, LT, LN, LNT 800, 8000, 9000 Models, LTS, LS 8000, 9000 Models, & LTL, LL 9000 Models with Link Cabmate Model FN89-A	1201-0012		010	83023
	1202-0012		010	83023

## APPLICATION GUIDE - TRUCKS, TRAILERS, AND BUSES

Year Año Année	Model Modelo Modèle	OEM #	Front		Rear	
						
			Fleetline	GasSLX	Fleetline	GasSLX

### FOREST RIVER INC





#### Class A MotorHomes

<b>01 - 20</b>	Georgetown Series MotorHomes with Ford F53 Chassis with 16,000 lb GVW to 22,000 lb GVW	1C34-18045-AA 1C34-18045-JA 9U94-18045-AA 9U94-18080-AA 9U9Z-18124-A 9U9Z-18125-A ASH-1022 ASH-1023 ASH-1205 ASH-1206 ASH-1228 ASH-1229 ASH-1230 ASH-137 ASH-25822 ASH-25823 ASH-25824 ASH-294 AT-620 AT-621 AT-766	OIO	<b>83209</b>	<b>89414</b>		...	...
			OIO	<b>83209</b>	<b>89414</b>		...	...
			OIO	<b>83209</b>	<b>89414</b>		...	...
			OIO	...	...	OIO	<b>83122</b>	<b>89406</b>
			OIO	<b>83209</b>	<b>89414</b>		...	...
			OIO	...	...	OIO	<b>83122</b>	<b>89406</b>
			OIO	<b>83209</b>	<b>89414</b>		...	...
			OIO	...	...	OIO	<b>83122</b>	<b>89406</b>
			OIO	<b>83209</b>	<b>89414</b>		...	...
			OIO	<b>83209</b>	<b>89414</b>		...	...
			OIO	...	...	OIO	<b>83122</b>	<b>89406</b>
			OIO	...	...	OIO	<b>83122</b>	<b>89406</b>
			OIO	<b>83209</b>	<b>89414</b>		...	...
			OIO	<b>83209</b>	<b>89414</b>		...	...
			OIO	...	...	OIO	<b>83122</b>	<b>89406</b>
			OIO	<b>83209</b>	<b>89414</b>		...	...
			OIO	<b>83209</b>	<b>89414</b>		...	...
			OIO	...	...	OIO	<b>83122</b>	<b>89406</b>
			OIO	<b>83209</b>	<b>89414</b>		...	...
				Models with Workhorse UFO Chassis with Hendrickson Softek Front Suspension	66153-002	OIO	<b>83124</b>	<b>89407</b>
F4-BE5-C832-MO	OIO	<b>83124</b>			<b>89407</b>		...	...
<b>02 - 04</b>	Reflection Series MotorHomes with Freightliner XC Chassis ADL200 Suspension w/ 20K Rear AS120 Front Suspension  Rear Shock with O.E.M. Number  ZF - IFS Front Suspension with 23,000 lb GVW or Greater	16-16873-000		...	...	OIO	<b>85029</b>	...
		141700131810	OIO	<b>83160</b>	...		...	...
		16-16737-000	OIO	<b>83160</b>	...		...	...
		16-16874-000	OIO	<b>83160</b>	...		...	...
		141700131809		...	...	OIO	<b>85029</b>	...
		16-16736-000		...	...	OIO	<b>85029</b>	...
		16-18103-000	-IO	<b>85900</b>	...		...	...
		481700000493	-IO	<b>85900</b>	...		...	...
<b>02 - 06</b>	Tsunami Series MotorHomes with Freightliner XC Chassis ADL200 Suspension w/ 20K Rear AS120 Front Suspension  Rear Shock with O.E.M. Number  ZF - IFS Front Suspension with 23,000 lb GVW or Greater	16-16873-000		...	...	OIO	<b>85029</b>	...
		141700131810	OIO	<b>83160</b>	...		...	...
		16-16737-000	OIO	<b>83160</b>	...		...	...
		16-16874-000	OIO	<b>83160</b>	...		...	...
		141700131809		...	...	OIO	<b>85029</b>	...
		16-16736-000		...	...	OIO	<b>85029</b>	...
		16-18103-000	-IO	<b>85900</b>	...		...	...
		481700000493	-IO	<b>85900</b>	...		...	...

#### Class C MotorHomes

<b>2017</b>	All American Series MotorHomes with Ford E350 & E450 Chassis	ASH-1136		...	...	-IO	<b>83178</b>	...
		ASH-1154	-IO	<b>83177</b>	...		...	...
<b>17 - 20</b>	Forester GTS Series MotorHomes with Ford E350 & E450 Chassis	ASH-1136		...	...	-IO	<b>83178</b>	...
		ASH-1154	-IO	<b>83177</b>	...		...	...
<b>04 - 20</b>	Forester Series MotorHomes with Ford E350 & E450 Chassis	ASH-1136		...	...	-IO	<b>83178</b>	...
		ASH-1154	-IO	<b>83177</b>	...		...	...
<b>04 - 15</b>	Lexington Series MotorHomes with Ford E350 & E450 Chassis	ASH-1136		...	...	-IO	<b>83178</b>	...
		ASH-1154	-IO	<b>83177</b>	...		...	...
<b>15 - 20</b>	Sunseeker Grand Touring Series MotorHomes with Ford E350 & E450 Chassis	ASH-1136		...	...	-IO	<b>83178</b>	...

**APPLICATION GUIDE - TRUCKS, TRAILERS, AND BUSES**

Year Año Année	Model Modelo Modèle	OEM #	Front		Rear	
						
			Fleetline	GasSLX	Fleetline	GasSLX

**FOREST RIVER INC(Cont'd.)**

**Class C MotorHomes(Cont'd.)**

15 - 20	Sunseeker Grand Touring Series MotorHomes with Ford E350 & E450 Chassis	ASH-1154	-IO	83177	...		...	...
16 - 20	Sunseeker GTS Series MotorHomes with Ford E350 & E450 Chassis	ASH-1136		...	...	-IO	83178	...
		ASH-1154	-IO	83177	...		...	...
99 - 20	Sunseeker Series MotorHomes with Ford E350 & E450 Chassis	ASH-1136		...	...	-IO	83178	...
		ASH-1154	-IO	83177	...		...	...

**FREIGHTLINER**

**Argosy**

99 - 07	Models with 12000 lb Taperleaf Front Suspension	10-12703-000	OIO	85918	89449		...	...
		10-13634-000	OIO	85918	89449		...	...
		47170000449	OIO	85918	89449		...	...
99 - 07	Models with Freightliner FAS II Rear Air Suspension	16-13957-000		...	...	OIO	85724	89443
		16-15817-000		...	...	OIO	85724	89443
		680611		...	...	OIO	85724	89443
	Models with Freightliner FAS II Rear Air Suspension USA78015	680339		...	...	OIO	85724	89443
99 - 07	Models with Freightliner Low Profile Rear Air Suspension (18,000 to 40,000 lb)	16-14259-000		...	...	OIO	85331	...
		16-18706-000		...	...	OIO	85331	...
		471700002992		...	...	OIO	85331	...
		680511		...	...	OIO	85331	...
99 - 07	Models with Rear 10000 lb - 15000 lb Low Profile AirLiner	16-16577-000		...	...	OIO	85335	...
		16-18711-000		...	...	OIO	85335	...
		471700002996		...	...	OIO	85335	...

**Cargo - FC70 & FC80**

99 - 07	FC70 & FC80 Models with 10,000 to 18,000 lb Suspension	10-13759-000	OIO	85006	...		...	...
		471700003009	OIO	85006	...		...	...
		6803230300	OIO	85006	...		...	...
		GBL665538	OIO	85006	...		...	...
99 - 07	FC70 & FC80 Models with 6000 to 9000 lb Front Axle	654654	OIO	85043	...		...	...
		6803230200	OIO	85043	...		...	...
99 - 07	FC70 & FC80 Models with FAS II Rear Air Suspension	16-13957-000		...	...	OIO	85724	89443
		16-15817-000		...	...	OIO	85724	89443
		680611		...	...	OIO	85724	89443
	FC70 & FC80 Models with FAS II Rear Air Suspension USA78015	680339		...	...	OIO	85724	89443

**Cascadia**

09 - 17	113 Models with 12000 to 13300 lb Taperleaf Front Suspension	10-13809-000	OIO	85958	...		...	...
		SDA471700003920	OIO	85958	...		...	...
09 - 19	125 Models with 12000 to 13300 lb Taperleaf Front Suspension	10-13809-000	OIO	85958	...		...	...
		SDA471700003920	OIO	85958	...		...	...
2008	125 Models with 12000 to 13300 lb Taperleaf Front Suspension	10-13211-000	OIO	85918	89449		...	...
		10-13634-000	OIO	85918	89449		...	...
		471700000449	OIO	85918	89449		...	...
		471700131155	OIO	85918	89449		...	...
09 - 19	Models with Hendrickson Front Airtek	471700006269	OIO	85932	89453		...	...
		471700131331	OIO	85932	89453		...	...
		58913-003	OIO	85932	89453		...	...
		58913-003L	OIO	85932	89453		...	...
		58913-012	OIO	85932	89453		...	...
		58913-012L	OIO	85932	89453		...	...
08 - 20	Models with FAS II (40,000 lb) Rear Air Suspension	16-15817-000		...	...	OIO	85724	89443
		16-18708-000		...	...	OIO	85724	89443

## APPLICATION GUIDE - TRUCKS, TRAILERS, AND BUSES

Year Año Année	Model Modelo Modèle	OEM #	Front		Rear	
			Fleetline	GasSLX	Fleetline	GasSLX

### FREIGHTLINER(Cont'd.)

#### Cascadia(Cont'd.)

08 - 20	Models with FAS II (40,000 lb) Rear Air Suspension	47170002809	...	...	OIO	85724	89443
		48170006848	...	...	OIO	85724	89443
		680611	...	...	OIO	85724	89443
		SDA471700002809	...	...	OIO	85724	89443

#### Century Class - C112, C120, CST112 & CST120

00 - 11	Models with 12000 lb Taperleaf Front Suspension	10-13021-000	OIO	85918	89449	...	...
		10-13063-000	OIO	85918	89449	...	...
		10-13211-000	OIO	85918	89449	...	...
		10-13634-000	OIO	85918	89449	...	...
		47170000449	OIO	85918	89449	...	...
		471700131155	OIO	85918	89449	...	...
97 - 99	Models with 12000 lb Taperleaf Front Suspension	10-12542-000	OIO	85901	...	...	...
97 - 11	Models with FAS II Rear Air Suspension	16-13957-000	...	...	OIO	85724	89443
		16-15817-000	...	...	OIO	85724	89443
		16-18708-000	...	...	OIO	85724	89443
		471700002809	...	...	OIO	85724	89443
		481700006848	...	...	OIO	85724	89443
		680611	...	...	OIO	85724	89443
		SDA471700002809	...	...	OIO	85724	89443
	Models with FAS II Rear Air Suspension USA78015	680339	...	...	OIO	85724	89443
97 - 11	Models with Freightliner Low Profile Rear Air Suspension (18,000 to 40,000 lb)	16-14259-000	...	...	OIO	85331	...
		16-18706-000	...	...	OIO	85331	...
		471700002992	...	...	OIO	85331	...
		680511	...	...	OIO	85331	...
02 - 11	Models with Hendrickson Front Airtek	471700131331	OIO	85932	89453	...	...
		58913-003	OIO	85932	89453	...	...
		58913-003L	OIO	85932	89453	...	...
	Models with Low Profile Front	10-12703-000	OIO	85918	89449	...	...









#### Classic/ClassicXL

03 - 11	Models with 12000 lb Taperleaf Front Suspension	10-13021-000	OIO	85918	89449	...	...
		10-13063-000	OIO	85918	89449	...	...
		10-13211-000	OIO	85918	89449	...	...
		10-13634-000	OIO	85918	89449	...	...
		47170000449	OIO	85918	89449	...	...
		471700131155	OIO	85918	89449	...	...
03 - 11	Models with FAS II Rear Air Suspension	16-15817-000	...	...	OIO	85724	89443
		16-18708-000	...	...	OIO	85724	89443
		471700002809	...	...	OIO	85724	89443
		481700006848	...	...	OIO	85724	89443
		680611	...	...	OIO	85724	89443
		SDA471700002809	...	...	OIO	85724	89443
03 - 11	Models with Hendrickson Front Airtek	471700131331	OIO	85932	89453	...	...
		58913-003	OIO	85932	89453	...	...
		58913-003L	OIO	85932	89453	...	...
03 - 11	Models with O.E.M. Number	10-12032-002	OIO	85320	89429	...	...
		10-12032-004	OIO	85320	89429	...	...
		680009	OIO	85302	89420	...	...
		70029	OIO	85308	89422	...	...

#### Columbia

00 - 08	Models with 12000 lb Taperleaf Front Suspension	10-13021-000	OIO	85918	89449	...	...
		10-13063-000	OIO	85918	89449	...	...
		10-13211-000	OIO	85918	89449	...	...
		10-13634-000	OIO	85918	89449	...	...

## APPLICATION GUIDE - TRUCKS, TRAILERS, AND BUSES

Year Año Année	Model Modelo Modèle	OEM #	Front		Rear	
						
						
			Fleetline	GasSLX	Fleetline	GasSLX

### FREIGHTLINER(Cont'd.)

#### Columbia(Cont'd.)

00 - 08	Models with 12000 lb Taperleaf Front Suspension	10-13684-000 471700000449 471700131155	O O	85918	89449		...	...
			O O	85918	89449		...	...
			O O	85918	89449		...	...
09 - 18	Models with 12000 lb Taperleaf Front Suspension	10-13809-000 SDA471700003920	O O	85958	...		...	...
			O O	85958	...		...	...
00 - 17	Models with Hendrickson Front Airtek	471700006269 471700131331 58913-003 58913-003L 58913-012 58913-012L	O O	85932	89453		...	...
			O O	85932	89453		...	...
			O O	85932	89453		...	...
			O O	85932	89453		...	...
			O O	85932	89453		...	...
			O O	85932	89453		...	...
	Models with O.E.M. Number	471700000470	O O	85918	89449		...	...
00 - 18	All Models with Freightliner TuffTrac Rear Air Suspension	16-15770-000 481700125969		...	...	O O	85956	...
				...	...	O O	85956	...
00 - 18	Models with FAS II Rear Air Suspension	16-15817-000 16-18708-000 471700002808 471700002809 481700006848 680611 SDA471700002809		...	...	O O	85724	89443
				...	...	O O	85724	89443
				...	...	O O	85724	89443
				...	...	O O	85724	89443
				...	...	O O	85724	89443
				...	...	O O	85724	89443
				...	...	O O	85724	89443

#### Condor

01 - 07	Models with 14,600 to 20,000 lb Front Suspension	10-13211-000 10-13634-000 471700000449 471700131155	O O	85918	89449		...	...
			O O	85918	89449		...	...
			O O	85918	89449		...	...
			O O	85918	89449		...	...
01 - 07	Models with Chalmers 46,000 lb Rear Suspension	665174		...	...	O O	85060	...
01 - 07	Models with FAS II Rear Air Suspension	16-13957-000 16-15817-000 16-18708-000 471700002809 481700006848 680339 SDA471700002809		...	...	O O	85724	89443
				...	...	O O	85724	89443
				...	...	O O	85724	89443
				...	...	O O	85724	89443
				...	...	O O	85724	89443
				...	...	O O	85724	89443
				...	...	O O	85724	89443
01 - 07	Models with Freightliner TuffTrac Rear Air Suspension	16-15770-000 481700125969		...	...	O O	85956	...
				...	...	O O	85956	...
02 - 07	Models with Hendrickson HMX 400/460 Haulmax with 16.5" Saddle	60680-004 60680-004L H60680004		...	...	O -	83143	...
				...	...	O -	83143	...
				...	...	O -	83143	...
02 - 07	Models with Hendrickson HMX 400/460 Haulmax with 17.5" or 18.5" Saddle Height	60680-005 60680-005L HDR60680-005		...	...	O -	83142	...
				...	...	O -	83142	...
				...	...	O -	83142	...

#### Coronado

04 - 20	Models with 12,000 lb to 20,000 Front Axle	471700003920	O O	85958	...		...	...
10 - 20	Models with 12,000 lb to 20,000 Front Axle	10-13809-000	O O	85958	...		...	...
04 - 09	Models with 12000 lb Taperleaf Front Suspension	10-13211-000	O O	85918	89449		...	...
04 - 16	Models with Hendrickson Front Airtek	471700006269 471700131331 58913-003 58913-003L 58913-012 58913-012L	O O	85932	89453		...	...
			O O	85932	89453		...	...
			O O	85932	89453		...	...
			O O	85932	89453		...	...
			O O	85932	89453		...	...
			O O	85932	89453		...	...
04 - 14	Models with Chalmers 46,000 lb Rear Suspension	665174		...	...	O O	85060	...

## APPLICATION GUIDE - TRUCKS, TRAILERS, AND BUSES

Year Año Année	Model Modelo Modèle	OEM #	Front			Rear		
			Fleetline	GasSLX				

### FREIGHTLINER(Cont'd.)

#### Coronado(Cont'd.)

04 - 20	Models with FAS II (40,000 lb) Rear Air Suspension	16-15817-000 16-18708-000 471700002809 481700006848 680611 SDA471700002809		...	...	OIO	85724	89443
				...	...	OIO	85724	89443
				...	...	OIO	85724	89443
				...	...	OIO	85724	89443
				...	...	OIO	85724	89443
				...	...	OIO	85724	89443
04 - 18	Models with Freightliner TufTrac Rear Air Suspension	16-15770-000 481700125969		...	...	OIO	85956	...
				...	...	OIO	85956	...
				...	...	OIO	85956	...

#### FL50, 60, 70, 80 - Business Class

	FAS Airliner, Single / Tandem Past Production	16-11133-000		...	...	OIO	85007	...
92 - 06	FL Models with 15000 lb Rear Suspension	6803260000 GBL654725		...	...	OIO	83120	...
				...	...	OIO	83120	...
92 - 06	FL Models with 10,000 to 18,000 lb Suspension	10-13759-000 471700003009 6803230300 GBL665538	OIO	85006	...		...	...
			OIO	85006	...		...	
			OIO	85006	...		...	
			OIO	85006	...		...	
92 - 06	FL Models with 6000 to 9000 lb Front axle	654654 6803230200	OIO	85043	...		...	...
			OIO	85043	...		...	
92 - 06	FL Models with FAS II Rear Air Suspension	16-13957-000 16-15817-000 680611		...	...	OIO	85724	89443
				...	...	OIO	85724	89443
				...	...	OIO	85724	89443
	FL Models with FAS II Rear Air Suspension USA78015	680339		...	...	OIO	85724	89443









#### FLA & FLB Series - COE Truck & Tractor

89 - 02	COE Models	10-12030-002 10-12032-000 10-12032-001 10-12032-002 10-12032-003 10-12032-004	OIO	85320	89429		...	...
			OIO	85320	89429		...	
			OIO	85320	89429		...	
			OIO	85320	89429		...	
			OIO	85320	89429		...	
			OIO	85320	89429		...	
89 - 02	COE Models with Airliner Rolling Lobe Spring Air Suspension	16-13947-000 681-326-0400		...	...	-IO	85319	89428
				...	...	-IO	85319	89428
89 - 02	COE Models with Convoluted Spring Air Suspension	16-12117-000 16-18705-000 471700002990 665236		...	...	OIO	85007	...
				...	...	OIO	85007	...
				...	...	OIO	85007	...
				...	...	OIO	85007	...
89 - 02	COE Models with FAS II Rear Air Suspension	16-13957-000 16-15817-000 680339 680611		...	...	OIO	85724	89443
				...	...	OIO	85724	89443
				...	...	OIO	85724	89443
				...	...	OIO	85724	89443
	COE Models with Neway Tag Axle Air Suspension	90044162		...	...	OIO	83128	89436

#### FLC & FLD Series - 112 & 120 Conventional Truck & Tractor

00 - 11	Conventional Models with 12000 lb Taperleaf Front Suspension	10-13021-000 10-13063-000 10-13211-000 10-13634-000 471700000449 471700131155	OIO	85918	89449		...	...
			OIO	85918	89449		...	
			OIO	85918	89449		...	
			OIO	85918	89449		...	
			OIO	85918	89449		...	
			OIO	85918	89449		...	
- 1994	Conventional Models with Airliner Rolling Lobe Spring Air Suspension	16-13947-000 681-326-0400		...	...	-IO	85319	89428
				...	...	-IO	85319	89428
- 2008	Conventional Models with Convoluted Spring Air Suspension	16-12117-000 16-18705-000 471700002990 665236		...	...	OIO	85007	...
				...	...	OIO	85007	...
				...	...	OIO	85007	...
				...	...	OIO	85007	...

**APPLICATION GUIDE - TRUCKS, TRAILERS, AND BUSES**

Year Año Année	Model Modelo Modèle	OEM #	Front		Rear	
						
						
			Fleetline	GasSLX	Fleetline	GasSLX

**FREIGHTLINER(Cont'd.)**

**FLC & FLD Series - 112 & 120 Conventional Truck & Tractor(Cont'd.)**

- 2011	Conventional Models with FAS II Rear Air Suspension	16-13957-000		...	...	010	85724	89443
		16-18708-000		...	...	010	85724	89443
95 - 11	Conventional Models with FAS II Rear Air Suspension	16-15817-000		...	...	010	85724	89443
		471700002809		...	...	010	85724	89443
		481700006848		...	...	010	85724	89443
		680611		...	...	010	85724	89443
		SDA471700002809		...	...	010	85724	89443
	Conventional Models with FAS II Rear Air Suspension USA78015	680339		...	...	010	85724	89443
02 - 11	Conventional Models with Hendrickson Front Airtek	471700131331	010	85932	89453		...	...
		58913-003	010	85932	89453		...	...
		58913-003L	010	85932	89453		...	...
	Conventional Models with Neway Tag Axle Air Suspension	90044162		...	...	010	83128	89436
89 -	Conventional Models with O.E.M. Number	10-12030-002	010	85320	89429		...	...
		10-12032-000	010	85320	89429		...	...
		10-12032-001	010	85320	89429		...	...
		10-12032-002	010	85320	89429		...	...
		10-12032-003	010	85320	89429		...	...
		10-12032-004	010	85320	89429		...	...
09 - 11	Models with 12000 lb Taperleaf Front Suspension	10-13809-000	010	85958	...		...	...
		SDA471700003920	010	85958	...		...	...
08 - 11	Models with Freightliner TufTrac Rear Air Suspension	16-15770-000		...	...	010	85956	...
		481700125969		...	...	010	85956	...
		SDA481700125969		...	...	010	85956	...

**L - Line 8500 Series - Conventional Cab**

	LT 8500 Models with Freightliner TufTrac Rear Air Suspension	16-15770-000		...	...	010	85956	...
		481700125969		...	...	010	85956	...

**L - Line 9500 Series - Conventional Cab**

	LT 9500 Models with Freightliner TufTrac Rear Air Suspension	16-15770-000		...	...	010	85956	...
		481700125969		...	...	010	85956	...

**Legacy**





- 1998	Models with FAS II Rear Air Suspension	16-13957-000		...	...	010	85724	89443
1999 -	Models with FAS II Rear Air Suspension	16-15817-000		...	...	010	85724	89443
		680611		...	...	010	85724	89443
- 1998	Models with FAS II Rear Air Suspension USA78015	680339		...	...	010	85724	89443
	Models with O.E.M. Number	681-323-0900	-10	85009	...		...	...

**M2 - Business Class**

01 - 08	M2-106 Models with 10000 to 12000 lb. Taper-leaf Spring Suspension	10-12390-000	010	85920	89503		...	...
01 - 08	M2-106 Models with 6000 to 9000 lb Front axle	10-12388-000	010	85920	89503		...	...
09 - 20	M2-106 Models with 8000 to 16000 lb Front Axle and Taperleaf Spring	10-13760-000	010	85959	89503		...	...
		471700002991	010	85959	89503		...	...
		SDA471700002991	010	85959	89503		...	...
03 - 08	M2-112 Models with 12000 lb to 20000 Front Axle	10-13211-000	010	85918	89449		...	...
		10-13634-000	010	85918	89449		...	...
		471700000449	010	85918	89449		...	...
		471700131155	010	85918	89449		...	...
09 - 19	M2-112 Models with 12000 lb to 20000 Front Axle	10-13809-000	010	85958	...		...	...
		471700003920	010	85958	...		...	...
	Models O.E.M. Number	10-13592-000	010	85959	89503		...	...
		471700000440	010	85959	89503		...	...
01 - 20	Models with FAS II Rear Air Suspension	16-15817-000		...	...	010	85724	89443
		16-18708-000		...	...	010	85724	89443



**APPLICATION GUIDE - TRUCKS, TRAILERS, AND BUSES**

Year Año Année	Model Modelo Modèle	OEM #	Front			Rear		
							Fleetline	GasSLX

**FREIGHTLINER(Cont'd.)**









**M2 - Business Class(Cont'd.)**

01 - 20	Models with FAS II Rear Air Suspension	47170002809	...	...	0 0	85724	89443
		48170006848	...	...	0 0	85724	89443
		680611	...	...	0 0	85724	89443
		SDA47170002809	...	...	0 0	85724	89443
01 - 15	Models with Freightliner Low Profile Rear Air Suspension (18,000 to 40,000 lb)	16-14259-000	...	...	0 0	85331	...
		16-18706-000	...	...	0 0	85331	...
		47170002992	...	...	0 0	85331	...
		680511	...	...	0 0	85331	...
01 - 19	Models with Freightliner TufTrac Rear Air Suspension	16-15770-000	...	...	0 0	85956	...
		481700125969	...	...	0 0	85956	...
- 2020	Models with Hendrickson HMX 400/460 Haulmax with 16.5" Saddle	60680-004	...	...	0 -	83143	...
		60680-004L	...	...	0 -	83143	...
		H60680004	...	...	0 -	83143	...
- 2020	Models with Hendrickson HMX 400/460 Haulmax with 17.5" or 18.5" Saddle Height	60680-005	...	...	0 -	83142	...
		60680-005L	...	...	0 -	83142	...
		HDR60680-005	...	...	0 -	83142	...
2001 -	Models with Rear 10000 lb - 15000 lb Low Profile AirLiner	16-16577-000	...	...	0 0	85335	...
		16-18711-000	...	...	0 0	85335	...
		47170002996	...	...	0 0	85335	...
01 - 14	Models with Rear 52" Spring ,10000 lb - 15000 lb	16-16486-000	...	...	- 0	83134	...
		16-18710-000	...	...	- 0	83134	...
		47170002995	...	...	- 0	83134	...
01 - 14	Models with Rear 52" Spring ,18000 lb - 23000 lb	16-16442-000	...	...	- 0	83134	...
		16-18709-000	...	...	- 0	83134	...
		47170002994	...	...	- 0	83134	...
2001 -	Models with Rear 60" Spring ,18000 lb - 23000 lb	16-15765-000	...	...	- 0	85921	...
		16-18707-000	...	...	- 0	85921	...
		47170002993	...	...	- 0	85921	...

**Severe Duty Series - 108SD, 114SD & 122SD**

12 - 19	All Models with 12,000 to 16,000 lb. Front Axle and Taperleaf Spring	10-13760-000	0 0	85959	89503	...	...
		47170002991	0 0	85959	89503	...	...
12 - 19	All Models with 12000 lb to 20000 lb Front Axle	10-13809-000	0 0	85958	...	...	...
		47170003920	0 0	85958	...	...	...
12 - 20	All Models with 18,000 lb Flat Leaf Spring	10-13684-000	0 0	85918	89449	...	...
		47170000470	0 0	85918	89449	...	...
12 - 14	All Models with O.E.M. Number	10-13934-000	0 -	85123	...	...	...
		47170006929	0 -	85123	...	...	...
12 - 20	All Models with FAS II (40,000 lb) Rear Air Suspension	16-15817-000	...	...	0 0	85724	89443
		16-18708-000	...	...	0 0	85724	89443
		47170002809	...	...	0 0	85724	89443
		48170006848	...	...	0 0	85724	89443
		680611	...	...	0 0	85724	89443
12 - 19	All Models with Freightliner TufTrac Rear Air Suspension	16-15770-000	...	...	0 0	85956	...
		481700125969	...	...	0 0	85956	...
12 - 20	All Models with Hendrickson HMX 400/460 Haulmax - with 16.5" Saddle	60680-004	...	...	0 -	83143	...
		60680-004L	...	...	0 -	83143	...
12 - 20	Models with Hendrickson HMX 400/460 Haulmax with 17.5" or 18.5" Saddle Height	60680-005	...	...	0 -	83142	...
		60680-005L	...	...	0 -	83142	...
		HDR60680-005	...	...	0 -	83142	...

**APPLICATION GUIDE - TRUCKS, TRAILERS, AND BUSES**

Year Año Année	Model Modelo Modèle	OEM #	Front		Rear	
						
						
			Fleetline	GasSLX	Fleetline	GasSLX

**FREIGHTLINER(Cont'd.)**

**Additional O.E.M. Interchanges(Cont'd.)**

	Models with 7000 lb Front Suspension	10-13776-000	○ ○	<b>85005</b>	<b>89430</b>		...	...
	Models with Neway Air Suspension with shock stamping	90045083		...	...	○ ○	<b>85910</b>	...
	Models with O.E.M. Number	10-12046-000	○ ○	<b>85320</b>	<b>89429</b>		...	...
		10-12396-000	○ ○	<b>85918</b>	<b>89449</b>		...	...
		10-13051-001	○ ○	<b>85005</b>	<b>89430</b>		...	...
		10-13859-000	○ ○	<b>85005</b>	<b>89430</b>		...	...
		16-10688-000		...	...	○ ○	<b>85042</b>	...
		16-14577-000	○ ○	<b>85043</b>	...		...	...
		16-14667-000		...	...	○ ○	<b>85005</b>	<b>89430</b>
		16-14668-000		...	...	○ ○	<b>83127</b>	...
		16-14669-000	○ ○	<b>G63403</b>	...		...	...
		16-14759-000	○ ○	<b>85000</b>	<b>89436</b>		...	...
		16-15591-000		...	...	○ ○	<b>85043</b>	...
		16-16765-000		...	...	○ ○	<b>85006</b>	...
		16-16826-000	○ ○	<b>85904</b>	...		...	...
		16-17211-000		...	...	○ ○	<b>85909</b>	...
		16-17759-000		...	...	○ ○	<b>85919</b>	...
		16-19138-000	○ ○	<b>85058</b>	<b>89431</b>		...	...
		3638112		...	...	○ ○	<b>G63183</b>	...
		4036892	○ ○	<b>G63605</b>	...		...	...
		47902-13		...	...	○ ○	<b>83122</b>	<b>89406</b>
		535228	○ ○	<b>85302</b>	<b>89420</b>		...	...
		61300224	○ ○	<b>85918</b>	<b>89449</b>		...	...
		61300240	○ ○	<b>85918</b>	<b>89449</b>		...	...
		650224		...	...	○ ○	<b>83225</b>	...
		651352		...	...	○ ○	<b>85042</b>	...
		654875		...	...	○ ○	<b>83117</b>	...
		654918	○ ○	<b>83118</b>	...		...	...
		659060	○ ○	<b>85920</b>	<b>89503</b>		...	...
		659062		...	...	- ○	<b>83134</b>	...
		659063		...	...	- ○	<b>83134</b>	...
		659300	○ ○	<b>85005</b>	<b>89430</b>		...	...
		660235		...	...	○ ○	<b>85042</b>	...
		665409	- ○	<b>85009</b>	...		...	...
		671908	○ ○	<b>85918</b>	<b>89449</b>		...	...
	671945	○ ○	<b>85920</b>	<b>89503</b>		...	...	
	671946		...	...	- ○	<b>85921</b>	...	
	680009	○ ○	<b>85302</b>	<b>89420</b>		...	...	
	680442		...	...	- ○	<b>85319</b>	<b>89428</b>	
	680651		...	...	○ ○	<b>85335</b>	...	
	680782	○ ○	<b>85302</b>	<b>89420</b>		...	...	
	6813230900	- ○	<b>85009</b>	...		...	...	
	70042	○ ○	<b>85302</b>	<b>89420</b>		...	...	
	SDA471700000440	○ ○	<b>85959</b>	<b>89503</b>		...	...	
	Additional O.E.M. Interchanges	10-13205-000	○ ○	<b>85918</b>	<b>89449</b>		...	...
		471700131646	○ ○	<b>85918</b>	<b>89449</b>		...	...
		680008	○ ○	85300 or 89419				
		680017	○ ○	85302 or 89420				
	681-323-1100	○ ○	85301					

**FREIGHTLINER CAB SHOCKS**

**Argosy**

<b>00 - 06</b>	Models with O.E.M. Number	18-37813-000	○ ○	<b>83044</b>			
----------------	---------------------------	--------------	-----	--------------	--	--	--

## APPLICATION GUIDE - TRUCKS, TRAILERS, AND BUSES

Year Año Année	Model Modelo Modèle	OEM #	Front		Rear	
			Fleetline	GasSLX	Fleetline	GasSLX

### FREIGHTLINER CAB SHOCKS(Cont'd.)

#### Cascadia(Cont'd.)

17 - 20	Day Cab and Sleeper cabs w/OEM Number and 12 mm Top mounting bolt	18-67845-000	010	83906
		18-69674-000	010	83906
		814903012666	010	83906
		814903015188	010	83906
09 - 19	Models with 72" High-Roof Sleeper and 1/2" Top mounting bolt	18-41762-000	010	83038
		18-60764-000	010	83038
		814903003528	010	83038

#### Century Class

	Day Cab Suspensions with O.E.M. Number	18-32999-001	010	83006
	Models with O.E.M. Number	18-41762-000	010	83038
		18-41762-001	010	83047
		18-41762-002	010	83038
	Sleeper-Cabs with O.E. Number	18-30378-000	010	83001
		18-32999-000	010	83001

#### Classic

	Models with O.E.M. Number	18-29846-000	010	83009
--	---------------------------	--------------	-----	-------

#### Columbia

	Models with O.E.M. Number	18-29846-000	010	83009
00 - 17	Models with Sleeper Cabs w/O.E.M. Numbers	18-41762-000	010	83038
		18-60764-000	010	83038
		814903003528	010	83038
17 - 18	Models with Sleeper Cabs w/O.E.M. Numbers	18-69674-000	010	83906
		814903015188	010	83906

#### Coronado

17 - 20	Day Cab and Sleeper Cabs w/O.E.M. Numbers	18-69674-000	010	83906
		814903015188	010	83906
04 - 17	Models with Sleeper Cabs w/O.E.M. Numbers	18-41762-000	010	83038
		18-41762-002	010	83038
		18-60764-000	010	83038
		18-60765-002	010	83038
		814903003528	010	83038

#### FL 60, 70, 80 & 106 Series - Business Class Conventional

	Models with O.E.M. Number	18-30378	010	83006
1991 -	Trucks with Link Cabmate Models FRT153BC-A , FRT106BC or FRT106HD-A	1201-0054	010	83021
		1202-0054	010	83021

#### FL112 Conventional

1997 -	FL112 Business Class Day Cab Tractors with Link Cabmate Model FRT112DC	1202-1044	010	83025
--------	--	-----------	-----	-------

#### FLA - COE Truck & Tractors

1989 -	Cabover Tractors with 86", 96" & 104" Cabs with Link Cabmate Model FRT285	1202-0032	010	83016
	Models with O.E.M. Number	681-891-02-05	010	83017





#### FLB - COE Truck & Tractors

1993 -	90", 100", & 110" Cabs with Link Cabmate Models FRT46-2P-A or FRT46-2P-B	1201-0054	010	83021
1984 -	Cabover Tractors with 86", 96" & 104" Cabs with Link Cabmate Model FRT285	1202-0032	010	83016
		Cabover Tractors with the rear cab mounts having a center to center measurement of 50" or 54" & with Link Cabmate Models FRT50-2P-C	1202-0054	010

#### FLC - 112 & 120 Conventional Tractors

1989 -	Conventional Tractors with Link Cabmate Model FRTE120-A	1201-1043	010	83025
		1202-1043	010	83025
1997 -	FL112 Models Business Class Day Cab Models with Link Cabmate Model FRT112DC	1201-1044	010	83025

**APPLICATION GUIDE - TRUCKS, TRAILERS, AND BUSES**

Year Año Année	Model Modelo Modèle	OEM #	Front		Rear	
						
			Fleetline	GasSLX	Fleetline	GasSLX

**FREIGHTLINER CAB SHOCKS(Cont'd.)**

**FLC - 112 & 120 Conventional Tractors(Cont'd.)**

- 03/88	Models with Link Cabmate FRTC120-A or FRTC120-AW Air Suspension	1201-0012	010	83023
		1202-0012	010	83023

**FLD 112 & 120 Conventional Truck & Tractor**

	FLD Sleeper with Air Suspension	18-29846-000	010	83009
--	---------------------------------	--------------	-----	-------

**FLD Series - 112 & 120 Conventional Truck & Tractor**

09/93 -	64" Able Body Sleepers with Link Bunkmate Models FRTA64 or FRTAS64-A	1202-1044	010	83025
1989 -	Conventional Tractors with Link Cabmate Model FRTE120-A	1202-1043	010	83025
	D2 Cab	18-41762-001	010	83047
		18-60765-001	010	83047
		814903003486	010	83047
	FLD112 Daycab with Air Suspension	18-31476-000	010	83020

**M2 - Business Class**

02 - 20	M2-106 Models with Spring Suspension	18-47350-000	010	83040
		18-60766-000	010	83040
		814903003482	010	83040
03 - 16	M2-112 Crew Cab Models with O.E.M. Number	18-41762-000	010	83038
		18-60764-000	010	83038
		814903003528	010	83038
03 - 18	M2-112 Day Cab Models with Leaf Spring Suspensions	18-47349-000	010	83039
		18-60767-000	010	83039
		814903003483	010	83039





**Severe Duty Series - 108SD, 114SD & 122SD**

12 - 19	108 SD Models with O.E.M. Number	18-60766-000	010	83040
		814903003482	010	83040
12 - 19	114 SD Models with O.E.M. Number	18-60766-000	010	83040
		814903003482	010	83040
12 - 16	122 SD Crew Cab Models with O.E.M. Number	18-60764-000	010	83038
		814903003528	010	83038
17 - 19	Models with O.E.M. Numbers	18-69674-000	010	83906
		814903015188	010	83906

**Additional Applications**

	Models with 60" Sleeper w/ Link Bunkmate Model FRTS60-A	1202-1043	010	83025
	Models with Link Cab Suspension	1202-0042	010	83025
		1202-0043	010	83025
		1202-0044	010	83025
	Models with O.E.M. Number	18-42613-000	010	83033
		18-44321-000	010	83009
		18-45067-000	010	83034
		18-60295-000	010	83006
		18-60765-000	010	83038
		18-60769-000	010	83009
		18-60772-000	010	83026
		18-60773-000	01-	83027
		654739	010	83009
		654819	010	83001
		654831	010	83006
		654841	010	83020
		654990	010	83038
		659079	010	83040
		659080	010	83039
		659125	010	83047
659178	010	83038		
659288	010	83006		

## APPLICATION GUIDE - TRUCKS, TRAILERS, AND BUSES

Year Año Année	Model Modelo Modèle	OEM #	Front		Rear	
			 Fleetline	 GasSLX	 Fleetline	 GasSLX

### FREIGHTLINER CAB SHOCKS(Cont'd.)

#### Additional Applications(Cont'd.)

Models with O.E.M. Number	814903003496	OIO	<b>83009</b>
	GBL 650361	OIO	<b>83017</b>

### FREIGHTLINER CUSTOM CHASSIS

05 - 18	B2 Bus Chassis	10-13211-000	OIO	85918	89449		...	...
		10-13634-000	OIO	85918	89449		...	...
05 - 19	B2 Bus Chassis With FAS II Rear Air Suspension	16-15817-000		...	...	OIO	85724	89443
		16-18708-000		...	...	OIO	85724	89443
97 - 08	F65 School bus chassis with 10,000 to 18,000 lb Suspension	10-13759-000	OIO	85006	...		...	...
		471700003009	OIO	85006	...		...	...
		6803230300	OIO	85006	...		...	...
		GBL665538	OIO	85006	...		...	...
97 - 08	F65 School bus chassis with Taperleaf Spring	6803260000		...	...	OIO	83120	...
		GBL654725		...	...	OIO	83120	...
	FB Shuttle bus chassis with O.E.M. Number	16-16765-000	OIO	85006	...		...	...
		471700131775	OIO	85006	...		...	...
	FedEx Trucks with O.E.M. Number	MAE16950	OIO	83118	...		...	...
		P117146	OIO	83118	...		...	...
	Fleetwood Motor Home with O.E.M. Number	GBL 651375	OIO	83119	...		...	...
		RW24285	OIO	83119	...		...	...
06 - 08	Front - Engine Diesel Chassis (FRED Chassis)	16-18455-000	OIO	85918	89449		...	...
		471700002726	OIO	85918	89449		...	...
	MB Chassis (VIP bus)	16-16827-000		...	...	OIO	85331	...
		16-17760-000		...	...	OIO	85331	...
		471700131778		...	...	OIO	85331	...
	MB55 & MT55 Models	16-17684-000	OIO	85058	89431		...	...
	MB55 Chassis	16-17759-000	OIO	85919	...		...	...
		471700000447	OIO	85919	...		...	...
	MB55 Shuttle bus w/8000 lb. flat leaf front suspension	16-15676-000	OIO	85058	89431		...	...
96 - 99	MC Chassis for Class A Motorhomes	654918	OIO	83118	...		...	...
		P117099		...	...	OIO	83120	...
		P117146	OIO	83118	...		...	...
	MC Chassis with Hendrickson Softek Front Suspension	16-18094-000	OIO	85959	...		...	...
		471700000466	OIO	85959	...		...	...
	MC Chassis with O.E.M. Number	16-18456-000		...	...	OIO	85959	...
		471700002727		...	...	OIO	85959	...
	MC-L Chassis with 9,000 lb Suspension	16-18455-000	OIO	85918	89449		...	...
		471700002726	OIO	85918	89449		...	...
	M-Line Walk in Van with O.E.M. Number	MAE 16949		...	...	OIO	83120	...
		MAE 16950	OIO	83118	...		...	...
		P117099		...	...	OIO	83120	...
		P117146	OIO	83118	...		...	...
05 - 18	Models with B2 Bus Chassis & 15000 lb Rear Suspension	6803260000		...	...	OIO	83120	...
		P116168		...	...	OIO	83117	...
	Motor Homes with O.E.M. Number	16-15475-000	OIO	83164	...		...	...
	MT135	GBL654875		...	...	OIO	83117	...
	MT45 Step Van	16-15064-000		...	...	OIO	83154	...
	MT45 Step Van - Rear - w/38" Front Spring	16-15394-000		...	...	OIO	83120	...
		16-15089-000	OIO	83164	...		...	...
	MT55 Step Van	16-15436-000		...	...	OIO	83154	...
		16-16542-000		...	...	OIO	83154	...
99 - 11	MT55 Step Van	16-15705-000		...	...	OIO	83120	...
		16-15934-000		...	...	OIO	83120	...
		16-16262-000		...	...	OIO	83120	...

## APPLICATION GUIDE - TRUCKS, TRAILERS, AND BUSES

Year Año Année	Model Modelo Modèle	OEM #	Front		Rear	
			Fleetline	GasSLX	Fleetline	GasSLX

### FREIGHTLINER CUSTOM CHASSIS(Cont'd.)

	MT55 Step Van - w/38" Front Spring	16-15089-000	010	83164	...		...	...
	MT55 Utility Van w/8000 lb. flat leaf front suspension	16-15676-000	010	85058	89431		...	...
	Oshkosh Motor Home with O.E.M. Number	1398980		83127	...	010	83127	...
		GBL654875		...	...	010	83117	...
	School Bus Chassis with 7,000 lb Suspension	10-13859-000	010	85005	89430		...	...
		471700005079	010	85005	89430		...	...
	Shuttle Bus Chassis	16-16082-000	010	85043	...		...	...
	Step Van and Motorhome chassis with O.E.M. Number	16-15475-000	010	83164	...		...	...
	Step Van Models with O.E.M. Number	16-19138-000	010	85058	89431		...	...
		471700003011	010	85058	89431		...	...
09-12	Type C School bus chassis with O.E.M. Number	16-18713-000		...	...	01-	85122	...
		471700003070		...	...	01-	85122	...
03 - 07	VC Chassis							
	ADL200 Suspension w/ 20K Rear	16-16873-000		...	...	010	85029	...
		471700131974		...	...	010	85029	...
	Rear Shock with O.E.M. Number	141700131809		...	...	010	85029	...
		16-16736-000		...	...	010	85029	...
	ZF - IFS Front Suspension with 23,000 lb GVW or Greater	16-18103-000	-1-	85900	...		...	...
		481700000493	-1-	85900	...		...	...
93 - 07	VC Chassis (Up To 22000 lb GVW) AS120 Front Suspension	16-16737-000	010	83160	...		...	...
	XC & XB MotorHome Chassis with Neway AS-120, 12,000 lb Front Air Suspension	141700000378	010	83160	...		...	...
		141700131975	010	83160	...		...	...
		16-16874-000	010	83160	...		...	...
		16-18076-000	010	83160	...		...	...
03 - 07	XC Chassis							
	ADL200 Suspension w/ 20K Rear	16-16873-000		...	...	010	85029	...
	AS120 Front Suspension	141700131810	010	83160	...		...	...
		16-16737-000	010	83160	...		...	...
		16-16874-000	010	83160	...		...	...
	Rear Shock with O.E.M. Number	141700131809		...	...	010	85029	...
		16-16736-000		...	...	010	85029	...
	ZF - IFS Front Suspension with 23,000 lb GVW or Greater	16-18103-000	-1-	85900	...		...	...
		481700000493	-1-	85900	...		...	...
93 - 07	XC Chassis (Up To 22000 lb GVW) AS120 Front Suspension	16-16737-000	010	83160	...		...	...
	XC MotorHome Chassis with ZF- IFS, 12,000 lb Front Air Suspension	16-17144-000	-1-	85900	...		...	...
		16-17361-000	-1-	85900	...		...	...
		481700000477	-1-	85900	...		...	...
		481700131919	-1-	85900	...		...	...
00 - 02	XCS Chassis (22000 lb GVW) w/ O.E.M. Number	16-15592-000	01-	83154	...		...	...
		16-15755-000	010	85043	...		...	...
		16-16043-000	010	85043	...		...	...
01 - 02	XCS Chassis with Freightliner Rear Air Suspension	16-16093-000	010	83160	...		...	...
	Models with O.E.M. Number	16-14794-000		...	...	01-	83154	...
		16-16083-000		...	...	010	85331	...
		16-16836-000		...	...	01-	83154	...
		654953	010	85058	89431		...	...
		659227	010	85058	89431		...	...
		GBL654918	010	83118	...		...	...
	Additional O.E.M. Interchanges	1745500	010	89430				
		665545401	010	89430				
	Models with O.E.M. Number	16-15805-000		...	...	01-	83120	...

## APPLICATION GUIDE - TRUCKS, TRAILERS, AND BUSES

Year Año Année	Model Modelo Modèle	OEM #	Front			Rear		
						Fleetline	GasSLX	Fleetline

### FRUEHAUF

	"L" Suspensions	UCD-006216-001		...	...	010	83203	89436
	"T" Suspensions	UCE-1295-901		...	...	010	85300	89419
	"T" Suspensions With Drop Frame ( NT Construction )	UCF-8339-001		...	...	010	85321	...
		UCF-8339-002		...	...	010	85321	...
	All with Air Suspension and O.E.M. Number	UCE-1295-1		...	...	010	85300	89419
	All with Lift Axle	UCE-9399-1		...	...	010	83122	89406
	Model UCA-5431	5352858		...	...	010	85305	...
	Model W24T1 Air Ride	UCE-2983-000		...	...	010	85322	...
		UCE-2983-001		...	...	010	85322	...
	Tractor & Trailer Lift Axle with O.E.M. Number	5116-117		...	...	010	83122	89406
	Models with O.E.M. Number	144-5910		...	...	010	85300	89419
		680117		...	...	010	85300	89419
		680298		...	...	010	85321	...
		UCA-01113		...	...	010	85304	...
		UCA-5431		...	...	010	85305	...
		UCD-6216-1		...	...	010	83203	89436
		UCE-2983-1		...	...	010	85322	...
		UEY 1124-001		...	...	010	85030	89440

### FWD TRUCK

	Models with O.E.M. Number	450739	010	85302	89420	...	...
--	---------------------------	--------	-----	-------	-------	-----	-----

### GENERAL TRAILER CO

	Models with Air Suspension	120-1		...	...	010	83125	...
	Additional O.E.M. Interchanges	12608	010	83125				

### GEORGIE BOY MANUFACTURING

	Models with Workhorse UFO Chassis with Hendrickson Softek Front Suspension	66153-002	010	83124	89407	...	...
		F4-BE5-C832-MO	010	83124	89407	...	...





### Class A MotorHomes

<b>99 - 09</b>	All Series MotorHomes with Ford F53 Chassis with 16,000 lb GVW to 22,000 lb GVW	1C34-18045-AA	010	83209	89414	...	...
		1C34-18045-JA	010	83209	89414	...	...
		9U94-18045-AA	010	83209	89414	...	...
		9U94-18080-AA		...	...	010	83122 89406
		9U9Z-18124-A	010	83209	89414	...	...
		9U9Z-18125-A		...	...	010	83122 89406
		ASH-1022	010	83209	89414	...	...
		ASH-1023		...	...	010	83122 89406
		ASH-1205	010	83209	89414	...	...
		ASH-1206		...	...	010	83122 89406
		ASH-1228	010	83209	89414	...	...
		ASH-1229	010	83209	89414	...	...
		ASH-1230		...	...	010	83122 89406
		ASH-137		...	...	010	83122 89406
		ASH-25822	010	83209	89414	...	...
		ASH-25823	010	83209	89414	...	...
		ASH-25824		...	...	010	83122 89406
		ASH-294	010	83209	89414	...	...
		AT-620	010	83209	89414	...	...
		AT-621		...	...	010	83122 89406
		AT-766	010	83209	89414	...	...

### Class C MotorHomes

<b>99 - 09</b>	Maverick Series MotorHomes with Ford E450 Chassis	ASH-1136		...	...	-10	83178	...
		ASH-1154	-10	83177	...	...	...	...

**APPLICATION GUIDE - TRUCKS, TRAILERS, AND BUSES**

Year Año Année	Model Modelo Modèle	OEM #	Front		Rear	
						
			Fleetline	GasSLX	Fleetline	GasSLX

**GILLIG BROS.**

	Models with Neway ARD-234 Models Truck & Tractor Air Suspension (ARD-234-6)	90044046		...	...	010	<b>83123</b>	<b>89405</b>	
	Phantom Models (30 Foot) with O.E.M. Number	90-2164 SP1	01-	<b>85723</b>	...		...	...	
<b>00 - 11</b>	Phantom Models with O.E.M. Number	90-2627		...	...	010	...	<b>89461</b>	
	School Bus w/1" Mounting Pins	200-171 53-176		<b>85304</b>	...	010	<b>85304</b>	...	
	School Bus w/3/4" Mounting Pins	57113 57131	010	<b>83219</b>	...		...	...	
	Transit Bus, Phantom 55, 40, TB40	53-14010 53-24685 695110 90F-1912	01-	...	...	-1-	<b>85318</b>	...	
	Models with O.E.M. Number	1583470 695109 82-01878 90044683 90044769 90044770 90-1951-SP1 90-1968 90-2423 H53-02132-14005 H53-20415-006 MR6394	01-	...	...	010	<b>85051</b>	...	
	Additional O.E.M. Interchanges	53-02132 53-02133-000 53-13952-000 53-14005-000 665568 680009 680333 70034 82-21542-000 82-30159-000 90-1908	01-	<b>85723</b>					...
				...	...	-1-	<b>85318</b>	...	
			01-	<b>85722</b>					...
			01-	<b>85723</b>					...
				...	...	010	<b>85051</b>	...	
			010	<b>85302 or 89420</b>					...
			-1-	<b>85708</b>					...
			010	<b>85302 or 89420</b>					...
			010	<b>85716</b>					...
			-1-	<b>85708</b>					...
			01-	<b>85723</b>					...



**GLAVAL BUS CO.**

**Concorde II - Series**

<b>00 - 15</b>	Models with F-650 chassis with 10,000 lb Front Suspension	3584116C1 3584116C2 4C4Z-18124-QA AA-616	010	<b>83175</b>	...		...	...
			010	<b>83175</b>	...		...	...
			010	<b>83175</b>	...		...	...
			010	<b>83175</b>	...		...	...
<b>00 - 15</b>	Models with F-650 chassis with 12,000 & 13,200 lb Front Springs	3584118C2 4C4Z-18124-JB 4C4Z-18124-RA AA-617 AT-812	010	<b>85928</b>	...		...	...
			010	<b>85928</b>	...		...	...
			010	<b>85928</b>	...		...	...
			010	<b>85928</b>	...		...	...
			010	<b>85928</b>	...		...	...
<b>July/2015 - 20</b>	Models with F-650 chassis with 13,500, 15,500 & 19,000 lb Multi-leaf Rear Springs	471700011531 ASH-24660 FC44-18080-AB FC4Z-18125-A		...	...	010	<b>85180</b>	...
				...	...	010	<b>85180</b>	...
				...	...	010	<b>85180</b>	...
				...	...	010	<b>85180</b>	...
<b>July/2015 - 20</b>	Models with F-650 chassis with 19.5" or 22.5" Wheels (22,000 lb GVW)	471700011530 ASH-24658 ASH-24659	010	<b>85181</b>	...		...	...
			010	<b>85181</b>	...		...	...
			010	<b>85181</b>	...		...	...

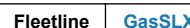

## APPLICATION GUIDE - TRUCKS, TRAILERS, AND BUSES

Year Año Année	Model Modelo Modèle	OEM #	Front		Rear	
						
			Wrench	Wrench	Wrench	Wrench
			Fleetline	GasSLX	Fleetline	GasSLX

### GLAVAL BUS CO.(Cont'd.)

#### Concorde II - Series(Cont'd.)

July/2015 - 20	Models with F-650 chassis with 19.5" or 22.5" Wheels (22,000 lb GVW)	FC44-18045-BB	010	85181	...	...	...	...
			010	85181	...	...	...	
			010	85181	...	...	...	
- 2015	Models with F-650 chassis with 21,000 lb Rear Air Suspension	3578858C1 3578858C2 4C4Z-18125-DA	...	...	010	85926	...	...
			...	...	010	85926	...	...
			...	...	010	85926	...	...
04 - 11	Models with F-650 chassis with 22,000 lb Multi-leaf Rear Springs	4C4Z-18125-B 501906C92	...	...	-10	83317	...	...
			...	...	-10	83317	...	...

#### E350 & E450 Ford Chassis Models

- 2020	Primetime Series Shuttle buses with Ford E350 Chassis	ASH-1136 ASH-1154	...	...	-10	83178	...	...
			-10	83177	...	...	...	
- 2020	Sport Series Shuttle buses with Ford E350 Chassis	ASH-1136 ASH-1154	...	...	-10	83178	...	...
			-10	83177	...	...	...	
- 2020	Universal Series Shuttle buses with Ford E350 & E450 Chassis	ASH-1136 ASH-1154	...	...	-10	83178	...	...
			-10	83177	...	...	...	

### GMC TRUCK

		1591501	...	...	-1-	85722	...	...
--	--	---------	-----	-----	-----	-------	-----	-----

#### 3500 & 4000 Series

60 - 62	3500, 4000, B-4000, L-4000, S-4000 with H-130, H-150 and 13800 Axles	.....	...	...	010	83221	...	...
63 - 66	Truck and School Bus	.....	010	85005	89430	010	83221	...









#### 4500 Series

66 - 72	CE-4500, CS-4500 Conventional Cab with V-8 Gas or In-line 6 Gas Engines	22012096 3192892	...	...	010	83221	...	...	
			...	...	010	83221	...	...	
66 - 72	EG-4500, EM-4500, ES-4500 Cab/Cowl with V-6 Gas or Diesel or In-line 6 Gas Engines	3171068 3192657 4940614 4963853 4963854 22012095 3171462 3192890	010	83216	...	...	...	...	
			010	83216	...	...	...		
			010	83216	...	...	...		
			010	83216	...	...	...		
			010	83216	...	...	...		
			...	...	010	83126	89430	...	...
			...	...	010	83126	89430	...	...
72 - 80	PS4620 P, 4650P Step Van (Walk-in) 3/4" Upper bolt	22002293 22007701 22012095 22012166 3192890 4940606 4975497	010	83126	89430	...	...	...	
			010	83126	89430	...	...		
			010	83126	89430	...	...		
			010	83126	89430	...	...		
			010	83126	89430	...	...		
72 - 80	PS4620 P, 4650P Step Van (Walk-in) 5/8" Upper bolt	22007751	010	83303	...	...	...		
72 - 80	PS4620 P, 4650P Step Van (Walk-in)	22012096 3192892	...	...	010	83221	...	...	
			...	...	010	83221	...	...	

#### 5000 Series

60 - 62	5000, B-5000, L-5000, S-5000 with 1618 or 16802 Axle	.....	...	...	010	83221	...	...
75 - 80	C Chassis - Conventional Cab	4975510	010	83221	...	...	...	...
76 - 89	C Chassis - Conventional Cab	22002294 22007752 22007757 22012096 22012196	010	83304	...	...	...	...
			010	83304	...	...	...	
			010	83304	...	...	...	
			...	...	010	83221	...	...
			...	...	010	83221	...	...
73 - 80	C, S Chassis - Conventional Cab	22007750	010	83207	89407	...	...	...

## APPLICATION GUIDE - TRUCKS, TRAILERS, AND BUSES

Year Año Année	Model Modelo Modèle	OEM #	Front		Rear	
						
						
			Fleetline	GasSLX	Fleetline	GasSLX

### GMC TRUCK(Cont'd.)

#### 5000 Series(Cont'd.)

73 - 80	C, S Chassis - Conventional Cab	4975467	010	83207	89407		...	...
		4975494	010	83207	89407		...	...
73 - 80	C,S Chassis - Conventional Cab and School Bus	22012096		...	...	010	83221	...
		3192892		...	...	010	83221	...
73 - 89	C,S Chassis - Conventional Cab and School Bus	22012095		...	...	010	83126	89430
		22012166		...	...	010	83126	89430
60 - 68	SP-5000, DSP-5000 School Bus	.....	010	85302	89420	010	85307	...
63 - 66	Truck and School Bus	.....	010	85005	89430		...	...
63 - 68	W-5000, BW-5000, DW-5000	.....	010	85005	89430		...	...









#### 5000 Series

66 - 72	CE-5500, CS-5500 Conventional Cab with V-8 Gas or In-line 6 Gas Engines	22012096		83221	...	010	83221	...
		3192891		83221	...	010	83221	...
		3192892		83221	...	010	83221	...
66 - 72	CG-5500, CM-5500, T-5500 Conventional & Tilt Cab with V-6 Gas or Diesel Engines	22012095	010	83126	89430		...	...
		3192890	010	83126	89430		...	...
		4940606	010	83126	89430		...	...
66 - 72	EG-5500, EM-5500, ES-5500 Cab/Cowl with 6 Cyl. Engines	3171068	010	83216	...		...	...
		3192657	010	83216	...		...	...
		4940614	010	83216	...		...	...
		4963853	010	83216	...		...	...
		4963854	010	83216	...		...	...
		22012095		...	...	010	83126	89430
		3171462		...	...	010	83126	89430
3192890		...	...	010	83126	89430		
60 - 68	LW-5500	.....	010	85307	...		...	...
67 - 68	Truck and School Bus	.....	010	85005	89430	010	83221	...
63 - 68	W-5500	.....	010	85005	89430		...	...

#### 6000 Series

76 - 89	C Chassis - Conventional Cab	22002294	010	83304	...		...	...
		22007752	010	83304	...		...	...
		22007757	010	83304	...		...	...
75 - 80	C, S Chassis - Conventional Cab and School Bus	4975510	010	83221	...		...	...
79 - 89	C, S Chassis - Conventional Cab and School Bus	22002295	010	83303	...		...	...
		22007753	010	83303	...		...	...
		22017530	010	83303	...		...	...
		22017531	010	83303	...		...	...
73 - 75	C, S Chassis - Conventional Cab and School Bus - Exc. with 18500, 20800 & 23000 lb Rear Axle	22007750	010	83207	89407		...	...
		4975467	010	83207	89407		...	...
		4975494	010	83207	89407		...	...
73 - 89	C, S Chassis - Conventional Cab and School Bus - Exc. with 18500, 20800 & 23000 lb Rear Axle	22012096		...	...	010	83221	...
		22012169		...	...	010	83221	...
		3192892		...	...	010	83221	...
73 - 89	C, S Chassis - Conventional Cab and School Bus with 18500, 20800 & 23000 lb Rear Axle	22012095		...	...	010	83126	89430
		22012166		...	...	010	83126	89430
		4940606		...	...	010	83126	89430
73 - 80	C, S, T Chassis - Conventional & Tilt Cab and School Bus with 5000 & 7000 lb Axle	22002293	010	83126	89430		...	...
		22007701	010	83126	89430		...	...
		22007751	010	83303	...		...	...
		22012095	010	83126	89430		...	...
		3192890	010	83126	89430		...	...
		4940606	010	83126	89430		...	...

## APPLICATION GUIDE - TRUCKS, TRAILERS, AND BUSES

Year Año Année	Model Modelo Modèle	OEM #	Front		Rear	
						
						
			Fleetline	GasSLX	Fleetline	GasSLX

### GMC TRUCK(Cont'd.)





#### 6000 Series(Cont'd.)

73 - 80	C, S, T Chassis - Conventional & Tilt Cab and School Bus with 5000 & 7000 lb Axle	4940662	OIO	83126	89430	...	...
			4975497	OIO	83126	89430	...
63 - 68	DW - 6000	.....	OIO	85005	89430	...	...
60 - 68	L - 6000	.....	OIO	85307	...	...	...
79 - 89	S Chassis - School Bus	22002294	OIO	83304	...	...	...
		22007702	OIO	83304	...	...	...
		22007752	OIO	83304	...	...	...
		22007757	OIO	83304	...	...	...
79 - 80	W Chassis - 72" BBC Steel Tilt Cab	22002293	OIO	83126	89430	...	...
		22007751	OIO	83303	...	...	...

#### 6500 Series

75 - 76	C, M Chassis - Conventional Cab	4975510	OIO	83221	...	...	...
76 - 89	C, M Chassis - Conventional Cab	22002294	OIO	83304	...	...	...
		22007752	OIO	83304	...	...	...
		22007757	OIO	83304	...	...	...
73 - 75	C, M Chassis - Conventional Cab with 9000 & 12000 lb Axle	22012095	OIO	83126	89430	...	...
		3192890	OIO	83126	89430	...	...
		4940606	OIO	83126	89430	...	...
		4940614	OIO	83216	...	...	...
		4963854	OIO	83216	...	...	...
		4975497	OIO	83126	89430	...	...
75 - 89	C, M Chassis - Conventional Cab with 9000 & 12000 lb Axle	22002295	OIO	83303	...	...	...
		22007751	OIO	83303	...	...	...
		22017530	OIO	83303	...	...	...
		22017531	OIO	83303	...	...	...
		4975511	OIO	83303	...	...	...
73 - 75	C, M, S Chassis - Conventional Cab and School Bus	22007750	OIO	83207	89407	...	...
		4975467	OIO	83207	89407	...	...
		4975494	OIO	83207	89407	...	...
73 - 80	C, M, S Chassis - Conventional Cab and School Bus - Exc. with 20800 or 23000 lb Rear Axle	22012096		...	...	OIO	83221
		22012169		...	...	OIO	83221
		3192892		...	...	OIO	83221
73 - 80	C, M, S Chassis - Conventional Cab and School Bus with 20800 or 23000 lb Rear Axle	22012095		...	...	OIO	83126 89430
		22012166		...	...	OIO	83126 89430
		4940606		...	...	OIO	83126 89430
73 - 80	C, S, T Chassis - Conventional & Tilt Cab and School Bus	22002293	OIO	83126	89430	...	...
		22012095	OIO	83126	89430	...	...
		3192890	OIO	83126	89430	...	...
		4940606	OIO	83126	89430	...	...
		4975497	OIO	83126	89430	...	...
66 - 72	CE-6500, CM-6500 Conventional Cab with V-6 Diesel or V-8 Gas Engine	3192892		...	...	OIO	83221
66 - 72	CE-6500, ME-6500 Conventional Cab with V-8 Gas Engine - Exc. 11000 lb Axle	22012096	OIO	83221	...	...	...
		3192891	OIO	83221	...	...	...
		3192892	OIO	83221	...	...	...
66 - 72	CE-6500, ME-6500 Conventional Cab with V-8 Gas Engine with 11000 lb Axle	22012095	OIO	83126	89430	...	...
		3192890	OIO	83126	89430	...	...
		4940606	OIO	83126	89430	...	...
66 - 72	CM-6500, TE-6500, TM-6500 Conventional Cab with V-6 Diesel or V-8 Gas Engine	22012095	OIO	83126	89430	...	...
		22012096		...	...	OIO	83221
		3192890	OIO	83126	89430	...	...

**APPLICATION GUIDE - TRUCKS, TRAILERS, AND BUSES**

Year Año Année	Model Modelo Modèle	OEM #	Front		Rear	
						
			Fleetline	GasSLX	Fleetline	GasSLX

**GMC TRUCK(Cont'd.)**

**6500 Series(Cont'd.)**

66 - 72	CM-6500, TE-6500, TM-6500 Conventional Cab with V-6 Diesel or V-8 Gas Engine	4940606	010	83126	89430		...	...
66 - 72	EG-6500, DM-6500, ES-6500 Cab/Cowl with V-6 Gas or Diesel or In-line 6 Gas Engines	3171068	010	83216	...		...	...
		3192657	010	83216	...		...	...
		4963853	010	83216	...		...	...
		22012095		...	...	010	83126	89430
		3171462		...	...	010	83126	89430
		3192890		...	...	010	83126	89430

**7000 Series**

79 - 89	C, M Chassis - 97" BBC Conventional Cab	22002294	010	83304	...		...	...
		22002295	010	83303	...		...	...
		22007752	010	83304	...		...	...
		22007753	010	83303	...		...	...
		22007757	010	83304	...		...	...
		22017530	010	83303	...		...	...
		22017531	010	83303	...		...	...
79 - 81	C, M Chassis - 97" BBC Conventional Cab - Exc. with 18500, 20800 & 23000 lb Rear Axle	22012096		...	...	010	83221	...
		22012169		...	...	010	83221	...
79 - 89	C, M Chassis - 97" BBC Conventional Cab with 18500, 20800 & 23000 lb Rear Axle	22012095		...	...	010	83126	89430
		22012166		...	...	010	83126	89430
79 - 80	W Chassis - 72" BBC Steel Tilt Cab	22002293	010	83126	89430		...	...
		22007751	010	83303	...		...	...

**7500 Series**

66 - 69	72" BBC Tilt Cab	22012095	010	83126	89430		...	...
		3171462	010	83126	89430		...	...
		4940606	010	83126	89430		...	...
66 - 72	72" BBC Tilt Cab with V-6 2 Cycle Diesel Engine with 17221 Axle	22012096		...	...	010	83221	...
		3192892		...	...	010	83221	...
66 - 72	72" BBC Tilt Cab with V-6 2 Cycle Diesel Engine with 19101 and 19201 Axle	4940600		...	...	010	83209	89414
70 - 72	72" BBC Tilt Cab with Air Brakes - Exc. Gas Engine	22012095	010	83126	89430		...	...
		3171462	010	83126	89430		...	...
		4940606	010	83126	89430		...	...
70 - 72	72" BBC Tilt Cab with Air Brakes & Gas Engine	22012091	010	85303	89422		...	...
		5552452	010	85303	89422		...	...
66 - 72	92" BBC Conventional Cab with Tapered 2-Leaf Softride 11000 lb Rating and F120 Axle (12000 lb)	22046483	010	85304	...		...	...
		22052336	010	85304	...		...	...
		3171069	010	85304	...		...	...
66 - 72	92" BBC Conventional Cab with Tapered 2-Leaf Softride 7000 & 9000 lb Rating and F070, F090, F120 Axle (7000, 9000 & 12000 lb)	3171068	010	83216	...		...	...
		3192657	010	83216	...		...	...
		4940614	010	83216	...		...	...
		4963853	010	83216	...		...	...
		4963854	010	83216	...		...	...
77 - 80	H, J Chassis - 92" BBC Conventional Cab	4963854	010	83216	...		...	...
		4984526	010	83216	...		...	...
73 - 80	H, J, M Chassis - 92" & 114" BBC Conventional Cab	22046483	010	85304	...		...	...
		22052336	010	85304	...		...	...
		3171069	010	85304	...		...	...
73 - 80	H, J, M Chassis - 92" & 114" BBC Conventional Cab with V-6, V-8 Gas or V-6 Diesel Engines	4940614	010	83216	...		...	...
		4963854	010	83216	...		...	...

## APPLICATION GUIDE - TRUCKS, TRAILERS, AND BUSES

Year Año Année	Model Modelo Modèle	OEM #	Front		Rear	
			Fleetline	GasSLX	Fleetline	GasSLX

### GMC TRUCK(Cont'd.)

#### 7500 Series(Cont'd.)

73 - 80	R Chassis - Rear Engine Bus	22012090	010	85308	89422	...	...
		22012091		...	...	010	85303 89422
		5552451	010	85308	89422	...	...
		5552452		...	...	010	85303 89422
		5552456		...	...	010	85307 ...
73 - 80	T, W Chassis - 72" BBC Steel Tilt Cab with V-6 Diesel Engine	22007751	010	83303	...	...	...
		22012095	010	83126	89430	...	...
		4940606	010	83126	89430	...	...
		4975497	010	83126	89430	...	...
73 - 80	T, W Chassis - 72" BBC Steel Tilt Cab with V-6 Gas Engine	22012091	010	85303	89422	...	...
		5552452	010	85303	89422	...	...



#### 8500 Series

66 - 72	72" BBC Tilt Cab	5544060	010	85302	89420	...	...
1967	92" BBC Conventional Cab	3171068	010	83216	...	...	...
		3192657	010	83216	...	...	...
		4940614	010	83216	...	...	...
		4963853	010	83216	...	...	...
		4963854	010	83216	...	...	...
66 - 72	92" BBC Conventional Cab with 7000 & 9000 lb Axles	22046483	010	85304	...	...	...
		22052336	010	85304	...	...	...
		3171069	010	85304	...	...	...
79 - 80	D, F Chassis - 54" BBC Aluminum Tilt Cab	22046483	010	85304	...	...	...
		22052336	010	85304	...	...	...
		3171069	010	85304	...	...	...
79 - 82	H, J Chassis - 92" BBC Conventional Cab 4 x 2 with Air Suspension	22012065	010	...	...	010	85304 ...
		22046483		...	...	010	85304 ...
		22052336		...	...	010	85304 ...
		3171069		...	...	010	85304 ...
73 - 81	H, J Chassis - 92" BBC Conventional Cab with V-6, V-8 Gas Engine	4940614	010	83216	...	...	...
		4963854	010	83216	...	...	...
		4984526	010	83216	...	...	...
73 - 86	H, J, M Chassis - 92" & 114" BBC Conventional Cab	22046483	010	85304	...	...	...
		22052336	010	85304	...	...	...
		3171069	010	85304	...	...	...
73 - 80	R Chassis - Rear Engine Bus	22012090	010	85308	89422	...	...
		22012091		...	...	010	85303 89422
		5552451	010	85308	89422	...	...
		5552452		...	...	010	85303 89422
		5552456		...	...	010	85307 ...
73 - 80	T, W Chassis - 72" BBC Steel Tilt Cab with V-6 Gas Engine	22012091	010	85303	89422	...	...
		5552452	010	85303	89422	...	...

#### 9500 Series

66 - 72	48" BBC Aluminum Tilt Cab	5552454	010	85302	89420	...	...
66 - 72	72" BBC Steel Tilt Cab	22012091	010	85303	89422	...	...
		5552452	010	85303	89422	...	...
67 - 72	92" & 114" BBC Conventional Cab	3171068	010	83216	...	...	...
		3192657	010	83216	...	...	...
		4940614	010	83216	...	...	...
		4963853	010	83216	...	...	...
		4963854	010	83216	...	...	...
73 - 89	D, F Chassis - 54" BBC Aluminum Tilt Cab with Rear GM Air Ride Suspension (4 Req'd)	22012065	010	85304	...	010	85304 ...
		22046483		85304	...	010	85304 ...

**APPLICATION GUIDE - TRUCKS, TRAILERS, AND BUSES**

Year Año Année	Model Modelo Modèle	OEM #	Front		Rear	
						
			Fleetline	GasSLX	Fleetline	GasSLX

**GMC TRUCK(Cont'd.)**

**9500 Series(Cont'd.)**

73 - 89	D, F Chassis - 54" BBC Aluminum Tilt Cab with Rear GM Air Ride Suspension (4 Req'd)	22052336		85304	...	010	85304	...
		3171069		85304	...	010	85304	...
73 - 89	H, J Chassis - 92" BBC Conventional Cab with Rear GM Air-Ride Suspension (4 req'd)	22012065		85304	...	010	85304	...
		22046483		85304	...	010	85304	...
		22052336		85304	...	010	85304	...
		3171069		85304	...	010	85304	...
				85304	...	010	85304	...
77 - 89	M, N Chassis - 114" BBC Conventional & 108" BBC Aluminum Conventional Cab with Rear GM Air-Ride Suspension (4 req'd)	22046483		85304	...	010	85304	...
		22052336		85304	...	010	85304	...
		3171069		85304	...	010	85304	...
73 - 80	T, W Chassis - 72" BBC Steel Tilt Cab	22012091	010	85303	89422		...	...
		5552452	010	85303	89422		...	...

**B - Series - School Bus**

90 - 06	B7 Model School Bus Chassis w/15000, 19000, 21000 lb Multileaf Springs	15174902		...	...	-1-	85071	...
		22064232		...	...	-1-	85071	...
- 2009	B6 , B7 Models with O.E.M. Number	15123676	-1-	83136	...		...	...
		15588554	-1-	83136	...		...	...
		22064230	-1-	83136	...		...	...
		88982682	-1-	83136	...		...	...

**C - Series (C4500, C5500) Topkick**

90 - 09	C Chassis - Conventional Cab with 15000, 19000, 21000 lb Multileaf Springs	15174902		...	...	-1-	85071	...
		22064232		...	...	-1-	85071	...
		88982686		...	...	-1-	85071	...
90 - 06	C Chassis - Conventional Cab with 16900 or 17850 lb Taperleaf Springs	21998392		...	...	-1-	85336	...
		22064489		...	...	-1-	85336	...
		88963409		...	...	-1-	85336	...
1990 -	C Chassis - Conventional Cab with 19000, 21000, 23000 lb Taperleaf Springs (EXC Low Profile Vehicle)	22064233		...	...	-1-	83136	...
83 - 99	C Chassis - Conventional Cab with 9100 to 17500 lb Rear Axle	22064432		...	...	010	83221	...
90 - 09	C Chassis - Conventional Cab with Front Shock with O.E.M. Number	15123676	-1-	83136	...		...	...
		15588554	-1-	83136	...		...	...
		15887728	-1-	83136	...		...	...
		19152843	-1-	83136	...		...	...
		22064230	-1-	83136	...		...	...
		88982682	-1-	83136	...		...	...
03 - 09	C Chassis - Conventional Cab with Taperleaf Rear Suspension Models with O.E.M. Number	15185643		...	...	010	83153	...
		88982684	-1-	83136	...		...	...
		88982688		...	...	-1-	85336	...

**C - Series (C6500, C7500, C8500) Topkick**

90 - 09	Conventional Cab Front Shock with O.E.M. Number	15123676	-1-	83136	...		...	...
		15174898	-1-	83136	...		...	...
		15588554	-1-	83136	...		...	...
		15887728	-1-	83136	...		...	...
		19152843	-1-	83136	...		...	...
		22064230	-1-	83136	...		...	...
		88982682	-1-	83136	...		...	...
		15174902		...	...	-1-	85071	...
		22064232		...	...	-1-	85071	...
		88982686		...	...	-1-	85071	...
90 - 06	Conventional Cab w/16900 or 17850 lb Taperleaf Springs	21998392		...	...	-1-	85336	...

## APPLICATION GUIDE - TRUCKS, TRAILERS, AND BUSES

Year Año Année	Model Modelo Modèle	OEM #	Front			Rear		
			Fleetline	GasSLX				

### GMC TRUCK(Cont'd.)

#### C - Series (C6500, C7500, C8500) Topkick(Cont'd.)

90 - 06	Conventional Cab w/16900 or 17850 lb Taperleaf Springs	22064489 88963409	...	...	- -	85336	...
			...	...	- -	85336	...
1990 -	Conventional Cab w/19000, 21000, 23000 lb Taperleaf Springs (EXC Low Profile Vehicle)	22064233	...	...	- -	83136	...
83 - 99	Conventional Cab with 9100 to 17500 lb Rear Axle	22064432	...	...	0 0	83221	...
95 - 02	Models with Hendrickson Air Suspension (Stamping number 47902-13)	12474915	...	...	0 0	83122	89406
		15963161	...	...	0 0	83122	89406
96 - 02	Models with Hendrickson Air Suspension (Stamping number 47902-29)	12474917	...	...	0 0	83137	...
		15740554	...	...	0 0	83137	...
	Models with O.E.M. Number	88982684	- -	83136	...	...	...
		88982688	...	...	- -	85336	...

#### Coaches

	4100, 4900 Models	3182842 3188599 3192416 4975552	85711	...	- 0	85711	...
			85711	...	- 0	85711	...
			85711	...	- 0	85711	...
			85711	...	- 0	85711	...
	4500, 5300 Models	3166657	85700	...	0 0	85700	...
		3192333	85700	...	0 0	85700	...
	Models with O.E.M. Number	3175509	85735	...	0 0	85735	...
		3178106	85700	...	0 0	85700	...
		3178507	85700	...	0 0	85700	...
		3178995	85700	...	0 0	85700	...
		3189265	85700	...	0 0	85700	...
		5304059	85700	...	0 0	85700	...
		5316784	85700	...	0 0	85700	...
		5316794	85700	...	0 0	85700	...
		5352857	85700	...	0 0	85700	...
		5527271	85700	...	0 0	85700	...
		5527272	85700	...	0 0	85700	...
		5549924	85700	...	0 0	85700	...

#### P - Series

92 - 96	Motorhome Chassis	22064233	...	...	- -	83136	...
---------	-------------------	----------	-----	-----	-----	-------	-----





#### T - Series (T5500, T6500, T7500, T8500)

1997 -	FL1 Tilt Cab with 8100 lb Axle	22064804 22064805 22165187 22165188	- -	83136	...	...	...
			- -	83136	...	...	...
			- -	83136	...	...	...
			- -	83136	...	...	...
1997 -	FL2 Tilt Cab with 5000 to 11000 lb Axle	22064807	- -	83136	...	...	...
		22166442	- -	83136	...	...	...
1997 -	FL3 Tilt Cab with 14575 lb Axle	22064806	- -	83136	...	...	...
		22165189	- -	83136	...	...	...
1999	Models with Hendrickson Air Suspension (Stamping number 47902-13)	12474915	...	...	0 0	83122	89406
		15963161	...	...	0 0	83122	89406
90 - 06	Tilt Cab with 15000, 19000, 21000 lb Multileaf Springs	15174902	...	...	- -	85071	...
		22064232	...	...	- -	85071	...
92 - 06	Tilt Cab with 16900 lb Taperleaf Springs RR SUSP(GZH) Heavy Duty	21998392	...	...	- -	85336	...
		22064489	...	...	- -	85336	...
		88963409	...	...	- -	85336	...
92 - 99	Tilt Cab with 19000, 21000, 23000 lb Taperleaf Springs (EXC Low Profile Veh.)	22064233	...	...	- -	83136	...

#### W - Series (Isuzu)

	Models with O.E.M. Number	8-97253664-0	...	...	0 0	83159	...
--	---------------------------	--------------	-----	-----	-----	-------	-----

**APPLICATION GUIDE - TRUCKS, TRAILERS, AND BUSES**

Year Año Année	Model Modelo Modèle	OEM #	Front		Rear	
						
			Fleetline	GasSLX	Fleetline	GasSLX

**GMC TRUCK(Cont'd.)**

**W - Series (Isuzu)(Cont'd.)**

	Models with O.E.M. Number	97253664		...	...	010	<b>83159</b>	...
<b>83 - 95</b>	W4 Models	8-51630-666-0		...	...	010	<b>85012</b>	<b>89413</b>
		9-51630-666-0		...	...	010	<b>85012</b>	<b>89413</b>
<b>89 - 90</b>	W4 Models Flatlow	9-51630-647-1	-10	<b>83515</b>	...		...	...
<b>89 - 92</b>	W4 Models Flatlow	8-51630-666-0		...	...	010	<b>85012</b>	<b>89413</b>
<b>86 - 09</b>	W4 Models with 11000 lb & 13000 lb Suspension	8-94454-986-0	-10	<b>83515</b>	...		...	...
		8-94454-987-0	-10	<b>83515</b>	...		...	...
		8-97253-620-0	-10	<b>83515</b>	...		...	...
		94454987	-10	<b>83515</b>	...		...	...
		9-51630-647-1	-10	<b>83515</b>	...		...	...
		97083027	-10	<b>83515</b>	...		...	...
		97083029	-10	<b>83515</b>	...		...	...
		97253620	-10	<b>83515</b>	...		...	...
		98232671	-10	<b>83515</b>	...		...	...
<b>01 - 08</b>	W4 Models with O.E.M. Number	97253651		...	...	010	<b>83159</b>	...
<b>02 - 14</b>	W4 Models with O.E.M. Number	8-97253665-0		...	...	010	<b>83159</b>	...
		898098-0580		...	...	010	<b>83159</b>	...
		898098-0581		...	...	010	<b>83159</b>	...
		898098-0590		...	...	010	<b>83159</b>	...
		97253665		...	...	010	<b>83159</b>	...
		98098058		...	...	010	<b>83159</b>	...
		98098059		...	...	010	<b>83159</b>	...
<b>88 - 99</b>	W5 Models	1-51630-217-0	-10	<b>83114</b>	...		...	...
		1-51630-217-1	-10	<b>83114</b>	...		...	...
		1-51630-219-1	-10	<b>83114</b>	...		...	...
<b>03 - 09</b>	W5 Models with 11000 lb & 13000 lb Suspension	97253620	-10	<b>83515</b>	...		...	...
<b>03 - 09</b>	W5 Models with O.E.M. Number	97253665		...	...	010	<b>83159</b>	...
<b>86 - 91</b>	W6 Models	1-51630-168-1	-10	<b>83515</b>	...		...	...
		1-51630-217-1	-10	<b>83114</b>	...		...	...
	Models with O.E.M. Number	8-94057-593-0	-10	<b>83114</b>	...		...	...
		8-97083-029-0	-10	<b>83515</b>	...		...	...
		8-97201-960-0	-10	<b>83515</b>	...		...	...
		898098-1250	-10	<b>83515</b>	...		...	...
		898098-1270	-10	<b>83515</b>	...		...	...
		90044769		...	...	010	<b>83207</b>	<b>89407</b>
		90044770		...	...	010	<b>83207</b>	<b>89407</b>
		94033786		...	...	-10	<b>83114</b>	...
		94051090	-10	<b>83114</b>	...		...	...
		94057593	-10	<b>83114</b>	...		...	...
		94454987	-10	<b>83515</b>	...		...	...
		9-51630-666-2		...	...	010	<b>85012</b>	<b>89413</b>
		97201960	-10	<b>83515</b>	...		...	...
		97253616	-10	<b>83515</b>	...		...	...
		97253621	-10	<b>83515</b>	...		...	...
		97253623	-10	<b>83515</b>	...		...	...
		98098125	-10	<b>83515</b>	...		...	...
		98098127	-10	<b>83515</b>	...		...	...

**WCA & WIA Series**





	Models with O.E.M. Number	37301-0016	01-	<b>85026</b>	<b>89417</b>		...	...
		37301-0021	01-	<b>85026</b>	<b>89417</b>		...	...
		37301-3202	01-	<b>85026</b>	<b>89417</b>		...	...

**WH Series**

	WHS, WHR, WHL or WHE Models with Front Dual Shocks	3082284	-1-	<b>83400</b>	...		...	...
--	--	---------	-----	--------------	-----	--	-----	-----



## APPLICATION GUIDE - TRUCKS, TRAILERS, AND BUSES

Year Año Année	Model Modelo Modèle	OEM #	Front		Rear	
						
			Fleetline	GasSLX	Fleetline	GasSLX

### GMC TRUCK(Cont'd.)





#### Additional Applications(Cont'd.)

1500 Models						
Models with Rear Suspension		35901-0005	...	...	010	<b>83219</b>
Models with O.E.M. Number		35901-0001	...	...	010	<b>83209</b> <b>89414</b>

#### Additional O.E.M. Interchanges

Models with O.E.M. Number		15642943 22024061 22025067 22025305 22046489 22065218 22065251 22099889 507-24 508-88 87-2520-00003 U0109-014				
			...	...	- -	<b>83136</b>
			...	...	010	<b>85704</b>
			...	...	010	<b>85704</b>
			...	...	010	<b>85704</b>
	010		<b>85303</b>	<b>89422</b>		...
	010		<b>G63347</b>	...		...
	010		<b>85030</b>	<b>89440</b>		...
			...	...	- -	<b>85336</b>
			...	...	- -	<b>85336</b>
			...	...	010	<b>83153</b>
			...	...	010	<b>85704</b>
			...	...	- -	<b>83400</b>
Additional O.E.M. Interchanges		22007703 22012067 22012082 22012083 22012083GS 22012114 22012131 22045526 22046481 22052014 3171696 3172948 3178157 3178233 3188626 3188729 35901-0003 35901-0004 35901-0017 4939852 4939967 4940601 4940627 4940640 4940650 4940654 4940660 4963844 4964853 4974401 4975429 4975479 4975480 4975501 4975516 4975518 4975538 4975549	010	<b>83303</b>	...	...
			010	<b>85700</b>	...	010
			010	<b>85702</b>		
			- 0	<b>85711</b>		
			- 0	<b>85711</b>		
			010	<b>85700</b>	...	010
			- 0	<b>85711</b>		
			010	...	...	010
			010	<b>85702</b>		
			010	...	...	010
			010	<b>85307</b>		
			010	<b>85303 or 89422</b>		
			010	<b>85700</b>		
			010	<b>85734</b>		
			010	<b>85300 or 89419</b>		
			010	<b>85303 or 89422</b>		
			010	<b>85301</b>		
			010	...	...	010
			010	<b>83314</b>	...	010
			010	<b>85308 or 89422</b>		
			010	...	...	010
			010	<b>83216</b>		
			010	<b>83203 or 89436</b>		
			010	<b>83216</b>		
			010	<b>83207 or 89407</b>		
			010	<b>83216</b>		
			010	<b>83207 or 89407</b>		
			010	<b>85307</b>		
			010	<b>83217</b>		
			010	<b>85700</b>		
			010	<b>85300 or 89419</b>		
			- -	<b>83400</b>	...	...
			- -	<b>83400</b>	...	...
			010	<b>85700</b>		
			010	<b>85702</b>		
			010	...	...	010
			010	<b>85700</b>		
			010	<b>83216</b>	...	...

**APPLICATION GUIDE - TRUCKS, TRAILERS, AND BUSES**









Year Año Année	Model Modelo Modèle	OEM #	Front		Rear	
						
			Fleetline	GasSLX	Fleetline	GasSLX

**GMC TRUCK(Cont'd.)**

**Additional O.E.M. Interchanges(Cont'd.)**

Additional O.E.M. Interchanges	OEM #	Interchange	Notes
	4975550	010	85702
	507-16	010	85702
	507-19	010	85700
	5171068	010	83216
	5316791	010	83219
	5316792	010	85305
	5316793	010	85305
	5321920	010	85307
	5321929	010	85307
	5348631	010	83203 or 89436
	5352858	010	85305
	5353054	010	85303   89422   ...   ...
	5355798	010	85307
	5357955	010	85300 or 89419
	5357956	010	85734
	5357959	010	85300 or 89419
	5361994	010	85734
	5374779	010	85308 or 89422
	5374999	010	85307
	5385939	010	85307
	5392387	010	85303   89422   ...   ...
	5394448	010	85305
	5394467	010	85305
	5394468	010	85735
	5455798	010	85307
	5513489	010	83216
	5513716	010	85304
	5516459	010	85305
	5522781	010	85735
	5522794	010	85308 or 89422
	5522818	010	85305
	5527001	010	85300 or 89419
	5527606	010	85305
	5531027	010	85301
	5531435	010	85307
	5531436	010	85307
	5531437	010	85307
	5532026	010	85304   ...   010   85304   ...
	5532425	010	83207 or 89407
	5532433	010	83207 or 89407
	5532675	010	...   ...   010   85307   ...
	5533699	010	85302 or 89420
	5534430	010	85303 or 89422
	5534439	010	85304
	5534447	010	85303 or 89422
	5544112	010	83216
	5544581	010	85302 or 89420
	5544716	010	85304
	5544717	010	85304
	5544812	010	83308
	5544818	010	85735
	5549899	010	83207 or 89407
	5549925	010	85304   ...   ...   ...
	5552111	010	85304
	5552112	010	85307

## APPLICATION GUIDE - TRUCKS, TRAILERS, AND BUSES

Year Año Année	Model Modelo Modèle	OEM #	Front		Rear	
						
						
			Fleetline	GasSLX	Fleetline	GasSLX

### GMC TRUCK(Cont'd.)

#### Additional O.E.M. Interchanges(Cont'd.)

Additional O.E.M. Interchanges	OEM #	OEM #	OEM #	OEM #	OEM #	OEM #	
	5552114	010				<b>83216</b>	
	5552205	010				<b>83217</b>	
	5552206	010				<b>83214</b>	
	5552207	010				<b>83217</b>	
	5552208	010				<b>83217</b>	
	5552209	010				<b>83215</b>	
	5552210	010				<b>85308 or 89422</b>	
	5552244	010				<b>85308 or 89422</b>	
	5552285	010				<b>83214</b>	
	5552286	010				<b>83217</b>	
	5552287	010				<b>83217</b>	
	5552288	010				<b>83217</b>	
	5552453	010				<b>85301</b>	
	5552527	010				<b>85735</b>	
	5554184	010				<b>85302 or 89420</b>	
	5554589	010				<b>85307</b>	
	5554596		...	...	010	<b>85303</b>	<b>89422</b>
	5554814	010				<b>85302 or 89420</b>	
	5554959	010	<b>83401</b>	...		...	...
	5554995	010				<b>85305</b>	
	5559363	010				<b>83203 or 89436</b>	
	5585939	010				<b>85307</b>	
	684280	010				<b>83209 or 89414</b>	
	97-2210-00156	010				<b>85702</b>	
	97-2210-00164	-1-				<b>85708</b>	
	97-2210-00170		<b>85733</b>	...	01-	<b>85733</b>	...

### GMC TRUCK CAB SHOCKS

	Astro Cabover (Sleeper & Non-Sleeper Trucks) with Link Cabmate Model GMC-2P-A	1202-0032	010				<b>83016</b>
	Brigadier Tractors with J9 Cabs with Link Cabmate Model GMC92J9	1202-0012	010				<b>83023</b>
<b>2003 -</b>	C4500 , C5500 Models Models with Link Cabmate Model GMT560	1201-1043	010				<b>83025</b>
		1202-1043	010				<b>83025</b>
<b>1979 -</b>	Conventional Trucks measuring 108" BBC or 116" BBC with Link Cabmate Model GMC816	1202-0012	010				<b>83023</b>
<b>1990 -</b>	TopKick Truck Cabs with Link Cabmate Model GMC104TK	1202-0054	010				<b>83021</b>
<b>- 1989</b>	TopKick Truck Cabs with Link Cabmate Model GMC92TK	1202-0012	010				<b>83023</b>

### GOSHEN COACH

<b>- 2020</b>	Impule Series Shuttle buses with Ford E350 & E450 Chassis	ASH-1136	-10	...	...	-10	<b>83178</b>	...
				<b>83177</b>	...		...	...
<b>- 2020</b>	Pacer II Series Shuttle buses with Ford E350 Chassis	ASH-1136	-10	...	...	-10	<b>83178</b>	...
				<b>83177</b>	...		...	...





### GRANNING SUSPENSION

	Models T950-1200, -1400, -1700	2697		...	...	010	<b>85712</b>	...
	Models with O.E.M. Number	1085		...	...	010	<b>83214</b>	...
		680162		...	...	010	<b>85300</b>	<b>89419</b>
		OE12425		...	...	010	<b>83214</b>	...

### GREAT DANE TRAILER

Identification of the trailer suspension is necessary to determine what section of the catalog to refer to. Some possible options can be Chalmers, Hendrickson, Neway, Ridewell, Reyco.								
	Trailers with Great Dane part number	HENS-20001		...	...	010	<b>83128</b>	<b>89436</b>

## APPLICATION GUIDE - TRUCKS, TRAILERS, AND BUSES

Year Año Année	Model Modelo Modèle	OEM #	Front		Rear	
						
			Fleetline	GasSLX	Fleetline	GasSLX

### GREAT DANE TRAILER(Cont'd.)

	Trailers with Great Dane part number	HENS-20002	...	...	010	85000	89436
		HENS-20126	...	...	010	85323	89436
		HENS-21292	...	...	010	85052	...
		HENS-23566	...	...	010	85000	89436
		HENS-23649	...	...	010	85064	...
		MER202447	...	...	010	85919	...
		REY18165-01	...	...	010	85006	...
			Trailers with Great Dane part number Heavy Duty Standard	HENS-24088	...	...	010
HENS-24088	...			...	010	83128	89436
	Trailers with Reyco 86 AR / RS 1015, 1035, 3015, 3035 Slider Air Suspension	18165-01	...	...	010	85006	...
	Trailers with Reyco Suspension 87	18163-01	...	...	010	83207	89407
	Trailers with Reyco Suspension 88	18164-01	...	...	010	83122	89406

### GRECH MOTORS

	Models with Freightliner M2 Chassis - See Freightliner section for proper year and model information	.....				.....		
- 2020	Shuttle buses with Ford E450 Chassis	ASH-1136		...	...	-10	83178	...
		ASH-1154	-10	83177	...		...	...

### GREYHOUND BUS

	City Cruiser	12TA-01-013		85303	...	010	85303	89422
	MC5, MC7, MC8	12B-5-1		85735	...	010	85735	...
		3178157		85700	...	010	85700	...
	Additional O.E.M. Interchanges	3166657	010	85700				
		3178154	010	85735				
		3192333	010	85700				
		690029	010	85700				

### GRUMMAN BUS





	Model 870 Flex Bus	22024506	-10	85703	...		...	...
		22025066	-10	85703	...		...	...
		22025067		...	...	010	85704	...
		22025305		...	...	010	85704	...
		97-2201-00001	-10	85703	...		...	...
		97-2201-00002	-10	85703	...		...	...
		97-2201-00003	-10	85703	...		...	...
		97-2201-00004	-10	85703	...		...	...
		97-2201-00005	-10	85703	...		...	...
		97-2210-00001		...	...	010	85704	...
		97-2210-00002		...	...	010	85704	...
		97-2210-00003		...	...	010	85704	...
		97-2210-00004		...	...	010	85704	...
		97-2210-00005		...	...	010	85704	...
			Additional O.E.M. Interchanges	690029	010	85700		

### GULF STREAM COACH

#### Class A MotorHomes

03 - 06	Atrium Series MotorHomes with Freightliner XC Chassis ADL200 Suspension w/ 20K Rear AS120 Front Suspension	16-16873-000		...	...	010	85029	...
		141700131810	010	83160	...		...	...
		16-16737-000	010	83160	...		...	...
		16-16874-000	010	83160	...		...	...
		Rear Shock with O.E.M. Number 141700131809		...	...	010	85029	...
		16-16736-000		...	...	010	85029	...

## APPLICATION GUIDE - TRUCKS, TRAILERS, AND BUSES

Year Año Année	Model Modelo Modèle	OEM #	Front		Rear	
						
			Fleetline	GasSLX	Fleetline	GasSLX

### GULF STREAM COACH(Cont'd.)

#### Class A MotorHomes(Cont'd.)

	ZF - IFS Front Suspension with 23,000 lb GVW or Greater	16-18103-000 481700000493	- -	<b>85900</b>	...		...	...
			- -	<b>85900</b>	...		...	...
<b>02 - 06</b>	Friendship & Scenic Cruiser Series MotorHomes with Freightliner XC Chassis ADL200 Suspension w/ 20K Rear AS120 Front Suspension  Rear Shock with O.E.M. Number  ZF - IFS Front Suspension with 23,000 lb GVW or Greater	16-16873-000		...	...	O O	<b>85029</b>	...
		141700131810	O O	<b>83160</b>	...		...	...
		16-16737-000	O O	<b>83160</b>	...		...	...
		16-16874-000	O O	<b>83160</b>	...		...	...
		141700131809		...	...	O O	<b>85029</b>	...
		16-16736-000		...	...	O O	<b>85029</b>	...
		16-18103-000	- -	<b>85900</b>	...		...	...
		481700000493	- -	<b>85900</b>	...		...	...
<b>2002</b>	Independence Series MotorHomes with Freightliner XC Chassis ADL200 Suspension w/ 20K Rear AS120 Front Suspension  Rear Shock with O.E.M. Number  ZF - IFS Front Suspension with 23,000 lb GVW or Greater	16-16873-000		...	...	O O	<b>85029</b>	...
		141700131810	O O	<b>83160</b>	...		...	...
		16-16737-000	O O	<b>83160</b>	...		...	...
		16-16874-000	O O	<b>83160</b>	...		...	...
		141700131809		...	...	O O	<b>85029</b>	...
		16-16736-000		...	...	O O	<b>85029</b>	...
		16-18103-000	- -	<b>85900</b>	...		...	...
		481700000493	- -	<b>85900</b>	...		...	...
<b>02 - 04</b>	Yellowstone Series MotorHomes with Freightliner XC Chassis ADL200 Suspension w/ 20K Rear AS120 Front Suspension  Rear Shock with O.E.M. Number  ZF - IFS Front Suspension with 23,000 lb GVW or Greater	16-16873-000		...	...	O O	<b>85029</b>	...
		141700131810	O O	<b>83160</b>	...		...	...
		16-16737-000	O O	<b>83160</b>	...		...	...
		16-16874-000	O O	<b>83160</b>	...		...	...
		141700131809		...	...	O O	<b>85029</b>	...
		16-16736-000		...	...	O O	<b>85029</b>	...
		16-18103-000	- -	<b>85900</b>	...		...	...
		481700000493	- -	<b>85900</b>	...		...	...

#### Class C MotorHomes

<b>02 - 20</b>	BT Cruiser Series MotorHomes with Ford E350 & E450 Chassis	ASH-1136		...	...	- O	<b>83178</b>	...
		ASH-1154	- O	<b>83177</b>	...		...	...
<b>99 - 06</b>	Cavalier Series MotorHomes with Ford E350 & E450 Chassis	ASH-1136		...	...	- O	<b>83178</b>	...
		ASH-1154	- O	<b>83177</b>	...		...	...
<b>93 - 20</b>	Conquest Series MotorHomes with Ford E350 & E450 Chassis	ASH-1136		...	...	- O	<b>83178</b>	...
		ASH-1154	- O	<b>83177</b>	...		...	...
<b>04 - 08</b>	Endura Series MotorHomes with Chevy Kodiak Chassis	.....	- -	<b>83136</b>	...		...	...
<b>03 - 08</b>	Independence Series MotorHomes with Ford E350 & E450 Chassis	ASH-1136		...	...	- O	<b>83178</b>	...
		ASH-1154	- O	<b>83177</b>	...		...	...
<b>00 - 08</b>	Ultra Series MotorHomes with Ford E350 & E450 Chassis	ASH-1136		...	...	- O	<b>83178</b>	...
		ASH-1154	- O	<b>83177</b>	...		...	...
<b>02 - 09</b>	Yellowstone Series MotorHomes with Ford E350 & E450 Chassis	ASH-1136		...	...	- O	<b>83178</b>	...
		ASH-1154	- O	<b>83177</b>	...		...	...

### HARDEE MFG

	Models with O.E.M. Number	8030223		...	...	O O	<b>83207</b>	<b>89407</b>
		AS789B		...	...	O O	<b>85014</b>	...

### HAUSMAN

	Models with O.E.M. Number	695110		...	...	- -	<b>85318</b>	...
		695119		...	...	O O	<b>85702</b>	...

## APPLICATION GUIDE - TRUCKS, TRAILERS, AND BUSES

Year Año Année	Model Modelo Modèle	OEM #	Front		Rear	
			Fleetline	GasSLX	Fleetline	GasSLX

### HENDRICKSON TRAILER SUSPENSION SYSTEMS

#### Intraax

	AA230T & AA250T Models with O.E.M. Number	A-20002	...	...	010	<b>85000</b>	<b>89436</b>
		A-20126	...	...	010	<b>85323</b>	<b>89436</b>
		A-20889	...	...	010	<b>85323</b>	<b>89436</b>
		B-22345	...	...	010	<b>85911</b>	...
	AAEDL Models For Models with 12" Ride Height For Models with 14" to 19" Ride Height For Models with 9" Ride Height	B-24023	...	...	010	<b>85738</b>	...
		B-23316	...	...	010	<b>85382</b>	...
		B-24579	...	...	010	<b>85939</b>	...
	AAEDT 30K Models ( w/14" and 15" Ride Height- High Damping) ( w/14" Ride Height) ( w/15", 16" & 17" Ride Height)	B-25436	...	...	010	<b>85916</b>	<b>89430</b>
		B-23361	...	...	010	<b>85911</b>	...
		B-25515	...	...	010	<b>85338</b>	...
	AAL 23K, 25K & 30K Models Front shocks with 12" Ride Height Front shocks with 14" to 19" Ride Height Front shocks with 6.5" to 9" Ride Height Rear shocks with 14" to 17" Ride Height Rear shocks with 6.5" to 7.5" Ride Height Rear shocks with 9" to 12" Ride Height	B-23566	...	...	010	<b>85000</b>	<b>89436</b>
		A-2212	...	...	010	<b>85029</b>	...
		B-23651	...	...	010	<b>85045</b>	...
		B-25437	...	...	010	<b>85337</b>	...
		B-20345	...	...	010	<b>85345</b>	...
		B-25436	...	...	010	<b>85916</b>	<b>89430</b>
	AANL 23K Models with 12" to 17" Ride Height - High Damping with 6.5" to 9" Ride Height - High Damping with 6.5" to 9" Ride Height - Standard	B-25515	...	...	010	<b>85338</b>	...
		B-24579	...	...	010	<b>85939</b>	...
		B-23651	...	...	010	<b>85045</b>	...
	AANLS - 20K with Rear shocks with 9" Ride Height	B-23316	...	...	010	<b>85382</b>	...
	AANT 23K Models (High Damping) (Hvy Duty) (Limited Rebound) (Standard)	B-24023	...	...	010	<b>85738</b>	...
		B-24125	...	...	010	<b>85323</b>	<b>89436</b>
		B-23361	...	...	010	<b>85911</b>	...
		B-23566	...	...	010	<b>85000</b>	<b>89436</b>
	AAT 23K Models (High Damping) (Hvy Duty) (Limited Rebound) (Standard)	B-24023	...	...	010	<b>85738</b>	...
		B-24125	...	...	010	<b>85323</b>	<b>89436</b>
		B-23361	...	...	010	<b>85911</b>	...
		B-23566	...	...	010	<b>85000</b>	<b>89436</b>
	AAT 25K Models (High Damping) (Hvy Duty) (Limited Rebound) (Standard)	B-24023	...	...	010	<b>85738</b>	...
		B-24125	...	...	010	<b>85323</b>	<b>89436</b>
		B-23361	...	...	010	<b>85911</b>	...
		B-23566	...	...	010	<b>85000</b>	<b>89436</b>
	AAT 30K Models	B-24023	...	...	010	<b>85738</b>	...
	AAZL 23K / 46K Models with 12" Ride Height - High Damping with 12" Ride Height - Standard with 6.5" to 9" Ride Height - High Damping with 6.5" to 9" Ride Height - Standard	B-24023	...	...	010	<b>85738</b>	...
		B-23566	...	...	010	<b>85000</b>	<b>89436</b>
		B-24579	...	...	010	<b>85939</b>	...
		B-23651	...	...	010	<b>85045</b>	...
	AAZNT 23K / 46K / 69K Models with 12" to 17" Ride Height - High Damping with 12" to 17" Ride Height - Standard	B-24023	...	...	010	<b>85738</b>	...
		B-23566	...	...	010	<b>85000</b>	<b>89436</b>
	Low Ride Height Models with (10.5" to 15" Ride Height) (15.5" to 21" Ride Height - High Damping) (15.5" to 21" Ride Height - Std Damping) (6.5" to 8" Ride Height - High Damping) (6.5" to 8" Ride Height)	B-23013	...	...	010	<b>85000</b>	<b>89436</b>
		B-23316	...	...	010	<b>85382</b>	...
		B-23315	...	...	010	<b>85029</b>	...
		B-22312	...	...	010	<b>85939</b>	...
		B-22311	...	...	010	<b>85045</b>	...

## APPLICATION GUIDE - TRUCKS, TRAILERS, AND BUSES

Year Año Année	Model Modelo Modèle	OEM #	Front			Rear		
						Fleetline	GasSLX	Fleetline

### HENDRICKSON TRAILER SUSPENSION SYSTEMS(Cont'd.)





#### Top Mount Style(Cont'd.)

	HT190T (All Models)	A-20001		...	...	010	83128	89436
	HT230T	A-20002		...	...	010	85000	89436
	All except Models listed below	B-22345		...	...	010	85911	...
	( TA14-020)	B-21553		...	...	010	85738	...
	( TA15-521, TA17-521)	B-21699		...	...	010	87018	...
	( TA15-522, TA17-522)	A-2212		...	...	010	85029	...
	(-14-020, -14-021, TA14-021)	A-20126		...	...	010	85323	89436
	(-14-17, -15-17,-15-517,-17-517,TA15-517,TA15-520,TA17-517)	A-2160		...	...	010	85014	...
	(-14-7,-14-11, -15-7,-15-11,-15-12,-15-28,TA14-7,TA15-7,TA16-7,TA17-7,TB14-33,TB15-28)							
	HT250T (All Models)	A-2212		...	...	010	85029	...
	HT300T & N-HT300T	A-20126		...	...	010	85323	89436
	(All except Models listed below)	A-2160		...	...	010	85014	...
	( -15-007, -15-011, -15-021,-17-007,-17-011, -17-012, TB19-007,TB19-020)	B-21553		...	...	010	85738	...
	( -15-017, -15-518, -17-518,-17-520)	B-24579		...	...	010	85939	...
	( TB15-027 )	B-21699		...	...	010	87018	...
	( TB15-518 )							
	T-15-140, -155, -172, 244, -376	A-2218		...	...	010	85030	89440
	T-15-324	A-2160		...	...	010	85014	...
	T-17-141, -174, -284	A-2218		...	...	010	85030	89440
	TMB-14-120	A-2213		...	...	010	85010	...
	TMB-17-135	A-4084		...	...	010	85005	89430

#### UnderSlung Style

	HT190U	A-2212		...	...	010	85029	...
	( -6.75-001 / -6.75-002 / -6.75-003 / -6.75-020 )	A-20002		...	...	010	85000	89436
	( U-7.5-517 )	B-23649		...	...	010	85064	...
	( U-9-022 / UB7-021 )	A-20001		...	...	010	83128	89436
	(All except Models listed above)							
	HT250U & N-HT250U	A-20002		...	...	010	85000	89436
	(All except Models listed below)	A-2160		...	...	010	85014	...
	(U-6.5-030, U-6.5-031)	B-21553		...	...	010	85738	...
	(U-6.5-27,U-9-27 & -28,U-14-28,UB6.5-522,UB7.5-27 & -522,UB9-522,UB12-27 & -28,UB14-27 & -28)	A-20126		...	...	010	85323	89436
	(U-6.5-517, U-7.5-17, U-7.5-517, U-9-517, U-12-517, U-14-514, UB6.5-517, UB7.5-517)	A-1667		...	...	010	85000	89436
	(U-7.5-021, U-7.5-022)	A-2212		...	...	010	85029	...
	(U-9-20 & -21 & -23, U-9.5-26, U-15-22, UB9-22, UB15-22)							
	HT250US - 5.5 to 6.5" Ride Height (High Damping)	B-23744		...	...	010	85344	...
		S-23744		...	...	010	85344	...
	HT250US (Models with Angled and Frame Clearance Mount)	B-24579		...	...	010	85939	...
	(Standard Travel w/ 6.5", 7.5" & 14" Ride Height -High Damping)	B-23651		...	...	010	85045	...
	(Standard Travel w/ 6.5", 7.5" & 14" Ride Height)							
	HT250US (Models with O.E.M. Number)	B-21936		...	...	010	85064	...
		B-21947		...	...	010	85052	...
		B-22862		...	...	010	85045	...
	HT250US (Models with Remote Shock Mount)	B-23316		...	...	010	85382	...
	(Extended Rebound w/ 6.5" to 9" Ride Height -High Damping)	A-2212		...	...	010	85029	...
	(Extended Rebound w/ 6.5" to 9" Ride Height)	A-2212		...	...	010	85029	...
	(Standard Travel w/ 12" to 14" Ride Height)	B-23650		...	...	010	85052	...
	(Standard Travel w/ 5.5" to 6.5" Ride Height)	B-23743		...	...	010	85938	...
	(Standard Travel w/ 7.5" to 9" Ride Height -High Damping)	B-23649		...	...	010	85064	...
	(Standard Travel w/ 7.5" to 9" Ride Height)							

**APPLICATION GUIDE - TRUCKS, TRAILERS, AND BUSES**

Year Año Année	Model Modelo Modèle	OEM #	Front		Rear	
						
			Fleetline	GasSLX	Fleetline	GasSLX

**HENDRICKSON TRAILER SUSPENSION SYSTEMS(Cont'd.)**

**UnderSlung Style(Cont'd.)**

HT250US (Models with Standard Shock Mount) (Extended Rebound w/ 6.5" Ride Height -High Damping) (Extended Rebound w/ 6.5" Ride Height) (Standard Travel w/ 3.5" to 4" Ride Height) (Standard Travel w/ 5.5" to 6.5" Ride Height) (Standard Travel w/ 7.5" to 14" Ride Height -High Damping) (Standard Travel w/ 7.5" to 14" Ride Height)	B-24579	...	...	010	<b>85939</b>	...
	B-23651	...	...	010	<b>85045</b>	...
	B-23548	...	...	010	<b>85079</b>	...
	B-23650	...	...	010	<b>85052</b>	...
	B-23743	...	...	010	<b>85938</b>	...
	B-23649	...	...	010	<b>85064</b>	...
HT250U-Y (All Models)	A-20002	...	...	010	<b>85000</b>	<b>89436</b>
HT300U & N-HT300U (All except Models listed below) (U-7.5-519,U-9-011,U-9-519,U-12-011,U-12-015,U-14-011,U-14-015,U-17-011)	A-20126	...	...	010	<b>85323</b>	<b>89436</b>
	B-21699	...	...	010	<b>87018</b>	...
T-12-139	A-2213	...	...	010	<b>85010</b>	...
T-23-US-9-011	A-2213	...	...	010	<b>85010</b>	...
T30-US-9, -17	A-10348	...	...	010	<b>85043</b>	...
T-4-392	A-2160	...	...	010	<b>85014</b>	...
T-6-062, -295, -370, -422	A-1667	...	...	010	<b>85000</b>	<b>89436</b>
T-6-071	A-2212	...	...	010	<b>85029</b>	...
T-9-084	A-2240	...	...	010	<b>85013</b>	<b>89414</b>
T-9-106, -278, -313	A-4084	...	...	010	<b>85005</b>	<b>89430</b>
T-9-175	A-2160	...	...	010	<b>85014</b>	...
T-9-325	A-2218	...	...	010	<b>85030</b>	<b>89440</b>
T-9-390	A-2213	...	...	010	<b>85010</b>	...

**Vantraax**

HKA180 Heavy Duty	B-24088	...	...	010	<b>85000</b>	<b>89436</b>	
	S-24088	...	...	010	<b>85000</b>	<b>89436</b>	
	Standard	B-24088	...	...	010	<b>83128</b>	<b>89436</b>
		S-24088	...	...	010	<b>83128</b>	<b>89436</b>
HKA200	B-23566	...	...	010	<b>85000</b>	<b>89436</b>	
	S-23566	...	...	010	<b>85000</b>	<b>89436</b>	
HKA250 (Standard)	B-24023	...	...	010	<b>85738</b>	...	
HKAL 46K Models	B-23566	...	...	010	<b>85000</b>	<b>89436</b>	
HKANT 40K Heavy Duty	B-24088	...	...	010	<b>85000</b>	<b>89436</b>	
	S-24088	...	...	010	<b>85000</b>	<b>89436</b>	
	Standard	B-24088	...	...	010	<b>83128</b>	<b>89436</b>
		S-24088	...	...	010	<b>83128</b>	<b>89436</b>
HKANT 46K	B-23566	...	...	010	<b>85000</b>	<b>89436</b>	
	S-23566	...	...	010	<b>85000</b>	<b>89436</b>	
HKANT 69K23	S-23566	...	...	010	<b>85000</b>	<b>89436</b>	
	S-23566	...	...	010	<b>85000</b>	<b>89436</b>	
HKARL 46K Disc Brake Applications	B-25436	...	...	010	<b>85916</b>	<b>89430</b>	
	S-25436	...	...	010	<b>85916</b>	<b>89430</b>	
	Drum Brake Applications	B-23566	...	...	010	<b>85000</b>	<b>89436</b>
		S-23566	...	...	010	<b>85000</b>	<b>89436</b>
HKAT 46K	B-23566	...	...	010	<b>85000</b>	<b>89436</b>	
	S-23566	...	...	010	<b>85000</b>	<b>89436</b>	
HKAT 50K	B-24023	...	...	010	<b>85738</b>	...	
	S-24023	...	...	010	<b>85738</b>	...	
HKAT 69K	B-24023	...	...	010	<b>85738</b>	...	
	S-24023	...	...	010	<b>85738</b>	...	



## APPLICATION GUIDE - TRUCKS, TRAILERS, AND BUSES

Year Año Année	Model Modelo Modèle	OEM #	Front		Rear	
			Fleetline	GasSLX	Fleetline	GasSLX

### HENDRICKSON TRAILER SUSPENSION SYSTEMS(Cont'd.)

#### Additional Applications(Cont'd.)

AB-32-001 Models	A-1667	...	...	010	85000	89436
HK190T (Slider Air Suspension)	A-21292	...	...	010	85052	...
HK230 (Slider Air Suspension)	A-21292	...	...	010	85052	...
HS190T (Slider Air Suspension)	A-20001	...	...	010	83128	89436
HS230 (Slider Air Suspension)	A-20002	...	...	010	85000	89436
MT-45,MTL45,MTL-50	S-1667	...	...	010	85000	89436
TDC-014	665267	...	...	010	85029	...
	A-2212	...	...	010	85029	...

#### Additional O.E.M. Interchanges

Models with O.E.M. Number	57905-2	...	...	010	85006	...
	60675-004	...	...	010	85006	...
	654951	...	...	010	85000	89436
	659024	...	...	010	85052	...
	665190	...	...	010	85006	...
	665246	...	...	010	85043	...
	665405	...	...	010	85030	89440
	665406	...	...	010	85010	...
	665531	...	...	010	85000	89436
	665532	...	...	010	85013	89414
	665533	...	...	010	85005	89430
	665536	...	...	010	85000	89436
	665693	...	...	010	85064	...
	665694	...	...	010	85052	...
	665698	...	...	010	85911	...
	665733	...	...	010	85045	...
	665756	...	...	010	85000	89436
	665758	...	...	010	85064	...
	665759	...	...	010	85052	...
	665760	...	...	010	85045	...
	665761	...	...	010	85911	...
	665763	...	...	010	85079	...
	665764	...	...	010	85029	...
	665765	...	...	010	83150	...
	665766	...	...	010	85000	89436
	665767	...	...	010	85045	...
	671779	...	...	010	...	89414
	671948	...	...	010	85000	89436
	680102	...	...	010	85712	...
	680341	...	...	010	85323	89436
	680463	...	...	010	...	89440
	680467	...	...	010	85323	89436
	680509	...	...	010	85738	...
	680565	...	...	010	85738	...
	680566	...	...	010	85938	...
	680568	...	...	010	85323	89436
	680570	...	...	010	...	89437
	680571	...	...	010	85738	...
	680573	...	...	010	85939	...
	680579	...	...	010	85939	...
	680614	...	...	010	85338	...
	680616	...	...	010	...	89430
	680617	...	...	010	85337	...
	680702	...	...	010	85323	89436
	680756	...	...	010	85323	89436

## APPLICATION GUIDE - TRUCKS, TRAILERS, AND BUSES





Year Año Année	Model Modelo Modèle	OEM #	Front		Rear	
			Fleetline	GasSLX	Fleetline	GasSLX

### HENDRICKSON TRAILER SUSPENSION SYSTEMS(Cont'd.)

#### Additional O.E.M. Interchanges(Cont'd.)

Models with O.E.M. Number	OEM #	Fleetline	GasSLX	Fleetline	GasSLX
680769	...	...	010	85911	...
680776	...	...	010	85338	...
98583-019	...	...	010	85323	89436
98583-020	...	...	010	...	89414
A-10023	...	...	010	85000	89436
A-11931	...	...	010	85000	89436
A-14583	...	...	010	85000	89436
A-1668	...	...	010	85000	89436
A-20345	...	...	010	85345	...
A-20886	...	...	010	85030	89440
A-20887	...	...	010	85005	89430
A-2230	...	...	010	85005	89430
A-2232	...	...	010	85005	89430
A-2240-1	...	...	010	85043	...
A-2471	...	...	010	85006	...
A-4089	...	...	010	83209	89414
A-4890	...	...	010	85712	...
A-6156	...	...	010	85301	...
B-21832	...	...	010	85323	89436
B-21936	...	...	010	85064	...
B-21994	...	...	010	85938	...
B-21995	...	...	010	85344	...
B-22715	...	...	010	85000	89436
B-23014	...	...	010	85738	...
B-23290	...	...	010	83150	...
B-23362	...	...	010	...	89437
B-25174	...	...	010	85029	...
B-26652	...	...	010	85000	89436
B-27058	...	...	010	83128	89436
B-27747	...	...	010	85911	...
B-29432	...	...	010	85323	89436
B-29678	...	...	010	85911	...
B-29826	...	...	010	85338	...
B-33312	...	...	010	85338	...
B-33313	...	...	010	85338	...
NS500699	...	...	010	85005	89430
S-10348	...	...	010	85043	...
S-14583	...	...	010	85000	89436
S-1668	...	...	010	85000	89436
S-20001	...	...	010	83128	89436
S-20002	...	...	010	85000	89436
S-20126	...	...	010	85323	89436
S-20345	...	...	010	85345	...
S-20886	...	...	010	85030	89440
S-20887	...	...	010	85005	89430
S-20889	...	...	010	85323	89436
S-21292	...	...	010	85052	...
S-21553	...	...	010	85738	...
S-2160	...	...	010	85014	...
S-21699	...	...	010	87018	...
S-21832	...	...	010	85323	89436
S-21936	...	...	010	85064	...
S-21947	...	...	010	85052	...
S-2212	...	...	010	85029	...
S-2213	...	...	010	85010	...

**APPLICATION GUIDE - TRUCKS, TRAILERS, AND BUSES**

Year Año Année	Model Modelo Modèle	OEM #	Front		Rear	
						
			Fleetline	GasSLX	Fleetline	GasSLX

**HENDRICKSON TRAILER SUSPENSION SYSTEMS(Cont'd.)**

**Additional O.E.M. Interchanges(Cont'd.)**









Models with O.E.M. Number	S-2218	...	...	010	<b>85030</b>	<b>89440</b>
	S-2230	...	...	010	<b>85005</b>	<b>89430</b>
	S-22311	...	...	010	<b>85045</b>	...
	S-22312	...	...	010	<b>85939</b>	...
	S-2232	...	...	010	<b>85005</b>	<b>89430</b>
	S-22345	...	...	010	<b>85911</b>	...
	S-2240	...	...	010	<b>85013</b>	<b>89414</b>
	S-22715	...	...	010	<b>85000</b>	<b>89436</b>
	S-22862	...	...	010	<b>85045</b>	...
	S-23013	...	...	010	<b>85000</b>	<b>89436</b>
	S-23014	...	...	010	<b>85738</b>	...
	S-23290	...	...	010	<b>83150</b>	...
	S-23315	...	...	010	<b>85029</b>	...
	S-23316	...	...	010	<b>85382</b>	...
	S-23361	...	...	010	<b>85911</b>	...
	S-23362	...	...	010	...	<b>89437</b>
	S-23548	...	...	010	<b>85079</b>	...
	S-23649	...	...	010	<b>85064</b>	...
	S-23650	...	...	010	<b>85052</b>	...
	S-23651	...	...	010	<b>85045</b>	...
	S-23743	...	...	010	<b>85938</b>	...
	S-24023	...	...	010	<b>85738</b>	...
	S-24125	...	...	010	<b>85323</b>	<b>89436</b>
	S-24579	...	...	010	<b>85939</b>	...
	S-2471	...	...	010	<b>85006</b>	...
	S-25437	...	...	010	<b>85337</b>	...
	S-25515	...	...	010	<b>85338</b>	...
	S-26652	...	...	010	<b>85000</b>	<b>89436</b>
	S-29432	...	...	010	<b>85323</b>	<b>89436</b>
	S-29678	...	...	010	<b>85911</b>	...
	S-29826	...	...	010	<b>85338</b>	...
	S-33312	...	...	010	<b>85338</b>	...
	S-33313	...	...	010	<b>85338</b>	...
	S-33313L	...	...	010	<b>85338</b>	...
S-4084	...	...	010	<b>85005</b>	<b>89430</b>	
S-4089	...	...	010	<b>83209</b>	<b>89414</b>	
S-4890	...	...	010	<b>85712</b>	...	
Models with O.E.M. Number						
Heavy Duty	S-24088	...	...	010	<b>85000</b>	<b>89436</b>
Standard	S-24088	...	...	010	<b>83128</b>	<b>89436</b>

**HENDRICKSON TRUCK SUSPENSION SYSTEMS**

**Airtek - Series**

Airtek Front Used on BlueBird	471700000456	010	<b>85959</b>	...	...	...	
	58913-007	010	<b>85959</b>	...	...	...	
	58913-007L	010	<b>85959</b>	...	...	...	
	58913-008	010	<b>85959</b>	...	...	...	
	58913-008L	010	<b>85959</b>	...	...	...	
	58913-009	010	<b>85959</b>	...	...	...	
	58913-009L	010	<b>85959</b>	...	...	...	
	65992-003	010	<b>85959</b>	...	...	...	
	Used on Freightliner / Western Star	471700006269	010	<b>85932</b>	<b>89453</b>	...	...
	58913-003	010	<b>85932</b>	<b>89453</b>	...	...	

## APPLICATION GUIDE - TRUCKS, TRAILERS, AND BUSES

Year Año Année	Model Modelo Modèle	OEM #	Front		Rear	
						
						
			Fleetline	GasSLX	Fleetline	GasSLX

### HENDRICKSON TRUCK SUSPENSION SYSTEMS(Cont'd.)

#### Airtek - Series(Cont'd.)

Used on BlueBird	Used on International	58913-003L	010	<b>85932</b>	<b>89453</b>	...	...	
		58913-012	010	<b>85932</b>	<b>89453</b>	...	...	
		58913-012L	010	<b>85932</b>	<b>89453</b>	...	...	
	Used on Volvo / Mack	Used on International	65992-001	010	<b>85955</b>	...	...	...
			65992-002	010	<b>85955</b>	...	...	...
			65992-002L	010	<b>85955</b>	...	...	...
			65992-006	010	<b>85986</b>	...	...	...
	Used on Volvo / Mack	Used on International	64838-001	010	<b>85933</b>	<b>89454</b>	...	...
			64838-001L	010	<b>85933</b>	<b>89454</b>	...	...
			64838-002	010	<b>85933</b>	<b>89454</b>	...	...
			64838-002L	010	<b>85933</b>	<b>89454</b>	...	...
			64838-003	010	<b>85933</b>	<b>89454</b>	...	...
		64838-003L	010	<b>85933</b>	<b>89454</b>	...	...	

#### All American Series (FE & RE Models)

Buses with Hendrickson 14,600 lb Capacity-Left Hand Drive Steertek Axle	58913-011	010	<b>85959</b>	...	...	...
		010	<b>85959</b>	...	...	...
	58913-011L	010	<b>85959</b>	...	...	...





#### Comfort Air - Series

Conventional Hino Models with Single Axle Air Suspension	60670-013	010	...	...	010	<b>83148</b>	...
		010	...	...	010	<b>83148</b>	...
Models with O.E.M. Number	471700131545	010	...	...	010	<b>85006</b>	...
	60998-001	010	...	...	010	<b>85006</b>	...
	60998-003	010	...	...	010	<b>85006</b>	...
			010	...	...	010	<b>85006</b>

#### Firemaax - Series

Firemaax 240 Air Suspensions	Disc Brake Applications with 8 1/2" to 10" Ride Height	60665-014	010	...	...	010	<b>85962</b>	...
		60665-018	010	...	...	010	<b>85961</b>	...
		60665-018L	010	...	...	010	<b>85961</b>	...
	Standard with 12 1/2" - 14 3/8" - 15 1/2" Ride Height	60665-011	010	...	...	010	<b>85967</b>	...
		60657-003	010	...	...	010	<b>85072</b>	...
		60657-003L	010	...	...	010	<b>85072</b>	...
Firemaax 270 Air Suspensions	Drum Brake Applications with 8 1/2" to 10" Ride Height	60665-013	010	...	...	010	<b>85965</b>	...
				010	...	...	010	<b>85965</b>
Firemaax 480 Air Suspensions	Disc Brake Applications with 8 1/2" to 10" Ride Height	60665-014	010	...	...	010	<b>85962</b>	...
		60665-018	010	...	...	010	<b>85961</b>	...
		60665-018L	010	...	...	010	<b>85961</b>	...
	Standard with 12 1/2" - 14 3/8" - 15 1/2" Ride Height	60665-011	010	...	...	010	<b>85967</b>	...
		60657-003	010	...	...	010	<b>85072</b>	...
		60657-003L	010	...	...	010	<b>85072</b>	...
Firemaax 540 Air Suspensions	Drum Brake Applications with 8 1/2" to 10" Ride Height	60665-013	010	...	...	010	<b>85965</b>	...
				010	...	...	010	<b>85965</b>
Firemaax EX 242 Air Suspensions	Standard with 12 1/2" - 14 3/8" - 15 1/2" Ride Height	60665-011	010	...	...	010	<b>85967</b>	...
		60657-003	010	...	...	010	<b>85072</b>	...
		60657-003L	010	...	...	010	<b>85072</b>	...
Firemaax EX 272 Air Suspensions	Drum Brake Applications with 8 1/2" to 10" Ride Height	60665-013	010	...	...	010	<b>85965</b>	...
				010	...	...	010	<b>85965</b>
Firemaax EX 482 Air Suspensions	Standard with 12 1/2" - 14 3/8" - 15 1/2" Ride Height	60665-011	010	...	...	010	<b>85967</b>	...
		60657-003	010	...	...	010	<b>85072</b>	...
		60657-003L	010	...	...	010	<b>85072</b>	...
Firemaax EX 542 Air Suspensions	Drum Brake Applications with 8 1/2" to 10" Ride Height	60665-013	010	...	...	010	<b>85965</b>	...
				010	...	...	010	<b>85965</b>

## APPLICATION GUIDE - TRUCKS, TRAILERS, AND BUSES

Year Año Année	Model Modelo Modèle	OEM #	Front		Rear	
						
			Fleetline	GasSLX	Fleetline	GasSLX

### HENDRICKSON TRUCK SUSPENSION SYSTEMS(Cont'd.)





#### HA - Series(Cont'd.)

	HA - 180 (Used on all except Mack)	47902-13 47902-8	...	...	010	<b>83122</b>	<b>89406</b>
			...	...	010	<b>83122</b>	<b>89406</b>
	HA - 200 (Used on all except Mack)	47902-13 47902-8	...	...	010	<b>83122</b>	<b>89406</b>
			...	...	010	<b>83122</b>	<b>89406</b>
	HA - 230 (Used on all except Mack)	47902-13 47902-8	...	...	010	<b>83122</b>	<b>89406</b>
			...	...	010	<b>83122</b>	<b>89406</b>
	HA - 360 (Used on all except Mack)	47902-13 47902-8	...	...	010	<b>83122</b>	<b>89406</b>
			...	...	010	<b>83122</b>	<b>89406</b>
	HA - 400 (Used on all except Mack)	47902-13 47902-8	...	...	010	<b>83122</b>	<b>89406</b>
			...	...	010	<b>83122</b>	<b>89406</b>
	HA - 460 (Used on all except Mack)	47902-13 47902-8	...	...	010	<b>83122</b>	<b>89406</b>
			...	...	010	<b>83122</b>	<b>89406</b>
	HA Series Air Suspension (All Models used on Mack)	47902-19 47902-9	...	...	010	<b>83123</b>	<b>89405</b>
			...	...	010	<b>83123</b>	<b>89405</b>
	HA-360/400/460 Edge System High Torque Rise	60675-003 60675-003L	...	...	010	<b>85976</b>	...
			...	...	010	<b>85976</b>	...

#### HAS - Series

	HAS - 120L	60670-010	...	...	010	<b>83149</b>	...
	HAS - 150L	60670-003	...	...	010	<b>83149</b>	...
	HAS - 190 With O.E.M. Number	60670-005	...	...	010	<b>83137</b>	...
		60675-003	...	...	010	<b>85976</b>	...
		60675-003L	...	...	010	<b>85976</b>	...
	HAS - 190L	60670-008	...	...	010	<b>83123</b>	<b>89405</b>
		60670-008L	...	...	010	<b>83123</b>	<b>89405</b>
	HAS - 210 With O.E.M. Number	60670-005	...	...	010	<b>83137</b>	...
		60675-003	...	...	010	<b>85976</b>	...
		60675-003L	...	...	010	<b>85976</b>	...
	HAS - 210L	60670-008	...	...	010	<b>83123</b>	<b>89405</b>
		60670-008L	...	...	010	<b>83123</b>	<b>89405</b>
	HAS - 230 With O.E.M. Number	60670-005	...	...	010	<b>83137</b>	...
		60675-003	...	...	010	<b>85976</b>	...
		60675-003L	...	...	010	<b>85976</b>	...
	HAS - 230L	60670-008	...	...	010	<b>83123</b>	<b>89405</b>
		60670-008L	...	...	010	<b>83123</b>	<b>89405</b>
	HAS - 360 With O.E.M. Number	60670-005	...	...	010	<b>83137</b>	...
		60675-003	...	...	010	<b>85976</b>	...
		60675-003L	...	...	010	<b>85976</b>	...
	HAS - 400 Mack & Kenworth Air Suspensions Standard Inboard Rear  With O.E.M. Number	47902-25	...	...	010	<b>83125</b>	...
		60670-007	...	...	010	<b>83144</b>	...
		60670-007L	...	...	010	<b>83144</b>	...
		60670-005	...	...	010	<b>83137</b>	...
		60675-003	...	...	010	<b>85976</b>	...
		60675-003L	...	...	010	<b>85976</b>	...
		60675-006	...	...	010	<b>85909</b>	...
60675-006L	...	...	010	<b>85909</b>	...		
	HAS - 400L	60670-008	...	...	010	<b>83123</b>	<b>89405</b>
		60670-008L	...	...	010	<b>83123</b>	<b>89405</b>
	HAS - 402 Standard Inboard Rear	60670-007	...	...	010	<b>83144</b>	...

**APPLICATION GUIDE - TRUCKS, TRAILERS, AND BUSES**

Year Año Année	Model Modelo Modèle	OEM #	Front		Rear	
						
			Fleetline	GasSLX	Fleetline	GasSLX

**HENDRICKSON TRUCK SUSPENSION SYSTEMS(Cont'd.)**

**HAS - Series(Cont'd.)**

Standard Inboard Rear With O.E.M. Number	60670-007L	...	...	010	83144	...
	60670-005	...	...	010	83137	...
	60675-003	...	...	010	85976	...
	60675-003L	...	...	010	85976	...
	60675-006	...	...	010	85909	...
	60675-006L	...	...	010	85909	...
HAS - 402L	60670-008	...	...	010	83123	89405
	60670-008L	...	...	010	83123	89405
HAS - 40LH With O.E.M. Number	60680-001	...	...	01-	83111	...
	60680-001L	...	...	01-	83111	...
	60685-001	...	...	01-	85977	...
HAS - 460 Standard Inboard Rear  With O.E.M. Number	60670-007	...	...	010	83144	...
	60670-007L	...	...	010	83144	...
	60670-005	...	...	010	83137	...
	60675-003	...	...	010	85976	...
	60675-003L	...	...	010	85976	...
	60675-006	...	...	010	85909	...
	60675-006L	...	...	010	85909	...
HAS - 460L	60670-008	...	...	010	83123	89405
	60670-008L	...	...	010	83123	89405
Models with O.E.M. Number	60675-014	...	...	010	85978	...
	60675-8Q	...	...	010	85976	...

**HN - Series**

HN - 400 Models built between Mar/96 - Sept/97  Models built between Nov/88 - Feb/96	60680-003	...	...	01-	83112	...
	60680-003L	...	...	01-	83112	...
	60670-002	...	...	010	83207	89407
	60670-002L	...	...	010	83207	89407
HN - 402 Models built between Apr/96 - Dec/04	57241-003	...	...	01-	83112	...
	60680-003	...	...	01-	83112	...
	60680-003L	...	...	01-	83112	...
HN - 460 Models built between Mar/96 - Sept/97  Models built between Nov/88 - Feb/96	57241-003	...	...	01-	83112	...
	60680-003	...	...	01-	83112	...
	60680-003L	...	...	01-	83112	...
	60670-002	...	...	010	83207	89407
	60670-002L	...	...	010	83207	89407
HN - 462 Models built between Apr/96 - 2015	57241-003	...	...	01-	83112	...
	60680-003	...	...	01-	83112	...
	60680-003L	...	...	01-	83112	...
96 - 15	HN - 522	60680-003	...	01-	83112	...
		60680-003L	...	01-	83112	...
	HNT - 460	47902-18	...	010	85030	89440

**HTB 400 LT - Series**

HTB 400LT Rear Air Suspensions	60657-006	...	...	010	85102	...
	60657-010	...	...	010	85102	...
	60657-011	...	...	010	85102	...

**Primaax - Series**

230 Air Suspensions For International Models with 9" Ride Height	60657-003	...	...	010	85072	...

## APPLICATION GUIDE - TRUCKS, TRAILERS, AND BUSES

Year Año Année	Model Modelo Modèle	OEM #	Front		Rear	
			Fleetline	GasSLX	Fleetline	GasSLX

### HENDRICKSON TRUCK SUSPENSION SYSTEMS(Cont'd.)

#### Primaax - Series(Cont'd.)

For International Models with 9" Ride Height Standard with 12 1/2" - 14 3/8" - 15 1/2" Ride Height Standard with 8 1/2" to 10" Ride Height	60657-003L	...	...	010	<b>85072</b>	...
	60665-011	...	...	010	<b>85967</b>	...
	60657-003	...	...	010	<b>85072</b>	...
	60657-003L	...	...	010	<b>85072</b>	...
260 Air Suspensions Drum Brake Applications with 8 1/2" to 10" Ride Height	60665-013	...	...	010	<b>85965</b>	...
460 Air Suspensions For International Models with 9" Ride Height Standard with 12 1/2" - 14 3/8" - 15 1/2" Ride Height Standard with 8 1/2" to 10" Ride Height	60657-003	...	...	010	<b>85072</b>	...
	60657-003L	...	...	010	<b>85072</b>	...
	60665-011	...	...	010	<b>85967</b>	...
	60657-003	...	...	010	<b>85072</b>	...
520 Air Suspensions Drum Brake Applications with 8 1/2" to 10" Ride Height	60657-003L	...	...	010	<b>85072</b>	...
	60665-013	...	...	010	<b>85965</b>	...
	60657-003	...	...	010	<b>85072</b>	...
	60657-003L	...	...	010	<b>85072</b>	...
690 Air Suspensions For International Models with 9" Ride Height Standard with 12 1/2" - 14 3/8" - 15 1/2" Ride Height Standard with 8 1/2" to 10" Ride Height	60657-003	...	...	010	<b>85072</b>	...
	60657-003L	...	...	010	<b>85072</b>	...
	60665-011	...	...	010	<b>85967</b>	...
	60657-003	...	...	010	<b>85072</b>	...
780 Air Suspensions Drum Brake Applications with 8 1/2" to 10" Ride Height	60657-003L	...	...	010	<b>85072</b>	...
	60665-013	...	...	010	<b>85965</b>	...
	60657-003	...	...	010	<b>85072</b>	...
	60657-003L	...	...	010	<b>85072</b>	...
EX 232 Air Suspensions Standard with 12 1/2" - 14 3/8" - 15 1/2" Ride Height Standard with 8 1/2" to 10" Ride Height	60665-011	...	...	010	<b>85967</b>	...
	60657-003	...	...	010	<b>85072</b>	...
	60657-003L	...	...	010	<b>85072</b>	...
EX 262 Air Suspensions Drum Brake Applications with 8 1/2" to 10" Ride Height	60665-013	...	...	010	<b>85965</b>	...
EX 462 Air Suspensions Standard with 12 1/2" - 14 3/8" - 15 1/2" Ride Height Standard with 8 1/2" to 10" Ride Height	60665-011	...	...	010	<b>85967</b>	...
	60657-003	...	...	010	<b>85072</b>	...
	60657-003L	...	...	010	<b>85072</b>	...
EX 522 Air Suspensions Drum Brake Applications with 8 1/2" to 10" Ride Height	60665-013	...	...	010	<b>85965</b>	...
EX 692 Air Suspensions Standard with 12 1/2" - 14 3/8" - 15 1/2" Ride Height Standard with 8 1/2" to 10" Ride Height	60665-011	...	...	010	<b>85967</b>	...
	60657-003	...	...	010	<b>85072</b>	...
	60657-003L	...	...	010	<b>85072</b>	...
EX 782 Air Suspensions Drum Brake Applications with 8 1/2" to 10" Ride Height	60665-013	...	...	010	<b>85965</b>	...
Models with O.E.M. Number	60657-005	...	...	010	<b>85087</b>	...
	60657-005L	...	...	010	<b>85087</b>	...

#### Additional Applications

Conventional Hino Models with Hendrickson Comfort Air Suspension	60670-020	...	...	010	<b>83148</b>	...
HAS 460 Suspensions with O.E.M. Number	60675-12	...	...	010	<b>85638</b>	...
Hendrickson Rear Air Suspension used on Conventional Hino Models ( 23,000 lb Capacity)	60670-018	...	...	010	<b>83166</b>	...
HMX 400/460 Haulmax with 16.5" Saddle Height	60680-004	...	...	01-	<b>83143</b>	...
	60680-004L	...	...	01-	<b>83143</b>	...
HMX 400/460 Haulmax with 17.5" or 18.5" Saddle Height	60680-005	...	...	01-	<b>83142</b>	...
	60680-005L	...	...	01-	<b>83142</b>	...
	60665-025	...	...	010	<b>85036</b>	<b>89405</b>
HTS 210 For Spartan Chassis (Type C School Bus Applications)	60665-025L	...	...	010	<b>85036</b>	<b>89405</b>
	57241-006	...	...	01-	<b>83111</b>	...

## APPLICATION GUIDE - TRUCKS, TRAILERS, AND BUSES

Year Año Année	Model Modelo Modèle	OEM #	Front		Rear	
			Fleetline	GasSLX	Fleetline	GasSLX

### HENDRICKSON TRUCK SUSPENSION SYSTEMS(Cont'd.)

#### Additional Applications(Cont'd.)

MaxAir / AL-405 Models	57241-006L		...	...	01-	<b>83111</b>	...
Parasteer Suspensions Models with O.E.M. Number	59483-000	010	<b>85919</b>	...		...	...
	60665-005	010	<b>85919</b>	...		...	...
	60665-005L	010	<b>85919</b>	...		...	...
	60998-002	010	<b>85919</b>	...		...	...
	60998-002L	010	<b>85919</b>	...		...	...
RT2 & RTE2 (400 / 520) Models Air Suspension (Note: For Ride Height of 10.41" to 12.27" with 52" & 54" Beams and 8.52" to 10.37" with 60" Beams.)	57324-6		...	...	010	<b>85904</b>	...

#### Additional O.E.M. Interchanges

Hendrickson Comfort Air Rear Air Suspension	60670-006		...	...	010	<b>83147</b>	...
	60670-006L		...	...	010	<b>83147</b>	...
Models with O.E.M. Number	12738		...	...	010	<b>83225</b>	...
	47902-11		...	...	010	<b>83207</b>	<b>89407</b>
	47902-15		...	...	010	<b>83137</b>	...
	47902-20		...	...	010	<b>85036</b>	<b>89405</b>
	47902-21		...	...	010	<b>85976</b>	...
	47902-22		...	...	010	<b>85916</b>	<b>89430</b>
	47902-24		...	...	010	<b>83137</b>	...
	47902-26		...	...	010	<b>83144</b>	...
	47902-27		...	...	010	<b>83123</b>	<b>89405</b>
	47902-28		...	...	010	<b>85013</b>	<b>89414</b>
	47902-29		...	...	010	<b>83149</b>	...
	47902-3		...	...	010	<b>85005</b>	<b>89430</b>
	503610C2		...	...	010	<b>83207</b>	<b>89407</b>
	5554596		...	...	010	<b>85303</b>	<b>89422</b>
	57241-001		...	...	01-	<b>83111</b>	...
	57241-002		...	...	01-	<b>83109</b>	...
	57241-004		...	...	01-	<b>83110</b>	...
	57324-1		...	...	010	<b>85036</b>	<b>89405</b>
	57324-11		...	...	010	<b>85305</b>	...
	57324-2		...	...	010	<b>85976</b>	...
	57324-3		...	...	010	<b>85916</b>	<b>89430</b>
	57905-1		...	...	010	<b>85976</b>	...
	58623-1		...	...	010	<b>85978</b>	...
	59048-001		...	...	010	<b>83148</b>	...
	59057-001		...	...	010	<b>83137</b>	...
	59057-002		...	...	010	<b>85036</b>	<b>89405</b>
	59305-1		...	...	010	<b>85979</b>	...
	59851-1		...	...	010	<b>85976</b>	...
	59852-1		...	...	01-	<b>85977</b>	...
	59852-2		...	...	01-	<b>85977</b>	...
60657-007		...	...	010	<b>85072</b>	...	
60665-003		...	...	010	<b>83137</b>	...	
60665-004		...	...	010	<b>85036</b>	<b>89405</b>	
60665-004L		...	...	010	<b>85036</b>	<b>89405</b>	
60665-008		...	...	010	<b>85978</b>	...	
60665-009		...	...	010	<b>85904</b>	...	
60665-020		...	...	010	<b>85919</b>	...	
60670-001		...	...	010	<b>83123</b>	<b>89405</b>	
60670-004		...	...	010	<b>83123</b>	<b>89405</b>	
60670-009		...	...	010	<b>85013</b>	<b>89414</b>	
60670-011		...	...	010	<b>83148</b>	...	
60670-012		...	...	010	<b>83168</b>	...	



## APPLICATION GUIDE - TRUCKS, TRAILERS, AND BUSES





Year Año Année	Model Modelo Modèle	OEM #	Front		Rear	
			Fleetline	GasSLX	Fleetline	GasSLX

### HENDRICKSON TRUCK SUSPENSION SYSTEMS(Cont'd.)

#### Additional O.E.M. Interchanges(Cont'd.)

Models with O.E.M. Number	OEM #	Fleetline	GasSLX	Fleetline	GasSLX
60670-014	...	...	010	83166	...
60670-019	...	...	010	83166	...
60670-12	...	...	010	83168	...
60675-001	...	...	010	85978	...
60675-001L	...	...	010	85978	...
60675-002	...	...	010	85979	...
60675-002L	...	...	010	85979	...
60675-017	...	...	010	85979	...
60680-002	...	...	01-	83109	...
654890	...	...	010	83207	89407
654891	...	...	010	83149	...
654894	...	...	010	83123	89405
654895	...	...	010	83137	...
654896	...	...	010	83147	...
654897	...	...	010	83144	...
654897	...	...	010	83144	...
654898	...	...	010	83123	89405
654899	...	...	010	85013	89414
654900	...	...	010	83149	...
654903	...	...	01-	83111	...
654904	...	...	01-	83109	...
654905	...	...	01-	83112	...
659000	...	...	010	83148	...
659004	...	...	010	83123	89405
659048	...	...	01-	83143	...
659049	...	...	01-	83142	...
659155	...	...	010	83147	...
659202	...	...	010	83148	...
659292	...	...	010	83148	...
665816	...	...	010	85072	...
665892	...	...	010	85072	...
671006	...	...	010	85036	89405
671007	...	...	010	83137	...
671009	...	...	010	85919	...
671105	...	...	010	85072	...
671603	...	...	010	85919	...
671606	010	85955	...	...	...
671611	010	85955	...	...	...
671704	...	...	010	85904	...
671764	...	...	010	85967	...
671792	...	...	010	85965	...
671798	...	...	010	85962	...
680091	...	...	010	85303	89422
680600	...	...	010	85305	...
70018	...	...	010	85303	89422
70021	...	...	010	85303	89422
70088	...	...	010	85307	...
98583-005	...	...	010	83168	...
98583-006	...	...	010	83148	...
98583-016	...	...	010	83147	...
98583-032	...	...	010	85072	...
AE76164-3	...	...	010	85307	...
AE76164-4	...	...	010	83225	...
BE76164-2	...	...	010	85303	89422
BE76164-3	...	...	010	85307	...

**APPLICATION GUIDE - TRUCKS, TRAILERS, AND BUSES**

Year Año Année	Model Modelo Modèle	OEM #	Front		Rear	
						
			Fleetline	GasSLX	Fleetline	GasSLX

**HENDRICKSON TRUCK SUSPENSION SYSTEMS(Cont'd.)**

**Additional O.E.M. Interchanges(Cont'd.)**

Models with O.E.M. Number	BE76164-4		...	...	010	83225	...
---------------------------	-----------	--	-----	-----	-----	-------	-----

**HIGHWAY PRODUCT**

Transit Bus with Air Suspension	.....	010	83203	89436		...	...
Transit Bus with Leaf Spring Suspension	.....		83203	...	010	83203	89436
	A1-6-134		...	...	010	83207	89407
	A1-6-135	010	83203	89436		...	...

**HINO**

**145 Series**

05 - 10	Models with O.E.M. Number	48500-3710	010	83126	89430		...	...
		485003710A	010	83126	89430		...	...
		S4850-03710	010	83126	89430		...	...
		48530-3280		...	...	010	G63440	...
		S4853-03280		...	...	010	G63440	...

**155 Series**

13 - 17	Models with O.E.M. Number	48511-37320	-10	83518	...		...	...
13 - 18	Models with O.E.M. Number	48511-80162	-10	83518	...		...	...

**165 Series**

05 - 10	Models with O.E.M. Number	48500-3710	010	83126	89430		...	...
		485003710A	010	83126	89430		...	...
		S4850-03710	010	83126	89430		...	...
		48530-3280		...	...	010	G63440	...
		S4853-03280		...	...	010	G63440	...

**185 Series**

05 - 10	Models with O.E.M. Number	48500-3710	010	83126	89430		...	...
		485003710A	010	83126	89430		...	...
		48500-3720	010	83140	...		...	...
		S4850-03710	010	83126	89430		...	...
		S4850-03720	010	83140	...		...	...
		48530-3280		...	...	010	G63440	...
		S4853-03280		...	...	010	G63440	...

**195 Series**

12 - 17	Models with Hendrickson Comfort Air Suspension ( 23,000 lb Capacity)	60670-018		...	...	010	83166	...
13 - 17	Models with O.E.M. Number	48511-37320	-10	83518	...		...	...
13 - 18	Models with O.E.M. Number	48511-80162	-10	83518	...		...	...
		48531-37361		...	...	010	83519	...
		48531-37362		...	...	010	83519	...













**238 Series**

05 - 14	Models with O.E.M. Number	48500-3720	010	83140	...		...	...
		S4850-03720	010	83140	...		...	...
15 - 16	Models with O.E.M. Number	48500-E0420	010	83391	...		...	...

**258 Series**

07 - 18	258 ALP Models with Hendrickson Rear Air Suspension	60670-014		...	...	010	83166	...
		60670-019		...	...	010	83166	...
07 - 18	258 LP Car Carrier Models with Hendrickson Rear Air Suspension	48530E0100		...	...	010	83166	...
		60670-014		...	...	010	83166	...
		60670-019		...	...	010	83166	...
07 - 18	258 Models with Hendrickson Rear Air Suspension	60670-014		...	...	010	83166	...
		60670-019		...	...	010	83166	...
05 - 14	Models with O.E.M. Number	48500-3720	010	83140	...		...	...
		S4850-03720	010	83140	...		...	...
15 - 19	Models with O.E.M. Number	48500-E0420	010	83391	...		...	...

## APPLICATION GUIDE - TRUCKS, TRAILERS, AND BUSES

Year Año Année	Model Modelo Modèle	OEM #	Front			Rear		
								
								
			Fleetline	GasSLX		Fleetline	GasSLX	

### HINO(Cont'd.)

#### 268, 268A Series(Cont'd.)

	Models with Hendrickson Rear Air Suspension (Shock stamping #)	60670-012		...	...	OIO	<b>83168</b>	...
05 - 14	Models with O.E.M. Number	48500-3720	OIO	<b>83140</b>	...		...	...
		S4850-03720	OIO	<b>83140</b>	...		...	...
15 - 19	Models with O.E.M. Number	48500-E0420	OIO	<b>83391</b>	...		...	...

#### 308 Series

07 - 10	Models with O.E.M. Number	48500-3720	OIO	<b>83140</b>	...		...	...
		S4850-03720	OIO	<b>83140</b>	...		...	...

#### 338 Series

08 - 17	Models with Hendrickson Rear Air Suspension	48530E0100		...	...	OIO	<b>83166</b>	...
		60670-014		...	...	OIO	<b>83166</b>	...
05 - 14	Models with O.E.M. Number	48500-3720	OIO	<b>83140</b>	...		...	...
		S4850-03720	OIO	<b>83140</b>	...		...	...
15 - 19	Models with O.E.M. Number	48500-E0420	OIO	<b>83391</b>	...		...	...

#### 358 Series

	Models with Hendrickson Rear Air Suspension	48530E0100		...	...	OIO	<b>83166</b>	...
		60670-014		...	...	OIO	<b>83166</b>	...
07 - 14	Models with O.E.M. Number	48500-3720	OIO	<b>83140</b>	...		...	...
		S4850-03720	OIO	<b>83140</b>	...		...	...
15 - 19	Models with O.E.M. Number	48500-E0420	OIO	<b>83391</b>	...		...	...

#### FA, FB Series

89 - 04	FA, FB Models Trucks with: Front Shock with O.E.M. Number	48500-1950	-IO	<b>G63610</b>	...		...	...	
		48500-2750	-IO	<b>G63610</b>	...		...	...	
		66639	-IO	<b>G63610</b>	...		...	...	
		S4850-01950	-IO	<b>G63610</b>	...		...	...	
		S4850-02750	-IO	<b>G63610</b>	...		...	...	
		34802		...	...	OIO	<b>83216</b>	...	
	Rear Shock with O.E.M. Number	48530-1910		...	...	OIO	<b>83216</b>	...	
		48530-2510		...	...	OIO	<b>83216</b>	...	
		S4853-01910		...	...	OIO	<b>83216</b>	...	
		S4853-02510		...	...	OIO	<b>83216</b>	...	
		89 - 96	FA14, FB14	48500-1950	-IO	<b>G63610</b>	...		...
				48530-1910		...	...	OIO	<b>83216</b>
93 - 97	FA1415 (FA15), FB1715 (FB15)	48500-1950	-IO	<b>G63610</b>	...		...		
		48530-1910		...	...	OIO	<b>83216</b>		
92 - 96	FA15, FB15	48500-1950	-IO	<b>G63610</b>	...		...		
		48530-1910		...	...	OIO	<b>83216</b>		
1998	FA1517, FA1817, FB1817	.....		...	...	OIO	<b>G63419</b>		
		48530-2510		...	...	OIO	<b>83216</b>		









#### FD Series

98 - 03	FD Models Trucks with O.E.M. Number	48500-1801	OIO	<b>83216</b>	...		...	...
		48530-1880		...	...	OIO	<b>83362</b>	...
86 - 87	FD16	48500-1801	OIO	<b>83216</b>	...		...	...
		48530-1880		...	...	OIO	<b>83362</b>	...
88 - 91	FD17	48500-1801	OIO	<b>83216</b>	...		...	...
		48530-1880		...	...	OIO	<b>83362</b>	...
1992	FD20	48500-1801	OIO	<b>83216</b>	...		...	...
93 - 97	FD2218, FD2218LD (FD5H). FE5H, FF5H	48500-1801	OIO	<b>83216</b>	...		...	...
		48530-1880		...	...	OIO	<b>83362</b>	...
1998	FD2220, FD2220 Lo Pro	48500-1801	OIO	<b>83216</b>	...		...	...

#### FE Series

86 - 87	FE16	48500-1801	OIO	<b>83216</b>	...		...	...
1998	FE2620	48530-1880		...	...	OIO	<b>83362</b>	...

## APPLICATION GUIDE - TRUCKS, TRAILERS, AND BUSES

Year Año Année	Model Modelo Modèle	OEM #	Front		Rear	
						
						
			Fleetline	GasSLX	Fleetline	GasSLX

### HINO(Cont'd.)

#### FE Series(Cont'd.)

<b>98 - 04</b>	FE Models Trucks with: Front Shock with O.E.M. Number	48500-1941	OIO	<b>83141</b>	...		...	...
		S4850-01941	OIO	<b>83141</b>	...		...	...
	Rear Shock with O.E.M. Number	48530-3280		...	...	OIO	<b>G63440</b>	...
		S4853-03280		...	...	OIO	<b>G63440</b>	...

#### FF Series

<b>98 - 03</b>	FF Models Trucks with O.E.M. Number	48500-1941	OIO	<b>83141</b>	...		...	...
<b>1998</b>	FF3320	48530-1880		...	...	OIO	<b>83362</b>	...

#### GC Series

<b>90 - 91</b>	GC17	48500-1801	OIO	<b>83216</b>	...		...	...
		48530-2050		...	...	OIO	<b>83217</b>	...
<b>1992</b>	GC20	48500-1801	OIO	<b>83216</b>	...		...	...
		48530-2050		...	...	OIO	<b>83217</b>	...

#### SG Series

<b>98 - 03</b>	SG Models Trucks with O.E.M. Number	48500-1941	OIO	<b>83141</b>	...		...	...
		S4850-01941	OIO	<b>83141</b>	...		...	...
<b>86 - 91</b>	SG19	48500-1941	OIO	<b>83141</b>	...		...	...
<b>1992</b>	SG20	48500-1941	OIO	<b>83141</b>	...		...	...
<b>1986</b>	SG22 Straight Truck	48500-1941	OIO	<b>83141</b>	...		...	...
<b>1986</b>	SG221 Tractor	48500-1941	OIO	<b>83141</b>	...		...	...
<b>87 - 92</b>	SG23 Straight Truck	48500-1941	OIO	<b>83141</b>	...		...	...
<b>87 - 92</b>	SG231 Tractor	48500-1941	OIO	<b>83141</b>	...		...	...
<b>93 - 97</b>	SG3320 (SG4H)	48500-1941	OIO	<b>83141</b>	...		...	...
<b>93 - 97</b>	SG3323 (SG1H) Straight Truck	48500-1941	OIO	<b>83141</b>	...		...	...
<b>93 - 97</b>	SG5523 (SG1HD) Tractor	48500-1941	OIO	<b>83141</b>	...		...	...

#### Additional Applications

	Conventional Hino Models with Hendrickson Comfort Air Suspension	60670-020		...	...	OIO	<b>83148</b>	...
	Conventional Hino Models with Hendrickson Comfort Air Suspension ( 23,000 lb Capacity)	60670-018		...	...	OIO	<b>83166</b>	...
	Conventional Hino Models with Hendrickson Comfort Air Suspension (19,000 lb & 21,000 lb Capacity)	60670-013		...	...	OIO	<b>83148</b>	...
	Conventional Hino Models with Hendrickson Rear Air Suspension	60670-014		...	...	OIO	<b>83166</b>	...
		60670-019		...	...	OIO	<b>83166</b>	...
	Models with O.E.M. Number	48500-1800	OIO	<b>83216</b>	...		...	...
		48500-1940	OIO	<b>83141</b>	...		...	...
		48530-1460		...	...	OIO	<b>83215</b>	...
		48530-1770		...	...	OIO	<b>83215</b>	...

### HOBBS TRAILERS

	Models with O.E.M. Number	680117		...	...	OIO	<b>85300</b>	<b>89419</b>
--	---------------------------	--------	--	-----	-----	-----	--------------	--------------





### HOLIDAY RAMBLER

	Models with Mor-Ryde Suspension	U0109-007		...	...	OIO	<b>G63183</b>	...
	Models with Neway Trailer Air Suspension	90044794		...	...	OIO	<b>83127</b>	...

#### Class A MotorHomes

<b>99 - 20</b>	Admiral, Endeavor Gas and Vacationer Models with Ford F53 Motorhome Chassis (16,000 lb to 22,000 lb GVW)	1C34-18045-AA	OIO	<b>83209</b>	<b>89414</b>		...	...
		1C34-18045-JA	OIO	<b>83209</b>	<b>89414</b>		...	...
		9U94-18045-AA	OIO	<b>83209</b>	<b>89414</b>		...	...
		9U94-18080-AA		...	...	OIO	<b>83122</b>	<b>89406</b>
		9U9Z-18124-A	OIO	<b>83209</b>	<b>89414</b>		...	...
		9U9Z-18125-A		...	...	OIO	<b>83122</b>	<b>89406</b>
		ASH-1022	OIO	<b>83209</b>	<b>89414</b>		...	...
		ASH-1023		...	...	OIO	<b>83122</b>	<b>89406</b>

## APPLICATION GUIDE - TRUCKS, TRAILERS, AND BUSES

Year Año Année	Model Modelo Modèle	OEM #	Front		Rear	
						
			Wrench	Wrench	Wrench	Wrench
			Fleetline	GasSLX	Fleetline	GasSLX

### HOLIDAY RAMBLER(Cont'd.)

#### Class A MotorHomes(Cont'd.)

99 - 20	Admiral, Endeavor Gas and Vacationer Models with Ford F53 Motorhome Chassis (16,000 lb to 22,000 lb GVW)	ASH-1205	010	83209	89414		...	...		
			...	...	010	83122	89406			
			010	83209	89414		...	...		
			010	83209	89414		...	...		
			010	83209	89414	010	83122	89406		
			010	83209	89414	010	83122	89406		
			010	83209	89414		...	...		
			010	83209	89414		...	...		
			010	83209	89414	010	83122	89406		
			010	83209	89414		...	...		
			010	83209	89414		...	...		
			010	83209	89414	010	83122	89406		
			010	83209	89414		...	...		
			05 - 14	Models with Workhorse W20 , W22, & W24 MotorHome Chassis with O.E.M. Number	24-153256		...	...	-1-	85124
F4-BE5-F325-HO		...			...	-1-	85124	...		
W0005663		...			...	-1-	85124	...		
98 - 04	Models with Workhorse W20 , W22, & W24 MotorHome Chassis with O.E.M. Number	24-186537		...	...	01-	85126	...		
		F4-BE5-A011-HO		...	...	01-	85126	...		
98 - 14	Models with Workhorse W20 , W22, & W24 MotorHome Chassis with O.E.M. Number	24-153249	010	85125	...		...	...		
		24-186629	010	85125	...		...	...		
		F4-BE5-A832-MO	010	85125	...		...	...		
		F4-BE5-B492-HO	010	85125	...		...	...		
		F4-BE5-F324-HO	010	85125	...		...	...		
		W0005662	010	85125	...		...	...		
		W0006254	010	85125	...		...	...		
95 - 99	MotorHomes with Freightliner XC Chassis (22,000 to 26,000 lb GVW)	.....	010	83160	...	010	85029	...		

#### Class C MotorHomes

18 - 20	Altera Series MotorHomes with Ford E450 Chassis	ASH-1136		...	...	-10	83178	...
		ASH-1154	-10	83177	...		...	...
99 - 06	Atlantis Models with Ford E450 Chassis	ASH-1136		...	...	-10	83178	...
		ASH-1154	-10	83177	...		...	...
07 - 19	Augusta Series MotorHomes with Ford E450 Chassis	ASH-1136		...	...	-10	83178	...
		ASH-1154	-10	83177	...		...	...
17 - 20	Vesta Series MotorHomes with Ford E450 Chassis	ASH-1136		...	...	-10	83178	...
		ASH-1154	-10	83177	...		...	...

### HOLLAND - BINKLEY

	Air Plus Integrated Air Susp. with ProPar Parallel Spindle Axles	6898		...	...	010	83125	...
	Holland ProPar NT2 Air Suspension	680298		...	...	010	85321	...

### HOLLAND (SEE NEWAY)

Refer to SAF Holland Section for application information								
--	--	--	--	--	--	--	--	--









### HUTCHENS SUSPENSION

	Models with O.E.M. Number	9423-00		...	...	010	83203	89436
--	---------------------------	---------	--	-----	-----	-----	-------	-------

### HYSTER

	Straddle Carrier	650150		83217	...	010	83217	...
		73516		83217	...	010	83217	...

## APPLICATION GUIDE - TRUCKS, TRAILERS, AND BUSES

Year Año Année	Model Modelo Modèle	OEM #	Front		Rear	
						
						
			Fleetline	GasSLX	Fleetline	GasSLX

### IC CORPORATION

#### AE Series School Bus

	AE Model School Buses with O.E.M. Number	3902993C1	OIO	83135	...	...	...
		3902993C2	OIO	83135	...	...	...
		3902993C3	OIO	83135	...	...	...

#### BE Series School Bus

- 2012	BE200 Model School Buses with 7000 lb Front Axle	3605735C1	OIO	83156	...	...	...
		3605735C2	OIO	83156	...	...	...

#### CE Series School Bus

06 - 18	CE Model School Buses (71 Capacity) with 9,000 to 10,000 lb Front Suspension	3578105C1	OIO	83163	...	...	...
		3578105C2	OIO	83163	...	...	...
		6127088C1	OIO	83163	...	...	...
		OE13402S	OIO	83163	...	...	...
10 - 15	CE Model School Buses with 20,000 lb International IROS Air Suspension	3578858C2		...	...	OIO	85926
16 - 17	CE Model School Buses with 20,000 lb Rear Air Suspension	3601600C3		...	...	OIO	85082
05 - 13	CE Model School Buses with 22,000 lb Rear Spring Suspension	501906C91		...	...	-IO	83317
		501906C92		...	...	-IO	83317
		OE13424S		...	...	-IO	83317
13 - 18	CE Model School Buses with 6,000 to 8,000 lb Front Axles	3533356C3	OIO	83169	...	...	...

#### RE Series School Bus

	Low-Profile models with O.E.M. Number	1660846C92		...	...	OIO	83101	
	RE Model School Buses with 12,000 to 14,000 lb Front Axles	2200327C1	-IO	85332	...	...	...	
03 - 17	RE Model School Buses with Hendrickson AirTek Front Suspension	3838241C1	OIO	85986	...	...	...	
		65992-006	OIO	85986	...	...	...	
		H65992-006	OIO	85986	...	...	...	
	RE Model School Buses with O.E.M. Number	1675455C1		...	...	OIO	85003	89411
		2018987C1		...	...	OIO	85003	89411
		3604282C1	-IO	85351	...	...	...	...
		472412C91	-I-	83456	89447	...	...	...
		501553C91		...	...	OIO	85003	89411
		537524C91		...	...	OIO	83123	89405

### INGERSOLL AXLES



	Ingersoll part number	653511-01		...	...	OIO	85323	89436
		653511-02		...	...	OIO	85938	...
		653511-03		...	...	OIO	85045	...
		653511-04		...	...	OIO	85052	...

### INTERNATIONAL (NAVISTAR)

#### A, B, AC and BC Conventional

	A-140 (4 x 4) Models	.....		...	...	OIO	83216	...
	A-160, A-170, A-180, AC-160, AC-170, AC-180, B-160, B-170, B-180, BC-160, BC-170, BC-180 Models	308649C91		...	...	OIO	83216	...
		308650C91		...	...	OIO	83216	...
		453567C91		...	...	OIO	83216	...
	A-170, B-170, AC-170, ACF-170, BC-170, A-180, B-180, AC-180, BC-180, BCF-170 Models	308646C91	OIO	85012	89413	...	...	
	AB-140 Models	.....		G63306	...	OIO	G63306	
	AC-170 & BC-170 (4 x 4) Models	.....		...	...	OIO	83216	
	AC-180 & BC-180 (4 x 4) Models	.....		...	...	OIO	83216	
	BCF-195-D Models	.....		...	...	OIO	83225	
	C-150 Models	.....	OIO	G63306	...	...	...	
		308649C91		...	...	OIO	83216	
		308668C91	OIO	85012	89413	...	...	

## APPLICATION GUIDE - TRUCKS, TRAILERS, AND BUSES

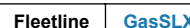
Year Año Année	Model Modelo Modèle	OEM #	Front		Rear	
						
			Wrench	Wrench	Wrench	Wrench
			Fleetline	GasSLX	Fleetline	GasSLX

### INTERNATIONAL (NAVISTAR)(Cont'd.)

#### A, B, AC and BC Conventional(Cont'd.)

	C-150 Models	453556C91	...	...	010	<b>85012</b>	<b>89413</b>
			453567C91	...	...	010	<b>83216</b>

#### BE Series School Bus

<b>- 2012</b>	BE200 Model School Bus Chassis with 7000 lb Front Axle	3605735C1	010	<b>83156</b>	...	...	...	...		
			3605735C2	010	<b>83156</b>	...	...	...	...	
			with 9000 lb Rear Suspension	3609400C1	...	...	-10	<b>83317</b>	...	...
			3609400C2	...	...	-10	<b>83317</b>	...	...	





#### Binder

	Binder	453556C91	010	<b>85012</b>	<b>89413</b>	...	...	...	
			453571C91	...	...	010	<b>83216</b>	...	
			467983C91	010	<b>85012</b>	<b>89413</b>	...	...	...
			467985C91	010	<b>85012</b>	<b>89413</b>	...	...	...
			471201C91	010	<b>85012</b>	<b>89413</b>	...	...	...
	S Models Binder	472367C91	-1-	<b>83318</b>	...	...	...	...	

#### Cargostar

	CO-1600, CO-1610A & B, CO-1630A & B, CO-1700, CO-1710A & B, CO-1730A & B, CO-1750, CO-1750A & B, CO-1800, CO-1810A & B, CO-1830A & B, CO-1850, and CO-1850A & B	206620R91	...	...	010	<b>83216</b>	...
		206621R92	...	...	010	<b>83216</b>	...
		294334C91	...	...	010	<b>83216</b>	...
		3085640C92	...	...	010	<b>83216</b>	...
		308646C91	...	...	010	<b>85012</b>	<b>89413</b>
		308649C91	...	...	010	<b>83216</b>	...
		308650C92	...	...	010	<b>83216</b>	...
		360444C91	...	...	010	<b>85012</b>	<b>89413</b>
		453564C91	...	...	010	<b>85012</b>	<b>89413</b>
		453567C91	...	...	010	<b>83216</b>	...
		453570C91	...	...	010	<b>83216</b>	...
		467983C91	...	...	010	<b>85012</b>	<b>89413</b>
		467984C91	...	...	010	<b>83216</b>	...
			CO-1610A & B, CO-1630A & B, CO-1710A & B, CO-1730A & B, CO-1750A & B, CO-1810A & B, CO-1830A & B, COF-1810A & B - Exc. with 9000, 10800, or 12000 lb Front Axle	453572C91	010	<b>83309</b>	...
	CO-1610A & B, CO-1630A & B, CO-1710A & B, CO-1730A & B, CO-1750A & B, CO-1810A & B, CO-1830A & B, COF-1810A & B - With 9000, 10800, or 12000 lb Front Axle	873619C92	010	<b>83314</b>	...	...	...
		873619C93	010	<b>83314</b>	...	...	...
	CO-190, VCO-190, CO-200, DCO-200, VCO-200, CO-220, VCO-220 With Air Ride Suspension After Chassis No G-387453	350425C1	...	...	010	<b>85300</b>	<b>89419</b>
		462557C91	...	...	010	<b>85300</b>	<b>89419</b>
	CO-190, VCO-190, CO-200, DCO-200, VCO-200, CO-220, VCO-220 With Air Ride Suspension before Chassis No G-387453	350426C91	...	...	010	<b>85734</b>	...
	CO-190, COF-190, CO-1950, COF-1950 & COT-1950, VCO-190, VCOF-190 & CO-200, DCO-200, VCO-200 & CO-220, VCO-220 & VCO-190 (4 man cab)	204994R91	010	<b>83225</b>	...	...	...
	CO-190, COF-190, VCO-190, VCOF-190 & CO-200, DCO-200, VCO-200 & CO-220, VCO-220 & VCO-190 (4 man cab)	210534R92	010	<b>83225</b>	...	...	...
		288920C91	010	<b>83225</b>	...	...	...
		288921R92	010	<b>83225</b>	...	...	...
		308648C91	010	<b>83225</b>	...	...	...
		452566C91	010	<b>83225</b>	...	...	...
		453561C91	010	<b>83225</b>	...	...	...
		453562C91	010	<b>83225</b>	...	...	...
		453565C91	010	<b>83225</b>	...	...	...
		453569C91	010	<b>83225</b>	...	...	...

**APPLICATION GUIDE - TRUCKS, TRAILERS, AND BUSES**

Year Año Année	Model Modelo Modèle	OEM #	Front		Rear	
						
					Fleetline	GasSLX

**INTERNATIONAL (NAVISTAR)(Cont'd.)**

**Cargostar(Cont'd.)**

	CO-190, COF-190, VCO-190, VCOF-190 & CO-200, DCO-200, VCO-200 & CO-220, VCO-220 & VCO-190 ( 4 man cab)	467371C91	010	83225	...		...	...
		467372C91	010	83225	...		...	...
	CO-1910A & B, CO-1950A & B, COF-1910A& B, COF-1950A & B	453572C91	010	83309	...		...	...
		873619C92	010	83314	...		...	...
	CO-1950 , COF-1950 & COT-1950	288920C91	010	83225	...		...	...
		288921C91	010	83225	...		...	...
		308648C91	010	83225	...		...	...
		453561C91	010	83225	...		...	...
		453565C91	010	83225	...		...	...
		453566C91	010	83225	...		...	...
		453569C91	010	83225	...		...	...
		467371C91	010	83225	...		...	...
		467372C91	010	83225	...		...	...
	CO-1950 with Air Ride Suspension After Chassis No. G-387453	350425C1		...	...	010	85300	89419
		462557C91		...	...	010	85300	89419
	CO-1950 with Air Ride Suspension Before Chassis No. G-387453	350426C1		...	...	010	85734	...

**CE Series School Bus**

06 - 18	CE Model School Buses (71 Capacity) with 9,000 to 10,000 lb Front Suspension	3578105C1	010	83163	...		...	...
		3578105C2	010	83163	...		...	...
		6127088C1	010	83163	...		...	...
		OE13402S	010	83163	...		...	...
10 - 18	CE Model School Buses with 20,000 lb International IROS Air Suspension	3578858C2		...	...	010	85926	...
		6127713C1		...	...	010	85926	...
05 - 13	CE Model School Buses with 22,000 lb Rear Spring Suspension	501906C92		...	...	-10	83317	...
		OE13424S		...	...	-10	83317	...
13 - 18	CE Model School Buses with 6,000 to 8,000 lb Front Axles	6127688C1	010	83169	...		...	...

**Co-Transtar and Transtar II**

	7070B, F-7070B, CO-7070B & COF-7070B Models	426744R91	010	85303	89422		...	...
		426744R92	010	85303	89422		...	...
		453576C91	010	85303	89422		...	...
		453576C92	010	85303	89422		...	...
		477132C1	010	85303	89422		...	...
	CO-4010, COF-4010, COT-4010, COT-4010D, CO-4050, COF-4050, COT-4050, CO-4040A & B, CO-4070D, COF-4070B, COF-4070D, COT-4070D, COF-4077, COF-4077A, COF-4080D, CO-4090A, COF-4090A	426744R91	010	85303	89422		...	...
		426744R92	010	85303	89422		...	...
		453576C91	010	85303	89422		...	...
		453576C92	010	85303	89422		...	...
		477132C1	010	85303	89422		...	...
	CO-4070A, COF-4070A, COF-4090A with Rear Suspension	462557C91		...	...	010	85300	89419

**CXT Series**

	CXT Models with 9,000 to 10,000 lb Front Suspension	3606770C1	010	83163	...		...	...
		3606770C2	010	83163	...		...	...

**DuraStar - 1000 Series**





	1300 Models	56110-T8123	-10	G63432	...		...	...
		56110-T8129	-10	G63432	...		...	...
		66400	-10	G63432	...		...	...

**DuraStar - 4300, 4400 Series**

2013	Low-Profile models with O.E.M. Number	1660846C92		...	...	010	83101	...
2016 -	Models with 10,500 or 13,500 lb Vari-Rate Rear Spring Suspension	6127087C1		...	...	010	83364	...



**APPLICATION GUIDE - TRUCKS, TRAILERS, AND BUSES**

Year Año Année	Model Modelo Modèle	OEM #	Front		Rear	
			 Fleetline	 GasSLX	 Fleetline	 GasSLX

**INTERNATIONAL (NAVISTAR)(Cont'd.)**









**DuraStar - 4300, 4400 Series(Cont'd.)**

16 - 20	Models with 11,000 lb to 14,000 lb Front axle	6127714C1	○ ○	85928	...		...	...
02 - 15	Models with 12,000 lb Front axle	3533357C1	○ ○	85957	...		...	...
		3533357C2	○ ○	85957	...		...	...
		3533357C3	○ ○	85957	...		...	...
- 2015	Models with 20,000 lb International IROS Air Suspension	3578858C1		...	...	○ ○	85926	...
		3578858C2		...	...	○ ○	85926	...
16 - 19	Models with 20,000 lb International IROS Air Suspension	6127713C1		...	...	○ ○	85926	...
02 - 13	Models with 22,000 lb Rear Spring Suspension	501906C91		...	...	- ○	83317	...
		501906C92		...	...	- ○	83317	...
- 2011	Models with 40,000 lb Rear Air Suspension	3549099C2		...	...	○ ○	85923	89458
02 - 12	Models with 6,000 to 8,000 lb Front Suspension	3533356C1	○ ○	83135	...		...	...
		3533356C2	○ ○	83135	...		...	...
13 - 18	Models with 6,000 to 8,000 lb Front Suspension	3533356C3	○ ○	83169	...		...	...
		6127688C1	○ ○	83169	...		...	...
- 2015	Models with 9,000 to 10,000 lb Front Suspension	3578105C2	○ ○	83163	...		...	...
16 - 19	Models with 9,000 to 10,000 lb Front Suspension	6127088C1	○ ○	83163	...		...	...
- 2020	Models with Hendrickson HAS - 230 or 460 Rear Air Suspension	3514952C1		...	...	○ ○	85976	...
		57905-001		...	...	○ ○	85976	...
		60675-003		...	...	○ ○	85976	...
		60675-003L		...	...	○ ○	85976	...
		H60675-003		...	...	○ ○	85976	...
	Models with International IROS Air Suspension	3553628C1		...	...	○ ○	85927	...
		3553628C2		...	...	○ ○	85927	...
		3553628C3		...	...	○ ○	85927	...
		3553628C4		...	...	○ ○	85927	...
	Models with O.E.M. Number	6127690C1		...	...	○ ○	85923	89458
16 - 17	Models with Vari-Rate Rear Spring Suspension	6127700C1		...	...	- ○	83395	...
02 - 12	School Bus models with 6,000 to 8,000 lb Front Suspension	3533356C1	○ ○	83135	...		...	...
		3533356C2	○ ○	83135	...		...	...

**F & S Series**

	1600, 1700, 1800, 1900, 2100 Models	3000070C91	- -	83456	89447		...	...
		453576C92	○ ○	85303	89422		...	...
	1600, 1700, 1800, 1900, 2100 Models with International Air Suspension	1675455C1		...	...	○ ○	85003	89411
		1690035C1		...	...	○ ○	85003	89411
		2018987C1		...	...	○ ○	85003	89411
		2018987C2		...	...	○ ○	85003	89411
		501553C91		...	...	○ ○	85003	89411
	1600, 1700, 1800, 1900, 2100 Models with Neway ARD-234 Air Suspension	537524C91		...	...	○ ○	83123	89405
	1624, 1654, 1724, 1754, 1824, 1854, 1924, F1924, 1925, 1954, F1954, 1955, 2124, 2125, F2125, 2154, 2155 Models Exc. with Rear Axle Codes 14029, 14030, 14187	501905C91		...	...	- ○	83301	...
		501906C91		...	...	- ○	83317	...
	1624, 1654, 1724, 1754, 1824, 1854, 1924, F1924, 1925, 1954, F1954, 1955, 2124, 2125, F2125, 2154, 2155 Models with 5000, 6000 or 7500 lb Front Axle	472367C91	- -	83318	...		...	...
	1624, 1654, 1724, 1754, 1824, 1854, 1924, F1924, 1925, 1954, F1954, 1955, 2124, 2125, F2125, 2154, 2155 Models with Rear Axle Codes 14029, 14030, 14187	501905C91		...	...	- ○	83301	...
	1624, 1654, 1724, 1754, 1824, 1854, 1924, F1924, 1925, 1954, F1954, 1955, 2124, 2125, F2125, 2154, 2155, 2275, F2275, 2524, F2524, 2554, F2554, 2574, F2574, 2575, F2575, F2624, F2654, F2674 Models with 9000, 10800 or 12000 lb Front Axle	472411C91	- -	83456	89447		...	...
		472412C91	- -	83456	89447		...	...
		586724C91	- -	83456	89447		...	...
	1924, 1954 (6 x 6) Models	472367C91	- -	83318	...		...	...

## APPLICATION GUIDE - TRUCKS, TRAILERS, AND BUSES

Year Año Année	Model Modelo Modèle	OEM #	Front		Rear	
						
						
			Fleetline	GasSLX	Fleetline	GasSLX

### INTERNATIONAL (NAVISTAR)(Cont'd.)

#### F & S Series(Cont'd.)

	1924, 1954 (6 x 6) Models	472414C91	- -	<b>83318</b>	...		...	...
	2275, F2275, 2524, F2524, 2554, F2554, 2574, F2574, 2575, F2575, F2624, F2654, F2674 Models with International Corporate Air Suspension	1675455C1		...	...	0 0	<b>85003</b>	<b>89411</b>
		1690035C1		...	...	0 0	<b>85003</b>	<b>89411</b>
		2018987C1		...	...	0 0	<b>85003</b>	<b>89411</b>
		2018987C2		...	...	0 0	<b>85003</b>	<b>89411</b>
		501553C91		...	...	0 0	<b>85003</b>	<b>89411</b>
	2275, F2275, 2524, F2524, 2554, F2554, 2574, F2574, 2575, F2575, F2624, F2654, F2674 Models with Neway ARD-125/244 Air Suspension	790335C91		...	...	0 0	<b>83209</b>	<b>89414</b>
	2275, F2275, 2524, F2524, 2554, F2554, 2574, F2574, 2575, F2575, F2624, F2654, F2674 Models with Neway ARD-234 Air Suspension	537524C91		...	...	0 0	<b>83123</b>	<b>89405</b>
	2275, F2275, 2524, F2524, 2554, F2554, 2574, F2574, 2575, F2575, F2624, F2654, F2674 Models with Ridwell Rear Suspension	534464C1		...	...	0 0	<b>85734</b>	...

#### Firetruck

	CO-8190	204994R91	0 0	<b>83225</b>	...		...	...
		308648C91	0 0	<b>83225</b>	...		...	...
		453561C91	0 0	<b>83225</b>	...		...	...
		453565C91	0 0	<b>83225</b>	...		...	...
		467371C91	0 0	<b>83225</b>	...		...	...
	Models with O.E.M. Number	210919R91		...	...	0 0	<b>85307</b>	...





#### Fleetstar - Conventional

	1900, F-1900, T-1900, 1950, F-1950, T-1950, 2000, 2000D, F-2000D & T-2000D Models	210535R91	0 0	<b>83225</b>	...		...	...
		453568C91	0 0	<b>83225</b>	...		...	...
		467372C91	0 0	<b>83225</b>	...		...	...
	1910A, F-1910A, 2010A, F-2010A, 2050A, F-2050A, 2070A, F-2070A, 2110A & 2150A Models	206621R92	0 0	<b>83216</b>	...		...	...
		308650C92	0 0	<b>83216</b>	...		...	...
		453570C91	0 0	<b>83216</b>	...		...	...
		467984C91	0 0	<b>83216</b>	...		...	...
	2000D, 2010A, 2050A, 2070A, 2110A, 2150A with Air Ride Suspension After Chassis No G-387453	350425C1		...	...	0 0	<b>85300</b>	<b>89419</b>
		462557C91		...	...	0 0	<b>85300</b>	<b>89419</b>
	2000D, 2010A, 2050A, 2070A, 2110A, 2150A with Air Ride Suspension Before Chassis No G-387453	350426C1		...	...	0 0	<b>85734</b>	...
	F-2010A, F-2050A, F-2000D with Air Ride Suspension	350425C1		...	...	0 0	<b>85300</b>	<b>89419</b>
		462557C91		...	...	0 0	<b>85300</b>	<b>89419</b>
	R-185, R-190, RD-190, R-200, RD-200, RF-200, RDF-200, R-220, RD-220, R210 & RF-210	210533R91	0 0	<b>83225</b>	...		...	...
		210534R92	0 0	<b>83225</b>	...		...	...
		210535R91	0 0	<b>83225</b>	...		...	...
		210536R91	0 0	<b>83225</b>	...		...	...
		210537R91	0 0	<b>83225</b>	...		...	...
		210538R91	0 0	<b>83225</b>	...		...	...
		453562C91	0 0	<b>83225</b>	...		...	...
		453568C91	0 0	<b>83225</b>	...		...	...
		467371C91	0 0	<b>83225</b>	...		...	...
		467372C91	0 0	<b>83225</b>	...		...	...

#### HV - Series

<b>19 - 20</b>	Models with 16,000 lb to 23,000 lb Parabolic Taperleaf Springs	3576464C2	0 0	<b>85957</b>	...		...	...
<b>19 - 20</b>	Models with Hendrickson HMX 400/460 Haulmax with 16.5" Saddle	60680-004		...	...	0 -	<b>83143</b>	...
		60680-004L		...	...	0 -	<b>83143</b>	...
		H60680004		...	...	0 -	<b>83143</b>	...
<b>19 - 20</b>	Models with Hendrickson HMX 400/460 Haulmax with 17.5" or 18.5" Saddle Height	60680-005		...	...	0 -	<b>83142</b>	...

**APPLICATION GUIDE - TRUCKS, TRAILERS, AND BUSES**

Year Año Année	Model Modelo Modèle	OEM #	Front			Rear		
							Fleetline	GasSLX

**INTERNATIONAL (NAVISTAR)(Cont'd.)**

**HV - Series(Cont'd.)**

19 - 20	Models with Hendrickson HMX 400/460 Haulmax with 17.5" or 18.5" Saddle Height	60680-005L	...	...	01-	<b>83142</b>	...
		H60680005	...	...	01-	<b>83142</b>	...
19 - 20	Models with Hendrickson Primaax 230/460 Air Suspension with 9" Ride Height	60657-003	...	...	010	<b>85072</b>	...
		60657-003L	...	...	010	<b>85072</b>	...
		H60657003	...	...	010	<b>85072</b>	...



**HX - Series**

17 - 20	Models with Hendrickson HAS - 230 or 460 Rear Air Suspension	60675-003	...	...	010	<b>85976</b>	...
		60675-003L	...	...	010	<b>85976</b>	...
		H60675003	...	...	010	<b>85976</b>	...
17 - 20	Models with Hendrickson HMX 400/460 Haulmax with 16.5" Saddle	60680-004	...	...	01-	<b>83143</b>	...
		H60680004	...	...	01-	<b>83143</b>	...
18 - 20	Models with Hendrickson HMX 400/460 Haulmax with 16.5" Saddle	60680-004L	...	...	01-	<b>83143</b>	...
17 - 20	Models with Hendrickson HMX 400/460 Haulmax with 17.5" or 18.5" Saddle Height	60680-005	...	...	01-	<b>83142</b>	...
		60680-005L	...	...	01-	<b>83142</b>	...
		H60680005	...	...	01-	<b>83142</b>	...
17 - 20	Models with Hendrickson Primaax 230/460 Air Suspension with 9" Ride Height	60657-003	...	...	010	<b>85072</b>	...
		60657-003L	...	...	010	<b>85072</b>	...
		H60657003	...	...	010	<b>85072</b>	...
18 - 19	Models with Hendrickson Primaax 520 Rear Air Suspension (10" Ride Height-Drum Brakes only)	60665-013	...	...	010	<b>85965</b>	...
		H60665013	...	...	010	<b>85965</b>	...

**Loadstar - Conventional**

1600, 1600 (4x4), 1610, 1610 (4x4), 1610FC, 1700, 1700 (4x4), 1710, 1710 (4x4), F-1700, 1750, 1800, 1810, F-1800, F-1800-D, 1850, F-1850, 1890 & 1890-D with 9000, 10800 or 12000 lb Front Axle	329316C92	010	<b>85012</b>	<b>89413</b>		...	...
	360444C91	010	<b>85012</b>	<b>89413</b>		...	...
	453564C91	010	<b>85012</b>	<b>89413</b>		...	...
	467983C91	010	<b>85012</b>	<b>89413</b>		...	...
	471201C91	010	<b>85012</b>	<b>89413</b>		...	...
1600, 1600 (4x4), 1610, 1610 (4x4), 1610FC, 1700, 1700 (4x4), 1710, 1710 (4x4), F-1700, 1750, 1800, 1810, F-1800, F-1800-D, 1850, F-1850, 1890 & 1890-D with Axle Codes 02089, 02091	206620R91	010	<b>83216</b>	...		...	...
	308649C91	010	<b>83216</b>	...		...	...
	453567C91	010	<b>83216</b>	...		...	...
1600, 1600 (4x4), 1610, 1610 (4x4), 1700, 1700 (4x4), 1710, 1710 (4x4), 1750, 1800, 1810, 1850, 1890 & 1890-D Models	206620R91		...	...	010	<b>83216</b>	...
	206621R91		...	...	010	<b>83216</b>	...
	308649C91		...	...	010	<b>83216</b>	...
	308650C92		...	...	010	<b>83216</b>	...
	329316C92		...	...	010	<b>85012</b>	<b>89413</b>
	360444C91		...	...	010	<b>85012</b>	<b>89413</b>
	383379C91		...	...	010	<b>83308</b>	...
	453564C91		...	...	010	<b>85012</b>	<b>89413</b>
	453567C91		...	...	010	<b>83216</b>	...
	453570C91		...	...	010	<b>83216</b>	...
	453575C91		...	...	010	<b>83308</b>	...
	467983C91		...	...	010	<b>85012</b>	<b>89413</b>
	467984C91		...	...	010	<b>83216</b>	...
	471203C91		...	...	010	<b>83308</b>	...
	474002C91		...	...	010	<b>83308</b>	...
	873622C91		...	...	010	<b>83308</b>	...

**APPLICATION GUIDE - TRUCKS, TRAILERS, AND BUSES**

Year Año Année	Model Modelo Modèle	OEM #	Front		Rear	
						
			Fleetline	GasSLX	Fleetline	GasSLX

**INTERNATIONAL (NAVISTAR)(Cont'd.)**

**Loadstar - Conventional(Cont'd.)**

1600, 1600 (4x4), 1610, 1610 (4x4), 1700, 1700 (4x4), 1710, 1710 (4x4), F-1700, 1750, 1800, 1810, F-1800, F-1800-D, 1850, F-1850, 1890 & 1890-D Exc. Axle Codes 02054, 02057, 02059, 02089, 02091, 02098, 02101, 02109, 02139, 02208, 02218, 02228, 02309, 0232	308668C92	010	85012	89413		...	...
	453556C91	010	85012	89413		...	...
	467985C91	010	85012	89413		...	...
	874695R91	010	85012	89413		...	...
	874695R92	010	85012	89413		...	...
1600, 1610FC, 1700, 1700 (4x4), 1800, 1890, 1890D Models	384435C91		...	...	010	83216	...
	453571C91		...	...	010	83216	...
	462753C91		...	...	010	83216	...
1700, 1750, 1800, 1850 Models with Air Ride Suspension	462557C91		...	...	010	85300	89419
M1600, M1700, M1800, M1900, M2100 Models	453576C92	010	85303	89422		...	...

**LoneStar - Series**

09 - 15	All models with 40,000 lb Rear Air Suspension	3620395C1		...	...	010	85931	89458
	Day Cab Models with O.E.M. Number	3688615C1		...	...	010	85931	89458
09 - 18	Models with 12,350 lb Front Mono Leaf Spring Suspension	3813341C1	010	85963	...		...	...
		3813341C2	010	85963	...		...	...
		3813341C3	010	85963	...		...	...
		3813341C4	010	85963	...		...	...
- 2017	Models with Hendrickson HAS - 230 or 460 Rear Air Suspension	3514952C1		...	...	010	85976	...
		57905-001		...	...	010	85976	...
		60675-003		...	...	010	85976	...
		60675-003L		...	...	010	85976	...
		H60675-003		...	...	010	85976	...
12 - 16	Models with International 40,000 lb Rear Air Suspension (52" Spacing- Heavy Duty Rear)	3688614C1		...	...	010	85923	89458
		3688616C1		...	...	010	85923	89458
17 - 20	Models with International 40,000 lb Rear Air Suspension (52" Spacing- Heavy Duty Rear)	4069435C1		...	...	010	85642	...
17 - 19	Models with O.E.M. Number	4069426C1		...	...	010	85642	...
		4069434C1		...	...	010	85642	...
2013 -	Models with O.E.M. Number	3810581C3	010	85995	...		...	...
		3810581C4	010	85995	...		...	...
09 - 20	Sleeper Cab models with 14,000 lb Parabolic Taperleaf Front Spring	3813340C1	010	85964	...		...	...
		3813340C2	010	85964	...		...	...
		3813340C3	010	85964	...		...	...
		3813340C4	010	85964	...		...	...





**LT - Series**

2018 - 19	LT-625 Models with 12,000 - 14,000 lb Taperleaf Spring Suspension	4050444C2	010	85994	...		...	...
2018 - 20	LT-625 Models with 12,000 lb - 13,200 lb Mono-Leaf Spring Suspension	4050443C2	010	85994	...		...	...
2018	Models with Hendrickson HTB 400LT Rear Air Suspension	3684524C1		...	...	010	85102	...
		60657-010		...	...	010	85102	...
		H60657-010		...	...	010	85102	...
17 - 20	Models with O.E.M. Number	6127666C1		...	...	010	85642	...

**Metro & Multi-Shop Series**

	AM and AMC-160, AMC-164	308649C91	010	83216	...		...	...
		453567C91	010	83216	...		...	...
	M1600, M1700, M1800, M1900, M2100 Models	453576C92	010	85303	89422		...	...
	M1600, M1700, M1800, M1900, M2100 Models - Exc. with Rear Axle Codes 14029, 14030, 14187	501905C91		...	...	-10	83301	...
		501906C91		...	...	-10	83317	...
	M1600, M1700, M1800, M1900, M2100 Models with 5000, 6000 or 7500 lb Front Axle	472367C91	-1-	83318	...		...	...

**APPLICATION GUIDE - TRUCKS, TRAILERS, AND BUSES**

Year Año Année	Model Modelo Modèle	OEM #	Front		Rear	
			 Fleetline	 GasSLX	 Fleetline	 GasSLX

**INTERNATIONAL (NAVISTAR)(Cont'd.)**

**Metro & Multi-Shop Series(Cont'd.)**

	M1600, M1700, M1800, M1900, M2100 Models with 9000, 10800 or 12000 Front Axle	472411C91	-1-	83456	89447		...	...
	M1600, M1700, M1800, M1900, M2100 Models with Front Axle Codes 02109, 02118, 02309, 02127, 02139, 02329, 02339	472412C91	-1-	83456	89447		...	...
		586724C91	-1-	83456	89447		...	...
	M1600, MC1600, M1700 & MC1700	206620R91		...	...	010	83216	...
		308649C91		...	...	010	83216	...
		308668C91	010	85012	89413		...	...
		308669C91	010	85012	89413		...	...
		453556C91	010	85012	89413		...	...
		453597C91		...	...	010	83216	...
		874695R91	010	85012	89413		...	...
		874696R91	010	85012	89413		...	...
	MA1200, M1400, M1500, MA1500	287318C91		G63306	...	010	G63306	...
		308649C91		...	...	010	83216	...
		308669C91		...	...	010	85012	89413
		453531C91		...	...	010	G63306	...
		453556C91		...	...	010	85012	89413
		453557C91		...	...	010	G63306	...
		453567C91		...	...	010	83216	...
		467980C91		G63306	...	010	G63306	...
66 - 72	Metro Models M1200 - Exc. Frame Code 01000.0962	....	010	G63299	...		...	...
66 - 72	Metro Models M1200 with 14016 Reg. Rear Springs & with 14020 Rear Axle Code	....		G63306	...	010	G63306	...
66 - 72	Metro Models M1200 with Axle Code 0208 & Frame Code 01000.0962	....		G63306	...	010	G63306	...
66 - 72	Metro Models M1200 with Code 03204 Aux. Springs	....		...	...	010	G63299	...
66 - 72	Metro Models M700, 800, 900-U, 1000, 1100,	....		G63306	...	010	G63306	...
73 - 75	Multi-Stop Models MS-1210 & 1510	....		...	...	010	G63306	...





**MV Series**

2019	MV607 Models with 11,000 lb to 14,000 lb Front axle	6127714C1	010	85928	...		...	...
2019	MV607 Models with 20,000 lb International IROS Air Suspension	6127713C1		...	...	010	85926	...
2019	MV607 Models with 40,000 lb Rear Air Suspension	3549099C3		...	...	010	85923	89458
2019	MV607 Models with 8,000 lb Front Suspension	3533356C3	010	83169	...		...	...
2019	MV607 Models with 9,000 to 10,000 lb Front Suspension	6127088C1	010	83163	...		...	...

**Paystar - 5000 Series**

	5010, F-5010, F-5050, F-5050SF, 5070, F-5070, F-5070SF Models	426744R91	010	85303	89422		...	...
		426744R92	010	85303	89422		...	...
		453576C91	010	85303	89422		...	...
		453576C92	010	85303	89422		...	...
		477132C1	010	85303	89422		...	...
- 2012	5600i Models with 16,000 lb Front axle	1667520C1	010	85058	89431		...	...
		4070336C1	010	85058	89431		...	...
04 - 12	5900 SB Models with 18,000 lb Front axle	1667520C1	010	85058	89431		...	...
04 - 15	5900 SB Models with 46,000 lb Hendrickson Rear Air Suspension	3626571C1		...	...	010	85072	...
		H60657-003		...	...	010	85072	...
- 2018	5900 SB Models with Hendrickson Primaax 230, 460 and 690 Air Suspension (8-1/2" to 10" Ride Height)	60657-003		...	...	010	85072	...
		60657-003L		...	...	010	85072	...
- 2018	5900 SB Models with Hendrickson Primaax EX 232, 462 and 692 Air Suspension (8-1/2" to 10" Ride Height)	60657-003		...	...	010	85072	...
		60657-003L		...	...	010	85072	...
09 - 11	5900i Models with 12,000 lb - 14,000 lb Front axle	2015556C1	-10	85316	89426		...	...
04 - 12	5900i SFA Models with 16,000 lb Front axle	1667520C1	010	85058	89431		...	...
04 - 09	5900i SFA Models with 46,000 lb Neway Rear Air Suspension	2029200C91		...	...	010	83126	89430

**APPLICATION GUIDE - TRUCKS, TRAILERS, AND BUSES**

Year Año Année	Model Modelo Modèle	OEM #	Front		Rear	
						
			Fleetline	GasSLX	Fleetline	GasSLX

**INTERNATIONAL (NAVISTAR)(Cont'd.)**

**Paystar - 5000 Series(Cont'd.)**

<b>04 - 09</b>	5900i SFA Models with 46,000 lb Neway Rear Air Suspension	90044626		...	...	0 0	<b>83126</b>	<b>89430</b>
	Models with 10,000 to 16,000 lb Front Suspension	3576465C1	0 0	<b>85999</b>	...		...	...
		3576465C2	0 0	<b>85999</b>	...		...	...
		3816234C1	0 0	<b>85999</b>	...		...	...
<b>10 - 13</b>	Models with 12,000 to 14,000 lb Front Taperleaf Suspension	3868264C1	0 0	<b>85998</b>	...		...	...
	Models with 14,000 lb Front axle	3596878C2	0 0	<b>85648</b>	...		...	...
		4070352C1	0 0	<b>85648</b>	...		...	...
<b>- 2013</b>	Models with Hendrickson HMX 400/460 Haulmax with 16.5" Saddle	60680-004		...	...	0 1-	<b>83143</b>	...
		60680-004L		...	...	0 1-	<b>83143</b>	...
	Models with O.E.M. Number	6127690C1		...	...	0 0	<b>85923</b>	<b>89458</b>

**ProStar - Series**

<b>2017 -</b>	6 x 4 Models with O.E.M. Number	6127666C1		...	...	0 0	<b>85642</b>	...
<b>09 - 17</b>	All models with 40,000 lb Rear Air Suspension	3620395C1		...	...	0 0	<b>85931</b>	<b>89458</b>
		4050340C1		...	...	0 0	<b>85931</b>	<b>89458</b>
		4050340C2		...	...	0 0	<b>85931</b>	<b>89458</b>
	Day Cab Models with O.E.M. Number	3737576C1		...	...	0 0	<b>85931</b>	<b>89458</b>
<b>2013 -</b>	Models with 113" Sleeper Cab	3806341C3	0 0	<b>85995</b>	...		...	...
		3806341C4	0 0	<b>85995</b>	...		...	...
		3810581C3	0 0	<b>85995</b>	...		...	...
		3810581C4	0 0	<b>85995</b>	...		...	...
<b>- 2013</b>	Models with 12,350 lb Front Mono Leaf Spring Suspension	3610198C1	0 0	<b>85963</b>	...		...	...
<b>09 - 18</b>	Models with 12,350 lb Front Mono Leaf Spring Suspension	3813341C3	0 0	<b>85963</b>	...		...	...
		3813341C4	0 0	<b>85963</b>	...		...	...
<b>16 - 17</b>	Models with Day Cab and 12,000 - 14,000 lb Taperleaf Front Spring Suspension	4050444C1	0 0	<b>85994</b>	...		...	...
		4050444C2	0 0	<b>85994</b>	...		...	...
<b>- 2015</b>	Models with Day Cab and 12,000 to 14,000 lb Taperleaf Front Spring Suspension	3606859C1	0 0	<b>85954</b>	...		...	...
		3606859C2	0 0	<b>85954</b>	...		...	...
		3606859C3	0 0	<b>85994</b>	...		...	...
		3737574C1	0 0	<b>85954</b>	...		...	...
		3812837C1	0 0	<b>85954</b>	...		...	...
	Models with Day Cab and Air Suspension	3610199C1	0 0	<b>85964</b>	...		...	...
<b>- 2017</b>	Models with Hendrickson HAS - 230 or 460 Rear Air Suspension	3514952C1		...	...	0 0	<b>85976</b>	...
		57905-001		...	...	0 0	<b>85976</b>	...
<b>- 2019</b>	Models with Hendrickson HAS - 230 or 460 Rear Air Suspension	60675-003		...	...	0 0	<b>85976</b>	...
		60675-003L		...	...	0 0	<b>85976</b>	...
		H60675-003		...	...	0 0	<b>85976</b>	...
	Models with Hendrickson HTB 400LT Rear Air Suspension	60657-006		...	...	0 0	<b>85102</b>	...
		60657-010		...	...	0 0	<b>85102</b>	...
		60657-011		...	...	0 0	<b>85102</b>	...
		H60657-006		...	...	0 0	<b>85102</b>	...
		H60657-010		...	...	0 0	<b>85102</b>	...
		H60657-011		...	...	0 0	<b>85102</b>	...
	Models with O.E.M. Number	3668566C1	0 0	<b>85954</b>	...		...	...
		3688729C1		...	...	0 0	<b>85931</b>	<b>89458</b>
		3688732C1		...	...	0 0	<b>85931</b>	<b>89458</b>
		3821760C1		...	...	0 0	<b>85931</b>	<b>89458</b>
<b>- 2014</b>	Models with Sleeper Cab and 12,350 lb Leaf Spring Suspension	3606857C1	0 0	<b>85954</b>	...		...	...
		3606857C2	0 0	<b>85954</b>	...		...	...
<b>14 - 15</b>	Models with Sleeper Cab and 12,350 lb Leaf Spring Suspension	3606857C3	0 0	<b>85994</b>	...		...	...

## APPLICATION GUIDE - TRUCKS, TRAILERS, AND BUSES

Year Año Année	Model Modelo Modèle	OEM #	Front		Rear	
			Fleetline	GasSLX	Fleetline	GasSLX

### INTERNATIONAL (NAVISTAR)(Cont'd.)

#### ProStar - Series(Cont'd.)

	Models with Sleeper Cab with O.E.M. Number	3737575C1	OIO	<b>85954</b>	...	...	...
2016 -	Sleeper Cabs with 12,000 lb - 13,200 lb Mono-Leaf Spring Suspension	4050443C1	OIO	<b>85994</b>	...	...	...
		4050443C2	OIO	<b>85994</b>	...	...	...





#### RH - Series

18 - 19	Models with O.E.M. Number	6127666C1		...	...	OIO	<b>85642</b>	...
2018 - 19	RH Models with 12,000 - 14,000 lb Taperleaf Spring Suspension	4050444C2	OIO	<b>85994</b>	...		...	...
2018 - 19	RH-613 Models with 12,000 lb - 13,200 lb Mono-Leaf Spring Suspension	4050443C2	OIO	<b>85994</b>	...		...	...

#### S Series School Bus

	1603, 1703, 1803 & 1853	206620R91 206621R91 306444C91 308649C91 308650C92 329316C92 383379C91 453564C91 453567C91 453570C91 453575C91 467983C91 471201C91 471203C91 474002C91 873622C91		...	...	OIO	<b>83216</b>	...
				...	...	OIO	<b>83216</b>	...
				...	...	OIO	<b>85012</b>	<b>89413</b>
				...	...	OIO	<b>83216</b>	...
				...	...	OIO	<b>83216</b>	...
				...	...	OIO	<b>85012</b>	<b>89413</b>
				...	...	OIO	<b>83308</b>	...
				...	...	OIO	<b>85012</b>	<b>89413</b>
				...	...	OIO	<b>83216</b>	...
				...	...	OIO	<b>83216</b>	...
				...	...	OIO	<b>83308</b>	...
				...	...	OIO	<b>85012</b>	<b>89413</b>
				OIO	<b>85012</b>	<b>89413</b>	...	...
				...	...	OIO	<b>83308</b>	...
				...	...	OIO	<b>83308</b>	...
	1603, 1703, 1803 & 1853 - Exc. Axle Codes 02054, 02057, 02059, 02089, 02091, 02098, 02101, 02109, 02139, 02208, 02218, 02228, 02309, 02329, 02339	308668C92	OIO	<b>85012</b>	<b>89413</b>		...	...
		453556C91	OIO	<b>85012</b>	<b>89413</b>		...	...
		467985C91	OIO	<b>85012</b>	<b>89413</b>		...	...
		874695R91	OIO	<b>85012</b>	<b>89413</b>		...	...
	1603, 1703, 1803 & 1853 with Axle Codes 02089, 02091	206620R91	OIO	<b>83216</b>	...		...	...
		308649C91	OIO	<b>83216</b>	...		...	...
		453567C91	OIO	<b>83216</b>	...		...	...
		467984C91	OIO	<b>83216</b>	...		...	...
	1603, 1703, 1803 & 1853 with 9000, 10800 or 12000 lb Front Axle	320444C91	OIO	<b>85012</b>	<b>89413</b>		...	...
		329316C92	OIO	<b>85012</b>	<b>89413</b>		...	...
		453564C91	OIO	<b>85012</b>	<b>89413</b>		...	...
		467983C91	OIO	<b>85012</b>	<b>89413</b>		...	...
	1723 S Models with 5000, 6000 or 7500 lb Front Axle	472367C91	- -	<b>83318</b>	...		...	...
	1723, 1823, 1853 Models with International Air Suspension	1675455C1		...	...	OIO	<b>85003</b>	<b>89411</b>
		1690035C1		...	...	OIO	<b>85003</b>	<b>89411</b>
		2018987C1		...	...	OIO	<b>85003</b>	<b>89411</b>
		2018987C2		...	...	OIO	<b>85003</b>	<b>89411</b>
		501553C91		...	...	OIO	<b>85003</b>	<b>89411</b>
	1723, 1823, 1853 Models with Neway ARD-234 Air Suspension	537524C91		...	...	OIO	<b>83123</b>	<b>89405</b>
	173 FC & 183 FC - Exc. Axle Codes 14149 & 14189	210918R91		...	...	OIO	<b>83215</b>	...
		453574C91		...	...	OIO	<b>85307</b>	...
	173 FC & 183 FC with Axle Codes 14149 & 14189	210535R91		...	...	OIO	<b>83225</b>	...
		453568C91		...	...	OIO	<b>83225</b>	...
		467372C91		...	...	OIO	<b>83225</b>	...
	173 FC, 183 FC, 183RE, 193 RE, 1853 FC & 1853 DFC	204994R91	OIO	<b>83225</b>	...		...	...
		308648C91	OIO	<b>83225</b>	...		...	...
		453561C91	OIO	<b>83225</b>	...		...	...

## APPLICATION GUIDE - TRUCKS, TRAILERS, AND BUSES

Year Año Année	Model Modelo Modèle	OEM #	Front		Rear	
						
			Fleetline	GasSLX	Fleetline	GasSLX

### INTERNATIONAL (NAVISTAR)(Cont'd.)

#### S Series School Bus(Cont'd.)

	173 FC, 183 FC, 183RE, 193 RE, 1853 FC & 1853 DFC	453565C91 467371C91	010	83225	...	...	...	
			010	83225	...	...	...	
	1823 S Models - Exc. with Rear Axle Codes 14029,14030, 14187	501906C91		...	...	-10	83317	...
	1823, 1853 S Models with 9000, 10800 or 12000 lb Front Axle	472411C91 472412C91 586724C91	-1-	83456	89447		...	...
			-1-	83456	89447		...	...
			-1-	83456	89447		...	...
	183 RE Models with Axle Codes 14043, 14147 & 14186	210533R91 210534R92 453562C91 467371C91		...	...	010	83225	...
				...	...	010	83225	...
				...	...	010	83225	...
				...	...	010	83225	...
	1853 DFC3	210920R91 453579C91	010	85308	89422		...	...
			010	85308	89422		...	...
	1853 FC & 1853 DFC with Axle Code 14136	210919R91 308664C91 453574C91		...	...	010	85307	...
				...	...	010	85307	...
				...	...	010	85307	...
	1853 FC & 1853 DFC with Axle Code 14149 with FD Serial Numbers	453567C91		...	...	010	83216	...
	1853 FC & 1853 DFC with Axle Codes 14039, 14139, 14149 & 14189 - Exc. 14149 with FD Serial Numbers	210533R91 210534R92 453562C91 467371C91		...	...	010	83225	...
				...	...	010	83225	...
				...	...	010	83225	...
				...	...	010	83225	...
	1853 FC & 1853 DFC with Axle Codes 14044, 14045, 14060, 14145, 14146, 14150 and 14186	208664C91 210919R91 453574C91		...	...	010	85307	...
				...	...	010	85307	...
				...	...	010	85307	...
	193 RE Models	210920R91 453579C91	010	85308	89422		...	...
			010	85308	89422		...	...
	193 RE Models - Exc. Axle Codes 14039 & 14189	210533R91 210534R92 453562C91 467371C91		...	...	010	83225	...
				...	...	010	83225	...
				...	...	010	83225	...
				...	...	010	83225	...
	RE Models	3604282C1	-10	85351	...		...	...

#### Series 1000 Forward Control Chassis





	1452, 1652 Models	453576C92 472412C91 586724C91	010	85303	89422		...	...
			-1-	83456	89447		...	...
			-1-	83456	89447		...	...
	1452, 1652 Models with International Air Suspension	1675455C1 1690035C1 2018987C1 2018987C2 501553C91		...	...	010	85003	89411
				...	...	010	85003	89411
				...	...	010	85003	89411
				...	...	010	85003	89411
				...	...	010	85003	89411
	1452, 1652 Models with MOR-RYDE Rear Suspension	548532C1		...	...	-1-	83103	...
	1654 LP Models (Low Profile Vehicle)	1660846C91 1660846C92 1663471C1		...	...	010	83101	...
				...	...	010	83101	...
			-1-	83103	...		...	...
	M1400, M1600 Models	472412C91 501905C91 586724C91	-1-	83456	89447		...	...
				...	...	-10	83301	...
			-1-	83456	89447		...	...

#### Series 2000 - Conventional Truck (Severe Service)

	2554, 2574, 2654, 2674 Models with International Air Suspension	1675455C1 1690035C1 2018987C1 2018987C2		...	...	010	85003	89411
				...	...	010	85003	89411
				...	...	010	85003	89411
				...	...	010	85003	89411



**APPLICATION GUIDE - TRUCKS, TRAILERS, AND BUSES**

Year Año Année	Model Modelo Modèle	OEM #	Front		Rear	
			 Fleetline	 GasSLX	 Fleetline	 GasSLX

**INTERNATIONAL (NAVISTAR)(Cont'd.)**

**Series 2000 - Conventional Truck (Severe Service)(Cont'd.)**

2554, 2574, 2654, 2674 Models with International Air Suspension	501553C91		...	...	010	<b>85003</b>	<b>89411</b>
2554, 2574, 2654, 2674 Models with International Vari-Rate Rear Suspension	501506C91		...	...	-10	<b>83317</b>	...
All 2000 Models							
With 12000 lb Front Axle	472412C91	-1-	<b>83456</b>	<b>89447</b>		...	...
With 16000 or 18000 lb Springs	1667520C1	010	<b>85058</b>	<b>89431</b>		...	...
Without 16000 or 18000 lb Springs	2015556C1	-10	<b>85316</b>	<b>89426</b>		...	...

**Series 3000 - School Bus Chassis**

3000, 3400 Models with 10,000 to 14,000 lb Front axle	3533357C1	010	<b>85957</b>	...		...	...
	3533357C2	010	<b>85957</b>	...		...	...
	3533357C3	010	<b>85957</b>	...		...	...
3000, 3400 Models with 6,000 to 8,000 lb Front axle	3533356C1	010	<b>83135</b>	...		...	...
	3533356C2	010	<b>83135</b>	...		...	...
3700, 3800 Models	472412C91	-1-	<b>83456</b>	<b>89447</b>		...	...
	501905C91		...	...	-10	<b>83301</b>	...
	501906C91		...	...	-10	<b>83317</b>	...
	586724C91	-1-	<b>83456</b>	<b>89447</b>		...	...
3700, 3800 Models with International Air Suspension	1675455C1		...	...	010	<b>85003</b>	<b>89411</b>
	1690035C1		...	...	010	<b>85003</b>	<b>89411</b>
	2018987C1		...	...	010	<b>85003</b>	<b>89411</b>
	2018987C2		...	...	010	<b>85003</b>	<b>89411</b>
	501553C91		...	...	010	<b>85003</b>	<b>89411</b>
3700, 3800 Models with MOR-RYDE Rear Suspension	548532C1		...	...	-1-	<b>83103</b>	...
3700, 3800 Models with Neway ARD-234 Air Suspension	537524C91		...	...	010	<b>83123</b>	<b>89405</b>
	537525C91		...	...	010	<b>83123</b>	<b>89405</b>
3900FC Models	1677707C1	010	<b>85030</b>	<b>89440</b>		...	...
	2015557C1	010	<b>85030</b>	<b>89440</b>		...	...
	467371C91		<b>83225</b>	...	010	<b>83225</b>	...
3900FC Models (Genesis - Front Engine)	2200327C1	-10	<b>85332</b>	...		...	...
3900FC Models (Genesis - Rear Engine)	2039549C1	-10	<b>85333</b>	...		...	...
03 - 17 RE Model School Buses with Hendrickson AirTek Front Suspension	3838241C1	010	<b>85986</b>	...		...	...
	65992-006	010	<b>85986</b>	...		...	...
	H65992-006	010	<b>85986</b>	...		...	...





**Series 400, 500, 600, 700, & 900 - Medium Cabover Truck & Tractor ( Nissan)**

400 Models	56101 Z5008	-10	<b>83114</b>	...		...	...
	56101 Z5011	-10	<b>G63610</b>	...		...	...
500 Models	56101 Z5011	-10	<b>G63610</b>	...		...	...
600, 700, 900 Models	56101 Z1030	-10	<b>85311</b>	<b>89424</b>		...	...
	56101 Z2000	-10	<b>85311</b>	<b>89424</b>		...	...

**Series 4000 - Short Conventional Medium Truck & Tractor**

4000 Models with Hendrickson HAS-230 Rear Air Suspension	AMS650420		...	...	010	<b>85013</b>	<b>89414</b>
4600, 4700, 4800, 4900 Models	1663606C91	-1-	<b>85027</b>	<b>89418</b>		...	...
	1667520C1	010	<b>85058</b>	<b>89431</b>		...	...
	586724C91	-1-	<b>83456</b>	<b>89447</b>		...	...
4600, 4700, 4800, 4900 Models with 10000 lb Front Axle	472412C91	-1-	<b>83456</b>	<b>89447</b>		...	...
4600, 4700, 4800, 4900 Models with International Air Suspension (Exc. Low Profile)	1675455C1		...	...	010	<b>85003</b>	<b>89411</b>
	1690035C1		...	...	010	<b>85003</b>	<b>89411</b>
	2018987C1		...	...	010	<b>85003</b>	<b>89411</b>
	2018987C2		...	...	010	<b>85003</b>	<b>89411</b>
	501553C91		...	...	010	<b>85003</b>	<b>89411</b>
4600LP, 4700LP Models (Low Profile Vehicle) U-Haul	540395C91	-1-	<b>83613</b>	...		...	...
	540395C92	-1-	<b>83613</b>	...		...	...

## APPLICATION GUIDE - TRUCKS, TRAILERS, AND BUSES

Year Año Année	Model Modelo Modèle	OEM #	Front		Rear	
						
			Fleetline	GasSLX	Fleetline	GasSLX

### INTERNATIONAL (NAVISTAR)(Cont'd.)

#### Series 4000 - Short Conventional Medium Truck & Tractor(Cont'd.)

	4600LP, 4700LP Models (Low Profile Vehicle) with Air Suspension	1660846C91		...	...	0 0	83101	...
		1660846C92		...	...	0 0	83101	...
	F-4900 & 4600LP Models (Low Profile Vehicle)	501906C91		...	...	- 0	83317	...
		501906C92		...	...	- 0	83317	...
<b>90 - 02</b>	F-4900 Models with 10000 lb Front Axle	472412C91	- -	<b>83456</b>	<b>89447</b>		...	...
<b>90 - 02</b>	F-4900 Models with Dual Doors	2015556C1	- 0	<b>85316</b>	<b>89426</b>		...	...
	F-4900 Models with Hendrickson HN - 400 Models Rear suspension	60680-003		...	...	0 -	83112	...
		60680-003L		...	...	0 -	83112	...

#### Series 405

	Models with O.E.M. Number	293009C91	0 0	<b>85308</b>	<b>89422</b>		...	...
		426744R91	0 0	<b>85303</b>	<b>89422</b>		...	...
		453576C91	0 0	<b>85303</b>	<b>89422</b>		...	...
		453577C91	0 0	<b>85308</b>	<b>89422</b>		...	...

#### Series 417

	DCO-417 & DCOF-417	426744R91	0 0	<b>85303</b>	<b>89422</b>		...	...
		453576C91	0 0	<b>85303</b>	<b>89422</b>		...	...

#### Series 5000, 5000i - Severe Service Conventional Truck & Tractor

	6 X 4 Models with Neway AD-246-10 Air Suspension and 60" Axle Spacing Heavy Duty	2029200C91		...	...	0 0	<b>85030</b>	<b>89440</b>	
		AMS 600172		...	...	0 0	<b>85030</b>	<b>89440</b>	
		Standard	2029200C91		...	...	0 0	<b>83126</b>	<b>89430</b>
			AMS 600172		...	...	0 0	<b>83126</b>	<b>89430</b>





#### Series 7000 - Short Conventional Medium Truck & Tractor

	7000 Models School Bus with O.E.M. Number	3609400C1		...	...	- 0	83317	...
		3609400C2		...	...	- 0	83317	...
	7100 Models	1663606C91	- -	<b>85027</b>	<b>89418</b>		...	...
		472412C91	- -	<b>83456</b>	<b>89447</b>		...	...
		586724C91	- -	<b>83456</b>	<b>89447</b>		...	...
	7100 Models with International Air Suspension	1675455C1		...	...	0 0	<b>85003</b>	<b>89411</b>
		1690035C1		...	...	0 0	<b>85003</b>	<b>89411</b>
		2018987C1		...	...	0 0	<b>85003</b>	<b>89411</b>
		2018987C2		...	...	0 0	<b>85003</b>	<b>89411</b>
		501553C91		...	...	0 0	<b>85003</b>	<b>89411</b>

#### Series 8000 - Conventional Heavy Duty Tractor

	8100 Models Car Hauler	1664524C1		...	...	- 0	<b>85935</b>	...
		472412C91	- -	<b>83456</b>	<b>89447</b>		...	...
	8100, 8200, 8300 Models	3000070C91	- -	<b>83456</b>	<b>89447</b>		...	...
		501906C91		...	...	- 0	83317	...
	8100, 8200, 8300 Models - with Hendrickson HA-460 Air Suspension with 55" & 60" axle spacing and 40000 & 46000 lb capacity	AMS 600102		...	...	0 0	<b>85005</b>	<b>89430</b>
	8100, 8200, 8300 Models with 12000 - 14000 lb Suspension	1664788C2	- 0	<b>85316</b>	<b>89426</b>		...	...
		2015556C1	- 0	<b>85316</b>	<b>89426</b>		...	...
	8100, 8200, 8300 Models with 15000 - 18000 lb Suspension	1667520C1	0 0	<b>85058</b>	<b>89431</b>		...	...
	8100, 8200, 8300 Models with Hendrickson HA-230 Rear Air Suspension	AMS 600102		...	...	0 0	<b>85005</b>	<b>89430</b>
	8100, 8200, 8300 Models with International Air Suspension (Except Lo-Profile and Carhauler)	1675455C1		...	...	0 0	<b>85003</b>	<b>89411</b>
		1690035C1		...	...	0 0	<b>85003</b>	<b>89411</b>
		2018987C1		...	...	0 0	<b>85003</b>	<b>89411</b>
		2018987C2		...	...	0 0	<b>85003</b>	<b>89411</b>
		501553C91		...	...	0 0	<b>85003</b>	<b>89411</b>
	8100LP, 8200LP & 8300LP Models - 6 X 4 & 4 X 2 Models with International Air Suspension for Lo-Profile and Carhauler	1660846C91		...	...	0 0	<b>83101</b>	...

**APPLICATION GUIDE - TRUCKS, TRAILERS, AND BUSES**

Year Año Année	Model Modelo Modèle	OEM #	Front		Rear	
						
			Fleetline	GasSLX	Fleetline	GasSLX

**INTERNATIONAL (NAVISTAR)(Cont'd.)**

**Series 8000 - Conventional Heavy Duty Tractor(Cont'd.)**

	8100LP, 8200LP & 8300LP Models - 6 X 4 & 4 X 2 Models with International Air Suspension for Lo-Profile and Carhauler	1660846C92		...	...	010	<b>83101</b>	...
<b>07 - 08</b>	8600 Models with Taperleaf Front Spring Suspension	3670156C1	010	<b>85954</b>	...		...	...
	Models with Neway AD-246-10 Air Suspension and 60" Axle Spacing							
	Heavy Duty	2029200C91		...	...	010	<b>85030</b>	<b>89440</b>
	AMS 600172	AMS 600172		...	...	010	<b>85030</b>	<b>89440</b>
	Standard	2029200C91		...	...	010	<b>83126</b>	<b>89430</b>
	AMS 600172	AMS 600172		...	...	010	<b>83126</b>	<b>89430</b>









**Series 9100, 9100i - Tractor & Straight Truck**

	6 X 4 Models with International Air Suspension For Lo-Profile	1660846C91		...	...	010	<b>83101</b>	...
		1660846C92		...	...	010	<b>83101</b>	...
	6 X 4 Models with Neway AD-246-10 Air Suspension and 60" Axle Spacing							
	Heavy Duty	2029200C91		...	...	010	<b>85030</b>	<b>89440</b>
	AMS 600172	AMS 600172		...	...	010	<b>85030</b>	<b>89440</b>
	Standard	2029200C91		...	...	010	<b>83126</b>	<b>89430</b>
	AMS 600172	AMS 600172		...	...	010	<b>83126</b>	<b>89430</b>
	9100 Models - with Hendrickson HA-460 Models Air Suspension	AMS 600102		...	...	010	<b>85005</b>	<b>89430</b>
	9100 Models with 12000 - 14000 lb Suspension	1664788C2	-10	<b>85316</b>	<b>89426</b>		...	...
		2015556C1	-10	<b>85316</b>	<b>89426</b>		...	...
		2032533C1	-10	<b>85316</b>	<b>89426</b>		...	...
	Models with International Air Suspension (Except Lo-Profile)	2018987C1		...	...	010	<b>85003</b>	<b>89411</b>
		2018987C2		...	...	010	<b>85003</b>	<b>89411</b>

**Series 9200, 9200i - Tractor & Straight Truck**

	4 X 2 Models with International Air Suspension	2018987C1		...	...	010	<b>85003</b>	<b>89411</b>
		2018987C2		...	...	010	<b>85003</b>	<b>89411</b>
	6 X 4 Models with 12,000 to 14,000 lb Front Axles	3581109C3	010	<b>85924</b>	<b>89457</b>		...	...
		3581109C4	010	<b>85924</b>	<b>89457</b>		...	...
	6 X 4 Models with International Air Suspension	2018987C1		...	...	010	<b>85003</b>	<b>89411</b>
		2018987C2		...	...	010	<b>85003</b>	<b>89411</b>
	6 X 4 Models with International Air Suspension For Lo-Profile	1660846C91		...	...	010	<b>83101</b>	...
		1660846C92		...	...	010	<b>83101</b>	...
	6 X 4 Models with Neway AD-246-10 Air Suspension and 60" Axle Spacing							
	Heavy Duty	2029200C91		...	...	010	<b>85030</b>	<b>89440</b>
	AMS 600172	AMS 600172		...	...	010	<b>85030</b>	<b>89440</b>
	Standard	2029200C91		...	...	010	<b>83126</b>	<b>89430</b>
	AMS 600172	AMS 600172		...	...	010	<b>83126</b>	<b>89430</b>
	Models with 12,000 - 18,000 lb Suspension	1664788C2	-10	<b>85316</b>	<b>89426</b>		...	...
		2015556C1	-10	<b>85316</b>	<b>89426</b>		...	...
		2032533C1	-10	<b>85316</b>	<b>89426</b>		...	...
<b>00 - 09</b>	Models with 12,000 lb Front Axle	3581107C1	010	<b>85924</b>	<b>89457</b>		...	...
		3581107C2	010	<b>85924</b>	<b>89457</b>		...	...
		3581107C3	010	<b>85924</b>	<b>89457</b>		...	...
		3584535C3	010	<b>85924</b>	<b>89457</b>		...	...
		6127705C1	010	<b>85924</b>	<b>89457</b>		...	...
<b>04 - 09</b>	Models with 40,000 lb Rear Air Suspension	3586883C1		...	...	010	<b>85931</b>	<b>89458</b>
	Models with Day Cab & Hendrickson AirTek Suspension	3613984C1	010	<b>85955</b>	...		...	...
		3660549C1	010	<b>85955</b>	...		...	...
		65992-002	010	<b>85955</b>	...		...	...
		65992-002L	010	<b>85955</b>	...		...	...
	Models with Hendrickson HA-460 Models Air Suspension	AMS 600102		...	...	010	<b>85005</b>	<b>89430</b>
	Models with IAS Suspension w/ 9.25" or 9.5" Ride Height	3573265C1		...	...	010	<b>85931</b>	<b>89458</b>
	Models with International Air Suspension	1675455C1		...	...	010	<b>85003</b>	<b>89411</b>

## APPLICATION GUIDE - TRUCKS, TRAILERS, AND BUSES

Year Año Année	Model Modelo Modèle	OEM #	Front		Rear	
						
						
			Fleetline	GasSLX	Fleetline	GasSLX

### INTERNATIONAL (NAVISTAR)(Cont'd.)

#### Series 9200, 9200i - Tractor & Straight Truck(Cont'd.)

	Models with International Air Suspension	1690035C1		...	...	OIO	<b>85003</b>	<b>89411</b>
		501553C91		...	...	OIO	<b>85003</b>	<b>89411</b>
	Models with Sleeper Cab & Hendrickson AirTek Suspension	3609178C1	OIO	<b>85955</b>	...		...	...
		3660548C1	OIO	<b>85955</b>	...		...	...
		65992-001	OIO	<b>85955</b>	...		...	...





#### Series 9300, 9300i, 9400 & 9400i Long Hood Conventional Truck & Tractor

	6 X 4 Models with International Air Suspension Exc. Lo-Profile	2018987C1		...	...	OIO	<b>85003</b>	<b>89411</b>
		2018987C2		...	...	OIO	<b>85003</b>	<b>89411</b>
	6 X 4 Models with International Air Suspension For Lo-Profile	1660846C91		...	...	OIO	<b>83101</b>	...
		1660846C92		...	...	OIO	<b>83101</b>	...
	6 X 4 Models with Neway AD-246-10 Air Suspension and 60" Axle Spacing Heavy Duty	2029200C91		...	...	OIO	<b>85030</b>	<b>89440</b>
		AMS 600172		...	...	OIO	<b>85030</b>	<b>89440</b>
		2029200C91		...	...	OIO	<b>83126</b>	<b>89430</b>
		AMS 600172		...	...	OIO	<b>83126</b>	<b>89430</b>
	Models with 10,800 lb Suspension	503610C2	OIO	<b>83207</b>	<b>89407</b>		...	...
	Models with 12,000 - 14,000 lb Suspension	1664788C2	-IO	<b>85316</b>	<b>89426</b>		...	...
		2015556C1	-IO	<b>85316</b>	<b>89426</b>		...	...
		2032533C1	-IO	<b>85316</b>	<b>89426</b>		...	...
<b>00 - 09</b>	Models with 12,000 lb Front Axle	3581107C1	OIO	<b>85924</b>	<b>89457</b>		...	...
		3581107C2	OIO	<b>85924</b>	<b>89457</b>		...	...
		3581107C3	OIO	<b>85924</b>	<b>89457</b>		...	...
		3584535C3	OIO	<b>85924</b>	<b>89457</b>		...	...
	Models with 16,000 - 18,000 lb Suspension	1667520C1	OIO	<b>85058</b>	<b>89431</b>		...	...
<b>04 - 09</b>	Models with 40,000 lb Rear Air Suspension	3586883C1		...	...	OIO	<b>85931</b>	<b>89458</b>
	Models with Day Cab & Hendrickson AirTek Suspension	3613984C1	OIO	<b>85955</b>	...		...	...
		3660549C1	OIO	<b>85955</b>	...		...	...
		65992-002	OIO	<b>85955</b>	...		...	...
		65992-002L	OIO	<b>85955</b>	...		...	...
	Models with Hendrickson HA-460 Models Air Suspension	AMS 600102		...	...	OIO	<b>85005</b>	<b>89430</b>
	Models with IAS Suspension w/ 9.25" or 9.5" Ride Height	3573265C1		...	...	OIO	<b>85931</b>	<b>89458</b>
	Models with International Air Suspension	1675455C1		...	...	OIO	<b>85003</b>	<b>89411</b>
		1690035C1		...	...	OIO	<b>85003</b>	<b>89411</b>
		501553C91		...	...	OIO	<b>85003</b>	<b>89411</b>
	Models with Neway ARD-125/244 Air Suspension	790335C91		...	...	OIO	<b>83209</b>	<b>89414</b>
	Models with O.E.M Number	3571713C1	-IO	<b>85333</b>	...		...	...
	Models with Sleeper Cab & Hendrickson AirTek Suspension	3609178C1	OIO	<b>85955</b>	...		...	...
		3660548C1	OIO	<b>85955</b>	...		...	...
		65992-001	OIO	<b>85955</b>	...		...	...
	Set Back Axle Models with 16,000 lb to 18,000 lb Suspension	1664149C1	OIO	<b>85029</b>	...		...	...
	Set Forward Axle Models with 16,000 lb to 18,000 lb Suspension	507202C1	OIO	<b>85030</b>	<b>89440</b>		...	...

#### Series 9600 & 9700 Premium Cabover Tractor

	9600, 9700 Models	507202C1	OIO	<b>85030</b>	<b>89440</b>		...	...
	9600, 9700 Models Except Low Profile	1664788C2	-IO	<b>85316</b>	<b>89426</b>		...	...
		2015556C1	-IO	<b>85316</b>	<b>89426</b>		...	...
	9600, 9700 Models for Low Profile	503610C2	OIO	<b>83207</b>	<b>89407</b>		...	...
	9600, 9700 Models with 16000 - 18000 lb Suspension	1667520C1	OIO	<b>85058</b>	<b>89431</b>		...	...
	9600, 9700 Models with Hendrickson HA-460 Air Suspension with 55" or 60" axle spacing and 40000 or 46000 lb capacity	AMS 600102		...	...	OIO	<b>85005</b>	<b>89430</b>
	9600, 9700 Models with International STL Spring Suspension	503550C1		...	...	OIO	<b>83207</b>	<b>89407</b>
	9600, 9700 Models with Neway ARD-125/244 Air Suspension	790335C91		...	...	OIO	<b>83209</b>	<b>89414</b>
	9600, 9700 Models with Neway ARD-234 Air Suspension	537524C91		...	...	OIO	<b>83123</b>	<b>89405</b>
	Models with International Air Suspension	1675455C1		...	...	OIO	<b>85003</b>	<b>89411</b>

**APPLICATION GUIDE - TRUCKS, TRAILERS, AND BUSES**

Year Año Année	Model Modelo Modèle	OEM #	Front		Rear	
						
			Fleetline	GasSLX	Fleetline	GasSLX

**INTERNATIONAL (NAVISTAR)(Cont'd.)**

**Series 9600 & 9700 Premium Cabover Tractor(Cont'd.)**

Models with International Air Suspension	1690035C1		...	...	010	<b>85003</b>	<b>89411</b>
	2018987C1		...	...	010	<b>85003</b>	<b>89411</b>
	2018987C2		...	...	010	<b>85003</b>	<b>89411</b>
	501553C91		...	...	010	<b>85003</b>	<b>89411</b>





**Series 9800 - Premium Cabover Tractor**

6 X 4 Models with International Air Suspension	2018987C1		...	...	010	<b>85003</b>	<b>89411</b>	
	2018987C2		...	...	010	<b>85003</b>	<b>89411</b>	
6 X 4 Models with Neway AD-246-10 Air Suspension and 60" Axle Spacing Heavy Duty	2029200C91		...	...	010	<b>85030</b>	<b>89440</b>	
	AMS 600172		...	...	010	<b>85030</b>	<b>89440</b>	
	Standard	2029200C91		...	...	010	<b>83126</b>	<b>89430</b>
		AMS 600172		...	...	010	<b>83126</b>	<b>89430</b>
9800 Models - with Hendrickson HA-460 Air Suspension with 55" & 60" axle spacing and 40000 & 46000 lb capacity	AMS 600102		...	...	010	<b>85005</b>	<b>89430</b>	
9800 Models - with Hendrickson HAS-402-60 Air Suspension	AMS 650420		...	...	010	<b>85013</b>	<b>89414</b>	
9800 Models - with Set Back axle	2015556C1	-10	<b>85316</b>	<b>89426</b>		...	...	
9800 Models - with Set Forward axle	503610C2	010	<b>83207</b>	<b>89407</b>		...	...	

**Series 9900, 9900i, 9900ix Long Hood Conventional Truck**

6 X 4 Models with International Air Suspension Exc. Lo-Profile	2018987C1		...	...	010	<b>85003</b>	<b>89411</b>	
	2018987C2		...	...	010	<b>85003</b>	<b>89411</b>	
6 X 4 Models with International Air Suspension For Lo-Profile	1660846C91		...	...	010	<b>83101</b>	...	
	1660846C92		...	...	010	<b>83101</b>	...	
6 X 4 Models with Neway AD-246-10 Air Suspension and 60" Axle Spacing Heavy Duty	2029200C91		...	...	010	<b>85030</b>	<b>89440</b>	
	AMS 600172		...	...	010	<b>85030</b>	<b>89440</b>	
	Standard	2029200C91		...	...	010	<b>83126</b>	<b>89430</b>
		AMS 600172		...	...	010	<b>83126</b>	<b>89430</b>
<b>- 2011</b> Day Cab Models with 12,000 lb Front Axles	3581106C1	010	<b>85924</b>	<b>89457</b>		...	...	
	3581106C2	010	<b>85924</b>	<b>89457</b>		...	...	
	3581106C3	010	<b>85924</b>	<b>89457</b>		...	...	
Models with 10,800 lb - 14,600 lb Suspension	503610C2	010	<b>83207</b>	<b>89407</b>		...	...	
Models with 12,000 - 14,000 lb Suspension	1664788C2	-10	<b>85316</b>	<b>89426</b>		...	...	
	2015556C1	-10	<b>85316</b>	<b>89426</b>		...	...	
	2032533C1	-10	<b>85316</b>	<b>89426</b>		...	...	
<b>04 - 09</b> Models with 12,000 lb Front axle	3584535C3	010	<b>85924</b>	<b>89457</b>		...	...	
<b>2013 -</b> Models with 12,000 lb Front axle	3810581C3	010	<b>85995</b>	...		...	...	
	3810581C4	010	<b>85995</b>	...		...	...	
Models with 16,000 - 18,000 lb Suspension	1667520C1	010	<b>85058</b>	<b>89431</b>		...	...	
<b>04 - 11</b> Models with 40,000 lb Rear Air Suspension	3586883C1		...	...	010	<b>85931</b>	<b>89458</b>	
<b>02 - 17</b> Models with Hendrickson HAS - 230 or 460 Rear Air Suspension	3514952C1		...	...	010	<b>85976</b>	...	
	57905-001		...	...	010	<b>85976</b>	...	
	60675-003		...	...	010	<b>85976</b>	...	
	60675-003L		...	...	010	<b>85976</b>	...	
	H60675-003		...	...	010	<b>85976</b>	...	
<b>- 2016</b> Models with International 40,000 lb Rear Air Suspension (52" Spacing- Heavy Duty Rear)	3688616C1		...	...	010	<b>85923</b>	<b>89458</b>	
	Models with International Air Suspension	1675455C1		...	010	<b>85003</b>	<b>89411</b>	
Models with Neway ARD-125/244 Air Suspension	1690035C1		...	...	010	<b>85003</b>	<b>89411</b>	
	501553C91		...	...	010	<b>85003</b>	<b>89411</b>	
	790335C91		...	...	010	<b>83209</b>	<b>89414</b>	
Models with O.E.M Number	3571713C1	-10	<b>85333</b>	...		...	...	
<b>14 - 16</b> Models with Sleeper Cab and 14,000 to 16,000 lb Taperleaf Front Spring Suspension	3977759C2	010	<b>85639</b>	...		...	...	
Set Back Axle Models with 16,000 lb to 18,000 lb Suspension	1664149C1	010	<b>85029</b>	...		...	...	

**APPLICATION GUIDE - TRUCKS, TRAILERS, AND BUSES**

Year Año Année	Model Modelo Modèle	OEM #	Front		Rear	
						
			Fleetline	GasSLX	Fleetline	GasSLX

**INTERNATIONAL (NAVISTAR)(Cont'd.)**

**Series 9900, 9900i, 9900ix Long Hood Conventional Truck(Cont'd.)**

	Set Foreward Axle Models with 16,000 lb to 18,000 lb Suspension	507202C1	○ ○	<b>85030</b>	<b>89440</b>		...	...
--	---	----------	-----	--------------	--------------	--	-----	-----

**TerraStar**

<b>2014</b>	4 WD Models with Rear Spring Suspension	3945165C1 6127096C1		...	...	○ ○	<b>83180</b>	...
<b>12 - 15</b>	Models with 10,000 & 13,500 lb Vari-Rate Rear Spring Suspension	3586902C2		...	...	○ ○	<b>83364</b>	...
<b>12 - 17</b>	Models with 10,500 or 13,500 lb Vari-Rate Rear Spring Suspension	3586902C3 6127087C1		...	...	○ ○	<b>83364</b>	...
<b>13 - 14</b>	Models with 6,000 to 7,000 lb Front Axle	3902993C3 3991991C1 OE 18513	○ ○	<b>83135</b>	...		...	...
	Models with International IROS Air Suspension	3892445C3		...	...	○ ○	<b>85931</b>	<b>89458</b>

**TranStar - 8500, 8600 Series**

<b>03 - 15</b>	Models with 10,000 to 14,000 lb Front axle	3533357C1 3533357C2 3588209C1 3588209C2	○ ○	<b>85957</b>	...		...	...
<b>03 - 18</b>	Models with 40,000 lb Rear Air Suspension	3549099C1 3549099C2 3549099C3		...	...	○ ○	<b>85923</b>	<b>89458</b>
	Models with O.E.M. Number	6127690C1		...	...	○ ○	<b>85923</b>	<b>89458</b>
<b>- 2013</b>	Models with O.E.M. Number	3674348C1	○ ○	<b>85954</b>	...		...	...
<b>14 - 17</b>	Models with O.E.M. Number	6127086C1	○ ○	<b>85637</b>	...		...	...

**Transtar - Conventional**

	4170, F-4170, 4200, F-4200, 4300 & F-4300 Models	426744R91 426744R92 453576C91 453576C92 477132C1	○ ○	<b>85303</b>	<b>89422</b>		...	...
	4170, F-4170, 4200, F-4200, 4300 & F-4300 with Air Ride Suspension	350425C1 462557C91		...	...	○ ○	<b>85300</b>	<b>89419</b>
	D-400, DF-400, DC-400, DCF-400 & DCF-400M - Exc. Axle Code 02136	426744R91 426744R92 453576C91	○ ○	<b>85303</b>	<b>89422</b>		...	...
	D-400, DF-400, DC-400, DCF-400 & DCF-400M with Axle Code 02136	293009C91 453577C91	○ ○	<b>85308</b>	<b>89422</b>		...	...





**Unistar**

	CO7044A	426744R91 426744R92 453576C91		<b>85303</b>	...	○ ○	<b>85303</b>	<b>89422</b>
	Additional O.E.M. Interchanges	56101 Z5008 596329C1	- ○	<b>83114</b>	...		...	...
			○ ○	<b>85014</b>				

**WorkStar - 7000 Series**

<b>08 - 15</b>	7300 Models with 12,000 lb Front Axles	3576464C1 3576464C2	○ ○	<b>85957</b>	...		...	...
<b>16 - 19</b>	7300, 7400, 7500, 7600 Models with 12,000 lb Front axle	6127714C1	○ ○	<b>85928</b>	...		...	...
<b>- 2019</b>	7400 Models with O.E.M. Number	3885832C1 3885832C2	○ ○	<b>83135</b>	...		...	...
<b>04 - 16</b>	7400, 7500, 7600 Models with 12,000 lb Front axle	3533357C1 3533357C2 3533357C3	○ ○	<b>85957</b>	...		...	...

**APPLICATION GUIDE - TRUCKS, TRAILERS, AND BUSES**

Year Año Année	Model Modelo Modèle	OEM #	Front		Rear	
			 Fleetline	 GasSLX	 Fleetline	 GasSLX

**INTERNATIONAL (NAVISTAR)(Cont'd.)**





**WorkStar - 7000 Series(Cont'd.)**

	7400, 7500, 7600 Models with 16,000 lb to 20,000 lb Multi-leaf Spring Severe Duty Standard	3541456C1 3558089C1 3558089C2 3558089C3	010 010 010 010	85929 85925 85925 85925	... ... ... ...	010 010 010 010	83144 83144 83144 83144	... ... ... ...
- 2018	7400, 7500, 7600 Models with 18,000 lb Front Axles	3576464C1 3576464C2		85957 85957	... ...		83144 83144	... ...
	7400, 7500, 7600 Models with Hendrickson HAS - 400 (Standard Inboard Rear)	60670-007 60670-007L		... ...	... ...	010 010	83144 83144	... ...
	7500 Models with 14,000 lb Front axle	3596878C2 4070352C1	010 010	85648 85648	... ...		83144 83144	... ...
	Models with 10,000 to 16,000 lb Front Suspension	3576465C1 3576465C2 3816234C1	010 010 010	85999 85999 85999	... ... ...		83144 83144 83144	... ... ...
10 - 13	Models with 12,000 to 14,000 lb Front Taperleaf Suspension	3868264C1	010	85998	...		83144	...
	Models with 18,000 to 20,000 lb Front Axle	3868265C1	010	85998	...		83144	...
- 2018	Models with 40,000 lb Rear Air Suspension	3549099C3		...	...	010	85923	89458
02 - 17	Models with Hendrickson HAS - 230 or 460 Rear Air Suspension	3514952C1 57905-001 60675-003 60675-003L H60675-003		... ... ... ... ...	... ... ... ... ...	010 010 010 010 010	85976 85976 85976 85976 85976	... ... ... ... ...
- 2014	Models with Hendrickson HMX 400/460 Haulmax with 16.5" Saddle	60680-004 60680-004L		... ...	... ...	01- 01-	83143 83143	... ...
- 2018	Models with Hendrickson Primaax 230, 460 and 690 Air Suspension (8-1/2" to 10" Ride Height)	60657-003 60657-003L		... ...	... ...	010 010	85072 85072	... ...
- 2018	Models with Hendrickson Primaax EX 232, 462 and 692 Air Suspension (8-1/2" to 10" Ride Height)	60657-003 60657-003L 60657-003L		... ... ...	... ... ...	010 010 010	85072 85072 85072	... ... ...
	Models with O.E.M. Number	4070336C1 6127690C1	010	85058	89431	010	85923	89458
	Additional O.E.M. Interchanges	453527C91 453528C91 462603C91 463926C91	-1- -1-	... ... ... ...	... ... ... ...	-10 -10	85311 85311	89424 89424
				85705 or 89447			85705 or 89447	

**Additional O.E.M. Interchanges**

	Models with Chalmers 40,000 lb Rear Suspension	800670		...	...	010	85060	...
	Models with Meritor AirLink Suspension	446-51-211		...	...	010	85739	...
	Models with O.E.M. Number	3000098C1 3571711C1 3581109C1 3584116C1 3584116C2 3584117C1 3584117C2 3584118C1 3584118C2 3584535C1 3584535C2 3601600C1 3601600C2	-10 010 010 010 010 010 010 010 010 010 010	... 85316 85924 83175 83175 83135 83135 85928 85928 85924 85924 ... ...	... 89426 89457 ... ... ... ... ... ... ... 89457 89457 ... ...	-10 010 010 010 010 010 010 010 010 010 010 010	83317 ... ... ... ... ... ... ... ... ... 85082 85082	... ... ... ... ... ... ... ... ... ... ... ...

**APPLICATION GUIDE - TRUCKS, TRAILERS, AND BUSES**

Year Año Année	Model Modelo Modèle	OEM #	Front		Rear	
						
			Fleetline	GasSLX	Fleetline	GasSLX

**INTERNATIONAL (NAVISTAR)(Cont'd.)**

**Additional O.E.M. Interchanges(Cont'd.)**





Models with O.E.M. Number	3601600C3	...	...	010	85082	...
	3892458C1	...	...	010	85926	...
	3892458C2	...	...	010	85926	...
	47902-24	...	...	010	83137	...
	4C4Z-18124-N	85957	...		...	...
	4C4Z-18125-DA	...	...	010	85926	...
	503610C1	...	...	010	83207	89407
	6ETZ-18125-A	...	...	010	83364	...
	90044025	...	...	010	83209	89414
	Additional O.E.M. Interchanges	3541456C1	85929	...		...
3544768C1		...	...	010	85926	...
3544768C2		...	...	010	85926	...
3549100C1		...	...	010	85926	...
3558989C1		85925				
3558989C2		85925				
3596107C1		...	...	010	85927	...
3596107C2		...	...	010	85927	...
3596107C3		...	...	010	85927	...
3596107C4		...	...	010	85927	...
70334		85316	89426		...	...
AMS650102		85001 or 89410				
AMS650107		85316	89426		...	...
AMS650400		...	...	-10	85033	89427
AMS650402		...	...	-10	85311	89424
AMS650404		...	...	-1-	85310	89423
AMS650405		85023 or 89415				
AMS650406		...	...	010	85024	...
AMS650408		...	...	-10	85319	89428

**INTERNATIONAL (NAVISTAR) CAB SHOCKS**

1997 -	Eagle Pro-Sleeper	1202-0054	010	83021
	Models with Link Cab Suspension NPS90	1202-0054	010	83021
	Models with Link Cabmate Suspensions with O.E.M. Number	1201-9007	010	83054
		1201-9009	010	83054
		1201-9013	01-	83062
		1201-9014	01-	83062
		1201-9018	01-	83062
		1201-9021	01-	83062
		1202-0012	010	83023
		1202-0032	010	83016
		1202-0042	010	83025
		1202-0043	010	83025
		1202-0044	010	83025
		1202-0054	010	83021
		1202-1212	010	83013
		1202-1213	01-	83005
	Models with O.E.M. Number	1201-1212	010	83013
		2023685C1	01-	83015
		2500013C1	010	83013
		2507948C1	010	83054
		2508326C1	010	83021
		2508327C1	010	83025
		2590915C1	01-	83062
		2590916C1	01-	83062
	2597458C91	01-	83062	



**APPLICATION GUIDE - TRUCKS, TRAILERS, AND BUSES**

Year Año Année	Model Modelo Modèle	OEM #	Front		Rear	
						
			Fleetline	GasSLX	Fleetline	GasSLX

**INTERNATIONAL (NAVISTAR) CAB SHOCKS(Cont'd.)**

	Models with O.E.M. Number	2601488C91	01-	<b>83062</b>
		2602021C1	01-	<b>83062</b>
		3557165C1	010	<b>83053</b>
		3557167C3	010	<b>83053</b>
		3560705C2	010	<b>83054</b>
		AMS66161	010	<b>83053</b>
		OE14771	01-	<b>83062</b>
- 1991	Navistar 60" Sleepers with Link Cabmate Model IHS60	1202-1043	010	<b>83025</b>
11 - 16	Pro-Star Models With 56" or 72" Hi Roof Sleeper	2593803C91	01-	<b>83062</b>
		2595314C1	01-	<b>83062</b>
2018 - 19	RH Models With 56" Hi Roof Sleeper	2595314C1	01-	<b>83062</b>
	S2500, S2600, 8100, 8200, & 8300 Models Conventional Tractors with Link Cabmate Model NAV80	1202-1043	010	<b>83025</b>
- 2017	TranStar 8600 Models With O.E.M. Number	2595314C1	01-	<b>83062</b>

**4000 Series**

	4600, 4700, 4800, 4900 Models with Link Cab Suspension	1201-1044	010	<b>83025</b>
		2012769C2	01-	<b>83005</b>
	Cabover Tractors with 74", 84" or 88" cabs with Link Cabmate Model IHB-2P	1202-0032	010	<b>83016</b>
	Conventional Tractors with Link Cabmate Model IHC43	1201-0012	010	<b>83023</b>
		1202-0012	010	<b>83023</b>
- 2017	DuraStar - 4300, 4400 Models Conventional Tractors with O.E.M. Number	2509221C91	010	<b>83054</b>

**4300 , 4400 Series**

18 - 19	DuraStar - 4300, 4400 Models Models with O.E.M. Number	2509223C91	010	<b>83054</b>
---------	--	------------	-----	--------------

**5000 Series**

09/94 -	Paystar - SBA Conventionals with Link Cabmate Model NP50 & NP50-A built after August of 1994	1201-1044	010	<b>83025</b>
		1202-1044	010	<b>83025</b>
09/96 -	Paystar - SFA Conventionals with Link Cabmate Model NP50 & NP50-A built after August of 1996	1201-1044	010	<b>83025</b>
		1202-1044	010	<b>83025</b>

**7000 Series**

	7300, 7400, 7500 & 7600 Models with Link Cabmate Suspensions with O.E.M. Number	1201-1043	010	<b>83025</b>
		1201-1049	010	<b>83025</b>
	7600 Models trucks with day cab or extended cabs with Link Cabmate Model IDC76	1201-9010	010	<b>83053</b>
- 2015	WorkStar - 7000 Models Models with O.E.M. Number	2509224C91	010	<b>83053</b>
- 2019	WorkStar - 7300, 7400 & 7500 Models trucks with day cab or extended cabs with Link Cabmate Model IDC7345	1201-9008	010	<b>83054</b>
		2509223C91	010	<b>83054</b>





**8000 Series**

	8100, 8200, & 8300 Model Trucks with Link Cabmate with O.E.M. Number	1201-1213	01-	<b>83005</b>
	8100, 8200, & 8300 Model Trucks with O.E.M. Number	2012768C1	010	<b>83013</b>
		2012769C1	01-	<b>83005</b>
		2025790C1	010	<b>83013</b>
	8500 Model trucks with day cab or extended cabs with Link Cabmate Model IDC85	1201-9008	010	<b>83054</b>
	8600 Model trucks with day cab or extended cabs with Link Cabmate Model IDC86	1201-9011	010	<b>83053</b>
- 2013	TranStar - 8500, 8600 Models Tractors with O.E.M. Number	2509223C91	010	<b>83054</b>
04 - 09	TranStar - 8500, 8600 Models Tractors with 36" Sleepers	2509222C91	010	<b>83053</b>

**9000 Series**

01/93-	48" & 60" Bentz Sleepers on 9000 Models Conventional Tractors with Link Cabmate Model IHS4860	1201-1044	010	<b>83025</b>
		1202-1044	010	<b>83025</b>
03/97 -	9100 & 9200 Models Conventionals with Link Cabmate Model ND92-A	1202-1043	010	<b>83025</b>

**APPLICATION GUIDE - TRUCKS, TRAILERS, AND BUSES**

Year Año Année	Model Modelo Modèle	OEM #	Front		Rear	
						
			Fleetline	GasSLX	Fleetline	GasSLX

**INTERNATIONAL (NAVISTAR) CAB SHOCKS(Cont'd.)**

**9000 Series(Cont'd.)**

	9200 Models with O.E. Number	2023684C1	0 -	<b>83015</b>
	9300 & 9400 Conventional Tractors with Link Cabmate Model IHC93-A	1202-1043	0 0	<b>83025</b>
		2503529C1	0 0	<b>83025</b>
<b>1981 -</b>	9670 Cabover Tractors with 89" or 110" cabs with Link Cabmate Models IH967-A or IH97110	1202-0032	0 0	<b>83016</b>
<b>1982 -</b>	9670, 9700 & 9800 Cabovers with 89" & 110" cabs with Link Cabmate Model NAV9876	1202-0054	0 0	<b>83021</b>
<b>1989 -</b>	9700 Cabover Tractors with 110" cabs with Link Cabmate Model IH97110	1202-0032	0 0	<b>83016</b>
<b>1989 -</b>	9700 Cabover Tractors with 89" cabs with Link Cabmate Model IH9789	1202-0032	0 0	<b>83016</b>
<b>04 - 09</b>	Models With 51" Low-Roof Sleeper	1201-0154	0 0	<b>83051</b>
		2585145C1	0 0	<b>83051</b>
<b>04 - 09</b>	Models with 72" High-Roof Sleeper	1201-0254	0 0	<b>83051</b>
		2589922C1	0 0	<b>83051</b>

**HV Series**

<b>19 - 20</b>	HV607 Models with O.E.M. Number	2509223C91	0 0	<b>83054</b>
----------------	---------------------------------	------------	-----	--------------

**LoneStar - Series**

<b>09 - 19</b>	LoneStar Models with O.E.M. Number	2595314C1	0 -	<b>83062</b>
		2600491C91	0 -	<b>83062</b>

**LT- Series**

<b>2018</b>	LT625 Daycab Models with O.E.M. Number	2595314C1	0 -	<b>83062</b>
-------------	--	-----------	-----	--------------

**MV Series**

<b>2019</b>	MV607 Models with O.E.M. Number	2509223C91	0 0	<b>83054</b>
-------------	---------------------------------	------------	-----	--------------

**ISUZU**

**EVR Series**

<b>87 - 92</b>	EVR Models	1-51630-160-0	- 0	<b>83162</b>	...		...	...
----------------	------------	---------------	-----	--------------	-----	--	-----	-----





**FSR Series**

<b>10/89 - 96</b>	FSR Models	1-51630-167-0		...	...	- -	<b>83613</b>	...
<b>86 - 92</b>	FSR Models	1-51630-160-0	- 0	<b>83162</b>	...		...	...
		1-51630-168-1	- 0	<b>83515</b>	...		...	...
		51630168	- 0	<b>83515</b>	...		...	...
<b>86 - 96</b>	FSR Models	1-51630-217-1	- 0	<b>83114</b>	...		...	...
<b>97 - 03</b>	Models with 15000, 19000, 21000 lb Multileaf Springs	8-22064232-0		...	...	- -	<b>85071</b>	...
<b>97 - 03</b>	Models with 16900 lb Taperleaf Springs	8-22064489-0		...	...	- -	<b>85336</b>	...
<b>97 - 03</b>	Models with 19000, 21000, 23000 lb Taperleaf Springs (EXC Low Profile Veh.)	8-22064233-0		...	...	- -	<b>83136</b>	...
<b>97 - 03</b>	Models with FL1 Tilt Cab with 8100 lb Axle (Including Low Profile)	8-22064804-0	- -	<b>83136</b>	...		...	...
		8-22064805-0	- -	<b>83136</b>	...		...	...

**FTR Series**

<b>97 - 03</b>	FL2 Tilt Cab with 5000 to 11000 lb Axle	8-22064807-0	- -	<b>83136</b>	...		...	...
<b>97 - 03</b>	FL3 Tilt Cab with 14575 lb Axle	8-22064806-0	- -	<b>83136</b>	...		...	...
<b>86 - 96</b>	FTR Models	1-51630-167-0		...	...	- -	<b>83613</b>	...
<b>05 - 09</b>	FTR Models with 15000, 19000, 21000 lb Multileaf Springs	15174902		...	...	- -	<b>85071</b>	...
		88982686		...	...	- -	<b>85071</b>	...
<b>05 - 09</b>	FTR Models with O.E.M. Number	15123676	- -	<b>83136</b>	...		...	...
		88982682	- -	<b>83136</b>	...		...	...
		8-98098-059-0		...	...	0 0	<b>83159</b>	...
		8-98098-059-1		...	...	0 0	<b>83159</b>	...
		8-98098-127-0	- 0	<b>83515</b>	...		...	...
		8982326720	- 0	<b>83515</b>	...		...	...
		8-98316-228-0		...	...	0 0	<b>83159</b>	...
98098059		...	...	0 0	<b>83159</b>	...		

## APPLICATION GUIDE - TRUCKS, TRAILERS, AND BUSES

Year Año Année	Model Modelo Modèle	OEM #	Front		Rear	
						
			Fleetline	GasSLX	Fleetline	GasSLX

### ISUZU(Cont'd.)

#### FTR Series(Cont'd.)

05 - 09	FTR Models with O.E.M. Number	98098127	- O	<b>83515</b>	...	...	...
97 - 03	Tilt Cab w/15000, 19000, 21000 lb Multileaf Springs	8-22064232-0		...	...	- -	<b>85071</b>
97 - 03	Tilt Cab w/16900 lb Taperleaf Springs	8-22064489-0		...	...	- -	<b>85336</b>
97 - 03	Tilt Cab w/19000, 21000, 23000 lb Taperleaf Springs (EXC Low Profile Veh.)	8-22064233-0		...	...	- -	<b>83136</b>









#### FVR Series

- 2009	FVR Models with Hendrickson HAS suspension	12474915 60670-005		...	...	O O	<b>83122</b>	<b>89406</b>
				...	...	O O	<b>83137</b>	...
00 - 09	FVR Models with O.E.M. Number	15887728 19152843	- -	<b>83136</b>	...		...	...
				<b>83136</b>	...	...	...	...
90 - 09	FVR Models with 15000, 19000, 21000 lb Multileaf Springs	8-22064232-0 88982686		...	...	- -	<b>85071</b>	...
				...	...	- -	<b>85071</b>	...
97 - 02	FVR Models with 14575 lb Axle	8-22064806-0	- -	<b>83136</b>	...	...	...	...
97 - 02	FVR Models with 16900 lb Taperleaf Springs	8-22064489-0		...	...	- -	<b>85336</b>	...
97 - 02	FVR Models with 19000, 21000, 23000 lb Taperleaf Springs (EXC Low Profile Veh.)	8-22064233-0		...	...	- -	<b>83136</b>	...
97 - 02	FVR Models with 5000 to 11000 lb Axle	8-22064807-0	- -	<b>83136</b>	...	...	...	...
86 - 96	FVR Models	1-51630-167-0		...	...	- -	<b>83613</b>	...
86 - 96	FVR Short & Middle Chassis	1-51630-160-0	- O	<b>83162</b>	...	...	...	...

#### NPR Series

86 - 17	NPR, NPR-HD Models with 11000 lb & 13000 lb Suspension	8-94454-987-0 8-97083-027-0 8-97083-029-0 8-97253-620-0 8-97253-620-1 8-98098-125-0 8982326710 8-98232671-0 8-98232671-1 94454987 97083027 97083029 97253620 98098125 98232671	- O	<b>83515</b>	...		...	...
			- O	<b>83515</b>	...	...	...	
			- O	<b>83515</b>	...	...	...	
			- O	<b>83515</b>	...	...	...	
			- O	<b>83515</b>	...	...	...	
			- O	<b>83515</b>	...	...	...	
			- O	<b>83515</b>	...	...	...	
			- O	<b>83515</b>	...	...	...	
			- O	<b>83515</b>	...	...	...	
			- O	<b>83515</b>	...	...	...	
			- O	<b>83515</b>	...	...	...	
			- O	<b>83515</b>	...	...	...	
			- O	<b>83515</b>	...	...	...	
			- O	<b>83515</b>	...	...	...	
03 - 17	NPR, NPR-HD Models with O.E.M Number	8-97253-665-0 8-98098-058-0 8-98098-058-1 898098-0581 8-98098-059-0 8-98098-059-1 8-98316227-0 8-98316-228-0 97253665 98098058 98098059 98316227		...	...	O O	<b>83159</b>	...
				...	...	O O	<b>83159</b>	...
				...	...	O O	<b>83159</b>	...
				...	...	O O	<b>83159</b>	...
				...	...	O O	<b>83159</b>	...
				...	...	O O	<b>83159</b>	...
				...	...	O O	<b>83159</b>	...
				...	...	O O	<b>83159</b>	...
				...	...	O O	<b>83159</b>	...
				...	...	O O	<b>83159</b>	...
01 - 07	NPR, NPR-HD ( Diesel Models)	8-97253-651-2 97253651		...	...	O O	<b>83159</b>	...
				...	...	O O	<b>83159</b>	...
03 - 08	NPR, NPR-HD ( Gas Models)	8-97253-651-2 97253651		...	...	O O	<b>83159</b>	...
				...	...	O O	<b>83159</b>	...
95 - 02	NPR, NPR-HD (Gas & Diesel Models)	8-97253-664-0 97253664		...	...	O O	<b>83159</b>	...
				...	...	O O	<b>83159</b>	...
86 - 95	NPR Models (NPC & NPN)	51630666 8-94454-647-1		...	...	O O	<b>85012</b>	<b>89413</b>
			- O	<b>83515</b>	...	...	...	...

## APPLICATION GUIDE - TRUCKS, TRAILERS, AND BUSES

Year Año Année	Model Modelo Modèle	OEM #	Front		Rear	
						
						
			Fleetline	GasSLX	Fleetline	GasSLX

### ISUZU(Cont'd.)

#### NPR Series(Cont'd.)

<b>86 - 95</b>	NPR Models (NPC & NPN)	8-94454-986-0	-10	<b>83515</b>	...		...	...
		8-94454-987-0	-10	<b>83515</b>	...		...	...
		8-97083-029-0	-10	<b>83515</b>	...		...	...
		94454986	-10	<b>83515</b>	...		...	...
		9-51630-666-0		...	...	010	<b>85012</b>	<b>89413</b>
		9-51630-666-2		...	...	010	<b>85012</b>	<b>89413</b>
		97083029	-10	<b>83515</b>	...		...	...
<b>89 - 92</b>	NPR Models Flatlow	9-51630-666-0		...	...	010	<b>85012</b>	<b>89413</b>
		9-51630-666-2		...	...	010	<b>85012</b>	<b>89413</b>
<b>89 - 90</b>	NPR Models Flatlow	51630647	-10	<b>83515</b>	...		...	...
		9-51630-647-1	-10	<b>83515</b>	...		...	...





#### NQR Series

<b>03 - 17</b>	NQR Models with O.E.M. Number	8-97253-620-0	-10	<b>83515</b>	...		...	...
		8-97253-665-0		...	...	010	<b>83159</b>	...
		8-98098-059-0		...	...	010	<b>83159</b>	...
		8-98098-059-1		...	...	010	<b>83159</b>	...
		8-98098-127-0	-10	<b>83515</b>	...		...	...
		8982326720	-10	<b>83515</b>	...		...	...
		8-98232672-0	-10	<b>83515</b>	...		...	...
		8-98232672-1	-10	<b>83515</b>	...		...	...
		8-98316-228-0		...	...	010	<b>83159</b>	...
		8-98343986-0		...	...	010	<b>83159</b>	...
		97253620	-10	<b>83515</b>	...		...	...
		97253665		...	...	010	<b>83159</b>	...
		98098059		...	...	010	<b>83159</b>	...
		98098127	-10	<b>83515</b>	...		...	...
		98232672	-10	<b>83515</b>	...		...	...
		98343986		...	...	010	<b>83159</b>	...
<b>2002</b>	NQR (Diesel)	8-97253-664-0		...	...	010	<b>83159</b>	...
		97253664		...	...	010	<b>83159</b>	...
<b>95 - 97</b>	NQR (Diesel)	8-97253-664-0		...	...	010	<b>83159</b>	...
		97253664		...	...	010	<b>83159</b>	...

#### NRR Series

<b>02 - 17</b>	NRR Models with O.E.M. Number	8-97253-620-0	-10	<b>83515</b>	...		...	...
		8-97253-665-0		...	...	010	<b>83159</b>	...
		8-98098-059-0		...	...	010	<b>83159</b>	...
		8-98098-059-1		...	...	010	<b>83159</b>	...
		8-98098-127-0	-10	<b>83515</b>	...		...	...
		8982326720	-10	<b>83515</b>	...		...	...
		8-98232672-0	-10	<b>83515</b>	...		...	...
		8-98232672-1	-10	<b>83515</b>	...		...	...
		8-98316-228-0		...	...	010	<b>83159</b>	...
		8-98343986-0		...	...	010	<b>83159</b>	...
		97253620	-10	<b>83515</b>	...		...	...
		97253665		...	...	010	<b>83159</b>	...
		98098059		...	...	010	<b>83159</b>	...
		98098127	-10	<b>83515</b>	...		...	...
		98232672	-10	<b>83515</b>	...		...	...
		98343986		...	...	010	<b>83159</b>	...
<b>88 - 99</b>	NRR Models (All)	1-51630-217-0	-10	<b>83114</b>	...		...	...
		1-51630-217-1	-10	<b>83114</b>	...		...	...
		1-51630-219-1	-10	<b>83114</b>	...		...	...
		51630217	-10	<b>83114</b>	...		...	...

## APPLICATION GUIDE - TRUCKS, TRAILERS, AND BUSES

Year Año Année	Model Modelo Modèle	OEM #	Front		Rear	
						
			Fleetline	GasSLX	Fleetline	GasSLX

### ISUZU(Cont'd.)

#### Additional Applications(Cont'd.)









95 - 03	FRR Models (All)	1-51630-219-0	-10	83114	...	...	...	...
		1-51630-219-1	-10	83114	...	...	...	...
		51630219	-10	83114	...	...	...	...
1985	KS22 Models (All)	8-97083-027-0	-10	83515	...	...	...	...
		9-51630-666-0		...	...	010	85012	89413
		9-51630-666-2		...	...	010	85012	89413
	Models with O.E.M. Number	8-22064-232-0		...	...	-1-	85071	...
		8-22064-233-0	-1-	83136	...	...	...	...
		8-22064-489-0		...	...	-1-	85336	...
		8-22064-804-0	-1-	83136	...	...	...	...
		8-22064-805-0	-1-	83136	...	...	...	...
		8-22064-806-0	-1-	83136	...	...	...	...
		8-22064-807-0	-1-	83136	...	...	...	...
		8-51630-666-0		...	...	010	85012	89413
		8972019600	-10	83515	...	...	...	...
		8-97253-616-0	-10	83515	...	...	...	...
		8-97253-621-0	-10	83515	...	...	...	...
		8-97253-623-0	-10	83515	...	...	...	...
		898098-1250	-10	83515	...	...	...	...
		898098-1270	-10	83515	...	...	...	...
		94033786	-10	83114	...	...	...	...

### ITASCA

#### Class A MotorHomes

2006	Ellipse Series MotorHomes with Freightliner XC Chassis ADL200 Suspension w/ 20K Rear AS120 Front Suspension  Rear Shock with O.E.M. Number  ZF - IFS Front Suspension with 23,000 lb GVW or Greater	16-16873-000		...	...	010	85029	...
		141700131810	010	83160	...	...	...	...
		16-16737-000	010	83160	...	...	...	...
		16-16874-000	010	83160	...	...	...	...
		141700131809		...	...	010	85029	...
		16-16736-000		...	...	010	85029	...
		16-18103-000	-1-	85900	...	...	...	...
		481700000493	-1-	85900	...	...	...	...
04 - 06	Horizon Series MotorHomes with Freightliner XC Chassis ADL200 Suspension w/ 20K Rear AS120 Front Suspension  Rear Shock with O.E.M. Number  ZF - IFS Front Suspension with 23,000 lb GVW or Greater	16-16873-000		...	...	010	85029	...
		141700131810	010	83160	...	...	...	...
		16-16737-000	010	83160	...	...	...	...
		16-16874-000	010	83160	...	...	...	...
		141700131809		...	...	010	85029	...
		16-16736-000		...	...	010	85029	...
		16-18103-000	-1-	85900	...	...	...	...
		481700000493	-1-	85900	...	...	...	...
02 - 06	Meridian Series MotorHomes with Freightliner XC Chassis ADL200 Suspension w/ 20K Rear AS120 Front Suspension  Rear Shock with O.E.M. Number  ZF - IFS Front Suspension with 23,000 lb GVW or Greater	16-16873-000		...	...	010	85029	...
		141700131810	010	83160	...	...	...	...
		16-16737-000	010	83160	...	...	...	...
		16-16874-000	010	83160	...	...	...	...
		141700131809		...	...	010	85029	...
		16-16736-000		...	...	010	85029	...
		16-18103-000	-1-	85900	...	...	...	...
		481700000493	-1-	85900	...	...	...	...
	Models with Workhorse UFO Chassis with Hendrickson Softek Front Suspension	66153-002	010	83124	89407	...	...	...
		F4-BE5-C832-MO	010	83124	89407	...	...	...

## APPLICATION GUIDE - TRUCKS, TRAILERS, AND BUSES

Year Año Année	Model Modelo Modèle	OEM #	Front		Rear	
						
						
			Fleetline	GasSLX	Fleetline	GasSLX

### ITASCA(Cont'd.)





#### Class A MotorHomes(Cont'd.)

<b>99 - 15</b>	SunCruiser Series MotorHomes with Ford F53 Chassis with 16,000 lb GVW to 22,000 lb GVW	1C34-18045-AA 1C34-18045-JA 9U94-18045-AA 9U94-18080-AA 9U9Z-18124-A 9U9Z-18125-A ASH-1022 ASH-1023 ASH-1205 ASH-1206 ASH-1228 ASH-1229 ASH-1230 ASH-137 ASH-25822 ASH-25823 ASH-25824 ASH-294 AT-620 AT-621 AT-766	010	83209	89414		...	...		
			010	83209	89414		...	...		
			010	83209	89414		...	...		
			010	...	...	010	83122	89406		...
			010	83209	89414		...	...		
			010	...	...	010	83122	89406		...
			010	83209	89414		...	...		
			010	...	...	010	83122	89406		...
			010	83209	89414		...	...		
			010	83209	89414		...	...		
			010	...	...	010	83122	89406		...
			010	...	...	010	83122	89406		...
			010	83209	89414		...	...		
			010	83209	89414		...	...		
			010	...	...	010	83122	89406		...
			010	83209	89414		...	...		
			010	83209	89414		...	...		
			010	...	...	010	83122	89406		...
			010	83209	89414		...	...		
			<b>03 - 04</b>	SunCruiser Series MotorHomes with W20 , W22, & W24 Workhorse Chassis	24-153249 24-186537 24-186629 F4-BE5-A011-HO F4-BE5-A832-MO F4-BE5-B492-HO F4-BE5-F324-HO W0005662 W0006254	010	85125	...		...
010	...	...				01-	85126	...	...	
010	85125	...					...	...		
010	...	...				01-	85126	...	...	
010	85125	...					...	...		
010	85125	...					...	...		
010	85125	...					...	...		
010	85125	...					...	...		
<b>05 - 14</b>	Sunova Models with W20 , W22, & W24 WorkHorse MotorHome Chassis	24-153256 F4-BE5-F325-HO W0005663		...	...	-1-	85124	...		
				...	...	-1-	85124	...		
				...	...	-1-	85124	...		
<b>98 - 14</b>	Sunova Models with W20 , W22, & W24 WorkHorse MotorHome Chassis	24-153249 F4-BE5-A832-MO F4-BE5-F324-HO W0005662 W0006254	010	85125	...		...	...		
			010	85125	...		...	...		
			010	85125	...		...	...		
			010	85125	...		...	...		
			010	85125	...		...	...		

#### Class C MotorHomes

<b>06 - 20</b>	Cambria Series Motorhomes with Ford E450 Chassis	8C24-18045-DA 8C24-18080-DB 8C2Z-18124-D 8C2Z-18125-D ASH-1136 ASH-1154 AT-163G AT-164G	-10	83177	...		...	...	
				...	...	-10	83178	...	...
			-10	83177	...		...	...	
				...	...	-10	83178	...	...
				...	...	-10	83178	...	...
			-10	83177	...		...	...	
			-10	83177	...		...	...	
				...	...	-10	83178	...	...
<b>07 - 14</b>	Impulse Series Motorhomes with Ford E450 Chassis	8C24-18045-DA 8C24-18080-DB 8C2Z-18124-D 8C2Z-18125-D ASH-1136	-10	83177	...		...	...	
				...	...	-10	83178	...	...
			-10	83177	...		...	...	
				...	...	-10	83178	...	...
				...	...	-10	83178	...	...

**APPLICATION GUIDE - TRUCKS, TRAILERS, AND BUSES**

Year Año Année	Model Modelo Modèle	OEM #	Front		Rear	
						
			Fleetline	GasSLX	Fleetline	GasSLX

**ITASCA(Cont'd.)**

**Class C MotorHomes(Cont'd.)**

07 - 14	Impulse Series Motorhomes with Ford E450 Chassis	ASH-1154	-10	83177	...		...	...
		AT-163G	-10	83177	...		...	...
		AT-164G		...	...	-10	83178	...
01 - 20	Spirit Series Motorhomes with Ford E450 Chassis	8C24-18045-DA	-10	83177	...		...	...
		8C24-18080-DB		...	...	-10	83178	...
		8C2Z-18124-D	-10	83177	...		...	...
		8C2Z-18125-D		...	...	-10	83178	...
		ASH-1136		...	...	-10	83178	...
		ASH-1154	-10	83177	...		...	...
		AT-163G	-10	83177	...		...	...
	AT-164G		...	...	-10	83178	...	

**JAY MADSEN**

	Additional O.E.M. Interchanges	3166657	010				85700	
		3192333	010				85700	

**JAYCO RV INC**

**Class A MotorHomes**

15 - 20	Alante Series MotorHomes with Ford F53 Chassis with 16,000 lb GVW to 22,000 lb GVW	ASH-1229	010	83209	89414		...	...
		ASH-25822	010	83209	89414		...	...
		ASH-25823	010	83209	89414		...	...
		ASH-25824		...	...	010	83122	89406
14 - 20	Precept Series MotorHomes with Ford F53 Chassis with 16,000 lb GVW to 22,000 lb GVW	ASH-1229	010	83209	89414		...	...
		ASH-25822	010	83209	89414		...	...
		ASH-25823	010	83209	89414		...	...
		ASH-25824		...	...	010	83122	89406

**Class C MotorHomes**

	Designer Series MotorHomes with Ford E350 & E450 Chassis	ASH-1136		...	...	-10	83178	...
		ASH-1154	-10	83177	...		...	...
03 - 06	Escapade Series MotorHomes with Ford E350 & E450 Chassis	ASH-1136		...	...	-10	83178	...
		ASH-1154	-10	83177	...		...	...
02 - 06	Granite Ridge Series MotorHomes with Ford E350 & E450 Chassis	ASH-1136		...	...	-10	83178	...
		ASH-1154	-10	83177	...		...	...
02 - 19	Greyhawk Series MotorHomes with Ford E350 & E450 Chassis	ASH-1136		...	...	-10	83178	...
02 - 20	Greyhawk Series MotorHomes with Ford E350 & E450 Chassis	ASH-1154	-10	83177	...		...	...
07 - 15	Melbourne Series MotorHomes with Ford E350 & E450 Chassis	ASH-1136		...	...	-10	83178	...
		ASH-1154	-10	83177	...		...	...
04 - 20	Redhawk Series MotorHomes with Ford E350 & E450 Chassis	ASH-1136		...	...	-10	83178	...
		ASH-1154	-10	83177	...		...	...

**JIFFLOX**

	Truck Dolly	CP-5222	010	85315	...		...	...
--	-------------	---------	-----	-------	-----	--	-----	-----

**JOHN DEERE**

	Models with O.E.M. Number	4036892	010	G63605	...		...	...
--	---------------------------	---------	-----	--------	-----	--	-----	-----

**Motorhome Chassis**





73 - 81	M & R-300, 400, 500 Motorhome Chassis	3638112		...	...	010	G63183	...
---------	---------------------------------------	---------	--	-----	-----	-----	--------	-----

**KENWORTH**

**C500, C500B, C500K, C540 & C550**

	All with Air Glide 100 Suspension with 8 air bags, 4 units required	K374-29		...	...	-1-	85310	89423
		K374-32		...	...	-1-	85310	89423

**APPLICATION GUIDE - TRUCKS, TRAILERS, AND BUSES**

Year Año Année	Model Modelo Modèle	OEM #	Front		Rear	
						
			Fleetline	GasSLX	Fleetline	GasSLX

**KENWORTH(Cont'd.)**

**C500, C500B, C500K, C540 & C550(Cont'd.)**

	All with Air Glide 200 with 40,000 lb Suspension with 8 air bags, 4 units required	665903		...	...	- -	85900	...
		665944		...	...	- -	85900	...
		70701		...	...	- -	85900	...
<b>01 - 16</b>	Models with Air Glide 380 (AG380) Rear Air Suspension	C71-1002		...	...	0 0	85067	89451
		C71-1016		...	...	0 0	85067	89451
	Models with Dual Steering Front Axle and Torsion Bar Bogey Rear Suspension	K374-28		...	...	0 0	85314	89425
		K374-4		...	...	0 0	85314	89425
<b>- 2009</b>	Models with Multiple Leaf Springs on Front Axle	B71-1003	0 0	83312	89409		...	...
		K374-3	0 0	83312	89409		...	...
		K374-33	0 0	83312	89409		...	...
	Models with Neway ADZ Rear Suspension	471700004423		...	...	0 0	85109	...
		90045605		...	...	0 0	85109	...
<b>87 - 16</b>	Models with Taper Leaf Springs on Front Axle	B71-1002	0 0	85001	89410		...	...
		K374-16	0 0	85001	89410		...	...
		K374-26	0 0	85001	89410		...	...
		K374-27	0 0	85001	89410		...	...
	All with Air Glide 200 with 46,000 lb Suspension with 8 air bags, 4 units required	665906		...	...	- -	85902	...
		665945		...	...	- -	85902	...

**ICON 900**

<b>16 - 17</b>	Models with 10,000 lb to 14,600 lb Taperleaf Springs and Set Back Front Axles	B71-6019	0 0	85989	...		...	...
<b>16 - 17</b>	Models with Air Glide 380 (AG380) Rear Air Suspension	C71-1016		...	...	0 0	85067	89451
		C71-6015		...	...	0 0	85067	89451
<b>16 - 17</b>	Models with Air Glide 400 (AG400) Rear Air Suspension	C71-1014		...	...	0 -	85936	89456
<b>16 - 17</b>	Models with Air Glide 460 (AG460) Rear Air Suspension	C71-1015		...	...	0 -	85937	...
		C71-1015 PLUS		...	...	0 -	85937	...
<b>16 - 17</b>	Models with Taper Leaf Springs on Front Axle	B71-1002	0 0	85001	89410		...	...

**K100, K100E, K125**

	All with Air Glide 100 Suspension with 8 air bags, 4 units required	K374-29		...	...	- -	85310	89423
		K374-32		...	...	- -	85310	89423
	All with Air Glide 200 with 40,000 lb Suspension with 8 air bags, 4 units required	665903		...	...	- -	85900	...
		665944		...	...	- -	85900	...
		70701		...	...	- -	85900	...
	All with Air Glide 200 with 46,000 lb Suspension with 8 air bags, 4 units required	665906		...	...	- -	85902	...
		665945		...	...	- -	85902	...
	Models with Dual Steering Front Axle and Torsion Bar Bogey Rear Suspension	K374-28		...	...	0 0	85314	89425
		K374-4		...	...	0 0	85314	89425
	Models with Multiple Leaf Springs on Front Axle	B71-1003	0 0	83312	89409		...	...
		K374-3	0 0	83312	89409		...	...
		K374-33	0 0	83312	89409		...	...
	Models with Set Back Front Axle	665331	0 -	85740	...		...	...
		K374-13	0 -	85740	...		...	...
		K374-13-1	0 -	85740	...		...	...
<b>87 - 06</b>	Models with Taper Leaf Springs on Front Axle	B71-1002	0 0	85001	89410		...	...
		K374-16	0 0	85001	89410		...	...
		K374-26	0 0	85001	89410		...	...
		K374-27	0 0	85001	89410		...	...

**K270, K370**

<b>13 - 19</b>	Models with 10,000 lb or 12,000 lb Front Axle	1707378PAC	- -	85182	...		...	...
		BFRG 072	- -	85182	...		...	...



## APPLICATION GUIDE - TRUCKS, TRAILERS, AND BUSES

Year Año Année	Model Modelo Modèle	OEM #	Front			Rear		
			Fleetline	GasSLX				

### KENWORTH(Cont'd.)

#### K270, K370(Cont'd.)

13 - 19	Models with 21,000 to 23,000 lb Reyco Spring Suspension	19495-01 TK19679	...	...	010	83126	89440
			...	...	010	83126	89440
13 - 19	Models with Hendrickson HAS - 210L or HAS - 230L Rear Air Suspension	60670-008 60670-008L	...	...	010	83123	89405
			...	...	010	83123	89405
13 - 19	Models with Reyco 102 or 79KB Suspension (Drive Axle)	16725-01 19495-01	...	...	010	83126	89440
			...	...	010	83126	89440

#### K300

	All with Air Glide 100 Suspension with 8 air bags, 4 units required	K374-29 K374-32	...	...	-1-	85310	89423
			...	...	-1-	85310	89423
	All with Air Glide 200 with 40,000 lb Suspension with 8 air bags, 4 units required	665903 665944 70701	...	...	-1-	85900	...
			...	...	-1-	85900	...
			...	...	-1-	85900	...
	All with Air Glide 200 with 46,000 lb Suspension with 8 air bags, 4 units required	665906 665945	...	...	-1-	85902	...
			...	...	-1-	85902	...
	K300 COE Medium Duty	665565	010	85007	...	...	...
	Models with 12,000 lb Taper Leaf Front Springs (5/8" Top Mounting bolt)	665617 B71-1000	010	85031	...	...	...
			010	85031	...	...	...
	Models with Hendrickson Rear Air Suspension	47902-19	...	...	010	83123	89405
	Models with Multiple Leaf Springs on Front Axle (3/4" Mounting bolts)	B71-1003 K374-3 K374-33	010	83312	89409	...	...
			010	83312	89409	...	...
			010	83312	89409	...	...
	Models with Reyco 102 or 79KB Suspension (Drive Axle)	16725-01 19495-01	...	...	010	83126	89440
			...	...	010	83126	89440
	Models with Reyco 1209 or 1212 Suspension (Steer Axle)	19495-01	010	83126	89440	...	...
	Models with Taper Leaf Springs on Front Axle (1" Mounting bolts)	B71-1002 K374-16 K374-26 K374-27	010	85001	89410	...	...
			010	85001	89410	...	...
			010	85001	89410	...	...
			010	85001	89410	...	...
	Models with Woodhead Shock (Stamping Number ACHB 966)	ACHB966	...	...	-1-	83136	...





#### T170

08 - 13	Models with 8,000 lb Taper Leaf Front Springs	665617	010	85031	...	...	...
08 - 19	Models with Reyco 79KB Rear Suspension	16725-01 19495-01	...	...	010	83126	89440
			...	...	010	83126	89440

#### T270, T370

10 - 14	Models with 10,000 lb to 12,000 lb Front Axle	B71-6005	010	85084	89460	...	...
15 - 20	Models with 10,000 lb to 14,600 lb Taperleaf Springs and Set Back Front Axles	B71-6019	010	85989	...	...	...
08 - 10	Models with 12,000 lb Front Axle	665617	010	85031	...	...	...
10 - 14	Models with 13,200 lb to 14,600 lb Front Axle	B71-6006	010	85084	89460	...	...
15 - 19	Models with 16,000 lb to 20,000 lb Taperleaf Springs and Set Back Front Axles	B71-6020	010	85989	...	...	...
10 - 14	Models with 8,000 lb Front Axle	B71-6004	010	85084	89460	...	...
10 - 20	Models with AG210L Rear Air Suspension	C71-1011 C71-1017	...	...	-1-	85069	89455
			...	...	-1-	85069	89455
10 - 20	Models with Air Glide 400L (AG400L) Rear Air Suspension	C71-1011 C71-1017	...	...	-1-	85069	89455
			...	...	-1-	85069	89455
08 - 20	Models with Hendrickson HAS - 210L or HAS - 230L Rear Air Suspension	60670-008 60670-008L	...	...	010	83123	89405
			...	...	010	83123	89405
08 - 14	Models with Hendrickson HAS - 400 (Standard) Rear Air Suspension	60670-005	...	...	010	83137	...

**APPLICATION GUIDE - TRUCKS, TRAILERS, AND BUSES**

Year Año Année	Model Modelo Modèle	OEM #	Front		Rear	
						
			Fleetline	GasSLX	Fleetline	GasSLX

**KENWORTH(Cont'd.)**

**T270, T370(Cont'd.)**

08 - 14	Models with Hendrickson HAS - 400 (Standard) Rear Air Suspension	60670-005L		...	...	0 0	83137	...
08 - 20	Models with Hendrickson HMX 400/460 Haulmax (with 16.5" Saddle)	60680-004		...	...	0 1	83143	...
		60680-004L		...	...	0 1	83143	...
		64178-001		...	...	0 1	83143	...
08 - 20	Models with Reyco 102 or 79KB Suspension (Drive Axle)	16725-01		...	...	0 0	83126	89440
		19495-01		...	...	0 0	83126	89440
		TK19679		...	...	0 0	83126	89440









**T300**

	All with Air Glide 100 Suspension with 8 air bags, 4 units required	K374-29		...	...	- 1	85310	89423
		K374-32		...	...	- 1	85310	89423
	All with Air Glide 200 with 40,000 lb Suspension with 8 air bags, 4 units required	665903		...	...	- 1	85900	...
		665944		...	...	- 1	85900	...
		70701		...	...	- 1	85900	...
	All with Air Glide 200 with 46,000 lb Suspension with 8 air bags, 4 units required	665906		...	...	- 1	85902	...
		665945		...	...	- 1	85902	...
11 - 18	Models with 10,000 lb to 14,600 lb Taperleaf Springs and Set Back Front Axles	B71-6019	0 0	85989	...		...	...
99 - 10	Models with 12,000 lb Taper Leaf Front Springs (5/8" Top Mounting bolt)	665617	0 0	85031	...		...	...
		B71-1000	0 0	85031	...		...	...
12 - 18	Models with Air Glide 400L (AG400L) Rear Air Suspension	C71-1011		...	...	- 1	85069	89455
		C71-1017		...	...	- 1	85069	89455
07 - 18	Models with Hendrickson HAS - 210L or HAS - 230L Rear Air Suspension	60670-008		...	...	0 0	83123	89405
		60670-008L		...	...	0 0	83123	89405
	Models with Hendrickson Rear Air Suspension	47902-19		...	...	0 0	83123	89405
		60670-004		...	...	0 0	83123	89405
	Models with Multiple Leaf Springs on Front Axle (3/4" Mounting bolts)	B71-1003	0 0	83312	89409		...	...
		K374-3	0 0	83312	89409		...	...
		K374-33	0 0	83312	89409		...	...
	Models with Reyco 102 or 79KB Suspension (Drive Axle)	16725-01		...	...	0 0	83126	89440
		19495-01		...	...	0 0	83126	89440
- 2018	Models with Reyco 1209 or 1212 Suspension (Steer Axle)	19495-01	0 0	83126	89440		...	...
	Models with Taper Leaf Springs on Front Axle (1" Mounting bolts)	B71-1002	0 0	85001	89410		...	...
		K374-16	0 0	85001	89410		...	...
		K374-26	0 0	85001	89410		...	...
		K374-27	0 0	85001	89410		...	...
	Models with Woodhead Shock (Stamping Number ACHB 966)	ACHB966		...	...	- 1	83136	...

**T400, T400B, T450B**

	All with Air Glide 100 Suspension with 8 air bags, 4 units required	K374-29		...	...	- 1	85310	89423
		K374-32		...	...	- 1	85310	89423
	All with Air Glide 200 with 40,000 lb Suspension with 8 air bags, 4 units required	665903		...	...	- 1	85900	...
		665944		...	...	- 1	85900	...
		70701		...	...	- 1	85900	...
	All with Air Glide 200 with 46,000 lb Suspension with 8 air bags, 4 units required	665906		...	...	- 1	85902	...
		665945		...	...	- 1	85902	...
	Models with Multiple Leaf Springs on Front Axle	B71-1003	0 0	83312	89409		...	...
		K374-3	0 0	83312	89409		...	...
		K374-33	0 0	83312	89409		...	...

## APPLICATION GUIDE - TRUCKS, TRAILERS, AND BUSES

Year Año Année	Model Modelo Modèle	OEM #	Front		Rear	
						
						
			Fleetline	GasSLX	Fleetline	GasSLX

### KENWORTH(Cont'd.)

#### T400, T400B, T450B(Cont'd.)

89 - 16	Models with Taper Leaf Springs on Front Axle	B71-1002 K374-16 K374-26 K374-27	○ ○	85001	89410		...	...
			○ ○	85001	89410		...	...
			○ ○	85001	89410		...	...
			○ ○	85001	89410		...	...
	Models with Torsion Bar Bogey (2 rear axles) and KW Air Ride Suspension (with 4 air bags)	K374-28  K374-4		...	...	○ ○	85314	89425
				...	...	○ ○	85314	89425





#### T440

12 - 19	Models with 12,000 to 20,000 lb Taperleaf Front Suspension	665858 B71-1001	○ ○	85070	89459		...	...
			○ ○	85070	89459		...	...
12 - 19	Models with 21,000 to 23,000 lb Reyco Spring Suspension	19495-01 TK19679		...	...	○ ○	83126	89440
				...	...	○ ○	83126	89440
12 - 20	Models with Air Glide 380 (AG380) Rear Air Suspension	C71-1002 C71-1016 C71-6015		...	...	○ ○	85067	89451
				...	...	○ ○	85067	89451
				...	...	○ ○	85067	89451
12 - 19	Models with Air Glide 400 (AG400) Rear Air Suspension	671962 C71-1014		...	...	○ -	85936	89456
				...	...	○ -	85936	89456
12 - 20	Models with Air Glide 400L (AG400L) Rear Air Suspension	C71-1011 C71-1017		...	...	- -	85069	89455
				...	...	- -	85069	89455
12 - 20	Models with Air Glide 460 (AG460) Rear Air Suspension	671963 C71-1015 C71-1015 PLUS		...	...	○ -	85937	...
				...	...	○ -	85937	...
				...	...	○ -	85937	...
12 - 18	Models with Chalmers 40,000 lb Rear Suspension	665174		...	...	○ ○	85060	...
12 - 17	Models with Hendrickson HAS - 230 Rear Air Suspension	60670-005		...	...	○ ○	83137	...
12 - 20	Models with Hendrickson HMX 400/460 Haulmax with 16.5" Saddle	60680-004  60680-004L		...	...	○ -	83143	...
				...	...	○ -	83143	...
12 - 20	Models with Hendrickson HMX 400/460 Haulmax with 17.5" & 18.5" Saddle	60680-005  60680-005L		...	...	○ -	83142	...
				...	...	○ -	83142	...
12 - 20	Models with Hendrickson Primaax 230, 460 and 690 Air Suspension (8-1/2" to 10" Ride Height)	60657-003  60657-003L		...	...	○ ○	85072	...
				...	...	○ ○	85072	...
12 - 20	Models with Hendrickson Primaax EX 232, 462 and 692 Air Suspension (8-1/2" to 10" Ride Height)	60657-003  60657-003L		...	...	○ ○	85072	...
				...	...	○ ○	85072	...
12 - 17	Models with Hendrickson Primaax EX 262S or 522S Rear Air Suspension (10" Ride Height)	60665-011		...	...	○ ○	85967	...
12 - 16	Models with Neway AD-123 or AD-246 Models Air Suspension with - Shock stamping	90045099 90045132		...	...	○ ○	85906	89407
				...	...	○ ○	85909	...
12 - 20	Models with Neway ADZ Rear Suspension	471700004423 90045605		...	...	○ ○	85109	...
				...	...	○ ○	85109	...
12 - 17	Models with Reyco 102 or 79KB Suspension (Drive Axle)	16725-01 19495-01		...	...	○ ○	83126	89440
				...	...	○ ○	83126	89440

#### T470

10 - 18	Models with 12,000 to 20,000 lb Taperleaf Front Suspension	665858 B71-1001	○ ○	85070	89459		...	...
			○ ○	85070	89459		...	...
10 - 19	Models with 21,000 to 23,000 lb Reyco Spring Suspension	19495-01 TK19679		...	...	○ ○	83126	89440
				...	...	○ ○	83126	89440
10 - 16	Models with Air Glide 230 (AG230) Rear Air Suspension	671656 C71-1013		...	...	○ -	85985	...
				...	...	○ -	85985	...
10 - 19	Models with Air Glide 380 (AG380) Rear Air Suspension	C71-1002 C71-1016 C71-6015		...	...	○ ○	85067	89451
				...	...	○ ○	85067	89451
				...	...	○ ○	85067	89451
10 - 17	Models with Air Glide 400 (AG400) Rear Air Suspension	671962		...	...	○ -	85936	89456

**APPLICATION GUIDE - TRUCKS, TRAILERS, AND BUSES**

Year Año Année	Model Modelo Modèle	OEM #	Front		Rear	
						
			Fleetline	GasSLX	Fleetline	GasSLX

**KENWORTH(Cont'd.)**

**T470(Cont'd.)**

10 - 17	Models with Air Glide 400 (AG400) Rear Air Suspension	C71-1014		...	...	0 -	85936	89456
12 - 19	Models with Air Glide 400L (AG400L) Rear Air Suspension	C71-1011		...	...	- -	85069	89455
		C71-1017		...	...	- -	85069	89455
10 - 19	Models with Air Glide 460 (AG460) Rear Air Suspension	671963		...	...	0 -	85937	...
		C71-1015		...	...	0 -	85937	...
		C71-1015 PLUS		...	...	0 -	85937	...
10 - 18	Models with Chalmers 40,000 lb Rear Suspension	665174		...	...	0 0	85060	...
10 - 16	Models with Hendrickson HAS - 230 Rear Air Suspension	60670-005		...	...	0 0	83137	...
10 - 19	Models with Hendrickson HMX 400/460 Haulmax with 16.5" Saddle	60680-004		...	...	0 -	83143	...
		60680-004L		...	...	0 -	83143	...
10 - 19	Models with Hendrickson HMX 400/460 Haulmax with 17.5" & 18.5" Saddle	60680-005		...	...	0 -	83142	...
		60680-005L		...	...	0 -	83142	...
10 - 19	Models with Hendrickson Primaax 230, 232, 460, 462, 690 and 692 Air Suspension (8-1/2" to 10" Ride Height)	60657-003		...	...	0 0	85072	...
		60657-003L		...	...	0 0	85072	...
10 - 16	Models with Neway AD-123 or AD-246 Models Air Suspension with - Shock stamping	90045099		...	...	0 0	85906	89407
		90045132		...	...	0 0	85909	...
10 - 20	Models with Neway ADZ Rear Suspension	471700004423		...	...	0 0	85109	...
		90045605		...	...	0 0	85109	...
10 - 18	Models with Reyco 102 or 79KB Suspension (Drive Axle)	16725-01		...	...	0 0	83126	89440
		19495-01		...	...	0 0	83126	89440





**T600, T600A, T600B, T602**

	All with Air Glide 100 Suspension with 8 air bags, 4 units required	K374-29		...	...	- -	85310	89423
		K374-32		...	...	- -	85310	89423
	All with Air Glide 200 with 40,000 lb Suspension with 8 air bags, 4 units required	665903		...	...	- -	85900	...
		665944		...	...	- -	85900	...
		70701		...	...	- -	85900	...
	All with Air Glide 200 with 46,000 lb Suspension with 8 air bags, 4 units required	665906		...	...	- -	85902	...
		665945		...	...	- -	85902	...
2006 -	Models with 13,000 lb Front Axle	665858	0 0	85070	89459		...	...
		B71-1001	0 0	85070	89459		...	...
01 - 07	Models with Air Glide 380 (AG380) Rear Air Suspension	C71-1002		...	...	0 0	85067	89451
		C71-1016		...	...	0 0	85067	89451
01 - 07	Models with Air Glide 400 (AG400) Rear Air Suspension	671962		...	...	0 -	85936	89456
		C71-1014		...	...	0 -	85936	89456
- 2007	Models with Air Glide 460 (AG460) Rear Air Suspension	671963		...	...	0 -	85937	...
	Models with Hendrickson Rear Air Suspension	47902-19		...	...	0 0	83123	89405
		47902-24		...	...	0 0	83137	...
	Models with Multiple Leaf Springs on Front Axle	B71-1003	0 0	83312	89409		...	...
		K374-3	0 0	83312	89409		...	...
		K374-33	0 0	83312	89409		...	...
	Models with Reyco 102 or 79KB Suspension (Drive Axle)	16725-01		...	...	0 0	83126	89440
		19495-01		...	...	0 0	83126	89440
- 2007	Models with Reyco 1209 or 1212 Suspension (Steer Axle)	19495-01	0 0	83126	89440		...	...
86 - 07	Models with Taper Leaf Springs on Front Axle	B71-1002	0 0	85001	89410		...	...
		K374-16	0 0	85001	89410		...	...
		K374-26	0 0	85001	89410		...	...
		K374-27	0 0	85001	89410		...	...

**T660**

	Carhauler with O.E.M. Number	K374-36	0 0	...	89432		...	...
--	------------------------------	---------	-----	-----	-------	--	-----	-----

**APPLICATION GUIDE - TRUCKS, TRAILERS, AND BUSES**

Year Año Année	Model Modelo Modèle	OEM #	Front		Rear	
			 Fleetline	 GasSLX	 Fleetline	 GasSLX

**KENWORTH(Cont'd.)**

**T660(Cont'd.)**

08 - 18	Models with 12,000 or 13,200 lb Front Axle	665858	○ ○	<b>85070</b>	<b>89459</b>		...	...
		B71-1001	○ ○	<b>85070</b>	<b>89459</b>		...	...
08 - 18	Models with Air Glide 230 (AG230) Rear Air Suspension	671656		...	...	○ -	<b>85985</b>	...
		C71-1013		...	...	○ -	<b>85985</b>	...
08 - 18	Models with Air Glide 380 (AG380) Rear Air Suspension	C71-1002		...	...	○ ○	<b>85067</b>	<b>89451</b>
		C71-1016		...	...	○ ○	<b>85067</b>	<b>89451</b>
		C71-6015		...	...	○ ○	<b>85067</b>	<b>89451</b>
13 - 18	Models with Air Glide 400 (AG400) Rear Air Suspension	671962		...	...	○ -	<b>85936</b>	<b>89456</b>
		C71-1014		...	...	○ -	<b>85936</b>	<b>89456</b>
08 - 18	Models with Air Glide 400L (AG400L) Rear Air Suspension	03-08781		...	...	- -	<b>85069</b>	<b>89455</b>
		C71-1011		...	...	- -	<b>85069</b>	<b>89455</b>
		C71-1017		...	...	- -	<b>85069</b>	<b>89455</b>
08 - 18	Models with Air Glide 460 (AG460) Rear Air Suspension	671963		...	...	○ -	<b>85937</b>	...
		C71-1015		...	...	○ -	<b>85937</b>	...
		C71-1015 PLUS		...	...	○ -	<b>85937</b>	...
13 - 18	Models with O.E.M. Number	B71-6012	○ ○	<b>85119</b>	...		...	...





**T680**

13 - 14	Models with 10,000 lb to 13,200 lb Front Axle	B71-6005	○ ○	<b>85084</b>	<b>89460</b>		...	...
14 - 20	Models with 10,000 lb to 14,600 lb Taperleaf Springs and Set Back Front Axles	B71-6019	○ ○	<b>85989</b>	...		...	...
14 - 19	Models with 16,000 lb to 20,000 lb Taperleaf Springs and Set Back Front Axles	B71-6020	○ ○	<b>85989</b>	...		...	...
13 - 19	Models with 21,000 to 23,000 lb Reyco Spring Suspension	19495-01		...	...	○ ○	<b>83126</b>	<b>89440</b>
		TK19679		...	...	○ ○	<b>83126</b>	<b>89440</b>
13 - 20	Models with Air Glide 380 (AG380) Rear Air Suspension	C71-1002		...	...	○ ○	<b>85067</b>	<b>89451</b>
		C71-1016		...	...	○ ○	<b>85067</b>	<b>89451</b>
		C71-6015		...	...	○ ○	<b>85067</b>	<b>89451</b>
13 - 19	Models with Air Glide 400 (AG400) Rear Air Suspension	671962		...	...	○ -	<b>85936</b>	<b>89456</b>
		C71-1014		...	...	○ -	<b>85936</b>	<b>89456</b>
13 - 20	Models with Air Glide 400L (AG400L) Rear Air Suspension	C71-1011		...	...	- -	<b>85069</b>	<b>89455</b>
		C71-1017		...	...	- -	<b>85069</b>	<b>89455</b>
13 - 20	Models with Air Glide 460 (AG460) Rear Air Suspension	671963		...	...	○ -	<b>85937</b>	...
		C71-1015		...	...	○ -	<b>85937</b>	...
		C71-1015 PLUS		...	...	○ -	<b>85937</b>	...
13 - 20	Models with Hendrickson HMX 400/460 Haulmax with 16.5" Saddle	60680-004		...	...	○ -	<b>83143</b>	...
		60680-004L		...	...	○ -	<b>83143</b>	...
13 - 20	Models with Hendrickson HMX 400/460 Haulmax with 17.5" & 18.5" Saddle	60680-005		...	...	○ -	<b>83142</b>	...
		60680-005L		...	...	○ -	<b>83142</b>	...
13 - 19	Models with Hendrickson Primaax EX 462 Air Suspensions Standard with 12 1/2" - 14 3/8" - 15 1/2" Ride Height Standard with 8 1/2" to 10" Ride Height	60665-011		...	...	○ ○	<b>85967</b>	...
		60657-003		...	...	○ ○	<b>85072</b>	...
		60657-003L		...	...	○ ○	<b>85072</b>	...
13 - 20	Models with Neway ADZ Rear Suspension	471700004423		...	...	○ ○	<b>85109</b>	...
		90045605		...	...	○ ○	<b>85109</b>	...
13 - 18	Models with O.E.M. Number	B71-6012	○ ○	<b>85119</b>	...		...	...
13 - 19	Models with Reyco 102 or 79KB Suspension (Drive Axle)	16725-01		...	...	○ ○	<b>83126</b>	<b>89440</b>
		19495-01		...	...	○ ○	<b>83126</b>	<b>89440</b>
13 - 19	Models with Watson & Chalin SL Series Steerable Lift Axle (8,000 to 13,500 lb)	11418		...	...	○ ○	<b>646177</b>	...

**T700**

11 - 16	Models with 13,000 lb Front Axle	665858	○ ○	<b>85070</b>	<b>89459</b>		...	...
		B71-1001	○ ○	<b>85070</b>	<b>89459</b>		...	...
11 - 16	Models with Air Glide 230 (AG230) Rear Air Suspension	671656		...	...	○ -	<b>85985</b>	...
		C71-1013		...	...	○ -	<b>85985</b>	...

**APPLICATION GUIDE - TRUCKS, TRAILERS, AND BUSES**

Year Año Année	Model Modelo Modèle	OEM #	Front		Rear	
						
			Fleetline	GasSLX	Fleetline	GasSLX

**KENWORTH(Cont'd.)**





**T700(Cont'd.)**

11 - 16	Models with Air Glide 380 (AG380) Rear Air Suspension	C71-1002	...	...	0 0	85067	89451
		C71-1016	...	...	0 0	85067	89451
		C71-6015	...	...	0 0	85067	89451
11 - 16	Models with Air Glide 400 (AG400) Rear Air Suspension	671962	...	...	0 -	85936	89456
		C71-1014	...	...	0 -	85936	89456
11 - 16	Models with Air Glide 400L (AG400L) Rear Air Suspension	03-08781	...	...	- -	85069	89455
		C71-1011	...	...	- -	85069	89455
		C71-1017	...	...	- -	85069	89455

**T800, T800B, T800B(8x4), T800SH, T800H, T800W**

	All with Air Glide 100 Suspension with 8 air bags, 4 units required	K374-29	...	...	- -	85310	89423
		K374-32	...	...	- -	85310	89423
	All with Air Glide 200 with 40,000 lb Suspension with 8 air bags, 4 units required	665903	...	...	- -	85900	...
		665944	...	...	- -	85900	...
		70701	...	...	- -	85900	...
	All with Air Glide 200 with 46,000 lb Suspension with 8 air bags, 4 units required	665906	...	...	- -	85902	...
		665945	...	...	- -	85902	...
05 - 19	Models with 12,000 to 20,000 lb Front Axles	665858	0 0	85070	89459	...	...
		B71-1001	0 0	85070	89459	...	...
06 - 18	Models with Air Glide 230 (AG230) Rear Air Suspension	671656	...	...	0 -	85985	...
		C71-1013	...	...	0 -	85985	...
01 - 20	Models with Air Glide 380 (AG380) Rear Air Suspension	C71-1002	...	...	0 0	85067	89451
		C71-1016	...	...	0 0	85067	89451
		C71-6015	...	...	0 0	85067	89451
07 - 18	Models with Air Glide 400 (AG400) Rear Air Suspension	671962	...	...	0 -	85936	89456
		C71-1014	...	...	0 -	85936	89456
14 - 20	Models with Air Glide 400L (AG400L) Rear Air Suspension	C71-1017	...	...	- -	85069	89455
07 - 20	Models with Air Glide 460 (AG460) Rear Air Suspension	671963	...	...	0 -	85937	...
		C71-1015	...	...	0 -	85937	...
		C71-1015 PLUS	...	...	0 -	85937	...
87 - 18	Models with Chalmers 40,000 lb Rear Suspension	665174	...	...	0 0	85060	...
02 - 20	Models with Hendrickson HMX 460 Haulmax with 16.5" Saddle	60680-004	...	...	0 -	83143	...
		60680-004L	...	...	0 -	83143	...
02 - 20	Models with Hendrickson HMX 460 Haulmax with 17.5" & 18.5" Saddle	60680-005	...	...	0 -	83142	...
		60680-005L	...	...	0 -	83142	...
10 - 20	Models with Hendrickson Primaax EX 232, 462 and 692 Air Suspension (8-1/2" to 10" Ride Height)	60657-003	...	...	0 0	85072	...
		60657-003L	...	...	0 0	85072	...
	Models with Hendrickson Rear Air Suspension	47902-19	...	...	0 0	83123	89405
		47902-24	...	...	0 0	83137	...
	Models with Multiple Leaf Springs on Front Axle	B71-1003	0 0	83312	89409	...	...
		K374-3	0 0	83312	89409	...	...
		K374-33	0 0	83312	89409	...	...
- 2020	Models with Neway ADZ Rear Suspension	471700004423	...	...	0 0	85109	...
		90045605	...	...	0 0	85109	...
	Models with Neway Rear Air Suspension	90044089	...	...	0 0	83124	89407
- 2018	Models with Neway Rear Air Suspension (AD123-, AD246- )	90045132	...	...	0 0	85909	...
- 2018	Models with Reyco 102 or 79KB Suspension (Drive Axle)	16725-01	...	...	0 0	83126	89440
		19495-01	...	...	0 0	83126	89440
- 2019	Models with Reyco 1209 or 1212 Suspension (Steer Axle)	19495-01	0 0	83126	89440	...	...
88 - 18	Models with Taper Leaf Springs on Front Axle	B71-1002	0 0	85001	89410	...	...
		K374-16	0 0	85001	89410	...	...
		K374-26	0 0	85001	89410	...	...

**APPLICATION GUIDE - TRUCKS, TRAILERS, AND BUSES**

Year Año Année	Model Modelo Modèle	OEM #	Front		Rear	
			 Fleetline	 GasSLX	 Fleetline	 GasSLX

**KENWORTH(Cont'd.)**

**T800, T800B, T800B(8x4), T800SH, T800H, T800W(Cont'd.)**

88 - 18	Models with Taper Leaf Springs on Front Axle	K374-27	○ ○	85001	89410		...	...
	Models with Torsion Bar Bogey (2 rear axles) and KW Air Ride Suspension (with 4 air bags)	K374-28		...	...	○ ○	85314	89425
		K374-4		...	...	○ ○	85314	89425

**T880**

14 - 20	Models with 10,000 lb to 14,600 lb Taperleaf Springs and Set Back Front Axles	B71-6019	○ ○	85989	...		...	...
14 - 19	Models with 16,000 lb to 20,000 lb Taperleaf Springs and Set Back Front Axles	B71-6020	○ ○	85989	...		...	...
14 - 20	Models with Air Glide 380 (AG380) Rear Air Suspension	C71-1002		...	...	○ ○	85067	89451
		C71-1016		...	...	○ ○	85067	89451
		C71-6015		...	...	○ ○	85067	89451
14 - 19	Models with Air Glide 400 (AG400) Rear Air Suspension	671962		...	...	○ -	85936	89456
		C71-1014		...	...	○ -	85936	89456
14 - 20	Models with Air Glide 400L (AG400L) Rear Air Suspension	C71-1017		...	...	- -	85069	89455
14 - 20	Models with Air Glide 460 (AG460) Rear Air Suspension	671963		...	...	○ -	85937	...
		C71-1015		...	...	○ -	85937	...
		C71-1015 PLUS		...	...	○ -	85937	...
14 - 20	Models with Hendrickson HMX 400/460 Haulmax with 16.5" Saddle	60680-004		...	...	○ -	83143	...
		60680-004L		...	...	○ -	83143	...
14 - 20	Models with Hendrickson HMX 400/460 Haulmax with 17.5" & 18.5" Saddle	60680-005		...	...	○ -	83142	...
		60680-005L		...	...	○ -	83142	...
14 - 19	Models with Hendrickson Primaax EX 462 Air Suspensions (Standard with 12 1/2" - 14 3/8" - 15 1/2" Ride Height)	60665-011		...	...	○ ○	85967	...
14 - 20	Models with Hendrickson Primaax EX 462 Air Suspensions (Standard with 8 1/2" to 10" Ride Height)	60657-003		...	...	○ ○	85072	...
		60657-003L		...	...	○ ○	85072	...
14 - 20	Models with Neway ADZ Rear Suspension	471700004423		...	...	○ ○	85109	...
		90045605		...	...	○ ○	85109	...
	Models with O.E.M. Number	C71-1015A		...	...	○ -	85937	...
14 - 16	Models with O.E.M. Number	B71-6012	○ ○	85119	...		...	...
14 - 19	Models with Reyco 102 or 79KB Suspension (Drive Axle)	16725-01		...	...	○ ○	83126	89440
		19495-01		...	...	○ ○	83126	89440
14 - 19	Models with Watson & Chalin SL Series Steerable Lift Axle (8,000 to 13,500 lb)	11418		...	...	○ ○	646177	...
	With Hendrickson Rear Suspension	60675-017		...	...	○ ○	85979	...





**W990**

19 - 20	Models with 14,600 lb Taperleaf Front Spring Suspension	B71-6013	○ ○	85012	89413		...	...
19 - 20	Models with Air Glide 460 (AG460) Rear Air Suspension	C71-1015		...	...	○ -	85937	...
		C71-1015 PLUS		...	...	○ -	85937	...
19 - 20	Models with Hendrickson Primaax 230, 460 and 690 Air Suspension (8-1/2" to 10" Ride Height)	60657-003		...	...	○ ○	85072	...
		60657-003L		...	...	○ ○	85072	...

**T2000**

97 - 11	All with Air Glide 100 Suspension with 8 air bags, 4 units required	K374-29		...	...	- -	85310	89423
		K374-32		...	...	- -	85310	89423
97 - 11	All with Air Glide 200 with 40,000 lb Suspension with 8 air bags, 4 units required	665903		...	...	- -	85900	...
		665944		...	...	- -	85900	...
		70701		...	...	- -	85900	...
97 - 11	All with Air Glide 200 with 46,000 lb Suspension with 8 air bags, 4 units required	665906		...	...	- -	85902	...
		665945		...	...	- -	85902	...
06 - 11	Models with 13,000 lb Front Axle	665858	○ ○	85070	89459		...	...
		B71-1001	○ ○	85070	89459		...	...
01 - 11	Models with Air Glide 380 (AG380) Rear Air Suspension	C71-1002		...	...	○ ○	85067	89451

**APPLICATION GUIDE - TRUCKS, TRAILERS, AND BUSES**

Year Año Année	Model Modelo Modèle	OEM #	Front		Rear	
						
			Fleetline	GasSLX	Fleetline	GasSLX

**KENWORTH(Cont'd.)**

**T2000(Cont'd.)**









01 - 11	Models with Air Glide 380 (AG380) Rear Air Suspension	C71-1016		...	...	010	85067	89451
05 - 11	Models with Air Glide 400 (AG400) Rear Air Suspension	671962		...	...	01-	85936	89456
		C71-1014		...	...	01-	85936	89456
05 - 11	Models with Air Glide 460 (AG460) Rear Air Suspension	671963		...	...	01-	85937	...
	Models with Multiple Leaf Springs on Front Axle	B71-1003	010	83312	89409		...	...
		K374-3	010	83312	89409		...	...
		K374-33	010	83312	89409		...	...
97 - 11	Models with Taper Leaf Springs on Front Axle	B71-1002	010	85001	89410		...	...
		K374-16	010	85001	89410		...	...
		K374-26	010	85001	89410		...	...
		K374-27	010	85001	89410		...	...

**W900, W900B, W900L, W900S**

	All with Air Glide 100 Suspension with 8 air bags, 4 units required	K374-29		...	...	-1-	85310	89423
		K374-32		...	...	-1-	85310	89423
	All with Air Glide 200 with 40,000 lb Suspension with 8 air bags, 4 units required	665903		...	...	-1-	85900	...
		665944		...	...	-1-	85900	...
		70701		...	...	-1-	85900	...
	All with Air Glide 200 with 46,000 lb Suspension with 8 air bags, 4 units required	665906		...	...	-1-	85902	...
		665945		...	...	-1-	85902	...
	Carhauler with O.E.M. Number	K374-36	010	...	89432		...	...
05 - 18	Models with 12,000 or 13,200 lb Front Axle	665858	010	85070	89459		...	...
		B71-1001	010	85070	89459		...	...
- 2020	Models with 18,000 lb to 23,000 lb Taperleaf Front Spring Suspension and Set Forward Front Axle.	B71-6011	010	85062	...		...	...
2010	Models with 46,000 lb Neway Rear Air Suspension	90045132		...	...	010	85909	...
06 - 18	Models with Air Glide 230 (AG230) Rear Air Suspension	671656		...	...	01-	85985	...
		C71-1013		...	...	01-	85985	...
01 - 20	Models with Air Glide 380 (AG380) Rear Air Suspension	C71-1002		...	...	010	85067	89451
		C71-1016		...	...	010	85067	89451
		C71-6015		...	...	010	85067	89451
05 - 18	Models with Air Glide 400 (AG400) Rear Air Suspension	671962		...	...	01-	85936	89456
		C71-1014		...	...	01-	85936	89456
08 - 20	Models with Air Glide 400L (AG400L) Rear Air Suspension	C71-1011		...	...	-1-	85069	89455
		C71-1017		...	...	-1-	85069	89455
05 - 20	Models with Air Glide 460 (AG460) Rear Air Suspension	671963		...	...	01-	85937	...
		C71-1015		...	...	01-	85937	...
		C71-1015 PLUS		...	...	01-	85937	...
- 2020	Models with Hendrickson HMX 400/460 Haulmax with 16.5" Saddle	60680-004		...	...	01-	83143	...
		60680-004L		...	...	01-	83143	...
- 2020	Models with Hendrickson HMX 400/460 Haulmax with 17.5" & 18.5" Saddle	60680-005		...	...	01-	83142	...
		60680-005L		...	...	01-	83142	...
- 2020	Models with Hendrickson Primaax EX 462 Air Suspensions Standard with 8 1/2" to 10" Ride Height	60657-003		...	...	010	85072	...
		60657-003L		...	...	010	85072	...
	Models with Hendrickson Rear Air Suspension	47902-19		...	...	010	83123	89405
		47902-24		...	...	010	83137	...
	Models with Multiple Leaf Springs on Front Axle	B71-1003	010	83312	89409		...	...
		K374-3	010	83312	89409		...	...
		K374-33	010	83312	89409		...	...
- 2020	Models with Neway ADZ Rear Suspension	471700004423		...	...	010	85109	...
		90045605		...	...	010	85109	...
- 2018	Models with Reyco 102 or 79KB Suspension (Drive Axle)	16725-01		...	...	010	83126	89440



## APPLICATION GUIDE - TRUCKS, TRAILERS, AND BUSES

Year Año Année	Model Modelo Modèle	OEM #	Front		Rear	
						
						
			Fleetline	GasSLX	Fleetline	GasSLX

### KENWORTH(Cont'd.)





#### W900, W900B, W900L, W900S(Cont'd.)

- 2018	Models with Reyco 102 or 79KB Suspension (Drive Axle)	19495-01		...	...	010	83126	89440
- 2019	Models with Reyco 1209 or 1212 Suspension (Steer Axle)	19495-01	010	83126	89440		...	...
87 - 19	Models with Taper Leaf Springs on Front Axle	B71-1002	010	85001	89410		...	...
		K374-16	010	85001	89410		...	...
		K374-26	010	85001	89410		...	...
		K374-27	010	85001	89410		...	...
	Models with Torsion Bar Bogey (2 rear axles) and KW Air Ride Suspension (with 4 air bags)	K374-28		...	...	010	85314	89425
		K374-4		...	...	010	85314	89425

#### Additional O.E.M. Interchanges

	Models with Hendrickson Primaax 260 or 520 Rear Air Suspension (10" Ride Height-Drum Brakes only)	60665-013		...	...	010	85965	...
	Models with Hendrickson Primaax EX 262 or 522 Rear Air Suspension (10" Ride Height)	60665-013		...	...	010	85965	...
	Models with Hendrickson Primaax EX 262S or 522S Rear Air Suspension (10" Ride Height)	60665-011		...	...	010	85967	...
	OE PLUS Shock Stamping Number	02-02736PLUS	010	85302	89420		...	...
		02-02737PLUS	010	85062	89408		...	...
		02-02738PLUS	010	85012	89413		...	...
		02-02739PLUS	010	85013	89414		...	...
		03-04176PLUS		...	...	010	85308	89422
		03-06084PLUS		...	...	-10	85033	89427
		03-07421PLUS		...	...	-10	85311	89424
		03-07423PLUS		...	...	-10	85033	89427
		10-12032-002PLUS	010	85320	89429		...	...
		10-12542-000PLUS	010	85901	...		...	...
		16-13947-000PLUS		...	...	-10	85319	89428
		2018987C1PLUS		...	...	010	85003	89411
		47902-13PLUS		...	...	010	83122	89406
		60670-005PLUS		...	...	010	83137	...
		60670-008PLUS		...	...	010	83123	89405
		665565PLUS		...	...	010	85007	...
		671962PLUS		...	...	01-	85936	89456
		70701PLUS		...	...	-1-	85900	...
		8086053PLUS		...	...	010	85047	89435
		90044025PLUS	010	83209	89414		...	...
		90044089PLUS		...	...	010	83124	89407
		B71-6015	010	85012	89413		...	...
		C71-1002PLUS		...	...	010	85067	89451
	C71-1011PLUS		...	...	-1-	85069	89455	
	K374-26PLUS	010	85001	89410		...	...	
	K374-28PLUS		...	...	010	85314	89425	
	K374-29PLUS		...	...	-1-	85310	89423	
	K374-33PLUS	010	83312	89409		...	...	
	TruckMaster Shock Stamping Number	665632	010	85013	89414		...	...
		665633		...	...	-10	85033	89427
		665783		...	...	010	83123	89405
		665784		...	...	010	83122	89406
		665785		...	...	010	83137	...
		665844		...	...	-1-	85069	89455
		665918		...	...	-1-	85900	...
		665926		...	...	010	85047	89435
		665927	010	85901	...		...	...
		665928	010	85062	89408		...	...
		665930	010	85001	89410		...	...
		665931	010	83312	89409		...	...

**APPLICATION GUIDE - TRUCKS, TRAILERS, AND BUSES**





Year Año Année	Model Modelo Modèle	OEM #	Front		Rear	
						
			Fleetline	GasSLX	Fleetline	GasSLX

**KENWORTH(Cont'd.)**

**Additional O.E.M. Interchanges(Cont'd.)**

TruckMaster Shock Stamping Number	665932	010	<b>85012</b>	<b>89413</b>		...	...
	665950		...	...	- -	<b>85902</b>	...
	671052	010	<b>85070</b>	<b>89459</b>		...	...
	671654		...	...	01-	<b>85936</b>	<b>89456</b>
	671699		...	...	01-	<b>85937</b>	...
	671794		...	...	010	<b>85067</b>	<b>89451</b>
	680237		<b>85303</b>	...	010	<b>85303</b>	<b>89422</b>
	680239		...	...	- -	<b>85310</b>	<b>89423</b>
	680240		...	...	010	<b>85302</b>	<b>89420</b>
	680242		...	...	010	<b>85308</b>	<b>89422</b>
	680253		...	...	010	<b>85314</b>	<b>89425</b>
	680261	010	<b>85062</b>	<b>89408</b>		...	...
	680279	010	<b>83209</b>	<b>89414</b>		...	...
	680280		...	...	010	<b>85906</b>	<b>89407</b>
	680281		...	...	010	<b>85003</b>	<b>89411</b>
	680283	01-	<b>85740</b>	...		...	...
	680303		...	...	010	<b>85007</b>	...
	680425	010	<b>85320</b>	<b>89429</b>		...	...
	680435		...	...	- 0	<b>85033</b>	<b>89427</b>
	680473		...	...	- 0	<b>85319</b>	<b>89428</b>
All with Air Glide 100 Suspension with 8 air bags, 4 units required	K374-C7		...	...	- -	<b>85310</b>	<b>89423</b>
Models with Multiple Leaf Springs on Front Axle	K374-14	010	<b>83312</b>	<b>89409</b>		...	...
	K374-5	010	<b>83312</b>	<b>89409</b>		...	...
Models with O.E.M. Number	665453	010	<b>85001</b>	<b>89410</b>		...	...
	665670	010	<b>85001</b>	<b>89410</b>		...	...
	665680	010	<b>83312</b>	<b>89409</b>		...	...
	665788		...	...	010	<b>85000</b>	<b>89436</b>
	665828		...	...	010	<b>85067</b>	<b>89451</b>
	671962SPL		...	...	01-	<b>85936</b>	<b>89456</b>
	675122	010	<b>85001</b>	<b>89410</b>		...	...
	680241		...	...	- 0	<b>85311</b>	<b>89424</b>
	680475		...	...	010	<b>85314</b>	<b>89425</b>
	680476		...	...	- -	<b>85310</b>	<b>89423</b>
	680486		...	...	- -	<b>85310</b>	<b>89423</b>
	680586		...	...	- 0	<b>85311</b>	<b>89424</b>
	B71-6000	010	<b>85959</b>	...		...	...
	B71-6002	010	<b>85012</b>	<b>89413</b>		...	...
	B71-6003	010	<b>85029</b>	...		...	...
	B71-6007	010	<b>85062</b>	<b>89408</b>		...	...
	B71-6008	010	<b>83312</b>	<b>89409</b>		...	...
	B71-6010	010	<b>85023 or 89415</b>			...	...
	B71-6011	010	<b>85062</b>	<b>89408</b>		...	...
	B71-6013	010	<b>85012</b>	<b>89413</b>		...	...
	B71-6016	010	<b>85012</b>	<b>89413</b>		...	...
	B71-6017	010	<b>85910</b>	...		...	...
	B71-6018	010	<b>85012</b>	<b>89413</b>		...	...
	C71-1011SPL		...	...	- -	<b>85069</b>	<b>89455</b>
	C71-6003		...	...	- 0	<b>85988</b>	...
	C71-6004		...	...	- 0	<b>85343</b>	...
	C71-6005		...	...	- -	<b>85069</b>	<b>89455</b>
	K374-7		...	...	- -	<b>85310</b>	<b>89423</b>
	K374-9		...	...	- -	<b>85310</b>	<b>89423</b>
	K374-C31	010	<b>83312</b>	<b>89409</b>		...	...
	R71-6006	010	<b>83063</b>			...	...

**APPLICATION GUIDE - TRUCKS, TRAILERS, AND BUSES**

Year Año Année	Model Modelo Modèle	OEM #	Front		Rear	
						
			Fleetline	GasSLX	Fleetline	GasSLX

**KENWORTH(Cont'd.)**

**Additional O.E.M. Interchanges(Cont'd.)**

	Models with O.E.M. Number	R71-6007 R71-6008 S-20126	010 010	83008 83035		
				...	...	010 85323 89436
	Models with Taper Leaf Springs on Front Axle	K374-11	010	85001	89410	... ..
	Additional O.E.M. Interchanges	3166657 665092 665118 K374-10 K374-3-1	010 010 010 010 010	85700 83312 89409 ... .. 83312 89409 ... .. ... .. 010 83362 ... .. 83312 89409 ... ..		

**KENWORTH CAB SHOCKS**

**Aerocab**

	Models with 38" Sleepers with Link Cabmate Models KWK1T03 or KWCSA 01-06	1202-1264	010	83031		
	Models with 62" and 74" Sleepers with O.E.M. Number	1202-1164	010	83031		
	Models with 72" Sleepers with Link Cabmate Models KWK1T02 or KWCSA 01-06	1202-1065	010	83002		
08 - 16	Models with 86" Sleepers with O.E.M. Number	1202-1286 1202K286 T71-1003	010 010 010	83056 83056 83056		

**C-500B**

	Models with Link Cabmate KWB500 Air Suspension	1202-0044	010	83025		
--	--	-----------	-----	-------	--	--

**COE Models**

	90" and 112" E Models with Link Cabmate KWE90112-B Air Suspension	1202K064 R71-1005	010 010	83024 83024		
	Models with Link Cabmate KW1102-B Air Suspension (Does not fit Non-Sleeper cabs)	1202-0032	010	83016		
	Models with Link Cabmate KWE90112-A Air Suspension	1202-0032	010	83016		

**ICON 900**

2016	Models with 86" Sleepers with O.E.M. Number	T71-1003	010	83056		
2016	Models with O.E.M. Number	T71-1002	010	83002		

**T400A**

06/92 -	Models with Link Cabmate Air Suspension KWB689-A with rear cab support Kenworth P/N K235-1646	1202-0012	010	83023		
- 05/92	Models with Link Cabmate KWB400-A Air Suspension	1202-0012	010	83023		
05/92 -	Models with Link Cabmate KWB689-B or KWB689-C Air Suspension	1201-1043	010	83025		
06/92 -	Models with Link Cabmate KWB689-B or KWB689-C Air Suspension	1202-1043	010	83025		





**T440**

	Models with Link Cabmate KWB689-D and Severe service crossmembers	1201-1046 1202-1046 1202K046 R71-1004	010 010 010 010	83049 83049 83049 83049		
--	---	--	--------------------------	----------------------------------	--	--

**T450**

06/92 -	Models with Link Cabmate Air Suspension KWB689-A with rear cab support Kenworth P/N K235-1646	1202-0012	010	83023		
- 05/92	Models with Link Cabmate KWB400-A Air Suspension	1202-0012	010	83023		
05/92 -	Models with Link Cabmate KWB689-B or KWB689-C Air Suspension	1201-1043	010	83025		
06/92 -	Models with Link Cabmate KWB689-B or KWB689-C Air Suspension	1202-1043	010	83025		
	Models with Link Cabmate KWB689-D and Severe service crossmembers	1202K046 R71-1004	010 010	83049 83049		

**APPLICATION GUIDE - TRUCKS, TRAILERS, AND BUSES**

Year Año Année	Model Modelo Modèle	OEM #	Front		Rear	
						
			Fleetline	GasSLX	Fleetline	GasSLX

**KENWORTH CAB SHOCKS(Cont'd.)**

**T600(Cont'd.)**

	Models with Link Cabmate KWMC642 Air Suspension	1202-0054	010	83021
--	---	-----------	-----	-------

**T600A**

	Models with Link Cabmate KWB689-A Air Suspension and rear cab mount Kenworth P/N K235-1436 or K235-1488	1202-0012	010	83023
	Models with Link Cabmate KWB689-B or KWB689-C Air Suspension and rear cab mount Kenworth part # K235-1436 or K235-1488	1201-1043	010	83025
		1202-1043	010	83025
	Models with Link Cabmate KWB689-D and Severe service crossmembers	1202K046	010	83049
		R71-1004	010	83049

**T660**

<b>08 - 17</b>	Models with 86" Sleepers with O.E.M. Number	1202-1286	010	83056
		1202K286	010	83056
		T71-1003	010	83056
<b>06 - 10</b>	Models with Link Cab Suspension	1202-1065	010	83002

**T680**

<b>13 - 20</b>	Models with Sleepers with O.E.M. Number	1201-8002	010	83081
		25523024	010	83081
		R71-6009	010	83081

**T700**

<b>11 - 16</b>	DayCab Models with O.E.M. Number	R71-6000	010	83067
		R71-6010	010	83067
<b>08 - 16</b>	Models with 86" Sleepers with O.E.M. Number	1202-1286	010	83056
		1202K286	010	83056
		T71-1003	010	83056
<b>11 - 16</b>	Models with Extended Sleeper Cab	1202-1064	010	83024
		1202K064	010	83024
		R71-1005	010	83024

**T800 / T800A**

<b>- 2012</b>	Models with Link Cab Suspension	1202-1046	010	83049
	Models with Link Cabmate KWB689-A Air Suspension and rear cab mount Kenworth P/N K235-1436 or K235-1488	1202-0012	010	83023
	Models with Link Cabmate KWB689-B or KWB689-C Air Suspension and rear cab mount Kenworth part # K235-1436 or K235-1488	1201-1043	010	83025
		1202-1043	010	83025
	Models with Link Cabmate KWB689-D and Severe service crossmembers	1202K046	010	83049
<b>- 2014</b>	Models with Link Cabmate KWB689-D and Severe service crossmembers	R71-1004	010	83049
	Models with Link Cabmate KWMC642 Air Suspension	1202-0054	010	83021

**T880**

<b>14 - 18</b>	Sleeper cab Models with Link Cab Suspension	1202-1046	010	83049
----------------	---	-----------	-----	-------

**W900 - Series**

<b>06 - 20</b>	Models with O.E.M. Number	1202K065	010	83002
		T71-1002	010	83002









**T2000**

<b>97 - 11</b>	Models with Link Cabmate KWT2000-A Air Suspension	1202-1064	010	83024
		1202K064	010	83024
		R71-1005	010	83024
<b>07/98 -</b>	Models with PowerPacker Cab Suspension after 6/28/98	PP2582870	010	83012
<b>- 06/98</b>	Models with PowerPacker Cab Suspension prior to 6/28/98	96027-10545	010	83011

**W-900 / W-900B**

	Models with Link Cabmate KWB689-A Air Suspension and rear cab mount Kenworth P/N K235-1436 or K235-1488	1202-0012	010	83023
--	---	-----------	-----	-------

## APPLICATION GUIDE - TRUCKS, TRAILERS, AND BUSES

Year Año Année	Model Modelo Modèle	OEM #	Front		Rear	
						
						
			Fleetline	GasSLX	Fleetline	GasSLX

### KENWORTH CAB SHOCKS(Cont'd.)

#### W-900 / W-900B(Cont'd.)

	Models with Link Cabmate KWB689-B or KWB689-C Air Suspension and rear cab mount Kenworth part # K235-1436 or K235-1488	1201-1043	010	<b>83025</b>
		1202-1043	010	<b>83025</b>
	Models with Link Cabmate KWB689-D and Severe service crossmembers	1202K046	010	<b>83049</b>
		R71-1004	010	<b>83049</b>
	Models with Link Cabmate KWMC642 Air Suspension	1202-0054	010	<b>83021</b>

#### Additional Applications

	60" Sleeper with Link Cab Suspension	1202-0043	010	<b>83025</b>
- 1982	Conventional Tractors with A-Model cabs & Link Cabmate Model KWA900	1201-0012	010	<b>83023</b>
		1202-0012	010	<b>83023</b>
1986 -	Kenworth Sleepers with Link Cabmate KWS60-A Air Suspension and round cornered doors.	1201-1044	010	<b>83025</b>
	Models with Link Cab Suspension	1202-0042	010	<b>83025</b>
	Models with O.E.M. Number	1202-K065	010	<b>83002</b>
		1202K164	010	<b>83031</b>
		1202K264	010	<b>83031</b>
		PP1058870	010	<b>83059</b>
		R71-6005	010	<b>83042</b>
		T71-1000	010	<b>83031</b>
		T71-1001	010	<b>83031</b>

### KIMBLE MIXER CO

	Rear Discharge Mixers with Self - Steering Axle Shock	T91-00002-00	010	<b>646155</b>	...
--	---	--------------	-----	---------------	-----

### KING OF THE ROAD

#### Class A MotorHomes

04 - 06	Genesis Series MotorHomes with Freightliner XC Chassis ADL200 Suspension w/ 20K Rear AS120 Front Suspension	16-16873-000	010	...	...	010	<b>85029</b>	...	
		141700131810		<b>83160</b>	...	...	...		
		16-16737-000		<b>83160</b>	...	...	...		
		16-16874-000		<b>83160</b>	...	...	...		
		Rear Shock with O.E.M. Number		141700131809	...	...	010	<b>85029</b>	...
		16-16736-000		...	...	010	<b>85029</b>	...	
		ZF - IFS Front Suspension with 23,000 lb GVW or Greater		16-18103-000	-1-	<b>85900</b>	...	...	...
		481700000493		-1-	<b>85900</b>	...	...	...	

### KRYSTAL BUS

- 2020	Krystal E-450 Shuttle bus	ASH-1136	...	...	-10	<b>83178</b>	...
		ASH-1154	-10	<b>83177</b>	...	...	...
	Krystal F-650 Shuttle bus - Refer to Ford section for detailed information on F-650 models						

### KWK-LOC (JIFFLOX)

	Truck Dolly	522217	010	<b>85315</b>	...	...	...
		CP-5222	010	<b>85315</b>	...	...	...





### LEYLAND TRUCK

	Models with Air Trac Suspension (38000 or 40000 lb)	1456033	...	...	-10	<b>85311</b>	<b>89424</b>
--	---	---------	-----	-----	-----	--------------	--------------

### LGE COACHWORKS

- 2020	All Shuttle buses with Ford E350 and E450 Chassis	ASH-1136	...	...	-10	<b>83178</b>	...
		ASH-1154	-10	<b>83177</b>	...	...	...
	Models with Freightliner M2 Chassis - See Freightliner section for proper year and model information	.....					





## APPLICATION GUIDE - TRUCKS, TRAILERS, AND BUSES

Year Año Année	Model Modelo Modèle	OEM #	Front		Rear	
						
			Fleetline	GasSLX	Fleetline	GasSLX

### LINK MANUFACTURING CAB SHOCKS

	Models with Link Cab Suspension	1202-1046	010	83049
		1201-0012	010	83023
		1201-0154	010	83051
		1201-0254	010	83051
		1201-1043	010	83025
		1201-1044	010	83025
		1201-1046	010	83049
		1201-1049	010	83025
		1201-1212	010	83013
		1201-1213	01-	83005
		1201-9007	010	83054
		1201-9008	010	83054
		1201-9009	010	83054
		1201-9010	010	83053
		1201-9011	010	83053
		1201-9013	01-	83062
		1201-9014	01-	83062
		1201-9018	01-	83062
		1201-9021	01-	83062
		1202-0012	010	83023
		1202-0032	010	83016
		1202-0042	010	83025
		1202-0043	010	83025
		1202-0044	010	83025
		1202-0052	010	83021
		1202-0054	010	83021
		1202-1042	010	83025
		1202-1043	010	83025
		1202-1044	010	83025
		1202-1064	010	83024
		1202-1065	010	83002
		1202-1164	010	83031
		1202-1212	010	83013
		1202-1213	01-	83005
		1202-1286	010	83056
		1202K065	010	83002
		1202K164	010	83031
		1202K264	010	83031
		1202K286	010	83056
		632129	010	83023
		635705	010	83016
		654669	010	83021
		654799	010	83025
		654811	010	83024
		654833	010	83021
		654847	010	83002
		654849	010	83031
		654867	010	83025
		LG40450	010	83016
		LG40470	010	83016
		R71-1004	010	83049
		R71-1005	010	83024
		T71-1000	010	83031
		T71-1001	010	83031
		T71-1002	010	83002

## APPLICATION GUIDE - TRUCKS, TRAILERS, AND BUSES

Year Año Année	Model Modelo Modèle	OEM #	Front		Rear	
						
			Wrench	Wrench	Wrench	Wrench
			Fleetline	GasSLX	Fleetline	GasSLX

### LINK MANUFACTURING LTD.

(See Specialty Application Section Also)							
	Sterling Models with Link Rear Air Suspension	1210-0528		...	...	OIO 85904	...
	Models with O.E.M. Number	1210-0005		...	...	OIO 85734	...
		671093		...	...	OIO 85904	...

### LION BUS

	Bus Chassis With Hendrickson HTS 210 Suspension (Type C School Bus Applications)	60665-025		...	...	OIO 85036	89405
		60665-025L		...	...	OIO 85036	89405
	Buses with Hendrickson Softek Suspension with Drum and Disc Brakes	58913-009	OIO	85959	...	...	...
		58913-009L	OIO	85959	...	...	...

### LODAL, INC.

	Refuse Truck	9960257	OIO	83122	89406	...	...
--	--------------	---------	-----	-------	-------	-----	-----

### MAC TRAILER MFG., INC.

Identification of the trailer suspension is necessary to determine what section of the catalog to refer to. Some possible options can be Chalmers, Hendrickson, Neway, Ridewell, Reyco.						
---	--	--	--	--	--	--

### MACK





#### ANTHEM Series

18 - 20	Anthem 64T Models with 13,200 lb Front Axles	141700005839	OIO	85098	89502	...	...
			21436096	OIO	85098	89502	...
18 - 20	Anthem 64T Models with 40,000 lb Rear Air Suspensions	22202560		...	...	OIO 85088	...
		471700009647		...	...	OIO 85088	...
18 - 20	Anthem 64T Models with Hendrickson HAS 400 or 460 Series Rear Suspension	60675-001		...	...	OIO 85978	...
		60675-001L		...	...	OIO 85978	...
		8083872		...	...	OIO 85978	...
18 - 19	Models with Hendrickson HMX 400/460 Haulmax with 16.5" Saddle	60680-004		...	...	OIO 83143	...
		60680-004L		...	...	OIO 83143	...
		H60680004		...	...	OIO 83143	...
18 - 19	Models with Hendrickson HMX 400/460 Haulmax with 17.5" or 18.5" Saddle Height	14QK-5142		...	...	OIO 83142	...
		25626196		...	...	OIO 83142	...
		60680-005		...	...	OIO 83142	...
		60680-005L		...	...	OIO 83142	...
		H60680005		...	...	OIO 83142	...
18 - 19	Models with Hendrickson HN - 522 Rear Suspension	60680-003		...	...	OIO 83112	...
		60680-003L		...	...	OIO 83112	...

#### CH Series

	CH Models with Hendrickson HA Series Air Suspension	14QK-410M2		...	...	OIO 83137	...
		14QK-410M3		...	...	OIO 83125	...
		25625254		...	...	OIO 83125	...
	CH600 Models with 12000 lb Taperleaf Spring	14QK-392AM	OIO	85005	89430	...	...
		14QK-392AM3	OIO	85005	89430	...	...
		14QK-392BM	OIO	85005	89430	...	...
		14QK-392BM3	OIO	85005	89430	...	...
		14QK-396	OIO	85005	89430	...	...
		14QK-396M	OIO	85005	89430	...	...
		25625743	OIO	85005	89430	...	...
	CH600 Models with AL Suspension	14QK-393M		...	...	OIO 85010	...
	CH600 Models with ALV Hendrickson Suspension	14QK-413M5		...	...	OIO 83138	...
		14QK-413M6		...	...	OIO 83111	...
		14QK-413M7		...	...	OIO 83111	...

**APPLICATION GUIDE - TRUCKS, TRAILERS, AND BUSES**

Year Año Année	Model Modelo Modèle	OEM #	Front		Rear	
						
			Fleetline	GasSLX	Fleetline	GasSLX

**MACK(Cont'd.)**

**CH Series(Cont'd.)**

	CH600 Models with ALV Hendrickson Suspension	25622221		...	...	01-	83111	...
		25625223		...	...	01-	83111	...
		57241-006		...	...	01-	83111	...
		57241-006L		...	...	01-	83111	...
	CH600 Models with HAS400 MACK Air Suspension	14QK-410M		...	...	010	83125	...
		25625234		...	...	010	83125	...
		47902-25		...	...	010	83125	...
	CH600 Models with Hendrickson AL-405 Rear Suspension	14QK-413M7		...	...	01-	83111	...
		25625223		...	...	01-	83111	...
		57241-006		...	...	01-	83111	...
		57241-006L		...	...	01-	83111	...
	CH600 Models with Hendrickson HAS-40LH Air Suspension (O.E. Number 57241-4)	14QK-413M4		...	...	01-	83110	...
		57241-4		...	...	01-	83110	...
	CH600 Models with Hendrickson HN-2 Series Suspension	14QK-415M		...	...	01-	83112	...
		14QK-415M7		...	...	01-	83112	...
		25624241		...	...	01-	83112	...
		60680-003		...	...	01-	83112	...
		60680-003L		...	...	01-	83112	...
	CH600 Models with Hendrickson Rear Air Suspension	14QK-393AM		...	...	010	83123	89405
		47902-9		...	...	010	83123	89405
	CH600 Models with Neway AD Air Suspension Shock w/ extended length of 21.70"  w/ extended length of 24.30"	14QK-414M		...	...	010	85906	89407
		90045099		...	...	010	85906	89407
		14QK-414M2		...	...	010	85909	...
		25624351		...	...	010	85909	...
	CH600 Models with ST34 Suspension	14QK-2133M	010	85001	89410		...	...
		25622466	010	85001	89410		...	...
	Models with O.E.M. Number	14QK-2113P6		...	...	010	85007	...
		14QK-421M	010	85014	...		...	...
		471700000426	010	85014	...		...	...

**CHN - Series**





04 - 07	CHN-613 Models w/ MACK Air Suspension	14QK-3101M		...	...	010	85066	89448
		471700000431		...	...	010	85066	89448
		SDA471700000431		...	...	010	85066	89448
04 - 07	CHN-613 Models with 12,000 lb Front Axle	14QK-3107M	010	85061	89450		...	...
		20973993	010	85061	89450		...	...
04 - 07	CHN-613 Models with 14,600 lb Front Axle	14QK-434M	010	85014	...		...	...
		20998401	010	85014	...		...	...
04 - 07	CHN-613 Models with Camelback Rear Suspension (SS34 & 38)	25625091		...	...	010	83215	...

**CHU - Pinnacle Series**

06 - 20	CHU-613 Models with 12,000 lb or 14,600 lb Front Axle	14QK-434M	010	85014	...		...	...
		20625775	010	85014	...		...	...
		20998401	010	85014	...		...	...
		471700002861	010	85014	...		...	...
		SDA471700002861	010	85014	...		...	...
11 - 17	CHU-613 Models with 40,000 lb Rear Air Suspensions	22202560		...	...	010	85088	...
		471700009647		...	...	010	85088	...
2007	CHU-613 Models with 40,000 lb Rear Air Suspensions	14-2136M		...	...	010	85061	89450
		20897198		...	...	010	85061	89450
- 2019	CHU-613 Models with Camelback Rear Suspension (SS34 & 38)	14QK-2107P2		...	...	010	83215	...
		25625091		...	...	010	83215	...
04 - 20	CHU-613 Models with Hendrickson 38,000 lb Rear Air Suspension	14QK-424M		...	...	010	83147	...



**APPLICATION GUIDE - TRUCKS, TRAILERS, AND BUSES**

Year Año Année	Model Modelo Modèle	OEM #	Front		Rear	
						
			Fleetline	GasSLX	Fleetline	GasSLX

**MACK(Cont'd.)**

**CHU - Pinnacle Series(Cont'd.)**

04 - 20	CHU-613 Models with Hendrickson 38,000 lb Rear Air Suspension	20570098	...	...	010	83147	...
		60670-006	...	...	010	83147	...
		60670-006L	...	...	010	83147	...
04 - 20	CHU-613 Models with Hendrickson HAS 400 or 460 Series Rear Suspension	60675-001	...	...	010	85978	...
		60675-001L	...	...	010	85978	...
		8083872	...	...	010	85978	...

**CL Series**

	CL600, CL700 Models with ALV Hendrickson Suspension	14QK-413M5	...	...	01-	83138	...
		14QK-413M6	...	...	01-	83111	...
		14QK-413M7	...	...	01-	83111	...
		25622221	...	...	01-	83111	...
		25625223	...	...	01-	83111	...
		57241-006	...	...	01-	83111	...
		57241-006L	...	...	01-	83111	...
	CL600, CL700 Models with HAS400 MACK Air Suspension	14QK-410M	...	...	010	83125	...
		25625234	...	...	010	83125	...
		47902-25	...	...	010	83125	...
	CL600, CL700 Models with Hendrickson HA Series Air Suspension	14QK-410M2	...	...	010	83137	...
		14QK-410M3	...	...	010	83125	...
		25625254	...	...	010	83125	...
	CL600, CL700 Models with Hendrickson HN-2 Series Suspension	14QK-415M	...	...	01-	83112	...
		14QK-415M7	...	...	01-	83112	...
		25624241	...	...	01-	83112	...
		60680-003	...	...	01-	83112	...
		60680-003L	...	...	01-	83112	...
	CL600, CL700 Models with Hendrickson Rear Air Suspension	14QK-393AM	...	...	010	83123	89405
		47902-9	...	...	010	83123	89405
	CL600, CL700 Models with Multileaf Spring Suspension	14QK-392BM2	010	85321	...	...	...
	CL600, CL700 Models with Neway AD Air Suspension Shock w/ extended length of 21.70"	14QK-414M	...	...	010	85906	89407
		90045099	...	...	010	85906	89407
		14QK-414M2	...	...	010	85909	...
		25624351	...	...	010	85909	...
	CL600, CL700 Models with ST34 Suspension	14QK-2113	010	85001	89410	...	...
		14QK-2133M	010	85001	89410	...	...
		25621955	010	85001	89410	...	...
		25622466	010	85001	89410	...	...
		25632145	010	85001	89410	...	...
	CL600, CL700 Models with Steering Axle & Taperleaf Spring	14QK-392AM	010	85005	89430	...	...
		14QK-392AM2	010	85005	89430	...	...
		14QK-392AM3	010	85005	89430	...	...
		14QK-392BM	010	85005	89430	...	...
		25625743	010	85005	89430	...	...









**CS, MS - Mid - Liner Series**

	CS Models Mid-Liner with O.E.M Number	4103-5000447861	-10	83105	...	...	...
		4103-5000546892	-10	83105	...	...	...
		V10234121	-10	83105	...	...	...
		V10242320	-10	83105	...	...	...
	MS200, MS300 Models Mid-Liner	V10234121	-10	83105	...	...	...

**CT, CTX Series**

	Models with O.E.M. Number	14QK-3108	01-	85080	...	...	...
		14QK-3108M	01-	85080	...	...	...

**APPLICATION GUIDE - TRUCKS, TRAILERS, AND BUSES**

Year Año Année	Model Modelo Modèle	OEM #	Front		Rear	
						
						
			Fleetline	GasSLX	Fleetline	GasSLX

**MACK(Cont'd.)**

**CT, CTX Series(Cont'd.)**

	Models with O.E.M. Number	14QK-3116M	○ ○	<b>83101</b>	...		...	...
		14QK-427M	○ -	<b>85080</b>	...		...	...
		14QK-428M	○ -	<b>85080</b>	...		...	...









**CV - Series**

<b>02 - 08</b>	CV-713 Models with 18,000 lb Front Axles	14QK-366	○ ○	<b>85036</b>	<b>89405</b>		...	...
		25625151	○ ○	<b>85036</b>	<b>89405</b>		...	...
<b>02 - 08</b>	CV-713 Models with Hendrickson HN-2 Models Suspension	14QK-415M		...	...	○ -	<b>83112</b>	...
		14QK-415M7		...	...	○ -	<b>83112</b>	...
		25624241		...	...	○ -	<b>83112</b>	...
		60680-003		...	...	○ -	<b>83112</b>	...
		60680-003L		...	...	○ -	<b>83112</b>	...
<b>02 - 08</b>	Models with Hendrickson HMX 400/460 Haulmax with 16.5" Saddle	60680-004		...	...	○ -	<b>83143</b>	...
		60680-004L		...	...	○ -	<b>83143</b>	...
		H60680004		...	...	○ -	<b>83143</b>	...
<b>02 - 08</b>	Models with Hendrickson HMX 400/460 Haulmax with 17.5" or 18.5" Saddle Height	14QK-5142		...	...	○ -	<b>83142</b>	...
		25626196		...	...	○ -	<b>83142</b>	...
		60680-005		...	...	○ -	<b>83142</b>	...
		60680-005L		...	...	○ -	<b>83142</b>	...
		H60680005		...	...	○ -	<b>83142</b>	...

**CX Series - Vision**

	CX Vision Models w/ Hendrickson Air Suspension	14QK-431M		...	...	○ ○	<b>85061</b>	<b>89450</b>
	CX Vision Models w/ Hendrickson HA Models Air Suspension	14QK-410M2		...	...	○ ○	<b>83137</b>	...
		14QK-410M3		...	...	○ ○	<b>83125</b>	...
		25625254		...	...	○ ○	<b>83125</b>	...
	CX Vision Models w/ Hendrickson HN-2 Models Suspension	14QK-415M		...	...	○ -	<b>83112</b>	...
		14QK-415M7		...	...	○ -	<b>83112</b>	...
		25624241		...	...	○ -	<b>83112</b>	...
		60680-003		...	...	○ -	<b>83112</b>	...
	CX Vision Models w/ Parabolic Spring	14QK-431M		...	...	○ ○	<b>85061</b>	<b>89450</b>
				...	...	○ ○	<b>85061</b>	<b>89450</b>
	CX Vision Models with Neway AD Air Suspension Shock w/ extended length of 21.70"	14QK-414M		...	...	○ ○	<b>85906</b>	<b>89407</b>
		90045099		...	...	○ ○	<b>85906</b>	<b>89407</b>
		14QK-414M2		...	...	○ ○	<b>85909</b>	...
	CX Vision Models w/ ALV Hendrickson Suspension	25624351		...	...	○ ○	<b>85909</b>	...
		14QK-413M5		...	...	○ -	<b>83138</b>	...
		14QK-413M6		...	...	○ -	<b>83111</b>	...
		25622221		...	...	○ -	<b>83111</b>	...
	CX Vision Models w/ MACK Air Suspension	25625223		...	...	○ -	<b>83111</b>	...
		14QK-3101M		...	...	○ ○	<b>85066</b>	<b>89448</b>
		471700000431		...	...	○ ○	<b>85066</b>	<b>89448</b>
	Models with 12000 lb Taperleaf Front Suspension	SDA471700000431		...	...	○ ○	<b>85066</b>	<b>89448</b>
				...	...	○ ○	<b>85066</b>	<b>89448</b>
	Models with 12000 lb Taperleaf Front Suspension	14QK-392BM3	○ ○	<b>85005</b>	<b>89430</b>		...	...
	Models with HAS400 MACK Air Suspension	14QK-410M		...	...	○ ○	<b>83125</b>	...
		25625234		...	...	○ ○	<b>83125</b>	...
		47902-25		...	...	○ ○	<b>83125</b>	...
	Models with Hendrickson Air Suspension (Stamping No. 57241-4)	14QK-413M4		...	...	○ -	<b>83110</b>	...
		25624341		...	...	○ -	<b>83110</b>	...
	Models with MAC AL405 Suspension	14QK-413M7		...	...	○ -	<b>83111</b>	...
		25625223		...	...	○ -	<b>83111</b>	...
		57241-006		...	...	○ -	<b>83111</b>	...
		57241-006L		...	...	○ -	<b>83111</b>	...

## APPLICATION GUIDE - TRUCKS, TRAILERS, AND BUSES

Year Año Année	Model Modelo Modèle	OEM #	Front		Rear	
						
						
			Fleetline	GasSLX	Fleetline	GasSLX

### MACK(Cont'd.)

#### CX Series - Vision(Cont'd.)

Models with O.E.M. Number	141700000373	OIO	<b>85061</b>	<b>89450</b>	...	...
	20513881	OIO	<b>85061</b>	<b>89450</b>	...	...

#### CXN Series

05 - 07	CXN-613 Models w/ MACK Air Suspension	14QK-3101M SDA471700000431	...	...	OIO	<b>85066</b>	<b>89448</b>
			...	...	OIO	<b>85066</b>	<b>89448</b>
11 - 14	CXN-613 Models with 12,000 - 14,600 lb Front Axles	141700005839 21436096	OIO	<b>85098</b>	<b>89502</b>	...	...
			OIO	<b>85098</b>	<b>89502</b>	...	...
	CXN-613 Models with 12,000 lb Front Axles	14QK-3114M 20973993 SDA141700000380	OIO	<b>85061</b>	<b>89450</b>	...	...
			OIO	<b>85061</b>	<b>89450</b>	...	...
			OIO	<b>85061</b>	<b>89450</b>	...	...
08 - 10	CXN-613 Models with 40,000 lb Rear Air Suspensions	14QK-2136M 20897198	...	...	OIO	<b>85061</b>	<b>89450</b>
			...	...	OIO	<b>85061</b>	<b>89450</b>
11 - 14	CXN-613 Models with 40,000 lb Rear Air Suspensions	21462382 471700006039	...	...	OIO	<b>85088</b>	...
			...	...	OIO	<b>85088</b>	...
05 - 15	CXN-613 Models with Hendrickson 38,000 lb Rear Air Suspension	14QK-424M 20570098 60670-006 60670-006L	...	...	OIO	<b>83147</b>	...
			...	...	OIO	<b>83147</b>	...
			...	...	OIO	<b>83147</b>	...
			...	...	OIO	<b>83147</b>	...
	CXN-613 Models with Hendrickson AirTek Front Air Suspension	14QK-322M 14QK-422M 20485633 64838-002	OIO	<b>85933</b>	<b>89454</b>	...	...
			OIO	<b>85933</b>	<b>89454</b>	...	...
			OIO	<b>85933</b>	<b>89454</b>	...	...
			OIO	<b>85933</b>	<b>89454</b>	...	...
	Models with O.E.M. Number	14QK-421M 471700000426	OIO	<b>85014</b>	...	...	...
			OIO	<b>85014</b>	...	...	...

#### CXP Series

06 - 07	CXP-613 Models with 12,000 lb Front Axles	14QK-3114M 20973993 SDA141700000380	OIO	<b>85061</b>	<b>89450</b>	...	...
			OIO	<b>85061</b>	<b>89450</b>	...	...
			OIO	<b>85061</b>	<b>89450</b>	...	...
06 - 07	CXP-613 Models with 40,000 lb Rear Air Suspensions	14QK-2136M 20897198 471700002626	...	...	OIO	<b>85061</b>	<b>89450</b>
			...	...	OIO	<b>85061</b>	<b>89450</b>
			...	...	OIO	<b>85061</b>	<b>89450</b>





#### CXU - Pinnacle Series

11 - 18	CXU-613 Models with 12,000 - 14,600 lb Front Axles	141700005839 21436096	OIO	<b>85098</b>	<b>89502</b>	...	...
			OIO	<b>85098</b>	<b>89502</b>	...	...
08 - 10	CXU-613 Models with 12,000 lb Front Axles	141700000380 14QK-3114M 20973993 SDA141700000380	OIO	<b>85061</b>	<b>89450</b>	...	...
			OIO	<b>85061</b>	<b>89450</b>	...	...
			OIO	<b>85061</b>	<b>89450</b>	...	...
			OIO	<b>85061</b>	<b>89450</b>	...	...
08 - 10	CXU-613 Models with 40,000 lb Rear Air Suspensions	14QK-2136M 20897198 471700002626	...	...	OIO	<b>85061</b>	<b>89450</b>
			...	...	OIO	<b>85061</b>	<b>89450</b>
			...	...	OIO	<b>85061</b>	<b>89450</b>
11 - 18	CXU-613 Models with 40,000 lb Rear Air Suspensions	21462382 21462384 22202559 22202560 471700006039 471700009646 471700009647	...	...	OIO	<b>85088</b>	...
			...	...	OIO	<b>85088</b>	...
			...	...	OIO	<b>85088</b>	...
			...	...	OIO	<b>85088</b>	...
			...	...	OIO	<b>85088</b>	...
			...	...	OIO	<b>85088</b>	...
			...	...	OIO	<b>85088</b>	...

#### DM Series

DM Models	.....	OIO	<b>83209</b>	<b>89414</b>	OIO	<b>83215</b>	...
Models with O.E.M. Number	14QK-2100P8 25622345	OIO	<b>83242</b>	...	...	...	...
		OIO	<b>83242</b>	...	...	...	...

**APPLICATION GUIDE - TRUCKS, TRAILERS, AND BUSES**

Year Año Année	Model Modelo Modèle	OEM #	Front		Rear	
						
			Fleetline	GasSLX	Fleetline	GasSLX

**MACK(Cont'd.)**

**F Series(Cont'd.)**

	F Models - Eastern	.....	010	83221	...		...	...
	F Models (exc. Eastern)	.....	010	83207	89407	010	83215	...
	F Models with Standard Suspension	.....		...	...	010	85305	...
	Fire Truck	.....		85302	...	010	85302	89420
	FL Models - Western	14QK-143	010	83207	89407		...	...
		14QK-2100P4	010	83207	89407		...	...









**Granite Series**

18 - 20	Granite 64BR & 64FR Models with 20,000 lb Front Axle	21010744	010	83101	...		...	...
18 - 20	Granite 64BR & 64FR Models with 46,000 lb Mack Mride Rear Suspension	21979343		...	...	01-	85065	...
12 - 17	GU-432 or GU-533 Models with 12,000 lb or 14,600 lb Front Axle	14QK-434M 20998401	010 010	85014	...		...	...
12 - 18	GU-432 or GU-533 Models with 14,600 lb to 18,000 lb Multi-Leaf Front Springs	21010744	010	83101	...		...	...
12 - 18	GU-432 or GU-533 Models with Hendrickson HAS 400 or 460 Series Rear Suspension	60675-001 60675-001L 8083872		...	...	010 010 010	85978 85978 85978	...
	GU-713 or GU-813 Models O.E.M. Number	21687170	010	85120	...		...	...
08 - 20	GU-713 or GU-813 Models with 14,600 lb to 18,000 lb Multi-Leaf Front Springs	14QK-3116M 21010744	010 010	83101	...		...	...
08 - 10	GU-713 or GU-813 Models with 20,000 lb Front Axles	14QK-3108M 14QK-427M 20863239 25626048 471700000445	01- 01- 01- 01- 01-	85080 85080 85080 85080	...		...	...
- 2020	GU-713 or GU-813 Models with 46,000 lb Mack Mride Rear Suspension	21979343		...	...	01-	85065	...
08 - 19	GU-713 or GU-813 Models with Hendrickson 38,000 lb Rear Air Suspension	14QK-424M 20570098 60670-006 60670-006L		...	...	010 010 010	83147 83147 83147	...
08 - 18	GU-713 or GU-813 Models with Hendrickson HAS 400 or 460 Series Rear Suspension	60675-001 60675-001L 8083872		...	...	010 010 010	85978 85978 85978	...
08 - 18	GU-713 or GU-813 Models with Hendrickson HAS Series Rear Suspension	22314111 60675-13		...	...	010 010	85036 85036	89405
- 2019	Models with Hendrickson HMX 400/460 Haulmax with 16.5" Saddle	60680-004 60680-004L H60680004		...	...	01- 01- 01-	83143 83143 83143	...
- 2019	Models with Hendrickson HMX 400/460 Haulmax with 17.5" or 18.5" Saddle Height	14QK-5142 25626196 60680-005 60680-005L H60680005		...	...	01- 01- 01- 01-	83142 83142 83142 83142	...
	Models with O.E.M. Number	21979343 471700008934		...	...	01- 01-	85065 85065	...

**LE & LEU Series**

	LE & LEU 613 Models with Ridewell RD-202S HD Tandem Drive Truck Suspension	1252607B000		...	...	010	85702	...
01 - 06	LE 613 Models with O.E.M Number	14QK-366P4 25625187	010 010	83209	89414		...	...

## APPLICATION GUIDE - TRUCKS, TRAILERS, AND BUSES

Year Año Année	Model Modelo Modèle	OEM #	Front		Rear	
						
						
			Fleetline	GasSLX	Fleetline	GasSLX

### MACK(Cont'd.)

#### LE & LEU Series(Cont'd.)

2009	LEU 613 Models with 18,000 lb Front Axle	14QK-372M2 25632561	OIO	<b>83209</b>	<b>89414</b>		...	...
			OIO	<b>83209</b>	<b>89414</b>		...	...
10 - 16	LEU 613 Models with 20,000 lb Front Axle	21002497	OIO	<b>85972</b>	...		...	...
	Models with Hendrickson HMX 400/460 Haulmax with 16.5" Saddle	60680-004		...	...	OIO	<b>83143</b>	...
		60680-004L		...	...	OIO	<b>83143</b>	...
		H60680004		...	...	OIO	<b>83143</b>	...
	Models with Hendrickson HMX 400/460 Haulmax with 17.5" or 18.5" Saddle Height	14QK-5142		...	...	OIO	<b>83142</b>	...
		25626196		...	...	OIO	<b>83142</b>	...
		60680-005		...	...	OIO	<b>83142</b>	...
		60680-005L		...	...	OIO	<b>83142</b>	...
		H60680005		...	...	OIO	<b>83142</b>	...

#### MH Series

	MH Models - 4" Wide Springs	14QK-373	OIO	<b>83215</b>	...		...	...
		14QK-378M	OIO	<b>83215</b>	...		...	...
		25623321	OIO	<b>83215</b>	...		...	...
	MH Models with Camelback Rear Suspension (SS34 & 38)	14QK-2107P1		...	...	OIO	<b>83215</b>	...
		14QK-2107P2		...	...	OIO	<b>83215</b>	...
		25625091		...	...	OIO	<b>83215</b>	...
	MH Models with Neway ARD-234 Air Suspension	14QK-375M		...	...	OIO	<b>83123</b>	<b>89405</b>
	MH Models with O.E.M. Number	14QK-2113P5	OIO	<b>85001</b>	<b>89410</b>		...	...
		14QK-2133M	OIO	<b>85001</b>	<b>89410</b>		...	...
		14QK-2133M2	OIO	<b>85001</b>	<b>89410</b>		...	...
		14QK-377M	OIO	<b>83215</b>	...		...	...
		14QK-392AM		<b>85005</b>	...	OIO	<b>85005</b>	<b>89430</b>
		25622466	OIO	<b>85001</b>	<b>89410</b>		...	...
	MH Models with Taperleaf Rear Suspension	14QK-2113P4		...	...	OIO	<b>85007</b>	...





#### MR Series

- 2008	MR600 Models with 20,000 lb Front Axle	14QK-366P4 25625187	OIO	<b>83209</b>	<b>89414</b>		...	...
			OIO	<b>83209</b>	<b>89414</b>		...	...
- 2008	MR600 Models with Camelback Rear Suspension (SS34 & 38)	14QK-2107P1		...	...	OIO	<b>83215</b>	...
		14QK-2107P2		...	...	OIO	<b>83215</b>	...
		25625091		...	...	OIO	<b>83215</b>	...
- 2008	MR600 Models with Hendrickson HMX 400/460 Haulmax with 16.5" Saddle	60680-004		...	...	OIO	<b>83143</b>	...
		60680-004L		...	...	OIO	<b>83143</b>	...
		H60680004		...	...	OIO	<b>83143</b>	...
- 2008	MR600 Models with Hendrickson HMX 400/460 Haulmax with 17.5" or 18.5" Saddle Height	14QK-5142		...	...	OIO	<b>83142</b>	...
		25626196		...	...	OIO	<b>83142</b>	...
		60680-005		...	...	OIO	<b>83142</b>	...
		60680-005L		...	...	OIO	<b>83142</b>	...
		H60680005		...	...	OIO	<b>83142</b>	...
- 2019	MRU613 Models with 20,000 lb Front Axle	14QK-3115M	OIO	<b>85972</b>	...		...	...
		21002497	OIO	<b>85972</b>	...		...	...
- 2020	MRU613 Models with 46,000 lb Mack Mride Rear Suspension	21979343		...	...	OIO	<b>85065</b>	...
		471700008934		...	...	OIO	<b>85065</b>	...
	MRU613 Models with O.E.M. Number	14QK-366P4	OIO	<b>83209</b>	<b>89414</b>		...	...
		25625187	OIO	<b>83209</b>	<b>89414</b>		...	...

#### R Series

	R, RU, RD600 Models-3 1/2" Wide springs	14QK-366P1	OIO	<b>85036</b>	<b>89405</b>		...	...
	R, U Models	....	OIO	<b>83221</b>	...	OIO	<b>83215</b>	...
	R, U, RD 600 Models	14QK-2115	OIO	<b>85305</b>	...		...	...
		14QK-29302	OIO	<b>83207</b>	<b>89407</b>		...	...
		25632147	OIO	<b>85305</b>	...		...	...

**APPLICATION GUIDE - TRUCKS, TRAILERS, AND BUSES**

Year Año Année	Model Modelo Modèle	OEM #	Front		Rear	
						
			Fleetline	GasSLX	Fleetline	GasSLX

**MACK(Cont'd.)**

**R Series(Cont'd.)**

	R, U, RD 600 Models/ MR600 Models with Front Taperleaf Springs	14QK-366	○IO	<b>85036</b>	<b>89405</b>		...	...
		14QK-366P1	○IO	<b>85036</b>	<b>89405</b>		...	...
		25625151	○IO	<b>85036</b>	<b>89405</b>		...	...
	RB 600 Models (Drive Axle)	14QK-2107		...	...	○IO	<b>83215</b>	...
		14QK-393M		...	...	○IO	<b>85010</b>	...
	RD Models with ST34 Suspension	14QK-2133M	○IO	<b>85001</b>	<b>89410</b>		...	...
		25622466	○IO	<b>85001</b>	<b>89410</b>		...	...
	RD800 Models with Shock Absorbers & Taperleaf Suspension (SWT & SWTL 561)(ST-34)	14QK-2110	○IO	<b>85305</b>	...		...	...

**RW Series**

	RW Models - 4" Wide Springs	14QK-373	○IO	<b>83215</b>	...		...	...
		14QK-378M	○IO	<b>83215</b>	...		...	...
		25623321	○IO	<b>83215</b>	...		...	...
	RW Models with Camelback Rear Suspension (SS34 & 38)	14QK-2107P1		...	...	○IO	<b>83215</b>	...
		14QK-2107P2		...	...	○IO	<b>83215</b>	...
		25625091		...	...	○IO	<b>83215</b>	...
	RW Models with Neway ARD-234 Air Suspension	14QK-375M		...	...	○IO	<b>83123</b>	<b>89405</b>
	RW Models with O.E.M. Number	14QK-2113P5	○IO	<b>85001</b>	<b>89410</b>		...	...
		14QK-2133M	○IO	<b>85001</b>	<b>89410</b>		...	...
		14QK-2133M2	○IO	<b>85001</b>	<b>89410</b>		...	...
		14QK-377M	○IO	<b>83215</b>	...		...	...
		14QK-392AM		<b>85005</b>	...	○IO	<b>85005</b>	<b>89430</b>
		25622466	○IO	<b>85001</b>	<b>89410</b>		...	...
	RW Models with Taperleaf Rear Suspension	14QK-2113P4		...	...	○IO	<b>85007</b>	...

**TD - Titan Series**

<b>08 - 10</b>	TD-713 Models with 20,000 lb Front Axle	14QK-493M	○IO	<b>83101</b>	...		...	...
		21155033	○IO	<b>83101</b>	...		...	...
<b>10 - 15</b>	TD-713 Models with Hendrickson 38,000 lb Rear Air Suspension	14QK-424M		...	...	○IO	<b>83147</b>	...
		20570098		...	...	○IO	<b>83147</b>	...
		60670-006		...	...	○IO	<b>83147</b>	...
		60670-006L		...	...	○IO	<b>83147</b>	...
<b>- 2016</b>	TD-713 Models with Hendrickson 40,000 lb Pimaax EX and FireMaax EX Air Suspension	20782199		...	...	○IO	<b>85072</b>	...
		60657-007		...	...	○IO	<b>85072</b>	...
<b>- 2017</b>	TD-713 Models with Hendrickson HAS 400 or 460 Series Rear Suspension	60675-001		...	...	○IO	<b>85978</b>	...
		60675-001L		...	...	○IO	<b>85978</b>	...
		8083872		...	...	○IO	<b>85978</b>	...
<b>- 2017</b>	TD-713 Models with Hendrickson HAS Series Rear Suspension	22314111		...	...	○IO	<b>85036</b>	<b>89405</b>
		60675-13		...	...	○IO	<b>85036</b>	<b>89405</b>





**TERRAPRO Series**

<b>2019</b>	Models with 20,000 lb Front Axle	14QK-3115M	○IO	<b>85972</b>	...		...	...
		21002497	○IO	<b>85972</b>	...		...	...

**Additional Applications**

	B Models	14QK-142		...	...	○IO	<b>85305</b>	...
	CF Fire Chassis	14QK-2102		...	...	○IO	<b>85304</b>	...
	CM 422 Tractor	14QK-390	-IO	<b>83105</b>	...		...	...
		V10242320	-IO	<b>83105</b>	...		...	...
	MB Models	.....	○IO	<b>83221</b>	...	○IO	<b>83215</b>	...
		14QK-2100P4	○IO	<b>83207</b>	<b>89407</b>		...	...
	Model 75 Bogie Axle	.....		...	...	○IO	<b>83215</b>	...
<b>06 - 16</b>	Models with Hendrickson 40,000 lb Primaax, Pimaax EX and FireMaax EX Air Suspension	60657-007		...	...	○IO	<b>85072</b>	...
		14QK-422M	○IO	<b>85933</b>	<b>89454</b>		...	...

## APPLICATION GUIDE - TRUCKS, TRAILERS, AND BUSES

Year Año Année	Model Modelo Modèle	OEM #	Front		Rear	
						
			Wrench	Wrench	Wrench	Wrench
			Fleetline	GasSLX	Fleetline	GasSLX

### MACK(Cont'd.)

#### Additional Applications(Cont'd.)

	Models with Hendrickson AirTek Front Air Suspension	20469001	010	85933	89454		...	...
		20469002	010	85933	89454		...	...
		20485632	010	85933	89454		...	...
		20485633	010	85933	89454		...	...
		471700131921	010	85933	89454		...	...
		64838-002	010	85933	89454		...	...
	Models with Hendrickson HAS-40LH Air Suspension (O.E. Number 57241-4)	14QK-413M4		...	...	01-	83110	...
	Models with Inverted Camelback Spring Suspension	14QK-142P1	010	83215	...		...	...
	Models with MAC AL405 Suspension	14QK-413M		...	...	01-	83111	...
	Models with Meritor AirLink Suspension	14QK-3100		...	...	010	85739	...
		446-51-211		...	...	010	85739	...
	Models with Neway Rear Suspension (With O.E.Stamping 90045099)	25633154		...	...	010	85906	89407
<b>75 - 79</b>	W Models - Western	....	010	83207	89407	010	83215	...

#### Additional O.E.M. Interchanges

	Models with O.E.M. Number	14QK-1200P4	010	83207	89407		...	...
		14QK-140	010	85304	...		...	...
		14QK-142AP1	010	83215	...		...	...
		14QK-145	010	85307	...		...	...
		14QK-2100P2	010	83209	89414		...	...
		14QK-2100P3	010	83207	89407		...	...
		14QK-2100P5	010	83221	...		...	...
		14QK-2100P6	010	85036	89405		...	...
		14QK-2100P7	010	83221	...		...	...
		14QK-2105	010	83209	89414		...	...
		14QK-2107P3	010	83215	...		...	...
		14QK-2108	010	83203	89436		...	...
		14QK-2108P1	010	83203	89436		...	...
		14QK-2113P3	010	85001	89410		...	...
		14QK-288-P1	010	85007	...		...	...
		14QK-29001P2	010	85303	89422		...	...
		14QK-29301P1	010	83207	89407		...	...
		14QK-29301P2	010	83207	89407		...	...
		14QK-366P2	010	85036	89405		...	...
		14QK-366P3	010	85036	89405		...	...
		14QK-372M3	010	83122	89406		...	...
		14QK-378	010	83215	...		...	...
		14QK-423M	010	...	...	010	85978	...
		14QK-428	01-	85080	...		...	...
		14QK-428M	01-	85080	...		...	...
		25621571	010	83215	...		...	...
		25626149	01-	85080	...		...	...
		471700000451	01-	85080	...		...	...
		57241-004		...	...	01-	83110	...
		5966-90044025	010	83209	89414		...	...
		651103	010	85036	89405		...	...
	Additional O.E.M. Interchanges	14QK-140P1	010	83225				
		14QK-20001P2	010	85308 or 89422				
		14QK-2100	010	83221				
		14QK-2100P1	010	83221				
		14QK-2110P1	010	85305	...		...	...
		14QK-282P1	010	83216	...		...	...
		14QK-282P3	010	83216	...		...	...
14QK-288P2	010	83217						

## APPLICATION GUIDE - TRUCKS, TRAILERS, AND BUSES

Year Año Année	Model Modelo Modèle	OEM #	Front		Rear	
			Fleetline	GasSLX	Fleetline	GasSLX

### MACK(Cont'd.)

#### Additional O.E.M. Interchanges(Cont'd.)

	Additional O.E.M. Interchanges	14QK-29302P1	010	83207 or 89407			
		14QK-372M	010	83221			
		14QK-392M	010	85005	89430	...	...
		25624365	010	83217			
		4940654	010	83216			
		5533699	010	85302 or 89420			
		5554184	010	85302 or 89420			
		650102	010	85001 or 89410			
		650107	-10	85316	89426	...	...
		650107MT	-10	85316	89426	...	...
		650400MT		...	...	-10	85033 89427
		650402		...	...	-10	85311 89424
		650402MT		...	...	-10	85311 89424
		650404		...	...	-1-	85310 89423
		650404MT		...	...	-1-	85310 89423
		650405	010	85023 or 89415			
		650405MT	010	85023 or 89415			
		650406		...	...	010	85024 ...
		650408		...	...	-10	85319 89428
		650408MT		...	...	-10	85319 89428
		651012	010	83221			
		651151	010	83209 or 89414			
		70042	010	85302 or 89420			

### MACK CAB SHOCKS

#### CH Series

	Models with O.E.M. Number	14QK-411	010	83007
		14QK-411AM	010	83007
		14QK-411M	010	83007
		25631922	010	83007

#### CHN - Series

05 - 07	CHN-613 Models with O.E.M. Number	14QK-3103M	01-	83050
		20874147	01-	83050

#### CHU - Pinnacle Series

- 2017	CHU-613 DayCab Models with O.E.M. Number	22662259	010	83901
		22662254	010	83901
		21345869	010	83066
		21490486	010	83066
- 2020	CHU-613 DayCab Models with O.E.M. Number	23145372	010	83066
		25625636	01-	83045
- 2017	CHU-613 Models with Hi - Roof Sleeper Cabs with O.E.M. Number	14QK-303M	01-	83050
		14QK-3103M	01-	83050
		20874147	01-	83050
06 - 19	CHU-613 Models with O.E.M. Number	14QK-303M	01-	83050
		14QK-3103M	01-	83050
		20874147	01-	83050

#### CL Series

	Models with O.E.M. Number	14QK-391AM	01-	83041
		14QK-391AM2	01-	83041

#### CT, CTX - Series









	Models with O.E.M. Number	14QK-303M	01-	83050
		14QK-3103M	01-	83050
		20874147	01-	83050

#### CX (Vision) Series

	Models with Sleeper Cabs w/O.E.M. Numbers	14QK-399M	01-	83045
		14QK-399M2	01-	83045



## APPLICATION GUIDE - TRUCKS, TRAILERS, AND BUSES

Year Año Année	Model Modelo Modèle	OEM #	Front		Rear	
						
						
			Fleetline	GasSLX	Fleetline	GasSLX

### MACK CAB SHOCKS(Cont'd.)

#### CX (Vision) Series(Cont'd.)

	Models with Sleeper Cabs w/O.E.M. Numbers	14QK-399M3	01-	83045
		25625635	01-	83045
		25625636	01-	83045
		25625637	01-	83045

#### CXN Series

05 - 08	CXN-613 Models with O.E.M. Number	14QK-3103M	01-	83050
		20874147	01-	83050
	DayCab Models with O.E.M. Number	21345869	010	83066
- 2014	Models with Sleeper Cabs w/O.E.M. Numbers	25625635	01-	83045

#### CXP - Series

06 - 07	CXP-613 Day Cab Models	14QK-3103M	01-	83050
		20874147	01-	83050
06 - 07	CXP-613 Models with Sleeper Cabs	25625636	01-	83045

#### CXU - Pinnacle Series

2008 - 17	CXU-613 Models with Hi - Roof Sleeper Cabs with O.E.M. Number	25625636	01-	83045
2011 - 16	CXU-613 Models with Mid - Roof Sleeper Cabs with O.E.M. Number	25625635	01-	83045
	CXU-613 Models with O.E.M. Number	22662259	010	83901
- 2018	CXU-613 Models with O.E.M. Number	22662254	010	83901
- 2020	CXU-613 Models with O.E.M. Number	21345869	010	83066
		21490486	010	83066
		23145372	010	83066
08 - 11	CXU-613 Models with O.E.M. Number	14QK-303M	01-	83050
		14QK-3103M	01-	83050
		20874147	01-	83050

#### Granite Series

17 - 20	Granite 64BR & 64FR Models with O.E.M. Number	22662259	010	83901
12 - 17	GU 432 and GU 533 Models with O.E.M. Number	22662259	010	83901
08 - 19	GU 713 and GU 813 Models with O.E.M. Number	20873442	01-	83050
08 - 20	GU 713 and GU 813 Models with O.E.M. Number	21345869	010	83066
		21490486	010	83066
		22662254	010	83901
		22662259	010	83901
2008 -	GU 713 and GU 813 Models with O.E.M. Number	14QK-432M	01-	83050





#### R - Series

	R 600 Tractors with Link Cabmate Model MCR600	1201-0012	010	83023
		1202-0012	010	83023
	R, RD Models	14QK-382	01-	83018
		14QK-382-P2	01-	83018
	R, RD400 & 600 Models with Cab Air suspension	14QK-2111-P4	01-	83019
	RS & Superliner Tractors with Link Cabmate Model MCRS600	1201-0012	010	83023
		1202-0012	010	83023

#### Additional Applications

02 - 07	CV-713 Models with O.E.M number	14QK-391BM	01-	83041
	MH Models with Air Cab	14QK-374	-10	83003
		14QK-376	-10	83003
	Models with Link Cab Suspension	1202-0012	010	83023
		1202-0032	010	83016
	Models with O.E.M. Number	14QK-2111	01-	83019
		14QK-2111-P2	01-	83019
		14QK-391BM2	01-	83041
		14QK-391M	01-	83041
		14QK-391M2	01-	83041
		14QK-397AM	010	83905

**APPLICATION GUIDE - TRUCKS, TRAILERS, AND BUSES**

Year Año Année	Model Modelo Modèle	OEM #	Front		Rear	
						
			Fleetline	GasSLX	Fleetline	GasSLX

**MACK CAB SHOCKS(Cont'd.)**





**Additional Applications(Cont'd.)**

Models with O.E.M. Number	14QK-439M	01-	83050
	21154393	01-	83050
	21345868	010	83066
	25622373	010	83905
	25622612	01-	83041
	25622613	01-	83041
	25624837	01-	83041

**MAECO**

Bus with O.E.M. Number	1668722		85030	...	010	85030	89440
FedEx Trucks with O.E.M. Number	16950	010	83118	...		...	...
UPS Trucks with O.E.M. Number	16949		...	...	01-	83120	...
Additional O.E.M. Interchanges	1085		...	...	010	83214	...
	12608	010	83125				
	12788	010	83216				
	12866	010	83207 or 89407				
	16385	010	83215				
	16720	010	83107	...		...	...
	16767	010	85013 or 89414				
	16768	010	83217				
	16769	010	83221				
	16770	010	83209 or 89414				
	16771	010	83126 or 89440				
	16772	010	83122 or 89406				
	16773	010	85005	89430		...	...
	16774	010	83215				
	16775	010	83207 or 89407				
	16776	010	83122 or 89406				
	16777	010	85006				
	16778	010	83203 or 89436				
	16779	010	83126 or 89440				
	16780	010	...	...	010	83123	89405
	16781	010	85006				
	16787	010	85030 or 89440				
	6025	010	83122 or 89406				
	6026	010	...	...	010	83204	...
	70018	010	...	...	010	85303	89422
	70021	010	...	...	010	85303	89422
	70029	010	85308	89422		...	...
	70034	010	85302 or 89420				
	70039	010	85303	...	010	85303	89422
	70041	010	85305	...	010	85305	...
	70042	010	85302 or 89420				
	70088	010	85307				
	70123	010	85716				
70127	010	85006	...		...	...	
70128	010	85006					
70162	010	85716					
70163	010	85302 or 89420					
70164	010	85716					
70300	010	85320	89429		...	...	
70312	010	85001 or 89410					
70315	010	85063	...		...	...	
70317	010	89432					
70331	010	...	...	010	85314	89425	

## APPLICATION GUIDE - TRUCKS, TRAILERS, AND BUSES

Year Año Année	Model Modelo Modèle	OEM #	Front		Rear	
						
			Wrench	Wrench	Wrench	Wrench
			Fleetline	GasSLX	Fleetline	GasSLX

### MAECO(Cont'd.)

Additional O.E.M. Interchanges	70332	010	83314	...	...	...	
	70334	-10	85316	89426	...	...	
	70397	010	85006				
	70402	010	85305				
	70642	010	85300 or 89419				
	70644	010	85334	...	010	85334	...
	70648	010	89414				
	70650	010	89440				
	70651	010	85013 or 89414				
	70652	010	85030	...	010	85030	89440
	70663	010	85013 or 89414				
	70691	010	...	...	010	85007	...
	70720	010	...	...	010	85934	...
	70721	010	83125				
	74039	010	85303 or 89422				
	OE10881	-10	85711				
	OE10882	010	...	...	01-	85740	...
	OE10883	010	...	...	010	85339	...
	OE12425	010	83214				
	SC-2920	010	83176				

### MAN BUS

Americana Bus with O.E.M. Numbers	25-1700-106-654	...	...	-1-	85708	...
	81-43701-6543	...	...	-1-	85708	...
	81-43701-6572	-1-	85708	...	...	...
	81-43701-6573	-1-	85722	...	...	...
Articulating Bus - Drive Axle	81-43701-6537	...	...	-1-	85709	...
Articulating Bus - Front Axle	81-43701-6538	-1-	85708	...	...	...
Articulating Bus - Trailing Axle	81-43701-6539	...	...	-1-	85708	...
Models with O.E.M. Number	134	...	...	-1-	85709	...
	81-43701-6609	...	...	-1-	85709	...
	9020M-1042	...	...	-1-	85709	...

### MANDALAY COACH





#### Class A MotorHomes

<b>04 - 06</b>	Mandalay Series MotorHomes with Freightliner XC Chassis ADL200 Suspension w/ 20K Rear AS120 Front Suspension  Rear Shock with O.E.M. Number  ZF - IFS Front Suspension with 23,000 lb GVW or Greater	16-16873-000	010	...	...	010	85029	...
		141700131810	010	83160	...	...	...	...
		16-16737-000	010	83160	...	...	...	...
		16-16874-000	010	83160	...	...	...	...
		141700131809	010	...	...	010	85029	...
		16-16736-000	010	...	...	010	85029	...
		16-18103-000	-1-	85900	...	...	...	...
		481700000493	-1-	85900	...	...	...	...
<b>2006</b>	Presidio & Valencia Series MotorHomes with Freightliner XC Chassis AS120 Front Suspension  Rear Shock with O.E.M. Number  ZF - IFS Front Suspension with 23,000 lb GVW or Greater	141700131810	010	83160	...	...	...	...
		16-16737-000	010	83160	...	...	...	...
		16-16874-000	010	83160	...	...	...	...
		141700131809	010	...	...	010	85029	...
		16-16736-000	010	...	...	010	85029	...
		16-18103-000	-1-	85900	...	...	...	...
		481700000493	-1-	85900	...	...	...	...

### MARMON

Models with O.E.M. Number	1-7001	010	83216	...	...	...
---------------------------	--------	-----	-------	-----	-----	-----

## APPLICATION GUIDE - TRUCKS, TRAILERS, AND BUSES

Year Año Année	Model Modelo Modèle	OEM #	Front		Rear	
						
			Fleetline	GasSLX	Fleetline	GasSLX

### MARMON(Cont'd.)

Models with O.E.M. Number	OEM #	O	I	F	G	S	L	X
	37-1-1	0	0					
	51-139-28							
	51-163-7							
	576451	0	0					
	665147	0	0					

### MARMON CAB SHOCKS

1981 -	Conventional Tractors with Link Cabmate Model MARC57-B	1202-0054	0	0	F	G	S	L	X
--------	--	-----------	---	---	---	---	---	---	---









### MATSON SCHOOL BUS

Models with O.E.M. Number	5392387	0	0	F	G	S	L	X
---------------------------	---------	---	---	---	---	---	---	---

### MC NEILUS TRUCK & MAN.

Mc Neilus part number	OEM #	O	I	F	G	S	L	X
1139039 MTM		0	0					
1139046 MTM								
1139059 MTM								
1139069 MTM								
12405FX1 MTM								
1323106 MTM								
1333575 MTM								
1340975 MTM								
1340976 MTM		0	0					
1340979 MTM								
1360386 MTM								
1367383 MTM								
1396513 MTM		0	0					
1398980 MTM								
1404068 MTM								
1410046 MTM		0	0					
1411765 MTM								
1429317 MTM		0	0					
1431085 MTM								
1432386 MTM								
1433009 MTM								
1468783 MTM								
1485576 MTM								
1491909 MTM								
1KK552 MTM								
2218640 MTM		0	0					
3215395 MTM								
3HR582 MTM								
3HR916 MTM								
4HA569 MTM		0	0					
4KP398 MTM		0	0					
5HA994 MTM								
5HB645 MTM								
5KK247 MTM								
64442AX MTM								
6HA961 MTM								
6HB390 MTM								
6HD720 MTM								
6HS773 MTM								
6KP857 MTM								
7HS237 MTM								
7HS534 MTM								

## APPLICATION GUIDE - TRUCKS, TRAILERS, AND BUSES

Year Año Année	Model Modelo Modèle	OEM #	Front		Rear	
						
						
			Fleetline	GasSLX	Fleetline	GasSLX

### MC NEILUS TRUCK & MAN.(Cont'd.)

Mc Neilus part number	8KK524 MTM		...	...	010	<b>83168</b>	...
	9HB362 MTM		...	...	010	<b>85976</b>	...
	9KK464 MTM		...	...	010	<b>85079</b>	...
Models with O.E.M. Number	217330	010	<b>85303 or 89422</b>				

### MERITOR

Air Link Suspensions with O.E.M. Number	14QK-3100		...	...	010	<b>85739</b>	...
	446-51-211		...	...	010	<b>85739</b>	...
AL460 Air Link Suspension	700115		...	...	010	<b>85712</b>	...
AL520 Air Link Suspension	700115		...	...	010	<b>85712</b>	...
RFS 23T / 25T / 30T Trailer Air Suspensions	21227751		...	...	010	<b>87015</b>	...
	A-7805L-1026		...	...	010	<b>87015</b>	...

### FS230 Trailer Suspension

FS230 Trailer Suspension (Light Duty)	680705		...	...	010	<b>85737</b>	...
	A-7805P-1030		...	...	010	<b>85737</b>	...
FS230 Trailer Suspension (Std Duty)	671507		...	...	010	<b>87015</b>	...
	A-7805L-1026		...	...	010	<b>87015</b>	...
FS230T	21227751		...	...	010	<b>87015</b>	...
	671020		...	...	010	<b>87015</b>	...
Meritor Kit 11210 includes washers and nuts (For Shock only)	KIT11210		...	...	010	<b>87015</b>	...

### MTA 25T / MTA 30T Trailer Air Suspension

Meritor Kit 11375 includes other components (For Shock only)	KIT11375		...	...	010	<b>86200</b>	...
Meritor Kit 11376 includes other components (For Shock only)	KIT11376		...	...	010	<b>86200</b>	...
Meritor Kit 11389 includes other components (For Shock only)	KIT11389		...	...	010	<b>86200</b>	...
Meritor Kit 11402 includes other components (For Shock only)	KIT11402		...	...	010	<b>86200</b>	...
MTA 25T / MTA 30T Trailer Air Suspension	671506		...	...	010	<b>86200</b>	...
	7805-F-1020		...	...	010	<b>86200</b>	...
	A-7805F-1020		...	...	010	<b>86200</b>	...

### RHP Trailer Suspension

1997 -	RHP11, RHP55 and RideSentry Trailer Suspension	202447		...	...	010	<b>85919</b>	...
		A-3280-M-9711		...	...	010	<b>85919</b>	...
2001 -	RHP11, RHP55 and RideSentry Trailer Suspension	671907		...	...	010	<b>85919</b>	...
		A-7805L-1000		...	...	010	<b>85919</b>	...

### MITSUBISHI-FUSO

#### FE Series

07/86 -	FE434, FE439, FE444, FE450	MB025382		.....				
		MB161497		...	...	010	<b>G63299</b>	...
96 - 97	FE639, FE639SP, FE639HDT	MC114595		...	...	010	<b>G63405</b>	...

#### FF Series

86 - 87	FF415	MC813511	-1-	<b>G63398</b>	...	...	...	...
---------	-------	----------	-----	---------------	-----	-----	-----	-----

#### FH Series

10/87 - 96	FH100 Suspension (All)	MC809390		...	...	-1-	<b>83103</b>	...
		MC826268		-10	<b>G63610</b>	...	...	...









#### FK Series

11/85- 11/86	FK414	MC813511	-1-	<b>G63398</b>	...	...	...	...
06/88- 02/91	FK455	MC814614	-10	<b>85009</b>	...	...	...	...
03/91- 06/93	FK457	MC814614	-10	<b>85009</b>	...	...	...	...

#### FM Series

06/88- 02/91	FM555	MC814614	-10	<b>85009</b>	...	...	...	...
11/85- 05/88	FM555	MC813135	-1-	<b>83456</b>	89447	...	...	...

## APPLICATION GUIDE - TRUCKS, TRAILERS, AND BUSES

Year Año Année	Model Modelo Modèle	OEM #	Front		Rear	
						
						
			Fleetline	GasSLX	Fleetline	GasSLX

### MITSUBISHI-FUSO(Cont'd.)

#### FM Series(Cont'd.)

05/89-06/93	FM557	MC814614	-10	85009	...	...	...
-------------	-------	----------	-----	-------	-----	-----	-----

### MOHAWK

Additional O.E.M. Interchanges	01-0100-905	010	<b>85303 or 89422</b>				
	020273544	010	<b>83203</b>	<b>89436</b>	...	...	
	050134508	010	<b>85732</b>	...	...	...	
	1235233	010	<b>85736</b>				
	22012082	010	<b>85702</b>				
	22012114	010	<b>85700</b>	...	010	<b>85700</b>	
	4968853	010	<b>83216</b>				
	6-367-7	010	<b>85305</b>				
	680323	010	<b>85700</b>				
	680485	010	...	...	01-	<b>85733</b>	
	97-2201-00007	-10	<b>85703</b>	...	...	...	
	97-2201-00011	010	...	...	010	<b>85704</b>	
	97-9999-02320	010	...	...	010	<b>85704</b>	
	MM-6886	010	<b>83207 or 89407</b>				
	MM-6957	010	<b>83225</b>				
MM-74029	010	<b>85308 or 89422</b>					





### MONACO

01 - 10	Monarch and LaPalma Models with W20 & W22 Workhorse Motorhome Chassis	24-186629	010	85125	...	...	...
		F4-BE5-B492-HO	010	<b>85125</b>	...	...	...
05 - 10	Monarch and LaPalma Models with W20 & W22 Workhorse Motorhome Chassis	24-153256		...	...	-1-	<b>85124</b>
		F4-BE5-F325-HO		...	...	-1-	<b>85124</b>
		W0005663		...	...	-1-	<b>85124</b>
01 - 04	Monarch and LaPalma Models with W20 & W22 Workhorse Motorhome Chassis	24-186537		...	...	01-	<b>85126</b>
		F4-BE5-A011-HO		...	...	01-	<b>85126</b>
01 - 04	Vacationer Models with W20 & W22 Workhorse Motorhome Chassis	24-186629	010	<b>85125</b>	...	...	...
		F4-BE5-B492-HO	010	<b>85125</b>	...	...	...
		24-186537		...	...	01-	<b>85126</b>
		F4-BE5-A011-HO		...	...	01-	<b>85126</b>
98 - 14	All Models with W20 & W22 Workhorse Motorhome Chassis	24-186629	010	<b>85125</b>	...	...	...
		F4-BE5-B492-HO	010	<b>85125</b>	...	...	...
95 - 99	MotorHomes with Freightliner XC Chassis (22,000 to 26,000 lb GVW)	.....	010	<b>83160</b>	...	010	<b>85029</b>
	Models with Workhorse UFO Chassis with Hendrickson Softek Front Suspension	66153-002	010	<b>83124</b>	<b>89407</b>	...	...
		F4-BE5-C832-MO	010	<b>83124</b>	<b>89407</b>	...	...

#### Class A MotorHomes

90 - 97	Monarch and LaPalma Models with F53 Motorhome Chassis (7.5 L, Gas V8)	.....	010	83209	89414	...	...
99 - 14	Monarch and LaPalma Series MotorHomes with Ford F53 Chassis with 16,000 lb GVW to 22,000 lb GVW	1C34-18045-AA	010	<b>83209</b>	<b>89414</b>	...	...
		1C34-18045-JA	010	<b>83209</b>	<b>89414</b>	...	...
		9U94-18045-AA	010	<b>83209</b>	<b>89414</b>	...	...
		9U94-18080-AA	010	...	...	010	<b>83122</b>
		9U9Z-18124-A	010	<b>83209</b>	<b>89414</b>	...	...
		9U9Z-18125-A	010	...	...	010	<b>83122</b>
		ASH-1022	010	<b>83209</b>	<b>89414</b>	...	...
		ASH-1023	010	...	...	010	<b>83122</b>
		ASH-1205	010	<b>83209</b>	<b>89414</b>	...	...
		ASH-1206	010	...	...	010	<b>83122</b>

**APPLICATION GUIDE - TRUCKS, TRAILERS, AND BUSES**

Year Año Année	Model Modelo Modèle	OEM #	Front		Rear	
						
			Fleetline	GasSLX	Fleetline	GasSLX

**MONACO(Cont'd.)**

**Class A MotorHomes(Cont'd.)**

99 - 14	Monarch and LaPalma Series MotorHomes with Ford F53 Chassis with 16,000 lb GVW to 22,000 lb GVW	ASH-1228	010	83209	89414		...	...
		ASH-1229	010	83209	89414		...	...
		ASH-1230		...	...	010	83122	89406
		ASH-137		...	...	010	83122	89406
		ASH-25822	010	83209	89414		...	...
		ASH-25823	010	83209	89414		...	...
		ASH-25824		...	...	010	83122	89406
		ASH-294	010	83209	89414		...	...
		AT-620	010	83209	89414		...	...
		AT-621		...	...	010	83122	89406
	AT-766	010	83209	89414		...	...	

**MOR-RYDE SUSPENSION**

Bus Suspension	.....		...	...	- -	83103	...
	U0109-006		...	...	010	G63866	...
Recreational Vehicle	U0109-014		...	...	- -	83400	...
	U0109-018		...	...	010	G63866	...
Trailer Rear	U0109-007		...	...	010	G63183	...

**MOTOR COACH INDUSTRIES**









**Additional Applications**

Drive Axle	12J-5-2		...	...	01-	85733	...
	12J-5-4		...	...	01-	85733	...
	12L-5-71		...	...	- -	85708	...
	T14-1081		...	...	01-	85729	...
Low Floor Bus Models with O.E.M. Number	12L-5-99		...	...	010	85339	...
MC5, MC7, MC8	12B-5-1		85735	...	010	85735	...
	3178157		85700	...	010	85700	...
	680323		85700	...	010	85700	...
RTS Bus with "V" Drive Rear	G1101590GS		...	...	010	85713	...
RTS Bus with Regular Rear	G1011822		...	...	010	85702	...
Steering - Tag Axle	12L-4-170		...	...	010	83158	...
	654789		...	...	010	83158	...
Tag Axle	12-05-6068		...	...	- -	85727	...
	T14-1082		...	...	- -	85727	...

**D - Series Coaches**

D 4000 Coach (Drive Axle)	12-05-1177		...	...	01-	85729	...	
	12-05-1261		...	...	01-	85729	...	
	12-05-1328		...	...	01-	85729	...	
	(Front Axle)	12-05-1176	- -	85728	...		...	...
		12-05-1260	- -	85728	...		...	...
		12-05-1327	- -	85728	...		...	...
	(Trailing Axle)	12-05-1178		...	...	010	85339	...
		12-05-1194		...	...	010	85339	...
		12L-5-99		...	...	010	85339	...
D 4005 Coach (Drive Axle)	12-05-1177		...	...	01-	85729	...	
	12-05-1261		...	...	01-	85729	...	
	12-05-1328		...	...	01-	85729	...	
	(Front Axle)	12-05-1176	- -	85728	...		...	...
		12-05-1260	- -	85728	...		...	...
		12-05-1327	- -	85728	...		...	...

**APPLICATION GUIDE - TRUCKS, TRAILERS, AND BUSES**

Year Año Année	Model Modelo Modèle	OEM #	Front		Rear	
						
						
			Fleetline	GasSLX	Fleetline	GasSLX

**MOTOR COACH INDUSTRIES(Cont'd.)**

**D - Series Coaches(Cont'd.)**





	(Drive Axle)	12L-5-97	- -	85728	...		...	...
	(Trailing Axle)	12-05-1194		...	...	0 0	85339	...
		12L-5-99		...	...	0 0	85339	...
	D 4500 Coach (Drive Axle)	12-05-1177		...	...	0 -	85729	...
		12-05-1328		...	...	0 -	85729	...
		12L-5-88		...	...	0 -	85729	...
		85729		...	...	0 -	85729	...
	(Front Axle)	12-05-1176	- -	85728	...		...	...
		12-05-1327	- -	85728	...		...	...
		12L-5-67	- -	85728	...		...	...
	(Trailing Axle)	12-05-1179		...	...	- -	85727	...
		12-05-1262		...	...	- -	85727	...
		12-05-1264		...	...	- -	85727	...
		12-05-1329		...	...	- -	85727	...
		12L-5-114		...	...	- -	85727	...
	D 4505 Coach (Drive Axle)	12-05-1177		...	...	0 -	85729	...
		12-05-1328		...	...	0 -	85729	...
		12L-5-88		...	...	0 -	85729	...
	(Front Axle)	12-05-1176	- -	85728	...		...	...
		12-05-1327	- -	85728	...		...	...
		12L-5-67	- -	85728	...		...	...
	(Trailing Axle)	12-05-1179		...	...	- -	85727	...
		12-05-1262		...	...	- -	85727	...
		12-05-1264		...	...	- -	85727	...
		12-05-1329		...	...	- -	85727	...
		12L-5-114		...	...	- -	85727	...
	DL3 Bus	12-05-1327	- -	85728	...		...	...
		12-05-1328		...	...	0 -	85729	...
		12L-5-88		...	...	0 -	85729	...
		12L-5-89		...	...	0 -	85729	...
		12L-5-96	- -	85728	...		...	...
		12L-5-97	- -	85728	...		...	...
	DL3 Bus -Drive Axle	12J-5-10		...	...	0 -	85733	...
	DL3 Bus -Tag Axle	01-205219		...	...	- -	85727	...
		12-05-1262		...	...	- -	85727	...
		12-05-1264		...	...	- -	85727	...
		12-05-1329		...	...	- -	85727	...
		12L-5-100		...	...	- -	85727	...
		12L-5-114		...	...	- -	85727	...
		T12-1208		...	...	- -	85727	...

**E - Series Coaches**

	E 4500 Coach (Drive Axle)	12-05-1022		...	...	0 -	85970	...
		12-05-1102		...	...	0 -	85970	...
		12-05-1138		...	...	0 -	85970	...
		12-05-1148		...	...	0 -	85970	...
		12-05-1188		...	...	0 -	85970	...
	(Front Axle)	12-05-1150	- 0	85711	...		...	...
		12-05-1165	- 0	85711	...		...	...
	(Trailing Axle)	12-05-1139		...	...	0 -	85341	...
		12-05-1147		...	...	0 -	85341	...
		12-05-1166		...	...	0 -	85341	...



**APPLICATION GUIDE - TRUCKS, TRAILERS, AND BUSES**

Year Año Année	Model Modelo Modèle	OEM #	Front		Rear	
						
			Fleetline	GasSLX	Fleetline	GasSLX

**MOTOR COACH INDUSTRIES(Cont'd.)**

**G - Series Coaches(Cont'd.)**

G 4500 Coach Drive Axle  Front Axle  Tag Axle Trailing Axle	12-05-6001						
	12-05-6054			01-	<b>85740</b>	...	
	12-05-6000	-10	<b>85711</b>	...		...	
	12-05-6053	-10	<b>85711</b>	...		...	
	1497835	-10	<b>85711</b>	...		...	
	1498565		...	...	010	<b>85339</b>	...
	12-05-6002		...	...	010	<b>85339</b>	...
	12-05-6033		...	...	010	<b>85339</b>	...
	12-05-6055		...	...	010	<b>85339</b>	...





**J - Series Coaches**

J 4500 Coach (Drive Axle)  (Front Axle with OEM Number)  (Trailing Axle)	12-05-1022		...	...	01-	<b>85970</b>	...
	12-05-1138		...	...	01-	<b>85970</b>	...
	12-05-1148		...	...	01-	<b>85970</b>	...
	12-05-1188		...	...	01-	<b>85970</b>	...
	12-05-1137	01-	<b>85340</b>	...		...	...
	12-05-1142	01-	<b>85340</b>	...		...	...
	12-05-1146	01-	<b>85340</b>	...		...	...
	12-05-1150	-10	<b>85711</b>	...		...	...
	12-05-1165	-10	<b>85711</b>	...		...	...
	12-05-1228	-10	<b>85711</b>	...		...	...
	12-05-1139		...	...	01-	<b>85341</b>	...
	12-05-1147		...	...	01-	<b>85341</b>	...
	12-05-1166		...	...	01-	<b>85341</b>	...

**Additional O.E.M. Interchanges**

Models with O.E.M. Number	12-05-1021	01-	<b>85340</b>	...		...	...
	12-05-1023		...	...	01-	<b>85341</b>	...
	12-05-1101	01-	<b>85340</b>	...		...	...
	12-05-1103		...	...	01-	<b>85341</b>	...
	12-05-1170	01-	<b>85340</b>	...		...	...
	12-05-1199		...	...	01-	<b>85729</b>	...
	12-05-1242	-1-	<b>85728</b>	...		...	...
	12-05-1243		...	...	01-	<b>85729</b>	...
	12-05-1244		...	...	-1-	<b>85727</b>	...
	12-5-1-G	010	<b>85700</b>	...		...	...
	12-5-1-GS	010	<b>85700</b>	...		...	...
	12B-5-1-G	010	<b>85700</b>	...		...	...
	12B-5-1-GS	010	<b>85700</b>	...		...	...
	12J-5-10GS		...	...	01-	<b>85733</b>	...
	12L-5-58	-1-	<b>85728</b>	...		...	...
	12L-5-69	010	<b>85700</b>	...		...	...
	12L-5-98		...	...	010	<b>85339</b>	...
	12T-1-13		<b>85303</b>	...	010	<b>85303</b>	<b>89422</b>
	12TA-01-013		<b>85303</b>	...	010	<b>85303</b>	<b>89422</b>
	1498200		...	...	01-	<b>85740</b>	...
	22012067	010	<b>85700</b>	...		...	...
	22024061		...	...	010	<b>85704</b>	...
	22045526		...	...	010	<b>85702</b>	...
	3178154		...	...	010	<b>85735</b>	...
	63-0127GS		<b>85303</b>	...	010	<b>85303</b>	<b>89422</b>
	680232		...	...	01-	<b>85733</b>	...
	680322		...	...	010	<b>85704</b>	...
	680323	010	<b>85700</b>	...		...	...

**APPLICATION GUIDE - TRUCKS, TRAILERS, AND BUSES**

Year Año Année	Model Modelo Modèle	OEM #	Front		Rear	
						
			Fleetline	GasSLX	Fleetline	GasSLX

**MOTOR COACH INDUSTRIES(Cont'd.)**

**Additional O.E.M. Interchanges(Cont'd.)**



Models with O.E.M. Number	680369	...	...	- -	85708	...
	680374	- -	85728	...	...	...
	680441	...	...	0 -	85729	...
	680452	...	...	0 0	85339	...
	680462	- -	85728	...	...	...
	680470	...	...	0 0	85713	...
	680482	...	...	- -	85727	...
	680485	...	...	0 -	85733	...
	680544	- 0	85711	...	...	...
	680546	...	...	0 0	85339	...
	680602	...	...	0 0	85339	...
	680677	- -	85728	...	...	...
	680680	...	...	0 -	85729	...
	680681	...	...	- -	85727	...
	695125	...	...	0 0	85704	...
	97-9999-02585	0 -	85723	...	...	...
	G1101590	...	...	0 0	85713	...
	G1201339	...	...	0 0	85702	...
	G5008069	0 0	85700	...	...	...
	OE10086S	...	...	0 0	85702	...
	OE10881	- 0	85711	...	...	...
	OE10882	...	...	0 -	85740	...
	OE10883	...	...	0 0	85339	...
	T14-1045GS	0 0	85700	...	...	...
	T14-1048	...	...	0 0	85302	89420
T14-1080	- -	85728	...	...	...	
Additional O.E.M. Interchanges	12G-5-1	0 0	85700	...	...	...
	12J-5-7	0 -	85733			
	12J-5-71	0 -	85733			
	12J-5-9	...	...	0 0	85700	...
	12L-5-70	0 0	85700	...	...	...
	12L-5-72	0 0	85709			
	22052014	...	...	0 0	85702	...
	6314933	- -	85708			
	680333	- -	85708			
	690029	0 0	85700			
	97-2201-00151	0 0	85700			
	97-2210-00164	- -	85708			
	97-9999-02514	0 0	85700			
	97-9999-02634	0 -	85733			

**MUNCIE RECLAMATION**

**Additional O.E.M. Interchanges**

Models with O.E.M. Number	665459	...	...	- -	89447	...
	665568	...	...	0 0	85051	...
	H53-20415-006	...	...	0 0	85051	...
	MR6394	0 -	85723	...	...	...
Additional O.E.M. Interchanges	665569	...	...	0 0	85045	...
	680334	- -	85709			
	97-2210-00164	- -	85708			
	H53-21144-004	...	...	0 0	85045	...
	MR1623	0 0	85700			
	MR1710	...	...	0 0	85713	...
MR1751	...	...	0 0	85713	...	

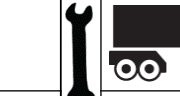
**APPLICATION GUIDE - TRUCKS, TRAILERS, AND BUSES**

Year Año Année	Model Modelo Modèle	OEM #	Front		Rear	
						
			Fleetline	GasSLX	Fleetline	GasSLX

**MUNCIE RECLAMATION(Cont'd.)**

**Additional O.E.M. Interchanges(Cont'd.)**

Additional O.E.M. Interchanges	MR1763	010	85300 or 89419			
	MR1765		...	...	010	85713
	MR25767	010	85702			
	MR2960	010	85702			
	MR2996		...	...	010	85704
	MR2997	-10	85703	...		...
	MR3303	-1-	85709			
	MR3304H	-1-	85709			
	MR3306	-1-	85705	89447		...
	MR6535	-1-	85708			
	MR6536		...	...	-1-	85722

**NATIONAL COACH CORP**









Eldorado Coach RE-29	C800853	010	83207	89407		...
----------------------	---------	-----	-------	-------	--	-----

**NATIONAL RV INC.**

**Class A MotorHomes**

99 - 08	Models with Ford F53 Chassis with 16,000 lb GVW to 22,000 lb GVW	1C34-18045-AA	010	83209	89414		...	
		1C34-18045-JA	010	83209	89414		...	
		9U94-18045-AA	010	83209	89414		...	
		9U94-18080-AA		...	...	010	83122	89406
		9U9Z-18124-A	010	83209	89414		...	
		9U9Z-18125-A		...	...	010	83122	89406
		ASH-1022	010	83209	89414		...	
		ASH-1023		...	...	010	83122	89406
		ASH-1205	010	83209	89414		...	
		ASH-1206		...	...	010	83122	89406
		ASH-1228	010	83209	89414		...	
		ASH-1229	010	83209	89414		...	
		ASH-1230		...	...	010	83122	89406
		ASH-137		...	...	010	83122	89406
		ASH-25822	010	83209	89414		...	
		ASH-25823	010	83209	89414		...	
		ASH-25824		...	...	010	83122	89406
		ASH-294	010	83209	89414		...	
		AT-620	010	83209	89414		...	
		AT-621		...	...	010	83122	89406
AT-766	010	83209	89414		...			
05 - 08	Models with Workhorse W20 , W22, & W24 MotorHome Chassis with O.E.M. Number	24-153256		...	...	-1-	85124	
		F4-BE5-F325-HO		...	...	-1-	85124	
		W0005663		...	...	-1-	85124	
98 - 04	Models with Workhorse W20 , W22, & W24 MotorHome Chassis with O.E.M. Number	24-186537		...	...	01-	85126	
		F4-BE5-A011-HO		...	...	01-	85126	
98 - 08	Models with Workhorse W20 , W22, & W24 MotorHome Chassis with O.E.M. Number	24-153249	010	85125	...		...	
		24-186629	010	85125	...		...	
		F4-BE5-A832-MO	010	85125	...		...	
		F4-BE5-B492-HO	010	85125	...		...	
		F4-BE5-F324-HO	010	85125	...		...	
		W0005662	010	85125	...		...	
		W0006254	010	85125	...		...	

## APPLICATION GUIDE - TRUCKS, TRAILERS, AND BUSES

Year Año Année	Model Modelo Modèle	OEM #	Front		Rear	
						
						
			Fleetline	GasSLX	Fleetline	GasSLX

### NAVISTAR - SEE INTERNATIONAL (NAVISTAR)

--	--

### NEOPLAN BUS

Year	Model	OEM #	Front	Front	Rear	Rear	Front	Rear
	Mini-Bus	24-1700-106-149		...	...	010	<b>83216</b>	...
		24-1700-999-362	-10	<b>85009</b>	...		...	...
		BN1002002	-10	<b>85009</b>	...		...	...
		BT1002011		...	...	010	<b>83216</b>	...
	Model 40	25-1700-101-426		<b>85705</b>	...	-1-	<b>85705</b>	<b>89447</b>
	Model 80B	CL1002003		<b>85705</b>	...	-1-	<b>85705</b>	<b>89447</b>
		DZ1002002		<b>85705</b>	...	-1-	<b>85705</b>	<b>89447</b>
	Models with O.E.M. Number	680307		<b>85705</b>	...	-1-	<b>85705</b>	<b>89447</b>
		AA1002002		<b>85705</b>	...	-1-	<b>85705</b>	<b>89447</b>
		AA1002003		<b>85705</b>	...	-1-	<b>85705</b>	<b>89447</b>
		AA1802002		<b>85705</b>	...	-1-	<b>85705</b>	<b>89447</b>
		AC1002002		<b>85705</b>	...	-1-	<b>85705</b>	<b>89447</b>
		AC1002002GS		<b>85705</b>	...	-1-	<b>85705</b>	<b>89447</b>
		AC1002003		<b>85705</b>	...	-1-	<b>85705</b>	<b>89447</b>
		DT1802002		<b>85705</b>	...	-1-	<b>85705</b>	<b>89447</b>
		GJ1002003		<b>85705</b>	...	-1-	<b>85705</b>	<b>89447</b>
		MM1002002		<b>85705</b>	...	-1-	<b>85705</b>	<b>89447</b>
		MM1002003		<b>85705</b>	...	-1-	<b>85705</b>	<b>89447</b>
	Additional O.E.M. Interchanges	CI 1002003	-1-	<b>85705</b>	<b>89447</b>		...	...

### NEW FLYER

Year	Model	OEM #	Front	Front	Rear	Rear	Front	Rear
	Diesel Low Floor Coach	015813		...	...	-1-	<b>85708</b>	...
<b>01 - 11</b>	Transit Buses (Low Profile) with O.E.M. Number	204428		...	...	-1-	<b>85347</b>	...
<b>1991 -</b>	Transit Buses (Low Profile) with O.E.M. Number	009863	-1-	<b>85722</b>	...		...	...
		016415	-1-	<b>85722</b>	...		...	...
		680346	-1-	<b>85722</b>	...		...	...
<b>2002 -</b>	Transit Buses (Low Profile) with O.E.M. Number	152959		...	...	-1-	<b>85708</b>	...
		680671		...	...	-1-	<b>85708</b>	...
	Additional O.E.M. Interchanges	015915	-10	<b>85711</b>				
		064845	-10	<b>85711</b>				
		68027440Y		...	...	010	<b>85716</b>	...
		680352	-10	<b>85711</b>				
		68037840B	010	<b>85720</b>	...		...	...
		68050440X		...	...	010	<b>85716</b>	...
		68050640Y	010	<b>85732</b>	...		...	...
		690102	-10	<b>85711</b>				
		69536640Y	010	<b>85732</b>	...		...	...
		97-2210-00164	-1-	<b>85708</b>				

### NEWAY (HOLLAND) SUSPENSION SYSTEMS - SEE SAF HOLLAND









Refer to SAF Holland Section for application information	
--	--

### NEWMAR CORP

#### Class A MotorHomes

Year	Model	OEM #	Front	Front	Rear	Rear	Front	Rear
<b>13 - 20</b>	Bay Star, Bay Star Sport & Canyon Star Series MotorHomes with Ford F53 Chassis with 16,000 lb GVW to 22,000 lb GVW	ASH-1229	010	<b>83209</b>	<b>89414</b>		...	...
		ASH-25822	010	<b>83209</b>	<b>89414</b>		...	...
		ASH-25823	010	<b>83209</b>	<b>89414</b>		...	...
		ASH-25824		...	...	010	<b>83122</b>	<b>89406</b>
<b>02 - 04</b>	Dutch Star & Moundain Aire Series MotorHomes with Freightliner XC Chassis AS120 Front Suspension	141700131810	010	<b>83160</b>	...		...	...

## APPLICATION GUIDE - TRUCKS, TRAILERS, AND BUSES

Year Año Année	Model Modelo Modèle	OEM #	Front		Rear	
						
						
			Fleetline	GasSLX	Fleetline	GasSLX

### NEWMAR CORP(Cont'd.)

#### Class A MotorHomes(Cont'd.)

02 - 04	AS120 Front Suspension	16-16737-000	010	83160	...		...	...		
			010	83160	...		...	...		
				...	...	010	85029	...	...	
				...	...	010	85029	...	...	
				ZF - IFS Front Suspension with 23,000 lb GVW or Greater	16-18103-000	-1-	85900	...		...
				481700000493	-1-	85900	...		...	
02 - 05	Kountry Star Series MotorHomes with Freightliner XC Chassis AS120 Front Suspension	141700131810	010	83160	...		...	...		
			010	83160	...		...	...		
			010	83160	...		...	...		
				...	...	010	85029	...	...	
				...	...	010	85029	...	...	
				ZF - IFS Front Suspension with 23,000 lb GVW or Greater	16-18103-000	-1-	85900	...		...
	481700000493	-1-	85900	...		...				
2006	Ventana Series MotorHomes with Freightliner XC Chassis AS120 Front Suspension	141700131810	010	83160	...		...	...		
			010	83160	...		...	...		
			010	83160	...		...	...		
				...	...	010	85029	...	...	
				...	...	010	85029	...	...	
				ZF - IFS Front Suspension with 23,000 lb GVW or Greater	16-18103-000	-1-	85900	...		...
	481700000493	-1-	85900	...		...				
	Ventana Series MotorHomes with Neway AS140 w/ 14,000 lb Front Suspension	90045455		...	...	010	85909	...		

### NEXUS RV

#### Class A MotorHomes

16 - 20	Maybach Series MotorHomes with Ford F53 Chassis with 16,000 lb GVW to 22,000 lb GVW	ASH-1229	010	83209	89414		...	...
			010	83209	89414		...	...
			010	83209	89414		...	...
				...	...	010	83122	89406

#### Class C MotorHomes

11 - 20	Phantom Series MotorHomes with Ford E350 & E450 Chassis	ASH-1136		...	...	-10	83178	...
			-10	83177	...		...	...
11 - 12	Scenic Traveler Series MotorHomes with Ford E450 Chassis	ASH-1136		...	...	-10	83178	...
			-10	83177	...		...	...
12 - 20	Viper Series MotorHomes with Ford E350 & E450 Chassis	ASH-1136		...	...	-10	83178	...
			-10	83177	...		...	...

### NISSAN

#### UD 1200 Series

99 - 04	U D 1200 Models with O.E.M. Number	561000T825	-10	83515	...		...	...
			-10	83515	...		...	...

#### UD 1300 Series

05 - 07	U D 1300 Models with O.E.M. Number	561000T825	-10	83515	...		...	...
			-10	83515	...		...	...
	UD 1300 Models Steer Axle	56110-T8123	-10	G63432	...		...	...
			-10	G63432	...		...	...
			-10	G63432	...		...	...

#### UD 1400 Series

94 - 10	U D 1400 Models with O.E.M. Number	561000T825	-10	83515	...		...	...
			-10	83515	...		...	...

#### UD 1800 Series

11 - 13	Models with 22.5" Tires	56101-30Z02	01-	G63610	...		...	...
---------	-------------------------	-------------	-----	--------	-----	--	-----	-----

## APPLICATION GUIDE - TRUCKS, TRAILERS, AND BUSES

Year Año Année	Model Modelo Modèle	OEM #	Front				Rear			
					<b>Fleetline</b>	<b>GasSLX</b>			<b>Fleetline</b>	<b>GasSLX</b>

### NISSAN(Cont'd.)

#### UD 1800 Series(Cont'd.)

11 - 13	Models with 22.5" Tires	56110-30Z02	01-	<b>G63610</b>	...		...	...
95 - 98	Models with 22.5" Tires	56101-30Z02	01-	<b>G63610</b>	...		...	...
		56110-30Z02	01-	<b>G63610</b>	...		...	...
89 - 94	Models with O.E.M. Number	56101-Z5008	-10	<b>83114</b>	...		...	...
		56110-Z5008	-10	<b>83114</b>	...		...	...

#### UD 18CS Series

99 - 04	Models with O.E.M. Number	56101-Z5008	-10	<b>83114</b>	...		...	...
		56110-Z5008	-10	<b>83114</b>	...		...	...

#### UD 18HD Series

99 - 10	Models with 22.5" Tires	56101-30Z02	01-	<b>G63610</b>	...		...	...
		56110-30Z02	01-	<b>G63610</b>	...		...	...

#### UD 2000 Series

	Models with 22.5" Tires	56110-Z5011	-10	<b>G63610</b>	...		...	...
95 - 13	Models with 22.5" Tires	56101-30Z02	01-	<b>G63610</b>	...		...	...
		56110-30Z02	01-	<b>G63610</b>	...		...	...
89 - 94	U D 2000 Models with O.E.M. Number	56101-Z5008	-10	<b>83114</b>	...		...	...
		56110-Z5008	-10	<b>83114</b>	...		...	...

#### UD 23DH Series

95 - 13	Models with 22.5" Tires	56101-30Z02	01-	<b>G63610</b>	...		...	...
		56110-30Z02	01-	<b>G63610</b>	...		...	...

#### UD 23LP Series

95 - 13	Models with 22.5" Tires	56101-30Z02	01-	<b>G63610</b>	...		...	...
		56110-30Z02	01-	<b>G63610</b>	...		...	...

#### UD 2600 Series

89 - 13	U D 2600 Models with O.E.M. Number	56101-Z5014	-10	<b>83162</b>	...		...	...
		56101-Z5017	-10	<b>83162</b>	...		...	...
		56110-Z5014	-10	<b>83162</b>	...		...	...
		56110-Z5017	-10	<b>83162</b>	...		...	...

#### UD 2800 Series

89 - 94	U D 2800 Models with O.E.M. Number	56101-Z5014	-10	<b>83162</b>	...		...	...
		56101-Z5017	-10	<b>83162</b>	...		...	...
		56110-Z5014	-10	<b>83162</b>	...		...	...
		56110-Z5017	-10	<b>83162</b>	...		...	...





#### UD 3000 Series

89 - 91	U D 3000 Models with O.E.M. Number	56101-Z5014	-10	<b>83162</b>	...		...	...
		56101-Z5017	-10	<b>83162</b>	...		...	...
		56110-Z5014	-10	<b>83162</b>	...		...	...
		56110-Z5017	-10	<b>83162</b>	...		...	...
95 - 00	U D 3000 Models with O.E.M. Number	56101-Z5014	-10	<b>83162</b>	...		...	...
		56101-Z5017	-10	<b>83162</b>	...		...	...
		56110-Z5014	-10	<b>83162</b>	...		...	...
		56110-Z5017	-10	<b>83162</b>	...		...	...
89 - 94	U D 3300 Models with O.E.M. Number	56101-Z5014	-10	<b>83162</b>	...		...	...
		56101-Z5017	-10	<b>83162</b>	...		...	...
		56110-Z5014	-10	<b>83162</b>	...		...	...
		56110-Z5017	-10	<b>83162</b>	...		...	...
99 - 13	U D 3300 Models with O.E.M. Number	56101-Z5014	-10	<b>83162</b>	...		...	...
		56101-Z5017	-10	<b>83162</b>	...		...	...
		56110-Z5014	-10	<b>83162</b>	...		...	...
		56110-Z5017	-10	<b>83162</b>	...		...	...

#### Additional Applications

92 - 94	30HD Models with O.E.M. Number	56101-Z5014	-10	<b>83162</b>	...		...	...
		56101-Z5017	-10	<b>83162</b>	...		...	...
		56110-Z5014	-10	<b>83162</b>	...		...	...

**APPLICATION GUIDE - TRUCKS, TRAILERS, AND BUSES**

Year Año Année	Model Modelo Modèle	OEM #	Front		Rear	
			 Fleetline	 GasSLX	 Fleetline	 GasSLX

**NISSAN(Cont'd.)**

**Additional Applications(Cont'd.)**

92 - 94	30HD Models with O.E.M. Number	56110-Z5017	-10	83162	...		...	...
92 - 94	30SD Models with O.E.M. Number	56101-Z5014	-10	83162	...		...	...
		56101-Z5017	-10	83162	...		...	...
		56110-Z5014	-10	83162	...		...	...
		56110-Z5017	-10	83162	...		...	...
89 - 91	500T Models with O.E.M. Number	56101-Z5014	-10	83162	...		...	...
		56101-Z5017	-10	83162	...		...	...
		56110-Z5014	-10	83162	...		...	...
		56110-Z5017	-10	83162	...		...	...
92 - 94	600T Models with O.E.M. Number	56101-Z5014	-10	83162	...		...	...
		56101-Z5017	-10	83162	...		...	...
		56110-Z5014	-10	83162	...		...	...
		56110-Z5017	-10	83162	...		...	...

**NOVA BUS**

	Classic Bus with O.E.M. Number	97-2201-00151		85700	...	010	85700	...
	Low Floor Bus Models with O.E.M. Number	481700131250	010	85377	...		...	...
		680480	010	85377	...		...	...
		695393	010	85377	...		...	...
		N16248	010	85377	...		...	...
		N31831	010	85377	...		...	...
	RTS Bus	22045526		...	...	010	85702	...
		22052014		...	...	010	85702	...
		G1011822		...	...	010	85702	...
		G1203223		...	...	010	85702	...
		OE 10086S		...	...	010	85702	...
	RTS Bus with "V" Drive	G1101590		...	...	010	85713	...
	Models with O.E.M. Number	12J-5-10		...	...	01-	85733	...
		680232		...	...	01-	85733	...
		680323	010	85700	...		...	...
		680326	010	85700	...		...	...
		680470		...	...	010	85713	...
		G1201339		...	...	010	85702	...
		G5008070	010	85700	...		...	...
N22212	010	85700	...		...	...		
	Additional O.E.M. Interchanges	97-9999-02514	010	85700				

**OLE GRANNING**

	Models with O.E.M. Number	1086	010	83217	...		...	...
--	---------------------------	------	-----	-------	-----	--	-----	-----

**ONEIDA PRODUCTS**

	School Bus w/Heavy Duty Suspension	.....		85307	...	010	85307	...
	School Bus w/Standard Suspension	.....		83216	...	010	83216	...



**OPTIMA BUS CORP**

	Buses with Ridewell RAS - 227 Models Steer Axle Air Suspension w/ O.E.M. Number	1260008		...	...	010	87017	...
		90-2610-SP1		...	...	010	87017	...

**ORION BUS INDUSTRIES**

	Orion 1	010234503-4		...	...	010	85308	89422
	Orion 102	050134501-4	010	85716	...		...	...
		050230501		...	...	010	85716	...
		050231505		...	...	010	85716	...
		680504		...	...	010	85716	...

**APPLICATION GUIDE - TRUCKS, TRAILERS, AND BUSES**

Year Año Année	Model Modelo Modèle	OEM #	Front		Rear	
						
			Fleetline	GasSLX	Fleetline	GasSLX

**ORION BUS INDUSTRIES(Cont'd.)**









Orion II	010234503-4	...	...	010	85308	89422
	020117503-4	85720	...		...	...
	020117504	85720	...		...	...
	020273541	83203	89436		...	...
	020273541-4	...	...	010	85000	89436
	020273544	83203	89436		...	...
	20117501	85720	...		...	...
	20117504	85720	...		...	...
	20117505	85720	...		...	...
	Orion V	010134508-4	85732	...		...
0501345024		85732	...		...	...
050134506-4		85732	...		...	...
050134509		85732	...		...	...
050134510		85732	...		...	...
050134511		85732	...		...	...
050134513		85732	...		...	...
050231505		...	...	010	85716	...
680504		...	...	010	85716	...
695347		85732	...		...	...
Orion VII - 30 ft Rear	070231527	...	...	01-	85729	...
Orion VII with O.E.M. Number	070231514	...	...	01-	85729	...
	6430645	...	...	01-	85729	...
Models with O.E.M. Number	680274	...	...	010	85716	...
	680378	85720	...		...	...
	695327	85732	...		...	...
	695343	85732	...		...	...
	695366	85732	...		...	...
	695420	...	...	01-	85729	...
	695440	...	...	01-	85729	...
Additional O.E.M. Interchanges	010134501-4	85307				
	050134508	85732	...		...	...
	0501345-11	85732				
	050231501-4	85716				
	050231502-4	85716				
	050231507	85716				
	680091	85303	...	010	85303	89422
	680102	85712				
	680352	85711				
	680506	85732	...		...	...
	690102	85711				
	97-9999-02635	85732				
	97-9999-02636	85716				
	A-4890	...	...	010	85712	...
	OB020570	85711				
	OB020764	85716				
	OB3166657	85700				

**OSHKOSH MOTORS**

Mobile Home - ForeTravel	1583470	...	...	010	85051	...
Models with 16" Long Shock Absorber w/1" Mounting Pins	....	85303	89422		...	...
Models with 3/4" Mounting Pins	....	83122	89406		...	...
Models with Neway Air Suspension	90044448	...	...	010	85051	...
Motor Homes with O.E.M. Number	1398980	83127	...	010	83127	...
	GBL654875	...	...	010	83117	...
	RW24285	83119	...		...	...



## APPLICATION GUIDE - TRUCKS, TRAILERS, AND BUSES

Year Año Année	Model Modelo Modèle	OEM #	Front		Rear	
						
						
			Fleetline	GasSLX	Fleetline	GasSLX

### OSHKOSH MOTORS(Cont'd.)

	V - Line Coach	1573280		...	...	OIO	83221	...
	Models with O.E.M. Number	12405F	OIO	85734	...		...	...
		12405F-1	OIO	85303	89422		...	...
		1583470		...	...	OIO	85051	...
		3638112		...	...	OIO	G63183	...
		4036892	OIO	G63605	...		...	...
		5353054	OIO	85303	89422		...	...
		5361994	OIO	85734	...		...	...
		651444		...	...	OIO	83221	...
		665040	OIO	85303	89422		...	...
		690049	OIO	85303	89422		...	...
		GBL654918	OIO	83118	...		...	...
		P117099		...	...	OIO	83120	...
		P117146	OIO	83118	...		...	...
	Additional O.E.M. Interchanges	12405FX1	OIO	85303 or 89422				
		1445910	OIO	85300 or 89419				
		1573270	OIO	83207 or 89407				
		1745500	OIO	89430				
		2173340	OIO	85303 or 89422				
		26228-A	OIO	83122 or 89406				
		2JD137	OIO	83119	...		...	...
		40-0242	OIO	83312	89409		...	...
		40-4845	OIO	85304				
		40-4951	OIO	85316	89426		...	...
		40-5348	OIO	85058	89431		...	...
		40-6967	OIO	85030 or 89440				
		665060	OIO	83122 or 89406				

### OSHKOSH MOTORS CAB SHOCKS

	Models with Link Cabmate Model OKTP with O.E.M. Number	1202-0054	OIO	83021				
	Models with O.E.M. Number	2218640	OIO	83009				

### OSTERLUND TRUCK

	Models with O.E.M. Number	59011	OIO	83214	...	...	...	...
		680117	OIO	85300	89419		...	...
	Additional O.E.M. Interchanges	220-S5-10		...	...	OIO	85712	...

### OTTAWA TRUCK

	Yard Tractor	59009		83217	...	OIO	83217	...
	Models with O.E.M. Number	59011	OIO	83214	...		...	...
		680117	OIO	85300	89419		...	...
	Additional O.E.M. Interchanges	53540451	OIO	85300 or 89419				
		90013787		...	...	OIO	85310	89423
		9007342	OIO	85303 or 89422				
	Yard Tractor	90027577	OIO	85720	...		...	...

### PACCAR





#### Additional Applications

	TruckMaster Shock Stamping Number	665633		...	...	OIO	85033	89427
--	-----------------------------------	--------	--	-----	-----	-----	-------	-------

### PACIFIC TRUCK & TRAILER

	Additional O.E.M. Interchanges	3178157C	OIO	85735				
		507202C1	OIO	85030	89440		...	...

## APPLICATION GUIDE - TRUCKS, TRAILERS, AND BUSES

Year Año Année	Model Modelo Modèle	OEM #	Front		Rear	
						
			Fleetline	GasSLX	Fleetline	GasSLX

### PAGE SUSPENSION

Model with LM-2000 Models Lift Axle Suspension	1080099		...	...	O O	83203	89436
Model with Trailmaster Air Spring Suspension	1081933		...	...	O O	83204	...
	A-2212		...	...	O O	85029	...
Models with O.E.M. Number	665133		...	...	O O	83203	89436
	665267		...	...	O O	85029	...

### PAI CORP

Models with O.E.M. Number	HSA-5067	O O	85305	...		...	...
	HSA-5080	O O	83221	...		...	...
	HSA-5095	O O	83215	...		...	...

### PEERLESS TRAILER

Models with Air Suspension	72-61		...	...	O O	83125	...
Models with O.E.M. Number	120-1		...	...	O O	83125	...

### PETERBILT

#### 210 Series

08 - 15	Models with Reyco 102 or 79KB Suspension (Drive Axle)	16725-01		...	...	O O	83126	89440
		19495-01		...	...	O O	83126	89440
		TK19679		...	...	O O	83126	89440

#### 220 Series

07 - 12	Models with 12,000 lb Front Axle	02-02738	O O	85012	89413		...	...
		B71-6016	O O	85012	89413		...	...
13 - 20	Models with 12,000 lb Front Axle	1707378PAC	- -	85182	...		...	...
		BFRG072	- -	85182	...		...	...
07 - 19	Models with Hendrickson HAS - 210L or HAS - 230L Rear Air Suspension	60670-008		...	...	O O	83123	89405
		60670-008L		...	...	O O	83123	89405
07 - 20	Models with Reyco 102AR (Standard) Rear Air Suspension	12887-01		...	...	O O	85013	89414
		12887-02		...	...	O O	85013	89414
07 - 20	Models with Reyco 21,000 lb Spring Suspension	19495-01		...	...	O O	83126	89440
		TK19679		...	...	O O	83126	89440
07 - 20	Models with Reyco 79KB Rear Steel Spring Suspension	16725-01		...	...	O O	83126	89440
		19495-01		...	...	O O	83126	89440
		TK19679		...	...	O O	83126	89440





#### 270 Series

Models with Woodhead Shock (Stamping Number ACHB 966)	ACHB966		...	...	- -	83136	...
---	---------	--	-----	-----	-----	-------	-----

#### 320 Series

87 - 18	Models with 12,000 lb to 14,600 lb Taperleaf Spring Suspension and Set Forward Front Axle.	02-01787	O O	85062	89408		...	...
		02-02737	O O	85062	89408		...	...
		B71-6009	O O	85062	89408		...	...
01 - 19	Models with 18,000 lb to 23,000 lb Taperleaf Front Spring Suspension and Set Forward Front Axle.	02-02742	O O	85062	89408		...	...
		B71-6011	O O	85062	89408		...	...
14 - 18	Models with Air Trac Suspension (40,000 lb)	C71-6003		...	...	- O	85988	...
87 - 18	Models with Air Trac Suspension (46,000 lb)	03-07421		...	...	- O	85311	89424
		C71-6002		...	...	- O	85311	89424
01 - 19	Models with Hendrickson HMX 400/460 Haulmax with 16.5" Saddle	60680-004		...	...	O -	83143	...
		60680-004L		...	...	O -	83143	...
01 - 19	Models with Hendrickson HMX 400/460 Haulmax with 17.5" & 18.5" Saddle	60680-005		...	...	O -	83142	...
		60680-005L		...	...	O -	83142	...
	Models with Neway AD-252-10 Tandem Axle	90045132		...	...	O O	85909	...
	Models with Neway ADZ Rear Suspension	471700004423		...	...	O O	85109	...
		90045605		...	...	O O	85109	...

**APPLICATION GUIDE - TRUCKS, TRAILERS, AND BUSES**

Year Año Année	Model Modelo Modèle	OEM #	Front			Rear		
							Fleetline	GasSLX

**PETERBILT(Cont'd.)**

**320 Series(Cont'd.)**

02 - 18	Models with Peterbilt Low Air Leaf Suspension	03-08781		...	...	- -	85069	89455
		C71-1011		...	...	- -	85069	89455
		C71-1017		...	...	- -	85069	89455
	Models with Quadraflex 4 Spring Rear Suspension	03-07420		...	...	- -	85336	...
	Models with Reyco 102AR (Standard) Rear Air Suspension	12887-01		...	...	0 0	85013	89414
		12887-02		...	...	0 0	85013	89414
	Models with Reyco 79KB Rear Steel Spring Suspension	16725-01		...	...	0 0	83126	89440
		19495-01		...	...	0 0	83126	89440
		TK19679		...	...	0 0	83126	89440

**325 Series**

08 - 19	Models with 12000 lb Set Back Front Axle	02-02738	0 0	85012	89413		...	...
		B71-6016	0 0	85012	89413		...	...
08 - 15	Models with 8,000 lb Front Axle	B71-6004	0 0	85084	89460		...	...
08 - 19	Models with Reyco 102 or 79KB Suspension (Drive Axle)	19495-01		...	...	0 0	83126	89440
		TK19679		...	...	0 0	83126	89440
		TK19679		...	...	0 0	83126	89440

**330 Series**

16 - 19	Models with 10,000 lb to 14,600 lb Taperleaf Springs and Set Back Front Axles	B71-6019	0 0	85989	...		...	...
95 - 16	Models with 12000 lb Set Back Front Axle	02-02738	0 0	85012	89413		...	...
		B71-6016	0 0	85012	89413		...	...
		B71-6016A	0 0	85012	89413		...	...
- 2019	Models with 21,000 lb Reyco Spring Suspension	19495-01		...	...	0 0	83126	89440
		TK19679		...	...	0 0	83126	89440
14 - 19	Models with Air Trac Suspension (40,000 lb)	C71-6003		...	...	- 0	85988	...
87 - 19	Models with Air Trac Suspension (46,000 lb)	03-07421		...	...	- 0	85311	89424
		C71-6002		...	...	- 0	85311	89424
95 - 02	Models with Peterbilt 40000 lb Low Air Leaf Suspension	03-07423		...	...	- 0	85033	89427
03 - 20	Models with Peterbilt Low Air Leaf Suspension	03-08781		...	...	- -	85069	89455
		C71-1011		...	...	- -	85069	89455
		C71-1017		...	...	- -	85069	89455
	Models with Reyco 102AR (Standard) Rear Air Suspension	12887-01		...	...	0 0	85013	89414
		12887-02		...	...	0 0	85013	89414
- 2019	Models with Reyco 79KB Rear Steel Spring Suspension	16725-01		...	...	0 0	83126	89440
		19495-01		...	...	0 0	83126	89440
		TK19679		...	...	0 0	83126	89440
	Models with O.E.M. Number	02-03020	0 0	85910	...		...	...
		B71-6017	0 0	85910	...		...	...





**335 Series**

05 - 10	Models with 12000 lb Set Back Front Axle	02-02738	0 0	85012	89413		...	...
		02-02741	0 0	85012	89413		...	...
		B71-6016	0 0	85012	89413		...	...
		B71-6016A	0 0	85012	89413		...	...
05 - 10	Models with Air Trac Suspension (46,000 lb)	03-07421		...	...	- 0	85311	89424
05 - 10	Models with Peterbilt Low Air Leaf Suspension	03-08781		...	...	- -	85069	89455
		C71-1011		...	...	- -	85069	89455
		C71-1017		...	...	- -	85069	89455

**337 Series**

10 - 14	Models with 10,000 lb to 12,000 lb Front Axle	B71-6005	0 0	85084	89460		...	...
15 - 20	Models with 10,000 lb to 14,600 lb Taperleaf Springs and Set Back Front Axles	B71-6019	0 0	85989	...		...	...
10 - 14	Models with 13,200 lb to 14,600 lb Front Axle	B71-6006	0 0	85084	89460		...	...
14 - 20	Models with Air Trac Suspension (40,000 lb)	C71-6003		...	...	- 0	85988	...
10 - 20	Models with Air Trac Suspension (46,000 lb)	03-07421		...	...	- 0	85311	89424
		C71-6002		...	...	- 0	85311	89424

**APPLICATION GUIDE - TRUCKS, TRAILERS, AND BUSES**

Year Año Année	Model Modelo Modèle	OEM #	Front		Rear	
						
			Fleetline	GasSLX	Fleetline	GasSLX

**PETERBILT(Cont'd.)**

**337 Series(Cont'd.)**

- 2020	Models with Neway ADZ Rear Suspension	471700004423	...	...	010	85109	...
		90045605	...	...	010	85109	...
10 - 20	Models with Peterbilt Low Air Leaf Suspension	03-08781	...	...	-1-	85069	89455
		C71-1011	...	...	-1-	85069	89455
		C71-1017	...	...	-1-	85069	89455
10 - 16	Models with Reyco 102AR (Standard) Rear Air Suspension	12887-01	...	...	010	85013	89414
		12887-02	...	...	010	85013	89414
10 - 19	Models with Reyco 79KB Rear Steel Spring Suspension	16725-01	...	...	010	83126	89440
		19495-01	...	...	010	83126	89440
		TK19679	...	...	010	83126	89440

**340 Series**

07 - 10	Models with 12000 lb Set Back Front Axle	02-02738	010	85012	89413	...	...
		02-02741	010	85012	89413	...	...
		B71-6016	010	85012	89413	...	...
		B71-6016A	010	85012	89413	...	...
07 - 10	Models with Air Trac Suspension (46,000 lb)	03-07421	...	...	-10	85311	89424

**348 Series**

12 - 13	Models with 10,000 lb to 12,000 lb Front Axle	B71-6005	010	85084	89460	...	...
14 - 19	Models with 10,000 lb to 14,600 lb Taperleaf Springs and Set Back Front Axles	B71-6019	010	85989	...	...	...
14 - 19	Models with 20,000 lb Taperleaf Springs and Set Back Front Axles	B71-6020	010	85989	...	...	...
14 - 19	Models with Air Trac Suspension (40,000 lb)	C71-6003	...	...	-10	85988	...
10 - 19	Models with Air Trac Suspension (46,000 lb)	03-07421	...	...	-10	85311	89424
		C71-6002	...	...	-10	85311	89424
10 - 20	Models with Hendrickson HMX 400/460 Haulmax with 16.5" Saddle	60680-004	...	...	01-	83143	...
		60680-004L	...	...	01-	83143	...
10 - 20	Models with Hendrickson HMX 400/460 Haulmax with 17.5" & 18.5" Saddle	60680-005	...	...	01-	83142	...
		60680-005L	...	...	01-	83142	...
10 - 20	Models with Neway ADZ Rear Suspension	471700004423	...	...	010	85109	...
		90045605	...	...	010	85109	...
15 - 16	Models with O.E.M. Number	B71-6012	010	85119	...	...	...
10 - 19	Models with Reyco 102AR (Standard) Rear Air Suspension	12887-01	...	...	010	85013	89414
		12887-02	...	...	010	85013	89414
10 - 19	Models with Reyco 79KB Rear Steel Spring Suspension	16725-01	...	...	010	83126	89440
		19495-01	...	...	010	83126	89440
		TK19679	...	...	010	83126	89440

**349 Series**

84 - 87	349 Conventional Models with 12000 lb capacity	02-00376	010	85302	89420	...	...
		02-00495	010	85302	89420	...	...
		02-02736	010	85302	89420	...	...

**353 Series**

81 - 93	353 Conventional Models with 12000 lb capacity	02-00376	010	85302	89420	...	...
		02-00495	010	85302	89420	...	...
		02-02736	010	85302	89420	...	...

**357 Series**

	Conventional Models with Front Air Suspension and Set Back Front Axle.	02-02739	010	85013	89414	...	...
	Conventional Models with Front Air Suspension and without Set Back Front Axle.	02-02740	010	85036	89405	...	...
87 - 08	Conventional Models with Spring Suspension and with Set Back Front Axle.	02-01890	010	85012	89413	...	...
		02-02738	010	85012	89413	...	...
		02-02741	010	85012	89413	...	...
		B71-6016	010	85012	89413	...	...

## APPLICATION GUIDE - TRUCKS, TRAILERS, AND BUSES

Year Año Année	Model Modelo Modèle	OEM #	Front		Rear	
			 Fleetline	 GasSLX	 Fleetline	 GasSLX

### PETERBILT(Cont'd.)

#### 357 Series(Cont'd.)

87 - 08	Conventional Models with Spring Suspension and with Set Back Front Axle.	B71-6016A	010	85012	89413	...	...
87 - 08	Models with 12,000 lb to 14,600 lb Taperleaf Spring Suspension and Set Forward Front Axle.	02-02737	010	85062	89408	...	...
		B71-6007	010	85062	89408	...	...
		B71-6009	010	85062	89408	...	...
87 - 08	Models with 18,000 lb to 23,000 lb Taperleaf Front Spring Suspension and Set Forward Front Axle.	02-02742	010	85062	89408	...	...
		B71-6011	010	85062	89408	...	...
87 - 08	Models with Air Trac Suspension (46,000 lb)	03-07421		...	...	010	85311 89424
97 - 08	Models with Air Track Tandem with TRD8000 Pusher Axle	03-08350		...	...	010	85343 ...
		C71-6004		...	...	010	85343 ...
87 - 08	Models with Chalmers 40,000 lb Rear Suspension	665174		...	...	010	85060 ...
		800670		...	...	010	85060 ...
02 - 08	Models with Hendrickson HMX 400/460 Haulmax with 16.5" Saddle	60680-004		...	...	01-	83143 ...
		60680-004L		...	...	01-	83143 ...
02 - 08	Models with Hendrickson HMX 400/460 Haulmax with 17.5" & 18.5" Saddle	60680-005		...	...	01-	83142 ...
		60680-005L		...	...	01-	83142 ...
87 - 08	Models with Neway ARD 125/244-8 Models Rear Air Suspension	90044011		...	...	010	85004 ...
02 - 08	Models with Peterbilt Low Air Leaf Suspension	03-08781		...	...	01-	85069 89455
		C71-1017		...	...	01-	85069 89455
87 - 01	Models with Peterbilt Low Air Leaf Suspension	03-07423		...	...	010	85033 89427
		665633		...	...	010	85033 89427

#### 359 Series

81 - 87	359 Conventional Models with 12000 lb capacity	02-00376	010	85302	89420	...	...
		02-00495	010	85302	89420	...	...
		02-02736	010	85302	89420	...	...
81 - 87	Models with Air Trac Suspension (46,000 lb)	03-07421		...	...	010	85311 89424





#### 362 Series

	C.O.E. Models with 12000 lb capacity	02-02736	010	85302	89420	...	...
	C.O.E. Models with 14600 lb Taper Leaf Springs and Set Back Front Axle	02-02740	010	85036	89405	...	...
81 - 06	C.O.E. Models with Progressive Springs	02-02738	010	85012	89413	...	...
		B71-6016	010	85012	89413	...	...
		B71-6016A	010	85012	89413	...	...
81 - 06	C.O.E. Models without Set Back Front Axle	02-00376	010	85302	89420	...	...
		02-00495	010	85302	89420	...	...
- 11/82	Models with Air Trac Suspension (38000 or 40000 lb)	03-04176		...	...	010	85308 89422
81 - 06	Models with Air Trac Suspension (46,000 lb)	03-07421		...	...	010	85311 89424
81 - 06	Models with Chalmers 40,000 lb Rear Suspension	665174		...	...	010	85060 ...
		800670		...	...	010	85060 ...
81 - 06	Models with Neway ARD 125/244-8 Models Rear Air Suspension	90044011		...	...	010	85004 ...
02 - 06	Models with Peterbilt Low Air Leaf Suspension	03-08781		...	...	01-	85069 89455
		C71-1017		...	...	01-	85069 89455
81 - 01	Models with Peterbilt Low Air Leaf Suspension	03-07423		...	...	010	85033 89427
		665633		...	...	010	85033 89427

#### 365 Series

08 - 20	Models with 12,000 lb to 14,600 lb Taperleaf Spring Suspension and Set Forward Front Axle.	B71-6007	010	85062	89408	...	...
08 - 15	Models with 12,000 lb to 16,000 lb Taperleaf Front Suspension (Set-Back Axle)	B71-6002	010	85012	89413	...	...
		B71-6013	010	85012	89413	...	...
08 - 20	Models with 18,000 lb to 23,000 lb Taperleaf Front Spring Suspension and Set Forward Front Axle.	02-02742	010	85062	89408	...	...

**APPLICATION GUIDE - TRUCKS, TRAILERS, AND BUSES**

Year Año Année	Model Modelo Modèle	OEM #	Front		Rear	
						
			Fleetline	GasSLX	Fleetline	GasSLX

**PETERBILT(Cont'd.)**





**365 Series(Cont'd.)**

08 - 20	Models with 18,000 lb to 23,000 lb Taperleaf Front Spring Suspension and Set Forward Front Axle.	B71-6011	○ ○	85062	89408		...	...
14 - 20	Models with Air Trac Suspension (40,000 lb)	C71-6003		...	...	- ○	85988	...
08 - 20	Models with Air Trac Suspension (46,000 lb)	03-07421		...	...	- ○	85311	89424
		C71-6002		...	...	- ○	85311	89424
08 - 19	Models with Chalmers 40,000 lb Rear Suspension	665174		...	...	○ ○	85060	...
		800670		...	...	○ ○	85060	...
08 - 20	Models with FlexAir Suspension (38000 lb)	C71-1002		...	...	○ ○	85067	89451
		C71-1016		...	...	○ ○	85067	89451
		C71-6000		...	...	○ ○	85067	89451
		C71-6015		...	...	○ ○	85067	89451
08 - 20	Models with Hendrickson HMX 400/460 Haulmax with 16.5" Saddle	60680-004		...	...	○ -	83143	...
		60680-004L		...	...	○ -	83143	...
08 - 20	Models with Hendrickson HMX 400/460 Haulmax with 17.5" & 18.5" Saddle	60680-005		...	...	○ -	83142	...
		60680-005L		...	...	○ -	83142	...
- 2020	Models with Neway ADZ Rear Suspension	471700004423		...	...	○ ○	85109	...
		90045605		...	...	○ ○	85109	...
08 - 20	Models with Peterbilt Low Air Leaf Suspension	03-08781		...	...	- -	85069	89455
		C71-1011		...	...	- -	85069	89455
		C71-1017		...	...	- -	85069	89455
		C71-6005		...	...	- -	85069	89455
08 - 12	Models with Quadraflex 4 Spring Rear Suspension	03-07420		...	...	- -	85336	...
10 - 19	Models with Reyco 102AR (Standard) Rear Air Suspension	12887-01		...	...	○ ○	85013	89414
		12887-02		...	...	○ ○	85013	89414
10 - 19	Models with Reyco 79KB Rear Steel Spring Suspension	16725-01		...	...	○ ○	83126	89440
		19495-01		...	...	○ ○	83126	89440
		TK19679		...	...	○ ○	83126	89440

**367 Series**

08 - 16	Models with 10,000 lb to 16,000 lb Taperleaf Front Spring Suspension and with Set Back Front Axle.	B71-6002	○ ○	85012	89413		...	...
		B71-6016	○ ○	85012	89413		...	...
14 - 20	Models with 12,000 lb to 14,600 lb Taperleaf Spring Suspension and Set Forward Front Axle.	B71-6009	○ ○	85062	89408		...	...
08 - 20	Models with 18,000 lb to 23,000 lb Taperleaf Front Spring Suspension and Set Forward Front Axle.	02-02742	○ ○	85062	89408		...	...
		B71-6007	○ ○	85062	89408		...	...
		B71-6011	○ ○	85062	89408		...	...
14 - 20	Models with Air Trac Suspension (40,000 lb)	C71-6003		...	...	- ○	85988	...
08 - 20	Models with Air Trac Suspension (46,000 lb)	03-07421		...	...	- ○	85311	89424
		C71-6002		...	...	- ○	85311	89424
	Models with Air Track Tri Drive Suspension	03-08350		...	...	- ○	85343	...
		C71-6004		...	...	- ○	85343	...
08 - 19	Models with Chalmers 40,000 lb Rear Suspension	665174		...	...	○ ○	85060	...
		800670		...	...	○ ○	85060	...
08 - 20	Models with FlexAir Suspension (38000 lb)	C71-1002		...	...	○ ○	85067	89451
		C71-1016		...	...	○ ○	85067	89451
		C71-6000		...	...	○ ○	85067	89451
		C71-6015		...	...	○ ○	85067	89451
08 - 19	Models with Hendrickson HMX 400/460 Haulmax with 16.5" Saddle	60680-004		...	...	○ -	83143	...
		60680-004L		...	...	○ -	83143	...
08 - 19	Models with Hendrickson HMX 400/460 Haulmax with 17.5" & 18.5" Saddle	60680-005		...	...	○ -	83142	...
		60680-005L		...	...	○ -	83142	...
- 2020	Models with Neway ADZ Rear Suspension	471700004423		...	...	○ ○	85109	...

**APPLICATION GUIDE - TRUCKS, TRAILERS, AND BUSES**

Year Año Année	Model Modelo Modèle	OEM #	Front		Rear	
						
			Fleetline	GasSLX	Fleetline	GasSLX

**PETERBILT(Cont'd.)**

**367 Series(Cont'd.)**

- 2020	Models with Neway ADZ Rear Suspension	90045605		...	...	0 0	85109	...
08 - 20	Models with Peterbilt Low Air Leaf Suspension	03-08781		...	...	- -	85069	89455
		C71-1011		...	...	- -	85069	89455
		C71-1017		...	...	- -	85069	89455
08 - 10	Models with Quadraflex 4 Spring Rear Suspension	03-07420		...	...	- -	85336	...

**372 Series**

89 - 93	C.O.E. Models with Front Air Suspension	02-02739	0 0	85013	89414		...	...
89 - 93	C.O.E. Models with Front Spring Suspension	02-02738	0 0	85012	89413		...	...
		B71-6016	0 0	85012	89413		...	...
		B71-6016A	0 0	85012	89413		...	...
89 - 93	Models with Air Trac Suspension (46,000 lb)	03-07421		...	...	- 0	85311	89424
89 - 93	Models with Chalmers 40,000 lb Rear Suspension	665174		...	...	0 0	85060	...
		800670		...	...	0 0	85060	...
89 - 93	Models with Neway ARD 125/244-8 Models Rear Air Suspension	90044011		...	...	0 0	85004	...
89 - 93	Models with Peterbilt Low Air Leaf Suspension	03-07423		...	...	- 0	85033	89427
		665633		...	...	- 0	85033	89427

**375 Series**

87 - 96	Conventional Models with Front Air Suspension and Set Back Front Axle.	02-02739	0 0	85013	89414		...	...
87 - 96	Conventional Models with Front Air Suspension and without Set Back Front Axle.	02-02740	0 0	85036	89405		...	...
87 - 96	Conventional Models with Spring Suspension and with Set Back Front Axle.	02-02738	0 0	85012	89413		...	...
		02-02741	0 0	85012	89413		...	...
		B71-6016	0 0	85012	89413		...	...
		B71-6016A	0 0	85012	89413		...	...
87 - 96	Models with 12,000 lb to 14,600 lb Taperleaf Spring Suspension and Set Forward Front Axle.	02-02737	0 0	85062	89408		...	...
		B71-6007	0 0	85062	89408		...	...
		B71-6009	0 0	85062	89408		...	...
87 - 96	Models with 18,000 lb to 23,000 lb Taperleaf Front Spring Suspension and Set Forward Front Axle.	02-02742	0 0	85062	89408		...	...
		B71-6011	0 0	85062	89408		...	...
87 - 96	Models with Air Trac Suspension (46,000 lb)	03-07421		...	...	- 0	85311	89424
87 - 96	Models with Chalmers 40,000 lb Rear Suspension	665174		...	...	0 0	85060	...
		800670		...	...	0 0	85060	...
87 - 96	Models with Neway ARD 125/244-8 Models Rear Air Suspension	90044011		...	...	0 0	85004	...
87 - 96	Models with Peterbilt Low Air Leaf Suspension	03-07423		...	...	- 0	85033	89427
		665633		...	...	- 0	85033	89427

**376 Series**

88 - 03	Conventional Models with Front Air Suspension and Set Back Front Axle.	02-02739	0 0	85013	89414		...	...
88 - 03	Conventional Models with Front Air Suspension and without Set Back Front Axle.	02-02740	0 0	85036	89405		...	...
88 - 03	Conventional Models with Spring Suspension and with Set Back Front Axle.	02-02738	0 0	85012	89413		...	...
		02-02741	0 0	85012	89413		...	...
		B71-6016	0 0	85012	89413		...	...
		B71-6016A	0 0	85012	89413		...	...
88 - 03	Models with 12,000 lb to 14,600 lb Taperleaf Spring Suspension and Set Forward Front Axle.	02-02737	0 0	85062	89408		...	...
		B71-6007	0 0	85062	89408		...	...
		B71-6009	0 0	85062	89408		...	...
88 - 03	Models with 18,000 lb to 23,000 lb Taperleaf Front Spring Suspension and Set Forward Front Axle.	02-02742	0 0	85062	89408		...	...
		B71-6011	0 0	85062	89408		...	...
88 - 03	Models with Air Trac Suspension (46,000 lb)	03-07421		...	...	- 0	85311	89424

## APPLICATION GUIDE - TRUCKS, TRAILERS, AND BUSES

Year Año Année	Model Modelo Modèle	OEM #	Front		Rear	
			Fleetline	GasSLX	Fleetline	GasSLX

### PETERBILT(Cont'd.)

#### 376 Series(Cont'd.)

88 - 03	Models with Chalmers 40,000 lb Rear Suspension	665174	...	...	010	85060	...
		800670	...	...	010	85060	...
88 - 03	Models with Neway ARD 125/244-8 Models Rear Air Suspension	90044011	...	...	010	85004	...
88 - 03	Models with Peterbilt Low Air Leaf Suspension	03-07423	...	...	-10	85033	89427
		665633	...	...	-10	85033	89427

#### 377 Series

87 - 01	Conventional Models with Front Air Suspension and Set Back Front Axle.	02-02739	010	85013	89414		...	...
87 - 01	Conventional Models with Front Air Suspension and without Set Back Front Axle.	02-02740	010	85036	89405		...	...
87 - 01	Conventional Models with Spring Suspension and with Set Back Front Axle.	02-02738	010	85012	89413		...	...
		02-02741	010	85012	89413		...	...
87 - 01	Models with 12,000 lb to 14,600 lb Taperleaf Spring Suspension and Set Forward Front Axle.	02-02737	010	85062	89408		...	...
		B71-6007	010	85062	89408		...	...
		B71-6009	010	85062	89408		...	...
87 - 01	Models with 18,000 lb to 23,000 lb Taperleaf Front Spring Suspension and Set Forward Front Axle.	02-02742	010	85062	89408		...	...
87 - 01	Models with 18,000 lb to 23,000 lb Taperleaf Spring Suspension and Set Forward Axles	B71-6011	010	85062	89408		...	...
87 - 01	Models with Air Trac Suspension (46,000 lb)	03-07421		...	...	-10	85311	89424
87 - 01	Models with Chalmers 40,000 lb Rear Suspension	665174		...	...	010	85060	...
		800670		...	...	010	85060	...
87 - 01	Models with Neway ARD 125/244-8 Models Rear Air Suspension	90044011		...	...	010	85004	...
87 - 01	Models with Peterbilt Low Air Leaf Suspension	03-07423		...	...	-10	85033	89427
		665633		...	...	-10	85033	89427

#### 378 Series

	Conventional Models with Front Air Suspension and Set Back Front Axle.	02-02739	010	85013	89414		...	...
	Conventional Models with Front Air Suspension and without Set Back Front Axle.	02-02740	010	85036	89405		...	...
88 - 07	Conventional Models with Spring Suspension and with Set Back Front Axle.	02-02738	010	85012	89413		...	...
		02-02741	010	85012	89413		...	...
		B71-6016	010	85012	89413		...	...
		B71-6016A	010	85012	89413		...	...
88 - 07	Models with 12,000 lb to 14,600 lb Taperleaf Spring Suspension and Set Forward Front Axle.	02-01787	010	85062	89408		...	...
		02-02737	010	85062	89408		...	...
		B71-6007	010	85062	89408		...	...
		B71-6009	010	85062	89408		...	...
88 - 07	Models with 18,000 lb to 23,000 lb Taperleaf Front Spring Suspension and Set Forward Front Axle.	02-02742	010	85062	89408		...	...
		B71-6011	010	85062	89408		...	...
88 - 07	Models with Air Trac Suspension (46,000 lb)	03-07421		...	...	-10	85311	89424
88 - 07	Models with Chalmers 40,000 lb Rear Suspension	665174		...	...	010	85060	...
		800670		...	...	010	85060	...
99 - 07	Models with FlexAir Suspension (38000 lb)	C71-1002		...	...	010	85067	89451
		C71-6000		...	...	010	85067	89451
88 - 07	Models with Neway ARD 125/244-8 Models Rear Air Suspension	90044011		...	...	010	85004	...
- 2003	Models with Peterbilt Low Air Leaf Suspension	03-07423		...	...	-10	85033	89427
		665633		...	...	-10	85033	89427
03 - 07	Models with Peterbilt Low Air Leaf Suspension	03-08781		...	...	-1-	85069	89455
		C71-1017		...	...	-1-	85069	89455



## APPLICATION GUIDE - TRUCKS, TRAILERS, AND BUSES

Year Año Année	Model Modelo Modèle	OEM #	Front		Rear	
			 Fleetline	 GasSLX	 Fleetline	 GasSLX

### PETERBILT(Cont'd.)

#### 379 Series(Cont'd.)

	Conventional Models with Front Air Suspension and Set Back Front Axle.	02-02739	010	<b>85013</b>	<b>89414</b>		...	...
	Conventional Models with Front Air Suspension and without Set Back Front Axle.	02-02740	010	<b>85036</b>	<b>89405</b>		...	...
85 - 09	Conventional Models with Spring Suspension and with Set Back Front Axle.	02-01890	010	<b>85012</b>	<b>89413</b>		...	...
		02-02738	010	<b>85012</b>	<b>89413</b>		...	...
		02-02741	010	<b>85012</b>	<b>89413</b>		...	...
		B71-6016	010	<b>85012</b>	<b>89413</b>		...	...
		B71-6016A	010	<b>85012</b>	<b>89413</b>		...	...
85 - 09	Models with 12,000 lb to 14,600 lb Taperleaf Spring Suspension and Set Forward Front Axle.	02-01787	010	<b>85062</b>	<b>89408</b>		...	...
		02-02737	010	<b>85062</b>	<b>89408</b>		...	...
		B71-6007	010	<b>85062</b>	<b>89408</b>		...	...
		B71-6009	010	<b>85062</b>	<b>89408</b>		...	...
85 - 09	Models with 18,000 lb to 23,000 lb Taperleaf Front Spring Suspension and Set Forward Front Axle.	02-02742	010	<b>85062</b>	<b>89408</b>		...	...
		B71-6011	010	<b>85062</b>	<b>89408</b>		...	...
85 - 09	Models with Air Trac Suspension (46,000 lb)	03-07421		...	...	-10	<b>85311</b>	<b>89424</b>
		03-07421SPL		...	...	-10	<b>85311</b>	<b>89424</b>
85 - 09	Models with Chalmers 40,000 lb Rear Suspension	665174		...	...	010	<b>85060</b>	...
		800670		...	...	010	<b>85060</b>	...
99 - 09	Models with FlexAir Suspension (38000 lb)	C71-1002		...	...	010	<b>85067</b>	<b>89451</b>
		C71-6000		...	...	010	<b>85067</b>	<b>89451</b>
	Models with Neway ARD 125/244-8 Models Rear Air Suspension	90044011		...	...	010	<b>85004</b>	...
03 - 09	Models with Peterbilt Low Air Leaf Suspension	03-08781		...	...	-1-	<b>85069</b>	<b>89455</b>
		C71-1011		...	...	-1-	<b>85069</b>	<b>89455</b>
		C71-1017		...	...	-1-	<b>85069</b>	<b>89455</b>
85 - 02	Models with Peterbilt Low Air Leaf Suspension	03-07423		...	...	-10	<b>85033</b>	<b>89427</b>
		665633		...	...	-10	<b>85033</b>	<b>89427</b>





#### 382 Series

2011 -	Models with 10,000 lb to 12,000 lb Front Axle	B71-6005	010	<b>85084</b>	<b>89460</b>		...	...
2011 -	Models with 12,000 lb to 14,600 lb Taperleaf Spring Suspension and Set Forward Front Axle.	02-02737	010	<b>85062</b>	<b>89408</b>		...	...
		B71-6009	010	<b>85062</b>	<b>89408</b>		...	...
11 - 17	Models with Air Trac Suspension (46,000 lb)	03-07421		...	...	-10	<b>85311</b>	<b>89424</b>
		C71-6002		...	...	-10	<b>85311</b>	<b>89424</b>
11 - 17	Models with FlexAir Suspension (38000 lb)	C71-1002		...	...	010	<b>85067</b>	<b>89451</b>
		C71-1016		...	...	010	<b>85067</b>	<b>89451</b>
		C71-6000		...	...	010	<b>85067</b>	<b>89451</b>
		C71-6015		...	...	010	<b>85067</b>	<b>89451</b>
11 - 17	Models with Peterbilt Low Air Leaf Suspension	03-08781		...	...	-1-	<b>85069</b>	<b>89455</b>
		C71-1011		...	...	-1-	<b>85069</b>	<b>89455</b>
		C71-1017		...	...	-1-	<b>85069</b>	<b>89455</b>
11 - 17	Models with Quadraflex 4 Spring Rear Suspension	03-07420		...	...	-1-	<b>85336</b>	...
11 - 17	Models with Reyco 102AR (Standard) Rear Air Suspension	12887-01		...	...	010	<b>85013</b>	<b>89414</b>
		12887-02		...	...	010	<b>85013</b>	<b>89414</b>
11 - 17	Models with Reyco 79KB Rear Steel Spring Suspension	16725-01		...	...	010	<b>83126</b>	<b>89440</b>
		19495-01		...	...	010	<b>83126</b>	<b>89440</b>
		TK19679		...	...	010	<b>83126</b>	<b>89440</b>

#### 384 Series

08 - 12	Models with 12,000 lb to 14,600 lb Taperleaf Spring Suspension and Set Forward Front Axle.	02-02737	010	<b>85062</b>	<b>89408</b>		...	...
13 - 16	Models with 12,000 lb to 14,600 lb Taperleaf Spring Suspension and Set Forward Front Axle. (Std Duty)	B71-6009	010	<b>83219</b>	...		...	...
		B71-6009	010	<b>85062</b>	<b>89408</b>		...	...

**APPLICATION GUIDE - TRUCKS, TRAILERS, AND BUSES**

Year Año Année	Model Modelo Modèle	OEM #	Front		Rear	
						
			Fleetline	GasSLX	Fleetline	GasSLX

**PETERBILT(Cont'd.)**

**384 Series(Cont'd.)**

08 - 16	Models with Air Trac Suspension (46,000 lb)	03-07421	...	...	-10	85311	89424
		C71-6002	...	...	-10	85311	89424
08 - 16	Models with FlexAir Suspension (38000 lb)	C71-1002	...	...	010	85067	89451
		C71-1016	...	...	010	85067	89451
		C71-6000	...	...	010	85067	89451
		C71-6015	...	...	010	85067	89451
08 - 16	Models with Peterbilt Low Air Leaf Suspension	03-08781	...	...	-1-	85069	89455
		C71-1011	...	...	-1-	85069	89455
		C71-1017	...	...	-1-	85069	89455
2008 -	Models with Quadraflex 4 Spring Rear Suspension	03-07420	...	...	-1-	85336	...

**385 Series**

- 2007	Conventional Models with Spring Suspension and with Set Back Front Axle.	02-02738	010	85012	89413		...	...
		02-02741	010	85012	89413		...	...
		B71-6016	010	85012	89413		...	...
		B71-6016A	010	85012	89413		...	...
- 2007	Models with 12,000 lb to 14,600 lb Taperleaf Spring Suspension and Set Forward Front Axle.	02-02737	010	85062	89408		...	...
		B71-6007	010	85062	89408		...	...
		B71-6009	010	85062	89408		...	...
- 2007	Models with 18,000 lb to 23,000 lb Taperleaf Front Spring Suspension and Set Forward Front Axle.	02-02742	010	85062	89408		...	...
		B71-6011	010	85062	89408		...	...
95 - 07	Models with Air Trac Suspension (46,000 lb)	03-07421		...	...	-10	85311	89424
	Models with Chalmers 40,000 lb Rear Suspension	665174 800670		...	...	010	85060	...
95 - 07	Models with FlexAir Suspension (38000 lb)	C71-1002		...	...	010	85067	89451
		C71-6000		...	...	010	85067	89451
	Models with Neway ARD 125/244-8 Models Rear Air Suspension	90044011		...	...	010	85004	...
- 2003	Models with Peterbilt Low Air Leaf Suspension	03-07423		...	...	-10	85033	89427
		665633		...	...	-10	85033	89427
04 - 07	Models with Peterbilt Low Air Leaf Suspension	03-08781		...	...	-1-	85069	89455
		C71-1017		...	...	-1-	85069	89455
	Models with Quadraflex 4 Spring Rear Suspension	03-07420		...	...	-1-	85336	...

**386 Series**

2006 -	Conventional Models with Front Air Suspension and Set Back Front Axle.	02-02739	010	85013	89414		...	...
2006 -	Conventional Models with Front Air Suspension and without Set Back Front Axle.	02-02740	010	85036	89405		...	...
06 - 16	Conventional Models with Spring Suspension and with Set Back Front Axle.	02-02738	010	85012	89413		...	...
		02-02741	010	85012	89413		...	...
		02-04010	010	85012	89413		...	...
		B71-6016	010	85012	89413		...	...
		B71-6016A	010	85012	89413		...	...
		B71-6018	010	85012	89413		...	...
06 - 16	Models with 12,000 lb to 14,600 lb Taperleaf Spring Suspension and Set Forward Front Axle.	02-02737	010	85062	89408		...	...
		B71-6007	010	85062	89408		...	...
		B71-6009	010	85062	89408		...	...
06 - 16	Models with 18,000 lb to 23,000 lb Taperleaf Front Spring Suspension and Set Forward Front Axle.	02-02742	010	85062	89408		...	...
		B71-6011	010	85062	89408		...	...
13 - 16	Models with Air Trac Suspension (40,000 lb)	C71-6003		...	...	-10	85988	...
06 - 16	Models with Air Trac Suspension (46,000 lb)	03-07421		...	...	-10	85311	89424
06 - 16	Models with FlexAir Suspension (38000 lb)	C71-1002		...	...	010	85067	89451
		C71-1016		...	...	010	85067	89451

## APPLICATION GUIDE - TRUCKS, TRAILERS, AND BUSES

Year Año Année	Model Modelo Modèle	OEM #	Front		Rear	
			Fleetline	GasSLX	Fleetline	GasSLX

### PETERBILT(Cont'd.)

#### 386 Series(Cont'd.)

06 - 16	Models with FlexAir Suspension (38000 lb)	C71-6000 C71-6015		...	...	010	85067	89451
								010
06 - 16	Models with Peterbilt Air Leaf Suspension	03-07421 C71-6002		...	...	-10	85311	89424
				...	...	-10	85311	89424
06 - 16	Models with Peterbilt Low Air Leaf Suspension	03-08781 C71-1011 C71-1017		...	...	-1-	85069	89455
				...	...	-1-	85069	89455
				...	...	-1-	85069	89455





#### 387 Series

- 2009	Conventional Models with Front Air Suspension and Set Back Front Axle.	02-02739	010	85013	89414		...	...
- 2009	Conventional Models with Front Air Suspension and without Set Back Front Axle.	02-02740	010	85036	89405		...	...
- 2011	Conventional Models with Spring Suspension and with Set Back Front Axle.	02-02738	010	85012	89413		...	...
		02-02741	010	85012	89413		...	...
		02-04010	010	85012	89413		...	...
		B71-6016	010	85012	89413		...	...
		B71-6016A B71-6018	010	85012	89413		...	...
- 2011	Models with 12,000 lb to 14,600 lb Taperleaf Spring Suspension and Set Forward Front Axle.	02-02737	010	85062	89408		...	...
		B71-6007	010	85062	89408		...	...
		B71-6009	010	85062	89408		...	...
- 2011	Models with 18,000 lb to 23,000 lb Taperleaf Front Spring Suspension and Set Forward Front Axle.	02-02742	010	85062	89408		...	...
		B71-6011	010	85062	89408		...	...
00 - 11	Models with FlexAir Suspension (38000 lb)	C71-1002		...	...	010	85067	89451
		C71-6000		...	...	010	85067	89451
00 - 11	Models with Peterbilt Air Leaf Suspension	03-07421		...	...	-10	85311	89424
- 2003	Models with Peterbilt Low Air Leaf Suspension	03-07423		...	...	-10	85033	89427
		665633		...	...	-10	85033	89427
03 - 11	Models with Peterbilt Low Air Leaf Suspension	03-08781		...	...	-1-	85069	89455
		C71-1011		...	...	-1-	85069	89455
		C71-1017		...	...	-1-	85069	89455

#### 388 Series

08 - 16	Conventional Models with Front Air Suspension and Set Back Front Axle.	02-02739	010	85013	89414		...	...
		85013A0C	010	85013	89414		...	...
2008 -	Conventional Models with Front Air Suspension and without Set Back Front Axle.	02-02740	010	85036	89405		...	...
2008 -	Conventional Models with Spring Suspension and with Set Back Front Axle.	02-04010	010	85012	89413		...	...
		B71-6018	010	85012	89413		...	...
08 - 17	Models with 12,000 lb to 14,600 lb Taperleaf Spring Suspension and Set Forward Front Axle.	B71-6007	010	85062	89408		...	...
13 - 17	Models with 12,000 lb to 14,600 lb Taperleaf Spring Suspension and Set Forward Front Axle. (Heavy Duty) (Std Duty)	B71-6009	010	85062	89408		...	...
		B71-6009	010	83219	...		...	...
08 - 17	Models with 18,000 lb to 23,000 lb Taperleaf Front Spring Suspension and Set Forward Front Axle.	02-02742	010	85062	89408		...	...
		B71-6011	010	85062	89408		...	...
14 - 17	Models with Air Trac Suspension (40,000 lb)	C71-6003		...	...	-10	85988	...
08 - 17	Models with Air Trac Suspension (46,000 lb)	03-07421		...	...	-10	85311	89424
		C71-6002		...	...	-10	85311	89424
08 - 17	Models with FlexAir Suspension (38000 lb)	C71-1002		...	...	010	85067	89451
		C71-1016		...	...	010	85067	89451
		C71-6000		...	...	010	85067	89451

**APPLICATION GUIDE - TRUCKS, TRAILERS, AND BUSES**

Year Año Année	Model Modelo Modèle	OEM #	Front		Rear	
						
			Fleetline	GasSLX	Fleetline	GasSLX

**PETERBILT(Cont'd.)**

**388 Series(Cont'd.)**

08 - 17	Models with FlexAir Suspension (38000 lb)	C71-6015	...	...	010	85067	89451
- 2017	Models with Hendrickson HMX 400/460 Haulmax with 16.5" Saddle	60680-004	...	...	01-	83143	...
		60680-004L	...	...	01-	83143	...
- 2017	Models with Hendrickson HMX 400/460 Haulmax with 17.5" & 18.5" Saddle	60680-005	...	...	01-	83142	...
		60680-005L	...	...	01-	83142	...
08 - 17	Models with Peterbilt Air Leaf Suspension	03-07421	...	...	-10	85311	89424
		03-07421PLUS	...	...	-10	85311	89424
08 - 17	Models with Peterbilt Low Air Leaf Suspension	03-08781	...	...	-1-	85069	89455
		C71-1011	...	...	-1-	85069	89455
		C71-1017	...	...	-1-	85069	89455





**389 Series**

2008 -	Conventional Models with Front Air Suspension and Set Back Front Axle.	02-02739	010	85013	89414	...	...
2008 -	Conventional Models with Front Air Suspension and without Set Back Front Axle.	02-02740	010	85036	89405	...	...
2008 -	Conventional Models with Spring Suspension and with Set Back Front Axle.	02-04010	010	85012	89413	...	...
		B71-6018	010	85012	89413	...	...
08 - 20	Models with 12,000 lb to 14,600 lb Taperleaf Spring Suspension and Set Forward Front Axle.	02-02737	010	85062	89408	...	...
		B71-6007	010	85062	89408	...	...
		B71-6009	010	85062	89408	...	...
08 - 20	Models with 18,000 lb to 23,000 lb Taperleaf Front Spring Suspension and Set Forward Front Axle.	02-02742	010	85062	89408	...	...
		B71-6011	010	85062	89408	...	...
14 - 20	Models with Air Trac Suspension (40,000 lb)	C71-6003	...	...	-10	85988	...
14 - 20	Models with Air Trac Suspension (46,000 lb)	C71-6002	...	...	-10	85311	89424
08 - 20	Models with FlexAir Suspension (38000 lb)	C71-1002	...	...	010	85067	89451
		C71-1016	...	...	010	85067	89451
		C71-6000	...	...	010	85067	89451
		C71-6015	...	...	010	85067	89451
08 - 20	Models with Hendrickson HMX 400/460 Haulmax with 16.5" Saddle	60680-004	...	...	01-	83143	...
		60680-004L	...	...	01-	83143	...
08 - 20	Models with Hendrickson HMX 400/460 Haulmax with 17.5" & 18.5" Saddle	60680-005	...	...	01-	83142	...
		60680-005L	...	...	01-	83142	...
08 - 19	Models with Hendrickson HN - 522 Rear Suspension	60680-003	...	...	01-	83112	...
		60680-003L	...	...	01-	83112	...
14 - 20	Models with Neway ADZ Rear Suspension	471700004423	...	...	010	85109	...
		90045605	...	...	010	85109	...
08 - 13	Models with Peterbilt Air Leaf Suspension	03-07421	...	...	-10	85311	89424
08 - 20	Models with Peterbilt Low Air Leaf Suspension	03-08781	...	...	-1-	85069	89455
		C71-1011	...	...	-1-	85069	89455
		C71-1017	...	...	-1-	85069	89455

**520 Series**

17 - 20	Models with 18,000 lb to 23,000 lb Taperleaf Front Spring Suspension and Set Forward Front Axle.	B71-6011	010	85062	89408	...	...
17 - 20	Models with Air Trac Suspension (40,000 lb)	C71-6003	...	...	-10	85988	...
17 - 20	Models with Air Trac Suspension (46,000 lb)	C71-6002	...	...	-10	85311	89424
17 - 20	Models with Hendrickson HMX 400/460 Haulmax with 16.5" Saddle	60680-004	...	...	01-	83143	...
		60680-004L	...	...	01-	83143	...
17 - 20	Models with Hendrickson HMX 400/460 Haulmax with 17.5" & 18.5" Saddle	60680-005	...	...	01-	83142	...
		60680-005L	...	...	01-	83142	...
17 - 19	Models with Neway AD-252-10 Tandem Axle	90045132	...	...	010	85909	...

**APPLICATION GUIDE - TRUCKS, TRAILERS, AND BUSES**

Year Año Année	Model Modelo Modèle	OEM #	Front		Rear	
						
			Fleetline	GasSLX	Fleetline	GasSLX

**PETERBILT(Cont'd.)**

**520 Series(Cont'd.)**

17 - 20	Models with Neway ADZ Rear Suspension	47170004423	...	...	010	85109	...
		90045605	...	...	010	85109	...
17 - 20	Models with Peterbilt Low Air Leaf Suspension	C71-1011	...	...	-1-	85069	89455
		C71-1017	...	...	-1-	85069	89455
17 - 19	Models with Reyco 102AR (Standard) Rear Air Suspension	12887-01	...	...	010	85013	89414
		12887-02	...	...	010	85013	89414
17 - 19	Models with Reyco 79KB Rear Steel Spring Suspension	16725-01	...	...	010	83126	89440
		19495-01	...	...	010	83126	89440
		TK19679	...	...	010	83126	89440





**567 Series**

14 - 19	Models with 10,000 lb to 14,600 lb Taperleaf Springs and Set Back Front Axles	B71-6019	010	85989	...	...	...
14 - 20	Models with 12,000 lb to 14,600 lb Taperleaf Spring Suspension and Set Forward Front Axle.	B71-6009	010	85062	89408	...	...
14 - 20	Models with 18,000 lb to 23,000 lb Taperleaf Spring Suspension and Set Forward Axles	B71-6011	010	85062	89408	...	...
14 - 19	Models with 20,000 lb Taperleaf Springs and Set Back Front Axles	B71-6020	010	85989	...	...	...
14 - 20	Models with Air Trac Suspension (40,000 lb)	C71-6003		...	...	-10	85988
14 - 20	Models with Air Trac Suspension (46,000 lb)	C71-6002		...	...	-10	85311
14 - 19	Models with Chalmers 40,000 lb Rear Suspension	665174		...	...	010	85060
		800670		...	...	010	85060
14 - 20	Models with FlexAir Suspension (38000 lb)	C71-1016		...	...	010	85067
		C71-6015		...	...	010	85067
14 - 20	Models with Hendrickson HMX 400/460 Haulmax with 16.5" Saddle	60680-004		...	...	01-	83143
		60680-004L		...	...	01-	83143
14 - 20	Models with Hendrickson HMX 400/460 Haulmax with 17.5" & 18.5" Saddle	60680-005		...	...	01-	83142
		60680-005L		...	...	01-	83142
14 - 20	Models with Neway ADZ Rear Suspension	47170004423		...	...	010	85109
		90045605		...	...	010	85109
14 - 20	Models with Peterbilt Low Air Leaf Suspension	C71-1017		...	...	-1-	85069
		C71-6005		...	...	-1-	85069

**579 Series**

13 - 16	Day Cab Models with 10,000 lb to 12,000 lb Front Axle	B71-6005	010	85084	89460	...	...
13 - 20	Models with 10,000 lb to 14,600 lb Taperleaf Springs and Set Back Front Axles	B71-6019	010	85989	...	...	...
13 - 18	Models with 12,000 lb to 14,600 lb Taperleaf Spring Suspension and Set Forward Front Axle.	02-02737	010	85062	89408	...	...
		B71-6009	010	85062	89408	...	...
14 - 19	Models with Air Trac Suspension (40,000 lb)	C71-6003		...	...	-10	85988
13 - 19	Models with Air Trac Suspension (46,000 lb)	03-07421		...	...	-10	85311
		C71-6002		...	...	-10	85311
13 - 20	Models with FlexAir Suspension (38000 lb)	C71-1002		...	...	010	85067
		C71-1016		...	...	010	85067
		C71-6000		...	...	010	85067
		C71-6015		...	...	010	85067
13 - 18	Models with Neway ADZ Rear Suspension	47170004423		...	...	010	85109
		90045605		...	...	010	85109
2013 -	Models with Peterbilt Front Air Leaf Suspension	B71-6000	010	85959	...	...	...
13 - 20	Models with Peterbilt Low Air Leaf Suspension	03-08781		...	...	-1-	85069
		C71-1011		...	...	-1-	85069
		C71-1017		...	...	-1-	85069
		C71-6005		...	...	-1-	85069
13 - 19	Models with Reyco 102AR (Standard) Rear Air Suspension	12887-01		...	...	010	85013
		12887-02		...	...	010	85013

## APPLICATION GUIDE - TRUCKS, TRAILERS, AND BUSES

Year Año Année	Model Modelo Modèle	OEM #	Front		Rear	
						
			Fleetline	GasSLX	Fleetline	GasSLX

### PETERBILT(Cont'd.)

#### 579 Series(Cont'd.)

13 - 19	Models with Reyco 79KB Rear Steel Spring Suspension	16725-01	...	...	OIO	83126	89440
		19495-01	...	...	OIO	83126	89440
		TK19679	...	...	OIO	83126	89440

#### 587 Series

11 - 16	Models with 12,000 lb to 14,600 lb Taperleaf Spring Suspension and Set Forward Front Axle.	02-02737	OIO	85062	89408	...	...
		B71-6009	OIO	85062	89408	...	...
11 - 18	Models with Air Trac Suspension (46,000 lb)	03-07421	...	...	-IO	85311	89424
		C71-6002	...	...	-IO	85311	89424
11 - 18	Models with FlexAir Suspension (38000 lb)	C71-1002	...	...	OIO	85067	89451
		C71-1016	...	...	OIO	85067	89451
		C71-6000	...	...	OIO	85067	89451
		C71-6015	...	...	OIO	85067	89451
11 - 13	Models with Peterbilt Front Air Leaf Suspension	B71-6000	OIO	85959	...	...	...
11 - 18	Models with Peterbilt Low Air Leaf Suspension	03-08781	...	...	-I-	85069	89455
		C71-1011	...	...	-I-	85069	89455
		C71-1017	...	...	-I-	85069	89455
11 - 18	Models with Quadraflex 4 Spring Rear Suspension	03-07420	...	...	-I-	85336	...
11 - 18	Models with Reyco 102AR (Standard) Rear Air Suspension	12887-01	...	...	OIO	85013	89414
		12887-02	...	...	OIO	85013	89414
11 - 18	Models with Reyco 79KB Rear Steel Spring Suspension	16725-01	...	...	OIO	83126	89440
		19495-01	...	...	OIO	83126	89440
		TK19679	...	...	OIO	83126	89440

#### Additional Applications

	OE PLUS Shock Stamping Number	02-02736PLUS	OIO	85302	89420	...	...
		02-02737PLUS	OIO	85062	89408	...	...
		02-02738PLUS	OIO	85012	89413	...	...
		02-02739PLUS	OIO	85013	89414	...	...
		03-04176PLUS	...	...	OIO	85308	89422
		03-06084PLUS	...	...	-IO	85033	89427
		03-07421PLUS	...	...	-IO	85311	89424
		03-07423PLUS	...	...	-IO	85033	89427
		10-12032-002PLUS	OIO	85320	89429	...	...
		10-12542-000PLUS	OIO	85901	...	...	...
		16-13947-000PLUS	...	...	-IO	85319	89428
		2018987C1PLUS	...	...	OIO	85003	89411
		47902-13PLUS	...	...	OIO	83122	89406
		60670-005PLUS	...	...	OIO	83137	...
		60670-008PLUS	...	...	OIO	83123	89405
		665565PLUS	...	...	OIO	85007	...
		671962PLUS	...	...	OI-	85936	89456
		70701PLUS	...	...	-I-	85900	...
		8086053PLUS	...	...	OIO	85047	89435
		90044025PLUS	OIO	83209	89414	...	...
		90044089PLUS	...	...	OIO	83124	89407
		B71-6015	OIO	85012	89413	...	...
		C71-1002PLUS	...	...	OIO	85067	89451
		C71-1011PLUS	...	...	-I-	85069	89455
		K374-26PLUS	OIO	85001	89410	...	...
		K374-28PLUS	...	...	OIO	85314	89425
		K374-29PLUS	...	...	-I-	85310	89423
		K374-33PLUS	OIO	83312	89409	...	...
	TruckMaster Shock Stamping Number	665632	OIO	85013	89414	...	...
		665783	...	...	OIO	83123	89405
		665784	...	...	OIO	83122	89406

## APPLICATION GUIDE - TRUCKS, TRAILERS, AND BUSES





Year Año Année	Model Modelo Modèle	OEM #	Front		Rear	
			Fleetline	GasSLX	Fleetline	GasSLX

### PETERBILT(Cont'd.)

#### Additional Applications(Cont'd.)

TruckMaster Shock Stamping Number	665785		...	...	010	<b>83137</b>	...	
	665844		...	...	-1-	<b>85069</b>	<b>89455</b>	
	665918		...	...	-1-	<b>85900</b>	...	
	665926		...	...	010	<b>85047</b>	<b>89435</b>	
	665927	010	<b>85901</b>	...		...	...	
	665928	010	<b>85062</b>	<b>89408</b>		...	...	
	665930	010	<b>85001</b>	<b>89410</b>		...	...	
	665931	010	<b>83312</b>	<b>89409</b>		...	...	
	665932	010	<b>85012</b>	<b>89413</b>		...	...	
	665950		...	...	-1-	<b>85902</b>	...	
	671052	010	<b>85070</b>	<b>89459</b>		...	...	
	671654		...	...	01-	<b>85936</b>	<b>89456</b>	
	671699		...	...	01-	<b>85937</b>	...	
	671794		...	...	010	<b>85067</b>	<b>89451</b>	
	680237		...	...	010	<b>85303</b>	<b>89422</b>	
	680239		...	...	-1-	<b>85310</b>	<b>89423</b>	
	680240		...	...	010	<b>85302</b>	<b>89420</b>	
	680242		...	...	010	<b>85308</b>	<b>89422</b>	
	680253		...	...	010	<b>85314</b>	<b>89425</b>	
	680261	010	<b>85062</b>	<b>89408</b>		...	...	
	680279	010	<b>83209</b>	<b>89414</b>		...	...	
	680280		...	...	010	<b>85906</b>	<b>89407</b>	
	680281		...	...	010	<b>85003</b>	<b>89411</b>	
	680303		...	...	010	<b>85007</b>	...	
	680425	010	<b>85320</b>	<b>89429</b>		...	...	
	680435		...	...	-10	<b>85033</b>	<b>89427</b>	
	680473		...	...	-10	<b>85319</b>	<b>89428</b>	
	Models with O.E.M. Number	02-01759	010	<b>83312</b>	<b>89409</b>		...	...
		02-01890	010	<b>85012</b>	<b>89413</b>		...	...
		02-02061	010	<b>85013</b>	<b>89414</b>		...	...
		02-02142	010	<b>85036</b>	<b>89405</b>		...	...
		02-02225	010	<b>85012</b>	<b>89413</b>		...	...
		03-01635		...	...	010	<b>85308</b>	<b>89422</b>
03-04629			...	...	-10	<b>85311</b>	<b>89424</b>	
03-05106			...	...	-10	<b>85033</b>	<b>89427</b>	
03-05384			...	...	-10	<b>85033</b>	<b>89427</b>	
03-06084			...	...	-10	<b>85033</b>	<b>89427</b>	
03-07281			...	...	-10	<b>85311</b>	<b>89424</b>	
03-07424			...	...	-10	<b>85311</b>	<b>89424</b>	
03-07424PLUS			...	...	-10	<b>85311</b>	<b>89424</b>	
23-08233			...	...	010	<b>85308</b>	<b>89422</b>	
23-10393			...	...	010	<b>85308</b>	<b>89422</b>	
23-12262		010	<b>85012</b>	<b>89413</b>		...	...	
665133			...	...	010	<b>83203</b>	<b>89436</b>	
665617		010	<b>85031</b>	...		...	...	
665655		010	<b>85062</b>	<b>89408</b>		...	...	
665656		010	<b>85012</b>	<b>89413</b>		...	...	
665657		010	<b>85013</b>	<b>89414</b>		...	...	
665658		010	<b>85036</b>	<b>89405</b>		...	...	
665660			...	...	-10	<b>85033</b>	<b>89427</b>	
665662		010	<b>85012</b>	<b>89413</b>		...	...	
665738		010	<b>85910</b>	...		...	...	
665752			...	...	010	<b>85067</b>	<b>89451</b>	
665762		010	<b>85012</b>	<b>89413</b>		...	...	
665788			...	...	010	<b>85000</b>	<b>89436</b>	

## APPLICATION GUIDE - TRUCKS, TRAILERS, AND BUSES

Year Año Année	Model Modelo Modèle	OEM #	Front		Rear	
						
			Fleetline	GasSLX	Fleetline	GasSLX

### PETERBILT(Cont'd.)

#### Additional Applications(Cont'd.)

	Models with O.E.M. Number	665826		...	...	- -	85069	89455
		665858	010	85070	89459		...	...
		665876	010	85959	...		...	...
		665945		...	...	- -	85902	...
		671091		...	...	- -	85069	89455
		671092	010	85012	89413		...	...
		671962SPL		...	...	0 -	85936	89456
		671963		...	...	0 -	85937	...
		680026		...	...	010	85302	89420
		680027		...	...	010	85308	89422
		680185		...	...	010	85308	89422
		680241		...	...	- 0	85311	89424
		680348	010	85012	89413		...	...
		680435		...	...	- 0	85033	89427
		680457	010	85302	89420		...	...
		680458		...	...	- -	85336	...
		680459		...	...	- 0	85311	89424
		680586		...	...	- 0	85311	89424
		B71-1000	010	85031	...		...	...
		B71-1001	010	85070	89459		...	...
		B71-1002	010	85001	89410		...	...
		B71-1003	010	83312	89409		...	...
		B71-6002	010	85012	89413		...	...
		B71-6003	010	85029	...		...	...
		B71-6004	010	85084	89460		...	...
		B71-6008	010	83312	89409		...	...
		C71-1011SPL		...	...	- -	85069	89455
		C71-1013		...	...	0 -	85985	...
C71-1014		...	...	0 -	85936	89456		
C71-6005		...	...	- -	85069	89455		
2013 -	Models with O.E.M. Number	B71-6010	010	85023 or 89415				
	Models with Quadraflex 4 spring rear suspension	03-04628		...	...	- -	85336	...

### PETERBILT CAB SHOCKS

	357, 375, 376, 377 & 378 Conventional Truck & Tractors with Link Cabmate Models PBC377 & PBC377-A	1202-0054	010	83021
1981 -	362 Cabovers with Link Cabmate Model PB-362-2P	1202-0032	010	83016
1978 -	48" Sleepers with Link Bunkmate Model PBS48-A	1202-1044	010	83025
1978 -	63" Sleepers with Link Bunkmate Model PBS63-A	1202-1044	010	83025
	Models with O.E.M. Number	654782	010	83008
		654812	010	83042
		654919	010	83035
		R71-1004	010	83049
		R71-1005	010	83024
	Models with PowerPacker Cab Suspension	96027-1054	010	83011
		PP1058870	010	83059
		PP2582870	010	83012

#### 348 Series





12 - 18	348 Conventional Day Cab with O.E.M. Number	R71-6005	010	83042
- 2020	348 Sleepers with O.E.M. Number	1201-8002	010	83081
		25523024	010	83081
		R71-6009	010	83081

#### 359 Series

81 - 87	359 Conventional Truck & Tractors with Link Cabmate Models PBC379 & PBC379-A	1202-0054	010	83021
---------	--	-----------	-----	-------



## APPLICATION GUIDE - TRUCKS, TRAILERS, AND BUSES

Year Año Année	Model Modelo Modèle	OEM #	Front		Rear	
						
			Fleetline	GasSLX	Fleetline	GasSLX

### PETERBILT CAB SHOCKS(Cont'd.)

#### 359 Series(Cont'd.)

81 - 87	359 Models (Older Models) Conventional Tractors with Link Cabmate Model PBCAL359	1201-0012	010		83023
		1202-0012	010		83023

#### 365 Series

08 - 20	365 Conventional Day Cab with O.E.M. Number	20-16755	010		83042
		R71-6005	010		83042

#### 367 Series

08 - 20	367 Conventional Day Cab with O.E.M. Number	20-16755	010		83042
		R71-6005	010		83042
08 - 20	367 Models with 70" Sleepers	29-02455	010		83008
		R71-6007	010		83008

#### 377 & 379 Series

	377 & 379 Conventional Models with Unibuilt Cab	29-02455	010		83008
		R71-6007	010		83008
	379 Conventional Truck & Tractors with Link Cabmate Models PBC379 & PBC379-A	1202-0054	010		83021

#### 384 Series

08 - 16	384 Conventional Day Cab with O.E.M. Number	20-16755	010		83042
		R71-6005	010		83042

#### 386 Series

06 - 16	386 Conventional Day Cab with O.E.M. Number	20-16755	010		83042
		R71-6005	010		83042
06 - 16	386 Models with Sleepers	29-02455	010		83008
		R71-6007	010		83008

#### 387 Series

1999 -	387 Models with 70" Sleepers	29-06032	010		83035
		R71-6008	010		83035
1999 -	387 Models with O.E.M. Number	29-06005	010		83035
08 - 11	DayCab Models with O.E.M. Number	R71-6000	010		83067
		R71-6010	010		83067

#### 388 Series

08 - 17	388 Conventional Day Cab with O.E.M. Number	20-16755	010		83042
		R71-6005	010		83042
08 - 17	388 Models with 70" Sleepers	29-02455	010		83008
		R71-6007	010		83008

#### 389 Series

08 - 20	389 Conventional Day Cab with O.E.M. Number	20-16755	010		83042
		R71-6005	010		83042
- 2019	389 Day Cab models with O.E.M. Number	20-19140	010		83063
		R71-6006	010		83063
08 - 20	389 Models with 70" Sleepers	29-02455	010		83008
		R71-6007	010		83008

#### 567 Series

16 - 20	Sleeper Cab models with O.E.M. Number (Shocks only)	1201-8006	010		83081
		25523024	010		83081

#### 579 Series

16 - 20	Sleeper Cab models with O.E.M. Number (Shocks only)	1201-8006	010		83081
		25523024	010		83081



#### 587 Series

11 - 16	587 Models with 70" Sleepers	29-06032	010		83035
		R71-6008	010		83035

### PHOENIX CRUISER RV

11 - 20	All models with Ford E350 & E450 Chassis	ASH-1136		...	...	-10	83178	...
---------	--	----------	--	-----	-----	-----	-------	-----

**APPLICATION GUIDE - TRUCKS, TRAILERS, AND BUSES**

Year Año Année	Model Modelo Modèle	OEM #	Front		Rear	
						
			Fleetline	GasSLX	Fleetline	GasSLX

**PHOENIX CRUISER RV(Cont'd.)**

<b>11 - 20</b>	All models with Ford E350 & E450 Chassis	ASH-1154	- O	<b>83177</b>	...		...	...
----------------	--	----------	-----	--------------	-----	--	-----	-----

**PIERCE MANUFACTURING INC.**

	Pierce FireTrucks with O.E.M. Number	680401	O O	<b>85307</b>	...		...	...
	Additional O.E.M. Interchanges	1445910	O O	<b>85300 or 89419</b>				
		40-0242	O O	<b>83312</b>	<b>89409</b>		...	...
		40-4845	O O	<b>85304</b>				
		40-4951	- O	<b>85316</b>	<b>89426</b>		...	...
		40-5348	O O	<b>85058</b>	<b>89431</b>		...	...
		40-6967	O O	<b>85030 or 89440</b>				

**POWERHOUSE COACH INC.**

<b>06 - 10</b>	Models with Volvo VNL780 Chassis with 12,500 - 14,600 lb Front Axle	20433424	O O	<b>85061</b>	<b>89450</b>		...	...
		20973993	O O	<b>85061</b>	<b>89450</b>		...	...
<b>11 - 18</b>	Models with Volvo VNL780 Chassis with 12,500 - 14,600 lb Front Axle	141700005838	O O	<b>85098</b>	<b>89502</b>		...	...
		21436086	O O	<b>85098</b>	<b>89502</b>		...	...
<b>06 - 11</b>	Models with Volvo VNL780 Chassis with 40,000 lb Rear Air Suspension	20551628		...	...	O O	<b>85066</b>	<b>89448</b>
		471700000443		...	...	O O	<b>85066</b>	<b>89448</b>
<b>11 - 18</b>	Models with Volvo VNL780 Chassis with 40,000 lb Rear Air Suspension	21462380		...	...	O O	<b>85088</b>	...
		471700006040		...	...	O O	<b>85088</b>	...
<b>06 - 16</b>	Models with Volvo VNL780 Chassis with Hendrickson Airtek	20485632	O O	<b>85933</b>	<b>89454</b>		...	...
		20485633	O O	<b>85933</b>	<b>89454</b>		...	...
		21137330	O O	<b>85933</b>	<b>89454</b>		...	...
		471700003832	O O	<b>85933</b>	<b>89454</b>		...	...
		64838-003	O O	<b>85933</b>	<b>89454</b>		...	...
		64838-003L	O O	<b>85933</b>	<b>89454</b>		...	...





**POWERPACKER CAB SHOCKS**

	Models with PowerPacker Cab Suspension	PP1058870	O O	<b>83059</b>			
--	--	-----------	-----	--------------	--	--	--

**PREVOST**

<b>04 - 09</b>	H3 Bus, H3 VIP Bus Drive and Tag Axle Shocks	630253		...	...	O O	<b>85713</b>	...	
		481700999386		...	...	O O	<b>85736</b>	...	
		630127		...	...	O O	<b>85736</b>	...	
		650407		...	...	O O	<b>85736</b>	...	
		With I-Beam Front Suspension	630252	O O	<b>85329</b>	...		...	...
			481700999376	O O	<b>85329</b>	...		...	...
	LeMirage XL 40 ft, 45 ft, & H Models Coaches with Independant Front Suspension	630136	O -	<b>85379</b>	...		...	...	
	LeMirage XL 40 ft, 45 ft, & H3-45 VIP Coaches with I-Beam Front Suspension	481700999376	O O	<b>85329</b>	...		...	...	
		630134	O O	<b>85329</b>	...		...	...	
	X3-45 Bus Drive and Tag Axle Shocks With Independant Front Suspension	630253		...	...	O O	<b>85713</b>	...	
		630136	O -	<b>85379</b>	...		...	...	
<b>04 - 06</b>	XL II Bus, XL II MTH Bus Drive and Tag Axle Shocks	630253		...	...	O O	<b>85713</b>	...	
		481700999386		...	...	O O	<b>85736</b>	...	
		630127		...	...	O O	<b>85736</b>	...	
		650407		...	...	O O	<b>85736</b>	...	
		With I-Beam Front Suspension	630252	O O	<b>85329</b>	...		...	...

**APPLICATION GUIDE - TRUCKS, TRAILERS, AND BUSES**

Year Año Année	Model Modelo Modèle	OEM #	Front		Rear	
						
			Fleetline	GasSLX	Fleetline	GasSLX





**PREVOST(Cont'd.)**

99 - 03	With I-Beam Front Suspension	481700999376	010	85329	...		...	...
		630134	010	85329	...		...	...
	With Independant Front Suspension	680422	010	85329	...		...	...
		481700999377	01-	85379	...		...	...
		630163	01-	85379	...		...	...
07 - 09	XL II MTH Bus Drive and Tag Axle Shocks Front Suspension	630253		...	...	010	85713	...
		630136	01-	85379	...		...	...
89 - 00	XL-45 Coach Drive and Tag Axle Shocks	481700999386		...	...	010	85736	...
		630127		...	...	010	85736	...
		650407		...	...	010	85736	...
	With I-Beam Front Suspension	481700999376	010	85329	...		...	...
		630134	010	85329	...		...	...
		680422	010	85329	...		...	...
	Models with O.E.M. Number	12L-5-89		...	...	01-	85729	...
		12T-1-13		85303	...	010	85303	89422
		19501288		...	...	01-	85729	...
		19501289	-1-	85728	...		...	...
		19501547		...	...	01-	85740	...
		481700000207	010	85329	...		...	...
		481700000209		...	...	010	85713	...
		630103	010	85329	...		...	...
		630161		...	...	010	85736	...
		630234	010	85329	...		...	...
		630235	01-	85379	...		...	...
		630236	010	85329	...		...	...
		680510	01-	85379	...		...	...
		G5008070	010	85700	...		...	...
			Additional O.E.M. Interchanges	01-0100-905	010	85303 or 89422		
0822045526	010			85702				
12B-5-1				85735	...	010	85735	...
19501669				...	...	010	85339	...
19502711	010			85702				
19506846				...	...	010	85339	...
196533	-1-			85708				
3166657	010			85700				
481700999377	01-			85379	...		...	...
52001	-1-			85708				
630001				...	...	010	85713	...
630080				...	...	010	85713	...
630091	010			85736				
63-1013	010			85329	...		...	...
680323	010			85700				
680492				...	...	010	85713	...
680555	01-			85379	...		...	...
690060				...	...	010	85713	...
74939852	010			85308 or 89422				
G1011822				...	...	010	85702	...
N22212	010	85700						

**RAM**

12 - 18	Ram 4500 / 5500 Models	05168284AC	-10	85649	...		...	...
		05168295AB	-10	85649	...		...	...
		05168296AA		...	...	010	85650	...

## APPLICATION GUIDE - TRUCKS, TRAILERS, AND BUSES

Year Año Année	Model Modelo Modèle	OEM #	Front		Rear	
						
			Fleetline	GasSLX	Fleetline	GasSLX

### RAM(Cont'd.)

12 - 18	Ram 4500 / 5500 Models	6811 1104AB	- O	<b>85649</b>	...	...	...	
			- O	<b>85649</b>	...	...	...	
			- O	<b>85649</b>	...	...	...	
			- O	<b>85649</b>	...	...	...	
				...	...	o O	<b>85650</b>	...
				...	...	o O	<b>85650</b>	...

### RAMERIZ TRAILER

Identification of the trailer suspension is necessary to determine what section of the catalog to refer to. Some possible options can be Chalmers, Hendrickson, Neway, Ridewell, Reyco.

#### Trailer

86 AR / RS 1015, 1035, 3015, 3035 Slider Air Suspension	18165-01	...	...	o O	<b>85006</b>	...
---	----------	-----	-----	-----	--------------	-----

### RAYDAN MANUFACTURING

Air Link Suspensions with O.E.M. Number	14QK-3100	...	...	o O	<b>85739</b>	...
		446-51-211	...	...	o O	<b>85739</b>
AL460 Air Link Suspension	700115	...	...	o O	<b>85712</b>	...
AL520 Air Link Suspension	700115	...	...	o O	<b>85712</b>	...

### RED LION TRAILER

Models with O.E.M. Number	90044989	o O	<b>85059</b>			
Trailers with Neway Air Susp. RL196-14, -15	90044978		...	...	o O	<b>85059</b>

### REINKE MANUFACTURING COMPANY, INC.

Identification of the trailer suspension is necessary to determine what section of the catalog to refer to. Some possible options can be Chalmers, Hendrickson, Neway, Ridewell, Reyco.

### RENEGADE RV





- 2019	All Models with Freightliner Airliner Rear Air Suspension	16-18708-000	...	...	o O	<b>85724</b>	<b>89443</b>	
			SDA471700002809	...	...	o O	<b>85724</b>	<b>89443</b>
12 - 19	Ikon Series Motorhomes with Freightliner Cascadia Chassis and 12,000 to 13,300 lb Taperleaf Front Suspension	10-13809-000	o O	<b>85958</b>	...	...	...	
			SDA471700003920	o O	<b>85958</b>	...	...	...
09 - 19	Models with Freightliner M2-112 Chassis with 12000 lb to 20000 Front Axle	10-13809-000	o O	<b>85958</b>	...	...	...	
			471700003920	o O	<b>85958</b>	...	...	...
06 - 10	Models with Volvo VNL630 Chassis with 12,500 - 14,600 lb Front Axle	20433424	o O	<b>85061</b>	<b>89450</b>	...	...	
			20973993	o O	<b>85061</b>	<b>89450</b>	...	...
11 - 18	Models with Volvo VNL630 Chassis with 12,500 - 14,600 lb Front Axle	141700005838	o O	<b>85098</b>	<b>89502</b>	...	...	
			21436086	o O	<b>85098</b>	<b>89502</b>	...	...
06 - 11	Models with Volvo VNL630 Chassis with 40,000 lb Rear Air Suspension	20551628	...	...	o O	<b>85066</b>	<b>89448</b>	
			471700000443	...	...	o O	<b>85066</b>	<b>89448</b>
11 - 18	Models with Volvo VNL630 Chassis with 40,000 lb Rear Air Suspension	21462380	...	...	o O	<b>85088</b>	...	
			471700006040	...	...	o O	<b>85088</b>	...
15 - 19	Renegade XL Series Motorhomes with Freightliner Cascadia Chassis and 12,000 to 13,300 lb Taperleaf Front Suspension	10-13809-000	o O	<b>85958</b>	...	...	...	
			SDA471700003920	o O	<b>85958</b>	...	...	...
16 - 19	Verona & Verona LE Series Motorhomes with Freightliner M2-106 Chassis	10-13760-000	o O	<b>85959</b>	<b>89503</b>	...	...	
			471700002991	o O	<b>85959</b>	<b>89503</b>	...	...
			SDA471700002991	o O	<b>85959</b>	<b>89503</b>	...	...

### REYCO SUSPENSION

#### Drive Axle

101A, 101AR Models	18166-01	...	...	o O	<b>85704</b>	...
--------------------	----------	-----	-----	-----	--------------	-----

**APPLICATION GUIDE - TRUCKS, TRAILERS, AND BUSES**

Year Año Année	Model Modelo Modèle	OEM #	Front		Rear	
						
			Fleetline	GasSLX	Fleetline	GasSLX

**REYCO SUSPENSION(Cont'd.)**

**Drive Axle(Cont'd.)**

102 Models	16725-01	...	...	010	83126	89440
	19495-01	...	...	010	83126	89440
102AR (Hvy Duty) Models	18286-01	...	...	010	...	89414
102AR (Special) Models	17146-01	...	...	010	83209	89414
102AR (Standard) Models	12887-01	...	...	010	85013	89414
	12887-02	...	...	010	85013	89414
102AR for Western Star Models	19824-01	...	...	010	85006	...
102AR-7 Models	17794-01	...	...	010	83215	...
102AR-LM Models	19623-01	...	...	010	83123	89405
102W Drive Models	21497-01	...	...	010	85005	89430
200 Models Air Suspension	20129-01	...	...	010	85007	...
200 Models Air Suspension With O.E.M. Number	22062-01	...	...	010	85007	...
		...	...			
21AR - 25000 lb Capacity	12887-01	...	...	010	85013	89414
	12887-02	...	...	010	85013	89414
240AR Air-Ride Suspension With O.E.M. Number	20125-01	...	...	010	85030	89440
	20126-01	...	...	010	...	89440
	20129-01	...	...	010	85007	...
74AR - 30000 lb Capacity	12887-01	...	...	010	85013	89414
	12887-02	...	...	010	85013	89414
79AR Models	12887-02	...	...	010	85013	89414
79KB Models	16725-01	...	...	010	83126	89440
	19495-01	...	...	010	83126	89440
AirGlide 400 Air Suspension	20129-01	...	...	010	85007	...





**Steer Axle**

1200 (Spartan Option) Models	21310-01	010	85307	...	...	...
1207 Models	17403-01	010	83122	89406	...	...
1209 (Alternate) Models	17408-01	010	85005	89430	...	...
1209, 1212 Models	17358-01	010	83126	89440	...	...
	19495-01	010	83126	89440	...	...
21B Models	14954-01	010	83217	...	...	...

**Trailer**

19AR / RS1062 Models with Unit # 700649-01 to -06	700098-01	...	...	010	83128	89436
19AR / RS1062 Models with Unit # 700649-07 to -12	24392-01	...	...	010	85051	...
20 AR / RS 3162 Models with O.E.M. number	18163-01	...	...	010	83207	89407
20AR & 22AR Models with O.E.M. Number	700098-03	...	...	010	85052	...
21B (Special) Models	18800-01	...	...	010	83203	89436
23 ART Models with O.E.M. Number	665748	...	...	010	85086	...
23 ARTB-14A, -15A, 16A or -19A Models	23523-01	...	...	010	85086	...
23 ARTB-14A-FS Models	702135-01	...	...	010	85045	...
	702135-01	...	...	010	85045	...
	702135-01	...	...	010	85045	...
23 ARTU Models (All except -14A-FS and , -15A-FS)	23523-01	...	...	010	85086	...
23 ARTU-14A-FS and -15A-FS Models	702135-01	...	...	010	85045	...
23 ARTUL Models (All except -14A-FS and , -15A-FS)	23523-01	...	...	010	85086	...
25 ARTB-13A, -14A, -15A, -16A, -17A Models	24392-01	...	...	010	85051	...
25 ARTBL-13A, -14A, -15A, -16A, -17A, -18A, -19A Models	24392-01	...	...	010	85051	...
25 ARTBL-14A-FS, -15A-FS, -16A-FS, -17A-FS Models	702135-01	...	...	010	85045	...
25 ARTBL-18A-FS, -19A-FS, -20A-FS Models	704672-01	...	...	010	85938	...
25 ARTU Models ( All except -12A-FS )	24392-01	...	...	010	85051	...
25 ARTU-12A-FS	702136-01	...	...	010	85052	...
25 ARTUL-13A, -13S, -14A, -14S, -15A, -15S, -16A, -16S, -17A, -17S, -18A, -18S, -19A, -19S Models	24392-01	...	...	010	85051	...

**APPLICATION GUIDE - TRUCKS, TRAILERS, AND BUSES**

Year Año Année	Model Modelo Modèle	OEM #	Front		Rear	
						
			Fleetline	GasSLX	Fleetline	GasSLX

**REYCO SUSPENSION(Cont'd.)**

**Trailer(Cont'd.)**

25 ARTUL-18A-FS, -19A-FS, -20A-FS, -21A-FS, -22A-FS, -23A-FS, -24A-FS, -18-FS, -19-FS, -20-FS, -21-FS, -22-FS, -23-FS, -24-FS Models	704672-01	...	...	010	85938	...
25 ARUU Models ( All except -06-5A-NZ )	23553-01	...	...	010	85938	...
25 ARUU-06-5A-NZ Models	702136-01	...	...	010	85052	...
25 ARUUL-09A, -09A-99, -9S, -09S-99 Models	702135-01	...	...	010	85045	...
25 ARUUL-10A, -10S, -11A, -11S, -12A, -12S, -13A, -13S, -14A, -14S, -15A, -15S Models	23553-01	...	...	010	85938	...
30 ART with O.E.M. Number	23524-01	...	...	010	85738	...
30 ARTB-14A, -15A, -16A, -17A, -18A, -19A, -20A Models	23524-01	...	...	010	85738	...
30 ARTB-19A-FS, -20A-FS Models	23553-01	...	...	010	85938	...
30 ARTBL-15A, -16A, -17A, -18A, -19A Models	23524-01	...	...	010	85738	...
30 ARTBL-19A-FS, -20A-FS Models	23553-01	...	...	010	85938	...
30 ARTU-14A, -14S, -15A, -15S, -16A, -16S, -17A, -17S, -18A, -18S, -19A, -19S, -20A Models	23524-01	...	...	010	85738	...
30 ARTU-20A-FS Models	23553-01	...	...	010	85938	...
30 ARTUL-15A, -15S, -16A, -16S, -17A, -17S, -18A, -19A, -19S, -20A-TTN Models	23524-01	...	...	010	85738	...
30 ARTUL-20A-FS Models	23553-01	...	...	010	85938	...
30 ARUU - 14 and -15 Models	23553-01	...	...	010	85938	...
30 ARUU - 9, -12 and -17 Models	23524-01	...	...	010	85738	...
30 ARUUL - 12 and -17 Models	23524-01	...	...	010	85738	...
30 ARUUL - 9, -14 and -15 Models	23553-01	...	...	010	85938	...
44 AR Models	19623-01	...	...	010	83123	89405
81C Models	12885-03	...	...	010	85300	89419
81LC Models	12885-01	...	...	010	85300	89419
81LM Models	12886-01	...	...	010	85334	...
81S Models	12885-03	...	...	010	85300	89419
86 AR / RS 1015, 1035, 3015, 3035 Slider Air Suspension	18165-01	...	...	010	85006	...
87 for Great Dane Models	18163-01	...	...	010	83207	89407
	18164-01	...	...	010	83122	89406
87-14, -17 Models	16230-01	...	...	010	85702	...
87-14, -17 Slider Models	12885-01	...	...	010	85300	89419
87-6, 87-9 Models	12885-01	...	...	010	85300	89419

**Additional Applications**





Models with O.E.M. Number	16824-01	...	...	010	85006	...
	17142-01	...	...	010	85001	89410
	20960-01	...	...	010	83204	...
	665519	...	...	010	...	89414
	665813	...	...	010	85051	...
	665830	...	...	010	85045	...
	665833	...	...	010	85052	...
	671707	...	...	010	85323	89436
	680551	...	...	010	85738	...
	680552	...	...	010	85938	...
	680700	...	...	010	85938	...
	702135-01	...	...	010	85045	...
	702136-01	...	...	010	85052	...
	702209-01	...	...	010	85014	...
	704672-01	...	...	010	85938	...

**RIDEWELL CORPORATION**

**Bus and R.V. Air-Rides**

Mobile Home & RV with Air Suspension	AS563B	...	...	010	83203	89436
	S6009B	...	...	010	83203	89436
RAS - 227 Models Steer Axles Air Suspension w/ O.E.M. Number	1260008	...	...	010	87017	...

**APPLICATION GUIDE - TRUCKS, TRAILERS, AND BUSES**

Year Año Année	Model Modelo Modèle	OEM #	Front		Rear	
			 Fleetline	 GasSLX	 Fleetline	 GasSLX

**RIDEWELL CORPORATION(Cont'd.)**

**Bus and R.V. Air-Rides(Cont'd.)**

RAS - 227 Models Steer Axles Air Suspension w/ O.E.M. Number	90-2610 SP1		...	...	010	<b>87017</b>	...
--	-------------	--	-----	-----	-----	--------------	-----









**Trailer Air-Rides**

RAR - 244 FeatherRide Light Duty Air Suspension (8,000 lb Capacity)	1270007		...	...	010	<b>85045</b>	...
RAR-210							
With Double Convolution Spring	AS789B		...	...	010	<b>85014</b>	...
	S5878B		...	...	010	<b>83207</b>	<b>89407</b>
With Shock Absorber Bracket 2-1/2" Above Frame Rail	.....		...	...	010	<b>85006</b>	...
With Shock Absorber Bracket 2-7/8" Above Lower Frame Rail	.....		...	...	010	<b>83207</b>	<b>89407</b>
With Shock Absorber Bracket 3" Above Lower Frame Rail	.....		...	...	010	<b>85005</b>	<b>89430</b>
With Shock Absorber Bracket Even With Underside of Frame	AS546B		...	...	010	<b>85006</b>	...
RAR-210 For Trailers with 25" Drop	1253069B000		...	...	010	<b>85005</b>	<b>89430</b>
	AS30698		...	...	010	<b>85005</b>	<b>89430</b>
	AS3069B		...	...	010	<b>85005</b>	<b>89430</b>
RAR-210 Tag Axle	AS563B		...	...	010	<b>83203</b>	<b>89436</b>
	S6009B		...	...	010	<b>83203</b>	<b>89436</b>
RAR-221 Tag Axle	AS563B		...	...	010	<b>83203</b>	<b>89436</b>
	AS789B		...	...	010	<b>85014</b>	...
	S5878B		...	...	010	<b>83207</b>	<b>89407</b>
	S6009B		...	...	010	<b>83203</b>	<b>89436</b>
RAR-221-11, 12, 13-USW Trailer with Shock Absorber and Hanger	AS563B		...	...	010	<b>83203</b>	<b>89436</b>
	S6009B		...	...	010	<b>83203</b>	<b>89436</b>
RAR-221AS-11-USW, RAR-221AS-11-1-USW Trailer	1253069B000		...	...	010	<b>85005</b>	<b>89430</b>
	AS30698		...	...	010	<b>85005</b>	<b>89430</b>
	AS3069B		...	...	010	<b>85005</b>	<b>89430</b>
RAR-221AS-12-USW, RAR-221AS-12-1-USW Trailer	1250546B000		...	...	010	<b>85006</b>	...
	AS546B		...	...	010	<b>85006</b>	...
RAR-240, RAR-240W (Mono Pivot Trailers with HD Air Suspension)							
With O.E.M. Number	1270563B000		...	...	010	<b>85000</b>	<b>89436</b>
	1270563B003		...	...	010	<b>85934</b>	...
	1270789B000		...	...	010	<b>85014</b>	...
RAR-243 (Mono Pivot Trailers with HD Air Suspension)	1270563B003		...	...	010	<b>85934</b>	...
RAR-260 Overslung Air Suspension (25,000 lb Capacity)	1270563B003		...	...	010	<b>85934</b>	...
RAR-260 Underslung Air Suspension (25,000 lb and 30,000 lb Capacity)	1270563B003		...	...	010	<b>85934</b>	...
RideLite Trailer Air Suspension	1270563B003		...	...	010	<b>85934</b>	...
Models with O.E.M. Number	1275943B		...	...	010	<b>85005</b>	<b>89430</b>
	57645		...	...	010	<b>85005</b>	<b>89430</b>
	665526		...	...	010	<b>85014</b>	...

**Truck Air-Rides**

Fire Truck with Ridewell Front Suspension	AS 4025B	010	<b>85712</b>	...		...	...
Pusher w/Axle Lift	AS563B		...	...	010	<b>83203</b>	<b>89436</b>
	S6009B		...	...	010	<b>83203</b>	<b>89436</b>
RAD-221R Drive Axle	S2607B		...	...	010	<b>85702</b>	...
	S5477B		...	...	010	<b>85307</b>	...
RCA-215 Models Air Suspension (RCA-215 LM, RCA-215 MM)	1250789B000		...	...	010	<b>85014</b>	...
RD-202B Tandem Drive Axle	S5478B		...	...	010	<b>85307</b>	...
RD-202S-54-48-BS Tandem Drive Air Suspension	1252607B000		...	...	010	<b>85702</b>	...
RD-202S-54-52T-SR Tandem Drive Air Suspension	1252607B000		...	...	010	<b>85702</b>	...
RSS-236, RSS-236R Self Steering Tag/Pusher Lift Axle (For 13000 lb & 16000 lb Capacity)	1253069B000		...	...	010	<b>85005</b>	<b>89430</b>
	AS30698		...	...	010	<b>85005</b>	<b>89430</b>

**APPLICATION GUIDE - TRUCKS, TRAILERS, AND BUSES**

Year Año Année	Model Modelo Modèle	OEM #	Front		Rear	
						
						
			Fleetline	GasSLX	Fleetline	GasSLX

**RIDEWELL CORPORATION(Cont'd.)**

**Truck Air-Rides(Cont'd.)**

	RSS-236, RSS-236R Self Steering Tag/Pusher Lift Axle (For 13000 lb & 16000 lb Capacity)	AS3069B		...	...	010	<b>85005</b>	<b>89430</b>
	RUA-220B-1-, 10, 10.5, 11, 11.5, 12, 12.5, 13 (Lift Tag Axle & Trailer Lift Suspension)	1250789B000		...	...	010	<b>85014</b>	...
		AS789B000		...	...	010	<b>85014</b>	...
	RUA-220B-1-, 7, 7.5, 8, 8.5, 9, 9.5, 10 (Lift Tag Axle & Trailer Lift Suspension)	1270563B000		...	...	010	<b>85000</b>	<b>89436</b>
	Models with O.E.M. Number	1250563B000		...	...	010	<b>85000</b>	<b>89436</b>
		1253069B000		...	...	010	<b>85005</b>	<b>89430</b>
		1254190B000		...	...	010	<b>85302</b>	<b>89420</b>
		1265157B000		...	...	010	<b>85712</b>	...
		1266009B000		...	...	010	<b>83130</b>	...
		1267120B000		...	...	010	<b>85734</b>	...
		1267395B000		...	...	010	<b>85302</b>	<b>89420</b>
		1275813B000		...	...	010	<b>85704</b>	...
		665198		...	...	010	<b>85005</b>	<b>89430</b>
		665267		...	...	010	<b>85029</b>	...
		680101		...	...	010	<b>85702</b>	...
		70654		...	...	010	<b>85000</b>	<b>89436</b>
		90-1813		...	...	010	<b>85712</b>	...
		AS575B		...	...	010	<b>85005</b>	<b>89430</b>
		S4025B		...	...	010	<b>85712</b>	...
		S5813B		...	...	010	<b>85704</b>	...
		S7120B		...	...	010	<b>85304</b>	...
	S7172B		...	...	010	<b>83207</b>	<b>89407</b>	
	S7249B		...	...	010	<b>85307</b>	...	
	S7365B		...	...	010	<b>85305</b>	...	
	Additional O.E.M. Interchanges	1250005	010	<b>85901</b>	...		...	...
		1254025B000	010				<b>85712</b>	
		1265478B000	010				<b>85736</b>	
		1267249B000	010				<b>85712</b>	

**ROADMASTER (MONACO)**

	Models with AD-123 Models Suspension (AD123-6,-8,-10,-8.75)	90045132		...	...	010	<b>85909</b>	...
	Models with O.E.M. Number	90045188		...	...	010	<b>85910</b>	...





**SAF HOLLAND**

**Trailer Air Suspension**

	AirLite 2 Model Trailer Air Suspension	90044025		...	...	010	<b>83209</b>	<b>89414</b>
	AR-120 Models Trailer Air Suspension (AR-120, AR-120-L, AR-120-US, AR-120-US-F) (AR-120-US-L, -1, -2, -3)	90044626		...	...	010	<b>83126</b>	<b>89430</b>
		90044625		...	...	010	<b>83125</b>	...
	AR-125 Models Trailer Air Suspension (AR-125, AR-125-L, AR-125-US, AR-125-US-F) (AR-125-US-L, -1, -2, -3)	90044626		...	...	010	<b>83126</b>	<b>89430</b>
		90044625		...	...	010	<b>83125</b>	...
	AR-165-US Models Trailer Air Suspension (AR165-US)	90044626		...	...	010	<b>83126</b>	<b>89430</b>
	AR-250 Models Trailer Air Suspension (AR-250-12) (AR-250-14, -15) (AR-250-16, -17)	90045054		...	...	010	<b>85051</b>	...
		90044642		...	...	010	<b>83127</b>	...
		90044089		...	...	010	<b>83124</b>	<b>89407</b>
	AR-41 Models Trailer Air Suspension (All)	90044162		...	...	010	<b>83128</b>	<b>89436</b>
	AR-45 Models Trailer Air Suspension (AR-45, AR-45-1)	90044162		...	...	010	<b>83128</b>	<b>89436</b>



**APPLICATION GUIDE - TRUCKS, TRAILERS, AND BUSES**

Year Año Année	Model Modelo Modèle	OEM #	Front		Rear	
						
			Fleetline	GasSLX	Fleetline	GasSLX

**SAF HOLLAND(Cont'd.)**

**Trailer Air Suspension(Cont'd.)**

AR-50 Models Trailer Air Suspension (AR-50-US, AR-50-US-F,-1,-2)	90044162	...	...	010	<b>83128</b>	<b>89436</b>
AR-51 Models Trailer Air Suspension (AR51-US)	90044162	...	...	010	<b>83128</b>	<b>89436</b>
AR-70 Models Trailer Air Suspension (AR-70-9, -14, AR-70A-9, 14)	90044626	...	...	010	<b>83126</b>	<b>89430</b>
AR-75 Models Trailer Air Suspension (AR-75-12)	90044625	...	...	010	<b>83125</b>	...
(AR-75-6, -9, -1-12)	90044626	...	...	010	<b>83126</b>	<b>89430</b>
AR-80 Models Trailer Air Suspension (AR-80-6.75)	90044046	...	...	010	<b>83123</b>	<b>89405</b>
(AR-80-9, -9FM)	90044868	...	...	010	<b>85045</b>	...
(AR-80-9-WST)	90044626	...	...	010	<b>83126</b>	<b>89430</b>
AR-85-A Models Trailer Air Suspension (AR-85-A)	90044625	...	...	010	<b>83125</b>	...
AR-90 Models Trailer Air Suspension (AR-90-14, -15, -16, -17)	90044089	...	...	010	<b>83124</b>	<b>89407</b>
AR-90-1 Models Trailer Air Suspension (AR-90-1-12, -14, -17)	90044162	...	...	010	<b>83128</b>	<b>89436</b>
(AR-90-1-15, -16)	90044448	...	...	010	<b>85051</b>	...
	90045054	...	...	010	<b>85051</b>	...
AR-92 Models Trailer Air Suspension (AR-92-12)	90044162	...	...	010	<b>83128</b>	<b>89436</b>
	90044992	...	...	010	<b>85000</b>	<b>89436</b>
(AR-92-14)	90045040	...	...	010	<b>83130</b>	...
(AR-92-15)	90044448	...	...	010	<b>85051</b>	...
	90045054	...	...	010	<b>85051</b>	...
(AR-92-16)	90044794	...	...	010	<b>83127</b>	...
(AR-92-17)	90044642	...	...	010	<b>83127</b>	...
(AR-92-18)	90044089	...	...	010	<b>83124</b>	<b>89407</b>
	90044769	...	...	010	<b>83207</b>	<b>89407</b>
AR-93 Models Trailer Air Suspension (AR-93-14)	90044448	...	...	010	<b>85051</b>	...
	90045054	...	...	010	<b>85051</b>	...
(AR-93-15)	90044794	...	...	010	<b>83127</b>	...
(AR-93-16)	90044642	...	...	010	<b>83127</b>	...
(AR-93-17)	90044089	...	...	010	<b>83124</b>	<b>89407</b>
	90044769	...	...	010	<b>83207</b>	<b>89407</b>
AR-95 Models Trailer Air Suspension (AR-95-9, -12, -14, -17, All -HD Models, AR-95A-9, -12, -14, -17)	90044625	...	...	010	<b>83125</b>	...
AR-955 Models Trailer Air Suspension (Liftaxle) (AR-955-9, -12, -14, -17)	90044625	...	...	010	<b>83125</b>	...
(AR-955-9HD, -12HD, -14HD, -17HD)	90044625	...	...	010	<b>83125</b>	...
(AR-955A-9, -12, -14, -17)	90044625	...	...	010	<b>83125</b>	...
(AR-955A-9HD, -12HD, -14HD, -17HD)	90044625	...	...	010	<b>83125</b>	...
ARA-93 Models Trailer Air Suspension (ARA-93-14)	90045054	...	...	010	<b>85051</b>	...
ARL20 Models Trailer Air Suspension (ARL20-D, ARL20-D-US)	90044162	...	...	010	<b>83128</b>	<b>89436</b>
ARS112 Models Trailer Air Suspension (ARS112-6)	90045096	...	...	010	<b>85916</b>	<b>89430</b>
ARU-92 Models Trailer Air Suspension (ARU-92-8, -9, -10, -12)	90044642	...	...	010	<b>83127</b>	...
ARU-93 Models Trailer Air Suspension (ARU-93-6)	90045040	...	...	010	<b>83130</b>	...
(ARU-93-7, -8, -9, -10)	90044642	...	...	010	<b>83127</b>	...
ARU-98 Models Trailer Air Suspension (ARU-98-17)	90045054	...	...	010	<b>85051</b>	...

## APPLICATION GUIDE - TRUCKS, TRAILERS, AND BUSES





Year Año Année	Model Modelo Modèle	OEM #	Front		Rear	
			Fleetline	GasSLX	Fleetline	GasSLX

### SAF HOLLAND(Cont'd.)

#### Trailer Air Suspension(Cont'd.)

CB 25Y/CBX 25Y Models with Fusion Axle and Beam Assembly (10.0" Ride Height)	90044162	...	...	010	<b>83128</b>	<b>89436</b>
CB 25Y/CBX 25Y Models with Fusion Axle and Beam Assembly (12.0" Ride Height)	90045040	...	...	010	<b>83130</b>	...
CB 25Y/CBX 25Y Models with Fusion Axle and Beam Assembly (7.0" Ride Height)	90044868	...	...	010	<b>85045</b>	...
CB 25Y/CBX 25Y Models with Fusion Axle and Beam Assembly (8.0" Ride Height)	90045381	...	...	010	<b>83150</b>	...
CB 25Y/CBX 25Y Models with Fusion Axle and Beam Assembly (9.0" Ride Height)	90045608	...	...	010	<b>83363</b>	...
CB-2300 Models Trailer Air Suspension (CB-2300-14)	90044868	...	...	010	<b>85045</b>	...
	90045381	...	...	010	<b>83150</b>	...
CB-2300 Models Trailer Air Suspension (16.0" & 17.0" Ride Height)	90045298	...	...	010	<b>83363</b>	...
CB-400/4000 Models Trailer Air Suspension 15.5" & 16.0" Ride Height (CB-400-15.5, CB-400-16.0) 16.5" & 17.0" Ride Height (CB-400-16.5, CB-400-17.0) 18.0" Ride Height (CB-400-18.0)	90045298	...	...	010	<b>83363</b>	...
	90044162	...	...	010	<b>83128</b>	<b>89436</b>
	90045040	...	...	010	<b>83130</b>	...
CBX 23 & CBX 25 Models Trailer Air Suspension (16.0" & 17.0" Ride Height)	90045298	...	...	010	<b>83363</b>	...
CBX 23 Models Trailer Air Suspension (CBX 23-14)	90044868	...	...	010	<b>85045</b>	...
	90045381	...	...	010	<b>83150</b>	...
CBX 23 Models with 245 or 317 Fusion Axle and Beam Assembly For Bracket Type #1, 3, 4, & 5 - 15.0" Ride Height	90045608	...	...	010	<b>83363</b>	...
CBX 23 with 245 or 317 Fusion Axle and Beam Assembly For Bracket Type #1, 3, 4, & 5 - 16.0" & 17.0" Ride Height	90045299	...	...	010	<b>83389</b>	<b>89436</b>
CBX 23U Models with 342 Fusion Axle and Beam Assembly (8.0" Ride Height)	90045608	...	...	010	<b>83363</b>	...
CBX 25 Models Trailer Air Suspension (CBX 25-14)	90045607	...	...	010	<b>83150</b>	...
	90045040	...	...	010	<b>83130</b>	...
CBX 25 Models with 245 or 338 Fusion Axle and Beam Assembly (15.0" Ride Height)	90045608	...	...	010	<b>83363</b>	...
CBX 25 with 245 Fusion Axle and Beam Assembly (16.0" & 17.0" Ride Height)	90045299	...	...	010	<b>83389</b>	<b>89436</b>
CBX 25U-4 Models with 342 Fusion Axle and Beam Assembly (9.0" Ride Height)	90045608	...	...	010	<b>83363</b>	...
CBX 30 Models with 245 or 338 Fusion Axle and Beam Assembly (15.0" Ride Height)	90045608	...	...	010	<b>83363</b>	...
CBX 30 with 245 Fusion Axle and Beam Assembly (16.0" & 17.0" Ride Height)	90045299	...	...	010	<b>83389</b>	<b>89436</b>
CBX 40 Models Trailer Air Suspension (CBX 40 -16.5, CBX 40 -17.0)	90044162	...	...	010	<b>83128</b>	<b>89436</b>
	90045040	...	...	010	<b>83130</b>	...
CBX 40 Models with 265 Fusion Axle and Beam Assembly (15.5" & 16.0" Ride Height)	90045298	...	...	010	<b>83363</b>	...
CBX 46 Models Trailer Air Suspension (16" Ride Height)	90045298	...	...	010	<b>83363</b>	...
CBX 46 Models Trailer Air Suspension (16.5" & 17.0" Ride Height)	90044162	...	...	010	<b>83128</b>	<b>89436</b>
CBX 50 Models Trailer Air Suspension (16" Ride Height)	90045298	...	...	010	<b>83363</b>	...
CBX 50 Models Trailer Air Suspension (16.5" & 17.0" Ride Height)	90044162	...	...	010	<b>83128</b>	<b>89436</b>
CBX 69 Trailer Air Suspension	90045669	...	...	010	<b>83389</b>	<b>89436</b>
NL-200 Models Non Steer - Auxiliary Lift Air Suspension (NL-200-1S, NL-200-2S)	90044162	...	...	010	<b>83128</b>	<b>89436</b>
NS-190 Models Trailer Air Suspension (NS-190-16.0)	90044162	...	...	010	<b>83128</b>	<b>89436</b>
	90045040	...	...	010	<b>83130</b>	...

**APPLICATION GUIDE - TRUCKS, TRAILERS, AND BUSES**





Year Año Année	Model Modelo Modèle	OEM #	Front		Rear	
						
			Fleetline	GasSLX	Fleetline	GasSLX

**SAF HOLLAND(Cont'd.)**

**Trailer Air Suspension(Cont'd.)**

	(NS-190-18.0)	90045054	...	...	010	<b>85051</b>	...
	NS-400 Models Trailer Air Suspension						
	(NS-400-16.0)	90045298	...	...	010	<b>83363</b>	...
	(NS-400-16.5)	90044162	...	...	010	<b>83128</b>	<b>89436</b>
	(NS-400-18.0)	90045040	...	...	010	<b>83130</b>	...
	NS-400 Models Trailer Air Suspension (17.0" Ride Height)	90045299	...	...	010	<b>83389</b>	<b>89436</b>
	NS-450 Models Trailer Air Suspension						
	(NS-450-16.0)	90045298	...	...	010	<b>83363</b>	...
	(NS-450-16.5)	90044162	...	...	010	<b>83128</b>	<b>89436</b>
	(NS-450-18.0)	90045040	...	...	010	<b>83130</b>	...
	NS-450 Models Trailer Air Suspension (17.0" Ride Height)	90045299	...	...	010	<b>83389</b>	<b>89436</b>
	RL-196 Models Trailer Air Suspension						
	(RL-196-14,-15)	90044978	...	...	010	<b>85059</b>	...
	(RL-196-16, -17)	90044979	...	...	010	<b>83113</b>	...
	RL-196A Models Trailer Air Suspension						
	(RL-196A-12)	90044162	...	...	010	<b>83128</b>	<b>89436</b>
	(RL-196A-14, -15)	90045040	...	...	010	<b>83130</b>	...
	(RL-196A-16, -17)	90044794	...	...	010	<b>83127</b>	...
	RL-228 Models Trailer Air Suspension						
	(RL-228-12-3)	90044162	...	...	010	<b>83128</b>	<b>89436</b>
	(RL-228-14-3,-14-4, -15-3, -16-3)	90044642	...	...	010	<b>83127</b>	...
	(RL-228-17-3)	90044089	...	...	010	<b>83124</b>	<b>89407</b>
	RL-230 Models Trailer Air Suspension						
	(RL-230-12-3)	90045381	...	...	010	<b>83150</b>	...
	(RL-230-14-3, -15-3)	90044642	...	...	010	<b>83127</b>	...
	(RL-230-16-3, -17-3)	90044089	...	...	010	<b>83124</b>	<b>89407</b>
	RL-230 Models Trailer Air Suspension (Hanger Mounted Shock)						
	(RL-230-14-3, -15-4)	90045381	...	...	010	<b>83150</b>	...
	(RL-230-16-4)	90045299	...	...	010	<b>83389</b>	<b>89436</b>
	(RL-230-17-4)	90045040	...	...	010	<b>83130</b>	...
	RL-230 Models Trailer Air Suspension (Single Stud Air Spring)						
	(RL-230-14-3, -15-4, -16-4)	90044642	...	...	010	<b>83127</b>	...
	(RL-230-17-4)	90044089	...	...	010	<b>83124</b>	<b>89407</b>
	RL-250 Models Trailer Air Suspension (Shock Below Frame)						
	(RL-250-14-3, -15-4)	90045040	...	...	010	<b>83130</b>	...
	(RL-250-16-4, -17-4)	90045299	...	...	010	<b>83389</b>	<b>89436</b>
	RL-250 Models Trailer Air Suspension (Std Suspension)						
	(RL-250-12)	90045054	...	...	010	<b>85051</b>	...
	(RL-250-14.0, -15.0)	90044642	...	...	010	<b>83127</b>	...
	(RL-250-16.0, -17.0)	90044089	...	...	010	<b>83124</b>	<b>89407</b>
	RL-300 Models Trailer Air Suspension (Offset Stud Air Spring)						
	(RL-300-13)	90045054	...	...	010	<b>85051</b>	...
	(RL-300-14, -15, -16, -17)	90045338	...	...	010	<b>85060</b>	...
	RL-300 Models Trailer Air Suspension (Std Suspension)						
	(RL-300-12, -13)	90045054	...	...	010	<b>85051</b>	...
	(RL-300-14, -15, -16, -17)	90045338	...	...	010	<b>85060</b>	...
	RLSA Models Trailer Air Suspension (RLSA-4214, -4215, -4814, -4815)	90044978	...	...	010	<b>85059</b>	...
	RLSA Models Trailer Air Suspension (RLSA-4216, -4217, -4816, -4817)	90044979	...	...	010	<b>83113</b>	...
	RLSA228 Models Trailer Air Suspension (RLSA-228-4214, -4215, -4216, -4814, -4815, -4816)	90044642	...	...	010	<b>83127</b>	...
	RLSA228 Models Trailer Air Suspension (RLSA-228-4217, -4817)	90044089	...	...	010	<b>83124</b>	<b>89407</b>

**APPLICATION GUIDE - TRUCKS, TRAILERS, AND BUSES**

Year Año Année	Model Modelo Modèle	OEM #	Front		Rear	
						
			Fleetline	GasSLX	Fleetline	GasSLX

**SAF HOLLAND(Cont'd.)**

**Trailer Air Suspension(Cont'd.)**

RLU-228 Models Trailer Air Suspension (RLU-228-10-3) (RLU-228-6-3) (RLU-228-7-3) (RLU-228-8-3, RLU-228-9-3)	90044089	...	...	010	<b>83124</b>	<b>89407</b>
	90045040	...	...	010	<b>83130</b>	...
	90044642	...	...	010	<b>83127</b>	...
	90044626	...	...	010	<b>83126</b>	<b>89430</b>
RLU-228 Models Trailer Air Suspension (Axle Mounted Shock Suspension) (RLU-228-8-3) (RLU-228-9-3, RLU-228-10-3, RLU-228-12-3)	90044162	...	...	010	<b>83128</b>	<b>89436</b>
	90044642	...	...	010	<b>83127</b>	...
RLU-228 Models Trailer Air Suspension (Current Production - w/3" Axle Travel Up) (RLU-228-10-3, RLU-228-12-3) (RLU-228-6-3) (RLU-228-7-3) (RLU-228-8-3) (RLU-228-9-3)	90044642	...	...	010	<b>83127</b>	...
	90045298	...	...	010	<b>83363</b>	...
	90044162	...	...	010	<b>83128</b>	<b>89436</b>
	90045040	...	...	010	<b>83130</b>	...
	90045054	...	...	010	<b>85051</b>	...
RLU-228 Models Trailer Air Suspension (Current Production - w/4" Axle Travel Up) (RLU-228-10-4) (RLU-228-8-4) (RLU-228-9-4, RLU-228-12-4)	90044642	...	...	010	<b>83127</b>	...
	90044162	...	...	010	<b>83128</b>	<b>89436</b>
	90044626	...	...	010	<b>83126</b>	<b>89430</b>
RLU-228 Models Trailer Air Suspension (Current Production - w/4" Axle Travel Up) HVY DTY (RLU-228-8-4)	90045337	...	...	010	<b>85911</b>	...
RLU-250 Models Trailer Air Suspension (RLU-250-12) (RLU-250-6.5) (RLU-250-9)	90044642	...	...	010	<b>83127</b>	...
	90045381	...	...	010	<b>83150</b>	...
	90044162	...	...	010	<b>83128</b>	<b>89436</b>
RLU-250 Models Trailer Air Suspension (Frame Mount Suspension) (RLU-250-12-FMT) (RLU-250-6.5-FMT) (RLU-250-9-FMT)	90045054	...	...	010	<b>85051</b>	...
	90045381	...	...	010	<b>83150</b>	...
	90044162	...	...	010	<b>83128</b>	<b>89436</b>
RLU-300 Models Trailer Air Suspension (Std Suspension) (RLU-300-6.5) (RLU-300-9)	90045471	...	...	010	<b>83150</b>	...
	90045337	...	...	010	<b>85911</b>	...
Trailer Air Suspension (RL196-16,-17)	90044979	...	...	010	<b>83113</b>	...
Models with O.E.M. Number	665454	...	...	010	<b>85045</b>	...
	671931	...	...	010	<b>85916</b>	<b>89430</b>
	680234	...	...	010	<b>85906</b>	<b>89407</b>
	680268	...	...	010	<b>85323</b>	<b>89436</b>
	90045000	...	...	010	<b>85906</b>	<b>89407</b>
	90045001	...	...	010	<b>85323</b>	<b>89436</b>
	90045002	...	...	010	<b>85906</b>	<b>89407</b>
	90045003	...	...	010	<b>85323</b>	<b>89436</b>
	90045083	...	...	010	<b>85910</b>	...
	90045188	...	...	010	<b>85910</b>	...
	90045207	...	...	010	...	<b>89405</b>
	90045433	...	...	010	<b>85916</b>	<b>89430</b>
	90045563	...	...	010	<b>85014</b>	...
	90045564	...	...	010	<b>83128</b>	<b>89436</b>
	90045572	...	...	010	<b>85045</b>	...
	90045574	...	...	010	<b>83130</b>	...
	90045575	...	...	010	<b>85051</b>	...
	90045576	...	...	010	<b>83150</b>	...
	90045665	...	...	010	<b>85029</b>	...

## APPLICATION GUIDE - TRUCKS, TRAILERS, AND BUSES

Year Año Année	Model Modelo Modèle	OEM #	Front		Rear	
			Fleetline	GasSLX	Fleetline	GasSLX

### SAF HOLLAND(Cont'd.)





#### Trailer Air Suspension(Cont'd.)

Models with O.E.M. Number	90045667		...	...	010	<b>85060</b>	...
	XB-SPN-053-36		...	...	010	<b>83125</b>	...
Models with O.E.M. Number (Hvy Duty)	90045666		...	...	010	<b>85051</b>	...
Models with O.E.M. Number (STD)	90045666		...	...	010	<b>83130</b>	...

#### Truck & Tractor Air Suspension (Tag Axle)

Models with O.E.M. Number	57639		...	...	010	<b>85000</b>	<b>89436</b>
	57643		...	...	010	<b>85013</b>	<b>89414</b>
	6025		...	...	010	<b>83122</b>	<b>89406</b>
	6026		...	...	010	<b>83204</b>	...
	665197		...	...	010	<b>85051</b>	...
	665514		...	...	010	<b>83127</b>	...
	665969		...	...	010	...	<b>89430</b>
	90044001		...	...	010	<b>85005</b>	<b>89430</b>
	90044071		...	...	010	<b>85000</b>	<b>89436</b>
	90044081		...	...	010	<b>85000</b>	<b>89436</b>
	90044086		...	...	010	<b>85000</b>	<b>89436</b>
	90044089C		...	...	010	<b>83124</b>	<b>89407</b>
	90044095		...	...	010	<b>83203</b>	<b>89436</b>
	90044679		...	...	010	<b>83122</b>	<b>89406</b>
	90044680		...	...	010	<b>83125</b>	...
	90044681		...	...	010	<b>83204</b>	...
	90044682		...	...	010	<b>83209</b>	<b>89414</b>
	90044683		...	...	010	<b>83122</b>	<b>89406</b>
	90044684		...	...	010	<b>83124</b>	<b>89407</b>
	90044685		...	...	010	<b>83389</b>	<b>89436</b>
	90044686		...	...	010	<b>85051</b>	...
	90044687		...	...	010	<b>83125</b>	...
	90044688		...	...	010	<b>83122</b>	<b>89406</b>
	90044770		...	...	010	<b>83207</b>	<b>89407</b>
	90044833		...	...	010	<b>85052</b>	...
	90044834		...	...	010	<b>85052</b>	...
	90044878		...	...	01-	<b>83635</b>	...
	90044915		...	...	010	<b>83127</b>	...
	90044981		...	...	010	<b>85000</b>	<b>89436</b>
	90044982		...	...	010	<b>85000</b>	<b>89436</b>
	90044991		...	...	010	<b>85000</b>	<b>89436</b>
	90045110		...	...	010	<b>83137</b>	...
	90045175		...	...	010	<b>85916</b>	<b>89430</b>
	90045384		...	...	010	...	<b>89430</b>
	AR-1008		...	...	010	<b>85006</b>	...
	AR-1141		...	...	010	<b>83204</b>	...
	AR-1141-C		...	...	010	<b>83204</b>	...
	AR-1202		...	...	010	<b>85300</b>	<b>89419</b>
	AR-134-C		...	...	010	<b>85005</b>	<b>89430</b>
	AR-1404		...	...	010	<b>85301</b>	...
	AR-1425		...	...	010	<b>85301</b>	...
	AR-1434		...	...	010	<b>83203</b>	<b>89436</b>
	AR-1654		...	...	010	<b>83209</b>	<b>89414</b>
	AR-1822		...	...	010	<b>85304</b>	...
	AR-2451		...	...	010	<b>83203</b>	<b>89436</b>
AR-2598		...	...	010	<b>83123</b>	<b>89405</b>	
AR-718-C		...	...	010	<b>83203</b>	<b>89436</b>	
AR-718-C-HD		...	...	010	<b>85000</b>	<b>89436</b>	
AR-781		...	...	010	<b>83203</b>	<b>89436</b>	

## APPLICATION GUIDE - TRUCKS, TRAILERS, AND BUSES

Year Año Année	Model Modelo Modèle	OEM #	Front		Rear	
						
			Fleetline	GasSLX	Fleetline	GasSLX

### SAF HOLLAND(Cont'd.)

#### Truck & Tractor Air Suspension (Tag Axle)(Cont'd.)

Models with O.E.M. Number	AR-958	...	...	010	<b>83207</b>	<b>89407</b>
	AR-995	...	...	010	<b>85734</b>	...

#### Truck, Bus & Motorhome Air Suspensions

AD-123 Models Truck and Tractor Air Suspension (AD123-6,-8,-10,-8.75)						
Shock Mount approx. 2-1/2" above bottom of frame	90045132	...	...	010	<b>85909</b>	...
Shock Mount flush with bottom of frame	90045099	...	...	010	<b>85906</b>	<b>89407</b>
AD-130 Models Truck and Tractor Air Suspension (AD123-6,-8,-10,-8.75)	90045466	...	...	010	...	<b>89406</b>
AD-130 Models Truck and Tractor Air Suspension W/ OEM Number	90045432	...	...	010	<b>85321</b>	...
AD-150 Models Truck & Tractor Air Suspension	90045075	...	...	010	<b>85911</b>	...
AD-200 Models Truck & Tractor Air Suspension (AD-200-7, -8, -9, -11)	90045138	...	...	010	<b>85910</b>	...
AD-246 Models Truck & Tractor Air Suspension (AD246 -6, -8, -10, -8.75)	90045099	...	...	010	<b>85906</b>	<b>89407</b>
	90045132	...	...	010	<b>85909</b>	...
<b>00 -</b> AD-246 Models with 10" Ride Height	90045504	...	...	010	<b>85030</b>	<b>89440</b>
AD-252-10 Tandem Axle	90045132	...	...	010	<b>85909</b>	...
<b>00 -</b> AD-369 Models with 10" Ride Height	90045504	...	...	010	<b>85030</b>	<b>89440</b>
ADZ-123 Models Truck and Bus Air Suspension	90045605	...	...	010	<b>85109</b>	...
ADZ-126 Models Truck and Bus Air Suspension	90045605	...	...	010	<b>85109</b>	...
ADZ-246 Models Truck and Bus Air Suspension	90045605	...	...	010	<b>85109</b>	...
ADZ-252 Models Truck and Bus Air Suspension	90045605	...	...	010	<b>85109</b>	...
ADZ-369 Models Truck and Bus Air Suspension	90045605	...	...	010	<b>85109</b>	...
ADZ-378 Models Truck and Bus Air Suspension	90045605	...	...	010	<b>85109</b>	...
ARD-120 Models Truck & Tractor Air Suspension (ARD-120-6)	90044025	...	...	010	<b>83209</b>	<b>89414</b>
	90044025	...	...	010	<b>83209</b>	<b>89414</b>
ARD-125 Models Truck & Tractor Air Suspension (ARD-125-6 use on Ford, GM, International (Navistar), Mack, White, Western Star, Freightliner) (ARD-125-8 use on Freightliner, White, Western Star) (ARD-125-8 use on Mack)	90044011	...	...	010	<b>85004</b>	...
	90044016	...	...	010	<b>85300</b>	<b>89419</b>
	90044011	...	...	010	<b>85004</b>	...
ARD-165 Models Truck & Tractor Air Suspension (ARD-165-A, ARD-165-B)	90044011	...	...	010	<b>85004</b>	...
ARD-190 Models Truck & Tractor Air Suspension (ARD-190-B)	90044016	...	...	010	<b>85300</b>	<b>89419</b>
ARD-234 Models Truck & Tractor Air Suspension (ARD-234-6)	90044046	...	...	010	<b>83123</b>	<b>89405</b>
ARD-238 Models Truck & Tractor Air Suspension (ARD-238-6)	90044025	...	...	010	<b>83209</b>	<b>89414</b>
ARD-244 Models Truck & Tractor Air Suspension (ARD-244-6 use on Ford, GM, International (Navistar), Mack, White, Western Star, Freightliner) (ARD-244-8 use on Freightliner, White, Western Star) (ARD-244-8 use on Mack)	90044025	...	...	010	<b>83209</b>	<b>89414</b>
	90044011	...	...	010	<b>85004</b>	...
	90044016	...	...	010	<b>85300</b>	<b>89419</b>
ARDAB-120 Models Truck & Tractor Air Suspension (ARDAB-120-5)	90044907	...	...	01-	<b>83635</b>	...
ARDAB-238-5 Models Truck & Tractor Air Suspension	90044907	...	...	01-	<b>83635</b>	...
ARDAB-240 Models Truck & Tractor Air Suspension (ARDAB-240-5)	90044907	...	...	01-	<b>83635</b>	...
ARDST-123 Models Truck & Tractor Air Suspension (ARDST-123-6, ARDSTML-123-6)	90044025	...	...	010	<b>83209</b>	<b>89414</b>
ARDST-244 Models Truck & Tractor Air Suspension (ARDST-244-6)	90044025	...	...	010	<b>83209</b>	<b>89414</b>
ARDST-246 Models Truck & Tractor Air Suspension (ARDST-246-6, ARDSTML-246-6)	90044025	...	...	010	<b>83209</b>	<b>89414</b>
ARDST-250-6 Models Truck & Tractor Air Suspension	90044025	...	...	010	<b>83209</b>	<b>89414</b>
ARDTB-125 Models Bus Air Suspension (ARDTB-125-6A)	90044448	...	...	010	<b>85051</b>	...
ARDTB-125-6A (Note: Rear shock)	90045053	...	...	010	<b>85908</b>	...
ART-500 Models Truck & Tractor Tag Axle Air Suspension (ART-500-B, ART-500-B-1)	90044162	...	...	010	<b>83128</b>	<b>89436</b>
	90044162	...	...	010	<b>83128</b>	<b>89436</b>

## APPLICATION GUIDE - TRUCKS, TRAILERS, AND BUSES

Year Año Année	Model Modelo Modèle	OEM #	Front			Rear		
						Fleetline	GasSLX	Fleetline

### SAF HOLLAND(Cont'd.)

#### Truck, Bus & Motorhome Air Suspensions(Cont'd.)

	(ART-500-US, ART-500-US-A)	90044008		...	...	○ ○	<b>85000</b>	<b>89436</b>
	ART-505 Models Truck & Tractor Tag Axle Air Suspension (ART-505-B, -1, ART-505-C, -1)	90044162		...	...	○ ○	<b>83128</b>	<b>89436</b>
	ART-541 Models Truck & Tractor Tag Axle Air Suspension (ART-541B)	90044162		...	...	○ ○	<b>83128</b>	<b>89436</b>
	ART-550 Models Truck & Tractor Tag Axle Air Suspension (ART-550-US-1, -2, -3)	90044012		...	...	○ ○	<b>85006</b>	...
	ART-551 Models Truck & Tractor Tag Axle Air Suspension (ART-551-B-1)	90044162		...	...	○ ○	<b>83128</b>	<b>89436</b>
	(ART-551-B-2, -3, ART-551-US-1, -2, -3)	90044017		...	...	○ ○	<b>83204</b>	...
	ART-555 Models Truck & Tractor Tag Axle Air Suspension (ART-555-B-1, ART-555-C-1)	90044162		...	...	○ ○	<b>83128</b>	<b>89436</b>
	(ART-555-B-2, -3, ART555C-2, -3)	90044642		...	...	○ ○	<b>83127</b>	...
	Models with Neway AS140 w/ 14,000 lb Front Suspension	90045455		...	...	○ ○	<b>85909</b>	...
	Models with O.E.M. Number	471700000436		...	...	○ ○	<b>85030</b>	<b>89440</b>
		471700000458		...	...	○ ○	<b>85014</b>	...
		471700000459		...	...	○ ○	<b>85030</b>	<b>89440</b>
		471700000461		...	...	○ ○	...	<b>89414</b>
		665002		...	...	○ ○	<b>85004</b>	...
		665003		...	...	○ ○	<b>85300</b>	<b>89419</b>
		671921		...	...	○ ○	<b>85916</b>	<b>89430</b>
		671922		...	...	○ ○	...	<b>89405</b>
		671923		...	...	○ ○	...	<b>89440</b>
		680645		...	...	○ ○	<b>85321</b>	...
		90045277		...	...	○ ○	<b>85030</b>	<b>89440</b>
		90045336		...	...	○ ○	<b>85014</b>	...
		90045418		...	...	○ ○	<b>85916</b>	<b>89430</b>
		90045419		...	...	○ ○	...	<b>89405</b>
		90045420		...	...	○ ○	...	<b>89440</b>
		90045504		...	...	○ ○	<b>85030</b>	<b>89440</b>
		90045532		...	...	○ ○	<b>85030</b>	<b>89440</b>
		90045534		...	...	○ ○	<b>85014</b>	...
		90045536		...	...	○ ○	...	<b>89414</b>
		90045568		...	...	○ ○	<b>85060</b>	...
	Models with O.E.M. Number	90044989	○ ○				<b>85059</b>	

### SEAGRAVE FIRE APPARATUS LLC

	Models with O.E.M. Number	680117		...	...	○ ○	<b>85300</b>	<b>89419</b>
		P0025500		...	...	○ ○	<b>85300</b>	<b>89419</b>

### SHASTA RV

	All models with Ford E350 & E450 Chassis	ASH-1136		...	...	- ○	<b>83178</b>	...
		ASH-1154	- ○	<b>83177</b>	...		...	...





### SHOWHAULER MOTORHOMES

	Models with Cascadia Chassis - See Freightliner section for proper year and model information	.....		.....				
	Models with Kenworth Chassis - See Kenworth section for proper year and model information	.....		.....				
	Models with Lonestar Chassis - See International section for proper year and model information	.....		.....				
	Models with VNL Chassis - See Volvo section for proper year and model information	.....		.....				

### SICARD

	Models with O.E.M. Number	3166657		<b>85700</b>	...	○ ○	<b>85700</b>	...
--	---------------------------	---------	--	--------------	-----	-----	--------------	-----

## APPLICATION GUIDE - TRUCKS, TRAILERS, AND BUSES

Year Año Année	Model Modelo Modèle	OEM #	Front		Rear	
						
			Fleetline	GasSLX	Fleetline	GasSLX

### SOUTHERN COACH

	Early Model Air Suspension	.....		<b>85304</b>	...	OIO	<b>85304</b>	...
	Late Model Air Suspension	.....		<b>83217</b>	...	OIO	<b>83217</b>	...
	U.S. Army Coaches	.....		<b>83217</b>	...	OIO	<b>83217</b>	...

### SPARTAN MOTORS

<b>97 - 00</b>	Alpine / Summit MotorHome Chassis with O.E.M. Number	0377-SS5 1300B46 B46-1725			...	...	OIO	<b>85029</b>	...	
					...	...	OIO	<b>85029</b>	...	
					...	...	OIO	<b>85029</b>	...	
	Buses with Hendrickson Softek Suspension with Drum and Disc Brakes	471700000456	OIO	<b>85959</b>	...	...	OIO	...	...	
				58913-009	OIO	<b>85959</b>	...	...	OIO	...
				58913-009L	OIO	<b>85959</b>	...	...	OIO	...
	Chassis With Hendrickson HTS 210 Suspension (Type C School Bus Applications)	60665-025 60665-025L		...	...	OIO	<b>85036</b>	<b>89405</b>		
				...	...	OIO	<b>85036</b>	<b>89405</b>		
	Fire Truck with O.E.M. Number	0272-SS5	OIO	<b>85712</b>	...	...	OIO	...		
<b>1986</b>	Fire Truck with Ridewell Front Suspension	AS 4025B	OIO	<b>85712</b>	...	...	OIO	...		
<b>97 - 00</b>	K2 / K3/ MountainMaster with O.E.M. Number	2200201 B46-2151		...	...	OIO	<b>85007</b>	...		
				...	...	OIO	<b>85007</b>	...		
<b>91 - 95</b>	K2 / K3/ MountainMaster with Tuthill 102 AR Air Suspension	0346-SS5 2502B46 B46-1594		...	...	OIO	<b>85013</b>	<b>89414</b>		
				...	...	OIO	<b>85013</b>	<b>89414</b>		
				...	...	OIO	<b>85013</b>	<b>89414</b>		
	Models with Reyco 1200 Steer Option)	21310-01	OIO	<b>85307</b>	...	...	OIO	...		
	Motorhome chassis with Ridewell Front Suspension	AS 4025B	OIO	<b>85712</b>	...	...	OIO	...		
	Models with O.E.M. Number	59011	OIO	<b>83214</b>	...	...	OIO	...		
	Additional O.E.M. Interchanges	78068	OIO	<b>85304</b>						





### STARCRAFT BUS CO.

#### Allstar XL & XLT - Series

<b>00 - 15</b>	Models with F-650 chassis with 10,000 lb Front Suspension	3584116C1 3584116C2 4C4Z-18124-QA AA-616		OIO	<b>83175</b>	...	...	...
				OIO	<b>83175</b>	...	...	...
				OIO	<b>83175</b>	...	...	...
				OIO	<b>83175</b>	...	...	...
<b>00 - 15</b>	Models with F-650 chassis with 12,000 & 13,200 lb Front Springs	3584118C2 4C4Z-18124-JB 4C4Z-18124-RA AA-617 AT-812		OIO	<b>85928</b>	...	...	...
				OIO	<b>85928</b>	...	...	...
				OIO	<b>85928</b>	...	...	...
				OIO	<b>85928</b>	...	...	...
				OIO	<b>85928</b>	...	...	...
<b>July/2015 - 20</b>	Models with F-650 chassis with 13,500, 15,500 & 19,000 lb Multi-leaf Rear Springs	471700011531 ASH-24660 FC44-18080-AB FC4Z-18125-A		...	...	OIO	<b>85180</b>	...
				...	...	OIO	<b>85180</b>	...
				...	...	OIO	<b>85180</b>	...
				...	...	OIO	<b>85180</b>	...
<b>July/2015 - 20</b>	Models with F-650 chassis with 19.5" or 22.5" Wheels (22,000 lb GVW)	471700011530 ASH-24658 ASH-24659 FC44-18045-BB FC4Z-18124-A FC4Z-18124-B		OIO	<b>85181</b>	...	...	...
				OIO	<b>85181</b>	...	...	...
				OIO	<b>85181</b>	...	...	...
				OIO	<b>85181</b>	...	...	...
				OIO	<b>85181</b>	...	...	...
				OIO	<b>85181</b>	...	...	...
<b>- 2015</b>	Models with F-650 chassis with 21,000 lb Rear Air Suspension	3578858C1 3578858C2 4C4Z-18125-DA		...	...	OIO	<b>85926</b>	...
				...	...	OIO	<b>85926</b>	...
				...	...	OIO	<b>85926</b>	...
<b>04 - 11</b>	Models with F-650 chassis with 22,000 lb Multi-leaf Rear Springs	4C4Z-18125-B 501906C92		...	...	-IO	<b>83317</b>	...
				...	...	-IO	<b>83317</b>	...



**APPLICATION GUIDE - TRUCKS, TRAILERS, AND BUSES**

Year Año Année	Model Modelo Modèle	OEM #	Front		Rear	
			 Fleetline	 GasSLX	 Fleetline	 GasSLX

**STARCRAFT BUS CO.(Cont'd.)**

**E350 & E450 Ford Chassis Models(Cont'd.)**

- 2020	Allstar Series Shuttle buses with Ford E350 & E450 Chassis	ASH-1136		...	...	-10	<b>83178</b>	...
		ASH-1154	-10	<b>83177</b>	...		...	...
- 2020	MVP Series Shuttle buses with Ford E450 Chassis	ASH-1136		...	...	-10	<b>83178</b>	...
		ASH-1154	-10	<b>83177</b>	...		...	...
- 2020	Starlite Series Shuttle buses with Ford E350 & E450 Chassis	ASH-1136		...	...	-10	<b>83178</b>	...
		ASH-1154	-10	<b>83177</b>	...		...	...
- 2020	Starquest Series Shuttle buses with Ford E350 & E450 Chassis	ASH-1136		...	...	-10	<b>83178</b>	...
		ASH-1154	-10	<b>83177</b>	...		...	...
- 2020	Ultra Star Series Shuttle buses with Ford E450 Chassis	ASH-1136		...	...	-10	<b>83178</b>	...
		ASH-1154	-10	<b>83177</b>	...		...	...
- 2020	Xpress Series Shuttle buses with Ford E350 & E450 Chassis	ASH-1136		...	...	-10	<b>83178</b>	...
		ASH-1154	-10	<b>83177</b>	...		...	...

**STERLING TRUCK**

08 - 10	Bullet 45 / 55 Models	05168284AC	-10	<b>85649</b>	...		...	...
		05168295AB	-10	<b>85649</b>	...		...	...
		6811 1104AB	-10	<b>85649</b>	...		...	...
		6811 1104AB-001	-10	<b>85649</b>	...		...	...
		6811 1105AC	-10	<b>85649</b>	...		...	...
		6811 1105AC-001	-10	<b>85649</b>	...		...	...





**A - Line 9500 Series (SilverStar)**

1998 -	A9513, A9522, AT9513, AT9522 (113" & 122" BBC) Models with 8500 or 9000 lb Axle and 54" Taperleaf Spring	F6HT-18045-HB	010	<b>85054</b>	...		...	...
		F6HT-18045-HC	010	<b>85054</b>	...		...	...
1998 -	A9513, A9522, AT9513, AT9522 (113" & 122" BBC) Models with 8500, 9000 or 10000 lb Axle and 54" Multileaf Spring	F6HT-18045-KA	010	...	<b>89402</b>		...	...
1998 -	All Models with 10000 lb or 12000 lb Axle and 54" Taperleaf Spring	F6HT-18045-AC	010	<b>85054</b>	...		...	...
1998 -	All Models with 12000 lb or 13200 lb Axle and 54" Multileaf Spring	F6HT-18045-BC	010	<b>85047</b>	<b>89435</b>		...	...
1998 -	All Models with 12000 lb, 13200 lb or 14600 lb Axle and 60" Taperleaf Spring	F6HT-18045-EB	010	<b>85055</b>	<b>89439</b>		...	...
		F6HT-18045-EC	010	<b>85055</b>	<b>89439</b>		...	...
1998 -	All Models with 13200 lb or 14600 lb Axle and 54" Taperleaf Spring	F6HT-18045-GC	010	<b>85030</b>	<b>89440</b>		...	...
1998 -	All Models with 14600 lb or 16000 lb Axle and 54" Multi-leaf Spring	F6HT-18045-CC	010	<b>85055</b>	<b>89439</b>		...	...
1998 -	All Models with 23000 lb Axle and 52" Taperleaf Softride Rear Suspension	F6HT-18080-CA		...	...	010	<b>85314</b>	<b>89425</b>
1998 -	All Models with Hendrickson 40LH Tandem Axle	57241-2		...	...	01-	<b>83109</b>	...
1998 -	All Models with Hendrickson HAS Rear Air Suspension	47902-28		...	...	010	<b>85013</b>	<b>89414</b>
		F6HT-18080-FC		...	...	010	<b>85013</b>	<b>89414</b>
1998 -	Models with FAS II Rear Air Suspension	16-15817-000		...	...	010	<b>85724</b>	<b>89443</b>
98 - 03	Models with O.E.M. Number	10-13205-000	010	<b>85918</b>	<b>89449</b>		...	...
		471700131646	010	<b>85918</b>	<b>89449</b>		...	...

**ACTERRA**

	All Models with Freightliner TufTrac Rear Air Suspension	16-15770-000		...	...	010	<b>85956</b>	...
		481700125969		...	...	010	<b>85956</b>	...
09 - 10	Models with 10000 to 12000 lb. Front Axle and 3" Taper-leaf Suspension	10-13592-000	010	<b>85959</b>	...		...	...
		SDA471700000440	010	<b>85959</b>	...		...	...
2003 -	Models with 10000 to 12000 lb. Taper-leaf Spring Suspension	10-12390-000	010	<b>85920</b>	<b>89503</b>		...	...
	Models with 11000 to 12000 lb Front axle	6803230300	010	<b>85006</b>	...		...	...
	Models with 15000 lb Rear Suspension	6803260000		...	...	01-	<b>83120</b>	...
- 2002	Models with 6000 to 9000 lb Front axle	6803230200	010	<b>85043</b>	...		...	...
03 - 08	Models with 6000 to 9000 lb Front axle	10-12388-000	010	<b>85920</b>	<b>89503</b>		...	...
03 - 10	Models with FAS II Rear Air Suspension	16-15817-000		...	...	010	<b>85724</b>	<b>89443</b>
		16-18708-000		...	...	010	<b>85724</b>	<b>89443</b>

**APPLICATION GUIDE - TRUCKS, TRAILERS, AND BUSES**

Year Año Année	Model Modelo Modèle	OEM #	Front		Rear	
						
			Fleetline	GasSLX	Fleetline	GasSLX

**STERLING TRUCK(Cont'd.)**

**ACTERRA(Cont'd.)**

03 - 10	Models with FAS II Rear Air Suspension	471700002809		...	...	010	85724	89443
		481700006848		...	...	010	85724	89443
		680611		...	...	010	85724	89443
		SDA471700002809		...	...	010	85724	89443
- 04/09	Models with Hendrickson Airtek Suspension	58913-003	010	85932	89453		...	...
		58913-003L	010	85932	89453		...	...

**Cargo Line**

1998	SC-7000 or SC-8000 Models with 12000 or 13000 lb. Axles	F6HT-18045-LA	010	85376	...		...	...
1998	SC-7000 or SC-8000 Models with 16000 lb. Multileaf Spring	F6HT-18045-AA	010	85054	...		...	...

**L - Line 7500 Series - Short Haul Tractor**

	Models with 10000 lb Front Axle	F6HT-18045-KA	010	...	89402		...	...
--	---------------------------------	---------------	-----	-----	-------	--	-----	-----





**L - Line 8500 Series - Conventional Cab**

1998	All Models with 10000 lb or 12000 lb Axle and 54" Taperleaf Spring	F6HT-18045-AC	010	85054	...		...	...
1998 -	All Models with 12000 lb or 13200 lb Axle and 54" Multileaf Spring	F6HT-18045-BC	010	85047	89435		...	...
1998 -	All Models with 12000 lb, 13200 lb or 14600 lb Axle and 60" Taperleaf Spring	F6HT-18045-EB	010	85055	89439		...	...
		F6HT-18045-EC	010	85055	89439		...	...
1998 -	All Models with 13200 lb or 14600 lb Axle and 54" Taperleaf Spring	F6HT-18045-GC	010	85030	89440		...	...
1998 -	All Models with 14600 lb or 16000 lb Axle and 54" Multi-leaf Spring	F6HT-18045-CC	010	85055	89439		...	...
1998 -	All Models with 23000 lb Axle and 52" Taperleaf Softride Rear Suspension	F6HT-18080-CA		...	...	010	85314	89425
1998	All with Hendrickson HAS Rear Air Suspension	47902-28		...	...	010	85013	89414
		F6HT-18080-FC		...	...	010	85013	89414
1998	LT-8000 Models with 12000 or 13000 lb Axles	F6HT-18045-LA	010	85376	...		...	...
1998	LT-8000 Models with 16000 lb. Multileaf Spring	F6HT-18045-AA	010	85054	...		...	...
1998	LT-8501 (101" BBC) Models with 8500 or 9000 lb Axle and 54" Multileaf Spring	F6HT-18045-JB	010	...	89402		...	...
		F6HT-18045-JC	010	...	89402		...	...
	LT-8501 (101" BBC) Models with 8500 or 9000 lb Axle and 54" Taperleaf Spring	F6HT-18045-HB	010	85054	...		...	...
		F6HT-18045-HC	010	85054	...		...	...
99 - 10	Models with FAS II Rear Air Suspension	16-15817-000		...	...	010	85724	89443
		680611		...	...	010	85724	89443
1998	Models with Hendrickson 40LH Tandem Axle	57241-2		...	...	01-	83109	...

**L - Line 9500 Series - Conventional Cab**

1998	All Models with 10000 lb or 12000 lb Axle and 54" Taperleaf Spring	F6HT-18045-AC	010	85054	...		...	...
1998 -	All Models with 12000 lb or 13200 lb Axle and 54" Multileaf Spring	F6HT-18045-BC	010	85047	89435		...	...
1998 -	All Models with 12000 lb, 13200 lb or 14600 lb Axle and 60" Taperleaf Spring	F6HT-18045-EB	010	85055	89439		...	...
		F6HT-18045-EC	010	85055	89439		...	...
1998 -	All Models with 13200 lb or 14600 lb Axle and 54" Taperleaf Spring	F6HT-18045-GC	010	85030	89440		...	...
1998 -	All Models with 14600 lb or 16000 lb Axle and 54" Multi-leaf Spring	F6HT-18045-CC	010	85055	89439		...	...
1998 -	All with 23000 lb Axle and 52" Taperleaf Softride Rear Suspension	F6HT-18080-CA		...	...	010	85314	89425
1998 -	All with Hendrickson HAS Rear Air Suspension	47902-28		...	...	010	85013	89414
		F6HT-18080-FC		...	...	010	85013	89414
1998 -	LT-9501, LT-9511, LT-9513 or LT-9513 (113" & 122" BBC) Models with 8500 or 9000 lb Axle and 54" Multileaf Spring	F6HT-18045-JB	010	...	89402		...	...
		F6HT-18045-JC	010	...	89402		...	...
1998 -	LT-9501, LT-9511, LT-9513 or LT-9513 (113" & 122" BBC) Models with 8500 or 9000 lb Axle and 54" Taperleaf Spring	F6HT-18045-HB	010	85054	...		...	...
		F6HT-18045-HC	010	85054	...		...	...

**APPLICATION GUIDE - TRUCKS, TRAILERS, AND BUSES**

Year Año Année	Model Modelo Modèle	OEM #	Front		Rear	
						
			Fleetline	GasSLX	Fleetline	GasSLX

**STERLING TRUCK(Cont'd.)**





**L - Line 9500 Series - Conventional Cab(Cont'd.)**

99 - 10	Models with FAS II Rear Air Suspension	16-13957-000	...	...	0 0	85724	89443
		XC45-18080-BA	...	...	0 0	85724	89443
1998 -	Models with Hendrickson 40LH Tandem Axle	57241-2	...	...	0 -	83109	...

**Additional O.E.M. Interchanges**

	Models with Link Rear Air Suspension	1210-0528		...	...	0 0	85904	...
	Models with Neway Rear Suspension	90045099		...	...	0 0	85906	89407
	Models with O.E.M. Number	16-15770-000		...	...	0 0	85956	...
		4C4Z-18124-N	0 0	85957	...	...	...	...
		4C4Z-18125-DA	0 0	...	...	0 0	85926	...
		6E7Z-18125-A	0 0	...	...	0 0	83364	...
		AT-560	0 0	G63809	...	...	...	...
		AX-267A	0 0	83309	...	...	...	...
		AX-310	0 0	...	...	0 0	83215	...
		C4HZ-18124-E	0 0	83309	...	...	...	...
		C4TZ-18124-AB	0 0	83308	...	...	...	...
		D8HZ-18124-A	0 0	85301	...	...	...	...
		E6HZ-18124-A	0 0	85301	...	...	...	...
		E6HZ-18124-D	0 0	85301	...	...	...	...
		E6HZ-18125-D	0 0	...	...	0 0	83215	...
		E7HZ-18124-A	0 0	85301	...	...	...	...
		E7XZ-18124-A	- 0	G63386	...	...	...	...
		E7XZ-18125-B	0 0	...	...	- 0	G63387	...
		E9HZ-18124-A	0 0	83309	...	...	...	...
		F0HZ-18124-B	0 0	85006	...	...	...	...
		F1HZ-18124-A	0 0	83309	...	...	...	...
		F1HZ-18124-B	0 0	83308	...	...	...	...
		F1HZ-18124-D	0 0	85006	...	...	...	...
		F1HZ-18124-E	0 0	85006	...	...	...	...
		F1HZ-18124-H	0 0	85040	...	...	...	...
		F1HZ-18124-J	0 0	83308	...	...	...	...
		F1HZ-18124-K	0 0	...	89402	...	...	...
		F2HZ-18124-A	0 0	85376	...	...	...	...
		F2HZ-18124-B	0 0	85301	...	...	...	...
		F4HT-18080-AB	0 0	...	...	0 0	85314	89425
		F4HT-18080-BA	0 0	...	...	0 0	85001	89410
		F5HZ-18124-A	0 0	83314	...	...	...	...
		F5HZ-18124-B	0 0	83107	...	...	...	...
		F5HZ-18124-C	0 0	85063	...	...	...	...
	F5HZ-18124-D	0 0	83125	...	...	...	...	
	F5HZ-18125-A	0 0	...	...	0 0	85314	89425	
	F5HZ-18125-B	0 0	...	...	0 0	85001	89410	
	F6HT-18045-GB	0 0	85030	89440	...	...	...	
	F6HT-18080-B	0 0	...	...	0 -	83109	...	
	F6HT-18080-DA	0 0	...	...	0 -	83109	...	
	F6HT-18080-EA	0 0	...	...	0 0	85906	89407	
	F6HT-18124-JC	0 0	...	89402	...	...	...	
	F6HT-18124-KA	0 0	...	89402	...	...	...	
	F6HZ-18124-A	0 0	85054	...	...	...	...	
	F6HZ-18124-B	0 0	83308	...	...	...	...	
	F6HZ-18124-C	0 0	85055	89439	...	...	...	
	F6HZ-18124-D	0 0	85055	89439	...	...	...	
	F6HZ-18124-E	0 0	85055	89439	...	...	...	
	F6HZ-18124-F	0 0	85055	89439	...	...	...	
	F6HZ-18124-G	0 0	85054	...	...	...	...	

## APPLICATION GUIDE - TRUCKS, TRAILERS, AND BUSES

Year Año Année	Model Modelo Modèle	OEM #	Front		Rear	
						
			Fleetline	GasSLX	Fleetline	GasSLX

### STERLING TRUCK(Cont'd.)

#### Additional O.E.M. Interchanges(Cont'd.)

Models with O.E.M. Number	F6HZ-18124-H	OIO	<b>85054</b>	...		...	...
	F6HZ-18124-J	OIO	...	<b>89402</b>		...	...
	F6HZ-18125-B		...	...	OI-	<b>83109</b>	...
	F6HZ-18125-D		...	...	OIO	<b>85013</b>	<b>89414</b>
	F81A-18045-AGB	OIO	<b>G63809</b>	...		...	...
	XC45-18045-AA	OIO	<b>83216</b>	...		...	...

### STERLING TRUCK CAB SHOCKS

8500 & 9500 Models with 113" & 122" BBC Conventional Tractors with Link Cabmate Models FH1322 & FH1322-A	1202-1043	OIO				<b>83025</b>	
AT-9500 Models with O.E.M. Number	F6HZ-5K407-BA	OIO				<b>83033</b>	
	F8HT-5K407-AA	OIO				<b>83033</b>	
L8501 & L9501 Models with 101" BBC Conventional Tractors with Link Cabmate Model FH101	1202-1043	OIO				<b>83025</b>	
LT-9500 Models with O.E.M. Number	F6HZ-5K407-AB	OIO				<b>83034</b>	
Models with O.E.M. Number	18-45067-000	OIO				<b>83034</b>	

### STOUGHTON TRAILERS INC.

Trailers with Hendrickson HT190T, HT190U, & HS190T Models Air Suspension	HTA20001		...	...	OIO	<b>83128</b>	<b>89436</b>
Trailers with Hendrickson HT230T Models Air Suspension	HTA20002		...	...	OIO	<b>85000</b>	<b>89436</b>
Trailers with Neway AR-90-1-12, -14, -17 Models Air Suspension	NW90044162		...	...	OIO	<b>83128</b>	<b>89436</b>
Trailers with Neway AR-90-1-15, -16 Models Air Suspension	NW90044448		...	...	OIO	<b>85051</b>	...
Trailers with Neway RL-196-14, -15, Models Air Suspension	NW90044978		...	...	OIO	<b>85059</b>	...
Trailers with Neway RL-196-16, -17, Models Air Suspension	NW90044979		...	...	OIO	<b>83113</b>	...
Trailers with Reyco 86AR/RS1015 Air Ride Suspension	RT18165-01		...	...	OIO	<b>85006</b>	...
Trailers with Reyco 86AR/RS1035 Anti-Dock Walk Air Suspension	RT18165-01		...	...	OIO	<b>85006</b>	...

### SUSPENSYS

FS230 Trailer Suspension (Light Duty)	218004872		...	...	OIO	<b>85737</b>	...
---------------------------------------	-----------	--	-----	-----	-----	--------------	-----





### THE BINKLEY COMPANY

1997	Trailers with Binkley AirLite Suspension	16965		...	...	OIO	<b>85006</b>	...
		6898		...	...	OIO	<b>83125</b>	...

### THOMAS SCHOOL BUS

	Buses with Neway Tandem Air Suspension	61310232		...	...	OIO	<b>85000</b>	<b>89436</b>
	Buses with O.E.M. Number	16-19138-000	OIO	<b>85058</b>	<b>89431</b>		...	...
	Model MVP	61310101		<b>85736</b>	...	OIO	<b>85736</b>	...
06 - 18	Models with B2 Bus Chassis with FAS II Rear Air Suspension	16-15817-000		...	...	OIO	<b>85724</b>	<b>89443</b>
		16-18708-000		...	...	OIO	<b>85724</b>	<b>89443</b>
- 2018	Models with Freightliner B2 Bus Chassis & 15000 lb Rear Suspension	6803260000		...	...	OI-	<b>83120</b>	...
06 - 15	Models with Freightliner CC B2 Bus Chassis	10-13634-000	OIO	<b>85918</b>	<b>89449</b>		...	...
06 - 18	Models with Freightliner CC B2 Bus Chassis	10-13211-000	OIO	<b>85918</b>	<b>89449</b>		...	...
	ROC Front, SAF-T-Liner	61300285	-I-	<b>83102</b>	...		...	...
		GBL651442	-I-	<b>83102</b>	...		...	...
	SAF-T-Liner HDX Models with Hendrickson Comfort Air Rear Air Suspension	471700131545		...	...	OIO	<b>85006</b>	...
		60998-001		...	...	OIO	<b>85006</b>	...
		60998-003		...	...	OIO	<b>85006</b>	...
2009	SAF-T-Liner School Bus with SAF Holland AD-246 Suspension	90045504	OIO	<b>85030</b>	<b>89440</b>		...	...
2009	SAF-T-Liner School Bus with SAF Holland AD-369 Suspension	90045504	OIO	<b>85030</b>	<b>89440</b>		...	...
	School Bus	300-0614966		...	...	OIO	<b>85307</b>	...
		614966		...	...	OIO	<b>85307</b>	...

**APPLICATION GUIDE - TRUCKS, TRAILERS, AND BUSES**

Year Año Année	Model Modelo Modèle	OEM #	Front		Rear	
			 Fleetline	 GasSLX	 Fleetline	 GasSLX





**THOMAS SCHOOL BUS(Cont'd.)**

	School Bus	614974 680010 680054	010	<b>85304</b>	...		...	...
			010	<b>85304</b>	...		...	...
				...	...	010	<b>85307</b>	...
<b>07 - 12</b>	Type C Conventional Buses (65 capacity) with 12000 lb Taperleaf Front Suspension	10-13634-000	010	<b>85918</b>	<b>89449</b>		...	...
<b>- 2017</b>	Type C Conventional Buses (65 capacity) with FAS II Rear Air Suspension	16-15817-000 16-18708-000 61310434 61310478		...	...	010	<b>85724</b>	<b>89443</b>
				...	...	010	<b>85724</b>	<b>89443</b>
				...	...	010	<b>85724</b>	<b>89443</b>
<b>2003</b>	Type C Conventional School buses (65 capacity) with O.E.M. Number	680-323-0300 GBL665538	010	<b>85006</b>	...		...	...
			010	<b>85006</b>	...		...	...
<b>09-12</b>	Type C School bus chassis with O.E.M. Number	16-18713-000 471700003070		...	...	01-	<b>85122</b>	...
				...	...	01-	<b>85122</b>	...
	Models with Hendrickson Comfort Air Rear Air Suspension	60670-006 60670-006L		...	...	010	<b>83147</b>	...
				...	...	010	<b>83147</b>	...
	Models with O.E.M. Number	128745 61300112 61300224 61300240 61310102 61310103 651442 659287 680-326-0000 GBL654725	-1-	<b>83102</b>	...		...	...
			-1-	<b>83613</b>	...		...	...
			010	<b>85918</b>	<b>89449</b>		...	...
			010	<b>85918</b>	<b>89449</b>		...	...
				...	...	010	<b>85308</b>	<b>89422</b>
				...	...	010	<b>85308</b>	<b>89422</b>
			-1-	<b>83102</b>	...		...	...
			-1-	<b>83102</b>	...		...	...
				...	...	01-	<b>83120</b>	...
				...	...	01-	<b>83120</b>	...
	Additional O.E.M. Interchanges	6130-0114 6130029 61310104 63-0001 680088 680102 728802 87002 A-4890	010	<b>89437</b>				
			010	<b>85712</b>				
				...	...	010	<b>85713</b>	...
				...	...	010	<b>85713</b>	...
				...	...	010	<b>85713</b>	...
			010	<b>85712</b>				
			010	<b>85736</b>				
			010	<b>85736</b>				
				...	...	010	<b>85712</b>	...

**Type A School Bus**

<b>92 - 20</b>	Minotour Type A School bus with Ford E350 Chassis	8C24-18045-DA 8C2Z-18124-D ASH-1154 AT-163G 8C24-18080-DB 8C2Z-18125-D ASH-1136 AT-164G	-10	<b>83177</b>	...		...	...
			-10	<b>83177</b>	...		...	...
			-10	<b>83177</b>	...		...	...
			-10	<b>83177</b>	...		...	...
				...	...	-10	<b>83178</b>	...
				...	...	-10	<b>83178</b>	...
				...	...	-10	<b>83178</b>	...
				...	...	-10	<b>83178</b>	...
<b>00 - 20</b>	Minotour Type A School bus with Ford E450 Chassis	8C24-18045-DA 8C2Z-18124-D ASH-1154 AT-163G 8C24-18080-DB 8C2Z-18125-D ASH-1136 AT-164G	-10	<b>83177</b>	...		...	...
			-10	<b>83177</b>	...		...	...
			-10	<b>83177</b>	...		...	...
			-10	<b>83177</b>	...		...	...
				...	...	-10	<b>83178</b>	...
				...	...	-10	<b>83178</b>	...
				...	...	-10	<b>83178</b>	...
				...	...	-10	<b>83178</b>	...

## APPLICATION GUIDE - TRUCKS, TRAILERS, AND BUSES





Year Año Année	Model Modelo Modèle	OEM #	Front		Rear	
						
			Fleetline	GasSLX	Fleetline	GasSLX

### THOR MOTOR COACH

#### Class A MotorHomes

<b>12 - 20</b>	ACE Series MotorHomes with Ford F53 Chassis with 16,000 lb GVW to 22,000 lb GVW	ASH-1229	010	<b>83209</b>	<b>89414</b>		...	...
		ASH-25822	010	<b>83209</b>	<b>89414</b>		...	...
		ASH-25823	010	<b>83209</b>	<b>89414</b>		...	...
		ASH-25824		...	...	010	<b>83122</b>	<b>89406</b>
<b>2006</b>	Astoria Series MotorHomes with Freightliner XC Chassis ADL200 Suspension w/ 20K Rear AS120 Front Suspension  Rear Shock with O.E.M. Number  ZF - IFS Front Suspension with 23,000 lb GVW or Greater	16-16873-000		...	...	010	<b>85029</b>	...
		141700131810	010	<b>83160</b>	...		...	...
		16-16737-000	010	<b>83160</b>	...		...	...
		16-16874-000	010	<b>83160</b>	...		...	...
		141700131809		...	...	010	<b>85029</b>	...
		16-16736-000		...	...	010	<b>85029</b>	...
		16-18103-000	-1-	<b>85900</b>	...		...	...
		481700000493	-1-	<b>85900</b>	...		...	...
<b>14 - 20</b>	Axis Series MotorHomes with Ford E450 Chassis	ASH-1136		...	...	-10	<b>83178</b>	...
		ASH-1154	-10	<b>83177</b>	...		...	...
<b>05 - 20</b>	Challenger Series MotorHomes with Ford F53 Chassis with 16,000 lb GVW to 22,000 lb GVW	ASH-1229	010	<b>83209</b>	<b>89414</b>		...	...
		ASH-25822	010	<b>83209</b>	<b>89414</b>		...	...
		ASH-25823	010	<b>83209</b>	<b>89414</b>		...	...
		ASH-25824		...	...	010	<b>83122</b>	<b>89406</b>
<b>02 - 05</b>	Escaper Series MotorHomes with Freightliner XC Chassis ADL200 Suspension w/ 20K Rear AS120 Front Suspension  Rear Shock with O.E.M. Number  ZF - IFS Front Suspension with 23,000 lb GVW or Greater	16-16873-000		...	...	010	<b>85029</b>	...
		141700131810	010	<b>83160</b>	...		...	...
		16-16737-000	010	<b>83160</b>	...		...	...
		16-16874-000	010	<b>83160</b>	...		...	...
		141700131809		...	...	010	<b>85029</b>	...
		16-16736-000		...	...	010	<b>85029</b>	...
		16-18103-000	-1-	<b>85900</b>	...		...	...
		481700000493	-1-	<b>85900</b>	...		...	...
<b>04 - 20</b>	Hurricane Series MotorHomes with Ford F53 Chassis with 16,000 lb GVW to 22,000 lb GVW	ASH-1229	010	<b>83209</b>	<b>89414</b>		...	...
		ASH-25822	010	<b>83209</b>	<b>89414</b>		...	...
		ASH-25823	010	<b>83209</b>	<b>89414</b>		...	...
		ASH-25824		...	...	010	<b>83122</b>	<b>89406</b>
<b>14 - 20</b>	Miramar Series MotorHomes with Ford F53 Chassis with 16,000 lb GVW to 22,000 lb GVW	ASH-1229	010	<b>83209</b>	<b>89414</b>		...	...
		ASH-25822	010	<b>83209</b>	<b>89414</b>		...	...
		ASH-25823	010	<b>83209</b>	<b>89414</b>		...	...
		ASH-25824		...	...	010	<b>83122</b>	<b>89406</b>
<b>07 - 20</b>	Outlaw Series MotorHomes with Ford F53 Chassis with 16,000 lb GVW to 22,000 lb GVW	ASH-1229	010	<b>83209</b>	<b>89414</b>		...	...
		ASH-25822	010	<b>83209</b>	<b>89414</b>		...	...
		ASH-25823	010	<b>83209</b>	<b>89414</b>		...	...
		ASH-25824		...	...	010	<b>83122</b>	<b>89406</b>
<b>2006</b>	Tuscany Series MotorHomes with Freightliner XC Chassis ADL200 Suspension w/ 20K Rear AS120 Front Suspension  Rear Shock with O.E.M. Number  ZF - IFS Front Suspension with 23,000 lb GVW or Greater	16-16873-000		...	...	010	<b>85029</b>	...
		141700131810	010	<b>83160</b>	...		...	...
		16-16737-000	010	<b>83160</b>	...		...	...
		16-16874-000	010	<b>83160</b>	...		...	...
		141700131809		...	...	010	<b>85029</b>	...
		16-16736-000		...	...	010	<b>85029</b>	...
		16-18103-000	-1-	<b>85900</b>	...		...	...
		481700000493	-1-	<b>85900</b>	...		...	...
<b>02 - 05</b>	UltraSport Series MotorHomes with Freightliner XC Chassis ADL200 Suspension w/ 20K Rear	16-16873-000		...	...	010	<b>85029</b>	...

## APPLICATION GUIDE - TRUCKS, TRAILERS, AND BUSES

Year Año Année	Model Modelo Modèle	OEM #	Front		Rear	
						
			Fleetline	GasSLX	Fleetline	GasSLX

### THOR MOTOR COACH(Cont'd.)

#### Class A MotorHomes(Cont'd.)

	AS120 Front Suspension	141700131810	010	83160	...		...	...
		16-16737-000	010	83160	...		...	...
	Rear Shock with O.E.M. Number	16-16874-000	010	83160	...		...	...
		141700131809		...	...	010	85029	...
	ZF - IFS Front Suspension with 23,000 lb GVW or Greater	16-16736-000		...	...	010	85029	...
		16-18103-000	-1-	85900	...		...	...
			481700000493	-1-	85900	...		...
	14 - 20	Vegas Series MotorHomes with Ford E450 Chassis	ASH-1136		...	...	-10	83178
		ASH-1154	-10	83177	...		...	...
06 - 20	WindSport Series MotorHomes with Ford F53 Chassis with 16,000 lb GVW to 22,000 lb GVW	ASH-1229	010	83209	89414		...	...
		ASH-25822	010	83209	89414		...	...
		ASH-25823	010	83209	89414		...	...
		ASH-25824		...	...	010	83122	89406

#### Class C MotorHomes

08 - 13	Chateau Citation Series MotorHomes with Ford E350 & E450 Chassis	ASH-1136		...	...	-10	83178	...
		ASH-1154	-10	83177	...		...	...
99 - 20	Chateau Series MotorHomes with Ford E350 & E450 Chassis	ASH-1136		...	...	-10	83178	...
		ASH-1154	-10	83177	...		...	...
01 - 14	Citation Series MotorHomes with Ford E350 & E450 Chassis	ASH-1136		...	...	-10	83178	...
		ASH-1154	-10	83177	...		...	...
01 - 20	Four Winds Series MotorHomes with Ford E350 & E450 Chassis	ASH-1136		...	...	-10	83178	...
		ASH-1154	-10	83177	...		...	...
10 - 20	Freedom Elite Series MotorHomes with Ford E350 & E450 Chassis	ASH-1136		...	...	-10	83178	...
		ASH-1154	-10	83177	...		...	...
12 - 14	Majestic Series MotorHomes with Ford E350 & E450 Chassis	ASH-1136		...	...	-10	83178	...
		ASH-1154	-10	83177	...		...	...
16 - 20	Outlaw Series MotorHomes with Ford E350 & E450 Chassis	ASH-1136		...	...	-10	83178	...
		ASH-1154	-10	83177	...		...	...
16 - 20	Quantum Series MotorHomes with Ford E350 & E450 Chassis	ASH-1136		...	...	-10	83178	...
		ASH-1154	-10	83177	...		...	...

### TIFFIN MOTORHOMES INC

	Models with Freightliner Chassis - See Freightliner section for proper year and model information	.....		.....				
	Models with Hendrickson Softek Suspension	58913-009	010	85959	...		...	...
		58913-009L	010	85959	...		...	...
	Models with Workhorse Chassis - See Workhorse section for proper year and model information	.....		.....				

### TIMBREN INDUSTRIES

	Additional O.E.M. Interchanges	665804		...	...	010	85939	...
--	--------------------------------	--------	--	-----	-----	-----	-------	-----





### TRAIL KING INDUSTRIES

Identification of the trailer suspension is necessary to determine what section of the catalog to refer to. Some possible options can be Chalmers, Hendrickson, Neway, Ridewell, Reyco.								
---	--	--	--	--	--	--	--	--

### TRAILMOBILE CANADA CORP.

	Trailers with Granning Air Susp. T-350A	43-8-022		...	...	010	83225	...
	Trailers with Hendrickson Air Susp. HT230T (23,000 lb Capacity)	43-6-118		...	...	010	85000	89436
	Trailers with Hendrickson Air Susp. HT250U, HT250U-Y	A-2212		...	...	010	85029	...
	Trailers with Hendrickson Air Susp. T23-RL-17	43-8-011		...	...	010	83207	89407
	Trailers with Hendrickson Air Susp. T23-US-6 (Non-Liftable)	43-8-015		...	...	010	85006	...

**APPLICATION GUIDE - TRUCKS, TRAILERS, AND BUSES**

Year Año Année	Model Modelo Modèle	OEM #	Front		Rear	
						
			Fleetline	GasSLX	Fleetline	GasSLX

**TRAILMOBILE CANADA CORP.(Cont'd.)**





	Trailers with Hendrickson Air Susp. T23-US-9 ( Lifiable & Non-Lifiable)	43-8-014		...	...	010	<b>85013</b>	<b>89414</b>
	Trailers with Hendrickson Air Susp. T30-US-9, -12, -14, -17	43-8-013		...	...	010	<b>85000</b>	<b>89436</b>
	Trailers with Neway Air Susp. AR90-1-14, AR90-1-17	90044089		...	...	010	<b>83124</b>	<b>89407</b>
	Trailers with Neway Air Susp. AR90-14, -17,	90044089		...	...	010	<b>83124</b>	<b>89407</b>
	Trailers with Neway Air Susp. AR92-14	90044992		...	...	010	<b>85000</b>	<b>89436</b>
	Trailers with Neway Air Susp. AR92-17	90044642		...	...	010	<b>83127</b>	...
	Trailers with Neway Air Susp. AR93-14	90045054		...	...	010	<b>85051</b>	...
	Trailers with Neway Air Susp. AR93-17	90044089		...	...	010	<b>83124</b>	<b>89407</b>
	Trailers with Neway Air Susp. AR95-9-HD, -12-HD,-14-HD, 17-HD	90044625		...	...	010	<b>83125</b>	...
	Trailers with Neway Air Susp. RL196-14, -15	90044978		...	...	010	<b>85059</b>	...
	Trailers with Neway Air Susp. RL196-16, -17	90044979		...	...	010	<b>83113</b>	...
	Trailers with Reyco Air Susp. Model # 21AR ( 25,000 LB Capacity)	43-8-002		...	...	010	<b>83209</b>	<b>89414</b>
	Trailers with Reyco Air Susp. Model # 74AR ( 30,000 LB Capacity)	43-8-002		...	...	010	<b>83209</b>	<b>89414</b>
	Trailers with Reyco Air Susp. Model # 86AR	43-8-015		...	...	010	<b>85006</b>	...
	Models with O.E.M. Number	43-4-235		...	...	010	<b>85051</b>	...
		43-4-236		...	...	010	<b>85029</b>	...
		43-4-237		...	...	010	<b>85000</b>	<b>89436</b>
		43-4-239		...	...	010	<b>83207</b>	<b>89407</b>
		43-4-241		...	...	010	<b>85006</b>	...
		43-4-277		...	...	010	<b>85000</b>	<b>89436</b>
		43-4-278		...	...	010	<b>85059</b>	...
		43-4-279		...	...	010	<b>83204</b>	...
		43-6-028		...	...	010	<b>85000</b>	<b>89436</b>
		43-6-137		...	...	010	<b>85006</b>	...
		43-6-158		...	...	010	<b>85013</b>	<b>89414</b>
		43-6-164		...	...	010	<b>83207</b>	<b>89407</b>
		43-8-031		...	...	010	<b>85029</b>	...

**TRANSPORTATION MFG. CORP**

	City Cruiser	12TA-01-13		<b>85303</b>	...	010	<b>85303</b>	<b>89422</b>
	Drive Axle	12J-5-10		...	...	01-	<b>85733</b>	...
		12J-5-2		...	...	01-	<b>85733</b>	...
		12J-5-4		...	...	01-	<b>85733</b>	...
	G 4500 Coach (Front) 45 ft Coach -Tag Axle Tag Axle	12-05-6000	-10	<b>85711</b>	...		...	...
		12-05-6033		...	...	010	<b>85339</b>	...
		12-05-6002		...	...	010	<b>85339</b>	...
	Low Floor Bus Models with O.E.M. Number	12L-5-99		...	...	010	<b>85339</b>	...
	RTS Bus with "V" Drive Rear	G1101590		...	...	010	<b>85713</b>	...
	RTS Bus with Regular Rear	22045526		...	...	010	<b>85702</b>	...
		22052014		...	...	010	<b>85702</b>	...
		G1011822		...	...	010	<b>85702</b>	...
	Tag Axle	12J-5-9		...	...	010	<b>85700</b>	...
	Models with O.E.M. Number	12B-5-1		...	...	010	<b>85735</b>	...
		12G-5-1	010	<b>85700</b>	...		...	...
		12T-1-13		<b>85303</b>	...	010	<b>85303</b>	<b>89422</b>
		680349		...	...	010	<b>85702</b>	...
		680470		...	...	010	<b>85713</b>	...
	Additional O.E.M. Interchanges	12L-5-69	010	<b>85700</b>	...		...	...
		12L-5-70	010	<b>85700</b>	...		...	...



## APPLICATION GUIDE - TRUCKS, TRAILERS, AND BUSES

Year Año Année	Model Modelo Modèle	OEM #	Front		Rear	
						
			Wrench	Wrench	Wrench	Wrench
			Fleetline	GasSLX	Fleetline	GasSLX

### TRINITY TRAILER MFG., INC.

Identification of the trailer suspension is necessary to determine what section of the catalog to refer to. Some possible options can be Chalmers, Hendrickson, Neway, Ridewell, Reyco.					
---	--	--	--	--	--

### TURNER-QUICK LIFT - SEE HENDRICKSON SUSPENSION

--	--	--	--	--	--

### TURTLETOP BUS

- 2020	Odyssey Series Shuttle buses with Ford E450 Chassis	ASH-1136	-	...	...	-10	<b>83178</b>	...
				<b>83177</b>	...		...	...
- 2020	Terra Transit Series Shuttle buses with Ford E350 & E450 Chassis	ASH-1136	-	...	...	-10	<b>83178</b>	...
				<b>83177</b>	...		...	...
- 2020	Vanterra Series Shuttle buses with Ford E350 Chassis	ASH-1136	-	...	...	-10	<b>83178</b>	...
				<b>83177</b>	...		...	...

### TUTHILL TECHNOLOGIES

#### Drive Axle

101A, 101AR Models	18166-01		...	...	010	<b>85704</b>	...
102AR (Hvy Duty) Models	18286-01		...	...	010	...	<b>89414</b>
102AR (Special) Models	17146-01		...	...	010	<b>83209</b>	<b>89414</b>
102AR (Standard) Models	12887-02		...	...	010	<b>85013</b>	<b>89414</b>
102AR for Western Star Models	19824-01		...	...	010	<b>85006</b>	...
102AR-7 Models	17794-01		...	...	010	<b>83215</b>	...
102AR-LM Models	19623-01		...	...	010	<b>83123</b>	<b>89405</b>
200 Models Air Suspension	20129-01		...	...	010	<b>85007</b>	...
240AR Air-Ride Suspension With O.E.M. Number	20125-01		...	...	010	<b>85030</b>	<b>89440</b>
	20126-01		...	...	010	...	<b>89440</b>
74AR - 30000 lb Capacity	12887-01		...	...	010	<b>85013</b>	<b>89414</b>
79KB Models	16725-01		...	...	010	<b>83126</b>	<b>89440</b>
	19495-01		...	...	010	<b>83126</b>	<b>89440</b>









#### Steer Axle

1207 Models	17403-01	010	<b>83122</b>	<b>89406</b>		...	...
1209 (Alternate) Models	17408-01	010	<b>85005</b>	<b>89430</b>		...	...
1209, 1212 Models	17358-01	010	<b>83126</b>	<b>89440</b>		...	...
	19495-01	010	<b>83126</b>	<b>89440</b>		...	...
21B Models	14954-01	010	<b>83217</b>	...		...	...

#### Trailer

21B (Special) Models	18800-01		...	...	010	<b>83203</b>	<b>89436</b>
25 ART Models with O.E.M. Number	24392-01		...	...	010	<b>85051</b>	...
25 ARU Models with O.E.M. Number	23553-01		...	...	010	<b>85938</b>	...
30 ARUUL - 12 and -17 Models	23524-01		...	...	010	<b>85738</b>	...
81S Models	12885-03		...	...	010	<b>85300</b>	<b>89419</b>
86 AR / RS 1015, 1035, 3015, 3035 Slider Air Suspension	18165-01		...	...	010	<b>85006</b>	...
87 for Great Dane Models	18163-01		...	...	010	<b>83207</b>	<b>89407</b>
	18164-01		...	...	010	<b>83122</b>	<b>89406</b>
87-14, -17 Models	16230-01		...	...	010	<b>85702</b>	...
87-6, 87-9 Models	12885-01		...	...	010	<b>85300</b>	<b>89419</b>
Models with O.E.M. Number	1085		...	...	010	<b>83214</b>	...
	16824-01		...	...	010	<b>85006</b>	...
	17142-01		...	...	010	<b>85001</b>	<b>89410</b>
	20960-01		...	...	010	<b>83204</b>	...
	21497-01		...	...	010	<b>85005</b>	<b>89430</b>
	2697		...	...	010	<b>85712</b>	...
680162		...	...	010	<b>85300</b>	<b>89419</b>	

## APPLICATION GUIDE - TRUCKS, TRAILERS, AND BUSES

Year Año Année	Model Modelo Modèle	OEM #	Front		Rear	
						
						
			Fleetline	GasSLX	Fleetline	GasSLX

### TUTHILL TECHNOLOGIES(Cont'd.)

#### Trailer(Cont'd.)

Models with O.E.M. Number	OEM #	Front	Rear	Front	Rear	Front	Rear
	702135-01	...	...	OIO	<b>85045</b>	...	...
	702136-01	...	...	OIO	<b>85052</b>	...	...
	702209-01	...	...	OIO	<b>85014</b>	...	...
	OE12425	...	...	OIO	<b>83214</b>	...	...

### TWIN COACH

Models with O.E.M. Number	OEM #	Front	Rear	Front	Rear	Front	Rear
	90044089	...	...	OIO	<b>83124</b>	<b>89407</b>	...
	90044089C	...	...	OIO	<b>83124</b>	<b>89407</b>	...
	90044162	...	...	OIO	<b>83128</b>	<b>89436</b>	...
	AR-718-C-HD	...	...	OIO	<b>85000</b>	<b>89436</b>	...
	AR-958	...	...	OIO	<b>83207</b>	<b>89407</b>	...

### UNITED MANUFACTURING

Models with O.E.M. Number	OEM #	Front	Rear	Front	Rear	Front	Rear
	K-96-41	...	...	OIO	<b>85304</b>	...	...

### UNIVERSAL COACH

Models with O.E.M. Number	OEM #	Front	Rear	Front	Rear	Front	Rear
	12-05-1199	...	...	OIO	<b>85729</b>	...	...
	680777	...	...	OIO	<b>85729</b>	...	...

### UPS TRUCK

Models with O.E.M. Number	OEM #	Front	Rear	Front	Rear	Front	Rear
	P117099	...	...	OIO	<b>83120</b>	...	...
	P117146	OIO	<b>83118</b>	...	...	...	...

### UTILITY TRAILER MANUFACTURING COMPANY

Identification of the trailer suspension is necessary to determine what section of the catalog to refer to. Some possible options can be Chalmers, Hendrickson, Neway, Ridewell, Reyco.

#### Flatbeds

Models with O.E.M. Number	OEM #	Front	Rear	Front	Rear	Front	Rear
4000A Model Trailers with Hendrickson AANT 23K Intraax Air Ride (High Damping) (Hvy Duty) (Limited Rebound) (Standard)	B-24023	...	...	OIO	<b>85738</b>	...	...
	B-24125	...	...	OIO	<b>85323</b>	<b>89436</b>	...
	B-23361	...	...	OIO	<b>85911</b>	...	...
	B-23566	...	...	OIO	<b>85000</b>	<b>89436</b>	...
Drop Deck Trailers with Hendrickson AANL 23K Intraax Air Ride with 12" to 17" Ride Height - High Damping with 6.5" to 9" Ride Height - High Damping with 6.5" to 9" Ride Height - Standard	B-25515	...	...	OIO	<b>85338</b>	...	...
	B-24579	...	...	OIO	<b>85939</b>	...	...
	B-23651	...	...	OIO	<b>85045</b>	...	...

#### Reefers & Dry Vans

Models with O.E.M. Number	OEM #	Front	Rear	Front	Rear	Front	Rear
3000R Multi-Temp Trailers with Hendrickson HKANT 40K Vantraax Air Ride Heavy Duty Standard	B-24088	...	...	OIO	<b>85000</b>	<b>89436</b>	...
	S-24088	...	...	OIO	<b>85000</b>	<b>89436</b>	...
	B-24088	...	...	OIO	<b>83128</b>	<b>89436</b>	...
	S-24088	...	...	OIO	<b>83128</b>	<b>89436</b>	...
4000D Trailers with Hendrickson HKANT 40K Vantraax Air Ride Heavy Duty Standard	B-24088	...	...	OIO	<b>85000</b>	<b>89436</b>	...
	S-24088	...	...	OIO	<b>85000</b>	<b>89436</b>	...
	B-24088	...	...	OIO	<b>83128</b>	<b>89436</b>	...
	S-24088	...	...	OIO	<b>83128</b>	<b>89436</b>	...
4000D-X Composite Trailers with Hendrickson HKANT 40K Vantraax Air Ride Heavy Duty Standard	B-24088	...	...	OIO	<b>85000</b>	<b>89436</b>	...
	S-24088	...	...	OIO	<b>85000</b>	<b>89436</b>	...
	B-24088	...	...	OIO	<b>83128</b>	<b>89436</b>	...
	S-24088	...	...	OIO	<b>83128</b>	<b>89436</b>	...

## APPLICATION GUIDE - TRUCKS, TRAILERS, AND BUSES

Year Año Année	Model Modelo Modèle	OEM #	Front		Rear	
			Fleetline	GasSLX	Fleetline	GasSLX

### VAN HOOL

00 - 09	T2145 and T2150 Buses with O.E.M. Number (Front & Tag Axle)	10685703		...	...	- -	<b>695406</b>	...
		624314570		...	...	- -	<b>695406</b>	...
		90-2291		...	...	- -	<b>695406</b>	...
	T811, T812, T813, T814 Buses	6243-14040		<b>85708</b>	...	- -	<b>85708</b>	...
		665563		<b>85708</b>	...	- -	<b>85708</b>	...
	T815 4D Buses	6243-14040		...	...	- -	<b>85708</b>	...
		665563		...	...	- -	<b>85708</b>	...
00 - 09	T940 and T945 Buses	624314570		...	...	- -	<b>695406</b>	...
		90-2291		...	...	- -	<b>695406</b>	...
	TL 13/14 Buses	6243-13790		<b>85708</b>	...	- -	<b>85708</b>	...
		665562		<b>85708</b>	...	- -	<b>85708</b>	...

### VOLVO

#### FE Series

	FE6 Models	6857668	- 0	<b>83105</b>	...		...	...
		6876828	- 0	<b>83105</b>	...		...	...
	FE611, FE614 Front after CH419306	6794358	0 0	<b>85040</b>	...		...	...
	FE614 Tractor	6790756		...	...	0 0	<b>83215</b>	...
		6794358	0 0	<b>85040</b>	...		...	...
	FE615, FE715	6772218	0 0	<b>85040</b>	...		...	...
		6775412	0 0	<b>85040</b>	...		...	...
	FE7 Models up to Chassis No. 20855	1505190		...	...	- -	<b>85722</b>	...
	FE7 Models with Rear Air Suspension (Drive Axle)	1591501		...	...	- -	<b>85722</b>	...
	FE715 with Rear Parabolic Spring	6790756		...	...	0 0	<b>83215</b>	...
	Models with Rear Air Suspension and O.E.M. Number	8056892		...	...	0 0	<b>85023</b>	<b>89415</b>

#### N Series

	N10 with 5.5 Ton Front Axle	1593843	0 0	<b>83215</b>	...		...	...
	N11 Models	1593843	0 0	<b>83215</b>	...		...	...
	N12 Models	1593843	0 0	<b>83215</b>	...		...	...

#### VAH Series

	VAH 430 Models with 12,000 to 22,000 lb Front Axles	20433426	0 -	<b>85081</b>	...		...	...
		SDA471700131258	0 -	<b>85081</b>	...		...	...
	VAH 430 Models with Hendrickson HAS 400 or 460 Series Rear Suspension	60675-001		...	...	0 0	<b>85978</b>	...
		60675-001L		...	...	0 0	<b>85978</b>	...
		8083872		...	...	0 0	<b>85978</b>	...
2014	VAH 430 Models with O.E.M. Number	141700005838	0 0	<b>85098</b>	<b>89502</b>		...	...
		21436086	0 0	<b>85098</b>	<b>89502</b>		...	...
17 - 18	VAH 630 Models with 40,000 lb Rear Air Suspension	21462378		...	...	0 0	<b>85088</b>	...
		21462380		...	...	0 0	<b>85088</b>	...
		471700006038		...	...	0 0	<b>85088</b>	...
		471700006040		...	...	0 0	<b>85088</b>	...

#### VHD - Series

02 - 20	Models with 12,000 to 22,000 lb Front Axles	20353932	0 -	<b>85081</b>	...		...	...
		20414440	0 -	<b>85081</b>	...		...	...
		20433426	0 -	<b>85081</b>	...		...	...
		20434880	0 -	<b>85081</b>	...		...	...
		471700131258	0 -	<b>85081</b>	...		...	...
		SDA471700131258	0 -	<b>85081</b>	...		...	...
- 2017	Models with Hendrickson 40,000 lb Pimaax EX and FireMaax EX Air Suspension	20782199		...	...	0 0	<b>85072</b>	...
		60657-007		...	...	0 0	<b>85072</b>	...
- 2020	Models with Hendrickson HMX 400/460 Haulmax with 16.5" Saddle	60680-004		...	...	0 -	<b>83143</b>	...
		60680-004L		...	...	0 -	<b>83143</b>	...

## APPLICATION GUIDE - TRUCKS, TRAILERS, AND BUSES

Year Año Année	Model Modelo Modèle	OEM #	Front		Rear	
			Fleetline	GasSLX	Fleetline	GasSLX

### VOLVO(Cont'd.)

#### VHD - Series(Cont'd.)

- 2020	Models with Hendrickson HMX 400/460 Haulmax with 17.5" & 18.5" Saddle	60680-005	...	...	01-	83142	...
		60680-005L	...	...	01-	83142	...
	Models with Neway ADZ Rear Suspension	471700004423	...	...	010	85109	...
		90045605	...	...	010	85109	...
		20433427	...	...	01-	85065	...
08 - 20	Models with T-Ride Rear Suspension	471700131256	...	...	01-	85065	...

#### VN Series - 2200

05/99 -	Models built after May 1999	20433425	...	...	010	85066	89448
		471700002627	...	...	010	85066	89448
		8086651	...	...	010	85066	89448
	Models with O.E.M. Number	20433424	010	85061	89450	...	...
		20513881	010	85061	89450	...	...
		20551628	...	...	010	85066	89448
		20973993	010	85061	89450	...	...
		47170000443	...	...	010	85066	89448
		665607	...	...	010	85047	89435
		8077874	...	...	010	85047	89435
		8077874-P01	...	...	010	85047	89435
		8078195	010	85061	89450	...	...
		8086053	...	...	010	85047	89435
		8169859	...	...	010	85047	89435

#### VNL Series

06 - 16	300 Models with Hendrickson 40,000 lb Pimaax EX and FireMaax EX Air Suspension	20782199	...	...	010	85072	...
		60657-007	...	...	010	85072	...
06 - 10	300, 300U Models with 12,000 - 13,200 lb Front Axles	20433424	010	85061	89450	...	...
		20973993	010	85061	89450	...	...
11 - 20	300, 300U Models with 12,000 - 13,200 lb Front Axles	141700005838	010	85098	89502	...	...
		21436086	010	85098	89502	...	...
06 - 11	300, 300U Models with 40,000 lb Rear Air Suspension	20433425	...	...	010	85066	89448
		20551628	...	...	010	85066	89448
		47170000443	...	...	010	85066	89448
		471700002627	...	...	010	85066	89448
11 - 20	300, 300U Models with 40,000 lb Rear Air Suspension	21462378	...	...	010	85088	...
		471700006038	...	...	010	85088	...
06 - 14	300, 300U Models with Hendrickson Airtek	20485632	010	85933	89454	...	...
		20485633	010	85933	89454	...	...
		21137330	010	85933	89454	...	...
		471700003832	010	85933	89454	...	...
		64838-003	010	85933	89454	...	...
		64838-003L	010	85933	89454	...	...
11 - 18	430 Models with 12,500 - 14,600 lb Front Axle	141700005838	010	85098	89502	...	...
		21436086	010	85098	89502	...	...
06 - 10	430 Models with 13,200 lb Front Axle	20433424	010	85061	89450	...	...
		20973993	010	85061	89450	...	...
05 - 11	430 Models with 40,000 lb Rear Air Suspension	20433425	...	...	010	85066	89448
		20551628	...	...	010	85066	89448
		47170000443	...	...	010	85066	89448
		471700002627	...	...	010	85066	89448
11 - 18	430 Models with 40,000 lb Rear Air Suspension	21462380	...	...	010	85088	...
		471700006040	...	...	010	85088	...
05 - 14	430 Models with Hendrickson Airtek	20485632	010	85933	89454	...	...
		20485633	010	85933	89454	...	...
		21137330	010	85933	89454	...	...

## APPLICATION GUIDE - TRUCKS, TRAILERS, AND BUSES



Year Año Année	Model Modelo Modèle	OEM #	Front		Rear	
			Fleetline	GasSLX	Fleetline	GasSLX

### VOLVO(Cont'd.)

#### VNL Series(Cont'd.)

05 - 14	430 Models with Hendrickson Airtek	47170003832	010	85933	89454		...	...
		64838-003	010	85933	89454		...	...
		64838-003L	010	85933	89454		...	...
11 - 19	630 & 670 Models with 12,500 - 14,600 lb Front Axle	141700005838	010	85098	89502		...	...
		21436086	010	85098	89502		...	...
06 - 10	630 & 670 Models with 13,200 lb Front Axle	20433424	010	85061	89450		...	...
		20973993	010	85061	89450		...	...
06 - 11	630 & 670 Models with 40,000 lb Rear Air Suspension	20551628		...	...	010	85066	89448
		471700000443		...	...	010	85066	89448
11 - 19	630 & 670 Models with 40,000 lb Rear Air Suspension	21462380		...	...	010	85088	...
		471700006040		...	...	010	85088	...
06 - 16	630 & 670 Models with Hendrickson Airtek	20485632	010	85933	89454		...	...
		20485633	010	85933	89454		...	...
		21137330	010	85933	89454		...	...
		47170003832	010	85933	89454		...	...
		64838-003	010	85933	89454		...	...
		64838-003L	010	85933	89454		...	...
06 - 16	64T-830 Models with Hendrickson 40,000 lb Pimaax EX and FireMaax EX Air Suspension	20782199		...	...	010	85072	...
06 - 16	64T-830 Models with Hendrickson 40,000 lb Primaax, Pimaax EX and FireMaax EX Air Suspension	60657-007		...	...	010	85072	...
11 - 18	730 & 780 Models with 12,500 - 14,600 lb Front Axle	141700005838	010	85098	89502		...	...
		21436086	010	85098	89502		...	...
06 - 10	730 & 780 Models with 13,200 lb Front Axle	20433424	010	85061	89450		...	...
		20973993	010	85061	89450		...	...
06 - 11	730 & 780 Models with 40,000 lb Rear Air Suspension	20551628		...	...	010	85066	89448
		471700000443		...	...	010	85066	89448
11 - 18	730 & 780 Models with 40,000 lb Rear Air Suspension	21462380		...	...	010	85088	...
		471700006040		...	...	010	85088	...
06 - 16	730 & 780 Models with Hendrickson Airtek	20485632	010	85933	89454		...	...
		20485633	010	85933	89454		...	...
		21137330	010	85933	89454		...	...
		47170003832	010	85933	89454		...	...
		64838-003	010	85933	89454		...	...
		64838-003L	010	85933	89454		...	...
2018 - 20	740 Models with 12,500 - 14,600 lb Front Axle	141700005838	010	85098	89502		...	...
		21436086	010	85098	89502		...	...
2018 - 20	740 Models with 40,000 lb Rear Air Suspension	21462380		...	...	010	85088	...
		471700006040		...	...	010	85088	...
2018 - 19	740 Models with Hendrickson Airtek	21137330	010	85933	89454		...	...
		47170003832	010	85933	89454		...	...
		64838-003	010	85933	89454		...	...
		64838-003L	010	85933	89454		...	...
2018 - 20	760 Models with 12,500 - 14,600 lb Front Axle	141700005838	010	85098	89502		...	...
		21436086	010	85098	89502		...	...
2018 - 20	760 Models with 40,000 lb Rear Air Suspension	21462380		...	...	010	85088	...
		471700006040		...	...	010	85088	...
	760 Models with Hendrickson Airtek	21137330	010	85933	89454		...	...
		47170003832	010	85933	89454		...	...
		64838-003	010	85933	89454		...	...
		64838-003L	010	85933	89454		...	...
2018 - 19	760 Models with Hendrickson HAS 400 or 460 Series Rear Suspension	60675-001		...	...	010	85978	...
		60675-001L		...	...	010	85978	...
		8083872		...	...	010	85978	...
2018 - 20	860 Models with 12,500 - 14,600 lb Front Axle	141700005838	010	85098	89502		...	...

**APPLICATION GUIDE - TRUCKS, TRAILERS, AND BUSES**

Year Año Année	Model Modelo Modèle	OEM #	Front		Rear	
						
			Fleetline	GasSLX	Fleetline	GasSLX

**VOLVO(Cont'd.)**

**VNL Series(Cont'd.)**

2018 - 20	860 Models with 12,500 - 14,600 lb Front Axle	21436086	○ ○	85098	89502		...	...
2018 - 20	860 Models with 40,000 lb Rear Air Suspension	21462380		...	...	○ ○	85088	...
		471700006040		...	...	○ ○	85088	...
06 - 10	All Models with 12,000 - 13,200 lb Front Axles	20433424	○ ○	85061	89450		...	...
		20973993	○ ○	85061	89450		...	...
		8071881	○ ○	85061	89450		...	...
05/99 -	Models with 38,000 lb Rear Air Suspension built after May 1999	20433425		...	...	○ ○	85066	89448
		471700002627		...	...	○ ○	85066	89448
- 2018	Models with Neway ADZ Rear Suspension	471700004423		...	...	○ ○	85109	...
		90045605		...	...	○ ○	85109	...

**VNM Series**

- 2017	200 Models with 12,000 lb Front Axles	21436086	○ ○	85098	89502		...	...
- 2016	200 Models with 46,000 lb T-Ride Rear Suspension	20433427		...	...	○ -	85065	...
- 2017	430 Models with 12,500 lb Front Axle	21436086	○ ○	85098	89502		...	...
- 2017	630 Models with 12,500 lb Front Axle	21436086	○ ○	85098	89502		...	...
- 2017	630 Models with 38,000 lb Rear Air Suspension	21462378		...	...	○ ○	85088	...
		21462380		...	...	○ ○	85088	...
		471700006038		...	...	○ ○	85088	...
		471700006040		...	...	○ ○	85088	...

**VNR Series**

18 - 19	300 Models with 40,000 lb Rear Air Suspension	21462378		...	...	○ ○	85088	...
		471700006038		...	...	○ ○	85088	...
18 - 19	400 Models with 38,000 lb Rear Air Suspension	21462380		...	...	○ ○	85088	...
		471700006040		...	...	○ ○	85088	...
	640 Models with 38,000 lb Rear Air Suspension	21462380		...	...	○ ○	85088	...
		471700006040		...	...	○ ○	85088	...
2018 - 19	Models with 12,500 lb Front Axle	141700005838	○ ○	85098	89502		...	...
		21436086	○ ○	85098	89502		...	...
2018 - 19	Models with Hendrickson Airtex	21137330	○ ○	85933	89454		...	...
		471700003832	○ ○	85933	89454		...	...
		64838-003	○ ○	85933	89454		...	...
		64838-003L	○ ○	85933	89454		...	...
2018	Models with Hendrickson HAS 400 or 460 Series Rear Suspension	60675-001		...	...	○ ○	85978	...
		60675-001L		...	...	○ ○	85978	...
		8083872		...	...	○ ○	85978	...

**VNX - Series**

	Models with 12,500 - 14,600 lb Front Axle	141700005838	○ ○	85098	89502		...	...
		21436086	○ ○	85098	89502		...	...
	Models with 40,000 lb Rear Air Suspension	21462380		...	...	○ ○	85088	...
		471700006040		...	...	○ ○	85088	...
	Models with Neway ADZ Rear Suspension	471700004423		...	...	○ ○	85109	...
		90045605		...	...	○ ○	85109	...

**Vocational Trucks**

	Models with T-Ride Rear Suspension	20433427		...	...	○ -	85065	...
		8060026		...	...	○ -	85065	...
		8073212		...	...	○ -	85065	...
		8075257		...	...	○ -	85065	...
	WX, WXR, WG, AC Models with Hendrickson HN-402 Rear Suspension	57241-3		...	...	○ -	83112	...
		60680-003		...	...	○ -	83112	...
		60680-003L		...	...	○ -	83112	...
	WX, WXML, WXR, WG, AC Models With Hendrickson HAS-400 Rear Air Suspension	47902-24		...	...	○ ○	83137	...
		47902-24		...	...	○ ○	83137	...

## APPLICATION GUIDE - TRUCKS, TRAILERS, AND BUSES

Year Año Année	Model Modelo Modèle	OEM #	Front			Rear		
			Fleetline	GasSLX				

### VOLVO(Cont'd.)

#### Vocational Trucks(Cont'd.)

	With Hendrickson HN-462 Rear Suspension	57241-3	...	...	01-	<b>83112</b>	...
		60680-003	...	...	01-	<b>83112</b>	...
		60680-003L	...	...	01-	<b>83112</b>	...

#### VT Series

<b>06 - 10</b>	64T-830 Models with 40,000 lb Rear Air Suspension	20551628	...	...	010	<b>85066</b>	<b>89448</b>
		471700000443	...	...	010	<b>85066</b>	<b>89448</b>
<b>06 - 10</b>	64T-830 Models with Hendrickson 40,000 lb Primaax, Pimaax EX and FireMaax EX Air Suspension	60657-007	...	...	010	<b>85072</b>	...
<b>06 - 10</b>	64T-880 Models with Hendrickson 40,000 lb Pimaax EX and FireMaax EX Air Suspension	20782199	...	...	010	<b>85072</b>	...
<b>06 - 10</b>	All Models with 12,000 - 13,200 lb Front Axles	20433424	010	<b>85061</b>	<b>89450</b>	...	...
		20973993	010	<b>85061</b>	<b>89450</b>	...	...
		8071881	010	<b>85061</b>	<b>89450</b>	...	...

#### WCA & WIA Series

<b>1995 -</b>	All with O.E.M. Number and after V.I.N. Number 723506	8169859	...	...	010	<b>85047</b>	<b>89435</b>
	Models with Front Dual Shocks	02-7005976	-1-	<b>83400</b>	...	...	...
		3082284	-1-	<b>83400</b>	...	...	...
<b>93 - 95</b>	Models with O.E.M. Number and after V.I.N. Number 657841	8026658	...	...	010	<b>85046</b>	<b>89434</b>
<b>- 1992</b>	Models with O.E.M. Number and up to V.I.N. Number 657250	8071524	...	...	010	<b>85024</b>	...
	Models with O.E.M. Number	37301-0016	01-	<b>85026</b>	<b>89417</b>	...	...
		37301-0021	01-	<b>85026</b>	<b>89417</b>	...	...
		37301-3201	-1-	<b>85027</b>	<b>89418</b>	...	...
		37301-3202	01-	<b>85026</b>	<b>89417</b>	...	...
		4975549	010	<b>83216</b>	...	...	...
		8065787	01-	<b>85026</b>	<b>89417</b>	...	...

#### WG Series

	Models with O.E.M. Number	35901-3201	...	...	010	<b>85024</b>	...
		37301-3201	-1-	<b>85027</b>	<b>89418</b>	...	...
		665623	...	...	010	<b>85046</b>	<b>89434</b>
<b>- 1992</b>	Models with O.E.M. Number	8065787	01-	<b>85026</b>	<b>89417</b>	...	...
		8071524	...	...	010	<b>85024</b>	...
<b>93 - 95</b>	Models with O.E.M. Number	8026658	...	...	010	<b>85046</b>	<b>89434</b>









#### WH Series

	WHS, WHR, WHL or WHE Models with Front Dual Shocks	02-7005976	-1-	<b>83400</b>	...	...	...
		3082284	-1-	<b>83400</b>	...	...	...
	WHS, WHR, WHL or WHE Models with Front Single Shocks	37301-0021	01-	<b>85026</b>	<b>89417</b>	...	...
<b>- 1992</b>	WHS, WHR, WHL or WHE Models with O.E.M. Number	35901-3201	...	...	010	<b>85024</b>	...
		8071524	...	...	010	<b>85024</b>	...
<b>1995 -</b>	WHS, WHR, WHL or WHE Models with O.E.M. Number	8169859	...	...	010	<b>85047</b>	<b>89435</b>
<b>93 - 95</b>	WHS, WHR, WHL or WHE Models with O.E.M. Number	8026658	...	...	010	<b>85046</b>	<b>89434</b>

#### Additional Applications

	1500 Models	.....	...	...	010	<b>83122</b>	<b>89406</b>
	1500 Models Models with Rear Suspension Models with Velvet Ride Suspension	35901-0005	...	...	010	<b>83219</b>	...
		530596	...	...	010	<b>85308</b>	<b>89422</b>
		3000, 4000 & 9000 Models - Special Unit - Four Shock Absorbers Required Per Axle	5554959	010	<b>83401</b>	...	...
	3014, 3015, 3016, 3020 C.O.E. and 1500	676081	010	<b>83401</b>	...	...	...
		676082	010	<b>83401</b>	...	...	...
		.....	010	<b>83122</b>	<b>89406</b>	...	...
	9000 Models	.....	010	<b>83122</b>	<b>89406</b>	...	...
	Brigadier Models	22012065	010	<b>85304</b>	...	...	...
		22046483	010	<b>85304</b>	...	...	...
		22052336	010	<b>85304</b>	...	...	...
	Models with Hendrickson HN - 400 Rear suspension	3971703	...	...	01-	<b>83112</b>	...

## APPLICATION GUIDE - TRUCKS, TRAILERS, AND BUSES

Year Año Année	Model Modelo Modèle	OEM #	Front		Rear	
						
						
			Fleetline	GasSLX	Fleetline	GasSLX

### VOLVO(Cont'd.)

#### Additional Applications(Cont'd.)





78 - 83	RC2	.....	-	...	...	OIO	83122	89406
	Road Boss, Road Boss II, Road Commander II, Road Expedito - (Four Shocks per Axle)	3946210	- -	<b>83103</b>	...		...	...
	Road Boss, Road Boss II, Road Commander, Road Commander II, Road Expedito II - (Four Shocks per Axle)	02-7005976	- -	<b>83400</b>	...		...	...
		02-7005977	- -	<b>83400</b>	...		...	...
		4975479	- -	<b>83400</b>	...		...	...
		4975480	- -	<b>83400</b>	...		...	...
	Models with Hendrickson Airtex	20469001	OIO	<b>85933</b>	<b>89454</b>		...	...
		20469002	OIO	<b>85933</b>	<b>89454</b>		...	...
		471700131920	OIO	<b>85933</b>	<b>89454</b>		...	...
		471700131921	OIO	<b>85933</b>	<b>89454</b>		...	...
		64838-001	OIO	<b>85933</b>	<b>89454</b>		...	...
		64838-002	OIO	<b>85933</b>	<b>89454</b>		...	...

#### Additional O.E.M. Interchanges

Additional O.E.M. Interchanges	03-1106460	OIO	85005	89430	...	...
	20863239	OIO	<b>85080</b>	...	...	...
	35901-0003	OIO	<b>85301</b>			
	35901-0004	OIO	...	...	OIO	<b>83219</b>
	35901-0011	OIO	...	...	OIO	<b>83123</b>
	35901-0017	OIO	<b>83314</b>	...	...	...
	35901-0022	OIO	...	...	OIO	<b>83635</b>
	35901-3406	OIO	<b>85305</b>			
	35901-3409	OIO	<b>85304</b>			
	35901-3410	OIO	<b>85307</b>			
	35901-3413	OIO	<b>85006</b>			
	35901-3420	OIO	<b>85303 or 89422</b>			
	37001-5	OIO	<b>83401</b>	...	...	...
	37301-0001	OIO	<b>85013 or 89414</b>			
	37301-0018	OIO	<b>85005 or 89430</b>			
	3953643	OIO	<b>85040</b>	...	...	...
	4940640	OIO	<b>83216</b>			
	494-660	OIO	<b>83219</b>			
	5322338	OIO	<b>83214</b>			
	5513989	OIO	<b>83216</b>			
	5531435	OIO	<b>85307</b>			
	5531436	OIO	<b>85307</b>			
	5531437	OIO	<b>85307</b>			
	5534430	OIO	<b>85303 or 89422</b>			
	5534447	OIO	<b>85303 or 89422</b>			
	5549899	OIO	<b>83207 or 89407</b>			
	5549925	OIO	<b>85304</b>	...	...	...
	629398	OIO	<b>85307</b>			
	629501	OIO	<b>85307</b>			
	646220	OIO	<b>85734</b>			
	66010-0016	OIO	<b>85025</b>			
	668302	OIO	<b>83216</b>			
	6771501	OIO	<b>85040</b>	...	...	...
	6775411	OIO	<b>85040</b>	...	...	...
	1091347	OIO	<b>83125</b>			
	1091348	OIO	<b>83122 or 89406</b>			
	1091349	OIO	...	...	OIO	<b>83204</b>
	1091350	OIO	<b>83207 or 89407</b>			
	1091351	OIO	<b>83209 or 89414</b>			
	1091353	OIO	<b>83215</b>			



**APPLICATION GUIDE - TRUCKS, TRAILERS, AND BUSES**





Year Año Année	Model Modelo Modèle	OEM #	Front		Rear	
			 	 		
			Fleetline	GasSLX	Fleetline	GasSLX

**VOLVO(Cont'd.)**

**Additional O.E.M. Interchanges(Cont'd.)**

Additional O.E.M. Interchanges	1091354	010	83216			
	1091355	010	83217			
	1091357		...	...	010	83219
	1091358	-1-	83456	89447		...
	1091359		...	...	010	83123 89405
	1091360	010	83303	...		...
	1091361	010	83304	...		...
	1091362	010	83309	...		...
	1091363	010	83221			
	1091364	010	83312	89409		...
	1091365	-1-	83400	...		...
	1091366	010	83401	...		...
	1091367		...	...	010	85000 89436
	1091368		...	...	010	85003 89411
	1091370	010	85006			
	1091371	010	85300 or 89419			
	1091372	010	85301			
	1091373	010	85302 or 89420			
	1091374	010	85303 or 89422			
	1091375	010	85304			
	1091376	010	85305			
	1091377	010	85307			
	1091378	010	85308 or 89422			
	1091379		...	...	-1-	85310 89423
	1091384	010	85735			
	1093100	-1-	85027	89418		...
	1093176		...	...	010	85024
	1093177	01-	85025			
	1093178	01-	85026	89417		...
	1093180	010	85030 or 89440			
	1716824	010	85304			
	19501669		...	...	010	85339
	19502711	010	85702			
	19506846		...	...	010	85339
	3130140	010	85315			
	3171696	010	85307			
	3172948	010	85303 or 89422			
	3199937	-10	85316	89426		...
	3199938	010	85030 or 89440			
	3199939	010	85058	89431		...
	3199940	010	85005 or 89430			
	3199941	010	85006			
	3199942	010	89402			
	3199943	010	85012 or 89413			
	3199944	010	85006			
	3199945	-1-	85027	89418		...
	3199946		...	...	-10	85033 89427
	3199947	010	85013 or 89414			
	3199948		...	...	-10	85311 89424
	3199949		...	...	-1-	85310 89423
3199950	010	85023 or 89415				
3199951		...	...	010	85024	
3199952	010	85736				
3199953		...	...	-10	85319 89428	
3199954		...	...	010	85003 89411	

**APPLICATION GUIDE - TRUCKS, TRAILERS, AND BUSES**







Year Año Année	Model Modelo Modèle	OEM #	Front		Rear	
						
			Fleetline	GasSLX	Fleetline	GasSLX

**VOLVO(Cont'd.)**

**Additional O.E.M. Interchanges(Cont'd.)**

Additional O.E.M. Interchanges	3199955	010	85300 or 89419			
	3199956		85036	...	010	85036 89405
	3199957	010	83122 or 89406			
	3199959		...	...	010	85323 89436
	3199960		...	...	010	85322 ...
	3199961	010	85307			
	3199962		...	...	010	85314 89425
	3199963	010	85315			
	3199965	010	85736			
	3199966	010	85303 or 89422			
	3199967	010	85302 or 89420			
	3199968	010	85308 or 89422			
	3199972	010	85320	89429		... ..
	3199973	-1-	85722			
	3199974	010	85712			
	3199975	010	85700			
	3199976	-10	85711			
	3199977	-10	85711			
	3199978	010	85712			
	3199979	010	85702			
	3199980		...	...	-1-	85310 89423
	3199982	-10	85703	...		... ..
	3199983		...	...	010	85704 ...
	3199984		...	...	010	85314 89425
	3199985	01-	85723			
	3199986		...	...	-1-	85318 ...
	3199987	-1-	85705 or 89447			
	3199988		...	...	-10	85311 89424
	3199989	-1-	85709			
	3199990		...	...	010	85003 89411
	3199991	-1-	85708			
	3199992	01-	85733			
	3199993	010	85712			
	3199994	010	85308 or 89422			
	3915917		...	...	-10	85319 89428
	3915947	010	85001 or 89410			
	3915948		...	...	-10	85311 89424
	3916352	010	85013 or 89414			
	3919055		...	...	010	85007 ...
	3919056	010	83203 or 89436			
	3919057	010	83225			
	3919526	010	83314	...		... ..
	3919561		...	...	010	85314 89425
	3919565	-1-	83103			
	3919567	-1-	83613			
	3919569		...	...	010	85052 ...
	3919570		...	...	010	83128 89436
	3919571		...	...	01-	83635 ...
	3919572		...	...	010	83130 ...
	3919573		...	...	010	83123 89405
3919574	010	85006				
3919575		...	...	01-	83120 ...	
3919582	010	83215				
3919585	010	83209 or 89414				
3919587	-10	83105	...		... ..	

## APPLICATION GUIDE - TRUCKS, TRAILERS, AND BUSES





Year Año Année	Model Modelo Modèle	OEM #	Front		Rear	
						
						
			Fleetline	GasSLX	Fleetline	GasSLX

### VOLVO(Cont'd.)

#### Additional O.E.M. Interchanges(Cont'd.)

Year	Model	OEM #	Front	Rear
	Additional O.E.M. Interchanges	3919588		<b>83216</b>
		3919589	<b>85026</b>	<b>89417</b>
		3919591	<b>83515</b>	...
		3919592	...	...
		3919593	...	<b>85024</b>
		3919594	...	<b>85003</b>
		3919596	...	<b>89411</b>
		3919598	<b>83312</b>	<b>89409</b>
		3919900	<b>85012 or 89413</b>	
		3919901	<b>83103</b>	
		3919902	<b>83126 or 89430</b>	
		3919903	<b>83216</b>	
		3919904	<b>G63183</b>	
		3919906	<b>83308</b>	
		3919907	<b>83309</b>	...
		3919909	<b>G63605</b>	
		3919910	<b>83221</b>	
		3919911	<b>83124 or 89407</b>	
		3919912	<b>83215</b>	
		3919913	<b>83203 or 89436</b>	
		3919914	<b>83209 or 89414</b>	
		3919915	<b>83127</b>	
		3919916	<b>83126 or 89430</b>	
		3919917	<b>83125</b>	
		3919918	<b>83401</b>	...
		3919919	<b>G63625</b>	
		3919920	<b>83303</b>	...
		3919921	...	...
		3919922	<b>83318</b>	<b>83123</b>
		3919923	...	<b>89405</b>
		3919924	<b>83318</b>	...
		3919925	<b>83456</b>	<b>89447</b>
		3919926	...	...
		3919927	<b>G63403</b>	
		3919928	<b>83101</b>	
		3919931	<b>83225</b>	
		3919932	<b>83126 or 89430</b>	
		3919933	<b>85062</b>	<b>89408</b>
		3919934	<b>85001 or 89410</b>	
		3919935	<b>85320</b>	<b>89429</b>
		3919936	<b>85026</b>	<b>89417</b>
		3919937	<b>83207 or 89407</b>	
		3919938	<b>85316</b>	<b>89426</b>
		3919939	<b>85030 or 89440</b>	
		3919940	<b>85058</b>	<b>89431</b>
		3919941	<b>85005 or 89430</b>	
		3919942	<b>85006</b>	
		3919943	<b>89402</b>	
		3919944	<b>85012 or 89413</b>	
		3919945	<b>85036</b>	<b>89405</b>
		3919946	<b>85027</b>	<b>89418</b>
		3919947	...	...
		3919948	...	<b>85033</b>
		3919949	<b>85013 or 89414</b>	
		3919950	...	<b>89427</b>
		3919951	...	<b>85311</b>
		3919952	...	<b>89424</b>
		3919953	...	<b>85310</b>
		3919954	<b>89423</b>	
		3919955	<b>83219</b>	

**APPLICATION GUIDE - TRUCKS, TRAILERS, AND BUSES**





Year Año Année	Model Modelo Modèle	OEM #	Front		Rear	
						
			Fleetline	GasSLX	Fleetline	GasSLX

**VOLVO(Cont'd.)**

**Additional O.E.M. Interchanges(Cont'd.)**

Year	Model	OEM #	Front	Rear
	Additional O.E.M. Interchanges	3919951	010 83309	... ..
		3919952	010	85736
		3919953	...	... -10 85319 89428
		3919954	...	... 010 85003 89411
		3919955	010	85300 or 89419
		3919956	85036	... 010 85036 89405
		3919957	010	83122 or 89406
		3919959	...	... 010 85000 89436
		3919960	...	... 010 85322 ...
		3919961	010	85302 or 89420
		3919962	010	85700
		3919963	010	
		3919964	010	85304
		3919965	010	85702
		3919966	010	85736
		3919967	010	85302 or 89420
		3919968	010	85736
		3919972	010 85320	89429 ... ..
		3919973	...	... 010 85956 ...
		3919974	010	85712
		3919975	010	85700
		3919976	...	... -10 85033 89427
		3919977	...	... -10 85033 89427
		3919978	010	85702
		3919979	010	85702
		3919980	010	85702
		3919982	-10 85703	... ..
		3919983	...	... 010 85704 ...
		3919984	010	85700
		3919985	01-	85723
		3919987	85706	... -1- 85706 ...
		3919988	...	... -10 85311 89424
		3919989	-1-	85709
		3919990	...	... 010 85003 89411
		3919991	-1-	85708
		3919992	01-	85733
		3919993	010	85712
		3919994	...	... -1- 85310 89423
		3945806	01-	89417
		3945807	010	
		3945808	010	89407
		3945809	010	89410
		3945810	010	89420
		3945811	010	89409
		3945812	-1-	89423
		3945813	-10	89428
		3945814	-10	89424
		3945815	010	89406
		3945816	010	89430
		3945817	010	89422
		3945818	010	89415
		3945819	010	89411
		3945820	010	89413
		3945821	010	89419
		3946217	010	83125

**APPLICATION GUIDE - TRUCKS, TRAILERS, AND BUSES**





Year Año Année	Model Modelo Modèle	OEM #	Front		Rear	
						
			Fleetline	GasSLX	Fleetline	GasSLX

**VOLVO(Cont'd.)**

**Additional O.E.M. Interchanges(Cont'd.)**

Additional O.E.M. Interchanges						
	3946219		...	...	- -	83400
	662211401	010	83215			
	83176191	01-	83019			
	83176192	01-	83041			
	83176193	01-	83045			
	83176194	010	83048			
	83176195	- -	83103			
	83176196	01-	83110			
	83176197	01-	83111			
	83176198		...	...	01-	83112
	83176199		...	...	010	83123
	83176200	010	83124 or 89407			
	83176201	010	83125			
	83176202	010	83126			
	83176203	010	83127			
	83176204		...	...	010	83128
	83176205	- -	83136	...		...
	83176206	010	83148	...		...
	83176207	010	83203 or 89436			
	83176208	010	83209 or 89414			
	83176209	010	83215			
	83176210	010	83216			
	83176211		...	...	010	85000
	83176212	010	85001 or 89410			
	83176213		...	...	010	85003
	83176214	010	85005 or 89430			
	83176215	010	85023 or 89415			
	83176216	01-	85026	89417		...
	83176217		...	...	- 0	85033
	83176218		85036	...	010	85036
	83176219		...	...	010	85045
	83176220		...	...	010	85046
	83176221		85047	...	010	85047
	83176222		...	...	010	85052
	83176223	010	85061	89450		...
	83176224	010	85062	89408		...
	83176225		...	...	010	85066
	83176226		...	...	010	85067
	83176227		...	...	- -	85069
	83176228	010	85070	89459		...
	83176229	010	85303 or 89422			
	83176230		...	...	- -	85310
	83176231		...	...	- 0	85311
	83176232	010	85320	89429		...
	83176233		...	...	010	85321
	83176234		...	...	010	85323
	83176235		...	...	010	85724
	83176236		...	...	- -	85900
	83176237		...	...	010	85916
	83176238	010	85918	89449		...
	83176239	010	85933	89454		...
	83176240	010	646155			
	85104186	010	85006			
	85106580	010	85918	89449		...
	85137234	010	83125			

**APPLICATION GUIDE - TRUCKS, TRAILERS, AND BUSES**





Year Año Année	Model Modelo Modèle	OEM #	Front		Rear	
						
			Fleetline	GasSLX	Fleetline	GasSLX

**VOLVO(Cont'd.)**

**Additional O.E.M. Interchanges(Cont'd.)**

Additional O.E.M. Interchanges	OEM #				
	85137420	...	...	0 0	85000 89436
	RC SA3041	0 -			83041
	RC SA3045	0 -			83045
	RC SA3048	0 0			83048
	RC SA3103	- -			83103
	RC SA3111	0 -			83111
	RC SA3112	...	...	0 -	83112 ...
	RC SA3124	0 0			83124 or 89407
	RC SA3125	0 0			83125
	RC SA3127	0 0			83127
	RC SA3128	...	...	0 0	83128 89436
	RC SA3136	- -			83136 ...
	RC SA3148	0 0			83148 ...
	RC SA3203	0 0			83203 or 89436
	RC SA3216	0 0			83216
	RC SA5000	...	...	0 0	85000 89436
	RC SA5001	0 0			85001 or 89410
	RC SA5003	...	...	0 0	85003 89411
	RC SA5005	0 0			85005 or 89430
	RC SA5047		85047	...	0 0 85047 89435
	RC SA5052	...	...	0 0	85052 ...
	RC SA5061	0 0	85061	89450	...
	RC SA5062	0 0	85062	89408	...
	RC SA5066	...	...	0 0	85066 89448
	RC SA5067	...	...	0 0	85067 89451
	RC SA5070	0 0	85070	89459	...
	RC SA5310	...	...	- -	85310 89423
	RC SA5320	0 0	85320	89429	...
	RC SA5724	...	...	0 0	85724 89443
	RC SA5900	...	...	- -	85900 ...
	RC SA5918	0 0	85918	89449	...
	RC SA5933	0 0	85933	89454	...
	RC SA6155	0 0			646155
	SA3019	0 -			83019
	SA3041	0 -			83041
	SA3045	0 -			83045
	SA3048	0 0			83048
	SA3103	- -			83103
	SA3110	0 -			83110
	SA3111	0 -			83111
	SA3112	...	...	0 -	83112 ...
	SA3123	...	...	0 0	83123 89405
	SA3124	0 0			83124 or 89407
	SA3125	0 0			83125
	SA3126	0 0			83126
	SA3127	0 0			83127
	SA3128	...	...	0 0	83128 89436
	SA3136	- -			83136 ...
	SA3148	0 0			83148 ...
	SA5000	0 0			85000 or 89436
	SA5001	0 0			85001 or 89410
	SA5003	...	...	0 0	85003 89411
	SA5005	0 0			85005 or 89430
	SA5023	0 0			85023 or 89415
	SA5026	0 -	85026	89417	...

## APPLICATION GUIDE - TRUCKS, TRAILERS, AND BUSES

Year Año Année	Model Modelo Modèle	OEM #	Front		Rear	
						
			Fleetline	GasSLX	Fleetline	GasSLX

### VOLVO(Cont'd.)





#### Additional O.E.M. Interchanges(Cont'd.)

	Additional O.E.M. Interchanges	SA5033	...	-10	85033	89427				
		SA5036	85036	...	010	85036	89405			
		SA5045	...	...	010	85045	...			
		SA5046	...	...	010	85046	89434			
		SA5047	85047	...	010	85047	89435			
		SA5052	...	...	010	85052	...			
		SA5061	010	85061	89450		...	...		
		SA5062	010	85062	89408		...	...		
		SA5066	...	...	010	85066	89448			
		SA5067	...	...	010	85067	89451			
		SA5069	...	...	-1-	85069	89455			
		SA5070	010	85070	89459		...	...		
		SA5303	010	85303 or 89422						
		SA5310	...	...	-1-	85310	89423			
		SA5311	...	...	-10	85311	89424			
		SA5320	010	85320	89429		...	...		
		SA5321	...	85321	...	010	85321	...		
		SA5323	...	...	...	010	85323	89436		
		SA5724	...	...	...	010	85724	89443		
		SA5900	...	...	-1-	85900	...			
		SA5916	...	...	...	010	85916	89430		
		SA5918	010	85918	89449		...	...		
		SA5933	010	85933	89454		...	...		
		SA6155	010	646155						
			Models with O.E.M. Number	14170000373	010	85061	89450	...	...	
				3092842	010	85061	89450		...	...
				35901-0001	...	...	010	83209	89414	
				35901-0008	...	...	010	85060	...	
37301-0008	-1-			83400	...		...	...		
3919958	...			...	010	85046	89434			
3946239	...			...	010	85724	89443			
3949240	...			...	010	85047	89435			
3949241	010			85061	89450		...	...		
3972662	...			...	010	85976	...			
665410	-1-			85027	89418		...	...		
665539	01-			85026	89417		...	...		
665739	...			...	010	85047	89435			
70042	010			85302	89420		...	...		
8075287	...			...	01-	85065	...			
8174749	...			...	010	85906	89407			
85104221	...			...	010	85066	89448			
85107238	...			...	010	85976	...			
85134402	010			85061	89450		...	...		

### VOLVO CAB SHOCKS

	Aero Models (WCA & WIA Models)	66010-0007	010		83004	
		66010-0008	010		83004	
		8162662	010		83004	
	Link Cabmate Model WRC-2P	1202-0032	010		83016	
	Models with O.E.M. Number	20874147	01-		83050	
		3945842	010		83009	
		635869	010		83004	
		8168617	010		83030	
		85107095	010		83009	
2014 -	VAH 430 Models with 42" Sleeper Cabs	20721254	010		83048	

## APPLICATION GUIDE - TRUCKS, TRAILERS, AND BUSES

Year Año Année	Model Modelo Modèle	OEM #	Front		Rear	
						
			○ ○	Fleetline   GasSLX	○ ○	Fleetline   GasSLX

### VOLVO CAB SHOCKS(Cont'd.)

2014 -	VAH 430 Models with 42" Sleeper Cabs	22662224	○ ○	83048
11 - 19	VNL / VNM & VNX DayCab Models with O.E.M. Number	21368411	○ ○	83905
		22662230	○ ○	83905
06 - 10	VT Models - All with 60" to 77" Mid - High Roof Sleepers (w/O.E.M. Number)	20721254	○ ○	83048
	WG Conventional Tractors with 112" cabs with Link Cabmate Model WWG112-A	1201-0012	○ ○	83023
		1202-0012	○ ○	83023

#### VAH - Series

- 2017	VAH 630 Models with 42" Flat Roof Sleeper	22662235	○ ○	83905
- 2018	VAH DayCab Models with O.E.M. Number	22662230	○ ○	83905

#### VHD - Series

11 - 20	DayCab Models with O.E.M. Number	22662230	○ ○	83905
08 - 09	VHD Models - With O.E.M. Number	20704334	○ ○	83048
		22662125	○ ○	83048
2002 -	VHD Models - With O.E.M. Number	8078546	○ ○	83028

#### VN Series - 2200

	VN Models - Horizontal Position	20496217	○ ○	83029
		8078547	○ ○	83029
	VN Models - Vertical Position (w/O.E.M. Number)	20496215	○ ○	83048
		20704334	○ ○	83048
		20721254	○ ○	83048
		21368413	○ ○	83048
		22662125	○ ○	83048
		8078546	○ ○	83028

#### VNL - Series

06 - 10	VNL 42T-300 Models - With O.E.M. Number	20704334	○ ○	83048
		22662125	○ ○	83048
11 - 19	VNL 42T-300 Models - With O.E.M. Number	22662230	○ ○	83905
11 - 20	VNL 64T-300 DayCab Models with O.E.M. Number	21368411	○ ○	83905
		22662230	○ ○	83905
19 - 20	VNL 64T-300 Models - With O.E.M. Number	22866844	○ ○	83048
13 - 16	VNL 64T-430 Models with Flat Top Sleepers	21391412	○ ○	83048
13 - 16	VNL 64T-630 Models with Flat Top Sleepers	21391412	○ ○	83048
- 2013	VNL 64T-670 Models with High Rise Sleeper Cabs	21368413	○ ○	83048
14 - 19	VNL 64T-670 Models with High Rise Sleeper Cabs	22662235	○ ○	83905
15 - 18	VNL 64T-730 Models with Mid Rise Sleeper Cabs	22662237	○ ○	83905
19 - 20	VNL 64T-740 Models with 60" to 77" Mid - High Roof Sleepers (w/O.E.M. Number)	22866844	○ ○	83048
2018 - 19	VNL 64T-740 Models with High Rise Sleeper Cabs	22662237	○ ○	83905
18 - 20	VNL 64T-760 Models with High Rise Sleeper Cabs	22866844	○ ○	83048
- 2014	VNL 64T-780 Models with High Rise Sleeper Cabs	20721254	○ ○	83048
		21368413	○ ○	83048
15 - 18	VNL 64T-780 Models with High Rise Sleeper Cabs	22662237	○ ○	83905
2018 - 20	VNL 64T-860 Models with High Rise Sleeper Cabs	22662237	○ ○	83905
06 - 11	VNL Models - All with 60" to 77" Mid - High Roof Sleepers (w/O.E.M. Number)	20721254	○ ○	83048

#### VNM - Series







2013	VNM 42T-200 Day Cab Models	21368411	○ ○	83905
13 - 17	VNM 64T-200 Day Cab Models	21368411	○ ○	83905
		22662230	○ ○	83905
		22662237	○ ○	83905
2016	VNM 64T-630 Models with High Rise Sleeper Cabs	22662235	○ ○	83905
- 2014	VNM Models - All with 60" to 77" Mid - High Roof Sleepers (w/O.E.M. Number)	21391412	○ ○	83048

#### VNR - Series

- 2019	VNR 64T-300 Day Cab Models	22662230	○ ○	83905
--------	----------------------------	----------	-----	-------

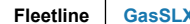

## APPLICATION GUIDE - TRUCKS, TRAILERS, AND BUSES

Year Año Année	Model Modelo Modèle	OEM #	Front		Rear	
						
						
			Fleetline	GasSLX	Fleetline	GasSLX

### VOLVO CAB SHOCKS(Cont'd.)

#### VNR - Series(Cont'd.)

- 2018	VNR 64T-400 Models with 42" Flat Roof Sleeper	22662235	010	<b>83905</b>
--------	---	----------	-----	--------------

### WABASH NATIONAL

Identification of the trailer suspension is necessary to determine what section of the catalog to refer to. Some possible options can be Chalmers, Hendrickson, Neway, Ridewell, Reyco.							
1997 -	RHP11, RHP55 and RideSentry Trailer Suspension	202447	...	...	010	<b>85919</b>	...
		203447	...	...	010	<b>85919</b>	...
	Trailers with Aurora part number	DANSR1VJ100	...	...	010	<b>85078</b>	...
		FLL83203-071	...	...	010	<b>83203</b>	<b>89436</b>
		FLL83207-071	...	...	010	<b>83207</b>	<b>89407</b>
		FLL85000-071	...	...	010	<b>85000</b>	<b>89436</b>
		FLL85030-071	...	...	010	<b>85030</b>	<b>89440</b>
		FRUUCE1295-1	...	...	010	<b>85300</b>	<b>89419</b>
		FRUUCE1295-901	...	...	010	<b>85300</b>	<b>89419</b>
		FRUUCE2983-1	...	...	010	<b>85322</b>	...
		FRUUCF8339-1	...	...	010	<b>85321</b>	...
		HENS-20001	...	...	010	<b>83128</b>	<b>89436</b>
		HENS-20002	...	...	010	<b>85000</b>	<b>89436</b>
		HENS-20126	...	...	010	<b>85323</b>	<b>89436</b>
		HENS-21292	...	...	010	<b>85052</b>	...
		HENS-23566	...	...	010	<b>85000</b>	<b>89436</b>
		NEW900-44-089	...	...	010	<b>83124</b>	<b>89407</b>
		NEW900-44-162	...	...	010	<b>83128</b>	<b>89436</b>
		NEW900-44-625	...	...	010	<b>83125</b>	...
		NEW900-44-626	...	...	010	<b>83126</b>	<b>89430</b>
		NEW900-44-642	...	...	010	<b>83127</b>	...
		NEW900-44-794	...	...	010	<b>83127</b>	...
		NEW900-44-868	...	...	010	<b>85045</b>	...
		NEW900-44-978	...	...	010	<b>85059</b>	...
		NEW900-44-979	...	...	010	<b>83113</b>	...
		NEW900-45-040	...	...	010	<b>83130</b>	...
		NEW900-45-054	...	...	010	<b>85051</b>	...
		NEW900-45-298	...	...	010	<b>83128</b>	<b>89436</b>
		NEW900-45-299	...	...	010	<b>85000</b>	<b>89436</b>
	Trailers with Aurora part number		...	...	010	<b>85000</b>	<b>89436</b>
	Heavy Duty	HENS-24088	...	...	010	<b>85000</b>	<b>89436</b>
	Standard	HENS-24088	...	...	010	<b>83128</b>	<b>89436</b>

### WATSON & CHALIN MFG. INC.

#### Heavy Duty Trailer Air Suspension

	TA-2590-14, 17 HD	10148	...	...	010	<b>83204</b>	...
	TA-3090-14, -17, -19	10148	...	...	010	<b>83204</b>	...
	TA-550-17	10148	...	...	010	<b>83204</b>	...

#### Light Weight Trailer Air Suspension

	TA-3175-9	17079	...	...	010	<b>85300</b>	<b>89419</b>
	TA-751-16	10148	...	...	010	<b>83204</b>	...





#### LWSL-1100-SR Self Steer Axle Suspension

	AL-1100-SR Models	10148	...	...	010	<b>83204</b>	...
	HL-1100-20	10148	...	...	010	<b>83204</b>	...
	HL-1100-20 FL	10147	...	...	010	<b>83203</b>	<b>89436</b>
	SL-1100-LR	12128	...	...	010	<b>85005</b>	<b>89430</b>

#### Trailer Air Suspension

	TA-2590-12, 14, 15, & 17,	12128	...	...	010	<b>85005</b>	<b>89430</b>
	TA-2590-12-1	10147	...	...	010	<b>83203</b>	<b>89436</b>

**APPLICATION GUIDE - TRUCKS, TRAILERS, AND BUSES**

Year Año Année	Model Modelo Modèle	OEM #	Front		Rear	
						
			Fleetline	GasSLX	Fleetline	GasSLX

**WATSON & CHALIN MFG. INC.(Cont'd.)**

**WCAL-2200 Series Pusher or Tag Axle Assembly(Cont'd.)**

AL-2200 Models	10148		...	...	010	83204	...
----------------	-------	--	-----	-----	-----	-------	-----

**WCTA Series Dump Trailer Air Suspension**

TA-1600-21	11604		...	...	010	83125	...
TA-1900-15	10147		...	...	010	83203	89436
TA-1900-16, -17	10148		...	...	010	83204	...
TA-1900-18, -19	12128		...	...	010	85005	89430
TA-5000-DB-19, -F-19	12128		...	...	010	85005	89430
TA-5000-DB-24, -DB-30, -F-24, -F-30,	11724		...	...	010	83123	89405
TA-525, -DB	10147		...	...	010	83203	89436

**WCTA Series Trailer Air Suspension**

TA-2075-6	10148		...	...	010	83204	...
TA-2075-9	12128		...	...	010	85005	89430
TA-250-12	10148		...	...	010	83204	...
TA-250-6, 7.5, 9,	10147		...	...	010	83203	89436
TA-251-12, -12FS,	10148		...	...	010	83204	...
TA-251-6.5, -6.5FS,	10147		...	...	010	83203	89436
TA-251-7.5, -7.5FS	10147		...	...	010	83203	89436
TA-251-8FS	10147		...	...	010	83203	89436
TA-251-9.0, -9.0FS, -10,	10147		...	...	010	83203	89436
TA-255-9	10147		...	...	010	83203	89436
TA-280-6.5, 7.5, -9.0,	11604		...	...	010	83125	...
TA-300-9	10147		...	...	010	83203	89436
TA-380-9	12128		...	...	010	85005	89430

**WCTA-1200 Series Trailer Air Suspension**

TA-1000	10634		...	...	010	G63357	...
TA-1200-5	10147		...	...	010	83203	89436

**WCTL-2200 Series Trailer Air Lift**

TL-1600-21	11604		...	...	010	83125	...
10/89 - TL-2590-12,14,15, & 17	12128		...	...	010	85005	89430





**WCWB Series Trailer Air Suspension**

WB-2500-6	10148		...	...	010	83204	...
WB-2500-7.5, -9,	12128		...	...	010	85005	89430
WB-251-6.5, 7.5, 9	10147		...	...	010	83203	89436
WB-280-9	11604		...	...	010	83125	...
Models with O.E.M. Number	17300		...	...	010	85052	...
	3946219		...	...	-1-	83400	...
	665727		...	...	010	85005	89430
	665769		...	...	010	85052	...

**Additional O.E.M. Interchanges**

Models with O.E.M. Number	10147HD		...	...	010	85000	89436
	17186		...	...	010	85323	89436
	17186-01		...	...	010	85323	89436
	17218		...	...	010	85029	...
	17297		...	...	010	85064	...
	17306		...	...	010	85938	...
	17317		...	...	010	85344	...
	17382		...	...	010	85014	...
	17430		...	...	010	85321	...
	17474		...	...	-10	85009	...
	19036		...	...	010	85934	...
	19249		...	...	010	85939	...
	19250		...	...	010	85382	...
	19603		...	...	010	85939	...
	665724		...	...	010	85000	89436

## APPLICATION GUIDE - TRUCKS, TRAILERS, AND BUSES

Year Año Année	Model Modelo Modèle	OEM #	Front		Rear	
						
			Wrench	GasSLX	Wrench	GasSLX

### WATSON & CHALIN MFG. INC.(Cont'd.)

#### Additional O.E.M. Interchanges(Cont'd.)

Models with O.E.M. Number	OEM #	Wrench	GasSLX	Wrench	Fleetline	GasSLX
665728		...	...	010	85060	...
665770		...	...	010	85064	...
665862		...	...	010	85000	89436
680547		...	...	010	85323	89436
680584		...	...	010	85938	...
680714		...	...	010	85934	...
727603		...	...	010	83203	89436
727604		...	...	010	83204	...
A-20345		...	...	010	85345	...
B-23649		...	...	010	85064	...
B-23650		...	...	010	85052	...
B-23651		...	...	010	85045	...
B-23743		...	...	010	85938	...

### WESTERN STAR

- 2020	Models with Neway ADZ Rear Suspension	471700004423	Wrench	GasSLX	Wrench	Fleetline	GasSLX
		90045605	...	...	010	85109	...
			...	...	010	85109	...

#### 3800 Series - Heritage Class

3842S, 3864S Models	37390-4401	010	85053	89442	Wrench	Fleetline	GasSLX
	37390-4402	010	85053	89442	...	...	...
	37390-4403	010	85053	89442	...	...	...
With Hendrickson Rear Suspension	47902-13		...	...	010	83122	89406
	47902-24		...	...	010	83137	...
	47902-8		...	...	010	83122	89406
With Neway Rear Suspension	90044025		...	...	010	83209	89414
	90044907		...	...	01-	83635	...





#### 4700 Series

11 - 20	Models with 18,000 lb - 20,000 lb Flat Leaf Spring and Set Forward Front Axle	10-13684-000	010	85918	89449	Wrench	Fleetline	GasSLX
		471700000470	010	85918	89449	...	...	...
11 - 20	Models with 20000 lb Set -Back Front Axle	10-13809-000	010	85958	...	...	...	...
		471700003920	010	85958	...	...	...	...
11 - 19	Models with FAS II Rear Air Suspension	16-18708-000		...	...	010	85724	89443
		471700002809		...	...	010	85724	89443
11 - 19	Models with Freightliner TufTrac Rear Air Suspension	16-15770-000		...	...	010	85956	...
		481700125969		...	...	010	85956	...
		SDA481700125969		...	...	010	85956	...
11 - 20	Models with Hendrickson HMX 400/460 Haulmax with 16.5" Saddle	60680-004		...	...	01-	83143	...
		60680-004L		...	...	01-	83143	...
11 - 20	Models with Hendrickson HMX 400/460 Haulmax with 17.5" & 18.5" Saddle	60680-005		...	...	01-	83142	...
		60680-005L		...	...	01-	83142	...
11 - 19	Models with Hendrickson HN - 462	60680-003		...	...	01-	83112	...
		60680-003L		...	...	01-	83112	...
11 - 19	Models with Hendrickson Primaax EX 462 Air Suspensions Standard with 8 1/2" to 10" Ride Height	60657-003L		...	...	010	85072	...
		60657-003		...	...	010	85072	...
11 - 19	Models with Reyco 79KB Rear Steel Spring Suspension	16725-01		...	...	010	83126	89440
		19495-01		...	...	010	83126	89440

#### 4800 & 4900 Series - Constellation Class

4842FX, 4864FX, 4964EX, 4964EX, 4942SX or 4964SX Constellation Class	37301-3401	010	85053	89442	Wrench	Fleetline	GasSLX
	37301-3404	010	85053	89442	...	...	...
	37301-3409	010	85053	89442	...	...	...
	37301-3412	010	85053	89442	...	...	...

**APPLICATION GUIDE - TRUCKS, TRAILERS, AND BUSES**

Year Año Année	Model Modelo Modèle	OEM #	Front		Rear	
						
			Fleetline	GasSLX	Fleetline	GasSLX

**WESTERN STAR(Cont'd.)**

**4800 & 4900 Series - Constellation Class(Cont'd.)**

	4842FX, 4864FX, 4964EX, 4964SX or 4964SX Constellation Class	37390-4401	010	<b>85053</b>	<b>89442</b>		...	...
		37390-4402	010	<b>85053</b>	<b>89442</b>		...	...
		37390-4403	010	<b>85053</b>	<b>89442</b>		...	...
<b>09 - 12</b>	Models w/ Low Profile Rear Air Suspension	16-18706-000		...	...	010	<b>85331</b>	...
<b>09 - 15</b>	Models with 12000 lb Taperleaf Front Suspension	10-13809-000	010	<b>85958</b>	...		...	...
		SDA471700003920	010	<b>85958</b>	...		...	...
<b>08 - 19</b>	Models with Freightliner TufTrac Rear Air Suspension	16-15770-000		...	...	010	<b>85956</b>	...
		SDA481700125969		...	...	010	<b>85956</b>	...
<b>- 2016</b>	Models with Hendrickson Front Airtek	471700006269	010	<b>85932</b>	<b>89453</b>		...	...
		471700131331	010	<b>85932</b>	<b>89453</b>		...	...
		58913-003	010	<b>85932</b>	<b>89453</b>		...	...
		58913-003L	010	<b>85932</b>	<b>89453</b>		...	...
		58913-012	010	<b>85932</b>	<b>89453</b>		...	...
		58913-012L	010	<b>85932</b>	<b>89453</b>		...	...
	With Hendrickson HAS-40LH Rear Suspension	57241-1		...	...	01-	<b>83111</b>	...
	With Hendrickson Rear Suspension	47902-13		...	...	010	<b>83122</b>	<b>89406</b>
		47902-24		...	...	010	<b>83137</b>	...
		47902-8		...	...	010	<b>83122</b>	<b>89406</b>
	With Neway Rear Suspension	90044025		...	...	010	<b>83209</b>	<b>89414</b>
		90044907		...	...	01-	<b>83635</b>	...
		90045099		...	...	010	<b>85906</b>	<b>89407</b>

**4800 & 4900 Series - Heritage Class**

	4842F, 4864F, 4843S, 4864S, 4942F, 4964F, 4942S or 4964S Heritage Class	37301-3401	010	<b>85053</b>	<b>89442</b>		...	...
		37301-3404	010	<b>85053</b>	<b>89442</b>		...	...
		37301-3409	010	<b>85053</b>	<b>89442</b>		...	...
		37301-3412	010	<b>85053</b>	<b>89442</b>		...	...
		37390-4401	010	<b>85053</b>	<b>89442</b>		...	...
		37390-4402	010	<b>85053</b>	<b>89442</b>		...	...
		37390-4403	010	<b>85053</b>	<b>89442</b>		...	...
<b>09 - 15</b>	Models with 12000 lb Taperleaf Front Suspension	10-13809-000	010	<b>85958</b>	...		...	...
		SDA471700003920	010	<b>85958</b>	...		...	...
<b>08 - 19</b>	Models with Freightliner TufTrac Rear Air Suspension	16-15770-000		...	...	010	<b>85956</b>	...
		SDA481700125969		...	...	010	<b>85956</b>	...
<b>- 2016</b>	Models with Hendrickson Front Airtek	471700006269	010	<b>85932</b>	<b>89453</b>		...	...
		471700131331	010	<b>85932</b>	<b>89453</b>		...	...
		58913-003	010	<b>85932</b>	<b>89453</b>		...	...
		58913-003L	010	<b>85932</b>	<b>89453</b>		...	...
		58913-012	010	<b>85932</b>	<b>89453</b>		...	...
		58913-012L	010	<b>85932</b>	<b>89453</b>		...	...
	With Hendrickson HAS-40LH Rear Suspension	57241-1		...	...	01-	<b>83111</b>	...
	With Hendrickson Rear Suspension	47902-13		...	...	010	<b>83122</b>	<b>89406</b>
		47902-24		...	...	010	<b>83137</b>	...
		47902-8		...	...	010	<b>83122</b>	<b>89406</b>
	With Neway Rear Suspension	90044025		...	...	010	<b>83209</b>	<b>89414</b>
		90044907		...	...	01-	<b>83635</b>	...
		90045099		...	...	010	<b>85906</b>	<b>89407</b>

**4900 Series**

<b>11 - 20</b>	Models with 20000 lb Set -Back Front Axle	10-13809-000	010	<b>85958</b>	...		...	...
		471700003920	010	<b>85958</b>	...		...	...
<b>11 - 20</b>	Models with Hendrickson HMX 400/460 Haulmax with 16.5" Saddle	60680-004		...	...	01-	<b>83143</b>	...
		60680-004L		...	...	01-	<b>83143</b>	...
<b>11 - 20</b>	Models with Hendrickson HMX 400/460 Haulmax with 17.5" & 18.5" Saddle	60680-005		...	...	01-	<b>83142</b>	...

## APPLICATION GUIDE - TRUCKS, TRAILERS, AND BUSES

Year Año Année	Model Modelo Modèle	OEM #	Front		Rear	
			Fleetline	GasSLX	Fleetline	GasSLX

### WESTERN STAR(Cont'd.)

#### 4900 Series(Cont'd.)

11 - 20	Models with Hendrickson HMX 400/460 Haulmax with 17.5" & 18.5" Saddle	60680-005L	...	...	01-	<b>83142</b>	...
---------	---	------------	-----	-----	-----	--------------	-----









#### 5800 & 5900 Series - Constellation Class

	5842SS, 5864SS, 5942SS or 5964SS Constellation Class	37301-3401 37301-3404 37301-3409 37301-3412 37390-4401 37390-4402 37390-4403	010	<b>85053</b>	<b>89442</b>		...	...
			010	<b>85053</b>	<b>89442</b>		...	...
			010	<b>85053</b>	<b>89442</b>		...	...
			010	<b>85053</b>	<b>89442</b>		...	...
			010	<b>85053</b>	<b>89442</b>		...	...
			010	<b>85053</b>	<b>89442</b>		...	...
			010	<b>85053</b>	<b>89442</b>		...	...
09 - 15	Models with 12000 lb Taperleaf Front Suspension	10-13809-000 SDA471700003920	010	<b>85958</b>	...		...	...
			010	<b>85958</b>	...		...	...
08 - 15	Models with Freightliner TufTrac Rear Air Suspension	16-15770-000 SDA481700125969		...	...	010	<b>85956</b>	...
				...	...	010	<b>85956</b>	...
				...	...	010	<b>83122</b>	<b>89406</b>
	With Hendrickson Rear Suspension	47902-13 47902-24 47902-8		...	...	010	<b>83137</b>	...
				...	...	010	<b>83122</b>	<b>89406</b>
				...	...	010	<b>83209</b>	<b>89414</b>
	With Neway Rear Suspension	90044025 90044907 90045099		...	...	01-	<b>83635</b>	...
				...	...	010	<b>85906</b>	<b>89407</b>
				...	...	010	<b>85006</b>	...
	With Hendrickson Rear Suspension	57905-2		...	...	010	<b>85006</b>	...

#### 5900 & 6900 Series - Heritage Class

	5942S, 5964S, 6964F or 6964S Heritage Class	37301-3401 37301-3404 37301-3409 37301-3412 37390-4401 37390-4402 37390-4403	010	<b>85053</b>	<b>89442</b>		...	...
			010	<b>85053</b>	<b>89442</b>		...	...
			010	<b>85053</b>	<b>89442</b>		...	...
			010	<b>85053</b>	<b>89442</b>		...	...
			010	<b>85053</b>	<b>89442</b>		...	...
			010	<b>85053</b>	<b>89442</b>		...	...
			010	<b>85053</b>	<b>89442</b>		...	...
	All with 4 shock Front System	.....	010	<b>83401</b>	...		...	...
09 - 15	Models with 12000 lb Taperleaf Front Suspension	10-13809-000 SDA471700003920	010	<b>85958</b>	...		...	...
			010	<b>85958</b>	...		...	...
08 - 15	Models with Freightliner TufTrac Rear Air Suspension	16-15770-000 SDA481700125969		...	...	010	<b>85956</b>	...
				...	...	010	<b>85956</b>	...
- 06/10	Models with Hendrickson Airtek Suspension	58913-003 58913-003L	010	<b>85932</b>	<b>89453</b>		...	...
			010	<b>85932</b>	<b>89453</b>		...	...
07/10 -	Models with Hendrickson Airtek Suspension	471700006269 58913-012 58913-012L	010	<b>85932</b>	<b>89453</b>		...	...
			010	<b>85932</b>	<b>89453</b>		...	...
			010	<b>85932</b>	<b>89453</b>		...	...
	With Hendrickson HAS-40LH Rear Suspension	57241-1		...	...	01-	<b>83111</b>	...
	With Hendrickson Rear Suspension	47902-13 47902-24 47902-8 60675-002 60675-002L		...	...	010	<b>83122</b>	<b>89406</b>
				...	...	010	<b>83137</b>	...
				...	...	010	<b>83122</b>	<b>89406</b>
				...	...	010	<b>85979</b>	...
				...	...	010	<b>85979</b>	...
	With Neway Rear Suspension	90044025 90044907 90045099		...	...	010	<b>83209</b>	<b>89414</b>
				...	...	01-	<b>83635</b>	...
				...	...	010	<b>85906</b>	<b>89407</b>
	Models with O.E.M. Number	02-7005976 02-7005977 04-9041375 28R010 35066-4413 35901-0001 35901-4403	-1-	<b>83400</b>	...		...	...
			-1-	<b>83400</b>	...		...	...
				...	...	010	<b>85315</b>	...
			010	<b>83216</b>	...		...	...
				...	...	010	<b>83122</b>	<b>89406</b>
				...	...	010	<b>83209</b>	<b>89414</b>
				...	...	010	<b>85060</b>	...

## APPLICATION GUIDE - TRUCKS, TRAILERS, AND BUSES

Year Año Année	Model Modelo Modèle	OEM #	Front		Rear	
						
						
			Fleetline	GasSLX	Fleetline	GasSLX

### WESTERN STAR(Cont'd.)

#### 5900 & 6900 Series - Heritage Class(Cont'd.)

	Models with O.E.M. Number	37301-3405	010	85053	89442		...	...
		57252	010	85308	89422		...	...
		57905-1		...	...	010	85976	...
		665682	010	85053	89442		...	...
		CP-5222		...	...	010	85315	...
	With Hendrickson Rear Suspension	57905-2		...	...	010	85006	...
	Additional O.E.M. Interchanges	1011839	010	83216	...		...	...
		35901-3406	010	85305				
		35901-3409	010	85304				
		35901-3410	010	85307				
		35901-3413	010	85006				
		35901-3420	010	85303 or 89422				
		615016	010	83401	...		...	...
		676081	010	83401	...		...	...
		676082	010	83401	...		...	...

### WESTERN STAR CAB SHOCKS

- 2020	4900 Series Day Cab Models	18-60772-000	010	83026			
	6900 Models	725470	010	83010			
01 - 15	6900 SX Models	66010-3407	010	83065			
	Constellation Day Cab Models	66010-3405	010	83026			
81-4903003500		010	83026				
	Constellation Sleeper Cab Models	18-60773-000	01-	83027			
		66010-3406	01-	83027			
		814903003501	01-	83027			
1986 -	Conventional Tractors with Link Cabmate Model WSC4000	1201-0012	010	83023			
	1202-0012	010	83023				
	For 4800, 4900, 6900 Heritage & Constellation Day Cab	66010-3402	010	83022			
		66010-3403	010	83022			
	Heritage Constellation models	66010-3404	010	83022			
	Models with Link Cab Suspension	1202-0032	010	83016			
	Models with O.E.M. Number	617547	010	83022			
		654846	01-	83027			
		GBL 654916	010	83026			

### WESTERN UNIT "STABILAIRE" SUSPENSION

	Model 893T Trailer Suspension	.....		...	...	010	85307	...
	Model TDA202, 203, 206, 240, 241, 243 Truck Drive Axle Suspension	.....		...	...	010	85735	...
	Model TDA204, 205, 242 - Truck Drive Axle Suspension	.....		...	...	010	85307	...
	Models with O.E.M. Number	101030		...	...	010	85307	...
		101364		...	...	010	85305	...
		4939967		...	...	010	85308	89422
		80370		...	...	010	85304	...
		80600		...	...	010	85300	89419

### WHEELED COACH IND





	Citimedic models with Ford E350 & E450 Chassis	ASH-1136		...	...	-10	83178	...
		ASH-1154	-10	83177	...		...	...

### WINNEBAGO

#### Class A MotorHomes

99 - 20	Adventurer Series MotorHomes with Ford F53 Chassis with 16,000 lb GVW to 22,000 lb GVW	1C34-18045-AA	010	83209	89414		...	...
		1C34-18045-JA	010	83209	89414		...	...

## APPLICATION GUIDE - TRUCKS, TRAILERS, AND BUSES









Year Año Année	Model Modelo Modèle	OEM #	Front		Rear	
						
			Wrench	Wrench	Wrench	Wrench
			Fleetline	GasSLX	Fleetline	GasSLX

### WINNEBAGO(Cont'd.)

#### Class A MotorHomes(Cont'd.)

<b>99 - 20</b>	Adventurer Series MotorHomes with Ford F53 Chassis with 16,000 lb GVW to 22,000 lb GVW	9U94-18045-AA 9U94-18080-AA 9U9Z-18124-A 9U9Z-18125-A ASH-1022 ASH-1023 ASH-1205 ASH-1206 ASH-1228 ASH-1229 ASH-1230 ASH-137 ASH-25822 ASH-25823 ASH-25824 ASH-294 AT-620 AT-621 AT-766	OIO	<b>83209</b>	<b>89414</b>		...	...		
			...	...	OIO	<b>83122</b>	<b>89406</b>			
			OIO	<b>83209</b>	<b>89414</b>		...	...		
			...	...	OIO	<b>83122</b>	<b>89406</b>			
			OIO	<b>83209</b>	<b>89414</b>		...	...		
			...	...	OIO	<b>83122</b>	<b>89406</b>			
			OIO	<b>83209</b>	<b>89414</b>		...	...		
			OIO	<b>83209</b>	<b>89414</b>		...	...		
			...	...	OIO	<b>83122</b>	<b>89406</b>			
			...	...	OIO	<b>83122</b>	<b>89406</b>			
			OIO	<b>83209</b>	<b>89414</b>		...	...		
			OIO	<b>83209</b>	<b>89414</b>		...	...		
			...	...	OIO	<b>83122</b>	<b>89406</b>			
			OIO	<b>83209</b>	<b>89414</b>		...	...		
			<b>03 - 04</b>	Adventurer Series MotorHomes with Workhorse W22, & W24 MotorHome Chassis with O.E.M. Number	24-186537 F4-BE5-A011-HO	...	...	OIO	<b>85126</b>	...
						...	...	OIO	<b>85126</b>	...
<b>03 - 10</b>	Adventurer Series MotorHomes with Workhorse W22, & W24 MotorHome Chassis with O.E.M. Number	24-153249 24-186629 F4-BE5-A832-MO F4-BE5-B492-HO F4-BE5-F324-HO W0005662 W0006254	OIO	<b>85125</b>	...	...	...			
			OIO	<b>85125</b>	...	...	...			
			OIO	<b>85125</b>	...	...	...			
			OIO	<b>85125</b>	...	...	...			
			OIO	<b>85125</b>	...	...	...			
			OIO	<b>85125</b>	...	...	...			
			OIO	<b>85125</b>	...	...	...			
<b>05 - 10</b>	Adventurer Series MotorHomes with Workhorse W22, & W24 MotorHome Chassis with O.E.M. Number	24-153256 F4-BE5-F325-HO W0005663	...	...	OIO	<b>85124</b>	...			
			...	...	OIO	<b>85124</b>	...			
			...	...	OIO	<b>85124</b>	...			
<b>18 - 20</b>	Intent Series MotorHomes with Ford F53 Chassis with 16,000 lb GVW to 22,000 lb GVW	ASH-1229 ASH-25822 ASH-25823 ASH-25824	OIO	<b>83209</b>	<b>89414</b>	...	...			
			OIO	<b>83209</b>	<b>89414</b>	...	...			
			OIO	<b>83209</b>	<b>89414</b>	...	...			
			...	...	OIO	<b>83122</b>	<b>89406</b>			
<b>03 - 06</b>	Journey Series MotorHomes with Freightliner XC Chassis ADL200 Suspension w/ 20K Rear AS120 Front Suspension  Rear Shock with O.E.M. Number  ZF - IFS Front Suspension with 23,000 lb GVW or Greater	16-16873-000 141700131810 16-16737-000 16-16874-000 141700131809 16-16736-000 16-18103-000 481700000493	...	...	OIO	<b>85029</b>	...			
			OIO	<b>83160</b>	...	...	...			
			OIO	<b>83160</b>	...	...	...			
			OIO	<b>83160</b>	...	...	...			
			...	...	OIO	<b>85029</b>	...			
			...	...	OIO	<b>85029</b>	...			
			OIO	<b>85900</b>	...	...	...			
			OIO	<b>85900</b>	...	...	...			
<b>03 - 06</b>	Models with Workhorse UFO Chassis with Hendrickson Softek Front Suspension	66153-002 F4-BE5-C832-MO	OIO	<b>83124</b>	<b>89407</b>	...	...			
			OIO	<b>83124</b>	<b>89407</b>	...	...			
<b>11 - 20</b>	Sightseer Series MotorHomes with Ford F53 Chassis with 16,000 lb GVW to 22,000 lb GVW	ASH-1229 ASH-25822 ASH-25823 ASH-25824	OIO	<b>83209</b>	<b>89414</b>	...	...			
			OIO	<b>83209</b>	<b>89414</b>	...	...			
			OIO	<b>83209</b>	<b>89414</b>	...	...			
			...	...	OIO	<b>83122</b>	<b>89406</b>			

## APPLICATION GUIDE - TRUCKS, TRAILERS, AND BUSES

Year Año Année	Model Modelo Modèle	OEM #	Front		Rear	
						
						
			Fleetline	GasSLX	Fleetline	GasSLX

### WINNEBAGO(Cont'd.)

#### Class A MotorHomes(Cont'd.)

11 - 20	Sunova Series MotorHomes with Ford F53 Chassis with 16,000 lb GVW to 22,000 lb GVW	ASH-1229	OIO	83209	89414		...	...
		ASH-25822	OIO	83209	89414		...	...
		ASH-25823	OIO	83209	89414		...	...
		ASH-25824		...	...	OIO	83122	89406
11 - 20	SunStar & SunStar LX Series MotorHomes with Ford F53 Chassis with 16,000 lb GVW to 22,000 lb GVW	ASH-1229	OIO	83209	89414		...	...
		ASH-25822	OIO	83209	89414		...	...
		ASH-25823	OIO	83209	89414		...	...
		ASH-25824		...	...	OIO	83122	89406
2006	Tour Series MotorHomes with Freightliner XC Chassis ADL200 Suspension w/ 20K Rear AS120 Front Suspension  Rear Shock with O.E.M. Number  ZF - IFS Front Suspension with 23,000 lb GVW or Greater	16-16873-000		...	...	OIO	85029	...
		141700131810	OIO	83160	...		...	...
		16-16737-000	OIO	83160	...		...	...
		16-16874-000	OIO	83160	...		...	...
		141700131809		...	...	OIO	85029	...
		16-16736-000		...	...	OIO	85029	...
		16-18103-000	-I-	85900	...		...	...
		481700000493	-I-	85900	...		...	...
04 - 06	Vetra Series MotorHomes with Freightliner XC Chassis ADL200 Suspension w/ 20K Rear AS120 Front Suspension  Rear Shock with O.E.M. Number  ZF - IFS Front Suspension with 23,000 lb GVW or Greater	16-16873-000		...	...	OIO	85029	...
		141700131810	OIO	83160	...		...	...
		16-16737-000	OIO	83160	...		...	...
		16-16874-000	OIO	83160	...		...	...
		141700131809		...	...	OIO	85029	...
		16-16736-000		...	...	OIO	85029	...
		16-18103-000	-I-	85900	...		...	...
		481700000493	-I-	85900	...		...	...
11 - 20	Vista & Vista LX Series MotorHomes with Ford F53 Chassis with 16,000 lb GVW to 22,000 lb GVW	ASH-1229	OIO	83209	89414		...	...
		ASH-25822	OIO	83209	89414		...	...
		ASH-25823	OIO	83209	89414		...	...
		ASH-25824		...	...	OIO	83122	89406

#### Class C MotorHomes





07 - 13	Access & Access Premier Series MotorHomes with Ford E350 & E450 Chassis	ASH-1136		...	...	-IO	83178	...
		ASH-1154	-IO	83177	...		...	...
05 - 20	Aspect Series MotorHomes with Ford E450 Chassis	ASH-1136		...	...	-IO	83178	...
		ASH-1154	-IO	83177	...		...	...
13 - 20	Cambria Series MotorHomes with Ford E450 Chassis	ASH-1136		...	...	-IO	83178	...
		ASH-1154	-IO	83177	...		...	...
99 - 20	Minnie Winnie Series MotorHomes with Ford E350 & E450 Chassis	ASH-1136		...	...	-IO	83178	...
		ASH-1154	-IO	83177	...		...	...
06 - 20	Outlook Series MotorHomes with Ford E350 & E450 Chassis	ASH-1136		...	...	-IO	83178	...
		ASH-1154	-IO	83177	...		...	...
15 - 20	Spirit Series MotorHomes with Ford E350 & E450 Chassis	ASH-1136		...	...	-IO	83178	...
		ASH-1154	-IO	83177	...		...	...

### WORKHORSE

	Models with O.E.M. Number	659223		...	...	OIO	G63866	...
		680672		...	...	OIO	85919	...
		W0011635	OIO	83221	...		...	...
		W0011636		...	...	OIO	G63366	...
	Models with RSAS Rear Suspension	7805-X-1012		...	...	OIO	85919	...
	Step Van Models with O.E.M. Number	W0007365		...	...	OIO	G63866	...



**APPLICATION GUIDE - TRUCKS, TRAILERS, AND BUSES**

Year Año Année	Model Modelo Modèle	OEM #	Front		Rear	
			 Fleetline	 GasSLX	 Fleetline	 GasSLX

**WORKHORSE(Cont'd.)**

	UFO Motorhome Chassis with Hendrickson Softek Front Suspension	66153-002	0 0	<b>83124</b>	<b>89407</b>		...	...
		F4-BE5-C832-MO	0 0	<b>83124</b>	<b>89407</b>		...	...
<b>06 - 09</b>	W16 & W18 MotorHome Chassis with O.E.M. Number	F4-BE5-F324-HO	0 0	<b>85125</b>	...		...	...
		W0005662	0 0	<b>85125</b>	...		...	...
<b>05 - 14</b>	W20 , W22, & W24 MotorHome Chassis with O.E.M. Number	24-153256		...	...	- -	<b>85124</b>	...
		F4-BE5-F325-HO		...	...	- -	<b>85124</b>	...
		W0005663		...	...	- -	<b>85124</b>	...
<b>98 - 04</b>	W20 , W22, & W24 MotorHome Chassis with O.E.M. Number	24-186537		...	...	0 -	<b>85126</b>	...
		F4-BE5-A011-HO		...	...	0 -	<b>85126</b>	...
<b>98 - 14</b>	W20 , W22, & W24 MotorHome Chassis with O.E.M. Number	24-153249	0 0	<b>85125</b>	...		...	...
		24-186629	0 0	<b>85125</b>	...		...	...
		F4-BE5-A832-MO	0 0	<b>85125</b>	...		...	...
		F4-BE5-B492-HO	0 0	<b>85125</b>	...		...	...
		F4-BE5-F324-HO	0 0	<b>85125</b>	...		...	...
		W0005662	0 0	<b>85125</b>	...		...	...
		W0006254	0 0	<b>85125</b>	...		...	...

**WORLD TRANS BUS CO.**

	E & G Series Commercial buses on Ford E350 or E450 Chassis	ASH-1136		...	...	- 0	<b>83178</b>	...
		ASH-1154	- 0	<b>83177</b>	...		...	...

**NUMERICAL LISTING  
LISTA NUMÉRICA  
LISTE NUMÉRIQUE**

GABRIEL#	APPLICATION	MTG ACC PKG NO	GABRIEL#	APPLICATION	MTG ACC PKG NO	GABRIEL#	APPLICATION	MTG ACC PKG NO
<b>Shocks for Special Applications</b>			G63398	W FORD MITSUBISHI-FUSO	141138	G63773	W FORD	Not Req'd.
83176	X VARIOUS	Not Req'd.	G63403	W FREIGHTLINER VOLVO	Not Req'd.	G63775	W FORD	Not Req'd.
632147	W CHALLENGE LINK/HIGH-STEER MC NEILUS TRUCK & MAN. WATSON & CHALIN MFG. INC.	Not Req'd.	G63405	W MITSUBISHI-FUSO	140884	G63778	W FORD	142700
646155	B ADVANCE MIXER GRANNING SUSPENSION HENDRICKSON TRAILER SUSPENSION SYSTEMS HENDRICKSON TRUCK SUSPENSION SYSTEMS KIMBLE MIXER CO LINK/HIGH-STEER LONDON MIXER MC NEILUS TRUCK & MAN. REX MIXER RIDEWELL CORPORATION SAF HOLLAND SUSPENSIONS INC. TEREX CORPORATION TUTHILL TECHNOLOGIES WATSON & CHALIN MFG. INC.	Not Req'd.	G63406	W FORD	Not Req'd.	G63808	W FORD	Not Req'd.
646177	A CHALLENGE LINK/HIGH-STEER OSHKOSH MOTORS PIERCE MANUFACTURING INC. SAF HOLLAND SPRING VALLEY WESTPORT AXLE CORP	Not Req'd.	G63409	W FORD	Not Req'd.	G63809	W FORD STERLING TRUCK	Not Req'd.
665472	W INGERSALL MACHINE	Not Req'd.	G63414	W FORD	140780	G63810	W FORD	Not Req'd.
665937	D LINK/HIGH-STEER REYCO SUSPENSION RIDEWELL CORPORATION	Not Req'd.	G63419	W HINO	Not Req'd.	G63811	W FORD	Not Req'd.
<b>Gas Light Truck Applications</b>			G63432	W INTERNATIONAL (NAVISTAR) NISSAN	141349 & 140169	G63837	W FORD	Not Req'd.
G63183	W CHRYSLER DODGE TRUCK FREIGHTLINER HOLIDAY RAMBLER JOHN DEERE MOR-RYDE SUSPENSION OSHKOSH MOTORS VOLVO	Not Req'd.	G63440	W HINO	Not Req'd.	G63866	W MOR-RYDE SUSPENSION WORKHORSE	Not Req'd.
G63299	W FORD INTERNATIONAL (NAVISTAR) MITSUBISHI-FUSO	140885(1)	G63455	W FORD	Not Req'd.	G63929	W FORD	140780
G63306	W FORD INTERNATIONAL (NAVISTAR)	Not Req'd.	G63461	W FORD	Not Req'd.	G63969	W FORD	143146
G63347	W CHEVROLET TRUCK (Also See GMC Truck) GMC TRUCK	Not Req'd.	G63484	W VOLVO	140524	<b>Fleetline Applications</b>		
G63350	W FORD	140126	G63500	W FORD	140780	83001	B FREIGHTLINER CAB SHOCKS	404702(1)
G63355	W CHALMERS SUSPENSION	140702	G63511	W FORD	141353	83002	C KENWORTH CAB SHOCKS LINK MANUFACTURING CAB SHOCKS	Not Req'd.
G63357	W WATSON & CHALIN MFG. INC.	Not Req'd.	G63524	W FORD	Not Req'd.	83003	W MACK CAB SHOCKS	140455(1)
G63366	W WORKHORSE	Not Req'd.	G63525	W FORD	Not Req'd.	83004	W VOLVO CAB SHOCKS	Not Req'd.
G63386	W FORD STERLING TRUCK	140780	G63605	W DODGE TRUCK FREIGHTLINER JOHN DEERE OSHKOSH MOTORS VOLVO	140169	83005	X INTERNATIONAL (NAVISTAR) CAB SHOCKS LINK MANUFACTURING CAB SHOCKS	140455(1)
G63387	W FORD STERLING TRUCK	140126	G63607	W FORD	140719	83006	W FREIGHTLINER CAB SHOCKS	404702(1)
G63396	W FORD	140780	G63608	W FORD	140780	83007	W MACK CAB SHOCKS	404702(2) & 140702(1)
			G63610	W HINO INTERNATIONAL (NAVISTAR) MITSUBISHI-FUSO NISSAN	142389	83008	A KENWORTH PETERBILT CAB SHOCKS	Not Req'd.
			G63614	W FORD	140780	83009	A FREIGHTLINER CAB SHOCKS MC NEILUS TRUCK & MAN. OSHKOSH MOTORS CAB SHOCKS VOLVO CAB SHOCKS	Not Req'd.
			G63622	W FORD	142617	83010	X WESTERN STAR CAB SHOCKS	Not Req'd.
			G63623	W FORD	142617	83011	W KENWORTH CAB SHOCKS PETERBILT CAB SHOCKS	404702(2)
			G63624	W FORD	140780	83012	W KENWORTH CAB SHOCKS PETERBILT CAB SHOCKS	404702(2)
			G63625	W VOLVO	140702	83013	X INTERNATIONAL (NAVISTAR) CAB SHOCKS LINK MANUFACTURING CAB SHOCKS	Not Req'd.
			G63676	W FORD	Not Req'd.	83015	W INTERNATIONAL (NAVISTAR) CAB SHOCKS	140455(1)
			G63678	W FORD	Not Req'd.	83016	W CHEVROLET TRUCK CAB SHOCKS FORD CAB SHOCKS FREIGHTLINER CAB SHOCKS GMC TRUCK CAB SHOCKS INTERNATIONAL (NAVISTAR) CAB SHOCKS KENWORTH CAB SHOCKS LINK MANUFACTURING CAB SHOCKS MACK CAB SHOCKS PETERBILT CAB SHOCKS VOLVO CAB SHOCKS WESTERN STAR CAB SHOCKS	Not Req'd.
			G63679	W FORD	140719			
			G63714	W FORD	142731			
			G63716	W FORD	142731			
			G63772	W FORD	141665			

X = Discontinued once inventory is gone

# NUMERICAL LISTING LISTA NUMÉRICA LISTE NUMÉRIQUE

GABRIEL#	APPLICATION	MTG ACC PKG NO	GABRIEL#	APPLICATION	MTG ACC PKG NO	GABRIEL#	APPLICATION	MTG ACC PKG NO
83017	W FREIGHTLINER CAB SHOCKS	Not Req'd.	83041	D MACK CAB SHOCKS VOLVO	140780(1)	83109	W MC NEILUS TRUCK & MAN. STERLING TRUCK	145128(1)
83018	W MACK CAB SHOCKS	140780(1)	83042	D KENWORTH CAB SHOCKS PETERBILT CAB SHOCKS	Not Req'd.	83110	W HENDRICKSON TRUCK SUSPENSION SYSTEMS MACK VOLVO	145128(1)
83019	W MACK CAB SHOCKS VOLVO	140780(1)	83044	W FREIGHTLINER CAB SHOCKS	Not Req'd.	83111	D HENDRICKSON TRUCK SUSPENSION SYSTEMS MACK VOLVO WESTERN STAR	145128(1)
83020	W FREIGHTLINER CAB SHOCKS	Not Req'd.	83045	W MACK CAB SHOCKS VOLVO	140780(1)	83112	C ADVANCE MIXER AUTOCAR HENDRICKSON TRUCK SUSPENSION SYSTEMS INTERNATIONAL (NAVISTAR) MACK MC NEILUS TRUCK & MAN. PETERBILT VOLVO WESTERN STAR	145128(1)
83021	C CHEVROLET TRUCK CAB SHOCKS CNH GLOBAL N V FREIGHTLINER CAB SHOCKS GMC TRUCK CAB SHOCKS INTERNATIONAL (NAVISTAR) CAB SHOCKS KENWORTH CAB SHOCKS LINK MANUFACTURING CAB SHOCKS MARMON CAB SHOCKS OSHKOSH MOTORS CAB SHOCKS PETERBILT CAB SHOCKS	Not Req'd.	83047	D FREIGHTLINER CAB SHOCKS	404702(1)	83113	W SAF HOLLAND STOUGHTON TRAILERS INC. TRAILMOBILE CANADA CORP. WABASH NATIONAL	Not Req'd.
83022	W CNH GLOBAL N V WESTERN STAR CAB SHOCKS	Not Req'd.	83048	C VOLVO VOLVO CAB SHOCKS	Not Req'd.	83114	W CHEVROLET TRUCK (Also See GMC Truck) GMC TRUCK INTERNATIONAL (NAVISTAR) ISUZU NISSAN	140780(1)
83023	W CHEVROLET TRUCK CAB SHOCKS FORD CAB SHOCKS FREIGHTLINER CAB SHOCKS GMC TRUCK CAB SHOCKS INTERNATIONAL (NAVISTAR) CAB SHOCKS KENWORTH CAB SHOCKS LINK MANUFACTURING CAB SHOCKS MACK CAB SHOCKS PETERBILT CAB SHOCKS VOLVO CAB SHOCKS WESTERN STAR CAB SHOCKS	Not Req'd.	83049	D KENWORTH CAB SHOCKS LINK MANUFACTURING CAB SHOCKS PETERBILT CAB SHOCKS	Not Req'd.	83117	W FREIGHTLINER FREIGHTLINER CUSTOM CHASSIS OSHKOSH MOTORS	404702(1)
83024	W KENWORTH CAB SHOCKS LINK MANUFACTURING CAB SHOCKS PETERBILT CAB SHOCKS	Not Req'd.	83050	W MACK CAB SHOCKS VOLVO CAB SHOCKS	140780(1)	83118	W FREIGHTLINER FREIGHTLINER CUSTOM CHASSIS MAECO OSHKOSH MOTORS UPS TRUCK	Not Req'd.
83025	C FORD CAB SHOCKS FREIGHTLINER CAB SHOCKS GMC TRUCK CAB SHOCKS INTERNATIONAL (NAVISTAR) CAB SHOCKS KENWORTH CAB SHOCKS LINK MANUFACTURING CAB SHOCKS PETERBILT CAB SHOCKS STERLING TRUCK CAB SHOCKS	Not Req'd.	83051	C INTERNATIONAL (NAVISTAR) CAB SHOCKS LINK MANUFACTURING CAB SHOCKS	Not Req'd.	83119	W FREIGHTLINER CUSTOM CHASSIS OSHKOSH MOTORS	Not Req'd.
83026	W FREIGHTLINER CAB SHOCKS WESTERN STAR CAB SHOCKS	Not Req'd.	83053	W INTERNATIONAL (NAVISTAR) CAB SHOCKS LINK MANUFACTURING CAB SHOCKS	Not Req'd.	83120	W FREIGHTLINER FREIGHTLINER CUSTOM CHASSIS MAECO OSHKOSH MOTORS STERLING TRUCK THOMAS SCHOOL BUS UPS TRUCK VOLVO	145089-000(1) & 145143(1)
83027	D FREIGHTLINER CAB SHOCKS WESTERN STAR CAB SHOCKS	140126(1)	83054	W INTERNATIONAL (NAVISTAR) CAB SHOCKS LINK MANUFACTURING CAB SHOCKS	Not Req'd.	83122	D ALLCO TRAILER AUTOCAR CHEVROLET TRUCK (Also See GMC Truck) COACHMEN RV DAMON MOTOR COACH ENTEGR COACH FLEETWOOD RV FORD FOREST RIVER INC FREIGHTLINER FRUEHAUF GEORGIE BOY MANUFACTURING GILLIG BROS. GMC TRUCK GREAT DANE TRAILER HENDRICKSON TRUCK SUSPENSION SYSTEMS HOLIDAY RAMBLER ISUZU ITASCA JAYCO RV INC KENWORTH LODAL, INC. MACK MAECO MARMON MC NEILUS TRUCK & MAN. MONACO NATIONAL RV INC. NEWMAR CORP NEXUS RV OSHKOSH MOTORS PETERBILT REYCO SUSPENSION SAF HOLLAND	Not Req'd.
83028	D VOLVO CAB SHOCKS	Not Req'd.	83055	W KENWORTH CAB SHOCKS LINK MANUFACTURING CAB SHOCKS	Not Req'd.			
83029	W VOLVO CAB SHOCKS	Not Req'd.	83056	W KENWORTH CAB SHOCKS LINK MANUFACTURING CAB SHOCKS	Not Req'd.			
83030	W VOLVO CAB SHOCKS	Not Req'd.	83059	W KENWORTH CAB SHOCKS PETERBILT CAB SHOCKS POWERPACKER CAB SHOCKS	Not Req'd.			
83031	C KENWORTH CAB SHOCKS LINK MANUFACTURING CAB SHOCKS	Not Req'd.	83062	D INTERNATIONAL (NAVISTAR) CAB SHOCKS LINK MANUFACTURING CAB SHOCKS	145128(1)			
83033	W FORD CAB SHOCKS FREIGHTLINER CAB SHOCKS STERLING TRUCK CAB SHOCKS	Not Req'd.	83063	W KENWORTH PETERBILT CAB SHOCKS	Not Req'd.			
83034	W FORD CAB SHOCKS FREIGHTLINER CAB SHOCKS STERLING TRUCK CAB SHOCKS	Not Req'd.	83065	W WESTERN STAR CAB SHOCKS	Not Req'd.			
83035	C KENWORTH PETERBILT CAB SHOCKS	Not Req'd.	83066	W MACK CAB SHOCKS	Not Req'd.			
83038	A FREIGHTLINER CAB SHOCKS	404702(1)	83067	W KENWORTH CAB SHOCKS PETERBILT CAB SHOCKS	Not Req'd.			
83039	W FREIGHTLINER CAB SHOCKS	Not Req'd.	83081	N KENWORTH CAB SHOCKS PETERBILT CAB SHOCKS	Not Req'd.			
83040	W FREIGHTLINER CAB SHOCKS	Not Req'd.	83101	W FORD IC CORPORATION INTERNATIONAL (NAVISTAR) MACK VOLVO	Not Req'd.			
			83102	W THOMAS SCHOOL BUS	145089-000(2)			
			83103	W AUTOCAR INTERNATIONAL (NAVISTAR) MITSUBISHI-FUSO MOR-RYDE SUSPENSION VOLVO	145054(2)			
			83105	W MACK VOLVO	140780(1)			
			83107	W FORD MAECO STERLING TRUCK	145080(2)			
			83109	W FORD HENDRICKSON TRUCK SUSPENSION SYSTEMS	145128(1)			

N = New

# NUMERICAL LISTING LISTA NUMÉRICA LISTE NUMÉRIQUE

GABRIEL#	APPLICATION	MTG ACC PKG NO	GABRIEL#	APPLICATION	MTG ACC PKG NO	GABRIEL#	APPLICATION	MTG ACC PKG NO
83122	D THOR MOTOR COACH TUTHILL TECHNOLOGIES VOLVO WESTERN STAR WINNEBAGO	Not Req'd.	83128	A WABASH NATIONAL	Not Req'd.	83149	W HENDRICKSON TRUCK SUSPENSION SYSTEMS	Not Req'd.
83123	C FORD GILLIG BROS. HENDRICKSON TRUCK SUSPENSION SYSTEMS IC CORPORATION INTERNATIONAL (NAVISTAR) KENWORTH MACK MAECO MARMON MC NEILUS TRUCK & MAN. PETERBILT REYCO SUSPENSION SAF HOLLAND TUTHILL TECHNOLOGIES VOLVO WATSON & CHALIN MFG. INC.	Not Req'd.	83130	D RIDEWELL CORPORATION SAF HOLLAND VOLVO WABASH NATIONAL	Not Req'd.	83150	W HENDRICKSON TRAILER SUSPENSION SYSTEMS SAF HOLLAND	Not Req'd.
83124	C BENSON TRUCK BODIES INC. BLUEBIRD SCHOOL BUS COACHMEN RV EAST MANUFACTURING CORP. FOREST RIVER INC GEORGIE BOY MANUFACTURING ITASCA KENWORTH MONACO PETERBILT SAF HOLLAND TRAILMOBILE CANADA CORP. TWIN COACH VOLVO WABASH NATIONAL WINNEBAGO WORKHORSE	Not Req'd.	83131	W FORD	Not Req'd.	83153	W CHEVROLET TRUCK (Also See GMC Truck) GMC TRUCK	Not Req'd.
83125	B CASCADE TRAILER EAST MANUFACTURING CORP. FORD GENERAL TRAILER CO HENDRICKSON TRUCK SUSPENSION SYSTEMS HOLLAND - BINKLEY MACK MAECO PEERLESS TRAILER SAF HOLLAND STERLING TRUCK THE BINKLEY COMPANY TRAILMOBILE CANADA CORP. VOLVO WABASH NATIONAL WATSON & CHALIN MFG. INC.	Not Req'd.	83134	W FREIGHTLINER	145054(1)	83154	W FREIGHTLINER CUSTOM CHASSIS	145089-000(1)
83126	D CHEVROLET TRUCK (Also See GMC Truck) GMC TRUCK HINO INTERNATIONAL (NAVISTAR) KENWORTH MAECO PETERBILT REYCO SUSPENSION SAF HOLLAND TUTHILL TECHNOLOGIES VOLVO WABASH NATIONAL WESTERN STAR	Not Req'd.	83135	C FORD IC CORPORATION INTERNATIONAL (NAVISTAR)	Not Req'd.	83156	X IC CORPORATION INTERNATIONAL (NAVISTAR)	Not Req'd.
83127	C BLUEBIRD SCHOOL BUS FREIGHTLINER FREIGHTLINER CUSTOM CHASSIS HOLIDAY RAMBLER MC NEILUS TRUCK & MAN. OSHKOSH MOTORS SAF HOLLAND TRAILMOBILE CANADA CORP. VOLVO WABASH NATIONAL	Not Req'd.	83136	D CHAMPION BUS INC CHEVROLET TRUCK (Also See GMC Truck) GMC TRUCK GULF STREAM COACH ISUZU KENWORTH PETERBILT VOLVO	145054(2)	83158	W MOTOR COACH INDUSTRIES	Not Req'd.
83128	A EAST MANUFACTURING CORP. FREIGHTLINER GREAT DANE TRAILER HENDRICKSON TRAILER SUSPENSION SYSTEMS MC NEILUS TRUCK & MAN. REYCO SUSPENSION SAF HOLLAND STOUGHTON TRAILERS INC. TWIN COACH UTILITY TRAILER MANUFACTURING COMPANY VOLVO	Not Req'd.	83137	C AUTOCAR BERING TRUCK CORP. BLUEBIRD SCHOOL BUS CHEVROLET TRUCK (Also See GMC Truck) GMC TRUCK HENDRICKSON TRUCK SUSPENSION SYSTEMS INTERNATIONAL (NAVISTAR) ISUZU KENWORTH MACK MC NEILUS TRUCK & MAN. PETERBILT SAF HOLLAND VOLVO WESTERN STAR	Not Req'd.	83159	W GMC TRUCK ISUZU	TR0027(4)
			83138	X MACK	145128(1)	83160	W COACHMEN RV FLEETWOOD RV FOREST RIVER INC FREIGHTLINER CUSTOM CHASSIS GULF STREAM COACH HOLIDAY RAMBLER ITASCA KING OF THE ROAD MANDALAY COACH MONACO NEWMAR CORP THOR MOTOR COACH WINNEBAGO	Not Req'd.
			83140	D FORD HINO	415010-802(2) & 145148(2)	83162	W ISUZU NISSAN	140780(1) & 145116 & 406422 & 415010-802(1)
			83141	W HINO	415010-802(2) & 145148(2)	83163	W FORD IC CORPORATION INTERNATIONAL (NAVISTAR)	Not Req'd.
			83142	D AUTOCAR CATERPILLAR FREIGHTLINER HENDRICKSON TRUCK SUSPENSION SYSTEMS INTERNATIONAL (NAVISTAR) KENWORTH MACK MC NEILUS TRUCK & MAN. PETERBILT VOLVO WESTERN STAR	145128(1)	83164	X ARVIN MERITOR FREIGHTLINER CUSTOM CHASSIS	Not Req'd.
			83143	W AUTOCAR CATERPILLAR CRANE CARRIER FREIGHTLINER HENDRICKSON TRUCK SUSPENSION SYSTEMS INTERNATIONAL (NAVISTAR) KENWORTH MACK MC NEILUS TRUCK & MAN. PETERBILT VOLVO WESTERN STAR	145128(1)	83166	W HENDRICKSON TRUCK SUSPENSION SYSTEMS HINO	Not Req'd.
			83144	W HENDRICKSON TRUCK SUSPENSION SYSTEMS INTERNATIONAL (NAVISTAR)	Not Req'd.	83168	W HENDRICKSON TRUCK SUSPENSION SYSTEMS HINO MC NEILUS TRUCK & MAN.	Not Req'd.
			83147	B HENDRICKSON TRUCK SUSPENSION SYSTEMS MACK MC NEILUS TRUCK & MAN. THOMAS SCHOOL BUS	Not Req'd.	83169	W IC CORPORATION INTERNATIONAL (NAVISTAR)	Not Req'd.
			83148	W HENDRICKSON TRUCK SUSPENSION SYSTEMS HINO MC NEILUS TRUCK & MAN. VOLVO	Not Req'd.	83175	W FORD GLAVAL BUS CO. INTERNATIONAL (NAVISTAR) STARCRAFT BUS CO.	Not Req'd.
						83176	X MAECO	Not Req'd.
						83177	W BERKSHIRE COACH BLUEBIRD SCHOOL BUS CHAMPION BUS INC COACH HOUSE RV COACHMEN RV COLLINS BUS CORP DIAMOND COACH DUTCHMEN RV DYNAMAX CORP (COUNTRY COACH) ELDORADO NATIONAL ELKHART COACH ENTEGR COACH FEDERAL COACH FLEETWOOD RV FORD FOREST RIVER INC GEORGIE BOY MANUFACTURING GLAVAL BUS CO. GOSHEN COACH GRECH MOTORS GULF STREAM COACH HOLIDAY RAMBLER ITASCA JAYCO RV INC KRYSAL BUS	140780(1) & 404702(1)

X = Discontinued once inventory is gone

# NUMERICAL LISTING LISTA NUMÉRICA LISTE NUMÉRIQUE

GABRIEL#	APPLICATION	MTG ACC PKG NO	GABRIEL#	APPLICATION	MTG ACC PKG NO	GABRIEL#	APPLICATION	MTG ACC PKG NO
83177	W 140780(1) & 404702(1) LGE COACHWORKS NEXUS RV PHOENIX CRUISER RV SHASTA RV STARCRAFT BUS CO. THOMAS SCHOOL BUS THOR MOTOR COACH TURTLETOP BUS WHEELED COACH IND WINNEBAGO WORLD TRANS BUS CO.		83207	C Not Req'd. GMC TRUCK GREAT DANE TRAILER HARDEE MFG HENDRICKSON TRUCK SUSPENSION SYSTEMS HIGHWAY PRODUCT INTERNATIONAL (NAVISTAR) MACK MAECO MC NEILUS TRUCK & MAN. MOHAWK NATIONAL COACH CORP OSHKOSH MOTORS REYCO SUSPENSION RIDEWELL CORPORATION SAF HOLLAND TRAILMOBILE CANADA CORP. TUTHILL TECHNOLOGIES TWIN COACH VOLVO WABASH NATIONAL		83216	W 140149(1) MARMON MOHAWK NEOPLAN BUS ONEIDA PRODUCTS STERLING TRUCK VOLVO WESTERN STAR	
83178	W 142095(1) BERKSHIRE COACH BLUEBIRD SCHOOL BUS CHAMPION BUS INC COACH HOUSE RV COACHMEN RV COLLINS BUS CORP DIAMOND COACH DUTCHMEN RV DYNAMAX CORP (COUNTRY COACH) ELDORADO NATIONAL ELKHART COACH ENTEGR COACH FEDERAL COACH FLEETWOOD RV FORD FOREST RIVER INC GEORGIE BOY MANUFACTURING GLAVAL BUS CO. GOSHEN COACH GRECH MOTORS GULF STREAM COACH HOLIDAY RAMBLER ITASCA JAYCO RV INC KRYSTAL BUS LGE COACHWORKS NEXUS RV PHOENIX CRUISER RV SHASTA RV STARCRAFT BUS CO. THOMAS SCHOOL BUS THOR MOTOR COACH TURTLETOP BUS WHEELED COACH IND WINNEBAGO WORLD TRANS BUS CO.		83209	C Not Req'd. ADVANCE MIXER ARVIN MERITOR BATCO CHEVROLET TRUCK (Also See GMC Truck) COACHMEN RV DAMON MOTOR COACH ENTEGR COACH FLEETWOOD RV FORD FOREST RIVER INC GEORGIE BOY MANUFACTURING GMC TRUCK HENDRICKSON TRAILER SUSPENSION SYSTEMS HOLIDAY RAMBLER INTERNATIONAL (NAVISTAR) ITASCA JAYCO RV INC KENWORTH MACK MAECO MC NEILUS TRUCK & MAN. MONACO NATIONAL RV INC. NEWMAR CORP NEXUS RV PETERBILT REYCO SUSPENSION SAF HOLLAND THOR MOTOR COACH TRAILMOBILE CANADA CORP. TUTHILL TECHNOLOGIES VOLVO WESTERN STAR WINNEBAGO		83217	W 401754(4) CHEVROLET TRUCK (Also See GMC Truck) DIAMOND-REO EAST MANUFACTURING CORP. FLXIBLE BUS FORD GMC TRUCK HINO HYSTER MACK MAECO OLE GRANNING OTTAWA TRUCK REYCO SUSPENSION SOUTHERN COACH TUTHILL TECHNOLOGIES VOLVO	
83180	W Not Req'd. INTERNATIONAL (NAVISTAR)		83214	W 401754(4) ARVIN MERITOR CHEVROLET TRUCK (Also See GMC Truck) DIAMOND-REO EAST MANUFACTURING CORP. GMC TRUCK GRANNING SUSPENSION MAECO OSTERLUND TRUCK OTTAWA TRUCK SPARTAN MOTORS TUTHILL TECHNOLOGIES VOLVO		83219	D 140149(1) ARVIN MERITOR CHEVROLET TRUCK (Also See GMC Truck) FORD GILLIG BROS. GMC TRUCK PETERBILT VOLVO	
83203	B Not Req'd. BATCO CHANCE COACH CHEVROLET TRUCK (Also See GMC Truck) DURA SUSPENSION FRUEHAUF GMC TRUCK HIGHWAY PRODUCT HUTCHENS SUSPENSION MACK MAECO MOHAWK ORION BUS INDUSTRIES PAGE SUSPENSION PETERBILT REYCO SUSPENSION RIDEWELL CORPORATION SAF HOLLAND TUTHILL TECHNOLOGIES VOLVO WABASH NATIONAL WATSON & CHALIN MFG. INC.		83215	W 401754(4) ACF BRILL BUS ARVIN MERITOR BROCKWAY SCHOOL BUS CHEVROLET TRUCK (Also See GMC Truck) FORD GMC TRUCK HINO INTERNATIONAL (NAVISTAR) MACK MAECO PAI CORP REYCO SUSPENSION STERLING TRUCK TUTHILL TECHNOLOGIES VOLVO		83221	D Not Req'd. BATCO CHEVROLET TRUCK (Also See GMC Truck) GMC TRUCK MACK MAECO OSHKOSH MOTORS PAI CORP VOLVO WORKHORSE	
83204	W Not Req'd. BATCO DUPLEX TRUCK DURA SUSPENSION MAECO PAGE SUSPENSION REYCO SUSPENSION SAF HOLLAND TRAILMOBILE CANADA CORP. TUTHILL TECHNOLOGIES VOLVO WATSON & CHALIN MFG. INC.		83216	W 140149(1) ARVIN MERITOR AUTOCAR BROCKWAY SCHOOL BUS CHEVROLET TRUCK (Also See GMC Truck) FORD GILLIG BROS. GMC TRUCK HINO INTERNATIONAL (NAVISTAR) MACK MAECO		83225	W 401754(4) ACF BRILL BUS ARVIN MERITOR BATCO FORD FREIGHTLINER HENDRICKSON TRUCK SUSPENSION SYSTEMS INTERNATIONAL (NAVISTAR) MACK MOHAWK TRAILMOBILE CANADA CORP. VOLVO	
83207	C Not Req'd. ADVANCE MIXER ARVIN MERITOR BATCO BLUEBIRD SCHOOL BUS BROCKWAY SCHOOL BUS CHANCE COACH CHEVROLET TRUCK (Also See GMC Truck) DURA SUSPENSION FORD GILLIG BROS.		83217	W 140149(1) ARVIN MERITOR FORD INTERNATIONAL (NAVISTAR) STERLING TRUCK VOLVO		83301	W 141083(1) ARVIN MERITOR INTERNATIONAL (NAVISTAR) VOLVO	
			83218	W 140149(1) ARVIN MERITOR FORD INTERNATIONAL (NAVISTAR) STERLING TRUCK VOLVO		83303	W 140702(1) ARVIN MERITOR CHEVROLET TRUCK (Also See GMC Truck) GMC TRUCK VOLVO	
			83219	W 140149(1) ARVIN MERITOR CHEVROLET TRUCK (Also See GMC Truck) GMC TRUCK VOLVO		83304	W 140702(1) ARVIN MERITOR CHEVROLET TRUCK (Also See GMC Truck) GMC TRUCK VOLVO	
			83220	W 140149(1) ARVIN MERITOR CHEVROLET TRUCK (Also See GMC Truck) GMC TRUCK VOLVO		83308	W 140149(1) ARVIN MERITOR CHEVROLET TRUCK (Also See GMC Truck) FORD GMC TRUCK INTERNATIONAL (NAVISTAR) STERLING TRUCK VOLVO	
			83221	W 140149(1) ARVIN MERITOR FORD INTERNATIONAL (NAVISTAR) STERLING TRUCK VOLVO		83309	W 140149(1) ARVIN MERITOR FORD INTERNATIONAL (NAVISTAR) STERLING TRUCK VOLVO	
			83222	W 140149(1) ARVIN MERITOR FORD INTERNATIONAL (NAVISTAR) STERLING TRUCK VOLVO		83312	W 140149(1) ARVIN MERITOR FORD	

# NUMERICAL LISTING LISTA NUMÉRICA LISTE NUMÉRIQUE

GABRIEL#	APPLICATION	MTG ACC PKG NO	GABRIEL#	APPLICATION	MTG ACC PKG NO	GABRIEL#	APPLICATION	MTG ACC PKG NO
83312	W KENWORTH OSHKOSH MOTORS PETERBILT PIERCE MANUFACTURING INC. VOLVO	140149(1)	83905	W VOLVO CAB SHOCKS	Not Req'd.	85006	A TRAILMOBILE CANADA CORP. TUTHILL TECHNOLOGIES VOLVO WESTERN STAR	Not Req'd.
83314	W ARVIN MERITOR FORD GMC TRUCK INTERNATIONAL (NAVISTAR) MAECO STERLING TRUCK VOLVO	140149(1)	83906	W FREIGHTLINER CAB SHOCKS	Not Req'd.	85007	W ARVIN MERITOR BATCO FREIGHTLINER KENWORTH MACK MAECO PETERBILT REYCO SUSPENSION SPARTAN MOTORS TUTHILL TECHNOLOGIES VOLVO	401754(4)
83317	W BATCO FORD GLAVAL BUS CO. IC CORPORATION INTERNATIONAL (NAVISTAR) STARCRAFT BUS CO. VOLVO	141083(1)	85000	A ARVIN MERITOR BENSON TRUCK BODIES INC. CUSH CORPORATION EAST MANUFACTURING CORP. FREIGHTLINER GREAT DANE TRAILER HENDRICKSON TRAILER SUSPENSION SYSTEMS KENWORTH MC NEILUS TRUCK & MAN. ORION BUS INDUSTRIES PETERBILT RIDEWELL CORPORATION SAF HOLLAND STOUGHTON TRAILERS INC. THOMAS SCHOOL BUS TRAILMOBILE CANADA CORP. TWIN COACH UTILITY TRAILER MANUFACTURING COMPANY VOLVO WABASH NATIONAL WATSON & CHALIN MFG. INC.	Not Req'd.	85009	W ARVIN MERITOR FREIGHTLINER MITSUBISHI-FUSO NEOPLAN BUS WATSON & CHALIN MFG. INC.	145054(1)
83318	W ARVIN MERITOR INTERNATIONAL (NAVISTAR) VOLVO	141083(2)	85001	A ARVIN MERITOR FORD INTERNATIONAL (NAVISTAR) KENWORTH MACK MAECO PETERBILT REYCO SUSPENSION STERLING TRUCK TUTHILL TECHNOLOGIES VOLVO	401754(4)	85010	W ARVIN MERITOR BLUEBIRD SCHOOL BUS HENDRICKSON TRAILER SUSPENSION SYSTEMS MACK	Not Req'd.
83362	S HINO KENWORTH	401754(4)	85003	A ARVIN MERITOR BATCO IC CORPORATION INTERNATIONAL (NAVISTAR) KENWORTH MARMON PETERBILT VOLVO	Not Req'd.	85012	A ARVIN MERITOR BLUEBIRD SCHOOL BUS BROCKWAY SCHOOL BUS CHANCE COACH CHEVROLET TRUCK (Also See GMC Truck) FORD GMC TRUCK INTERNATIONAL (NAVISTAR) ISUZU KENWORTH PETERBILT VOLVO	145080(2)
83363	W SAF HOLLAND	Not Req'd.	85004	W ARVIN MERITOR PETERBILT SAF HOLLAND	401754(4)	85013	B ARVIN MERITOR BLUEBIRD SCHOOL BUS FORD HENDRICKSON TRAILER SUSPENSION SYSTEMS HENDRICKSON TRUCK SUSPENSION SYSTEMS INTERNATIONAL (NAVISTAR) KENWORTH MAECO MC NEILUS TRUCK & MAN. PETERBILT REYCO SUSPENSION SAF HOLLAND SPARTAN MOTORS STERLING TRUCK TRAILMOBILE CANADA CORP. TUTHILL TECHNOLOGIES VOLVO	Not Req'd.
83364	W FORD INTERNATIONAL (NAVISTAR) STERLING TRUCK	Not Req'd.	85005	C ARVIN MERITOR AUTOCAR BATCO BLUEBIRD SCHOOL BUS BOYDSTUN EQUIPMENT MANUFACTURING CHEVROLET TRUCK (Also See GMC Truck) CUSH CORPORATION EAST MANUFACTURING CORP. FREIGHTLINER FREIGHTLINER CUSTOM CHASSIS GMC TRUCK HENDRICKSON TRAILER SUSPENSION SYSTEMS HENDRICKSON TRUCK SUSPENSION SYSTEMS INTERNATIONAL (NAVISTAR) MACK MAECO REYCO SUSPENSION RIDEWELL CORPORATION SAF HOLLAND TUTHILL TECHNOLOGIES VOLVO WATSON & CHALIN MFG. INC.	Not Req'd.	85014	D ARVIN MERITOR CHANCE COACH CUSH CORPORATION HARDEE MFG HENDRICKSON TRAILER SUSPENSION SYSTEMS INTERNATIONAL (NAVISTAR) MACK REYCO SUSPENSION RIDEWELL CORPORATION SAF HOLLAND TUTHILL TECHNOLOGIES WATSON & CHALIN MFG. INC.	Not Req'd.
83389	W SAF HOLLAND	Not Req'd.	85006	A ARVIN MERITOR BLUEBIRD SCHOOL BUS BUILT RITE DEXTER AXLE FORD FREIGHTLINER FREIGHTLINER CUSTOM CHASSIS GREAT DANE TRAILER HENDRICKSON TRAILER SUSPENSION SYSTEMS HENDRICKSON TRUCK SUSPENSION SYSTEMS MAECO RAMERIZ TRAILER REYCO SUSPENSION RIDEWELL CORPORATION SAF HOLLAND STERLING TRUCK STOUGHTON TRAILERS INC. THE BINKLEY COMPANY THOMAS SCHOOL BUS	Not Req'd.	85023	D INTERNATIONAL (NAVISTAR) KENWORTH MACK PETERBILT VOLVO	140149(1)
83391	W HINO	145177(2)	85024	W AUTOCAR INTERNATIONAL (NAVISTAR) MACK VOLVO	140149(1)	85025	X VOLVO	140169(1) & 145054(1)
83395	W INTERNATIONAL (NAVISTAR)	145054(1)	85026	W ARVIN MERITOR AUTOCAR GMC TRUCK VOLVO	145054(1)			
83400	W CHEVROLET TRUCK (Also See GMC Truck) FORD GMC TRUCK MOR-RYDE SUSPENSION VOLVO WATSON & CHALIN MFG. INC. WESTERN STAR	140455(2)						
83401	W CHEVROLET TRUCK (Also See GMC Truck) GMC TRUCK VOLVO WESTERN STAR	404702(2)						
83456	D IC CORPORATION INTERNATIONAL (NAVISTAR) MITSUBISHI-FUSO VOLVO	142998(2)						
83515	W CHEVROLET TRUCK (Also See GMC Truck) GMC TRUCK ISUZU NISSAN VOLVO	141041(1)						
83518	W HINO	141041(1) & TR0027(2)						
83519	W HINO	401011(4)						
83613	W ARVIN MERITOR INTERNATIONAL (NAVISTAR) ISUZU THOMAS SCHOOL BUS VOLVO	141083(2)						
83635	W SAF HOLLAND VOLVO WESTERN STAR	145054(1)						
83901	W MACK CAB SHOCKS	Not Req'd.						
83905	W MACK CAB SHOCKS	Not Req'd.						

S = Superseded, X = Discontinued once inventory is gone

# NUMERICAL LISTING LISTA NUMÉRICA LISTE NUMÉRIQUE

GABRIEL#	APPLICATION	MTG ACC PKG NO	GABRIEL#	APPLICATION	MTG ACC PKG NO	GABRIEL#	APPLICATION	MTG ACC PKG NO
85027	W ARVIN MERITOR AUTOCAR INTERNATIONAL (NAVISTAR) VOLVO	145054(2)	85045	A RIDEWELL CORPORATION SAF HOLLAND TUTHILL TECHNOLOGIES UTILITY TRAILER MANUFACTURING COMPANY VOLVO WABASH NATIONAL WATSON & CHALIN MFG. INC.	Not Req'd.	85064	C CUSH CORPORATION GREAT DANE TRAILER HENDRICKSON TRAILER SUSPENSION SYSTEMS WATSON & CHALIN MFG. INC.	Not Req'd.
85029	B ARVIN MERITOR BLUEBIRD SCHOOL BUS COACHMEN RV DURA SUSPENSION EAST MANUFACTURING CORP. FLEETWOOD RV FOREST RIVER INC FREIGHTLINER CUSTOM CHASSIS GULF STREAM COACH HENDRICKSON TRAILER SUSPENSION SYSTEMS HOLIDAY RAMBLER INTERNATIONAL (NAVISTAR) ITASCA KENWORTH KING OF THE ROAD MANDALAY COACH MONACO NEWMAR CORP PAGE SUSPENSION PETERBILT RIDEWELL CORPORATION SAF HOLLAND SPARTAN MOTORS THOR MOTOR COACH TRAILMOBILE CANADA CORP. WATSON & CHALIN MFG. INC. WINNEBAGO	Not Req'd.	85046	D AUTOCAR VOLVO	140149(1)	85065	W MACK VOLVO	145128(1)
85030	C ARVIN MERITOR BLUEBIRD SCHOOL BUS CHEVROLET TRUCK (Also See GMC Truck) EAST MANUFACTURING CORP. FORD FRUEHAUF GMC TRUCK HENDRICKSON TRAILER SUSPENSION SYSTEMS HENDRICKSON TRUCK SUSPENSION SYSTEMS INTERNATIONAL (NAVISTAR) MAECO OSHKOSH MOTORS PACIFIC TRUCK & TRAILER PIERCE MANUFACTURING INC. REYCO SUSPENSION SAF HOLLAND STERLING TRUCK THOMAS SCHOOL BUS TUTHILL TECHNOLOGIES VOLVO WABASH NATIONAL	Not Req'd.	85047	C FORD KENWORTH PETERBILT STERLING TRUCK VOLVO	140149(1)	85066	A MACK POWERHOUSE COACH INC. RENEGADE RV VOLVO	Not Req'd.
85031	D KENWORTH PETERBILT	145147(1) & TR0027(2)	85051	D BLUEBIRD SCHOOL BUS GILLIG BROS. MUNCIE RECLAMATION OSHKOSH MOTORS REYCO SUSPENSION SAF HOLLAND STOUGHTON TRAILERS INC. TRAILMOBILE CANADA CORP. TUTHILL TECHNOLOGIES WABASH NATIONAL	Not Req'd.	85067	A KENWORTH PETERBILT VOLVO	Not Req'd.
85033	A INTERNATIONAL (NAVISTAR) KENWORTH MACK PACCAR PETERBILT VOLVO	145099(1)	85052	A ARVIN MERITOR BLUEBIRD SCHOOL BUS GREAT DANE TRAILER HENDRICKSON TRAILER SUSPENSION SYSTEMS INGERSOLL AXLES REYCO SUSPENSION SAF HOLLAND TUTHILL TECHNOLOGIES VOLVO WABASH NATIONAL WATSON & CHALIN MFG. INC.	Not Req'd.	85069	A ARVIN MERITOR KENWORTH PETERBILT VOLVO	145089-000(2)
85036	C AUTOCAR BLUEBIRD SCHOOL BUS HENDRICKSON TRUCK SUSPENSION SYSTEMS LION BUS MACK PETERBILT SPARTAN MOTORS VOLVO	Not Req'd.	85053	C WESTERN STAR	145126(2)	85070	A KENWORTH PETERBILT VOLVO	401754(2)
85040	W FORD STERLING TRUCK VOLVO	401754(4)	85054	W FORD STERLING TRUCK	145080(2)	85071	W CHEVROLET TRUCK (Also See GMC Truck) GMC TRUCK ISUZU	145054(2)
85042	W FREIGHTLINER	401754(4)	85055	W FORD STERLING TRUCK	145080(2)	85072	C AUTOCAR HENDRICKSON TRUCK SUSPENSION SYSTEMS INTERNATIONAL (NAVISTAR) KENWORTH MACK MC NEILUS TRUCK & MAN. VOLVO WESTERN STAR	Not Req'd.
85043	C FREIGHTLINER FREIGHTLINER CUSTOM CHASSIS HENDRICKSON TRAILER SUSPENSION SYSTEMS STERLING TRUCK	Not Req'd.	85058	B BLUEBIRD SCHOOL BUS FREIGHTLINER FREIGHTLINER CUSTOM CHASSIS INTERNATIONAL (NAVISTAR) OSHKOSH MOTORS PIERCE MANUFACTURING INC. THOMAS SCHOOL BUS VOLVO	Not Req'd.	85078	W DANA WABASH NATIONAL	Not Req'd.
85045	A ARVIN MERITOR CUSH CORPORATION HENDRICKSON TRAILER SUSPENSION SYSTEMS INGERSOLL AXLES MUNCIE RECLAMATION REYCO SUSPENSION	Not Req'd.	85059	W RED LION TRAILER SAF HOLLAND STOUGHTON TRAILERS INC. TRAILMOBILE CANADA CORP. WABASH NATIONAL	Not Req'd.	85079	W HENDRICKSON TRAILER SUSPENSION SYSTEMS MC NEILUS TRUCK & MAN.	Not Req'd.
			85060	D AUTOCAR CHALMERS SUSPENSION FREIGHTLINER INTERNATIONAL (NAVISTAR) KENWORTH PETERBILT SAF HOLLAND VOLVO WATSON & CHALIN MFG. INC. WESTERN STAR	Not Req'd.	85080	W MACK VOLVO	145054(1)
			85061	A MACK POWERHOUSE COACH INC. RENEGADE RV VOLVO	Not Req'd.	85081	W VOLVO	145090(1)
			85062	A KENWORTH PETERBILT VOLVO	145080(2)	85082	W IC CORPORATION INTERNATIONAL (NAVISTAR)	Not Req'd.
			85063	W FORD MAECO STERLING TRUCK	145080(2)	85084	C KENWORTH PETERBILT	Not Req'd.
						85086	W AUTOCAR BLUEBIRD SCHOOL BUS REYCO SUSPENSION	Not Req'd.
						85087	W HENDRICKSON TRUCK SUSPENSION SYSTEMS MC NEILUS TRUCK & MAN.	Not Req'd.
						85088	A MACK POWERHOUSE COACH INC. RENEGADE RV VOLVO	Not Req'd.
						85090	W BLUEBIRD SCHOOL BUS	Not Req'd.
						85098	B MACK POWERHOUSE COACH INC. RENEGADE RV VOLVO	Not Req'd.
						85102	W HENDRICKSON TRUCK SUSPENSION SYSTEMS INTERNATIONAL (NAVISTAR)	Not Req'd.
						85106	W BLUEBIRD SCHOOL BUS	Not Req'd.

# NUMERICAL LISTING LISTA NUMÉRICA LISTE NUMÉRIQUE

GABRIEL#	APPLICATION	MTG ACC PKG NO	GABRIEL#	APPLICATION	MTG ACC PKG NO	GABRIEL#	APPLICATION	MTG ACC PKG NO
85109	W KENWORTH PETERBILT SAF HOLLAND VOLVO WESTERN STAR	Not Req'd.	85301	W STERLING TRUCK VOLVO	401754(4)	85305	D RIDEWELL CORPORATION VOLVO WESTERN STAR WESTERN UNIT "STABILAIRE" SUSPENSION	401754(4)
85119	W KENWORTH PETERBILT	Not Req'd.	85302	D AM GENERAL ARVIN MERITOR CHEVROLET TRUCK (Also See GMC Truck) CRANE CARRIER FORD FREIGHTLINER FWD TRUCK GILLIG BROS. GMC TRUCK KENWORTH MACK MAECO MOTOR COACH INDUSTRIES PETERBILT RIDEWELL CORPORATION VOLVO	401754(4)	85307	W ACF BRILL BUS ARVIN MERITOR BECK BUS BLUEBIRD SCHOOL BUS BROCKWAY SCHOOL BUS CHEVROLET TRUCK (Also See GMC Truck) CLARK EQUIPMENT CONTINENTAL TRAILWAYS-EAGLE INT'L CRANE CARRIER DIAMOND-REO EAGLE MOTOR COACH FLXIBLE BUS FORD GMC TRUCK HENDRICKSON TRUCK SUSPENSION SYSTEMS INTERNATIONAL (NAVISTAR) MACK MAECO ONEIDA PRODUCTS ORION BUS INDUSTRIES PIERCE MANUFACTURING INC. REYCO SUSPENSION RIDEWELL CORPORATION SPARTAN MOTORS THOMAS SCHOOL BUS VOLVO WESTERN STAR WESTERN UNIT "STABILAIRE" SUSPENSION	401754(4)
85120	W MACK	Not Req'd.	85303	D ACF BRILL BUS BROCKWAY SCHOOL BUS BUILT RITE BUS & TRUCK CO. CHEVROLET TRUCK (Also See GMC Truck) CONTINENTAL TRAILWAYS-EAGLE INT'L CRANE CARRIER CROWN COACH EAGLE MOTOR COACH GMC TRUCK GREYHOUND BUS HENDRICKSON TRUCK SUSPENSION SYSTEMS INTERNATIONAL (NAVISTAR) KENWORTH MACK MAECO MATSON SCHOOL BUS MC NEILUS TRUCK & MAN. MOHAWK MOTOR COACH INDUSTRIES ORION BUS INDUSTRIES OSHKOSH MOTORS OTTAWA TRUCK PETERBILT PREVOST TRANSPORTATION MFG. CORP VOLVO WESTERN STAR	401754(4)	85308	C ACF BRILL BUS ARVIN MERITOR BATCO CHEVROLET TRUCK (Also See GMC Truck) EAGLE MOTOR COACH FREIGHTLINER GMC TRUCK INTERNATIONAL (NAVISTAR) KENWORTH MACK MAECO MOHAWK ORION BUS INDUSTRIES PETERBILT PREVOST THOMAS SCHOOL BUS VOLVO WESTERN STAR WESTERN UNIT "STABILAIRE" SUSPENSION	401754(4)
85122	W FREIGHTLINER CUSTOM CHASSIS THOMAS SCHOOL BUS	145089-000(1)	85304	D ARVIN MERITOR BECK BUS BLUEBIRD SCHOOL BUS BROCKWAY SCHOOL BUS CHEVROLET TRUCK (Also See GMC Truck) CONTINENTAL TRAILWAYS-EAGLE INT'L CRANE CARRIER CROWN COACH DIAMOND-REO DIAMOND T EAGLE MOTOR COACH FLXIBLE BUS FORD FRUEHAUF GILLIG BROS. GMC TRUCK MACK OSHKOSH MOTORS PIERCE MANUFACTURING INC. RIDEWELL CORPORATION SAF HOLLAND SOUTHERN COACH SPARTAN MOTORS THOMAS SCHOOL BUS UNITED MANUFACTURING VOLVO WESTERN STAR WESTERN UNIT "STABILAIRE" SUSPENSION	401754(4)	85310	A ARVIN MERITOR INTERNATIONAL (NAVISTAR) KENWORTH MACK OTTAWA TRUCK PETERBILT VOLVO	141108(1)
85123	W FREIGHTLINER	145090(1)	85305	D ARVIN MERITOR BATCO BROCKWAY SCHOOL BUS BUILT RITE BUS & TRUCK CO. CHEVROLET TRUCK (Also See GMC Truck) CONTINENTAL TRAILWAYS-EAGLE INT'L EAGLE MOTOR COACH FLXIBLE BUS FORD FRUEHAUF GMC TRUCK HENDRICKSON TRUCK SUSPENSION SYSTEMS MACK MAECO MC NEILUS TRUCK & MAN. MOHAWK PAI CORP	401754(4)	85311	A ARVIN MERITOR BATCO FLXIBLE BUS INTERNATIONAL (NAVISTAR) KENWORTH LEYLAND TRUCK MACK PETERBILT VOLVO	141247(1)
85124	W DAMON MOTOR COACH FLEETWOOD RV HOLIDAY RAMBLER ITASCA MONACO NATIONAL RV INC. WINNEBAGO WORKHORSE	145054(2)	85312	W ARVIN MERITOR BATCO CHEVROLET TRUCK (Also See GMC Truck) FREIGHTLINER FRUEHAUF GMC TRUCK GRANNING SUSPENSION HOBBS TRAILERS INTERNATIONAL (NAVISTAR) MAECO MUNCIE RECLAMATION OSHKOSH MOTORS OSTERLUND TRUCK OTTAWA TRUCK PIERCE MANUFACTURING INC. REYCO SUSPENSION SAF HOLLAND SEAGRAVE FIRE APPARATUS LLC TUTHILL TECHNOLOGIES VOLVO WABASH NATIONAL WATSON & CHALIN MFG. INC. WESTERN UNIT "STABILAIRE" SUSPENSION	401754(4)	85314	W ARVIN MERITOR AUTOCAR CHALMERS SUSPENSION EAGLE MOTOR COACH FORD KENWORTH MAECO PETERBILT STERLING TRUCK VOLVO	401754(4)
85125	W DAMON MOTOR COACH FLEETWOOD RV HOLIDAY RAMBLER ITASCA MONACO NATIONAL RV INC. WINNEBAGO WORKHORSE	Not Req'd.	85301	W BATCO BECK BUS CHEVROLET TRUCK (Also See GMC Truck) CLARK EQUIPMENT FLXIBLE BUS FORD FREIGHTLINER GMC TRUCK HENDRICKSON TRAILER SUSPENSION SYSTEMS SAF HOLLAND	401754(4)	85315	W CLARK EQUIPMENT CUNHA PRODUCTS OHD FORD JIFFFLOX KWK-LOC (JIFFFLOX) VOLVO WESTERN STAR	401754(4)
85126	W DAMON MOTOR COACH FLEETWOOD RV HOLIDAY RAMBLER ITASCA MONACO NATIONAL RV INC. WINNEBAGO WORKHORSE	145054(1)	85316	C INTERNATIONAL (NAVISTAR) MACK	145090(1)			
85180	W FORD GLAVAL BUS CO. STARCRAFT BUS CO.	Not Req'd.						
85181	W FORD GLAVAL BUS CO. STARCRAFT BUS CO.	Not Req'd.						
85182	W KENWORTH PETERBILT	145089-200(2)						



# NUMERICAL LISTING LISTA NUMÉRICA LISTE NUMÉRIQUE

GABRIEL#	APPLICATION	MTG ACC PKG NO	GABRIEL#	APPLICATION	MTG ACC PKG NO	GABRIEL#	APPLICATION	MTG ACC PKG NO
85316	C MAECO OSHKOSH MOTORS PIERCE MANUFACTURING INC. VOLVO	145090(1)	85340	W MOTOR COACH INDUSTRIES	145089-000(1)	85702	W VOLVO	401754(4)
85318	W ARVIN MERITOR GILLIG BROS. HAUSMAN VOLVO	145054(2)	85341	W MOTOR COACH INDUSTRIES	145089-000(1)	85703	X FLXIBLE BUS GRUMMAN BUS MOHAWK MUNCIE RECLAMATION VOLVO	141247(1) & 401754(2)
85319	C FREIGHTLINER INTERNATIONAL (NAVISTAR) KENWORTH MACK PETERBILT VOLVO	145089-000(1)	85343	W KENWORTH PETERBILT	145089-000(1) & 401754(2)	85704	W ARVIN MERITOR CHEVROLET TRUCK (Also See GMC Truck) FLXIBLE BUS GMC TRUCK GRUMMAN BUS MOHAWK MOTOR COACH INDUSTRIES MUNCIE RECLAMATION REYCO SUSPENSION RIDEWELL CORPORATION TUTHILL TECHNOLOGIES VOLVO	401754(4)
85320	A FREIGHTLINER KENWORTH MAECO PETERBILT VOLVO	401754(4)	85344	W HENDRICKSON TRAILER SUSPENSION SYSTEMS WATSON & CHALIN MFG. INC.	Not Req'd.	85705	W ARVIN MERITOR FLXIBLE BUS INTERNATIONAL (NAVISTAR) MUNCIE RECLAMATION NEOPLAN BUS VOLVO	145090(2)
85321	W ARVIN MERITOR FRUEHAUF HOLLAND - BINKLEY MACK SAF HOLLAND VOLVO WABASH NATIONAL WATSON & CHALIN MFG. INC.	Not Req'd.	85345	W HENDRICKSON TRAILER SUSPENSION SYSTEMS MC NEILUS TRUCK & MAN. WATSON & CHALIN MFG. INC.	Not Req'd.	85706	Z VOLVO	145090(2)
85322	W FRUEHAUF VOLVO WABASH NATIONAL	401754(2)	85347	X NEW FLYER	145090(2)	85708	W ABC BUS ARVIN MERITOR CHEVROLET TRUCK (Also See GMC Truck) FLXIBLE BUS FLYER INDUSTRIES GILLIG BROS. GMC TRUCK MAN BUS MOTOR COACH INDUSTRIES MUNCIE RECLAMATION NEW FLYER PREVOST VAN HOOL VOLVO	145090(2)
85323	A ARVIN MERITOR EAST MANUFACTURING CORP. GREAT DANE TRAILER HENDRICKSON TRAILER SUSPENSION SYSTEMS INGERSOLL AXLES KENWORTH MC NEILUS TRUCK & MAN. REYCO SUSPENSION SAF HOLLAND UTILITY TRAILER MANUFACTURING COMPANY VOLVO WABASH NATIONAL WATSON & CHALIN MFG. INC.	Not Req'd.	85351	W IC CORPORATION INTERNATIONAL (NAVISTAR)	145090(1)	85709	W ABC BUS MAN BUS MOTOR COACH INDUSTRIES MUNCIE RECLAMATION VOLVO	145090(2)
85329	W ARVIN MERITOR BLUEBIRD SCHOOL BUS PREVOST	401754(4)	85376	W FORD STERLING TRUCK	401754(4)	85711	W ARVIN MERITOR CHEVROLET TRUCK (Also See GMC Truck) FLXIBLE BUS FLYER INDUSTRIES GMC TRUCK MAECO MOTOR COACH INDUSTRIES NEW FLYER ORION BUS INDUSTRIES TRANSPORTATION MFG. CORP VOLVO	145054(1) & 401754(2)
85331	C FREIGHTLINER FREIGHTLINER CUSTOM CHASSIS WESTERN STAR	Not Req'd.	85377	W NOVA BUS	Not Req'd.	85712	D ARVIN MERITOR BLUEBIRD SCHOOL BUS CARPENTER BUS CRANE CARRIER DIAMOND-REO FLUIDRIVE FLXIBLE BUS FORD GILLIG BROS. GRANNING SUSPENSION HENDRICKSON TRAILER SUSPENSION SYSTEMS MERITOR ORION BUS INDUSTRIES OSTERLUND TRUCK RAYDAN MANUFACTURING RIDEWELL CORPORATION SPARTAN MOTORS THOMAS SCHOOL BUS TUTHILL TECHNOLOGIES VOLVO	401754(4)
85332	W IC CORPORATION INTERNATIONAL (NAVISTAR)	145128(1)	85379	Z PREVOST	145054(1)	85713	W CARPENTER BUS CRANE CARRIER EAGLE MOTOR COACH MOTOR COACH INDUSTRIES MUNCIE RECLAMATION NOVA BUS PREVOST	401754(4)
85333	W INTERNATIONAL (NAVISTAR)	145128(1)	85382	W HENDRICKSON TRAILER SUSPENSION SYSTEMS WATSON & CHALIN MFG. INC.	Not Req'd.			
85334	W ADVANCE MIXER MAECO MC NEILUS TRUCK & MAN. REYCO SUSPENSION	401754(4)	85637	W INTERNATIONAL (NAVISTAR)	Not Req'd.			
85335	W FREIGHTLINER	Not Req'd.	85638	W HENDRICKSON TRUCK SUSPENSION SYSTEMS	Not Req'd.			
85336	X CHEVROLET TRUCK (Also See GMC Truck) GMC TRUCK ISUZU PETERBILT	145054(2)	85639	W INTERNATIONAL (NAVISTAR)	Not Req'd.			
85337	W HENDRICKSON TRAILER SUSPENSION SYSTEMS	Not Req'd.	85642	N INTERNATIONAL (NAVISTAR)	Not Req'd.			
85338	D HENDRICKSON TRAILER SUSPENSION SYSTEMS UTILITY TRAILER MANUFACTURING COMPANY	Not Req'd.	85648	N INTERNATIONAL (NAVISTAR)	Not Req'd.			
85339	W MAECO MOTOR COACH INDUSTRIES PREVOST TRANSPORTATION MFG. CORP VOLVO	401754(4)	85649	N RAM STERLING TRUCK	143146(1)			
			85650	N RAM	Not Req'd.			
			85700	W ABC BUS AM GENERAL ARVIN MERITOR CHEVROLET TRUCK (Also See GMC Truck) FLXIBLE BUS FLYER INDUSTRIES GMC TRUCK GREYHOUND BUS GRUMMAN BUS JAY MADSEN KENWORTH MOHAWK MOTOR COACH INDUSTRIES MUNCIE RECLAMATION NOVA BUS ORION BUS INDUSTRIES PREVOST SICARD TRANSPORTATION MFG. CORP VOLVO	401754(4)			
			85702	W ACF BRILL BUS ARVIN MERITOR CHEVROLET TRUCK (Also See GMC Truck) FLXIBLE BUS GMC TRUCK HAUSMAN MACK MOHAWK MOTOR COACH INDUSTRIES MUNCIE RECLAMATION NOVA BUS PREVOST REYCO SUSPENSION RIDEWELL CORPORATION TRANSPORTATION MFG. CORP TUTHILL TECHNOLOGIES	401754(4)			

N = New, X = Discontinued once inventory is gone, Z = Discontinued

# NUMERICAL LISTING LISTA NUMÉRICA LISTE NUMÉRIQUE

GABRIEL#	APPLICATION	MTG ACC PKG NO	GABRIEL#	APPLICATION	MTG ACC PKG NO	GABRIEL#	APPLICATION	MTG ACC PKG NO
85713	W THOMAS SCHOOL BUS TRANSPORTATION MFG. CORP	401754(4)	85735	W GMC TRUCK GREYHOUND BUS MOTOR COACH INDUSTRIES PACIFIC TRUCK & TRAILER PREVOST TRANSPORTATION MFG. CORP VOLVO WESTERN UNIT "STABILAIRE" SUSPENSION	401754(4)	85909	C KENWORTH MACK MC NEILUS TRUCK & MAN. NEWMAR CORP PETERBILT ROADMASTER (MONACO) SAF HOLLAND	Not Req'd.
85716	W CRANE CARRIER FLXIBLE BUS FORD GILLIG BROS. MAECO NEW FLYER ORION BUS INDUSTRIES	145093(1)	85736	W ACF BRILL BUS ARVIN MERITOR BATCO BLUEBIRD SCHOOL BUS FLXIBLE BUS MOHAWK PREVOST RIDEWELL CORPORATION THOMAS SCHOOL BUS VOLVO	401754(4)	85910	W BLUEBIRD SCHOOL BUS FREIGHTLINER KENWORTH PETERBILT ROADMASTER (MONACO) SAF HOLLAND	Not Req'd.
85720	W NEW FLYER ORION BUS INDUSTRIES OTTAWA TRUCK	401754(4)	85737	W MERITOR SUSPENSYS	Not Req'd.	85911	W HENDRICKSON TRAILER SUSPENSION SYSTEMS SAF HOLLAND UTILITY TRAILER MANUFACTURING COMPANY	Not Req'd.
85722	D ARVIN MERITOR FLYER INDUSTRIES GILLIG BROS. GMC TRUCK MAN BUS MUNCIE RECLAMATION NEW FLYER VOLVO	145090(2)	85738	B EAST MANUFACTURING CORP. HENDRICKSON TRAILER SUSPENSION SYSTEMS MC NEILUS TRUCK & MAN. REYCO SUSPENSION TUTHILL TECHNOLOGIES UTILITY TRAILER MANUFACTURING COMPANY	Not Req'd.	85916	W HENDRICKSON TRAILER SUSPENSION SYSTEMS HENDRICKSON TRUCK SUSPENSION SYSTEMS MC NEILUS TRUCK & MAN. SAF HOLLAND VOLVO	Not Req'd.
85723	W GILLIG BROS. MOTOR COACH INDUSTRIES MUNCIE RECLAMATION VOLVO	145075(1)	85739	W INTERNATIONAL (NAVISTAR) MACK MERITOR RAYDAN MANUFACTURING	Not Req'd.	85918	A DYNAMAX CORP (COUNTRY COACH) FREIGHTLINER FREIGHTLINER CUSTOM CHASSIS STERLING TRUCK THOMAS SCHOOL BUS VOLVO WESTERN STAR	Not Req'd.
85724	A DYNAMAX CORP (COUNTRY COACH) FEDERAL COACH FREIGHTLINER FREIGHTLINER CUSTOM CHASSIS RENEGADE RV STERLING TRUCK THOMAS SCHOOL BUS VOLVO WESTERN STAR	Not Req'd.	85740	W KENWORTH MAECO MOTOR COACH INDUSTRIES PREVOST	145090(1) & 401754(2)	85919	B BLUEBIRD SCHOOL BUS FREIGHTLINER FREIGHTLINER CUSTOM CHASSIS GREAT DANE TRAILER HENDRICKSON TRUCK SUSPENSION SYSTEMS MC NEILUS TRUCK & MAN. MERITOR WABASH NATIONAL WORKHORSE	Not Req'd.
85727	D ABC BUS MOTOR COACH INDUSTRIES	145176(2)	85745	W ELDORADO NATIONAL	145090(2)	85920	C FEDERAL COACH FREIGHTLINER STERLING TRUCK	Not Req'd.
85728	D MOTOR COACH INDUSTRIES PREVOST	145176(2)	85746	W ELDORADO NATIONAL	145090(2)	85921	W FREIGHTLINER	145054(1)
85729	C ABC BUS MOTOR COACH INDUSTRIES ORION BUS INDUSTRIES PREVOST UNIVERSAL COACH	145176(1) & 401754(2)	85900	B COACHMEN RV FLEETWOOD RV FOREST RIVER INC FREIGHTLINER CUSTOM CHASSIS GULF STREAM COACH ITASCA KENWORTH KING OF THE ROAD MANDALAY COACH NEWMAR CORP PETERBILT THOR MOTOR COACH VOLVO WINNEBAGO	145054(2)	85922	D INTERNATIONAL (NAVISTAR)	Not Req'd.
85732	W ABC BUS ARVIN MERITOR FLXIBLE BUS MOHAWK NEW FLYER ORION BUS INDUSTRIES	145116(2)	85901	C FREIGHTLINER KENWORTH PETERBILT RIDEWELL CORPORATION	401754(4)	85924	B INTERNATIONAL (NAVISTAR)	Not Req'd.
85733	W ABC BUS ARVIN MERITOR CHEVROLET TRUCK (Also See GMC Truck) EAGLE MOTOR COACH FLXIBLE BUS GMC TRUCK MOHAWK MOTOR COACH INDUSTRIES NOVA BUS TRANSPORTATION MFG. CORP VOLVO	145089-000(1)	85902	D KENWORTH PETERBILT	145054(2)	85925	W INTERNATIONAL (NAVISTAR)	Not Req'd.
85734	W BATCO BLUEBIRD SCHOOL BUS CHEVROLET TRUCK (Also See GMC Truck) CROWN COACH FLXIBLE BUS GILLIG BROS. GMC TRUCK INTERNATIONAL (NAVISTAR) LINK MANUFACTURING LTD. OSHKOSH MOTORS RIDEWELL CORPORATION SAF HOLLAND VOLVO	401754(4)	85904	X FREIGHTLINER HENDRICKSON TRUCK SUSPENSION SYSTEMS LINK MANUFACTURING LTD. STERLING TRUCK	Not Req'd.	85926	D FORD GLAVAL BUS CO. IC CORPORATION INTERNATIONAL (NAVISTAR) STARCRAFT BUS CO. STERLING TRUCK	Not Req'd.
85735	W ABC BUS BATCO CHEVROLET TRUCK (Also See GMC Truck) EAGLE MOTOR COACH	401754(4)	85906	W FORD KENWORTH MACK MC NEILUS TRUCK & MAN. PETERBILT SAF HOLLAND STERLING TRUCK VOLVO WESTERN STAR	Not Req'd.	85927	W FORD INTERNATIONAL (NAVISTAR)	Not Req'd.
			85908	W SAF HOLLAND	Not Req'd.	85928	W FORD GLAVAL BUS CO. INTERNATIONAL (NAVISTAR) STARCRAFT BUS CO.	Not Req'd.
			85909	C FORD FREIGHTLINER HENDRICKSON TRUCK SUSPENSION SYSTEMS	Not Req'd.	85929	W INTERNATIONAL (NAVISTAR)	Not Req'd.

X = Discontinued once inventory is gone

**NUMERICAL LISTING  
LISTA NUMÉRICA  
LISTE NUMÉRIQUE**

GABRIEL#	APPLICATION	MTG ACC PKG NO	GABRIEL#	APPLICATION	MTG ACC PKG NO	GABRIEL#	APPLICATION	MTG ACC PKG NO
85933	C VOLVO	Not Req'd.	85972	W MACK	Not Req'd.	695406	X ABC BUS ARVIN MERITOR VAN HOOL	145090(2)
85934	A MAECO RIDEWELL CORPORATION WATSON & CHALIN MFG. INC.	Not Req'd.	85976	D AUTOCAR BLUEBIRD SCHOOL BUS FORD HENDRICKSON TRUCK SUSPENSION SYSTEMS INTERNATIONAL (NAVISTAR) MC NEILUS TRUCK & MAN. VOLVO WESTERN STAR	Not Req'd.	<b>GasSLX Applications</b>		
85935	W INTERNATIONAL (NAVISTAR)	145090(1)	85977	W HENDRICKSON TRUCK SUSPENSION SYSTEMS MC NEILUS TRUCK & MAN.	145128(1)	89402	W ARVIN MERITOR BLUEBIRD SCHOOL BUS FORD STERLING TRUCK VOLVO	140149(1)
85936	B KENWORTH PETERBILT	145089-200(1)	85978	C HENDRICKSON TRUCK SUSPENSION SYSTEMS MACK VOLVO	Not Req'd.	89405	W AUTOCAR BLUEBIRD SCHOOL BUS FORD GILLIG BROS. HENDRICKSON TRUCK SUSPENSION SYSTEMS IC CORPORATION INTERNATIONAL (NAVISTAR) KENWORTH LION BUS MACK MAECO MARMON MC NEILUS TRUCK & MAN. PETERBILT REYCO SUSPENSION SAF HOLLAND SPARTAN MOTORS TUTHILL TECHNOLOGIES VOLVO WATSON & CHALIN MFG. INC.	Not Req'd.
85937	B KENWORTH PETERBILT	145089-200(1)	85979	D HENDRICKSON TRUCK SUSPENSION SYSTEMS KENWORTH MC NEILUS TRUCK & MAN. WESTERN STAR	Not Req'd.	89406	W ALLCO TRAILER AUTOCAR CHEVROLET TRUCK (Also See GMC Truck) COACHMEN RV COUNTRY COACH DAMON MOTOR COACH ENTEGR COACH FLEETWOOD RV FORD FOREST RIVER INC FREIGHTLINER FRUEHAUF GEORGIE BOY MANUFACTURING GILLIG BROS. GMC TRUCK GREAT DANE TRAILER HENDRICKSON TRUCK SUSPENSION SYSTEMS HOLIDAY RAMBLER ISUZU ITASCA JAYCO RV INC KENWORTH LODAL, INC. MACK MAECO MARMON MC NEILUS TRUCK & MAN. MONACO NATIONAL RV INC. NEWMAR CORP NEXUS RV OSHKOSH MOTORS PETERBILT REYCO SUSPENSION SAF HOLLAND THOR MOTOR COACH TUTHILL TECHNOLOGIES VOLVO WESTERN STAR WINNEBAGO	Not Req'd.
85938	C ARVIN MERITOR HENDRICKSON TRAILER SUSPENSION SYSTEMS INGERSOLL AXLES REYCO SUSPENSION TUTHILL TECHNOLOGIES WATSON & CHALIN MFG. INC.	Not Req'd.	85985	W KENWORTH PETERBILT	145089-200(1)	89407	W ADVANCE MIXER ARVIN MERITOR BENSON TRUCK BODIES INC. BLUEBIRD SCHOOL BUS BROCKWAY SCHOOL BUS CHANCE COACH CHEVROLET TRUCK (Also See GMC Truck) COACHMEN RV DURA SUSPENSION EAST MANUFACTURING CORP. FORD FOREST RIVER INC GEORGIE BOY MANUFACTURING GILLIG BROS. GMC TRUCK GREAT DANE TRAILER HARDEE MFG HENDRICKSON TRUCK SUSPENSION SYSTEMS HIGHWAY PRODUCT	Not Req'd.
85939	D ARVIN MERITOR HENDRICKSON TRAILER SUSPENSION SYSTEMS TIMBREN INDUSTRIES UTILITY TRAILER MANUFACTURING COMPANY WATSON & CHALIN MFG. INC.	Not Req'd.	85986	W HENDRICKSON TRUCK SUSPENSION SYSTEMS IC CORPORATION INTERNATIONAL (NAVISTAR)	Not Req'd.			
85954	A INTERNATIONAL (NAVISTAR)	Not Req'd.	85988	W KENWORTH PETERBILT	145099(1)			
85955	W HENDRICKSON TRUCK SUSPENSION SYSTEMS INTERNATIONAL (NAVISTAR)	Not Req'd.	85989	C KENWORTH PETERBILT	Not Req'd.			
85956	C FREIGHTLINER STERLING TRUCK VOLVO WESTERN STAR	Not Req'd.	85994	W INTERNATIONAL (NAVISTAR)	Not Req'd.			
85957	D FORD INTERNATIONAL (NAVISTAR) STERLING TRUCK	Not Req'd.	85995	W INTERNATIONAL (NAVISTAR)	Not Req'd.			
85958	A DYNAMAX CORP (COUNTRY COACH) FREIGHTLINER RENEGADE RV WESTERN STAR	Not Req'd.	85998	W INTERNATIONAL (NAVISTAR)	Not Req'd.			
85959	B BLUEBIRD SCHOOL BUS DYNAMAX CORP (COUNTRY COACH) FEDERAL COACH FREIGHTLINER FREIGHTLINER CUSTOM CHASSIS HENDRICKSON TRUCK SUSPENSION SYSTEMS KENWORTH LION BUS MC NEILUS TRUCK & MAN. PETERBILT RENEGADE RV SPARTAN MOTORS STERLING TRUCK TIFFIN MOTORHOMES INC	Not Req'd.	85999	W INTERNATIONAL (NAVISTAR)	Not Req'd.			
85961	W HENDRICKSON TRUCK SUSPENSION SYSTEMS	Not Req'd.	86200	D MERITOR	Not Req'd.			
85962	W HENDRICKSON TRUCK SUSPENSION SYSTEMS MC NEILUS TRUCK & MAN.	Not Req'd.	87015	W ARVIN MERITOR EAST MANUFACTURING CORP. MERITOR	Not Req'd.			
85963	W INTERNATIONAL (NAVISTAR)	Not Req'd.	87017	Z BLUEBIRD SCHOOL BUS OPTIMA BUS CORP RIDEWELL CORPORATION	Not Req'd.			
85964	W INTERNATIONAL (NAVISTAR)	Not Req'd.	87018	W ARVIN MERITOR HENDRICKSON TRAILER SUSPENSION SYSTEMS	Not Req'd.			
85965	W AUTOCAR HENDRICKSON TRUCK SUSPENSION SYSTEMS INTERNATIONAL (NAVISTAR) KENWORTH MC NEILUS TRUCK & MAN.	Not Req'd.	89402	W VOLVO	140149(1)			
85967	W AUTOCAR HENDRICKSON TRUCK SUSPENSION SYSTEMS KENWORTH MC NEILUS TRUCK & MAN.	Not Req'd.	89414	W MAECO	Not Req'd.			
85970	W MOTOR COACH INDUSTRIES	145089-000(1)	89440	W MAECO	Not Req'd.			
			89447	W MUNCIE RECLAMATION	141108(1)			
			632147	W CHALLENGE COOK	Not Req'd.			
			646155	B ADVANCE MIXER CHALLENGE COOK KIMBLE MIXER CO VOLVO	Not Req'd.			
			646177	A CHALLENGE COOK KENWORTH	Not Req'd.			
			665937	D CRANE CARRIER	Not Req'd.			

X = Discontinued once inventory is gone, Z = Discontinued

# NUMERICAL LISTING LISTA NUMÉRICA LISTE NUMÉRIQUE

GABRIEL#	APPLICATION	MTG ACC PKG NO	GABRIEL#	APPLICATION	MTG ACC PKG NO	GABRIEL#	APPLICATION	MTG ACC PKG NO
89407	W	Not Req'd.	89414	W	Not Req'd.	89422	W	401754(4)
INTERNATIONAL (NAVISTAR) ITASCA KENWORTH MACK MAECO MC NEILUS TRUCK & MAN. MOHAWK MONACO NATIONAL COACH CORP OSHKOSH MOTORS PETERBILT REYCO SUSPENSION RIDEWELL CORPORATION SAF HOLLAND STERLING TRUCK TRAILMOBILE CANADA CORP. TUTHILL TECHNOLOGIES TWIN COACH VOLVO WABASH NATIONAL WESTERN STAR WINNEBAGO WORKHORSE			NEWMAR CORP NEXUS RV PETERBILT REYCO SUSPENSION SAF HOLLAND SPARTAN MOTORS STERLING TRUCK THOR MOTOR COACH TRAILMOBILE CANADA CORP. TUTHILL TECHNOLOGIES VOLVO WESTERN STAR WINNEBAGO			PETERBILT PREVOST THOMAS SCHOOL BUS TRANSPORTATION MFG. CORP VOLVO WESTERN STAR WESTERN UNIT "STABILAIRE" SUSPENSION		
89408	B	145080(2)	89415	W	140149(1)	89423	D	141108(1)
KENWORTH PETERBILT VOLVO			INTERNATIONAL (NAVISTAR) KENWORTH MACK PETERBILT VOLVO			ARVIN MERITOR INTERNATIONAL (NAVISTAR) KENWORTH MACK OTTAWA TRUCK PETERBILT VOLVO		
89409	W	140149(1)	89417	W	145054(1)	89424	B	141247(1)
ARVIN MERITOR FORD KENWORTH OSHKOSH MOTORS PETERBILT PIERCE MANUFACTURING INC. VOLVO			ARVIN MERITOR AUTOCAR INTERNATIONAL (NAVISTAR) VOLVO			ARVIN MERITOR FLXIBLE BUS INTERNATIONAL (NAVISTAR) KENWORTH LEYLAND TRUCK MACK PETERBILT VOLVO		
89410	C	401754(4)	89418	W	145054(2)	89425	W	401754(4)
ARVIN MERITOR FORD INTERNATIONAL (NAVISTAR) KENWORTH MACK MAECO PETERBILT REYCO SUSPENSION STERLING TRUCK TUTHILL TECHNOLOGIES VOLVO			ARVIN MERITOR AUTOCAR INTERNATIONAL (NAVISTAR) VOLVO			ARVIN MERITOR AUTOCAR CHALMERS SUSPENSION EAGLE MOTOR COACH FORD KENWORTH MAECO PETERBILT STERLING TRUCK VOLVO		
89411	W	Not Req'd.	89419	W	401754(4)	89426	W	145090(1)
ARVIN MERITOR IC CORPORATION INTERNATIONAL (NAVISTAR) KENWORTH MARMON PETERBILT VOLVO			CHEVROLET TRUCK (Also See GMC Truck) FREIGHTLINER FRUEHAUF GMC TRUCK GRANNING SUSPENSION HOBBS TRAILERS INTERNATIONAL (NAVISTAR) MAECO MUNCIE RECLAMATION OSHKOSH MOTORS OSTERLUND TRUCK OTTAWA TRUCK PIERCE MANUFACTURING INC. REYCO SUSPENSION SAF HOLLAND SEAGRAVE FIRE APPARATUS LLC TUTHILL TECHNOLOGIES VOLVO WABASH NATIONAL WATSON & CHALIN MFG. INC. WESTERN UNIT "STABILAIRE" SUSPENSION			INTERNATIONAL (NAVISTAR) MACK MAECO OSHKOSH MOTORS PIERCE MANUFACTURING INC. VOLVO		
89413	D	145080(2)	89420	W	401754(4)	89427	C	145099(1)
ARVIN MERITOR BLUEBIRD SCHOOL BUS BROCKWAY SCHOOL BUS CHANCE COACH CHEVROLET TRUCK (Also See GMC Truck) FORD GMC TRUCK INTERNATIONAL (NAVISTAR) ISUZU KENWORTH PETERBILT VOLVO			AM GENERAL ARVIN MERITOR CHEVROLET TRUCK (Also See GMC Truck) CRANE CARRIER FORD FREIGHTLINER FWD TRUCK GILLIG BROS. GMC TRUCK KENWORTH MACK MAECO MOTOR COACH INDUSTRIES PETERBILT RIDEWELL CORPORATION VOLVO			INTERNATIONAL (NAVISTAR) KENWORTH MACK PACCAR PETERBILT VOLVO		
89414	W	Not Req'd.	89422	W	401754(4)	89428	W	145089-000(1)
ADVANCE MIXER ARVIN MERITOR BLUEBIRD SCHOOL BUS CHEVROLET TRUCK (Also See GMC Truck) COACHMEN RV COUNTRY COACH DAMON MOTOR COACH ENTEGR COACH FLEETWOOD RV FORD FOREST RIVER INC GEORGIE BOY MANUFACTURING GMC TRUCK HENDRICKSON TRAILER SUSPENSION SYSTEMS HENDRICKSON TRUCK SUSPENSION SYSTEMS HOLIDAY RAMBLER INTERNATIONAL (NAVISTAR) ITASCA JAYCO RV INC KENWORTH MACK MAECO MC NEILUS TRUCK & MAN. MONACO NATIONAL RV INC.			ACF BRILL BUS ARVIN MERITOR BROCKWAY SCHOOL BUS BUILT RITE BUS & TRUCK CO. CHEVROLET TRUCK (Also See GMC Truck) CONTINENTAL TRAILWAYS-EAGLE INT'L CRANE CARRIER CROWN COACH EAGLE MOTOR COACH FREIGHTLINER GMC TRUCK GREYHOUND BUS HENDRICKSON TRUCK SUSPENSION SYSTEMS INTERNATIONAL (NAVISTAR) KENWORTH MACK MAECO MATSON SCHOOL BUS MC NEILUS TRUCK & MAN. MOHAWK MOTOR COACH INDUSTRIES ORION BUS INDUSTRIES OSHKOSH MOTORS OTTAWA TRUCK			FREIGHTLINER INTERNATIONAL (NAVISTAR) KENWORTH MACK PETERBILT VOLVO		
						89429	D	401754(4)
						FREIGHTLINER KENWORTH MAECO PETERBILT VOLVO		
						89430	D	Not Req'd.
						ARVIN MERITOR AUTOCAR BLUEBIRD SCHOOL BUS BOYDSTUN EQUIPMENT MANUFACTURING CHEVROLET TRUCK (Also See GMC Truck) CUSH CORPORATION EAST MANUFACTURING CORP. FREIGHTLINER FREIGHTLINER CUSTOM CHASSIS GMC TRUCK HENDRICKSON TRAILER SUSPENSION SYSTEMS HENDRICKSON TRUCK SUSPENSION SYSTEMS HINO INTERNATIONAL (NAVISTAR) MACK MAECO MC NEILUS TRUCK & MAN. OSHKOSH MOTORS REYCO SUSPENSION RIDEWELL CORPORATION SAF HOLLAND TUTHILL TECHNOLOGIES VOLVO WABASH NATIONAL WATSON & CHALIN MFG. INC.		
						89431	W	Not Req'd.
						BLUEBIRD SCHOOL BUS FREIGHTLINER		

**NUMERICAL LISTING  
LISTA NUMÉRICA  
LISTE NUMÉRIQUE**

GABRIEL#	APPLICATION	MTG ACC PKG NO	GABRIEL#	APPLICATION	MTG ACC PKG NO	GABRIEL#	APPLICATION	MTG ACC PKG NO
89431	W FREIGHTLINER CUSTOM CHASSIS INTERNATIONAL (NAVISTAR) OSHKOSH MOTORS PIERCE MANUFACTURING INC. THOMAS SCHOOL BUS VOLVO	Not Req'd.	89443	B FREIGHTLINER FREIGHTLINER CUSTOM CHASSIS RENEGADE RV STERLING TRUCK THOMAS SCHOOL BUS VOLVO WESTERN STAR	Not Req'd.			
89432	W KENWORTH MAECO	Not Req'd.	89447	W BLUEBIRD SCHOOL BUS FLXIBLE BUS IC CORPORATION INTERNATIONAL (NAVISTAR) MITSUBISHI-FUSO MUNCIE RECLAMATION NEOPLAN BUS VOLVO	141108(1)			
89434	W AUTOCAR VOLVO	140149(1)	89448	D MACK POWERHOUSE COACH INC. RENEGADE RV VOLVO	Not Req'd.			
89435	W FORD KENWORTH PETERBILT STERLING TRUCK VOLVO	140149(1)	89449	C DYNAMAX CORP (COUNTRY COACH) FREIGHTLINER FREIGHTLINER CUSTOM CHASSIS STERLING TRUCK THOMAS SCHOOL BUS VOLVO WESTERN STAR	Not Req'd.			
89436	B ARVIN MERITOR BENSON TRUCK BODIES INC. CHANCE COACH CHEVROLET TRUCK (Also See GMC Truck) CUSH CORPORATION DURA SUSPENSION EAST MANUFACTURING CORP. FREIGHTLINER FRUEHAUF GMC TRUCK GREAT DANE TRAILER HENDRICKSON TRAILER SUSPENSION SYSTEMS HIGHWAY PRODUCT HUTCHENS SUSPENSION INGERSOLL AXLES KENWORTH MACK MAECO MC NEILUS TRUCK & MAN. MOHAWK ORION BUS INDUSTRIES PAGE SUSPENSION PETERBILT REYCO SUSPENSION RIDEWELL CORPORATION SAF HOLLAND STOUGHTON TRAILERS INC. THOMAS SCHOOL BUS TRAILMOBILE CANADA CORP. TUTHILL TECHNOLOGIES TWIN COACH UTILITY TRAILER MANUFACTURING COMPANY VOLVO WABASH NATIONAL WATSON & CHALIN MFG. INC.	Not Req'd.	89450	W MACK POWERHOUSE COACH INC. RENEGADE RV VOLVO	Not Req'd.			
89437	W EAST MANUFACTURING CORP. HENDRICKSON TRAILER SUSPENSION SYSTEMS THOMAS SCHOOL BUS	Not Req'd.	89451	C KENWORTH PETERBILT VOLVO	Not Req'd.			
89439	W FORD STERLING TRUCK	145080(2)	89453	W FREIGHTLINER HENDRICKSON TRUCK SUSPENSION SYSTEMS MC NEILUS TRUCK & MAN. STERLING TRUCK WESTERN STAR	Not Req'd.			
89440	W ARVIN MERITOR BLUEBIRD SCHOOL BUS CHEVROLET TRUCK (Also See GMC Truck) EAST MANUFACTURING CORP. FORD FRUEHAUF GMC TRUCK HENDRICKSON TRAILER SUSPENSION SYSTEMS HENDRICKSON TRUCK SUSPENSION SYSTEMS INTERNATIONAL (NAVISTAR) KENWORTH MAECO OSHKOSH MOTORS PACIFIC TRUCK & TRAILER PETERBILT PIERCE MANUFACTURING INC. REYCO SUSPENSION SAF HOLLAND STERLING TRUCK THOMAS SCHOOL BUS TUTHILL TECHNOLOGIES VOLVO WABASH NATIONAL WESTERN STAR	Not Req'd.	89454	W HENDRICKSON TRUCK SUSPENSION SYSTEMS MACK MC NEILUS TRUCK & MAN. POWERHOUSE COACH INC. VOLVO	Not Req'd.			
89442	W WESTERN STAR	145126(2)	89455	B ARVIN MERITOR KENWORTH PETERBILT VOLVO	141108(1)			
89443	B DYNAMAX CORP (COUNTRY COACH) FEDERAL COACH	Not Req'd.	89456	D KENWORTH PETERBILT	145089-200(1)			
			89457	W INTERNATIONAL (NAVISTAR)	Not Req'd.			
			89458	D INTERNATIONAL (NAVISTAR)	Not Req'd.			
			89459	C KENWORTH PETERBILT VOLVO	401754(2)			
			89460	W KENWORTH PETERBILT	Not Req'd.			
			89461	W GILLIG BROS.	Not Req'd.			
			89502	N MACK POWERHOUSE COACH INC. RENEGADE RV VOLVO	Not Req'd.			
			89503	N DYNAMAX CORP (COUNTRY COACH) FEDERAL COACH FREIGHTLINER RENEGADE RV STERLING TRUCK	Not Req'd.			

N = New





Fleetline®



GasSLX® Interchange

Intercambio  
Échange

Fleetline	GasSLX
83122	89406
83123	89405
83124	89407
83126	89430
83128	89436
83203	89436
83207	89407
83209	89414
83309	89446
83312	89409
83389	89436
83456	89447
85000	89436
85001	89410
85003	89411
85005	89430
85007	89412
85012	89413
85013	89414
85023	89415
85024	89416
85026	89417
85027	89418
85030	89440
85033	89427
85036	89405
85046	89434
85047	89435
85053	89442
85054	89438
85055	89439
85058	89431

Fleetline	GasSLX
85061	89450
85062	89408
85066	89448
85067	89451
85069	89455
85070	89459
85084	89460
85300	89419
85302	89420
85303	89422
85308	89422
85310	89423
85311	89424
85314	89425
85316	89426
85319	89428
85320	89429
85323	89436
85705	89447
85724	89443
85906	89407
85916	89430
85918	89449
85920	89503
85923	89458
85924	89457
85931	89458
85932	89453
85933	89454
85936	89456



**IMPORTANT NOTE:** Interchange must only be used for FLEETLINE to GAS SLX upgrade. Interchange is **NOT REVERSABLE**.

**NOTA IMPORTANTE:** El intercambio se debe utilizar solamente de FLEETLINE a GAS SLX mejorado. El intercambio **NO ES REVERSIBLE**.

**REMARQUE IMPORTANTE:** L'échange ne peut se faire que pour le surclassement du FLEETLINE au GAS SLX. L'échange **N'EST PAS REVERSIBLE**.

**Gabriel HD**  
THE ORIGINAL

# COMPETITIVE & O.E.M. INTERCHANGE LIST

## Lista de Intercambios contra Competidores y Equipo Original.

### Liste d'interchange de produits compétitifs & d'équipement original (OEM)

#### ABC BUS

O.E.M #	Gabriel	Upgrade	O.E.M #	Gabriel	Upgrade	O.E.M #	Gabriel	Upgrade	O.E.M #	Gabriel	Upgrade
050134513	85732		12L-5-114	85727		6243-13790	85708		90-2291	695406	
10685703	695406		12L-5-72	85709		6243-14040	85708				
12B-5-1	85735		12L-5-88	85729		624314570	695406				
12J-5-10	85733		3166657	85700		680323	85700				

#### AC DELCO

Ac delco	Gabriel	Upgrade	Ac delco	Gabriel	Upgrade	Ac delco	Gabriel	Upgrade	Ac delco	Gabriel	Upgrade
501-13	83318		508-13	85012	89413	508-35	G63371		508-70	G63416	
501-74	83304		508-14	83216		508-39	G63347		508-71	83314	
501-75	83303		508-14	85012	89413	508-42	G63353		508-71	G63398	
507-1	85304		508-15	83216		508-42	G63389		508-72	G63386	
507-10	85711		508-16	83308	89435	508-47	G63350		508-74	G63511	
507-11	85308	89422	508-17	83312	89409	508-47	G63377		508-78	83400	
507-13	85704		508-18	83309	89446	508-48	G63409		508-79	G63424	
507-15	85703		508-19	83314		508-48	G63427		508-80	G63425	
507-16	85702		508-20	83207	89407	508-5	G63359		508-82	G63410	
507-17	85304		508-21	83214		508-5	G63360		508-86	83136	
507-18	85305		508-22	83217		508-50	G63299		508-87	85071	
507-19	85700		508-23	83217		508-50	G63907		508-88	83153	
507-2	85302	89420	508-23	83225		508-52	G63405		508-9	85000	89436
507-24	85336		508-24	83215		508-52	G63419		508-90	83136	
507-3	85307		508-26	83203	89436	508-52	G63492		550-13	85005	89430
507-4	85303	89422	508-26	85030	89440	508-56	G63605		550-73	83303	
507-5	85308	89422	508-28	83207	89407	508-57	83123	89405	550-73	85005	89430
507-6	85314	89425	508-29	85030	89440	508-59	G63183		550-74	83304	
507-7	85301		508-3	83400		508-68	83209	89414	550-75	83303	
507-8	85301		508-30	85005	89430	508-68	85006		550-77	83221	
507-9	85700		508-35	G63306		508-70	G63396				

#### ACF BRILL BUS

O.E.M #	Gabriel	Upgrade	O.E.M #	Gabriel	Upgrade	O.E.M #	Gabriel	Upgrade	O.E.M #	Gabriel	Upgrade
610513	85307		641521	85308	89422	659129	85303	89422	661733	83225	
631237	85308	89422	649648	85308	89422	661732	83215		995891	85307	

#### ADVANCE MIXER

O.E.M #	Gabriel	Upgrade	O.E.M #	Gabriel	Upgrade	O.E.M #	Gabriel	Upgrade	O.E.M #	Gabriel	Upgrade
12111 ADV	646155		13883	85334		14626 ADV	83209	89414	680087	85334	
13424 ADV	83207	89407	13883 ADV	85334		23458 ADV	83112		85334	85334	

#### ALLCO TRAILER

O.E.M #	Gabriel	Upgrade	O.E.M #	Gabriel	Upgrade	O.E.M #	Gabriel	Upgrade	O.E.M #	Gabriel	Upgrade
727602	83122	89406									

#### AM GENERAL

O.E.M #	Gabriel	Upgrade	O.E.M #	Gabriel	Upgrade	O.E.M #	Gabriel	Upgrade	O.E.M #	Gabriel	Upgrade
3166657	85700		5957136	85700		5979484	85302	89420			
4975501	85700		5969438	85700		5979574	85700				
5565748	85700		5978712	85700		5982537	85700				

#### ARALMEX

Aralmex	Gabriel	Upgrade	Aralmex	Gabriel	Upgrade	Aralmex	Gabriel	Upgrade	Aralmex	Gabriel	Upgrade
2AMG037	G63375		3AMG007	G63357		3AMG023	G63421		3AMG031	G63360	
3AMG001	G63355		3AMG008	G63500		3AMG026	G63455		3AMG032	G63502	
3AMG004	G63306		3AMG009	G63406		3AMG027	G63426		3AMG033	G63614	
3AMG005	G63359		3AMG021	G63409		3AMG029	G63488		3AMG034	G63608	
3AMG006	G63377		3AMG022	G63454		3AMG030	G63818		3AMG035	G63607	

#### ARVIN MERITOR

O.E.M #	Gabriel	Upgrade	O.E.M #	Gabriel	Upgrade	O.E.M #	Gabriel	Upgrade	O.E.M #	Gabriel	Upgrade
085009	85009		665044	83209	89414	665804	85939		680102	85712	
085014	85014		665724	85000	89436	671091	85069	89455			
085321	85321		665746	85000	89436	671092	85012	89413			
654907	85000	89436	665760	85045		671507	87015				
654958	83164		665769	85052		671707	85323	89436			

**Important Note:** Competitive Interchanges are to be used for stocking purposes only. Where multiple crosses are identified, please reference the applications section of this catalog. / **Remarque importante:** Les interchanges concurrentiels ne s'utilisent qu'aux fins de stocks. Dans le cas de références multiples, consulter la section des applications du catalogue. / **Nota importante:** Dans le cas de références multiples, consulter la section des applications du catalogue. / **Nota importante:** Se pueden usar intercambios competitivos para propósitos de almacenamiento solamente. Cuando se identifican intercambios múltiples, consulte la sección de aplicaciones de este catálogo.



# COMPETITIVE & O.E.M. INTERCHANGE LIST

## Lista de Intercambios contra Competidores y Equipo Original.

### Liste d'interchange de produits compétitifs & d'équipement original (OEM)

#### ARVIN MERITOR... cont'd

O.E.M #	Gabriel	Upgrade	O.E.M #	Gabriel	Upgrade	O.E.M #	Gabriel	Upgrade	O.E.M #	Gabriel	Upgrade
680322	85704		727614	83214		728601	85001	89410	728622	85010	
680331	85702		727615	83215		728603	85003	89411	728624	85012	89413
680337	85708		727616	83216		728604	85300		728625	85013	89414
680347	85732		727619	83219		728606	85302	89420	728626	85733	
680464	85005	89430	727625	83225		728608	85304		728628	85314	89425
680518	85700		727628	83301		728609	85305		728631	85029	
680584	85938		727630	83303		728611	85307		728632	85030	89440
680671	85708		727631	83304		728612	85308	89422	728635	85318	
695180	85705		727635	83308		728614	85310	89423	728639	85026	89417
695214	85722		727636	83309		728615	85311	89424	728640	85027	89418
695348	87018		727639	83312	89409	728616	85004		728800	85711	
695406	695406		727641	83314		728617	85005	89430	728806	85736	
727600		89402	727645	83318		728618	85006		728812	85705	
727607	83207	89407	727671	83613		728619	85007		7805-N-1002	85329	
727609	83209	89414	727672	83242		728621	85009		7805-S-1007	85329	

#### AUTOCAR

O.E.M #	Gabriel	Upgrade	O.E.M #	Gabriel	Upgrade	O.E.M #	Gabriel	Upgrade	O.E.M #	Gabriel	Upgrade
03-1106460	85005	89430	3946210	83103		60675-003	85976		660186	83216	
1011839	83216		60657-003	85072		60675-003L	85976		800670	85060	
28CFG-910	83216		60657-003L	85072		60680-003	83112		800781	85314	89425
28CFG-910Z	83216		60665-011	85967		60680-003L	83112		8026658	85046	89434
28R010	83216		60665-013	85965		60680-004	83143		8071524	85024	
35901-3201	85024		60665-025	85036	89405	60680-004L	83143		849246	83216	
37301-3201	85027	89418	60665-025L	85036	89405	60680-005	83142		A3730008-001	85086	
37301-3202	85026	89417	60670-005	83137		60680-005L	83142				

#### BATCO

O.E.M #	Gabriel	Upgrade	Batco	Gabriel	Upgrade	O.E.M #	Gabriel	Upgrade	O.E.M #	Gabriel	Upgrade
1083203	83203	89436	1083225	83225		1085007	85007		1085311	85311	
1083203	83203		1083310	83221		1085007	85007		1087001	85734	
1083204	83204		1083310	83221		1085300	85300	89419	1087001	85734	
1083204	83204		1083317	83317		1085300	85300		1087004	85735	
1083207	83207	89407	1083317	83317		1085301	85301		1087004	85735	
1083207	83207		1085003	85003	89411	1085305	85305		1087006	85736	
1083209	83209	89414	1085003	85003		1085305	85305		1087006	85736	
1083209	83209		1085005	85005	89430	1085308	85308				
1083225	83225		1085005	85005		1085311	85311	89424			

#### BECK BUS

O.E.M #	Gabriel	Upgrade	O.E.M #	Gabriel	Upgrade	O.E.M #	Gabriel	Upgrade	O.E.M #	Gabriel	Upgrade
14QK-140	85304		14QK-2102	85304							

#### BENSON TRUCK BODIES INC.

O.E.M #	Gabriel	Upgrade	O.E.M #	Gabriel	Upgrade	O.E.M #	Gabriel	Upgrade	O.E.M #	Gabriel	Upgrade
90044089	83124	89407	A-20002	85000	89436						

#### BERING TRUCK CORP.

O.E.M #	Gabriel	Upgrade	O.E.M #	Gabriel	Upgrade	O.E.M #	Gabriel	Upgrade	O.E.M #	Gabriel	Upgrade
47902-24	83137										

#### BERKSHIRE COACH

O.E.M #	Gabriel	Upgrade	O.E.M #	Gabriel	Upgrade	O.E.M #	Gabriel	Upgrade	O.E.M #	Gabriel	Upgrade
ASH-1136	83178		ASH-1154	83177							

#### BILSTEIN

Bilstein	Gabriel	Upgrade	Bilstein	Gabriel	Upgrade	Bilstein	Gabriel	Upgrade	Bilstein	Gabriel	Upgrade
B46-1594	85013	89414	B46-1725	85029		B46-2151	85007				

#### BLUEBIRD SCHOOL BUS

O.E.M #	Gabriel	Upgrade	O.E.M #	Gabriel	Upgrade	O.E.M #	Gabriel	Upgrade	O.E.M #	Gabriel	Upgrade
00085991	85006		0014985	83137		0055008	85959				
00119797	85959		0015222	85919		0055017	85959				
00119798	85106		0020326	85976		0075916	85086				
0014605	85036	89405	0040015	85919		0085990	85959				

**Important Note:** Competitive Interchanges are to be used for stocking purposes only. Where multiple crosses are identified, please reference the applications section of this catalog. / **Remarque importante:** Les interchanges concurrentiels ne s'utilisent qu'aux fins de stocks. Dans le cas de références multiples, consulter la section des applications du catalogue. / **Nota importante:** Dans le cas de références multiples, consulter la section des applications du catalogue. / **Nota importante:** Se pueden usar intercambios competitivos para propósitos de almacenamiento solamente. Cuando se identifican intercambios múltiples, consulte la sección de aplicaciones de este catálogo.

**COMPETITIVE & O.E.M. INTERCHANGE LIST**  
**Lista de Intercambios contra Competidores y Equipo Original.**  
**Liste d'interchange de produits compétitifs & d'équipement original (OEM)**

**BLUEBIRD SCHOOL BUS... cont'd**

O.E.M #	Gabriel	Upgrade	O.E.M #	Gabriel	Upgrade	O.E.M #	Gabriel	Upgrade	O.E.M #	Gabriel	Upgrade
0088035	85090		300-0614974	85304		58913-011	85959		7805-M-1001	85919	
0106303	85106		300-0823047	85736		58913-011L	85959		7805-N-1002	85329	
0110808	83124	89407	300-0823054	85304		59057-001	83137		7805-S-1007	85329	
0523047	85736		300-09612284	85734		59057-002	85036	89405	87001-01A	85734	
0823054	85304		300-1316546	85006		59483-000	85919		8C24-18045-DA	83177	
1004167	85712		300-1317767	85029		60665-005	85919		8C24-18080-DB	83178	
1217934	85304		303-1350628	85712		60665-005L	85919		8C2Z-18124-D	83177	
1260008	87017		305-0961284	85734		609180	85304		8C2Z-18125-D	83178	
1316546	85006		471700000428	85006		60998-001	85006		90-1813	85712	
1317767	85029		471700000456	85959		60998-002	85919		90-1951-SP1	85734	
1526417	85052		471700000464	85090		60998-002L	85919		90-1968	85712	
1658533	85010		471700002919	85106		60998-003	85006		90-1968-SP1	85712	
1667831	85029		471700131545	85006		614958	85307		90-2610 SP1	87017	
1668722	85030	89440	4759272		89447	614966	85307		90044448	85051	
1668730	85013	89414	4760958	85086		614974	85304		90044915	83127	
1707405	85005	89430	481700131438	85919		65992-003	85959		90045083	85910	
1722214	85030	89440	58913-007	85959		65992-004	85106		A-4890	85712	
1722222	85013	89414	58913-007L	85959		671933	85919		AMS65109	85058	89431
1746163	85006		58913-008	85959		680102	85712		AMS65110	85005	89430
1750793	85712		58913-008L	85959		680155	85712		AMS65119	85029	
1962422	85304		58913-009	85959		680667		89447	ASH-1136	83178	
1962430	83207	89407	58913-009L	85959		680783	85304		ASH-1154	83177	
2021459	85012	89413	58913-010	85106		70317		89402	AT-163G	83177	
300-0614966	85307		58913-010L	85106		70397	85006		AT-164G	83178	

**BOGE**

Boge	Gabriel	Upgrade	Boge	Gabriel	Upgrade	Boge	Gabriel	Upgrade	Boge	Gabriel	Upgrade
40-A85-0	85708										

**BOYDSTUN EQUIPMENT MANUFACTURING**

O.E.M #	Gabriel	Upgrade	O.E.M #	Gabriel	Upgrade	O.E.M #	Gabriel	Upgrade	O.E.M #	Gabriel	Upgrade
1253069B000	85005	89430									

**BROCKWAY SCHOOL BUS**

O.E.M #	Gabriel	Upgrade	O.E.M #	Gabriel	Upgrade	O.E.M #	Gabriel	Upgrade	O.E.M #	Gabriel	Upgrade
14QK-281P10	85305		152398	85304		515231	85303	89422			
14QK-282P1	83216		152412	83215		530873	83207	89407			
14QK-282P3	83216		508657	85307		532397	85307				

**BUILT RITE**

O.E.M #	Gabriel	Upgrade	O.E.M #	Gabriel	Upgrade	O.E.M #	Gabriel	Upgrade	O.E.M #	Gabriel	Upgrade
318-06-100	85006		70039	85303	89422	70041	85305				

**BUS & TRUCK CO.**

O.E.M #	Gabriel	Upgrade	O.E.M #	Gabriel	Upgrade	O.E.M #	Gabriel	Upgrade	O.E.M #	Gabriel	Upgrade
680091	85303	89422	70039	85303	89422	70041	85305				

**CARPENTER BUS**

O.E.M #	Gabriel	Upgrade	O.E.M #	Gabriel	Upgrade	O.E.M #	Gabriel	Upgrade	O.E.M #	Gabriel	Upgrade
0272-SS5	85712		63-0001	85713							

**CASCADE TRAILER**

O.E.M #	Gabriel	Upgrade	O.E.M #	Gabriel	Upgrade	O.E.M #	Gabriel	Upgrade	O.E.M #	Gabriel	Upgrade
120-1	83125										

**CATERPILLAR**

O.E.M #	Gabriel	Upgrade	O.E.M #	Gabriel	Upgrade	O.E.M #	Gabriel	Upgrade	O.E.M #	Gabriel	Upgrade
60680-004	83143		60680-004L	83143		60680-005	83142		60680-005L	83142	

**CHALLENGE**

O.E.M #	Gabriel	Upgrade	O.E.M #	Gabriel	Upgrade	O.E.M #	Gabriel	Upgrade	O.E.M #	Gabriel	Upgrade
632147	632147		632155	646177							

**CHALLENGE COOK**

O.E.M #	Gabriel	Upgrade	O.E.M #	Gabriel	Upgrade	O.E.M #	Gabriel	Upgrade	O.E.M #	Gabriel	Upgrade
1540212	646155		632147	632147							
1540459	646155		632155	646177							

**Important Note:** Competitive Interchanges are to be used for stocking purposes only. Where multiple crosses are identified, please reference the applications section of this catalog. / **Remarque importante:** Les interchanges concurrentiels ne s'utilisent qu'aux fins de stocks. Dans le cas de références multiples, consulter la section des applications du catalogue. / **Nota importante:** Dans le cas de références multiples, consulter la section des applications du catalogue. / **Nota importante:** Se pueden usar intercambios competitivos para propósitos de almacenamiento solamente. Cuando se identifican intercambios múltiples, consulte la sección de aplicaciones de este catálogo.

# COMPETITIVE & O.E.M. INTERCHANGE LIST

## Lista de Intercambios contra Competidores y Equipo Original.

### Liste d'interchange de produits compétitifs & d'équipement original (OEM)

#### CHALLENGE COOK... cont'd

#### CHALMERS SUSPENSION

O.E.M #	Gabriel	Upgrade	O.E.M #	Gabriel	Upgrade	O.E.M #	Gabriel	Upgrade	O.E.M #	Gabriel	Upgrade
21335	G63355		800781	85314	89425	K880247	85060				
665174	85060		K800199	85060		K880248	85314	89425			
800670	85060		K880233	85060		K880642	85060				

#### CHAMPION BUS INC

O.E.M #	Gabriel	Upgrade	O.E.M #	Gabriel	Upgrade	O.E.M #	Gabriel	Upgrade	O.E.M #	Gabriel	Upgrade
22064230	83136		ASH-1136	83178		ASH-1154	83177				

#### CHANCE COACH

O.E.M #	Gabriel	Upgrade	O.E.M #	Gabriel	Upgrade	O.E.M #	Gabriel	Upgrade	O.E.M #	Gabriel	Upgrade
2021459	85012	89413	59039	83207	89407	6892	83207	89407	728600	83203	89436
270-6708	85014		665017	85014		6893	83203	89436	AS789B	85014	

#### CHEVROLET TRUCK (Also See GMC Truck)

O.E.M #	Gabriel	Upgrade	O.E.M #	Gabriel	Upgrade	O.E.M #	Gabriel	Upgrade	O.E.M #	Gabriel	Upgrade
1-51630-168-1	83515		22017531	83303		4940601	83216		5357955	85300	89419
1-51630-217-0	83114		22045526	85702		4940606	83126	89430	5357956	85734	
1-51630-217-1	83114		22046481	85702		4940614	83216		5357959	85300	89419
1-51630-219-1	83114		22046483	85304		4940627	83203	89436	5361994	85734	
12474915	83122	89406	22046489	85303	89422	4940640	83216		5374779	85308	89422
12474917	83137		2204683	85304		4940650	83207	89407	5374999	85307	
15123676	83136		22052014	85702		4940654	83216		5385939	85307	
15174898	83136		22052336	85304		4940660	83207	89407	5392387	85303	89422
15174902	85071		22064230	83136		4940662	83126	89430	5394448	85305	
15185643	83153		22064232	85071		4963844	85307		5394467	85305	
15588554	83136		22064233	83136		4963853	83216		5394468	85735	
15642943	83136		22064432	83221		4963854	83216		5455798	85307	
15740554	83137		22064489	85336		4964853	83217		5513489	83216	
15887728	83136		22064804	83136		4974401	85700		5513716	85304	
15963161	83122	89406	22064805	83136		4975429	85300	89419	5516459	85305	
19152843	83136		22064806	83136		4975467	83207	89407	5522781	85735	
21998392	85336		22064807	83136		4975479	83400		5522794	85308	89422
22002293	83126	89430	22065218	G63347		4975480	83400		5522818	85305	
22002294	83304		22065251	85030	89440	4975494	83207	89407	5527001	85300	89419
22002295	83303		22099889	85336		4975497	83126	89430	5527271	85700	
22007700	83207	89407	22165187	83136		4975510	83221		5527272	85700	
22007701	83126	89430	22165188	83136		4975516	85702		5527606	85305	
22007702	83304		22165189	83136		4975518	85704		5531027	85301	
22007703	83303		22166442	83136		4975538	85700		5531435	85307	
22007750	83207	89407	3171068	83216		4975549	83216		5531436	85307	
22007751	83303		3171069	85304		4975550	85702		5531437	85307	
22007752	83304		3171462	83126	89430	4984526	83216		5532026	85304	
22007753	83303		3171696	85307		507-24	85336		5532425	83207	89407
22012065	85304		3172948	85303	89422	507-3	85307		5532433	83207	89407
22012067	85700		3175509	85735		508-86	83136		5532675	85307	
22012082	85702		3178157	85700		508-88	83153		5534430	85303	89422
22012083	85711		3178233	85734		5171068	83216		5534439	85304	
22012090	85308	89422	3178507	85700		5316784	85700		5534447	85303	89422
22012091	85303	89422	3178995	85700		5316791	83219		5544060	85302	89420
22012095	83126	89430	3188626	85300	89419	5316792	85305		5544112	83216	
22012096	83221		3188729	85303	89422	5316793	85305		5544581	85302	89420
22012114	85700		3192657	83216		5321920	85307		5544716	85304	
22012131	85711		3192890	83126	89430	5321929	85307		5544717	85304	
22012166	83126	89430	3192892	83221		5348631	83203	89436	5544812	83308	
22012169	83221		4939852	85308	89422	5352858	85305		5544818	85735	
22012196	83221		4939967	85308	89422	5353054	85303	89422	5549899	83207	89407
22017530	83303		4940600	83209	89414	5355798	85307		5549924	85700	

**Important Note:** Competitive Interchanges are to be used for stocking purposes only. Where multiple crosses are identified, please reference the applications section of this catalog. / Remarque importante: Les interchanges concurrentiels ne s'utilisent qu'aux fins de stocks. Dans le cas de références multiples, consulter la section des applications du catalogue. / Nota importante: Dans le cas de références multiples, consulter la section des applications du catalogue. / Nota importante: Se pueden usar intercambios competitivos para propósitos de almacenamiento solamente. Cuando se identifican intercambios múltiples, consulte la sección de aplicaciones de este catálogo.

**COMPETITIVE & O.E.M. INTERCHANGE LIST**  
**Lista de Intercambios contra Competidores y Equipo Original.**  
**Liste d'interchange de produits compétitifs & d'équipement original (OEM)**

**CHEVROLET TRUCK (Also See GMC Truck)... cont'd**

O.E.M #	Gabriel	Upgrade	O.E.M #	Gabriel	Upgrade	O.E.M #	Gabriel	Upgrade	O.E.M #	Gabriel	Upgrade
5549925	85304		5552287	83217		5554995	85305		9-51630-647-1	83515	
5552111	85304		5552288	83217		5559363	83203	89436	9-51630-666-0	85012	89413
5552112	85307		5552451	85308	89422	5585939	85307		9-51630-666-2	85012	89413
5552114	83216		5552452	85303	89422	684280	83209	89414	94033786	83114	
5552205	83217		5552453	85301		8-94057-593-0	83114		94051090	83114	
5552206	83214		5552456	85307		8-94454-986-0	83515		94057593	83114	
5552207	83217		5552527	85735		8-94454-987-0	83515		94454987	83515	
5552208	83217		5552552	85303	89422	8-97201-960-0	83515		97-2210-00164	85708	
5552209	83215		5554184	85302	89420	88963409	85336		97-2210-00170	85733	
5552210	85308	89422	5554589	85307		88982682	83136		97083027	83515	
5552244	85308	89422	5554596	85303	89422	88982684	83136		97083029	83515	
5552285	83214		5554814	85302	89420	88982686	85071		97201960	83515	
5552286	83217		5554959	83401		88982688	85336				

**CHEVROLET TRUCK CAB SHOCKS**

O.E.M #	Gabriel	Upgrade	O.E.M #	Gabriel	Upgrade	O.E.M #	Gabriel	Upgrade	O.E.M #	Gabriel	Upgrade
1202-0012	83023		1202-0032	83016		1202-0054	83021				

**CHRYSLER**

O.E.M #	Gabriel	Upgrade	O.E.M #	Gabriel	Upgrade	O.E.M #	Gabriel	Upgrade	O.E.M #	Gabriel	Upgrade
2961043	G63183		3633744	G63183		3638112	G63183				

**CLARK EQUIPMENT**

O.E.M #	Gabriel	Upgrade	O.E.M #	Gabriel	Upgrade	O.E.M #	Gabriel	Upgrade	O.E.M #	Gabriel	Upgrade
355778	85315		5532675	85307		680042	85301				

**CNH GLOBAL N V**

O.E.M #	Gabriel	Upgrade	O.E.M #	Gabriel	Upgrade	O.E.M #	Gabriel	Upgrade	O.E.M #	Gabriel	Upgrade
87019546	83022		87268250	83021							

**COACH HOUSE RV**

O.E.M #	Gabriel	Upgrade	O.E.M #	Gabriel	Upgrade	O.E.M #	Gabriel	Upgrade	O.E.M #	Gabriel	Upgrade
ASH-1136	83178		ASH-1154	83177							

**COACHMEN RV**

O.E.M #	Gabriel	Upgrade	O.E.M #	Gabriel	Upgrade	O.E.M #	Gabriel	Upgrade	O.E.M #	Gabriel	Upgrade
141700131809	85029		481700000493	85900		ASH-1154	83177		ASH-25824	83122	89406
141700131810	83160		66153-002	83124	89407	ASH-1205	83209	89414	ASH-294	83209	89414
16-16736-000	85029		9U94-18045-AA	83209	89414	ASH-1206	83122	89406	AT-620	83209	89414
16-16737-000	83160		9U94-18080-AA	83122	89406	ASH-1228	83209	89414	AT-621	83122	89406
16-16873-000	85029		9U9Z-18124-A	83209	89414	ASH-1229	83209	89414	AT-766	83209	89414
16-16874-000	83160		9U9Z-18125-A	83122	89406	ASH-1230	83122	89406	F4-BE5-C832-MO	83124	89407
16-18103-000	85900		ASH-1022	83209	89414	ASH-137	83122	89406			
1C34-18045-AA	83209	89414	ASH-1023	83122	89406	ASH-25822	83209	89414			
1C34-18045-JA	83209	89414	ASH-1136	83178		ASH-25823	83209	89414			

**COFAP**

Cofap	Gabriel	Upgrade	Cofap	Gabriel	Upgrade	Cofap	Gabriel	Upgrade	Cofap	Gabriel	Upgrade
45011	85702		45095	85948		45240	85981		L-12477	85073	
45054	85301		45096	85951		8482	85026	89417	L-12488	85073	
45056	85315		45117	85918	89449	ATG-046	G63457		L-12590	85074	
45058	85301		45137	85948		ATG-051	G63426		L-12601	85077	
45058	85941		45139C-Y	85901		ATG-081	G63502		L-12602	85076	
45086	85949		45160	85946		ATG-084	G63608		L-12687	83030	
45087	85943		45174	85947		ATG-085	G63607		L-12703	85071	
45089	85949		45189	85950		L-12039	85065		L-12713	83136	
45090	85942		45200	85941		L-12040	85073		L-13092	85073	
45091	85944		45235	85946		L-12151	85075				
45094	85949		45238	85949		L-12476	85074				

**COLLINS BUS CORP**

O.E.M #	Gabriel	Upgrade	O.E.M #	Gabriel	Upgrade	O.E.M #	Gabriel	Upgrade	O.E.M #	Gabriel	Upgrade
ASH-1136	83178		ASH-1154	83177							

**Important Note:** Competitive Interchanges are to be used for stocking purposes only. Where multiple crosses are identified, please reference the applications section of this catalog. / **Remarque importante:** Les interchanges concurrentiels ne s'utilisent qu'aux fins de stocks. Dans le cas de références multiples, consulter la section des applications du catalogue. / **Nota importante:** Dans le cas de références multiples, consulter la section des applications du catalogue. / **Nota importante:** Se pueden usar intercambios competitivos para propósitos de almacenamiento solamente. Cuando se identifican intercambios múltiples, consulte la sección de aplicaciones de este catálogo.

**COMPETITIVE & O.E.M. INTERCHANGE LIST**  
**Lista de Intercambios contra Competidores y Equipo Original.**  
**Liste d'interchange de produits compétitifs & d'équipement original (OEM)**

**CONDUMEX**

Condumex	Gabriel	Upgrade	Condumex	Gabriel	Upgrade	Condumex	Gabriel	Upgrade	Condumex	Gabriel	Upgrade
43066	83309	89446	58038	85001	89410	69680		89402	69752	85316	89426
43136	83017		58040	85026	89417	69685	83136		69753	85031	
43137	83009		58041	83456	89447	69688	85302	89420	78001	85314	89425
43138	83004		58047	85381		69705	83122	89406	78002	85702	
43139	83021		58048	83137		69711	83207	89407	78003	85308	89422
43145	83021		58049	85323	89436	69712	85013	89414	78005	85310	89423
53010	83136		58050	85061	89450	69713	85046	89434	78007	85307	
53018	83317		58055	85003	89411	69714	83215		78009	85303	89422
53019	83456	89447	58056	83137		69715	85000	89436	78013	85323	89436
53038	85103		58057	83456	89447	69716	85024		78015	85724	89443
53039	85006		58058	85031		69717	85310	89423	78016	85001	89410
53040	85006		58059	85005	89430	69720	85736		78020	85712	
53041	85310	89423	58061	83122	89406	69725	85918	89449	78023	85705	89447
53042	83309	89446	58061	85916		69726	85319	89428	78025	85009	
53043	83215		58062	85096		69728	85055	89439	78027	85314	89425
53059	85051		58065	85949		69729	85314	89425	78030	85316	89426
53062	83009		58067	85942		69732	85300	89419	78034	85920	
53063	83025		69500	83122	89406	69741	85906	89407	78039	85311	89424
53065	83136		69515	83124	89407	69743	85061	89450	USA53085	83512	
53066	83124	89407	69669	83123	89405	69745	85058	89431	USA53086	83511	
53079	85074		69670	85051		69746	83137		USA53087	83506	
53080	83015		69671	85006		69747	85003	89411	USA53088	83513	
58012	85314	89425	69672	85043		69748	85001	89410	USA53091	83508	
58034	85013	89414	69673	83209	89414	69750	85314	89425	USA53092	83509	

**CONTINENTAL TRAILWAYS-EAGLE INT'L**

O.E.M #	Gabriel	Upgrade	O.E.M #	Gabriel	Upgrade	O.E.M #	Gabriel	Upgrade	O.E.M #	Gabriel	Upgrade
01-0100-020	85307		5394467	85305		6-05-5	85307		70039	85303	89422
01-0100-905	85303	89422	5532026	85304		680091	85303	89422	70041	85305	

**COUNTRY COACH**

O.E.M #	Gabriel	Upgrade	O.E.M #	Gabriel	Upgrade	O.E.M #	Gabriel	Upgrade	O.E.M #	Gabriel	Upgrade
89406		89406	89414		89414						

**CRANE CARRIER**

O.E.M #	Gabriel	Upgrade	O.E.M #	Gabriel	Upgrade	O.E.M #	Gabriel	Upgrade	O.E.M #	Gabriel	Upgrade
1265157B000	85712		277A-12	85304		277A-9	85307		680088	85713	
1310002	665937		277A-13	85302	89420	60680-004	83143		680091	85303	89422
227A-14	85716		277A-14	85304		60680-004L	83143				
277A-1	85307		277A-8	85303	89422	64178-001	83143				

**CROWN COACH**

O.E.M #	Gabriel	Upgrade	O.E.M #	Gabriel	Upgrade	O.E.M #	Gabriel	Upgrade	O.E.M #	Gabriel	Upgrade
3188729	85303	89422	5532026	85304		5532036	85734				

**CUNHA PRODUCTS OHD**

O.E.M #	Gabriel	Upgrade	O.E.M #	Gabriel	Upgrade	O.E.M #	Gabriel	Upgrade	O.E.M #	Gabriel	Upgrade
CP-5222	85315										

**CUSH CORPORATION**

O.E.M #	Gabriel	Upgrade	O.E.M #	Gabriel	Upgrade	O.E.M #	Gabriel	Upgrade	O.E.M #	Gabriel	Upgrade
C0062-D	85000	89436	C0226	85064		C0228	85005	89430			
C0078	85000	89436	C0227	85014		C04045	85045				

**DAMON MOTOR COACH**

O.E.M #	Gabriel	Upgrade	O.E.M #	Gabriel	Upgrade	O.E.M #	Gabriel	Upgrade	O.E.M #	Gabriel	Upgrade
24-153249	85125		ASH-1229	83209	89414	F4-BE5-A011-HO	85126		F4-BE5-F325-HO	85124	
24-153256	85124		ASH-25822	83209	89414	F4-BE5-A832-MO	85125		W0005662	85125	
24-186537	85126		ASH-25823	83209	89414	F4-BE5-B492-HO	85125		W0005663	85124	
24-186629	85125		ASH-25824	83122	89406	F4-BE5-F324-HO	85125		W0006254	85125	

**DANA**

O.E.M #	Gabriel	Upgrade	O.E.M #	Gabriel	Upgrade	O.E.M #	Gabriel	Upgrade	O.E.M #	Gabriel	Upgrade
SR1VJ100	85078										

**Important Note:** Competitive Interchanges are to be used for stocking purposes only. Where multiple crosses are identified, please reference the applications section of this catalog. / **Remarque importante:** Les interchanges concurrentiels ne s'utilisent qu'aux fins de stocks. Dans le cas de références multiples, consulter la section des applications du catalogue. / **Nota importante:** Dans le cas de références multiples, consulter la section des applications du catalogue. / **Nota importante:** Se pueden usar intercambios competitivos para propósitos de almacenamiento solamente. Cuando se identifican intercambios múltiples, consulte la sección de aplicaciones de este catálogo.

# COMPETITIVE & O.E.M. INTERCHANGE LIST

## Lista de Intercambios contra Competidores y Equipo Original.

### Liste d'interchange de produits compétitifs & d'équipement original (OEM)

#### DEXTER AXLE

O.E.M #	Gabriel	Upgrade	O.E.M #	Gabriel	Upgrade	O.E.M #	Gabriel	Upgrade	O.E.M #	Gabriel	Upgrade
18165-01	85006										

#### DIAMOND COACH

O.E.M #	Gabriel	Upgrade	O.E.M #	Gabriel	Upgrade	O.E.M #	Gabriel	Upgrade	O.E.M #	Gabriel	Upgrade
ASH-1136	83178		ASH-1154	83177							

#### DIAMOND T

O.E.M #	Gabriel	Upgrade	O.E.M #	Gabriel	Upgrade	O.E.M #	Gabriel	Upgrade	O.E.M #	Gabriel	Upgrade
5549925	85304										

#### DIAMOND-REO

O.E.M #	Gabriel	Upgrade	O.E.M #	Gabriel	Upgrade	O.E.M #	Gabriel	Upgrade	O.E.M #	Gabriel	Upgrade
220-55-1	83214		220-55-6	83214		220-55-8	83217				
220-55-2	85304		220-55-7	85304		220-S5-10	85712				

#### DODGE TRUCK

O.E.M #	Gabriel	Upgrade	O.E.M #	Gabriel	Upgrade	O.E.M #	Gabriel	Upgrade	O.E.M #	Gabriel	Upgrade
2516009	G63183		2961043	G63183		3633744	G63183		3638631	G63605	
2960707	G63183		3633643	G63183		3638112	G63183		4036892	G63605	

#### DUPLEX TRUCK

O.E.M #	Gabriel	Upgrade	O.E.M #	Gabriel	Upgrade	O.E.M #	Gabriel	Upgrade	O.E.M #	Gabriel	Upgrade
59024	83204		7604-3371	83204							

#### DURA SUSPENSION

O.E.M #	Gabriel	Upgrade	O.E.M #	Gabriel	Upgrade	O.E.M #	Gabriel	Upgrade	O.E.M #	Gabriel	Upgrade
1080099	83203	89436	59024	83204		665133	83203	89436	7604-3371	83204	
12866	83207	89407	59030	83203	89436	665267	85029		A-2212	85029	

#### DUTCHMEN RV

O.E.M #	Gabriel	Upgrade	O.E.M #	Gabriel	Upgrade	O.E.M #	Gabriel	Upgrade	O.E.M #	Gabriel	Upgrade
8C24-18045-DA	83177		8C2Z-18124-D	83177		ASH-1136	83178		AT-163G	83177	
8C24-18080-DB	83178		8C2Z-18125-D	83178		ASH-1154	83177		AT-164G	83178	

#### DYNAMAX CORP (COUNTRY COACH)

O.E.M #	Gabriel	Upgrade	O.E.M #	Gabriel	Upgrade	O.E.M #	Gabriel	Upgrade	O.E.M #	Gabriel	Upgrade
10-13634-000	85918	89449	471700002809	85724	89443	8C2Z-18124-D	83177		AT-164G	83178	
10-13760-000	85959	89503	471700002991	85959	89503	8C2Z-18125-D	83178		SDA471700002991	85959	89503
10-13809-000	85958		471700003920	85958		ASH-1136	83178				
16-18708-000	85724	89443	8C24-18045-DA	83177		ASH-1154	83177				
471700000449	85918	89449	8C24-18080-DB	83178		AT-163G	83177				

#### EAGLE MOTOR COACH

O.E.M #	Gabriel	Upgrade	O.E.M #	Gabriel	Upgrade	O.E.M #	Gabriel	Upgrade	O.E.M #	Gabriel	Upgrade
01-0100-020	85307		101364	85305		5394467	85305		690060	85713	
01-0100-905	85303	89422	12B-5-1	85735		5532026	85304		70039	85303	89422
014-0100-905	85308	89422	12J-5-10	85733		6-05-5	85307		70041	85305	
0140100-905	85308	89422	154-0100-514	85314	89425	680091	85303	89422			

#### EAST MANUFACTURING CORP.

O.E.M #	Gabriel	Upgrade	O.E.M #	Gabriel	Upgrade	O.E.M #	Gabriel	Upgrade	O.E.M #	Gabriel	Upgrade
517-05001-18	87015		517-05010-07	83214		517-05805-20	85000	89436	517-05916-14	83124	89407
517-05001-23	85005	89430	517-05022-07	83217		517-05806-20	85029		A-20002	85000	89436
517-05006-20	85030	89440	517-05110-20	85000	89436	517-05808-20	85738		A-20126	85323	89436
517-05009-14	83125		517-05511-14	83128	89436	517-05809-20		89437			

#### ELDORADO NATIONAL

O.E.M #	Gabriel	Upgrade	O.E.M #	Gabriel	Upgrade	O.E.M #	Gabriel	Upgrade	O.E.M #	Gabriel	Upgrade
13208701	85746		13208801	85745		ASH-1136	83178		ASH-1154	83177	

#### ELKHART COACH

O.E.M #	Gabriel	Upgrade	O.E.M #	Gabriel	Upgrade	O.E.M #	Gabriel	Upgrade	O.E.M #	Gabriel	Upgrade
ASH-1136	83178		ASH-1154	83177							

#### ENTEGRA COACH

O.E.M #	Gabriel	Upgrade	O.E.M #	Gabriel	Upgrade	O.E.M #	Gabriel	Upgrade	O.E.M #	Gabriel	Upgrade
ASH-1136	83178		ASH-1229	83209	89414	ASH-25823	83209	89414			
ASH-1154	83177		ASH-25822	83209	89414	ASH-25824	83122	89406			

**Important Note:** Competitive Interchanges are to be used for stocking purposes only. Where multiple crosses are identified, please reference the applications section of this catalog. / **Remarque importante:** Les interchanges concurrentiels ne s'utilisent qu'aux fins de stocks. Dans le cas de références multiples, consulter la section des applications du catalogue. / **Nota importante:** Dans le cas de références multiples, consulter la section des applications du catalogue. / **Nota importante:** Se pueden usar intercambios competitivos para propósitos de almacenamiento solamente. Cuando se identifican intercambios múltiples, consulte la sección de aplicaciones de este catálogo.

**COMPETITIVE & O.E.M. INTERCHANGE LIST**  
**Lista de Intercambios contra Competidores y Equipo Original.**  
**Liste d'interchange de produits compétitifs & d'équipement original (OEM)**

**EUCLID**

Euclid	Gabriel	Upgrade	Euclid	Gabriel	Upgrade	Euclid	Gabriel	Upgrade	Euclid	Gabriel	Upgrade
E14009	85933	89454	E83218	83122	89406	E85000	85000	89436	E85308	85308	89422
E14021	85955		E83219	83219		E85001	85001	89410	E85310	85310	89423
E14022	85955		E83221	83221		E85003	85003	89411	E85311	85311	89424
E14037	85967		E83223	83223		E85005	85005	89430	E85312	85733	
E14042	85965		E83225	83225		E85006	85006		E85314	85314	89425
E14045	83143		E83242	83242		E85007	85007		E85318	85318	
E14046	83142		E83300	83300		E85008	85008		E85700	85700	
E83200		89402	E83301	83301		E85010	85010		E85702	85702	
E83201	83201		E83302	83302		E85012	85012	89413	E85703	85703	
E83202	83202		E83303	83303		E85013	85013	89414	E85704	85704	
E83203	83203	89436	E83304	83304		E85014	85014		E85705	85705	89447
E83204	83204		E83308	83308	89435	E85024	85024		E85709	85709	
E83205	83209	89414	E83309	83309	89446	E85026	85026	89417	E85711	85711	
E83206	83206		E83310	83221		E85029	85029		E85712	85712	
E83207	83207	89407	E83311	83311		E85030	85030	89440	E85713	85713	
E83209	83209	89414	E83312	83312	89409	E85300	85300	89419	E87000	85711	
E83213	83213		E83314	83314		E85302	85302	89420	E87001	85734	
E83214	83214		E83318	83318		E85303	85303	89422	E87003	85700	
E83215	83215		E83353	85740		E85304	85304		E87004	85735	
E83216	83216		E83400	83400		E85305	85305		E87006	85736	
E83217	83217		E83401	83401		E85307	85307		E87012	85705	89447

**FEDERAL COACH**

O.E.M #	Gabriel	Upgrade	O.E.M #	Gabriel	Upgrade	O.E.M #	Gabriel	Upgrade	O.E.M #	Gabriel	Upgrade
10-12388-000	85920	89503	16-18708-000	85724	89443	ASH-1136	83178				
10-12390-000	85920	89503	471700002809	85724	89443	ASH-1154	83177				
10-13760-000	85959	89503	471700002991	85959	89503	SDA471700002991	85959	89503			

**FLEETRITE**

Fleetrite	Gabriel	Upgrade	Fleetrite	Gabriel	Upgrade	Fleetrite	Gabriel	Upgrade	Fleetrite	Gabriel	Upgrade
AMS600101	85003	89411	AMS600136	85740		AMS650102	85001	89410	AMS650405	85023	89415
AMS600102	85005	89430	AMS600139	85740		AMS650103	85320	89429	AMS650406	85024	
AMS600103	85014		AMS600142	83209	89414	AMS650104	65104		AMS650407	85736	
AMS600104	85000	89436	AMS600145	85040		AMS650105	85026	89417	AMS650408	85319	89428
AMS600105	83304		AMS600146	83105		AMS650106	65106		AMS650409	85003	89411
AMS600106	83312	89409	AMS600147	83216		AMS650107	85316	89426	AMS650410	85300	89419
AMS600107	83309	89446	AMS600148	85026	89417	AMS650108	85030	89432	AMS650411	85036	89405
AMS600108	83209	89414	AMS600149	83217		AMS650109	85058	89431	AMS650412	83122	89406
AMS600109	83217		AMS600150	85009		AMS650110	85005	89430	AMS650413	65413	
AMS600110	83303		AMS600151	85024		AMS650111	85006		AMS650414	65414	
AMS600111	83301		AMS600152	83242		AMS650112	89402		AMS650415	85046	89434
AMS600112	83456	89447	AMS600153	85003	89411	AMS650113	85012	89413	AMS650416	85323	89436
AMS600113	83215		AMS600154	83104		AMS650114	85006		AMS650417	85322	
AMS600114	83125		AMS600155	83103		AMS650115	85027	89418	AMS650418	85906	89407
AMS600116	83216		AMS600156	83103		AMS650116	85303	89422	AMS650419	85000	89436
AMS600117	83308	89435	AMS600157	83221		AMS650118	83215		AMS650420	85013	89414
AMS600118	83219		AMS600162	83103		AMS650119	85029		AMS650421	85916	89430
AMS600119	83314		AMS600163	83101		AMS650120	85010		AMS650425	89441	
AMS600120	G63605		AMS600164	83613		AMS650121	89432		AMS650426	85054	89438
AMS600123	G63183		AMS600166	85052		AMS650122	85063		AMS650427	85903	
AMS600125	83123	89405	AMS600167	83128	89436	AMS650123	85054	89438	AMS650428	85321	
AMS600126	83400		AMS600168	83635		AMS650124	85053	89442	AMS650429	85030	89440
AMS600128	83401		AMS600169	85051		AMS650128	85031		AMS650430	85712	
AMS600129	83317		AMS600172	85005	89430	AMS650130	85061	89450	AMS650431	85909	
AMS600130	83204		AMS600173	85043		AMS650139	85918	89449	AMS650432	85910	
AMS600131	83318		AMS600174	83125		AMS650400	85033	89427			
AMS600132	83215		AMS600175	83120		AMS650401	85013	89414			
AMS600133	83362		AMS600202	83009		AMS650402	85311	89424			
AMS600134	83221		AMS650101	85062	89408	AMS650404	85310	89423			

**Important Note:** Competitive Interchanges are to be used for stocking purposes only. Where multiple crosses are identified, please reference the applications section of this catalog. / **Remarque importante:** Les interchanges concurrentiels ne s'utilisent qu'aux fins de stocks. Dans le cas de références multiples, consulter la section des applications du catalogue. / **Nota importante:** Dans le cas de références multiples, consulter la section des applications du catalogue. / **Nota importante:** Se pueden usar intercambios competitivos para propósitos de almacenamiento solamente. Cuando se identifican intercambios múltiples, consulte la sección de aplicaciones de este catálogo.

**COMPETITIVE & O.E.M. INTERCHANGE LIST**  
**Lista de Intercambios contra Competidores y Equipo Original.**  
**Liste d'interchange de produits compétitifs & d'équipement original (OEM)**

**FLEETRITE... cont'd**

Fleetrite	Gabriel	Upgrade	Fleetrite	Gabriel	Upgrade	Fleetrite	Gabriel	Upgrade	Fleetrite	Gabriel	Upgrade
AMS650433	85910		AMS660110	83303		AMS660183	85012	89413	AMS700107	85307	
AMS650434	85012	89413	AMS660111	83301		AMS660187	85071		AMS700108	85315	
AMS650435	85901		AMS660112	83456	89447	AMS660188	85045		AMS700111	85320	89429
AMS650436	85900		AMS660113	83215		AMS660189	83136		AMS700112	85722	
AMS650439	85732		AMS660114	85006		AMS660190	83107		AMS700113	85736	
AMS650440	85711		AMS660116	83216		AMS660191	83216		AMS700115	85712	
AMS650441	85704		AMS660117	83308	89435	AMS660192	85001	89410	AMS700116	83136	
AMS650442	85700		AMS660118	85012	89413	AMS660193	83001		AMS700119	85336	
AMS650444	85311	89424	AMS660119	83314		AMS660194	83207	89407	AMS700120	85332	
AMS650447	85703		AMS660120	G63605		AMS660195	83130		AMS700121	83136	
AMS650448	85700		AMS660123	G63183		AMS660196	G63610		AMS700401	85700	
AMS650449	85702		AMS660125	83123	89405	AMS660197	G63866		AMS700402	85310	89423
AMS650451	85029		AMS660126	83400		AMS660198	83007		AMS700403	85702	
AMS650452	85733		AMS660128	83401		AMS660200	83008		AMS700404	85311	89424
AMS650453	85904		AMS660129	83317		AMS660201	83308	89435	AMS700405	85300	89419
AMS650454	85713		AMS660130	83204		AMS660202	83009		AMS700406	85711	
AMS650455	85716		AMS660131	83318		AMS660203	83112		AMS700407	85712	
AMS650456	85376		AMS660132	83215		AMS660204	83010		AMS700408	85704	
AMS650458	85908		AMS660133	83362		AMS660205	83003		AMS700410	85314	89425
AMS650459	85043		AMS660134	83221		AMS660208	G63616		AMS700411	85703	
AMS650463	85040		AMS660136	85740		AMS660211	83110		AMS700413	85705	89447
AMS650464	85716		AMS660142	83209	89414	AMS660212	83015		AMS700414	85723	
AMS650465	85914		AMS660145	85040		AMS660213	85009		AMS700415	85318	
AMS650466	85047	89435	AMS660146	83105		AMS660214	83002		AMS700416	85709	
AMS650468	85069	89455	AMS660147	83216		AMS660215	85059		AMS700418	85003	89411
AMS650471	85302	89420	AMS660148	85026	89417	AMS660216	83123	89405	AMS700419	85708	
AMS650472	85379		AMS660149	85042		AMS660218	83137		AMS700420	85733	
AMS650473	85329		AMS660150	G63616		AMS660219	83215		AMS700421	85712	
AMS650474	85712		AMS660153	85003	89411	AMS660220	83109		AMS700422	85308	89422
AMS650475	85065		AMS660154	83104		AMS660223	85055	89439	AMS700423	85724	89443
AMS650478	85030	89440	AMS660155	83103		AMS660224	83111		AMS700424	85333	
AMS650479	83122	89406	AMS660157	85030	89440	AMS660225		89402	AMS74421	85708	
AMS650480	83109		AMS660160	83114		AMS660232	83114		AMS85722	83400	
AMS650480	83111		AMS660161	G63610		AMS660233	83023		AMS85736	G63394	
AMS650481	83123	89405	AMS660162	83103		AMS660234	83013		AMS85768	83209	89414
AMS650482	85006		AMS660164	83613		AMS660236	83025		AMS85802	83216	
AMS650486	85066	89448	AMS660166	85052		AMS660237	83005		AMS85803	G63306	
AMS65107	85316	89426	AMS660167	83128	89436	AMS660238	83101		AMS85821	G63406	
AMS65109	85058	89431	AMS660168	83635		AMS660244	83125		AMS85853	G63183	
AMS65144	85957		AMS660169	85051		AMS660247	83116		AMS85895	83207	89407
AMS65146	85925		AMS660170	83016		AMS660247	83118		AMS85900	G63386	
AMS65158	85954		AMS660171	83017		AMS660248	83117		AMS85901	G63387	
AMS660102	85005	89430	AMS660172	83126	89430	AMS660502	646155		AMS85904	G63299	
AMS660103	85014		AMS660173	85043		AMS660504	632147		AMS85905	G63405	
AMS660104	85000	89436	AMS660174	83125		AMS700101	85308	89422	AMS85909	G63398	
AMS660105	83304		AMS660175	83120		AMS700102	85303	89422	AMS85932	G63398	
AMS660106	83312	89409	AMS660176	83018		AMS700103	85302	89420	AMS85960	G63366	
AMS660107	83309	89446	AMS660177	83019		AMS700104	85304				
AMS660108	83209	89414	AMS660179	83162		AMS700105	85314	89425			
AMS660109	83217		AMS660182	83004		AMS700106	85301				

**FLEETWOOD RV**

O.E.M #	Gabriel	Upgrade	O.E.M #	Gabriel	Upgrade	O.E.M #	Gabriel	Upgrade	O.E.M #	Gabriel	Upgrade
141700131809	85029		16-16874-000	83160		24-153256	85124		9U94-18080-AA	83122	89406
141700131810	83160		16-18103-000	85900		24-186537	85126				
16-16736-000	85029		1C34-18045-AA	83209	89414	24-186629	85125				
16-16737-000	83160		1C34-18045-JA	83209	89414	481700000493	85900				
16-16873-000	85029		24-153249	85125		9U94-18045-AA	83209	89414			

**Important Note:** Competitive Interchanges are to be used for stocking purposes only. Where multiple crosses are identified, please reference the applications section of this catalog. / **Remarque importante:** Les interchanges concurrentiels ne s'utilisent qu'aux fins de stocks. Dans le cas de références multiples, consulter la section des applications du catalogue. / **Nota importante:** Dans le cas de références multiples, consulter la section des applications du catalogue. / **Nota importante:** Se pueden usar intercambios competitivos para propósitos de almacenamiento solamente. Cuando se identifican intercambios múltiples, consulte la sección de aplicaciones de este catálogo.



**COMPETITIVE & O.E.M. INTERCHANGE LIST**  
**Lista de Intercambios contra Competidores y Equipo Original.**  
**Liste d'interchange de produits compétitifs & d'équipement original (OEM)**

**FLEETWOOD RV... cont'd**

O.E.M #	Gabriel	Upgrade	O.E.M #	Gabriel	Upgrade	O.E.M #	Gabriel	Upgrade	O.E.M #	Gabriel	Upgrade
9U9Z-18124-A	83209	89414	ASH-1206	83122	89406	ASH-25824	83122	89406	F4-BE5-B492-HO	85125	
9U9Z-18125-A	83122	89406	ASH-1228	83209	89414	ASH-294	83209	89414	F4-BE5-F324-HO	85125	
ASH-1022	83209	89414	ASH-1229	83209	89414	AT-620	83209	89414	F4-BE5-F325-HO	85124	
ASH-1023	83122	89406	ASH-1230	83122	89406	AT-621	83122	89406	W0005662	85125	
ASH-1136	83178		ASH-137	83122	89406	AT-766	83209	89414	W0005663	85124	
ASH-1154	83177		ASH-25822	83209	89414	F4-BE5-A011-HO	85126		W0006254	85125	
ASH-1205	83209	89414	ASH-25823	83209	89414	F4-BE5-A832-MO	85125				

**FLUIDRIVE**

O.E.M #	Gabriel	Upgrade	O.E.M #	Gabriel	Upgrade	O.E.M #	Gabriel	Upgrade	O.E.M #	Gabriel	Upgrade
2697	85712										

**FLXIBLE BUS**

O.E.M #	Gabriel	Upgrade	O.E.M #	Gabriel	Upgrade	O.E.M #	Gabriel	Upgrade	O.E.M #	Gabriel	Upgrade
015813	85708		6-05-4	85736		680155	85712		97-2210-00004	85704	
06-0367-00151	85700		6-05-5	85307		680320	85703		97-2210-00005	85704	
06-0367-00156	85702		6-05-6	85736		695125	85704		97-2210-00006	85704	
22012067	85700		6-05-7	85736		74412	85704		97-2210-00009	85704	
22012114	85700		6-05-8	85736		87-2519-00001	85703		97-2210-00011	85704	
22024061	85704		6-05-9	85304		87-2519-00003	85703		97-2210-00156	85702	
22024506	85703		6-367-1	85711		87-2520-00001	85704		97-2210-00157	85708	
22025066	85703		6-367-11	85711		87-2520-00003	85704		97-2210-00160	85705	89447
22025067	85704		6-367-12	85700		97-2201-00001	85703		97-2210-00164	85708	
22025305	85704		6-367-14	85700		97-2201-00002	85703		97-2210-00170	85733	
3166657	85700		6-367-16	85700		97-2201-00003	85703		97-9999-00807	85307	
3192333	85700		6-367-17	85700		97-2201-00004	85703		97-9999-02514	85700	
48-1-239	85736		6-367-2	85736		97-2201-00005	85703		97-9999-02515	85702	
48-1-241	85712		6-367-3	85304		97-2201-00006	85703		97-9999-02632	85711	
4975518	85704		6-367-4	83217		97-2201-00007	85703		97-9999-02633	85311	89424
6-05-1	85736		6-367-6	85711		97-2201-00009	85703		97-9999-02634	85733	
6-05-10	85734		6-367-7	85305		97-2201-00151	85700		97-9999-02635	85732	
6-05-13	85304		6-367-8	85700		97-2210-00001	85704		97-9999-02636	85716	
6-05-2	85736		6-367-9	85711		97-2210-00002	85704				
6-05-3	85736		680029	85301		97-2210-00003	85704				

**FLYER INDUSTRIES**

O.E.M #	Gabriel	Upgrade	O.E.M #	Gabriel	Upgrade	O.E.M #	Gabriel	Upgrade	O.E.M #	Gabriel	Upgrade
009863	85722		22012067	85700		3192333	85700		592-6568	85700	
015915	85711		22012114	85700		4975501	85700		5979574	85700	
15813	85708		3166657	85700		4975552	85711				

**FORD**

O.E.M #	Gabriel	Upgrade	O.E.M #	Gabriel	Upgrade	O.E.M #	Gabriel	Upgrade	O.E.M #	Gabriel	Upgrade
1C34-18045-AA	83209	89414	3U2Z-18124-FA	G63608		4C4O-18045-DB	85927		4C4Z-18124-KA	85976	
1C34-18045-JA	83209	89414	3U2Z-18124-FAA	G63809		4C4O-18045-EA	85926		4C4Z-18124-LA	85976	
1C44-18080-AA	83123	89405	3U2Z-18124-JAA	G63614		4C4O-18045-GA	83175		4C4Z-18124-M	85926	
2C4Z-18124-BA	83175		3U2Z-18124-MAA	83131		4C4O-18045-HA	83135		4C4Z-18124-P	83135	
2C7Z-18125-AA	G63837		3U2Z-18124-YAA	G63809		4C4O-18045-JA	85928		4C4Z-18124-QA	83175	
2C7Z-18125-CA	G63607		3U2Z-18125-AD	69575		4C4O-18045-KA	85976		4C4Z-18124-RA	85928	
3553628C1	85927		3U2Z-18125-CA	G63607		4C4O-18045-LA	85976		4C4Z-18125-AB	83101	
3553628C2	85927		3U2Z-18125-DA	G63525		4C4O-18045-MA	85926		4C4Z-18125-B	83317	
3578858C1	85926		3U2Z-18125-EA	G63524		4C4O-18080-AA	83101		4C4Z-18125-CA	85976	
3578858C2	85926		3U2Z-18125-RA	G63623		4C4O-18080-BA	83317		4C4Z-18125-DA	85926	
3584116C1	83175		471700011530	85181		4C4Z-18124-AB	83163		4U2Z-18V124-AA	G63678	
3584116C2	83175		471700011531	85180		4C4Z-18124-BB	83135		501906C92	83317	
3584117C2	83135		47902-13	83122	89406	4C4Z-18124-CB	85957		57241-2	83109	
3584118C2	85928		47902-28	85013	89414	4C4Z-18124-DC	85927		57365-111	85006	
3U2Z-18124-BAA	G63809		47902-8	83122	89406	4C4Z-18124-EA	85926				
3U2Z-18124-BV	G63614		4C4O-18045-AA	83163		4C4Z-18124-GB	83175				
3U2Z-18124-BW	G63614		4C4O-18045-BB	83135		4C4Z-18124-HB	83135				
3U2Z-18124-EA	G63772		4C4O-18045-CA	85957		4C4Z-18124-JB	85928				

**Important Note:** Competitive Interchanges are to be used for stocking purposes only. Where multiple crosses are identified, please reference the applications section of this catalog. / **Remarque importante:** Les interchanges concurrentiels ne s'utilisent qu'aux fins de stocks. Dans le cas de références multiples, consulter la section des applications du catalogue. / **Nota importante:** Dans le cas de références multiples, consulter la section des applications du catalogue. / **Nota importante:** Se pueden usar intercambios competitivos para propósitos de almacenamiento solamente. Cuando se identifican intercambios múltiples, consulte la sección de aplicaciones de este catálogo.

**COMPETITIVE & O.E.M. INTERCHANGE LIST**  
**Lista de Intercambios contra Competidores y Equipo Original.**  
**Liste d'interchange de produits compétitifs & d'équipement original (OEM)**

**FORD... cont'd**

O.E.M #	Gabriel	Upgrade	O.E.M #	Gabriel	Upgrade	O.E.M #	Gabriel	Upgrade	O.E.M #	Gabriel	Upgrade
5C3Z-18124-JA	G63969		ASH-1105	85976		C1TT-18045-C	83312	89409	D0HA-18045-E	83312	89409
5C3Z-18125-CF	77969		ASH-1136	83178		C1TT-18045-D	G63406		D0HZ-18124-A	83309	
5C3Z-18125-DA	77968		ASH-1154	83177		C1TT-18045-E	83314		D0HZ-18124-B	83312	89409
5U2Z-18V124-AA	G63714		ASH-1205	83209	89414	C1TT-18045-G	83216		D0HZ-18124-C	83314	
5U2Z-18V124-AHA	G63622		ASH-1206	83122	89406	C1TT-18080-B	83217		D1TF-18045-LA	83312	89409
5U2Z-18V124-AU	G63772		ASH-1228	83209	89414	C1TZ-18045-C	83312	89409	D1TZ-18124-D	83308	
5U2Z-18V124-BA	G63716		ASH-1229	83209	89414	C1TZ-18124-A	83217		D1TZ-18124-E	83216	
5U2Z-18V124-CAA	G63809		ASH-1230	83122	89406	C1TZ-18124-B	83216		D1TZ-18124-F	83312	89409
5U2Z-18V124-DB	G63455		ASH-137	83122	89406	C1TZ-18124-C	83312	89409	D1TZ-18125-E	83217	
5U2Z-18V124-GA	G63809		ASH-23486	G63461		C1TZ-18124-D	83309		D2EF-18045-AA	83312	89409
5U2Z-18V124-LA	G63929		ASH-24446	83215		C1TZ-18124-E	83312	89409	D2EF-18124-AA	83312	89409
5U2Z-18V125-AE	G63808		ASH-2447	83140		C1TZ-18124-F	83312	89409	D2HA-18045-E1A	85304	
5U2Z-18V125-AF	G63810		ASH-24658	85181		C1TZ-18124-N	83314		D2HA-18045-E1B	85304	
5U2Z-18V125-BDA	G63623		ASH-24659	85181		C1TZ-18124-P	83312	89409	D2HA-18045-E2A	85304	
5U2Z-18V125-BGA	G63778		ASH-24660	85180		C1TZ-18125-B	83217		D2HA-18045-E2B	85304	
5U2Z-18V125-BS	G63607		ASH-247	G63461		C1VT-18080-B	83217		D2HA-18045-E2B	85301	
5U2Z-18V125-BT	G63525		ASH-25822	83209	89414	C2TA-18045-A	83216		D2HA-18045-F1A	85301	
5U2Z-18V125-BU	G63524		ASH-25823	83209	89414	C2TA-18045-B	83308		D2HA-18045-F1B	85301	
5U2Z-18V125-F	G63676		ASH-25824	83122	89406	C2TZ-18124-A	83308		D2HA-18045-F2A	85301	
5U2Z-18V125-G	G63837		ASH-294	83209	89414	C3TA-18045-A	83216		D2HA-18045-F2B	85301	
5U2Z-18V125-H	G63406		ASH-397	83131		C3TZ-18124-A	83308		D2HF-18045-A	83314	
60670-008	83123	89405	ASH-722	85976		C4HZ-18124-A	83312	89409	D2HF-18045-AA	83314	
60670-008L	83123	89405	AT-163G	83177		C4HZ-18124-B	83309		D2HF-18045-BA	83309	
60675-003	85976		AT-164G	83178		C4HZ-18124-C	83314		D2HF-18045-CA	83308	
60675-003L	85976		AT-504G	G63679		C4HZ-18124-D	83312	89409	D2HF-18045-DA	83312	89409
680029	85301		AT-610	G63461		C4HZ-18124-E	83309		D2HF-18124-AA	83314	
6C2Z-18124-B	G63929		AT-611	G63461		C4HZ-18124-F	83308		D2HT-18045-CA	83314	
6E7O-18B038-AA	83364		AT-620	83209	89414	C4PF-18045-H	83216		D2HT-18045-EA	83312	89409
6E7Z-18124-AB	83364		AT-621	83122	89406	C4TZ-18124-AA	83308		D2HT-18045-GA	83308	
6ETZ-18125-A	83364		AT-696	83140		C4TZ-18124-AB	83308		D2HT-18080-HA	83225	
6U2Z-18V125-B	G63607		AT-766	83209	89414	C4TZ-18124-B	83308		D2HZ-18080-A	83209	89414
6U2Z-18V125A	G63837		AT-811	83135		C5TZ-18124-A	83308		D2HZ-18125-A	83209	89414
70127	85006		AT-812	85928		C6PF-18077-A	G63306		D2HZ-18125-B	83209	89414
70128	85006		AX-267A	83309		C6PF-18077-DD	83216		D2KF-18045-AA	83312	89409
7C34-18045-HB	G63969		AX-310	83215		C6PF-18077-DE	83219		D2KF-18124-AA	83312	89409
7C34-18080-DCB	77968		AX131A	83217		C6PF-18077-DL	83312	89409	D2TA-18045-AAA	83219	
7W7Z-18125-B	69574		AX85A	83219		C6PF-18077-DN	83314		D2TA-18045-ZA	83219	
87HU-18045-AA	85301		B3Q-18124-A	83219		C6PF-18077-F	83225		D2TF-18045-AA	83312	89409
8C24-18045-DA	83177		B3Q-18125-A	83217		C6TA-18045-U	85301		D2TF-18045-FA	83312	89409
8C24-18080-DB	83178		B3TZ-18125-A	83217		C6TA-18045-V	85301		D2TF-18045-GA	83308	
8C2Z-18124-D	83177		B6TZ-18124-A	83219		C6TA-18045-Y	85301		D2TF-18080-HA	83225	
8C2Z-18125-D	83178		B7C-18125-A	83217		C6TA-18045-Z	85301		D2TF-18080-NA	83217	
90044769	83207	89407	B7T-18124-C	83225		C6TS-18080-A	83217		D2TF-18124-F	83309	
90044770	83207	89407	B7TZ-18124-B	83216		C6TZ-18124-D	85301		D2TZ-18124-A	83308	
90045099	85906	89407	B7TZ-18124-C	83216		C6TZ-18124-E	85301		D2TZ-18124-E	83312	89409
90045132	85909		B7TZ-18124-D	83219		C6TZ-18124-H	85301		D2TZ-18124-F	83309	
9U94-18045-AA	83209	89414	B7TZ-18124-E	83217		C6TZ-18124-J	85301		D2TZ-18124-G	83314	
9U94-18080-AA	83122	89406	B7TZ-18125-C	83217		C7HZ-18124-A	83312	89409	D2TZ-18124-H	83308	
9U9Z-18124-A	83209	89414	B8Q-18125-A	85307		C7PF-18077-A	83225		D2TZ-18124-J	83312	89409
9U9Z-18125-A	83122	89406	B8QZ-18124-A	83312	89409	C7PF-18077-Z	83217		D3TA-18045-BA	83219	
AA-494	83131		B8TZ-18124-A	83219		C7TA-18045-R	83216		D3TZ-18124-B	83219	
AA-615	83135		B9TT-18045-C	83219		C7TA-18045-Z	85301		D3TZ-18125-C	83217	
AA-616	83175		B9TT-18045-D	83219		C8HA-18045-A	83312	89409	D3TZ-18125-D	83217	
AA-617	85928		C0TT-18045-A	83219		C8PF-18045-CM	83216		D4HA-18080-A	83209	89414
ASH-1022	83209	89414	C0TT-18045-D	83216		C8TA-18045-AA	G63386		D4HA-18080-AA	83209	89414
ASH-1023	83122	89406	C0TZ-18124-A	83216		D0HA-18045-D	83309		D4TF-18045-AA	83312	89409

**Important Note:** Competitive Interchanges are to be used for stocking purposes only. Where multiple crosses are identified, please reference the applications section of this catalog. / **Remarque importante:** Les interchanges concurrentiels ne s'utilisent qu'aux fins de stocks. Dans le cas de références multiples, consulter la section des applications du catalogue. / **Nota importante:** Dans le cas de références multiples, consulter la section des applications du catalogue. / **Nota importante:** Se pueden usar intercambios competitivos para propósitos de almacenamiento solamente. Cuando se identifican intercambios múltiples, consulte la sección de aplicaciones de este catálogo.

**COMPETITIVE & O.E.M. INTERCHANGE LIST**  
**Lista de Intercambios contra Competidores y Equipo Original.**  
**Liste d'interchange de produits compétitifs & d'équipement original (OEM)**

**FORD... cont'd**

O.E.M #	Gabriel	Upgrade	O.E.M #	Gabriel	Upgrade	O.E.M #	Gabriel	Upgrade	O.E.M #	Gabriel	Upgrade
D4TZ-18124-J	83308		E7HZ-18124-A	85301		F2HZ-18124-A	85376		F6HT-18080-DA	83109	
D5TZ-18124-B	83308		E7XZ-18124-A	G63386		F2HZ-18124-B	85301		F6HT-18080-EA	85906	89407
D5TZ-18124-C	83312	89409	E7XZ-18124-B	G63500		F2HZ-18124-C	85006		F6HT-18080-FA	85013	89414
D7HA-18080-AA	83123	89405	E7XZ-18124-C	G63511		F2HZ-18124-CA	85006		F6HT-18080-JA	85305	
D7HF-18045-FA	83312	89409	E7XZ-18124-D	G63396		F2HZ-18125-A	85712		F6HZ-18080-FC	85013	89414
D7HF-18080-AA	83215		E7XZ-18124-F	G63398		F2HZ-18125-AA	85712		F6HZ-18124-A	85054	
D7HF-18125-AA	83215		E7XZ-18124-G	G63398		F4HT-18045-AB	83314		F6HZ-18124-B	83308	
D7HT-18045-BA	83312	89409	E7XZ-18125-A	G63350		F4HT-18045-AC	83314		F6HZ-18124-C	85055	89439
D7HT-18045-CA	83314		E7XZ-18125-B	G63387		F4HT-18045-CB	83107		F6HZ-18124-D	85055	89439
D7HT-18045-DA	83309		E7XZ-18125-C	G63409		F4HT-18045-DA	85063		F6HZ-18124-E	85055	89439
D7HT-18045-EA	83312	89409	E7XZ-18125-D	G63406		F4HT-18045-EA	83125		F6HZ-18124-F	85055	89439
D7HT-18045-GA	83308		E7XZ-18125-E	G63406		F4HT-18080-AA	85314	89425	F6HZ-18124-G	85054	
D7HT-18045-HA	85012	89413	E7XZ-18125-G	G63811		F4HT-18080-AB	85314	89425	F6HZ-18124-H	85054	
D7HT-18045-JA	83308		E7XZ-18125-J	G63299		F4HT-18080-BA	85001	89410	F6HZ-18124-J		89402
D7HT-18045-NA	85301		E9HS-18045-AA	83309		F4TA-18045-TA	G63455		F6HZ-18124-KA		89402
D7HT-18080-AA	83215		E9HS-18080-AA	85716		F4TA-18080-PA	G63461		F6HZ-18124-MA	85006	
D7HT-18080-BA	83225		E9HZ-18124-A	83309		F4TZ-18124-D	G63414		F6HZ-18125-A	85314	89425
D7HT-18080-CA	83225		E9HZ-18125-A	85716		F4TZ-18124-K	G63455		F6HZ-18125-B	83109	
D7HT-18080-DA	83215		E9HZ-18125-AA	85716		F4TZ-18125-E	G63461		F6HZ-18125-D	85013	89414
D7HT-18124-BA	83312	89409	F0HS-18045-AA	85006		F4TZ-18125-L	G63406		F6HZ-18125-JA	85305	
D7HT-18124-CA	83314		F0HT-18045-AA	85006		F57Z-18125-AC	G63679		F77A-18045-AA	G63608	
D7HT-18124-DA	83309		F0HT-18045-CA	85006		F57Z-18125-BB	G63679		F77A-18080-AA	G63679	
D7HT-18124-EA	83312	89409	F0HT-18080-AA	83122	89406	F5HZ-18124-A	83314		F77A-18080-BA	G63607	
D7HT-18124-FA	83312	89409	F0HZ-18124-A	85006		F5HZ-18124-AA	83314		F77D-18080-BA	G63679	
D7HT-18124-GA	83308		F0HZ-18124-B	85006		F5HZ-18124-B	83107		F7C2Z-18124-BR	G63929	
D7HT-18124-HA	83219		F0HZ-18125-A	83122	89406	F5HZ-18124-C	85063		F7TA-18045-AA	G63608	
D7HT-18124-JA	83308		F1HT-18045-AA	83309		F5HZ-18124-D	83125		F7TA-18080-BA	G63607	
D7HT-18124-NA	85301		F1HT-18045-CA	83308		F5HZ-18124-DA	83125		F81A-18080-DCA	G63461	
D7HT-18125-BA	83217		F1HT-18045-CB	83216		F5HZ-18125-A	85314	89425	F81A-18080-ZC	83140	
D7HT-18125-CA	83217		F1HT-18045-DA	83312	89409	F5HZ-18125-AA	85314	89425	F81D-18045-CD	83209	89414
D7HT-18125-DA	83215		F1HT-18045-DB	83308		F5HZ-18125-B	85001	89410	F81D-18080-CD	83122	89406
D7HT-18125-FA	83123	89405	F1HT-18045-EA		89402	F5HZ-18125-BA	85001	89410	F81Z-18124-AL	G63622	
D7HZ-18125-A	83215		F1HT-18045-EB		89402	F5HZ-18125-DA	85314	89425	F81Z-18124-BK	G63809	
D7KF-18045-EA	83312	89409	F1HT-18045-GA	85006		F5TZ-18124-B	G63608		F81Z-18124-CA	83209	89414
D7TA-18124-GA	83314		F1HT-18045-GB	85006		F5TZ-18125-BC	G63607		F81Z-18124-PA	85928	
D7TZ-18125-C	83217		F1HT-18045-HB	85006		F5UZ-18124-A	G63622		F81Z-18125-DC	G63461	
D8HZ-18124-A	85301		F1HT-18045-KB	85006		F5UZ-18124-B	G63622		F81Z-18125-FA	83122	89406
D8HZ-18125-A	83209	89414	F1HT-18045-LB	85006		F5UZ-18125-A	G63623		F81Z-18125-ZA	83140	
D8HZ-18125-B	83123	89405	F1HT-18045-NA	85040		F5UZ-18125-C	G63624		F87A-18045-AH	G63772	
E0HT-18045-AA	83309		F1HT-18045-RA		89402	F6HT-18045-AA	85054		F87A-18045-CC	G63678	
E0HT-18045-AB	83309		F1HT-18045-RB		89402	F6HT-18045-AC	85054		F87A-18045-JA	G63678	
E0HT-18080-AA	83215		F1HZ-18124-A	83309		F6HT-18045-BC	85047	89435	F87A-18080-AC	G63773	
E0HZ-18124-A	83309		F1HZ-18124-AA	83309		F6HT-18045-CC	85055	89439	F87A-18080-BC	G63773	
E1TA-18045-AA	83309		F1HZ-18124-B	83308		F6HT-18045-EB	85055	89439	F87Z-18124-AA	G63772	
E1TD-18045-AA	83309		F1HZ-18124-C		89402	F6HT-18045-EC	85055	89439	F87Z-18124-CA	G63678	
E5HT-18045-AA	85301		F1HZ-18124-D	85006		F6HT-18045-EB	85055	89439	F87Z-18124-PA	G63678	
E5HT-18045-DA	85301		F1HZ-18124-E	85006		F6HT-18045-GB	85030	89440	F87Z-18125-AA	G63773	
E5HT-18045-EA	85301		F1HZ-18124-F	85006		F6HT-18045-GC	85030	89440	F87Z-18125-BA	G63773	
E5HT-18080-DA	85315		F1HZ-18124-G	85006		F6HT-18045-HB	85054		F87Z-18125-CA	G63773	
E5HT-18080-EA	85315		F1HZ-18124-H	85040		F6HT-18045-HC	85054		F87Z-18125-RA	G63775	
E6HT-18080-AA	83215		F1HZ-18124-J	83308		F6HT-18045-JB		89402	FC44-18045-BB	85181	
E6HZ-18124-A	85301		F1HZ-18124-K		89402	F6HT-18045-JC		89402	FC44-18080-AB	85180	
E6HZ-18124-D	85301		F2HT-18045-BA	85376		F6HT-18045-KA		89402	FC4Z-18124-A	85181	
E6HZ-18125-D	83215		F2HT-18045-CA	85376		F6HT-18045-LA	85376		FC4Z-18124-B	85181	
E6HZ-18125-E	85315		F2HT-18045-DA	85006		F6HT-18045-MA	85006		FC4Z-18124-HB	83135	
E6HZ-18125-F	85315		F2HT-18080-DA	85712		F6HT-18080-B	83109		FC4Z-18125-A	85180	
						F6HT-18080-CA	85314	89425			

**Important Note:** Competitive Interchanges are to be used for stocking purposes only. Where multiple crosses are identified, please reference the applications section of this catalog. / **Remarque importante:** Les interchanges concurrentiels ne s'utilisent qu'aux fins de stocks. Dans le cas de références multiples, consulter la section des applications du catalogue. / **Nota importante:** Dans le cas de références multiples, consulter la section des applications du catalogue. / **Nota importante:** Se pueden usar intercambios competitivos para propósitos de almacenamiento solamente. Cuando se identifican intercambios múltiples, consulte la sección de aplicaciones de este catálogo.

**COMPETITIVE & O.E.M. INTERCHANGE LIST**  
**Lista de Intercambios contra Competidores y Equipo Original.**  
**Liste d'interchange de produits compétitifs & d'équipement original (OEM)**

**FORD... cont'd**

O.E.M #	Gabriel	Upgrade	O.E.M #	Gabriel	Upgrade	O.E.M #	Gabriel	Upgrade	O.E.M #	Gabriel	Upgrade
TACAA-18045-A	83216		TDBE-18045-A	83219		XC3Z-18124-JA	83131		XL2Z-18124-JA	G63678	
TANNA-18045-A	83312	89409	TFAA-18045-B	83219		XC45-18045-AA	83216		XL2Z-18125-BA	G63679	
TBDA-18080-A	83217		TFAA-18045-C	83219		XL24-18045-BA	G63678		XL2Z-18125-CA	G63679	
TBDA-18080-B	83217		TFAA-18080-A	85307		XL24-18045-EA	G63678		XL2Z-18125-EA	G63679	
TDA A-18080-B	83217		THAB-18045-A	83219		XL24-18045-JA	G63678		XL58-18080-AC	G63773	
TDBA-18045-A	83219		THAB-18045-B	83219		XL24-18080-BA	G63679		XL5Z-18125-AA	G63773	
TDBA-18045-B	83219		TQSH-18045-A	83309		XL24-18080-CA	G63679		YL5Z-18124-AA	G63772	
TDBA-18080-A	83217		XC35-18045-AB	83131		XL24-18080-EA	G63679				
TDBA-18080-B	83217		XC35-18045-AD	83131		XL2Z-18124-BA	G63678				
TDBA-18080-C	83217		XC35-18045-JA	83131		XL2Z-18124-EA	G63678				

**FORD CAB SHOCKS**

O.E.M #	Gabriel	Upgrade	O.E.M #	Gabriel	Upgrade	O.E.M #	Gabriel	Upgrade	O.E.M #	Gabriel	Upgrade
1201-0012	83023		1202-0012	83023		1202-1043	83025		F6HZ-5K407-BA	83033	
1201-1043	83025		1202-0032	83016		1202-1044	83025		F8HT-5K407-AA	83033	
1201-1044	83025		1202-0042	83025		F6HZ-5K407-AB	83034				

**FOREST RIVER INC**

O.E.M #	Gabriel	Upgrade	O.E.M #	Gabriel	Upgrade	O.E.M #	Gabriel	Upgrade	O.E.M #	Gabriel	Upgrade
141700131809	85029		481700000493	85900		ASH-1154	83177		ASH-25824	83122	89406
141700131810	83160		66153-002	83124	89407	ASH-1205	83209	89414	ASH-294	83209	89414
16-16736-000	85029		9U94-18045-AA	83209	89414	ASH-1206	83122	89406	AT-620	83209	89414
16-16737-000	83160		9U94-18080-AA	83122	89406	ASH-1228	83209	89414	AT-621	83122	89406
16-16873-000	85029		9U9Z-18124-A	83209	89414	ASH-1229	83209	89414	AT-766	83209	89414
16-16874-000	83160		9U9Z-18125-A	83122	89406	ASH-1230	83122	89406	F4-BE5-C832-MO	83124	89407
16-18103-000	85900		ASH-1022	83209	89414	ASH-137	83122	89406			
1C34-18045-AA	83209	89414	ASH-1023	83122	89406	ASH-25822	83209	89414			
1C34-18045-JA	83209	89414	ASH-1136	83178		ASH-25823	83209	89414			

**FREIGHTLINER**

O.E.M #	Gabriel	Upgrade	O.E.M #	Gabriel	Upgrade	O.E.M #	Gabriel	Upgrade	O.E.M #	Gabriel	Upgrade
10-12030-002	85320	89429	16-13947-000	85319	89428	471700000440	85959	89503	60680-005	83142	
10-12032-000	85320	89429	16-13957-000	85724	89443	471700000449	85918	89449	60680-005L	83142	
10-12032-001	85320	89429	16-14259-000	85331		471700000470	85918	89449	61300224	85918	89449
10-12032-002	85320	89429	16-14577-000	85043		471700002808	85724	89443	61300240	85918	89449
10-12032-003	85320	89429	16-14667-000	85005	89430	471700002809	85724	89443	650224	83225	
10-12032-004	85320	89429	16-14668-000	83127		471700002990	85007		651352	85042	
10-12046-000	85320	89429	16-14669-000	G63403		471700002991	85959	89503	654654	85043	
10-12388-000	85920	89503	16-14759-000	85000	89436	471700002992	85331		654875	83117	
10-12390-000	85920	89503	16-15591-000	85043		471700002993	85921		654918	83118	
10-12396-000	85918	89449	16-15765-000	85921		471700002994	83134		659060	85920	89503
10-12542-000	85901		16-15770-000	85956		471700002995	83134		659062	83134	
10-12703-000	85918	89449	16-15817-000	85724	89443	471700002996	85335		659063	83134	
10-13021-000	85918	89449	16-16442-000	83134		471700003009	85006		659300	85005	89430
10-13051-001	85005	89430	16-16486-000	83134		471700003920	85958		660235	85042	
10-13063-000	85918	89449	16-16577-000	85335		471700006269	85932	89453	665174	85060	
10-13205-000	85918	89449	16-16765-000	85006		471700006929	85123		665236	85007	
10-13211-000	85918	89449	16-16826-000	85904		471700131155	85918	89449	665409	85009	
10-13592-000	85959	89503	16-17211-000	85909		471700131331	85932	89453	671908	85918	89449
10-13634-000	85918	89449	16-17759-000	85919		471700131646	85918	89449	671945	85920	89503
10-13684-000	85918	89449	16-18705-000	85007		47902-13	83122	89406	671946	85921	
10-13759-000	85006		16-18706-000	85331		481700006848	85724	89443	680008	85300	89419
10-13760-000	85959	89503	16-18707-000	85921		481700125969	85956		680009	85302	89420
10-13776-000	85005	89430	16-18708-000	85724	89443	535228	85302	89420	680017	85302	89420
10-13809-000	85958		16-18709-000	83134		58913-003	85932	89453	6803230200	85043	
10-13859-000	85005	89430	16-18710-000	83134		58913-003L	85932	89453	6803230300	85006	
10-13934-000	85123		16-18711-000	85335		58913-012	85932	89453			
16-10688-000	85042		16-19138-000	85058	89431	58913-012L	85932	89453			
16-11133-000	85007		3638112	G63183		60680-004	83143				
16-12117-000	85007		4036892	G63605		60680-004L	83143				

**Important Note:** Competitive Interchanges are to be used for stocking purposes only. Where multiple crosses are identified, please reference the applications section of this catalog. / **Remarque importante:** Les interchanges concurrentiels ne s'utilisent qu'aux fins de stocks. Dans le cas de références multiples, consulter la section des applications du catalogue. / **Nota importante:** Dans le cas de références multiples, consulter la section des applications du catalogue. / **Nota importante:** Se pueden usar intercambios competitivos para propósitos de almacenamiento solamente. Cuando se identifican intercambios múltiples, consulte la sección de aplicaciones de este catálogo.

# COMPETITIVE & O.E.M. INTERCHANGE LIST

## Lista de Intercambios contra Competidores y Equipo Original.

### Liste d'interchange de produits compétitifs & d'équipement original (OEM)

#### FREIGHTLINER... cont'd

O.E.M #	Gabriel	Upgrade	O.E.M #	Gabriel	Upgrade	O.E.M #	Gabriel	Upgrade	O.E.M #	Gabriel	Upgrade
6803260000	83120		680782	85302	89420	70042	85302	89420	HDR60680-005	83142	
680339	85724	89443	681-323-0900	85009		90044162	83128	89436	SDA47170000440	85959	89503
680442	85319	89428	681-323-1100	85301		90045083	85910		SDA471700002809	85724	89443
680511	85331		681-326-0400	85319	89428	GBL654725	83120		SDA471700002991	85959	89503
680611	85724	89443	6813230900	85009		GBL665538	85006		SDA471700003920	85958	
680651	85335		70029	85308	89422	H60680004	83143		SDA481700125969	85956	

#### FREIGHTLINER CAB SHOCKS

O.E.M #	Gabriel	Upgrade	O.E.M #	Gabriel	Upgrade	O.E.M #	Gabriel	Upgrade	O.E.M #	Gabriel	Upgrade
1201-0012	83023		18-31476-000	83020		18-60765-001	83047		659080	83039	
1201-0054	83021		18-32999-000	83001		18-60765-002	83038		659125	83047	
1201-1043	83025		18-32999-001	83006		18-60766-000	83040		659178	83038	
1201-1044	83025		18-37813-000	83044		18-60767-000	83039		659288	83006	
1202-0012	83023		18-41762-000	83038		18-60769-000	83009		681-891-02-05	83017	
1202-0032	83016		18-41762-001	83047		18-60772-000	83026		814903003482	83040	
1202-0042	83025		18-41762-002	83038		18-60773-000	83027		814903003483	83039	
1202-0043	83025		18-42613-000	83033		18-67845-000	83906		814903003486	83047	
1202-0044	83025		18-44321-000	83009		18-69674-000	83906		814903003496	83009	
1202-0054	83021		18-45067-000	83034		654739	83009		814903003528	83038	
1202-1043	83025		18-47349-000	83039		654819	83001		814903012666	83906	
1202-1044	83025		18-47350-000	83040		654831	83006		814903015188	83906	
18-29846-000	83009		18-60295-000	83006		654841	83020		GBL 650361	83017	
18-30378	83006		18-60764-000	83038		654990	83038				
18-30378-000	83001		18-60765-000	83038		659079	83040				

#### FREIGHTLINER CUSTOM CHASSIS

O.E.M #	Gabriel	Upgrade	O.E.M #	Gabriel	Upgrade	O.E.M #	Gabriel	Upgrade	O.E.M #	Gabriel	Upgrade
10-13211-000	85918	89449	16-15934-000	83120		16-18103-000	85900		654918	83118	
10-13634-000	85918	89449	16-16043-000	85043		16-18455-000	85918	89449	654953	85058	89431
10-13759-000	85006		16-16082-000	85043		16-18456-000	85959		659227	85058	89431
10-13859-000	85005	89430	16-16083-000	85331		16-18708-000	85724	89443	665545401		89430
1398980	83127		16-16093-000	83160		16-18713-000	85122		6803230300	85006	
141700000378	83160		16-16262-000	83120		16-19138-000	85058	89431	6803260000	83120	
141700131809	85029		16-16542-000	83154		1745500		89430	GBL 651375	83119	
141700131810	83160		16-16736-000	85029		471700000447	85919		GBL654725	83120	
141700131975	83160		16-16737-000	83160		471700000466	85959		GBL654875	83117	
16-14794-000	83154		16-16765-000	85006		471700002726	85918	89449	GBL654918	83118	
16-15064-000	83154		16-16827-000	85331		471700002727	85959		GBL665538	85006	
16-15089-000	83164		16-16836-000	83154		471700003009	85006		MAE 16949	83120	
16-15394-000	83120		16-16873-000	85029		471700003011	85058	89431	MAE 16950	83118	
16-15436-000	83154		16-16874-000	83160		471700003070	85122		MAE16950	83118	
16-15475-000	83164		16-17144-000	85900		471700005079	85005	89430	P116168	83117	
16-15592-000	83154		16-17361-000	85900		471700131775	85006		P117099	83120	
16-15676-000	85058	89431	16-17684-000	85058	89431	471700131778	85331		P117146	83118	
16-15705-000	83120		16-17759-000	85919		471700131974	85029		RW24285	83119	
16-15755-000	85043		16-17760-000	85331		481700000477	85900				
16-15805-000	83120		16-18076-000	83160		481700000493	85900				
16-15817-000	85724	89443	16-18094-000	85959		481700131919	85900				

#### FRUEHAUF

O.E.M #	Gabriel	Upgrade	O.E.M #	Gabriel	Upgrade	O.E.M #	Gabriel	Upgrade	O.E.M #	Gabriel	Upgrade
144-5910	85300	89419	UCA-01113	85304		UCE-1295-901	85300	89419	UCF-8339-001	85321	
5116-117	83122	89406	UCA-5431	85305		UCE-2983-000	85322		UCF-8339-002	85321	
5352858	85305		UCD-006216-001	83203	89436	UCE-2983-001	85322		UEY 1124-001	85030	89440
680117	85300	89419	UCD-6216-1	83203	89436	UCE-2983-1	85322				
680298	85321		UCE-1295-1	85300	89419	UCE-9399-1	83122	89406			

#### FWD TRUCK

O.E.M #	Gabriel	Upgrade	O.E.M #	Gabriel	Upgrade	O.E.M #	Gabriel	Upgrade	O.E.M #	Gabriel	Upgrade
450739	85302	89420									

**Important Note:** Competitive Interchanges are to be used for stocking purposes only. Where multiple crosses are identified, please reference the applications section of this catalog. / **Remarque importante:** Les interchanges concurrentiels ne s'utilisent qu'aux fins de stocks. Dans le cas de références multiples, consulter la section des applications du catalogue. / **Nota importante:** Dans le cas de références multiples, consulter la section des applications du catalogue. / **Nota importante:** Se pueden usar intercambios competitivos para propósitos de almacenamiento solamente. Cuando se identifican intercambios múltiples, consulte la sección de aplicaciones de este catálogo.

**COMPETITIVE & O.E.M. INTERCHANGE LIST**  
**Lista de Intercambios contra Competidores y Equipo Original.**  
**Liste d'interchange de produits compétitifs & d'équipement original (OEM)**

**GENERAL TRAILER CO**

O.E.M #	Gabriel	Upgrade	O.E.M #	Gabriel	Upgrade	O.E.M #	Gabriel	Upgrade	O.E.M #	Gabriel	Upgrade
120-1	83125		12608	83125							

**GEORGIE BOY MANUFACTURING**

O.E.M #	Gabriel	Upgrade	O.E.M #	Gabriel	Upgrade	O.E.M #	Gabriel	Upgrade	O.E.M #	Gabriel	Upgrade
1C34-18045-AA	83209	89414	ASH-1022	83209	89414	ASH-1229	83209	89414	AT-620	83209	89414
1C34-18045-JA	83209	89414	ASH-1023	83122	89406	ASH-1230	83122	89406	AT-621	83122	89406
66153-002	83124	89407	ASH-1136	83178		ASH-137	83122	89406	AT-766	83209	89414
9U94-18045-AA	83209	89414	ASH-1154	83177		ASH-25822	83209	89414	F4-BE5-C832-MO	83124	89407
9U94-18080-AA	83122	89406	ASH-1205	83209	89414	ASH-25823	83209	89414			
9U9Z-18124-A	83209	89414	ASH-1206	83122	89406	ASH-25824	83122	89406			
9U9Z-18125-A	83122	89406	ASH-1228	83209	89414	ASH-294	83209	89414			

**GILLIG BROS.**

O.E.M #	Gabriel	Upgrade	O.E.M #	Gabriel	Upgrade	O.E.M #	Gabriel	Upgrade	O.E.M #	Gabriel	Upgrade
1583470	85051		57113	83219		82-21542-000	85716		90044683	83122	89406
200-171	85304		57131	83216		82-30159-000	85708		90044769	83207	89407
53-02132	85723		665568	85051		90-1908	85723		90044770	83207	89407
53-02133-000	85318		680009	85302	89420	90-1951-SP1	85734		90F-1912	85318	
53-13952-000	85722		680333	85708		90-1968	85712		H53-02132-14005	85723	
53-14005-000	85723		695109	85723		90-2164 SP1	85723		H53-20415-006	85051	
53-14010	85318		695110	85318		90-2423	85723		MR6394	85723	
53-176	85304		70034	85302	89420	90-2627		89461			
53-24685	85723		82-01878	83122	89406	90044046	83123	89405			

**GLAVAL BUS CO.**

O.E.M #	Gabriel	Upgrade	O.E.M #	Gabriel	Upgrade	O.E.M #	Gabriel	Upgrade	O.E.M #	Gabriel	Upgrade
3578858C1	85926		4C4Z-18124-JB	85928		AA-617	85928		FC44-18045-BB	85181	
3578858C2	85926		4C4Z-18124-QA	83175		ASH-1136	83178		FC44-18080-AB	85180	
3584116C1	83175		4C4Z-18124-RA	85928		ASH-1154	83177		FC4Z-18124-A	85181	
3584116C2	83175		4C4Z-18125-B	83317		ASH-24658	85181		FC4Z-18124-B	85181	
3584118C2	85928		4C4Z-18125-DA	85926		ASH-24659	85181		FC4Z-18125-A	85180	
471700011530	85181		501906C92	83317		ASH-24660	85180				
471700011531	85180		AA-616	83175		AT-812	85928				

**GMC TRUCK**

O.E.M #	Gabriel	Upgrade	O.E.M #	Gabriel	Upgrade	O.E.M #	Gabriel	Upgrade	O.E.M #	Gabriel	Upgrade
1-51630-168-1	83515		22007751	83303		22046483	85304		3171696	85307	
1-51630-217-0	83114		22007752	83304		22046489	85303	89422	3172948	85303	89422
1-51630-217-1	83114		22007753	83303		22052014	85702		3175509	85735	
1-51630-219-1	83114		22007757	83304		22052336	85304		3178106	85700	
12474915	83122	89406	22012065	85304		22064230	83136		3178157	85700	
12474917	83137		22012067	85700		22064232	85071		3178233	85734	
15123676	83136		22012082	85702		22064233	83136		3178507	85700	
15174898	83136		22012083	85711		22064432	83221		3178995	85700	
15174902	85071		22012083GS	85711		22064489	85336		3182842	85711	
15185643	83153		22012090	85308	89422	22064804	83136		3188599	85711	
15588554	83136		22012091	85303	89422	22064805	83136		3188626	85300	89419
15642943	83136		22012095	83126	89430	22064806	83136		3188729	85303	89422
15740554	83137		22012096	83221		22064807	83136		3189265	85700	
15887728	83136		22012114	85700		22065218	G63347		3192333	85700	
1591501	85722		22012131	85711		22065251	85030	89440	3192416	85711	
15963161	83122	89406	22012166	83126	89430	22099889	85336		3192657	83216	
19152843	83136		22012169	83221		22165187	83136		3192890	83126	89430
21998392	85336		22012196	83221		22165188	83136		3192891	83221	
22002293	83126	89430	22017530	83303		22165189	83136		3192892	83221	
22002294	83304		22017531	83303		22166442	83136		35901-0001	83209	89414
22002295	83303		22024061	85704		3082284	83400		35901-0003	85301	
22007701	83126	89430	22025067	85704		3166657	85700				
22007702	83304		22025305	85704		3171068	83216				
22007703	83303		22045526	85702		3171069	85304				
22007750	83207	89407	22046481	85702		3171462	83126	89430			

**Important Note:** Competitive Interchanges are to be used for stocking purposes only. Where multiple crosses are identified, please reference the applications section of this catalog. / **Remarque importante:** Les interchanges concurrentiels ne s'utilisent qu'aux fins de stocks. Dans le cas de références multiples, consulter la section des applications du catalogue. / **Nota importante:** Dans le cas de références multiples, consulter la section des applications du catalogue. / **Nota importante:** Se pueden usar intercambios competitivos para propósitos de almacenamiento solamente. Cuando se identifican intercambios múltiples, consulte la sección de aplicaciones de este catálogo.

**COMPETITIVE & O.E.M. INTERCHANGE LIST**  
**Lista de Intercambios contra Competidores y Equipo Original.**  
**Liste d'interchange de produits compétitifs & d'équipement original (OEM)**

**GMC TRUCK... cont'd**

O.E.M #	Gabriel	Upgrade	O.E.M #	Gabriel	Upgrade	O.E.M #	Gabriel	Upgrade	O.E.M #	Gabriel	Upgrade
35901-0004	83219		5316784	85700		5534447	85303	89422	8-97201-960-0	83515	
35901-0005	83219		5316791	83219		5544060	85302	89420	8-97253-620-0	83515	
35901-0017	83314		5316792	85305		5544112	83216		8-97253664-0	83159	
37301-0016	85026	89417	5316793	85305		5544581	85302	89420	8-97253665-0	83159	
37301-0021	85026	89417	5316794	85700		5544716	85304		87-2520-00003	85704	
37301-3202	85026	89417	5321920	85307		5544717	85304		88963409	85336	
4939852	85308	89422	5321929	85307		5544812	83308		88982682	83136	
4939967	85308	89422	5348631	83203	89436	5544818	85735		88982684	83136	
4940600	83209	89414	5352857	85700		5549899	83207	89407	88982686	85071	
4940601	83216		5352858	85305		5549924	85700		88982688	85336	
4940606	83126	89430	5353054	85303	89422	5549925	85304		898098-0580	83159	
4940614	83216		5355798	85307		5552111	85304		898098-0581	83159	
4940627	83203	89436	5357955	85300	89419	5552112	85307		898098-0590	83159	
4940640	83216		5357956	85734		5552114	83216		898098-1250	83515	
4940650	83207	89407	5357959	85300	89419	5552205	83217		898098-1270	83515	
4940654	83216		5361994	85734		5552206	83214		9-51630-647-1	83515	
4940660	83207	89407	5374779	85308	89422	5552207	83217		9-51630-666-0	85012	89413
4940662	83126	89430	5374999	85307		5552208	83217		9-51630-666-2	85012	89413
4963844	85307		5385939	85307		5552209	83215		90044769	83207	89407
4963853	83216		5392387	85303	89422	5552210	85308	89422	90044770	83207	89407
4963854	83216		5394448	85305		5552244	85308	89422	94033786	83114	
4964853	83217		5394467	85305		5552285	83214		94051090	83114	
4974401	85700		5394468	85735		5552286	83217		94057593	83114	
4975429	85300	89419	5455798	85307		5552287	83217		94454987	83515	
4975467	83207	89407	5513489	83216		5552288	83217		97-2210-00156	85702	
4975479	83400		5513716	85304		5552451	85308	89422	97-2210-00164	85708	
4975480	83400		5516459	85305		5552452	85303	89422	97-2210-00170	85733	
4975494	83207	89407	5522781	85735		5552453	85301		97083027	83515	
4975497	83126	89430	5522794	85308	89422	5552454	85302	89420	97083029	83515	
4975501	85700		5522818	85305		5552456	85307		97201960	83515	
4975510	83221		5527001	85300	89419	5552527	85735		97253616	83515	
4975511	83303		5527271	85700		5554184	85302	89420	97253620	83515	
4975516	85702		5527272	85700		5554589	85307		97253621	83515	
4975518	85704		5527606	85305		5554596	85303	89422	97253623	83515	
4975538	85700		5531027	85301		5554814	85302	89420	97253651	83159	
4975549	83216		5531435	85307		5554959	83401		97253664	83159	
4975550	85702		5531436	85307		5554995	85305		97253665	83159	
4975552	85711		5531437	85307		5559363	83203	89436	98098058	83159	
4984526	83216		5532026	85304		5585939	85307		98098059	83159	
507-16	85702		5532425	83207	89407	684280	83209	89414	98098125	83515	
507-19	85700		5532433	83207	89407	8-51630-666-0	85012	89413	98098127	83515	
507-24	85336		5532675	85307		8-94057-593-0	83114		98232671	83515	
508-88	83153		5533699	85302	89420	8-94454-986-0	83515		U0109-014	83400	
5171068	83216		5534430	85303	89422	8-94454-987-0	83515				
5304059	85700		5534439	85304		8-97083-029-0	83515				

**GMC TRUCK CAB SHOCKS**

O.E.M #	Gabriel	Upgrade	O.E.M #	Gabriel	Upgrade	O.E.M #	Gabriel	Upgrade	O.E.M #	Gabriel	Upgrade
1201-1043	83025		1202-0032	83016		1202-1043	83025				
1202-0012	83023		1202-0054	83021							

**GOLD**

Gold	Gabriel	Upgrade	Gold	Gabriel	Upgrade	Gold	Gabriel	Upgrade	Gold	Gabriel	Upgrade
5000736	83039		5000744	85090		5000750	83035		5000761	85024	
5000738	85071		5000745	83314		5000751	85055	89439	5000762	83160	
5000740	83105		5000745	85013	89414	5000754	83015				
5000741	83136		5000747	83101		5000758	85055	89439			
5000742	83308	89435	5000748	83135		5000759	83142				
5000743	83107		5000749	85308	89422	5000760	85934				

**Important Note:** Competitive Interchanges are to be used for stocking purposes only. Where multiple crosses are identified, please reference the applications section of this catalog. / **Remarque importante:** Les interchanges concurrentiels ne s'utilisent qu'aux fins de stocks. Dans le cas de références multiples, consulter la section des applications du catalogue. / **Nota importante:** Dans le cas de referencias multiples, consultar la sección de aplicaciones del catálogo. / **Nota importante:** Se pueden usar intercambios competitivos para propósitos de almacenamiento solamente. Cuando se identifican intercambios múltiples, consulte la sección de aplicaciones de este catálogo.

**COMPETITIVE & O.E.M. INTERCHANGE LIST**  
**Lista de Intercambios contra Competidores y Equipo Original.**  
**Liste d'interchange de produits compétitifs & d'équipement original (OEM)**

**GOLD... cont'd**

Gold	Gabriel	Upgrade	Gold	Gabriel	Upgrade	Gold	Gabriel	Upgrade	Gold	Gabriel	Upgrade
5000764	85957		5000850	83053		8160848	85088		9160697	G63622	
5000765	83216		5000852	85376		8160849	83051		9160761	G63461	
5000768	83401		5000853	83101		8160906	83147		9160789	G63866	
5000769	83063		5000855	83154		8160907	85036	89405	9160820	83312	89409
5000772	85120		5000856	85978		8160908	83019		9160932	83156	
5000773	85065		5000857	85929		8160909	83123	89405	9160933	83209	89414
5000776	85005	89430	5000859	83031		8160910	83050		9160934	83047	
5000777	83143		5000861	83025		8160911	83041		9160936	83048	
5000778	83054		5000862	83140		8160912	83001		9160972	83025	
5000781	85926		5000865	85910		8160935	83140		9160976	83053	
5000782	83017		5000869	83216		8160938	85062	89408	9160980	83135	
5000783	83025		5000870	83022		8170098	85045		9160983	83112	
5000784	85080		5000871	83164		8180050	85001	89410	9170007	85918	89449
5000785	83216		5000872	85082		8180139	85936	89456	9180126	85012	89413
5000786	83103		5000873	85745		8180171	85958		9180130	85005	89430
5000787	85938		5000874	85091		8180172	85919		9180131	85001	89410
5000789	83110		5000877	85722		8180173	85954		9180134	85921	
5000790	83180		5000879	85970		8190008	85320	89429	9180136	83128	89436
5000791	83157		5000880	85711		8190076	85300	89419	9180137	85924	89457
5000792	83134		5000881	85736		8190087	85738		9180138	85954	
5000793	83400		8150240	83125		8190096	85729		9180140	85061	89450
5000796	632147		8150241	83207	89407	8190097	85727		9180142	85323	89436
5000797	85307		8150242	83128	89436	9150063	83216		9180143	85918	89449
5000798	85712		8150243	83009		9150639	83009		9180144	85303	89422
5000799	85711		8150371	83127		9160091	85006		9180145	85067	89451
5000800	85736		8150372	83137		9160092	85043		9180146	85033	89427
5000802	85341		8160090	85000	89436	9160093	83317		9180147	83136	
5000804	85308	89422	8160091	85006		9160094	85003	89411	9180148	85064	
5000806	83027		8160098	83456	89447	9160095	85062	89408	9180149	85900	
5000807	85343		8160099	83318		9160096	85001	89410	9180151	85070	89459
5000808	85916	89430	8160100	85052		9160097	85001	89410	9180152	85003	89411
5000809	83635		8160101	85001	89410	9160117	85320	89429	9180153	85931	89458
5000813	83221		8160102	83215		9160121	85067	89451	9180184	83163	
5000816	85956		8160103	83312	89409	9160190	85070	89459	9180186	85933	89454
5000818	83120		8160111	85066	89448	9160268	85058	89431	9180187	85084	89460
5000819	83067		8160112	85061	89450	9160470	83124	89407	9180188	85069	89455
5000822	83004		8160113	85931	89458	9160488	83456	89447	9180190	85072	
5000825	83225		8160114	85918	89449	9160493	83136		9180191	85053	89442
5000826	85029		8160115	85031		9160498	83136		9180192	85026	89417
5000827	85908		8160116	85012	89413	9160500	85000	89436	9180193	85030	89440
5000828	83044		8160118	85900		9160513	85029		9180194	85014	
5000830	83175		8160119	85902		9160536	85005	89430	9180195	83111	
5000831	83024		8160120	85069	89455	9160538	85045		9180196	83122	89406
5000835	83150		8160189	85937		9160539	83203	89436	9180197	85046	89434
5000839	83131		8160195	85013	89414	9160540	85052		9180198	85901	
5000840	83162		8160195	85043		9160545	83154		9180199	85301	
5000844	83030		8160522	83029		9160546	83008		9190007	85724	89443
5000849	85054	89438	8160523	83021		9160547	83001		9450993	646155	

**GOSHEN COACH**

O.E.M #	Gabriel	Upgrade	O.E.M #	Gabriel	Upgrade	O.E.M #	Gabriel	Upgrade	O.E.M #	Gabriel	Upgrade
ASH-1136	83178		ASH-1154	83177							

**GRANNING SUSPENSION**

O.E.M #	Gabriel	Upgrade	O.E.M #	Gabriel	Upgrade	O.E.M #	Gabriel	Upgrade	O.E.M #	Gabriel	Upgrade
1085	83214		680162	85300	89419	OE12425	83214				
2697	85712		701071-01	646155							

**Important Note:** Competitive Interchanges are to be used for stocking purposes only. Where multiple crosses are identified, please reference the applications section of this catalog. / **Remarque importante:** Les interchanges concurrentiels ne s'utilisent qu'aux fins de stocks. Dans le cas de références multiples, consulter la section des applications du catalogue. / **Nota importante:** Dans le cas de références multiples, consulter la section des applications du catalogue. / **Nota importante:** Se pueden usar intercambios competitivos para propósitos de almacenamiento solamente. Cuando se identifican intercambios múltiples, consulte la sección de aplicaciones de este catálogo.



# COMPETITIVE & O.E.M. INTERCHANGE LIST

## Lista de Intercambios contra Competidores y Equipo Original.

### Liste d'interchange de produits compétitifs & d'équipement original (OEM)

#### GREAT DANE TRAILER

O.E.M #	Gabriel	Upgrade	O.E.M #	Gabriel	Upgrade	O.E.M #	Gabriel	Upgrade	O.E.M #	Gabriel	Upgrade
18163-01	83207	89407	HENS-20002	85000	89436	HENS-23649	85064		REY18165-01	85006	
18164-01	83122	89406	HENS-20126	85323	89436	HENS-24088	83128	89436			
18165-01	85006		HENS-21292	85052		HENS-24088	85000	89436			
HENS-20001	83128	89436	HENS-23566	85000	89436	MER202447	85919				

#### GRECH MOTORS

O.E.M #	Gabriel	Upgrade	O.E.M #	Gabriel	Upgrade	O.E.M #	Gabriel	Upgrade	O.E.M #	Gabriel	Upgrade
ASH-1136	83178		ASH-1154	83177							

#### GREYHOUND BUS

O.E.M #	Gabriel	Upgrade	O.E.M #	Gabriel	Upgrade	O.E.M #	Gabriel	Upgrade	O.E.M #	Gabriel	Upgrade
12B-5-1	85735		3166657	85700		3178157	85700		690029	85700	
12TA-01-013	85303	89422	3178154	85735		3192333	85700				

#### GRUMMAN BUS

O.E.M #	Gabriel	Upgrade	O.E.M #	Gabriel	Upgrade	O.E.M #	Gabriel	Upgrade	O.E.M #	Gabriel	Upgrade
22024506	85703		690029	85700		97-2201-00004	85703		97-2210-00003	85704	
22025066	85703		97-2201-00001	85703		97-2201-00005	85703		97-2210-00004	85704	
22025067	85704		97-2201-00002	85703		97-2210-00001	85704		97-2210-00005	85704	
22025305	85704		97-2201-00003	85703		97-2210-00002	85704				

#### GULF STREAM COACH

O.E.M #	Gabriel	Upgrade	O.E.M #	Gabriel	Upgrade	O.E.M #	Gabriel	Upgrade	O.E.M #	Gabriel	Upgrade
141700131809	85029		16-16737-000	83160		16-18103-000	85900		ASH-1154	83177	
141700131810	83160		16-16873-000	85029		481700000493	85900				
16-16736-000	85029		16-16874-000	83160		ASH-1136	83178				

#### HARDEE MFG

O.E.M #	Gabriel	Upgrade	O.E.M #	Gabriel	Upgrade	O.E.M #	Gabriel	Upgrade	O.E.M #	Gabriel	Upgrade
8030223	83207	89407	AS789B	85014							

#### HAUSMAN

O.E.M #	Gabriel	Upgrade	O.E.M #	Gabriel	Upgrade	O.E.M #	Gabriel	Upgrade	O.E.M #	Gabriel	Upgrade
695110	85318		695119	85702							

#### HENDRICKSON TRAILER SUSPENSION SYSTEMS

O.E.M #	Gabriel	Upgrade	O.E.M #	Gabriel	Upgrade	O.E.M #	Gabriel	Upgrade	O.E.M #	Gabriel	Upgrade
57905-2	85006		671779		89414	A-14583	85000	89436	B-21832	85323	89436
60675-004	85006		671948	85000	89436	A-1667	85000	89436	B-21936	85064	
654951	85000	89436	680102	85712		A-1668	85000	89436	B-21947	85052	
659024	85052		680341	85323	89436	A-20001	83128	89436	B-21994	85938	
665190	85006		680463		89440	A-20002	85000	89436	B-21995	85344	
665246	85043		680467	85323	89436	A-20126	85323	89436	B-22311	85045	
665267	85029		680509	85738		A-20345	85345		B-22312	85939	
665405	85030	89440	680565	85738		A-20886	85030	89440	B-22345	85911	
665406	85010		680566	85938		A-20887	85005	89430	B-22715	85000	89436
665531	85000	89436	680568	85323	89436	A-20889	85323	89436	B-22862	85045	
665532	85013	89414	680570		89437	A-21292	85052		B-23013	85000	89436
665533	85005	89430	680571	85738		A-2160	85014		B-23014	85738	
665536	85000	89436	680573	85939		A-2212	85029		B-23290	83150	
665693	85064		680579	85939		A-2213	85010		B-23315	85029	
665694	85052		680614	85338		A-2218	85030	89440	B-23316	85382	
665698	85911		680616		89430	A-2230	85005	89430	B-23361	85911	
665733	85045		680617	85337		A-2232	85005	89430	B-23362		89437
665756	85000	89436	680702	85323	89436	A-2240	85013	89414	B-23548	85079	
665758	85064		680756	85323	89436	A-2240-1	85043		B-23566	85000	89436
665759	85052		680769	85911		A-2471	85006		B-23649	85064	
665760	85045		680776	85338		A-4084	85005	89430	B-23650	85052	
665761	85911		98583-019	85323	89436	A-4089	83209	89414	B-23651	85045	
665763	85079		98583-020		89414	A-4890	85712		B-23743	85938	
665764	85029		A-10023	85000	89436	A-6156	85301				
665765	83150		A-10348	85043		B-20345	85345				
665766	85000	89436	A-11931	85000	89436	B-21553	85738				
665767	85045		A-14496	646155		B-21699	87018				

**Important Note:** Competitive Interchanges are to be used for stocking purposes only. Where multiple crosses are identified, please reference the applications section of this catalog. / **Remarque importante:** Les interchanges concurrentiels ne s'utilisent qu'aux fins de stocks. Dans le cas de références multiples, consulter la section des applications du catalogue. / **Nota importante:** Dans le cas de références multiples, consulter la section des applications du catalogue. / **Nota importante:** Se pueden usar intercambios competitivos para propósitos de almacenamiento solamente. Cuando se identifican intercambios múltiples, consulte la sección de aplicaciones de este catálogo.

**COMPETITIVE & O.E.M. INTERCHANGE LIST**  
**Lista de Intercambios contra Competidores y Equipo Original.**  
**Liste d'interchange de produits compétitifs & d'équipement original (OEM)**

**HENDRICKSON TRAILER SUSPENSION SYSTEMS... cont'd**

O.E.M #	Gabriel	Upgrade	O.E.M #	Gabriel	Upgrade	O.E.M #	Gabriel	Upgrade	O.E.M #	Gabriel	Upgrade
B-23744	85344		S-1667	85000	89436	S-22312	85939		S-24088	83128	89436
B-24023	85738		S-1668	85000	89436	S-2232	85005	89430	S-24088	85000	89436
B-24088	83128	89436	S-20001	83128	89436	S-22345	85911		S-24125	85323	89436
B-24088	85000	89436	S-20002	85000	89436	S-2240	85013	89414	S-24579	85939	
B-24125	85323	89436	S-20126	85323	89436	S-22715	85000	89436	S-2471	85006	
B-24579	85939		S-20345	85345		S-22862	85045		S-25436	85916	89430
B-25174	85029		S-20886	85030	89440	S-23013	85000	89436	S-25437	85337	
B-25436	85916	89430	S-20887	85005	89430	S-23014	85738		S-25515	85338	
B-25437	85337		S-20889	85323	89436	S-23290	83150		S-26652	85000	89436
B-25515	85338		S-21292	85052		S-23315	85029		S-29432	85323	89436
B-26652	85000	89436	S-21553	85738		S-23316	85382		S-29678	85911	
B-27058	83128	89436	S-2160	85014		S-23361	85911		S-29826	85338	
B-27747	85911		S-21699	87018		S-23362		89437	S-33312	85338	
B-29432	85323	89436	S-21832	85323	89436	S-23548	85079		S-33313	85338	
B-29678	85911		S-21936	85064		S-23566	85000	89436	S-33313L	85338	
B-29826	85338		S-21947	85052		S-23649	85064		S-4084	85005	89430
B-33312	85338		S-2212	85029		S-23650	85052		S-4089	83209	89414
B-33313	85338		S-2213	85010		S-23651	85045		S-4890	85712	
NS500699	85005	89430	S-2218	85030	89440	S-23743	85938				
S-10348	85043		S-2230	85005	89430	S-23744	85344				
S-14583	85000	89436	S-22311	85045		S-24023	85738				

**HENDRICKSON TRUCK SUSPENSION SYSTEMS**

O.E.M #	Gabriel	Upgrade	O.E.M #	Gabriel	Upgrade	O.E.M #	Gabriel	Upgrade	O.E.M #	Gabriel	Upgrade
12738	83225		57905-1	85976		60665-005L	85919		60675-001	85978	
471700000456	85959		58623-1	85978		60665-008	85978		60675-001L	85978	
471700006269	85932	89453	58913-003	85932	89453	60665-009	85904		60675-002	85979	
471700131545	85006		58913-003L	85932	89453	60665-011	85967		60675-002L	85979	
47902-11	83207	89407	58913-007	85959		60665-013	85965		60675-003	85976	
47902-13	83122	89406	58913-007L	85959		60665-014	85962		60675-003L	85976	
47902-15	83137		58913-008	85959		60665-018	85961		60675-006	85909	
47902-18	85030	89440	58913-008L	85959		60665-018L	85961		60675-006L	85909	
47902-19	83123	89405	58913-009	85959		60665-020	85919		60675-014	85978	
47902-20	85036	89405	58913-009L	85959		60665-025	85036	89405	60675-017	85979	
47902-21	85976		58913-011	85959		60665-025L	85036	89405	60675-12	85638	
47902-22	85916	89430	58913-011L	85959		60670-001	83123	89405	60675-8Q	85976	
47902-24	83137		58913-012	85932	89453	60670-002	83207	89407	60680-001	83111	
47902-25	83125		58913-012L	85932	89453	60670-002L	83207	89407	60680-001L	83111	
47902-26	83144		59048-001	83148		60670-003	83149		60680-002	83109	
47902-27	83123	89405	59057-001	83137		60670-004	83123	89405	60680-003	83112	
47902-28	85013	89414	59057-002	85036	89405	60670-005	83137		60680-003L	83112	
47902-29	83149		59305-1	85979		60670-006	83147		60680-004	83143	
47902-3	85005	89430	59483-000	85919		60670-006L	83147		60680-004L	83143	
47902-8	83122	89406	59851-1	85976		60670-007	83144		60680-005	83142	
47902-9	83123	89405	59852-1	85977		60670-007L	83144		60680-005L	83142	
503610C2	83207	89407	59852-2	85977		60670-008	83123	89405	60685-001	85977	
5554596	85303	89422	60657-003	85072		60670-008L	83123	89405	60998-001	85006	
57241-001	83111		60657-003L	85072		60670-009	85013	89414	60998-002	85919	
57241-002	83109		60657-005	85087		60670-010	83149		60998-002L	85919	
57241-003	83112		60657-005L	85087		60670-011	83148		60998-003	85006	
57241-004	83110		60657-006	85102		60670-012	83168		64838-001	85933	89454
57241-006	83111		60657-007	85072		60670-013	83148		64838-001L	85933	89454
57241-006L	83111		60657-010	85102		60670-014	83166		64838-002	85933	89454
57324-1	85036	89405	60657-011	85102		60670-017	83148		64838-002L	85933	89454
57324-11	85305		60665-003	83137		60670-018	83166				
57324-2	85976		60665-004	85036	89405	60670-019	83166				
57324-3	85916	89430	60665-004L	85036	89405	60670-020	83148				
57324-6	85904		60665-005	85919		60670-12	83168				

**Important Note:** Competitive Interchanges are to be used for stocking purposes only. Where multiple crosses are identified, please reference the applications section of this catalog. / **Remarque importante:** Les interchanges concurrentiels ne s'utilisent qu'aux fins de stocks. Dans le cas de références multiples, consulter la section des applications du catalogue. / **Nota importante:** Dans le cas de références multiples, consulter la section des applications du catalogue. / **Nota importante:** Se pueden usar intercambios competitivos para propósitos de almacenamiento solamente. Cuando se identifican intercambios múltiples, consulte la sección de aplicaciones de este catálogo.

# COMPETITIVE & O.E.M. INTERCHANGE LIST

## Lista de Intercambios contra Competidores y Equipo Original.

### Liste d'interchange de produits compétitifs & d'équipement original (OEM)

#### HENDRICKSON TRUCK SUSPENSION SYSTEMS... cont'd

O.E.M #	Gabriel	Upgrade	O.E.M #	Gabriel	Upgrade	O.E.M #	Gabriel	Upgrade	O.E.M #	Gabriel	Upgrade
64838-003	85933	89454	659000	83148		671006	85036	89405	70021	85303	89422
64838-003L	85933	89454	659004	83123	89405	671007	83137		70088	85307	
654890	83207	89407	659048	83143		671009	85919		98583-005	83168	
654891	83149		659049	83142		671105	85072		98583-006	83148	
654894	83123	89405	659155	83147		671603	85919		98583-016	83147	
654895	83137		659202	83148		671606	85955		98583-032	85072	
654896	83147		659292	83148		671611	85955		A-14496	646155	
654897	83144		65992-001	85955		671704	85904		AE76164-3	85307	
654898	83123	89405	65992-002	85955		671764	85967		AE76164-4	83225	
654899	85013	89414	65992-002L	85955		671792	85965		BE76164-2	85303	89422
654900	83149		65992-003	85959		671798	85962		BE76164-3	85307	
654903	83111		65992-006	85986		680091	85303	89422	BE76164-4	83225	
654904	83109		665816	85072		680600	85305				
654905	83112		665892	85072		70018	85303	89422			

#### HIGHWAY PRODUCT

O.E.M #	Gabriel	Upgrade	O.E.M #	Gabriel	Upgrade	O.E.M #	Gabriel	Upgrade	O.E.M #	Gabriel	Upgrade
A1-G-134	83207	89407	A1-G-135	83203	89436						

#### HINO

O.E.M #	Gabriel	Upgrade	O.E.M #	Gabriel	Upgrade	O.E.M #	Gabriel	Upgrade	O.E.M #	Gabriel	Upgrade
34802	83216		485003710A	83126	89430	48530E0100	83166		S4850-01941	83141	
48500-1800	83216		48511-37320	83518		48531-37361	83519		S4850-01950	G63610	
48500-1801	83216		48511-80162	83518		48531-37362	83519		S4850-02750	G63610	
48500-1940	83141		48530-1460	83215		60670-012	83168		S4850-03710	83126	89430
48500-1941	83141		48530-1770	83215		60670-013	83148		S4850-03720	83140	
48500-1950	G63610		48530-1880	83362		60670-014	83166		S4853-01910	83216	
48500-2750	G63610		48530-1910	83216		60670-018	83166		S4853-02510	83216	
48500-3710	83126	89430	48530-2050	83217		60670-019	83166		S4853-03280	G63440	
48500-3720	83140		48530-2510	83216		60670-020	83148				
48500-E0420	83391		48530-3280	G63440		66639	G63610				

#### HOBBS TRAILERS

O.E.M #	Gabriel	Upgrade	O.E.M #	Gabriel	Upgrade	O.E.M #	Gabriel	Upgrade	O.E.M #	Gabriel	Upgrade
680117	85300	89419									

#### HOLIDAY RAMBLER

O.E.M #	Gabriel	Upgrade	O.E.M #	Gabriel	Upgrade	O.E.M #	Gabriel	Upgrade	O.E.M #	Gabriel	Upgrade
1C34-18045-AA	83209	89414	9U9Z-18125-A	83122	89406	ASH-137	83122	89406	F4-BE5-B492-HO	85125	
1C34-18045-JA	83209	89414	ASH-1022	83209	89414	ASH-25822	83209	89414	F4-BE5-F324-HO	85125	
24-153249	85125		ASH-1023	83122	89406	ASH-25823	83209	89414	F4-BE5-F325-HO	85124	
24-153256	85124		ASH-1136	83178		ASH-25824	83122	89406	U0109-007	G63183	
24-186537	85126		ASH-1154	83177		ASH-294	83209	89414	W0005662	85125	
24-186629	85125		ASH-1205	83209	89414	AT-620	83209	89414	W0005663	85124	
90044794	83127		ASH-1206	83122	89406	AT-621	83122	89406	W0006254	85125	
9U94-18045-AA	83209	89414	ASH-1228	83209	89414	AT-766	83209	89414			
9U94-18080-AA	83122	89406	ASH-1229	83209	89414	F4-BE5-A011-HO	85126				
9U9Z-18124-A	83209	89414	ASH-1230	83122	89406	F4-BE5-A832-MO	85125				

#### HOLLAND - BINKLEY

O.E.M #	Gabriel	Upgrade	O.E.M #	Gabriel	Upgrade	O.E.M #	Gabriel	Upgrade	O.E.M #	Gabriel	Upgrade
680298	85321		6898	83125							

#### HUTCHENS SUSPENSION

O.E.M #	Gabriel	Upgrade	O.E.M #	Gabriel	Upgrade	O.E.M #	Gabriel	Upgrade	O.E.M #	Gabriel	Upgrade
9423-00	83203	89436									

#### HYSTER

O.E.M #	Gabriel	Upgrade	O.E.M #	Gabriel	Upgrade	O.E.M #	Gabriel	Upgrade	O.E.M #	Gabriel	Upgrade
650150	83217		73516	83217							

#### IC CORPORATION

O.E.M #	Gabriel	Upgrade	O.E.M #	Gabriel	Upgrade	O.E.M #	Gabriel	Upgrade	O.E.M #	Gabriel	Upgrade
1660846C92	83101		2018987C1	85003	89411						
1675455C1	85003	89411	2200327C1	85332							

**Important Note:** Competitive Interchanges are to be used for stocking purposes only. Where multiple crosses are identified, please reference the applications section of this catalog. / **Remarque importante:** Les interchanges concurrentiels ne s'utilisent qu'aux fins de stocks. Dans le cas de références multiples, consulter la section des applications du catalogue. / **Nota importante:** Dans le cas de références multiples, consulter la section des applications du catalogue. / **Nota importante:** Se pueden usar intercambios competitivos para propósitos de almacenamiento solamente. Cuando se identifican intercambios múltiples, consulte la sección de aplicaciones de este catálogo.

**COMPETITIVE & O.E.M. INTERCHANGE LIST**  
**Lista de Intercambios contra Competidores y Equipo Original.**  
**Liste d'interchange de produits compétitifs & d'équipement original (OEM)**

**IC CORPORATION... cont'd**

O.E.M #	Gabriel	Upgrade	O.E.M #	Gabriel	Upgrade	O.E.M #	Gabriel	Upgrade	O.E.M #	Gabriel	Upgrade
3533356C3	83169		3605735C1	83156		472412C91	83456	89447	65992-006	85986	
3578105C1	83163		3605735C2	83156		501553C91	85003	89411	H65992-006	85986	
3578105C2	83163		3838241C1	85986		501906C91	83317		OE13402S	83163	
3578858C2	85926		3902993C1	83135		501906C92	83317		OE13424S	83317	
3601600C3	85082		3902993C2	83135		537524C91	83123	89405			
3604282C1	85351		3902993C3	83135		6127088C1	83163				

**INGERSALL MACHINE**

O.E.M #	Gabriel	Upgrade	O.E.M #	Gabriel	Upgrade	O.E.M #	Gabriel	Upgrade	O.E.M #	Gabriel	Upgrade
665472	665472		665904	665472							

**INGERSOLL AXLES**

O.E.M #	Gabriel	Upgrade	O.E.M #	Gabriel	Upgrade	O.E.M #	Gabriel	Upgrade	O.E.M #	Gabriel	Upgrade
653511-01	85323	89436	653511-02	85938		653511-03	85045		653511-04	85052	

**INTERNATIONAL (NAVISTAR)**

O.E.M #	Gabriel	Upgrade	O.E.M #	Gabriel	Upgrade	O.E.M #	Gabriel	Upgrade	O.E.M #	Gabriel	Upgrade
1660846C91	83101		306444C91	85012	89413	3576464C1	85957		3605735C2	83156	
1660846C92	83101		3085640C92	83216		3576464C2	85957		3606770C1	83163	
1663471C1	83103		308646C91	85012	89413	3576465C1	85999		3606770C2	83163	
1663606C91	85027	89418	308648C91	83225		3576465C2	85999		3606857C1	85954	
1664149C1	85029		308649C91	83216		3578105C1	83163		3606857C2	85954	
1664524C1	85935		308650C91	83216		3578105C2	83163		3606857C3	85994	
1664788C2	85316	89426	308650C92	83216		3578858C1	85926		3606859C1	85954	
1667520C1	85058	89431	308664C91	85307		3578858C2	85926		3606859C2	85954	
1675455C1	85003	89411	308668C91	85012	89413	3581106C1	85924	89457	3606859C3	85994	
1677707C1	85030	89440	308668C92	85012	89413	3581106C2	85924	89457	3609178C1	85955	
1690035C1	85003	89411	308669C91	85012	89413	3581106C3	85924	89457	3609400C1	83317	
2015556C1	85316	89426	320444C91	85012	89413	3581107C1	85924	89457	3609400C2	83317	
2015557C1	85030	89440	329316C92	85012	89413	3581107C2	85924	89457	3610198C1	85963	
2018987C1	85003	89411	350425C1	85300	89419	3581107C3	85924	89457	3610199C1	85964	
2018987C2	85003	89411	350426C1	85734		3581109C1	85924	89457	3613984C1	85955	
2029200C91	83126	89430	350426C91	85734		3581109C3	85924	89457	3620395C1	85931	89458
2029200C91	85030	89440	3514952C1	85976		3581109C4	85924	89457	3626571C1	85072	
2032533C1	85316	89426	3533356C1	83135		3584116C1	83175		3660548C1	85955	
2039549C1	85333		3533356C2	83135		3584116C2	83175		3660549C1	85955	
204994R91	83225		3533356C3	83169		3584117C1	83135		3668566C1	85954	
206620R91	83216		3533357C1	85957		3584117C2	83135		3670156C1	85954	
206621R91	83216		3533357C2	85957		3584118C1	85928		3674348C1	85954	
206621R92	83216		3533357C3	85957		3584118C2	85928		3688614C1	85923	89458
208664C91	85307		3541456C1	85929		3584535C1	85924	89457	3688615C1	85931	89458
210533R91	83225		3544768C1	85926		3584535C2	85924	89457	3688616C1	85923	89458
210534R92	83225		3544768C2	85926		3584535C3	85924	89457	3688729C1	85931	89458
210535R91	83225		3549099C1	85923	89458	3586883C1	85931	89458	3688732C1	85931	89458
210536R91	83225		3549099C2	85923	89458	3586902C2	83364		3737574C1	85954	
210537R91	83225		3549099C3	85923	89458	3586902C3	83364		3737575C1	85954	
210538R91	83225		3549100C1	85926		3588209C1	85957		3737576C1	85931	89458
210918R91	83215		3553628C1	85927		3588209C2	85957		3806341C3	85995	
210919R91	85307		3553628C2	85927		3596107C1	85927		3806341C4	85995	
210920R91	85308	89422	3553628C3	85927		3596107C2	85927		3810581C3	85995	
2200327C1	85332		3553628C4	85927		3596107C3	85927		3810581C4	85995	
287318C91	G63306		3558089C1	85925		3596107C4	85927		3812837C1	85954	
288920C91	83225		3558089C2	85925		3596878C2	85648		3813340C1	85964	
288921C91	83225		3558089C3	85925		3601600C1	85082		3813340C2	85964	
288921R92	83225		3558989C1	85925		3601600C2	85082		3813340C3	85964	
293009C91	85308	89422	3558989C2	85925		3601600C3	85082		3813340C4	85964	
294334C91	83216		3571711C1	85316	89426	3604282C1	85351		3813341C1	85963	
3000070C91	83456	89447	3571713C1	85333		360444C91	85012	89413	3813341C2	85963	
3000098C1	83317		3573265C1	85931	89458	3605735C1	83156		3813341C3	85963	

**Important Note:** Competitive Interchanges are to be used for stocking purposes only. Where multiple crosses are identified, please reference the applications section of this catalog. / **Remarque importante:** Les interchanges concurrentiels ne s'utilisent qu'aux fins de stocks. Dans le cas de références multiples, consulter la section des applications du catalogue. / **Nota importante:** Dans le cas de referencias multiples, consultar la sección de aplicaciones del catálogo. / **Nota importante:** Se pueden usar intercambios competitivos para propósitos de almacenamiento solamente. Cuando se identifican intercambios múltiples, consulte la sección de aplicaciones de este catálogo.

# COMPETITIVE & O.E.M. INTERCHANGE LIST

## Lista de Intercambios contra Competidores y Equipo Original.

### Liste d'interchange de produits compétitifs & d'équipement original (OEM)

#### INTERNATIONAL (NAVISTAR)... cont'd

O.E.M #	Gabriel	Upgrade	O.E.M #	Gabriel	Upgrade	O.E.M #	Gabriel	Upgrade	O.E.M #	Gabriel	Upgrade
3813341C4	85963		453568C91	83225		537524C91	83123	89405	65992-002L	85955	
3816234C1	85999		453569C91	83225		537525C91	83123	89405	65992-006	85986	
3821760C1	85931	89458	453570C91	83216		540395C91	83613		66400	G63432	
383379C91	83308		453571C91	83216		540395C92	83613		6ETZ-18125-A	83364	
3838241C1	85986		453572C91	83309		548532C1	83103		70334	85316	89426
384435C91	83216		453574C91	85307		56101 Z1030	85311	89424	790335C91	83209	89414
3868264C1	85998		453575C91	83308		56101 Z2000	85311	89424	800670	85060	
3868265C1	85998		453576C91	85303	89422	56101 Z5008	83114		873619C92	83314	
3885832C1	83135		453576C92	85303	89422	56101 Z5011	G63610		873619C93	83314	
3885832C2	83135		453577C91	85308	89422	56110-T8123	G63432		873622C91	83308	
3892445C3	85931	89458	453579C91	85308	89422	56110-T8129	G63432		874695R91	85012	89413
3892458C1	85926		453597C91	83216		57905-001	85976		874695R92	85012	89413
3892458C2	85926		462557C91	85300	89419	586724C91	83456	89447	874696R91	85012	89413
3902993C3	83135		462603C91	85705	89447	596329C1	85014		90044025	83209	89414
3945165C1	83180		462753C91	83216		60657-003	85072		90044626	83126	89430
3977759C2	85639		463926C91	85705	89447	60657-003L	85072		AMS 600102	85005	89430
3991991C1	83135		467371C91	83225		60657-006	85102		AMS 600172	83126	89430
4050340C1	85931	89458	467372C91	83225		60657-010	85102		AMS 600172	85030	89440
4050340C2	85931	89458	467980C91	G63306		60657-011	85102		AMS 650420	85013	89414
4050443C1	85994		467983C91	85012	89413	60665-013	85965		AMS650102	85001	89410
4050443C2	85994		467984C91	83216		60670-007	83144		AMS650107	85316	89426
4050444C1	85994		467985C91	85012	89413	60670-007L	83144		AMS650400	85033	89427
4050444C2	85994		471201C91	85012	89413	60675-003	85976		AMS650402	85311	89424
4069426C1	85642		471203C91	83308		60675-003L	85976		AMS650404	85310	89423
4069434C1	85642		472367C91	83318		60680-003	83112		AMS650405	85023	89415
4069435C1	85642		472411C91	83456	89447	60680-003L	83112		AMS650406	85024	
4070336C1	85058	89431	472412C91	83456	89447	60680-004	83143		AMS650408	85319	89428
4070352C1	85648		472414C91	83318		60680-004L	83143		AMS650420	85013	89414
426744R91	85303	89422	474002C91	83308		60680-005	83142		H60657-003	85072	
426744R92	85303	89422	477132C1	85303	89422	60680-005L	83142		H60657-006	85102	
446-51-211	85739		47902-24	83137		6127086C1	85637		H60657-010	85102	
452566C91	83225		4C4Z-18124-N	85957		6127087C1	83364		H60657-011	85102	
453527C91	85311	89424	4C4Z-18125-DA	85926		6127088C1	83163		H60657003	85072	
453528C91	85311	89424	501506C91	83317		6127096C1	83180		H60665013	85965	
453531C91	G63306		501553C91	85003	89411	6127666C1	85642		H60675-003	85976	
453556C91	85012	89413	501905C91	83301		6127688C1	83169		H60675003	85976	
453557C91	G63306		501906C91	83317		6127690C1	85923	89458	H60680004	83143	
453561C91	83225		501906C92	83317		6127700C1	83395		H60680005	83142	
453562C91	83225		503550C1	83207	89407	6127705C1	85924	89457	H65992-006	85986	
453564C91	85012	89413	503610C1	83207	89407	6127713C1	85926		OE 18513	83135	
453565C91	83225		503610C2	83207	89407	6127714C1	85928		OE13402S	83163	
453566C91	83225		507202C1	85030	89440	65992-001	85955		OE13424S	83317	
453567C91	83216		534464C1	85734		65992-002	85955				

#### INTERNATIONAL (NAVISTAR) CAB SHOCKS

O.E.M #	Gabriel	Upgrade	O.E.M #	Gabriel	Upgrade	O.E.M #	Gabriel	Upgrade	O.E.M #	Gabriel	Upgrade
1201-0012	83023		1201-9011	83053		1202-1044	83025		2508326C1	83021	
1201-0154	83051		1201-9013	83062		1202-1212	83013		2508327C1	83025	
1201-0254	83051		1201-9014	83062		1202-1213	83005		2509221C91	83054	
1201-1043	83025		1201-9018	83062		2012768C1	83013		2509222C91	83053	
1201-1044	83025		1201-9021	83062		2012769C1	83005		2509223C91	83054	
1201-1049	83025		1202-0012	83023		2012769C2	83005		2509224C91	83053	
1201-1212	83013		1202-0032	83016		2023684C1	83015		2585145C1	83051	
1201-1213	83005		1202-0042	83025		2023685C1	83015		2589922C1	83051	
1201-9007	83054		1202-0043	83025		2025790C1	83013				
1201-9008	83054		1202-0044	83025		2500013C1	83013				
1201-9009	83054		1202-0054	83021		2503529C1	83025				
1201-9010	83053		1202-1043	83025		2507948C1	83054				

**Important Note:** Competitive Interchanges are to be used for stocking purposes only. Where multiple crosses are identified, please reference the applications section of this catalog. / **Remarque importante:** Les interchanges concurrentiels ne s'utilisent qu'aux fins de stocks. Dans le cas de références multiples, consulter la section des applications du catalogue. / **Nota importante:** Dans le cas de références multiples, consulter la section des applications du catalogue. / **Nota importante:** Se pueden usar intercambios competitivos para propósitos de almacenamiento solamente. Cuando se identifican intercambios múltiples, consulte la sección de aplicaciones de este catálogo.

**COMPETITIVE & O.E.M. INTERCHANGE LIST**  
**Lista de Intercambios contra Competidores y Equipo Original.**  
**Liste d'interchange de produits compétitifs & d'équipement original (OEM)**

**INTERNATIONAL (NAVISTAR) CAB SHOCKS... cont'd**

O.E.M #	Gabriel	Upgrade	O.E.M #	Gabriel	Upgrade	O.E.M #	Gabriel	Upgrade	O.E.M #	Gabriel	Upgrade
2590915C1	83062		2597458C91	83062		3557165C1	83053		OE14771	83062	
2590916C1	83062		2600491C91	83062		3557167C3	83053				
2593803C91	83062		2601488C91	83062		3560705C2	83054				
2595314C1	83062		2602021C1	83062		AMS66161	83053				

**ISUZU**

O.E.M #	Gabriel	Upgrade	O.E.M #	Gabriel	Upgrade	O.E.M #	Gabriel	Upgrade	O.E.M #	Gabriel	Upgrade
1-51630-160-0	83162		8-22064-805-0	83136		8-97253-664-0	83159		8982326720	83515	
1-51630-167-0	83613		8-22064-806-0	83136		8-97253-665-0	83159		9-51630-647-1	83515	
1-51630-168-1	83515		8-22064-807-0	83136		8-98098-058-0	83159		9-51630-666-0	85012	89413
1-51630-217-0	83114		8-22064232-0	85071		8-98098-058-1	83159		9-51630-666-2	85012	89413
1-51630-217-1	83114		8-22064233-0	83136		8-98098-059-0	83159		94033786	83114	
1-51630-219-0	83114		8-22064489-0	85336		8-98098-059-1	83159		94454986	83515	
1-51630-219-1	83114		8-22064804-0	83136		8-98098-125-0	83515		94454987	83515	
12474915	83122	89406	8-22064805-0	83136		8-98098-127-0	83515		97083027	83515	
15123676	83136		8-22064806-0	83136		8-98232671-0	83515		97083029	83515	
15174902	85071		8-22064807-0	83136		8-98232671-1	83515		97253620	83515	
15887728	83136		8-51630-666-0	85012	89413	8-98232672-0	83515		97253651	83159	
19152843	83136		8-94454-647-1	83515		8-98232672-1	83515		97253664	83159	
51630168	83515		8-94454-986-0	83515		8-98316-228-0	83159		97253665	83159	
51630217	83114		8-94454-987-0	83515		8-98316227-0	83159		98098058	83159	
51630219	83114		8-97083-027-0	83515		8-98343986-0	83159		98098059	83159	
51630647	83515		8-97083-029-0	83515		88982682	83136		98098125	83515	
51630666	85012	89413	8-97253-616-0	83515		88982686	85071		98098127	83515	
60670-005	83137		8-97253-620-0	83515		8972019600	83515		98232671	83515	
8-22064-232-0	85071		8-97253-620-1	83515		898098-0581	83159		98232672	83515	
8-22064-233-0	83136		8-97253-621-0	83515		898098-1250	83515		98316227	83159	
8-22064-489-0	85336		8-97253-623-0	83515		898098-1270	83515		98343986	83159	
8-22064-804-0	83136		8-97253-651-2	83159		8982326710	83515				

**ITASCA**

O.E.M #	Gabriel	Upgrade	O.E.M #	Gabriel	Upgrade	O.E.M #	Gabriel	Upgrade	O.E.M #	Gabriel	Upgrade
141700131809	85029		481700000493	85900		ASH-1154	83177		AT-620	83209	89414
141700131810	83160		66153-002	83124	89407	ASH-1205	83209	89414	AT-621	83122	89406
16-16736-000	85029		8C24-18045-DA	83177		ASH-1206	83122	89406	AT-766	83209	89414
16-16737-000	83160		8C24-18080-DB	83178		ASH-1228	83209	89414	F4-BE5-A011-HO	85126	
16-16873-000	85029		8C2Z-18124-D	83177		ASH-1229	83209	89414	F4-BE5-A832-MO	85125	
16-16874-000	83160		8C2Z-18125-D	83178		ASH-1230	83122	89406	F4-BE5-B492-HO	85125	
16-18103-000	85900		9U94-18045-AA	83209	89414	ASH-137	83122	89406	F4-BE5-C832-MO	83124	89407
1C34-18045-AA	83209	89414	9U94-18080-AA	83122	89406	ASH-25822	83209	89414	F4-BE5-F324-HO	85125	
1C34-18045-JA	83209	89414	9U9Z-18124-A	83209	89414	ASH-25823	83209	89414	F4-BE5-F325-HO	85124	
24-153249	85125		9U9Z-18125-A	83122	89406	ASH-25824	83122	89406	W0005662	85125	
24-153256	85124		ASH-1022	83209	89414	ASH-294	83209	89414	W0005663	85124	
24-186537	85126		ASH-1023	83122	89406	AT-163G	83177		W0006254	85125	
24-186629	85125		ASH-1136	83178		AT-164G	83178				

**JAY MADSEN**

O.E.M #	Gabriel	Upgrade	O.E.M #	Gabriel	Upgrade	O.E.M #	Gabriel	Upgrade	O.E.M #	Gabriel	Upgrade
3166657	85700		3192333	85700							

**JAYCO RV INC**

O.E.M #	Gabriel	Upgrade	O.E.M #	Gabriel	Upgrade	O.E.M #	Gabriel	Upgrade	O.E.M #	Gabriel	Upgrade
ASH-1136	83178		ASH-1229	83209	89414	ASH-25823	83209	89414			
ASH-1154	83177		ASH-25822	83209	89414	ASH-25824	83122	89406			

**JIFFLOX**

O.E.M #	Gabriel	Upgrade	O.E.M #	Gabriel	Upgrade	O.E.M #	Gabriel	Upgrade	O.E.M #	Gabriel	Upgrade
CP-5222	85315										

**JOHN DEERE**

O.E.M #	Gabriel	Upgrade	O.E.M #	Gabriel	Upgrade	O.E.M #	Gabriel	Upgrade	O.E.M #	Gabriel	Upgrade
3638112	G63183		4036892	G63605							

**Important Note:** Competitive Interchanges are to be used for stocking purposes only. Where multiple crosses are identified, please reference the applications section of this catalog. / **Remarque importante:** Les interchanges concurrentiels ne s'utilisent qu'aux fins de stocks. Dans le cas de références multiples, consulter la section des applications du catalogue. / **Nota importante:** Dans le cas de références multiples, consulter la section des applications du catalogue. / **Nota importante:** Se pueden usar intercambios competitivos para propósitos de almacenamiento solamente. Cuando se identifican intercambios múltiples, consulte la sección de aplicaciones de este catálogo.

**COMPETITIVE & O.E.M. INTERCHANGE LIST**  
**Lista de Intercambios contra Competidores y Equipo Original.**  
**Liste d'interchange de produits compétitifs & d'équipement original (OEM)**

JOHN DEERE... cont'd

**KENWORTH**

O.E.M #	Gabriel	Upgrade	O.E.M #	Gabriel	Upgrade	O.E.M #	Gabriel	Upgrade	O.E.M #	Gabriel	Upgrade
02-02736PLUS	85302	89420	665565PLUS	85007		680283	85740		C71-1011	85069	89455
02-02737PLUS	85062	89408	665617	85031		680303	85007		C71-1011PLUS	85069	89455
02-02738PLUS	85012	89413	665632	85013	89414	680425	85320	89429	C71-1011SPL	85069	89455
02-02739PLUS	85013	89414	665633	85033	89427	680435	85033	89427	C71-1013	85985	
03-04176PLUS	85308	89422	665670	85001	89410	680473	85319	89428	C71-1014	85936	89456
03-06084PLUS	85033	89427	665680	83312	89409	680475	85314	89425	C71-1015	85937	
03-07421PLUS	85311	89424	665783	83123	89405	680476	85310	89423	C71-1015 PLUS	85937	
03-07423PLUS	85033	89427	665784	83122	89406	680486	85310	89423	C71-1015A	85937	
03-08781	85069	89455	665785	83137		680586	85311	89424	C71-1016	85067	89451
10-12032-002PLUS	85320	89429	665788	85000	89436	70701	85900		C71-1017	85069	89455
10-12542-000PLUS	85901		665828	85067	89451	70701PLUS	85900		C71-6003	85988	
11418	646177		665844	85069	89455	8086053PLUS	85047	89435	C71-6004	85343	
16-13947-000PLUS	85319	89428	665858	85070	89459	90044025PLUS	83209	89414	C71-6005	85069	89455
16725-01	83126	89440	665903	85900		90044089	83124	89407	C71-6015	85067	89451
1707378PAC	85182		665906	85902		90044089PLUS	83124	89407	K374-10	83362	
19495-01	83126	89440	665918	85900		90045099	85906	89407	K374-11	85001	89410
2018987C1PLUS	85003	89411	665926	85047	89435	90045132	85909		K374-13	85740	
3166657	85700		665927	85901		90045605	85109		K374-13-1	85740	
471700004423	85109		665928	85062	89408	ACHB966	83136		K374-14	83312	89409
47902-13PLUS	83122	89406	665930	85001	89410	B71-1000	85031		K374-16	85001	89410
47902-19	83123	89405	665931	83312	89409	B71-1001	85070	89459	K374-26	85001	89410
47902-24	83137		665932	85012	89413	B71-1002	85001	89410	K374-26PLUS	85001	89410
60657-003	85072		665944	85900		B71-1003	83312	89409	K374-27	85001	89410
60657-003L	85072		665945	85902		B71-6000	85959		K374-28	85314	89425
60665-011	85967		665950	85902		B71-6002	85012	89413	K374-28PLUS	85314	89425
60665-013	85965		671052	85070	89459	B71-6003	85029		K374-29	85310	89423
60670-004	83123	89405	671654	85936	89456	B71-6004	85084	89460	K374-29PLUS	85310	89423
60670-005	83137		671656	85985		B71-6005	85084	89460	K374-3	83312	89409
60670-005L	83137		671699	85937		B71-6006	85084	89460	K374-3-1	83312	89409
60670-005PLUS	83137		671794	85067	89451	B71-6007	85062	89408	K374-32	85310	89423
60670-008	83123	89405	671962	85936	89456	B71-6008	83312	89409	K374-33	83312	89409
60670-008L	83123	89405	671962PLUS	85936	89456	B71-6010	85023	89415	K374-33PLUS	83312	89409
60670-008PLUS	83123	89405	671962SPL	85936	89456	B71-6011	85062		K374-36		89432
60675-017	85979		671963	85937		B71-6011	85062	89408	K374-4	85314	89425
60680-004	83143		675122	85001	89410	B71-6012	85119		K374-5	83312	89409
60680-004L	83143		680237	85303	89422	B71-6013	85012	89413	K374-7	85310	89423
60680-005	83142		680239	85310	89423	B71-6015	85012	89413	K374-9	85310	89423
60680-005L	83142		680240	85302	89420	B71-6016	85012	89413	K374-C31	83312	89409
64178-001	83143		680241	85311	89424	B71-6017	85910		K374-C7	85310	89423
665092	83312	89409	680242	85308	89422	B71-6018	85012	89413	R71-6006	83063	
665118	83312	89409	680253	85314	89425	B71-6019	85989		R71-6007	83008	
665174	85060		680261	85062	89408	B71-6020	85989		R71-6008	83035	
665331	85740		680279	83209	89414	BFRG 072	85182		S-20126	85323	89436
665453	85001	89410	680280	85906	89407	C71-1002	85067	89451	TK19679	83126	89440
665565	85007		680281	85003	89411	C71-1002PLUS	85067	89451			

**KENWORTH CAB SHOCKS**

O.E.M #	Gabriel	Upgrade	O.E.M #	Gabriel	Upgrade	O.E.M #	Gabriel	Upgrade	O.E.M #	Gabriel	Upgrade
1201-0012	83023		1202-0043	83025		1202-1264	83031		1202K286	83056	
1201-1043	83025		1202-0044	83025		1202-1286	83056		25523024	83081	
1201-1044	83025		1202-0054	83021		1202-K065	83002		96027-10545	83011	
1201-1046	83049		1202-1043	83025		1202K046	83049		PP1058870	83059	
1201-8002	83081		1202-1046	83049		1202K064	83024				
1202-0012	83023		1202-1064	83024		1202K065	83002				
1202-0032	83016		1202-1065	83002		1202K164	83031				
1202-0042	83025		1202-1164	83031		1202K264	83031				

**Important Note:** Competitive Interchanges are to be used for stocking purposes only. Where multiple crosses are identified, please reference the applications section of this catalog. / **Remarque importante:** Les interchanges concurrentiels ne s'utilisent qu'aux fins de stocks. Dans le cas de références multiples, consulter la section des applications du catalogue. / **Nota importante:** Dans le cas de références multiples, consulter la section des applications du catalogue. / **Nota importante:** Se pueden usar intercambios competitivos para propósitos de almacenamiento solamente. Cuando se identifican intercambios múltiples, consulte la sección de aplicaciones de este catálogo.

**COMPETITIVE & O.E.M. INTERCHANGE LIST**  
**Lista de Intercambios contra Competidores y Equipo Original.**  
**Liste d'interchange de produits compétitifs & d'équipement original (OEM)**

**KENWORTH CAB SHOCKS... cont'd**

O.E.M #	Gabriel	Upgrade	O.E.M #	Gabriel	Upgrade	O.E.M #	Gabriel	Upgrade	O.E.M #	Gabriel	Upgrade
PP2582870	83012		R71-6000	83067		R71-6010	83067		T71-1002	83002	
R71-1004	83049		R71-6005	83042		T71-1000	83031		T71-1003	83056	
R71-1005	83024		R71-6009	83081		T71-1001	83031				

**KIMBLE MIXER CO**

O.E.M #	Gabriel	Upgrade	O.E.M #	Gabriel	Upgrade	O.E.M #	Gabriel	Upgrade	O.E.M #	Gabriel	Upgrade
OE10455	646155		T91-00002-00	646155							

**KING OF THE ROAD**

O.E.M #	Gabriel	Upgrade	O.E.M #	Gabriel	Upgrade	O.E.M #	Gabriel	Upgrade	O.E.M #	Gabriel	Upgrade
141700131809	85029		16-16736-000	85029		16-16873-000	85029		16-18103-000	85900	
141700131810	83160		16-16737-000	83160		16-16874-000	83160		481700000493	85900	

**KONI**

Koni	Gabriel	Upgrade	Koni	Gabriel	Upgrade	Koni	Gabriel	Upgrade	Koni	Gabriel	Upgrade
090-2209-SP2	85001	89410	8240-1148	G63720		8805-1002	85124		90-2166	83165	
30-1348	G63424		84-1168	83130		8805-1003	85126		90-2209	85308	89422
30-1350	G63511		88-1385	83105		8805-1018	83209	89414	90-2253-SP2	85732	
30-1351	G63490		88-1417	83312	89409	8805-1019	83122	89406	90-2254	85720	
30-1365	G63611		88-1419	83136		8805-1022	85724	89443	90-2256	85732	
30-1366	G63610		88-1422	85030	89440	8805-1023	83136		90-2257	85716	
30-1381	G63426		88-1457-SP1	83209	89414	8805-1042	83177		90-2291	695406	
30-1421	G63547		88-1458-SP1	83122	89406	8805-1043	83178		90-2325	85340	
30-1422	G63548		88-1458-SP2	83122	89406	90-1400	83104		90-2326	85970	
30-1456	G63782		88-1468	83209	89414	90-1409-SP1	85722		90-2327	85341	
30-1457	G63781		88-1476	85740		90-1577-SP1	85310	89423	90-2396-SP1	85000	89436
30-1501	G63608		88-1489	85036	89405	90-1608	83104		90-2396-SP1	85323	89436
30-1502	G63679		88-1490	83124	89407	90-1811	85301		90-2407	85709	
30-1565	G63707		88-1499	85001	89410	90-1813-SP1	85712		90-2434	85702	
30-1566	G63708		88-1509	85027	89418	90-1862	85708		90-2477	85900	
30-1606	G63423		88-1510	85708		90-1867	85053	89442	90-2478	85902	
30-1607	G63422		88-1517	85040		90-1868	85307		90-2497S-P1	85712	
30-1614	G63678		88-1518	85040		90-1868-SP1	85307		90-2563	85006	
30-1624	G63424		88-1520	85040		90-1896	85302	89420	90-2572	85329	
30-1627	G63690		88-1525	85040		90-1897	85303	89422	90-2573	85329	
30-1630	G63425		88-1532	85708		90-1898	83215		90-2574	85379	
30-1630	G63722		88-1540	85051		90-1907-SP1	85300	89419	90-2575	85700	
80-2516	G63421		88-1541	85045		90-1908-SP1	85723		90-2576	85700	
80-2517	G63422		88-1558	85013	89414	90-1909-SP1	85722		90-2586	85728	
80-2633	G63423		88-1559-SP1	85036	89405	90-1910	85704		90-2587	85729	
80-2634	G63422		88-1560	85062	89408	90-1912	85318		90-2588	85339	
82-1952	G63347		88-1561	85012	89413	90-1922	85900		90-2589	85727	
82-1954	G63355		88-1562	85003	89411	90-1943	85307		90-2610-SP1	87017	
82-1955	G63349		88-1616	85014		90-1951-SP1	85734		90-2627	89461	
82-1969	G63500		88-1639	83130		90-1951-SP5	85712		90-2816	85711	
82-1970	G63350		88-1641	85029		90-1965	85304		90-5055-SP2	85318	
82-2158	G63357		88-1642	83124	89407	90-1968	85720		90-5180	85300	89419
82-2246	G63299		88-1644	85000	89436	90-1974	85311	89424	9005-1018	85970	
82-2345	G63413		88-1646	83613		90-2059	85722		9005-1019	85341	
82-2372	G63609		88-1647	83317		90-2060	85722		9020-1042	85708	
82-2384	G63488		88-1704	85030	89440	90-2089	83165		90F-1235	85700	
8240-1029	G63386		88-5162	83209	89414	90-2102-SP1	85708		92-1227	85722	
8240-1054	G63375		88-5163	83122	89406	90-2148	85304		99B-3178	85179	
8240-1055	G63454		8805-1001	85125		90-2164-SP1	85723				

**KRYSTAL BUS**

O.E.M #	Gabriel	Upgrade	O.E.M #	Gabriel	Upgrade	O.E.M #	Gabriel	Upgrade	O.E.M #	Gabriel	Upgrade
ASH-1136	83178		ASH-1154	83177							

**Important Note:** Competitive Interchanges are to be used for stocking purposes only. Where multiple crosses are identified, please reference the applications section of this catalog. / **Remarque importante:** Les interchanges concurrentiels ne s'utilisent qu'aux fins de stocks. Dans le cas de références multiples, consulter la section des applications du catalogue. / **Nota importante:** Dans le cas de références multiples, consulter la section des applications du catalogue. / **Nota importante:** Se pueden usar intercambios competitivos para propósitos de almacenamiento solamente. Cuando se identifican intercambios múltiples, consulte la sección de aplicaciones de este catálogo.



**COMPETITIVE & O.E.M. INTERCHANGE LIST**  
**Lista de Intercambios contra Competidores y Equipo Original.**  
**Liste d'interchange de produits compétitifs & d'équipement original (OEM)**

**KWK-LOC (JIFFLOX)**

O.E.M #	Gabriel	Upgrade	O.E.M #	Gabriel	Upgrade	O.E.M #	Gabriel	Upgrade	O.E.M #	Gabriel	Upgrade
522217	85315		CP-5222	85315							

**KYB**

Kyb	Gabriel	Upgrade	Kyb	Gabriel	Upgrade	Kyb	Gabriel	Upgrade	Kyb	Gabriel	Upgrade
340043	G63909		344068	G63355		344373	G63675		345621	85003	89411
341302	G63678		344069	G63500		344374	G63778		349004	G63886	
341312	G63865		344072	G63349		344375	G63715		349009	G63897	
341339	G63918		344074	G63811		344377	G63717		349009	G63919	
341343	G63893		344075	G63413		344380	G63783		349010	G64006	
341374	G63884		344076	G63410		344381	G63803		349119	89439	
341613	85062	89408	344077	G63406		344382	G63887		441600	85310	89423
341614	85001	89410	344078	G63683		344385	G63866		441602	85724	89443
341615	83215		344079	G63775		344387	G63617		444058	83156	
341617	85005	89430	344080	G63426		344397	G63772		444328	85055	89439
341618	85918	89449	344081	G63375		344398	G63958		444329	83509	
341619	83136		344082	G63454		344399	G63848		553360	G63937	
341620	85033	89427	344083	G63457		344401	G63970		553361	G63689	
341621	85311	89424	344084	G63490		344402	G63817		554347	G63886	
341622	85023	89415	344085	G63306		344404	G63844		KG4159	G63892	
341623	85003	89411	344086	G63353		344410	G63885		KG4160	G64016	
341624	85036	89405	344088	G63424		344419	G63888		KG4613A	G63909	
341625	85000	89436	344089	G63425		344426	G63299		KG4616	G63798	
341626	85000	89436	344090	G63492		344427	G63904		KG5194	G64000	
341627	85006		344091	G63511		344428	G63494		KG5196	G64013	
341628	85724	89443	344092	G63490		344430	G63611		KG5198A	G63606	
341629	85938		344093	G63905		344431	G63620		KG5401	G63299	
341630	85052		344094	G63915		344435	G63721		KG5406	G63386	
341631	646155		344095	G63499		344438	G63869		KG5417	G63371	
341632	83124	89407	344096	G63460		344464	G63882		KG5420	G63366	
341633	83215		344097	G63907		344466	G63879		KG5421	G63387	
343030	G63949		344098	G63612		344481	G63894		KG5422	G63183	
343127	G63900		344202	G63479		344496	G64012		KG5424	G63187	
343160	G63914		344263	G63488		345005	G63694		KG5426	G63396	
343208	G63909		344264	G63387		345022	G63832		KG5429	G63398	
343209	G63903		344265	G63489		345023	G63828		KG54300	G63615	
343210	G63799		344266	G63818		345024	G63864		KG54301	G63616	
343272	G63860		344267	G63455		345030	83304		KG54302	G63782	
343353	G63880		344268	G63614		345030	G63394		KG54303	G63781	
343379	G63845		344269	G63679		345042	G63883		KG54304	G63707	
343388	G63712		344272	G63386		345043	G63878		KG54305	G63640	
343395	G63842		344273	G63638		345055	G63872		KG54307	G63812	
343395	G64014		344291	G63873		345080	83177		KG54308	G63708	
343403	G63660		344299	G63710		345601	83613		KG5431	G63511	
344040	G63421		344338	G63776		345602	85052		KG54317	G63726	
344041	G63422		344341	G63847		345604	85051		KG54330	G63809	
344042	G63423		344342	G63829		345605	85012	89413	KG54331	G63837	
344043	G63813		344353	G63877		345606	83136		KG54333	G63810	
344044	G63907		344356	G63862		345607	83130		KG54335	G63815	
344045	G63492		344359	G63720		345608	85060		KG5438	G63492	
344046	G63491		344364	G63673		345609	83515		KG5440	G63350	
344047	G63950		344365	G63662		345611	83120		KG5442	G63626	
344049	G63414		344366	G63366		345613	85005	89430	KG5444	G63904	
344050	G63773		344367	G63714		345614	83309	89446	KG5446	G63909	
344051	G63420		344368	G63716		345615	83314		KG5447	G63491	
344054	G63444		344369	G63624		345616	83125				
344055	G63484		344370	G63622		345617	83203	89436			
344066	G63359		344371	83178		345618	83126	89430			
344067	G63347		344372	G63661		345620	83456	89447			

**Important Note:** Competitive Interchanges are to be used for stocking purposes only. Where multiple crosses are identified, please reference the applications section of this catalog. / **Remarque importante:** Les interchanges concurrentiels ne s'utilisent qu'aux fins de stocks. Dans le cas de références multiples, consulter la section des applications du catalogue. / **Nota importante:** Dans le cas de références multiples, consulter la section des applications du catalogue. / **Nota importante:** Se pueden usar intercambios competitivos para propósitos de almacenamiento solamente. Cuando se identifican intercambios múltiples, consulte la sección de aplicaciones de este catálogo.

**COMPETITIVE & O.E.M. INTERCHANGE LIST**  
**Lista de Intercambios contra Competidores y Equipo Original.**  
**Liste d'interchange de produits compétitifs & d'équipement original (OEM)**

**KYB... cont'd**

Kyb	Gabriel	Upgrade	Kyb	Gabriel	Upgrade	Kyb	Gabriel	Upgrade	Kyb	Gabriel	Upgrade
KG5455	G63456		KG5484	G63635		KG5534	G63610		KG6010	83308	89435
KG5456	G63416		KG5485	G63639		KG5538	G63484		KG6198	G63616	
KG5462	G63494		KG5487	G63525		KG5555	G63914		KG6199	85012	89413
KG5466	G63492		KG5488	G63403		KG6001A	83304		KG6201	83456	89447
KG5474	G63479		KG5489	G63614		KG6002A	85030	89440	KG6403	G63605	
KG5475	G63432		KG5491	G63604		KG6003	83309	89446	KG6406	G63183	
KG5476	G63611		KG5494	G63620		KG6004	85320	89429	KG6412	G63625	
KG5477	G63906		KG5495	G63929		KG6005	83216		KG6413	83177	
KG5478	G63489		KG5496	G63624		KG6006	85012	89413	KG6415	85013	89414
KG5479	G63488		KG5497	G63622		KG6007	85007		KG6416	83123	89405
KG5480	G63609		KG5498	G63623		KG6008A	83122	89406			
KG5482	G63675		KG5499	G63621		KG6009A	83303				

**LEYLAND TRUCK**

O.E.M #	Gabriel	Upgrade	O.E.M #	Gabriel	Upgrade	O.E.M #	Gabriel	Upgrade	O.E.M #	Gabriel	Upgrade
1456033	85311	89424									

**LGE COACHWORKS**

O.E.M #	Gabriel	Upgrade	O.E.M #	Gabriel	Upgrade	O.E.M #	Gabriel	Upgrade	O.E.M #	Gabriel	Upgrade
ASH-1136	83178		ASH-1154	83177							

**LINK MANUFACTURING CAB SHOCKS**

O.E.M #	Gabriel	Upgrade	O.E.M #	Gabriel	Upgrade	O.E.M #	Gabriel	Upgrade	O.E.M #	Gabriel	Upgrade
1201-0012	83023		1201-9013	83062		1202-1046	83049		654799	83025	
1201-0154	83051		1201-9014	83062		1202-1064	83024		654811	83024	
1201-0254	83051		1201-9018	83062		1202-1065	83002		654833	83021	
1201-1043	83025		1201-9021	83062		1202-1164	83031		654847	83002	
1201-1044	83025		1202-0012	83023		1202-1212	83013		654849	83031	
1201-1046	83049		1202-0032	83016		1202-1213	83005		654867	83025	
1201-1049	83025		1202-0042	83025		1202-1286	83056		LG40450	83016	
1201-1212	83013		1202-0043	83025		1202K065	83002		LG40470	83016	
1201-1213	83005		1202-0044	83025		1202K164	83031		R71-1004	83049	
1201-9007	83054		1202-0052	83021		1202K264	83031		R71-1005	83024	
1201-9008	83054		1202-0054	83021		1202K286	83056		T71-1000	83031	
1201-9009	83054		1202-1042	83025		632129	83023		T71-1001	83031	
1201-9010	83053		1202-1043	83025		635705	83016		T71-1002	83002	
1201-9011	83053		1202-1044	83025		654669	83021				

**LINK MANUFACTURING LTD.**

O.E.M #	Gabriel	Upgrade	O.E.M #	Gabriel	Upgrade	O.E.M #	Gabriel	Upgrade	O.E.M #	Gabriel	Upgrade
1210-0005	85734		1210-0528	85904		671093	85904				

**LINK/HIGH-STEER**

O.E.M #	Gabriel	Upgrade	O.E.M #	Gabriel	Upgrade	O.E.M #	Gabriel	Upgrade	O.E.M #	Gabriel	Upgrade
1210-0001	646155		1210-0007	665937		1210-0010	646155		632155	646177	
1210-0002	632147		1210-0009	665937		1210-0012	646155		646168	646155	

**LION BUS**

O.E.M #	Gabriel	Upgrade	O.E.M #	Gabriel	Upgrade	O.E.M #	Gabriel	Upgrade	O.E.M #	Gabriel	Upgrade
58913-009	85959		58913-009L	85959		60665-025	85036	89405	60665-025L	85036	89405

**LODAL, INC.**

O.E.M #	Gabriel	Upgrade	O.E.M #	Gabriel	Upgrade	O.E.M #	Gabriel	Upgrade	O.E.M #	Gabriel	Upgrade
9960257	83122	89406									

**LONDON MIXER**

O.E.M #	Gabriel	Upgrade	O.E.M #	Gabriel	Upgrade	O.E.M #	Gabriel	Upgrade	O.E.M #	Gabriel	Upgrade
MB-37737-30	646155										

**MACK**

O.E.M #	Gabriel	Upgrade	O.E.M #	Gabriel	Upgrade	O.E.M #	Gabriel	Upgrade	O.E.M #	Gabriel	Upgrade
1252607B000	85702		14QK-1200P4	83207	89407	14QK-142P1	83215		14QK-2100P1	83221	
14-2136M	85061	89450	14QK-140	85304		14QK-143	83207	89407			
141700000373	85061	89450	14QK-140P1	83225		14QK-145	85307				
141700000380	85061	89450	14QK-142	85305		14QK-20001P2	85308	89422			
141700005839	85098	89502	14QK-142AP1	83215		14QK-2100	83221				

**Important Note:** Competitive Interchanges are to be used for stocking purposes only. Where multiple crosses are identified, please reference the applications section of this catalog. / **Remarque importante:** Les interchanges concurrentiels ne s'utilisent qu'aux fins de stocks. Dans le cas de références multiples, consulter la section des applications du catalogue. / **Nota importante:** Dans le cas de références multiples, consulter la section des applications du catalogue. / **Nota importante:** Se pueden usar intercambios competitivos para propósitos de almacenamiento solamente. Cuando se identifican intercambios múltiples, consulte la sección de aplicaciones de este catálogo.

**COMPETITIVE & O.E.M. INTERCHANGE LIST**  
**Lista de Intercambios contra Competidores y Equipo Original.**  
**Liste d'interchange de produits compétitifs & d'équipement original (OEM)**

**MACK... cont'd**

O.E.M #	Gabriel	Upgrade	O.E.M #	Gabriel	Upgrade	O.E.M #	Gabriel	Upgrade	O.E.M #	Gabriel	Upgrade
14QK-2100P2	83209	89414	14QK-372M3	83122	89406	20973993	85061	89450	47902-25	83125	
14QK-2100P3	83207	89407	14QK-373	83215		20998401	85014		47902-9	83123	89405
14QK-2100P4	83207	89407	14QK-375M	83123	89405	21002497	85972		4940654	83216	
14QK-2100P5	83221		14QK-377M	83215		21010744	83101		5533699	85302	89420
14QK-2100P6	85036	89405	14QK-378	83215		21155033	83101		5554184	85302	89420
14QK-2100P7	83221		14QK-378M	83215		21436096	85098	89502	57241-004	83110	
14QK-2100P8	83242		14QK-390	83105		21462382	85088		57241-006	83111	
14QK-2102	85304		14QK-392AM	85005	89430	21462384	85088		57241-006L	83111	
14QK-2105	83209	89414	14QK-392AM2	85005	89430	21687170	85120		57241-4	83110	
14QK-2107	83215		14QK-392AM3	85005	89430	21979343	85065		5966-90044025	83209	89414
14QK-2107P1	83215		14QK-392BM	85005	89430	22202559	85088		60657-007	85072	
14QK-2107P2	83215		14QK-392BM2	85321		22202560	85088		60670-006	83147	
14QK-2107P3	83215		14QK-392BM3	85005	89430	22314111	85036	89405	60670-006L	83147	
14QK-2108	83203	89436	14QK-392M	85005	89430	25621571	83215		60675-001	85978	
14QK-2108P1	83203	89436	14QK-393AM	83123	89405	25621955	85001	89410	60675-001L	85978	
14QK-2110	85305		14QK-393M	85010		25622221	83111		60675-13	85036	89405
14QK-2110P1	85305		14QK-396	85005	89430	25622345	83242		60680-003	83112	
14QK-2113	85001	89410	14QK-396M	85005	89430	25622466	85001	89410	60680-003L	83112	
14QK-2113P3	85001	89410	14QK-410M	83125		25623321	83215		60680-004	83143	
14QK-2113P4	85007		14QK-410M2	83137		25624241	83112		60680-004L	83143	
14QK-2113P5	85001	89410	14QK-410M3	83125		25624341	83110		60680-005	83142	
14QK-2113P6	85007		14QK-413M	83111		25624351	85909		60680-005L	83142	
14QK-2115	85305		14QK-413M4	83110		25624365	83217		64838-002	85933	89454
14QK-2133M	85001	89410	14QK-413M5	83138		25625091	83215		650102	85001	89410
14QK-2133M2	85001	89410	14QK-413M6	83111		25625151	85036	89405	650107	85316	89426
14QK-2136M	85061	89450	14QK-413M7	83111		25625187	83209	89414	650107MT	85316	89426
14QK-282P1	83216		14QK-414M	85906	89407	25625223	83111		650400MT	85033	89427
14QK-282P3	83216		14QK-414M2	85909		25625234	83125		650402	85311	89424
14QK-288-P1	85007		14QK-415M	83112		25625254	83125		650402MT	85311	89424
14QK-288P2	83217		14QK-415M7	83112		25625743	85005	89430	650404	85310	89423
14QK-29001P2	85303	89422	14QK-421M	85014		25626048	85080		650404MT	85310	89423
14QK-29301P1	83207	89407	14QK-422M	85933	89454	25626149	85080		650405	85023	89415
14QK-29301P2	83207	89407	14QK-423M	85978		25626196	83142		650405MT	85023	89415
14QK-29302	83207	89407	14QK-424M	83147		25632145	85001	89410	650406	85024	
14QK-29302P1	83207	89407	14QK-427M	85080		25632147	85305		650408	85319	89428
14QK-3100	85739		14QK-428	85080		25632561	83209	89414	650408MT	85319	89428
14QK-3101M	85066	89448	14QK-428M	85080		25633154	85906	89407	651012	83221	
14QK-3107M	85061	89450	14QK-431M	85061	89450	4103-5000447861	83105		651103	85036	89405
14QK-3108	85080		14QK-434M	85014		4103-5000546892	83105		651151	83209	89414
14QK-3108M	85080		14QK-493M	83101		446-51-211	85739		70042	85302	89420
14QK-3114M	85061	89450	14QK-5142	83142		471700000426	85014		8083872	85978	
14QK-3115M	85972		20469001	85933	89454	471700000431	85066	89448	90045099	85906	89407
14QK-3116M	83101		20469002	85933	89454	471700000445	85080		H60680004	83143	
14QK-322M	85933	89454	20485632	85933	89454	471700000451	85080		H60680005	83142	
14QK-366	85036	89405	20485633	85933	89454	471700002626	85061	89450	SDA141700000380	85061	89450
14QK-366P1	85036	89405	20513881	85061	89450	471700002861	85014		SDA471700000431	85066	89448
14QK-366P2	85036	89405	20570098	83147		471700006039	85088		SDA471700002861	85014	
14QK-366P3	85036	89405	20625775	85014		471700008934	85065		V10234121	83105	
14QK-366P4	83209	89414	20782199	85072		471700009646	85088		V10242320	83105	
14QK-372M	83221		20863239	85080		471700009647	85088				
14QK-372M2	83209	89414	20897198	85061	89450	471700131921	85933	89454			

**MACK CAB SHOCKS**

O.E.M #	Gabriel	Upgrade	O.E.M #	Gabriel	Upgrade	O.E.M #	Gabriel	Upgrade	O.E.M #	Gabriel	Upgrade
1201-0012	83023		14QK-2111-P2	83019		14QK-374	83003				
1202-0012	83023		14QK-2111-P4	83019		14QK-376	83003				
1202-0032	83016		14QK-303M	83050		14QK-382	83018				
14QK-2111	83019		14QK-3103M	83050		14QK-382-P2	83018				

**Important Note:** Competitive Interchanges are to be used for stocking purposes only. Where multiple crosses are identified, please reference the applications section of this catalog. / **Remarque importante:** Les interchanges concurrentiels ne s'utilisent qu'aux fins de stocks. Dans le cas de références multiples, consulter la section des applications du catalogue. / **Nota importante:** Dans le cas de références multiples, consulter la section des applications du catalogue. / **Nota importante:** Se pueden usar intercambios competitivos para propósitos de almacenamiento solamente. Cuando se identifican intercambios múltiples, consulte la sección de aplicaciones de este catálogo.

**COMPETITIVE & O.E.M. INTERCHANGE LIST**  
**Lista de Intercambios contra Competidores y Equipo Original.**  
**Liste d'interchange de produits compétitifs & d'équipement original (OEM)**

**MACK CAB SHOCKS... cont'd**

O.E.M #	Gabriel	Upgrade	O.E.M #	Gabriel	Upgrade	O.E.M #	Gabriel	Upgrade	O.E.M #	Gabriel	Upgrade
14QK-391AM	83041		14QK-399M2	83045		20874147	83050		25622373	83905	
14QK-391AM2	83041		14QK-399M3	83045		21154393	83050		25622612	83041	
14QK-391BM	83041		14QK-411	83007		21345868	83066		25622613	83041	
14QK-391BM2	83041		14QK-411AM	83007		21345869	83066		25624837	83041	
14QK-391M	83041		14QK-411M	83007		21490486	83066		25625635	83045	
14QK-391M2	83041		14QK-432M	83050		22662254	83901		25625636	83045	
14QK-397AM	83905		14QK-439M	83050		22662259	83901		25625637	83045	
14QK-399M	83045		20873442	83050		23145372	83066		25631922	83007	

**MAECO**

O.E.M #	Gabriel	Upgrade	O.E.M #	Gabriel	Upgrade	O.E.M #	Gabriel	Upgrade	O.E.M #	Gabriel	Upgrade
1085	83214		16777	85006		70088	85307		70644	85334	
12608	83125		16778	83203	89436	70123	85716		70648	89414	
12788	83216		16779	83126	89440	70127	85006		70650	89440	
12866	83207	89407	16780	83123	89405	70128	85006		70651	85013	89414
16385	83215		16781	85006		70162	85716		70652	85030	89440
1668722	85030	89440	16787	85030	89440	70163	85302	89420	70663	85013	89414
16720	83107		16949	83120		70164	85716		70691	85007	
16767	85013	89414	16950	83118		70300	85320	89429	70720	85934	
16768	83217		6025	83122	89406	70312	85001	89410	70721	83125	
16769	83221		6026	83204		70315	85063		74039	85303	89422
16770	83209	89414	70018	85303	89422	70317		89432	OE10881	85711	
16771	83126	89440	70021	85303	89422	70331	85314	89425	OE10882	85740	
16772	83122	89406	70029	85308	89422	70332	83314		OE10883	85339	
16773	85005	89430	70034	85302	89420	70334	85316	89426	OE12425	83214	
16774	83215		70039	85303	89422	70397	85006		SC-2920	83176	
16775	83207	89407	70041	85305		70402	85305				
16776	83122	89406	70042	85302	89420	70642	85300	89419			

**MAN BUS**

O.E.M #	Gabriel	Upgrade	O.E.M #	Gabriel	Upgrade	O.E.M #	Gabriel	Upgrade	O.E.M #	Gabriel	Upgrade
134	85709		81-43701-6538	85708		81-43701-6572	85708		9020M-1042	85709	
25-1700-106-654	85708		81-43701-6539	85708		81-43701-6573	85722				
81-43701-6537	85709		81-43701-6543	85708		81-43701-6609	85709				

**MANDALAY COACH**

O.E.M #	Gabriel	Upgrade	O.E.M #	Gabriel	Upgrade	O.E.M #	Gabriel	Upgrade	O.E.M #	Gabriel	Upgrade
141700131809	85029		16-16736-000	85029		16-16873-000	85029		16-18103-000	85900	
141700131810	83160		16-16737-000	83160		16-16874-000	83160		481700000493	85900	

**MARMON**

O.E.M #	Gabriel	Upgrade	O.E.M #	Gabriel	Upgrade	O.E.M #	Gabriel	Upgrade	O.E.M #	Gabriel	Upgrade
1-7001	83216		51-139-28	85003	89411	576451	83122	89406			
37-1-1	83122	89406	51-163-7	83123	89405	665147	83216				

**MARMON CAB SHOCKS**

O.E.M #	Gabriel	Upgrade	O.E.M #	Gabriel	Upgrade	O.E.M #	Gabriel	Upgrade	O.E.M #	Gabriel	Upgrade
1202-0054	83021										

**MATSON SCHOOL BUS**

O.E.M #	Gabriel	Upgrade	O.E.M #	Gabriel	Upgrade	O.E.M #	Gabriel	Upgrade	O.E.M #	Gabriel	Upgrade
5392387	85303	89422									

**MAXPRO**

Maxpro	Gabriel	Upgrade	Maxpro	Gabriel	Upgrade	Maxpro	Gabriel	Upgrade	Maxpro	Gabriel	Upgrade
17E-Z10042	85061	89450									

**MC NEILUS TRUCK & MAN.**

O.E.M #	Gabriel	Upgrade	O.E.M #	Gabriel	Upgrade	O.E.M #	Gabriel	Upgrade	O.E.M #	Gabriel	Upgrade
1139039 MTM	85334		1323106 MTM	85305		1367383 MTM	83147		1429317 MTM	85919	
1139046 MTM	83112		1333575 MTM	85072		1396513 MTM	85959		1431085 MTM	85738	
1139059 MTM	83207	89407	1340975 MTM	83142		1398980 MTM	83127				
1139069 MTM	83209	89414	1340976 MTM	85919		1404068 MTM	85087				
1170719	632147		1340979 MTM	83143		1410046 MTM	85919				
12405FX1 MTM	85303	89422	1360386 MTM	85323	89436	1411765 MTM	83148				

**Important Note:** Competitive Interchanges are to be used for stocking purposes only. Where multiple crosses are identified, please reference the applications section of this catalog. / **Remarque importante:** Les interchanges concurrentiels ne s'utilisent qu'aux fins de stocks. Dans le cas de références multiples, consulter la section des applications du catalogue. / **Nota importante:** Dans le cas de références multiples, consulter la section des applications du catalogue. / **Nota importante:** Se pueden usar intercambios competitivos para propósitos de almacenamiento solamente. Cuando se identifican intercambios múltiples, consulte la sección de aplicaciones de este catálogo.

# COMPETITIVE & O.E.M. INTERCHANGE LIST

## Lista de Intercambios contra Competidores y Equipo Original.

### Liste d'interchange de produits compétitifs & d'équipement original (OEM)

#### MC NEILUS TRUCK & MAN.... cont'd

O.E.M #	Gabriel	Upgrade	O.E.M #	Gabriel	Upgrade	O.E.M #	Gabriel	Upgrade	O.E.M #	Gabriel	Upgrade
1432386 MTM	85965		217330	85303	89422	5HB645 MTM	83109		6HD720 MTM	85909	
1433009 MTM	85962		2218640 MTM	83009		5KK247 MTM	85977		6HS773 MTM	83122	89406
1468783 MTM	85345		3215395 MTM	83112		600-115994B	632147		6KP857 MTM	85000	89436
1473224	646155		3HR582 MTM	85013	89414	600-11599M	632147		7HS237 MTM	83122	89406
1485576 MTM	85979		3HR916 MTM	83207	89407	600-188206	646155		7HS534 MTM	85906	89407
1491909 MTM	83128	89436	4HA569 MTM	85932	89453	64442AX MTM	83128	89436	8KK524 MTM	83168	
1KK552 MTM	85967		4KP398 MTM	85933	89454	6HA961 MTM	83123	89405	9HB362 MTM	85976	
2034140 MTM	646155		5HA994 MTM	85916	89430	6HB390 MTM	83137		9KK464 MTM	85079	

#### MERITOR

Meritor	Gabriel	Upgrade	Meritor	Gabriel	Upgrade	Meritor	Gabriel	Upgrade	Meritor	Gabriel	Upgrade
14QK-3100	85739		M83111	83111		M85045	85045		M85901	85901	
202447	85919		M83112	83112		M85046	85046	89434	M85902	85902	
21227751	87015		M83122	83122	89406	M85047	85047	89435	M85909	85909	
446-51-211	85739		M83123	83123	89405	M85052	85052		M85918	85918	89449
671020	87015		M83124	83124	89407	M85053	85053	89442	M85919	85919	
671506	86200		M83125	83125		M85058	85058	89431	M85920	85920	89503
671507	87015		M83127	83127		M85061	85061	89450	M85923	85923	89458
671907	85919		M83128	83128	89436	M85062	85062	89408	M85924	85924	89457
680705	85737		M83130	83130		M85064	85064		M85931	85931	89458
700115	85712		M83135	83135		M85066	85066	89448	M85933	85933	89454
7805-F-1020	86200		M83136	83136		M85067	85067	89451	M85934	85934	
A-3280-M-9711	85919		M83147	83147		M85069	85069	89455	M85936	85936	89456
A-7805F-1020	86200		M83203	83203	89436	M85070	85070	89459	M85937	85937	
A-7805L-1000	85919		M83207	83207	89407	M85072	85072		M89408	89408	
A-7805L-1026	87015		M83209	83209	89414	M85300	85300	89419	M89410	89410	
A-7805P-1030	85737		M83215	83215		M85301	85301		M89411	89411	
KIT11210	87015		M83456	83456	89447	M85303	85303	89422	M89413	89413	
KIT11375	86200		M85000	85000	89436	M85305	85305		M89414	89414	
KIT11376	86200		M85001	85001	89410	M85310	85310	89423	M89423	89423	
KIT11389	86200		M85003	85003	89411	M85311	85311	89424	M89424	89424	
KIT11402	86200		M85005	85005	89430	M85316	85316	89426	M89427	89427	
M646155	646155		M85006	85006	89401	M85319	85319	89428	M89429	89429	
M83001	83001		M85007	85007		M85320	85320	89429	M89430	89430	
M83008	83008		M85012	85012	89413	M85323	85323	89436	M89436	89436	
M83009	83009		M85013	85013	89414	M85331	85331		M89443	89443	
M83021	83021		M85014	85014		M85708	85708		M89448	89448	
M83025	83025		M85026	85026	89417	M85724	85724	89443	M89449	89449	
M83028	83028		M85029	85029		M85727	85727		M89450	89450	
M83029	83029		M85030	85030	89440	M85729	85729		M89451	89451	
M83038	83038		M85033	85033	89427	M85732	85732				
M83041	83041		M85036	85036	89405	M85738	85738				
M83110	83110		M85043	85043		M85900	85900				

#### MITSUBISHI-FUSO

O.E.M #	Gabriel	Upgrade	O.E.M #	Gabriel	Upgrade	O.E.M #	Gabriel	Upgrade	O.E.M #	Gabriel	Upgrade
MB161497	G63299		MC809390	83103		MC813511	G63398		MC826268	G63610	
MC114595	G63405		MC813135	83456	89447	MC814614	85009				

#### MOHAWK

O.E.M #	Gabriel	Upgrade	O.E.M #	Gabriel	Upgrade	O.E.M #	Gabriel	Upgrade	O.E.M #	Gabriel	Upgrade
01-0100-905	85303	89422	22012082	85702		680323	85700		97-9999-02320	85704	
020273544	83203	89436	22012114	85700		680485	85733		MM-6886	83207	89407
050134508	85732		4968853	83216		97-2201-00007	85703		MM-6957	83225	
1235233	85736		6-367-7	85305		97-2201-00011	85704		MM-74029	85308	89422

#### MONACO

O.E.M #	Gabriel	Upgrade	O.E.M #	Gabriel	Upgrade	O.E.M #	Gabriel	Upgrade	O.E.M #	Gabriel	Upgrade
1C34-18045-AA	83209	89414	24-153256	85124		24-186629	85125		9U94-18045-AA	83209	89414
1C34-18045-JA	83209	89414	24-186537	85126		66153-002	83124	89407	9U94-18080-AA	83122	89406

**Important Note:** Competitive Interchanges are to be used for stocking purposes only. Where multiple crosses are identified, please reference the applications section of this catalog. / **Remarque importante:** Les interchanges concurrentiels ne s'utilisent qu'aux fins de stocks. Dans le cas de références multiples, consulter la section des applications du catalogue. / **Nota importante:** Dans le cas de références multiples, consulter la section des applications du catalogue. / **Nota importante:** Se pueden usar intercambios competitivos para propósitos de almacenamiento solamente. Cuando se identifican intercambios múltiples, consulte la sección de aplicaciones de este catálogo.

**COMPETITIVE & O.E.M. INTERCHANGE LIST**  
**Lista de Intercambios contra Competidores y Equipo Original.**  
**Liste d'interchange de produits compétitifs & d'équipement original (OEM)**

**MONACO... cont'd**

O.E.M #	Gabriel	Upgrade	O.E.M #	Gabriel	Upgrade	O.E.M #	Gabriel	Upgrade	O.E.M #	Gabriel	Upgrade
9U9Z-18124-A	83209	89414	ASH-1228	83209	89414	ASH-25824	83122	89406	F4-BE5-B492-HO	85125	
9U9Z-18125-A	83122	89406	ASH-1229	83209	89414	ASH-294	83209	89414	F4-BE5-C832-MO	83124	89407
ASH-1022	83209	89414	ASH-1230	83122	89406	AT-620	83209	89414	F4-BE5-F325-HO	85124	
ASH-1023	83122	89406	ASH-137	83122	89406	AT-621	83122	89406	W0005663	85124	
ASH-1205	83209	89414	ASH-25822	83209	89414	AT-766	83209	89414			
ASH-1206	83122	89406	ASH-25823	83209	89414	F4-BE5-A011-HO	85126				

**MONROE**

Monroe	Gabriel	Upgrade	Monroe	Gabriel	Upgrade	Monroe	Gabriel	Upgrade	Monroe	Gabriel	Upgrade
12872	83219		34756	G63638		34929	G63403		37060	G63621	
16385	83215		34759	G63624		34930	G63811		37061	G63502	
16721	83125		34760	G63622		34944	61516		37062	G63818	
171322	G63679		34761	G63623		34954	G63484		37063	G63375	
171341	G64014		34762	G63638		34958	G63377		37064	G63454	
31029	G63798		34763	58638		34959	G63432		37065	G63426	
32066	G63900		34767	G63638		34960	G63366		37066	G63915	
32207	G63949		34768	83209	89414	34963	G63406		37067	G63460	
32217	G63612		34776	G63661		34964	G63456		37068	G63905	
32273	G63782		34777	G63662		34972	G63610		37069	G63499	
32274	G63781		34778	G63673		34975	G63511		37070	G63799	
32314	G63604		34781	G63675		34983	G63489		37071	G63914	
32341	G63675		34782	G63674		34985	61543		37072	G63903	
32392	G63848		34787	G63615		37011	G63414		37073	G63907	
33049	G63610		34788	G63616		37012	G63603		37074	G63620	
34504	G63817		34791	G63692		37013	G63525		37075	G63606	
34514	G63958		34793	61520		37014	G63524		37076	G63639	
34515	G63675		34794	G63360		37015	G63614		37077	G63909	
34516	G63848		34796	G63929		37016	G63635		37080	G63624	
34517	G63837		34797	G63406		37017	G63639		37082	G63626	
34518	G63809		34798	G63609		37021	G63422		37085	G63896	
34519	G63837		34799	G63609		37022	G63495		37086	G63897	
34523	G63969		34802	83216		37024	G63610		37088	G63500	
34524	77968		34803	G63306		37026	G63424		37089	G63350	
34530	G63895		34817	G63355		37027	G63425		37090	G63357	
34612	83017		34821	G63406		37028	G63904		37091	G63413	
34617	83019		34822	G63371		37029	G63928		37093	G63359	
34655	G63714		34824	G63349		37030	G63547		37094	G63353	
34656	G63778		34828	G63510		37031	G63404		37097	G63950	
34657	G63716		34831	G63359		37032	G63494		37099	G63423	
34658	G63715		34832	61526		37033	G63548		37100	G63904	
34675	G63783		34839	G63671		37035	G63607		37101	G63660	
34676	G63662		34868	61650		37036	G63410		37102	G63661	
34677	G63803		34895	83207	89407	37038	G63461		37103	G63662	
34684	G63622		34899	G63500		37040	G63347		37104	G63673	
34685	G63808		34900	G63386		37041	G63349		37108	G63707	
34686	G63809		34901	G63387		37042	G63906		37109	G63708	
34687	G63810		34904	G63299		37044	G63488		37110	G63676	
34690	G63675		34905	G63405		37045	G63183		37111	G63937	
34721	83103		34906	G63396		37046	G63389		37112	G63689	
34722	83400		34907	G63511		37047	G63902		37113	G64005	
34729	G63414		34909	G63187		37048	G63492		37114	G64004	
34730	G63386		34910	61516		37049	G63355		37120	G63511	
34732	G63455		34911	G63350		37050	G63489		37121	G63490	
34733	G63617		34912	83304		37051	G63490		37122	G63678	
34736	G63394		34919	G63411		37052	G63406				
34741	G63489		34920	G63675		37053	G63386				
34751	G63607		34927	G63409		37055	G63455				
34755	G63812		34928	G63416		37058	G63457				

**Important Note:** Competitive Interchanges are to be used for stocking purposes only. Where multiple crosses are identified, please reference the applications section of this catalog. / **Remarque importante:** Les interchanges concurrentiels ne s'utilisent qu'aux fins de stocks. Dans le cas de références multiples, consulter la section des applications du catalogue. / **Nota importante:** Dans le cas de références multiples, consulter la section des applications du catalogue. / **Nota importante:** Se pueden usar intercambios competitivos para propósitos de almacenamiento solamente. Cuando se identifican intercambios múltiples, consulte la sección de aplicaciones de este catálogo.

**COMPETITIVE & O.E.M. INTERCHANGE LIST**  
**Lista de Intercambios contra Competidores y Equipo Original.**  
**Liste d'interchange de produits compétitifs & d'équipement original (OEM)**

**MONROE... cont'd**

Monroe	Gabriel	Upgrade	Monroe	Gabriel	Upgrade	Monroe	Gabriel	Upgrade	Monroe	Gabriel	Upgrade
37123	G63690		550051	43140		65102	85001	89410	65178	85998	
37128	G63929		551001	83125		65103	85320	89429	65179	85995	
37129	G63421		551002	83122	89406	65104	85026	89417	65180	85639	
37130	G63609		553001	79900		65105	85026	89417	65181	85650	
37131	G63714		553002	G56778		65106	83124	89407	65183	85181	
37132	G63778		555004	G63299		65107	85316	89426	65184	85180	
37133	G63716		555005	G63689		65108	85030	89432	65185	85180	
37134	G63715		555006	G63173		65109	85058	89431	65400	85033	89427
37135	G63722		555010	77623		65110	85005	89430	65401	85013	89414
37144	G63717		555011	83119		65111	85006		65402	85311	89424
37149	G63783		555012	G63183		65112	89402		65404	85310	89423
37151	G63803		555019	85069	89455	65113	85012	89413	65405	85023	89415
37153	G63772		555026	83124	89407	65114	85036	89405	65406	85024	
37155	G63676		555027	83124	89407	65115	85027	89418	65407	85736	
37156	G63869		555028	83207	89407	65116	85329		65408	85319	89428
37157	G63726		555029	83144		65118	85001	89410	65409	85003	89411
37158	G63712		555031	83177		65119	85029		65410	85300	89419
37160	G63710		555032	83178		65120	85010		65411	85036	89405
37161	G63847		555033	G63386		65122	85063		65412	83122	89406
37162	G63829		555034	G63387		65123	85054	89438	65413	83136	
37163	G63817		555035	G63357		65124	85053	89442	65415	85046	89434
37164	G63675		555036	77403		65128	85031		65416	85000	89436
37166	G63866		555037	G63359		65130	85061	89450	65417	85322	
37178	G63803		555038	G63413		65133	85935		65418	85906	89407
37191	G63506		555039	G63359		65139	85918	89449	65419	85000	89436
37198	G63694		555041	G63866		65140	85918	89449	65420	85013	89414
37199	G63860		555043	83400		65142	83131		65421	85916	
37202	G64002		555045	G63394		65143	83163		65425	85056	
37203	G63844		557001	85013	89414	65144	85928		65426	85054	89438
37204	G63845		557004	G63866		65145	85929		65427	85903	
37206	G63958		557005	83136		65146	85925		65428	85321	
37217	G63862		557006	83136		65147	85924	89457	65429	85030	89440
37218	G63877		557008	85029		65148	85918	89449	65431	85909	
37231	G63720		557009	85007		65150	85953		65432	85910	
37238	G63815		557010	83144		65151	85953		65433	85910	
37240	G63865		557011	83160		65153	85921		65434	85012	89413
37241	G63842		557012	85029		65155	83175		65435	85901	
37242	G64014		557013	83127		65156	85005		65436	85900	
37243	G63610		557014	83126	89430	65157	85954		65439	85716	
37244	G63864		557015	83209	89414	65158	85954		65440	85711	
37246	G64003		557017	85029		65159	85070	89459	65441	85704	
37249	G63434		557018	83127		65160	85080		65442	85700	
37803	G63306		557020	83123	89405	65161	83136		65444	85311	89424
38072	83043		557021	85051		65162	85959		65447	85703	
39052	G63868		557022	85051		65163	85954		65448	85700	
54487	85073		557023	83144		65164	85649		65449	85702	
54488	85074		557026	83127		65166	85090		65451	85029	
550010	G63375		557027	83144		65167	G63969		65452	85733	
550011	69606		557028	85010		65168	77968		65453	85904	
550012	G63375		557031	85010		65171	85964		65454	85030	89440
550013	69724		557032	85126		65172	83153		65455	85716	
550016	G63424		557033	85900		65173	85336		65456	85376	
550017	G63425		557038	85125		65174	58942		65457	85909	
550018	69575		557039	85959		65175	85084	89460	65458	85908	
550019	G63918		5777	G63880		65176	85084	89460	65459	85043	
550020	G63919		65101	85062	89408	65177	85012	89413	65461	85059	

**Important Note:** Competitive Interchanges are to be used for stocking purposes only. Where multiple crosses are identified, please reference the applications section of this catalog. / **Remarque importante:** Les interchanges concurrentiels ne s'utilisent qu'aux fins de stocks. Dans le cas de références multiples, consulter la section des applications du catalogue. / **Nota importante:** Dans le cas de références multiples, consulter la section des applications du catalogue. / **Nota importante:** Se pueden usar intercambios competitivos para propósitos de almacenamiento solamente. Cuando se identifican intercambios múltiples, consulte la sección de aplicaciones de este catálogo.

**COMPETITIVE & O.E.M. INTERCHANGE LIST**  
**Lista de Intercambios contra Competidores y Equipo Original.**  
**Liste d'interchange de produits compétitifs & d'équipement original (OEM)**

**MONROE... cont'd**

Monroe	Gabriel	Upgrade	Monroe	Gabriel	Upgrade	Monroe	Gabriel	Upgrade	Monroe	Gabriel	Upgrade
65463	85040		65523	85937		66143	83007		66443	83150	
65465	85939		65524	85936	89456	66145	83008		66445	83135	
65466	85047	89435	65525	87015		66147	83009		66447	83180	
65467	85054	89438	65526	85956		66149	83022		66448	85058	89431
65468	85069	89455	65527	85955		6615	83120		66454	83166	
65469	85708		65528	85069	89455	66150	83003		66455	83166	
65470	85708		65530	85932	89453	66152	83012		66486	85066	89448
65471	85302	89420	65531	85334		66157	83015		66502	646155	
65472	85379		65532	85967		66159	83031		66503	646155	
65473	85329		65533	85120		66161	83054		66504	632147	
65474	85712		65534	85343		66162	83025		66506	646155	
65475	85065		65535	85954		66169	83027		66535	85062	89408
65476	85736		65536	85965		66178	83023		6658	85009	
65477	85702		65537	85962		66179	83013		66601	83114	
65478	85058	89431	65539	85961		66181	83025		66603	83103	
65479	83122	89406	65541	85119		66182	83005		66604	83101	
65480	83111		65542	85102		66189	83041		66605	83613	
65481	85036	89405	65546	85986		66193	83034		66607	85052	
65482	85006		65547	85650		66195	83033		66608	83128	89436
65483	85978		6603	83103		66196	83027		66609	83635	
65484	85976		6604	83101		66198	83158		66610	83130	
65485	85972		6605	83613		66199	83048		66611	83016	
65486	85066	89448	6607	85052		66200	83066		66612	83017	
65487	85927		6608	83128	89436	66201	83081		66613	83123	89405
65488	85926		6609	83635		66203	83067		66614	83125	
65489	85331		6610	85051		66204	83024		66615	83120	
65490	85724	89443	66101	83042		66205	83063		66616	83018	
65492	85931	89458	66102	83059		66400	G63432		66617	83019	
65493	85934		66102	83063		66402	83157		66618	83159	
65494	85061	89450	66104	83021		66403	83154		66620	83162	
65495	85067	89451	66105	83044		66405	83154		66623	83004	
65496	83138		66106	83016		66406	85920		66624	83141	
65497	85933	89454	66107	83048		66407	83134		66625	83162	
65498	85964		66108	83028		66409	83364		66626	85071	
65499	85963		66109	83048		66412	83156		66627	85045	
65500	85738		66111	83016		66415	G63918		66628	83136	
65501	85323	89436	66112	83017		66417	G63919		66629	83107	
65502	85938		66113	83050		66418	85918	89449	66630	83216	
65503	85919		66114	83045		66419	85931	89458	66631	83140	
65504	85072		66115	83045		66422	83163		66632	83006	
65505	85006		66116	83018		66423	85001	89410	66633	83127	
65506	83168		66117	83019		66424	85310	89423	66634	83203	89436
65507	83143		66118	83001		66425	85920		66636	83127	
65508	83142		66120	85006		66426	85924	89457	66637	83304	
65509	85079		66121	83047		66427	89441		66638	83123	89405
65510	85052		66122	83038		66428	85033	89427	66642	G63866	
65511	85939		66123	83004		66429	85311	89424	66643	83007	
65512	85938		66124	83040		66430	83309	89446	66645	83008	
65513	85338		66125	83035		66431	85066	89448	66646	83308	89435
65516	85013	89414	66126	83051		66432	85319	89428	66647	83009	
65517	83165		6613	83123	89405	66433	85918	89449	66648	83112	
65518	85089		66131	83062		66434	85069	89455	66649	83010	
65519	85060		66132	83001		66435	83219		66650	83003	
65520	85121		66135	83905		66436	85067	89451	66653	83515	
65521	85014		6614	83125		66438	83363		66656	83110	
65522	85082		66142	83039		66442	83150		66657	83015	

**Important Note:** Competitive Interchanges are to be used for stocking purposes only. Where multiple crosses are identified, please reference the applications section of this catalog. / **Remarque importante:** Les interchanges concurrentiels ne s'utilisent qu'aux fins de stocks. Dans le cas de références multiples, consulter la section des applications du catalogue. / **Nota importante:** Dans le cas de références multiples, consulter la section des applications du catalogue. / **Nota importante:** Se pueden usar intercambios competitivos para propósitos de almacenamiento solamente. Cuando se identifican intercambios múltiples, consulte la sección de aplicaciones de este catálogo.



**COMPETITIVE & O.E.M. INTERCHANGE LIST**  
**Lista de Intercambios contra Competidores y Equipo Original.**  
**Liste d'interchange de produits compétitifs & d'équipement original (OEM)**

**MONROE... cont'd**

Monroe	Gabriel	Upgrade	Monroe	Gabriel	Upgrade	Monroe	Gabriel	Upgrade	Monroe	Gabriel	Upgrade
66658	85009		66894	83137		6903	83400		74409	85310	89423
66659	83002		66897	83126	89430	6910	G63413		74411	85703	
66660	85059		66898	83125		6911	G63350		74412	85704	
66661	83123	89405	66902	83401		6912	83304		74414	85723	
66664	83215		66903	83400		6913	83303		74415	85318	
66665	83109		66912	83304		6916	83123	89405	74416	85705	89447
66666	G63671		66913	83303		6920	G63411		74417	85311	89424
66668	83312	89439	66921	83318		6921	83318		74418	85709	
66669	83111		66922	83301		6922	83301		74420	85003	89411
66670		89402	66923	83456	89447	6923	83456	89447	74421	85708	
66671	83123	89405	66924	83317		6927	G63409		74422	85733	
66672	83209	89414	66956	83101		6945	G63421		74423	85712	
66677	83114		66957	83225		6956	83101		74424	85308	89422
66678	83023		66966	85740		6957	83225		74425	85724	89443
66679	83013		66969	83126	89430	6960	G63366		74426	85333	
66680	83317		6701	83215		6969	83126	89430	74427	85308	89422
66681	83025		6707	83215		6994	83122	89406	74429	85919	
66682	83005		6710	83209	89414	70039	85303	89422	74430	85340	
66683	83101		6712	85040		70166	85301		74431	85341	
66684	85007		6713	83105		70300	85320	89429	74432	85970	
66686	85014		6714	83216		70312	85001	89410	74433	85331	
66691	83118		6715	85026	89417	70331	85314	89425	74434	85711	
66692	83120		6716	85042		70332	83314		74435	87017	
66693	83034		6717	G63616		70334	85316	89426	74436	85334	
66695	83033		6718	85024		70402	85305		74437	89461	
66697	83164		6719	83242		70447	85949		74438	85734	
66699	83113		6720	85003	89411	70448	85943		74439	85728	
66701	83215		6721	83103		70449	85942		74440	85729	
66707	83215		6801	G63484		70454	85941		74441	85339	
66710	83209	89414	6803	G63907		70459	85948		74442	85727	
66713	83105		6811	83312	89409	70459	85951		74443	85377	
66714	83216		6817	G63355		70477	85949		74445	85381	
66715	85026	89417	6824	G63349		70720	85934		74446	85352	
66716	85042		6828	83219		74001	85307		74451	85711	
66717	83515		6829	83103		74003	85314	89425	74452	85740	
66719	83242		6831	G63359		74004	85315		74453	85339	
66720	85003	89411	6833	83126	89430	74006	85304		74454	85314	89425
66811	83312	89409	6839	G63357		74012	85736		74457	695406	
66813	83303		6840	83217		74024	85308	89422	74458	695406	
66828	83159		6841	83216		74025	85303	89422	74464	85318	
66829	83103		6860	83308	89435	74028	85302	89420	74465	85708	
66833	83126	89430	6861	83309	89446	74029	85308	89422	74466	85318	
66841	83216		6863	83314		74069	85301		74467	85723	
66858	G63183		6864	83104		74070	85716		74469	85345	
66860	83308	89435	6868	G63360		74073	85320	89429	74470	89461	
66861	83309	89446	6878	83221		74074	85722		74471	85736	
66863	83314		6886	83124	89407	74075	85712		74472	85303	89422
66864	83104		6891	83215		74078	85027	89418	74473	85716	
66868	83219		6893	83203	89436	74079	85336		74475	85746	
66871	G63605		6894	83209	89414	74080	85332		74476	85745	
66878	83221		6895	83204		74081	85727		74477	83165	
66883	83314		6897	83126	89430	74400	85700		74478	85089	
66884	83125		6898	83125		74402	85711		911030	G63479	
66886	83124	89407	6900	G63386		74405	85300	89419	911171	G63813	
66891	83215		6901	G63387		74406	85712		911172	G63491	
66893	83203	89436	6902	83401		74408	85702		911183	G63832	

**Important Note:** Competitive Interchanges are to be used for stocking purposes only. Where multiple crosses are identified, please reference the applications section of this catalog. / **Remarque importante:** Les interchanges concurrentiels ne s'utilisent qu'aux fins de stocks. Dans le cas de références multiples, consulter la section des applications du catalogue. / **Nota importante:** Dans le cas de références multiples, consulter la section des applications du catalogue. / **Nota importante:** Se pueden usar intercambios competitivos para propósitos de almacenamiento solamente. Cuando se identifican intercambios múltiples, consulte la sección de aplicaciones de este catálogo.

**COMPETITIVE & O.E.M. INTERCHANGE LIST**  
**Lista de Intercambios contra Competidores y Equipo Original.**  
**Liste d'interchange de produits compétitifs & d'équipement original (OEM)**

**MONROE... cont'd**

Monroe	Gabriel	Upgrade	Monroe	Gabriel	Upgrade	Monroe	Gabriel	Upgrade	Monroe	Gabriel	Upgrade
911184	G63828		911256	G63893		911270	G63885		911534	G64011	
911222	G63970		911257	G63895		911277	G63890		911535	G64013	
911228	G63882		911258	G63872		911278	G64012		911536	G64008	
911229	G63884		911259	G64016		911279	G63889		911538	G63966	
911230	G63879		911260	G63892		911280	G64007		911539	G63967	
911251	G63878		911265	G64010		911508	G64000		SC-2920	83176	
911252	G63883		911266	G63886		911527	G64001				
911253	G63875		911267	G63887		911528	G63965				
911255	G63894		911268	G63888		911533	G63959				

**MOR-RYDE SUSPENSION**

O.E.M #	Gabriel	Upgrade	O.E.M #	Gabriel	Upgrade	O.E.M #	Gabriel	Upgrade	O.E.M #	Gabriel	Upgrade
U0109-006	G63866		U0109-007	G63183		U0109-014	83400		U0109-018	G63866	

**MOTOR COACH INDUSTRIES**

O.E.M #	Gabriel	Upgrade	O.E.M #	Gabriel	Upgrade	O.E.M #	Gabriel	Upgrade	O.E.M #	Gabriel	Upgrade
01-205219	85727		12-05-1264	85727		12L-5-71	85708		680482	85727	
12-05-1021	85340		12-05-1327	85728		12L-5-72	85709		680485	85733	
12-05-1022	85970		12-05-1328	85729		12L-5-88	85729		680544	85711	
12-05-1023	85341		12-05-1329	85727		12L-5-89	85729		680546	85339	
12-05-1101	85340		12-05-6000	85711		12L-5-96	85728		680602	85339	
12-05-1102	85970		12-05-6001	85740		12L-5-97	85728		680677	85728	
12-05-1103	85341		12-05-6002	85339		12L-5-98	85339		680680	85729	
12-05-1137	85340		12-05-6033	85339		12L-5-99	85339		680681	85727	
12-05-1138	85970		12-05-6053	85711		12T-1-13	85303	89422	690029	85700	
12-05-1139	85341		12-05-6054	85740		12TA-01-013	85303	89422	695125	85704	
12-05-1142	85340		12-05-6055	85339		1497835	85711		85729	85729	
12-05-1146	85340		12-05-6068	85727		1498200	85740		97-2201-00151	85700	
12-05-1147	85341		12-5-1-G	85700		1498565	85339		97-2210-00164	85708	
12-05-1148	85970		12-5-1-GS	85700		22012067	85700		97-9999-02514	85700	
12-05-1150	85711		12B-5-1	85735		22024061	85704		97-9999-02585	85723	
12-05-1165	85711		12B-5-1-G	85700		22045526	85702		97-9999-02634	85733	
12-05-1166	85341		12B-5-1-GS	85700		22052014	85702		G1011822	85702	
12-05-1170	85340		12G-5-1	85700		3178154	85735		G1101590	85713	
12-05-1176	85728		12J-5-10	85733		3178157	85700		G1101590GS	85713	
12-05-1177	85729		12J-5-10GS	85733		63-0127GS	85303	89422	G1201339	85702	
12-05-1178	85339		12J-5-2	85733		6314933	85708		G5008069	85700	
12-05-1179	85727		12J-5-4	85733		654789	83158		OE10086S	85702	
12-05-1188	85970		12J-5-7	85733		680232	85733		OE10881	85711	
12-05-1194	85339		12J-5-71	85733		680322	85704		OE10882	85740	
12-05-1199	85729		12J-5-9	85700		680323	85700		OE10883	85339	
12-05-1228	85711		12L-4-170	83158		680333	85708		T12-1208	85727	
12-05-1242	85728		12L-5-100	85727		680369	85708		T14-1045GS	85700	
12-05-1243	85729		12L-5-114	85727		680374	85728		T14-1048	85302	89420
12-05-1244	85727		12L-5-58	85728		680441	85729		T14-1080	85728	
12-05-1260	85728		12L-5-67	85728		680452	85339		T14-1081	85729	
12-05-1261	85729		12L-5-69	85700		680462	85728		T14-1082	85727	
12-05-1262	85727		12L-5-70	85700		680470	85713				

**MOTORCRAFT**

Motorcraft	Gabriel	Upgrade	Motorcraft	Gabriel	Upgrade	Motorcraft	Gabriel	Upgrade	Motorcraft	Gabriel	Upgrade
AA-229	G63773		AA-494	83131		AA-617	85928		ASH-1023	83122	89406
AA-450	G63773		AA-500	G63809		AS-1086	G63678		ASH-1130	G63622	
AA-456	G63772		AA-501	G63809		AS-413	G63414		ASH-1131	G63622	
AA-457	G63678		AA-502	G63614		AS-433	G63406		ASH-1132	G63622	
AA-483	G63837		AA-503	G63614		AS-485G	G63622		ASH-1135	G63623	
AA-484	G63837		AA-504	G63614		AS-498G	G63608		ASH-1136	83178	
AA-485	G63837		AA-615	83135		AS-500G	G63624		ASH-1154	83177	
AA-486	G63607		AA-616	83175		ASH-1022	83209	89414	ASH-1155	G63623	

**Important Note:** Competitive Interchanges are to be used for stocking purposes only. Where multiple crosses are identified, please reference the applications section of this catalog. / **Remarque importante:** Les interchanges concurrentiels ne s'utilisent qu'aux fins de stocks. Dans le cas de références multiples, consulter la section des applications du catalogue. / **Nota importante:** Dans le cas de referencias multiples, consultar la sección de aplicaciones del catálogo. / **Nota importante:** Se pueden usar intercambios competitivos para propósitos de almacenamiento solamente. Cuando se identifican intercambios múltiples, consulte la sección de aplicaciones de este catálogo.

**COMPETITIVE & O.E.M. INTERCHANGE LIST**  
**Lista de Intercambios contra Competidores y Equipo Original.**  
**Liste d'interchange de produits compétitifs & d'équipement original (OEM)**

**MOTORCRAFT... cont'd**

Motorcraft	Gabriel	Upgrade	Motorcraft	Gabriel	Upgrade	Motorcraft	Gabriel	Upgrade	Motorcraft	Gabriel	Upgrade
ASH-119	G63809		ASHV-1028	G63778		AX-332	85928		CAT-832	G63353	
ASH-120	G63837		ASHV-1046	G63772		AX-79A	83221		CAT-839	G63357	
ASH-1205	83209	89414	ASHV-1047	G63607		AX-79A	85030	89440	CAT-853	G63183	
ASH-1206	83122	89406	ASHV-1048	G63525		AX-85A	83219		CAT-854	G63389	
ASH-121	G63607		ASHV-1049	G63524		AX-97A	83122	89406	CAT-868	G63360	
ASH-122	G63614		ASHV-1050	G63608		AX-97A	85005	89430	CAT-895	83207	89407
ASH-1228	83209	89414	ASHV-1051	G63837		CAH-001	85307		CAT-899	G63500	
ASH-1230	83122	89406	ASHV-13	G63676		CAH-001	85711		CAT-900	G63386	
ASH-132	G63614		ASHV-14	G63837		CAH-003	83215		CAT-901	G63387	
ASH-137	83122	89406	ASHV-3	G63714		CAH-006	85304		CAT-904	G63299	
ASH-23454	G63614		ASHV-4	G63716		CAH-012	85736		CAT-905	G63405	
ASH-23458	G63614		ASHV-6	G63809		CAH-025	85007		CAT-906	G63396	
ASH-24401	G63809		ASHV-864	G63929		CAH-028	85302	89420	CAT-907	G63511	
ASH-24402	85928		ASHV-865	G63808		CAH-029	85308	89422	CAT-909	G63398	
ASH-24433	G63837		ASHV-866	G63810		CAH-069	83219		CAT-910	G63413	
ASH-24434	G63607		ASHV-867	G63455		CAH-069	85301		CAT-911	G63350	
ASH-24492	83175		ASHV-868	G63406		CAHL-400	85303	89422	CAT-912	G63625	
ASH-24659	85181		ASHV-871	G63809		CAHL-400	85700		CAT-919	G63411	
ASH-24660	85180		ASHV-879	G63455		CAHL-405	85300	89419	CAT-920	G63675	
ASH-25	83309	89446	AST-260	G63929		CAHL-406	85004		CAT-926	G63410	
ASH-25822	83209	89414	AT-163G	83177		CAHL-409	85310	89423	CAT-927	G63409	
ASH-25823	83209	89414	AT-164G	83178		CAHL-417	85311	89424	CAT-927	G63690	
ASH-25824	83122	89406	AT-504G	G63679		CAT-722	83400		CAT-928	G63410	
ASH-26	85006		AT-506G	G63679		CAT-729	G63414		CAT-929	G63403	
ASH-29	83314		AT-507G	G63607		CAT-730	G63386		CAT-930	G63461	
ASH-294	83209	89414	AT-546	G63678		CAT-731	G63409		CAT-932	G63398	
ASH-32	83125		AT-547	G63775		CAT-732	G63455		CAT-935	G63424	
ASH-322	77969		AT-554	85305		CAT-733	G63617		CAT-936	G63425	
ASH-324	77968		AT-568	G63622		CAT-736	G63394		CAT-944	G63347	
ASH-335	G63969		AT-579	G63809		CAT-737	G63502		CAT-944	G63908	
ASH-36	85716		AT-610	G63461		CAT-739	G63603		CAT-945	G63421	
ASH-362	G63607		AT-611	G63461		CAT-740	G63423		CAT-945	G63457	
ASH-363	G63525		AT-620	83209	89414	CAT-741	G63489		CAT-948	G63909	
ASH-364	G63524		AT-621	83122	89406	CAT-745	G63608		CAT-953	G63375	
ASH-365	G63772		AT-682	G63678		CAT-745	G63614		CAT-953	G63900	
ASH-366	G63608		AT-683	G63679		CAT-750	G63359		CAT-953	G63903	
ASH-37	85712		AT-684	G63679		CAT-751	G63607		CAT-955	G63454	
ASH-38	85314	89425	AT-685	G63679		CAT-758	G63909		CAT-958	G63377	
ASH-387	G63809		AT-696	83140		CAT-759	G63624		CAT-960	G63366	
ASH-39	85001	89410	AT-710	G63809		CAT-760	G63622		CAT-963	G63427	
ASH-391	G63809		AT-713	G63614		CAT-761	G63623		CAT-963	G63525	
ASH-394	G63614		AT-715	G63614		CAT-762	G63638		CAT-964	G63420	
ASH-397	83131		AT-716	G63809		CAT-768	83209	89414	CAT-964	G63456	
ASH-398	85928		AT-764	G63678		CAT-776	G63661		CAT-972	G63610	
ASH-407	G63809		AT-765	G63772		CAT-777	G63662		CAT-975	G63511	
ASH-408	G63809		AT-766	83209	89414	CAT-778	G63673		CAT-976	G63490	
ASH-51	G63773		AT-811	83135		CAT-793	G63414		CAT-977	G63915	
ASH-684	G63623		AX-131A	83217		CAT-802	G63419		CAT-978	G63460	
ASH-69	83175		AX-135A	G63406		CAT-802	G63492		CAT-983	G63489	
ASH-706	G63614		AX-267A	83309	89446	CAT-802	G63928		CAT-984	G63609	
ASH-707	G63614		AX-269A	83308	89435	CAT-803	G63306		CAT-984	G63818	
ASH-712	69575		AX-269A	83312	89409	CAT-817	G63355		CAT-985	G63488	
ASH-824	G63929		AX-277A	83219		CAT-824	G63349		CAT-986	G63489	
ASHV-1	G63678		AX-282A	85010		CAT-826	G63187		CAT-990	G63906	
ASHV-1015	G63622		AX-310	83215		CAT-828	G63494		CAX-001	85307	
ASHV-1025	G63623		AX-327	G63773		CAT-831	G63359		CAX-707	83215	

**Important Note:** Competitive Interchanges are to be used for stocking purposes only. Where multiple crosses are identified, please reference the applications section of this catalog. / **Remarque importante:** Les interchanges concurrentiels ne s'utilisent qu'aux fins de stocks. Dans le cas de références multiples, consulter la section des applications du catalogue. / **Nota importante:** Dans le cas de références multiples, consulter la section des applications du catalogue. / **Nota importante:** Se pueden usar intercambios competitivos para propósitos de almacenamiento solamente. Cuando se identifican intercambios múltiples, consulte la sección de aplicaciones de este catálogo.

**COMPETITIVE & O.E.M. INTERCHANGE LIST**  
**Lista de Intercambios contra Competidores y Equipo Original.**  
**Liste d'interchange de produits compétitifs & d'équipement original (OEM)**

**MOTORCRAFT... cont'd**

Motorcraft	Gabriel	Upgrade	Motorcraft	Gabriel	Upgrade	Motorcraft	Gabriel	Upgrade	Motorcraft	Gabriel	Upgrade
CAX-707	85001	89410	CAX-863	83314		CAX-894	85013	89414	CAX-957	83217	
CAX-710	83209	89414	CAX-878	83221		CAX-898	83125		CAX-957	83225	
CAX-720	85003	89411	CAX-886	83207	89407	CAX-898	85006		CAX-969	83221	
CAX-811	83312	89409	CAX-886	85014		CAX-912	83304		CAX-969	85030	89440
CAX-828	83207	89407	CAX-891	83215		CAX-913	83303		CLT-109	G63614	
CAX-828	85012	89413	CAX-891	85314	89425	CAX-916	83123	89405	CLT-112	G63525	
CAX-833	83303		CAX-893	83203	89436	CAX-916	85036	89405	CLT-113	G63524	
CAX-833	85005	89430	CAX-893	85000	89436	CAX-921	83318		CLT-114	G63635	
CAX-841	83216		CAX-893	85043		CAX-923	83102		CLT-116	G63902	
CAX-860	83308	89435	CAX-894	83209	89414	CAX-923	83456	89447	CLT-124	G63610	
CAX-861	83309	89446	CAX-894	85005	89430	CAX-924	83317		CLT-138	G63502	

**MUNCIE RECLAMATION**

O.E.M #	Gabriel	Upgrade	O.E.M #	Gabriel	Upgrade	O.E.M #	Gabriel	Upgrade	O.E.M #	Gabriel	Upgrade
665459	89447		H53-21144-004	85045		MR25767	85702		MR3306	85705	89447
665568	85051		MR1623	85700		MR2960	85702		MR6394	85723	
665569	85045		MR1710	85713		MR2996	85704		MR6535	85708	
680334	85709		MR1751	85713		MR2997	85703		MR6536	85722	
97-2210-00164	85708		MR1763	85300	89419	MR3303	85709				
H53-20415-006	85051		MR1765	85713		MR3304H	85709				

**NATIONAL COACH CORP**

O.E.M #	Gabriel	Upgrade	O.E.M #	Gabriel	Upgrade	O.E.M #	Gabriel	Upgrade	O.E.M #	Gabriel	Upgrade
C800853	83207	89407									

**NATIONAL RV INC.**

O.E.M #	Gabriel	Upgrade	O.E.M #	Gabriel	Upgrade	O.E.M #	Gabriel	Upgrade	O.E.M #	Gabriel	Upgrade
1C34-18045-AA	83209	89414	9U9Z-18125-A	83122	89406	ASH-25822	83209	89414	F4-BE5-B492-HO	85125	
1C34-18045-JA	83209	89414	ASH-1022	83209	89414	ASH-25823	83209	89414	F4-BE5-F324-HO	85125	
24-153249	85125		ASH-1023	83122	89406	ASH-25824	83122	89406	F4-BE5-F325-HO	85124	
24-153256	85124		ASH-1205	83209	89414	ASH-294	83209	89414	W0005662	85125	
24-186537	85126		ASH-1206	83122	89406	AT-620	83209	89414	W0005663	85124	
24-186629	85125		ASH-1228	83209	89414	AT-621	83122	89406	W0006254	85125	
9U94-18045-AA	83209	89414	ASH-1229	83209	89414	AT-766	83209	89414			
9U94-18080-AA	83122	89406	ASH-1230	83122	89406	F4-BE5-A011-HO	85126				
9U9Z-18124-A	83209	89414	ASH-137	83122	89406	F4-BE5-A832-MO	85125				

**NEOPLAN BUS**

O.E.M #	Gabriel	Upgrade	O.E.M #	Gabriel	Upgrade	O.E.M #	Gabriel	Upgrade	O.E.M #	Gabriel	Upgrade
24-1700-106-149	83216		AA1002003	85705	89447	BN1002002	85009		DZ1002002	85705	89447
24-1700-999-362	85009		AA1802002	85705	89447	BT1002011	83216		GJ1002003	85705	89447
25-1700-101-426	85705	89447	AC1002002	85705	89447	CI 1002003	85705	89447	MM1002002	85705	89447
680307	85705	89447	AC1002002GS	85705	89447	CL1002003	85705	89447	MM1002003	85705	89447
AA1002002	85705	89447	AC1002003	85705	89447	DT1802002	85705	89447			

**NEW FLYER**

O.E.M #	Gabriel	Upgrade	O.E.M #	Gabriel	Upgrade	O.E.M #	Gabriel	Upgrade	O.E.M #	Gabriel	Upgrade
009863	85722		152959	85708		68037840B	85720		69536640Y	85732	
015813	85708		204428	85347		68050440X	85716		97-2210-00164	85708	
015915	85711		68027440Y	85716		68050640Y	85732				
016415	85722		680346	85722		680671	85708				
064845	85711		680352	85711		690102	85711				

**NEWMAR CORP**

O.E.M #	Gabriel	Upgrade	O.E.M #	Gabriel	Upgrade	O.E.M #	Gabriel	Upgrade	O.E.M #	Gabriel	Upgrade
141700131809	85029		16-16737-000	83160		481700000493	85900		ASH-25822	83209	89414
141700131810	83160		16-16874-000	83160		90045455	85909		ASH-25823	83209	89414
16-16736-000	85029		16-18103-000	85900		ASH-1229	83209	89414	ASH-25824	83122	89406

**NEXUS RV**

O.E.M #	Gabriel	Upgrade	O.E.M #	Gabriel	Upgrade	O.E.M #	Gabriel	Upgrade	O.E.M #	Gabriel	Upgrade
ASH-1136	83178		ASH-1229	83209	89414	ASH-25823	83209	89414			
ASH-1154	83177		ASH-25822	83209	89414	ASH-25824	83122	89406			

**Important Note:** Competitive Interchanges are to be used for stocking purposes only. Where multiple crosses are identified, please reference the applications section of this catalog. / **Remarque importante:** Les interchanges concurrentiels ne s'utilisent qu'aux fins de stocks. Dans le cas de références multiples, consulter la section des applications du catalogue. / **Nota importante:** Dans le cas de références multiples, consulter la section des applications du catalogue. / **Nota importante:** Se pueden usar intercambios competitivos para propósitos de almacenamiento solamente. Cuando se identifican intercambios múltiples, consulte la sección de aplicaciones de este catálogo.

# COMPETITIVE & O.E.M. INTERCHANGE LIST

## Lista de Intercambios contra Competidores y Equipo Original.

### Liste d'interchange de produits compétitifs & d'équipement original (OEM)

NEXUS RV... cont'd

#### NISSAN

O.E.M #	Gabriel	Upgrade	O.E.M #	Gabriel	Upgrade	O.E.M #	Gabriel	Upgrade	O.E.M #	Gabriel	Upgrade
561000T825	83515		56101-Z5017	83162		56110-Z5008	83114		66400	G63432	
56101-30Z02	G63610		56110-30Z02	G63610		56110-Z5011	G63610		E61000T825	83515	
56101-Z5008	83114		56110-T8123	G63432		56110-Z5014	83162				
56101-Z5014	83162		56110-T8129	G63432		56110-Z5017	83162				

#### NOVA BUS

O.E.M #	Gabriel	Upgrade	O.E.M #	Gabriel	Upgrade	O.E.M #	Gabriel	Upgrade	O.E.M #	Gabriel	Upgrade
12J-5-10	85733		680326	85700		G1011822	85702		N22212	85700	
22045526	85702		680470	85713		G1101590	85713		N31831	85377	
22052014	85702		680480	85377		G1201339	85702		OE 10086S	85702	
481700131250	85377		695393	85377		G1203223	85702				
680232	85733		97-2201-00151	85700		G5008070	85700				
680323	85700		97-9999-02514	85700		N16248	85377				

#### OLE GRANNING

O.E.M #	Gabriel	Upgrade	O.E.M #	Gabriel	Upgrade	O.E.M #	Gabriel	Upgrade	O.E.M #	Gabriel	Upgrade
1086	83217										

#### OPTIMA BUS CORP

O.E.M #	Gabriel	Upgrade	O.E.M #	Gabriel	Upgrade	O.E.M #	Gabriel	Upgrade	O.E.M #	Gabriel	Upgrade
1260008	87017		90-2610-SP1	87017							

#### ORION BUS INDUSTRIES

O.E.M #	Gabriel	Upgrade	O.E.M #	Gabriel	Upgrade	O.E.M #	Gabriel	Upgrade	O.E.M #	Gabriel	Upgrade
010134501-4	85307		050134508	85732		20117501	85720		695327	85732	
010134508-4	85732		050134509	85732		20117504	85720		695343	85732	
010234503-4	85308	89422	050134510	85732		20117505	85720		695347	85732	
020117503-4	85720		050134511	85732		6430645	85729		695366	85732	
020117504	85720		050134513	85732		680091	85303	89422	695420	85729	
020273541	83203	89436	050230501	85716		680102	85712		695440	85729	
020273541-4	85000	89436	050231501-4	85716		680274	85716		97-9999-02635	85732	
020273544	83203	89436	050231502-4	85716		680352	85711		97-9999-02636	85716	
0501345-11	85732		050231505	85716		680378	85720		A-4890	85712	
050134501-4	85716		050231507	85716		680504	85716		OB020570	85711	
0501345024	85732		070231514	85729		680506	85732		OB020764	85716	
050134506-4	85732		070231527	85729		690102	85711		OB3166657	85700	

#### OSHKOSH MOTORS

O.E.M #	Gabriel	Upgrade	O.E.M #	Gabriel	Upgrade	O.E.M #	Gabriel	Upgrade	O.E.M #	Gabriel	Upgrade
12405F	85734		1745500		89430	40-4951	85316	89426	665060	83122	89406
12405F-1	85303	89422	2034140	646177		40-5348	85058	89431	690049	85303	89422
12405FX1	85303	89422	2173340	85303	89422	40-6967	85030	89440	90044448	85051	
1398980	83127		26228-A	83122	89406	4036892	G63605		GBL654875	83117	
1445910	85300	89419	2JD137	83119		5353054	85303	89422	GBL654918	83118	
1573270	83207	89407	3638112	G63183		5361994	85734		P117099	83120	
1573280	83221		40-0242	83312	89409	651444	83221		P117146	83118	
1583470	85051		40-4845	85304		665040	85303	89422	RW24285	83119	

#### OSHKOSH MOTORS CAB SHOCKS

O.E.M #	Gabriel	Upgrade	O.E.M #	Gabriel	Upgrade	O.E.M #	Gabriel	Upgrade	O.E.M #	Gabriel	Upgrade
1202-0054	83021		2218640	83009							

#### OSTERLUND TRUCK

O.E.M #	Gabriel	Upgrade	O.E.M #	Gabriel	Upgrade	O.E.M #	Gabriel	Upgrade	O.E.M #	Gabriel	Upgrade
220-S5-10	85712		59011	83214		680117	85300	89419			

#### OTTAWA TRUCK

O.E.M #	Gabriel	Upgrade	O.E.M #	Gabriel	Upgrade	O.E.M #	Gabriel	Upgrade	O.E.M #	Gabriel	Upgrade
53540451	85300	89419	59011	83214		90013787	85310	89423	9007342	85303	89422
59009	83217		680117	85300	89419	90027577	85720				

**Important Note:** Competitive Interchanges are to be used for stocking purposes only. Where multiple crosses are identified, please reference the applications section of this catalog. / **Remarque importante:** Les interchanges concurrentiels ne s'utilisent qu'aux fins de stocks. Dans le cas de références multiples, consulter la section des applications du catalogue. / **Nota importante:** Dans le cas de références multiples, consulter la section des applications du catalogue. / **Nota importante:** Se pueden usar intercambios competitivos para propósitos de almacenamiento solamente. Cuando se identifican intercambios múltiples, consulte la sección de aplicaciones de este catálogo.

**COMPETITIVE & O.E.M. INTERCHANGE LIST**  
**Lista de Intercambios contra Competidores y Equipo Original.**  
**Liste d'interchange de produits compétitifs & d'équipement original (OEM)**

**PACCAR**

O.E.M #	Gabriel	Upgrade	O.E.M #	Gabriel	Upgrade	O.E.M #	Gabriel	Upgrade	O.E.M #	Gabriel	Upgrade
665633	85033	89427									

**PACIFIC TRUCK & TRAILER**

O.E.M #	Gabriel	Upgrade	O.E.M #	Gabriel	Upgrade	O.E.M #	Gabriel	Upgrade	O.E.M #	Gabriel	Upgrade
3178157C	85735		507202C1	85030	89440						

**PAGE SUSPENSION**

O.E.M #	Gabriel	Upgrade	O.E.M #	Gabriel	Upgrade	O.E.M #	Gabriel	Upgrade	O.E.M #	Gabriel	Upgrade
1080099	83203	89436	665133	83203	89436	A-2212	85029				
1081933	83204		665267	85029							

**PAI CORP**

O.E.M #	Gabriel	Upgrade	O.E.M #	Gabriel	Upgrade	O.E.M #	Gabriel	Upgrade	O.E.M #	Gabriel	Upgrade
HSA-5067	85305		HSA-5080	83221		HSA-5095	83215				

**PEERLESS TRAILER**

O.E.M #	Gabriel	Upgrade	O.E.M #	Gabriel	Upgrade	O.E.M #	Gabriel	Upgrade	O.E.M #	Gabriel	Upgrade
120-1	83125		72-61	83125							

**PETERBILT**

O.E.M #	Gabriel	Upgrade	O.E.M #	Gabriel	Upgrade	O.E.M #	Gabriel	Upgrade	O.E.M #	Gabriel	Upgrade
02-00376	85302	89420	10-12032-002PLUS	85320	89429	665785	83137		680457	85302	89420
02-00495	85302	89420	10-12542-000PLUS	85901		665788	85000	89436	680458	85336	
02-01759	83312	89409	12887-01	85013	89414	665826	85069	89455	680459	85311	89424
02-01787	85062	89408	12887-02	85013	89414	665844	85069	89455	680473	85319	89428
02-01890	85012	89413	16-13947-000PLUS	85319	89428	665858	85070	89459	680586	85311	89424
02-02061	85013	89414	16725-01	83126	89440	665876	85959		70701PLUS	85900	
02-02142	85036	89405	1707378PAC	85182		665918	85900		800670	85060	
02-02225	85012	89413	19495-01	83126	89440	665926	85047	89435	8086053PLUS	85047	89435
02-02736	85302	89420	2018987C1PLUS	85003	89411	665927	85901		85013A0C	85013	89414
02-02736PLUS	85302	89420	23-08233	85308	89422	665928	85062	89408	90044011	85004	
02-02737	85062	89408	23-10393	85308	89422	665930	85001	89410	90044025PLUS	83209	89414
02-02737PLUS	85062	89408	23-12262	85012	89413	665931	83312	89409	90044089PLUS	83124	89407
02-02738	85012	89413	471700004423	85109		665932	85012	89413	90045132	85909	
02-02738PLUS	85012	89413	47902-13PLUS	83122	89406	665945	85902		90045605	85109	
02-02739	85013	89414	60670-005PLUS	83137		665950	85902		ACHB966	83136	
02-02739PLUS	85013	89414	60670-008	83123	89405	671052	85070	89459	B71-1000	85031	
02-02740	85036	89405	60670-008L	83123	89405	671091	85069	89455	B71-1001	85070	89459
02-02741	85012	89413	60670-008PLUS	83123	89405	671092	85012	89413	B71-1002	85001	89410
02-02742	85062	89408	60680-003	83112		671654	85936	89456	B71-1003	83312	89409
02-03020	85910		60680-003L	83112		671699	85937		B71-6000	85959	
02-04010	85012	89413	60680-004	83143		671794	85067	89451	B71-6002	85012	89413
03-01635	85308	89422	60680-004L	83143		671962PLUS	85936	89456	B71-6003	85029	
03-04176	85308	89422	60680-005	83142		671962SPL	85936	89456	B71-6004	85084	89460
03-04176PLUS	85308	89422	60680-005L	83142		671963	85937		B71-6005	85084	89460
03-04628	85336		665133	83203	89436	680026	85302	89420	B71-6006	85084	89460
03-04629	85311	89424	665174	85060		680027	85308	89422	B71-6007	85062	89408
03-05106	85033	89427	665565PLUS	85007		680185	85308	89422	B71-6008	83312	89409
03-05384	85033	89427	665617	85031		680237	85303	89422	B71-6009	83219	
03-06084	85033	89427	665632	85013	89414	680239	85310	89423	B71-6009	85062	89408
03-06084PLUS	85033	89427	665633	85033	89427	680240	85302	89420	B71-6010	85023	89415
03-07281	85311	89424	665655	85062	89408	680241	85311	89424	B71-6011	85062	89408
03-07420	85336		665656	85012	89413	680242	85308	89422	B71-6012	85119	
03-07421	85311	89424	665657	85013	89414	680253	85314	89425	B71-6013	85012	89413
03-07421PLUS	85311	89424	665658	85036	89405	680261	85062	89408	B71-6015	85012	89413
03-07421SPL	85311	89424	665660	85033	89427	680279	83209	89414	B71-6016	85012	89413
03-07423	85033	89427	665662	85012	89413	680280	85906	89407	B71-6016A	85012	89413
03-07423PLUS	85033	89427	665738	85910		680281	85003	89411	B71-6017	85910	
03-07424	85311	89424	665752	85067	89451	680303	85007				
03-07424PLUS	85311	89424	665762	85012	89413	680348	85012	89413			
03-08350	85343		665783	83123	89405	680425	85320	89429			
03-08781	85069	89455	665784	83122	89406	680435	85033	89427			

**Important Note:** Competitive Interchanges are to be used for stocking purposes only. Where multiple crosses are identified, please reference the applications section of this catalog. / **Remarque importante:** Les interchanges concurrentiels ne s'utilisent qu'aux fins de stocks. Dans le cas de références multiples, consulter la section des applications du catalogue. / **Nota importante:** Dans le cas de références multiples, consulter la section des applications du catalogue. / **Nota importante:** Se pueden usar intercambios competitivos para propósitos de almacenamiento solamente. Cuando se identifican intercambios múltiples, consulte la sección de aplicaciones de este catálogo.

# COMPETITIVE & O.E.M. INTERCHANGE LIST

## Lista de Intercambios contra Competidores y Equipo Original.

### Liste d'interchange de produits compétitifs & d'équipement original (OEM)

#### PETERBILT... cont'd

O.E.M #	Gabriel	Upgrade	O.E.M #	Gabriel	Upgrade	O.E.M #	Gabriel	Upgrade	O.E.M #	Gabriel	Upgrade
B71-6018	85012	89413	C71-1011	85069	89455	C71-1017	85069	89455	C71-6015	85067	89451
B71-6019	85989		C71-1011PLUS	85069	89455	C71-6000	85067	89451	K374-26PLUS	85001	89410
B71-6020	85989		C71-1011SPL	85069	89455	C71-6002	85311	89424	K374-28PLUS	85314	89425
BFRG072	85182		C71-1013	85985		C71-6003	85988		K374-29PLUS	85310	89423
C71-1002	85067	89451	C71-1014	85936	89456	C71-6004	85343		K374-33PLUS	83312	89409
C71-1002PLUS	85067	89451	C71-1016	85067	89451	C71-6005	85069	89455	TK19679	83126	89440

#### PETERBILT CAB SHOCKS

O.E.M #	Gabriel	Upgrade	O.E.M #	Gabriel	Upgrade	O.E.M #	Gabriel	Upgrade	O.E.M #	Gabriel	Upgrade
1201-0012	83023		20-16755	83042		654812	83042		R71-6000	83067	
1201-8002	83081		20-19140	83063		654919	83035		R71-6005	83042	
1201-8006	83081		25523024	83081		96027-1054	83011		R71-6006	83063	
1202-0012	83023		29-02455	83008		PP1058870	83059		R71-6007	83008	
1202-0032	83016		29-06005	83035		PP2582870	83012		R71-6008	83035	
1202-0054	83021		29-06032	83035		R71-1004	83049		R71-6009	83081	
1202-1044	83025		654782	83008		R71-1005	83024		R71-6010	83067	

#### PHOENIX CRUISER RV

O.E.M #	Gabriel	Upgrade	O.E.M #	Gabriel	Upgrade	O.E.M #	Gabriel	Upgrade	O.E.M #	Gabriel	Upgrade
ASH-1136	83178		ASH-1154	83177							

#### PIERCE MANUFACTURING INC.

O.E.M #	Gabriel	Upgrade	O.E.M #	Gabriel	Upgrade	O.E.M #	Gabriel	Upgrade	O.E.M #	Gabriel	Upgrade
1445910	85300	89419	40-0242	83312	89409	40-4951	85316	89426	40-6967	85030	89440
2034140	646177		40-4845	85304		40-5348	85058	89431	680401	85307	

#### POWERHOUSE COACH INC.

O.E.M #	Gabriel	Upgrade	O.E.M #	Gabriel	Upgrade	O.E.M #	Gabriel	Upgrade	O.E.M #	Gabriel	Upgrade
141700005838	85098	89502	20551628	85066	89448	21462380	85088		64838-003	85933	89454
20433424	85061	89450	20973993	85061	89450	471700000443	85066	89448	64838-003L	85933	89454
20485632	85933	89454	21137330	85933	89454	471700003832	85933	89454			
20485633	85933	89454	21436086	85098	89502	471700006040	85088				

#### POWERPACKER CAB SHOCKS

O.E.M #	Gabriel	Upgrade	O.E.M #	Gabriel	Upgrade	O.E.M #	Gabriel	Upgrade	O.E.M #	Gabriel	Upgrade
PP1058870	83059										

#### PREVOST

O.E.M #	Gabriel	Upgrade	O.E.M #	Gabriel	Upgrade	O.E.M #	Gabriel	Upgrade	O.E.M #	Gabriel	Upgrade
01-0100-905	85303	89422	3166657	85700		630127	85736		680422	85329	
0822045526	85702		481700000207	85329		630134	85329		680492	85713	
12B-5-1	85735		481700000209	85713		630136	85379		680510	85379	
12L-5-89	85729		481700999376	85329		630161	85736		680555	85379	
12T-1-13	85303	89422	481700999377	85379		630163	85379		690060	85713	
19501288	85729		481700999386	85736		630234	85329		74939852	85308	89422
19501289	85728		52001	85708		630235	85379		G1011822	85702	
19501547	85740		63-1013	85329		630236	85329		G5008070	85700	
19501669	85339		630001	85713		630252	85329		N22212	85700	
19502711	85702		630080	85713		630253	85713				
19506846	85339		630091	85736		650407	85736				
196533	85708		630103	85329		680323	85700				

#### RAM

O.E.M #	Gabriel	Upgrade	O.E.M #	Gabriel	Upgrade	O.E.M #	Gabriel	Upgrade	O.E.M #	Gabriel	Upgrade
05168284AC	85649		6811 1104AB	85649		6811 1105AC-001	85649				
05168295AB	85649		6811 1104AB-001	85649		6811 1107AA	85650				
05168296AA	85650		6811 1105AC	85649		6811 1107AA-001	85650				

#### RAMERIZ TRAILER

O.E.M #	Gabriel	Upgrade	O.E.M #	Gabriel	Upgrade	O.E.M #	Gabriel	Upgrade	O.E.M #	Gabriel	Upgrade
18165-01	85006										

#### RAYDAN MANUFACTURING

O.E.M #	Gabriel	Upgrade	O.E.M #	Gabriel	Upgrade	O.E.M #	Gabriel	Upgrade	O.E.M #	Gabriel	Upgrade
14QK-3100	85739		446-51-211	85739		700115	85712				

**Important Note:** Competitive Interchanges are to be used for stocking purposes only. Where multiple crosses are identified, please reference the applications section of this catalog. / **Remarque importante:** Les interchanges concurrentiels ne s'utilisent qu'aux fins de stocks. Dans le cas de références multiples, consulter la section des applications du catalogue. / **Nota importante:** Dans le cas de références multiples, consulter la section des applications du catalogue. / **Nota importante:** Se pueden usar intercambios competitivos para propósitos de almacenamiento solamente. Cuando se identifican intercambios múltiples, consulte la sección de aplicaciones de este catálogo.

**COMPETITIVE & O.E.M. INTERCHANGE LIST**  
**Lista de Intercambios contra Competidores y Equipo Original.**  
**Liste d'interchange de produits compétitifs & d'équipement original (OEM)**

**RAYDAN MANUFACTURING... cont'd**

**RED LION TRAILER**

O.E.M #	Gabriel	Upgrade	O.E.M #	Gabriel	Upgrade	O.E.M #	Gabriel	Upgrade	O.E.M #	Gabriel	Upgrade
90044978	85059		90044989	85059							

**RENEGADE RV**

O.E.M #	Gabriel	Upgrade	O.E.M #	Gabriel	Upgrade	O.E.M #	Gabriel	Upgrade	O.E.M #	Gabriel	Upgrade
10-13760-000	85959	89503	20433424	85061	89450	21462380	85088		471700006040	85088	
10-13809-000	85958		20551628	85066	89448	471700000443	85066	89448	SDA471700002809	85724	89443
141700005838	85098	89502	20973993	85061	89450	471700002991	85959	89503	SDA471700002991	85959	89503
16-18708-000	85724	89443	21436086	85098	89502	471700003920	85958		SDA471700003920	85958	

**REX MIXER**

O.E.M #	Gabriel	Upgrade	O.E.M #	Gabriel	Upgrade	O.E.M #	Gabriel	Upgrade	O.E.M #	Gabriel	Upgrade
102-13441-10	646155										

**REYCO SUSPENSION**

O.E.M #	Gabriel	Upgrade	O.E.M #	Gabriel	Upgrade	O.E.M #	Gabriel	Upgrade	O.E.M #	Gabriel	Upgrade
12885-01	85300	89419	17408-01	85005	89430	20129-01	85007		665833	85052	
12885-03	85300	89419	17794-01	83215		20960-01	83204		671707	85323	89436
12886-01	85334		18163-01	83207	89407	21310-01	85307		680551	85738	
12887-01	85013	89414	18164-01	83122	89406	21497-01	85005	89430	680552	85938	
12887-02	85013	89414	18165-01	85006		22062-01	85007		680700	85938	
14954-01	83217		18166-01	85704		23523-01	85086		700098-01	83128	89436
16230-01	85702		18286-01		89414	23524-01	85738		700098-03	85052	
16725-01	83126	89440	18800-01	83203	89436	23553-01	85938		701071-01	665937	
16824-01	85006		19495-01	83126	89440	24392-01	85051		702135-01	85045	
17142-01	85001	89410	19623-01	83123	89405	665519		89414	702136-01	85052	
17146-01	83209	89414	19824-01	85006		665748	85086		702209-01	85014	
17358-01	83126	89440	20125-01	85030	89440	665813	85051		704672-01	85938	
17403-01	83122	89406	20126-01		89440	665830	85045				

**RIDEWELL CORPORATION**

O.E.M #	Gabriel	Upgrade	O.E.M #	Gabriel	Upgrade	O.E.M #	Gabriel	Upgrade	O.E.M #	Gabriel	Upgrade
1250005	85901		1267249B000	85712		665267	85029		AS789B000	85014	
1250546B000	85006		1267395B000	85302	89420	665526	85014		S2607B	85702	
1250563B000	85000	89436	1270007	85045		680101	85702		S4025B	85712	
1250789B000	85014		1270563B000	85000	89436	70654	85000	89436	S5477B	85307	
1252607B000	85702		1270563B003	85934		90-1813	85712		S5478B	85307	
1253069B000	85005	89430	1270789B000	85014		90-2610 SP1	87017		S5813B	85704	
1254025B000	85712		1275813B000	85704		AS 4025B	85712		S5878B	83207	89407
1254190B000	85302	89420	1275943B	85005	89430	AS30698	85005	89430	S6009B	83203	89436
1260008	87017		1310002	665937		AS3069B	85005	89430	S7120B	85304	
1265157B000	85712		1310004	665937		AS546B	85006		S7172B	83207	89407
1265478B000	85736		1317570B001	646155		AS563B	83203	89436	S7249B	85307	
1266009B000	83130		57645	85005	89430	AS575B	85005	89430	S7365B	85305	
1267120B000	85734		665198	85005	89430	AS789B	85014				

**ROADMASTER (MONACO)**

O.E.M #	Gabriel	Upgrade	O.E.M #	Gabriel	Upgrade	O.E.M #	Gabriel	Upgrade	O.E.M #	Gabriel	Upgrade
90045132	85909		90045188	85910							

**SABO**

Sabo	Gabriel	Upgrade	Sabo	Gabriel	Upgrade	Sabo	Gabriel	Upgrade	Sabo	Gabriel	Upgrade
8901020	85300	89419	8901026	85064		8901031	85900		890165B	85121	
8901021	85320	89429	8901027	85310	89423	8901032	85901		890414	85323	89436
8901023	85066	89448	8901028	85316	89426	8901033	85918	89449	890449	85300	89419
8901024	85314	89425	8901029	85319	89428	8901156	G63299		895315	83009	
8901025	83128	89436	8901029	85724	89443	890120	85300	89419	895316	83002	
8901025	85000	89436	8901030	85323	89436	890164B	85179				

**SACHS**

Sachs	Gabriel	Upgrade	Sachs	Gabriel	Upgrade	Sachs	Gabriel	Upgrade	Sachs	Gabriel	Upgrade
101892	85708		106282	85722							
101968	85708		106884	85708							

**Important Note:** Competitive Interchanges are to be used for stocking purposes only. Where multiple crosses are identified, please reference the applications section of this catalog. / **Remarque importante:** Les interchanges concurrentiels ne s'utilisent qu'aux fins de stocks. Dans le cas de références multiples, consulter la section des applications du catalogue. / **Nota importante:** Dans le cas de références multiples, consulter la section des applications du catalogue. / **Nota importante:** Se pueden usar intercambios competitivos para propósitos de almacenamiento solamente. Cuando se identifican intercambios múltiples, consulte la sección de aplicaciones de este catálogo.



**COMPETITIVE & O.E.M. INTERCHANGE LIST**  
**Lista de Intercambios contra Competidores y Equipo Original.**  
**Liste d'interchange de produits compétitifs & d'équipement original (OEM)**

**SACHS... cont'd**

Sachs	Gabriel	Upgrade	Sachs	Gabriel	Upgrade	Sachs	Gabriel	Upgrade	Sachs	Gabriel	Upgrade
106885	85722		315414	85959		315621	85080		410058	83122	89406
112885	85709		315415	85933	89454	315622	85081		410068	85030	89440
124693	85708		315416	85003	89411	315623	85918	89449	410068	85054	89438
125756	83165		315417	85923	89458	315624	85959		410069	83165	
125756	85094		315418	83456	89447	315626	85933	89454	410069	85094	
125757	85089		315420	85014		315655	85985		410070	85089	
141700000373	85061	89450	315421	85088		315656	83040		471700000426	85014	
141700000378	83160		315423	83127		315657	83039		471700000428	85006	
141700000380	85061	89450	315424	85067	89451	315658	83057		471700000431	85066	89448
141700000443	85066	89448	315425	85379		315659	83047		471700000436	85030	89440
141700000800	85179		315426	85329		315660	83009		471700000440	85959	
141700000901	83165		315427	85713		315661	85932	89453	471700000443	85066	89448
141700002626	85061	89450	315431	85014		316308	89406		471700000445	85080	
141700005838	85098	89502	315432	89414		316475	85123		471700000447	85919	
141700005839	85098	89502	315434	85065		316821	85977		471700000449	85918	89449
141700125243	85089		315435	85088		316823	85087		471700000451	85080	
141700125275	83165		315536	85086		317533	85344		471700000458	85014	
141700125757	85089		315540	83613		317534	85989		471700000459	85030	89440
141700131809	85029		315541	85052		317774	89406		471700000461	89414	
141700131810	83160		315542	83122	89406	317931	83049		471700000464	85090	
141700131975	83160		315543	83125		317937	83148		471700000466	85959	
170210	83104		315544	85014		317943	85979		471700000470	85918	89449
170211	83104		315545	85333		317956	83025		471700000802	85121	
170606	85089		315546	85005	89430	317964	85382		471700002580	83165	
280499	85300	89419	315547	85924	89457	40-A85-0	85708		471700002627	85066	89448
290146	85012	89413	315548	85070	89459	410009	83102		471700002726	85918	89449
290460	85005	89430	315549	85033	89427	410010	83317		471700002727	85959	
290465	83125		315550	85311	89424	410011	83173		471700002809	85724	89443
290488	85040		315551	85310	89423	410011	85093		471700002861	85014	
311229	85918	89449	315552	83128	89436	410021	83125		471700002919	85106	
311230	85956		315553	85900		410022	85006		471700002990	85007	
311631	85906	89407	315554	85006		410023	85103		471700002991	85959	
311632	85909		315555	83038		410024	85302	89420	471700002992	85331	
311633	85900		315556	85314	89425	410025	83215		471700002993	85921	
311634	85001	89410	315593	85029		410026	85918	89449	471700002994	83134	
311635	85030	89440	315594	85029		410032	85320	89429	471700002995	83134	
312724	85311	89424	315597	85959		410035	85001	89410	471700002996	85335	
313709	85377		315598	85933	89454	410035	85337		471700003009	85006	
315389	85090		315599	85109		410036	85061	89450	471700003011	85058	89431
315390	85918	89449	315600	85959		410037	85081		471700003832	85933	89454
315391	85956		315601	85920		410038	85100		471700003920	85958	
315392	85007		315603	83134		410040	85005	89430	471700004270	85117	
315393	85331		315606	85061	89450	410042	85310	89423	471700004423	85109	
315394	85921		315607	85061	89450	410043	85957		471700005079	85005	89430
315395	85724	89443	315608	85066	89448	410044	85031		471700006039	85088	
315396	85335		315609	85066	89448	410046	83136		471700006040	85088	
315397	83120	85122	315610	83026		410047	85071		471700006048	83165	
315398	85058	89431	315611	85337		410048	83207	89407	471700006269	85932	89453
315399	85005	89430	315612	85006		410048	83304		471700009646	85088	
315400	85006		315613	85030	89440	410048	85014		471700009647	85088	
315401	85331		315615	83027		410050	85121		471700010957	85186	
315402	85900		315616	83038		410051	85108		471700011530	85181	
315403	85919		315617	85918	89449	410052	85096		471700011531	85180	
315404	85900		315618	83160		410053	85095		471700012516	85186	
315406	85918	89449	315619	83160		410056	85000	89436	471700125245	85089	
315411	83128	89436	315620	85080		410057	85013	89414	471700131155	85918	89449

**Important Note:** Competitive Interchanges are to be used for stocking purposes only. Where multiple crosses are identified, please reference the applications section of this catalog. / **Remarque importante:** Les interchanges concurrentiels ne s'utilisent qu'aux fins de stocks. Dans le cas de références multiples, consulter la section des applications du catalogue. / **Nota importante:** Dans le cas de références multiples, consulter la section des applications du catalogue. / **Nota importante:** Se pueden usar intercambios competitivos para propósitos de almacenamiento solamente. Cuando se identifican intercambios múltiples, consulte la sección de aplicaciones de este catálogo.

**COMPETITIVE & O.E.M. INTERCHANGE LIST**  
**Lista de Intercambios contra Competidores y Equipo Original.**  
**Liste d'interchange de produits compétitifs & d'équipement original (OEM)**

**SACHS... cont'd**

Sachs	Gabriel	Upgrade	Sachs	Gabriel	Upgrade	Sachs	Gabriel	Upgrade	Sachs	Gabriel	Upgrade
471700131256	85065		481700001177	TBR		481700999386	85376		510024	85381	
471700131258	85081			85647		510001	85303	89422	510039	85982	
471700131331	85932	89453	481700004271	85993		510002	85302	89420	510040	85110	
471700131545	85006		481700004476	85982		510002	85983		814903003482	83040	
471700131646	85918	89449	481700005414	85179		510003	85004		814903003483	83039	
471700131775	85006		481700008666	87020		510004	85307		814903003484	83057	
471700131778	85331		481700010978	85645		510005	85303	89422	814903003486	83047	
471700131920	85933	89454	481700010981	85645		510006	85705	89447	814903003496	83009	
471700131921	85933	89454	481700012514	85645		510011	87020		814903003500	83026	
471700131974	85029		481700125969	85956		510014	85352		814903003501	83027	
481700000207	85329		481700131250	85377		510017	85323	89436	814903003528	83038	
481700000209	85713		481700131438	85919		510018	85724	89443	823196420	85100	
481700000477	85900		481700131919	85900		510019	85916	89430			
481700000493	85900		481700999376	85329		510023	85316	89426			
			481700999377	85379							

**SAF HOLLAND**

O.E.M #	Gabriel	Upgrade	O.E.M #	Gabriel	Upgrade	O.E.M #	Gabriel	Upgrade	O.E.M #	Gabriel	Upgrade
471700000436	85030	89440	90044089C	83124	89407	90045002	85906	89407	90045536		89414
471700000458	85014		90044095	83203	89436	90045003	85323	89436	90045563	85014	
471700000459	85030	89440	90044162	83128	89436	90045040	83130		90045564	83128	89436
471700000461		89414	90044448	85051		90045053	85908		90045568	85060	
57639	85000	89436	90044625	83125		90045054	85051		90045572	85045	
57643	85013	89414	90044626	83126	89430	90045075	85911		90045574	83130	
6025	83122	89406	90044642	83127		90045083	85910		90045575	85051	
6026	83204		90044679	83122	89406	90045096	85916	89430	90045576	83150	
632155	646177		90044680	83125		90045099	85906	89407	90045605	85109	
646201	646177		90044681	83204		90045110	83137		90045607	83150	
665002	85004		90044682	83209	89414	90045132	85909		90045608	83363	
665003	85300	89419	90044683	83122	89406	90045138	85910		90045665	85029	
665197	85051		90044684	83124	89407	90045175	85916	89430	90045666	83130	
665454	85045		90044685	83389	89436	90045188	85910		90045666	85051	
665514	83127		90044686	85051		90045207		89405	90045667	85060	
665969		89430	90044687	83125		90045277	85030	89440	90045669	83389	89436
671921	85916	89430	90044688	83122	89406	90045298	83363		AR-1008	85006	
671922		89405	90044769	83207	89407	90045299	83389	89436	AR-1141	83204	
671923		89440	90044770	83207	89407	90045331	646155		AR-1141-C	83204	
671931	85916	89430	90044794	83127		90045336	85014		AR-1202	85300	89419
680234	85906	89407	90044833	85052		90045337	85911		AR-134-C	85005	89430
680268	85323	89436	90044834	85052		90045338	85060		AR-1404	85301	
680645	85321		90044868	85045		90045381	83150		AR-1425	85301	
90044001	85005	89430	90044878	83635		90045384		89430	AR-1434	83203	89436
90044008	85000	89436	90044907	83635		90045418	85916	89430	AR-1654	83209	89414
90044011	85004		90044915	83127		90045419		89405	AR-1822	85304	
90044012	85006		90044978	85059		90045420		89440	AR-2451	83203	89436
90044016	85300	89419	90044979	83113		90045432	85321		AR-2598	83123	89405
90044017	83204		90044981	85000	89436	90045433	85916	89430	AR-718-C	83203	89436
90044025	83209	89414	90044982	85000	89436	90045455	85909		AR-718-C-HD	85000	89436
90044046	83123	89405	90044989	85059		90045466		89406	AR-781	83203	89436
90044071	85000	89436	90044991	85000	89436	90045471	83150		AR-958	83207	89407
90044081	85000	89436	90044992	85000	89436	90045504	85030	89440	AR-995	85734	
90044086	85000	89436	90045000	85906	89407	90045532	85030	89440	XB-SPN-053-36	83125	
90044089	83124	89407	90045001	85323	89436	90045534	85014				

**SEAGRAVE FIRE APPARATUS LLC**

O.E.M #	Gabriel	Upgrade	O.E.M #	Gabriel	Upgrade	O.E.M #	Gabriel	Upgrade	O.E.M #	Gabriel	Upgrade
680117	85300	89419	P0025500	85300	89419						

**Important Note:** Competitive Interchanges are to be used for stocking purposes only. Where multiple crosses are identified, please reference the applications section of this catalog. / **Remarque importante:** Les interchanges concurrentiels ne s'utilisent qu'aux fins de stocks. Dans le cas de références multiples, consulter la section des applications du catalogue. / **Nota importante:** Dans le cas de références multiples, consulter la section des applications du catalogue. / **Nota importante:** Se pueden usar intercambios competitivos para propósitos de almacenamiento solamente. Cuando se identifican intercambios múltiples, consulte la sección de aplicaciones de este catálogo.

**COMPETITIVE & O.E.M. INTERCHANGE LIST**  
**Lista de Intercambios contra Competidores y Equipo Original.**  
**Liste d'interchange de produits compétitifs & d'équipement original (OEM)**

**SHASTA RV**

O.E.M #	Gabriel	Upgrade	O.E.M #	Gabriel	Upgrade	O.E.M #	Gabriel	Upgrade	O.E.M #	Gabriel	Upgrade
ASH-1136	83178		ASH-1154	83177							

**SICARD**

O.E.M #	Gabriel	Upgrade	O.E.M #	Gabriel	Upgrade	O.E.M #	Gabriel	Upgrade	O.E.M #	Gabriel	Upgrade
3166657	85700										

**SPARTAN MOTORS**

O.E.M #	Gabriel	Upgrade	O.E.M #	Gabriel	Upgrade	O.E.M #	Gabriel	Upgrade	O.E.M #	Gabriel	Upgrade
0272-SS5	85712		2200201	85007		59011	83214		B46-1594	85013	89414
0346-SS5	85013	89414	2502B46	85013	89414	60665-025	85036	89405	B46-1725	85029	
0377-SS5	85029		471700000456	85959		60665-025L	85036	89405	B46-2151	85007	
1300B46	85029		58913-009	85959		78068	85304				
21310-01	85307		58913-009L	85959		AS 4025B	85712				

**SPRING VALLEY**

O.E.M #	Gabriel	Upgrade	O.E.M #	Gabriel	Upgrade	O.E.M #	Gabriel	Upgrade	O.E.M #	Gabriel	Upgrade
632155	646177										

**STARCRAFT BUS CO.**

O.E.M #	Gabriel	Upgrade	O.E.M #	Gabriel	Upgrade	O.E.M #	Gabriel	Upgrade	O.E.M #	Gabriel	Upgrade
3578858C1	85926		4C4Z-18124-JB	85928		AA-617	85928		FC44-18045-BB	85181	
3578858C2	85926		4C4Z-18124-QA	83175		ASH-1136	83178		FC44-18080-AB	85180	
3584116C1	83175		4C4Z-18124-RA	85928		ASH-1154	83177		FC4Z-18124-A	85181	
3584116C2	83175		4C4Z-18125-B	83317		ASH-24658	85181		FC4Z-18124-B	85181	
3584118C2	85928		4C4Z-18125-DA	85926		ASH-24659	85181		FC4Z-18125-A	85180	
471700011530	85181		501906C92	83317		ASH-24660	85180				
471700011531	85180		AA-616	83175		AT-812	85928				

**STERLING TRUCK**

O.E.M #	Gabriel	Upgrade	O.E.M #	Gabriel	Upgrade	O.E.M #	Gabriel	Upgrade	O.E.M #	Gabriel	Upgrade
05168284AC	85649		6811 1104AB	85649		F1HZ-18124-J	83308		F6HT-18045-LA	85376	
05168295AB	85649		6811 1104AB-001	85649		F1HZ-18124-K		89402	F6HT-18080-B	83109	
10-12388-000	85920	89503	6811 1105AC	85649		F2HZ-18124-A	85376		F6HT-18080-CA	85314	89425
10-12390-000	85920	89503	6811 1105AC-001	85649		F2HZ-18124-B	85301		F6HT-18080-DA	83109	
10-13205-000	85918	89449	6E7Z-18125-A	83364		F4HT-18080-AB	85314	89425	F6HT-18080-EA	85906	89407
10-13592-000	85959		90045099	85906	89407	F4HT-18080-BA	85001	89410	F6HT-18080-FC	85013	89414
1210-0528	85904		AT-560	G63809		F5HZ-18124-A	83314		F6HT-18124-JC		89402
16-13957-000	85724	89443	AX-267A	83309		F5HZ-18124-B	83107		F6HT-18124-KA		89402
16-15770-000	85956		AX-310	83215		F5HZ-18124-C	85063		F6HZ-18124-A	85054	
16-15817-000	85724	89443	C4HZ-18124-E	83309		F5HZ-18124-D	83125		F6HZ-18124-B	83308	
16-18708-000	85724	89443	C4TZ-18124-AB	83308		F5HZ-18125-A	85314	89425	F6HZ-18124-C	85055	89439
471700002809	85724	89443	D8HZ-18124-A	85301		F5HZ-18125-B	85001	89410	F6HZ-18124-D	85055	89439
471700131646	85918	89449	E6HZ-18124-A	85301		F6HT-18045-AA	85054		F6HZ-18124-E	85055	89439
47902-28	85013	89414	E6HZ-18124-D	85301		F6HT-18045-AC	85054		F6HZ-18124-F	85055	89439
481700006848	85724	89443	E6HZ-18125-D	83215		F6HT-18045-BC	85047	89435	F6HZ-18124-G	85054	
481700125969	85956		E7HZ-18124-A	85301		F6HT-18045-CC	85055	89439	F6HZ-18124-H	85054	
4C4Z-18124-N	85957		E7XZ-18124-A	G63386		F6HT-18045-EB	85055	89439	F6HZ-18124-J		89402
4C4Z-18125-DA	85926		E7XZ-18125-B	G63387		F6HT-18045-EC	85055	89439	F6HZ-18125-B	83109	
57241-2	83109		E9HZ-18124-A	83309		F6HT-18045-GB	85030	89440	F6HZ-18125-D	85013	89414
58913-003	85932	89453	F0HZ-18124-B	85006		F6HT-18045-GC	85030	89440	F81A-18045-AGB	G63809	
58913-003L	85932	89453	F1HZ-18124-A	83309		F6HT-18045-HB	85054		SDA471700000440	85959	
6803230200	85043		F1HZ-18124-B	83308		F6HT-18045-HC	85054		SDA471700002809	85724	89443
6803230300	85006		F1HZ-18124-D	85006		F6HT-18045-JB		89402	XC45-18045-AA	83216	
6803260000	83120		F1HZ-18124-E	85006		F6HT-18045-JC		89402	XC45-18080-BA	85724	89443
680611	85724	89443	F1HZ-18124-H	85040		F6HT-18045-KA		89402			

**STERLING TRUCK CAB SHOCKS**

O.E.M #	Gabriel	Upgrade	O.E.M #	Gabriel	Upgrade	O.E.M #	Gabriel	Upgrade	O.E.M #	Gabriel	Upgrade
1202-1043	83025		F6HZ-5K407-AB	83034		F8HT-5K407-AA	83033				
18-45067-000	83034		F6HZ-5K407-BA	83033							

**Important Note:** Competitive Interchanges are to be used for stocking purposes only. Where multiple crosses are identified, please reference the applications section of this catalog. / **Remarque importante:** Les interchanges concurrentiels ne s'utilisent qu'aux fins de stocks. Dans le cas de références multiples, consulter la section des applications du catalogue. / **Nota importante:** Dans le cas de références multiples, consulter la section des applications du catalogue. / **Nota importante:** Se pueden usar intercambios competitivos para propósitos de almacenamiento solamente. Cuando se identifican intercambios múltiples, consulte la sección de aplicaciones de este catálogo.

**COMPETITIVE & O.E.M. INTERCHANGE LIST**  
**Lista de Intercambios contra Competidores y Equipo Original.**  
**Liste d'interchange de produits compétitifs & d'équipement original (OEM)**

**STOUGHTON TRAILERS INC.**

O.E.M #	Gabriel	Upgrade	O.E.M #	Gabriel	Upgrade	O.E.M #	Gabriel	Upgrade	O.E.M #	Gabriel	Upgrade
HTA20001	83128	89436	NW90044162	83128	89436	NW90044978	85059		RT18165-01	85006	
HTA20002	85000	89436	NW90044448	85051		NW90044979	83113				

**SUSPENSIONS INC.**

O.E.M #	Gabriel	Upgrade	O.E.M #	Gabriel	Upgrade	O.E.M #	Gabriel	Upgrade	O.E.M #	Gabriel	Upgrade
200188	646155										

**SUSPENSYS**

O.E.M #	Gabriel	Upgrade	O.E.M #	Gabriel	Upgrade	O.E.M #	Gabriel	Upgrade	O.E.M #	Gabriel	Upgrade
218004872	85737										

**TEREX CORPORATION**

O.E.M #	Gabriel	Upgrade	O.E.M #	Gabriel	Upgrade	O.E.M #	Gabriel	Upgrade	O.E.M #	Gabriel	Upgrade
12111	646155										

**THE BINKLEY COMPANY**

O.E.M #	Gabriel	Upgrade	O.E.M #	Gabriel	Upgrade	O.E.M #	Gabriel	Upgrade	O.E.M #	Gabriel	Upgrade
16965	85006		6898	83125							

**THOMAS SCHOOL BUS**

O.E.M #	Gabriel	Upgrade	O.E.M #	Gabriel	Upgrade	O.E.M #	Gabriel	Upgrade	O.E.M #	Gabriel	Upgrade
10-13211-000	85918	89449	6130-0114		89437	614974	85304		8C24-18080-DB	83178	
10-13634-000	85918	89449	61300112	83613		63-0001	85713		8C2Z-18124-D	83177	
128745	83102		61300224	85918	89449	651442	83102		8C2Z-18125-D	83178	
16-15817-000	85724	89443	61300240	85918	89449	659287	83102		90045504	85030	89440
16-18708-000	85724	89443	61300285	83102		680-323-0300	85006		A-4890	85712	
16-18713-000	85122		6130029	85712		680-326-0000	83120		ASH-1136	83178	
16-19138-000	85058	89431	61310101	85736		680010	85304		ASH-1154	83177	
300-0614966	85307		61310102	85308	89422	680054	85307		AT-163G	83177	
471700003070	85122		61310103	85308	89422	680088	85713		AT-164G	83178	
471700131545	85006		61310104	85713		680102	85712		GBL651442	83102	
60670-006	83147		61310232	85000	89436	6803260000	83120		GBL654725	83120	
60670-006L	83147		61310434	85724	89443	728802	85736		GBL665538	85006	
60998-001	85006		61310478	85724	89443	87002	85736				
60998-003	85006		614966	85307		8C24-18045-DA	83177				

**THOR MOTOR COACH**

O.E.M #	Gabriel	Upgrade	O.E.M #	Gabriel	Upgrade	O.E.M #	Gabriel	Upgrade	O.E.M #	Gabriel	Upgrade
141700131809	85029		16-16873-000	85029		ASH-1136	83178		ASH-25823	83209	89414
141700131810	83160		16-16874-000	83160		ASH-1154	83177		ASH-25824	83122	89406
16-16736-000	85029		16-18103-000	85900		ASH-1229	83209	89414			
16-16737-000	83160		481700000493	85900		ASH-25822	83209	89414			

**TIFFIN MOTORHOMES INC**

O.E.M #	Gabriel	Upgrade	O.E.M #	Gabriel	Upgrade	O.E.M #	Gabriel	Upgrade	O.E.M #	Gabriel	Upgrade
58913-009	85959		58913-009L	85959							

**TIMBREN INDUSTRIES**

O.E.M #	Gabriel	Upgrade	O.E.M #	Gabriel	Upgrade	O.E.M #	Gabriel	Upgrade	O.E.M #	Gabriel	Upgrade
665804	85939										

**TRAILMOBILE CANADA CORP.**

O.E.M #	Gabriel	Upgrade	O.E.M #	Gabriel	Upgrade	O.E.M #	Gabriel	Upgrade	O.E.M #	Gabriel	Upgrade
43-4-235	85051		43-4-279	83204		43-8-011	83207	89407	90044625	83125	
43-4-236	85029		43-6-028	85000	89436	43-8-013	85000	89436	90044642	83127	
43-4-237	85000	89436	43-6-118	85000	89436	43-8-014	85013	89414	90044978	85059	
43-4-239	83207	89407	43-6-137	85006		43-8-015	85006		90044979	83113	
43-4-241	85006		43-6-158	85013	89414	43-8-022	83225		90044992	85000	89436
43-4-277	85000	89436	43-6-164	83207	89407	43-8-031	85029		90045054	85051	
43-4-278	85059		43-8-002	83209	89414	90044089	83124	89407	A-2212	85029	

**TRANSPORTATION MFG. CORP**

O.E.M #	Gabriel	Upgrade	O.E.M #	Gabriel	Upgrade	O.E.M #	Gabriel	Upgrade	O.E.M #	Gabriel	Upgrade
12-05-6000	85711		12G-5-1	85700		12J-5-9	85700				
12-05-6002	85339		12J-5-10	85733		12L-5-69	85700				
12-05-6033	85339		12J-5-2	85733		12L-5-70	85700				
12B-5-1	85735		12J-5-4	85733		12L-5-99	85339				

**Important Note:** Competitive Interchanges are to be used for stocking purposes only. Where multiple crosses are identified, please reference the applications section of this catalog. / **Remarque importante:** Les interchanges concurrentiels ne s'utilisent qu'aux fins de stocks. Dans le cas de références multiples, consulter la section des applications du catalogue. / **Nota importante:** Dans le cas de références multiples, consulter la section des applications du catalogue. / **Nota importante:** Se pueden usar intercambios competitivos para propósitos de almacenamiento solamente. Cuando se identifican intercambios múltiples, consulte la sección de aplicaciones de este catálogo.

# COMPETITIVE & O.E.M. INTERCHANGE LIST

## Lista de Intercambios contra Competidores y Equipo Original.

### Liste d'interchange de produits compétitifs & d'équipement original (OEM)

#### TRANSPORTATION MFG. CORP... cont'd

O.E.M #	Gabriel	Upgrade	O.E.M #	Gabriel	Upgrade	O.E.M #	Gabriel	Upgrade	O.E.M #	Gabriel	Upgrade
12T-1-13	85303	89422	22045526	85702		680349	85702		G1011822	85702	
12TA-01-13	85303	89422	22052014	85702		680470	85713		G1101590	85713	

#### TRUCKMASTER

Truckmaster	Gabriel	Upgrade	Truckmaster	Gabriel	Upgrade	Truckmaster	Gabriel	Upgrade	Truckmaster	Gabriel	Upgrade
665632	85013	89414	665930	85001	89410	680240	85302	89420	680303	85007	
665633	85033	89427	665931	83312	89409	680241	85311	89424	680348	85012	89413
665783	83123	89405	665932	85012	89413	680242	85308	89422	680385	85311	89424
665784	83122	89406	665950	85902		680243	85001	89410	680425	85320	89429
665785	83137		671052	85070	89459	680253	85314	89425	680435	85033	89427
665844	85069	89455	671654	85936	89456	680261	85062	89408	680473	85319	89428
665918	85900		671699	85937		680279	83209	89414	680586	85311	89424
665926	85047	89435	671794	85067	89451	680280	85906	89407	680601	85012	89413
665927	85901		680237	85303	89422	680281	85003	89411			
665928	85062	89408	680239	85310	89423	680283	85740				

#### TURTLETOP BUS

O.E.M #	Gabriel	Upgrade	O.E.M #	Gabriel	Upgrade	O.E.M #	Gabriel	Upgrade	O.E.M #	Gabriel	Upgrade
ASH-1136	83178		ASH-1154	83177							

#### TUTHILL TECHNOLOGIES

O.E.M #	Gabriel	Upgrade	O.E.M #	Gabriel	Upgrade	O.E.M #	Gabriel	Upgrade	O.E.M #	Gabriel	Upgrade
1085	83214		17146-01	83209	89414	18800-01	83203	89436	23553-01	85938	
12885-01	85300	89419	17358-01	83126	89440	19495-01	83126	89440	24392-01	85051	
12885-03	85300	89419	17403-01	83122	89406	19623-01	83123	89405	2697	85712	
12887-01	85013	89414	17408-01	85005	89430	19824-01	85006		66502	646155	
12887-02	85013	89414	17794-01	83215		20125-01	85030	89440	680162	85300	89419
14954-01	83217		18163-01	83207	89407	20126-01		89440	702135-01	85045	
16230-01	85702		18164-01	83122	89406	20129-01	85007		702136-01	85052	
16725-01	83126	89440	18165-01	85006		20960-01	83204		702209-01	85014	
16824-01	85006		18166-01	85704		21497-01	85005	89430	OE12425	83214	
17142-01	85001	89410	18286-01		89414	23524-01	85738				

#### TWIN COACH

O.E.M #	Gabriel	Upgrade	O.E.M #	Gabriel	Upgrade	O.E.M #	Gabriel	Upgrade	O.E.M #	Gabriel	Upgrade
90044089	83124	89407	90044162	83128	89436	AR-958	83207	89407			
90044089C	83124	89407	AR-718-C-HD	85000	89436						

#### UNITED MANUFACTURING

O.E.M #	Gabriel	Upgrade	O.E.M #	Gabriel	Upgrade	O.E.M #	Gabriel	Upgrade	O.E.M #	Gabriel	Upgrade
K-96-41	85304										

#### UNIVERSAL COACH

O.E.M #	Gabriel	Upgrade	O.E.M #	Gabriel	Upgrade	O.E.M #	Gabriel	Upgrade	O.E.M #	Gabriel	Upgrade
12-05-1199	85729		680777	85729							

#### UPS TRUCK

O.E.M #	Gabriel	Upgrade	O.E.M #	Gabriel	Upgrade	O.E.M #	Gabriel	Upgrade	O.E.M #	Gabriel	Upgrade
P117099	83120		P117146	83118							

#### UTILITY TRAILER MANUFACTURING COMPANY

O.E.M #	Gabriel	Upgrade	O.E.M #	Gabriel	Upgrade	O.E.M #	Gabriel	Upgrade	O.E.M #	Gabriel	Upgrade
B-23361	85911		B-24023	85738		B-24125	85323	89436	S-24088	83128	89436
B-23566	85000	89436	B-24088	83128	89436	B-24579	85939		S-24088	85000	89436
B-23651	85045		B-24088	85000	89436	B-25515	85338				

#### VAN HOOL

O.E.M #	Gabriel	Upgrade	O.E.M #	Gabriel	Upgrade	O.E.M #	Gabriel	Upgrade	O.E.M #	Gabriel	Upgrade
10685703	695406		6243-14040	85708		665562	85708		90-2291	695406	
6243-13790	85708		624314570	695406		665563	85708				

#### VARIOUS

O.E.M #	Gabriel	Upgrade	O.E.M #	Gabriel	Upgrade	O.E.M #	Gabriel	Upgrade	O.E.M #	Gabriel	Upgrade
SC-2920	83176										

**Important Note:** Competitive Interchanges are to be used for stocking purposes only. Where multiple crosses are identified, please reference the applications section of this catalog. / **Remarque importante:** Les interchanges concurrentiels ne s'utilisent qu'aux fins de stocks. Dans le cas de références multiples, consulter la section des applications du catalogue. / **Nota importante:** Dans le cas de références multiples, consulter la section des applications du catalogue. / **Nota importante:** Se pueden usar intercambios competitivos para propósitos de almacenamiento solamente. Cuando se identifican intercambios múltiples, consulte la sección de aplicaciones de este catálogo.

**COMPETITIVE & O.E.M. INTERCHANGE LIST**  
**Lista de Intercambios contra Competidores y Equipo Original.**  
**Liste d'interchange de produits compétitifs & d'équipement original (OEM)**

**VOLVO**

O.E.M #	Gabriel	Upgrade	O.E.M #	Gabriel	Upgrade	O.E.M #	Gabriel	Upgrade	O.E.M #	Gabriel	Upgrade
02-7005976	83400		20469002	85933	89454	3199978	85712		3919582	83215	
02-7005977	83400		20485632	85933	89454	3199979	85702		3919585	83209	89414
03-1106460	85005	89430	20485633	85933	89454	3199980	85310	89423	3919587	83105	
1091347	83125		20513881	85061	89450	3199982	85703		3919588	83216	
1091348	83122	89406	20551628	85066	89448	3199983	85704		3919589	85026	89417
1091349	83204		20782199	85072		3199984	85314	89425	3919591	83515	
1091350	83207	89407	20863239	85080		3199985	85723		3919592	85024	
1091351	83209	89414	20973993	85061	89450	3199986	85318		3919593	83242	
1091353	83215		21137330	85933	89454	3199987	85705	89447	3919594	85003	89411
1091354	83216		21436086	85098	89502	3199988	85311	89424	3919596	G63484	
1091355	83217		21462378	85088		3199989	85709		3919598	83312	89409
1091357	83219		21462380	85088		3199990	85003	89411	3919900	85012	89413
1091358	83456	89447	22012065	85304		3199991	85708		3919901	83103	
1091359	83123	89405	22046483	85304		3199992	85733		3919902	83126	89430
1091360	83303		22052336	85304		3199993	85712		3919903	83216	
1091361	83304		3082284	83400		3199994	85308	89422	3919904	G63183	
1091362	83309		3092842	85061	89450	35901-0001	83209	89414	3919906	83308	
1091363	83221		3130140	85315		35901-0003	85301		3919907	83309	
1091364	83312	89409	3171696	85307		35901-0004	83219		3919909	G63605	
1091365	83400		3172948	85303	89422	35901-0005	83219		3919910	83221	
1091366	83401		3199937	85316	89426	35901-0008	85060		3919911	83124	89407
1091367	85000	89436	3199938	85030	89440	35901-0011	83123	89405	3919912	83215	
1091368	85003	89411	3199939	85058	89431	35901-0017	83314		3919913	83203	89436
1091370	85006		3199940	85005	89430	35901-0022	83635		3919914	83209	89414
1091371	85300	89419	3199941	85006		35901-3201	85024		3919915	83127	
1091372	85301		3199942		89402	35901-3406	85305		3919916	83126	89430
1091373	85302	89420	3199943	85012	89413	35901-3409	85304		3919917	83125	
1091374	85303	89422	3199944	85006		35901-3410	85307		3919918	83401	
1091375	85304		3199945	85027	89418	35901-3413	85006		3919919	G63625	
1091376	85305		3199946	85033	89427	35901-3420	85303	89422	3919920	83303	
1091377	85307		3199947	85013	89414	37001-5	83401		3919921	83123	89405
1091378	85308	89422	3199948	85311	89424	37301-0001	85013	89414	3919922	83318	
1091379	85310	89423	3199949	85310	89423	37301-0008	83400		3919923	83301	
1091384	85735		3199950	85023	89415	37301-0016	85026	89417	3919924	83456	89447
1093100	85027	89418	3199951	85024		37301-0018	85005	89430	3919925	83317	
1093176	85024		3199952	85736		37301-0021	85026	89417	3919926	G63403	
1093177	85025		3199953	85319	89428	37301-3201	85027	89418	3919927	83101	
1093178	85026	89417	3199954	85003	89411	37301-3202	85026	89417	3919928	83225	
1093180	85030	89440	3199955	85300	89419	3915917	85319	89428	3919931	83126	89430
14170000373	85061	89450	3199956	85036	89405	3915947	85001	89410	3919932	85062	89408
141700005838	85098	89502	3199957	83122	89406	3915948	85311	89424	3919933	85001	89410
1505190	85722		3199959	85323	89436	3916352	85013	89414	3919934	85320	89429
1591501	85722		3199960	85322		3919055	85007		3919935	85026	89417
1593843	83215		3199961	85307		3919056	83203	89436	3919936	83207	89407
1716824	85304		3199962	85314	89425	3919057	83225		3919937	85316	89426
19501669	85339		3199963	85315		3919526	83314		3919938	85030	89440
19502711	85702		3199965	85736		3919561	85314	89425	3919939	85058	89431
19506846	85339		3199966	85303	89422	3919565	83103		3919940	85005	89430
20353932	85081		3199967	85302	89420	3919567	83613		3919941	85006	
20414440	85081		3199968	85308	89422	3919569	85052		3919942	89402	
20433424	85061	89450	3199972	85320	89429	3919570	83128	89436	3919943	85012	89413
20433425	85066	89448	3199973	85722		3919571	83635		3919944	85036	89405
20433426	85081		3199974	85712		3919572	83130		3919945	85027	89418
20433427	85065		3199975	85700		3919573	83123	89405	3919946	85033	89427
20434880	85081		3199976	85711		3919574	85006		3919947	85013	89414
20469001	85933	89454	3199977	85711		3919575	83120		3919948	85311	89424

**Important Note:** Competitive Interchanges are to be used for stocking purposes only. Where multiple crosses are identified, please reference the applications section of this catalog. / **Remarque importante:** Les interchanges concurrentiels ne s'utilisent qu'aux fins de stocks. Dans le cas de références multiples, consulter la section des applications du catalogue. / **Nota importante:** Dans le cas de références multiples, consulter la section des applications du catalogue. / **Nota importante:** Se pueden usar intercambios competitivos para propósitos de almacenamiento solamente. Cuando se identifican intercambios múltiples, consulte la sección de aplicaciones de este catálogo.

**COMPETITIVE & O.E.M. INTERCHANGE LIST**  
**Lista de Intercambios contra Competidores y Equipo Original.**  
**Liste d'interchange de produits compétitifs & d'équipement original (OEM)**

**VOLVO... cont'd**

O.E.M #	Gabriel	Upgrade	O.E.M #	Gabriel	Upgrade	O.E.M #	Gabriel	Upgrade	O.E.M #	Gabriel	Upgrade
3919949	85310	89423	3946217	83125		665607	85047	89435	83176215	85023	89415
3919950	83219		3946219	83400		665623	85046	89434	83176216	85026	89417
3919951	83309		3946239	85724	89443	665739	85047	89435	83176217	85033	89427
3919952	85736		3949240	85047	89435	668302	83216		83176218	85036	89405
3919953	85319	89428	3949241	85061	89450	676081	83401		83176219	85045	
3919954	85003	89411	3953643	85040		676082	83401		83176220	85046	89434
3919955	85300	89419	3971703	83112		6771501	85040		83176221	85047	89435
3919956	85036	89405	3972662	85976		6772218	85040		83176222	85052	
3919957	83122	89406	471700000443	85066	89448	6775411	85040		83176223	85061	89450
3919958	85046	89434	471700002627	85066	89448	6775412	85040		83176224	85062	89408
3919959	85000	89436	471700003832	85933	89454	6790756	83215		83176225	85066	89448
3919960	85322		471700004423	85109		6794358	85040		83176226	85067	89451
3919961	85302	89420	471700006038	85088		6857668	83105		83176227	85069	89455
3919962	85700		471700006040	85088		6876828	83105		83176228	85070	89459
3919964	85304		471700131256	85065		70042	85302	89420	83176229	85303	89422
3919965	85702		471700131258	85081		8026658	85046	89434	83176230	85310	89423
3919966	85736		471700131920	85933	89454	8056892	85023	89415	83176231	85311	89424
3919967	85302	89420	471700131921	85933	89454	8060026	85065		83176232	85320	89429
3919968	85736		47902-24	83137		8065787	85026	89417	83176233	85321	
3919972	85320	89429	494-660	83219		8071524	85024		83176234	85323	89436
3919973	85956		4940640	83216		8071881	85061	89450	83176235	85724	89443
3919974	85712		4975479	83400		8073212	85065		83176236	85900	
3919975	85700		4975480	83400		8075257	85065		83176237	85916	89430
3919976	85033	89427	4975549	83216		8075287	85065		83176238	85918	89449
3919977	85033	89427	530596	85308	89422	8077874	85047	89435	83176239	85933	89454
3919978	85702		5322338	83214		8077874-P01	85047	89435	83176240	646155	
3919979	85702		5513989	83216		8078195	85061	89450	85104186	85006	
3919980	85702		5531435	85307		8083872	85978		85104221	85066	89448
3919982	85703		5531436	85307		8086053	85047	89435	85106580	85918	89449
3919983	85704		5531437	85307		8086651	85066	89448	85107238	85976	
3919984	85700		5534430	85303	89422	8169859	85047	89435	85134402	85061	89450
3919985	85723		5534447	85303	89422	8174749	85906	89407	85137234	83125	
3919987	85706		5549899	83207	89407	83176191	83019		85137420	85000	89436
3919988	85311	89424	5549925	85304		83176192	83041		90045605	85109	
3919989	85709		5554959	83401		83176193	83045		RC SA3041	83041	
3919990	85003	89411	57241-3	83112		83176194	83048		RC SA3045	83045	
3919991	85708		60657-007	85072		83176195	83103		RC SA3048	83048	
3919992	85733		60675-001	85978		83176196	83110		RC SA3103	83103	
3919993	85712		60675-001L	85978		83176197	83111		RC SA3111	83111	
3919994	85310	89423	60680-003	83112		83176198	83112		RC SA3112	83112	
3945806		89417	60680-003L	83112		83176199	83123	89405	RC SA3124	83124	89407
3945808		89407	60680-004	83143		83176200	83124	89407	RC SA3125	83125	
3945809		89410	60680-004L	83143		83176201	83125		RC SA3127	83127	
3945810		89420	60680-005	83142		83176202	83126		RC SA3128	83128	89436
3945811		89409	60680-005L	83142		83176203	83127		RC SA3136	83136	
3945812		89423	629398	85307		83176204	83128	89436	RC SA3148	83148	
3945813		89428	629501	85307		83176205	83136		RC SA3203	83203	89436
3945814		89424	646220	85734		83176206	83148		RC SA3216	83216	
3945815		89406	64838-001	85933	89454	83176207	83203	89436	RC SA5000	85000	89436
3945816		89430	64838-002	85933	89454	83176208	83209	89414	RC SA5001	85001	89410
3945817		89422	64838-003	85933	89454	83176209	83215		RC SA5003	85003	89411
3945818		89415	64838-003L	85933	89454	83176210	83216		RC SA5005	85005	89430
3945819		89411	66010-0016	85025		83176211	85000	89436	RC SA5047	85047	89435
3945820		89413	66221140I	83215		83176212	85001	89410	RC SA5052	85052	
3945821		89419	665410	85027	89418	83176213	85003	89411	RC SA5061	85061	89450
3946210	83103		665539	85026	89417	83176214	85005	89430	RC SA5062	85062	89408

**Important Note:** Competitive Interchanges are to be used for stocking purposes only. Where multiple crosses are identified, please reference the applications section of this catalog. / **Remarque importante:** Les interchanges concurrentiels ne s'utilisent qu'aux fins de stocks. Dans le cas de références multiples, consulter la section des applications du catalogue. / **Nota importante:** Dans le cas de références multiples, consulter la section des applications du catalogue. / **Nota importante:** Se pueden usar intercambios competitivos para propósitos de almacenamiento solamente. Cuando se identifican intercambios múltiples, consulte la sección de aplicaciones de este catálogo.

**COMPETITIVE & O.E.M. INTERCHANGE LIST**  
**Lista de Intercambios contra Competidores y Equipo Original.**  
**Liste d'interchange de produits compétitifs & d'équipement original (OEM)**

**VOLVO... cont'd**

O.E.M #	Gabriel	Upgrade	O.E.M #	Gabriel	Upgrade	O.E.M #	Gabriel	Upgrade	O.E.M #	Gabriel	Upgrade
RC SA5066	85066	89448	SA3110	83110		SA5023	85023	89415	SA5310	85310	89423
RC SA5067	85067	89451	SA3111	83111		SA5026	85026	89417	SA5311	85311	89424
RC SA5070	85070	89459	SA3112	83112		SA5033	85033	89427	SA5320	85320	89429
RC SA5310	85310	89423	SA3123	83123	89405	SA5036	85036	89405	SA5321	85321	
RC SA5320	85320	89429	SA3124	83124	89407	SA5045	85045		SA5323	85323	89436
RC SA5724	85724	89443	SA3125	83125		SA5046	85046	89434	SA5724	85724	89443
RC SA5900	85900		SA3126	83126		SA5047	85047	89435	SA5900	85900	
RC SA5918	85918	89449	SA3127	83127		SA5052	85052		SA5916	85916	89430
RC SA5933	85933	89454	SA3128	83128	89436	SA5061	85061	89450	SA5918	85918	89449
RC SA6155	646155		SA3136	83136		SA5062	85062	89408	SA5933	85933	89454
SA3019	83019		SA3148	83148		SA5066	85066	89448	SA6155	646155	
SA3041	83041		SA5000	85000	89436	SA5067	85067	89451	SDA471700131258	85081	
SA3045	83045		SA5001	85001	89410	SA5069	85069	89455			
SA3048	83048		SA5003	85003	89411	SA5070	85070	89459			
SA3103	83103		SA5005	85005	89430	SA5303	85303	89422			

**VOLVO CAB SHOCKS**

O.E.M #	Gabriel	Upgrade	O.E.M #	Gabriel	Upgrade	O.E.M #	Gabriel	Upgrade	O.E.M #	Gabriel	Upgrade
1201-0012	83023		20874147	83050		22662235	83905		8078546	83028	
1202-0012	83023		21368411	83905		22662237	83905		8078547	83029	
1202-0032	83016		21368413	83048		22866844	83048		8162662	83004	
20496215	83048		21391412	83048		3945842	83009		8168617	83030	
20496217	83029		22662125	83048		635869	83004		85107095	83009	
20704334	83048		22662224	83048		66010-0007	83004				
20721254	83048		22662230	83905		66010-0008	83004				

**WABASH NATIONAL**

O.E.M #	Gabriel	Upgrade	O.E.M #	Gabriel	Upgrade	O.E.M #	Gabriel	Upgrade	O.E.M #	Gabriel	Upgrade
202447	85919		FRUUCE1295-901	85300	89419	HENS-24088	83128	89436	NEW900-44-868	85045	
203447	85919		FRUUCE2983-1	85322		HENS-24088	85000	89436	NEW900-44-978	85059	
DANSR1VJ100	85078		FRUUCF8339-1	85321		NEW900-44-089	83124	89407	NEW900-44-979	83113	
FLL83203-07I	83203	89436	HENS-20001	83128	89436	NEW900-44-162	83128	89436	NEW900-45-040	83130	
FLL83207-07I	83207	89407	HENS-20002	85000	89436	NEW900-44-625	83125		NEW900-45-054	85051	
FLL85000-07I	85000	89436	HENS-20126	85323	89436	NEW900-44-626	83126	89430	NEW900-45-298	83128	89436
FLL85030-07I	85030	89440	HENS-21292	85052		NEW900-44-642	83127		NEW900-45-299	85000	89436
FRUUCE1295-1	85300	89419	HENS-23566	85000	89436	NEW900-44-794	83127				

**WATSON & CHALIN MFG. INC.**

O.E.M #	Gabriel	Upgrade	O.E.M #	Gabriel	Upgrade	O.E.M #	Gabriel	Upgrade	O.E.M #	Gabriel	Upgrade
10147	83203	89436	17186-01	85323	89436	19250	85382		680714	85934	
10147HD	85000	89436	17218	85029		19603	85939		727603	83203	89436
10148	83204		17297	85064		3946219	83400		727604	83204	
10634	G63357		17300	85052		665724	85000	89436	A-20345	85345	
11418	646155		17306	85938		665727	85005	89430	B-23649	85064	
11604	83125		17317	85344		665728	85060		B-23650	85052	
11724	83123	89405	17382	85014		665769	85052		B-23651	85045	
12128	85005	89430	17430	85321		665770	85064		B-23743	85938	
17069	632147		17474	85009		665862	85000	89436			
17079	85300	89419	19036	85934		680547	85323	89436			
17186	85323	89436	19249	85939		680584	85938				

**WESTERN STAR**

O.E.M #	Gabriel	Upgrade	O.E.M #	Gabriel	Upgrade	O.E.M #	Gabriel	Upgrade	O.E.M #	Gabriel	Upgrade
02-7005976	83400		16-18708-000	85724	89443	35901-3410	85307		37301-3412	85053	89442
02-7005977	83400		16725-01	83126	89440	35901-3413	85006		37390-4401	85053	89442
04-9041375	85315		19495-01	83126	89440	35901-3420	85303	89422	37390-4402	85053	89442
10-13684-000	85918	89449	28R010	83216		35901-4403	85060		37390-4403	85053	89442
10-13809-000	85958		35066-4413	83122	89406	37301-3401	85053	89442			
1011839	83216		35901-0001	83209	89414	37301-3404	85053	89442			
16-15770-000	85956		35901-3406	85305		37301-3405	85053	89442			
16-18706-000	85331		35901-3409	85304		37301-3409	85053	89442			

**Important Note:** Competitive Interchanges are to be used for stocking purposes only. Where multiple crosses are identified, please reference the applications section of this catalog. / **Remarque importante:** Les interchanges concurrentiels ne s'utilisent qu'aux fins de stocks. Dans le cas de références multiples, consulter la section des applications du catalogue. / **Nota importante:** Dans le cas de références multiples, consulter la section des applications du catalogue. / **Nota importante:** Se pueden usar intercambios competitivos para propósitos de almacenamiento solamente. Cuando se identifican intercambios múltiples, consulte la sección de aplicaciones de este catálogo.



**COMPETITIVE & O.E.M. INTERCHANGE LIST**  
**Lista de Intercambios contra Competidores y Equipo Original.**  
**Liste d'interchange de produits compétitifs & d'équipement original (OEM)**

**WESTERN STAR... cont'd**

O.E.M #	Gabriel	Upgrade	O.E.M #	Gabriel	Upgrade	O.E.M #	Gabriel	Upgrade	O.E.M #	Gabriel	Upgrade
47170000470	85918	89449	57241-1	83111		60675-002	85979		676081	83401	
471700002809	85724	89443	57252	85308	89422	60675-002L	85979		676082	83401	
471700003920	85958		57905-1	85976		60680-003	83112		90044025	83209	89414
471700004423	85109		57905-2	85006		60680-003L	83112		90044907	83635	
471700006269	85932	89453	58913-003	85932	89453	60680-004	83143		90045099	85906	89407
471700131331	85932	89453	58913-003L	85932	89453	60680-004L	83143		90045605	85109	
47902-13	83122	89406	58913-012	85932	89453	60680-005	83142		CP-5222	85315	
47902-24	83137		58913-012L	85932	89453	60680-005L	83142		SDA471700003920	85958	
47902-8	83122	89406	60657-003	85072		615016	83401		SDA481700125969	85956	
481700125969	85956		60657-003L	85072		665682	85053	89442			

**WESTERN STAR CAB SHOCKS**

O.E.M #	Gabriel	Upgrade	O.E.M #	Gabriel	Upgrade	O.E.M #	Gabriel	Upgrade	O.E.M #	Gabriel	Upgrade
1201-0012	83023		617547	83022		66010-3405	83026		814903003501	83027	
1202-0012	83023		654846	83027		66010-3406	83027		GBL 654916	83026	
1202-0032	83016		66010-3402	83022		66010-3407	83065				
18-60772-000	83026		66010-3403	83022		725470	83010				
18-60773-000	83027		66010-3404	83022		81-4903003500	83026				

**WESTERN UNIT "STABILAIR" SUSPENSION**

O.E.M #	Gabriel	Upgrade	O.E.M #	Gabriel	Upgrade	O.E.M #	Gabriel	Upgrade	O.E.M #	Gabriel	Upgrade
101030	85307		4939967	85308	89422	80600	85300	89419			
101364	85305		80370	85304							

**WESTPORT AXLE CORP**

O.E.M #	Gabriel	Upgrade	O.E.M #	Gabriel	Upgrade	O.E.M #	Gabriel	Upgrade	O.E.M #	Gabriel	Upgrade
143699-0185	646177		646124	646177							

**WHEELED COACH IND**

O.E.M #	Gabriel	Upgrade	O.E.M #	Gabriel	Upgrade	O.E.M #	Gabriel	Upgrade	O.E.M #	Gabriel	Upgrade
ASH-1136	83178		ASH-1154	83177							

**WINNEBAGO**

O.E.M #	Gabriel	Upgrade	O.E.M #	Gabriel	Upgrade	O.E.M #	Gabriel	Upgrade	O.E.M #	Gabriel	Upgrade
141700131809	85029		24-186629	85125		ASH-1206	83122	89406	F4-BE5-A011-HO	85126	
141700131810	83160		481700000493	85900		ASH-1228	83209	89414	F4-BE5-A832-MO	85125	
16-16736-000	85029		66153-002	83124	89407	ASH-1229	83209	89414	F4-BE5-B492-HO	85125	
16-16737-000	83160		9U94-18045-AA	83209	89414	ASH-1230	83122	89406	F4-BE5-C832-MO	83124	89407
16-16873-000	85029		9U94-18080-AA	83122	89406	ASH-137	83122	89406	F4-BE5-F324-HO	85125	
16-16874-000	83160		9U9Z-18124-A	83209	89414	ASH-25822	83209	89414	F4-BE5-F325-HO	85124	
16-18103-000	85900		9U9Z-18125-A	83122	89406	ASH-25823	83209	89414	W0005662	85125	
1C34-18045-AA	83209	89414	ASH-1022	83209	89414	ASH-25824	83122	89406	W0005663	85124	
1C34-18045-JA	83209	89414	ASH-1023	83122	89406	ASH-294	83209	89414	W0006254	85125	
24-153249	85125		ASH-1136	83178		AT-620	83209	89414			
24-153256	85124		ASH-1154	83177		AT-621	83122	89406			
24-186537	85126		ASH-1205	83209	89414	AT-766	83209	89414			

**WORKHORSE**

O.E.M #	Gabriel	Upgrade	O.E.M #	Gabriel	Upgrade	O.E.M #	Gabriel	Upgrade	O.E.M #	Gabriel	Upgrade
24-153249	85125		66153-002	83124	89407	F4-BE5-B492-HO	85125		W0005663	85124	
24-153256	85124		680672	85919		F4-BE5-C832-MO	83124	89407	W0006254	85125	
24-186537	85126		7805-X-1012	85919		F4-BE5-F324-HO	85125		W0007365	G63866	
24-186629	85125		F4-BE5-A011-HO	85126		F4-BE5-F325-HO	85124		W0011635	83221	
659223	G63866		F4-BE5-A832-MO	85125		W0005662	85125		W0011636	G63366	

**WORLD TRANS BUS CO.**

O.E.M #	Gabriel	Upgrade	O.E.M #	Gabriel	Upgrade	O.E.M #	Gabriel	Upgrade	O.E.M #	Gabriel	Upgrade
ASH-1136	83178		ASH-1154	83177							

**Important Note:** Competitive Interchanges are to be used for stocking purposes only. Where multiple crosses are identified, please reference the applications section of this catalog. / **Remarque importante:** Les interchanges concurrentiels ne s'utilisent qu'aux fins de stocks. Dans le cas de références multiples, consulter la section des applications du catalogue. / **Nota importante:** Dans le cas de références multiples, consulter la section des applications du catalogue. / **Nota importante:** Se pueden usar intercambios competitivos para propósitos de almacenamiento solamente. Cuando se identifican intercambios múltiples, consulte la sección de aplicaciones de este catálogo.

# HOW TO DETERMINE THE CORRECT SHOCK FOR YOUR TRUCK

## CÓMO ESCOGER EL MEJOR AMORTIGUADOR PARA SU CAMIÓN COMMENT CHOISIR LE BON AMORTISSEUR POUR VOTRE CAMION

**Part Number:** The catalog number for the individual shock absorber.

**Extended Length\*:** The length of the shock absorber when it is fully extended. See "How to Measure" instructions.

**Collapsed Length\*:** The length of the shock absorber when it is fully collapsed. See "How to Measure" instructions

**Stroke:** This is the approximate length of the stroke of the individual shock absorber being described.

**Mounting Codes:** Indicates the type of mounting ends for the upper and lower end of each shock absorber.

They are listed as follows:

- Stud type mounts ("S" & "DS")
- Eye ring and bushing mounts ("EB")
- Eye ring and bushing with sleeve mounts ("ES")
- Eye ring and bushing with bar pin mounts ("BP")
- Special mounting codes ("SP")

**Número de parte:** El número de catálogo para el amortiguador individual.

**Longitud extendida\*:** La longitud del amortiguador cuando está totalmente extendido. Consulte las instrucciones "Cómo medir".

**Longitud colapsada\*:** La longitud del amortiguador cuando está totalmente colapsado. Consulte las instrucciones "Cómo medir".

**Carrera:** Esta es la longitud aproximada de la carrera del amortiguador individual que se está describiendo.

**Códigos de montura:** Indica el tipo de extremos de montura para el extremo superior e inferior de cada amortiguador.

Se enumeran de la siguiente manera:

- Monturas tipo perno ("S" y "DS")
- Monturas de anillo y casquillo ("EB")
- Monturas de anillo y casquillo con funda ("ES")
- Monturas de anillo y casquillo con pasador de barra ("BP")
- Códigos especiales de montura ("SP")

**Numéro de pièce :** Le numéro de catalogue pour l'amortisseur individuel.

**Longueur en extension\*:** La longueur de l'amortisseur lorsqu'il est en extension complète. Voir les instructions « Comment mesurer ».

**Longueur plié\*:** La longueur de l'amortisseur lorsqu'il est complètement plié. Voir les instructions « Comment mesurer ».

**Course:** Ceci est la longueur approximative de la course de l'amortisseur individuel décrit ici.

**Codes de fixation:** Indique le type d'extrémité de fixation pour l'extrémité supérieure et inférieure de chaque amortisseur.

Ils sont classés comme suit :

- Fixations à goujons (« S » et « DS »)
- Fixations à œillet et à douille (« EB »)
- Fixations à œillet et douille de glissement (« ES »)
- Fixations à œillet et à douille avec broche (« BP »)
- Codes de fixations spéciales (« SP »)

### CONVERSION CHART | TABLA DE CONVERSIÓN | TABLEAU DE CONVERSION

Fraction   Fracción	Decimal   Décimal	Metric   Métrico   Métrique	Fraction   Fracción	Decimal   Décimal	Metric   Métrico   Métrique
(INCHES)	(INCHES)	(MM)	(INCHES)	(INCHES)	(MM)
1/64	0.016	0.397	33/64	0.516	13.097
1/32	0.031	0.794	17/32	0.531	13.494
3/64	0.047	1.191	35/64	0.547	13.891
1/16	0.063	1.588	9/16	0.563	14.288
5/64	0.078	1.984	37/64	0.578	14.684
3/32	0.094	2.381	19/32	0.594	15.081
7/64	0.109	2.778	39/64	0.609	15.478
1/8	0.125	3.175	5/8	0.625	15.875
9/64	0.141	3.572	41/64	0.641	16.272
5/32	0.156	3.969	21/32	0.656	16.669
11/64	0.172	4.366	43/64	0.672	17.066
3/16	0.188	4.763	11/16	0.688	17.463
13/64	0.203	5.159	45/64	0.703	17.859
7/32	0.219	5.556	23/32	0.719	18.256
15/64	0.234	5.953	47/64	0.734	18.653
1/4	0.250	6.350	3/4	0.750	19.050
17/64	0.266	6.747	49/64	0.766	19.447
9/32	0.281	7.144	25/32	0.781	19.844
19/64	0.297	7.541	51/64	0.797	20.241
5/16	0.313	7.938	13/16	0.813	20.638
21/64	0.328	8.334	53/64	0.828	21.034
11/32	0.344	8.731	27/32	0.844	21.431
23/64	0.359	9.128	55/64	0.859	21.828
3/8	0.375	9.525	7/8	0.875	22.225
25/64	0.391	9.922	57/64	0.891	22.622
13/32	0.406	10.319	29/32	0.906	23.019
27/64	0.422	10.716	59/64	0.922	23.416
7/16	0.438	11.113	15/16	0.938	23.813
29/64	0.453	11.509	61/64	0.953	24.209
15/32	0.469	11.906	31/32	0.969	24.606
31/64	0.484	12.303	63/64	0.984	25.003
1/2	0.500	12.700	1	1.000	25.400

### METRIC CONVERSION CHART | TABLA DE CONVERSIÓN MÉTRICA | TABLEAU DE CONVERSION

(MM)	(INCHES)	(MM)	(INCHES)	(MM)	(INCHES)
1	0.03937	10	0.39370	19	0.74803
2	0.07874	11	0.43307	20	0.78740
3	0.11811	12	0.47244	21	0.82677
4	0.15748	13	0.51181	22	0.86614
5	0.19685	14	0.55118	23	0.90551
6	0.23622	15	0.59055	24	0.94488
7	0.27559	16	0.62992	25	0.98425
8	0.31496	17	0.66929		
9	0.35433	18	0.70866		

# HOW TO DETERMINE THE CORRECT SHOCK FOR YOUR TRUCK

## CÓMO ESCOGER EL MEJOR AMORTIGUADOR PARA SU CAMIÓN COMMENT CHOISIR LE BON AMORTISSEUR POUR VOTRE CAMION

**STEP 1:** Measure the diameter of the dust tube and cylinder to determine the series.

**1<sup>ER</sup> PASO:** Mida el diámetro del tubo de polvo y del cilindro para determinar la serie.

**1<sup>RE</sup> ÉTAPE:** Mesurez le diamètre du tube de poussière et du cylindre pour déterminer la série.

### EXTERNAL DIMENSIONS DIMENSIONES EXTERNAS DIMENSIONS EXTÉRIEURES

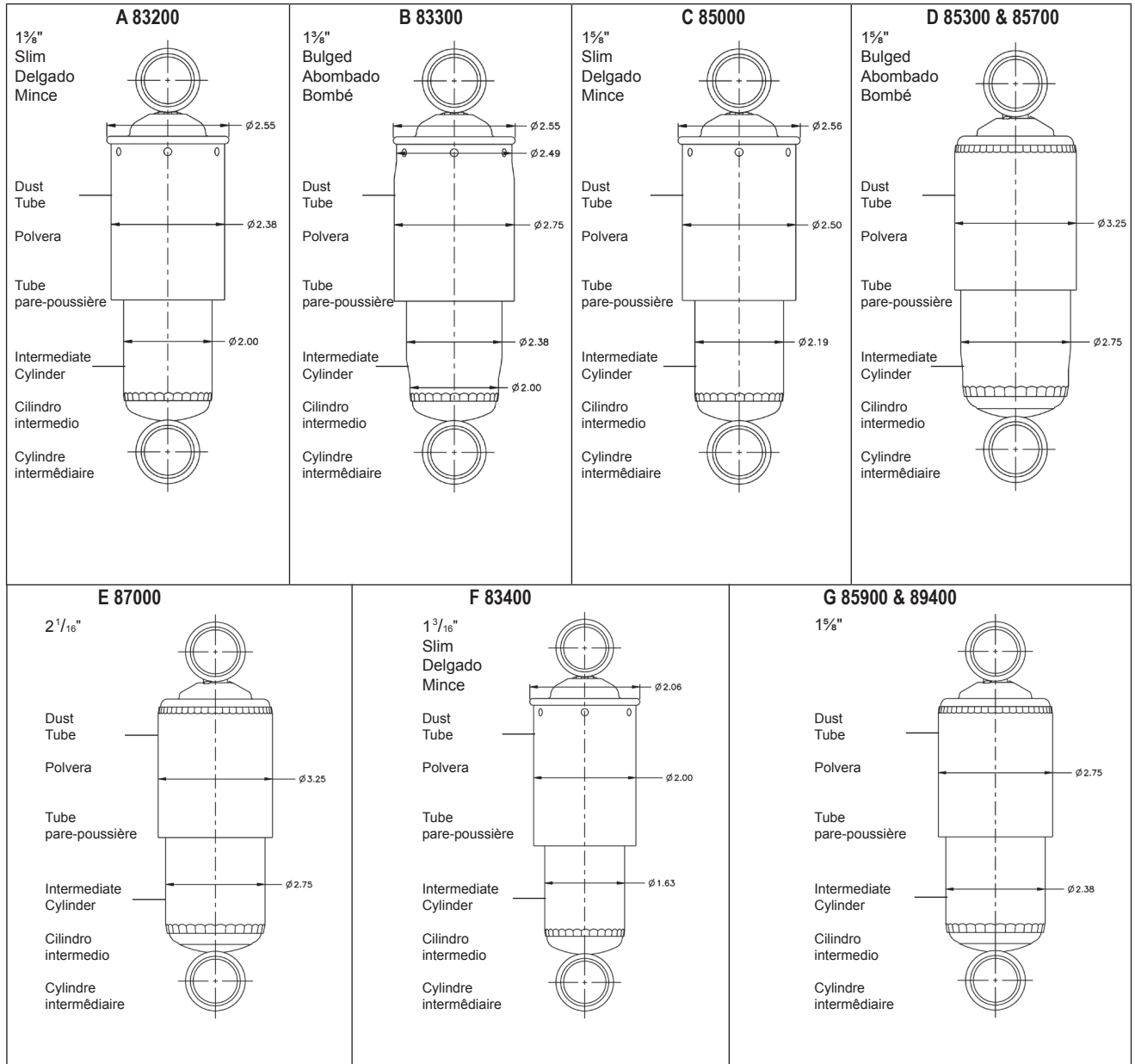

# HOW TO DETERMINE THE CORRECT SHOCK FOR YOUR TRUCK

## CÓMO ESCOGER EL MEJOR AMORTIGUADOR PARA SU CAMIÓN COMMENT CHOISIR LE BON AMORTISSEUR POUR VOTRE CAMION

- STEP 2:** Identify the mounting style. Measure fully extended and fully collapsed lengths at the locations indicated for mounting style.
- 2º PASO:** Identifique el tipo de montaje. Mida la longitud totalmente extendida y totalmente comprimida, en los puntos indicados para cada tipo de montaje.
- 2È ÉTAPE:** Identifiez la méthode de fixation. Mesurez la longueur en pleine extension et en pleine compression, aux endroits indiqués pour la méthode de fixation.

### HOW TO MEASURE EXTENDED & COLLAPSED LENGTHS OF SHOCK ABSORBERS COMO MEDIR LAS LONGITUDES EXTENDIDA Y COMPRIMIDA DE LOS AMORTIGUADORES COMMENT MESURER LES LONGUEURS ALLONGÉ ET COMPRIMÉ DES AMORTISSEURS

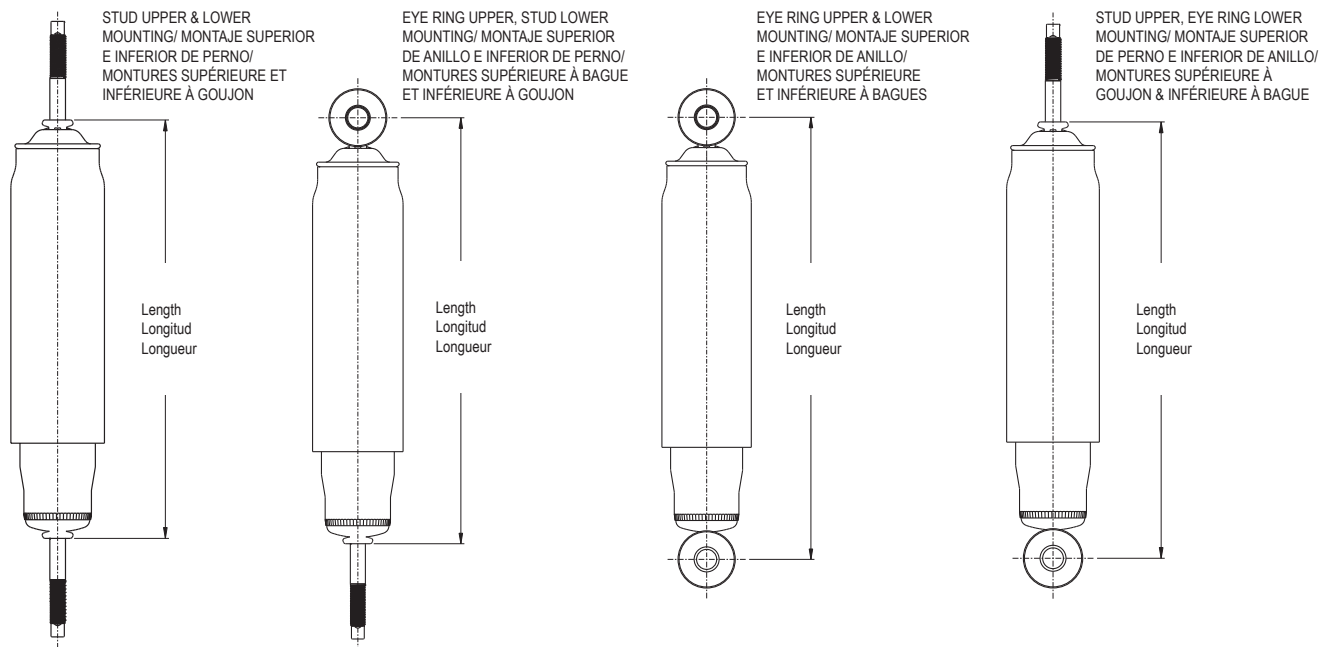

#### INSTRUCTIONS:

- Using the proper measuring points as shown above find the nearest replacement shock absorber from the listing by increments of extended length.
- Identify the proper mounting from the mounting codes and match these requirements by carefully measuring the mounting dimensions (top and bottom) of the shock absorber to be replaced.
- Carefully take note of the following requirements:
  - Dust tubes** - This requirement should be noted in comparison with the shock absorber to be replaced. Shock absorber environment in its application makes this requirement necessary for piston rod protection and extended shock absorber life.
  - Recoil Cutoff and Compression Bumper** - Carefully note these specifications - deviation of length requirements should not exceed  $\pm 1/4"$ . These shock absorber designs are footnoted for easy identification.

**Note:** Shock absorbers used for installations other than those recommended in our catalog are **not subject to warranty**.

#### INSTRUCCIONES:

- Usando los puntos de medida adecuados como mencionado, encuentre el amortiguador más cercano en la lista por incrementos de la longitud extendida.
- Identifique la montaje adecuado por medio de los códigos de fijación y compare estas especificaciones, midiendo cuidadosamente las dimensiones de la montaje (superior e inferior) del amortiguador por reemplazar.
- Note cuidadosamente las exigencias siguientes:
  - Polvera** - Este componente debe estar presente en el amortiguador por reemplazar. El ambiente de trabajo del amortiguador hacen a la polvera necesaria para proteger la barra del pistón y extender la vida del producto.
  - Tope de retorno y tope de compresión** - Note cuidadosamente las especificaciones siguientes : las exigencias de longitud no deben de ser excedidas  $\pm 1/4"$ . Estos diseños de amortiguadores están marcados para facilitar su identificación.

**Nota:** Los amortiguadores usados para instalaciones otras que las recomendadas en nuestro catálogo **no son garantizados**.

#### INSTRUCTIONS:

- En utilisant les points de mesure appropriés comme indiqués ci-dessus, trouvez l'amortisseur de rechange le plus près de cette mesure d'après la longueur allongée.
- Repérez les montures appropriées sur les codes des montures et faites correspondre ces exigences en mesurant attentivement les dimensions des montures (haut et bas) de l'amortisseur à replacer.
- Avec soin, prenez note des exigences suivantes:
  - Tubes pare-poussière** - Cette exigence devrait être notée en comparaison de l'amortisseur à remplacer. Le milieu de service rend cette exigence nécessaire pour la protection de la tige de piston et une meilleure longévité de l'amortisseur.
  - Arrêt de retour et butée de compression** - Notez avec soin ces spécifications. La déviation par rapport aux exigences de longueurs ne doit pas dépasser  $\pm 1/4$  po. Ces modèles d'amortisseurs portent une note pour une identification facile.

**Note:** Les amortisseurs utilisés pour des installations autres que celles recommandées dans notre catalogue **ne sont pas couverts par la garantie**.

# HOW TO DETERMINE THE CORRECT SHOCK FOR YOUR TRUCK

## CÓMO ESCOGER EL MEJOR AMORTIGUADOR PARA SU CAMIÓN COMMENT CHOISIR LE BON AMORTISSEUR POUR VOTRE CAMION

**STEP 3:** Measure end mount diameters, widths, and lengths. Refer to the following end mount tables to determine the appropriate or matching mounting code.

**3ER PASO:** Mida las dimensiones del tubo, así como el diámetro, la anchura y la longitud de las fijaciones. Consulte las tablas siguientes de conteras para determinar el código de montaje apropiado o concorde.

**3E ÉTAPE:** Mesurez le diamètre, la largeur et la longueur des bagues. Consultez les tableaux d'embouts suivants afin d'établir le code de montage approprié ou concordant.

### MOUNTING CODE "EB" EYE RING AND BUSHING CODIGO DE FIJACION «EB» ANILLO Y BUJE CODE DE MONTURE "EB" À BAGUE ET MANCHON

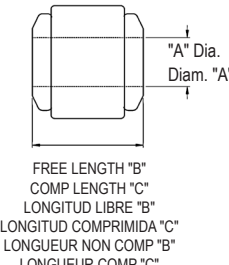
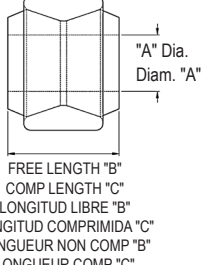
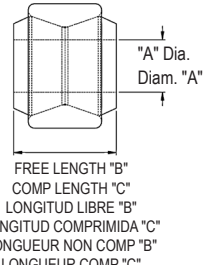
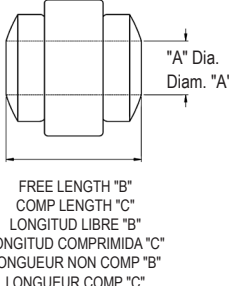
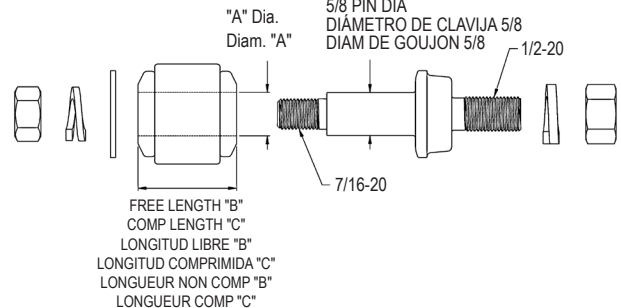
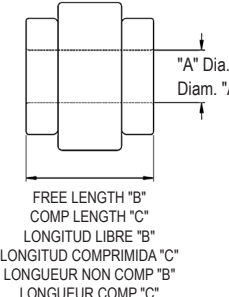
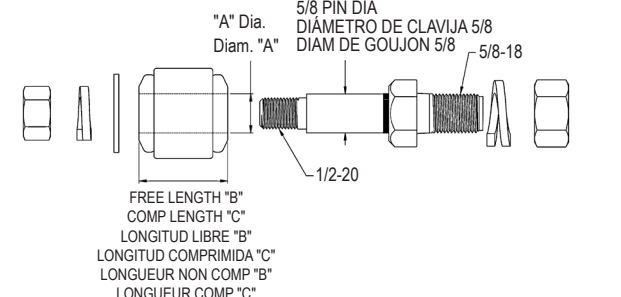
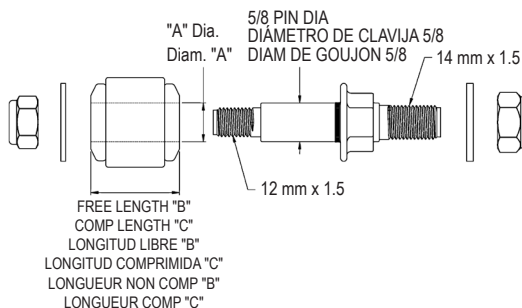
<p><b>EB1</b></p>  <p>"A" Dia. Diam. "A"</p> <p>FREE LENGTH "B" COMP LENGTH "C" LONGITUD LIBRE "B" LONGITUD COMPRIMIDA "C" LONGUEUR NON COMP "B" LONGUEUR COMP "C"</p>	<p><b>EB2</b></p>  <p>"A" Dia. Diam. "A"</p> <p>FREE LENGTH "B" COMP LENGTH "C" LONGITUD LIBRE "B" LONGITUD COMPRIMIDA "C" LONGUEUR NON COMP "B" LONGUEUR COMP "C"</p>	<p><b>EB3</b></p>  <p>"A" Dia. Diam. "A"</p> <p>FREE LENGTH "B" COMP LENGTH "C" LONGITUD LIBRE "B" LONGITUD COMPRIMIDA "C" LONGUEUR NON COMP "B" LONGUEUR COMP "C"</p>
<p><b>EB4</b></p>  <p>"A" Dia. Diam. "A"</p> <p>FREE LENGTH "B" COMP LENGTH "C" LONGITUD LIBRE "B" LONGITUD COMPRIMIDA "C" LONGUEUR NON COMP "B" LONGUEUR COMP "C"</p>	<p><b>EB6</b></p>  <p>"A" Dia. Diam. "A"</p> <p>5/8 PIN DIA DIÁMETRO DE CLAVIJA 5/8 DIAM DE GOUJON 5/8</p> <p>1/2-20</p> <p>7/16-20</p> <p>FREE LENGTH "B" COMP LENGTH "C" LONGITUD LIBRE "B" LONGITUD COMPRIMIDA "C" LONGUEUR NON COMP "B" LONGUEUR COMP "C"</p>	
<p><b>EB5</b></p>  <p>"A" Dia. Diam. "A"</p> <p>FREE LENGTH "B" COMP LENGTH "C" LONGITUD LIBRE "B" LONGITUD COMPRIMIDA "C" LONGUEUR NON COMP "B" LONGUEUR COMP "C"</p>	<p><b>EB7</b></p>  <p>"A" Dia. Diam. "A"</p> <p>5/8 PIN DIA DIÁMETRO DE CLAVIJA 5/8 DIAM DE GOUJON 5/8</p> <p>5/8-18</p> <p>1/2-20</p> <p>FREE LENGTH "B" COMP LENGTH "C" LONGITUD LIBRE "B" LONGITUD COMPRIMIDA "C" LONGUEUR NON COMP "B" LONGUEUR COMP "C"</p>	
<p><b>EB8</b></p>  <p>"A" Dia. Diam. "A"</p> <p>5/8 PIN DIA DIÁMETRO DE CLAVIJA 5/8 DIAM DE GOUJON 5/8</p> <p>14 mm x 1.5</p> <p>12 mm x 1.5</p> <p>FREE LENGTH "B" COMP LENGTH "C" LONGITUD LIBRE "B" LONGITUD COMPRIMIDA "C" LONGUEUR NON COMP "B" LONGUEUR COMP "C"</p>		

# HOW TO DETERMINE THE CORRECT SHOCK FOR YOUR TRUCK

## CÓMO ESCOGER EL MEJOR AMORTIGUADOR PARA SU CAMIÓN COMMENT CHOISIR LE BON AMORTISSEUR POUR VOTRE CAMION

### MOUNTING CODE "EB" EYE RING AND BUSHING (Cont'd)

#### CÓDIGO DE MONTAJE «EB» ANILLO Y BUJE

#### CODE DE MONTURE "EB" A BAGUE ET MANCHON

Mounting Code Código de montaje Code de monture	"A" Dia. Diámetro "A" Diam. "A"	B Free Length Longitud libre Long. non comp.	C Comp. Length Longitud comprimida Long. comp.	Vehicle Mounting Pin Dia. Diámetro de clavija de montaje del vehículo Diam. du goujon de montage du véhicule
EB1	5/8	1.44	1.31	5/8
EB2	3/4	1.75	1.50	3/4
EB3	1.00	1.91	1.75	1.00
EB4	11/16	1.72	1.55	11/16
EB5	5/8	1.51	1.25	5/8
EB6	5/8	1.44	1.31	Mounting pin furnished with shock absorber for 1/2" dia. vehicle mounting hole. Perno proveído con el amortiguador para orificio de montaje de 1/2" de diámetro. Goujon de montage fourni avec l'amortisseur pour trou de montage de 1/2 po de diam. sur véhicule.
EB7	5/8	1.44	1.31	Mounting pin furnished with shock absorber for 5/8" dia. vehicle mounting hole. Perno proveído con el amortiguador para orificio de montaje de 5/8" de diámetro. Goujon de montage fourni avec l'amortisseur pour trou de montage de 5/8 po de diam. sur véhicule.
EB8	5/8	1.44	1.31	Mounting pin furnished with shock absorber for 14 mm dia. vehicle mounting hole. Perno proveído con el amortiguador para orificio de montaje de 14 mm de diámetro. Goujon de montage fourni avec l'amortisseur pour trou de montage de 14 mm de diam. sur véhicule.
EB9	1	1.75	--	1
EB10	1.00	1.00	--	1.00
EB11	3/8	0.83	--	3/8
EB12	10MM	1.18	--	10MM
EB13	12MM	1.03	--	12MM
EB14	15MM	1.41	--	15MM
EB15	15MM	1.76	--	15MM
EB16	16MM	1.5	--	16MM
EB17	17MM	1.18	--	17MM
EB18	19MM	1.65	--	19MM
EB19	20MM	1.75	--	20MM
EB20	45/64	1.05	--	45/64
EB21	45/64	1.39	--	45/64

# HOW TO DETERMINE THE CORRECT SHOCK FOR YOUR TRUCK

## CÓMO ESCOGER EL MEJOR AMORTIGUADOR PARA SU CAMIÓN

### COMMENT CHOISIR LE BON AMORTISSEUR POUR VOTRE CAMION

#### MOUNTING CODE "ES" & "CB" EYE RING AND BUSHING WITH STEEL SLEEVE

CÓDIGO DE MONTAJE «ES» Y «CB» ANILLO Y BUJE CON CAMISA DE ACERO

CODE DE MONTURE "ES" & "CB" BAGUE ET MANCHON AVEC COLLET EN ACIER

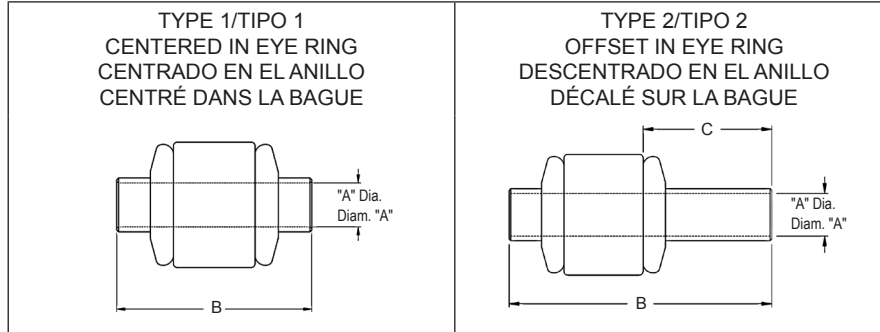

MOUNTING CODE	TYPE	DIMENSION		
		A	B	C
ES1	1	10MM	1.25	--
ES2	1	10MM	1.42	--
ES3	1	10MM	1.56	--
ES4	2	1/2	2.20	0.77
ES5	1	10MM	2.07	--
ES6	1	10MM	2.35	--
ES7	1	9/16	1.25	--
ES8	1	7/16	1.25	--
ES9	1	7/16	1.31	--
ES10	1	7/16	1.38	--
ES11	1	7/16	1.50	--
ES12	1	7/16	1.62	--
ES13	1	9/16	1.89	--
ES14	1	7/16	1.88	--
ES15	1	9/16	2.79	--
ES16	1	7/16	3.15	--
ES17	1	12MM	1.25	--
ES18	1	12MM	1.65	--
ES19	1	12MM	1.88	--
ES20	1	12MM	1.95	--
ES21	1	12MM	2.28	--
ES22	1	1/2	1.25	--
ES23	1	1/2	1.31	--
ES24	1	1/2	1.38	--
ES25	1	1/2	1.50	--
ES26	1	1/2	1.56	--
ES27	1	1/2	1.62	--
ES28	1	9/16	3.15	--
ES29	1	10MM	2.95	--
ES30	1	12MM	2.57	--
ES31	2	1/2	2.25	1.00
ES32	1	1/2	3.34	--
ES33	1	12MM	3.15	--
ES34	1	9/16	1.66	--
ES35	1	5/8	1.38	--
ES36	1	3/4	1.75	--
ES37	1	12MM	1.01	--
ES38	1	7/16	2.18	--
ES39	1	10MM	1.31	--
ES40	1	7/16	3.38	--
ES41	1	12MM	3.48	--
ES42	1	12MM	3.77	--
ES43	1	13MM	1.31	--
ES44	1	10MM	2.28	--
ES45	1	13MM	1.68	--
ES46	1	13MM	1.73	--
ES47	1	13MM	2.50	--

MOUNTING CODE	TYPE	DIMENSION		
		A	B	C
ES48	1	14MM	1.42	--
ES49	1	14MM	1.66	--
ES50	1	14MM	1.81	--
ES51	1	14MM	1.89	--
ES52	1	14MM	1.96	--
ES53	1	10MM	1.38	--
ES54	1	12MM	2.91	--
ES55	1	14MM	2	--
ES56	1	14MM	1.58	--
ES57	1	10MM	1.03	--
ES58	1	14MM	2.13	--
ES59	1	15MM	1.56	--
ES60	1	14MM	1.26	--
ES61	1	12MM	1.76	--
ES62	1	12MM	0.98	--
ES63	1	15MM	2.28	--
ES64	1	16MM	1.25	--
ES65	1	12MM	1.38	--
ES66	1	16MM	1.38	--
ES67	1	16MM	1.56	--
ES68	1	9/16	1.35	--
ES69	1	12MM	1.58	--
ES70	2	7/16	1.88	0.70
ES71	1	15MM	2.15	--
ES72	1	16MM	1.65	--
ES73	1	16MM	1.74	--
ES74	1	16MM	1.93	--
ES75	1	16MM	2.04	--
ES76	1	17/32	1.49	--
ES77	1	20MM	2.35	--
ES78	1	10MM	1.92	--
ES79	1	21/32	1.58	--
ES80	2	25/32	1.69	0.07
ES81	1	31/64	1.26	--
ES82	1	31/64	1.53	--
ES83	1	12MM	1.48	--
ES84	1	10MM	1.62	--
ES85	1	12MM	2.36	--
ES86	1	14MM	2.44	--
ES87	1	31/64	1.65	--
ES88	1	12MM	1.81	--
ES89	1	39/64	2.16	--
ES90	1	5/8	2.00	--
ES91	1	1/2	2.10	--
ES92	2	39/64	2.20	0.88
ES93	2	39/64	2.57	0.79
ES94	1	1/2	2.15	--

MOUNTING CODE	TYPE	DIMENSION		
		A	B	C
ES95	1	41/64	2	--
ES96	1	45/64	1.57	--
ES99	1	14MM	1.42	--
ES102	1	10MM	1.77	--
ES104	1	20MM	1.58	--
ES106	1	10MM	1.48	--
ES107	1	12MM	2.15	--
ES109	1	10MM	0.95	--
ES110	1	16MM	1.61	--
ES111	1	9MM	1.78	--
ES112	1	12MM	1.08	--
ES113	1	16MM	1.49	--
ES114	1	12MM	2.04	--
ES115	1	10MM	2.02	--
ES118	1	12MM	1.31	--
ES120	1	3/4	2.76	--
ES121	1	3/4	2.06	--
ES123	1	16MM	1.57	--
ES126	1	1/2	2.44	--
ES128	1	1/2	1.66	--
ES130	1	1/2	1.56	--
ES133	1	12MM	1.93	--
ES136	1	5/8	1.75	--
ES137	1	1/2	1.73	--
ES138	1	5/8	1.70	--
ES139	1	12MM	1.35	--
ES141	1	12MM	1.61	--
ES142	1	16MM	1.43	--
ES143	1	9/16	1.60	--
ES145	1	7/16	2.25	--
ES146	1	12MM	1.37	--
ES147	1	12MM	1.97	--
ES149	1	1/2	2.36	--
ES150	1	3/4	2.24	--
ES152	1	20MM	1.69	--
ES153	1	14MM	1.55	--
ES157	2	1/2	2.05	0.95
ES158	1	3/4	3.80	--
ES159	2	3/4	3.21	1.03
ES160	1	1.00	2.01	--
ES161	1	16MM	3.95	--
ES162	1	16MM	2.60	--
ES163	1	7/16	2.50	--
ES164	1	1/2	2.26	--
ES165	1	1/2	1.75	--
ES166	1	5/8	2.97	--
ES167	1	14MM	2.31	--

# HOW TO DETERMINE THE CORRECT SHOCK FOR YOUR TRUCK

## CÓMO ESCOGER EL MEJOR AMORTIGUADOR PARA SU CAMIÓN COMMENT CHOISIR LE BON AMORTISSEUR POUR VOTRE CAMION

### MOUNTING CODE "ES" & "CB" EYE RING AND BUSHING WITH STEEL SLEEVE (Cont'd)

CÓDIGO DE MONTAJE «ES» Y «CB» ANILLO Y BUJE CON CAMISA DE ACERO

CODE DE MONTURE "ES" & "CB" BAGUE ET MANCHON AVEC COLLET EN ACIER

MOUNTING CODE	TYPE	DIMENSION		
		A	B	C
ES168	1	14MM	2.62	--
ES169	1	14MM	1.91	--
ES171	1	1/2	1.88	--
ES172	1	1/2	2.72	--
ES173	1	7/8	2.28	--
ES174	1	5/8	3.25	--
ES175	1	16MM	1.96	--
ES176	1	16MM	3.72	--

MOUNTING CODE	TYPE	DIMENSION		
		A	B	C
ES177	1	16MM	3.55	--
ES178	1	3/4	1.96	--
ES179	1	20MM	1.75	--
ES181	1	7/16	1.98	--
ES182	1	20MM	1.96	--
ES183	1	20MM	3.80	--
ES184	1	20MM	2.44	--
ES185	1	12MM	2.44	--

MOUNTING CODE	TYPE	DIMENSION		
		A	B	C
ES187	1	1.00	1.75	--
ES188	1	16MM	1.81	--
ES190	1	22MM	1.75	--
ES191	1	1.00	2.44	--
ES192	1	24MM	2.44	--
ES193	1	24MM	2.28	--
ES194	1	7/8	2.28	--
ES195	1	20MM	4.07	--

### MOUNTING CODE "BP" EYE RING AND BUSHING WITH BAR PIN

CÓDIGO DE MONTAJE «BP» ANILLO Y BUJE CON CLAVIJA TIPO BARRA

CODE DE MONTURE "BP" BAGUE ET MANCHON AVEC GOUPÏLE

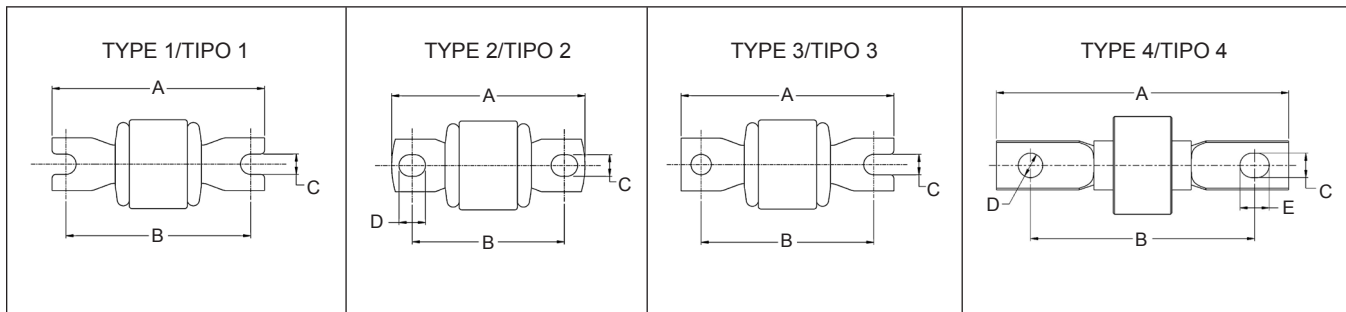

MOUNTING CODE	TYPE	A	B	C	D	E
BP1	1	2.72	2.20	0.33	--	--
BP2	1	3.59	3.12	0.32	--	--
BP3	1	2.82	2.38	0.33	--	--
BP4	1	3.19	2.38	0.33	--	--
BP5	1	3.19	2.75	0.33	--	--
BP6	1	4.25	3.62	0.33	--	--
BP7	2	3.13	2.50	0.35	0.42	--
BP8	2	3.50	2.87	0.35	0.42	--
BP9	1	3.38	2.60	0.35	0.57	--
BP10	2	3.5	2.74	0.50	0.50	--
BP11	1	2.96	2.52	0.33	--	--
BP12	1	3.75	3.14	0.33	--	--
BP13	1	3.45	3.00	0.33	--	--
BP14	2	3.43	2.87	0.45	--	--
BP15	4	4.56	3.62	0.39	0.47	0.39

MOUNTING CODE	TYPE	A	B	C	D	E
BP17	1	3.11	2.61	0.33	--	--
BP18	1	3.75	3.14	0.39	--	--
BP19	1	3.19	2.62	0.33	--	--
BP20	1	3.59	3.12	0.33	--	--
BP26	3	3.06	2.37	0.26	--	--
BP27	2	4.00	2.95	0.52	0.50	--
BP29	2	4.00	2.95	0.37	0.49	--
BP30	1	3.00	2.25	0.34	--	--
BP31	3	3.50	2.87	0.35	--	--
BP32	2	3.45	2.83	0.42	--	--
BP33	2	4.44	3.62	0.39	0.47	--
BP34	1	3.81	2.99	0.41	--	--
BP35	2	3.53	2.73	0.38	0.38	--
BP36	2	4.72	3.38	0.52	0.52	--



# HOW TO DETERMINE THE CORRECT SHOCK FOR YOUR TRUCK

## CÓMO ESCOGER EL MEJOR AMORTIGUADOR PARA SU CAMIÓN COMMENT CHOISIR LE BON AMORTISSEUR POUR VOTRE CAMION

### MOUNTING CODES "S" & "DS" STUD MOUNTS CÓDIGOS DE MONTAJE «S» Y «DS» MONTAJES DE DOBLE PERNO CODES DE MONTURE "S" & "DS" À GOUJON

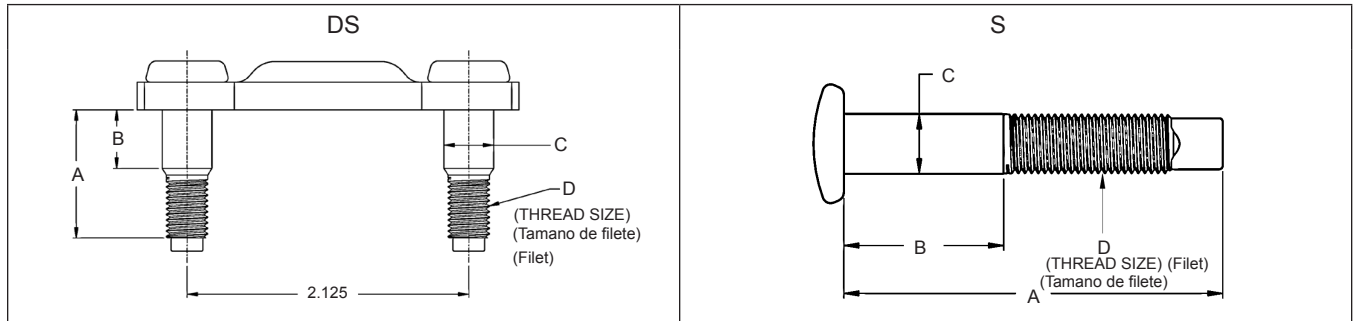

MOUNTING CODE	A	B	C	D
<b>DS1</b>	1.27	0.66	3/8	5/16-24
<b>S1</b>	2.37	1.00	3/8	3/8-24
<b>S2</b>	2.06	1.00	3/8	3/8-24
<b>S3</b>	2.67	1.37	10MM	3/8-16
<b>S4</b>	1.85	1.00	3/8	3/8-24
<b>S5</b>	1.29	1.14	13MM	3/8-24
<b>S6</b>	2.47	1.47	7/16	3/8-24
<b>S7</b>	1.97	1.00	3/8	3/8-24
<b>S8</b>	1.75	1.00	10MM	3/8-24
<b>S9</b>	1.84	1.05	7/16	3/8-24
<b>S10</b>	2.37	1.33	7/16	3/8-24
<b>S11</b>	3.00	1.12	3/8	3/8-24
<b>S12</b>	2.37	1.15	7/16	3/8-24
<b>S13</b>	2.06	1.35	3/8	3/8-24
<b>S14</b>	2.25	1.33	7/16	3/8-24
<b>S15</b>	3.29	1.98	3/8	3/8-24
<b>S16</b>	2.95	1.45	16MM	16MM
<b>S17</b>	2.15	1.03	7/16	3/8-24
<b>S18</b>	2.67	1.81	10MM	M10x1.25
<b>S19</b>	1.34	0.41	7/16	M10x1
<b>S20</b>	1.34	0.41	10MM	M10x1
<b>S21</b>	3.28	1.75	5/8	5/8-18
<b>S22</b>	0.75	0.35	10MM	M10x1
<b>S23</b>	1.84	1.05	3/8	3/8-24
<b>S24</b>	1.22	0.31	11MM	M10x1
<b>S25</b>	1.81	1.50	3/8	M10x1
<b>S26</b>	2.02	0.82	12MM	M10x1
<b>S27</b>	2.36	1.14	10MM	M10x1
<b>S28</b>	2.44	1.37	12MM	M10x1
<b>S29</b>	2.99	1.87	3/8	3/8-24
<b>S30</b>	2.59	1.41	10MM	M10x1
<b>S31</b>	0.79	0.40	17MM	10MM
<b>S32</b>	2.31	1.38	14MM	12MM
<b>S33</b>	3.44	2.17	10MM	M10x1
<b>S34</b>	1.06	0.59	5/16	M8x1.25
<b>S35</b>	2.60	1.12	7/16	3/8-24

MOUNTING CODE	A	B	C	D
<b>S36</b>	2.49	1.33	7/16	3/8-24
<b>S37</b>	3.18	1.41	12MM	M10x1
<b>S38</b>	2.75	1.70	14MM	12MM
<b>S39</b>	2.20	1.31	10MM	10MM
<b>S40</b>	2.52	1.33	7/16	3/8-24
<b>S41</b>	3.48	2.32	5/8	1/2-20
<b>S42</b>	3.50	2.00	5/8	5/8-18
<b>S43</b>	2.75	1.25	5/8	5/8-18
<b>S44</b>	1.57	0.39	10MM	M10x1.25
<b>S45</b>	2.36	1.00	10MM	M10x1.25
<b>S46</b>	1.57	1.18	10MM	M10x1.25
<b>S47</b>	2.20	1.31	10MM	M10x1.25
<b>S48</b>	2.55	1.51	10MM	M10x1.25
<b>S49</b>	2.67	1.29	10MM	M10x1.25
<b>S50</b>	2.95	1.57	10MM	M10x1.25
<b>S51</b>	3.00	1.65	10MM	M10x1.25
<b>S52</b>	1.18	0.74	10MM	M10x1.5
<b>S53</b>	2.16	1.89	10MM	M10x1.5
<b>S54</b>	2.42	1.28	15MM	M10x1.5
<b>S55</b>	2.51	1.39	10MM	M10x1.5
<b>S56</b>	2.67	1.53	11MM	M10x1.5
<b>S57</b>	2.95	1.40	27/64	M10x1.5
<b>S58</b>	2.98	1.68	10MM	M10x1.5
<b>S59</b>	2.98	1.68	12MM	M10x1.5
<b>S60</b>	3.46	1.96	9/16	M10x1.5
<b>S61</b>	3.11	1.45	14MM	M12x1.25
<b>S62</b>	3.24	1.70	9/16	M12x1.25
<b>S63</b>	3.54	2.24	17MM	M12x1.25
<b>S64</b>	2.36	1.18	12MM	M12x1.5
<b>S65</b>	2.89	1.65	12MM	M12x1.5
<b>S66</b>	1.39	0.15	12MM	M12x1.75
<b>S67</b>	2.40	1.53	9/16	M14x1.5
<b>S68</b>	2.95	1.45	5/8	M16x1.5
<b>S69</b>	1.32	1.37	39/64	M16x2
<b>S70</b>	1.88	0.90	7/16	M8x1.25

# HOW TO DETERMINE THE CORRECT SHOCK FOR YOUR TRUCK

## CÓMO ESCOGER EL MEJOR AMORTIGUADOR PARA SU CAMIÓN

### COMMENT CHOISIR LE BON AMORTISSEUR POUR VOTRE CAMION

#### EXPLANATION OF COLUMN HEADINGS

#### EXPLICACIÓN DE LOS TÍTULOS DE LAS COLUMNAS

#### EXPLICATION DES EN-TÊTES DE COLONNES

<b>SHOCK ABSORBER PART NUMBER:</b> The catalog number for the individual shock absorber.	<b>Número de parte del amortiguador:</b> El número de catálogo para el amortiguador individual.	<b>Numéro de pièce de l'amortisseur:</b> Le numéro de catalogue pour l'amortisseur individuel.
<b>EXTENDED LENGTH:*</b> The length of the shock absorber when it is fully extended. See "How to Measure" instructions.	<b>Longitud extendida :*</b> La longitud del amortiguador cuando está totalmente extendido. Ver instrucciones «Cómo medir».	<b>Longueur étirée:*</b> La longueur de l'amortisseur entièrement étiré. Voir "Comment mesurer".
<b>COLLAPSED LENGTH:*</b> The length of the shock absorber when it is fully compressed. See "How to Measure" instructions.	<b>Longitud comprimida :*</b> La longitud del amortiguador cuando está totalmente comprimido. Ver instrucciones «Cómo medir».	<b>Longueur comprimée:*</b> La longueur de l'amortisseur entièrement comprimé. Voir "Comment mesurer".
<b>STROKE:</b> This is the approximate length of the stroke of the individual shock absorber being described.	<b>Carrera :</b> Es la longitud aproximada del recorrido del amortiguador descrito.	<b>Course:</b> C'est la longueur approximative de la course de l'amortisseur individuel décrit.
<b>MOUNTING CODES:</b> Indicates the type of mounting ends for the upper and lower end of each shock absorber. They are listed as follows: Stud Type Mounts ("S" & "DS") Eye Ring and Bushing Mounts ("EB") Eye Ring and Bushing with Sleeve Mounts ("ES") Eye Ring and Bushing with Bar Pin Mounts ("BP") Special Mounting Codes ("SP")	<b>Códigos de montaje :</b> Indica el tipo de montantes de montaje superior e inferior para cada amortiguador. Se enlistan como sigue : Montajes tipo perno («S» y «DS») Montajes anillo y buje («EB») Montajes anillo y buje con camisa («ES») Montajes anillo y buje con clavija («BP») Códigos de montajes especiales («SP»)	<b>Codes de montage:</b> Indique le type de montures supérieure et inférieure de chaque amortisseur. Ils sont énumérés comme suit: Montures de type goujon ("S" et "DS") Montures à bague et manchon ("EB") Montures à bague et manchon avec collet ("ES") Montures à bague et manchon avec goupille ("BP") Codes de montures spéciales ("SP")
<b>DUST TUBE:</b> Indicates whether the shock absorber is supplied with a dust tube.	<b>Polvera:</b> Indica si el amortiguador cuenta un polvera.	<b>Tube pare-poussière:</b> Indique que l'amortisseur est fourni avec un tube pare-poussière.
<b>MOUNTING ACCESSORY PACKAGE NUMBER:</b> The part number of the Mount Accessory Package supplied with the shock absorber.	<b>Número de paquete de accesorios de montaje:</b> El número de parte del paquete de accesorios de montaje proveído con el amortiguador.	<b>Numéro d'emballage d'accessoires de montage:</b> Le numéro de pièce de l'emballage d'accessoires de montage fourni avec l'amortisseur.
<b>*NOTE:</b> All dimensions shown are in inches	<b>*Nota :</b> Todas las dimensiones son en pulgadas	<b>*Note:</b> Toutes les dimensions indiquées sont en pouces

**STEP 4:** Refer to shock absorber specifications by end mount. Start first by finding the appropriate series. Next, match the extended/collapsed length and find the correct mounting codes. Refer to the far left column of the chart for the correct Gabriel shock absorber part number.

**SPECIFICATIONS BY END MOUNT**  
**ESPECIFICACIONES POR TIPO DE MONTAJE**  
**SPECIFICATIONS PAR FIXATION DES EXTRÉMITÉS**

Gabriel	Mounting		Bore	External Diameter Illustration	Lengths			Dust Tube	Recoil Cutoff	Controls*	
	Upper	Lower			Extended	Collapsed	Stroke			Rebound	Compression
G63864			1-3/8"		15	10.56	4.44				
83171		ES36	1-3/8"	A	23.98	14.51	9.47	YES	YES	513	146
G64011	0	0	1-3/8"		23.36	14.21	9.14				
G64010	0	0	1-3/8"		26.94	16	10.94				
G64009	0	0	1-3/8"		23.29	14.25	9.04				
632147	0	0	1-3/16"		22.45	14.1	8.35	NO	NO		
G64008	373768	ES26	1-3/8"		21.79	13.6	8.19				
G63885	375166	413004	1-3/8"		22.24	13.56	8.69				
G63969	412847	ES34	1-3/8"		20.75	13.31	7.44				
G63872	412998	ES82	1-3/8"		21.65	13.29	8.36				
G63877	413000	413000	1-3/8"		16.93	11.24	5.69				
G64003	413000	413000	1-3/8"		16.83	11.27	5.56				
G63878	413001	ES186	1-3/8"		24.16	14.97	9.19				
G63883	413001	ES186	1-3/8"		22.82	14.38	8.44				
G63867	413002	413002	1-3/8"		27.31	16.37	10.94				
G63870	413002	413002	1-3/8"		24.89	15.2	9.69				
G63873	413002	413002	1-3/8"		15.75	10.56	5.19				
G63460	BP1	ES27	1-3/8"		23.16	14.13	9.03	YES	NO		
G63499	BP1	ES130	1-3/8"		25.58	15.3	10.28	YES	NO		
G63425	BP2	EB1	1-3/8"		20	12.47	7.53	YES	NO		
83013	BP8	BP8	1-3/16"	2" D/T	7.66	6.63†	1.7	YES	NO	646	480
G63965	BP8	ES24	1-3/8"		24.13	15.2	8.94				
G63488	BP8	ES34	1-3/8"		26.61	16.33	10.28	YES	YES		
G63898	BP8	ES34	1-3/8"		25.19	15.31	9.88				
G63638	BP8	ES34	1-3/8"		24.33	14.8	9.53	YES	NO		
G63422	BP8	ES34	1-3/8"		24	14.47	9.53	YES	NO		
G63897	BP8	ES34	1-3/8"		23.87	14.68	9.19				
G63896	BP8	ES34	1-3/8"		22.36	13.92	8.44				
G63837	BP8	ES83	1-3/8"		28.23	17.95	10.28				
G63679	BP8	ES83	1-3/8"		25	14.97	10.03	YES	NO		
83015	BP8	S1	1-3/8"	A	9.84	7.59	2.25	YES	YES	735	430
83005	BP8	S10	1-3/16"	2" D/T	7.34	5.87	1.47	YES	NO	858	216
G63880	BP18	ES18	1-3/8"		22.5	14.06	8.44				
G63722	BP18	ES24	1-3/8"		19.49	12.21	7.28	YES	NO		
G63966	BP18	ES130	1-3/8"		22.44	14.5	7.94				
G63967	BP18	ES130	1-3/8"		22.62	14.43	8.19				
83041	BP27	S10	1-3/8"	A	10.51†	8.34†	3.02	YES	YES	486	189

\* Damping force, in pounds, to either extend or collapse the shock absorber at an average operating velocity. Fuerza de amortiguación en libras para extender o comprimir el amortiguador a una velocidad de operación promedio. La puissance d'amortissement en poids de l'amortisseur, soit comprimé, doit détendu, à une vitesse de fonctionnement moyenne.

**SPECIFICATIONS BY END MOUNT**  
**ESPECIFICACIONES POR TIPO DE MONTAJE**  
**SPECIFICATIONS PAR FIXATION DES EXTRÉMITÉS**

Gabriel	Mounting		Bore	External Diameter Illustration	Lengths			Dust Tube	Recoil Cutoff	Controls*	
	Upper	Lower			Extended	Collapsed	Stroke			Rebound	Compression
G63607	BP33	ES83	1-3/8"		25.58	15.3	10.28	YES	NO		
G63879	BP34	ES34	1-3/8"		23	14.31	8.69				
G63882	BP34	ES34	1-3/8"		21	13.31	7.69				
83060	EB	BP7	1-3/8"	A	9.76	7.98†	2.25	NO	YES	431	441
G63692	EB1	EB1	1-3/8"		27.58	16.3	11.28	YES	NO		
G63440	EB1	EB1	1-3/8"		26.33	15.55	10.78	NO	NO		
G63660	EB1	EB1	1-3/8"		25.08	15.05	10.03	YES	NO		
83401	EB1	EB1	1-3/16"	F	24.09	14.26	9.83	YES	NO	341	252
G63419	EB1	EB1	1-3/8"		24.08	14.55	9.53	YES	NO		
G63443	EB1	EB1	1-3/8"		23.33	13.95	9.38	NO	NO		
G63928	EB1	EB1	1-3/8"		22.73	13.87	8.86	YES	YES		
G63492	EB1	EB1	1-3/8"		22.58	13.8	8.78	YES	NO		
G63173	EB1	EB1	1-3/8"		21.99	13.71	8.28	YES	NO	396	158
G63907	EB1	EB1	1-3/16"		20.23	12.37	7.86	YES	NO	680	228
G63405	EB1	EB1	1-3/8"		20	12.47	7.53	YES	NO	572	115
G63689	EB1	EB1	1-3/8"		19.08	12.05	7.03	YES	NO	478	211
83007	EB1	EB1	1-3/8"	A	18.55	11.67	6.87	NO	NO	489	343
G63299	EB1	EB1	1-3/8"		18.08	11.55	6.53	YES	NO	396	109
G63949	EB1	EB1	1-3/8"		17.73	11.12	6.61	YES	NO	255	171
83011	EB1	EB1	1-3/8"	A	11.55†	8.48	3.61	YES	YES	738	330
83012	EB1	EB1	1-3/8"	A	11.07†	8.21	3.37	YES	YES	738	330
G63394	EB1	ES24	1-3/8"		16	10.47	5.53	YES	NO		
G63441	EB1	ES25	1-3/8"		26.33	15.55	10.78	NO	NO		
G63377	EB1	ES25	1-3/8"		20.08	12.55	7.53	YES	NO		
G63490	EB1	ES25	1-3/8"		19.08	12.05	7.03	YES	NO		
G63438	EB1	ES34	1-3/8"		29.33	17.3	12.03	NO	NO		
G63810	EB1	ES83	1-3/8"		31.51	18.48	13.03	YES	NO	429	127
G63888	EB1	ES83	1-3/8"		31.36	18.67	12.69				
G63439	EB1	ES83	1-3/8"		29.75	17.22	12.53	NO	NO		
G63887	EB1	ES83	1-3/8"		29.71	17.77	11.94				
G63808	EB1	ES83	1-3/8"		28.86	17.08	11.78	YES	NO		
G63524	EB1	ES83	1-3/8"		27.08	16.05	11.03	YES	NO		
G63775	EB1	ES83	1-3/8"		27.08	16.05	11.03	YES	NO		
G63456	EB1	ES83	1-3/8"		26.76	15.98	10.78	YES	NO		
G63461	EB1	ES83	1-3/8"		25.5	15.22	10.28	YES	NO		
G63811	EB1	ES83	1-3/8"		25.5	15.22	10.28	YES	NO		
G63964	EB1	ES83	1-3/8"		25.47	15.53	9.94				

\* Damping force, in pounds, to either extend or collapse the shock absorber at an average operating velocity. Fuerza de amortiguación en libras para extender o comprimir el amortiguador a una velocidad de operación promedio. La puissance d'amortissement en poids de l'amortisseur, soit comprimé, doit détendu, à une vitesse de fonctionnement moyenne.

† At bumper contact / Al contacto con el tope de goma / Au contact avec le butoir

**SPECIFICATIONS BY END MOUNT**  
**ESPECIFICACIONES POR TIPO DE MONTAJE**  
**SPÉCIFICATIONS PAR FIXATION DES EXTRÉMITÉS**

Gabriel	Mounting		Bore	External Diameter Illustration	Lengths			Dust Tube	Recoil Cutoff	Controls*	
	Upper	Lower			Extended	Collapsed	Stroke			Rebound	Compression
G63963	EB1	ES83	1-3/8"		24.75	15.06	9.69				
G63525	EB1	ES83	1-3/8"		23.08	14.05	9.03	YES	NO		
G63773	EB1	ES83	1-3/8"		23.08	14.05	9.03	YES	NO		
G63406	EB1	ES83	1-3/8"		23	13.97	9.03	YES	NO		
G63809	EB1	ES83	1-3/8"		23	13.97	9.03	YES	NO		
G63409	EB1	ES83	1-3/8"		21.58	13.3	8.28	YES	NO		
G63420	EB1	ES106	1-3/8"		27.08	16.05	11.03	NO	NO		
G63427	EB1	ES106	1-3/8"		23.08	14.05	9.03	YES	NO		
G63604	EB1	ES142	1-3/8"		19.74	12.46	7.28	YES	NO		
G63491	EB1	S1	1-3/8"		19.05	11.77	7.28	YES	NO		
G63620	EB1	S7	1-3/8"		19.55	12.27	7.28	YES	YES		
85063	EB2	EB2	1-5/8"	C	32.01	18.85	13.16	YES	NO	762	174
83107	EB2	EB2	1-3/8"	A	31.66	18.4	13.25	YES	NO	352	77
83314	EB2	EB2	1-3/8"	B	30.64	18.11	12.53	YES	YES	633	143
85024	EB2	EB2	1-5/8"	C	28.77	17.25	11.52	YES	YES	1008	539
83309	EB2	EB2	1-3/8"	B	28.64	17.11	11.53	YES	YES	589	135
89416	EB2	EB2	1-5/8"	G	28.62	17.54	11.08	YES	YES	1155‡	514
89401	EB2	EB2	1-5/8"	G	28.41	17.16	11.25	YES	NO	665‡	194
89446	EB2	EB2	1-5/8"	G	28.36	17.41	10.95	YES	YES	702‡	204
85046	EB2	EB2	1-5/8"	C	27.55	16.62	10.93	YES	YES	1008	539
89409	EB2	EB2	1-5/8"	G	27.13	16.92	10.2	YES	YES	567‡	165
89434	EB2	EB2	1-5/8"	G	27.12	16.79	10.33	YES	YES	1155‡	514
89403	EB2	EB2	1-5/8"	G	26.86	17.16	9.7	YES	YES	929‡	281
83312	EB2	EB2	1-3/8"	B	26.64	16.11	10.53	YES	YES	527	152
89439	EB2	EB2	1-5/8"	G	25.67	15.79	9.88	YES	NO	518‡	103
85055	EB2	EB2	1-5/8"	C	25.63	15.63	10	YES	NO	577	102
85047	EB2	EB2	1-5/8"	C	25.31	15.52	9.79	YES	YES	1008	539
83308	EB2	EB2	1-3/8"	B	25.14	15.36	9.78	YES	YES	445	180
89435	EB2	EB2	1-5/8"	G	24.92	15.82	9.1	YES	YES	1155‡	514
83200	EB2	EB2	1-3/8"	A	24.51	15.1	9.53	YES	NO	806	370
89402	EB2	EB2	1-5/8"	G	24.41	15.16	9.25	YES	NO	874‡	206
83519	EB2	EB2	1-3/16"	F	23.83	14.35	9.48	YES	NO	292	132
83216	EB2	EB2	1-3/8"	A	23.51	14.48	9.03	YES	YES	776	262
85054	EB2	EB2	1-5/8"	C	23.26	14.37	8.89	YES	NO	602	104
89438	EB2	EB2	1-5/8"	G	23.17	14.54	8.63	YES	NO	583‡	103
G63494	EB2	EB2	1-3/8"		22.39	13.86	8.53	YES	NO		
83404	EB2	EB2	1-3/16"	F	22.01	13.44	8.58	YES	NO	545	171

\* Damping force, in pounds, to either extend or collapse the shock absorber at an average operating velocity. Fuerza de amortiguación en libras para extender o comprimir el amortiguador a una velocidad de operación promedio. La puissance d'amortissement en poids de l'amortisseur, soit comprimé, soit détendu, à une vitesse de fonctionnement moyenne.

**SPECIFICATIONS BY END MOUNT  
ESPECIFICACIONES POR TIPO DE MONTAJE  
SPÉCIFICATIONS PAR FIXATION DES EXTRÉMITÉS**

Gabriel	Mounting		Bore	External Diameter Illustration	Lengths			Dust Tube	Recoil Cutoff	Controls*	
	Upper	Lower			Extended	Collapsed	Stroke			Rebound	Compression
83159	EB2	EB2	1-3/8"	A	21.85	13.56	8.29	YES	NO	658	149
G63510	EB2	EB2	1-3/8"		21.39	13.36	8.03	YES	NO		
85012	EB2	EB2	1-5/8"	C	21.02	13.23	7.79	YES	NO	523	199
89413	EB2	EB2	1-5/8"	G	20.94	13.53	7.41	YES	NO	536†	201
85023	EB2	EB2	1-5/8"	C	20.27	13	7.27	YES	YES	1008	539
89415	EB2	EB2	1-5/8"	G	20.12	13.29	6.83	YES	YES	1155†	514
83219	EB2	EB2	1-3/8"	A	20.01	12.73	7.28	YES	YES	299	125
85062	EB2	EB2	1-5/8"	C	19.76	12.6	7.16	YES	NO	523	199
89408	EB2	EB2	1-5/8"	G	19.68	12.9	6.78	YES	NO	536†	201
G63605	EB2	ES27	1-3/8"		24.24	14.71	9.53	YES	NO		
85025	EB2	S21	1-5/8"	C	23.02	14.01	9.01	YES	NO	1079	539
G63434	EB2	S32	1-3/8"		22.78	14	8.78	YES	NO		
85376	EB3	EB3	1-5/8"	D	33.27	19.73	13.54	YES	NO	668	134
85301	EB3	EB3	1-5/8"	D	31.92	19.03	12.89	YES	NO	1442	455
85339	EB3	EB3	1-5/8"	D	31.68	19.02	12.66	YES	YES	804	463
85040	EB3	EB3	1-5/8"	C	30.91	18.51	12.4	YES	NO	889	114
85730	EB3	EB3	1-5/8"	D	30.75	18.72	12.03	YES	YES	1517	293
85315	EB3	EB3	1-5/8"	D	29.61	18.07	11.53	YES	NO	380	142
85901	EB3	EB3	1-5/8"	G	29.09	17.68	11.42	YES	NO	1830	418
85704	EB3	EB3	1-5/8"	D	28.75	18.72	10.03	YES	YES	1435	186
83104	EB3	EB3	1-3/8"	A	28.24	17.12	11.12	YES	NO	698	133
85305	EB3	EB3	1-5/8"	D	27.25	16.7	10.55	YES	NO	1120	225
83362	EB3	EB3	1-3/8"	B	27	16.25	10.75	YES	NO	539	202
87004	EB3	EB3	2-1/16"	E	26.76	16.76	10	YES	YES	1158	190
85735	EB3	EB3	1-5/8"	D	26.72	16.7	10.02	YES	YES	1288	227
83215	EB3	EB3	1-3/8"	A	26.64	16.36	10.28	YES	YES	697	108
89425	EB3	EB3	1-5/8"	G	26.5	16.93	9.57	YES	YES	1352†	167
85314	EB3	EB3	1-5/8"	D	26.49	16.46	10.03	YES	YES	1216	169
89410	EB3	EB3	1-5/8"	G	26.34	16.57	9.77	YES	NO	1185†	182
85001	EB3	EB3	1-5/8"	C	26.3	16.39	9.92	YES	NO	1202	186
85313	EB3	EB3	1-5/8"	D	26.26	16.35	9.91	YES	YES	717	111
87003	EB3	EB3	2-1/16"	E	26.26	16.51	9.75	YES	YES	1332	395
89429	EB3	EB3	1-5/8"	G	26.22	16.57	9.65	YES	NO	941†	266
85320	EB3	EB3	1-5/8"	D	26.15	16.35	9.8	YES	NO	970	308
85700	EB3	EB3	1-5/8"	D	26.09	16.58	9.51	YES	YES	1446	328
83140	EB3	EB3	1-3/8"	A	25.28	15.53	9.75	YES	NO	738	88
83141	EB3	EB3	1-3/8"	A	25.27	15.52	9.75	YES	NO	408	113

\* Damping force, in pounds, to either extend or collapse the shock absorber at an average operating velocity. Fuerza de amortiguación en libras para extender o comprimir el amortiguador a una velocidad de operación promedio. La puissance d'amortissement en poids de l'amortisseur, soit comprimé, doit détendu, à une vitesse de fonctionnement moyenne.

† At bumper contact / Al contacto cone el tope de goma / Au contact avec le butoir

**SPECIFICATIONS BY END MOUNT**  
**ESPECIFICACIONES POR TIPO DE MONTAJE**  
**SPECIFICATIONS PAR FIXATION DES EXTRÉMITÉS**

Gabriel	Mounting		Bore	External Diameter Illustration	Lengths			Dust Tube	Recoil Cutoff	Controls*	
	Upper	Lower			Extended	Collapsed	Stroke			Rebound	Compression
83132	EB3	EB3	1-3/8"	A	25.24	15.5	9.74	YES	NO	828	150
85714	EB3	EB3	1-5/8"	D	25.13	15.85	9.28	YES	YES	1220	175
85715	EB3	EB3	1-5/8"	D	25.13	15.85	9.28	YES	YES	1915	200
85717	EB3	EB3	1-5/8"	D	25.13	15.85	9.28	YES	YES	1915	200
89422	EB3	EB3	1-5/8"	G	25.12	16.3	8.83	YES	YES	794‡	253
85308	EB3	EB3	1-5/8"	D	25.11	15.83	9.28	YES	YES	764	254
85303	EB3	EB3	1-5/8"	D	24.76	15.48	9.29	YES	NO	1019	221
89442	EB3	EB3	1-5/8"	G	24.72	15.74	8.98	YES	NO	1055‡	224
85053	EB3	EB3	1-5/8"	C	24.69	15.52	9.17	YES	NO	1019	227
85329	EB3	EB3	1-5/8"	D	24.52	15.48	9.04	YES	YES	1550	232
85713	EB3	EB3	1-5/8"	D	24.51	15.48	9.04	YES	YES	1157	180
85007	EB3	EB3	1-5/8"	C	24.33	15.4	8.93	YES	YES	1008	171
89412	EB3	EB3	1-5/8"	G	24.26	15.68	8.58	YES	YES	1155‡	169
83225	EB3	EB3	1-3/8"	A	24.14	15.11	9.03	YES	YES	482	159
85307	EB3	EB3	1-5/8"	D	23.98	15.08	8.89	YES	NO	1094	173
85702	EB3	EB3	1-5/8"	D	23.76	15.85	7.91	YES	YES	1093	825
87006	EB3	EB3	2-1/16"	E	23.75	15.25	8.5	YES	YES	1158	272
85736	EB3	EB3	1-5/8"	D	23.61	15.2	8.41	YES	YES	1155	352
87002	EB3	EB3	2-1/16"	E	23.5	15.41	8.09	YES	YES	879	203
89420	EB3	EB3	1-5/8"	G	22.8	14.8	8	YES	NO	862‡	258
83217	EB3	EB3	1-3/8"	A	22.77	14.49	8.28	YES	YES	633	159
85302	EB3	EB3	1-5/8"	D	22.75	14.61	8.14	YES	NO	836	253
85304	EB3	EB3	1-5/8"	D	22.25	14.22	8.03	YES	NO	767	325
85718	EB3	EB3	1-5/8"	D	22.13	15.04	7.09	YES	YES	2506	206
85732	EB3	EB3	2-1/16"	E	22.13	15.11	7.03	YES	YES	2632	382
85716	EB3	EB3	1-5/8"	D	21.99	14.33	7.66	YES	YES	1220	175
87001	EB3	EB3	2-1/16"	E	20.76	13.76	7	YES	YES	1158	190
85734	EB3	EB3	1-5/8"	D	20.73	13.7	7.03	YES	YES	1288	227
85004	EB3	EB3	1-5/8"	C	20.68	13.67	7.01	YES	YES	1019	219
85042	EB3	EB3	1-5/8"	C	20.64	13.61	7.03	YES	YES	333	161
85712	EB3	EB3	1-5/8"	D	20.5	13.47	7.04	YES	YES	1435	562
85720	EB3	EB3	1-5/8"	D	20.5	13.47	7.03	YES	YES	1435	562
85968	EB3	EB3	1-5/8"	G	19.87	13.39	6.48	YES	YES	1069	227
83214	EB3	EB3	1-3/8"	A	19.64	12.86	6.78	YES	YES	269	90
89419	EB3	EB3	1-5/8"	G	18.04	12.67	5.36	YES	YES	1352‡	636
85300	EB3	EB3	1-5/8"	D	17.98	12.21	5.78	YES	YES	1435	676
85719	EB3	EB3	1-5/8"	D	17.25	11.97	5.28	YES	YES	1517	213

\* Damping force, in pounds, to either extend or collapse the shock absorber at an average operating velocity. Fuerza de amortiguación en libras para extender o comprimir el amortiguador a una velocidad de operación promedio. La puissance d'amortissement en poids de l'amortisseur, soit comprimé, doit détendu, à une vitesse de fonctionnement moyenne.

**SPECIFICATIONS BY END MOUNT  
ESPECIFICACIONES POR TIPO DE MONTAJE  
SPÉCIFICATIONS PAR FIXATION DES EXTRÉMITÉS**

Gabriel	Mounting		Bore	External Diameter Illustration	Lengths			Dust Tube	Recoil Cutoff	Controls*	
	Upper	Lower			Extended	Collapsed	Stroke			Rebound	Compression
85334	EB3	EB3	1-5/8"	D	14.52	10.48	4.04	YES	YES	1271	319
85912	EB3	ES36	1-5/8"	G	18.68	12.57	6.11	YES	YES	1020	219
85327	EB3	ES160	1-5/8"	D	16.01	12.1	3.91	YES	YES	764	162
85322	EB3	ES160	1-5/8"	D	15.26	11.85	3.41	YES	YES	764	162
83353	EB3	S21	1-3/8"	B	24.84	15.06	9.78	YES	NO	432	214
85740	EB3	S21	1-5/8"	D	24.7	15.15	9.55	YES	YES	848	305
85380	EB3	S21	1-5/8"	D	23.95	14.79	9.15	YES	YES	1568	227
85312	EB3	S21	1-5/8"	D	23.68	14.8	8.88	YES	YES	717	111
85733	EB3	S21	1-5/8"	D	23.57	14.73	8.84	YES	YES	717	111
85379	EB3	S21	1-5/8"	D	22.69	14.4	8.29	YES	YES	1658	176
85330	EB3	S21	1-5/8"	D	22.44	14.16	8.28	YES	YES	1140	176
85729	EB3	S21	1-5/8"	D	21.55	13.77	7.78	YES	YES	783	111
85723	EB3	S21	1-5/8"	D	19.93	12.9	7.03	YES	YES	1318	248
83117	EB4	EB1	1-3/8"	A	23.98	14.47	9.51	YES	NO	354	300
G63183	EB4	EB4	1-3/8"		20.89	13.11	7.78	YES	NO		
83119	EB4	ES165	1-3/8"	A	23.96	14.84	9.12	YES	NO	354	300
G63683	EB5	ES24	1-3/8"		21.16	13.38	7.78	YES	YES		
G63626	EB5	ES83	1-3/8"		21.16	13.38	7.78	YES	NO		
G63355	EB7	ES24	1-3/8"		15	9.97	5.03	YES	NO		
G63349	EB7	ES34	1-3/8"		23.33	14.3	9.03	YES	NO		
83303	EB7	ES36	1-3/8"	B	24.86	15.08	9.78	YES	YES	470	122
83304	EB7	ES36	1-3/8"	B	22.86	14.08	8.78	YES	YES	470	122
G63625	EB7	ES36	1-3/8"		22.48	13.96	8.53	YES	NO		
G63454	ES1	ES18	1-3/8"		22.81	14.03	8.78	YES	NO		
G63426	ES1	ES18	1-3/8"		18	11.47	6.53	YES	NO		
G63502	ES1	ES25	1-3/8"		18.41	11.88	6.53	YES	NO		
G63389	ES2	EB4	1-3/8"		28.74	16.96	11.78	YES	NO		
G63353	ES2	EB4	1-3/8"		24.74	14.96	9.78	YES	NO		
G63306	ES2	ES24	1-3/8"		19.86	12.58	7.28	YES	NO		
G63906	ES2	ES27	1-3/8"		20.49	12.63	7.86	YES	NO		
G63908	ES3	ES24	1-3/8"		18.23	11.37	6.86	YES	NO		
G63347	ES3	ES24	1-3/8"		18.08	11.55	6.53	YES	NO		
G63411	ES3	ES82	1-3/8"		18.58	11.8	6.78	YES	NO		
G63423	ES8	ES82	1-3/8"		16.75	10.72	6.03	NO	NO		
G63455	ES8	ES83	1-3/8"		23	13.97	9.03	YES	NO		
83002	ES10	ES10	1-3/8"	A	11.65	8.66	3	YES	YES	3112	590
83024	ES10	ES10	1-3/8"	2-1/2" D/T	11.65	8.66	3	YES	YES	811	320

\* Damping force, in pounds, to either extend or collapse the shock absorber at an average operating velocity. Fuerza de amortiguación en libras para extender o comprimir el amortiguador a una velocidad de operación promedio. La puissance d'amortissement en poids de l'amortisseur, soit comprimé, doit détendu, à une vitesse de fonctionnement moyenne.

† At bumper contact / Al contacto cone el tope de goma / Au contact avec le butoir



**SPECIFICATIONS BY END MOUNT**  
**ESPECIFICACIONES POR TIPO DE MONTAJE**  
**SPECIFICATIONS PAR FIXATION DES EXTRÉMITÉS**

Gabriel	Mounting		Bore	External Diameter Illustration	Lengths			Dust Tube	Recoil Cutoff	Controls*	
	Upper	Lower			Extended	Collapsed	Stroke			Rebound	Compression
83031	ES10	ES10	1-3/8"	2-1/2" D/T	11.54	8.66	2.88	YES	YES	811	314
83016	ES10	ES10	1"	1-5/8"	11.51	8.14	3.37	NO	YES	506	139
83021	ES10	ES10	1-3/8"	A	9.41	7.4	2.01	YES	YES	745	315
83051	ES10	ES10	1-3/8"	2-1/2" D/T	9.41	7.4	2.01	YES	YES	579	163
83061	ES10	ES10	1-3/8"	2-1/2" D/T	9.41	7.4	2.01	YES	YES	1030	220
83046	ES10	ES181	1-3/16"		9.23†	7.62†	2.73	NO	YES	514	173
83023	ES10	ES181	1"	1-5/8"	8.7	7.09†	2.14	NO	YES	484	157
G63890	ES18	ES18	1-3/8"		23.97	15.28	8.69				
G63891	ES18	ES18	1-3/8"		23.97	15.28	8.69				
G63690	ES18	ES18	1-3/8"		18	11.47	6.53	YES	NO		
G63842	ES18	ES126	1-3/8"		23.33	14.8	8.53				
G63845	ES18	ES138	1-3/8"		24.58	14.8	9.78				
G63892	ES19	ES141	1-3/8"		23.97	15.28	8.69				
G63844	ES19	ES141	1-3/8"		22.58	13.8	8.78				
83045	ES19	S10	1-3/8"	A	11.53†	8.58†	3.81	YES	NO	510	153
83050	ES19	S10	1-3/8"	A	10.43†	8.38†	2.9	YES	YES	599	321
83058	ES19	S10	1-3/8"	A	10.43†	8.38†	2.9	YES	YES	742	243
83158	ES22	ES22	1-3/8"	A	12.96	8.97	4	YES	NO	783	484
G63371	ES24	ES24	1-3/8"		21.98	13.45	8.53	YES	NO	521	132
G63357	ES24	ES24	1-3/8"		15	9.97	5.03	YES	NO		
83022	ES24	ES24	1"	2" D/T	14.28	9.33	4.95	YES	NO	840	152
83010	ES24	ES24	1"	2" D/T	14.15†	9.33	5.07	YES	YES	188	70
83026	ES24	ES24	1-3/8"	A	13.11	9.12	3.99	YES	YES	602	104
83027	ES24	S10	1-3/8"	A	13.82	9.2	4.61	YES	YES	602	104
83018	ES24	S10	1-3/8"	A	10.3†	8.42†	3.24	YES	YES	515	174
83019	ES24	S10	1-3/8"	A	9.48	8.21†	2.29	YES	YES	509	121
G63413	ES27	ES27	1-3/8"		20.76	12.98	7.78	YES	NO	991	195
83908	ES27	ES91	1-3/8"	A	9.3	7.03	2.27	YES	NO	904	279
83044	ES27	ES164	1-3/8"	A	10.91	7.93	2.98	YES	YES	789	296
G63868	ES31	412715	1-3/8"		15.62	10.68	4.94				
G63437	ES31	ES24	1-3/8"		23.33	14.05	9.28	NO	NO		
G63970	ES34	ES34	1-3/8"		27.58	17.14	10.44				
G63971	ES34	ES34	1-3/8"		27.58	17.14	10.44				
G64000	ES34	ES34	1-3/8"		27.36	17.67	9.69				
G63675	ES34	ES34	1-3/8"		26.86	16.08	10.78	YES	NO		
G63961	ES34	ES34	1-3/8"		26.51	16.12	10.39				
G63962	ES34	ES34	1-3/8"		26.05	15.87	10.18				

\* Damping force, in pounds, to either extend or collapse the shock absorber at an average operating velocity. Fuerza de amortiguación en libras para extender o comprimir el amortiguador a una velocidad de operación promedio. La puissance d'amortissement en poids de l'amortisseur, soit comprimé, soit détendu, à une vitesse de fonctionnement moyenne.

**SPECIFICATIONS BY END MOUNT**  
**ESPECIFICACIONES POR TIPO DE MONTAJE**  
**SPECIFICATIONS PAR FIXATION DES EXTRÉMITÉS**

Gabriel	Mounting		Bore	External Diameter Illustration	Lengths			Dust Tube	Recoil Cutoff	Controls*	
	Upper	Lower			Extended	Collapsed	Stroke			Rebound	Compression
G63959	ES34	ES34	1-3/8"		24.78	15.84	8.94				
G63662	ES34	ES34	1-3/8"		24.58	15.05	9.53	YES	NO		
G63366	ES34	ES34	1-3/8"		23.36	14.33	9.03	YES	NO		
G63866	ES34	ES34	1-3/8"		22.81	14.12	8.69				
83153	ES34	ES34	1-3/8"	A	21.69	13.62	8.07	YES	YES	974	206
83155	ES34	ES34	1-3/8"	A	21.69	13.62	8.07	YES	YES	507	80
G63812	ES34	ES36	1-3/8"		22.49	13.95	8.53	YES	NO		
G63918	ES34	ES141	1-3/8"		21.25	13.56	7.69				
83059	ES35	ES35	1-3/8"	A	12.06†	8.68	3.88	YES	YES	738	350
83004	ES35	ES136	1"	2" D/T	9.36†	7.29	2.32	YES	YES	539	324
85905	ES36	EB3	1-5/8"	G	23.81	16.16	7.66	YES	YES	1020	219
85913	ES36	EB3	1-5/8"	G	22.56	15.2	7.36	YES	YES	1020	219
85057	ES36	EB3	1-5/8"	C	21.45	14.23	7.22	YES	YES	1216	115
85907	ES36	EB3	1-5/8"	G	21.43	14.2	7.23	YES	YES	1216	251
83113	ES36	EB3	1-3/8"	A	20.47	13.46	7.01	YES	YES	997	238
85059	ES36	EB3	1-5/8"	C	19.09	12.8	6.29	YES	YES	928	151
85915	ES36	EB3	1-5/8"	G	19.06	12.7	6.36	YES	YES	1020	219
83115	ES36	EB3	1-3/8"	A	16.19	13.32	4.87	YES	YES	997	238
83242	ES36	ES36	1-3/8"	A	33.73	20.98	12.75	YES	YES	721	135
85903	ES36	ES36	1-5/8"	G	31.99	19.13	12.86	YES	YES	666	113
85979	ES36	ES36	1-5/8"	G	31.18	18.66	12.52	YES	YES	582	138
85972	ES36	ES36	1-5/8"	G	30.78	18.26	12.52	YES	NO	1493	261
83121	ES36	ES36	1-3/8"	A	30.25	18.32	11.93	YES	YES	689	126
83137	ES36	ES36	1-3/8"	A	30.04	17.79	12.25	YES	YES	517	132
85976	ES36	ES36	1-5/8"	G	29.92	18.12	11.8	YES	YES	582	138
85013	ES36	ES36	1-5/8"	C	29.79	17.76	12.04	YES	YES	1019	219
83205	ES36	ES36	1-3/8"	A	29.69	17.69	12	YES	YES	660	76
89414	ES36	ES36	1-5/8"	G	29.65	18.18	11.46	YES	YES	1045†	217
83209	ES36	ES36	1-3/8"	A	29.64	17.61	12.03	YES	YES	670	78
85337	ES36	ES36	1-5/8"	D	28.72	17.44	11.28	YES	YES	1318	374
85006	ES36	ES36	1-5/8"	C	28.54	17.13	11.41	YES	YES	1019	219
83125	ES36	ES36	1-3/8"	A	28.15	17.16	10.99	YES	YES	625	115
85097	ES36	ES36	1-5/8"	C	27.95	17.11	10.84	YES	YES	1086	109
85043	ES36	ES36	1-5/8"	C	27.63	16.85	10.78	YES	YES	628	163
85904	ES36	ES36	1-5/8"	G	27.61	16.88	10.73	YES	YES	666	113
85010	ES36	ES36	1-5/8"	C	26.8	16.26	10.54	YES	YES	1019	219
83123	ES36	ES36	1-3/8"	A	26.65	16.41	10.24	YES	YES	589	119

\* Damping force, in pounds, to either extend or collapse the shock absorber at an average operating velocity. Fuerza de amortiguación en libras para extender o comprimir el amortiguador a una velocidad de operación promedio. La puissance d'amortissement en poids de l'amortisseur, soit comprimé, doit détendu, à une vitesse de fonctionnement moyenne.

† At bumper contact / Al contacto cone el tope de goma / Au contact avec le butoir

**SPECIFICATIONS BY END MOUNT**  
**ESPECIFICACIONES POR TIPO DE MONTAJE**  
**SPECIFICATIONS PAR FIXATION DES EXTRÉMITÉS**

Gabriel	Mounting		Bore	External Diameter Illustration	Lengths			Dust Tube	Recoil Cutoff	Controls*	
	Upper	Lower			Extended	Collapsed	Stroke			Rebound	Compression
83176	ES36	ES36	1-3/8"	A	26.62	15.96	10.66	NO	NO	406	275
85036	ES36	ES36	1-5/8"	C	26.38	16.29	10.09	YES	YES	633	119
89405	ES36	ES36	1-5/8"	G	26.3	16.57	9.73	YES	YES	1009‡	249
85099	ES36	ES36	1-5/8"	C	26.02	15.93	10.09	YES	YES	1152	135
85974	ES36	ES36	1-5/8"	G	26.02	16.11	9.91	YES	YES	3087	230
85321	ES36	ES36	1-5/8"	D	25.38	15.59	9.79	YES	YES	1435	676
83122	ES36	ES36	1-3/8"	A	25.28	15.79	9.49	YES	YES	661	201
83149	ES36	ES36	1-3/8"	A	25.28	15.78	9.49	YES	YES	332	101
83218	ES36	ES36	1-3/8"	A	25.19	15.44	9.75	YES	YES	721	194
665472	ES36	ES36	1-5/8"	G	25.14	15.61	9.53	NO	NO	925	977
85005	ES36	ES36	1-5/8"	C	24.76	15.24	9.52	YES	YES	1019	219
89406	ES36	ES36	1-5/8"	G	24.76	15.82	8.93	YES	YES	658‡	125
85916	ES36	ES36	1-5/8"	G	24.65	15.55	9.1	YES	YES	1149	219
89430	ES36	ES36	1-5/8"	G	24.61	15.66	8.94	YES	YES	1462‡	279
83126	ES36	ES36	1-3/8"	A	24.41	15.27	9.14	YES	YES	625	115
85909	ES36	ES36	1-5/8"	G	24.25	15.19	9.06	YES	YES	700	255
85975	ES36	ES36	1-5/8"	G	24.24	15.15	9.09	YES	YES	1658	219
83310	ES36	ES36	1-3/8"	B	24.06	14.69	9.37	YES	NO	559	153
85030	ES36	ES36	1-5/8"	C	24.05	14.89	9.16	YES	YES	1019	219
83221	ES36	ES36	1-3/8"	A	24.01	14.73	9.28	YES	YES	599	153
89440	ES36	ES36	1-5/8"	G	23.9	15.31	8.59	YES	YES	1498‡	561
83144	ES36	ES36	1-3/8"	A	23.78	15.03	8.74	YES	YES	596	93
89432	ES36	ES36	1-5/8"	G	23.42	14.79	8.63	YES	NO	1507‡	561
85050	ES36	ES36	1-5/8"	C	23.28	14.5	9.03	YES	NO	525	138
665937	ES36	ES36	1-5/8"	G	22.91	16.09	6.82	YES	NO		
85058	ES36	ES36	1-5/8"	C	22.67	14.26	8.41	YES	YES	722	114
85044	ES36	ES36	1-5/8"	C	22.63	14.1	8.53	YES	NO	722	212
85971	ES36	ES36	1-5/8"	G	22.56	14.17	8.39	YES	NO	2315	451
85919	ES36	ES36	1-5/8"	G	22.52	14.33	8.19	YES	YES	1265	121
646155	ES36	ES36	1-3/16"		22.45	14.1	8.35	YES	NO		
646177	ES36	ES36	1-3/16"		22.45	14.1	8.35	NO	NO		
89431	ES36	ES36	1-5/8"	G	22.41	14.16	8.25	YES	NO	751‡	211
85345	ES36	ES36	1-5/8"	D	21.83	13.82	8.01	YES	YES	1093	219
85906	ES36	ES36	1-5/8"	G	21.77	14.05	7.72	YES	YES	700	255
85014	ES36	ES36	1-5/8"	C	21.76	13.74	8.02	YES	YES	1019	219
83124	ES36	ES36	1-3/8"	A	21.65	13.77	7.88	YES	YES	750	137
83207	ES36	ES36	1-3/8"	A	21.64	13.61	8.03	YES	YES	553	143

\* Damping force, in pounds, to either extend or collapse the shock absorber at an average operating velocity. Fuerza de amortiguación en libras para extender o comprimir el amortiguador a una velocidad de operación promedio. La puissance d'amortissement en poids de l'amortisseur, soit comprimé, doit détendu, à une vitesse de fonctionnement moyenne.

**SPECIFICATIONS BY END MOUNT**  
**ESPECIFICACIONES POR TIPO DE MONTAJE**  
**SPECIFICATIONS PAR FIXATION DES EXTRÉMITÉS**

Gabriel	Mounting		Bore	External Diameter Illustration	Lengths			Dust Tube	Recoil Cutoff	Controls*	
	Upper	Lower			Extended	Collapsed	Stroke			Rebound	Compression
89407	ES36	ES36	1-5/8"	G	21.61	14.17	7.45	YES	YES	652†	218
85091	ES36	ES36	1-5/8"	C	21.38	13.56	7.82	YES	NO	1121	331
85910	ES36	ES36	1-5/8"	G	20.79	13.54	7.25	YES	YES	1074	219
85029	ES36	ES36	1-5/8"	C	20.54	13.11	7.43	YES	YES	1019	219
85382	ES36	ES36	1-5/8"	D	20.22	13.07	7.15	YES	YES	1658	420
83127	ES36	ES36	1-3/8"	A	20.16	13.14	7.01	YES	YES	940	218
83204	ES36	ES36	1-3/8"	A	20.14	12.86	7.28	YES	YES	451	110
89437	ES36	ES36	1-5/8"	G	20.12	13.42	6.7	YES	YES	1155†	514
85060	ES36	ES36	1-5/8"	C	19.79	12.76	7.04	YES	YES	943	405
85338	ES36	ES36	1-5/8"	D	19.47	12.68	6.79	YES	YES	1664	420
85051	ES36	ES36	1-5/8"	C	18.54	12.13	6.41	YES	YES	1019	139
85908	ES36	ES36	1-5/8"	G	18.48	12.25	6.23	YES	YES	1020	219
83130	ES36	ES36	1-3/8"	A	18.03	12.04	5.99	YES	YES	871	177
85934	ES36	ES36	1-5/8"	G	17.8	12.04	5.75	YES	YES	3511	1063
85086	ES36	ES36	1-5/8"	C	17.55	11.63	5.92	YES	YES	2027	389
85738	ES36	ES36	1-5/8"	D	17.46	11.69	5.77	YES	YES	1830	416
85323	ES36	ES36	1-5/8"	D	17.36	11.58	5.78	YES	YES	1085	163
87018	ES36	ES36	2-1/16"	E	17.36	11.71	5.65	YES	YES	2479	1000
83389	ES36	ES36	1-3/8"	A	17.32	11.57	5.75	YES	YES	1084	228
85000	ES36	ES36	1-5/8"	C	17.28	11.5	5.78	YES	YES	1019	219
89436	ES36	ES36	1-5/8"	G	17.24	12.04	5.2	YES	YES	998†	217
83203	ES36	ES36	1-3/8"	A	17.1	11.36	5.74	YES	YES	609	114
83128	ES36	ES36	1-3/8"	A	16.89	11.53	5.36	YES	YES	940	218
85911	ES36	ES36	1-5/8"	G	16.89	11.53	5.36	YES	YES	1020	219
83363	ES36	ES36	1-3/8"	A	16.46	11.35	5.11	YES	YES	1084	201
85938	ES36	ES36	1-5/8"	G	16.06	10.82	5.24	YES	YES	1581	432
85064	ES36	ES36	1-5/8"	C	16.02	10.75	5.27	YES	YES	1481	340
83150	ES36	ES36	1-3/8"	A	15.24	10.43	4.81	YES	YES	940	216
85078	ES36	ES36	1-5/8"	C	14.76	10.12	4.64	YES	YES	1409	282
85045	ES36	ES36	1-5/8"	C	14.52	10.12	4.4	YES	YES	1020	219
85939	ES36	ES36	1-5/8"	G	14.44	10.04	4.41	YES	YES	1719	420
85914	ES36	ES36	1-5/8"	G	14.36	10.25	4.11	YES	YES	1020	219
85052	ES36	ES36	1-5/8"	C	13.26	9.49	3.77	YES	YES	1429	335
85344	ES36	ES36	1-5/8"	D	13.22	9.45	3.77	YES	YES	1581	443
85079	ES36	ES36	1-5/8"	C	12.04	8.87	3.17	YES	YES	1494	325
83157	ES36	ES90	1-3/8"	A	26.38	15.76	10.61	YES	NO	446	303
85102	ES36	ES136	1-5/8"	C	21.52	14.93	6.59	YES	YES	1224	342

\* Damping force, in pounds, to either extend or collapse the shock absorber at an average operating velocity. Fuerza de amortiguación en libras para extender o comprimir el amortiguador a una velocidad de operación promedio. La puissance d'amortissement en poids de l'amortisseur, soit comprimé, doit détendu, à une vitesse de fonctionnement moyenne.

† At bumper contact / Al contacto cone el tope de goma / Au contact avec le butoir

**SPECIFICATIONS BY END MOUNT**  
**ESPECIFICACIONES POR TIPO DE MONTAJE**  
**SPECIFICATIONS PAR FIXATION DES EXTRÉMITÉS**

Gabriel	Mounting		Bore	External Diameter Illustration	Lengths			Dust Tube	Recoil Cutoff	Controls*	
	Upper	Lower			Extended	Collapsed	Stroke			Rebound	Compression
83164	ES36	ES165	1-3/8"	C	24.22	14.59	9.63	YES	NO	426	274
85072	ES36	ES176	1-5/8"	C	24.17	14.81	9.36	YES	YES	1387	305
85087	ES36	ES176	1-5/8"	C	22.78	14.7	8.08	YES	YES	1568	403
85109	ES36	ES195	1-5/8"	C	24.21	15.14	9.07	YES	YES	1123	149
83635	ES36	S21	1-3/8"	A	21.74	13.25	8.49	YES	NO	558	119
85977	ES36	S42	1-5/8"	G	26.2	15.91	10.29	YES	YES	582	138
83109	ES36	S42	1-3/8"	A	26.17	15.93	10.24	YES	YES	345	78
83111	ES36	S42	1-3/8"	A	26.17	15.93	10.24	YES	YES	560	141
83138	ES36	S42	1-3/8"	A	23.55	14.42	9.12	YES	YES	997	231
83110	ES36	S42	1-3/8"	A	22.94	14.31	8.63	YES	YES	450	143
83112	ES36	S42	1-3/8"	A	21.52	13.41	8.11	YES	YES	1064	343
83033	ES53	ES53	1-3/8"	A	13.99	10.37	3.62	YES	YES	494	312
G63829	ES61	ES65	1-3/8"		22.58	13.8	8.78				
G63676	ES69	ES69	1-3/8"		15.58	10.55	5.03	YES	YES		
G63403	ES82	ES82	1-3/8"		24.58	14.8	9.78	YES	NO		
G63671	ES82	ES82	1-3/8"		22.58	13.8	8.78	YES	NO		
G63617	ES83	EB1	1-3/8"		27.58	16.3	11.28	YES	NO		
83131	ES83	ES83	1-3/8"	A	27.8	18.18	9.62	YES	NO	212	129
G63717	ES83	ES83	1-3/8"		23	13.97	9.03	YES	NO		
G63776	ES83	ES83	1-3/8"		20.76	12.98	7.78	YES	NO		
G63869	ES83	ES83	1-3/8"		20.26	12.82	7.44				
G64002	ES83	ES83	1-3/8"		20.15	13.95	6.192				
83145	ES83	ES83	1-3/8"	A	19.93	12.32	7.54	YES	NO	479	153
83906	ES85	EB1	1-3/8"	2-1/2" D/T	10.45†	8.41†	3.01	YES	YES	586	320
83048	ES86	ES167	1-3/8"	A	9.97	8.43†	2.37	YES	YES	904	415
83028	ES86	ES167	1-3/8"	A	9.96	7.6	2.33	YES	YES	445	531
83905	ES86	ES167	1-3/8"	2-1/2" D/T	9.3†	7.81†	2.21	YES	YES	1105	170
85639	ES90	ES36	1-5/8"	G	27.08	17.79	9.29	YES	NO	795	109
85963	ES90	ES36	1-5/8"	G	25.49	18.68	6.81	YES	YES	1490	206
85964	ES90	ES36	1-5/8"	G	25.49	18.68	6.81	YES	YES	1981	205
85995	ES90	ES36	1-5/8"	G	23.5	14.52	8.98	YES	NO	1830	173
85994	ES90	ES36	1-5/8"	G	21.21	13.4	7.81	YES	NO	1824	263
85637	ES90	ES36	1-5/8"	G	20.74	13.19	7.55	YES	NO	2256	327
85954	ES90	ES36	1-5/8"	G	20.43	13	7.43	YES	NO	1812	148
85924	ES90	ES36	1-5/8"	G	20.39	12.99	7.41	YES	NO	1036	122
89457	ES90	ES36	1-5/8"	G	19.92	13.02	6.89	YES	NO	941‡	156
85969	ES90	ES36	1-5/8"	G	18.38	11.93	6.45	YES	NO	1612	125

\* Damping force, in pounds, to either extend or collapse the shock absorber at an average operating velocity. Fuerza de amortiguación en libras para extender o comprimir el amortiguador a una velocidad de operación promedio. La puissance d'amortissement en poids de l'amortisseur, soit comprimé, doit détendu, à une vitesse de fonctionnement moyenne.

**SPECIFICATIONS BY END MOUNT**  
**ESPECIFICACIONES POR TIPO DE MONTAJE**  
**SPECIFICATIONS PAR FIXATION DES EXTRÉMITÉS**

Gabriel	Mounting		Bore	External Diameter Illustration	Lengths			Dust Tube	Recoil Cutoff	Controls*	
	Upper	Lower			Extended	Collapsed	Stroke			Rebound	Compression
83180	ES90	ES83	1-3/8"		30.2	21.24	8.96	YES	NO	909	204
83364	ES90	ES83	1-3/8"	A	24.06	15.07	8.99	YES	YES	855	206
83146	ES90	ES83	1-3/8"	A	24.02	14.68	9.33	YES	YES	479	119
85082	ES90	ES90	1-5/8"	C	28.6	20.64	7.97	YES	YES	1435	266
83636	ES90	ES90	1-3/8"	A	27.72	16.95	10.77	YES	YES	505	148
83100	ES90	ES90	1-3/8"	A	26.6	16.11	10.49	YES	YES	481	142
85926	ES90	ES90	1-5/8"	G	26.5	17.96	8.54	YES	YES	1387	279
85953	ES90	ES90	1-5/8"	G	26.13	15.86	10.27	YES	NO	2001	153
85003	ES90	ES90	1-5/8"	C	25.42	15.63	9.79	YES	YES	437	182
89411	ES90	ES90	1-5/8"	G	25.39	16.06	9.34	YES	YES	436†	186
85927	ES90	ES90	1-5/8"	G	24.76	15.47	9.3	YES	YES	1288	388
83101	ES90	ES90	1-3/8"	A	24.63	15.13	9.49	YES	YES	481	142
85998	ES90	ES90	1-5/8"	G	22.83	14.17	8.66	YES	NO	1345	178
85925	ES90	ES90	1-5/8"	G	22.56	15.6	6.95	YES	NO	761	144
85648	ES90	ES90	1-5/8"	G	22.28	13.97	8.31	YES	NO	761	247
85957	ES90	ES90	1-5/8"	G	20.78	13.19	7.6	YES	NO	1583	138
85928	ES90	ES90	1-5/8"	G	20.31	13.24	7.07	YES	NO	957	229
85929	ES90	ES90	1-5/8"	G	20.28	13.21	7.08	YES	NO	2214	267
85999	ES90	ES90	1-5/8"	G	19.84	12.79	7.05	YES	NO	2214	259
83135	ES90	ES90	1-3/8"	A	19.49	12.38	7.11	YES	NO	519	121
83167	ES90	ES90	1-3/8"	A	19.49	12.38	7.11	YES	NO	285	90
83156	ES90	ES90	1-3/8"	A	18.55	11.91	6.64	YES	NO	778	135
83169	ES90	ES90	1-3/8"	A	18.55	11.91	6.64	YES	NO	599	171
83020	ES91	ES91	1-3/8"	A	9.41	7.17	2.24	YES	YES	796	255
G63708	ES99	EB2	1-3/8"		19.74	12.46	7.28	YES	NO		
G63639	ES104	ES69	1-3/8"		24.16	14.63	9.53	YES	NO		
G63712	ES110	ES19	1-3/8"		22.58	13.8	8.78	YES	NO		
83034	ES115	ES115	1-3/16"	1-5/8"	10.04†	7.32	2.97	NO	YES	430	129
G63919	ES117	ES153	1-3/8"		20.25	13.06	7.19				
G63694	ES119	S38	1-3/8"		22.28	13.5	8.78	YES	NO		
83634	ES120	ES120	1-3/8"	A	27.48	16.23	11.25	YES	YES	779	157
85011	ES120	ES121	1-5/8"	C	27.49	16.46	11.03	YES	NO	1268	186
85122	ES120	S21	1-5/8"	C	22.22	13.78	8.44	YES	YES	926	162
83120	ES120	S21	1-3/8"	A	22.17	13.66	8.51	YES	YES	779	164
85123	ES120	S21	1-5/8"	C	21.49	13.26	8.23	YES	NO	1809	246
83154	ES120	S21	1-3/8"	A	20.78	12.72	8.06	YES	YES	599	140
G63818	ES126	ES128	1-3/8"		16.5	10.97	5.53	YES	NO		

\* Damping force, in pounds, to either extend or collapse the shock absorber at an average operating velocity. Fuerza de amortiguación en libras para extender o comprimir el amortiguador a una velocidad de operación promedio. La puissance d'amortissement en poids de l'amortisseur, soit comprimé, doit détendu, à une vitesse de fonctionnement moyenne.

† At bumper contact / Al contacto cone el tope de goma / Au contact avec le butoir

**SPECIFICATIONS BY END MOUNT**  
**ESPECIFICACIONES POR TIPO DE MONTAJE**  
**SPECIFICATIONS PAR FIXATION DES EXTRÉMITÉS**

Gabriel	Mounting		Bore	External Diameter Illustration	Lengths			Dust Tube	Recoil Cutoff	Controls*	
	Upper	Lower			Extended	Collapsed	Stroke			Rebound	Compression
83081	ES126	ES172	1-3/8"	A	13.39	9.98†	4	YES	YES	1004	232
83160	ES128	ES36	1-3/8"	A	24.31	14.9	9.37	YES	YES	920	161
83174	ES128	ES36	1-3/8"	A	24.31	14.9	9.37	YES	YES	795	160
85650	ES136	ES34	1-5/8"	G	24.88	16.35	8.53	YES	NO	941	463
83008	ES136	ES136	1-3/8"	A	13†	10.13†	4	YES	YES	699	307
83056	ES136	ES136	1-5/8"	C	11.53	8.63	2.89	YES	YES	3830	737
83042	ES136	ES136	1-3/8"	A	9.89†	8.52†	2.39	YES	YES	954	541
83030	ES136	ES136	1-3/8"	A	9.61†	7.61	2.5	YES	YES	308	87
85026	ES136	S21	1-5/8"	C	23.02	14.01	9.01	YES	NO	1079	539
89417	ES136	S21	1-5/8"	G	22.94	14.31	8.63	YES	NO	1226‡	515
83907	ES147	ES147	1-3/8"	A	14.97	10.61	4.36	YES	YES	460	365
83047	ES149	EB1	1-3/8"	A	11.78†	9.74†	3	YES	YES	364	314
83006	ES149	EB1	1-3/8"	A	10.71	8.52†	2.78	YES	YES	525	182
83001	ES149	EB1	1-3/8"	A	10.45†	8.41†	3	YES	YES	793	363
83038	ES149	EB1	1-3/8"	A	10.45†	8.41†	3	YES	YES	336	242
83017	ES149	ES149	1-3/8"	A	10.95	8.41†	3.13	YES	YES	353	138
83009	ES149	ES149	1-3/8"	A	10.45†	8.41†	3	YES	YES	793	363
83039	ES149	ES149	1-3/8"	A	10.44†	8.4†	3	YES	YES	876	326
83064	ES149	ES149	1-3/8"	A	10.41†	8.36†	2.99	YES	YES	635	323
85090	ES150	ES36	1-5/8"	C	25.31	15.52	9.79	YES	YES	943	99
85180	ES150	ES36	1-5/8"	C	20.94	13.83	7.11	YES	YES	681	283
85181	ES150	ES150	1-5/8"	C	26.33	17.06	9.27	YES	YES	681	285
89449	ES150	ES150	1-5/8"	G	23.25	14.9	8.35	YES	NO	1519‡	324
85918	ES150	ES150	1-5/8"	G	22.97	14.58	8.39	YES	NO	1726	412
85958	ES150	ES150	1-5/8"	G	22.89	14.5	8.39	YES	YES	1926	281
89503	ES150	ES150	1-5/8"	G	21.28	13.72	7.56	YES	NO	1033‡	123
85106	ES150	ES150	1-5/8"	C	20.03	12.89	7.14	YES	YES	1054	109
85119	ES150	ES150	1-5/8"	C	21.39	13.81	7.68	YES	YES	1387	185
85922	ES150	ES150	1-5/8"	G	21.19	13.53	7.66	YES	NO	878	185
85920	ES150	ES150	1-5/8"	G	21.16	13.57	7.59	YES	NO	845	49
85959	ES150	ES150	1-5/8"	G	21.16	13.57	7.59	YES	YES	1021	123
85092	ES150	S21	1-5/8"	C	21.95	15.04	6.89	YES	YES	1597	138
G63609	ES151	ES128	1-3/8"		16.5	10.97	5.53	YES	YES		
G63640	ES152	ES153	1-3/8"		23.89	15.11	8.78	YES	YES		
G63606	ES152	ES153	1-3/8"		21.39	13.61	7.78	YES	YES		
83066	ES153	ES153	1-3/8"	A	11.15†	9.2†	2.78	YES	YES	599	221
83901	ES153	ES153	1-3/8"	A	11.15†	9.2†	2.78	YES	YES	509	204

\* Damping force, in pounds, to either extend or collapse the shock absorber at an average operating velocity. Fuerza de amortiguación en libras para extender o comprimir el amortiguador a una velocidad de operación promedio. La puissance d'amortissement en poids de l'amortisseur, soit comprimé, doit détendu, à une vitesse de fonctionnement moyenne.

**SPECIFICATIONS BY END MOUNT**  
**ESPECIFICACIONES POR TIPO DE MONTAJE**  
**SPECIFICATIONS PAR FIXATION DES EXTRÉMITÉS**

Gabriel	Mounting		Bore	External Diameter Illustration	Lengths			Dust Tube	Recoil Cutoff	Controls*	
	Upper	Lower			Extended	Collapsed	Stroke			Rebound	Compression
85984	ES158	ES150	1-5/8"	G	25.44	15.96	9.48	YES	YES	2248	1168
85125	ES158	ES159	1-5/8"	C	26.9	16.64	10.26	YES	YES	1479	183
85724	ES158	ES159	1-5/8"	D	22.81	14.51	8.3	YES	YES	1235	454
89443	ES158	ES159	1-5/8"	G	22.19	14.66	7.53	YES	YES	1206‡	466
85331	ES158	ES159	1-5/8"	D	19.62	12.85	6.77	YES	YES	1757	396
85335	ES158	ES159	1-5/8"	D	19.62	12.85	6.77	YES	YES	827	107
85126	ES158	S21	1-5/8"	C	21.76	13.63	8.13	YES	YES	1086	215
87019	ES160	ES160	2-1/16"	E	24.84	15.85	8.9	YES	YES	2972	665
87017	ES160	ES160	2-1/16"	E	23.35	15.31	8.07	YES	YES	1876	220
89461	ES160	ES160	1-5/8"	G	19.96	13.58	6.38	YES	YES	897‡	103
85088	ES161	ES162	1-5/8"	C	25.31	15.52	9.79	YES	YES	616	178
85061	ES161	ES162	1-5/8"	C	24.76	15.25	9.51	YES	YES	1216	195
85066	ES161	ES162	1-5/8"	C	24.64	15.25	9.39	YES	YES	812	322
85098	ES161	ES162	1-5/8"	C	24.64	15.24	9.4	YES	YES	747	158
89448	ES161	ES162	1-5/8"	G	24.61	15.66	8.94	YES	YES	782‡	323
89450	ES161	ES162	1-5/8"	G	24.61	15.66	8.94	YES	YES	1282‡	193
89502	ES161	ES162	1-5/8"	G	24.61	15.66	8.94	YES	YES	1240‡	300
85065	ES161	S21	1-5/8"	C	28.05	17	11.05	YES	YES	1059	300
85083	ES162	S42	1-5/8"	C	27.81	16.53	11.28	YES	YES	1429	184
83142	ES162	S42	1-3/8"	A	23.92	14.49	9.43	YES	YES	367	131
83143	ES162	S42	1-3/8"	A	21.92	13.51	8.41	YES	YES	403	137
83025	ES163	ES163	1-3/8"	A	8.02	6.53	1.48	YES	YES	710	230
83049	ES163	ES163	1-3/8"	A	8.02	6.53	1.48	YES	YES	2879	705
83032	ES163	ES163	1-3/8"	A	7.85	6.36	1.49	NO	YES	779	135
83116	ES164	ES165	1-3/8"	A	23.81	14.68	9.12	YES	NO	354	300
83118	ES164	ES90	1-3/8"	A	24.45	14.71	9.74	YES	NO	410	311
83035	ES166	ES136	1-3/8"	A	13.04†	9.33	4.22	YES	YES	320	100
83067	ES166	ES136	1-3/16"	2" D/T	12.33†	9.27	3.56	YES	YES	424	101
83029	ES168	ES169	1-5/8"	C	10.35	7.87	2.41	YES	NO	1303	1349
83040	ES171	ES172	1-3/8"	A	10.44†	8.4†	3	YES	YES	876	326
83057	ES171	ES172	1-3/8"	2-1/2" D/T	10.44†	8.4†	2.99	YES	YES	364	242
87015	ES173	ES173	45MM	E	15.51	11.18	4.33	YES	YES	4950	900
85737	ES173	ES173	1-5/8"	D	15.11	10.84	4.27	YES	YES	3066	782
89459	ES174	EB3	1-5/8"	G	25.63	16.14	9.49	YES	NO	1179‡	314
85070	ES174	EB3	1-5/8"	C	25.59	15.83	9.76	YES	NO	1100	310
85067	ES174	ES136	1-5/8"	C	30.54	18.15	12.39	YES	YES	676	170
89451	ES174	ES136	1-5/8"	G	30.39	18.54	11.86	YES	YES	645‡	172

\* Damping force, in pounds, to either extend or collapse the shock absorber at an average operating velocity. Fuerza de amortiguación en libras para extender o comprimir el amortiguador a una velocidad de operación promedio. La puissance d'amortissement en poids de l'amortisseur, soit comprimé, doit détendu, à une vitesse de fonctionnement moyenne.

† At bumper contact / Al contacto cone el tope de goma / Au contact avec le butoir



**SPECIFICATIONS BY END MOUNT**  
**ESPECIFICACIONES POR TIPO DE MONTAJE**  
**SPÉCIFICATIONS PAR FIXATION DES EXTRÉMITÉS**

Gabriel	Mounting		Bore	External Diameter Illustration	Lengths			Dust Tube	Recoil Cutoff	Controls*	
	Upper	Lower			Extended	Collapsed	Stroke			Rebound	Compression
85989	ES174	ES136	1-5/8"	G	20.78	13.15	7.63	YES	NO	1812	351
85084	ES174	ES136	1-5/8"	C	20.59	13.03	7.57	YES	NO	1145	407
89460	ES174	ES136	1-5/8"	G	20.58	13.03	7.55	YES	NO	997‡	384
85937	ES174	S43	1-5/8"	G	19.04	12.35	6.7	YES	YES	1479	337
85985	ES174	S43	1-5/8"	G	19.04	12.31	6.73	YES	YES	2068	723
85936	ES174	S43	1-5/8"	G	17.27	11.48	5.79	YES	YES	1479	337
89456	ES174	S43	1-5/8"	G	17.04	11.63	5.4	YES	YES	975‡	377
83063	ES175	ES136	1-3/8"	A	10.76†	9.26†	3.01	YES	YES	954	541
85955	ES175	ES150	1-5/8"	G	21.25	13.66	7.59	YES	YES	1034	397
85986	ES175	ES150	1-5/8"	G	21.25	13.66	7.59	YES	YES	1754	221
85120	ES175	ES175	1-5/8"	C	23.67	15.06	8.61	YES	NO	2083	519
83163	ES175	ES175	1-3/8"	A	20.75	13.01	7.74	YES	NO	828	98
83175	ES175	ES175	1-3/8"	A	20.48	13.19	7.29	YES	NO	1245	156
85933	ES175	ES175	1-5/8"	G	18.27	12.72	5.54	YES	YES	1089	383
89454	ES175	ES175	1-5/8"	G	18.27	12.91	5.36	YES	YES	938‡	388
85081	ES175	S21	1-5/8"	C	23.44	14.33	9.11	YES	YES	1658	250
85080	ES175	S21	1-5/8"	C	22.51	13.77	8.74	YES	NO	447	138
85031	ES176	EB2	1-5/8"	C	25.63	15.87	9.76	YES	NO	941	257
85642	ES177	ES90	1-5/8"	G	22.52	14.52	8	YES	YES	1920	309
85923	ES177	ES161	1-5/8"	G	22.52	14.52	8	YES	YES	1940	221
85931	ES177	ES161	1-5/8"	G	22.52	14.52	8	YES	YES	1435	220
89458	ES177	ES161	1-5/8"	G	22.48	14.6	7.88	YES	YES	1575‡	222
85930	ES177	ES161	1-5/8"	G	17.86	12	5.86	YES	YES	1617	342
85932	ES178	ES150	1-5/8"	G	21.26	13.7	7.56	YES	YES	1102	430
89453	ES178	ES150	1-5/8"	G	21.14	13.93	7.21	YES	YES	860‡	435
85965	ES178	ES161	1-5/8"	G	24.24	15.15	9.09	YES	YES	2206	238
85966	ES178	ES161	1-5/8"	G	23.25	14.64	8.62	YES	YES	2206	238
85967	ES178	ES176	1-5/8"	G	23.93	14.86	9.07	YES	YES	2206	238
85961	ES178	ES176	1-5/8"	G	22.83	14.17	8.66	YES	YES	2206	240
85962	ES178	ES176	1-5/8"	G	21.8	13.66	8.15	YES	YES	2206	240
85980	ES179	ES179	1-5/8"	G	31.17	18.66	12.52	YES	YES	582	138
83148	ES179	ES179	1-3/8"	A	30	17.83	12.17	YES	YES	604	149
85978	ES179	ES179	1-5/8"	G	29.84	18.16	11.69	YES	YES	582	138
85638	ES179	ES179	1-5/8"	G	28.58	17.4	11.18	YES	YES	643	138
83147	ES179	ES179	1-3/8"	A	28.54	17.4	11.15	YES	YES	358	128
83166	ES179	ES179	1-3/8"	A	25.28	15.78	9.49	YES	YES	622	132
83168	ES179	ES179	1-3/8"	A	25.28	15.78	9.49	YES	YES	246	88
83396	ES179	ES179	1-3/8"		20.75	14.04	6.71	YES	YES	583	334

\* Damping force, in pounds, to either extend or collapse the shock absorber at an average operating velocity. Fuerza de amortiguación en libras para extender o comprimir el amortiguador a una velocidad de operación promedio. La puissance d'amortissement en poids de l'amortisseur, soit comprimé, doit détendu, à une vitesse de fonctionnement moyenne.

**SPECIFICATIONS BY END MOUNT**  
**ESPECIFICACIONES POR TIPO DE MONTAJE**  
**SPECIFICATIONS PAR FIXATION DES EXTRÉMITÉS**

Gabriel	Mounting		Bore	External Diameter Illustration	Lengths			Dust Tube	Recoil Cutoff	Controls*	
	Upper	Lower			Extended	Collapsed	Stroke			Rebound	Compression
85377	ES182	ES182	1-5/8"	D	23.8	14.84	8.96	YES	YES	1937	570
85378	ES182	ES182	1-5/8"	D	23.8	14.84	8.96	YES	YES	1110	240
85956	ES183	ES184	1-5/8"	G	30.65	18.77	11.88	YES	YES	979	373
83053	ES185	ES185	1-3/8"	A	10.91	7.93	2.98	YES	YES	968	214
83054	ES185	ES185	1-3/8"	A	10.28	7.56	2.72	YES	YES	1004	184
83052	ES185	ES185	1-3/8"	2-1/2" D/T	9.41	7.19	2.23	YES	NO	1101	149
83062	ES185	S42	1-3/8"	A	12.71	9.18	3.53	YES	NO	704	153
G63875	ES186	ES186	1-3/8"		17.67	11.73	5.94				
85739	ES187	ES187	1-5/8"	D	20.73	13.54	7.19	YES	YES	3247	334
85341	ES188	S21	1-5/8"	D	30.96	18.1	12.86	YES	YES	1807	333
85970	ES188	S21	1-5/8"	G	27.23	16.44	10.79	YES	YES	1092	147
85340	ES188	S21	1-5/8"	D	26.46	15.85	10.61	YES	YES	1807	165
83391	ES190	ES190	1-3/8"	A	25.52	15.61	9.91	YES	NO	590	105
86203	ES193	ES193	45 MM	D	16.88	11.61	5.27	YES	YES	4238	910
86202	ES193	ES193	45 MM	D	14.52	10.43	4.09	YES	YES	4238	688
86201	ES193	ES193	45 MM	D	13.26	9.94	3.32	YES	YES	4238	688
86200	ES194	ES194	45 MM	D	14.24	10.45	3.79	YES	YES	4238	688
83065	ES206	ES171	1-5/8"	G	12.52	9.32	3.2	YES	YES	680	184
G64006	S1	413003	1-3/8"		22.75	13.81	8.94				
G64007	S1	413003	1-3/8"		22.75	13.81	8.94				
G63889	S1	413003	1-3/8"		20.44	12.75	7.69				
G64005	S1	413003	1-3/8"		19.75	12.31	7.44				
G64004	S1	413003	1-3/8"		19.07	12.13	6.94				
G63418	S1	BP4	1-3/8"		14.05	9.27	4.78	YES	NO		
G63457	S1	BP4	1-3/8"		13.8	9.02	4.78	NO	NO		
G63424	S1	BP7	1-3/8"		20.47	12.69	7.78	YES	YES	387	197
G63847	S1	BP7	1-3/8"		20.47	12.69	7.78				
G63950	S1	BP7	1-3/8"		14.2	9.09	5.11	NO	NO		
G63375	S1	BP7	1-3/8"		13.95	9.28	4.67	NO	NO		
G63915	S1	BP7	1-3/8"		13.2	8.59	4.61	NO	NO		
83003	S1	BP7	1-3/8"	A	11.76	8.95†	3.4	YES	YES	248	100
G63903	S1	BP8	1-3/8"		14.7	9.34	5.36	YES	NO		
G63360	S1	BP13	1-3/8"		15.8	10.02	5.78	NO	NO		
G63359	S1	BP13	1-3/8"		13.8	9.02	4.78	NO	NO		
G63937	S1	BP17	1-3/8"		14.7	9.34	5.36	NO	NO		
G63900	S1	BP26	1-3/8"		14.1	9.34	4.76	YES	YES		
G63421	S1	BP30	1-3/8"		13.8	9.02	4.78	NO	NO		
G63860	S1	EB1	1-3/8"		24.33	14.39	9.94	YES	NO	132	76

\* Damping force, in pounds, to either extend or collapse the shock absorber at an average operating velocity. Fuerza de amortiguación en libras para extender o comprimir el amortiguador a una velocidad de operación promedio. La puissance d'amortissement en poids de l'amortisseur, soit comprimé, doit détendu, à une vitesse de fonctionnement moyenne.

† At bumper contact / Al contacto con el tope de goma / Au contact avec le butoir

**SPECIFICATIONS BY END MOUNT**  
**ESPECIFICACIONES POR TIPO DE MONTAJE**  
**SPECIFICATIONS PAR FIXATION DES EXTRÉMITÉS**

Gabriel	Mounting		Bore	External Diameter Illustration	Lengths			Dust Tube	Recoil Cutoff	Controls*	
	Upper	Lower			Extended	Collapsed	Stroke			Rebound	Compression
G63610	S1	EB1	1-3/8"		21.55	13.27	8.28	YES	NO		
83161	S1	EB1	1-3/8"	A	20.82	12.56	8.25	YES	NO	400	70
G63798	S1	EB1	1-3/8"		15.97	10.19	5.78	YES	NO		
83518	S1	EB2	1-3/16"		24.4	14.26	10.14	YES	NO	153	82
83515	S1	EB2	1-3/16"		23.34	13.89	9.45	YES	NO	643	205
G63432	S1	EB2	1-3/8"		21.21	12.93	8.28	YES	NO		
G63444	S1	ES17	1-3/8"		23.3	14.02	9.28	NO	YES		
G63495	S1	ES17	1-3/8"		15.05	9.77	5.28	YES	NO		
G63611	S1	ES17	1-3/8"		15.05	9.77	5.28	YES	NO		
G63904	S1	ES17	1-3/8"		14.95	9.59	5.36	YES	NO		
G63909	S1	ES17	1-3/8"		14.11	9	5.11	YES	NO		
G63902	S1	ES17	1-3/8"		12.6	8.59	4.01	YES	YES		
G63905	S1	ES24	1-3/8"		14.7	9.34	5.36	NO	NO		
G63387	S1	ES25	1-3/8"		23.33	14.05	9.28	YES	NO		
G63511	S1	ES25	1-3/8"		22.55	13.52	9.03	YES	NO		
G63350	S1	ES25	1-3/8"		18.83	11.8	7.03	YES	NO		
G63881	S1	ES25	1-3/8"		14.71	9.48	5.22				
G63674	S1	ES34	1-3/8"		23.27	14.24	9.03	YES	YES		
G63673	S1	ES34	1-3/8"		22.3	13.77	8.53	YES	YES		
G63661	S1	ES34	1-3/8"		13.87	9.59	4.28	YES	YES		
G63404	S1	ES64	1-3/8"		17.05	11.02	6.03	YES	YES		
G63862	S1	ES67	1-3/8"		25.07	14.94	10.13				
G63635	S1	ES69	1-3/8"		14.55	9.52	5.03	YES	NO		
G63799	S1	ES83	1-3/8"		18.55	11.77	6.78	YES	NO		
G63781	S1	ES113	1-3/8"		18.45	11.93	6.52	YES	YES		
G63479	S1	ES113	1-3/8"		14.05	9.27	4.78	YES	NO		
G63547	S1	ES113	1-3/8"		13.71	9.18	4.53	YES	NO		
G63782	S1	ES118	1-3/8"		13.8	9.27	4.53	YES	NO		
G63710	S1	ES153	1-3/8"		18.96	11.93	7.03	YES	NO		
G63187	S1	S1	1-3/8"		23.02	13.49	9.53	YES	NO		
83400	S1	S1	1-3/16"	F	22.02	12.82	9.2	YES	NO	301	120
G63398	S1	S1	1-3/8"		20.52	12.24	8.28	YES	NO		
83014	S1	S1	1-3/8"	A	10.48	7.11	3.37	NO	NO	544	501
G63484	S4	EB1	1-3/8"		20.05	12.52	7.53	YES	NO		
G63714	S6	BP7	1-3/8"		15.54	10.01	5.53	YES	NO		
G63772	S6	BP35	1-3/8"		13.83	9.55	4.28	YES	YES		
G63720	S6	ES22	1-3/8"		21.3	13.02	8.28	YES	NO		
G63612	S7	ES17	1-3/8"		14.55	9.77	4.78				

\* Damping force, in pounds, to either extend or collapse the shock absorber at an average operating velocity. Fuerza de amortiguación en libras para extender o comprimir el amortiguador a una velocidad de operación promedio. La puissance d'amortissement en poids de l'amortisseur, soit comprimé, doit détendu, à une vitesse de fonctionnement moyenne.

**SPECIFICATIONS BY END MOUNT**  
**ESPECIFICACIONES POR TIPO DE MONTAJE**  
**SPECIFICATIONS PAR FIXATION DES EXTRÉMITÉS**

Gabriel	Mounting		Bore	External Diameter Illustration	Lengths			Dust Tube	Recoil Cutoff	Controls*	
	Upper	Lower			Extended	Collapsed	Stroke			Rebound	Compression
G63621	S10	BP7	1-3/8"		16.46	10.93	5.53	YES	YES		
G63721	S10	BP11	1-3/8"		20.21	12.43	7.78	YES	NO		
G63446	S10	EB6	1-3/8"		23.3	14.02	9.28	NO	YES		
G63410	S10	EB6	1-3/8"		18.55	11.77	6.78	YES	NO		
G63707	S10	ES17	1-3/8"		15.8	10.27	5.53	YES	NO		
G63447	S10	ES25	1-3/8"		30.18	17.65	12.53	NO	YES		
G63445	S10	ES25	1-3/8"		23.24	13.99	9.25	NO	YES		
G63416	S10	ES25	1-3/8"		18.55	11.77	6.78	YES	NO		
G63396	S10	ES25	1-3/8"		16.55	10.77	5.78	YES	NO		
G63783	S12	BP11	1-3/8"		14.8	10.27	4.53	YES	NO		
G63548	S12	EB2	1-3/8"		21.21	13.18	8.03	YES	YES		
G63726	S12	EB2	1-3/8"		20.96	12.93	8.03	YES	NO		
G63715	S12	ES25	1-3/8"		28.55	16.52	12.03	YES	NO		
G63716	S12	ES26	1-3/8"		15.54	10.01	5.53	YES	NO		
G63817	S12	ES60	1-3/8"		15.8	11.02	4.78	YES	NO		
G63778	S12	ES171	1-3/8"		24.55	14.52	10.03	YES	NO		
G63803	S12	U-Brkt	1-3/8"		15.48	10.69	4.79	YES	NO		
83317	S16	ES90	1-3/8"	B	27.03	16	11.34	YES	YES		
83301	S16	ES90	1-3/8"	B	24.52	14.74	9.78	YES	YES	653	86
83318	S16	S16	1-3/8"	B	22.53	13.5	9.03	YES	YES	323	77
83613	S16	S16	1-3/8"	A	21.04	12.76	8.28	YES	YES	601	242
85731	S21	EB3	1-5/8"	D	30.57	18.54	12.03	YES	YES	1517	293
85703	S21	EB3	1-5/8"	D	29.57	18.54	11.03	YES	YES	1435	186
85033	S21	EB3	1-5/8"	C	27.26	17.4	9.86	YES	YES	764	254
89427	S21	EB3	1-5/8"	G	27.19	17.62	9.57	YES	YES	794†	253
85317	S21	EB3	1-5/8"	D	27.18	17.42	9.76	YES	YES	764	254
85711	S21	EB3	1-5/8"	D	24.54	15.26	9.27	YES	YES	1435	208
87000	S21	EB3	2-1/16"	E	24.46	15.21	9.25	YES	YES	1332	300
85311	S21	EB3	1-5/8"	D	23.95	14.79	9.16	YES	YES	764	254
85988	S21	EB3	1-5/8"	G	23.84	14.87	8.97	YES	YES	1200	138
89424	S21	EB3	1-5/8"	G	23.73	15.14	8.59	YES	YES	794†	253
85710	S21	EB3	1-5/8"	D	23.45	15.1	8.34	YES	YES	994	248
85343	S21	EB3	1-5/8"	D	22.96	14.79	8.17	YES	YES	858	289
87016	S21	EB3	2-1/16"	E	21.17	13.91	7.26	YES	YES	1808	238
85009	S21	ES36	1-5/8"	C	23.56	14.4	9.16	YES	YES	857	144
G63828	S21	ES36	1-3/8"		23.16	15.13	8.03				
83134	S21	ES36	1-3/8"	A	22.27	13.51	8.77	YES	NO	430	49

\* Damping force, in pounds, to either extend or collapse the shock absorber at an average operating velocity. Fuerza de amortiguación en libras para extender o comprimir el amortiguador a una velocidad de operación promedio. La puissance d'amortissement en poids de l'amortisseur, soit comprimé, doit détendu, à une vitesse de fonctionnement moyenne.

† At bumper contact / Al contacto cone el tope de goma / Au contact avec le butoir

**SPECIFICATIONS BY END MOUNT**  
**ESPECIFICACIONES POR TIPO DE MONTAJE**  
**SPECIFICATIONS PAR FIXATION DES EXTRÉMITÉS**

Gabriel	Mounting		Bore	External Diameter Illustration	Lengths			Dust Tube	Recoil Cutoff	Controls*	
	Upper	Lower			Extended	Collapsed	Stroke			Rebound	Compression
85921	S21	ES36	1-5/8"	G	22.07	13.57	8.5	YES	NO	2053	339
85316	S21	ES36	1-5/8"	D	20.61	12.82	7.8	YES	NO	943	443
85351	S21	ES36	1-5/8"	D	20.61	12.82	7.79	YES	NO	1887	259
89426	S21	ES36	1-5/8"	G	20.46	13.05	7.41	YES	NO	926‡	419
85056	S21	ES36	1-5/8"	C	20.15	12.87	7.28	YES	YES	732	114
89441	S21	ES36	1-5/8"	G	20.14	13.06	7.08	YES	YES	761‡	126
85935	S21	ES36	1-5/8"	G	18.7	11.92	6.78	YES	NO	1054	419
85319	S21	ES150	1-5/8"	D	22.22	13.93	8.3	YES	YES	988	454
89428	S21	ES150	1-5/8"	G	22	14.27	7.72	YES	YES	958‡	446
G63832	S21	ES153	1-3/8"		17.16	11.38	5.78				
83395	S21	ES178	1-3/8"	A	27.19	16.28	10.91	YES	NO	616	105
85709	S21	S21	1-5/8"	D	31.64	18.36	13.28	YES	YES	700	203
85727	S21	S21	1-5/8"	D	29.88	17.34	12.54	YES	YES	783	111
83136	S21	S21	1-3/8"	A	29.31	16.8	12.51	YES	NO	914	65
83106	S21	S21	1-3/8"	A	29.25	16.76	12.49	YES	NO	451	80
85048	S21	S21	1-5/8"	C	29.16	16.88	12.28	YES	NO	432	106
85318	S21	S21	1-5/8"	D	27.37	16.36	11.01	YES	YES	1372	192
85722	S21	S21	1-5/8"	D	27.16	16.41	10.76	YES	YES	1264	369
85069	S21	S21	1-5/8"	C	26.31	15.97	10.33	YES	YES	762	255
89455	S21	S21	1-5/8"	G	26.31	16.03	10.28	YES	YES	791‡	276
85328	S21	S21	1-5/8"	D	25.64	15.36	10.28	YES	NO	930	383
85071	S21	S21	1-5/8"	C	25.57	15.02	10.55	YES	NO	610	107
85049	S21	S21	1-5/8"	C	25.53	15	10.53	YES	NO	597	107
85085	S21	S21	1-5/8"	C	24.95	14.67	10.23	YES	NO	970	101
85728	S21	S21	1-5/8"	D	24.37	14.86	9.51	YES	YES	1435	510
83456	S21	S21	1-3/8"	B	24.03	14.25	9.78	YES	YES	566	80
85706	S21	S21	1-5/8"	D	23.65	14.24	9.41	YES	YES	1086	696
85707	S21	S21	2-1/16"	D	23.65	14.4	9.25	YES	YES	1761	986
87011	S21	S21	2-1/16"	E	23.65	14.4	9.25	YES	YES	1750	1050
87012	S21	S21	2-1/16"	E	23.65	14.4	9.25	YES	YES	650	364
87013	S21	S21	2-1/16"	E	23.65	14.4	9.25	YES	YES	1075	585
85325	S21	S21	1-5/8"	D	23.64	14.36	9.28	YES	NO	1024	240
89447	S21	S21	1-5/8"	G	23.63	14.69	8.94	YES	YES	702‡	241
85347	S21	S21	1-5/8"	D	23.62	14.22	9.4	YES	YES	961	122
85705	S21	S21	1-5/8"	D	23.62	14.23	9.39	YES	YES	639	436
85342	S21	S21	1-5/8"	D	23.28	13.99	9.29	YES	NO	893	188
83102	S21	S21	1-3/8"	A	22.89	13.54	9.35	YES	YES	513	333

\* Damping force, in pounds, to either extend or collapse the shock absorber at an average operating velocity. Fuerza de amortiguación en libras para extender o comprimir el amortiguador a una velocidad de operación promedio. La puissance d'amortissement en poids de l'amortisseur, soit comprimé, doit détendu, à une vitesse de fonctionnement moyenne.

**SPECIFICATIONS BY END MOUNT**  
**ESPECIFICACIONES POR TIPO DE MONTAJE**  
**SPECIFICATIONS PAR FIXATION DES EXTRÉMITÉS**

Gabriel	Mounting		Bore	External Diameter Illustration	Lengths			Dust Tube	Recoil Cutoff	Controls*	
	Upper	Lower			Extended	Collapsed	Stroke			Rebound	Compression
85324	S21	S21	1-5/8"	D	22.14	13.61	8.53	YES	NO	579	114
85346	S21	S21	1-5/8"	D	22.12	13.48	8.64	YES	YES	2016	285
85027	S21	S21	1-5/8"	C	21.59	13.05	8.54	YES	NO	1008	539
89418	S21	S21	1-5/8"	G	21.44	13.19	8.25	YES	NO	1266†	515
695406	S21	S21	2-1/16"	E	21.39	13.26	8.13	YES	YES	1854	274
85124	S21	S21	1-5/8"	C	20.91	12.9	8.01	YES	YES	1086	222
85708	S21	S21	1-5/8"	D	20.63	12.85	7.78	YES	YES	914	204
85745	S21	S21	1-5/8"	D	19.88	12.34	7.54	YES	YES	3064	231
85746	S21	S21	1-5/8"	D	19.88	12.34	7.54	YES	YES	1754	167
83103	S21	S21	1-3/8"	A	19.66	11.93	7.74	YES	YES	517	301
85326	S21	S21	1-5/8"	D	19.64	12.36	7.28	YES	NO	799	142
85902	S21	S21	1-5/8"	G	19.03	12.09	6.93	YES	YES	1441	267
85336	S21	S21	1-5/8"	D	18.76	11.86	6.9	YES	NO	861	200
89423	S21	S21	1-5/8"	G	18.67	12.21	6.46	YES	YES	1352†	573
85310	S21	S21	1-5/8"	D	18.63	11.71	6.92	YES	YES	1379	578
85900	S21	S21	1-5/8"	G	17.33	11.23	6.11	YES	YES	1467	337
87007	S21	S21	2-1/16"	E	15.65	10.4	5.25	YES	YES	879	253
85701	S21	S21	1-5/8"	D	15.64	10.36	5.28	YES	YES	914	204
G63500	S28	ES25	1-3/8"		15.09	10.06	5.03	NO	YES		
G63414	S28	ES83	1-3/8"		15.09	10.06	5.03	NO	YES		
G63489	S29	BP11	1-3/8"		14.44	9.66	4.78	NO	YES		
G63958	S29	BP13	1-3/8"		13.8	9.13	4.67				
G63914	S29	ES84	1-3/8"		21.12	16.31	4.81	YES	YES		
G63895	S29	413042	1-3/8"		14.12	9.68	4.44				
G63894	S29	413042	1-3/8"		12.82	8.88	3.94				
G63893	S29	U-Brkt	1-3/8"		15.07	10.44	4.64				
G64001	S29	U-Brkt	1-3/8"		14.67	11.47	3.194				
G63506	S32	S32	1-3/8"		21.41	12.88	8.53	YES	NO		
G63678	S36	BP7	1-3/8"		18.09	13.56	4.53	YES	NO		
G63622	S36	EB1	1-3/8"		15.42	10.39	5.03	YES	YES		
G63614	S36	EB1	1-3/8"		15.12	10.09	5.03	NO	YES		
G63929	S36	EB1	1-3/8"		14.72	9.71	5.01	YES	YES		
G63608	S36	EB1	1-3/8"		14.58	9.81	4.78	YES	YES		
G63386	S36	ES25	1-3/8"		17.19	11.16	6.03	NO	YES		
G63623	S36	ES83	1-3/8"		22.67	14.39	8.28	YES	YES		
G63624	S36	ES83	1-3/8"		20.17	12.64	7.53	YES	YES		
G63603	S36	ES83	1-3/8"		16.11	10.58	5.53	YES	YES		
G63616	S38	EB2	1-3/8"		23.78	14.25	9.53	YES	NO	610	164

\* Damping force, in pounds, to either extend or collapse the shock absorber at an average operating velocity. Fuerza de amortiguación en libras para extender o comprimir el amortiguador a una velocidad de operación promedio. La puissance d'amortissement en poids de l'amortisseur, soit comprimé, doit détendu, à une vitesse de fonctionnement moyenne.

† At bumper contact / Al contacto cone el tope de goma / Au contact avec le butoir

**SPECIFICATIONS BY END MOUNT**  
**ESPECIFICACIONES POR TIPO DE MONTAJE**  
**SPÉCIFICATIONS PAR FIXATION DES EXTRÉMITÉS**

Gabriel	Mounting		Bore	External Diameter Illustration	Lengths			Dust Tube	Recoil Cutoff	Controls*	
	Upper	Lower			Extended	Collapsed	Stroke			Rebound	Compression
G63886	S38	ES34	1-3/8"		20.8	13.36	7.44				
G63848	S38	ES34	1-3/8"		15.87	10.59	5.28				
83178	S38	ES83	1-3/8"	A	21.95	13.26	8.69	YES	NO	690	275
G63615	S38	S38	1-3/8"		23.66	13.88	9.78	YES	NO		
G63815	S39	ES17	1-3/8"		22.05	13.27	8.78	YES	NO		
G63813	S39	ES17	1-3/8"		12.3	8.5	3.8	YES	NO		
G63865	S39	ES36	1-3/8"		22.49	13.55	8.94				
G63884	S39	ES112	1-3/8"		14.72	9.78	4.94				
83177	S40	EB1	1-3/8"	A	14.99†	10.12	5.38	YES	NO	690	275
83114	S40	ES35	1-3/8"	A	23.02	13.78	9.24	YES	NO	450	102
83105	S40	ES179	1-3/8"	A	31.91	18.3	13.61	YES	NO	559	150
83162	S40	ES190	1-3/8"	A	24.35	14.69	9.67	YES	NO	877	52
85333	S42	ES36	1-5/8"	D	20.65	12.98	7.67	YES	YES	1241	534
85332	S42	ES36	1-5/8"	D	20.64	12.98	7.66	YES	YES	2351	967
85182	S43	S43	1-5/8"	C	26.86	16.04	10.82	YES	NO	708	232
85649	S62	ES34	1-5/8"	G	23.16	16.46	6.7	YES	NO	875	421

\* Damping force, in pounds, to either extend or collapse the shock absorber at an average operating velocity. Fuerza de amortiguación en libras para extender o comprimir el amortiguador a una velocidad de operación promedio. La puissance d'amortissement en poids de l'amortisseur, soit comprimé, doit détendu, à une vitesse de fonctionnement moyenne.

## SPECIFICATIONS BY PART NUMBER

Gabriel	Mounting		Bore	External Diameter Illustration	Lengths			Dust Tube	Recoil Cutoff	Controls*	
	Upper	Lower			Extended	Collapsed	Stroke			Rebound	Compression
632147	0	0	1-3/16"		22.45	14.1	8.35	NO	NO		
646155	ES36	ES36	1-3/16"		22.45	14.1	8.35	YES	NO		
646177	ES36	ES36	1-3/16"		22.45	14.1	8.35	NO	NO		
665472	ES36	ES36	1-5/8"	G	25.14	15.61	9.53	NO	NO	925	977
665937	ES36	ES36	1-5/8"	G	22.91	16.09	6.82	YES	NO		
695406	S21	S21	2-1/16"	E	21.39	13.26	8.13	YES	YES	1854	274
83001	ES149	EB1	1-3/8"	A	10.45†	8.41†	3	YES	YES	793	363
83002	ES10	ES10	1-3/8"	A	11.65	8.66	3	YES	YES	3112	590
83003	S1	BP7	1-3/8"	A	11.76	8.95†	3.4	YES	YES	248	100
83004	ES35	ES136	1"	2" D/T	9.36†	7.29	2.32	YES	YES	539	324
83005	BP8	S10	1-3/16"	2" D/T	7.34	5.87	1.47	YES	NO	858	216
83006	ES149	EB1	1-3/8"	A	10.71	8.52†	2.78	YES	YES	525	182
83007	EB1	EB1	1-3/8"	A	18.55	11.67	6.87	NO	NO	489	343
83008	ES136	ES136	1-3/8"	A	13†	10.13†	4	YES	YES	699	307
83009	ES149	ES149	1-3/8"	A	10.45†	8.41†	3	YES	YES	793	363
83010	ES24	ES24	1"	2" D/T	14.15†	9.33	5.07	YES	YES	188	70
83011	EB1	EB1	1-3/8"	A	11.55†	8.48	3.61	YES	YES	738	330
83012	EB1	EB1	1-3/8"	A	11.07†	8.21	3.37	YES	YES	738	330
83013	BP8	BP8	1-3/16"	2" D/T	7.66	6.63†	1.7	YES	NO	646	480
83014	S1	S1	1-3/8"	A	10.48	7.11	3.37	NO	NO	544	501
83015	BP8	S1	1-3/8"	A	9.84	7.59	2.25	YES	YES	735	430
83016	ES10	ES10	1"	1-5/8"	11.51	8.14	3.37	NO	YES	506	139
83017	ES149	ES149	1-3/8"	A	10.95	8.41†	3.13	YES	YES	353	138
83018	ES24	S10	1-3/8"	A	10.3†	8.42†	3.24	YES	YES	515	174
83019	ES24	S10	1-3/8"	A	9.48	8.21†	2.29	YES	YES	509	121
83020	ES91	ES91	1-3/8"	A	9.41	7.17	2.24	YES	YES	796	255
83021	ES10	ES10	1-3/8"	A	9.41	7.4	2.01	YES	YES	745	315
83022	ES24	ES24	1"	2" D/T	14.28	9.33	4.95	YES	NO	840	152
83023	ES10	ES181	1"	1-5/8"	8.7	7.09†	2.14	NO	YES	484	157
83024	ES10	ES10	1-3/8"	2-1/2" D/T	11.65	8.66	3	YES	YES	811	320
83025	ES163	ES163	1-3/8"	A	8.02	6.53	1.48	YES	YES	710	230
83026	ES24	ES24	1-3/8"	A	13.11	9.12	3.99	YES	YES	602	104
83027	ES24	S10	1-3/8"	A	13.82	9.2	4.61	YES	YES	602	104
83028	ES86	ES167	1-3/8"	A	9.96	7.6	2.33	YES	YES	445	531
83029	ES168	ES169	1-5/8"	C	10.35	7.87	2.41	YES	NO	1303	1349
83030	ES136	ES136	1-3/8"	A	9.61†	7.61	2.5	YES	YES	308	87
83031	ES10	ES10	1-3/8"	2-1/2" D/T	11.54	8.66	2.88	YES	YES	811	314

\* Damping force, in pounds, to either extend or collapse the shock absorber at an average operating velocity.



## SPECIFICATIONS BY PART NUMBER

Gabriel	Mounting		Bore	External Diameter Illustration	Lengths			Dust Tube	Recoil Cutoff	Controls*	
	Upper	Lower			Extended	Collapsed	Stroke			Rebound	Compression
83032	ES163	ES163	1-3/8"	A	7.85	6.36	1.49	NO	YES	779	135
83033	ES53	ES53	1-3/8"	A	13.99	10.37	3.62	YES	YES	494	312
83034	ES115	ES115	1-3/16"	1-5/8"	10.04†	7.32	2.97	NO	YES	430	129
83035	ES166	ES136	1-3/8"	A	13.04†	9.33	4.22	YES	YES	320	100
83038	ES149	EB1	1-3/8"	A	10.45†	8.41†	3	YES	YES	336	242
83039	ES149	ES149	1-3/8"	A	10.44†	8.4†	3	YES	YES	876	326
83040	ES171	ES172	1-3/8"	A	10.44†	8.4†	3	YES	YES	876	326
83041	BP27	S10	1-3/8"	A	10.51†	8.34†	3.02	YES	YES	486	189
83042	ES136	ES136	1-3/8"	A	9.89†	8.52†	2.39	YES	YES	954	541
83044	ES27	ES164	1-3/8"	A	10.91	7.93	2.98	YES	YES	789	296
83045	ES19	S10	1-3/8"	A	11.53†	8.58†	3.81	YES	NO	510	153
83046	ES10	ES181	1-3/16"		9.23†	7.62†	2.73	NO	YES	514	173
83047	ES149	EB1	1-3/8"	A	11.78†	9.74†	3	YES	YES	364	314
83048	ES86	ES167	1-3/8"	A	9.97	8.43†	2.37	YES	YES	904	415
83049	ES163	ES163	1-3/8"	A	8.02	6.53	1.48	YES	YES	2879	705
83050	ES19	S10	1-3/8"	A	10.43†	8.38†	2.9	YES	YES	599	321
83051	ES10	ES10	1-3/8"	2-1/2" D/T	9.41	7.4	2.01	YES	YES	579	163
83052	ES185	ES185	1-3/8"	2-1/2" D/T	9.41	7.19	2.23	YES	NO	1101	149
83053	ES185	ES185	1-3/8"	A	10.91	7.93	2.98	YES	YES	968	214
83054	ES185	ES185	1-3/8"	A	10.28	7.56	2.72	YES	YES	1004	184
83056	ES136	ES136	1-5/8"	C	11.53	8.63	2.89	YES	YES	3830	737
83057	ES171	ES172	1-3/8"	2-1/2" D/T	10.44†	8.4†	2.99	YES	YES	364	242
83058	ES19	S10	1-3/8"	A	10.43†	8.38†	2.9	YES	YES	742	243
83059	ES35	ES35	1-3/8"	A	12.06†	8.68	3.88	YES	YES	738	350
83060	EB	BP7	1-3/8"	A	9.76	7.98†	2.25	NO	YES	431	441
83061	ES10	ES10	1-3/8"	2-1/2" D/T	9.41	7.4	2.01	YES	YES	1030	220
83062	ES185	S42	1-3/8"	A	12.71	9.18	3.53	YES	NO	704	153
83063	ES175	ES136	1-3/8"	A	10.76†	9.26†	3.01	YES	YES	954	541
83064	ES149	ES149	1-3/8"	A	10.41†	8.36†	2.99	YES	YES	635	323
83065	ES206	ES171	1-5/8"	G	12.52	9.32	3.2	YES	YES	680	184
83066	ES153	ES153	1-3/8"	A	11.15†	9.2†	2.78	YES	YES	599	221
83067	ES166	ES136	1-3/16"	2" D/T	12.33†	9.27	3.56	YES	YES	424	101
83081	ES126	ES172	1-3/8"	A	13.39	9.98†	4	YES	YES	1004	232
83100	ES90	ES90	1-3/8"	A	26.6	16.11	10.49	YES	YES	481	142
83101	ES90	ES90	1-3/8"	A	24.63	15.13	9.49	YES	YES	481	142
83102	S21	S21	1-3/8"	A	22.89	13.54	9.35	YES	YES	513	333
83103	S21	S21	1-3/8"	A	19.66	11.93	7.74	YES	YES	517	301

\* Damping force, in pounds, to either extend or collapse the shock absorber at an average operating velocity.

## SPECIFICATIONS BY PART NUMBER

Gabriel	Mounting		Bore	External Diameter Illustration	Lengths			Dust Tube	Recoil Cutoff	Controls*	
	Upper	Lower			Extended	Collapsed	Stroke			Rebound	Compression
83104	EB3	EB3	1-3/8"	A	28.24	17.12	11.12	YES	NO	698	133
83105	S40	ES179	1-3/8"	A	31.91	18.3	13.61	YES	NO	559	150
83106	S21	S21	1-3/8"	A	29.25	16.76	12.49	YES	NO	451	80
83107	EB2	EB2	1-3/8"	A	31.66	18.4	13.25	YES	NO	352	77
83109	ES36	S42	1-3/8"	A	26.17	15.93	10.24	YES	YES	345	78
83110	ES36	S42	1-3/8"	A	22.94	14.31	8.63	YES	YES	450	143
83111	ES36	S42	1-3/8"	A	26.17	15.93	10.24	YES	YES	560	141
83112	ES36	S42	1-3/8"	A	21.52	13.41	8.11	YES	YES	1064	343
83113	ES36	EB3	1-3/8"	A	20.47	13.46	7.01	YES	YES	997	238
83114	S40	ES35	1-3/8"	A	23.02	13.78	9.24	YES	NO	450	102
83115	ES36	EB3	1-3/8"	A	16.19	13.32	4.87	YES	YES	997	238
83116	ES164	ES165	1-3/8"	A	23.81	14.68	9.12	YES	NO	354	300
83117	EB4	EB1	1-3/8"	A	23.98	14.47	9.51	YES	NO	354	300
83118	ES164	ES90	1-3/8"	A	24.45	14.71	9.74	YES	NO	410	311
83119	EB4	ES165	1-3/8"	A	23.96	14.84	9.12	YES	NO	354	300
83120	ES120	S21	1-3/8"	A	22.17	13.66	8.51	YES	YES	779	164
83121	ES36	ES36	1-3/8"	A	30.25	18.32	11.93	YES	YES	689	126
83122	ES36	ES36	1-3/8"	A	25.28	15.79	9.49	YES	YES	661	201
83123	ES36	ES36	1-3/8"	A	26.65	16.41	10.24	YES	YES	589	119
83124	ES36	ES36	1-3/8"	A	21.65	13.77	7.88	YES	YES	750	137
83125	ES36	ES36	1-3/8"	A	28.15	17.16	10.99	YES	YES	625	115
83126	ES36	ES36	1-3/8"	A	24.41	15.27	9.14	YES	YES	625	115
83127	ES36	ES36	1-3/8"	A	20.16	13.14	7.01	YES	YES	940	218
83128	ES36	ES36	1-3/8"	A	16.89	11.53	5.36	YES	YES	940	218
83130	ES36	ES36	1-3/8"	A	18.03	12.04	5.99	YES	YES	871	177
83131	ES83	ES83	1-3/8"	A	27.8	18.18	9.62	YES	NO	212	129
83132	EB3	EB3	1-3/8"	A	25.24	15.5	9.74	YES	NO	828	150
83134	S21	ES36	1-3/8"	A	22.27	13.51	8.77	YES	NO	430	49
83135	ES90	ES90	1-3/8"	A	19.49	12.38	7.11	YES	NO	519	121
83136	S21	S21	1-3/8"	A	29.31	16.8	12.51	YES	NO	914	65
83137	ES36	ES36	1-3/8"	A	30.04	17.79	12.25	YES	YES	517	132
83138	ES36	S42	1-3/8"	A	23.55	14.42	9.12	YES	YES	997	231
83140	EB3	EB3	1-3/8"	A	25.28	15.53	9.75	YES	NO	738	88
83141	EB3	EB3	1-3/8"	A	25.27	15.52	9.75	YES	NO	408	113
83142	ES162	S42	1-3/8"	A	23.92	14.49	9.43	YES	YES	367	131
83143	ES162	S42	1-3/8"	A	21.92	13.51	8.41	YES	YES	403	137
83144	ES36	ES36	1-3/8"	A	23.78	15.03	8.74	YES	YES	596	93

\* Damping force, in pounds, to either extend or collapse the shock absorber at an average operating velocity.

## SPECIFICATIONS BY PART NUMBER

Gabriel	Mounting		Bore	External Diameter Illustration	Lengths			Dust Tube	Recoil Cutoff	Controls*	
	Upper	Lower			Extended	Collapsed	Stroke			Rebound	Compression
83145	ES83	ES83	1-3/8"	A	19.93	12.32	7.54	YES	NO	479	153
83146	ES90	ES83	1-3/8"	A	24.02	14.68	9.33	YES	YES	479	119
83147	ES179	ES179	1-3/8"	A	28.54	17.4	11.15	YES	YES	358	128
83148	ES179	ES179	1-3/8"	A	30	17.83	12.17	YES	YES	604	149
83149	ES36	ES36	1-3/8"	A	25.28	15.78	9.49	YES	YES	332	101
83150	ES36	ES36	1-3/8"	A	15.24	10.43	4.81	YES	YES	940	216
83153	ES34	ES34	1-3/8"	A	21.69	13.62	8.07	YES	YES	974	206
83154	ES120	S21	1-3/8"	A	20.78	12.72	8.06	YES	YES	599	140
83155	ES34	ES34	1-3/8"	A	21.69	13.62	8.07	YES	YES	507	80
83156	ES90	ES90	1-3/8"	A	18.55	11.91	6.64	YES	NO	778	135
83157	ES36	ES90	1-3/8"	A	26.38	15.76	10.61	YES	NO	446	303
83158	ES22	ES22	1-3/8"	A	12.96	8.97	4	YES	NO	783	484
83159	EB2	EB2	1-3/8"	A	21.85	13.56	8.29	YES	NO	658	149
83160	ES128	ES36	1-3/8"	A	24.31	14.9	9.37	YES	YES	920	161
83161	S1	EB1	1-3/8"	A	20.82	12.56	8.25	YES	NO	400	70
83162	S40	ES190	1-3/8"	A	24.35	14.69	9.67	YES	NO	877	52
83163	ES175	ES175	1-3/8"	A	20.75	13.01	7.74	YES	NO	828	98
83164	ES36	ES165	1-3/8"	C	24.22	14.59	9.63	YES	NO	426	274
83166	ES179	ES179	1-3/8"	A	25.28	15.78	9.49	YES	YES	622	132
83167	ES90	ES90	1-3/8"	A	19.49	12.38	7.11	YES	NO	285	90
83168	ES179	ES179	1-3/8"	A	25.28	15.78	9.49	YES	YES	246	88
83169	ES90	ES90	1-3/8"	A	18.55	11.91	6.64	YES	NO	599	171
83171		ES36	1-3/8"	A	23.98	14.51	9.47	YES	YES	513	146
83174	ES128	ES36	1-3/8"	A	24.31	14.9	9.37	YES	YES	795	160
83175	ES175	ES175	1-3/8"	A	20.48	13.19	7.29	YES	NO	1245	156
83176	ES36	ES36	1-3/8"	A	26.62	15.96	10.66	NO	NO	406	275
83177	S40	EB1	1-3/8"	A	14.99†	10.12	5.38	YES	NO	690	275
83178	S38	ES83	1-3/8"	A	21.95	13.26	8.69	YES	NO	690	275
83180	ES90	ES83	1-3/8"		30.2	21.24	8.96	YES	NO	909	204
83200	EB2	EB2	1-3/8"	A	24.51	15.1	9.53	YES	NO	806	370
83203	ES36	ES36	1-3/8"	A	17.1	11.36	5.74	YES	YES	609	114
83204	ES36	ES36	1-3/8"	A	20.14	12.86	7.28	YES	YES	451	110
83205	ES36	ES36	1-3/8"	A	29.69	17.69	12	YES	YES	660	76
83207	ES36	ES36	1-3/8"	A	21.64	13.61	8.03	YES	YES	553	143
83209	ES36	ES36	1-3/8"	A	29.64	17.61	12.03	YES	YES	670	78
83214	EB3	EB3	1-3/8"	A	19.64	12.86	6.78	YES	YES	269	90
83215	EB3	EB3	1-3/8"	A	26.64	16.36	10.28	YES	YES	697	108

\* Damping force, in pounds, to either extend or collapse the shock absorber at an average operating velocity.

## SPECIFICATIONS BY PART NUMBER

Gabriel	Mounting		Bore	External Diameter Illustration	Lengths			Dust Tube	Recoil Cutoff	Controls*	
	Upper	Lower			Extended	Collapsed	Stroke			Rebound	Compression
83216	EB2	EB2	1-3/8"	A	23.51	14.48	9.03	YES	YES	776	262
83217	EB3	EB3	1-3/8"	A	22.77	14.49	8.28	YES	YES	633	159
83218	ES36	ES36	1-3/8"	A	25.19	15.44	9.75	YES	YES	721	194
83219	EB2	EB2	1-3/8"	A	20.01	12.73	7.28	YES	YES	299	125
83221	ES36	ES36	1-3/8"	A	24.01	14.73	9.28	YES	YES	599	153
83225	EB3	EB3	1-3/8"	A	24.14	15.11	9.03	YES	YES	482	159
83242	ES36	ES36	1-3/8"	A	33.73	20.98	12.75	YES	YES	721	135
83301	S16	ES90	1-3/8"	B	24.52	14.74	9.78	YES	YES	653	86
83303	EB7	ES36	1-3/8"	B	24.86	15.08	9.78	YES	YES	470	122
83304	EB7	ES36	1-3/8"	B	22.86	14.08	8.78	YES	YES	470	122
83308	EB2	EB2	1-3/8"	B	25.14	15.36	9.78	YES	YES	445	180
83309	EB2	EB2	1-3/8"	B	28.64	17.11	11.53	YES	YES	589	135
83310	ES36	ES36	1-3/8"	B	24.06	14.69	9.37	YES	NO	559	153
83312	EB2	EB2	1-3/8"	B	26.64	16.11	10.53	YES	YES	527	152
83314	EB2	EB2	1-3/8"	B	30.64	18.11	12.53	YES	YES	633	143
83317	S16	ES90	1-3/8"	B	27.03	16	11.34	YES	YES		
83318	S16	S16	1-3/8"	B	22.53	13.5	9.03	YES	YES	323	77
83353	EB3	S21	1-3/8"	B	24.84	15.06	9.78	YES	NO	432	214
83362	EB3	EB3	1-3/8"	B	27	16.25	10.75	YES	NO	539	202
83363	ES36	ES36	1-3/8"	A	16.46	11.35	5.11	YES	YES	1084	201
83364	ES90	ES83	1-3/8"	A	24.06	15.07	8.99	YES	YES	855	206
83389	ES36	ES36	1-3/8"	A	17.32	11.57	5.75	YES	YES	1084	228
83391	ES190	ES190	1-3/8"	A	25.52	15.61	9.91	YES	NO	590	105
83395	S21	ES178	1-3/8"	A	27.19	16.28	10.91	YES	NO	616	105
83396	ES179	ES179	1-3/8"		20.75	14.04	6.71	YES	YES	583	334
83400	S1	S1	1-3/16"	F	22.02	12.82	9.2	YES	NO	301	120
83401	EB1	EB1	1-3/16"	F	24.09	14.26	9.83	YES	NO	341	252
83404	EB2	EB2	1-3/16"	F	22.01	13.44	8.58	YES	NO	545	171
83456	S21	S21	1-3/8"	B	24.03	14.25	9.78	YES	YES	566	80
83515	S1	EB2	1-3/16"		23.34	13.89	9.45	YES	NO	643	205
83518	S1	EB2	1-3/16"		24.4	14.26	10.14	YES	NO	153	82
83519	EB2	EB2	1-3/16"	F	23.83	14.35	9.48	YES	NO	292	132
83613	S16	S16	1-3/8"	A	21.04	12.76	8.28	YES	YES	601	242
83634	ES120	ES120	1-3/8"	A	27.48	16.23	11.25	YES	YES	779	157
83635	ES36	S21	1-3/8"	A	21.74	13.25	8.49	YES	NO	558	119
83636	ES90	ES90	1-3/8"	A	27.72	16.95	10.77	YES	YES	505	148
83901	ES153	ES153	1-3/8"	A	11.15†	9.2†	2.78	YES	YES	509	204

\* Damping force, in pounds, to either extend or collapse the shock absorber at an average operating velocity.

## SPECIFICATIONS BY PART NUMBER

Gabriel	Mounting		Bore	External Diameter Illustration	Lengths			Dust Tube	Recoil Cutoff	Controls*	
	Upper	Lower			Extended	Collapsed	Stroke			Rebound	Compression
83905	ES86	ES167	1-3/8"	2-1/2" D/T	9.3†	7.81†	2.21	YES	YES	1105	170
83906	ES85	EB1	1-3/8"	2-1/2" D/T	10.45†	8.41†	3.01	YES	YES	586	320
83907	ES147	ES147	1-3/8"	A	14.97	10.61	4.36	YES	YES	460	365
83908	ES27	ES91	1-3/8"	A	9.3	7.03	2.27	YES	NO	904	279
85000	ES36	ES36	1-5/8"	C	17.28	11.5	5.78	YES	YES	1019	219
85001	EB3	EB3	1-5/8"	C	26.3	16.39	9.92	YES	NO	1202	186
85003	ES90	ES90	1-5/8"	C	25.42	15.63	9.79	YES	YES	437	182
85004	EB3	EB3	1-5/8"	C	20.68	13.67	7.01	YES	YES	1019	219
85005	ES36	ES36	1-5/8"	C	24.76	15.24	9.52	YES	YES	1019	219
85006	ES36	ES36	1-5/8"	C	28.54	17.13	11.41	YES	YES	1019	219
85007	EB3	EB3	1-5/8"	C	24.33	15.4	8.93	YES	YES	1008	171
85009	S21	ES36	1-5/8"	C	23.56	14.4	9.16	YES	YES	857	144
85010	ES36	ES36	1-5/8"	C	26.8	16.26	10.54	YES	YES	1019	219
85011	ES120	ES121	1-5/8"	C	27.49	16.46	11.03	YES	NO	1268	186
85012	EB2	EB2	1-5/8"	C	21.02	13.23	7.79	YES	NO	523	199
85013	ES36	ES36	1-5/8"	C	29.79	17.76	12.04	YES	YES	1019	219
85014	ES36	ES36	1-5/8"	C	21.76	13.74	8.02	YES	YES	1019	219
85023	EB2	EB2	1-5/8"	C	20.27	13	7.27	YES	YES	1008	539
85024	EB2	EB2	1-5/8"	C	28.77	17.25	11.52	YES	YES	1008	539
85025	EB2	S21	1-5/8"	C	23.02	14.01	9.01	YES	NO	1079	539
85026	ES136	S21	1-5/8"	C	23.02	14.01	9.01	YES	NO	1079	539
85027	S21	S21	1-5/8"	C	21.59	13.05	8.54	YES	NO	1008	539
85029	ES36	ES36	1-5/8"	C	20.54	13.11	7.43	YES	YES	1019	219
85030	ES36	ES36	1-5/8"	C	24.05	14.89	9.16	YES	YES	1019	219
85031	ES176	EB2	1-5/8"	C	25.63	15.87	9.76	YES	NO	941	257
85033	S21	EB3	1-5/8"	C	27.26	17.4	9.86	YES	YES	764	254
85036	ES36	ES36	1-5/8"	C	26.38	16.29	10.09	YES	YES	633	119
85040	EB3	EB3	1-5/8"	C	30.91	18.51	12.4	YES	NO	889	114
85042	EB3	EB3	1-5/8"	C	20.64	13.61	7.03	YES	YES	333	161
85043	ES36	ES36	1-5/8"	C	27.63	16.85	10.78	YES	YES	628	163
85044	ES36	ES36	1-5/8"	C	22.63	14.1	8.53	YES	NO	722	212
85045	ES36	ES36	1-5/8"	C	14.52	10.12	4.4	YES	YES	1020	219
85046	EB2	EB2	1-5/8"	C	27.55	16.62	10.93	YES	YES	1008	539
85047	EB2	EB2	1-5/8"	C	25.31	15.52	9.79	YES	YES	1008	539
85048	S21	S21	1-5/8"	C	29.16	16.88	12.28	YES	NO	432	106
85049	S21	S21	1-5/8"	C	25.53	15	10.53	YES	NO	597	107
85050	ES36	ES36	1-5/8"	C	23.28	14.5	9.03	YES	NO	525	138

\* Damping force, in pounds, to either extend or collapse the shock absorber at an average operating velocity.

## SPECIFICATIONS BY PART NUMBER

Gabriel	Mounting		Bore	External Diameter Illustration	Lengths			Dust Tube	Recoil Cutoff	Controls*	
	Upper	Lower			Extended	Collapsed	Stroke			Rebound	Compression
85051	ES36	ES36	1-5/8"	C	18.54	12.13	6.41	YES	YES	1019	139
85052	ES36	ES36	1-5/8"	C	13.26	9.49	3.77	YES	YES	1429	335
85053	EB3	EB3	1-5/8"	C	24.69	15.52	9.17	YES	NO	1019	227
85054	EB2	EB2	1-5/8"	C	23.26	14.37	8.89	YES	NO	602	104
85055	EB2	EB2	1-5/8"	C	25.63	15.63	10	YES	NO	577	102
85056	S21	ES36	1-5/8"	C	20.15	12.87	7.28	YES	YES	732	114
85057	ES36	EB3	1-5/8"	C	21.45	14.23	7.22	YES	YES	1216	115
85058	ES36	ES36	1-5/8"	C	22.67	14.26	8.41	YES	YES	722	114
85059	ES36	EB3	1-5/8"	C	19.09	12.8	6.29	YES	YES	928	151
85060	ES36	ES36	1-5/8"	C	19.79	12.76	7.04	YES	YES	943	405
85061	ES161	ES162	1-5/8"	C	24.76	15.25	9.51	YES	YES	1216	195
85062	EB2	EB2	1-5/8"	C	19.76	12.6	7.16	YES	NO	523	199
85063	EB2	EB2	1-5/8"	C	32.01	18.85	13.16	YES	NO	762	174
85064	ES36	ES36	1-5/8"	C	16.02	10.75	5.27	YES	YES	1481	340
85065	ES161	S21	1-5/8"	C	28.05	17	11.05	YES	YES	1059	300
85066	ES161	ES162	1-5/8"	C	24.64	15.25	9.39	YES	YES	812	322
85067	ES174	ES136	1-5/8"	C	30.54	18.15	12.39	YES	YES	676	170
85069	S21	S21	1-5/8"	C	26.31	15.97	10.33	YES	YES	762	255
85070	ES174	EB3	1-5/8"	C	25.59	15.83	9.76	YES	NO	1100	310
85071	S21	S21	1-5/8"	C	25.57	15.02	10.55	YES	NO	610	107
85072	ES36	ES176	1-5/8"	C	24.17	14.81	9.36	YES	YES	1387	305
85078	ES36	ES36	1-5/8"	C	14.76	10.12	4.64	YES	YES	1409	282
85079	ES36	ES36	1-5/8"	C	12.04	8.87	3.17	YES	YES	1494	325
85080	ES175	S21	1-5/8"	C	22.51	13.77	8.74	YES	NO	447	138
85081	ES175	S21	1-5/8"	C	23.44	14.33	9.11	YES	YES	1658	250
85082	ES90	ES90	1-5/8"	C	28.6	20.64	7.97	YES	YES	1435	266
85083	ES162	S42	1-5/8"	C	27.81	16.53	11.28	YES	YES	1429	184
85084	ES174	ES136	1-5/8"	C	20.59	13.03	7.57	YES	NO	1145	407
85085	S21	S21	1-5/8"	C	24.95	14.67	10.23	YES	NO	970	101
85086	ES36	ES36	1-5/8"	C	17.55	11.63	5.92	YES	YES	2027	389
85087	ES36	ES176	1-5/8"	C	22.78	14.7	8.08	YES	YES	1568	403
85088	ES161	ES162	1-5/8"	C	25.31	15.52	9.79	YES	YES	616	178
85090	ES150	ES36	1-5/8"	C	25.31	15.52	9.79	YES	YES	943	99
85091	ES36	ES36	1-5/8"	C	21.38	13.56	7.82	YES	NO	1121	331
85092	ES150	S21	1-5/8"	C	21.95	15.04	6.89	YES	YES	1597	138
85097	ES36	ES36	1-5/8"	C	27.95	17.11	10.84	YES	YES	1086	109
85098	ES161	ES162	1-5/8"	C	24.64	15.24	9.4	YES	YES	747	158

\* Damping force, in pounds, to either extend or collapse the shock absorber at an average operating velocity.

## SPECIFICATIONS BY PART NUMBER

Gabriel	Mounting		Bore	External Diameter Illustration	Lengths			Dust Tube	Recoil Cutoff	Controls*	
	Upper	Lower			Extended	Collapsed	Stroke			Rebound	Compression
85099	ES36	ES36	1-5/8"	C	26.02	15.93	10.09	YES	YES	1152	135
85102	ES36	ES136	1-5/8"	C	21.52	14.93	6.59	YES	YES	1224	342
85106	ES150	ES150	1-5/8"	C	20.03	12.89	7.14	YES	YES	1054	109
85109	ES36	ES195	1-5/8"	C	24.21	15.14	9.07	YES	YES	1123	149
85119	ES150	ES150	1-5/8"	C	21.39	13.81	7.68	YES	YES	1387	185
85120	ES175	ES175	1-5/8"	C	23.67	15.06	8.61	YES	NO	2083	519
85122	ES120	S21	1-5/8"	C	22.22	13.78	8.44	YES	YES	926	162
85123	ES120	S21	1-5/8"	C	21.49	13.26	8.23	YES	NO	1809	246
85124	S21	S21	1-5/8"	C	20.91	12.9	8.01	YES	YES	1086	222
85125	ES158	ES159	1-5/8"	C	26.9	16.64	10.26	YES	YES	1479	183
85126	ES158	S21	1-5/8"	C	21.76	13.63	8.13	YES	YES	1086	215
85180	ES150	ES36	1-5/8"	C	20.94	13.83	7.11	YES	YES	681	283
85181	ES150	ES150	1-5/8"	C	26.33	17.06	9.27	YES	YES	681	285
85182	S43	S43	1-5/8"	C	26.86	16.04	10.82	YES	NO	708	232
85300	EB3	EB3	1-5/8"	D	17.98	12.21	5.78	YES	YES	1435	676
85301	EB3	EB3	1-5/8"	D	31.92	19.03	12.89	YES	NO	1442	455
85302	EB3	EB3	1-5/8"	D	22.75	14.61	8.14	YES	NO	836	253
85303	EB3	EB3	1-5/8"	D	24.76	15.48	9.29	YES	NO	1019	221
85304	EB3	EB3	1-5/8"	D	22.25	14.22	8.03	YES	NO	767	325
85305	EB3	EB3	1-5/8"	D	27.25	16.7	10.55	YES	NO	1120	225
85307	EB3	EB3	1-5/8"	D	23.98	15.08	8.89	YES	NO	1094	173
85308	EB3	EB3	1-5/8"	D	25.11	15.83	9.28	YES	YES	764	254
85310	S21	S21	1-5/8"	D	18.63	11.71	6.92	YES	YES	1379	578
85311	S21	EB3	1-5/8"	D	23.95	14.79	9.16	YES	YES	764	254
85312	EB3	S21	1-5/8"	D	23.68	14.8	8.88	YES	YES	717	111
85313	EB3	EB3	1-5/8"	D	26.26	16.35	9.91	YES	YES	717	111
85314	EB3	EB3	1-5/8"	D	26.49	16.46	10.03	YES	YES	1216	169
85315	EB3	EB3	1-5/8"	D	29.61	18.07	11.53	YES	NO	380	142
85316	S21	ES36	1-5/8"	D	20.61	12.82	7.8	YES	NO	943	443
85317	S21	EB3	1-5/8"	D	27.18	17.42	9.76	YES	YES	764	254
85318	S21	S21	1-5/8"	D	27.37	16.36	11.01	YES	YES	1372	192
85319	S21	ES150	1-5/8"	D	22.22	13.93	8.3	YES	YES	988	454
85320	EB3	EB3	1-5/8"	D	26.15	16.35	9.8	YES	NO	970	308
85321	ES36	ES36	1-5/8"	D	25.38	15.59	9.79	YES	YES	1435	676
85322	EB3	ES160	1-5/8"	D	15.26	11.85	3.41	YES	YES	764	162
85323	ES36	ES36	1-5/8"	D	17.36	11.58	5.78	YES	YES	1085	163
85324	S21	S21	1-5/8"	D	22.14	13.61	8.53	YES	NO	579	114

\* Damping force, in pounds, to either extend or collapse the shock absorber at an average operating velocity.

## SPECIFICATIONS BY PART NUMBER

Gabriel	Mounting		Bore	External Diameter Illustration	Lengths			Dust Tube	Recoil Cutoff	Controls*	
	Upper	Lower			Extended	Collapsed	Stroke			Rebound	Compression
85325	S21	S21	1-5/8"	D	23.64	14.36	9.28	YES	NO	1024	240
85326	S21	S21	1-5/8"	D	19.64	12.36	7.28	YES	NO	799	142
85327	EB3	ES160	1-5/8"	D	16.01	12.1	3.91	YES	YES	764	162
85328	S21	S21	1-5/8"	D	25.64	15.36	10.28	YES	NO	930	383
85329	EB3	EB3	1-5/8"	D	24.52	15.48	9.04	YES	YES	1550	232
85330	EB3	S21	1-5/8"	D	22.44	14.16	8.28	YES	YES	1140	176
85331	ES158	ES159	1-5/8"	D	19.62	12.85	6.77	YES	YES	1757	396
85332	S42	ES36	1-5/8"	D	20.64	12.98	7.66	YES	YES	2351	967
85333	S42	ES36	1-5/8"	D	20.65	12.98	7.67	YES	YES	1241	534
85334	EB3	EB3	1-5/8"	D	14.52	10.48	4.04	YES	YES	1271	319
85335	ES158	ES159	1-5/8"	D	19.62	12.85	6.77	YES	YES	827	107
85336	S21	S21	1-5/8"	D	18.76	11.86	6.9	YES	NO	861	200
85337	ES36	ES36	1-5/8"	D	28.72	17.44	11.28	YES	YES	1318	374
85338	ES36	ES36	1-5/8"	D	19.47	12.68	6.79	YES	YES	1664	420
85339	EB3	EB3	1-5/8"	D	31.68	19.02	12.66	YES	YES	804	463
85340	ES188	S21	1-5/8"	D	26.46	15.85	10.61	YES	YES	1807	165
85341	ES188	S21	1-5/8"	D	30.96	18.1	12.86	YES	YES	1807	333
85342	S21	S21	1-5/8"	D	23.28	13.99	9.29	YES	NO	893	188
85343	S21	EB3	1-5/8"	D	22.96	14.79	8.17	YES	YES	858	289
85344	ES36	ES36	1-5/8"	D	13.22	9.45	3.77	YES	YES	1581	443
85345	ES36	ES36	1-5/8"	D	21.83	13.82	8.01	YES	YES	1093	219
85346	S21	S21	1-5/8"	D	22.12	13.48	8.64	YES	YES	2016	285
85347	S21	S21	1-5/8"	D	23.62	14.22	9.4	YES	YES	961	122
85351	S21	ES36	1-5/8"	D	20.61	12.82	7.79	YES	NO	1887	259
85376	EB3	EB3	1-5/8"	D	33.27	19.73	13.54	YES	NO	668	134
85377	ES182	ES182	1-5/8"	D	23.8	14.84	8.96	YES	YES	1937	570
85378	ES182	ES182	1-5/8"	D	23.8	14.84	8.96	YES	YES	1110	240
85379	EB3	S21	1-5/8"	D	22.69	14.4	8.29	YES	YES	1658	176
85380	EB3	S21	1-5/8"	D	23.95	14.79	9.15	YES	YES	1568	227
85382	ES36	ES36	1-5/8"	D	20.22	13.07	7.15	YES	YES	1658	420
85637	ES90	ES36	1-5/8"	G	20.74	13.19	7.55	YES	NO	2256	327
85638	ES179	ES179	1-5/8"	G	28.58	17.4	11.18	YES	YES	643	138
85639	ES90	ES36	1-5/8"	G	27.08	17.79	9.29	YES	NO	795	109
85642	ES177	ES90	1-5/8"	G	22.52	14.52	8	YES	YES	1920	309
85648	ES90	ES90	1-5/8"	G	22.28	13.97	8.31	YES	NO	761	247
85649	S62	ES34	1-5/8"	G	23.16	16.46	6.7	YES	NO	875	421
85650	ES136	ES34	1-5/8"	G	24.88	16.35	8.53	YES	NO	941	463

\* Damping force, in pounds, to either extend or collapse the shock absorber at an average operating velocity.



## SPECIFICATIONS BY PART NUMBER

Gabriel	Mounting		Bore	External Diameter Illustration	Lengths			Dust Tube	Recoil Cutoff	Controls*	
	Upper	Lower			Extended	Collapsed	Stroke			Rebound	Compression
85700	EB3	EB3	1-5/8"	D	26.09	16.58	9.51	YES	YES	1446	328
85701	S21	S21	1-5/8"	D	15.64	10.36	5.28	YES	YES	914	204
85702	EB3	EB3	1-5/8"	D	23.76	15.85	7.91	YES	YES	1093	825
85703	S21	EB3	1-5/8"	D	29.57	18.54	11.03	YES	YES	1435	186
85704	EB3	EB3	1-5/8"	D	28.75	18.72	10.03	YES	YES	1435	186
85705	S21	S21	1-5/8"	D	23.62	14.23	9.39	YES	YES	639	436
85706	S21	S21	1-5/8"	D	23.65	14.24	9.41	YES	YES	1086	696
85707	S21	S21	2-1/16"	D	23.65	14.4	9.25	YES	YES	1761	986
85708	S21	S21	1-5/8"	D	20.63	12.85	7.78	YES	YES	914	204
85709	S21	S21	1-5/8"	D	31.64	18.36	13.28	YES	YES	700	203
85710	S21	EB3	1-5/8"	D	23.45	15.1	8.34	YES	YES	994	248
85711	S21	EB3	1-5/8"	D	24.54	15.26	9.27	YES	YES	1435	208
85712	EB3	EB3	1-5/8"	D	20.5	13.47	7.04	YES	YES	1435	562
85713	EB3	EB3	1-5/8"	D	24.51	15.48	9.04	YES	YES	1157	180
85714	EB3	EB3	1-5/8"	D	25.13	15.85	9.28	YES	YES	1220	175
85715	EB3	EB3	1-5/8"	D	25.13	15.85	9.28	YES	YES	1915	200
85716	EB3	EB3	1-5/8"	D	21.99	14.33	7.66	YES	YES	1220	175
85717	EB3	EB3	1-5/8"	D	25.13	15.85	9.28	YES	YES	1915	200
85718	EB3	EB3	1-5/8"	D	22.13	15.04	7.09	YES	YES	2506	206
85719	EB3	EB3	1-5/8"	D	17.25	11.97	5.28	YES	YES	1517	213
85720	EB3	EB3	1-5/8"	D	20.5	13.47	7.03	YES	YES	1435	562
85722	S21	S21	1-5/8"	D	27.16	16.41	10.76	YES	YES	1264	369
85723	EB3	S21	1-5/8"	D	19.93	12.9	7.03	YES	YES	1318	248
85724	ES158	ES159	1-5/8"	D	22.81	14.51	8.3	YES	YES	1235	454
85727	S21	S21	1-5/8"	D	29.88	17.34	12.54	YES	YES	783	111
85728	S21	S21	1-5/8"	D	24.37	14.86	9.51	YES	YES	1435	510
85729	EB3	S21	1-5/8"	D	21.55	13.77	7.78	YES	YES	783	111
85730	EB3	EB3	1-5/8"	D	30.75	18.72	12.03	YES	YES	1517	293
85731	S21	EB3	1-5/8"	D	30.57	18.54	12.03	YES	YES	1517	293
85732	EB3	EB3	2-1/16"	E	22.13	15.11	7.03	YES	YES	2632	382
85733	EB3	S21	1-5/8"	D	23.57	14.73	8.84	YES	YES	717	111
85734	EB3	EB3	1-5/8"	D	20.73	13.7	7.03	YES	YES	1288	227
85735	EB3	EB3	1-5/8"	D	26.72	16.7	10.02	YES	YES	1288	227
85736	EB3	EB3	1-5/8"	D	23.61	15.2	8.41	YES	YES	1155	352
85737	ES173	ES173	1-5/8"	D	15.11	10.84	4.27	YES	YES	3066	782
85738	ES36	ES36	1-5/8"	D	17.46	11.69	5.77	YES	YES	1830	416
85739	ES187	ES187	1-5/8"	D	20.73	13.54	7.19	YES	YES	3247	334

\* Damping force, in pounds, to either extend or collapse the shock absorber at an average operating velocity.

## SPECIFICATIONS BY PART NUMBER

Gabriel	Mounting		Bore	External Diameter Illustration	Lengths			Dust Tube	Recoil Cutoff	Controls*	
	Upper	Lower			Extended	Collapsed	Stroke			Rebound	Compression
85740	EB3	S21	1-5/8"	D	24.7	15.15	9.55	YES	YES	848	305
85745	S21	S21	1-5/8"	D	19.88	12.34	7.54	YES	YES	3064	231
85746	S21	S21	1-5/8"	D	19.88	12.34	7.54	YES	YES	1754	167
85900	S21	S21	1-5/8"	G	17.33	11.23	6.11	YES	YES	1467	337
85901	EB3	EB3	1-5/8"	G	29.09	17.68	11.42	YES	NO	1830	418
85902	S21	S21	1-5/8"	G	19.03	12.09	6.93	YES	YES	1441	267
85903	ES36	ES36	1-5/8"	G	31.99	19.13	12.86	YES	YES	666	113
85904	ES36	ES36	1-5/8"	G	27.61	16.88	10.73	YES	YES	666	113
85905	ES36	EB3	1-5/8"	G	23.81	16.16	7.66	YES	YES	1020	219
85906	ES36	ES36	1-5/8"	G	21.77	14.05	7.72	YES	YES	700	255
85907	ES36	EB3	1-5/8"	G	21.43	14.2	7.23	YES	YES	1216	251
85908	ES36	ES36	1-5/8"	G	18.48	12.25	6.23	YES	YES	1020	219
85909	ES36	ES36	1-5/8"	G	24.25	15.19	9.06	YES	YES	700	255
85910	ES36	ES36	1-5/8"	G	20.79	13.54	7.25	YES	YES	1074	219
85911	ES36	ES36	1-5/8"	G	16.89	11.53	5.36	YES	YES	1020	219
85912	EB3	ES36	1-5/8"	G	18.68	12.57	6.11	YES	YES	1020	219
85913	ES36	EB3	1-5/8"	G	22.56	15.2	7.36	YES	YES	1020	219
85914	ES36	ES36	1-5/8"	G	14.36	10.25	4.11	YES	YES	1020	219
85915	ES36	EB3	1-5/8"	G	19.06	12.7	6.36	YES	YES	1020	219
85916	ES36	ES36	1-5/8"	G	24.65	15.55	9.1	YES	YES	1149	219
85918	ES150	ES150	1-5/8"	G	22.97	14.58	8.39	YES	NO	1726	412
85919	ES36	ES36	1-5/8"	G	22.52	14.33	8.19	YES	YES	1265	121
85920	ES150	ES150	1-5/8"	G	21.16	13.57	7.59	YES	NO	845	49
85921	S21	ES36	1-5/8"	G	22.07	13.57	8.5	YES	NO	2053	339
85922	ES150	ES150	1-5/8"	G	21.19	13.53	7.66	YES	NO	878	185
85923	ES177	ES161	1-5/8"	G	22.52	14.52	8	YES	YES	1940	221
85924	ES90	ES36	1-5/8"	G	20.39	12.99	7.41	YES	NO	1036	122
85925	ES90	ES90	1-5/8"	G	22.56	15.6	6.95	YES	NO	761	144
85926	ES90	ES90	1-5/8"	G	26.5	17.96	8.54	YES	YES	1387	279
85927	ES90	ES90	1-5/8"	G	24.76	15.47	9.3	YES	YES	1288	388
85928	ES90	ES90	1-5/8"	G	20.31	13.24	7.07	YES	NO	957	229
85929	ES90	ES90	1-5/8"	G	20.28	13.21	7.08	YES	NO	2214	267
85930	ES177	ES161	1-5/8"	G	17.86	12	5.86	YES	YES	1617	342
85931	ES177	ES161	1-5/8"	G	22.52	14.52	8	YES	YES	1435	220
85932	ES178	ES150	1-5/8"	G	21.26	13.7	7.56	YES	YES	1102	430
85933	ES175	ES175	1-5/8"	G	18.27	12.72	5.54	YES	YES	1089	383
85934	ES36	ES36	1-5/8"	G	17.8	12.04	5.75	YES	YES	3511	1063

\* Damping force, in pounds, to either extend or collapse the shock absorber at an average operating velocity.

## SPECIFICATIONS BY PART NUMBER

Gabriel	Mounting		Bore	External Diameter Illustration	Lengths			Dust Tube	Recoil Cutoff	Controls*	
	Upper	Lower			Extended	Collapsed	Stroke			Rebound	Compression
85935	S21	ES36	1-5/8"	G	18.7	11.92	6.78	YES	NO	1054	419
85936	ES174	S43	1-5/8"	G	17.27	11.48	5.79	YES	YES	1479	337
85937	ES174	S43	1-5/8"	G	19.04	12.35	6.7	YES	YES	1479	337
85938	ES36	ES36	1-5/8"	G	16.06	10.82	5.24	YES	YES	1581	432
85939	ES36	ES36	1-5/8"	G	14.44	10.04	4.41	YES	YES	1719	420
85953	ES90	ES90	1-5/8"	G	26.13	15.86	10.27	YES	NO	2001	153
85954	ES90	ES36	1-5/8"	G	20.43	13	7.43	YES	NO	1812	148
85955	ES175	ES150	1-5/8"	G	21.25	13.66	7.59	YES	YES	1034	397
85956	ES183	ES184	1-5/8"	G	30.65	18.77	11.88	YES	YES	979	373
85957	ES90	ES90	1-5/8"	G	20.78	13.19	7.6	YES	NO	1583	138
85958	ES150	ES150	1-5/8"	G	22.89	14.5	8.39	YES	YES	1926	281
85959	ES150	ES150	1-5/8"	G	21.16	13.57	7.59	YES	YES	1021	123
85961	ES178	ES176	1-5/8"	G	22.83	14.17	8.66	YES	YES	2206	240
85962	ES178	ES176	1-5/8"	G	21.8	13.66	8.15	YES	YES	2206	240
85963	ES90	ES36	1-5/8"	G	25.49	18.68	6.81	YES	YES	1490	206
85964	ES90	ES36	1-5/8"	G	25.49	18.68	6.81	YES	YES	1981	205
85965	ES178	ES161	1-5/8"	G	24.24	15.15	9.09	YES	YES	2206	238
85966	ES178	ES161	1-5/8"	G	23.25	14.64	8.62	YES	YES	2206	238
85967	ES178	ES176	1-5/8"	G	23.93	14.86	9.07	YES	YES	2206	238
85968	EB3	EB3	1-5/8"	G	19.87	13.39	6.48	YES	YES	1069	227
85969	ES90	ES36	1-5/8"	G	18.38	11.93	6.45	YES	NO	1612	125
85970	ES188	S21	1-5/8"	G	27.23	16.44	10.79	YES	YES	1092	147
85971	ES36	ES36	1-5/8"	G	22.56	14.17	8.39	YES	NO	2315	451
85972	ES36	ES36	1-5/8"	G	30.78	18.26	12.52	YES	NO	1493	261
85974	ES36	ES36	1-5/8"	G	26.02	16.11	9.91	YES	YES	3087	230
85975	ES36	ES36	1-5/8"	G	24.24	15.15	9.09	YES	YES	1658	219
85976	ES36	ES36	1-5/8"	G	29.92	18.12	11.8	YES	YES	582	138
85977	ES36	S42	1-5/8"	G	26.2	15.91	10.29	YES	YES	582	138
85978	ES179	ES179	1-5/8"	G	29.84	18.16	11.69	YES	YES	582	138
85979	ES36	ES36	1-5/8"	G	31.18	18.66	12.52	YES	YES	582	138
85980	ES179	ES179	1-5/8"	G	31.17	18.66	12.52	YES	YES	582	138
85984	ES158	ES150	1-5/8"	G	25.44	15.96	9.48	YES	YES	2248	1168
85985	ES174	S43	1-5/8"	G	19.04	12.31	6.73	YES	YES	2068	723
85986	ES175	ES150	1-5/8"	G	21.25	13.66	7.59	YES	YES	1754	221
85988	S21	EB3	1-5/8"	G	23.84	14.87	8.97	YES	YES	1200	138
85989	ES174	ES136	1-5/8"	G	20.78	13.15	7.63	YES	NO	1812	351
85994	ES90	ES36	1-5/8"	G	21.21	13.4	7.81	YES	NO	1824	263

\* Damping force, in pounds, to either extend or collapse the shock absorber at an average operating velocity.

## SPECIFICATIONS BY PART NUMBER

Gabriel	Mounting		Bore	External Diameter Illustration	Lengths			Dust Tube	Recoil Cutoff	Controls*	
	Upper	Lower			Extended	Collapsed	Stroke			Rebound	Compression
85995	ES90	ES36	1-5/8"	G	23.5	14.52	8.98	YES	NO	1830	173
85998	ES90	ES90	1-5/8"	G	22.83	14.17	8.66	YES	NO	1345	178
85999	ES90	ES90	1-5/8"	G	19.84	12.79	7.05	YES	NO	2214	259
86200	ES194	ES194	45 MM	D	14.24	10.45	3.79	YES	YES	4238	688
86201	ES193	ES193	45 MM	D	13.26	9.94	3.32	YES	YES	4238	688
86202	ES193	ES193	45 MM	D	14.52	10.43	4.09	YES	YES	4238	688
86203	ES193	ES193	45 MM	D	16.88	11.61	5.27	YES	YES	4238	910
87000	S21	EB3	2-1/16"	E	24.46	15.21	9.25	YES	YES	1332	300
87001	EB3	EB3	2-1/16"	E	20.76	13.76	7	YES	YES	1158	190
87002	EB3	EB3	2-1/16"	E	23.5	15.41	8.09	YES	YES	879	203
87003	EB3	EB3	2-1/16"	E	26.26	16.51	9.75	YES	YES	1332	395
87004	EB3	EB3	2-1/16"	E	26.76	16.76	10	YES	YES	1158	190
87006	EB3	EB3	2-1/16"	E	23.75	15.25	8.5	YES	YES	1158	272
87007	S21	S21	2-1/16"	E	15.65	10.4	5.25	YES	YES	879	253
87011	S21	S21	2-1/16"	E	23.65	14.4	9.25	YES	YES	1750	1050
87012	S21	S21	2-1/16"	E	23.65	14.4	9.25	YES	YES	650	364
87013	S21	S21	2-1/16"	E	23.65	14.4	9.25	YES	YES	1075	585
87015	ES173	ES173	45MM	E	15.51	11.18	4.33	YES	YES	4950	900
87016	S21	EB3	2-1/16"	E	21.17	13.91	7.26	YES	YES	1808	238
87017	ES160	ES160	2-1/16"	E	23.35	15.31	8.07	YES	YES	1876	220
87018	ES36	ES36	2-1/16"	E	17.36	11.71	5.65	YES	YES	2479	1000
87019	ES160	ES160	2-1/16"	E	24.84	15.85	8.9	YES	YES	2972	665
89401	EB2	EB2	1-5/8"	G	28.41	17.16	11.25	YES	NO	665‡	194
89402	EB2	EB2	1-5/8"	G	24.41	15.16	9.25	YES	NO	874‡	206
89403	EB2	EB2	1-5/8"	G	26.86	17.16	9.7	YES	YES	929‡	281
89405	ES36	ES36	1-5/8"	G	26.3	16.57	9.73	YES	YES	1009‡	249
89406	ES36	ES36	1-5/8"	G	24.76	15.82	8.93	YES	YES	658‡	125
89407	ES36	ES36	1-5/8"	G	21.61	14.17	7.45	YES	YES	652‡	218
89408	EB2	EB2	1-5/8"	G	19.68	12.9	6.78	YES	NO	536‡	201
89409	EB2	EB2	1-5/8"	G	27.13	16.92	10.2	YES	YES	567‡	165
89410	EB3	EB3	1-5/8"	G	26.34	16.57	9.77	YES	NO	1185‡	182
89411	ES90	ES90	1-5/8"	G	25.39	16.06	9.34	YES	YES	436‡	186
89412	EB3	EB3	1-5/8"	G	24.26	15.68	8.58	YES	YES	1155‡	169
89413	EB2	EB2	1-5/8"	G	20.94	13.53	7.41	YES	NO	536‡	201
89414	ES36	ES36	1-5/8"	G	29.65	18.18	11.46	YES	YES	1045‡	217
89415	EB2	EB2	1-5/8"	G	20.12	13.29	6.83	YES	YES	1155‡	514
89416	EB2	EB2	1-5/8"	G	28.62	17.54	11.08	YES	YES	1155‡	514

\* Damping force, in pounds, to either extend or collapse the shock absorber at an average operating velocity.

## SPECIFICATIONS BY PART NUMBER

Gabriel	Mounting		Bore	External Diameter Illustration	Lengths			Dust Tube	Recoil Cutoff	Controls*	
	Upper	Lower			Extended	Collapsed	Stroke			Rebound	Compression
89417	ES136	S21	1-5/8"	G	22.94	14.31	8.63	YES	NO	1226‡	515
89418	S21	S21	1-5/8"	G	21.44	13.19	8.25	YES	NO	1266‡	515
89419	EB3	EB3	1-5/8"	G	18.04	12.67	5.36	YES	YES	1352‡	636
89420	EB3	EB3	1-5/8"	G	22.8	14.8	8	YES	NO	862‡	258
89422	EB3	EB3	1-5/8"	G	25.12	16.3	8.83	YES	YES	794‡	253
89423	S21	S21	1-5/8"	G	18.67	12.21	6.46	YES	YES	1352‡	573
89424	S21	EB3	1-5/8"	G	23.73	15.14	8.59	YES	YES	794‡	253
89425	EB3	EB3	1-5/8"	G	26.5	16.93	9.57	YES	YES	1352‡	167
89426	S21	ES36	1-5/8"	G	20.46	13.05	7.41	YES	NO	926‡	419
89427	S21	EB3	1-5/8"	G	27.19	17.62	9.57	YES	YES	794‡	253
89428	S21	ES150	1-5/8"	G	22	14.27	7.72	YES	YES	958‡	446
89429	EB3	EB3	1-5/8"	G	26.22	16.57	9.65	YES	NO	941‡	266
89430	ES36	ES36	1-5/8"	G	24.61	15.66	8.94	YES	YES	1462‡	279
89431	ES36	ES36	1-5/8"	G	22.41	14.16	8.25	YES	NO	751‡	211
89432	ES36	ES36	1-5/8"	G	23.42	14.79	8.63	YES	NO	1507‡	561
89434	EB2	EB2	1-5/8"	G	27.12	16.79	10.33	YES	YES	1155‡	514
89435	EB2	EB2	1-5/8"	G	24.92	15.82	9.1	YES	YES	1155‡	514
89436	ES36	ES36	1-5/8"	G	17.24	12.04	5.2	YES	YES	998‡	217
89437	ES36	ES36	1-5/8"	G	20.12	13.42	6.7	YES	YES	1155‡	514
89438	EB2	EB2	1-5/8"	G	23.17	14.54	8.63	YES	NO	583‡	103
89439	EB2	EB2	1-5/8"	G	25.67	15.79	9.88	YES	NO	518‡	103
89440	ES36	ES36	1-5/8"	G	23.9	15.31	8.59	YES	YES	1498‡	561
89441	S21	ES36	1-5/8"	G	20.14	13.06	7.08	YES	YES	761‡	126
89442	EB3	EB3	1-5/8"	G	24.72	15.74	8.98	YES	NO	1055‡	224
89443	ES158	ES159	1-5/8"	G	22.19	14.66	7.53	YES	YES	1206‡	466
89446	EB2	EB2	1-5/8"	G	28.36	17.41	10.95	YES	YES	702‡	204
89447	S21	S21	1-5/8"	G	23.63	14.69	8.94	YES	YES	702‡	241
89448	ES161	ES162	1-5/8"	G	24.61	15.66	8.94	YES	YES	782‡	323
89449	ES150	ES150	1-5/8"	G	23.25	14.9	8.35	YES	NO	1519‡	324
89450	ES161	ES162	1-5/8"	G	24.61	15.66	8.94	YES	YES	1282‡	193
89451	ES174	ES136	1-5/8"	G	30.39	18.54	11.86	YES	YES	645‡	172
89453	ES178	ES150	1-5/8"	G	21.14	13.93	7.21	YES	YES	860‡	435
89454	ES175	ES175	1-5/8"	G	18.27	12.91	5.36	YES	YES	938‡	388
89455	S21	S21	1-5/8"	G	26.31	16.03	10.28	YES	YES	791‡	276
89456	ES174	S43	1-5/8"	G	17.04	11.63	5.4	YES	YES	975‡	377
89457	ES90	ES36	1-5/8"	G	19.92	13.02	6.89	YES	NO	941‡	156
89458	ES177	ES161	1-5/8"	G	22.48	14.6	7.88	YES	YES	1575‡	222

\* Damping force, in pounds, to either extend or collapse the shock absorber at an average operating velocity.

## SPECIFICATIONS BY PART NUMBER

Gabriel	Mounting		Bore	External Diameter Illustration	Lengths			Dust Tube	Recoil Cutoff	Controls*	
	Upper	Lower			Extended	Collapsed	Stroke			Rebound	Compression
89459	ES174	EB3	1-5/8"	G	25.63	16.14	9.49	YES	NO	1179‡	314
89460	ES174	ES136	1-5/8"	G	20.58	13.03	7.55	YES	NO	997‡	384
89461	ES160	ES160	1-5/8"	G	19.96	13.58	6.38	YES	YES	897‡	103
89502	ES161	ES162	1-5/8"	G	24.61	15.66	8.94	YES	YES	1240‡	300
89503	ES150	ES150	1-5/8"	G	21.28	13.72	7.56	YES	NO	1033‡	123
G63173	EB1	EB1	1-3/8"		21.99	13.71	8.28	YES	NO	396	158
G63183	EB4	EB4	1-3/8"		20.89	13.11	7.78	YES	NO		
G63187	S1	S1	1-3/8"		23.02	13.49	9.53	YES	NO		
G63299	EB1	EB1	1-3/8"		18.08	11.55	6.53	YES	NO	396	109
G63306	ES2	ES24	1-3/8"		19.86	12.58	7.28	YES	NO		
G63347	ES3	ES24	1-3/8"		18.08	11.55	6.53	YES	NO		
G63349	EB7	ES34	1-3/8"		23.33	14.3	9.03	YES	NO		
G63350	S1	ES25	1-3/8"		18.83	11.8	7.03	YES	NO		
G63353	ES2	EB4	1-3/8"		24.74	14.96	9.78	YES	NO		
G63355	EB7	ES24	1-3/8"		15	9.97	5.03	YES	NO		
G63357	ES24	ES24	1-3/8"		15	9.97	5.03	YES	NO		
G63359	S1	BP13	1-3/8"		13.8	9.02	4.78	NO	NO		
G63360	S1	BP13	1-3/8"		15.8	10.02	5.78	NO	NO		
G63366	ES34	ES34	1-3/8"		23.36	14.33	9.03	YES	NO		
G63371	ES24	ES24	1-3/8"		21.98	13.45	8.53	YES	NO	521	132
G63375	S1	BP7	1-3/8"		13.95	9.28	4.67	NO	NO		
G63377	EB1	ES25	1-3/8"		20.08	12.55	7.53	YES	NO		
G63386	S36	ES25	1-3/8"		17.19	11.16	6.03	NO	YES		
G63387	S1	ES25	1-3/8"		23.33	14.05	9.28	YES	NO		
G63389	ES2	EB4	1-3/8"		28.74	16.96	11.78	YES	NO		
G63394	EB1	ES24	1-3/8"		16	10.47	5.53	YES	NO		
G63396	S10	ES25	1-3/8"		16.55	10.77	5.78	YES	NO		
G63398	S1	S1	1-3/8"		20.52	12.24	8.28	YES	NO		
G63403	ES82	ES82	1-3/8"		24.58	14.8	9.78	YES	NO		
G63404	S1	ES64	1-3/8"		17.05	11.02	6.03	YES	YES		
G63405	EB1	EB1	1-3/8"		20	12.47	7.53	YES	NO	572	115
G63406	EB1	ES83	1-3/8"		23	13.97	9.03	YES	NO		
G63409	EB1	ES83	1-3/8"		21.58	13.3	8.28	YES	NO		
G63410	S10	EB6	1-3/8"		18.55	11.77	6.78	YES	NO		
G63411	ES3	ES82	1-3/8"		18.58	11.8	6.78	YES	NO		
G63413	ES27	ES27	1-3/8"		20.76	12.98	7.78	YES	NO	991	195
G63414	S28	ES83	1-3/8"		15.09	10.06	5.03	NO	YES		

\* Damping force, in pounds, to either extend or collapse the shock absorber at an average operating velocity.

## SPECIFICATIONS BY PART NUMBER

Gabriel	Mounting		Bore	External Diameter Illustration	Lengths			Dust Tube	Recoil Cutoff	Controls*	
	Upper	Lower			Extended	Collapsed	Stroke			Rebound	Compression
G63416	S10	ES25	1-3/8"		18.55	11.77	6.78	YES	NO		
G63418	S1	BP4	1-3/8"		14.05	9.27	4.78	YES	NO		
G63419	EB1	EB1	1-3/8"		24.08	14.55	9.53	YES	NO		
G63420	EB1	ES106	1-3/8"		27.08	16.05	11.03	NO	NO		
G63421	S1	BP30	1-3/8"		13.8	9.02	4.78	NO	NO		
G63422	BP8	ES34	1-3/8"		24	14.47	9.53	YES	NO		
G63423	ES8	ES82	1-3/8"		16.75	10.72	6.03	NO	NO		
G63424	S1	BP7	1-3/8"		20.47	12.69	7.78	YES	YES	387	197
G63425	BP2	EB1	1-3/8"		20	12.47	7.53	YES	NO		
G63426	ES1	ES18	1-3/8"		18	11.47	6.53	YES	NO		
G63427	EB1	ES106	1-3/8"		23.08	14.05	9.03	YES	NO		
G63432	S1	EB2	1-3/8"		21.21	12.93	8.28	YES	NO		
G63434	EB2	S32	1-3/8"		22.78	14	8.78	YES	NO		
G63437	ES31	ES24	1-3/8"		23.33	14.05	9.28	NO	NO		
G63438	EB1	ES34	1-3/8"		29.33	17.3	12.03	NO	NO		
G63439	EB1	ES83	1-3/8"		29.75	17.22	12.53	NO	NO		
G63440	EB1	EB1	1-3/8"		26.33	15.55	10.78	NO	NO		
G63441	EB1	ES25	1-3/8"		26.33	15.55	10.78	NO	NO		
G63443	EB1	EB1	1-3/8"		23.33	13.95	9.38	NO	NO		
G63444	S1	ES17	1-3/8"		23.3	14.02	9.28	NO	YES		
G63445	S10	ES25	1-3/8"		23.24	13.99	9.25	NO	YES		
G63446	S10	EB6	1-3/8"		23.3	14.02	9.28	NO	YES		
G63447	S10	ES25	1-3/8"		30.18	17.65	12.53	NO	YES		
G63454	ES1	ES18	1-3/8"		22.81	14.03	8.78	YES	NO		
G63455	ES8	ES83	1-3/8"		23	13.97	9.03	YES	NO		
G63456	EB1	ES83	1-3/8"		26.76	15.98	10.78	YES	NO		
G63457	S1	BP4	1-3/8"		13.8	9.02	4.78	NO	NO		
G63460	BP1	ES27	1-3/8"		23.16	14.13	9.03	YES	NO		
G63461	EB1	ES83	1-3/8"		25.5	15.22	10.28	YES	NO		
G63479	S1	ES113	1-3/8"		14.05	9.27	4.78	YES	NO		
G63484	S4	EB1	1-3/8"		20.05	12.52	7.53	YES	NO		
G63488	BP8	ES34	1-3/8"		26.61	16.33	10.28	YES	YES		
G63489	S29	BP11	1-3/8"		14.44	9.66	4.78	NO	YES		
G63490	EB1	ES25	1-3/8"		19.08	12.05	7.03	YES	NO		
G63491	EB1	S1	1-3/8"		19.05	11.77	7.28	YES	NO		
G63492	EB1	EB1	1-3/8"		22.58	13.8	8.78	YES	NO		
G63494	EB2	EB2	1-3/8"		22.39	13.86	8.53	YES	NO		

\* Damping force, in pounds, to either extend or collapse the shock absorber at an average operating velocity.

## SPECIFICATIONS BY PART NUMBER

Gabriel	Mounting		Bore	External Diameter Illustration	Lengths			Dust Tube	Recoil Cutoff	Controls*	
	Upper	Lower			Extended	Collapsed	Stroke			Rebound	Compression
G63495	S1	ES17	1-3/8"		15.05	9.77	5.28	YES	NO		
G63499	BP1	ES130	1-3/8"		25.58	15.3	10.28	YES	NO		
G63500	S28	ES25	1-3/8"		15.09	10.06	5.03	NO	YES		
G63502	ES1	ES25	1-3/8"		18.41	11.88	6.53	YES	NO		
G63506	S32	S32	1-3/8"		21.41	12.88	8.53	YES	NO		
G63510	EB2	EB2	1-3/8"		21.39	13.36	8.03	YES	NO		
G63511	S1	ES25	1-3/8"		22.55	13.52	9.03	YES	NO		
G63524	EB1	ES83	1-3/8"		27.08	16.05	11.03	YES	NO		
G63525	EB1	ES83	1-3/8"		23.08	14.05	9.03	YES	NO		
G63547	S1	ES113	1-3/8"		13.71	9.18	4.53	YES	NO		
G63548	S12	EB2	1-3/8"		21.21	13.18	8.03	YES	YES		
G63603	S36	ES83	1-3/8"		16.11	10.58	5.53	YES	YES		
G63604	EB1	ES142	1-3/8"		19.74	12.46	7.28	YES	NO		
G63605	EB2	ES27	1-3/8"		24.24	14.71	9.53	YES	NO		
G63606	ES152	ES153	1-3/8"		21.39	13.61	7.78	YES	YES		
G63607	BP33	ES83	1-3/8"		25.58	15.3	10.28	YES	NO		
G63608	S36	EB1	1-3/8"		14.58	9.81	4.78	YES	YES		
G63609	ES151	ES128	1-3/8"		16.5	10.97	5.53	YES	YES		
G63610	S1	EB1	1-3/8"		21.55	13.27	8.28	YES	NO		
G63611	S1	ES17	1-3/8"		15.05	9.77	5.28	YES	NO		
G63612	S7	ES17	1-3/8"		14.55	9.77	4.78				
G63614	S36	EB1	1-3/8"		15.12	10.09	5.03	NO	YES		
G63615	S38	S38	1-3/8"		23.66	13.88	9.78	YES	NO		
G63616	S38	EB2	1-3/8"		23.78	14.25	9.53	YES	NO	610	164
G63617	ES83	EB1	1-3/8"		27.58	16.3	11.28	YES	NO		
G63620	EB1	S7	1-3/8"		19.55	12.27	7.28	YES	YES		
G63621	S10	BP7	1-3/8"		16.46	10.93	5.53	YES	YES		
G63622	S36	EB1	1-3/8"		15.42	10.39	5.03	YES	YES		
G63623	S36	ES83	1-3/8"		22.67	14.39	8.28	YES	YES		
G63624	S36	ES83	1-3/8"		20.17	12.64	7.53	YES	YES		
G63625	EB7	ES36	1-3/8"		22.48	13.96	8.53	YES	NO		
G63626	EB5	ES83	1-3/8"		21.16	13.38	7.78	YES	NO		
G63635	S1	ES69	1-3/8"		14.55	9.52	5.03	YES	NO		
G63638	BP8	ES34	1-3/8"		24.33	14.8	9.53	YES	NO		
G63639	ES104	ES69	1-3/8"		24.16	14.63	9.53	YES	NO		
G63640	ES152	ES153	1-3/8"		23.89	15.11	8.78	YES	YES		
G63660	EB1	EB1	1-3/8"		25.08	15.05	10.03	YES	NO		

\* Damping force, in pounds, to either extend or collapse the shock absorber at an average operating velocity.



## SPECIFICATIONS BY PART NUMBER

Gabriel	Mounting		Bore	External Diameter Illustration	Lengths			Dust Tube	Recoil Cutoff	Controls*	
	Upper	Lower			Extended	Collapsed	Stroke			Rebound	Compression
G63661	S1	ES34	1-3/8"		13.87	9.59	4.28	YES	YES		
G63662	ES34	ES34	1-3/8"		24.58	15.05	9.53	YES	NO		
G63671	ES82	ES82	1-3/8"		22.58	13.8	8.78	YES	NO		
G63673	S1	ES34	1-3/8"		22.3	13.77	8.53	YES	YES		
G63674	S1	ES34	1-3/8"		23.27	14.24	9.03	YES	YES		
G63675	ES34	ES34	1-3/8"		26.86	16.08	10.78	YES	NO		
G63676	ES69	ES69	1-3/8"		15.58	10.55	5.03	YES	YES		
G63678	S36	BP7	1-3/8"		18.09	13.56	4.53	YES	NO		
G63679	BP8	ES83	1-3/8"		25	14.97	10.03	YES	NO		
G63683	EB5	ES24	1-3/8"		21.16	13.38	7.78	YES	YES		
G63689	EB1	EB1	1-3/8"		19.08	12.05	7.03	YES	NO	478	211
G63690	ES18	ES18	1-3/8"		18	11.47	6.53	YES	NO		
G63692	EB1	EB1	1-3/8"		27.58	16.3	11.28	YES	NO		
G63694	ES119	S38	1-3/8"		22.28	13.5	8.78	YES	NO		
G63707	S10	ES17	1-3/8"		15.8	10.27	5.53	YES	NO		
G63708	ES99	EB2	1-3/8"		19.74	12.46	7.28	YES	NO		
G63710	S1	ES153	1-3/8"		18.96	11.93	7.03	YES	NO		
G63712	ES110	ES19	1-3/8"		22.58	13.8	8.78	YES	NO		
G63714	S6	BP7	1-3/8"		15.54	10.01	5.53	YES	NO		
G63715	S12	ES25	1-3/8"		28.55	16.52	12.03	YES	NO		
G63716	S12	ES26	1-3/8"		15.54	10.01	5.53	YES	NO		
G63717	ES83	ES83	1-3/8"		23	13.97	9.03	YES	NO		
G63720	S6	ES22	1-3/8"		21.3	13.02	8.28	YES	NO		
G63721	S10	BP11	1-3/8"		20.21	12.43	7.78	YES	NO		
G63722	BP18	ES24	1-3/8"		19.49	12.21	7.28	YES	NO		
G63726	S12	EB2	1-3/8"		20.96	12.93	8.03	YES	NO		
G63772	S6	BP35	1-3/8"		13.83	9.55	4.28	YES	YES		
G63773	EB1	ES83	1-3/8"		23.08	14.05	9.03	YES	NO		
G63775	EB1	ES83	1-3/8"		27.08	16.05	11.03	YES	NO		
G63776	ES83	ES83	1-3/8"		20.76	12.98	7.78	YES	NO		
G63778	S12	ES171	1-3/8"		24.55	14.52	10.03	YES	NO		
G63781	S1	ES113	1-3/8"		18.45	11.93	6.52	YES	YES		
G63782	S1	ES118	1-3/8"		13.8	9.27	4.53	YES	NO		
G63783	S12	BP11	1-3/8"		14.8	10.27	4.53	YES	NO		
G63798	S1	EB1	1-3/8"		15.97	10.19	5.78	YES	NO		
G63799	S1	ES83	1-3/8"		18.55	11.77	6.78	YES	NO		
G63803	S12	U-Brkt	1-3/8"		15.48	10.69	4.79	YES	NO		

\* Damping force, in pounds, to either extend or collapse the shock absorber at an average operating velocity.

## SPECIFICATIONS BY PART NUMBER

Gabriel	Mounting		Bore	External Diameter Illustration	Lengths			Dust Tube	Recoil Cutoff	Controls*	
	Upper	Lower			Extended	Collapsed	Stroke			Rebound	Compression
G63808	EB1	ES83	1-3/8"		28.86	17.08	11.78	YES	NO		
G63809	EB1	ES83	1-3/8"		23	13.97	9.03	YES	NO		
G63810	EB1	ES83	1-3/8"		31.51	18.48	13.03	YES	NO	429	127
G63811	EB1	ES83	1-3/8"		25.5	15.22	10.28	YES	NO		
G63812	ES34	ES36	1-3/8"		22.49	13.95	8.53	YES	NO		
G63813	S39	ES17	1-3/8"		12.3	8.5	3.8	YES	NO		
G63815	S39	ES17	1-3/8"		22.05	13.27	8.78	YES	NO		
G63817	S12	ES60	1-3/8"		15.8	11.02	4.78	YES	NO		
G63818	ES126	ES128	1-3/8"		16.5	10.97	5.53	YES	NO		
G63828	S21	ES36	1-3/8"		23.16	15.13	8.03				
G63829	ES61	ES65	1-3/8"		22.58	13.8	8.78				
G63832	S21	ES153	1-3/8"		17.16	11.38	5.78				
G63837	BP8	ES83	1-3/8"		28.23	17.95	10.28				
G63842	ES18	ES126	1-3/8"		23.33	14.8	8.53				
G63844	ES19	ES141	1-3/8"		22.58	13.8	8.78				
G63845	ES18	ES138	1-3/8"		24.58	14.8	9.78				
G63847	S1	BP7	1-3/8"		20.47	12.69	7.78				
G63848	S38	ES34	1-3/8"		15.87	10.59	5.28				
G63860	S1	EB1	1-3/8"		24.33	14.39	9.94	YES	NO	132	76
G63862	S1	ES67	1-3/8"		25.07	14.94	10.13				
G63864			1-3/8"		15	10.56	4.44				
G63865	S39	ES36	1-3/8"		22.49	13.55	8.94				
G63866	ES34	ES34	1-3/8"		22.81	14.12	8.69				
G63867	413002	413002	1-3/8"		27.31	16.37	10.94				
G63868	ES31	412715	1-3/8"		15.62	10.68	4.94				
G63869	ES83	ES83	1-3/8"		20.26	12.82	7.44				
G63870	413002	413002	1-3/8"		24.89	15.2	9.69				
G63872	412998	ES82	1-3/8"		21.65	13.29	8.36				
G63873	413002	413002	1-3/8"		15.75	10.56	5.19				
G63875	ES186	ES186	1-3/8"		17.67	11.73	5.94				
G63877	413000	413000	1-3/8"		16.93	11.24	5.69				
G63878	413001	ES186	1-3/8"		24.16	14.97	9.19				
G63879	BP34	ES34	1-3/8"		23	14.31	8.69				
G63880	BP18	ES18	1-3/8"		22.5	14.06	8.44				
G63881	S1	ES25	1-3/8"		14.71	9.48	5.22				
G63882	BP34	ES34	1-3/8"		21	13.31	7.69				
G63883	413001	ES186	1-3/8"		22.82	14.38	8.44				

\* Damping force, in pounds, to either extend or collapse the shock absorber at an average operating velocity.

## SPECIFICATIONS BY PART NUMBER

Gabriel	Mounting		Bore	External Diameter Illustration	Lengths			Dust Tube	Recoil Cutoff	Controls*	
	Upper	Lower			Extended	Collapsed	Stroke			Rebound	Compression
G63884	S39	ES112	1-3/8"		14.72	9.78	4.94				
G63885	375166	413004	1-3/8"		22.24	13.56	8.69				
G63886	S38	ES34	1-3/8"		20.8	13.36	7.44				
G63887	EB1	ES83	1-3/8"		29.71	17.77	11.94				
G63888	EB1	ES83	1-3/8"		31.36	18.67	12.69				
G63889	S1	413003	1-3/8"		20.44	12.75	7.69				
G63890	ES18	ES18	1-3/8"		23.97	15.28	8.69				
G63891	ES18	ES18	1-3/8"		23.97	15.28	8.69				
G63892	ES19	ES141	1-3/8"		23.97	15.28	8.69				
G63893	S29	U-Brkt	1-3/8"		15.07	10.44	4.64				
G63894	S29	413042	1-3/8"		12.82	8.88	3.94				
G63895	S29	413042	1-3/8"		14.12	9.68	4.44				
G63896	BP8	ES34	1-3/8"		22.36	13.92	8.44				
G63897	BP8	ES34	1-3/8"		23.87	14.68	9.19				
G63898	BP8	ES34	1-3/8"		25.19	15.31	9.88				
G63900	S1	BP26	1-3/8"		14.1	9.34	4.76	YES	YES		
G63902	S1	ES17	1-3/8"		12.6	8.59	4.01	YES	YES		
G63903	S1	BP8	1-3/8"		14.7	9.34	5.36	YES	NO		
G63904	S1	ES17	1-3/8"		14.95	9.59	5.36	YES	NO		
G63905	S1	ES24	1-3/8"		14.7	9.34	5.36	NO	NO		
G63906	ES2	ES27	1-3/8"		20.49	12.63	7.86	YES	NO		
G63907	EB1	EB1	1-3/16"		20.23	12.37	7.86	YES	NO	680	228
G63908	ES3	ES24	1-3/8"		18.23	11.37	6.86	YES	NO		
G63909	S1	ES17	1-3/8"		14.11	9	5.11	YES	NO		
G63914	S29	ES84	1-3/8"		21.12	16.31	4.81	YES	YES		
G63915	S1	BP7	1-3/8"		13.2	8.59	4.61	NO	NO		
G63918	ES34	ES141	1-3/8"		21.25	13.56	7.69				
G63919	ES117	ES153	1-3/8"		20.25	13.06	7.19				
G63928	EB1	EB1	1-3/8"		22.73	13.87	8.86	YES	YES		
G63929	S36	EB1	1-3/8"		14.72	9.71	5.01	YES	YES		
G63937	S1	BP17	1-3/8"		14.7	9.34	5.36	NO	NO		
G63949	EB1	EB1	1-3/8"		17.73	11.12	6.61	YES	NO	255	171
G63950	S1	BP7	1-3/8"		14.2	9.09	5.11	NO	NO		
G63958	S29	BP13	1-3/8"		13.8	9.13	4.67				
G63959	ES34	ES34	1-3/8"		24.78	15.84	8.94				
G63961	ES34	ES34	1-3/8"		26.51	16.12	10.39				
G63962	ES34	ES34	1-3/8"		26.05	15.87	10.18				

\* Damping force, in pounds, to either extend or collapse the shock absorber at an average operating velocity.

## SPECIFICATIONS BY PART NUMBER

Gabriel	Mounting		Bore	External Diameter Illustration	Lengths			Dust Tube	Recoil Cutoff	Controls*	
	Upper	Lower			Extended	Collapsed	Stroke			Rebound	Compression
G63963	EB1	ES83	1-3/8"		24.75	15.06	9.69				
G63964	EB1	ES83	1-3/8"		25.47	15.53	9.94				
G63965	BP8	ES24	1-3/8"		24.13	15.2	8.94				
G63966	BP18	ES130	1-3/8"		22.44	14.5	7.94				
G63967	BP18	ES130	1-3/8"		22.62	14.43	8.19				
G63969	412847	ES34	1-3/8"		20.75	13.31	7.44				
G63970	ES34	ES34	1-3/8"		27.58	17.14	10.44				
G63971	ES34	ES34	1-3/8"		27.58	17.14	10.44				
G64000	ES34	ES34	1-3/8"		27.36	17.67	9.69				
G64001	S29	U-Brkt	1-3/8"		14.67	11.47	3.194				
G64002	ES83	ES83	1-3/8"		20.15	13.95	6.192				
G64003	413000	413000	1-3/8"		16.83	11.27	5.56				
G64004	S1	413003	1-3/8"		19.07	12.13	6.94				
G64005	S1	413003	1-3/8"		19.75	12.31	7.44				
G64006	S1	413003	1-3/8"		22.75	13.81	8.94				
G64007	S1	413003	1-3/8"		22.75	13.81	8.94				
G64008	373768	ES26	1-3/8"		21.79	13.6	8.19				
G64009	0	0	1-3/8"		23.29	14.25	9.04				
G64010	0	0	1-3/8"		26.94	16	10.94				
G64011	0	0	1-3/8"		23.36	14.21	9.14				

\* Damping force, in pounds, to either extend or collapse the shock absorber at an average operating velocity.

## MOUNTING ACCESSORY PACKAGES AND COMPONENT PARTS

<b>140126</b>	401006	1	Hex nut / Tuerca hexagonal / Écrou hexagonal	3/8" x 24 UNF thread
	401383	2	Retainer (washer) / Seguro (arandela) / Arrêt (rondelle)	3/8 in. I.D. x 1-1/2 in. O.D. x .093 in. thick
	402263	2	Bushing / Buje / Bague	7/8" centering lip for 3/8" O.D. stud
<b>140149</b>	401011	4	Bushing / Buje / Bague	EB2 style - for 1-3/4" O.D. eye ring - 3/4" diam. Stud
<b>140169</b>	401011	2	Bushing / Buje / Bague	EB2 style - for 1-3/4" O.D. eye ring - 3/4" diam. Stud
<b>140357</b>	401164	1	Hex nut / Tuerca hexagonal / Écrou hexagonal	1/2" x 20 UNF Thread
	401166	1	Lock washer / Arandela de seguridad / Rondelle-frein	1/2" lock washer
	401174	1	Hex nut / Tuerca hexagonal / Écrou hexagonal	5/8" x 18 thread
	401193	1	Lock washer / Arandela de seguridad / Rondelle-frein	5/8" I.D. (thin)
	401266	1	Retainer (washer) / Seguro (arandela) / Arrêt (rondelle)	5/8" I.D. x 1-1/4" O.D. x .075" thick
	402519	1	Retainer (washer) / Seguro (arandela) / Arrêt (rondelle)	1/2" I.D. x 1-1/4" O.D. x .104" thick
	403050	1	Stud / Perno / Goujon	1/2" x 20 and 5/8" x 18 thread
<b>140455</b>	401006	1	Hex nut / Tuerca hexagonal / Écrou hexagonal	3/8" x 24 UNF thread
	401008	2	Retainer (washer) / Seguro (arandela) / Arrêt (rondelle)	3/8 in. I.D. x 1-1/4 in. O.D. x .075 in. thick
	403489	2	Bushing / Buje / Bague	5/8" centering lip for 3/8" O.D. stud
<b>140524</b>	401006	1	Hex nut / Tuerca hexagonal / Écrou hexagonal	3/8" x 24 UNF thread
	401376	2	Retainer (washer) / Seguro (arandela) / Arrêt (rondelle)	3/8 in. I.D. x 1-3/8 in. O.D. x .089 in. thick
	402294	2	Bushing / Buje / Bague	5/8" lip for 3/8" dia. stud-5/8" or 7/8" holes
<b>140526</b>	403813	2	Boot / Bota / Gaine	
	403815	2	Cotter pin / Chaveta / Goupille	
	404046	2	Nut / Tuerca / Écrou	1/2" x 20 UNF Thread
<b>140673</b>	401006	1	Hex nut / Tuerca hexagonal / Écrou hexagonal	3/8" x 24 UNF thread
	401008	2	Retainer (washer) / Seguro (arandela) / Arrêt (rondelle)	3/8 in. I.D. x 1-1/4 in. O.D. x .075 in. thick
	403962	2	Bushing / Buje / Bague	1/2" centering lip for 3/8" O.D. stud
<b>140689</b>	401006	3	Hex nut / Tuerca hexagonal / Écrou hexagonal	3/8" x 24 UNF thread
	402263	2	Bushing / Buje / Bague	7/8" centering lip for 3/8" O.D. stud
	404001	2	Retainer (washer) / Seguro (arandela) / Arrêt (rondelle)	10 mm I.D. x 1-1/2" O.D. x .120" thick
<b>140702</b>	401174	1	Hex nut / Tuerca hexagonal / Écrou hexagonal	5/8" x 18 thread
	401184	1	Lock washer / Arandela de seguridad / Rondelle-frein	7/16" Lock washer
	401193	1	Lock washer / Arandela de seguridad / Rondelle-frein	5/8" I.D. (thin)
	402844	1	Hex nut / Tuerca hexagonal / Écrou hexagonal	7/16" x 20 UNF Thread
	403878	1	Washer / Arandela / Rondelle	0.453" I.D. x 1.25" O.D. x .075" thick
	404782	1	Stud / Perno / Goujon	5/8" x 18 and 7/16" x 20
<b>140719</b>	402653-001	2	Lock washer / Arandela de seguridad / Rondelle-frein	5/16" I.D. (med.)
	403870-001	2	Bolt / Tornillo / Boulon	Hex Head 5/16" x 18 x 3/4 in. long
	403871-001	2	Hex nut / Tuerca hexagonal / Écrou hexagonal	5/16" x 18 thread
<b>140780</b>	401006	1	Hex nut / Tuerca hexagonal / Écrou hexagonal	3/8" x 24 UNF thread
	402943	1	Retainer (washer) / Seguro (arandela) / Arrêt (rondelle)	0.457" I.D. x 1.68" O.D. x .120" thick
	403298	1	Retainer (washer) / Seguro (arandela) / Arrêt (rondelle)	0.390" I.D. x 1.68" O.D. x .120" thick
	403299	2	Bushing / Buje / Bague	7/8" centering lip for 7/16" O.D. stud
<b>140857</b>	401006	1	Hex nut / Tuerca hexagonal / Écrou hexagonal	3/8" x 24 UNF thread
	401008	1	Retainer (washer) / Seguro (arandela) / Arrêt (rondelle)	3/8 in. I.D. x 1-1/4 in. O.D. x .075 in. thick
	401383	1	Retainer (washer) / Seguro (arandela) / Arrêt (rondelle)	3/8 in. I.D. x 1-1/2 in. O.D. x .093 in. thick
	403489	2	Bushing / Buje / Bague	5/8" centering lip for 3/8" O.D. stud
	429680-030	1	Instruction sheet / Hoja de instr. / Feuillet d'instr.	
<b>140884</b>	401267	1	Retainer (washer) / Seguro (arandela) / Arrêt (rondelle)	5/8" I.D. x 1-1/4" O.D. x .075" thick
	402662	1	Spacer / Espaciador / Entretoise	5/8" I.D. x 1-1/4" O.D. x 1/4" thick
	412016	1	Extn nut / Tuerca ext. / Écrou ext.	7/16" x 20 UNF Thread
	427030	1	Instruction sheet / Hoja de instr. / Feuillet d'instr.	

## MOUNTING ACCESSORY PACKAGES AND COMPONENT PARTS

<b>140885</b>	401267	1	Retainer (washer) / Seguro (arandela) / Arrêt (rondelle)	5/8" I.D. x 1-1/4" O.D. x .075" thick
	402662	1	Spacer / Espaciador / Entretoise	5/8" I.D. x 1-1/4" O.D. x 1/4" thick
	403189	2	Spacer / Espaciador / Entretoise	1/2" I.D. x 1-1/4" O.D.
	411012	2	Sleeve / Camisa / Manchon	13 mm I.D. x 5/8 in. O.D. x 1-5/16 in. long
	412016	1	Extn nut / Tuerca ext. / Écrou ext.	7/16" x 20 UNF Thread
	427031	1	Instruction sheet / Hoja de instr. / Feuillet d'instr.	
<b>140921</b>	401006	1	Hex nut / Tuerca hexagonal / Écrou hexagonal	3/8" x 24 UNF thread
	401007	1	Pal nut / Tuerca de cierre / Écrou Pal	3/8" x 24 UNF thread
	401011	2	Bushing / Buje / Bague	EB2 style - for 1-3/4" O.D. eye ring - 3/4" diam. Stud
	401377	1	Retainer (washer) / Seguro (arandela) / Arrêt (rondelle)	1/2" I.D. x 1-3/8" O.D. x .075" thick
	401383	1	Retainer (washer) / Seguro (arandela) / Arrêt (rondelle)	3/8 in. I.D. x 1-1/2 in. O.D. x .093 in. thick
	402267	2	Bushing / Buje / Bague	9/16" centering lip for 7/16" O.D. stud
<b>140947</b>	401193	1	Lock washer / Arandela de seguridad / Rondelle-frein	5/8" I.D. (thin)
	404451	2	Hex nut / Tuerca hexagonal / Écrou hexagonal	16 x 1.5 metric thread
	404452	4	Retainer (washer) / Seguro (arandela) / Arrêt (rondelle)	5/8" I.D. x 2-3/4" O.D. x .180" thick
	404453	2	Sleeve / Camisa / Manchon	16 mm I.D. x 1-3/16" O.D. x 1-1/2" long
	404454	4	Bushing / Buje / Bague	1-3/16" centering lip for 13/16" O.D. stud
<b>141041</b>	401006	1	Hex nut / Tuerca hexagonal / Écrou hexagonal	3/8" x 24 UNF thread
	401376	2	Retainer (washer) / Seguro (arandela) / Arrêt (rondelle)	3/8 in. I.D. x 1-3/8 in. O.D. x .089 in. thick
	404652	2	Bushing / Buje / Bague	Used with 5/8" dia. hole or 7/8" dia. Hole
<b>141045</b>	401006	1	Hex nut / Tuerca hexagonal / Écrou hexagonal	3/8" x 24 UNF thread
	401377	1	Retainer (washer) / Seguro (arandela) / Arrêt (rondelle)	1/2" I.D. x 1-3/8" O.D. x .075" thick
	401383	1	Retainer (washer) / Seguro (arandela) / Arrêt (rondelle)	3/8 in. I.D. x 1-1/2 in. O.D. x .093 in. thick
	402284	2	Bushing / Buje / Bague	5/8" centering lip for 3/8" O.D. stud
<b>141047</b>	401006	1	Hex nut / Tuerca hexagonal / Écrou hexagonal	3/8" x 24 UNF thread
	401164	1	Hex nut / Tuerca hexagonal / Écrou hexagonal	1/2" x 20 UNF Thread
	401166	1	Lock washer / Arandela de seguridad / Rondelle-frein	1/2" lock washer
	401184	1	Lock washer / Arandela de seguridad / Rondelle-frein	7/16" Lock washer
	402844	1	Hex nut / Tuerca hexagonal / Écrou hexagonal	7/16" x 20 UNF Thread
	402943	1	Retainer (washer) / Seguro (arandela) / Arrêt (rondelle)	0.457" I.D. x 1.68" O.D. x .120" thick
	403298	1	Retainer (washer) / Seguro (arandela) / Arrêt (rondelle)	0.390" I.D. x 1.68" O.D. x .120" thick
	403299	2	Bushing / Buje / Bague	7/8" centering lip for 7/16" O.D. stud
	403877	1	Stud / Perno / Goujon	1/2" x 20 and 7/16" x 20
	403878	1	Washer / Arandela / Rondelle	0.453" I.D. x 1.25" O.D. x .075" thick
<b>141083</b>	401193	1	Lock washer / Arandela de seguridad / Rondelle-frein	5/8" I.D. (thin)
	404451	1	Hex nut / Tuerca hexagonal / Écrou hexagonal	16 x 1.5 metric thread
	404452	2	Retainer (washer) / Seguro (arandela) / Arrêt (rondelle)	5/8" I.D. x 2-3/4" O.D. x .180" thick
	404453	1	Sleeve / Camisa / Manchon	16 mm I.D. x 1-3/16" O.D. x 1-1/2" long
	404454	2	Bushing / Buje / Bague	1-3/16" centering lip for 13/16" O.D. stud
<b>141108</b>	401174	2	Hex nut / Tuerca hexagonal / Écrou hexagonal	5/8" x 18 thread
	405360	4	Retainer (washer) / Seguro (arandela) / Arrêt (rondelle)	5/8" I.D. x 2-3/16" O.D. x .120" thick
	405361-000	4	Bushing / Buje / Bague	1" centering lip for 5/8" O.D. stud (1.00" thick)
<b>141137</b>	402812	1	Sleeve / Camisa / Manchon	13 mm I.D. x 5/8 in. O.D. x 1-5/16 in. long
<b>141138</b>	401006	2	Hex nut / Tuerca hexagonal / Écrou hexagonal	3/8" x 24 UNF thread
	403489	4	Bushing / Buje / Bague	5/8" centering lip for 3/8" O.D. stud
	403575	4	Retainer (washer) / Seguro (arandela) / Arrêt (rondelle)	25/64" I.D. x 1-1/4" O.D. x .12" thick
	404949	4	Washer / Arandela / Rondelle	1/2" I.D. x 1-1/2" O.D. x .04" thick

## MOUNTING ACCESSORY PACKAGES AND COMPONENT PARTS

<b>141168</b>	401006	1	Hex nut / Tuerca hexagonal / Écrou hexagonal	3/8" x 24 UNF thread
	401008	1	Retainer (washer) / Seguro (arandela) / Arrêt (rondelle)	3/8 in. I.D. x 1-1/4 in. O.D. x .075 in. thick
	404350	1	Retainer (washer) / Seguro (arandela) / Arrêt (rondelle)	3/8 in. I.D. x 1-5/8 in. O.D. x .119 in. thick
	404985	1	Bushing / Buje / Bague	5/8" centering lip for 3/8" O.D. stud
	404986	1	Bushing / Buje / Bague	5/8" centering lip for 3/8" O.D. stud
	429680-015	1	Instruction sheet / Hoja de instr. / Feuillet d'instr.	
<b>141247</b>	401174	1	Hex nut / Tuerca hexagonal / Écrou hexagonal	5/8" x 18 thread
	401754	2	Bushing / Buje / Bague	EB3 - style for 2.39 in. O.D. eye ring - 1" diam. Stud
	405360	2	Retainer (washer) / Seguro (arandela) / Arrêt (rondelle)	5/8" I.D. x 2-3/16" O.D. x .120" thick
	405361	2	Bushing / Buje / Bague	1" centering lip for 5/8" O.D. stud
<b>141349</b>	401006	1	Hex nut / Tuerca hexagonal / Écrou hexagonal	3/8" x 24 UNF thread
	401007	1	Pal nut / Tuerca de cierre / Écrou Pal	3/8" x 24 UNF thread
	401376	2	Retainer (washer) / Seguro (arandela) / Arrêt (rondelle)	3/8 in. I.D. x 1-3/8 in. O.D. x .089 in. thick
	404652	2	Bushing / Buje / Bague	Used with 5/8" dia. hole or 7/8" dia. Hole
	429680-030	1	Instruction sheet / Hoja de instr. / Feuillet d'instr.	
<b>141350</b>	401006	1	Hex nut / Tuerca hexagonal / Écrou hexagonal	3/8" x 24 UNF thread
	401376	2	Retainer (washer) / Seguro (arandela) / Arrêt (rondelle)	3/8 in. I.D. x 1-3/8 in. O.D. x .089 in. thick
	402294	2	Bushing / Buje / Bague	5/8" lip for 3/8" dia. stud-5/8" or 7/8" holes
	411520	1	Jam nut / Contratuercas / Contre-Écrou	3/8" x 24 UNF thread
<b>141353</b>	401006	1	Hex nut / Tuerca hexagonal / Écrou hexagonal	3/8" x 24 UNF thread
	401007	1	Jam nut / Contratuercas / Contre-Écrou	3/8" x 24 UNF thread
	401383	2	Retainer (washer) / Seguro (arandela) / Arrêt (rondelle)	3/8 in. I.D. x 1-1/2 in. O.D. x .093 in. thick
	402263	2	Bushing / Buje / Bague	7/8" centering lip for 3/8" O.D. stud
<b>141354</b>	401006	1	Hex nut / Tuerca hexagonal / Écrou hexagonal	3/8" x 24 UNF thread
	401007	1	Pal nut / Tuerca de cierre / Écrou Pal	3/8" x 24 UNF thread
	404350	1	Retainer (washer) / Seguro (arandela) / Arrêt (rondelle)	3/8 in. I.D. x 1-5/8 in. O.D. x .119 in. thick
	404485	1	Retainer (washer) / Seguro (arandela) / Arrêt (rondelle)	0.453" I.D. x 1.63" O.D. x 0.120" thick
	404959	2	Bushing / Buje / Bague	3/4" centering lip for 7/16" O.D. stud
<b>141356</b>	401006	1	Hex nut / Tuerca hexagonal / Écrou hexagonal	3/8" x 24 UNF thread
	401007	1	Pal nut / Tuerca de cierre / Écrou Pal	3/8" x 24 UNF thread
	401008	2	Retainer (washer) / Seguro (arandela) / Arrêt (rondelle)	3/8 in. I.D. x 1-1/4 in. O.D. x .075 in. thick
	403962	2	Bushing / Buje / Bague	1/2" centering lip for 3/8" O.D. stud
<b>141368</b>	401006	1	Hex nut / Tuerca hexagonal / Écrou hexagonal	3/8" x 24 UNF thread
	401007	1	Jam nut / Contratuercas / Contre-Écrou	3/8" x 24 UNF thread
	401008	1	Retainer (washer) / Seguro (arandela) / Arrêt (rondelle)	3/8 in. I.D. x 1-1/4 in. O.D. x .075 in. thick
	401383	1	Retainer (washer) / Seguro (arandela) / Arrêt (rondelle)	3/8 in. I.D. x 1-1/2 in. O.D. x .093 in. thick
	403489	2	Bushing / Buje / Bague	5/8" centering lip for 3/8" O.D. stud
	429680-030	1	Instruction sheet / Hoja de instr. / Feuillet d'instr.	
<b>141376</b>	401006	1	Hex nut / Tuerca hexagonal / Écrou hexagonal	3/8 in. -24 thread
	401007	1	Pal nut / Tuerca de cierre / Écrou Pal	3/8" x 24 UNF thread
	401008	2	Retainer (washer) / Seguro (arandela) / Arrêt (rondelle)	3/8 in. I.D. x 1-1/4 in. O.D. x .075 in. thick
	403489	2	Bushing / Buje / Bague	5/8" centering lip for 3/8" O.D. stud
<b>141439</b>	401011	2	Bushing / Buje / Bague	EB2 style - for 1-3/4" O.D. eye ring - 3/4" diam. Stud
	411165	1	Lock nut / Contratuercas / Contre-Écrou	12 x 1.25 metric thread
	411445	2	Bushing / Buje / Bague	Flat Bushing for 9/16" O.D. stud
	411446	2	Retainer (washer) / Seguro (arandela) / Arrêt (rondelle)	3/4" I.D. x 1 7/8" O.D. x .047" thick
	411447	1	Retainer (washer) / Seguro (arandela) / Arrêt (rondelle)	9/16" I.D. x 1-3/4" O.D. x .087" thick
	412554	1	Retainer (washer) / Seguro (arandela) / Arrêt (rondelle)	0.485" O.D. x 1.76" O.D. x .089" thick

## MOUNTING ACCESSORY PACKAGES AND COMPONENT PARTS

<b>141448</b>	404715	1	Spacer / Espaciador / Entretoise	0.737" I.D x 1.75" O.D. x .120 thick
	411165	1	Lock nut / Contratuerca / Contre-Écrou	12 x 1.25 metric thread
	411445	2	Bushing / Buje / Bague	Flat Bushing for 9/16" O.D. stud
	411446	1	Retainer (washer) / Seguro (arandela) / Arrêt (rondelle)	3/4" I.D. x 1 7/8" O.D. x .047" thick
	411447	1	Washer / Arandela / Rondelle	9/16" I.D. x 1-3/4" O.D. x .087" thick
	412554	1	Retainer (washer) / Seguro (arandela) / Arrêt (rondelle)	0.485" O.D x 1.76" O.D. x .089" thick
<b>141514</b>	401006	1	Hex nut / Tuerca hexagonal / Écrou hexagonal	3/8" x 24 UNF thread
	401007	1	Pal nut / Tuerca de cierre / Écrou Pal	3/8" x 24 UNF thread
	401383	2	Retainer (washer) / Seguro (arandela) / Arrêt (rondelle)	3/8 in. I.D. x 1-1/2 in. O.D. x .093 in. thick
	404947	2	Bushing / Buje / Bague	3/8 in. I.D. x 1-3/16 in. x 9/16 in. thick
<b>141537</b>	401006	1	Hex nut / Tuerca hexagonal / Écrou hexagonal	3/8" x 24 UNF thread
	404350	2	Retainer (washer) / Seguro (arandela) / Arrêt (rondelle)	3/8 in. I.D. x 1-5/8 in. O.D. x .119 in. thick
	404985	2	Bushing / Buje / Bague	5/8" centering lip for 3/8" O.D. stud
<b>141665</b>	401006	1	Hex nut / Tuerca hexagonal / Écrou hexagonal	3/8" x 24 UNF thread
	402943	1	Retainer (washer) / Seguro (arandela) / Arrêt (rondelle)	0.457" I.D. x 1.68" O.D. x .120" thick
	403298	1	Retainer (washer) / Seguro (arandela) / Arrêt (rondelle)	0.390" I.D. x 1.68" O.D. x .120" thick
	404959	2	Bushing / Buje / Bague	3/4" centering lip for 7/16" O.D. stud
	411520	1	Jam nut / Contratuerca / Contre-Écrou	3/8" x 24 UNF thread
<b>142036</b>	411497	1	Lock nut / Contratuerca / Contre-Écrou	10 x 1.25 metric thread
<b>142069</b>	411165	2	Lock nut / Contratuerca / Contre-Écrou	12 x 1.25 metric thread
	411447	2	Washer / Arandela / Rondelle	9/16" I.D. x 1-3/4" O.D. x .087" thick
	412103	2	Retainer (washer) / Seguro (arandela) / Arrêt (rondelle)	9/16" I.D. x 1-3/4" O.D. x 1/4" thick
	412116	4	Bushing / Buje / Bague	Flat bushing for 9/16" O.D. Stud
	412554	2	Retainer (washer) / Seguro (arandela) / Arrêt (rondelle)	0.485" O.D x 1.76" O.D. x .089" thick
<b>142095</b>	411165	1	Lock nut / Contratuerca / Contre-Écrou	12 x 1.25 metric thread
	411447	2	Retainer (washer) / Seguro (arandela) / Arrêt (rondelle)	9/16" I.D. x 1-3/4" O.D. x .087" thick
	412103	1	Retainer (washer) / Seguro (arandela) / Arrêt (rondelle)	9/16" I.D. x 1-3/4" O.D. x 1/4" thick
	412116	2	Bushing / Buje / Bague	Flat bushing for 9/16" O.D. Stud
<b>142280</b>	411633	2	Bushing / Buje / Bague	0.810" centering lip for 7/16" O.D. stud
	411672	1	Retainer (washer) / Seguro (arandela) / Arrêt (rondelle)	0.410" I.D. x 2.05" O.D. x 0.175" thick
	412046	1	Lock nut / Contratuerca / Contre-Écrou	10 x 1.5 metric thread
	412479	1	Retainer (washer) / Seguro (arandela) / Arrêt (rondelle)	0.490" I.D. x 2.15" O.D. x 0.180" thick
<b>142389</b>	404287	2	Retainer (washer) / Seguro (arandela) / Arrêt (rondelle)	0.453" I.D x 1.50" O.D x 0.090" thick
	404947	2	Bushing / Buje / Bague	For 3/8" O.D. stud- no centering lip
	411497	1	Lock nut / Contratuerca / Contre-Écrou	10 x 1.25 metric thread
<b>142592</b>	402539	2	Bolt / Tornillo / Boulon	5/16" x 24 UNF thread x 1" long
	402573	2	Nut / Tuerca / Écrou	5/16" x 24 UNF thread
	402653	2	Lock washer / Arandela de seguridad / Rondelle-frein	5/16" Lock washer
	411385	2	Retainer (washer) / Seguro (arandela) / Arrêt (rondelle)	0.355" I.D x 0.74" O.D. x 0.075" thick
<b>142615</b>	401006	1	Hex nut / Tuerca hexagonal / Écrou hexagonal	3/8" x 24 UNF thread
	401376	1	Retainer (washer) / Seguro (arandela) / Arrêt (rondelle)	3/8 in. I.D. x 1-3/8 in. O.D. x .089 in. thick
	402943	1	Retainer (washer) / Seguro (arandela) / Arrêt (rondelle)	0.457" I.D. x 1.68" O.D. x .120" thick
	404652	2	Bushing / Buje / Bague	Used with 5/8" dia. hole or 7/8" dia. Hole
<b>142617</b>	401006	1	Hex nut / Tuerca hexagonal / Écrou hexagonal	3/8" x 24 UNF thread
	402943	1	Retainer (washer) / Seguro (arandela) / Arrêt (rondelle)	0.457" I.D. x 1.68" O.D. x .120" thick
	403298	1	Retainer (washer) / Seguro (arandela) / Arrêt (rondelle)	0.390" I.D. x 1.68" O.D. x .120" thick
	412661	2	Bushing / Buje / Bague	0.790" centering lip for 7/16" O.D. stud



## MOUNTING ACCESSORY PACKAGES AND COMPONENT PARTS

<b>142656</b>	411165	1	Lock nut / Contratuerca / Contre-Écrou	12 x 1.25 metric thread
	411446	1	Retainer (washer) / Seguro (arandela) / Arrêt (rondelle)	3/4" I.D. x 1 7/8" O.D. x .047" thick
	411447	1	Retainer (washer) / Seguro (arandela) / Arrêt (rondelle)	9/16" I.D. x 1-3/4" O.D. x .087" thick
	412103	1	Retainer (washer) / Seguro (arandela) / Arrêt (rondelle)	9/16" I.D. x 1-3/4" O.D. x 1/4" thick
	412116	2	Bushing / Buje / Bague	Flat bushing for 9/16" O.D. Stud
	412554	1	Retainer (washer) / Seguro (arandela) / Arrêt (rondelle)	0.485" O.D x 1.76" O.D. x .089" thick
<b>142657</b>	411165	2	Lock nut / Contratuerca / Contre-Écrou	12 x 1.25 metric thread
	411446	2	Retainer (washer) / Seguro (arandela) / Arrêt (rondelle)	3/4" I.D. x 1 7/8" O.D. x .047" thick
	411447	2	Retainer (washer) / Seguro (arandela) / Arrêt (rondelle)	9/16" I.D. x 1-3/4" O.D. x .087" thick
	412103	2	Retainer (washer) / Seguro (arandela) / Arrêt (rondelle)	9/16" I.D. x 1-3/4" O.D. x 1/4" thick
	412116	4	Bushing / Buje / Bague	Flat bushing for 9/16" O.D. Stud
	412554	2	Retainer (washer) / Seguro (arandela) / Arrêt (rondelle)	0.485" O.D x 1.76" O.D. x .089" thick
<b>142700</b>	401006	1	Hex nut / Tuerca hexagonal / Écrou hexagonal	3/8" x 24 UNF thread
	402943	1	Retainer (washer) / Seguro (arandela) / Arrêt (rondelle)	0.457" I.D. x 1.68" O.D. x .120" thick
	403298	1	Retainer (washer) / Seguro (arandela) / Arrêt (rondelle)	0.390" I.D. x 1.68" O.D. x .120" thick
	404959	2	Bushing / Buje / Bague	3/4" centering lip for 7/16" O.D. stud
	411520	1	Jam nut / Contratuerca / Contre-Écrou	3/8" x 24 UNF thread
	412682	1	Sleeve / Camisa / Manchon	0.479" I.D. x 0.548" O.D. x 1.48" long
	429680-008	1	Instruction sheet / Hoja de instr. / Feuillet d'instr.	
<b>142731</b>	411165	1	Lock nut / Contratuerca / Contre-Écrou	12 x 1.25 metric thread
	411447	1	Retainer (washer) / Seguro (arandela) / Arrêt (rondelle)	9/16" I.D. x 1-3/4" O.D. x .087" thick
	412554	1	Retainer (washer) / Seguro (arandela) / Arrêt (rondelle)	0.485" O.D x 1.76" O.D. x .089" thick
	412675	2	Bushing / Buje / Bague	0.950" centering lip for 9/16" O.D. stud
<b>142973</b>	411633	2	Bushing / Buje / Bague	0.810" centering lip for 7/16" O.D. stud
	411672	1	Retainer (washer) / Seguro (arandela) / Arrêt (rondelle)	0.410" I.D. x 2.05" O.D. x 0.175" thick
	412046	1	Lock nut / Contratuerca / Contre-Écrou	10 x 1.5 metric thread
	412479	1	Retainer (washer) / Seguro (arandela) / Arrêt (rondelle)	0.490" I.D. x 2.15" O.D. x 0.180" thick
<b>142976</b>	401174	1	Hex nut / Tuerca hexagonal / Écrou hexagonal	5/8" x 18 thread
	405360	2	Retainer (washer) / Seguro (arandela) / Arrêt (rondelle)	5/8" I.D. x 2-3/16" O.D. x .120" thick
	405361-000	2	Bushing / Buje / Bague	1" centering lip for 5/8" O.D. stud (1.00" thick)
	429680-031	1	Instruction sheet / Hoja de instr. / Feuillet d'instr.	
<b>142998</b>	404452	2	Retainer (washer) / Seguro (arandela) / Arrêt (rondelle)	5/8" I.D. x 2-3/4" O.D. x .180" thick
	404454	2	Bushing / Buje / Bague	1-3/16" centering lip for 13/16" O.D. stud
	405862	1	Self locking nut / Tuerca de seguridad / Écrou indesserrable	5/8" x 18 thread
	412872	1	Sleeve / Camisa / Manchon	0.643" I.D. x .815" O.D. x 1.44" long
<b>143000</b>	404695	1	Retainer (washer) / Seguro (arandela) / Arrêt (rondelle)	0.709" centering lip x 1.97" O.D. x .060" thick
	404715	1	Spacer / Espaciador / Entretoise	0.737" I.D x 1.75" O.D. x .120 thick
	411165	1	Lock nut / Contratuerca / Contre-Écrou	12 x 1.25 metric thread
	411447	1	Retainer (washer) / Seguro (arandela) / Arrêt (rondelle)	9/16" I.D. x 1-3/4" O.D. x .087" thick
	412116	2	Bushing / Buje / Bague	Flat bushing for 9/16" O.D. Stud
	412554	1	Retainer (washer) / Seguro (arandela) / Arrêt (rondelle)	0.485" O.D x 1.76" O.D. x .089" thick
	429680-033	1	Instruction sheet / Hoja de instr. / Feuillet d'instr.	
<b>143078</b>	401006	1	Hex nut / Tuerca hexagonal / Écrou hexagonal	3/8" x 24 UNF thread
	404969	1	Sleeve / Camisa / Manchon	0.400" I.D. x .620" O.D. x 1.48" long
	412554	2	Retainer (washer) / Seguro (arandela) / Arrêt (rondelle)	0.485" O.D x 1.76" O.D. x .089" thick
	412675	2	Bushing / Buje / Bague	0.950" centering lip for 9/16" O.D. stud
<b>143146</b>	411165	1	Lock nut / Contratuerca / Contre-Écrou	12 x 1.25 metric thread
	411447	2	Retainer (washer) / Seguro (arandela) / Arrêt (rondelle)	9/16" I.D. x 1-3/4" O.D. x .087" thick
	412675	2	Bushing / Buje / Bague	0.950" centering lip for 9/16" O.D. stud

## MOUNTING ACCESSORY PACKAGES AND COMPONENT PARTS

<b>145054</b>	401174	1	Hex nut / Tuerca hexagonal / Écrou hexagonal	5/8 in. -18 thread
	401175	1	Lock washer / Arandela de seguridad / Rondelle-frein	
	405360	2	Retainer (washer) / Seguro (arandela) / Arrêt (rondelle)	5/8" I.D. x 2-3/16" O.D. x .120" thick
	405361-000	2	Bushing / Buje / Bague	1" centering lip for 5/8" O.D. stud (1.00" thick)
<b>145075</b>	401750	1	Retainer (washer) / Seguro (arandela) / Arrêt (rondelle)	3/4" I.D. x 2-3/8" O.D. x .105" thick
	401752	1	Retainer (washer) / Seguro (arandela) / Arrêt (rondelle)	1" I.D. x 2-3/8" O.D. x .105" thick
	401754	2	Bushing / Buje / Bague	EB3 - style for 2.39 in. O.D. eye ring - 1" diam. Stud
	405360	2	Retainer (washer) / Seguro (arandela) / Arrêt (rondelle)	5/8" I.D. x 2-3/16" O.D. x .120" thick
	405361-000	2	Bushing / Buje / Bague	1" centering lip for 5/8" O.D. stud (1.00" thick)
<b>145080</b>	401011	2	Bushing / Buje / Bague	EB2 style - for 1-3/4" O.D. eye ring - 3/4" diam. Stud
	401429	1	Retainer (washer) / Seguro (arandela) / Arrêt (rondelle)	1/2" I.D. x 1-5/8" O.D. x .090" thick
	401430	1	Retainer (washer) / Seguro (arandela) / Arrêt (rondelle)	3/4" I.D. x 1-5/8" O.D. x .090" thick
<b>145089-000</b>	405360	2	Retainer (washer) / Seguro (arandela) / Arrêt (rondelle)	5/8" I.D. x 2-3/16" O.D. x .120" thick
	405361-000	2	Bushing / Buje / Bague	1" centering lip for 5/8" O.D. stud (1.00" thick)
	405862	1	Self locking nut / Tuerca de seguridad / Écrou indesserrable	5/8" x 18 thread
<b>145089-200</b>	405360	2	Retainer (washer) / Seguro (arandela) / Arrêt (rondelle)	5/8" I.D. x 2-3/16" O.D. x .120" thick
	405361-100	2	Bushing / Buje / Bague	1" centering lip for 5/8" O.D. stud (0.75" thick)
	415196-001	1	Nylon lock nut / Contratuerca / Contre-Écrou	5/8" x 18 thread
<b>145090</b>	405643	1	Sleeve / Camisa / Manchon	0.645" I.D x 0.810" O.D. x 2.00" long
	405859	2	Bushing / Buje / Bague	0.815" I.D. x 2.35" O.D x 1.05" thick with 1.15" centering lip
	405860	2	Retainer (washer) / Seguro (arandela) / Arrêt (rondelle)	0.650" I.D. x 2.75" O.D. x .180" thick
	405862	1	Self locking nut / Tuerca de seguridad / Écrou indesserrable	5/8" x 18 thread
	424276	1	Instruction sheet / Hoja de instr. / Feuillet d'instr.	
<b>145093</b>	401750	2	Retainer (washer) / Seguro (arandela) / Arrêt (rondelle)	3/4" I.D. x 2-3/8" O.D. x .105" thick
	401752	2	Retainer (washer) / Seguro (arandela) / Arrêt (rondelle)	1" I.D. x 2-3/8" O.D. x .105" thick
	401754	4	Bushing / Buje / Bague	EB3 - style for 2.39 in. O.D. eye ring - 1" diam. Stud
<b>145099</b>	401174	1	Hex nut / Tuerca hexagonal / Écrou hexagonal	5/8" x 18 thread
	401175	1	Lock washer / Arandela de seguridad / Rondelle-frein	
	401754	2	Bushing / Buje / Bague	EB3 - style for 2.39 in. O.D. eye ring - 1" diam. Stud
	405360	2	Retainer (washer) / Seguro (arandela) / Arrêt (rondelle)	5/8" I.D. x 2-3/16" O.D. x .120" thick
	405361-000	2	Bushing / Buje / Bague	1" centering lip for 5/8" O.D. stud (1.00" thick)
	424274	1	Instruction sheet / Hoja de instr. / Feuillet d'instr.	
<b>145112</b>	401164	1	Hex nut / Tuerca hexagonal / Écrou hexagonal	1/2" x 20 UNF Thread
	401165	1	Lock washer / Arandela de seguridad / Rondelle-frein	1/2" lock washer
	405360	1	Retainer (washer) / Seguro (arandela) / Arrêt (rondelle)	5/8" I.D. x 2-3/16" O.D. x .120" thick
	405361-000	2	Bushing / Buje / Bague	1" centering lip for 5/8" O.D. stud (1.00" thick)
	405934	1	Retainer (washer) / Seguro (arandela) / Arrêt (rondelle)	0.530" I.D. x 2-3/16" O.D. x .120" thick
<b>145116</b>	401750	1	Retainer (washer) / Seguro (arandela) / Arrêt (rondelle)	3/4" I.D. x 2-3/8" O.D. x .105" thick
	401752	1	Retainer (washer) / Seguro (arandela) / Arrêt (rondelle)	1" I.D. x 2-3/8" O.D. x .105" thick
	415169	2	Bushing / Buje / Bague (Durometer 80)	EB3 - style for 2.39 in. O.D. eye ring - 1" diam. Stud
<b>145123</b>	405360	2	Retainer (washer) / Seguro (arandela) / Arrêt (rondelle)	5/8" I.D. x 2-3/16" O.D. x .120" thick
	405862	1	Self locking nut / Tuerca de seguridad / Écrou indesserrable	5/8" x 18 thread
	415017-001	2	Bushing / Buje / Bague	1" centering lip for a 5/8" O.D. stud
<b>145126</b>	401750	2	Retainer (washer) / Seguro (arandela) / Arrêt (rondelle)	3/4" I.D. x 2-3/8" O.D. x .105" thick
	401754	2	Bushing / Buje / Bague	EB3 - style for 2.39 in. O.D. eye ring - 1" diam. Stud
	403752	1	Sleeve / Camisa / Manchon	3/4" I.D. x 15/16" O.D. x 1-3/4" long
	415277	1	Spacer / Espaciador / Entretoise	1-3/16" I.D. x 1-1/4" O.D. x .200" thick
	424281	1	Instruction sheet / Hoja de instr. / Feuillet d'instr.	

## MOUNTING ACCESSORY PACKAGES AND COMPONENT PARTS

<b>145128</b>	405360	2	Retainer (washer) / Seguro (arandela) / Arrêt (rondelle)	5/8" I.D. x 2-3/16" O.D. x .120" thick
	405361-000	2	Bushing / Buje / Bague	1" centering lip for 5/8" O.D. stud (1.00" thick)
	415196-001	1	Nylon lock nut / Contratuerca / Contre-Écrou	5/8" x 18 thread
<b>145132</b>	415305-000	2	Rubber spacer / Espaciador de goma / Entretoise de caout.	0.910" I.D. x 1.58" O.D. x 1.1" long
	415305-001	2	Rubber spacer / Espaciador de goma / Entretoise de caout.	0.910" I.D. x 1.58" O.D. x 0.427" long
	424282	1	Instruction sheet / Hoja de instr. / Feuillet d'instr.	
<b>145140</b>	405360	2	Retainer (washer) / Seguro (arandela) / Arrêt (rondelle)	5/8" I.D. x 2-3/16" O.D. x .120" thick
	405862	1	Self locking nut / Tuerca de seguridad / Écrou indesserrable	5/8" x 18 thread
	415326-001	2	Urethane bushing / Buje de uretano / Bague urÉthane	1" centering lip for 5/8" O.D. stud (replacing Bushing P/N 415017)
<b>145143</b>	415305-001	2	Rubber spacer / Espaciador de goma / Entretoise de caout.	0.910" I.D. x 1.58" O.D. x 0.427" long
	424284	1	Instruction sheet / Hoja de instr. / Feuillet d'instr.	
<b>145144</b>	415305-000	2	Rubber spacer / Espaciador de goma / Entretoise de caout.	0.910" I.D. x 1.58" O.D. x 1.1" long
	424284	1	Instruction sheet / Hoja de instr. / Feuillet d'instr.	
<b>145147</b>	401429	1	Retainer (washer) / Seguro (arandela) / Arrêt (rondelle)	1/2" I.D. x 1-5/8" O.D. x .090" thick
	401430	1	Retainer (washer) / Seguro (arandela) / Arrêt (rondelle)	3/4" I.D. x 1-5/8" O.D. x .090" thick
<b>145148</b>	401750	1	Retainer (washer) / Seguro (arandela) / Arrêt (rondelle)	3/4" I.D. x 2-3/8" O.D. x .105" thick
	401752	1	Retainer (washer) / Seguro (arandela) / Arrêt (rondelle)	1" I.D. x 2-3/8" O.D. x .105" thick
<b>145149</b>	401265	1	Retainer (washer) / Seguro (arandela) / Arrêt (rondelle)	1/2" I.D. x 1-1/4" O.D. x .075" thick
	401266	1	Retainer (washer) / Seguro (arandela) / Arrêt (rondelle)	5/8" I.D. x 1-1/4" O.D. x .075" thick
<b>145168</b>	405643-100	1	Sleeve / Camisa / Manchon	0.645" I.D x 0.810" O.D. x 1.50" long
	405859-100	2	Bushing / Buje / Bague	0.815" I.D. x 2.35" O.D x 0.800" thick with 1.15" centering lip
	405860	2	Retainer (washer) / Seguro (arandela) / Arrêt (rondelle)	0.650" I.D. x 2.75" O.D. x .180" thick
	405862	1	Self locking nut / Tuerca de seguridad / Écrou indesserrable	5/8" x 18 thread
	424276	1	Instruction sheet / Hoja de instr. / Feuillet d'instr.	
<b>145177</b>	401754	2	Bushing / Buje / Bague	EB3 - style for 2.39 in. O.D. eye ring - 1" diam. Stud
	406422-000	2	Retainer (washer) / Seguro (arandela) / Arrêt (rondelle)	22 mm I.D. x 60.2 mm O.D. x 2.7 mm thick
	415010-802	1	Sleeve / Camisa / Manchon	22 mm I.D. x 1.00" O.D. x 1-3/4" long
	424296-000	1	Instruction sheet / Hoja de instr. / Feuillet d'instr.	
<b>401011</b>		1	Bushing / Buje / Bague	EB2 style - for 1-3/4" O.D. eye ring - 3/4" diam. Stud - Replaced by TR0027
<b>401754</b>		1	Bushing / Buje / Bague	EB3 - style for 2.39 in. O.D. eye ring - 1" diam. Stud
<b>404702</b>		1	Bushing / Buje / Bague	EB1 style - 1 pc Spool shaped bushing (5/8" I.D.)
<b>405360</b>		1	Retainer (washer) / Seguro (arandela) / Arrêt (rondelle)	5/8" I.D. x 2-3/16" O.D. x .120" thick
<b>405361-000</b>		1	Bushing / Buje / Bague	1" centering lip for 5/8" O.D. stud (1.00" thick)
<b>406422</b>		1	Retainer (washer) / Seguro (arandela) / Arrêt (rondelle)	22 mm I.D. x 60.2 mm O.D. x 2.7 mm thick
<b>415010-802</b>		1	Sleeve / Camisa / Manchon	22 mm I.D. x 1.00" O.D. x 1-3/4" long
<b>415015-001</b>		1	Urethane bushing / Buje de uretano / Bague urÉthane	EB3 - style for 2.39 in. O.D. eye ring - 1" diam. Stud
<b>415017</b>		1	Urethane bushing / Buje de uretano / Bague urÉthane	1" centering lip for 5/8" O.D. stud
<b>415025-001</b>		1	Urethane bushing / Buje de uretano / Bague urÉthane	EB2 style for 1-3/4" O.D. eye ring - 3/4" diam. Stud
<b>415326-001</b>		1	Urethane bushing / Buje de uretano / Bague urÉthane	1" centering lip for 5/8" O.D. stud (replacing Bushing P/N 415017)
<b>TR0027</b>		1	Bushing / Buje / Bague	EB2 style - for 1-3/4" O.D. eye ring - 3/4" diam. Stud - (Replaces 401011)

## MOUNTING ACCESSORY PACKAGES - BUYER'S GUIDE

Kit #	Gabriel #	
<b>140126</b>	34052	
	43099	
	58350	
	58359	
	58360	
	58387	
	61518	
	61523	
	61540	
	61647	
	61650	
	77359	
	G63350	
	G63359	
	G63360	
	G63387	
	G63457	
	14016	
	83027	
	G63350	
	G63359	
	G63360	
	G63387	
	G63457	
	G63881	
	<b>140149</b>	61510
		61699
		61700
		77494
		G63494
		83200
		83216
		83219
83308		
83309		
83312		
83314		
85023		
85024		
85046		
85047		
89401		
89402		

Kit #	Gabriel #	
<b>140149 Cont.</b>	89403	
	89409	
	89415	
	89416	
	89434	
	89435	
	G63494	
	G63510	
	61597	
	G63605	
	G63639	
	G63616	
	85025	
	G63605	
	G63708	
	85031	
	G63432	
	<b>140357</b>	34036
		58349
58438		
61524		
77349		
G63349		
G63438		
G63349		
G63438		
G63349		
G63438		
<b>140455</b>	34051	
	58421	
	61504	
	61509	
	69900	
	77421	
	G63421	
	G63862	
	83003	
	83005	
	83014	
	83015	
	83400	
G63421		
G63798		
G63860		
G63862		

Kit #	Gabriel #	
<b>140455 Cont.</b>	G63950	
<b>140505</b>	69574	
	69575	
<b>140523</b>	61502	
<b>140524</b>	61513	
	61552	
	61593	
	61596	
	77479	
	G63479	
	G63484	
	G63635	
	83161	
	83507	
	G63479	
	G63484	
	G63491	
	G63611	
	G63635	
	<b>140629</b>	69604
		69724
	6851SE	
	<b>140630</b>	43049
43060		
<b>140673</b>	61529	
	61606	
	77937	
G63900		
G63937		
G63900		
G63937		
<b>140702</b>	43111	
	58355	
	58394	
	61525	
	77355	
	G63355	
	G63394	
	G63625	
	83303	
	83304	
	G63355	
	G63394	

## MOUNTING ACCESSORY PACKAGES - BUYER'S GUIDE

Kit #	Gabriel #
<b>140702 Cont.</b>	G63625
	83007
<b>140719</b>	43171
	43172
	61590
	61624
	77607
	77679
	G63607
	G63679
	G63607
	G63679
<b>140724</b>	43085
<b>140739</b>	43058
<b>140780</b>	34057
	34058
	34076
	58386
	58414
	58416
	58500
	58609
	58624
	58929
	61520
	61521
	61553
	61561
	61569
	61591
	61595
	77375
	77414
	77608
	77614
	77772
	G63386
	G63396
	G63414
	G63416
	G63445
	G63447
	G63500
	G63603
	G63608
	G63614
	G63621
	G63624
	G63929
	83162
	63432
	63448
<b>140857</b>	61501
	61508
	77902
	G63902
	G63902
<b>140873</b>	43138
	69703

Kit #	Gabriel #
<b>140780 Cont.</b>	G63603
	G63608
	G63614
	G63621
	G63624
	G63929
	G63375
	G63375
	83177
	63130
	63211
	63350
	83018
	83019
	83041
	83045
	83050
	83058
	83105
	83114
	G63386
	G63396
	G63414
	G63416
	G63445
	G63447
	G63500
	G63603
	G63608
	G63614
	G63621
	G63624
	G63929
	83162
	63432
	63448
<b>140857</b>	61501
	61508
	77902
	G63902
	G63902
<b>140873</b>	43138
	69703

Kit #	Gabriel #
<b>140884</b>	77405
	G63405
	G63405
<b>140885</b>	G63299
	63178
	63299
	G63299
<b>140896</b>	G55507
<b>140921</b>	61588
	77726
	G63548
	G63726
	G63548
	G63726
<b>140953</b>	G51760
	G51761
<b>141041</b>	34073
	69675
	G63444
	G63889
	G64004
	G64005
	G64006
	G64007
	83509
	G63444
	G63889
	G64004
	G64005
	G64006
	G64007
	63451
	63548
	83513
	83514
	83515
<b>141047</b>	58410
	61546
	77410
	G63410
	G63446
	63220
	63320

## MOUNTING ACCESSORY PACKAGES - BUYER'S GUIDE

Kit #	Gabriel #
<b>141047 Cont.</b>	G63410
	G63446
<b>141058</b>	43093
<b>141083</b>	83301
	83317
	83318
	83613
<b>141108</b>	85310
	89423
	89447
	89455
<b>141137</b>	61506
	61519
	77377
	77492
	G63377
	G63492
	G63377
	G63492
	G63712
<b>141138</b>	G63187
	G63398
	G63187
	G63398
<b>141150</b>	43140
	69606
<b>141191</b>	69861
<b>141247</b>	85703
	85710
	85711
	85311
	85312
	89424
<b>141277</b>	61544
	77489
	G63489
	G63489
<b>141349</b>	61545
	G63404
	G63612
	G63432
	G63404
<b>141350</b>	G63495

Kit #	Gabriel #
<b>141350 Cont.</b>	G63547
	G63495
	G63547
	G63781
	G63782
<b>141353</b>	61535
	61551
	77424
	G63511
	61664
	G63424
	G63847
	77847
	G63847
	G63424
	G63511
<b>141354</b>	G63707
<b>141356</b>	77418
	77904
	G63418
	G63904
	G63418
	G63904
<b>141368</b>	77909
	G63909
	G63909
<b>141376</b>	77903
	G63903
	G63903
<b>141387</b>	85107
<b>141397</b>	6805SE
	6804SE
<b>141405</b>	G63620
<b>141439</b>	G63434
<b>141448</b>	G63506
	G63694
<b>141514</b>	G63799
<b>141537</b>	58489
<b>141665</b>	58783
	58803
	58817
	61615
	61626

Kit #	Gabriel #
<b>141665 Cont.</b>	61641
	61643
	61663
	77783
	77817
	G63721
	G63772
	G63783
	G63803
	G63817
	G63721
	G63772
	G63783
	G63803
<b>141682</b>	G52081
	G52082
<b>141716</b>	G51842
<b>141727</b>	G56807
	G56838
	G56839
<b>141998</b>	6802SE
	6803SE
	6826SE
	6805SE
	6805SE
<b>142000</b>	6805SE
	6805SE
<b>142036</b>	G63884
<b>142037</b>	6801SE
<b>142038</b>	6807SE
<b>142095</b>	63104
	63600
	83178
<b>142101</b>	G51047
<b>142154</b>	G51721
<b>142169</b>	G55948
	G55949
<b>142277</b>	61623
	77678
	G63678
<b>142280</b>	G63885
<b>142387</b>	14017
<b>142389</b>	61662

## MOUNTING ACCESSORY PACKAGES - BUYER'S GUIDE

Kit #	Gabriel #
<b>142389 Cont.</b>	77815
	G63813
	G63815
	G63610
	G63865
<b>142467</b>	G51077
<b>142486</b>	77955
<b>142491</b>	85101
<b>142592</b>	77847
	61664
	G63424
	G63847
	G63847
<b>142615</b>	61555
	G63375
	G63375
<b>142617</b>	58622
	58623
	58807
	61646
	77807
	G63622
	G63623
	G63622
	G63623
<b>142656</b>	83512
	G63616
<b>142657</b>	G63615
<b>142700</b>	58715
	58778
	61612
	61638
	77715
	77778
	G63715
	G63778
	G63715
	G63778
<b>142718</b>	6828SE
	6854SE
<b>142731</b>	58673
	58674
	58714

Kit #	Gabriel #
<b>142731 Cont.</b>	58716
	61611
	61613
	61634
	61635
	61680
	61712
	61714
	77623
	77673
	77674
	77714
	77716
	77947
	77948
	77951
	G63674
	G63714
	G63716
	G63848
	G63886
	G64009
	G64011
	G64029
	G64030
	G63674
	G63714
	G63716
	G63848
	G63886
	G64009
	G64011
<b>142973</b>	61711
	G64008
	G64008
<b>142976</b>	G63828
	G63832
<b>142998</b>	83456
<b>143000</b>	58661
	61599
	77949
	G63661
	G63673

Kit #	Gabriel #
<b>143000 Cont.</b>	G63661
	G63673
<b>143008</b>	G51477
<b>143077</b>	6856SE
<b>143078</b>	61685
	G63893
	G63894
	G63895
	G63958
	G64001
<b>143146</b>	77967
	G63969
	G63969
<b>143154</b>	6855SE
<b>143155</b>	6853SE
<b>143156</b>	6856SE
<b>143157</b>	6857SE
<b>143159</b>	6862SE
<b>143160</b>	6861SE
<b>143161</b>	6858SE
<b>143162</b>	6860SE
<b>143163</b>	6848SE
<b>143164</b>	6863SE
<b>143165</b>	6852SE
<b>143166</b>	6859SE
<b>143167</b>	6849SE
<b>143168</b>	6850SE
<b>143172</b>	G56778
<b>143177</b>	6851SE
<b>143248</b>	G57021
<b>143276</b>	61683
	61684
	77803
	77954
	G63893
	G63894
	G63895
	G63958
	G64001
<b>143312</b>	G63884
<b>143340</b>	G64038
<b>145054</b>	85729
	85731

## MOUNTING ACCESSORY PACKAGES - BUYER'S GUIDE

Kit #	Gabriel #
<b>145054 Cont.</b>	83103
	83134
	83136
	83635
	85009
	85026
	85027
	85071
	85080
	85085
	85092
	85096
	85318
	85324
	85330
	85336
	85342
	85379
	85701
	85900
	85902
	85921
	89417
	89418
	89441
	85025
<b>145075</b>	85723
<b>145080</b>	83107
	85012
	85054
	85055
	85062
	85063
	89408
	89413
	89438
	89439
<b>145090</b>	85380
	85740
	695406
	85081
	85093
	85103

Kit #	Gabriel #
<b>145090 Cont.</b>	85110
	85117
	85123
	85316
	85346
	85347
	85705
	85706
	85707
	85708
	85709
	85722
	85745
	85746
	85935
	85973
	85982
	85993
	87020
	89426
	85987
	87016
<b>145093</b>	85714
	85715
	85716
	85717
	85718
	85719
<b>145099</b>	83353
	85033
	85988
	89427
<b>145116</b>	87016
	85732
	83162
<b>145126</b>	85053
	89442
<b>145128</b>	85065
	83062
	83109
	83110
	83111
	83112

Kit #	Gabriel #
<b>145128 Cont.</b>	83138
	83142
	83143
	85083
	85332
	85333
	85977
<b>145140</b>	85727
	85728
<b>145143</b>	83120
<b>145144</b>	85065
<b>145148</b>	83140
	83141
<b>145158</b>	63322
<b>145168</b>	83173
	85981
<b>145177</b>	85118
<b>401011</b>	83179
	83404
	83505
	83506
<b>401754</b>	83214
	83215
	83217
	83225
	83362
	85001
	85004
	85007
	85040
	85042
	85070
	85300
	85301
	85302
	85303
	85304
	85305
	85307
	85308
	85313
	85314
	85315



## MOUNTING ACCESSORY PACKAGES - BUYER'S GUIDE

Kit #	Gabriel #
<b>401754 Cont.</b>	85320
	85322
	85327
	85329
	85334
	85339
	85376
	85700
	85702
	85704
	85712
	85713
	85720
	85730
	85734
	85735
	85736
	85901
	85905
	85912
	85913
	85940
	85941
	85942
	85943
	85944
	85948
	85949
	85951
	85968
	85983
	89410
	89412
	89419
	89420
	89422
	89425
	89429
	89459
	85703
	85710
	85711
	85729

Kit #	Gabriel #
<b>401754 Cont.</b>	85731
	85343
	85380
	85740
<b>404702</b>	83007
	83001
	83006
	83011
	83012
	83038
	83047
	83117
	83401
	83508
	83510
	83161
	83177
	83509
<b>405360</b>	85727
<b>406422</b>	83162
<b>500498</b>	14040
	6804SE
	6801SE
	6807SE
<b>415010-802</b>	83162
<b>142280</b>	
<b>142280</b>	G63885
<b>145089-000</b>	83120
	85343
	83102
	83154
	85069
	85073
	85122
	85319
	85340
	85341
	85733
	85970
	89428
<b>145089-200</b>	85936
<b>145089-200</b>	85937
<b>145089-200</b>	85985

Kit #	Gabriel #
<b>145089-200 Cont.</b>	89456
<b>145168-000</b>	85996
	85997
<b>415010-802</b>	83140
	83141
	63322
<b>415015-001</b>	85987
	63449
	63449
<b>TR0027</b>	63450
	83159
	83511
	85074
	85077
	89446
	85031
	63432
	63448
	63451
	63548
	83513
	83514
	83515
	83512