

The background features two large, semi-transparent grey silhouettes. On the left, a hand is shown holding a pen. On the right, a pen nib is shown vertically. The overall background is a dark, textured grey.

Gabriel[®]
THE ORIGINAL

2018
CATALOG

Table of Contents

New Part Numbers	2
14 Year Supersedure List.....	5
Vehicle Model to Make Index.....	9
Footnote Index	18
Sales Popularity Listing	19
New Catalog Layout and Key Descriptions	20
Application Data	
Passenger Cars & Light Trucks	21
Numerical Listing	
Steering Stabilizers	314
Steering Dampers	317
Front Load Carriers	317
Rear Load Carriers.....	318
Ultra Strut Cartridges	321
HiJackers	322
Ultra Spring Seats	326
Ultra Struts	326
Guardian Struts	344
ReadyMount Strut Assemblies	349
Guardian ReadyMount Assemblies	359
LTV Shocks.....	364
ProGuard Shocks	369
Ultra Truck Shocks	376
Ultra Shocks	387
MaxControl Monotube Shocks	392
Guardian Shocks	397
Classic Shocks	406
Suspension Mounts	409
Strut Cushions.....	417
Reference Section:	
A..... Air Adjustable Hose Kit Cross Reference	420
Self-leveling System Electronic Compressor Deactivation Procedure for GM Models	423
B..... Strut Mount Photos	426
C..... Steering Stabilizers Boots	
D..... Electronic Adjustable Suspension Conversion.....	436
E..... Left / Right Combinations	442
F..... Mounting Codes / Extended and Collapsed Length Charts	447
G..... Disposal of Old or Defective Shocks & Struts	482

NEW PART NUMBERS IN THIS CATALOG

14072	143424	G51979	G52365	G52454	G64157	M55657	M55896
14074	143455	G51980	G52366	G52524	G64164	M55658	M55901
14077	143458	G51981	G52367	G52525	M51022	M55661	M55909
49255	143460	G51982	G52368	G52592	M51077	M55662	M55910
61732	143461	G51983	G52369	G56640	M51087	M55663	M55912
61734	143462	G51984	G52370	G56641	M51204	M55664	M55913
69587	143463	G51985	G52374	G57063	M51230	M55665	M55920
69590	143469	G51990	G52375	G57064	M51252	M55666	M55921
70064	143475	G51994	G52376	G57123	M51254	M55667	M55948
70065	143476	G51995	G52377	G57124	M51267	M55675	M55949
70077	143477	G51996	G52380	G57133	M51268	M55676	M55960
70086	143492	G51997	G52381	G57134	M51279	M55679	M55970
70089	143495	G51998	G52382	G57141	M51700	M55680	M55971
70095	143496	G52175	G52383	G57142	M51703	M55681	M55974
70096	143498	G52176	G52384	G57147	M51704	M55685	M55975
70098	143528	G52235	G52385	G57148	M51713	M55693	M55976
77980	143530	G52236	G52386	G57156	M51714	M55697	M55977
77981	143531	G52253	G52387	G57159	M51718	M55698	M55978
77983	143552	G52254	G52389	G57160	M51722	M55733	M55990
143379	143554	G52293	G52390	G57161	M51723	M55745	M55991
143385	G511004	G52294	G52395	G57162	M51724	M55774	M55993
143386	G511019	G52295	G52396	G57163	M51736	M55786	M55994
143387	G511020	G52299	G52398	G57164	M51737	M55788	M55999
143388	G511021	G52300	G52399	G57165	M51738	M55800	M56501
143389	G511043	G52301	G52400	G57166	M51760	M55801	M56502
143393	G511057	G52329	G52401	G57167	M51761	M55802	M56504
143394	G511071	G52330	G52406	G57168	M52028	M55803	M56506
143395	G51716	G52331	G52412	G57172	M52029	M55804	M56509
143397	G51830	G52332	G52413	G57173	M52573	M55817	M56514
143398	G51916	G52346	G52418	G57176	M52574	M55820	M56515
143399	G51925	G52348	G52419	G57177	M55514	M55825	M56516
143401	G51926	G52349	G52432	G57178	M55518	M55831	M56517
143402	G51927	G52351	G52433	G57202	M55525	M55847	M56518
143404	G51930	G52352	G52435	G57203	M55526	M55848	M56520
143406	G51933	G52353	G52436	G57204	M55551	M55856	M56539
143408	G51934	G52354	G52437	G57205	M55557	M55870	M56540
143410	G51937	G52355	G52438	G64063	M55579	M55871	M56558
143411	G51961	G52356	G52439	G64074	M55590	M55877	M56559
143413	G51966	G52360	G52440	G64105	M55591	M55879	M56606
143414	G51969	G52361	G52447	G64111	M55607	M55892	M56612
143418	G51975	G52362	G52448	G64114	M55608	M55893	M56618
143422	G51976	G52363	G52453	G64146	M55616	M55894	M56619

NEW PART NUMBERS IN THIS CATALOG

M56620	M56805	M56937	M56975	M57024	M57057	M57100	M57162
M56621	M56806	M56938	M56976	M57025	M57058	M57114	M57163
M56622	M56810	M56939	M56977	M57026	M57059	M57115	M57164
M56660	M56903	M56940	M56981	M57030	M57060	M57119	M57167
M56661	M56907	M56943	M56991	M57031	M57063	M57120	M57168
M56671	M56909	M56947	M56992	M57034	M57064	M57125	M57173
M56672	M56910	M56948	M56996	M57035	M57067	M57126	M57176
M56673	M56911	M56949	M56997	M57036	M57068	M57127	M57177
M56674	M56912	M56950	M56998	M57039	M57069	M57128	M57178
M56675	M56924	M56951	M57007	M57040	M57070	M57130	M57202
M56676	M56925	M56956	M57008	M57041	M57071	M57131	M57203
M56677	M56926	M56957	M57011	M57042	M57072	M57132	M57206
M56678	M56927	M56961	M57012	M57043	M57083	M57135	M57207
M56700	M56928	M56962	M57013	M57044	M57086	M57136	M57208
M56707	M56929	M56963	M57014	M57047	M57088	M57139	M57299
M56708	M56930	M56964	M57017	M57048	M57089	M57140	M57316
M56718	M56931	M56965	M57018	M57049	M57090	M57144	
M56719	M56932	M56967	M57019	M57050	M57091	M57145	
M56720	M56933	M56970	M57020	M57051	M57092	M57156	
M56727	M56934	M56971	M57021	M57054	M57095	M57159	
M56736	M56935	M56973	M57022	M57055	M57096	M57160	
M56739	M56936	M56974	M57023	M57056	M57099	M57161	

PART NUMBERS SUPERSEDED

DELETE	THEN USE
G51101	G511057
G51743	G511057
69782	G63864
G63877	69909

PARTS TO BE DISCONTINUED WHEN INVENTORY IS DEPLETED

14020	82062	142234	142426	142749	143196
34076	82608	142240	142427	142751	143197
43143	82614	142241	142429	142752	143199
43172	141580	142242	142430	142753	143206
49131	141974	142244	142437	142755	143207
49157	142091	142245	142440	142757	143210
49199	142092	142247	142442	142762	143219
49207	142103	142248	142444	142763	143220
49214	142108	142249	142521	142803	143222
49216	142132	142250	142524	142825	143227
49225	142133	142251	142527	142826	143228
49310	142134	142252	142529	142828	143233
58353	142135	142254	142530	142832	143235
58377	142136	142292	142532	142834	143236
58387	142141	142295	142543	142836	143240
58410	142142	142296	142547	142840	143262
58416	142144	142298	142550	142842	143263
58456	142145	142300	142556	142847	143265
58500	142146	142301	142559	142850	143278
58671	142148	142302	142561	142851	143279
61507	142150	142306	142562	142853	143280
61513	142173	142311	142570	142855	143317
61534	142183	142316	142572	142856	143320
61545	142189	142317	142573	142857	143328
61568	142190	142321	142626	142858	143357
61598	142194	142325	142639	142859	143528
61681	142195	142329	142640	142860	6862SE
69773	142196	142334	142641	142861	6863SE
69880	142197	142335	142642	142880	G44477
69884	142217	142393	142643	142933	G44773
69885	142219	142396	142647	142936	G44783
75755	142220	142399	142649	142940	G44918
75795	142221	142402	142650	142942	G44937
81542	142223	142403	142653	142943	G44943
81554	142224	142404	142734	143035	G44947
81555	142225	142405	142735	143073	G44969
81557	142226	142406	142738	143074	G44991
81674	142227	142408	142741	143083	G51007
81739	142228	142409	142744	143112	G51013
81741	142229	142411	142745	143113	G51030
81907	142231	142412	142746	143116	G51031
82020	142233	142415	142747	143139	G51064

PARTS TO BE DISCONTINUED WHEN INVENTORY IS DEPLETED

G51165	G55593	G55796	G56716	M57289	M57302
G51181	G55594	G55923	G56765	M57290	M57303
G51182	G55609	G55924	G56766	M57291	M57304
G51192	G55716	G55927	G56767	M57292	M57305
G51232	G55722	G55928	G56768	M57293	M57306
G51290	G55724	G55931	G56918	M57294	M57307
G51330	G55729	G55932	G56919	M57295	
G52063	G55730	G56571	G63868	M57296	
G52064	G55737	G56579	M57285	M57297	
G55509	G55738	G56580	M57286	M57298	
G55533	G55784	G56637	M57287	M57300	
G55584	G55785	G56713	M57288	M57301	

14 YEAR SUPERSEDURE LIST

LAST YEAR IN CATALOG	DELETE	THEN USE	LAST YEAR IN CATALOG	DELETE	THEN USE	LAST YEAR IN CATALOG	DELETE	THEN USE
2004	61514	61593	2016	69950	70064	2005	141275	143060
			2016	69951	70065	2005	141551	143061
2004	61548	61541	2013	69954	70023	2005	141577	143059
			2013	69955	70024			
2004	61577	61593	2016	69956	70064	2005	141744	143057
			2016	69957	70065	2006	142082	142844
2004	61581	61506	2003	69963	69462	2006	142083	142846
2004	61585	61593	2014	79900	G51887	2006	142182	142846
2004	61587	61552	2015	79901	G51888	2006	142184	142847
2004	61602	61591	2004	81457	82126	2006	142185	142803
2004	61604	61500	2002	81561	61552	2006	142188	142832
2004	61628	61623	2004	81673	81583			142854
2004	61636	61642	2004	81724	82066	2006	142191	142855
2004	61644	61614	2004	81822	81744	2006	142192	142861
2007-2008	61652	61651	2004	81827	81744	2011	142193	143281
2004	61661	61575	2004	81832	81744	2006	142198	142844
2010	69577	69587	2004	82014	81676	2006	142216	142839
2002	69631	69996	2004	82073	82099			
2017	69782	G63864	2004	82152	81091	2006	142218	142842
2007-2008	69810	69813	2004	82154	81318	2006	142236	142856
2002	69908	69407	2005	141269	143066	2004	142238	142240
			2005	141274	143058	2006	142243	142623

14 YEAR SUPERSEDURE LIST

LAST YEAR IN CATALOG	DELETE	THEN USE	LAST YEAR IN CATALOG	DELETE	THEN USE	LAST YEAR IN CATALOG	DELETE	THEN USE
2006	142266	142842	2006	142563	142854	2004	G55613	G55518
2006	142272	142839	2006	142564	142847	2004	G55614	G55518
2006	142299	143036 L 143037 R	2006	142565	142623	2004	G55654	G55830
2011	142303	143277	2006	142566	142832	2004	G55655	G55830
2011	142304	143278	2006	142732	142734	2002	G55659	G55999
2011	142305	143279	2006	142733	142734	2002	G55660	G55999
2006	142314	142840	2006	142736	142827	2002	G55677	G55914
2006	142315	142840	2006	142742	143036	2002	G55678	G55914
2006	142322	142852	2006	142743	143037	2005	G55760	G55742
2006	142324	142853	2006	142756	142827	2004	G55779	G55891
2005	142331	143062	2006	142849	143067	2004	G55791	G55976
2005	142332	143063	2011	143066	143059	2004	G55830	G55780
2005	142333	143064	2016	143071	143073	2002	G55900	G55995
2006	142394	142841	2016	143072	143074	2007-2008	G55995	G55960
2006	142395	142841	2016	143093	143201	2010	G56521	G56522
2006	142397	142843	2010	143189	142653	2012	G56549	G56682
2006	142398	142843	2004	801514	801541	2013	G56549	G56682
2006	142400	142845	2007-2008	801617	801620	2012	G56550	G55810
2006	142401	142845	2007-2008	6827SE	6854SE	2013	G56550	G56681
2005	142407	143071 L 143072 R	2002	G51018	G51232	2007-2008	G56564	G51712
2006	142423	142858	2002	G51020	G51229	2007-2008	G56609	G56750 G56752 G56754
2006	142424	142859	2002	G51045	G51249	2004	G51079	G51253 G56751
2006	142425	142860	2004	G51101	G511057	2007-2008	G56610	G56753 G56755
2006	142431	142862	2004	G51257	G51477			G56750 G56752
2011	142435	143280	2012	G51265	G51796	2007-2008	G56613	G56754 G56756 see applications
2006	142438	142561	2016	G51705	69907			G56751 G56753 G56755
2011	142523	143031	2007-2008	G51708	G51254	2007-2008	G56614	G56757 see applications
2005	142533	143073 L 143074 R	2017	G51743	G511057			
2006	142537	142851	2010	G51745	G51746			
2006	142541	142857	2012	G51779	G51810			
2006	142544	142546	2012	G51780	G51811			
2006	142545	142546	2015	G52071	G52073	2006	G56638	G56539
2005	142557	142836	2015	G52072	G52074	2006	G56639	G56540
2006	142558	142559	2002	G55517	G55616	2005	G56737	G56719
2006	142560	142561	2005	G55595	G55847	2005	G56738	G56720
			2005	G55596	G55847	2016	G56752	G52235
			2005	G55597	G55848	2016	G56753	G52236
			2005	G55598	G55848	2015	G56754	G52237

14 YEAR SUPERSEDURE LIST

LAST YEAR IN CATALOG	DELETE	THEN USE
2015	G56755	G52338
2015	G56756	G52237
2015	G56757	G52238
2010	G56783	G56817
2011	G56788	G55948
2011	G56789	G55949
2011	G56808	G56809
2011	G56811	G56810
2015	G56815	G52124
2015	G56816	G52123
2007-2008	G56915	G56937
2007-2008	G56922	G56952
2007-2008	G56923	G56954
2012	G56944	G57063
2012	G56944	G57063
2012	G56945	G57064
2012	G56945	G57064
2012	G56946	G57060
2012	G56946	G57060
2004	G63399	G63511
2004	G63412	G63675
2004	G63435	G63506
2004	G63458	G63490
2004	G63497	G63610
2004	G63498	G63612
2004	G63518	G63495
2004	G63519	G63610
2004	G63695	G63615
2004	G63706	G63799
2004	G63774	G63678
2004	G63807	G63622
2004	G63814	G63610
2007-2008	G63861	G63860
2017	G63877	69909
2002	G63901	G63818
2002	G63930	G63781
2002	G63933	G63782

FUTURE PART NUMBERS

58943	G511002	G52520	M51891	M56882	M57108
58944	G511030	G52586	M52008	M56883	M57112
58945	G511031	G52587	M52009	M56884	M57113
70004	G511032	G52588	M52121	M56885	M57118
70105	G511037	G52589	M52122	M56886	M57121
70110	G511040	G52591	M52803	M56887	M57122
77975	G511041	G52594	M52804	M56899	M57123
77976	G511042	G52595	M52805	M56906	M57124
77978	G511061	G52600	M52806	M56908	M57129
143400	G511062	G52601	M52807	M56913	M57133
143405	G511063	G52622	M52808	M56914	M57134
143409	G511066	G52623	M52810	M56916	M57137
143412	G511070	G52638	M52811	M56917	M57138
143415	G511074	G52639	M52812	M56918	M57141
143416	G511076	G56742	M52813	M56919	M57142
143417	G51928	G57157	M52814	M56920	M57147
143421	G51960	G57158	M52815	M56921	M57148
143456	G51971	G57171	M52816	M56942	M57157
143457	G51972	G57206	M52817	M56958	M57158
143459	G52420	G64107	M52818	M56959	M57165
143464	G52421	G64121	M52819	M56960	M57166
143465	G52422	G64128	M52820	M56966	M57172
143466	G52423	G64129	M52821	M56968	M57204
143468	G52425	G64130	M52822	M56969	M57205
143473	G52426	G64131	M52823	M56985	M57212
143474	G52428	G64140	M52824	M56989	M57308
143486	G52429	G64143	M52825	M56990	M57309
143491	G52449	G64144	M56561	M56993	M57310
143497	G52450	G64157	M56562	M56994	M57311
143509	G52459	G64163	M56640	M56995	M57312
143510	G52460	M51715	M56641	M57001	M57313
143516	G52485	M51719	M56683	M57002	M57314
143517	G52486	M51727	M56684	M57003	M57315
143522	G52491	M51728	M56685	M57004	M57318
143532	G52492	M51743	M56686	M57032	M57319
143533	G52494	M51842	M56687	M57033	
143553	G52495	M51859	M56688	M57052	
143564	G52502	M51860	M56758	M57087	
G511000	G52503	M51861	M56759	M57103	
G511001	G52519	M51864	M56809	M57107	

VEHICLE MODEL TO MAKE INDEX

2	MAZDA	960	VOLVO	260E	MERCEDES-BENZ
3	MAZDA	1010	INTERNATIONAL	260Z	NISSAN
5	MAZDA	1100	FIAT	280C	MERCEDES-BENZ
6	MAZDA	1110	INTERNATIONAL	280CE / 280E / 280S / 280SE / 280SEL	MERCEDES-BENZ
80	AUDI	1200	NISSAN	280Z	NISSAN
88	OLDSMOBILE	1210	INTERNATIONAL	280ZX	NISSAN
90	AUDI	1310	INTERNATIONAL	3000GT	MITSUBISHI
93	SAAB	1500	FIAT	300D	MERCEDES-BENZ
95	SAAB	1500	RAM	300E	MERCEDES-BENZ
96	SAAB	1600	NISSAN	300M	CHRYSLER
98	OLDSMOBILE	1800	VOLVO	300SD / 300SDL / 300SE / 300SEL / 300TD / 350SD / 350 SL / 380SE / 380SEC / 380SEL	MERCEDES-BENZ
99	SAAB	1900	OPEL		
100	AUDI	2000	NISSAN		
100	INTERNATIONAL	2500	RAM	300ZX	NISSAN
122	VOLVO	3500	RAM	318I	BMW
124	FIAT	4000	AUDI	318IS	BMW
131	FIAT	5000	AUDI	318TI	BMW
150	INTERNATIONAL	6000	PONTIAC	320I	BMW
200	AUDI	9000	SAAB	323CI	BMW
200	CHRYSLER	9-3	SAAB	323I	BMW
200	INTERNATIONAL	9-5	SAAB	325CI	BMW
210	NISSAN	100 QUATTRO	AUDI	325E	BMW
230	MERCEDES-BENZ	1000B	INTERNATIONAL	325I	BMW
250	MERCEDES-BENZ	1000C	INTERNATIONAL	325IS	BMW
280	MERCEDES-BENZ	1000D	INTERNATIONAL	325IX	BMW
300	CHRYSLER	1100B	INTERNATIONAL	328CI	BMW
310	NISSAN	1100C	INTERNATIONAL	328I	BMW
323	MAZDA	1100D	INTERNATIONAL	330CI	BMW
325	BMW	1200B	INTERNATIONAL	330I	BMW
330	DODGE	1200C	INTERNATIONAL	335I	BMW
400	DODGE	1200D	INTERNATIONAL	350Z	NISSAN
403	PEUGEOT	128I	BMW	380SL / 380SLC	MERCEDES-BENZ
404	PEUGEOT	1300B	INTERNATIONAL	4000 QUATTRO	AUDI
410	NISSAN	1300C	INTERNATIONAL	400E / 400SE / 400SEL / 420SEL / 450SE / 450SEL	MERCEDES-BENZ
411	NISSAN	1300D	INTERNATIONAL	450SL / 450SLC	MERCEDES-BENZ
440	DODGE	135I	BMW	4RUNNER	TOYOTA
510	NISSAN	142 / 144 / 145 / 164	VOLVO	500SEC / 500SEL / 560SEC / 560SEL	MERCEDES-BENZ
544	VOLVO	190D	MERCEDES-BENZ	500SL	MERCEDES-BENZ
600	DODGE	190E	MERCEDES-BENZ	504 / 505 / 604	PEUGEOT
610	NISSAN	190SL	MERCEDES-BENZ	521 PICKUP	NISSAN
626	MAZDA	200 QUATTRO	AUDI	524TD	BMW
710	NISSAN	2000 GTX	DODGE	525I	BMW
808	MAZDA	2000 GTX	EAGLE	528E	BMW
810	NISSAN	200D	MERCEDES-BENZ	528I	BMW
850	VOLVO	200SX	NISSAN	530I	BMW
880	DODGE	220 / 220D	MERCEDES-BENZ	533I	BMW
900	SAAB	240 / 242 / 244 / 245 / 262 / 264 / 265	VOLVO	535I	BMW
924	PORSCHE	240D	MERCEDES-BENZ	535IS	BMW
929	MAZDA	240D	MERCEDES-BENZ	540I	BMW
940	VOLVO	240SX	NISSAN		
944	PORSCHE	240Z	NISSAN		

VEHICLE MODEL TO MAKE INDEX

60 SPECIAL	CADILLAC	ASTRO	CHEVROLET	C250	MERCEDES-BENZ
600SL	MERCEDES-BENZ	ATTITUDE	DODGE	C280	MERCEDES-BENZ
620 PICKUP	NISSAN	AURA	SATURN	C30	VOLVO
635CSI	BMW	AURORA	OLDSMOBILE	C300	MERCEDES-BENZ
720 PICKUP	NISSAN	AVALANCHE 1500	CHEVROLET	C320	MERCEDES-BENZ
735I	BMW	AVALANCHE 2500	CHEVROLET	C350	MERCEDES-BENZ
735IL	BMW	AVALON	TOYOTA	C70	VOLVO
740 / 745 / 760 / 780	VOLVO	AVANTI	STUDEBAKER	CABRIO	VOLKSWAGEN
740I	BMW	AVENGER	DODGE	CABRIOLET	VOLKSWAGEN
740IL	BMW	AVEO	CHEVROLET	CADENZA	KIA
750IL	BMW	AVIATOR	LINCOLN	CALAIS	CADILLAC
80 QUATTRO	AUDI	AXXESS	NISSAN	CALAIS	OLDSMOBILE
90 QUATTRO	AUDI	AZERA	HYUNDAI	CALIBER	DODGE
908B	INTERNATIONAL	AZTEK	PONTIAC	CAMARO	CHEVROLET
908C	INTERNATIONAL	B1600	MAZDA	CAMBRIDGE	PLYMOUTH
93B	SAAB	B1800	MAZDA	CAMRY	TOYOTA
9-7X	SAAB	B2000	MAZDA	CANYON	GMC
A100 TRUCK	DODGE	B210	NISSAN	CAPRI	MERCURY
A3	AUDI	B2200	MAZDA	CAPRICE	CHEVROLET
A4	AUDI	B2300	MAZDA	CARAVAN / GRAND CARAVAN	DODGE
A4 QUATTRO	AUDI	B2500	MAZDA	CARAVELLE	PLYMOUTH
A6	AUDI	B2600	MAZDA	CARINA	TOYOTA
A6 QUATTRO	AUDI	B3000	MAZDA	CATALINA	PONTIAC
A8	AUDI	B4000	MAZDA	CATERA	CADILLAC
ACADIA	GMC	B9 TRIBECA	SUBARU	CAVALIER	CHEVROLET
ACADIAN	PONTIAC	BAJA	SUBARU	CC	VOLKSWAGEN
ACCENT	HYUNDAI	BARRACUDA	PLYMOUTH	CELEBRITY	CHEVROLET
ACCLAIM	PLYMOUTH	BEETLE	VOLKSWAGEN	CELICA	TOYOTA
ACCORD	HONDA	BELAIR	CHEVROLET	CENTURION	BUICK
ACHIEVA	OLDSMOBILE	BELVEDERE	PLYMOUTH	CENTURY	BUICK
AERIO	SUZUKI	BERETTA	CHEVROLET	CHALLENGER	DODGE
AEROSTAR	FORD	BERMUDA	EDSEL	CHAMP	PLYMOUTH
ALERO	OLDSMOBILE	BISCAYNE	CHEVROLET	CHAMPION	STUDEBAKER
ALLANTE	CADILLAC	BLAZER	CHEVROLET	CHARADE	DAIHATSU
ALLURE	BUICK	BLAZER S MODELS	CHEVROLET	CHARGER	DODGE
ALTIMA	NISSAN	BOBCAT	MERCURY	CHEROKEE	JEEP
AMANTI	KIA	BONNEVILLE	PONTIAC	CHEVELLE	CHEVROLET
AMBASSADOR	AMERICAN MOTORS	BORA	VOLKSWAGEN	CHEVETTE	CHEVROLET
AMERICAN	AMERICAN MOTORS	BRAT	SUBARU	CHEVY II	CHEVROLET
AMIGO	ISUZU	BRAVA	FIAT	CHIEFTAIN	PONTIAC
AMX	AMERICAN MOTORS	BRAVADA	OLDSMOBILE	CIERA / CUTLASS CIERA	OLDSMOBILE
APOLLO	BUICK	BREEZE	PLYMOUTH	CIMARRON	CADILLAC
ARIES	DODGE	BREEZEWAY	MERCURY	CIRRUS	CHRYSLER
ARMADA	NISSAN	BRONCO	FORD	CITATION	EDSEL
ARROW	PLYMOUTH	BRONCO II	FORD	CITATION / CITATION II	CHEVROLET
ASCENDER	ISUZU	BROOKWOOD	CHEVROLET	CITY	HONDA
ASPEN	CHRYSLER	BROUGHAM	CADILLAC	CIVIC	HONDA
ASPEN	DODGE	BROUGHAM	MERCURY	CIVIC DEL SOL	HONDA
ASPIRE	FORD	C220	MERCEDES-BENZ	CJ3	JEEP
ASTRA	SATURN	C230	MERCEDES-BENZ	CJ5	JEEP
ASTRE	PONTIAC	C240	MERCEDES-BENZ	CJ6	JEEP

VEHICLE MODEL TO MAKE INDEX

CJ7	JEEP	CRESTLINE	FORD	E-550 ECONOLINE SUPER DUTY	FORD
CL	ACURA	CROSSFIRE	CHRYSLER	E-550 SUPER DUTY	FORD
CLASSIC	AMERICAN MOTORS	CROWN	TOYOTA	EAGLE	AMERICAN MOTORS
CLASSIC	CHEVROLET	CROWN VICTORIA	FORD	ECHO	TOYOTA
CLK320	MERCEDES-BENZ	CR-V	HONDA	ECLIPSE	MITSUBISHI
CLK350	MERCEDES-BENZ	CRX	HONDA	ECONOLINE	FORD
CLK430	MERCEDES-BENZ	CTS	CADILLAC	EDGE	FORD
CLK500	MERCEDES-BENZ	CUBE	NISSAN	EL	ACURA
CLK550	MERCEDES-BENZ	CUSTOM	DODGE	EL CAMINO	CHEVROLET
COBALT	CHEVROLET	CUSTOM	FORD	ELANTRA	HYUNDAI
COLONY PARK	MERCURY	CUSTOM	MERCURY	ELDORADO	CADILLAC
COLORADO	CHEVROLET	CUSTOM	PLYMOUTH	ELECTRA	BUICK
COLT	DODGE	CUSTOM 300	FORD	ELEMENT	HONDA
COLT	PLYMOUTH	CUSTOM 500	FORD	ENCLAVE	BUICK
COMANCHE	JEEP	CUSTOM CRUISER	OLDSMOBILE	ENCORE	BUICK
COMET	MERCURY	CUSTOMLINE	FORD	ENTOURAGE	HYUNDAI
COMMANDER	JEEP	CUTLASS / CUTLASS SUPREME	OLDSMOBILE	ENVOY	GMC
COMMANDER	STUDEBAKER	CUTLASS CALAIS	OLDSMOBILE	ENVOY XL	GMC
COMMERCIAL CHASSIS	BUICK	CUTLASS CLASSIC / CUTLASS CRUISER	OLDSMOBILE	ENVOY XUV	GMC
COMMERCIAL CHASSIS	CADILLAC	CX-7	MAZDA	EOS	VOLKSWAGEN
COMMUTER	MERCURY	CX-9	MAZDA	EQUINOX	CHEVROLET
COMPASS	JEEP	D50	DODGE	ES250	LEXUS
CONCORD	AMERICAN MOTORS	DAKOTA	DODGE	ES300	LEXUS
CONCORD	PLYMOUTH	DART	DODGE	ES330	LEXUS
CONCORDE	CHRYSLER	DAYTONA	CHRYSLER	ES350	LEXUS
CONQUEST	CHRYSLER	DAYTONA	DODGE	ESCALADE	CADILLAC
CONQUEST	DODGE	DEL RAY	CHEVROLET	ESCALADE ESV	CADILLAC
CONTINENTAL	LINCOLN	DEL RIO WAGON	FORD	ESCALADE EXT	CADILLAC
CONTOUR	FORD	DELUXE	FORD	ESCAPE	FORD
COOPER	MINI	DEVILLE	CADILLAC	ESCORT	FORD
CORDIA	MITSUBISHI	DIAMANTE	MITSUBISHI	ESTATE WAGON	BUICK
CORDOBA	CHRYSLER	DIPLOMAT	DODGE	ESTEEM	SUZUKI
COROLLA	TOYOTA	DISCOVERY	LAND ROVER	EXCEL	HYUNDAI
CORONA	TOYOTA	DISPATCHER	JEEP	EXCURSION	FORD
CORONET	DODGE	DJ5	JEEP	EXECUTIVE	PONTIAC
CORRADO	VOLKSWAGEN	DJ6	JEEP	EXECUTIVE LIMOUSINE	CHRYSLER
CORSAIR	EDSEL	DL	SUBARU	EXECUTIVE SEDAN	CHRYSLER
CORSICA	CHEVROLET	DL	VOLVO	EXP	FORD
CORVAIR	CHEVROLET	DTS	CADILLAC	EXPEDITION	FORD
CORVAIR TRUCK	CHEVROLET	DURANGO	DODGE	EXPLORER	FORD
CORVETTE	CHEVROLET	DUSTER	PLYMOUTH	EXPLORER SPORT TRAC	FORD
COUGAR	MERCURY	DYNASTY	CHRYSLER	EXPO	MITSUBISHI
COUNTRY CRUISER	MERCURY	DYNASTY	DODGE	EXPO	PLYMOUTH
COUNTRY SEDAN	FORD	E CLASS	CHRYSLER	F10	NISSAN
COUNTRY SQUIRE	FORD	E300	MERCEDES-BENZ	F85	OLDSMOBILE
COUPE	AUDI	E320	MERCEDES-BENZ	FAIRLANE	FORD
COUPE QUATTRO	AUDI	E420	MERCEDES-BENZ	FAIRMONT	FORD
COURIER	FORD	E430	MERCEDES-BENZ	FALCON	FORD
COURIER SEDAN DELIVERY	FORD	E500	MERCEDES-BENZ	FASTBACK	VOLKSWAGEN
CRANBROOK	PLYMOUTH			FC150	JEEP
CRESSIDA	TOYOTA				

VEHICLE MODEL TO MAKE INDEX

FC170	JEEP	GRAND MARQUIS	FORD	JAVELIN	AMERICAN MOTORS
FESTIVA	FORD	GRAND MARQUIS	MERCURY	JEEPSTER	JEEP
FIERO	PONTIAC	GRAND PRIX	PONTIAC	JETFIRE	OLDSMOBILE
FIESTA	FORD	GRAND SAFARI	PONTIAC	JETTA	VOLKSWAGEN
FIESTA	OLDSMOBILE	GRAND VITARA	SUZUKI	JIMMY	GMC
FIFTH AVENUE	CHRYSLER	GRAND WAGONEER	JEEP	JOURNEY	DODGE
FIREBIRD	PONTIAC	GRANDVILLE	PONTIAC	JUKE	NISSAN
FIREFLY	PONTIAC	GREMLIN	AMERICAN MOTORS	KADETT	OPEL
FIRENZA	OLDSMOBILE	GS / GS350 / GS400 / GS445	BUICK	KINGSWOOD	CHEVROLET
FIT	HONDA	GS300	LEXUS	L / LS / LW SERIES	SATURN
FIVE HUNDRED	FORD	GS400	LEXUS	LACROSSE	BUICK
FJ CRUISER	TOYOTA	GS430	LEXUS	LANCER	DODGE
FLEET SPECIAL	PLYMOUTH	GT / SE	ASUMA	LANCER	MITSUBISHI
FLEETWOOD	CADILLAC	GT750	SAAB	LAND CRUISER	TOYOTA
FLEETWOOD / 60 SERIES / 70 SERIES	CADILLAC	GT850	SAAB	LANOS	DAEWOO
FLEX	FORD	GTI	VOLKSWAGEN	LARK	STUDEBAKER
FOCUS	FORD	GTO	PONTIAC	LASER	CHRYSLER
FORD	FORD	GTX	PLYMOUTH	LASER	PLYMOUTH
FORD 300	FORD	H2	HUMMER	LAURENTIAN	PONTIAC
FORENZA	SUZUKI	H3	HUMMER	LEAF	NISSAN
FORESTER	SUBARU	HAWK	STUDEBAKER	LEBARON	CHRYSLER
FORSA	SUZUKI	HHR	CHEVROLET	LEGACY	SUBARU
FOX	AUDI	HIGHLANDER	TOYOTA	LEGANZA	DAEWOO
FOX	VOLKSWAGEN	HOMBRE	ISUZU	LEGEND	ACURA
FREESTAR	FORD	HORIZON	PLYMOUTH	LEMANS	PONTIAC
FREESTYLE	FORD	HORNET	AMERICAN MOTORS	LESABRE	BUICK
FRONTIER	NISSAN	I-280	ISUZU	LHS	CHRYSLER
FURY	PLYMOUTH	I-290	ISUZU	LIBERTY	JEEP
FUSION	FORD	I30	INFINITI	LIMITED	BUICK
FX35	INFINITI	I35	INFINITI	LN7	MERCURY
FX45	INFINITI	I-350	ISUZU	LOYALE	SUBARU
G20	INFINITI	I-370	ISUZU	LS	LINCOLN
G3	PONTIAC	II	AVANTI	LS400	LEXUS
G35	INFINITI	I-MARK	ISUZU	LS430	LEXUS
G5	PONTIAC	IMPALA	CHEVROLET	LSS	OLDSMOBILE
G6	PONTIAC	IMPERIAL	CHRYSLER	LTD / COUNTRY SEDAN / COUNTRY SQUIRE / CROWN VICTORIA	FORD
GALANT	MITSUBISHI	IMPENZA	SUBARU	LTD II	FORD
GALAXIE	FORD	IMPULSE	ISUZU	LUMINA	CHEVROLET
GALAXIE 500	FORD	INTEGRA	ACURA	LUMINA APV	CHEVROLET
GL	SUBARU	INTREPID	CHRYSLER	LUV PICKUP	CHEVROLET
GLADIATOR	JEEP	INTREPID	DODGE	LX450	LEXUS
GLC	MAZDA	INTRIGUE	OLDSMOBILE	LX470	LEXUS
GLE	VOLVO	INVICTA	BUICK	LYNX	MERCURY
GOLDEN HAWK	STUDEBAKER	ION	SATURN	M SERIES VAN	INTERNATIONAL
GOLF	VOLKSWAGEN	IS250	LEXUS	M1100 / M1200	INTERNATIONAL
GRAN FURY	PLYMOUTH	IS300	LEXUS	M1400	INTERNATIONAL
GRAN SPORT	BUICK	J10 PICKUP	JEEP	M3	BMW
GRANADA	FORD	J20 PICKUP	JEEP	M300	DODGE
GRAND AM	PONTIAC	J2000 / SUMBIRD	PONTIAC	M350	DODGE
GRAND CHEROKEE	JEEP	J-2500 PICKUP	JEEP		
GRAND LEMANS	PONTIAC				

VEHICLE MODEL TO MAKE INDEX

M5	BMW	MONZA	CHEVROLET	PICKUP	TOYOTA
MAGENTIS	KIA	MOUNTAINEER	MERCURY	PICKUP 1 TON C30	CHEVROLET
MAGNUM	DODGE	MPV	MAZDA	PICKUP 1 TON C35 / C3500	CHEVROLET
MAINLINE	FORD	MR2	TOYOTA	PICKUP 1 TON C35/ C3500	GMC
MALIBU	CHEVROLET	MULTI	NISSAN	PICKUP 1 TON D300 SERIES	DODGE
MANTA	OPEL	MURANO	NISSAN	PICKUP 1 TON F350 / SUPERDUTY	FORD
MARAUDER	MERCURY	MUSTANG / MUSTANG II	FORD	PICKUP 1 TON K30	CHEVROLET
MARINER	MERCURY	MX-5	MAZDA	PICKUP 1 TON K35 / K3500	CHEVROLET
MARK III	LINCOLN	MX-6	MAZDA	PICKUP 1 TON K35 / K3500	GMC
MARK IV	LINCOLN	MYSTIQUE	MERCURY	PICKUP 1 TON R30	CHEVROLET
MARK LT	LINCOLN	NASSAU	CHRYSLER	PICKUP 1 TON R3500	CHEVROLET
MARK V	LINCOLN	NAVAJO	MAZDA	PICKUP 1 TON RAM 3500	DODGE
MARK VI	LINCOLN	NAVIGATOR	LINCOLN	PICKUP 1 TON SIL-VERADO 3500	CHEVROLET
MARK VII	LINCOLN	NEON	CHRYSLER	PICKUP 1 TON SIL-VERADO 3500 HD	CHEVROLET
MARLIN	AMERICAN MOTORS	NEON	DODGE	PICKUP 1 TON V30	CHEVROLET
MARQUIS	MERCURY	NEON	PLYMOUTH	PICKUP 1 TON V3000 / V3500	CHEVROLET
MATADOR	AMERICAN MOTORS	NEW YORKER	CHRYSLER	PICKUP 1 TON V3000 / V3500	GMC
MATRIX	TOYOTA	NEWPORT	CHRYSLER	PICKUP 1 TON W300 SERIES	DODGE
MAVERICK	FORD	NITRO	DODGE	PICKUP 1/2 TON C10	CHEVROLET
MAXIMA	NISSAN	NOVA	CHEVROLET	PICKUP 1/2 TON C15 / C1500	CHEVROLET
MDX	ACURA	NUBIRA	DAEWOO	PICKUP 1/2 TON C15/ C1500	GMC
MEADOWBROOK	DODGE	NX	NISSAN	PICKUP 1/2 TON D100 SERIES	DODGE
MEDALIST	MERCURY	OASIS	ISUZU	PICKUP 1/2 TON F SUPERDUTY	FORD
MEDALLION	EAGLE	ODYSSEY	HONDA	PICKUP 1/2 TON F-100	FORD
MERCURY	MERCURY	OMEGA	OLDSMOBILE	PICKUP 1/2 TON F-150	FORD
METEOR	MERCURY	OMNI	DODGE	PICKUP 1/2 TON K10	CHEVROLET
METRO	CHEVROLET	ONE-FIFTY SERIES	CHEVROLET	PICKUP 1/2 TON K15 / K1500	CHEVROLET
METRO	GEO	OPEL	OPEL	PICKUP 1/2 TON K15/ K1500	GMC
MIATA	MAZDA	OPTIMA	KIA	PICKUP 1/2 TON R10	CHEVROLET
MIGHTY MAX	MITSUBISHI	OPTRA	CHEVROLET	PICKUP 1/2 TON R1500	GMC
MILAN	MERCURY	OUTBACK	SUBARU	PICKUP 1/2 TON RAM 1500	DODGE
MILLENNIA	MAZDA	OUTLANDER	MITSUBISHI	PICKUP 1/2 TON SIL-VERADO 1500	CHEVROLET
MINI RAM	DODGE	OUTLOOK	SATURN	PICKUP 1/2 TON SIL-VERADO 1500 HD	CHEVROLET
MIRADA	DODGE	PACER	AMERICAN MOTORS	PICKUP 1/2 TON V10	CHEVROLET
MIRAGE	MITSUBISHI	PACER	EDSEL	PICKUP 1/2 TON V1500	GMC
MKX	LINCOLN	PACIFICA	CHRYSLER	PICKUP 1/2 TON W100 SERIES	DODGE
MKZ	LINCOLN	PARISIENNE	PONTIAC	PICKUP 1/2 TON W100 SERIES	DODGE
ML320	MERCEDES-BENZ	PARK AVENUE	BUICK		
ML350	MERCEDES-BENZ	PARK LANE	MERCURY		
ML430	MERCEDES-BENZ	PARK LANE WAGON	FORD		
ML500	MERCEDES-BENZ	PASEO	TOYOTA		
ML55 AMG	MERCEDES-BENZ	PASSAT	VOLKSWAGEN		
MONACO	DODGE	PASSPORT	HONDA		
MONARCH	MERCURY	PATHFINDER	NISSAN		
MONTANA	PONTIAC	PATRIOT	JEEP		
MONTCLAIR	MERCURY	PHOENIX	PONTIAC		
MONTE CARLO	CHEVROLET	PICKUP	CHEVROLET		
MONTEGO	MERCURY	PICKUP	GMC		
MONTEREY	MERCURY	PICKUP	ISUZU		
MONTERO	MITSUBISHI	PICKUP	NISSAN		
MONTERO SPORT	MITSUBISHI	PICKUP	PLYMOUTH		

VEHICLE MODEL TO MAKE INDEX

PICKUP 1000 SERIES	GMC	PROTÉGÉ / PROTÉGÉS	MAZDA	RX330	LEXUS
PICKUP 1500 SERIES	GMC	PT CRUISER	CHRYSLER	RX350	LEXUS
PICKUP 2500 SERIES	GMC	PULSAR / PULSAR NX	NISSAN	RX-4	MAZDA
PICKUP 3/4 TON C20	CHEVROLET	PURSUIT	PONTIAC	RX400H	LEXUS
PICKUP 3/4 TON C25 / C2500	CHEVROLET	PV444	VOLVO	RX-7	MAZDA
PICKUP 3/4 TON C25/ C2500	GMC	Q45	INFINITI	RX-8	MAZDA
PICKUP 3/4 TON D200 SERIES	DODGE	QUANTUM	VOLKSWAGEN	S10	CHEVROLET
PICKUP 3/4 TON F-250 / SUPERDUTY	FORD	QUEST	NISSAN	S15 JIMMY	GMC
PICKUP 3/4 TON K20	CHEVROLET	QX4	INFINITI	S2000	HONDA
PICKUP 3/4 TON K25 / K2500	CHEVROLET	QX56	INFINITI	S320 / S350 / S420 / S500 / S600	MERCEDES-BENZ
PICKUP 3/4 TON K25/ K2500	GMC	R / E SERIES 1/2 / 3/4 TON	STUDEBAKER	S4	AUDI
PICKUP 3/4 TON R20	CHEVROLET	R32	VOLKSWAGEN	S40	VOLVO
PICKUP 3/4 TON R2500	CHEVROLET	RABBIT	VOLKSWAGEN	S6	AUDI
PICKUP 3/4 TON R2500	GMC	RABBIT PICKUP	VOLKSWAGEN	S60	VOLVO
PICKUP 3/4 TON R20	CHEVROLET	RAIDER	DODGE	S70	VOLVO
PICKUP 3/4 TON R2500	CHEVROLET	RAIDER	MINITUBISHI	S80	VOLVO
PICKUP 3/4 TON R2500	GMC	RAINIER	BUICK	S90	VOLVO
PICKUP 3/4 TON RAM 2500	DODGE	RAMBLER	AMERICAN MOTORS	SABLE	MERCURY
PICKUP 3/4 TON SILVERADO 2500	CHEVROLET	RAMCHARGER	DODGE	SAFARI	GMC
PICKUP 3/4 TON SILVERADO 2500 HD	CHEVROLET	RAMPAGE	DODGE	SAFARI	PONTIAC
PICKUP 3/4 TON V20	CHEVROLET	RANCH WAGON	FORD	SAMURAI	SUZUKI
PICKUP 3/4 TON V2500	GMC	RANCHERO	FORD	SANTA FE	HYUNDAI
PICKUP 3/4 TON W200 SERIES	DODGE	RANGE ROVER	LAND ROVER	SAPORO	PLYMOUTH
PICKUP F-450 SUPERDUTY	FORD	RANGER	EDSEL	SARATOGA	CHRYSLER
PICKUP F-550	FORD	RANGER	FORD	SATELLITE	PLYMOUTH
PICKUP F-550 SUPER DUTY	FORD	RAV4	TOYOTA	SAVOY	PLYMOUTH
PICKUP F-SERIES	FORD	RD200	DODGE	SC / SL / SW SERIES	SATURN
PICKUP P100	FORD	RDX	ACURA	SC300	LEXUS
PICKUP P350	FORD	REATA	BUICK	SC400	LEXUS
PICKUP P400	FORD	REGAL	BUICK	SC430	LEXUS
PICKUP RAM 50	DODGE	REGENCY	OLDSMOBILE	SCAMP	PLYMOUTH
PILOT	HONDA	RELAY	SATURN	SCIROCCO	VOLKSWAGEN
PINTO	FORD	RELIANT	PLYMOUTH	SCOUPE	HYUNDAI
PLAZA	PLYMOUTH	RENDEZVOUS	BUICK	SCOUT	INTERNATIONAL
POLARA	DODGE	RENO	SUZUKI	SCOUT II	INTERNATIONAL
PONY	HYUNDAI	RIDGELINE	HONDA	SCRAMBLER / CJ8	JEEP
POWER HAWK	STUDEBAKER	RIO	KIA	SEBRING	CHRYSLER
PRECIS	MINITUBISHI	RIVIERA	BUICK	SEDONA	KIA
PRELUDE	HONDA	RL	ACURA	SENTRA	NISSAN
PREMIER	EAGLE	ROADMASTER	BUICK	SEPHIA	KIA
PRESIDENT	STUDEBAKER	ROADRUNNER	PLYMOUTH	SEQUOIA	TOYOTA
PREVIA	TOYOTA	ROCKY	DAIHATSU	SEVILLE	CADILLAC
PRIUS	TOYOTA	RODEO	ISUZU	SHADOW	DODGE
PRIUS C	TOYOTA	ROGUE	NISSAN	SIDEKICK	SUZUKI
PRIZM	CHEVROLET	RONDO	KIA	SIENNA	TOYOTA
PRIZM	GEO	ROUNDUP	EDSEL	SIERRA 1500	GMC
PROBE	FORD	ROUTAN	VOLKSWAGEN	SIERRA 1500 HD	GMC
		ROYAL MONACO	DODGE	SIERRA 2500	GMC
		RSX	ACURA	SIERRA 2500 HD	GMC
		RX-3	MAZDA	SIERRA 3500	GMC
		RX300	LEXUS	SIERRA 3500 HD	GMC

VEHICLE MODEL TO MAKE INDEX

TURNPIKE CRUISER	MERCURY	VENZA	TOYOTA	ZEPHYR	MERCURY
TWO-TEN SERIES	CHEVROLET	VERACRUZ	HYUNDAI	TEMPO	FORD
TYPHOON	GMC	VERSA	NISSAN	TERCEL	TOYOTA
UNIVERSAL	JEEP	VERSAILLES	LINCOLN	TERRAIN	GMC
UPLANDER	CHEVROLET	VIBE	PONTIAC	TERRAZA	BUICK
V40	VOLVO	VICTORIA	FORD	THING	VOLKSWAGEN
V50	VOLVO	VIGOR	ACURA	THUNDERBIRD	FORD
V70	VOLVO	VILLAGER	EDSEL	TIBURON	HYUNDAI
V8 QUATTRO	AUDI	VILLAGER	MERCURY	TIGUAN	VOLKSWAGEN
V90	VOLVO	VIP	PLYMOUTH	TITAN	NISSAN
VALIANT	PLYMOUTH	VISION	EAGLE	TL	ACURA
VAN	MITSUBISHI	VISTA	EAGLE	TOPAZ	MERCURY
VAN	TOYOTA	VISTA CRUISER	OLDSMOBILE	TORINO	FORD
VAN 1 TON A / B SERIES / RAM	DODGE	VITARA	SUZUKI	TORNADO	CHEVROLET
VAN 1 TON ECONO-LINE / CLUB WAGON / SUPERDUTY	FORD	VOLARE	PLYMOUTH	TORONADO	OLDSMOBILE
VAN 1 TON G / EXPRESS	CHEVROLET	VOYAGER	MERCURY	TORRENT	PONTIAC
VAN 1 TON G / SAVANA	GMC	VOYAGER / GRAND VOYAGER	CHRYSLER	TOUAREG	VOLKSWAGEN
VAN 1 TON P SERIES	CHEVROLET	VOYAGER / GRAND VOYAGER	PLYMOUTH	TOWN & COUNTRY	CHRYSLER
VAN 1 TON P SERIES	DODGE	VUE	SATURN	TOWN CAR	LINCOLN
VAN 1 TON P SERIES	GMC	WAGONEER	JEEP	TOWNSMAN	CHEVROLET
VAN 1 TON PB SERIES	PLYMOUTH	WAVE	PONTIAC	TRACER	MERCURY
VAN 1/2 TON A / B SERIES / RAM	DODGE	WILDCAT	BUICK	TRACKER	CHEVROLET
VAN 1/2 TON ECONO-LINE / CLUB WAGON	FORD	WINDSOR	CHRYSLER	TRACKER	GEO
VAN 1/2 TON G / EXPRESS	CHEVROLET	WINDSTAR	FORD	TRACKER	GMC
VAN 1/2 TON G / SAVANA	GMC	WRANGLER	JEEP	TRAILBLAZER	CHEVROLET
VAN 1/2 TON P SERIES	CHEVROLET	X3	BMW	TRAILDUSTER	PLYMOUTH
VAN 1/2 TON P SERIES	DODGE	X5	BMW	TRANSPORTER	VOLKSWAGEN
VAN 1/2 TON P SERIES	GMC	X-90	SUZUKI	TRANS SPORT	PONTIAC
VAN 1/2 TON PB SERIES	PLYMOUTH	XA	SCION	TRANSIT CONNECT	FORD
VAN 3/4 TON A / B SERIES / RAM	DODGE	XB	SCION	TRAVELALL	INTERNATIONAL
VAN 3/4 TON ECONO-LINE / CLUB WAGON / SUPERDUTY	FORD	XC90	VOLVO	TRAVERSE	CHEVROLET
VAN 3/4 TON G / EXPRESS	CHEVROLET	XD	SCION	TRAX	CHEVROLET
VAN 3/4 TON G / SAVANA	GMC	XG300	HYUNDAI	TREDIA	MITSUBISHI
VAN 3/4 TON P SERIES	CHEVROLET	XG350	HYUNDAI	TRIBUTE	MAZDA
VAN 3/4 TON P SERIES	DODGE	XJ12	JAGUAR	TROOPER	ISUZU
VAN 3/4 TON PB SERIES	PLYMOUTH	XJ6	JAGUAR	TRUCK	CHEVROLET
VAN CB300	DODGE	XJS	JAGUAR	TRUCK	DODGE
VAN PB 1000 SERIES	GMC	XK150	JAGUAR	TRUCK	GMC
VAN WAGON	TOYOTA	XKE	JAGUAR	TSX	ACURA
VANAGON	VOLKSWAGEN	XL-7	SUZUKI	TT	AUDI
VEGA	CHEVROLET	XT	SUBARU	TT QUATTRO	AUDI
VEHICROSS	ISUZU	XTERRA	NISSAN	TUCSON	HYUNDAI
VENTURA	PONTIAC	X-TRAIL	NISSAN	TUNDRA	TOYOTA
VENTURE	CHEVROLET	X-TYPE	JAGUAR	TURISMO	PLYMOUTH
		YARIS	TOYOTA	TURNPIKE CRUISER	MERCURY
		YUKON	GMC	TWO-TEN SERIES	CHEVROLET
		YUKON XL	GMC	TYPHOON	GMC
		YUKON XL 1/2 TON	GMC	UNIVERSAL	JEEP
		YUKON XL 3/4 TON	GMC	UPLANDER	CHEVROLET
		Z3	BMW	V10 TRUCK	CHEVROLET
		ZEPHYR	LINCOLN	V1500 SUBURBAN	GMC
				V1500 TRUCK	GMC

VEHICLE MODEL TO MAKE INDEX

V20 SUBURBAN	CHEVROLET	WINDSTAR	FORD
V20 TRUCK	CHEVROLET	WRANGLER	JEEP
V2500 SUBURBAN	CHEVROLET	WRX	SUBARU
V2500 SUBURBAN	GMC	X3	BMW
V2500 TRUCK	GMC	X5	BMW
V30 TRUCK	CHEVROLET	X-5	MAZDA
V3500 TRUCK	CHEVROLET	X-90	SUZUKI
V3500 TRUCK	GMC	XC90	VOLVO
V40	VOLVO	XG300	HYUNDAI
V70	VOLVO	XG350	HYUNDAI
V8 QUATTRO	AUDI	XJ12	JAGUAR
V90	VOLVO	XJ6	JAGUAR
VALIANT	PLYMOUTH	XJS	JAGUAR
VAN	MITSUBISHI	XK150	JAGUAR
VAN	TOYOTA	XKE	JAGUAR
VAN WAGON	TOYOTA	XL-7	SUZUKI
VANAGON	VOLKSWAGEN	XT	SUBARU
VEGA	CHEVROLET	XTERRA	NISSAN
VEHICROSS	ISUZU	X-TRAIL	NISSAN
VELOSTER	HYUNDAI	XTS	CADILLAC
VENTURA	PONTIAC	XV CROSSTREK	SUBARU
VENTURE	CHEVROLET	YARIS	TOYOTA
VENZA	TOYOTA	YUKON	GMC
VERANO	BUICK	YUKON DENALI	GMC
VERSA	NISSAN	YUKON DENALI XL	GMC
VERSAILLES	LINCOLN	YUKON XL 1500	GMC
VIBE	PONTIAC	YUKON XL 2500	GMC
VICTORIA	FORD	Z3	BMW
VIGOR	ACURA	ZDX	ACURA
VILLAGER	EDSEL	ZEPHYR	LINCOLN
VILLAGER	MERCURY	ZEPHYR	MERCURY
VIP	PLYMOUTH		
VISION	EAGLE		
VISTA	EAGLE		
VISTA CRUISER	OLDSMOBILE		
VITARA	SUZUKI		
VOLARE	PLYMOUTH		
VOLT	CHEVROLET		
VOYAGER	CHRYSLER		
VOYAGER	MERCURY		
VOYAGER	PLYMOUTH		
VUE	SATURN		
W100 PICKUP	DODGE		
W150 PICKUP	DODGE		
W200 PICKUP	DODGE		
W250 PICKUP	DODGE		
W300 PICKUP	DODGE		
W350 PICKUP	DODGE		
WAGONEER	JEEP		
WAVE	PONTIAC		
WILDCAT	BUICK		
WINDSOR	CHRYSLER		

FOOTNOTE INDEX

- 1 Future Part, available 3rd Quarter of 2017
- 2 Future Part, available 4th Quarter of 2017
- 3 Future Part, available 1st Quarter of 2017
- 4 Future Part, available 2nd Quarter of 2017
- 5 Use kit no. 140719 to replace O.E. hardware for lower shock absorber mounting when studs break or self-tapping screws are no longer useable.
- 6 It is recommended that when replacing shocks on vehicles with "quad shocks" option, all 4 shocks should be matched by series.
- 7 Pair Packs. Air hose kit included.
- 8 Pair Packs.
- 9 See Ref. D for procedures to replace Elec. Adj. Susp. with non-adj. product.
- 10 The Nivomat leveling shocks are on the rear only. If suspension spring contacts units, rotate suspension spring 180 degrees.
- 30 For GM Vehicles equipped with factory installed leveling systems, see Ref. A.
- 31 With Nivomat Self-Leveling Suspension replace spring with Volvo No. 1229052/4.
- 32 With Nivomat Self-Leveling Suspension replace spring with Volvo No. 1359710 or 1273977.
- 33 Also works as conventional type replacement for Nivomat suspension.
- 34 If suspension spring contacts this unit, rotate suspension spring 180 degrees.
- 35 Sight grinding of control arm opening is required to install product made before Aug. 1988.
- 36 Requires special strut installation tool.
- 37 Jounce Bumper hardware from O.E. part may need to be reused.
- 39 Conventional gas-charged strut can be used to replace O.E. air adjustable gas-charged strut. However, the self-leveling system must be deactivated. See Ref. A for instructions.
- 40 ReadyMount Strut. Complete Assembled Unit.
- 41 ReadyMount Strut. Complete Assembled Unit. See Ref. D for procedures to replace Elec. Adj. Susp. with non-adj. product.
- 42 ReadyMount Strut, does not include springs due to vehicle design.
- 43 ReadyMount Strut, does not include springs due to vehicle design. See Ref. D for procedures to replace Elec. Adj. Susp. with non-adj. product.
- 44 This strut is not gas pressurized therefore the piston rod will not extend without assistance.
- 45 Strut must be rotated to align notch with lower control arm.
- 46 Upper Mount orientation may be required.
- 50 Bellows Kit No.141242 is recommended for use to protect piston rod from potentially harmful road debris.
- 51 Strut Cushion.
- 52 See Ref. C for optional Steering Stabilizer Boots.
- 53 Strut Mount. **Hardware from O.E. Part may need to be reused.**
- 54 Kit with Mount and Bearing. **Hardware from O.E. Part may need to be reused.**
- 55 Mount Kit includes Mount, Spring Seat, Bearing & Isolator. **Hardware from O.E. Part may need to be reused.**
- 56 Mount Kit includes Mount, Bumper/Bellow & Retainers. **Hardware from O.E. Part may need to be reused.**
- 57 Mount Kit includes Lower Spring Seat with Internal Bearing & Isolator. **Hardware from O.E. Part may need to be reused.**
- 58 Mount Kit includes Suspension Bearing. **Hardware from O.E. Part may need to be reused.**
- 59 Strut Mount Contains a Plastic Bearing. **Hardware from O.E. Part may need to be reused.**
- 60 Strut Mount Contains a Metal Bearing. **Hardware from O.E. Part may need to be reused.**
- 61 Mount Kit includes Upper Spring Seat. **Hardware from O.E. Part may need to be reused.**
- 62 Mount Kit includes Lower Suspension Mount Bushing. **Hardware from O.E. Part may need to be reused.**
- 63 Mount Kit includes Isolator. **Hardware from O.E. Part may need to be reused.**
- 64 Mount Kit includes Lower Rubber Spring Seat Isolator. **Hardware from O.E. Part may need to be reused.**
- 65 Mount Kit includes Upper Spring Seat with Isolator. **Hardware from O.E. Part may need to be reused.**
- 66 Upper Spring Seat with Spacer. **Hardware from O.E. Part may need to be reused.**
- 80 Mounting bracket not required, install on O.E. Shock Mounts. See Ref. C for optional Steering Stabilizer Boots.
- 81 Mounting bracket kit is required for installation. See Numeric Listing. See Ref. C for optional Steering Stabilizer Boots.
- 82 Use kit if listed. See Ref. C for optional Steering Stabilizer Boots.
- 83 For dual system, two stabilizers and one bracket kit are to be ordered. See Ref. C for optional Steering Stabilizer Boots.
- 98 Notice: The level of difficulty to install this product is moderately high. Please review the installation instructions carefully before proceeding.
- 99 Notice: The level of difficulty to install this product is moderately high. Please review the installation instructions carefully before proceeding. Requires special strut installation tool.

SALES POPULARITY LISTING

A FAST

B GOOD

C FAIR

D SLOW

FF NEW ITEM, AVAILABILITY TO BE ANNOUNCED

N NEW ITEM

S SUPERSEDED - SELL UNTIL FACTORY INVENTORY IS DEPLETED,
THEN USE REPLACEMENT PART NUMBER

W EXTREMELY SLOW

X DISCONTINUE WHEN CURRENT FACTORY INVENTORY IS DEPLETED -
LAST YEAR IN CATALOG

NEW CATALOG LAYOUT

Gabriel's 2017 Light Vehicle catalog contains new layout updates and adjustments. The Light Vehicle application section is now categorized into Front and Rear and then broken up into the Gabriel product lines.

KEY DESCRIPTIONS IN CATALOG



$\frac{O}{O}$ Eye Ring
Eye Ring



$\frac{O}{\ominus}$ Eye Ring
Barpin



$\frac{O}{T}$ Eye Ring
Stud



$\frac{T}{T}$ Stud
Stud

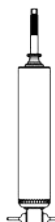

$\frac{T}{\ominus}$ Stud
Barpin



$\frac{T}{O}$ Stud
Eye Ring



$\frac{\ominus}{\ominus}$ Barpin
Barpin



$\frac{\ominus}{T}$ Barpin
Stud



$\frac{\ominus}{O}$ Barpin
Eye Ring



$\frac{O}{n}$ Eye Ring
U-Bracket





$\frac{\ominus}{n}$ Barpin
U-Bracket



$\frac{T}{n}$ Stud
U-Bracket

Images are for reference purposes only.

APPLICATION GUIDE

Year	Fitment Notes										
		Ultra	ProGuard\ Guardian\ Classic	Max Control\ LTV	Strut Cushion\ Strut Mount	HiJackers\ Load Carrier	Ultra	ProGuard\ Guardian\ Classic	Max Control\ LTV	Strut Cushion\ Strut Mount	HiJackers\ Load Carrier

ACURA

ACURA

CL

01-03	All	G55870	M55870	142230 ⁵³	G55871	M55871	142231 ⁵³
97-99	All	G55877	M55877	142230 ⁵³	G55786	M55786	142231 ⁵³ 143064 ⁵¹

CL READYMOUNTS

		Front		Rear	
		Ultra Readymount	Guardian Readymount	Ultra Readymount	Guardian Readymount
01-03	All	G57284 ⁴⁰

EL

01-03	Left	G56621	M56621	142230 ⁵³	G51700	M51700
	Right	G56622	M56622	142230 ⁵³	G51700	M51700
97-00	All	G55909	M55909	142230 ⁵³	G55910	M55910
	CAN	G55909	M55909	143064 ⁵¹ 142230 ⁵³	G55910	M55910	143064 ⁵¹

INTEGRA

99-01	Exc.Type R Models	G55802 ⁴⁵	142230 ⁵³ 143064 ⁵¹	G55803	143064 ⁵¹
94-01	All	142230 ⁵³ 143064 ⁵¹	143064 ⁵¹
	Exc. RS & Type R Models	M55802 ⁴⁵	142230 ⁵³ 143064 ⁵¹	M55803	143064 ⁵¹
95-98	Exc.Type R Models	G55802	142230 ⁵³ 143064 ⁵¹	G55803	143064 ⁵¹
94	Exc.Type R Models	G55802 ⁴⁵	142230 ⁵³ 143064 ⁵¹	G55803	143064 ⁵¹
90-93	All	G55787	142230 ⁵³ 143064 ⁵¹	G55788	M55788	142230 ⁵³ 142300 ⁶⁷ 143064 ⁵¹
86-89	All	G55731	G51034	142231 ⁵³

INTEGRA READYMOUNTS

		Front		Rear	
		Ultra Readymount	Guardian Readymount	Ultra Readymount	Guardian Readymount
97-01	GS, GS-R, Left	M56993 ⁴⁰	M56995 ⁴⁰
	GS, GS-R, Right	M56994 ⁴⁰	M56995 ⁴⁰
94-01	Exc.Type R Models Left	G56993 ⁴⁰	G56995 ⁴⁰
	Exc.Type R Models Right	G56994 ⁴⁰	G56995 ⁴⁰
95-96	Right	M56994 ⁴⁰
	GS-R, Right	M56994 ⁴⁰
	GS-R, Special Edition	M56995 ⁴⁰
	GS-R, Special Edition, Left	M56993 ⁴⁰
94	GS-R, Left	M56993 ⁴⁰	M56995 ⁴⁰
	GS-R, Right	M56994 ⁴⁰	M56995 ⁴⁰

LEGEND

91-95	Left	G55958	G55952	143063 ⁵¹
	Right	G55951	G55952	143063 ⁵¹
89-90	Auto Leveling System	G55770	142230 ⁵³ 143064 ⁵¹	142231 ⁵³ 143063 ⁵¹
87-88	Coupe	G55770	142230 ⁵³ 143064 ⁵¹	142231 ⁵³ 143063 ⁵¹

40 Complete Assembled Unit.

51 Strut Cushion for use with the Strut/Cartridge/Shocks.

67 Strut Mount Kit. Hardware from O.E. Part may need to be reused.

Bold Type - New / Future Part

46 Upper Mount orientation may be required.

53 Strut Mount. Hardware from O.E. Part may need to be reused.

APPLICATION GUIDE

Year	Fitment Notes	Front					Rear				
		Ultra	ProGuard\Guardian\Classic	Max Control\LTV	Strut Cushion\Strut Mount	HiJackers\Load Carrier	Ultra	ProGuard\Guardian\Classic	Max Control\LTV	Strut Cushion\Strut Mount	HiJackers\Load Carrier

ACURA

ACURA

LEGEND (cont)

86-88	All	142230 ⁵³ 143064 ⁵¹	143063 ⁵¹
-------	-----	-------	-------	-------	--	-------	-------	-------	-------	----------------------	-------

MDX

07-13	Left Exc. Active Suspension	G52249	G64080
	Right Exc. Active Suspension	G52250	G64080
03-06	Left	G52140	143315 ⁵⁴	G64003	61704
	Right	G52141	143315 ⁵⁴	G64003	61704
01-02	Left	G56759	M56759	143315 ⁵⁴	G64003	61704
	Right	G56758	M56758	143315 ⁵⁴	G64003	61704

MDX READYMOUNTS

		Front		Rear	
		Ultra Readymount	Guardian Readymount	Ultra Readymount	Guardian Readymount
07-13	Left	G57560 ⁴⁰
	Right	G57561 ⁴⁰
01-02	Left	G57119 ⁴⁰	M57119 ⁴⁰
	Right	G57120 ⁴⁰	M57120 ⁴⁰

RDX

07-12	Left	G52187	G51966
	Right	G52188	G51966

RDX READYMOUNTS

		Front		Rear	
		Ultra Readymount	Guardian Readymount	Ultra Readymount	Guardian Readymount
07-12	Left	G57574 ⁴⁰
	Right	G57575 ⁴⁰

RL

05-12	Left	G51911	G51912
	Right	G51911	G51913
96-04	Left	G52057	G51829
	Right	G52058	G51829

RSX

05-06	Left	G52346	G51914	142230 ⁵³
	Right	G52347	G51914	142230 ⁵³
	Type-S Left	143233 ⁶⁰
	Type-S Right	143265 ⁶⁰
02-06	Base and Type-S	143353 ⁵⁴

40 Complete Assembled Unit.



53 Strut Mount. Hardware from O.E. Part may need to be reused.

60 Strut Mount Contains a Metal Bearing. Hardware from O.E. Part may need to be reused.

51 Strut Cushion for use with the Strut/Cartridge/Shocks.

54 Kit with Mount and Bearing. Hardware from O.E. Part may need to be reused.





APPLICATION GUIDE

Year	Fitment Notes										
		Ultra	ProGuard/ Guardian/ Classic	Max Control/ LTV	Strut Cushion/ Strut Mount	HiJackers/ Load Carrier	Ultra	ProGuard/ Guardian/ Classic	Max Control/ LTV	Strut Cushion/ Strut Mount	HiJackers/ Load Carrier

ACURA

ACURA



RSX (cont)

02-04	Left	 G56794	 G51830	142230 ⁵³
	Right	 G56793	 G51830	142230 ⁵³















RSX READYMOUNTS

		Front		Rear	
		Ultra Readymount	Guardian Readymount	Ultra Readymount	Guardian Readymount
02-05	Left	G57523 ⁴⁰	G57442 ⁴⁰
	Right	G57524 ⁴⁰	G57441 ⁴⁰

SLX

96-99	All	 G63707	61607	 G63708	61608 81909
-------	-----	--	-------	------	------	------	--	----------------	------	------	------





TL

13-14	Left	 G51917	142230 ⁶⁷	 G51919
	Right	 G51918	142230 ⁶⁷	 G51919
09-12	Left	 G51917	142230 ⁵³	 G51919	142230 ⁵³
	Right	 G51918	142230 ⁵³	 G51919	142230 ⁵³
04-08	All	 G51737	M51737	142230 ⁵³	 G51738	M51738	142230 ⁵³
99-03	All	 G55870	M55870	142230 ⁵³	 G55871	M55871	142230 ⁵³
95-98	All		142230 ⁵³	



TL READYMOUNTS

		Front		Rear	
		Ultra Readymount	Guardian Readymount	Ultra Readymount	Guardian Readymount
04-08	All	G57056 ⁴⁰	M57056 ⁴⁰
99-03	All	G57284 ⁴⁰	G57576 ⁴⁰

TSX

09-14	All		 G51919
04-08	All	 G51737	M51737	 G51847







VIGOR

92-94	All		142230 ⁵³ 143064 ⁵¹		142231 ⁵³ 143064 ⁵¹
-------	-----	---	------	------	--	------	---	------	------	--	------





AMERICAN MOTORS

AMERICAN MOTORS



AMBASSADOR

70-74	All		82126		81340
67-69	All			82155
60-66	All			82066

AMERICAN

64-68	All		82069		82155
59-63	All			82155

AMX

78-80	All		82126		82125
-------	-----	---	-------	------	------	------	---	-------	------	------	------

40 Complete Assembled Unit.



53 Strut Mount. Hardware from O.E. Part may need to be reused.

Bold Type - New / Future Part

51 Strut Cushion for use with the Strut/Cartridge/Shocks.

67 Strut Mount Kit. Hardware from O.E. Part may need to be reused.

APPLICATION GUIDE

Year	Fitment Notes										
		Ultra	ProGuard\Guardian\Classic	Max Control\LTV	Strut Cushion\Strut Mount	HiJackers\Load Carrier	Ultra	ProGuard\Guardian\Classic	Max Control\LTV	Strut Cushion\Strut Mount	HiJackers\Load Carrier

AMERICAN MOTORS

AMX (cont)

70	All		82126	81340
68-69	All		82069	82155

CLASSIC

61-66	All		82066
-------	-----	--	------	------	------	------	------	--	------	-------	------	------	------

CONCORD

78-83	All		82126	82125
-------	-----	--	------	-------	------	------	------	--	------	-------	------	------	------

EAGLE

80-88	All		81491	81340
-------	-----	--	------	-------	------	------	------	--	------	-------	------	------	------

EAGLE STEERING STABILIZERS

80-88	All									Front		Rear	
										6804SE ⁸⁰		

GREMLIN

71-78	All		82126	82125
70	All		82126	82051

HORNET

71-77	All		82126	82125
70	All		82126	82051

JAVELIN

70-74	All		82126	81340
68-69	All		82069	82155

MARLIN

67	All		82155
65-66	All		82066

MATADOR

71-78	All		82126	81340
-------	-----	--	------	-------	------	------	------	--	------	-------	------	------	------

PACER

75-80	All		82025	81270	49105 ⁷
-------	-----	--	------	-------	------	------	------	--	------	-------	------	------	--------------------

RAMBLER

69	All		82069	82155
59-60	All		82155

SPIRIT

79-83	All		82126	82125
-------	-----	--	------	-------	------	------	------	--	------	-------	------	------	------

ASUNA

GT, SE

94	All		G44903	143057		69749	81530	141974	49371
93	All		G44903 ⁹⁸	143057 ⁵¹		69749	81530	141974 ⁶⁷	49371 ⁷
92	All		G44903	143057		69749	81530	141974	49371

ASUNA

7 Pair Packs, air hose kit included.



67 Strut Mount Kit. Hardware from O.E. Part may need to be reused.

98 Notice: The level of difficulty to install this product is moderately high. Please review the installation instructions carefully before proceeding.

51 Strut Cushion for use with the Strut/Cartridge/Shocks.

80 Mounting bracket not required, install on O.E. Shock Mounts. See Ref. C for optional Steering Stabilizer Boots.

APPLICATION GUIDE

Year	Fitment Notes										
		Ultra	ProGuard\ Guardian\ Classic	Max Control\ LTV	Strut Cushion\ Strut Mount	HiJackers\ Load Carrier	Ultra	ProGuard\ Guardian\ Classic	Max Control\ LTV	Strut Cushion\ Strut Mount	HiJackers\ Load Carrier

ASUNA

ASUNA

SUNFIRE (CANADIAN VEHICLE)

93	All	G55780	142317 ⁵³ 143058 ⁵¹
	Exc. Lotus Suspension	G55780	142317 ⁵³ 143058 ⁵¹	G55776	143061 ⁵¹

SUNRUNNER

94-98	All	M56518	142294	G63799	61560 81904	49613
	Non-ABS	G56518	M56518	142294	G63799	61560 81904	49613
92-93	All	142294 ⁵⁴	G63799	61560 81904	49613 ⁷
	Non-ABS	G56518	M56518	142294 ⁵⁴	G63799	61560 81904	49613 ⁷

AUDI

AUDI

80

88-92	All	G44902 ⁹⁸	142195 ⁵³ 143057 ⁵¹	143061 ⁵¹
-------	-----	----------------------	------	------	--	------	------	------	------	----------------------	------

80 QUATTRO

88-92	All	G44902 ⁹⁸	142195 ⁵³ 143057 ⁵¹
-------	-----	----------------------	------	------	--	------	------	------	------	------	------

90

93-95	All	G44902 ⁹⁸	142195 ⁵³ 143057 ⁵¹	143061 ⁵¹
88-91	All	G44902 ⁹⁸	142195 ⁵³ 143057 ⁵¹	143061 ⁵¹

90 QUATTRO

93-95	All	G44902 ⁹⁸	142195 ⁵³ 143057 ⁵¹
88-91	All	G44902 ⁹⁸	142195 ⁵³ 143057 ⁵¹

100

91-94	Mfg. Late 91	G44450 ⁹⁸	143061 ⁵¹
89-90	Mfg. Late 91	G44450 ⁹⁸	143060 ⁵¹	143061 ⁵¹

100 QUATTRO

91-94	All	G44450 ⁹⁸
89-90	All	G44450 ⁹⁸	143057 ⁵¹

200

91	All	G44450
89-90	All	G44450 ⁹⁸	143060 ⁵¹	143061 ⁵¹

200 QUATTRO

91	Wagon	G44450
89-90	Wagon	G44450 ⁹⁸	143057 ⁵¹

7 Pair Packs, air hose kit included.



53 Strut Mount. Hardware from O.E. Part may need to be reused.

98 Notice: The level of difficulty to install this product is moderately high. Please review the installation instructions carefully before proceeding.

51 Strut Cushion for use with the Strut/Cartridge/Shocks.

54 Kit with Mount and Bearing. Hardware from O.E. Part may need to be reused.

APPLICATION GUIDE

Year	Fitment Notes										
		Ultra	ProGuard\ Guardian\ Classic	Max Control\ LTV	Strut Cushion\ Strut Mount	HiJackers\ Load Carrier	Ultra	ProGuard\ Guardian\ Classic	Max Control\ LTV	Strut Cushion\ Strut Mount	HiJackers\ Load Carrier

AUDI

AUDI

4000

80-87	All	G44902 ⁹⁸	142195 ⁵³ 143057 ⁵¹	143061 ⁵¹
-------	-----	----------------------	------	------	--	------	------	------	----------------------	------

4000 QUATTRO

84-87	All	G44902 ⁹⁸	142195 ⁵³ 143057 ⁵¹	143061 ⁵¹
-------	-----	----------------------	------	------	--	------	------	------	----------------------	------

5000

78-88	All	G44450 ⁹⁸	143060 ⁵¹
-------	-----	----------------------	------	------	----------------------	------	------	------	------	------

A3

06-11	All	143344 ⁵³	143345 ⁵³
-------	-----	------	------	------	----------------------	------	------	------	----------------------	------

A3 READYMOUNTS

		Front		Rear	
		Ultra Readymount	Guardian Readymount	Ultra Readymount	Guardian Readymount
06-13	All	G57371 ⁴⁰	

A4

09-12	Sport Suspension	G511076 ²
01-08	All	G51740	142652 ⁵⁴	69586
00	All	G51740	142652 ⁵⁴	G51100
98-99	Sport Suspension	G51099	142652 ⁵⁴	G51100
96-99	All	142652 ⁵⁴	G51100
	Exc. Sport Suspension	G51097	142652 ⁵⁴	G51100
96-97	Sport Suspension	G51099	142652 ⁵⁴	G51100

A4 QUATTRO

09-12	Sport Suspension	G511076 ²
08	All	69586 G511062 ²
	Mfg. from 11/00; Exc. Sport Suspension	G51740	69586 G511062 ²
02-07	All	69586
	Mfg. from 11/00; Exc. Sport Suspension	G51740	69586
00-01	Mfg. from 11/00; Exc. Sport Suspension	G51740
96-00	Mfg. to 11/00; Exc. Sport Suspension	G51097
	Sport Suspension	G51099

A6

00-04	All	M51743	142652 ⁵⁴	69946
	Exc. Sport Suspension	G511057	M51743	142652 ⁵⁴	69946

2 Future Part, available 2nd Quarter of 2017.

51 Strut Cushion for use with the Strut/Cartridge/Shocks.



54 Kit with Mount and Bearing. Hardware from O.E. Part may need to be reused.

40 Complete Assembled Unit.

53 Strut Mount. Hardware from O.E. Part may need to be reused.

98 Notice: The level of difficulty to install this product is moderately high. Please review the installation instructions carefully before proceeding.

APPLICATION GUIDE

Year	Fitment Notes										
		Ultra	ProGuard\Guardian\Classic	Max Control\LTV	Strut Cushion\Strut Mount	HiJackers\Load Carrier	Ultra	ProGuard\Guardian\Classic	Max Control\LTV	Strut Cushion\Strut Mount	HiJackers\Load Carrier

AUDI

AUDI

A6 (cont)

00	Sport Suspension	G51099	M51743	142652 ⁵⁴	69946
98-99	All	142652 ⁵⁴	69946
	Exc. Sport Suspension	G511057	142652 ⁵⁴	69946
	Sport Suspension	G51099	142652 ⁵⁴	69946
95-97	All	G44450

A6 QUATTRO

08	Exc. Air and Sport Suspension	G51915	G51968
05-07	All	142652 ⁵⁴
	Exc. Air and Sport Suspension	G51915	142652 ⁵⁴	G51968
00-04	All	G511057	M51743	142652 ⁵⁴	G51742
98-99	All	G511057	142652 ⁵⁴	G51742
95-97	All	G44450 ⁹⁸	143061 ⁵¹	G51742

A6 QUATTRO READYMOUNTS

		Front		Rear	
		Ultra Readymount	Guardian Readymount	Ultra Readymount	Guardian Readymount
00-04	Left	G57135 ⁴⁰	M57135⁴⁰
	Right	G57136 ⁴⁰	M57136⁴⁰

A6 READYMOUNTS

		Front		Rear	
		Ultra Readymount	Guardian Readymount	Ultra Readymount	Guardian Readymount
00-04	Left	G57135 ⁴⁰	M57135⁴⁰
	Right	G57136 ⁴⁰	M57136⁴⁰

A8

97-99	All	142652 ⁵⁴
-------	-----	------	------	------	----------------------	------	------	------	------	------

CABRIOLET

94-98	All	G44902
-------	-----	--------	------	------	------	------	------	------	------	------

COUPE

83-87	All	G44902 ⁹⁸	142195 ⁵³ 143057 ⁵¹	143061 ⁵¹
81-82	All	G44902

COUPE QUATTRO

90-91	All	G44902 ⁹⁸	142195 ⁵³ 143057 ⁵¹
-------	-----	----------------------	------	------	--	------	------	------	------	------

FOX

73-79	All	G44902 ⁹⁸	143059 ⁵¹
-------	-----	----------------------	------	------	------	------	------	------	----------------------	------

40 Complete Assembled Unit.

53 Strut Mount. Hardware from O.E. Part may need to be reused.



98 Notice: The level of difficulty to install this product is moderately high. Please review the installation instructions carefully before proceeding.

Bold Type - New / Future Part

51 Strut Cushion for use with the Strut/Cartridge/Shocks.

54 Kit with Mount and Bearing. Hardware from O.E. Part may need to be reused.



APPLICATION GUIDE

Year	Fitment Notes										
		Ultra	ProGuard\ Guardian\ Classic	Max Control\ LTV	Strut Cushion\ Strut Mount	HiJackers\ Load Carrier	Ultra	ProGuard\ Guardian\ Classic	Max Control\ LTV	Strut Cushion\ Strut Mount	HiJackers\ Load Carrier





AUDI

AUDI



QUATTRO

84-86	All	 G44450	 G51742
-------	-----	--	------	------	------	------	--	------	------	------	------





S4

00-02	All		142652 ⁵⁴	
92-94	All	 G44450 ⁹⁸	





S6

95-97	All	 G44450 ⁹⁸	
-------	-----	--	------	------	------	------	---	------	------	------	------



TT

08-09	All		143344 ⁵³		143345 ⁵³
00-06	All	 G56611	142651 ⁵⁴	 69420	142654 ⁵³

TT QUATTRO

08-10	All		143344 ⁵³		143345 ⁵³
00-06	All	 G56611	142651 ⁵⁴	 69416





V8 QUATTRO

90-94	All	 G44450 ⁹⁸	143057 ⁵¹	
-------	-----	--	------	------	----------------------	------	---	------	------	------	------

AVANTI

AVANTI





II

89-91	All	 69600	 69724
87-88	All	 69600	 69604

BMW

BMW





128i

08-13	Left	 G52142	 70045
	Right	 G52143	 70045

128i READYMOUNTS

		Front		Rear	
		Ultra Readymount	Guardian Readymount	Ultra Readymount	Guardian Readymount
08-11	Left	G57363 ⁴⁰
	Right	G57364 ⁴⁰

135i

08-11	Left	 G52142	 70045
	Right	 G52143	 70045

135i READYMOUNTS

		Front		Rear	
		Ultra Readymount	Guardian Readymount	Ultra Readymount	Guardian Readymount
08-11	Left	G57363 ⁴⁰
	Right	G57364 ⁴⁰

40 Complete Assembled Unit.



53 Strut Mount. Hardware from O.E. Part may need to be reused.

98 Notice: The level of difficulty to install this product is moderately high. Please review the installation instructions carefully before proceeding.

51 Strut Cushion for use with the Strut/Cartridge/Shocks.

54 Kit with Mount and Bearing. Hardware from O.E. Part may need to be reused.













APPLICATION GUIDE

Year	Fitment Notes										
		Ultra	ProGuard\ Guardian\ Classic	Max Control\ LTV	Strut Cushion\ Strut Mount	HiJackers\ Load Carrier	Ultra	ProGuard\ Guardian\ Classic	Max Control\ LTV	Strut Cushion\ Strut Mount	HiJackers\ Load Carrier







BMW

BMW





318I

99	Left		G56602		69863
	Right		G56603		69863
92-98	Left		G56602	143061 ⁵¹		69863	142135 ⁵³
	Right		G56603	143061 ⁵¹		69863	142135 ⁵³
91	All		G44745 ⁹⁸	143061 ⁵¹		69725	142135 ⁵³
84-85	All		G44745 ⁹⁸	143061 ⁵¹		69725	142135 ⁵³



318IS

92-98	Left		G56602	143061 ⁵¹		69863	142135 ⁵³
	Right		G56603	143061 ⁵¹		69863	142135 ⁵³
91	All		G44745 ⁹⁸	143061 ⁵¹		69725	142135 ⁵³

318TI

95-99	Left		G56602	143057 ⁵¹		69903	142135 ⁵³
	Right		G56603	143057 ⁵¹		69903	142135 ⁵³













320I

77-83	All		G44713 ⁹⁸		G51007
-------	-----	---	----------------------	------	------	------	------	---	--------	------	------	------	------

320I READYMOUNTS

		Front		Rear	
		Ultra Readymount	Guardian Readymount	Ultra Readymount	Guardian Readymount
02-05	Right	G57382 ⁴⁰
01-05	Left	G57381 ⁴⁰

323CI

00	All			69863
	Coupe		143082 ⁵³		69863
	Coupe Left Exc. Sport Suspension		G52237		69863
	Coupe Left Sport Suspension		G52235		69863
	Coupe Right Exc. Sport Suspension		G52238		69863
	Coupe Right Sport Suspension		G52236		69863

323CI READYMOUNTS

		Front		Rear	
		Ultra Readymount	Guardian Readymount	Ultra Readymount	Guardian Readymount
00	Left	G57379 ⁴⁰
	Right	G57380 ⁴⁰

323I

06	Sedan Left Sport Suspension		G52235
----	-----------------------------	---	--------	------	------	------	------	------	------	------	------	------



40 Complete Assembled Unit.

53 Strut Mount. Hardware from O.E. Part may need to be reused.

51 Strut Cushion for use with the Strut/Cartridge/Shocks.

98 Notice: The level of difficulty to install this product is moderately high. Please review the installation instructions carefully before proceeding.

APPLICATION GUIDE

Year	Fitment Notes										
		Ultra	ProGuard\Guardian\Classic	Max Control\LTV	Strut Cushion\Strut Mount	HiJackers\Load Carrier	Ultra	ProGuard\Guardian\Classic	Max Control\LTV	Strut Cushion\Strut Mount	HiJackers\Load Carrier

BMW

BMW

323i (cont)

06	Sedan Right Sport Suspension	G52236
00-01	Sedan Left Sport Suspension	G52235
	Sedan Right Sport Suspension	G52236
00	Sedan Left Exc. Sport Suspension	G52237
	Sedan Right Exc. Sport Suspension	G52238
	Wagon	143082 ⁵³	...	69863
	Wagon Left Sport Suspension	G56750
	Wagon Right Sport Suspension	G56751
98-99	All	143061 ⁵¹	...	69863	142135 ⁵³
	E36(MfrBodyCode) Left	G56604	143061 ⁵¹	...	69863	142135 ⁵³
	E36(MfrBodyCode) Right	G56605	143061 ⁵¹	...	69863	142135 ⁵³

323iS

98-99	Left	G56602	69863
	Right	G56603	69863

325

87-88	All	143061 ⁵¹	...	69725	142135 ⁵³
	Exc. Sport Suspension	G44775 ⁹⁸	143061 ⁵¹	...	69725	142135 ⁵³
86	All	G44775	69725

325Ci

01-06	All	69863
	Left Exc. Sport Suspension	G52237	69863
	Left Sport Suspension	G52235	69863
	Right Exc. Sport Suspension	G52238	69863
	Right Sport Suspension	G52236	69863
	Sport Suspension; Exc. M-Sport Pack II	143082 ⁵³	...	69863

325E

84-87	All	143061 ⁵¹	...	69725	142135 ⁵³
	Exc. Sport Suspension	G44775 ⁹⁸	143061 ⁵¹	...	69725	142135 ⁵³

325i



06	All	70045
----	-----	-----	-----	-----	-----	-----	-------	-----	-----	-----

51 Strut Cushion for use with the Strut/Cartridge/Shocks.

53 Strut Mount. Hardware from O.E. Part may need to be reused.

98 Notice: The level of difficulty to install this product is moderately high. Please review the installation instructions carefully before proceeding.

APPLICATION GUIDE

Year	Fitment Notes										
		Ultra	ProGuard\Guardian\Classic	Max Control\LTV	Strut Cushion\Strut Mount	HiJackers\Load Carrier	Ultra	ProGuard\Guardian\Classic	Max Control\LTV	Strut Cushion\Strut Mount	HiJackers\Load Carrier

BMW

BMW

325I (cont)

06	Exc. Sport Suspension M-Sport Pack II	143082 ⁵³	70045
	Left	G52142	70045
	Right	G52143	70045
02-05	Wagon Left Sport Suspension	G56750	69863
01-05	All	69863
	Exc. Sport Suspension M-Sport Pack II	143082 ⁵³	69863
	Sedan Left Exc. Sport Suspension	G52237	69863
	Sedan Right Exc. Sport Suspension	G52238	69863
	Wagon Right Sport Suspension	G56751	69863
01	Wagon Left Mfg. to 9/01; Sport Suspension	G56750	69863
	Wagon Right Mfg. to 9/01; Sport Suspension	G56751	69863
92-95	All	143061 ⁵¹
	E36(MfrBodyCode) Left	G56604	143061 ⁵¹	69863	142135 ⁵³
	E36(MfrBodyCode) Right	G56605	143061 ⁵¹	69863	142135 ⁵³
92	E30(MfrBodyCode) Exc. Sport Suspension	G44775 ⁹⁸	143061 ⁵¹	69725
87-91	All	143061 ⁵¹	142135 ⁵³
	E30(MfrBodyCode) Exc. Sport Suspension	G44775 ⁹⁸	143061 ⁵¹	69725	142135 ⁵³

325I READYMOUNTS

		Front		Rear	
		Ultra Readymount	Guardian Readymount	Ultra Readymount	Guardian Readymount
06	Left w/o Sport Suspension	G57363 ⁴⁰
	Right w/o Sport Suspension	G57364 ⁴⁰

325IS

87-92	All	143061 ⁵¹	69725	142135 ⁵³
	Exc. Sport Suspension	G44775 ⁹⁸	143061 ⁵¹	69725	142135 ⁵³

325IX

88-91	All	143061 ⁵¹	142135 ⁵³
-------	-----	-------	-------	-------	----------------------	-------	-------	-------	-------	----------------------	-------

328CI

00	All	143082 ⁵³	69863
	Left Sport Suspension	G52235	143082 ⁵³	69863
	Right Sport Suspension	G52236	143082 ⁵³	69863

40 Complete Assembled Unit.



53 Strut Mount. Hardware from O.E. Part may need to be reused.

51 Strut Cushion for use with the Strut/Cartridge/Shocks.

98 Notice: The level of difficulty to install this product is moderately high. Please review the installation instructions carefully before proceeding.

Bold Type - New / Future Part

APPLICATION GUIDE

Year	Fitment Notes										
		Ultra	ProGuard\ Guardian\ Classic	Max Control\ LTV	Strut Cushion\ Strut Mount	HiJackers\ Load Carrier	Ultra	ProGuard\ Guardian\ Classic	Max Control\ LTV	Strut Cushion\ Strut Mount	HiJackers\ Load Carrier

BMW

BMW

328Ci (cont)

00	Coupe Left Exc. Sport Suspension	G52237	143082 ⁵³	69863
	Coupe Right Exc. Sport Suspension	G52238	143082 ⁵³	69863

328CI READMOUNTS

		Front		Rear	
		Ultra Readymount	Guardian Readymount	Ultra Readymount	Guardian Readymount
00	Left	G57379 ⁴⁰
	Right	G57380 ⁴⁰

328I

07-13	Left	G52142	70045
	Right	G52143	70045
99-00	All	143082 ⁵³	69863
96-98	Left	G56604	143061 ⁵¹	69863	142135 ⁵³
	Right	G56605	143061 ⁵¹	69863	142135 ⁵³

328I READMOUNTS

		Front		Rear	
		Ultra Readymount	Guardian Readymount	Ultra Readymount	Guardian Readymount
07-13	Left	G57363 ⁴⁰
	Right	G57364 ⁴⁰

328IS

96-99	Left	G56602	69863
	Right	G56603	69863

330Ci

02-06	Left Sport Suspension	G52235	69863
	Right Sport Suspension	G52236	69863
01-06	All	69863
	Exc. Sport Suspension M-Sport Pack II	143082 ⁵³	69863
	Left Exc. Sport Suspension	G52237	69863
	Right Exc. Sport Suspension	G52238	69863
01	Convertible Left Sport Suspension	G56750	69863
	Convertible Right Sport Suspension	G56751	69863
	Coupe Left Mfg. from 9/01; Sport Suspension	G52235	69863
	Coupe Right Sport Suspension	G52236	69863

330I



06	Left	G52142	70045
----	------	--------	------	------	------	------	-------	------	------	------	------

40 Complete Assembled Unit.

53 Strut Mount. Hardware from O.E. Part may need to be reused.

51 Strut Cushion for use with the Strut/Cartridge/Shocks.

APPLICATION GUIDE

Year	Fitment Notes										
		Ultra	ProGuard\ Guardian\ Classic	Max Control\ LTV	Strut Cushion\ Strut Mount	HiJackers\ Load Carrier	Ultra	ProGuard\ Guardian\ Classic	Max Control\ LTV	Strut Cushion\ Strut Mount	HiJackers\ Load Carrier

BMW

BMW

330i (cont)

06	Right	G52143	70045
01-05	All	69863
	Left Sport Suspension	G52235	69863
	Right Sport Suspension	G52236	69863

330i READYMOUNTS

		Front		Rear	
		Ultra Readymount	Guardian Readymount	Ultra Readymount	Guardian Readymount
06	Left	G57363 ⁴⁰
	Right	G57364 ⁴⁰

335i

07-13	Left	G52142	70045
	Right	G52143	70045

335i READYMOUNTS

		Front		Rear	
		Ultra Readymount	Guardian Readymount	Ultra Readymount	Guardian Readymount
07-13	Left	G57363 ⁴⁰
	Right	G57364 ⁴⁰

524TD

85-86	All	G51330
-------	-----	------	------	------	------	------	--------	------	------	------	------

525i

08	All	G51900
04-07	All	G52314	G51900
01-03	Sedan Exc. Electronic Adjustable Suspension	G56608	G51216
	Wagon Exc. Electronic Adjustable Suspension	69998
92-95	All	143061 ⁵¹	G51346
	Exc. Electronic Adjustable Suspension	G44493 ⁹⁸	143061 ⁵¹	G51346	142735 ⁵³
92	Mfg. to 9/92	G44497 ⁹⁸	143061 ⁵¹	G51346
91	All	G44497 ⁹⁸	143061 ⁵¹	G51346	142735 ⁵³
90	All	143061 ⁵¹	142735 ⁵³
	Mfg. from 8/90	G44497 ⁹⁸	143061 ⁵¹	G51346	142735 ⁵³
	Mfg. to 8/90	G44991 ⁹⁸	143061 ⁵¹	142735 ⁵³
89	All	G44991 ⁹⁸	143061 ⁵¹	G51346	142735 ⁵³

528E

82-88	All	143061 ⁵¹
-------	-----	------	------	------	----------------------	------	------	------	------	------	------

40 Complete Assembled Unit.



53 Strut Mount. Hardware from O.E. Part may need to be reused.

51 Strut Cushion for use with the Strut/Cartridge/Shocks.

98 Notice: The level of difficulty to install this product is moderately high. Please review the installation instructions carefully before proceeding.

Bold Type - New / Future Part



APPLICATION GUIDE

Year	Fitment Notes										
		Ultra	ProGuard\ Guardian\ Classic	Max Control\ LTV	Strut Cushion\ Strut Mount	HiJackers\ Load Carrier	Ultra	ProGuard\ Guardian\ Classic	Max Control\ LTV	Strut Cushion\ Strut Mount	HiJackers\ Load Carrier











BMW

BMW











528E (cont)

82-88	Auto-Leveling System	 G44920 ⁹⁸	143061 ⁵¹	 G51330
-------	----------------------	--	------	------	----------------------	------	--	------	------	------	------





528i

08-10	All	 G52314	
99-00	All		143082 ⁵³	
	Wagon		143082 ⁵³		69998
97-00	Sedan		G56608	143082 ⁵³		G51216
97-98	All		143082 ⁵³		G51216























530i

08	All			G51900
04-07	All		G52314		G51900
01-03	Exc. Electronic Adjustable Suspension		G56608		G51216
94-95	All		143061 ⁵¹	
	Sedan		G44497 ⁹⁸	143061 ⁵¹		G51346	142735 ⁵³

533i

83-84	All		143061 ⁵¹	
	Auto-Leveling System		G44920 ⁹⁸	143061 ⁵¹		G51330

535i



08-10	All		G52314	
90-93	Mfg. from 8/90		G44497 ⁹⁸	143061 ⁵¹		G51346	142735 ⁵³
89-93	All			G51346
90	Mfg. to 8/90		G44991 ⁹⁸		G51346
89	All		G44991 ⁹⁸	143061 ⁵¹		G51346
	Mfg. from 8/90			G51346	142735 ⁵³
85-88	All		143061 ⁵¹	
	Auto-Leveling System		G44920 ⁹⁸	143061 ⁵¹		G51330
88	Exc. Auto-Leveling System		G44991 ⁹⁸	143061 ⁵¹	
	Mfg. from 8/90		143061 ⁵¹		142735 ⁵³
	Mfg. from 8/90; Exc. Auto-Leveling System		143061 ⁵¹		G51346

51 Strut Cushion for use with the Strut/Cartridge/Shocks.

53 Strut Mount. Hardware from O.E. Part may need to be reused.

98 Notice: The level of difficulty to install this product is moderately high. Please review the installation instructions carefully before proceeding.

APPLICATION GUIDE

Year	Fitment Notes										
		Ultra	ProGuard\ Guardian\ Classic	Max Control\ LTV	Strut Cushion\ Strut Mount	HiJackers\ Load Carrier	Ultra	ProGuard\ Guardian\ Classic	Max Control\ LTV	Strut Cushion\ Strut Mount	HiJackers\ Load Carrier

BMW

BMW

535IS

88	All	143061 ⁵¹	142735 ⁵³
	Auto-Leveling System	G44920 ⁹⁸	143061 ⁵¹	G51330	142735 ⁵³
	Exc. Auto-Leveling System	G44991 ⁹⁸	143061 ⁵¹	G51346	142735 ⁵³

540I

00-03	Wagon Exc. Electronic Adjustable Suspension	69998
97-03	Mfg. to 10/03; Exc. Electronic Adjustable Suspension	G56607	G51216
95	Mfg. to 10/03; Exc. Electronic Adjustable Suspension	G44497 ⁹⁸	G51216
94	Mfg. to 10/03; Exc. Electronic Adjustable Suspension	G44497 ⁹⁸

545I

04-05	All	G52314
-------	-----	--------	-------	-------	-------	-------	-------	-------	-------	-------	-------

550I

06-10	All	G52314
-------	-----	--------	-------	-------	-------	-------	-------	-------	-------	-------	-------

635CSI

85-89	All	143061 ⁵¹	143063 ⁵¹
	Exc. Auto-Leveling System	G44920 ⁹⁸	143061 ⁵¹	G51330	143063 ⁵¹

735I

92	All	143061 ⁵¹
91	All	G44497	143061 ⁵¹
86-90	All	143061 ⁵¹

735IL

88-92	All	143061 ⁵¹
-------	-----	-------	-------	-------	----------------------	-------	-------	-------	-------	-------	-------

740I

97-01	Left Exc. Electronic Adjustable Suspension	G56771	G51744
	Right Exc. Electronic Adjustable Suspension	G56770	G51744
94-95	Left Exc. Electronic Adjustable Suspension	G56771	G51744
	Right Exc. Electronic Adjustable Suspension	G56770	G51744
93	All	G44497
	Exc. Electronic Adjustable Suspension	G44497	G51744

740IL





94-01	Left Exc. Electronic Adjustable Suspension	G56771	G51744
-------	--	--------	-------	-------	-------	-------	--------	-------	-------	-------	-------

51 Strut Cushion for use with the Strut/Cartridge/Shocks.

53 Strut Mount. Hardware from O.E. Part may need to be reused.

98 Notice: The level of difficulty to install this product is moderately high. Please review the installation instructions carefully before proceeding.



APPLICATION GUIDE

Year	Fitment Notes										
		 Ultra	ProGuard\ Guardian\ Classic	Max Control\ LTV	Strut Cushion\ Strut Mount	HiJackers\ Load Carrier	 Ultra	ProGuard\ Guardian\ Classic	Max Control\ LTV	Strut Cushion\ Strut Mount	HiJackers\ Load Carrier

BMW

BMW

740iL (cont)

94-01	Right Exc. Electronic Adjustable Suspension	 G56770	 G51744
93	Exc. Electronic Adjustable Suspension	 G51744

745i

02-05	All	 G511070
-------	-----	------	------	------	------	------	---	------	------	------	------









745Li

02-05	All	 G511070
-------	-----	------	------	------	------	------	---	------	------	------	------

750i

06-08	All	 G511070
-------	-----	------	------	------	------	------	---	------	------	------	------

750iL

97-01	Left Exc. Electronic Adjustable Suspension	 G56771
	Right Exc. Electronic Adjustable Suspension	 G56770
94-96	All	 G51744
	Left Exc. Electronic Adjustable Suspension	 G56771	 G51744
	Right Exc. Electronic Adjustable Suspension	 G56770	 G51744
88-93	All	 G44497

750Li

06-08	All	 G511070
-------	-----	------	------	------	------	------	---	------	------	------	------



760i

04-06	All	 G511070
-------	-----	------	------	------	------	------	---	------	------	------	------





760Li

03-08	All	 G511070
-------	-----	------	------	------	------	------	---	------	------	------	------





M3

95-99	Left		142826 ⁵³
	Right		142825 ⁵³
88-91	All	 69725	142135 ⁵³



X3

04-10	Left	 G52199	 70034
	Right	 G52200	 70034

X5

00-06	All	 G64046	143259 ⁵³
	AWD	143084 ⁵³	 G64046	143259 ⁵³
	Coil(FrontSpringType) Left	 G52144	 G64046	143259 ⁵³

APPLICATION GUIDE

Year	Fitment Notes										
		Ultra	ProGuard\ Guardian\ Classic	Max Control\ LTV	Strut Cushion\ Strut Mount	HiJackers\ Load Carrier	Ultra	ProGuard\ Guardian\ Classic	Max Control\ LTV	Strut Cushion\ Strut Mount	HiJackers\ Load Carrier

BMW

BMW

X5 (cont)

00-06	Coil(FrontSpringType) Right	G52145	G64046	143259 ⁵³
-------	-----------------------------	--------	------	------	------	------	--------	------	------	----------------------	------

Z3

96-02	Left	G56761
	Right	G56760

BUICK

BUICK

ALLURE

10	AWD, Left Exc. Electronic Suspension	G52600	G511074 ¹
	AWD, Right Exc. Electronic Suspension	G52601	G511074 ¹
	FWD, Left Exc. Electronic Suspension	G52278	70059
	FWD, Right Exc. Electronic Suspension	G52279	70059
05-09	All	G55948	M55948	142524 ⁵⁷ 142525 ⁵³ 142526 ⁵⁴ 143060 ⁵¹	143061 ⁵¹
	Exc. Models with 17" or 18" Wheels	G55948	M55948	142524 ⁵⁷ 142525 ⁵³ 142526 ⁵⁴ 143060 ⁵¹	G55949	M55949	143061 ⁵¹
	Left	G55948	M55948	142524 ⁵⁷ 142525 ⁵³ 142526 ⁵⁴ 143060 ⁵¹	143073 ⁵³ 143061 ⁵¹
	Models with 17" or 18" Wheels	G55948	M55948	142524 ⁵⁷ 142525 ⁵³ 142526 ⁵⁴ 143060 ⁵¹	G52244	143061 ⁵¹
	Right	G55948	M55948	142524 ⁵⁷ 142525 ⁵³ 142526 ⁵⁴ 143060 ⁵¹	143074 ⁵³ 143061 ⁵¹

ALLURE READYMOUNTS

		Front		Rear	
		Ultra Readymount	Guardian Readymount	Ultra Readymount	Guardian Readymount
05-09	All	G57060 ⁴⁰	M57060 ⁴⁰
	Left Exc. Models with 17" or 18" Wheels	G57060 ⁴⁰	M57060 ⁴⁰	G56924 ⁴⁰	M56924 ⁴⁰
	Right Exc. Models with 17" or 18" Wheels	G57060 ⁴⁰	M57060 ⁴⁰	G56925 ⁴⁰	M56925 ⁴⁰

APOLLO

74-75	All	69600	81494	34051 ⁸	82093	49193 ⁷
73	All	69600	81494	34051 ⁸
	Exc. HD Suspension	69600	81494	34051 ⁸	82093	49193 ⁷
	HD Suspension	69600	81494	34051 ⁸	69724	81514	49157 ⁷

CENTURION

71-73	All	69675 ⁵	81446	34073 ⁸	69724 ⁵	81514	43049 ⁸ 49131 ³⁰
-------	-----	--------------------	-------	------	------	--------------------	--------------------	-------	------	------	---

1 Future Part, available 1st Quarter of 2017.

7 Pair Packs, air hose kit included.

30 For GM Vehicles equipped with factory installed leveling systems, see Ref A.

51 Strut Cushion for use with the Strut/Cartridge/Shocks.

54 Kit with Mount and Bearing. Hardware from O.E. Part may need to be reused.

5 Use kit No. 140719 to replace O.E. hardware for lower shock absorber mounting when studs break or self-tapping screws are not longer useable.



8 Pair Packs.

40 Complete Assembled Unit.

53 Strut Mount. Hardware from O.E. Part may need to be reused.

67 Strut Mount Kit. Hardware from O.E. Part may need to be reused.



























APPLICATION GUIDE

Year	Fitment Notes										
		Ultra	ProGuard/ Guardian/ Classic	Max Control/ LTV	Strut Cushion/ Strut Mount	HiJackers/ Load Carrier	Ultra	ProGuard/ Guardian/ Classic	Max Control/ LTV	Strut Cushion/ Strut Mount	HiJackers/ Load Carrier

BUICK

BUICK

CENTURY

97-05	All		G55948	M55948	142524 ⁶⁷ 142525 ⁵³ 142526 ⁵⁴ 143060 ⁵¹		G55949	M55949	143061 ⁵¹
	Left		G55948	M55948	142524 ⁶⁷ 142525 ⁵³ 142526 ⁵⁴ 143060 ⁵¹		G55949	M55949	143073 ⁵³ 143061 ⁵¹
	Right		G55948	M55948	142524 ⁶⁷ 142525 ⁵³ 142526 ⁵⁴ 143060 ⁵¹		G55949	M55949	143074 ⁵³ 143061 ⁵¹
85-96	All		G55514	M55514	142223 ⁵³ 142749 ⁶⁷ 143060 ⁵¹		69723	81517	141974 ⁶⁷	49370 ³⁰
84	All		142223 ⁵³ 143060 ⁵¹		69723	81517	141974 ⁶⁷	49370 ³⁰
	Exc. HD Suspension		G55505	142223 ⁵³ 143060 ⁵¹		69723	81517	141974 ⁶⁷	49370 ³⁰
	HD Suspension		G55514	M55514	142223 ⁵³ 143060 ⁵¹		69723	81517	141974 ⁶⁷	49370 ³⁰
82-83	All		G55505	142223 ⁵³ 143060 ⁵¹		69723	81517	141974 ⁶⁷	49370 ³⁰
78-81	All		69600	81494	34051 ⁸		69604	81492	43060 ⁸ 49334 ³⁰
73-77	All		69600	81494	34051 ⁸		69604	81492	43060 ⁸ 49152 ³⁰
58	All		81270		82156
57	All			82156
56	All		82087	















CENTURY READYMOUNTS

		Front		Rear	
		Ultra Readymount	Guardian Readymount	Ultra Readymount	Guardian Readymount
97-05	Left	G57060 ⁴⁰	M57060 ⁴⁰	G56924 ⁴⁰	M56924 ⁴⁰
	Right	G57060 ⁴⁰	M57060 ⁴⁰	G56925 ⁴⁰	M56925 ⁴⁰
85-96	All	G56908 ⁴⁰	M56908 ⁴⁰
84	All	M56908 ⁴⁰
	HD Suspension	G56908 ⁴⁰	M56908 ⁴⁰

COMMERCIAL CHASSIS

92-96	All		43049 ⁸
-------	-----	------	------	------	------	---	------	------	------	------	------	--------------------

ELECTRA

85-90	All		G56701	142227 ⁶⁷ 143061 ⁵¹		142132 ⁵³ 143060 ⁵¹
	Air(RearSpringType) Conventional Replacement for Air Assist Rear Susp. Strut Only		G56701	142227 ⁶⁷ 143061 ⁵¹		G56707 ⁹	M56707 ⁹	142132 ⁵³ 143060 ⁵¹
	Air(RearSpringType) w/Air assist Rear Susp. Std. Equip. Strut Only		G56701	142227 ⁶⁷ 143061 ⁵¹		G56903	M56903	142132 ⁵³ 143060 ⁵¹
85-89	Estate Wagon		G56701	142227 ⁶⁷ 143061 ⁵¹	34073 ⁸		142132 ⁵³ 143060 ⁵¹
71-84	All		69675 ⁵	81446	34073 ⁸		69724	81514	43049 ⁸ 49131 ³⁰
65-70	All		82601		82602
61-64	All		82087		82609

5 Use kit No. 140719 to replace O.E. hardware for lower shock absorber mounting when studs break or self-tapping screws are not longer useable.

9 See Ref. D for procedures to replace Elec Adj Susp with non-adj product.

40 Complete Assembled Unit.

53 Strut Mount. Hardware from O.E. Part may need to be reused.

67 Strut Mount Kit. Hardware from O.E. Part may need to be reused.



8 Pair Packs.

30 For GM Vehicles equipped with factory installed leveling systems, see Ref A.

51 Strut Cushion for use with the Strut/Cartridge/Shocks.

54 Kit with Mount and Bearing. Hardware from O.E. Part may need to be reused.

APPLICATION GUIDE

Year	Fitment Notes										
		Ultra	ProGuard/ Guardian/ Classic	Max Control/ LTV	Strut Cushion/ Strut Mount	HiJackers/ Load Carrier	Ultra	ProGuard/ Guardian/ Classic	Max Control/ LTV	Strut Cushion/ Strut Mount	HiJackers/ Load Carrier

BUICK

BUICK

ELECTRA (cont)

59-60	Exc. Air Suspension	82155
-------	---------------------	-------	-------	-------	-------	-------	-------	-------	-------	-------	-------

ELECTRA READYMOUNTS

		Front		Rear	
		Ultra Readymount	Guardian Readymount	Ultra Readymount	Guardian Readymount
85-90	All	G56914 ⁴⁰	M56914 ⁴⁰
	Air(RearSpringType)	G56914 ⁴⁰	M56914 ⁴⁰	M56906 ⁴⁰
	Air(RearSpringType) Conventional Replacement for Air Assist Rear Susp. Strut w/Upper Mount	G56914 ⁴⁰	M56914 ⁴⁰	G56726 ⁴¹
	Air(RearSpringType) w/Air Assist Rear Susp. Std. Equip. Strut w/Upper Mount	G56914 ⁴⁰	M56914 ⁴⁰	G56906 ⁴³

ENCLAVE

13-16	All	G64040
08-12	All	G52125	143366 ⁵³	G64040

ENCLAVE READYMOUNTS

		Front		Rear	
		Ultra Readymount	Guardian Readymount	Ultra Readymount	Guardian Readymount
12	All	G57109 ⁴⁰
08-11	All	G57109 ⁴⁰	M57314 ⁴⁰

ENCORE

13-16	Left	G52494	G511030 ²
	Right	G52495	G511030 ²

ESTATE WAGON

87	All	69675	81446	69604	81492	49152
71-83	All	69675 ⁵	81446	34073 ⁸	69604	81492	43060 ⁹ 49152 ³⁰
70	All	82601	69724	81514	49128 ³⁰

GRAN SPORT

65-67	All	82138	69604	81492	43060 ⁹ 49152 ³⁰
-------	-----	-------	-------	-------	-------	-------	-------	-------	-------	-------	---

GS / GS350 / GS400 / GS455

68-72	All	69600	81494	69604	81492	43060 ⁹ 49152 ³⁰
-------	-----	-------	-------	-------	-------	-------	-------	-------	-------	-------	---

INVICTA

61-63	All	82087	82609
59-60	Exc. Air Suspension	82155

LACROSSE

10-16	FWD, Left Exc. Electronic Suspension	G52278	70059
	FWD, Right Exc. Electronic Suspension	G52279	70059
10-12	AWD, Left Exc. Electronic Suspension	G52600	G511074 ¹
	AWD, Right Exc. Electronic Suspension	G52601	G511074 ¹

1 Future Part, available 1st Quarter of 2017.

5 Use kit No. 140719 to replace O.E. hardware for lower shock absorber mounting when studs break or self-tapping screws are not longer useable.

30 For GM Vehicles equipped with factory installed leveling systems, see Ref. A.

41 Complete Assembled Unit. See Ref. D for procedures to replace Elec Adj Susp with non-adj product.

53 Strut Mount. Hardware from O.E. Part may need to be reused.

2 Future Part, available 2nd Quarter of 2017.

8 Pair Packs.

40 Complete Assembled Unit.

43 Does not include springs due to vehicle design. See Ref. D for procedures to replace Elec Adj Susp with non-adj product.

APPLICATION GUIDE

Year	Fitment Notes										
		Ultra	ProGuard/ Guardian/ Classic	Max Control/ LTV	Strut Cushion/ Strut Mount	HiJackers/ Load Carrier	Ultra	ProGuard/ Guardian/ Classic	Max Control/ LTV	Strut Cushion/ Strut Mount	HiJackers/ Load Carrier

BUICK

BUICK

LACROSSE (cont)

05-09	All	G55948	M55948	142524 ⁶⁷ 142525 ⁵³ 142526 ⁵⁴ 143060 ⁵¹	143061 ⁵¹
	Exc. Models with 17" or 18" Wheels	G55948	M55948	142524 ⁶⁷ 142525 ⁵³ 142526 ⁵⁴ 143060 ⁵¹	G55949	M55949	143061 ⁵¹
	Left	G55948	M55948	142524 ⁶⁷ 142525 ⁵³ 142526 ⁵⁴ 143060 ⁵¹	143073 ⁵³ 143061 ⁵¹
	Models with 17" or 18" Wheels	G55948	M55948	142524 ⁶⁷ 142525 ⁵³ 142526 ⁵⁴ 143060 ⁵¹	G52244	143061 ⁵¹
	Right	G55948	M55948	142524 ⁶⁷ 142525 ⁵³ 142526 ⁵⁴ 143060 ⁵¹	143074 ⁵³ 143061 ⁵¹

LACROSSE READYMOUNTS

		Front		Rear	
		Ultra Readymount	Guardian Readymount	Ultra Readymount	Guardian Readymount
05-09	All	G57060 ⁴⁰	M57060 ⁴⁰
	Left Exc. Models with 17" or 18" Wheels	G57060 ⁴⁰	M57060 ⁴⁰	G56924 ⁴⁰	M56924 ⁴⁰
	Right Exc. Models with 17" or 18" Wheels	G57060 ⁴⁰	M57060 ⁴⁰	G56925 ⁴⁰	M56925 ⁴⁰

LESABRE

00-05	All	G56509	M56509	142524 ⁶⁷ 142640 ⁵⁴	142647 ⁵³	
	All w/o OE Style air fitting	G56509	M56509	142524 ⁶⁷ 142640 ⁵⁴	142647 ⁵³	49228 ³⁰	
	With OE Style air fitting	G56509	M56509	142524 ⁶⁷ 142640 ⁵⁴	142647 ⁵³	49255 ⁷	
97-99	All	G56718 ⁹	M56718 ⁹	142524 ⁶⁷ 142751 ⁶⁷ 143060 ⁵¹	142132 ⁵³ 143060 ⁵¹	
	Air(RearSpringType) Optional O.E. Hydraulic Self Leveling System	G56718 ⁹	M56718 ⁹	142524 ⁶⁷ 142751 ⁶⁷ 143060 ⁵¹	G56903	M56903	142132 ⁵³ 143060 ⁵¹
	Coil(RearSpringType)	G56718 ⁹	M56718 ⁹	142524 ⁶⁷ 142751 ⁶⁷ 143060 ⁵¹	G56707 ⁹	M56707 ⁹	142132 ⁵³ 143060 ⁵¹
91-96	All	G56718 ⁹	M56718 ⁹	142226 ⁵⁴ 142751 ⁶⁷ 143060 ⁵¹	142132 ⁵³ 143060 ⁵¹	
	Air(RearSpringType) Optional O.E. Hydraulic Self Leveling System	G56718 ⁹	M56718 ⁹	142226 ⁵⁴ 142751 ⁶⁷ 143060 ⁵¹	G56903	M56903	142132 ⁵³ 143060 ⁵¹
	Coil(RearSpringType)	G56718 ⁹	M56718 ⁹	142226 ⁵⁴ 142751 ⁶⁷ 143060 ⁵¹	G56707 ⁹	M56707 ⁹	142132 ⁵³ 143060 ⁵¹
90	All	142226 ⁵⁴ 142227 ⁶⁷ 142752 ⁶⁷	142132 ⁵³ 143060 ⁵¹	
	Early Design Front Strut with Spring Guard	G56701	143061 ⁵¹ 142226 ⁵⁴ 142227 ⁶⁷ 142752 ⁶⁷	142132 ⁵³ 143060 ⁵¹	
	Late Design Front Strut without Spring Guard	G56718 ⁹	M56718 ⁹	143060 ⁵¹ 142226 ⁵⁴ 142227 ⁶⁷ 142752 ⁶⁷	142132 ⁵³ 143060 ⁵¹	
	Air(RearSpringType) Optional O.E. Hydraulic Self Leveling System	142226 ⁵⁴ 142227 ⁶⁷ 142752 ⁶⁷	G56903	M56903	142132 ⁵³ 143060 ⁵¹
	Coil(RearSpringType)	142226 ⁵⁴ 142227 ⁶⁷ 142752 ⁶⁷	G56707 ⁹	M56707 ⁹	142132 ⁵³ 143060 ⁵¹

7 Pair Packs, air hose kit included.

30 For GM Vehicles equipped with factory installed leveling systems, see Ref A.

51 Strut Cushion for use with the Strut/Cartridge/Shocks.

54 Kit with Mount and Bearing. Hardware from O.E. Part may need to be reused.



9 See Ref. D for procedures to replace Elec Adj Susp with non-adj product.

40 Complete Assembled Unit.

53 Strut Mount. Hardware from O.E. Part may need to be reused.

67 Strut Mount Kit. Hardware from O.E. Part may need to be reused.

APPLICATION GUIDE

Year	Fitment Notes										
		Ultra	ProGuard\Guardian\Classic	Max Control\LTV	Strut Cushion\Strut Mount	HiJackers\Load Carrier	Ultra	ProGuard\Guardian\Classic	Max Control\LTV	Strut Cushion\Strut Mount	HiJackers\Load Carrier

BUICK

BUICK

LESABRE (cont)

88-89	All	G56701	142227 ⁵⁷ 142752 ⁵⁷ 143061 ⁵¹	34073 ⁸	142132 ⁵³ 143060 ⁵¹
	Air(RearSpringType) Optional O.E. Hydraulic Self Leveling System	G56701	142227 ⁵⁷ 142752 ⁵⁷ 143061 ⁵¹	34073 ⁸	G56903	M56903	142132 ⁵³ 143060 ⁵¹
	Coil(RearSpringType)	G56701	142227 ⁵⁷ 142752 ⁵⁷ 143061 ⁵¹	34073 ⁸	G56707 ⁹	M56707⁹	142132 ⁵³ 143060 ⁵¹
86-87	All	G56701	142227 ⁵⁷ 142752 ⁵⁷ 143061 ⁵¹	142132 ⁵³ 143060 ⁵¹
	Air(RearSpringType) Optional O.E. Hydraulic Self Leveling System	G56701	142227 ⁵⁷ 142752 ⁵⁷ 143061 ⁵¹	G56903	M56903	142132 ⁵³ 143060 ⁵¹
	Coil(RearSpringType)	G56701	142227 ⁵⁷ 142752 ⁵⁷ 143061 ⁵¹	G56707 ⁹	M56707⁹	142132 ⁵³ 143060 ⁵¹
71-85	All	69675 ⁵	81446	34073 ⁸	69724	81514	43049 ⁹ 49131 ³⁰
65-70	All	82601	82602
61-64	All	82087	82609
60	All	82155
59	Exc. Air Suspension	82155

LESABRE READYMOUNTS

		Front		Rear	
		Ultra Readymount	Guardian Readymount	Ultra Readymount	Guardian Readymount
00-05	Exc. Electronic Adjustable Suspension	G57051 ⁴⁰	M57051⁴⁰
91-99	All	G56909 ⁴¹	M56909⁴¹
	Air(RearSpringType)	G56909 ⁴¹	M56909⁴¹	M56906⁴⁰
	Air(RearSpringType) Optional O.E. Hydraulic Self Leveling System	G56909 ⁴¹	M56909⁴¹	G56906 ⁴³
	Coil(RearSpringType)	G56909 ⁴¹	M56909⁴¹	G56726 ⁴³
90	All	M56914⁴⁰
	Early Design Front Strut with Spring Guard	G56914 ⁴⁰	M56914⁴⁰
	Late Design Front Strut without Spring Guard	G56909 ⁴¹	M56909⁴⁰ M56914⁴⁰
	Air(RearSpringType)	M56914⁴⁰	M56906⁴⁰
	Air(RearSpringType) Optional O.E. Hydraulic Self Leveling System	M56914⁴⁰	G56906 ⁴³
	Coil(RearSpringType)	M56914⁴⁰	G56726 ⁴³
86-89	All	G56914 ⁴⁰	M56914⁴⁰
	Air(RearSpringType)	G56914 ⁴⁰	M56914⁴⁰	M56906⁴⁰
	Air(RearSpringType) Optional O.E. Hydraulic Self Leveling System	G56914 ⁴⁰	M56914⁴⁰	G56906 ⁴³
	Coil(RearSpringType)	G56914 ⁴⁰	M56914⁴⁰	G56726 ⁴³

LIMITED

58	All	81270	82156
----	-----	------	-------	------	------	------	------	-------	------	------	------

LUCERNE

06-11	All	142647
	Exc. Magnetic Ride Control Suspension	G52116	142647

5 Use kit No. 140719 to replace O.E. hardware for lower shock absorber mounting when studs break or self-tapping screws are not longer useable.

9 See Ref. D for procedures to replace Elec Adj Susp with non-adj product.

40 Complete Assembled Unit.

43 Does not include springs due to vehicle design. See Ref. D for procedures to replace Elec Adj Susp with non-adj product.

53 Strut Mount. Hardware from O.E. Part may need to be reused.

8 Pair Packs.

30 For GM Vehicles equipped with factory installed leveling systems, see Ref A.

41 Complete Assembled Unit. See Ref. D for procedures to replace Elec Adj Susp with non-adj product.

51 Strut Cushion for use with the Strut/Cartridge/Shocks.

67 Strut Mount Kit. Hardware from O.E. Part may need to be reused.

Bold Type - New / Future Part

APPLICATION GUIDE

Year	Fitment Notes	Front					Rear				
		Ultra	ProGuard/ Guardian/ Classic	Max Control/ LTV	Strut Cushion/ Strut Mount	HiJackers/ Load Carrier	Ultra	ProGuard/ Guardian/ Classic	Max Control/ LTV	Strut Cushion/ Strut Mount	HiJackers/ Load Carrier

BUICK

BUICK

LUCERNE (cont)

06-11	Exc. Magnetic Ride Control System	142647	49228 ³⁰
-------	-----------------------------------	------	------	------	------	------	------	------	------	--------	---------------------

LUCERNE READYMOUNTS

		Front		Rear	
		Ultra Readymount	Guardian Readymount	Ultra Readymount	Guardian Readymount
06-11	All	G57324 ⁴⁰

PARK AVENUE

98-05	All	G56508	142524 ⁶⁷ 142640 ⁵⁴ 143057 ⁵¹	142647 ⁵³
	All w/o OE Style air fitting	G56508	142524 ⁶⁷ 142640 ⁵⁴ 143057 ⁵¹	142647 ⁵³	49228 ³⁰
	With OE Style air fitting	G56508	142524 ⁶⁷ 142640 ⁵⁴ 143057 ⁵¹	142647 ⁵³	49255 ⁷
97	All	G55878	142524 ⁶⁷ 143057 ⁵¹	142647 ⁵³
	All w/o OE Style air fitting	G55878	142524 ⁶⁷ 143057 ⁵¹	142647 ⁵³	49228 ³⁰
	With OE Style air fitting	G55878	142524 ⁶⁷ 143057 ⁵¹	142647 ⁵³	49255 ⁷
91-96	All	G56718 ⁹	M56718 ⁹	142226 ⁵⁴ 142227 ⁶⁷ 142751 ⁶⁷ 143060 ⁵¹	142132 ⁵³ 143060 ⁵¹
	Air(RearSpringType) Conventional Replacement for Air Assist Susp; Exc. Elec. Adj. Susp.	G56718 ⁹	M56718 ⁹	142226 ⁵⁴ 142227 ⁶⁷ 142751 ⁶⁷ 143060 ⁵¹	G56707 ⁹	M56707 ⁹	142132 ⁵³ 143060 ⁵¹
	Air(RearSpringType) Exc. Electronic Adjustable Suspension	G56718 ⁹	M56718 ⁹	142226 ⁵⁴ 142227 ⁶⁷ 142751 ⁶⁷ 143060 ⁵¹	G56903 ⁹	M56903 ⁹	142132 ⁵³ 143060 ⁵¹

PARK AVENUE READYMOUNTS

		Front		Rear	
		Ultra Readymount	Guardian Readymount	Ultra Readymount	Guardian Readymount
98-05	All	G56929 ⁴⁰	M56929 ⁴⁰
91-96	All	M56906 ⁴⁰
	CCR Computer Command Ride	G56909 ⁴¹	M56909 ⁴¹	M56906 ⁴⁰
	Air(RearSpringType)	G56906 ⁴³	M56906 ⁴⁰
	Air(RearSpringType) Conventional Replacement for Air Assist Susp; Exc. Elec. Adj. Susp.	G56726 ⁴²	M56906 ⁴⁰

RAINIER

04-07	All	G51718 ⁴⁵	M51718 ⁴⁵	143241 ⁵³	61717
	Coil(FrontSpringType)	G51718 ⁴⁵	M51718 ⁴⁵	143241 ⁵³	G63842	61717

RAINIER READYMOUNTS

		Front		Rear	
		Ultra Readymount	Guardian Readymount	Ultra Readymount	Guardian Readymount
04-07	All	G57022 ⁴⁰	M57022 ⁴⁰

REATA

90-91	All	G56717 ⁹	142297 ⁵⁴	142405 ⁵³
-------	-----	---------------------	------	------	----------------------	------	------	------	----------------------	------

7 Pair Packs, air hose kit included.

30 For GM Vehicles equipped with factory installed leveling systems, see Ref A.

41 Complete Assembled Unit. See Ref. D for procedures to replace Elec Adj Susp with non-adj product.

43 Does not include springs due to vehicle design. See Ref. D for procedures to replace Elec Adj Susp with non-adj product.

51 Strut Cushion for use with the Strut/Cartridge/Shocks.

54 Kit with Mount and Bearing. Hardware from O.E. Part may need to be reused.

9 See Ref. D for procedures to replace Elec Adj Susp with non-adj product.

40 Complete Assembled Unit.



42 Does not include springs due to vehicle design.

45 Strut must be rotated to align notch with lower control arm.

53 Strut Mount. Hardware from O.E. Part may need to be reused.

67 Strut Mount Kit. Hardware from O.E. Part may need to be reused.

APPLICATION GUIDE

Year	Fitment Notes										
		Ultra	ProGuard\ Guardian\ Classic	Max Control\ LTV	Strut Cushion\ Strut Mount	HiJackers\ Load Carrier	Ultra	ProGuard\ Guardian\ Classic	Max Control\ LTV	Strut Cushion\ Strut Mount	HiJackers\ Load Carrier

BUICK

BUICK

REATA (cont)

88-89	All	G56717 ⁹	142298 ⁵⁴	142405 ⁵³
-------	-----	---------------------	------	------	----------------------	------	------	------	----------------------	------

REGAL

13	Left Exc. Active Suspension	G52435
	Right Exc. Active Suspension	G52436
11-12	Left Exc. Active Suspension	G52435	G51982
	Right Exc. Active Suspension	G52436	G51982
97-04	All	G55948	M55948	142524 ⁶⁷ 142525 ⁵³ 142526 ⁵⁴ 143060 ⁵¹	G55949	M55949	143061 ⁵¹
	Left	G55948	M55948	142524 ⁶⁷ 142525 ⁵³ 142526 ⁵⁴ 143060 ⁵¹	G55949	M55949	143073 ⁵³ 143061 ⁵¹
	Right	G55948	M55948	142524 ⁶⁷ 142525 ⁵³ 142526 ⁵⁴ 143060 ⁵¹	G55949	M55949	143074 ⁵³ 143061 ⁵¹
88-96	All	G44459 ³⁶	142143 ⁵³ 143060 ⁵¹	G56708	M56708	143062 ⁵¹
78-87	All	69600	81494	34051 ⁸	69604	81492	43060 ⁸ 49334 ³⁰
73-77	All	69600	81494	34051 ⁸	69604	81492	43060 ⁸ 49152 ³⁰

REGAL READYMOUNTS

		Front		Rear	
		Ultra Readymount	Guardian Readymount	Ultra Readymount	Guardian Readymount
97-04	Left	G57060 ⁴⁰	M57060 ⁴⁰	G56924 ⁴⁰	M56924 ⁴⁰
	Right	G57060 ⁴⁰	M57060 ⁴⁰	G56925 ⁴⁰	M56925 ⁴⁰
88-96	All	G56727 ⁴²	M56727 ⁴²

RENDEZVOUS

02-07	Exc. Hydraulic Self Leveling System	G55834	143091 ⁵³	G63868	61777
-------	-------------------------------------	--------	------	------	----------------------	------	--------	-------	------	------

RENDEZVOUS READYMOUNTS

		Front		Rear	
		Ultra Readymount	Guardian Readymount	Ultra Readymount	Guardian Readymount
02-07	All	G57274 ⁴⁰	

RIVIERA

98-99	All	G56508	142524 ⁶⁷ 142640 ⁵⁴ 143057 ⁵¹	142647 ⁵³	49228 ³⁰
	With OE Style air fitting	G56508	142524 ⁶⁷ 142640 ⁵⁴ 143057 ⁵¹	142647 ⁵³	49255 ⁷ 49228 ³⁰
97	All	G55878	142751 ⁶⁷ 143057 ⁵¹	142647 ⁵³
	All w/o OE Style air fitting	G55878	142751 ⁶⁷ 143057 ⁵¹	142647 ⁵³	49228 ³⁰
	With OE Style air fitting	G55878	142751 ⁶⁷ 143057 ⁵¹	142647 ⁵³	49255 ⁷
95-96	All	G56718 ⁹	M56718 ⁸	142751 ⁶⁷ 143060 ⁵¹	142647 ⁵³

7 Pair Packs, air hose kit included.

9 See Ref. D for procedures to replace Elec Adj Susp with non-adj product.

36 Requires special strut installation tool.

42 Does not include springs due to vehicle design.

53 Strut Mount. Hardware from O.E. Part may need to be reused.

67 Strut Mount Kit. Hardware from O.E. Part may need to be reused.

Bold Type - New / Future Part

8 Pair Packs.



30 For GM Vehicles equipped with factory installed leveling systems, see Ref A.

40 Complete Assembled Unit.

51 Strut Cushion for use with the Strut/Cartridge/Shocks.

54 Kit with Mount and Bearing. Hardware from O.E. Part may need to be reused.

















APPLICATION GUIDE

Year	Fitment Notes										
		Ultra	ProGuard\Guardian\Classic	Max Control\LTV	Strut Cushion\Strut Mount	HiJackers\Load Carrier	Ultra	ProGuard\Guardian\Classic	Max Control\LTV	Strut Cushion\Strut Mount	HiJackers\Load Carrier

BUICK

BUICK

RIVIERA (cont)

95-96	All w/o OE Style air fitting		G56718 ⁹	M56718⁹	142751 ⁶⁷ 143060 ⁵¹		142647 ⁵³	49228 ³⁰
	With OE Style air fitting		G56718 ⁹	M56718⁹	142751 ⁶⁷ 143060 ⁵¹		142647 ⁵³	49255⁷
90-93	All		G56717 ⁹	142297 ⁵⁴		G56704 ⁹	142405 ⁵³
86-89	All		G56703	142298 ⁵⁴ 143061 ⁵¹		G56704 ⁹	142405 ⁵³
79-85	All		69706	81445		49345 ³⁰
71-78	All		69675 ⁵	81446	34073 ⁸		69724	81514	43049 ⁸ 49131 ³⁰
66-70	All		82601		82618
63-65	All		82087		82609

















RIVIERA READYMOUNTS

		Front		Rear	
		Ultra Readymount	Guardian Readymount	Ultra Readymount	Guardian Readymount
98-99	All	G56929 ⁴⁰	M56929⁴⁰

















RIVIERA STEERING STABILIZERS

		Front	Rear
79-85	All	14020

ROADMASTER

92-96	All		69675 ⁵	81446	34073 ⁸	
	Sedan		69675 ⁵	81446	34073 ⁸		69724	81514	43049 ⁸ 49131 ³⁰
	Wagon		69675 ⁵	81446	34073 ⁸		69604	81492	43060 ⁸ 49152 ³⁰
91	All		34073 ⁸	
	Wagon		69675 ⁵	81446	34073 ⁸		69604	81492	43060 ⁸ 49152 ³⁰
58	Exc. Air Suspension		81270		82156
57	Exc. Air Suspension			82156
56	Exc. Air Suspension		82087		81147

SKYHAWK

87-89	Left		G56706	142762 ⁶⁷ 143060 ⁵¹		69749	81530	141974 ⁶⁷	49371 ⁷
	Right		G56705	142762 ⁶⁷ 143060 ⁵¹		69749	81530	141974 ⁶⁷	49371 ⁷
84-86	All		142762 ⁶⁷ 143060 ⁵¹		69749	81530	141974 ⁶⁷	49371 ⁷
	Left Non-Rebuildable O.E. Struts		G56706	142762 ⁶⁷ 143060 ⁵¹		69749	81530	141974 ⁶⁷	49371 ⁷
	Rebuildable O.E. Struts		G44451 ⁹⁸	142762 ⁶⁷ 143060 ⁵¹		69749	81530	141974 ⁶⁷	49371 ⁷
	Right Non-Rebuildable O.E. Struts		G56705	142762 ⁶⁷ 143060 ⁵¹		69749	81530	141974 ⁶⁷	49371 ⁷
82-83	All		142762 ⁶⁷		69749	81530	141974 ⁶⁷	49371 ⁷
75-80	All		82129		81438

5 Use kit No. 140719 to replace O.E. hardware for lower shock absorber mounting when studs break or self-tapping screws are not longer useable.

8 Pair Packs.

30 For GM Vehicles equipped with factory installed leveling systems, see Ref A.

51 Strut Cushion for use with the Strut/Cartridge/Shocks.

54 Kit with Mount and Bearing. Hardware from O.E. Part may need to be reused.

98 Notice: The level of difficulty to install this product is moderately high. Please review the installation instructions carefully before proceeding.

7 Pair Packs, air hose kit included.

9 See Ref. D for procedures to replace Elec Adj Susp with non-adj product.

40 Complete Assembled Unit.

53 Strut Mount. Hardware from O.E. Part may need to be reused.

67 Strut Mount Kit. Hardware from O.E. Part may need to be reused.

APPLICATION GUIDE

Year	Fitment Notes	Front					Rear				
		Ultra	ProGuard\ Guardian\ Classic	Max Control\ LTV	Strut Cushion\ Strut Mount	HiJackers\ Load Carrier	Ultra	ProGuard\ Guardian\ Classic	Max Control\ LTV	Strut Cushion\ Strut Mount	HiJackers\ Load Carrier

BUICK

BUICK

SKYHAWK READYMOUNTS		Front		Rear	
		Ultra Readymount	Guardian Readymount	Ultra Readymount	Guardian Readymount
83-89	Left	G57327 ⁴⁰
	Right	G57328 ⁴⁰

SKYLARK

95-98	Left	G56720 ⁹	M56720 ⁹	142227 ⁵⁷ 143059 ⁵¹	69407 ⁹	81790	141974 ⁶⁷	49614 ⁷
	Right	G56719	M56719	142227 ⁵⁷ 143059 ⁵¹	69407 ⁹	81790	141974 ⁶⁷	49614 ⁷
92-94	All	143059 ⁵¹	69749	81530	141974 ⁶⁷	49371 ⁷
	Exc. FE3 and Electronic Ride Control	142227 ⁵⁷ 143059 ⁵¹	69749	81530	141974 ⁶⁷	49371 ⁷
	Left Exc. FE3 and Electronic Ride Control	G56720 ⁹	M56720 ⁹	143059 ⁵¹	69749	81530	141974 ⁶⁷	49371 ⁷
	Left FE3 Suspension	G56723	143059 ⁵¹	69749	81530	141974 ⁶⁷	49371 ⁷
	Right Exc. FE3 and Electronic Ride Control	G56719 ⁹	M56719 ⁹	143059 ⁵¹	69749	81530	141974 ⁶⁷	49371 ⁷
	Right FE3 Suspension	G56724	143059 ⁵¹	69749	81530	141974 ⁶⁷	49371 ⁷
86-91	All	142762 ⁵⁷ 143060 ⁵¹	69749	81530	141974 ⁶⁷	49371 ⁷
	Left Non-Rebuildable O.E. Struts	G56706	142762 ⁵⁷ 143060 ⁵¹	69749	81530	141974 ⁶⁷	49371 ⁷
	Rebuildable O.E. Struts	G44451 ⁹⁸	142762 ⁵⁷ 143060 ⁵¹	69749	81530	141974 ⁶⁷	49371 ⁷
	Right Non-Rebuildable O.E. Struts	G56705	142762 ⁵⁷ 143060 ⁵¹	69749	81530	141974 ⁶⁷	49371 ⁷
85	All	G55514	M55514	142223 ⁵³ 142749 ⁵⁷ 143060 ⁵¹	69723	81517	141974 ⁶⁷	49370 ³⁰
84	All	142223 ⁵³ 143060 ⁵¹	69723	81517	141974 ⁶⁷	49370 ³⁰
	Exc. HD Suspension	G55505	142223 ⁵³ 143060 ⁵¹	69723	81517	141974 ⁶⁷	49370 ³⁰
	HD Suspension	G55514	M55514	142223 ⁵³ 143060 ⁵¹	69723	81517	141974 ⁶⁷	49370 ³⁰
80-83	All	G55505	142223 ⁵³ 143060 ⁵¹	69723	81517	49370 ³⁰
75-79	All	69600	81494	34051 ⁸	69600	81492	49193 ⁷
69-72	All	69600	81494	34051 ⁸	69604	81492	43060 ⁸ 49152 ³⁰
68	All	69600	81494	69604	81492	43060 ⁸ 49152 ³⁰
	HD Suspension; Exc. Sportwagon	69600	81494	34051 ⁸	69604	81492	43060 ⁸ 49152 ³⁰
64-67	Exc. HD Suspension	69724	81514	43049 ⁸ 49131 ³⁰
	HD Suspension; Exc. Sportwagon	82138	69604	81492	43060 ⁸ 49152 ³⁰
61-63	All	81495

7 Pair Packs, air hose kit included.

9 See Ref. D for procedures to replace Elec Adj Susp with non-adj product.

40 Complete Assembled Unit.

53 Strut Mount. Hardware from O.E. Part may need to be reused.

98 Notice: The level of difficulty to install this product is moderately high. Please review the installation instructions carefully before proceeding.

Bold Type - New / Future Part



8 Pair Packs.

30 For GM Vehicles equipped with factory installed leveling systems, see Ref. A.

51 Strut Cushion for use with the Strut/Cartridge/Shocks.

67 Strut Mount Kit. Hardware from O.E. Part may need to be reused.

APPLICATION GUIDE

Year	Fitment Notes										
		Ultra	ProGuard\ Guardian\ Classic	Max Control\ LTV	Strut Cushion\ Strut Mount	HiJackers\ Load Carrier	Ultra	ProGuard\ Guardian\ Classic	Max Control\ LTV	Strut Cushion\ Strut Mount	HiJackers\ Load Carrier

BUICK

BUICK

SKYLARK READYMOUNTS		Front		Rear	
		Ultra Readymount	Guardian Readymount	Ultra Readymount	Guardian Readymount
97-98	Left	G56917 ⁴⁰	M56917 ⁴⁰
	Right	G56916 ⁴⁰	M56916 ⁴⁰
95-96	Left	G56917 ⁴⁰	M56917 ⁴⁰ M56908 ⁴⁰
	Right	G56916 ⁴⁰	M56916 ⁴⁰ M56908 ⁴⁰
92-96	All	M56908 ⁴⁰
92-94	Left	M56919 ⁴⁰ M56908 ⁴⁰
	Right	M56918 ⁴⁰ M56908 ⁴⁰
86-91	Left	G57327 ⁴⁰	M56908 ⁴⁰
	Right	G57328 ⁴⁰	M56908 ⁴⁰
85	All	G56908 ⁴⁰	M56908 ⁴⁰
84	All	M56908 ⁴⁰
	HD Suspension	G56908 ⁴⁰	M56908 ⁴⁰

SOMERSET / SOMERSET REGAL

85-87	All	↓	14276 ⁶⁷ 143060 ⁵¹	↓	69749	81530	141974 ⁶⁷	49371 ⁷
	Left Non-Rebuildable O.E. Struts	↓	G56706	14276 ⁶⁷ 143060 ⁵¹	↓	69749	81530	141974 ⁶⁷	49371 ⁷
	Rebuildable O.E. Struts	↓	G44451 ⁹⁸	14276 ⁶⁷ 143060 ⁵¹	↓	69749	81530	141974 ⁶⁷	49371 ⁷
	Right Non-Rebuildable O.E. Struts	↓	G56705	14276 ⁶⁷ 143060 ⁵¹	↓	69749	81530	141974 ⁶⁷	49371 ⁷

SOMERSET / SOMERSET REGAL READYMOUNTS

SOMERSET / SOMERSET REGAL READYMOUNTS		Front		Rear	
		Ultra Readymount	Guardian Readymount	Ultra Readymount	Guardian Readymount
85	Left	G57327 ⁴⁰
	Right	G57328 ⁴⁰

SPECIAL

68-69	All	⊕	69600	81494	34051 ⁸	⊕	69604	81492	43060 ⁸ 49152 ³⁰
64-67	Exc. HD Suspension	⊕	⊕	69724	81514	43049 ⁸ 49131 ³⁰
	HD Suspension; Exc. Sportwagon	⊕	82138	⊕	69604	81492	43060 ⁸ 49152 ³⁰
61-63	All	⊕	⊕	81495
58	Exc. Air Suspension	⊕	81270	⊕	82156
57	Exc. Air Suspension	⊕	⊕	82156
56	All	⊕	82087	⊕	81147

SPORTWAGON

70-72	All	⊕	69600	81494	34051 ⁸	⊕	69604	81492	43060 ⁸ 49152 ³⁰
68-69	All	⊕	69600	81494	34051 ⁸	⊕	69606	81495	49114 ⁷
64-67	All	⊕	82138	⊕	69606	81495	49114 ⁷

SUPER

58	Exc. Air Suspension	⊕	81270	⊕	82156
----	---------------------	---	------	-------	------	------	------	---	------	-------	------	------	------

7 Pair Packs, air hose kit included.

30 For GM Vehicles equipped with factory installed leveling systems, see Ref A.

51 Strut Cushion for use with the Strut/Cartridge/Shocks.

98 Notice: The level of difficulty to install this product is moderately high. Please review the installation instructions carefully before proceeding.

8 Pair Packs.

40 Complete Assembled Unit.

67 Strut Mount Kit. Hardware from O.E. Part may need to be reused.

APPLICATION GUIDE

Year	Fitment Notes	Front					Rear				
		Ultra	ProGuard/ Guardian/ Classic	Max Control/ LTV	Strut Cushion/ Strut Mount	HiJackers/ Load Carrier	Ultra	ProGuard/ Guardian/ Classic	Max Control/ LTV	Strut Cushion/ Strut Mount	HiJackers/ Load Carrier

BUICK

SUPER (cont)

BUICK

57	Exc. Air Suspension	82156
56	All	81147
	Exc. Air Suspension	82087	81147

TERRAZA

05-07	Exc. Air-Leveling Suspension	G52025
	FWD	142526 ⁵⁴
	FWD, Exc. Air-Leveling Suspension	G63776
	FWD, Exc. Air-Leveling Suspension & Independent Rear Suspension	49230 ⁷
05-06	AWD	G55948	M55948

TERRAZA READYMOUNTS

		Front		Rear	
		Ultra Readymount	Guardian Readymount	Ultra Readymount	Guardian Readymount
05-07	FWD	G57142 ⁴⁰	M57142 ⁴⁰

VERANO

12-16	Left	G52432
	Right	G52433

VERANO READYMOUNTS

		Front		Rear	
		Ultra Readymount	Guardian Readymount	Ultra Readymount	Guardian Readymount
12-15	Left	G57377 ⁴⁰
	Right	G57378 ⁴⁰

WILDCAT

65-70	All	82601	82602
63-64	All	82087	82609

CADILLAC

60 SPECIAL

CADILLAC

93	All	G56718 ⁹	M56718 ⁹	142226 ⁵⁴ 142227 ⁵⁷ 142751 ⁵⁷ 143060 ⁵¹	142132 ⁵³ 143060 ⁵¹
	Coil(RearSpringType) Conventional Type Replacement for Air Assist Rear Suspension	G56718 ⁹	M56718 ⁹	142226 ⁵⁴ 142227 ⁵⁷ 142751 ⁵⁷ 143060 ⁵¹	G56707 ⁹	M56707 ⁹	142132 ⁵³ 143060 ⁵¹

60 SPECIAL READYMOUNTS

		Front		Rear	
		Ultra Readymount	Guardian Readymount	Ultra Readymount	Guardian Readymount
93	All	G56909 ⁴⁰	M56909 ⁴¹	M56906 ⁴⁰
	Air Assist Rear Suspension; Exc. Electronic Adjustable Suspension	G56909 ⁴⁰	M56909 ⁴¹	G56906 ⁴²	M56906 ⁴⁰
	Coil(RearSpringType) Conventional Type Replacement for Air Assist Rear Suspension	G56909 ⁴⁰	M56909 ⁴¹	G56726 ⁴²	M56906 ⁴⁰

7 Pair Packs, air hose kit included.

40 Complete Assembled Unit.

42 Does not include springs due to vehicle design.

53 Strut Mount. Hardware from O.E. Part may need to be reused.

67 Strut Mount Kit. Hardware from O.E. Part may need to be reused.

Bold Type - New / Future Part



9 See Ref. D for procedures to replace Elec Adj Susp with non-adj product.

41 Complete Assembled Unit. See Ref. D for procedures to replace Elec Adj Susp with non-adj product.

51 Strut Cushion for use with the Strut/Cartridge/Shocks.

54 Kit with Mount and Bearing. Hardware from O.E. Part may need to be reused.

APPLICATION GUIDE

Year	Fitment Notes										
		Ultra	ProGuard\ Guardian\ Classic	Max Control\ LTV	Strut Cushion\ Strut Mount	HiJackers\ Load Carrier	Ultra	ProGuard\ Guardian\ Classic	Max Control\ LTV	Strut Cushion\ Strut Mount	HiJackers\ Load Carrier

CADILLAC

CADILLAC

ALLANTE

89-93	All	↓	142227 ⁶⁷	↓
89-92	Exc. Electronic Adjustable Suspension	↓	G56717	142297 ⁵⁴ 142227 ⁶⁷	↓	142405 ⁵³
87-88	All	↓	142227 ⁶⁷ 143061 ⁵¹	↓
	Exc. Electronic Adjustable Suspension	↓	G56703	142297 ⁵⁴ 142227 ⁶⁷ 143061 ⁵¹	↓	142405 ⁵³

ATS

13-16	AWD, Left	↓	G52622	↓
	AWD, Right	↓	G52623	↓

BROUGHAM

91-92	All	⊕	69675 ⁵	81446	142226 ⁵⁴ 143060 ⁵¹	34073 ⁸	⊕	69724	81514	43049 ⁸ 49131 ³⁰
87-90	All	⊕	69675 ⁵	81446	143061 ⁵¹	34073 ⁸	⊕	69724	81514	43049 ⁸ 49131 ³⁰

BROUGHAM STEERING STABILIZERS

		Front		Rear	
87-92	All	14019

CALAIS

71-76	All	⊕	82601	⊕	82602
69-70	All	⊕	82601	⊕	82610
65-68	All	⊕	82601	⊕	82060

CATERA

97-01	All	↓	G56769	↓
-------	-----	---	--------	------	------	------	------	---	------	------	------	------	------

CIMARRON

87-88	Left	↓	G56706	142762 ⁶⁷ 143060 ⁵¹	⊕	69749	81530	141974 ⁶⁷	49371 ⁷
	Right	↓	G56705	142762 ⁶⁷ 143060 ⁵¹	⊕	69749	81530	141974 ⁶⁷	49371 ⁷
84-86	All	↓	142762 ⁶⁷ 143060 ⁵¹	⊕	69749	81530	141974 ⁶⁷	49371 ⁷
	Left Non-Rebuildable O.E. Struts	↓	G56706	142762 ⁶⁷ 143060 ⁵¹	⊕	69749	81530	141974 ⁶⁷	49371 ⁷
	Rebuildable O.E. Struts	↓	G44451 ⁹⁸	142762 ⁶⁷ 143060 ⁵¹	⊕	69749	81530	141974 ⁶⁷	49371 ⁷
	Right Non-Rebuildable O.E. Struts	↓	G56705	142762 ⁶⁷ 143060 ⁵¹	⊕	69749	81530	141974 ⁶⁷	49371 ⁷
82-83	All	↓	142762 ⁶⁷ 143060 ⁵¹	⊕	69749	81530	49371 ⁷

CIMARRON READYMOUNTS

		Front		Rear	
		Ultra Readymount	Guardian Readymount	Ultra Readymount	Guardian Readymount
83-88	Left	G57327 ⁴⁰
	Right	G57328 ⁴⁰

5 Use kit No. 140719 to replace O.E. hardware for lower shock absorber mounting when studs break or self-tapping screws are not longer useable.

8 Pair Packs.

40 Complete Assembled Unit.

53 Strut Mount. Hardware from O.E. Part may need to be reused.

67 Strut Mount Kit. Hardware from O.E. Part may need to be reused.

7 Pair Packs, air hose kit included.



30 For GM Vehicles equipped with factory installed leveling systems, see Ref A.

51 Strut Cushion for use with the Strut/Cartridge/Shocks.

54 Kit with Mount and Bearing. Hardware from O.E. Part may need to be reused.

98 Notice: The level of difficulty to install this product is moderately high. Please review the installation instructions carefully before proceeding.























APPLICATION GUIDE

Year	Fitment Notes										
		Ultra	ProGuard/ Guardian/ Classic	Max Control/ LTV	Strut Cushion/ Strut Mount	HiJackers/ Load Carrier	Ultra	ProGuard/ Guardian/ Classic	Max Control/ LTV	Strut Cushion/ Strut Mount	HiJackers/ Load Carrier

CADILLAC

CADILLAC

COMMERCIAL CHASSIS

92-96	RWD		69675 ⁵	81446	34073 ⁸		69724	81514	43049 ⁹ 49131 ³⁰	
91-93	FWD		G56718 ⁸	M56718⁸	142226 ⁶⁴ 142227 ⁶⁷ 142751 ⁶⁷ 143060 ⁶¹		143060 ⁶¹	
	FWD; Air Assist Rear Suspension; Exc. Electronic Adjustable Suspension			G56903	M56903	142132 ⁵³	
	FWD; Conventional Type Replacement for Air Assist Rear Suspension; Exc. Electronic Suspension			G56707 ⁹	M56707⁹
85-90	All		G56701	142752 ⁶⁷ 143061 ⁶¹		
	Air Assist Rear Suspension Standard Equipment		G56701	142752 ⁶⁷ 143061 ⁶¹		142132 ⁵³	
	FWD		G56701	142227 ⁶⁷ 142752 ⁶⁷ 143061 ⁶¹		143060 ⁶¹	
	FWD; Air Assist Rear Suspension Standard Equipment		G56701	142752 ⁶⁷ 143061 ⁶¹		G56903	M56903
	FWD; Conventional Type Replacement for Air Assist Rear Suspension; Exc. Electronic Suspension		G56701	142752 ⁶⁷ 143061 ⁶¹		G56707 ⁹	M56707⁹
77-84	All		69675 ⁵	81446	34073 ⁸		69724	81514	43049 ⁹ 49131 ³⁰	
75-76	All		82601		82125	





COMMERCIAL CHASSIS READYMOUNTS

		Front		Rear	
		Ultra Readymount	Guardian Readymount	Ultra Readymount	Guardian Readymount
91-93	FWD	G56909 ⁴¹	M56909⁴¹
85-90	All	G56914 ⁴⁰	M56914⁴⁰









COMMERCIAL CHASSIS STEERING STABILIZERS

		Front	Rear
92-96	RWD	14019
77-84	All	14019

CTS

09-11	Exc. Magnetic Ride Control Suspension		G51901		
03-07	All		143092 ⁵³	
	Exc. Magnetic Ride Control Suspension		G51746	143092 ⁵³		70031

DEVILLE

00-05	Exc. Electronic Adjustable Suspension		G56509	M56509	142640 ⁶⁴		142647 ⁵³	49228 ³⁰
	With OE Style air fitting Exc. Electronic Adjustable Suspension			49255⁷
98-99	Coil(RearSpringType) Exc. Electronic Adjustable Suspension			G56664
97-99	Electronic Ride Control		142527 ⁶⁴	

5 Use kit No. 140719 to replace O.E. hardware for lower shock absorber mounting when studs break or self-tapping screws are not longer useable.

8 Pair Packs.

30 For GM Vehicles equipped with factory installed leveling systems, see Ref A.

41 Complete Assembled Unit. See Ref. D for procedures to replace Elec Adj Susp with non-adj product.

53 Strut Mount. Hardware from O.E. Part may need to be reused.

67 Strut Mount Kit. Hardware from O.E. Part may need to be reused.

Bold Type - New / Future Part

7 Pair Packs, air hose kit included.



9 See Ref. D for procedures to replace Elec Adj Susp with non-adj product.

40 Complete Assembled Unit.

51 Strut Cushion for use with the Strut/Cartridge/Shocks.

54 Kit with Mount and Bearing. Hardware from O.E. Part may need to be reused.

APPLICATION GUIDE

Year	Fitment Notes										
		Ultra	ProGuard\ Guardian\ Classic	Max Control\ LTV	Strut Cushion\ Strut Mount	HiJackers\ Load Carrier	Ultra	ProGuard\ Guardian\ Classic	Max Control\ LTV	Strut Cushion\ Strut Mount	HiJackers\ Load Carrier

CADILLAC

CADILLAC

DEVILLE (cont)

97-99	Exc. Electronic Adjustable Suspension	↑	142640 ⁵⁴	↑
94-97	Air(RearSpringType) Exc. Electronic Adjustable Suspension	↑	↑	G56664
94-95	Left Exc. Electronic Adjustable Suspension	↑	G56669	↑
	Right Exc. Electronic Adjustable Suspension	↑	G56670	↑
91-93	All	↑	142227 ⁶⁷ 142751 ⁶⁷ 143060 ⁵¹	↑	142132 ⁵³ 143060 ⁵¹
	Exc. Electronic Adjustable Suspension	↑	G56718 ⁹	M56718⁹	142226 ⁵⁴ 142227 ⁶⁷ 142751 ⁶⁷ 143060 ⁵¹	↑	142132 ⁵³ 143060 ⁵¹
	Air(RearSpringType) CCR Computer Command Ride	↑	142227 ⁶⁷ 142751 ⁶⁷ 143060 ⁵¹	↑	G56903	M56903	142132 ⁵³ 143060 ⁵¹
	Air(RearSpringType) Conventional Type Replacement for Air Assist Rear Suspension	↑	142227 ⁶⁷ 142751 ⁶⁷ 143060 ⁵¹	↑	G56707 ⁹	M56707⁹	142132 ⁵³ 143060 ⁵¹
85-90	All	↑	G56701	142227 ⁶⁷ 142752 ⁶⁷ 143061 ⁵¹	↑	142132 ⁵³ 143060 ⁵¹
	Air(RearSpringType) Air Assist Rear Suspension Standard Equipment	↑	G56701	142227 ⁶⁷ 142752 ⁶⁷ 143061 ⁵¹	↑	G56903	M56903	142132 ⁵³ 143060 ⁵¹
	Air(RearSpringType) Conventional Type Replacement for Air Assist Rear Suspension	↑	G56701	142227 ⁶⁷ 142752 ⁶⁷ 143061 ⁵¹	↑	G56707 ⁹	M56707⁹	142132 ⁵³ 143060 ⁵¹
77-84	All	⊕	69675 ⁵	81446	34073 ⁸	⊕	69724	81514	43049 ⁸ 49131 ³⁰
71-76	All	⊕	82601	⊕	82602
69-70	All	⊕	82601	⊕	82610
65-68	All	⊕	82601	⊕	82060
61-64	All	⊕	82109	⊕	82125
58-60	All	⊕	82099	⊕	82125
56	All	⊕	82099	⊕	82034
55	All	⊕	⊕	82034
54	All	⊕	⊕	82066
53	All	⊕	82026	⊕	82066

DEVILLE READYMOUNTS

		Front		Rear	
		Ultra Readymount	Guardian Readymount	Ultra Readymount	Guardian Readymount
00-05	Exc. Electronic Adjustable Suspension	G57051 ⁴⁰	M57051⁴⁰
91-93	All	M56906⁴⁰
	Exc. Electronic Adjustable Suspension	G56909 ⁴¹	M56909⁴¹	M56906⁴⁰
	Air(RearSpringType) CCR Computer Command Ride	G56906 ⁴³	M56906⁴⁰
	Air(RearSpringType) Conventional Type Replacement for Air Assist Rear Suspension	G56726 ⁴³	M56906⁴⁰
85-90	All	G56914 ⁴⁰	M56914⁴⁰	M56906⁴⁰
	Air(RearSpringType) Air Assist Rear Suspension Standard Equipment	G56914 ⁴⁰	M56914⁴⁰	G56906 ⁴³	M56906⁴⁰

5 Use kit No. 140719 to replace O.E. hardware for lower shock absorber mounting when studs break or self-tapping screws are not longer useable.

9 See Ref. D for procedures to replace Elec Adj Susp with non-adj product.

40 Complete Assembled Unit.

43 Does not include springs due to vehicle design. See Ref. D for procedures to replace Elec Adj Susp with non-adj product.

53 Strut Mount. Hardware from O.E. Part may need to be reused.

67 Strut Mount Kit. Hardware from O.E. Part may need to be reused.

8 Pair Packs.

30 For GM Vehicles equipped with factory installed leveling systems, see Ref A.

41 Complete Assembled Unit. See Ref. D for procedures to replace Elec Adj Susp with non-adj product.

51 Strut Cushion for use with the Strut/Cartridge/Shocks.

54 Kit with Mount and Bearing. Hardware from O.E. Part may need to be reused.

APPLICATION GUIDE

Year	Fitment Notes	Front					Rear				
		Ultra	ProGuard\Guardian\Classic	Max Control\LTV	Strut Cushion\Strut Mount	HiJackers\Load Carrier	Ultra	ProGuard\Guardian\Classic	Max Control\LTV	Strut Cushion\Strut Mount	HiJackers\Load Carrier

CADILLAC

CADILLAC

DEVILLE READYMOUNTS (cont)		Front		Rear	
		Ultra Readymount	Guardian Readymount	Ultra Readymount	Guardian Readymount
85-90	Air(RearSpringType) Conventional Type Replacement for Air Assist Rear Suspension	G56914 ⁴⁰	M56914 ⁴⁰	G56726 ⁴³	M56906 ⁴⁰

DTS

06-11	All	49228 ³⁰
	Exc. Magnetic Ride Control Suspension	G52116	49228 ³⁰

DTS READYMOUNTS		Front		Rear	
		Ultra Readymount	Guardian Readymount	Ultra Readymount	Guardian Readymount
06-11	All	G57324 ⁴⁰

ELDORADO

97-02	Electronic Ride Control	142527 ⁵⁴ 142227 ⁵⁷ 142297 ⁵⁴
	Exc. Electronic Ride Control	142227 ⁵⁷ 142297 ⁵⁴	49254 ⁹
	Left Exc. Electronic Adjustable Suspension	G56775	142227 ⁵⁷ 142297 ⁵⁴
	Right Exc. Electronic Adjustable Suspension	G56776	142227 ⁵⁷ 142297 ⁵⁴
94-02	All	142227 ⁵⁷ 142297 ⁵⁴
91-93	All	G56717 ⁹	142227 ⁵⁷ 142297 ⁵⁴	G56704 ⁹	142405 ⁵³
90	All	G56717 ⁹	142297 ⁵⁴	G56704 ⁹	142405 ⁵³
87-89	All	G56703	142297 ⁵⁴ 143061 ⁵¹	G56704 ⁹	142405 ⁵³
86	All	G56703	142298 ⁵⁴ 143061 ⁵¹	G56704 ⁹	142405 ⁵³
79-85	All	69706	81445	49345 ³⁰
71-78	All	82010
68-70	Vertically Mounted	82010	82040	49122 ⁷
67	Vertically Mounted	82010	82034

ELDORADO STEERING STABILIZERS

		Front	Rear
79-85	All	14020
67-78	All	14010

ESCALADE

07-13	All	G63866	58930 77953
	Exc. Electronic Ride Control	143316 ⁵³	G63866	61675	58930 77953
02-06	All	58803 77803	G63866	58930 77953
	Exc. Electronic Ride Control	58803 77803	G63866	61675	58930 77953
99-00	All	G63609	61542 81726	58609 77609	G63638	61565 81789	58638 77638	43180 ⁹ 49231 ⁷

7 Pair Packs, air hose kit included.

9 See Ref. D for procedures to replace Elec Adj Susp with non-adj product.

40 Complete Assembled Unit.

51 Strut Cushion for use with the Strut/Cartridge/Shocks.

54 Kit with Mount and Bearing. Hardware from O.E. Part may need to be reused.

8 Pair Packs.



30 For GM Vehicles equipped with factory installed leveling systems, see Ref A.

43 Does not include springs due to vehicle design. See Ref. D for procedures to replace Elec Adj Susp with non-adj product.

53 Strut Mount. Hardware from O.E. Part may need to be reused.

67 Strut Mount Kit. Hardware from O.E. Part may need to be reused.

APPLICATION GUIDE

Year	Fitment Notes										
		Ultra	ProGuard/ Guardian/ Classic	Max Control/ LTV	Strut Cushion/ Strut Mount	HiJackers/ Load Carrier	Ultra	ProGuard/ Guardian/ Classic	Max Control/ LTV	Strut Cushion/ Strut Mount	HiJackers/ Load Carrier

CADILLAC

CADILLAC

ESCALADE ESV

11-13	Exc. Electronic Ride Control	⌋	143316 ⁵³
07-10	Exc. Electronic Ride Control	⌋	143316 ⁵³	⊗	61675
03-06	Exc. Electronic Ride Control	⌋	⊗	61675

ESCALADE EXT

11-13	Exc. Electronic Ride Control	⌋	143316 ⁵³
07-10	Exc. Electronic Ride Control	⌋	143316 ⁵³	⊗	61675
05-06	Exc. Electronic Ride Control	⌋	⊗	61675
02-04	All	⌋	58803 77803	⊗
	Exc. Electronic Ride Control	⌋	58803 77803	⊗	61675

FLEETWOOD

94-96	All	⊗	34073 ⁸	⊗
	RWD	⊗	69675 ⁵	81446	34073 ⁸	⊗	69724	81514	43049 ⁸ 49131 ³⁰
93	All	⌋	G56718 ⁹	M56718⁹	142226 ⁵⁴ 142227 ⁶⁷ 142751 ⁶⁷ 143060 ⁵¹	34073 ⁸	⌋	143060 ⁵¹
	Air Assist Rear Suspension; Exc. Electronic Adjustable Suspension	⌋	G56718 ⁹	M56718⁹	142226 ⁵⁴ 142227 ⁶⁷ 142751 ⁶⁷ 143060 ⁵¹	34073 ⁸	⌋	G56903	M56903	142132 ⁵³ 143060 ⁵¹
	Conventional Type Replacement for Air Assist Rear Suspension	⌋	G56718 ⁹	M56718⁹	142226 ⁵⁴ 142227 ⁶⁷ 142751 ⁶⁷ 143060 ⁵¹	34073 ⁸	⌋	G56707 ⁹	M56707⁹	143060 ⁵¹
	RWD	⊗	69675 ⁵	81446 M56718⁹	142226 ⁵⁴ 142227 ⁶⁷ 142751 ⁶⁷ 143060 ⁵¹	34073 ⁸	⊗	69724	81514	143060 ⁵¹	43049 ⁸ 49131 ³⁰
91-92	All	⌋	G56718 ⁹	M56718⁹	142226 ⁵⁴ 142227 ⁶⁷ 142751 ⁶⁷ 143060 ⁵¹	⌋	143060 ⁵¹
	Air Assist Rear Suspension; Exc. Electronic Adjustable Suspension	⌋	G56718 ⁹	M56718⁹	142226 ⁵⁴ 142227 ⁶⁷ 142751 ⁶⁷ 143060 ⁵¹	⌋	G56903	M56903	142132 ⁵³ 143060 ⁵¹
	Conventional Type Replacement for Air Assist Rear Suspension	⌋	G56718 ⁹	M56718⁹	142226 ⁵⁴ 142227 ⁶⁷ 142751 ⁶⁷ 143060 ⁵¹	⌋	G56707 ⁹	M56707⁹	143060 ⁵¹
87-90	All	⌋	G56701	142227 ⁶⁷ 142752 ⁶⁷ 143061 ⁵¹	⌋	143060 ⁵¹
	Air Assist Rear Suspension Standard Equipment	⌋	G56701	142227 ⁶⁷ 142752 ⁶⁷ 143061 ⁵¹	⌋	G56903	M56903	142132 ⁵³ 143060 ⁵¹
	Conventional Type Replacement for Air Assist Rear Suspension	⌋	G56701	142227 ⁶⁷ 142752 ⁶⁷ 143061 ⁵¹	⌋	G56707 ⁹	M56707⁹	143060 ⁵¹
85-86	All	⌋	G56701	142227 ⁶⁷ 143061 ⁵¹	⌋	143060 ⁵¹
	Air Assist Rear Suspension Standard Equipment	⌋	G56701	142227 ⁶⁷ 143061 ⁵¹	⌋	G56903	M56903	143060 ⁵¹
	Air Assist Rear Suspension; Exc. Electronic Adjustable Suspension	⌋	G56701	142227 ⁶⁷ 143061 ⁵¹	⌋	142132 ⁵³ 143060 ⁵¹

5 Use kit No. 140719 to replace O.E. hardware for lower shock absorber mounting when studs break or self-tapping screws are not longer useable.

9 See Ref. D for procedures to replace Elec Adj Susp with non-adj product.

51 Strut Cushion for use with the Strut/Cartridge/Shocks.

54 Kit with Mount and Bearing. Hardware from O.E. Part may need to be reused.

8 Pair Packs.

30 For GM Vehicles equipped with factory installed leveling systems, see Ref A.

53 Strut Mount. Hardware from O.E. Part may need to be reused.

67 Strut Mount Kit. Hardware from O.E. Part may need to be reused.

APPLICATION GUIDE

Year	Fitment Notes	Front					Rear				
		Ultra	ProGuard\Guardian\Classic	Max Control\LTV	Strut Cushion\Strut Mount	HiJackers\Load Carrier	Ultra	ProGuard\Guardian\Classic	Max Control\LTV	Strut Cushion\Strut Mount	HiJackers\Load Carrier

CADILLAC

CADILLAC

FLEETWOOD (cont)

85-86	Conventional Type Replacement for Air Assist Rear Suspension	↓	G56701	142227 ⁵⁷ 143061 ⁵¹	↓	G56707 ⁹	M56707⁹	143060 ⁵¹
	RWD	⊖	69675 ⁵	81446	142227 ⁵⁷ 143061 ⁵¹	34073 ⁸	⊖	69724	81514	143060 ⁵¹	43049 ⁸ 49131 ³⁰
77-84	All	⊖	34073 ⁸	⊖
	RWD	⊖	69675 ⁵	81446	34073 ⁸	⊖	69724	81514	43049 ⁸ 49131 ³⁰
71-76	All	⊖	82601	⊖	82602
69-70	All	⊖	82601	⊖	82610
65-68	All	⊖	82601	⊖	82060

FLEETWOOD / 60 SERIES / 70 SERIES

61-64	All	⊖	82109	⊖	82125
57-60	All	⊖	82099	⊖	82125
56	All	⊖	82099	⊖	82034
55	All	⊖	⊖	82034
54	All	⊖	⊖	82066
52-53	All	⊖	82026	⊖	82066
50-51	All	⊖	82026	⊖	82060

FLEETWOOD READYMOUNTS

		Front		Rear	
		Ultra Readymount	Guardian Readymount	Ultra Readymount	Guardian Readymount
91-93	All	G56909 ⁴¹	M56909⁴¹	M56906⁴⁰
	Air Assist Rear Suspension; Exc. Electronic Adjustable Suspension	G56909 ⁴¹	M56909⁴¹	G56906 ⁴³	M56906⁴⁰
	Conventional Type Replacement for Air Assist Rear Suspension	G56909 ⁴¹	M56909⁴¹	G56726 ⁴³	M56906⁴⁰
85-90	All	G56914 ⁴⁰	M56914⁴⁰	M56906⁴⁰
	Air Assist Rear Suspension Standard Equipment	G56914 ⁴⁰	M56914⁴⁰	G56906 ⁴³	M56906⁴⁰
	Conventional Type Replacement for Air Assist Rear Suspension	G56914 ⁴⁰	M56914⁴⁰	G56726 ⁴³	M56906⁴⁰

FLEETWOOD STEERING STABILIZERS

		Front	Rear
85-96	RWD	14019

SEVILLE

98-04	All	↓	142524 ⁵⁷	↓
	All w/o OE Style air fitting	↓	142524 ⁵⁷	⊖	49228 ³⁰
	Exc. Electronic Adjustable Suspension	↓	G56509	M56509	142640 ⁵⁴ 142524 ⁵⁷	↓	142647 ⁵³
	With OE Style air fitting Exc. Electronic Adjustable Suspension	↓	142524 ⁵⁷	⊖	49255⁷
94-97	All	↓	142227 ⁵⁷ 142527 ⁵⁴	↓
93	All	↓	142227 ⁵⁷ 142527 ⁵⁴	↓	142405 ⁵³
	SSS Speed Sensitive Suspension or CCR Computer Command Ride; Non adjustable	↓	G56717 ⁹	142227 ⁵⁷ 142527 ⁵⁴	↓	G56704 ⁹	142405 ⁵³

5 Use kit No. 140719 to replace O.E. hardware for lower shock absorber mounting when studs break or self-tapping screws are not longer useable.

8 Pair Packs.

30 For GM Vehicles equipped with factory installed leveling systems, see Ref A.

41 Complete Assembled Unit. See Ref. D for procedures to replace Elec Adj Susp with non-adj product.

51 Strut Cushion for use with the Strut/Cartridge/Shocks.

54 Kit with Mount and Bearing. Hardware from O.E. Part may need to be reused.

Bold Type - New / Future Part

7 Pair Packs, air hose kit included.

9 See Ref. D for procedures to replace Elec Adj Susp with non-adj product.



40 Complete Assembled Unit.

43 Does not include springs due to vehicle design. See Ref. D for procedures to replace Elec Adj Susp with non-adj product.

53 Strut Mount. Hardware from O.E. Part may need to be reused.

67 Strut Mount Kit. Hardware from O.E. Part may need to be reused.

APPLICATION GUIDE

Year	Fitment Notes										
		Ultra	ProGuard\ Guardian\ Classic	Max Control\ LTV	Strut Cushion\ Strut Mount	HiJackers\ Load Carrier	Ultra	ProGuard\ Guardian\ Classic	Max Control\ LTV	Strut Cushion\ Strut Mount	HiJackers\ Load Carrier

CADILLAC

CADILLAC

SEVILLE (cont)

90-92	All	↓	142227 ⁶⁷ 142297 ⁵⁴	↓	142405 ⁵³
	SSS Speed Sensitive Suspension or CCR Computer Command Ride; Non adjustable	↓	G56717 ⁹	142227 ⁶⁷ 142297 ⁵⁴	↓	G56704 ⁹	142405 ⁵³
87-89	All	↓	G56703	142227 ⁶⁷ 142297 ⁵⁴ 143061 ⁵¹	↓	G56704 ⁹	142405 ⁵³
86	All	↓	G56703	142298 ⁵⁴ 143061 ⁵¹	↓	G56704 ⁹	142405 ⁵³
80-85	All	⊖	69706	81445	⊖	49345 ³⁰
76-79	All	⊖	69600	81494	34051 ⁸	⊖	82093

SEVILLE READYMOUNTS

		Front		Rear	
		Ultra Readymount	Guardian Readymount	Ultra Readymount	Guardian Readymount
98-04	Exc. Electronic Adjustable Suspension	G57051 ⁴⁰	M57051 ⁴⁰

SEVILLE STEERING STABILIZERS

		Front	Rear
80-85	All	14020
76-79	All	14018

CHEVROLET

CHEVROLET

ASTRO

90-05	All	↓	⊖	G63454	61539 81581	77454	43161 ⁸ 49215 ⁷
	AWD	⊖	G63818	61542 81726	58609 77609	⊖	G63454	61539 81581	77454	43161 ⁸ 49215 ⁷
	RWD	↓	G63375 ⁵	61555 81713 ⁵	77375	⊖	G63454	61539 81581	77454	43161 ⁸ 49215 ⁷
85-89	RWD	↓	G63375 ⁵	61555 81713 ⁵	77375	⊖	G63454	61539 81581	77454	43161 ⁸ 49215 ⁷

AVALANCHE 1500

12-13	Exc. Electronic Ride Control	↓	143316 ⁵³	↓
	Exc. Z55 or ZW7 Ride Suspension	↓	G51891	↓
07-11	All	↓	M51891	↓
	Exc. Electronic Ride Control	↓	M51891	143316 ⁵³	↓
	Exc. Z55 or ZW7 Ride Suspension	↓	G51891	M51891	⊖	G63866	61675 81930	58930 77953
02-06	Exc. Electronic Ride Control	↓	G63803	61643 81922	58803 77803	⊖	G63866	61675 81930	58930 77953

AVALANCHE 1500 READYMOUNTS

		Front		Rear	
		Ultra Readymount	Guardian Readymount	Ultra Readymount	Guardian Readymount
12-13	Exc. Z55 or ZW7 Ride Suspension	G57125 ⁴⁰
07-11	Exc. Z55 or ZW7 Ride Suspension	G57125 ⁴⁰	M57125 ⁴⁰

AVALANCHE 2500

02-06	Exc. Electronic Ride Control	⊖	G63817	61663 81925	58817 77817	⊖	G63866	61675 81930	58930 77953
-------	------------------------------	---	--------	----------------	----------------	------	------	---	--------	----------------	----------------	------	------

5 Use kit No. 140719 to replace O.E. hardware for lower shock absorber mounting when studs break or self-tapping screws are not longer useable.

8 Pair Packs.

30 For GM Vehicles equipped with factory installed leveling systems, see Ref A.

51 Strut Cushion for use with the Strut/Cartridge/Shocks.

54 Kit with Mount and Bearing. Hardware from O.E. Part may need to be reused.

7 Pair Packs, air hose kit included.



9 See Ref. D for procedures to replace Elec Adj Susp with non-adj product.

40 Complete Assembled Unit.

53 Strut Mount. Hardware from O.E. Part may need to be reused.





67 Strut Mount Kit. Hardware from O.E. Part may need to be reused.

APPLICATION GUIDE

Year	Fitment Notes										
		Ultra	ProGuard/ Guardian/ Classic	Max Control/ LTV	Strut Cushion/ Strut Mount	HiJackers/ Load Carrier	Ultra	ProGuard/ Guardian/ Classic	Max Control/ LTV	Strut Cushion/ Strut Mount	HiJackers/ Load Carrier

CHEVROLET AVEO























CHEVROLET

04-11	Left	 G56886	M56886	143239 ⁵³	 G51747	143375 ⁵³
	Right	 G56887	M56887	143239 ⁵³	 G51747	143375 ⁵³











AVEO READYMOUNTS

		Front		Rear	
		Ultra Readymount	Guardian Readymount	Ultra Readymount	Guardian Readymount
04-11	Left	G57130 ⁴⁰	M57130 ⁴⁰
	Right	G57131 ⁴⁰	M57131 ⁴⁰

BEL AIR

81	All		77375	
	Sedan		81446	77375	34073 ⁸	 69724	81514	43049 ⁹ 49131 ³⁰
	Sedan Exc. Police and Taxi Models	 69675 ⁵	77375	
	Sedan Police and Taxi Models	 G63375 ⁵	61555	77375	
75	All		77375	 69724	81514
	Sedan		81446	77375	34073 ⁸	 69724	81514	43049 ⁹ 49131 ³⁰
	Sedan Exc. Police and Taxi Models	 69675 ⁵	77375	 69724	81514
	Sedan Police and Taxi Models	 G63375 ⁵	61555	77375	 69724	81514
	Wagon		81713 ⁵	77375	 69724	81514
71-74	All		77375	34073 ⁸	 69724	81514	43049 ⁹ 49131 ³⁰
	Sedan		81446	77375	34073 ⁸	 69724	81514	43049 ⁹ 49131 ³⁰
	Sedan Exc. Police and Taxi Models	 69675 ⁵	77375	34073 ⁸	 69724	81514	43049 ⁹ 49131 ³⁰
	Sedan Police and Taxi Models	 G63375 ⁵	61555	77375	34073 ⁸	 69724	81514	43049 ⁹ 49131 ³⁰
	Wagon		81713 ⁵	77375	34073 ⁸	 69724	81514	43049 ⁹ 49131 ³⁰
65-70	All	 69675 ⁵	81446	34073 ⁸	 69724	81514	43049 ⁹ 49131 ³⁰
58-64	All		82118		82051
55-57	All	 69625	82099		82066
51-54	All		82026		82155
50	All		82026	
	Exc. Air Suspension		82026		82155

BERETTA

95-96	Left	 G56720 ⁹	M56720 ⁹	142227 ⁶⁷ 143059 ⁵¹	 69407 ⁹	81790	141974 ⁶⁷	49614 ⁷
	Right	 G56719 ⁹	M56719 ⁹	142227 ⁶⁷ 143059 ⁵¹	 69407 ⁹	81790	141974 ⁶⁷	49614 ⁷
92-94	All		142227 ⁶⁷ 143059 ⁵¹	
	Base, Left Exc. FE7 Suspension	 G56720 ⁹	M56720 ⁹	142227 ⁶⁷ 143059 ⁵¹	 69749	81530	141974 ⁶⁷	49371 ⁷
	Base, Right Exc. FE7 Suspension	 G56719 ⁹	M56719 ⁹	142227 ⁶⁷ 143059 ⁵¹	 69749	81530	141974 ⁶⁷	49371 ⁷

5 Use kit No. 140719 to replace O.E. hardware for lower shock absorber mounting when studs break or self-tapping screws are not longer useable.

8 Pair Packs.

30 For GM Vehicles equipped with factory installed leveling systems, see Ref A.

51 Strut Cushion for use with the Strut/Cartridge/Shocks.

67 Strut Mount Kit. Hardware from O.E. Part may need to be reused.

7 Pair Packs, air hose kit included.



9 See Ref. D for procedures to replace Elec Adj Susp with non-adj product.

40 Complete Assembled Unit.

53 Strut Mount. Hardware from O.E. Part may need to be reused.

Bold Type - New / Future Part

APPLICATION GUIDE

Year	Fitment Notes										
		Ultra	ProGuard/ Guardian/ Classic	Max Control/ LTV	Strut Cushion/ Strut Mount	HiJackers/ Load Carrier	Ultra	ProGuard/ Guardian/ Classic	Max Control/ LTV	Strut Cushion/ Strut Mount	HiJackers/ Load Carrier

CHEVROLET

CHEVROLET

BERETTA (cont)

94	Z26, Left FE7 Suspension	↓	G56723	142227 ⁶⁷ 143059 ⁵¹	
	Z26, Right FE7 Suspension	↓	G56724	142227 ⁶⁷ 143059 ⁵¹	
92-93	GT, GTZ, Left FE7 Suspension	↓	G56723	142227 ⁶⁷ 143059 ⁵¹	
	GT, GTZ, Right FE7 Suspension	↓	G56724	142227 ⁶⁷ 143059 ⁵¹	
87-91	Left	↓	G56706	142762 ⁶⁷ 143060 ⁵¹	⊕	69749	81530	141974 ⁶⁷ 49371 ⁷
	Right	↓	G56705	142762 ⁶⁷ 143060 ⁵¹	⊕	69749	81530	141974 ⁶⁷ 49371 ⁷

BERETTA READYMOUNTS

		Front		Rear	
		Ultra Readymount	Guardian Readymount	Ultra Readymount	Guardian Readymount
95-96	Left	G56917 ⁴⁰	M56917 ⁴⁰
	Right	G56916 ⁴⁰	M56916 ⁴⁰
92-94	Base, Left	M56919 ⁴⁰
	Base, Right	M56918 ⁴⁰
87-91	Left	G56921 ⁴⁰	M56921 ⁴⁰
	Right	G56920 ⁴⁰	M56920 ⁴⁰

BISCAYNE

71-72	All	⊕	69675 ⁵	77375	34073 ⁸	⊕	69724	81514	43049 ⁸ 49131 ³⁰
	Exc. Police and Taxi Models	⊕	69675 ⁵	81446	77375	34073 ⁸	⊕	69724	81514	43049 ⁸ 49131 ³⁰
	Police and Taxi Models	⊕	69675 ⁵	61555 81713 ⁵	77375	34073 ⁸	⊕	69724	81514	43049 ⁸ 49131 ³⁰
65-70	All	⊕	34073 ⁸	⊕	69724	81514	43049 ⁸ 49131 ³⁰
	Exc. Police and Taxi Models	⊕	81446	34073 ⁸	⊕	69724	81514	43049 ⁸ 49131 ³⁰
58-64	All	⊕	82118	⊕	82051

BLAZER 2WD

95-05	RWD: S Models, Exc. Xtreme Models	⊕	G63421	61504 81750	58421 77421	34051 ⁸	⊕	G63422	61528 81482	58422 77422	43162 ⁸ 49213 ⁷
81-84	Exc. Lift Kit	⊕	⊕	G63349	61524 81164	58349 ⁵⁰ 77349	43111 ⁸
73-84	RWD	⊕	G63355	61525 81039	58355 77355	34036 ⁸	⊕
73-80	Exc. Lift Kit	⊕	⊕	G63349	61524 81164	58349 ⁵⁰ 77349	43111 ⁸ 49155 ⁷
73-74	4WD w/4" Lift Kit; Exc. Quad Suspension	⊕	G63437 ⁵⁰	⊕	58438 ⁵⁰
	4WD; 4" Lift Kit; Exc. Quad Suspension	⊕	58437 ⁵⁰	⊕	G63438 ⁵⁰
	4WD; Exc. Quad Suspension and Lift Kit	⊕	G63347	61516 ⁶ 81113 ⁶	58347 ⁵⁰	43107 ⁸	⊕
69-72	4WD	⊕	61516 ⁶ 81113 ⁶	58347 ⁵⁰	43107 ⁸	⊕
72	All	⊕	81113 ⁶	⊕
	Coil(RearSpringType)	⊕	81113 ⁶	⊕	82003	49107 ⁷
	Leaf(RearSpringType)	⊕	81113 ⁶	⊕	82006	49162 ⁷

5 Use kit No. 140719 to replace O.E. hardware for lower shock absorber mounting when studs break or self-tapping screws are not longer useable.

7 Pair Packs, air hose kit included.

30 For GM Vehicles equipped with factory installed leveling systems, see Ref A.

50 Bellows Kit No.141242 is recommended for use to protect piston rod from potentially harmful road debris.

67 Strut Mount Kit. Hardware from O.E. Part may need to be reused.



6 It is recommended that when replacing shocks on vehicles with "quad shocks" all 4 shocks should be matched by series.

8 Pair Packs.

40 Complete Assembled Unit.

51 Strut Cushion for use with the Strut/Cartridge/Shocks.

APPLICATION GUIDE

Year	Fitment Notes										
		Ultra	ProGuard\Guardian\Classic	Max Control\LTV	Strut Cushion\Strut Mount	HiJackers\Load Carrier	Ultra	ProGuard\Guardian\Classic	Max Control\LTV	Strut Cushion\Strut Mount	HiJackers\Load Carrier

CHEVROLET

CHEVROLET

BLAZER 2WD (cont)

72	4WD; Exc. Lift Kit	○	G63347	81113 ⁶	
	RWD	○	81113 ⁶	○	G63306
	RWD	○	G63355	61525 81039 81113 ⁶	58355 77355
	RWD w/Coil(RearSpringType)	○	81113 ⁶	○	43062 ⁸
	RWD; Leaf(RearSpringType)	○	81113 ⁶	○	43093 ⁸
69-71	Coil(RearSpringType)	○	○	82003	49107 ⁷
	Leaf(RearSpringType)	○	○	82006	49162 ⁷
	4WD; Exc. Lift Kit	○	G63347
	RWD	○	○	G63306
	RWD	○	G63355	61525 81039	58355 77355
	RWD w/Coil(RearSpringType)	○	43062 ⁸
	RWD; Leaf(RearSpringType)	○	○	43093 ⁸



BLAZER 4WD

95-05	4WD; S Models; Exc. ZR2	○	G63423	61531 81516	58423 77423	○	G63422	61528 81482	58422 77422	43162 ⁸ 49213 ⁷
92-94	4WD, Full Size	○	G63609	61542 81726	58609 77609	○	G63638 ⁵⁰	61565 81789	58638 77638	43180 ⁸ 49231 ⁷
87-91	4WD, Full Size; Quad Suspension Long Shock; Exc. Lift Kit	○	G63906 ⁶	61522 ⁶ 81496 ⁶	58906 ⁶
	4WD, Full Size; Quad Suspension Short Shock; Exc. Lift Kit	○	G63908 ⁶	61516 ⁶ 81113 ⁶	58908 ⁶
	4WD; Full Size; Exc. Quad Suspension and Lift Kit	○	G63347	58347 ⁵⁰	43107 ⁸	○	G63349	61524 81164	58349 ⁵⁰ 77349	43111 ⁸ 49155 ⁷
91	4WD; Full Size; 4" Lift Kit; Exc. Quad Suspension	○	G63437 ⁵⁰	58437 ⁵⁰
87-90	4WD; Full Size; 4" Lift Kit; Exc. Quad Suspension	○	G63437 ⁵⁰	58437 ⁵⁰	○	G63438 ⁵⁰	58438 ⁵⁰
85-86	4WD; Exc. Quad Suspension and Lift Kit	○	G63347	58347 ⁵⁰	43107 ⁸	○	G63349	61524 81164	58349 ⁵⁰ 77349	43111 ⁸ 49155 ⁷
81-86	4WD, Quad Suspension Long Shock; Exc. Lift Kit	○	G63906 ⁶	61522 ⁶ 81496 ⁶	58906 ⁶
	4WD, Quad Suspension Short Shock; Exc. Lift Kit	○	G63908 ⁶	61516 ⁶ 81113 ⁶	58908 ⁶
75-86	4WD; 4" Lift Kit; Exc. Quad Suspension	○	G63437 ⁵⁰	58437 ⁵⁰	○	G63438 ⁵⁰	58438 ⁵⁰
81-84	Exc. Lift Kit	○	○	G63349	61524 81164	58349 ⁵⁰ 77349	43111 ⁸
	4WD; Exc. Quad Suspension and Lift Kit	○	G63347	58347 ⁵⁰	43107 ⁸	○	49155 ⁷
73-80	Exc. Lift Kit	○	○	G63349	61524 81164	58349 ⁵⁰ 77349	43111 ⁸ 49155 ⁷
	4WD; Exc. Quad Suspension and Lift Kit	○	G63347	61516 ⁶ 81113 ⁶	58347 ⁵⁰	43107 ⁸
73-74	4WD w/4" Lift Kit; Exc. Quad Suspension	○	G63437 ⁵⁰	○	58438 ⁵⁰
	4WD; 4" Lift Kit; Exc. Quad Suspension	○	58437 ⁵⁰	○	G63438 ⁵⁰
	RWD	○	G63355	61525 81039	58355 77355	34036 ⁸
69-72	4WD	○	61516 ⁶ 81113 ⁶	58347 ⁵⁰	43107 ⁸
72	All	○	81113 ⁶
	Coil(RearSpringType)	○	81113 ⁶	○	82003	49107 ⁷
	Leaf(RearSpringType)	○	81113 ⁶	○	82006	49162 ⁷

6 It is recommended that when replacing shocks on vehicles with "quad shocks" all 4 shocks should be matched by series.
8 Pair Packs.

7 Pair Packs, air hose kit included.
50 Bellows Kit No.141242 is recommended for use to protect piston rod from potentially harmful road debris.

APPLICATION GUIDE

Year	Fitment Notes										
		Ultra	ProGuard\Guardian\Classic	Max Control\LTV	Strut Cushion\Strut Mount	HiJackers\Load Carrier	Ultra	ProGuard\Guardian\Classic	Max Control\LTV	Strut Cushion\Strut Mount	HiJackers\Load Carrier

CHEVROLET

CHEVROLET

BLAZER 4WD (cont)

72	4WD	⊙	81113 ⁶	⊙	G63371
	4WD; Exc. Lift Kit	⊙	G63347	81113 ⁶	⊙
	RWD	⊙	G63355	61525 81039 81113 ⁶	58355 77355	34036 ⁶	⊙
	RWD w/Coil(RearSpringType)	⊙	81113 ⁶	⊙	43062 ²
	RWD; Leaf(RearSpringType)	⊙	81113 ⁶	⊙	43093 ⁸
69-71	Coil(RearSpringType)	⊙	⊙	82003	49107 ⁷
	Leaf(RearSpringType)	⊙	⊙	82006	49162 ⁷
	4WD	⊙	⊙	G63371
	4WD; Exc. Lift Kit	⊙	G63347	⊙
	RWD	⊙	G63355	61525 81039	58355 77355	34036 ⁶	⊙
	RWD w/Coil(RearSpringType)	⊙	⊙	43062 ⁸
RWD; Leaf(RearSpringType)	⊙	⊙	43093 ⁸	

BLAZER STEERING STABILIZERS 2WD

		Front	Rear
79-84	RWD, Dual System Steering Stabilizer	6802SE ⁸⁴
75-84	RWD	14017
	RWD, Single System Steering Stabilizer	6804SE ⁸⁰
69-72	Single System Steering Stabilizer	6803SE ⁸⁴

BLAZER STEERING STABILIZERS 4WD

		Front	Rear
87-91	4WD, Full Size	14017
79-86	4WD, Dual System Steering Stabilizer	6802SE ⁸⁴
75-86	4WD	14017
	4WD, Single System Steering Stabilizer	6804SE ⁸⁰
69-72	Single System Steering Stabilizer	6803SE ⁸⁴

BLAZER, S MODELS

88-94	4WD, Torsion Bar(FrontSpringType)	⊙	142316 ⁵³	⊙	G63422	61528 81482	58422 77422	43162 ⁸ 49213 ⁷
83-94	All	⊙	⊙	G63422	61528 81482	58422 77422	43162 ⁸ 49213 ⁷
	4WD	⊙	G63423	61531 81516	58423 77423	⊙	G63422	61528 81482	58422 77422	43162 ⁸ 49213 ⁷
	RWD	⊙	G63421	61504 81750	58421 77421	34051 ⁸	⊙	G63422	61528 81482	58422 77422	43162 ⁸ 49213 ⁷

BLAZER, S MODELS STEERING STABILIZERS

		Front	Rear
83-94	Single System Steering Stabilizer; with a factory mounting hole in the steering linkage.	6801SE

BROOKWOOD

71-72	All	⊙	69675 ⁵	81446	34073 ⁸	⊙	69604	81492
69-70	All	⊙	69675 ⁵	81446	34073 ⁸	⊙	69724	81514	43049 ⁸ 49131 ³⁰

C3500HD

91-02	HD Solid Front Axle	⊙	58812	⊙	61543	58488	43163
91-00	HD Solid Front Axle	⊙	G63812	⊙

5 Use kit No. 140719 to replace O.E. hardware for lower shock absorber mounting when studs break or self-tapping screws are not longer useable.

7 Pair Packs, air hose kit included.

30 For GM Vehicles equipped with factory installed leveling systems, see Ref A.

80 Mounting bracket not required, install on O.E. Shock Mounts. See Ref. C for optional Steering Stabilizer Boots.

6 It is recommended that when replacing shocks on vehicles with "quad shocks" all 4 shocks should be matched by series.

8 Pair Packs.

53 Strut Mount. Hardware from O.E. Part may need to be reused.

84 Replacement damper for vehicles with the Gabriel Aftermarket mounting kit

APPLICATION GUIDE

Year	Fitment Notes	Front					Rear				
		Ultra	ProGuard\ Guardian\ Classic	Max Control\ LTV	Strut Cushion\ Strut Mount	HiJackers\ Load Carrier	Ultra	ProGuard\ Guardian\ Classic	Max Control\ LTV	Strut Cushion\ Strut Mount	HiJackers\ Load Carrier

CHEVROLET

CHEVROLET

C3500HD STEERING STABILIZERS

		Front	Rear
91-02	O.E. Replacement Stabilizer Single System	6807SE ⁸⁰

CAMARO

14-15	Exc. Electronic	G51916
13-15	SS, Left	G52395
	SS, Right	G52396
10-13	3.6L V6 Left	G52280	G51916
	3.6L V6 Right	G52281	G51916
10-12	Left	143460 ⁶⁸	143461 ⁶³
	Right	143460 ⁶⁸	143462 ⁶³
	SS, Left	G52395	G51975
	SS, Right	G52396	G51975
93-02	All	G51204	M51204	142412 ⁶⁷	69676	81481	75676	49203 ⁷
82-92	All	G56700	M56700	69676	81481	75676	49203 ⁷
70-81	All	69675 ⁵	81446	34073 ⁸	69624	81095	43084 ⁸ 49135 ³⁰
68-69	All	69600	81494
	Leaf(RearSpringType)	69600	81494	69606
	Multi-Leaf Rear Spring	69600	81494	81495
	Single Leaf Rear Springs	69600	81494	49122 ⁷
	Leaf(RearSpringType) Single Leaf Rear Springs	69600	81494	82040
67	All	69600	81494	82040	49122 ⁷

CAMARO READYMOUNTS

		Front		Rear	
		Ultra Readymount	Guardian Readymount	Ultra Readymount	Guardian Readymount
93-02	Left	G57107 ⁴⁰	M57107 ⁴⁰
	Right	G57108 ⁴⁰	M57108 ⁴⁰

CAPRICE

81-96	Sedan Police and Taxi Models	G63375 ⁵	61555 81713 ⁵	77375	34073 ⁸	69724	81514	43049 ⁸ 49131 ³⁰
77-96	Wagon	69675 ⁵	81446	34073 ⁸	69604	81492	43060 ⁸ 49152 ³⁰
71-96	All	69675 ⁵	34073 ⁸
75-80	Exc. Wagon	69675 ⁵	34073 ⁸	43049 ⁸ 49131 ³⁰
	Sedan Police and Taxi Models	G63375 ⁵	61555 81713 ⁵	77375	34073 ⁸	69724	81514
73-76	Wagon	69675 ⁵	81446	34073 ⁸	69604	81492	49152 ³⁰

5 Use kit No. 140719 to replace O.E. hardware for lower shock absorber mounting when studs break or self-tapping screws are not longer useable.

8 Pair Packs.

40 Complete Assembled Unit.

67 Strut Mount Kit. Hardware from O.E. Part may need to be reused.

80 Mounting bracket not required, install on O.E. Shock Mounts. See Ref. C for optional Steering Stabilizer Boots.

Bold Type - New / Future Part



7 Pair Packs, air hose kit included.

30 For GM Vehicles equipped with factory installed leveling systems, see Ref A.

53 Strut Mount. Hardware from O.E. Part may need to be reused.

68 Strut Mount Kit. Hardware from O.E. Part may need to be reused.

APPLICATION GUIDE

Year	Fitment Notes										
		Ultra	ProGuard\Guardian\Classic	Max Control\LTV	Strut Cushion\Strut Mount	HiJackers\Load Carrier	Ultra	ProGuard\Guardian\Classic	Max Control\LTV	Strut Cushion\Strut Mount	HiJackers\Load Carrier

CHEVROLET

CHEVROLET

CAPRICE (cont)

73-74	Sedan Police and Taxi Models	⊥ ⊕	G63375 ⁵	61555 81713 ⁵	77375	34073 ⁸	⊥ ⊕	69724	81514	43049 ⁸ 49131 ³⁰
71-72	Police and Taxi Models	⊥ ⊕	G63375 ⁵	61555	34073 ⁸	⊥ ⊕	43049 ⁸
	Sedan; Police and Taxi Models	⊥ ⊕	69675 ⁵	77375	34073 ⁸	⊥ ⊕
	Hardtop Exc. Police and Taxi Models	⊥ ⊕	69675 ⁵	81446	34073 ⁸	⊥ ⊕
	Hardtop Police and Taxi Models	⊥ ⊕	69675 ⁵	81713 ⁵	34073 ⁸	⊥ ⊕	69724	81514	49131 ³⁰
	Wagon	⊥ ⊕	69675 ⁵	34073 ⁸	⊥ ⊕	69604	81492	49152 ³⁰
70	All	⊥ ⊕	69675 ⁵	34073 ⁸	⊥ ⊕	69724	81514	43049 ⁸ 49131 ³⁰
	Hardtop	⊥ ⊕	69675 ⁵	81446	34073 ⁸	⊥ ⊕	69724	81514	43049 ⁸ 49131 ³⁰
66-69	All	⊥ ⊕	69675 ⁵	81446	34073 ⁸	⊥ ⊕	69724	81514	43049 ⁸ 49131 ³⁰

CAPTIVA SPORT READYMOUNTS

		Front		Rear	
		Ultra Readymount	Guardian Readymount	Ultra Readymount	Guardian Readymount
12-13	Left	G57549⁴⁰
	Right	G57550⁴⁰

CAVALIER

99-05	All	⊥ ⊕	G55698	M55698	143035 ⁵⁴ 143057 ⁵¹	⊥ ⊕	G55825	M55825	142413 ⁵³
95-98	All	⊥ ⊕	G55698	M55698	142227 ⁶⁷ 143057 ⁵¹	⊥ ⊕	G55825	M55825	142413 ⁵³
87-94	Left	⊥ ⊕	G56706	142762 ⁶⁷ 143059 ⁵¹	⊥ ⊕	69749	81530	141974 ⁶⁷	49371 ⁷
	Right	⊥ ⊕	G56705	142762 ⁶⁷ 143059 ⁵¹	⊥ ⊕	69749	81530	141974 ⁶⁷	49371 ⁷
84-86	All	⊥ ⊕	142762 ⁶⁷ 143060 ⁵¹	⊥ ⊕	69749	81530	49371 ⁷
	Left Non-Rebuildable O.E. Struts	⊥ ⊕	G56706	142762 ⁶⁷ 143060 ⁵¹	⊥ ⊕	69749	81530	49371 ⁷
	Rebuildable O.E. Struts	⊥ ⊕	G44451 ⁹⁸	142762 ⁶⁷ 143060 ⁵¹	⊥ ⊕	69749	81530	141974 ⁶⁷	49371 ⁷
	Right Non-Rebuildable O.E. Struts	⊥ ⊕	G56705	142762 ⁶⁷ 143060 ⁵¹	⊥ ⊕	69749	81530	49371 ⁷
82-83	All	⊥ ⊕	142762 ⁶⁷ 143060 ⁵¹	⊥ ⊕	69749	81530	141974 ⁶⁷	49371 ⁷

CAVALIER READYMOUNTS

		Front		Rear	
		Ultra Readymount	Guardian Readymount	Ultra Readymount	Guardian Readymount
99-05	All	G56951 ⁴⁰	M56951⁴⁰	G56938 ⁴⁰	M56938⁴⁰
95-98	All	G56939 ⁴⁰	M56939⁴⁰	G56938 ⁴⁰	M56938⁴⁰
92-94	Left	G56921 ⁴⁰	M56921⁴⁰
	Right	G56920 ⁴⁰	M56920⁴⁰
83-91	Left	G57327⁴⁰
	Right	G57328⁴⁰

CELEBRITY

85-90	All	⊥ ⊕	G55514	M55514	142223 ⁵³ 142749 ⁶⁷ 143060 ⁵¹	⊥ ⊕	69723	81517	141974 ⁶⁷	49370 ³⁰
-------	-----	--------	--------	--------	------	--	------	--------	-------	-------	------	----------------------	---------------------

5 Use kit No. 140719 to replace O.E. hardware for lower shock absorber mounting when studs break or self-tapping screws are not longer useable.

8 Pair Packs.

40 Complete Assembled Unit.

53 Strut Mount. Hardware from O.E. Part may need to be reused.

67 Strut Mount Kit. Hardware from O.E. Part may need to be reused.

7 Pair Packs, air hose kit included.



30 For GM Vehicles equipped with factory installed leveling systems, see Ref A.

51 Strut Cushion for use with the Strut/Cartridge/Shocks.

54 Kit with Mount and Bearing. Hardware from O.E. Part may need to be reused.

98 Notice: The level of difficulty to install this product is moderately high. Please review the installation instructions carefully before proceeding.

APPLICATION GUIDE

Year	Fitment Notes										
		Ultra	ProGuard/ Guardian/ Classic	Max Control/ LTV	Strut Cushion/ Strut Mount	HiJackers/ Load Carrier	Ultra	ProGuard/ Guardian/ Classic	Max Control/ LTV	Strut Cushion/ Strut Mount	HiJackers/ Load Carrier

CHEVROLET

CHEVROLET

CELEBRITY (cont)

84	All	142223 ⁵³ 142749 ⁶⁷ 143060 ⁵¹	69723	81517	141974 ⁶⁷	49370 ³⁰
	Exc. HD Suspension	G55505	142223 ⁵³ 142749 ⁶⁷ 143060 ⁵¹	69723	81517	141974 ⁶⁷	49370 ³⁰
	HD Suspension	G55514	M55514	142223 ⁵³ 142749 ⁶⁷ 143060 ⁵¹	69723	81517	141974 ⁶⁷	49370 ³⁰
82-83	All	G55505	142223 ⁵³ 143060 ⁵¹	69723	81517	141974 ⁶⁷	49370 ³⁰

CELEBRITY READYMOUNTS

		Front		Rear	
		Ultra Readymount	Guardian Readymount	Ultra Readymount	Guardian Readymount
85-90	All	G56908 ⁴⁰	M56908 ⁴⁰
84	All	M56908 ⁴⁰
	HD Suspension	G56908 ⁴⁰	M56908 ⁴⁰

CHEVELLE

68-73	All	69600	81494	34051 ⁸	69604	81492	43060 ⁸ 49152 ³⁰
64-67	All	82138
	Exc. HD Suspension	82138	69724	81514	43049 ⁸ 49131 ³⁰
	HD Suspension	82138	69604	81492	43060 ⁸ 49152 ³⁰

CHEVETTE

76-87	All	81322	81340
-------	-----	-------	-------	-------	-------	-------	-------	-------	-------	-------	-------

CHEVY II

68	All	69600	81494
	Multi-Leaf Rear Spring	69600	81494	69724	81514	49157 ⁷
	Single Leaf Rear Springs	69600	81494	82093
	Single-Leaf Rear Spring	69600	81494	49193 ⁷
	Leaf(RearSpringType) Multi-Leaf Rear Spring	69600	81494	43049 ⁸
62-67	All	82070	82074

CITATION / CITATION II

84-85	All	142223 ⁵³ 142749 ⁶⁷ 143060 ⁵¹	69723	81517	141974 ⁶⁷	49370 ³⁰
	Exc. HD Suspension	G55505	142223 ⁵³ 142749 ⁶⁷ 143060 ⁵¹	69723	81517	141974 ⁶⁷	49370 ³⁰
	HD Suspension	G55514	M55514	142223 ⁵³ 142749 ⁶⁷ 143060 ⁵¹	69723	81517	141974 ⁶⁷	49370 ³⁰
80-83	All	G55505	142223 ⁵³ 143060 ⁵¹	69723	81517	49370 ³⁰

CITATION / CITATION II READYMOUNTS

		Front		Rear	
		Ultra Readymount	Guardian Readymount	Ultra Readymount	Guardian Readymount
84-85	All	M56908 ⁴⁰
	HD Suspension	G56908 ⁴⁰	M56908 ⁴⁰

7 Pair Packs, air hose kit included.

30 For GM Vehicles equipped with factory installed leveling systems, see Ref A.

51 Strut Cushion for use with the Strut/Cartridge/Shocks.

67 Strut Mount Kit. Hardware from O.E. Part may need to be reused.



Bold Type - New / Future Part

8 Pair Packs.

40 Complete Assembled Unit.

53 Strut Mount. Hardware from O.E. Part may need to be reused.





APPLICATION GUIDE

Year	Fitment Notes										
		Ultra	ProGuard\Guardian\Classic	Max Control\LTV	Strut Cushion\Strut Mount	HiJackers\Load Carrier	Ultra	ProGuard\Guardian\Classic	Max Control\LTV	Strut Cushion\Strut Mount	HiJackers\Load Carrier



CHEVROLET

CHEVROLET

CITY EXPRESS

15-16	Left		G52591		G64146
	Right		G52592		G64146



CLASSIC

04-05	All		G55974	M55974	143060 ⁵¹		G56501	M56501	142532 ⁵³ 143057 ⁵¹
-------	-----	---	--------	--------	------	----------------------	------	---	--------	--------	------	--	------

CLASSIC READYMOUNTS

		Front				Rear			
		Ultra Readymount	Guardian Readymount	Ultra Readymount	Guardian Readymount	Ultra Readymount	Guardian Readymount	Ultra Readymount	Guardian Readymount
04-05	All	G56927 ⁴⁰	M56927 ⁴⁰	G56928 ⁴⁰	M56928 ⁴⁰











COBALT

05-10	Exc. SS & Sport Models		G56810	M56810	143323 ⁵³		69587
-------	------------------------	---	--------	--------	------	----------------------	------	---	-------	------	------	------	------

COBALT READYMOUNTS

		Front				Rear			
		Ultra Readymount	Guardian Readymount	Ultra Readymount	Guardian Readymount	Ultra Readymount	Guardian Readymount	Ultra Readymount	Guardian Readymount
05-10	Left	M57047 ⁴⁰
	Right	M57048 ⁴⁰
	Exc. SS & Sport Models Left	G57047 ⁴⁰
	Exc. SS & Sport Models Right	G57048 ⁴⁰



















COLORADO

04-12	RWD			77422	43162 49213
	RWD, Coil(FrontSpringType) D Standard Suspension; Exc. Z71 Off Road Package			G63882
09-11	Torsion Bar(FrontSpringType)			G63879
04-11	RWD, Coil(FrontSpringType) Exc. Z71 Off Road Package		G51850	
04-08	Torsion Bar(FrontSpringType)		G63884		G63879

COLORADO READYMOUNTS

		Front				Rear			
		Ultra Readymount	Guardian Readymount	Ultra Readymount	Guardian Readymount	Ultra Readymount	Guardian Readymount	Ultra Readymount	Guardian Readymount
04-11	All	G57282 ⁴⁰

CORSICA

95-96	Left		G56720 ⁹	M56720 ⁹	142227 ⁶⁷ 143059 ⁵¹		69407 ⁹	81790	141974 ⁶⁷	49614 ⁷
	Right		G56719	M56719	142227 ⁶⁷ 143059 ⁵¹		69407 ⁹	81790	141974 ⁶⁷	49614 ⁷
92-94	All		142227 ⁶⁷ 143059 ⁵¹		69749	81530	141974 ⁶⁷
	Exc. FE7 Suspension Left		G56720 ⁹	M56720 ⁹	142227 ⁶⁷ 143059 ⁵¹		69749	81530	141974 ⁶⁷	49371 ⁷
	Exc. FE7 Suspension Right		G56719 ⁹	M56719 ⁹	142227 ⁶⁷ 143059 ⁵¹		69749	81530	141974 ⁶⁷	49371 ⁷
	FE7 Suspension Left		G56723	142227 ⁶⁷ 143059 ⁵¹		69749	81530	141974 ⁶⁷
	FE7 Suspension Right		G56724	142227 ⁶⁷ 143059 ⁵¹		69749	81530	141974 ⁶⁷
87-91	Left		G56706	142762 ⁶⁷ 143060 ⁵¹		69749	81530	141974 ⁶⁷	49371 ⁷
	Right		G56705	142762 ⁶⁷ 143060 ⁵¹		69749	81530	141974 ⁶⁷	49371 ⁷

7 Pair Packs, air hose kit included.

40 Complete Assembled Unit.



53 Strut Mount. Hardware from O.E. Part may need to be reused.

9 See Ref. D for procedures to replace Elec Adj Susp with non-adj product.

51 Strut Cushion for use with the Strut/Cartridge/Shocks.

67 Strut Mount Kit. Hardware from O.E. Part may need to be reused.

APPLICATION GUIDE

Year	Fitment Notes										
		Ultra	ProGuard\ Guardian\ Classic	Max Control\ LTV	Strut Cushion\ Strut Mount	HiJackers\ Load Carrier	Ultra	ProGuard\ Guardian\ Classic	Max Control\ LTV	Strut Cushion\ Strut Mount	HiJackers\ Load Carrier

CHEVROLET

CHEVROLET

CORSIKA READYMOUNTS		Front		Rear	
		Ultra Readymount	Guardian Readymount	Ultra Readymount	Guardian Readymount
95-96	Left	G56917 ⁴⁰	M56917 ⁴⁰
	Right	G56916 ⁴⁰	M56916 ⁴⁰
94	Left	M56919 ⁴⁰
	Base Submodel Right	M56918 ⁴⁰
92-93	Exc. LTZ Left	M56919 ⁴⁰
	Exc. LTZ Right	M56918 ⁴⁰
90-91	Left	G56921 ⁴⁰	M56921 ⁴⁰
	Right	G56920 ⁴⁰	M56920 ⁴⁰
89	Left	G56921 ⁴⁰
	Right	G56920 ⁴⁰
87-88	Left	G56921 ⁴⁰	M56921 ⁴⁰
	Right	G56920 ⁴⁰	M56920 ⁴⁰















CORVAIR

60-64	All		82099
-------	-----	---	------	-------	------	------	------	------	------	------







CORVAIR TRUCK

61-64	All		82099
-------	-----	---	------	-------	------	------	------	------	------	------





CORVETTE

97-04	Exc. Electronic Adjustable Suspension		G51904		G51871
89-96	Exc. Electronic Adjustable Suspension		69811 ⁹	81792	75811 ⁹		69795 ⁹	81791	75795
88	All		69794 ⁹		69795 ⁹	81791	75795
84-87	All		69714	75811 ⁹		69715
63-82	All		69625		69622	81880	49304 ⁷
60-62	All		82026		82155
53-59	All		82026		82039

CRUZE

11-15	Left		G52432	143473 ⁵³		G51971 ²	143474 ⁵³
	Right		G52433	143473 ⁵³		G51971 ²	143474 ⁵³
10	All		143473 ⁵³		143474 ⁵³

CRUZE LIMITED

16	Left		G52432	143473 ⁵³		G51971	143474 ⁵³
	Right		G52433	143473 ⁵³		G51971	143474 ⁵³

CRUZE LIMITED READYMOUNTS		Front		Rear	
		Ultra Readymount	Guardian Readymount	Ultra Readymount	Guardian Readymount
16	Left	G57377 ⁴⁰
	Right	G57378 ⁴⁰

CRUZE READYMOUNTS		Front		Rear	
		Ultra Readymount	Guardian Readymount	Ultra Readymount	Guardian Readymount
11-16	Left	G57377 ⁴⁰
	Right	G57378 ⁴⁰

2 Future Part, available 2nd Quarter of 2017.

9 See Ref. D for procedures to replace Elec Adj Susp with non-adj product.



53 Strut Mount. Hardware from O.E. Part may need to be reused.

Bold Type - New / Future Part

7 Pair Packs, air hose kit included.

40 Complete Assembled Unit.

APPLICATION GUIDE

Year	Fitment Notes										
		Ultra	ProGuard\ Guardian\ Classic	Max Control\ LTV	Strut Cushion\ Strut Mount	HiJackers\ Load Carrier	Ultra	ProGuard\ Guardian\ Classic	Max Control\ LTV	Strut Cushion\ Strut Mount	HiJackers\ Load Carrier

CHEVROLET

DEL RAY

CHEVROLET

58	All	⊕	82118	⊕	82051
----	-----	---	-------	-------	-------	-------	-------	---	-------	-------	-------	-------	-------

EL CAMINO

78-87	All	⊕	61504 81750	34051 ⁸	⊕	81492	43060 ⁸ 49334 ³⁰
68-77	All	⊕	61504 81750	34051 ⁸	⊕	81492	43060 ⁸ 49152 ³⁰
64-67	All	⊕	82138	⊕	81514	43049 ⁸
	Exc. HD Suspension	⊕	82138	⊕	69724	81514	49131 ⁷ 43049 ⁸
59-60	All	⊕	82118	⊕	82051

EL CAMINO STEERING STABILIZERS

										Front	Rear		
73-77	All											14019

EQUINOX

14-16	All	⊕	⊕	G64140
12-13	All	⊕	⊕	G64015	61718
12	Left Exc. Sport Suspension	⊕	G52127	⊕	G64015	61718
	Right Exc. Sport Suspension	⊕	G52128	⊕	G64015	61718
07-11	All	⊕	143469 ⁶⁸	⊕	G64015	61718
	Left Exc. Sport Suspension	⊕	G52127	143469 ⁶⁸	⊕	G64015	61718
	Right Exc. Sport Suspension	⊕	G52128	143469 ⁶⁸	⊕	G64015	61718
05-06	Left	⊕	G56773	M52824	143363 ⁵³	⊕	G64015	61718
	Right	⊕	G56774	M52825	143363 ⁵³	⊕	G64015	61718

EQUINOX READYMOUNTS

		Front		Rear	
		Ultra Readymount	Guardian Readymount	Ultra Readymount	Guardian Readymount
07-12	Left 19" Wheels	G57322 ⁴⁰
	Left Exc. 19" Wheels	G57197 ⁴⁰
	Right 19" Wheels	G57323 ⁴⁰
	Right Exc. 19" Wheels	G57198 ⁴⁰
05-06	Left	G57110 ⁴⁰
	Right	G57111 ⁴⁰

EXPRESS 4500

10-15	All	⊕	⊕	G63897	61687
-------	-----	---	-------	-------	-------	-------	-------	---	--------	-------	-------	-------	-------

HHR

11	All	⊕	143323 ⁵³	⊕
	Exc. SS Models	⊕	G56810	M56810	143323 ⁵³	⊕	69587
06-10	Exc. SS Models	⊕	G56810	M56810	143323 ⁵³	⊕	69587

7 Pair Packs, air hose kit included.

30 For GM Vehicles equipped with factory installed leveling systems, see Ref A.

53 Strut Mount. Hardware from O.E. Part may need to be reused.

8 Pair Packs.

40 Complete Assembled Unit.

68 Strut Mount Kit. Hardware from O.E. Part may need to be reused.

APPLICATION GUIDE

Year	Fitment Notes	Front					Rear				
		Ultra	ProGuard/ Guardian/ Classic	Max Control/ LTV	Strut Cushion/ Strut Mount	HiJackers/ Load Carrier	Ultra	ProGuard/ Guardian/ Classic	Max Control/ LTV	Strut Cushion/ Strut Mount	HiJackers/ Load Carrier

CHEVROLET

CHEVROLET

HHR READYMOUNTS		Front		Rear	
		Ultra Readymount	Guardian Readymount	Ultra Readymount	Guardian Readymount
06-11	Left	M57047 ⁴⁰
	Right	M57048 ⁴⁰
	Exc. SS Models Right	G57048 ⁴⁰
06-10	Exc. SS Models Left	G57047 ⁴⁰

IMPALA

12-16	All	G55948	M55948	142525 ⁵³ 142526 ⁵⁴	G55949
04-11	Models with 17" or 18" Wheels	G55948	M55948	142524 ⁵⁷ 142525 ⁵³ 142526 ⁵⁴ 143060 ⁵¹	G52244	143061 ⁵¹
00-11	All	G55948	M55948	142524 ⁵⁷ 142525 ⁵³ 142526 ⁵⁴ 143060 ⁵¹	143061 ⁵¹
	Exc. Models with 17" or 18" Wheels	G55948	M55948	142524 ⁵⁷ 142525 ⁵³ 142526 ⁵⁴ 143060 ⁵¹	G55949	M55949	143061 ⁵¹
	Left	G55948	M55948	142524 ⁵⁷ 142525 ⁵³ 142526 ⁵⁴ 143060 ⁵¹	143073 ⁵³ 143061 ⁵¹
	Right	G55948	M55948	142524 ⁵⁷ 142525 ⁵³ 142526 ⁵⁴ 143060 ⁵¹	143074 ⁵³ 143061 ⁵¹
94-96	All	69675 ⁵	34073 ⁸	69724	81514	43049 ⁸ 49131 ³⁰
	Exc. Police and Taxi Models	69675 ⁵	81446	34073 ⁸	69724	81514	43049 ⁸ 49131 ³⁰
83-85	All	69675 ⁵	34073 ⁸	69724	81514	43049 ⁸ 49131 ³⁰
	Police and Taxi Models	G63375 ⁵	61555 81713 ⁵	77375	34073 ⁸	69724	81514	43049 ⁸ 49131 ³⁰
	Exc. Police and Taxi Models	69675 ⁵	81446	34073 ⁸	69724	81514	43049 ⁸ 49131 ³⁰
82	All	69675 ⁵
	Exc. Wagon	69675 ⁵	34073 ⁸	69724	81514	43049 ⁸ 49131 ³⁰
	Sedan Police and Taxi Models	G63375 ⁵	61555 81713 ⁵	77375
	Wagon	69675 ⁵	81446	69604	81492	43060 ⁸ 49152 ³⁰
73-81	Exc. Wagon	69675 ⁵	34073 ⁸	69724	81514	43049 ⁸ 49131 ³⁰
71-81	All	69675 ⁵	34073 ⁸
	Sedan Police and Taxi Models	G63375 ⁵	61555 81713 ⁵	77375	34073 ⁸
	Wagon	69675 ⁵	81446	34073 ⁸	69604	81492	43060 ⁸ 49152 ³⁰
71-72	Exc. Wagon	69675 ⁵	34073 ⁸	49131 ³⁰
70-72	Sedan	69675 ⁵	34073 ⁸	69724	81514	43049 ⁸
70	All	69675 ⁵	34073 ⁸	69724
	Exc. Wagon	69675 ⁵	34073 ⁸	69724	49131 ³⁰
	Wagon	69675 ⁵	81446	34073 ⁸	69724
67-69	Wagon	69675 ⁵	81446	34073 ⁸	69724	49131 ³⁰

5 Use kit No. 140719 to replace O.E. hardware for lower shock absorber mounting when studs break or self-tapping screws are not longer useable.

30 For GM Vehicles equipped with factory installed leveling systems, see Ref A.

51 Strut Cushion for use with the Strut/Cartridge/Shocks.

54 Kit with Mount and Bearing. Hardware from O.E. Part may need to be reused.

8 Pair Packs.



40 Complete Assembled Unit.

53 Strut Mount. Hardware from O.E. Part may need to be reused.

67 Strut Mount Kit. Hardware from O.E. Part may need to be reused.

Bold Type - New / Future Part

APPLICATION GUIDE

Year	Fitment Notes										
		Ultra	ProGuard\ Guardian\ Classic	Max Control\ LTV	Strut Cushion\ Strut Mount	HiJackers\ Load Carrier	Ultra	ProGuard\ Guardian\ Classic	Max Control\ LTV	Strut Cushion\ Strut Mount	HiJackers\ Load Carrier

CHEVROLET

CHEVROLET

IMPALA (cont)

65-69	All	⊕	69675 ⁵	34073 ⁸	⊕	69724	49131 ³⁰
	Sedan	⊕	69675 ⁵	34073 ⁸	⊕	69724	81514	43049 ⁸ 49131 ³⁰
66	Wagon Exc. Police and Taxi Models	⊕	69675 ⁵	81446	34073 ⁸	⊕	69724	49131 ³⁰
65	Wagon	⊕	69675 ⁵	81446	34073 ⁸	⊕	69724	49131 ³⁰
59-64	All	⊕	82118	⊕	82051

IMPALA READYMOUNTS

		Front		Rear	
		Ultra Readymount	Guardian Readymount	Ultra Readymount	Guardian Readymount
12-16	Left	G57060 ⁴⁰	M57060 ⁴⁰	G56924 ⁴⁰	M56924 ⁴⁰
	Right	G57060 ⁴⁰	M57060 ⁴⁰	G56925 ⁴⁰	M56925 ⁴⁰
00-11	All	G57060 ⁴⁰	M57060 ⁴⁰
	Left Exc. Models with 17" or 18" Wheels	G57060 ⁴⁰	M57060 ⁴⁰	G56924 ⁴⁰	M56924 ⁴⁰
	Right Exc. Models with 17" or 18" Wheels	G57060 ⁴⁰	M57060 ⁴⁰	G56925 ⁴⁰	M56925 ⁴⁰

KINGSWOOD

71-72	All	⊕	69675 ⁵	81446	34073 ⁸	⊕	69604	81492
69-70	All	⊕	69675 ⁵	81446	34073 ⁸	⊕	69724	81514	43049 ⁸ 49131 ³⁰

LUMINA

97-01	All	⊕	G44459 ³⁶	142143 ⁵³ 143060 ⁵¹	⊕	G55831	M55831	143061 ⁵¹
	Left	⊕	G44459 ³⁶	142143 ⁵³ 143060 ⁵¹	⊕	G55831	M55831	143073 ⁵³ 143061 ⁵¹
	Right	⊕	G44459 ³⁶	142143 ⁵³ 143060 ⁵¹	⊕	G55831	M55831	143074 ⁵³ 143061 ⁵¹
95-96	All	⊕	G44459 ³⁶	142143 ⁵³ 143060 ⁵¹	⊕	G55817	M55817	143061 ⁵¹
	Left	⊕	G44459 ³⁶	142143 ⁵³ 143060 ⁵¹	⊕	G55817	M55817	143073 ⁵³ 143061 ⁵¹
	Right	⊕	G44459 ³⁶	142143 ⁵³ 143060 ⁵¹	⊕	G55817	M55817	143074 ⁵³ 143061 ⁵¹
90-94	All	⊕	G44459 ³⁶	142143 ⁵³ 143060 ⁵¹	⊕	G56708	M56708	143062 ⁵¹

LUMINA APV

90-96	All	⊕	G55992	142223 ⁵³ 142749 ⁶⁷ 143060 ⁵¹	⊕	G63914	61503	141974 ⁶⁷	49370 ³⁰
-------	-----	---	--------	------	------	--	------	---	--------	-------	------	----------------------	---------------------

LUMINA APV READYMOUNTS

		Front		Rear	
		Ultra Readymount	Guardian Readymount	Ultra Readymount	Guardian Readymount
90-96	All	G57389 ⁴⁰	

LUMINA READYMOUNTS

		Front		Rear	
		Ultra Readymount	Guardian Readymount	Ultra Readymount	Guardian Readymount
95-96	Left	G56952 ⁴⁰
	Right	G56953 ⁴⁰
90-94	All	G56727 ⁴²	M56727 ⁴²

LUV PICKUP

81-82	All	⊕	⊕	G63492	61506 81318	77492	49311 ⁷
-------	-----	---	------	------	------	------	------	---	--------	----------------	-------	------	--------------------

5 Use kit No. 140719 to replace O.E. hardware for lower shock absorber mounting when studs break or self-tapping screws are not longer useable.

8 Pair Packs.

36 Requires special strut installation tool.

42 Does not include springs due to vehicle design.

53 Strut Mount. Hardware from O.E. Part may need to be reused.

7 Pair Packs, air hose kit included.



30 For GM Vehicles equipped with factory installed leveling systems, see Ref A.

40 Complete Assembled Unit.

51 Strut Cushion for use with the Strut/Cartridge/Shocks.

67 Strut Mount Kit. Hardware from O.E. Part may need to be reused.

APPLICATION GUIDE

Year	Fitment Notes										
		Ultra	ProGuard/ Guardian/ Classic	Max Control/ LTV	Strut Cushion/ Strut Mount	HiJackers/ Load Carrier	Ultra	ProGuard/ Guardian/ Classic	Max Control/ LTV	Strut Cushion/ Strut Mount	HiJackers/ Load Carrier

CHEVROLET

CHEVROLET

LUV PICKUP (cont)

81-82	4WD	↓ ○	G63909	61508 81507	77909	○	G63492	61506 81318	77492	49311 ⁷
	RWD	↓ ○	G63902	61501 81478	77902	○	G63492	61506 81318	77492	49311 ⁷
72-80	All	↓ ○	G63909	61508 81507	77909	○	G63907	61500 81147	77907	43048 ⁸ 49151 ⁷

LUV PICKUP STEERING STABILIZERS

		Front	Rear
79-82	4WD, Single System Steering Stabilizer, with a factory mounting hole in the steering linkage.	6801SE ⁸⁰

MALIBU

08-12	Exc. Classic Models Left	↓	143354 ⁵³	↓ ○	69590
	Exc. Classic Models Right	↓	143355 ⁵³	↓ ○	69590
04-12	Left	↓	G52028	M52028	↓
	Right	↓	G52029	M52029	↓
08	Classis Models	↓	↓ ○	69589
	Maxx Models	↓	↓	143425 ⁵⁸
04-07	Exc. Classic Models Left	↓	143354 ⁵³	↓
	Exc. Classic Models Right	↓	143355 ⁵³	↓
	Exc. Maxx Models	↓	↓ ○	69589
	Maxx Models	↓	↓ ○	69590	143425 ⁵⁸
98-03	Rear Strut Lower Mounting holes at 2.4" Apart	↓	G55974	M55974	143060 ⁵¹	↓	G56501	M56501	142532 ⁵³ 143057 ⁵¹
97-03	All	↓	G55974	M55974	143060 ⁵¹	↓	142532 ⁵³ 143057 ⁵¹
97-98	Rear Strut Lower Mounting holes at 3.2" Apart	↓	G55974	M55974	143060 ⁵¹	↓	G55975	M55975	142532 ⁵³ 143057 ⁵¹
78-83	All	↓ ○	69600	81494	34051 ⁸	↓ ○	69604	81492	43060 ⁸ 49334 ³⁰
73-77	All	↓ ○	69600	81494	34051 ⁸	↓ ○	69604	81492	43060 ⁸ 49152 ³⁰
64-67	All	↓ ○	82138	↓ ○
	Exc. HD Suspension	↓ ○	82138	↓ ○	69724	81514	43049 ⁸ 49131 ³⁰
	HD Suspension	↓ ○	82138	↓ ○	69604	81492	43060 ⁸ 49152 ³⁰

MALIBU READYMOUNTS

		Front		Rear	
		Ultra Readymount	Guardian Readymount	Ultra Readymount	Guardian Readymount
04-12	Exc. Hybrid Models Left	G57069 ⁴⁰	M57069⁴⁰
	Exc. Hybrid Models Right	G57070 ⁴⁰	M57070⁴⁰
08-10	4Cyl: Exc. Classic and Hybrid Models Left	G57121 ⁴⁰
	4Cyl: Exc. Classic and Hybrid Models Right	G57122 ⁴⁰
	4cyl; Exc Hybrid Models Left	M57121⁴⁰
	4cyl; Exc Hybrid Models Right	M57122⁴⁰
98-03	Rear Strut Lower Mounting holes at 2.4" Apart	G56927 ⁴⁰	M56927⁴⁰	G56928 ⁴⁰	M56928⁴⁰
97-03	All	G56927 ⁴⁰	M56927⁴⁰

7 Pair Packs, air hose kit included.

30 For GM Vehicles equipped with factory installed leveling systems, see Ref. A.

51 Strut Cushion for use with the Strut/Cartridge/Shocks.

68 Strut Mount Kit. Hardware from O.E. Part may need to be reused.



8 Pair Packs.

40 Complete Assembled Unit.

53 Strut Mount. Hardware from O.E. Part may need to be reused.



80 Mounting bracket not required, install on O.E. Shock Mounts. See Ref. C for optional Steering Stabilizer Boots.

APPLICATION GUIDE









































Year	Fitment Notes										
		Ultra	ProGuard/ Guardian/ Classic	Max Control/ LTV	Strut Cushion/ Strut Mount	HiJackers/ Load Carrier	Ultra	ProGuard/ Guardian/ Classic	Max Control/ LTV	Strut Cushion/ Strut Mount	HiJackers/ Load Carrier

CHEVROLET METRO

CHEVROLET

98-01	Non-ABS	 G55891	142293 ⁵⁴ 143059 ⁵¹	 G55772	142295 ⁵³ 143057 ⁵¹
-------	---------	--	------	------	--	------	--	------	------	--	------

MONTE CARLO

07	All	 G55948	M55948	142526 ⁵⁴ 143060 ⁵¹		143059 ⁵¹
	Exc. Models with 17" or 18" Wheels	 G55948	M55948	142526 ⁵⁴ 143060 ⁵¹		G55949	M55949	143059 ⁵¹
	Left	 G55948	M55948	142526 ⁵⁴ 143060 ⁵¹		143073 ⁵³ 143059 ⁵¹
	Models with 17" or 18" Wheels	 G55948	M55948	142526 ⁵⁴ 143060 ⁵¹		G52244	143059 ⁵¹
	Right	 G55948	M55948	142526 ⁵⁴ 143060 ⁵¹		143074 ⁵³ 143059 ⁵¹
05-06	Models with 17" or 18" Wheels	 G55948	M55948	142524 ⁶⁷ 142525 ⁵³ 142526 ⁵⁴ 143060 ⁵¹		G52244	143059 ⁵¹
00-06	All	 G55948	M55948	142524 ⁶⁷ 142525 ⁵³ 142526 ⁵⁴ 143060 ⁵¹		143059 ⁵¹
	Exc. Models with 17" or 18" Wheels	 G55948	M55948	142524 ⁶⁷ 142525 ⁵³ 142526 ⁵⁴ 143060 ⁵¹		G55949	M55949	143059 ⁵¹
	Left	 G55948	M55948	142524 ⁶⁷ 142525 ⁵³ 142526 ⁵⁴ 143060 ⁵¹		143073 ⁵³ 143059 ⁵¹
	Right	 G55948	M55948	142524 ⁶⁷ 142525 ⁵³ 142526 ⁵⁴ 143060 ⁵¹		143074 ⁵³ 143059 ⁵¹
97-99	All	 G44459 ³⁶	143060 ⁵¹		G55831	M55831	143059 ⁵¹
	Exc. HD Suspension	 G44459 ³⁶	142143 ⁵³ 143060 ⁵¹		G55831	M55831	143059 ⁵¹
	Left	 G44459 ³⁶	143060 ⁵¹		G55831	M55831	143073 ⁵³ 143059 ⁵¹
	Right	 G44459 ³⁶	143060 ⁵¹		G55831	M55831	143074 ⁵³ 143059 ⁵¹
95-96	All	 G44459 ³⁶	143060 ⁵¹		G55817	M55817	143059 ⁵¹
	Exc. HD Suspension	 G44459 ³⁶	142143 ⁵³ 143060 ⁵¹		G55817	M55817	143059 ⁵¹
	Left	 G44459 ³⁶	143060 ⁵¹		G55817	M55817	143073 ⁵³ 143059 ⁵¹
	Right	 G44459 ³⁶	143060 ⁵¹		G55817	M55817	143074 ⁵³ 143059 ⁵¹
73-88	All	 69600	81494	34051 ⁸	 69604	81492	43060 ⁸ 49334 ³⁰
70-72	All	 69600	81494	34051 ⁸	 69604	81492	43060 ⁸ 49152 ³⁰

MONTE CARLO READYMOUNTS

		Front		Rear	
		Ultra Readymount	Guardian Readymount	Ultra Readymount	Guardian Readymount
00-07	All	G57060 ⁴⁰	M57060 ⁴⁰
	Left Exc. Models with 17" or 18" Wheels	G57060 ⁴⁰	M57060 ⁴⁰	G56924 ⁴⁰	M56924 ⁴⁰
	Right Exc. Models with 17" or 18" Wheels	G57060 ⁴⁰	M57060 ⁴⁰	G56925 ⁴⁰	M56925 ⁴⁰

8 Pair Packs.

36 Requires special strut installation tool.

51 Strut Cushion for use with the Strut/Cartridge/Shocks.

54 Kit with Mount and Bearing. Hardware from O.E. Part may need to be reused.

30 For GM Vehicles equipped with factory installed leveling systems, see Ref A.

40 Complete Assembled Unit.

53 Strut Mount. Hardware from O.E. Part may need to be reused.

67 Strut Mount Kit. Hardware from O.E. Part may need to be reused.

APPLICATION GUIDE

Year	Fitment Notes	Front					Rear				
		Ultra	ProGuard\Guardian\Classic	Max Control\LTV	Strut Cushion\Strut Mount	HiJackers\Load Carrier	Ultra	ProGuard\Guardian\Classic	Max Control\LTV	Strut Cushion\Strut Mount	HiJackers\Load Carrier

CHEVROLET

CHEVROLET

MONTE CARLO STEERING STABILIZERS

		Front	Rear
73-77	All	14019

MONZA

75-80	All	82129	81438
-------	-----	------	-------	------	------	------	------	-------	------	------	------

NOVA

85-88	All	G55715	143059 ⁵¹	G55752	142249 ⁵³	143058 ⁵¹
74-79	All	69600	81494	34051 ⁸	82093
69-73	All	69600	81494	34051 ⁸
73	Exc. HD Suspension	69600	81494	34051 ⁸	82093	49193 ⁷
	HD Suspension	69600	81494	34051 ⁸	69724	81514	49157 ⁷
69-72	Multi-Leaf Rear Spring	69600	81494	34051 ⁸	69724	81514	43049 ⁹
	Single Leaf Rear Springs	69600	81494	34051 ⁸	82093	49157 ⁷
	Single-Leaf Rear Spring	69600	81494	34051 ⁸	49193 ⁷

ONE-FIFTY SERIES

55-57	All	69625	82099	82066
53-54	All	82026	82155

OPTRA

08	All	143349 ⁶⁸	143350 ⁵³
06-07	Left	G56882	143349 ⁶⁸	G56884	143350 ⁵³
	Right	G56883	143349 ⁶⁸	G56885	143350 ⁵³
04-05	Left	G56882	G56884
	Right	G56883	G56885

PICKUP

60	All	82035	82086
57-58	All	82047
	3100, 3200 & 3600 Models	82047	82060
	3800 2nd Series	82047	82155
55-56	All	G63405
	3200	G63405	77405
	3200 & 3600 2nd Series	G63405	81147
	3800 2nd Series	G63405	61500	77405	43048 ⁸	82155
56	3100	G63405	61500	77405	43048 ⁸	
55	1st Series	G63405	81270
	3100, 3124 2nd Series	G63405	61500	77405	43048 ⁸	81318
54	All	81270	82155
50-53	3100, 3200, 3600 & 3800	81270	82066

7 Pair Packs, air hose kit included.



51 Strut Cushion for use with the Strut/Cartridge/Shocks.

68 Strut Mount Kit. Hardware from O.E. Part may need to be reused.

8 Pair Packs.

53 Strut Mount. Hardware from O.E. Part may need to be reused.

APPLICATION GUIDE

Year	Fitment Notes										
		Ultra	ProGuard\Guardian\Classic	Max Control\LTV	Strut Cushion\Strut Mount	HiJackers\Load Carrier	Ultra	ProGuard\Guardian\Classic	Max Control\LTV	Strut Cushion\Strut Mount	HiJackers\Load Carrier

CHEVROLET

CHEVROLET

PICKUP 1/2 TON, C10

75-86	All	⊖	G63355	61525 81039	58355 77355	34036 ⁶	⊖	G63349	61524 81164	58349 77349	43111 ⁸ 49155 ⁷
73-74	All	⊖	G63355	61525 81039	58355 77355	34036 ⁶	⊖	61524 81164	58349 77349	43111 ⁸ 49155 ⁷
67-72	Coil(RearSpringType)	⊖	G63355	61525 81039	58355 77355	34036 ⁶	⊖	82003	43062 ⁸ 49107 ⁷
63-72	All	⊖	G63355	61525 81039	58355 77355	34036 ⁶	⊖
	Leaf(RearSpringType)	⊖	G63355	61525 81039	58355 77355	34036 ⁶	⊖	G63306	82006	43093 ⁸ 49162 ⁷
60-62	All	⊖	82035	⊖	82086

PICKUP 1/2 TON, C10 STEERING STABILIZERS

		Front		Rear	
73-86	Single System Steering Stabilizer	6802SE ⁸⁴		

PICKUP 1/2 TON, C15 / C1500

88-99	All	⊖	G63489	61544 81668	58489 77489	⊖	G63488	61543 81667	58488 77488	43163 ⁸ 49218 ⁷
-------	-----	---	--------	----------------	----------------	------	------	---	--------	----------------	----------------	------	--

PICKUP 1/2 TON, C15 / C1500 STEERING STABILIZERS

		Front		Rear	
92-99	Exc. O.E. Steering Stabilizer	6853SE ⁸²		

PICKUP 1/2 TON, K10

81-86	Exc. Lift Kit	⊖	G63347	⊖	G63349	61524 81164	77349	43111 ⁸
	Quad Suspension Long Shock; Exc. Lift Kit	⊖	G63906 ⁶	61522 ⁶ 81496 ⁶	58906 ⁶	⊖
	Quad Suspension Short Shock; Exc. Lift Kit	⊖	G63908 ⁶	61516 ⁶	58908 ⁶	⊖
	Standard Suspension; Exc. Lift Kit	⊖	81113 ⁶	58347	43107 ⁸	⊖	58349	49155 ⁷
73-86	4" Lift Kit; Exc. Quad Suspension	⊖	G63437 ⁵⁰	58437 ⁵⁰	⊖	G63438 ⁵⁰	58438 ⁵⁰
73-80	Exc. Lift Kit	⊖	G63347	61516 ⁶ 81113 ⁶	58347	43107 ⁸	⊖	G63349	61524 81164	58349 77349	43111 ⁸ 49155 ⁷
69-72	All	⊖	G63347	⊖	G63371
	Exc. Lift Kit	⊖	G63347	61516 ⁶ 81113 ⁶	58347	43107 ⁸	⊖	G63371

PICKUP 1/2 TON, K10 STEERING STABILIZERS

		Front		Rear	
73-86	All	14017		
	Dual System Steering Stabilizer	6802SE ⁸⁴		
	Single System Steering Stabilizer	6804SE ⁸⁰		
67-72	Dual System Steering Stabilizer	6802SE ⁸⁴		
61-72	Single System Steering Stabilizer	6803SE ⁸⁴		

PICKUP 1/2 TON, K15 / K1500

88-99	All	⊖	G63818	58901 77609	⊖	G63488	61543 81667	58488 77488	43163 ⁸ 49218 ⁷
88	Quad Suspension Long Shock; Exc. Lift Kit	⊖	G63818	61522 ⁶	58901 77609	⊖	G63488	61543 81667	58488 77488	43163 ⁸ 49218 ⁷
	Quad Suspension Short Shock; Exc. Lift Kit	⊖	G63818	61516 ⁶	58901 77609	⊖	G63488	61543 81667	58488 77488	43163 ⁸ 49218 ⁷

PICKUP 1/2 TON, K15 / K1500 STEERING STABILIZERS

		Front		Rear	
88-99	Single System Steering Stabilizer	6807SE ⁸⁰		
92-97	Exc. O.E. Steering Stabilizer	6853SE ⁸⁰		

PICKUP 1/2 TON, R10

87	All	⊖	G63355	61525 81039	58355 77355	34036 ⁶	⊖	G63349	61524 81164	58349 77349	43111 ⁸
----	-----	---	--------	----------------	----------------	------	--------------------	---	--------	----------------	----------------	------	--------------------

6 It is recommended that when replacing shocks on vehicles with "quad shocks" all 4 shocks should be matched by series.

8 Pair Packs.

80 Mounting bracket not required, install on O.E. Shock Mounts. See Ref. C for optional Steering Stabilizer Boots.

84 Replacement damper for vehicles with the Gabriel Aftermarket mounting kit

7 Pair Packs, air hose kit included.

50 Bellows Kit No. 141242 is recommended for use to protect piston rod from potentially harmful road debris.

82 Use kit if listed, See Ref. C for optional Steering Stabilizer Boots.

APPLICATION GUIDE

Year	Fitment Notes										
		Ultra	ProGuard/ Guardian/ Classic	Max Control/ LTV	Strut Cushion/ Strut Mount	HiJackers/ Load Carrier	Ultra	ProGuard/ Guardian/ Classic	Max Control/ LTV	Strut Cushion/ Strut Mount	HiJackers/ Load Carrier

CHEVROLET

CHEVROLET

PICKUP 1/2 TON, R10 (cont)

87	RWD	○	G63355	61525 81039	58355 77355	34036 ⁸	○	G63349	61524 81164	58349 77349	49155 ⁷ 43111 ⁸
----	-----	---	--------	----------------	----------------	------	--------------------	---	--------	----------------	----------------	------	--

PICKUP 1/2 TON, R10 STEERING STABILIZERS

		Front	Rear
87	Single System Steering Stabilizer	6802SE ⁸⁴

PICKUP 1/2 TON, SILVERADO 1500

16-17	All		77976
	Exc. Electronic Adjustable Suspension	○	○	61690	77976
	Exc. Classic Models and Electronic Adjustable Suspension	○	○	G63959	77976
14-15	All		G51949	77976
	Exc. Classic Models and Electronic Adjustable Suspension	○	G51949	○	G63959	61690	77976
07-13	All		M52803	77976
	Exc. Classic Models and Electronic Adjustable Suspension	○	G51870	M52803	143316 ⁸³	○	G63959	61690	77976
07	4WD; Classic and Old Body Style; Exc. Electronic Adjustable Suspension		G63803	61643 81922 M52803	58803 77803		G63675	61642 81921	58412 77412 77662 77976
	RWD, Exc. Electronic Adjustable Suspension	○	M52803	○	61600	77976
	RWD; Classic Models Only; Exc. Electronic Adjustable Suspension	○	G63783	61641 81920 M52803	58783 77783	○	G63662	81873	58662 77976	43181 ⁸ 49235 ⁷
99-06	4WD; Classic and Old Body Style; Exc. Electronic Adjustable Suspension		G63803	61643 81922	58803 77803		G63675	61642 81921	58412 77412
	RWD; Classic Models Only; Exc. Electronic Adjustable Suspension	○	G63783	61641 81920	58783 77783	○	G63662	61600 81873	58662 77662	43181 ⁸ 49235 ⁷

PICKUP 1/2 TON, SILVERADO 1500 HD

05-06	All		G63817	61663 81925	58817 77817	○	G63675	61642 81921	58412 77412
01-03	All		G63817	61663 81925	58817 77817	○	G63675	61642 81921	58412 77412

PICKUP 1/2 TON, SILVERADO 1500 READYMOUNTS

		Front		Rear	
		Ultra Readymount	Guardian Readymount	Ultra Readymount	Guardian Readymount
13-16	All	G57448⁴⁰		
13	RWD	G57448⁴⁰		M57023⁴⁰	
	RWD; Exc. Classic Models and Electronic Ride	G57023 ⁴⁰		
	RWD; Exc. Standard Cab	G57000 ⁴⁰		
07-12	RWD		M57023⁴⁰	
	RWD; Exc. Classic Models and Electronic Ride	G57023 ⁴⁰		
	RWD; Exc. Standard Cab	G57000 ⁴⁰		

PICKUP 1/2 TON, V10

87	All		○	49155 ⁷
	4" Lift Kit; Exc. Quad Suspension	○	G63437 ⁵⁰	58437 ⁵⁰	○	G63438 ⁵⁰	58438 ⁵⁰	49155 ⁷
	Exc. Lift Kit	○	G63347	58347	43107 ⁸	○	G63349	61524 81164	58349 77349	43111 ⁸ 49155 ⁷

7 Pair Packs, air hose kit included.

40 Complete Assembled Unit.



53 Strut Mount. Hardware from O.E. Part may need to be reused.

8 Pair Packs.

50 Bellows Kit No. 141242 is recommended for use to protect piston rod from potentially harmful road debris.

84 Replacement damper for vehicles with the Gabriel Aftermarket mounting kit

APPLICATION GUIDE

Year	Fitment Notes										
		Ultra	ProGuard\Guardian\Classic	Max Control\LTV	Strut Cushion\Strut Mount	HiJackers\Load Carrier	Ultra	ProGuard\Guardian\Classic	Max Control\LTV	Strut Cushion\Strut Mount	HiJackers\Load Carrier

CHEVROLET

CHEVROLET

PICKUP 1/2 TON, V10 (cont)

87	Quad Suspension Long Shock; Exc. Lift Kit	⊖	G63906 ⁶	61522 ⁶ 81496 ⁶	58906 ⁶	⊖	49155 ⁷
	Quad Suspension Short Shock; Exc. Lift Kit	⊖	G63908 ⁶	61516 ⁶ 81113 ⁶	58908 ⁶	⊖	49155 ⁷

PICKUP 1/2 TON, V10 STEERING STABILIZERS

		Front		Rear	
87	All	14017		
	Dual System Steering Stabilizer	6802SE ⁸⁴		
	Single System Steering Stabilizer	6804SE ⁸⁰		

PICKUP 3/4 TON, C20

75-86	Crew Cab Pickup	⊖	G63355	61525 81039	58355 77355	34036 ⁸	⊖	G63366	61649 81174	58366
	Standard Cab Pickup	⊖	G63355	61525 81039	58355 77355	34036 ⁸	⊖	G63349	61524 81164	58349 77349	43111 ⁸ 49155 ⁷
73-74	Crew Cab Pickup	⊖	G63355	61525 81039	58355 77355	34036 ⁸	⊖	61649 81174	58366
	Standard Cab Pickup	⊖	⊖	61524 81164	58349 77349	43111 ⁸ 49155 ⁷
67-72	All	⊖	G63355	61525 81039	58355 77355	34036 ⁸	⊖	G63306
	Coil(RearSpringType)	⊖	G63355	61525 81039	58355 77355	34036 ⁸	⊖	G63306	82003	43062 ⁸ 49107 ⁷
	Leaf(RearSpringType)	⊖	G63355	61525 81039	58355 77355	34036 ⁸	⊖	G63306	82006	43093 ⁸ 49162 ⁷
63-66	All	⊖	G63355	61525 81039	58355 77355	34036 ⁸	⊖	G63306	43093 ⁸ 49162 ⁷
60-62	All	⊖	82035	⊖	82086

PICKUP 3/4 TON, C20 STEERING STABILIZERS

		Front		Rear	
63-86	Single System Steering Stabilizer	6802SE ⁸⁴		

PICKUP 3/4 TON, C25 / C2500

88-00	All	⊖	G63489	61544 81668	58489 77489	⊖	G63488	61543 81667	58488 77488	43163 ⁸ 49218 ⁷
-------	-----	---	--------	----------------	----------------	------	------	---	--------	----------------	----------------	------	--

PICKUP 3/4 TON, C25 / C2500 STEERING STABILIZERS

		Front		Rear	
92-99	Exc. O.E. Steering Stabilizer	6853SE ⁸²		

PICKUP 3/4 TON, K20

81-86	Exc. Lift Kit	⊖	G63347	⊖	G63349	61524 81164	77349	43111 ⁸
	Quad Suspension Long Shock; Exc. Lift Kit	⊖	G63906 ⁶	61522 ⁶ 81496 ⁶	58906 ⁶	⊖
	Quad Suspension Short Shock; Exc. Lift Kit	⊖	G63908 ⁶	61516 ⁶	58908 ⁶	⊖
	Standard Suspension; Exc. Lift Kit	⊖	81113 ⁶	58347	43107 ⁸	⊖	58349	49155 ⁷
73-86	4" Lift Kit; Exc. Quad Suspension	⊖	G63437 ⁵⁰	58437 ⁵⁰	⊖	G63438 ⁵⁰	58438 ⁵⁰
75-80	Exc. Lift Kit	⊖	G63347	61516 ⁶ 81113 ⁶	58347	43107 ⁸	⊖	G63349	61524 81164	58349 77349	43111 ⁸ 49155 ⁷
73-74	Exc. Lift Kit	⊖	G63347	61516 ⁶ 81113 ⁶	58347	43107 ⁸	⊖	61524 81164	58349 77349	43111 ⁸ 49155 ⁷
71-72	All	⊖	⊖	G63371
	Exc. Lift Kit	⊖	G63347	61516 ⁶ 81113 ⁶	58347	⊖	G63371
69-70	Exc. Lift Kit	⊖	G63347	61516 ⁶ 81113 ⁶	58347	⊖

6 It is recommended that when replacing shocks on vehicles with "quad shocks" all 4 shocks should be matched by series.

8 Pair Packs.

80 Mounting bracket not required, install on O.E. Shock Mounts. See Ref. C for optional Steering Stabilizer Boots.

84 Replacement damper for vehicles with the Gabriel Aftermarket mounting kit

7 Pair Packs, air hose kit included.

50 Bellows Kit No.141242 is recommended for use to protect piston rod from potentially harmful road debris.

82 Use kit if listed, See Ref. C for optional Steering Stabilizer Boots.

APPLICATION GUIDE

Year	Fitment Notes	Front					Rear				
		Ultra	ProGuard\ Guardian\ Classic	Max Control\ LTV	Strut Cushion\ Strut Mount	HiJackers\ Load Carrier	Ultra	ProGuard\ Guardian\ Classic	Max Control\ LTV	Strut Cushion\ Strut Mount	HiJackers\ Load Carrier

CHEVROLET

CHEVROLET

PICKUP 3/4 TON, K20 STEERING STABILIZERS

		Front	Rear
73-86	All	14017
	Dual System Steering Stabilizer	6802SE ⁸⁴
	Single System Steering Stabilizer	6804SE ⁸⁰
67-72	Dual System Steering Stabilizer	6802SE ⁸⁴
61-72	Single System Steering Stabilizer	6803SE ⁸⁴

PICKUP 3/4 TON, K25 / K2500

88-00	All	⊖ G63609	61542 81726	58609 77609	⊖ G63488	61543 81667	58488 77488	43163 ⁸ 49218 ⁷
-------	-----	----------	----------------	----------------	------	------	----------	----------------	----------------	------	--

PICKUP 3/4 TON, K25 / K2500 STEERING STABILIZERS

		Front	Rear
99-00	Exc. O.E. Steering Stabilizer	6853SE ⁸²
88-99	Single System Steering Stabilizer	6807SE ⁸⁰

PICKUP 3/4 TON, R20

88	All	⊖ G63355	61525 81039
	Crew Cab Pickup	⊖ G63355	61525 81039	58355 77355	34036 ⁸	⊖ G63366	61649 81174	58366
87	All	⊖ G63355	61525 81039	34036 ⁸
	Crew Cab Pickup	⊖ G63355	61525 81039	58355 77355	34036 ⁸	⊖ G63366	61649 81174	58366
	Standard Cab Pickup	⊖ G63355	61525 81039	58355	34036 ⁸	⊖ G63349	61524 81164	58349 77349	43111 ⁸ 49155 ⁷

PICKUP 3/4 TON, R20 STEERING STABILIZERS

		Front	Rear
87-88	Single System Steering Stabilizer	6802SE ⁸⁴

PICKUP 3/4 TON, R2500

89	All	⊖ G63355	61525 81039	58355 77355	34036 ⁸	⊖ G63366	61649	58366
	RWD	⊖ G63355	61525 81039	58355 77355	34036 ⁸	⊖ G63366	81174 61649	58366

PICKUP 3/4 TON, R2500 STEERING STABILIZERS

		Front	Rear
89	Single System Steering Stabilizer	6802SE ⁸⁴

PICKUP 3/4 TON, SILVERADO 2500

14	All	⊖ G64121
11-13	All	⊖ G64121	58943
05-08	All	⊖ G63817	61663 81925	58817 77817	⊖ G63675	61642 81921	58412 77412
99-04	All	⊖ G63675	61642 81921	58412 77412
	4WD	⊖ G63817	61663 81925	58817 77817	⊖ G63675	61642 81921	58412 77412

PICKUP 3/4 TON, SILVERADO 2500 HD

11-13	All	58943
08-10	All	⊖ G63675	61642 81921	58412 77412
	9200# GVW	⊖ G63817	61663	58817 77817	⊖ G63675	61642 81921	58412 77412
07	All	⊖ G63675	61642 81921	77412
	9200# GVW	⊖ G63817	61663	58817 77817	⊖ G63675	61642 81921	77412
01-06	All	⊖ G63675	61642 81921	58412 77412

7 Pair Packs, air hose kit included.



80 Mounting bracket not required, install on O.E. Shock Mounts. See Ref. C for optional Steering Stabilizer Boots.

84 Replacement damper for vehicles with the Gabriel Aftermarket mounting kit

8 Pair Packs.

82 Use kit if listed, See Ref. C for optional Steering Stabilizer Boots.

APPLICATION GUIDE

Year	Fitment Notes										
		Ultra	ProGuard/ Guardian/ Classic	Max Control/ LTV	Strut Cushion/ Strut Mount	HiJackers/ Load Carrier	Ultra	ProGuard/ Guardian/ Classic	Max Control/ LTV	Strut Cushion/ Strut Mount	HiJackers/ Load Carrier

CHEVROLET

CHEVROLET

PICKUP 3/4 TON, SILVERADO 2500 HD (cont)

01-06	9200# GVW	⊕ ⊖	G63817	61663	58817 77817	⊕ ⊖	G63675	61642 81921	58412 77412
-------	-----------	--------	--------	-------	----------------	------	------	--------	--------	----------------	----------------	------	------

PICKUP 3/4 TON, SILVERADO 2500 HD STEERING STABILIZERS

		Front		Rear	
11-13	All	14075		
01-09	9200# GVW w/o O.E. Unit - 15059138 15155638	6803SE ⁸⁴		
	4WD, 9200# GVW with O.E. Unit - 15059138 15155638	6853SE ⁸²		

PICKUP 3/4 TON, V20

87	All	⊕ ⊖	⊕ ⊖	49155 ⁷
	4" Lift Kit; Exc. Quad Suspension	⊕ ⊖	G63437 ⁵⁰	58437 ⁵⁰	⊕ ⊖	G63438 ⁵⁰	58438 ⁵⁰	49155 ⁷
	Exc. Quad Suspension and Lift Kit	⊕ ⊖	G63347	61516	58347	43107 ⁸	⊕ ⊖	G63349	61524 81164	58349 77349	43111 ⁸ 49155 ⁷
	Quad Suspension Long Shock; Exc. Lift Kit	⊕ ⊖	G63906 ⁸	61522 ⁶ 81496 ⁶	58906 ⁵	⊕ ⊖	49155 ⁷
	Quad Suspension Short Shock; Exc. Lift Kit	⊕ ⊖	G63908 ⁸	58908 ⁵	⊕ ⊖	49155 ⁷

PICKUP 3/4 TON, V20 STEERING STABILIZERS

		Front		Rear	
87	All	14017		
	Dual System Steering Stabilizer	6802SE ⁸⁴		
	Single System Steering Stabilizer	6804SE ⁸⁰		

PICKUP 1 TON, C30

75-86	All	⊕ ⊖	G63355	61525 81039	58355 77355	34036 ⁸	⊕ ⊖	G63366	61649 81174	58366
73-74	All	⊕ ⊖	G63355	61525 81039	58355 77355	34036 ⁸	⊕ ⊖	61649 81174	58366
67-72	Exc. 11,000# Rear Axle	⊕ ⊖	G63355	61525 81039	58355 77355	34036 ⁸	⊕ ⊖	G63306	82006	43093 ⁸ 49162 ⁷
63-72	All	⊕ ⊖	G63355	61525 81039	58355 77355	34036 ⁸	⊕ ⊖
61-62	All	⊕ ⊖	82035	⊕ ⊖

PICKUP 1 TON, C30 STEERING STABILIZERS

		Front		Rear	
73-86	Single System Steering Stabilizer; with Cooler	6802SE ⁸⁴		
61-72	Single System Steering Stabilizer	6802SE ⁸⁴		

PICKUP 1 TON, C35/3500

01-03	Exc. HD Straight Front Axle	⊕ ⊖	77489	⊕ ⊖	G63488	81667	77488	49218 ⁷
97-03	All	⊕ ⊖	⊕ ⊖	77488
03	HD Solid Front Axle	⊕ ⊖	⊕ ⊖	61543	58488 77488
01-02	HD Solid Front Axle	⊕ ⊖	⊕ ⊖	58488 77488
	HD, Solid Front Axle	⊕ ⊖	G63812	⊕ ⊖	77488
98-00	Exc. HD Straight Front Axle	⊕ ⊖	81668	77489	⊕ ⊖	77488	49218 ⁷
	Crew Cab Pickup Exc. HD Straight Front Axle	⊕ ⊖	G63489	61544	58489	⊕ ⊖	G63488	77488
	Extended Cab Pickup Exc. HD Straight Front Axle	⊕ ⊖	G63489	61544	58489	⊕ ⊖	G63488	81667	77488
	Standard Cab Pickup Exc. HD Straight Front Axle	⊕ ⊖	G63489	61544	58489	⊕ ⊖	G63488	81667	77488
97	Exc. HD Straight Front Axle	⊕ ⊖	81668	⊕ ⊖	77488	49218 ⁷

6 It is recommended that when replacing shocks on vehicles with "quad shocks" all 4 shocks should be matched by series.

8 Pair Packs.

80 Mounting bracket not required, install on O.E. Shock Mounts. See Ref. C for optional Steering Stabilizer Boots.

84 Replacement damper for vehicles with the Gabriel Aftermarket mounting kit

7 Pair Packs, air hose kit included.

50 Bellows Kit No. 141242 is recommended for use to protect piston rod from potentially harmful road debris.

82 Use kit if listed, See Ref. C for optional Steering Stabilizer Boots.

APPLICATION GUIDE

Year	Fitment Notes										
		Ultra	ProGuard\Guardian\Classic	Max Control\LTV	Strut Cushion\Strut Mount	HiJackers\Load Carrier	Ultra	ProGuard\Guardian\Classic	Max Control\LTV	Strut Cushion\Strut Mount	HiJackers\Load Carrier

CHEVROLET

CHEVROLET

PICKUP 1 TON, C35/3500 (cont)

97	Crew Cab Pickup Exc. HD Straight Front Axle	⊕	G63489	61544	58489 77489	⊕	G63488	77488
	Extended Cab Pickup Exc. HD Straight Front Axle	⊕	G63489	61544	58489 77489	⊕	G63488	81667	77488
	Standard Cab Pickup Exc. HD Straight Front Axle	⊕	G63489	61544	58489 77489	⊕	G63488	81667	77488
96	All	⊕	⊕	77488	49218 ⁷
	Exc. HD Straight Front Axle	⊕	81668	⊕	77488	49218 ⁷
	Crew Cab Pickup Exc. HD Straight Front Axle	⊕	G63489	61544	58489 77489	⊕	G63488	77488	49218 ⁷
	Extended Cab Pickup Exc. HD Straight Front Axle	⊕	G63489	61544	58489 77489	⊕	G63488	81667	77488	49218 ⁷
	Standard Cab Pickup Exc. HD Straight Front Axle	⊕	G63489	61544	58489 77489	⊕	G63488	81667	77488	49218 ⁷
92-95	Exc. HD Straight Front Axle	⊕	81668	⊕	77488	49218 ⁷
	Crew Cab Pickup Exc. HD Straight Front Axle	⊕	G63489	61544	58489 77489	⊕	G63488	77488
	Extended Cab Pickup Exc. HD Straight Front Axle	⊕	G63489	61544	58489 77489	⊕	G63488	81667	77488
	Standard Cab Pickup Exc. HD Straight Front Axle	⊕	G63489	61544	58489 77489	⊕	G63488	81667	77488
91-95	All	⊕	⊕	77488
	Exc. HD Straight Front Axle	⊕	⊕	77488	49218 ⁷
91	Cab & Chassis Exc. HD Solid Front Axle	⊕	G63355	61525 81039	58355 77355	34036 ⁸	⊕	G63366	61649 81174	58366 77488
	Extended Cab Pickup Exc. HD Straight Front Axle	⊕	G63489	61544 81668	58489 77489	⊕	G63488	81667	77488
	Standard Cab Pickup Exc. HD Straight Front Axle	⊕	G63489	61544 81668	58489 77489	⊕	81667	77488
	Cab & Chassis Exc. HD Solid Front Axle	⊕	G63355	61525 81039	58355 77355	34036 ⁸	⊕	G63366	61649 81174	58366
88-90	Extended Cab Pickup Exc. HD Straight Front Axle	⊕	G63489	61544 81668	58489 77489	⊕	G63488	61543 81667	58488 77488	43163 ⁹ 49218 ⁷
	Standard Cab Pickup Exc. HD Straight Front Axle	⊕	G63489	61544 81668	58489 77489	⊕	G63488	61543 81667	58488 77488	43163 ⁹ 49218 ⁷
	Cab & Chassis Exc. HD Solid Front Axle	⊕	G63355	61525 81039	58355 77355	34036 ⁸	⊕	G63366	61649 81174	58366

PICKUP 1 TON, C35/3500 STEERING STABILIZERS

							Front	Rear
03	HD Pick UP; O.E. Replacement Stabilizer Single System						6807SE ⁸⁰

PICKUP 1 TON, K30

77-86	All	⊕	G63411	58411	⊕	G63675	61642 81921	58412 77412
-------	-----	---	--------	------	-------	------	------	------	---	--------	----------------	----------------	------	------

PICKUP 1 TON, K30 STEERING STABILIZERS

							Front	Rear
77-86	All						14017
	Dual System Steering Stabilizer						6802SE ⁸⁴
	Single System Steering Stabilizer						6804SE ⁸⁰
73-74	All						14017

PICKUP 1 TON, K35 / K3500

88-00	All	⊕	G63609	61542 81726	58609 77609	43163 ⁹ 49218 ⁷	⊕	G63488	61543 81667	58488 77488
-------	-----	---	--------	----------------	----------------	------	------	------	--	---	--------	----------------	----------------	------	------

PICKUP 1 TON, K35 / K3500 STEERING STABILIZERS

							Front	Rear
95-00	Exc. O.E. Steering Stabilizer						6853SE
88-00	Single System Steering Stabilizer						6807SE ⁸⁰

PICKUP 1 TON, R30

87-88	All	⊕	G63355	61525 81039	58355 77355	34036 ⁸	⊕	G63366	61649	58366
	RWD	⊕	G63355	61525 81039	58355 77355	34036 ⁸	⊕	G63366	81174 61649	58366



7 Pair Packs, air hose kit included.

80 Mounting bracket not required, install on O.E. Shock Mounts. See Ref. C for optional Steering Stabilizer Boots.

8 Pair Packs.

84 Replacement damper for vehicles with the Gabriel Aftermarket mounting kit

APPLICATION GUIDE

Year	Fitment Notes										
		Ultra	ProGuard\Guardian\Classic	Max Control\LTV	Strut Cushion\Strut Mount	HiJackers\Load Carrier	Ultra	ProGuard\Guardian\Classic	Max Control\LTV	Strut Cushion\Strut Mount	HiJackers\Load Carrier

CHEVROLET

CHEVROLET

PICKUP 1 TON, R30 STEERING STABILIZERS

		Front	Rear
87-88	Single System Steering Stabilizer; with Cooler	6802SE ⁸⁴

PICKUP 1 TON, R3500

90-91	All	⊙ G63411	81039	58411	⊙ G63675	61642 81921	58412 77412
89	All	⊙	81039	⊙
	Exc. Standard Cab	⊙ G63411	81039	58411	⊙ G63675	61642 81921	58412 77412
	Standard Cab Pickup	⊙ G63355	61525 81039	58355 77355	34036 ⁸	⊙ G63366	61649 81174	58366

PICKUP 1 TON, R3500 STEERING STABILIZERS

		Front	Rear
89-91	Single System Steering Stabilizer; with Cooler	6802SE ⁸⁴
	RWD	14017

PICKUP 1 TON, SILVERADO 3500

11-13	All	⊙	⊙ G64121	58943
08-09	All	⊙ G63817	61663	58817 77817	⊙ G63675	61642 81921	58412 77412
07	All	⊙ G63817	61663	58817 77817	⊙ G63675	61642 81921	77412
01-06	All	⊙ G63817	61663	58817 77817	⊙ G63675	61642 81921	58412 77412

PICKUP 1 TON, SILVERADO 3500 HD

11-13	All	⊙	⊙	58943
07-10	All	⊙ G63817	61663	58817 77817	⊙ G63675	61642 81921	58412 77412

PICKUP 1 TON, SILVERADO 3500 HD STEERING STABILIZERS

		Front	Rear
11-13	All	14075

PICKUP 1 TON, V30

87-88	All	⊙ G63411	58411	⊙ G63675	61642 81921	58412 77412
-------	-----	----------	------	-------	------	------	----------	----------------	----------------	------	------

PICKUP 1 TON, V30 STEERING STABILIZERS

		Front	Rear
87-88	All	14017

PICKUP 1 TON, V3000 / V3500

89-91	All	⊙ G63411	58411	⊙ G63675	61642 81921	58412 77412
-------	-----	----------	------	-------	------	------	----------	----------------	----------------	------	------

PICKUP 1 TON, V3000 / V3500 STEERING STABILIZERS

		Front	Rear
89-91	All	14017

PICKUP STEERING STABILIZERS

		Front	Rear
60	Truck Dana 60 Axle up to 3 1/2" O.D. or Napco axle up to 3 3/8" O.D.	6803SE ⁸⁴
57-58	Truck Dana 60 Axle up to 3 1/2" O.D. or Napco axle up to 3 3/8" O.D.	6803SE ⁸⁴
50-58	Truck Single System Steering Stabilizer; with I-Beam Axle	6802SE ⁸⁴

PRIZM

98-02	Left	⊙ G55999	M55999	143059 ⁵¹ 143281 ⁵³	⊙ G55661	M55661	143058 ⁵¹
	Right	⊙ G55999	M55999	143059 ⁵¹ 143281 ⁵³	⊙ G55662	M55662	142229 ⁵³

8 Pair Packs.

51 Strut Cushion for use with the Strut/Cartridge/Shocks.

APPLICATION GUIDE

















Year	Fitment Notes	Front					Rear				
		Ultra	ProGuard\ Guardian\ Classic	Max Control\ LTV	Strut Cushion\ Strut Mount	HiJackers\ Load Carrier	Ultra	ProGuard\ Guardian\ Classic	Max Control\ LTV	Strut Cushion\ Strut Mount	HiJackers\ Load Carrier

CHEVROLET

CHEVROLET

PRIZM READYMOUNTS		Front		Rear	
		Ultra Readymount	Guardian Readymount	Ultra Readymount	Guardian Readymount
98-02	Left	G56948 ⁴⁰	M56948 ⁴⁰	G56949 ⁴⁰	M56949 ⁴⁰
	Right	G56948 ⁴⁰	M56948 ⁴⁰	G56950 ⁴⁰	M56950 ⁴⁰





S10

99-04	4WD; Exc. ZR2, ZR5 or Sport Chassis	 G63423	61531 81516	58423 77423	 G63422	61528 81482	58422 77422	43162 ³ 49213 ⁷
88-04	4WD, Torsion Bar(FrontSpringType)		142316 ⁵³
99-03	RWD; Exc. Sport Chassis or Xtreme Chassis	 G63421	61504 81750	58421 77421	34051 ⁸	 G63422	61528 81482	58422 77422	43162 ³ 49213 ⁷
92-98	4WD; Exc. ZR2, ZR5 or Sport Chassis	 G63423	61531 81516	58423 77423
	Exc. ZR2, ZR5 or Sport Chassis		 G63422	61528 81482	58422 77422	43162 ³ 49213 ⁷
	RWD; Exc. Sport Chassis or Xtreme Chassis	 G63421	61504 81750	58421 77421	34051 ⁸
91	4WD; Exc. ZR2, Baja & Sport Chassis	 G63423	61531 81516	58423 77423
	Exc. ZR2, Baja & Sport Chassis		 G63422	61528 81482	58422 77422	43162 ³ 49213 ⁷
	RWD; Exc. ZR2, Baja & Sport Chassis	 G63421	61504 81750	58421 77421	34051 ⁸
83-90	4WD; Exc. ZR2, ZR5 or Sport Chassis	 G63423	61531 81516	58423 77423
82-90	Exc. ZR2, ZR5 or Sport Chassis		 G63422	61528 81482	58422 77422	43162 ³ 49213 ⁷
	RWD; Exc. Sport Chassis or Xtreme Chassis	 G63421	61504 81750	58421 77421	34051 ⁸





S10 STEERING STABILIZERS

		Front	Rear
83-04	4WD, Single System Steering Stabilizer; with a factory mounting hole in the steering linkage.	6801SE
	4WD, Single System Steering Stabilizer; without a factory mounting hole in the steering linkage.	6851SE
82-03	RWD, Single System Steering Stabilizer	6802SE ⁸⁴

SILVERADO 1500 HD CLASSIC

07	All	 G63817	61663 81925	58817 77817	 G63675	81921	58412
	4WD	 G63817	61663 81925	58817 77817	 G63675	61642 81921	77412 58412



SILVERADO 2500 HD CLASSIC

07	All			58412 77412
	9200# GVW		58817		58412 77412





SILVERADO 3500 CLASSIC

07	All			58412
----	-----	---	------	------	------	------	---	------	-------	------	------

SPECTRUM

85-88	All	 G55719	143058 ⁵¹		81558
-------	-----	--	------	------	----------------------	------	---	-------	------	------	------

SPRINT

89-91	All	 G55891	142293 ⁵⁴ 143059 ⁵¹	 G55772	142295 ⁵³ 143057 ⁵¹
85-88	All	 G55749	

7 Pair Packs, air hose kit included.

40 Complete Assembled Unit.

53 Strut Mount. Hardware from O.E. Part may need to be reused.

84 Replacement damper for vehicles with the Gabriel Aftermarket mounting kit



Bold Type - New / Future Part

8 Pair Packs.

51 Strut Cushion for use with the Strut/Cartridge/Shocks.

54 Kit with Mount and Bearing. Hardware from O.E. Part may need to be reused.



APPLICATION GUIDE

Year	Fitment Notes										
		Ultra	ProGuard/ Guardian/ Classic	Max Control/ LTV	Strut Cushion/ Strut Mount	HiJackers/ Load Carrier	Ultra	ProGuard/ Guardian/ Classic	Max Control/ LTV	Strut Cushion/ Strut Mount	HiJackers/ Load Carrier



CHEVROLET

CHEVROLET



SSR

03-06	All		G51718 ⁴⁵	M51718⁴⁵	143241 ⁵³		G63842
-------	-----	---	----------------------	----------------------------	------	----------------------	------	---	--------	------	------	------	------





















STYLELINE DELUXE

49-52	All		82026		82155
-------	-----	---	------	-------	------	------	------	---	------	-------	------	------	------

STYLELINE SPECIAL

49-52	All		82026		82155
-------	-----	---	------	-------	------	------	------	---	------	-------	------	------	------

SUBURBAN 1/2 TON, 1500

15-16	All			G64101
14	All			G64101	77975
	Exc. Z55 or ZW7 Ride Suspension		G51891		G64101	77975
12-13	All			G64101
	Exc. Z55 or ZW7 Ride Suspension		G51891	143316 ⁵³		G64101
07-11	All		M51891	
	Exc. Z55 or ZW7 Ride Suspension		G51891	M51891	143316 ⁵³		G63866	61675 81930	58930 77953
00-06	Exc. Z55 Auto Ride Suspension		G63803	61643 81922	58803 77803		G63866	61675 81930	58930 77953
63-66	All		G63355	61525 81039	58355 77355	34036 ⁸		G63306	82006	43093 ⁸ 49162 ⁷
61-62	All		82035		82086







SUBURBAN 1/2 TON, 1500 READYMOUNTS

		Front				Rear			
		Ultra Readymount		Guardian Readymount		Ultra Readymount		Guardian Readymount	
12-13	Exc. Z55 or ZW7 Ride Suspension	G57125 ⁴⁰		
07-11	All		M57125⁴⁰		
	Exc. Z55 or ZW7 Ride Suspension	G57125 ⁴⁰		M57125⁴⁰		

SUBURBAN 1/2 TON, 1500 STEERING STABILIZERS

		Front	Rear
00-05	4WD, Exc. O.E. Steering Stabilizer	6853SE ⁸²

SUBURBAN 1/2 TON, C10

73-86	All		G63355	61525 81039	58355 77355	34036 ⁸		G63349	61524 81164	58349 77349	43111 ⁸ 49155 ⁷
68-72	All		G63355	61525 81039	58355 77355	34036 ⁸		82003	43062 ⁸ 49107 ⁷
67	All		G63355	61525 81039	58355 77355	34036 ⁸		43062 ⁸

SUBURBAN 1/2 TON, C10 STEERING STABILIZERS

		Front	Rear
68-86	Single System Steering Stabilizer	6802SE ⁸⁴

SUBURBAN 1/2 TON, C15 / C1500

92-99	All		G63489	61544 81668	58489 77489		G63896	61565 81789	58638 77638	43180 ⁸ 49231 ⁷
-------	-----	---	--------	----------------	----------------	------	------	---	--------	----------------	----------------	------	--

SUBURBAN 1/2 TON, C15 / C1500 STEERING STABILIZERS

		Front	Rear
92-99	RWD	6852SE ⁸²

7 Pair Packs, air hose kit included.

40 Complete Assembled Unit.

53 Strut Mount. Hardware from O.E. Part may need to be reused.



84 Replacement damper for vehicles with the Gabriel Aftermarket mounting kit

8 Pair Packs.

45 Strut must be rotated to align notch with lower control arm.

82 Use kit if listed, See Ref. C for optional Steering Stabilizer Boots.

APPLICATION GUIDE

Year	Fitment Notes										
		Ultra	ProGuard\ Guardian\ Classic	Max Control\ LTV	Strut Cushion\ Strut Mount	HiJackers\ Load Carrier	Ultra	ProGuard\ Guardian\ Classic	Max Control\ LTV	Strut Cushion\ Strut Mount	HiJackers\ Load Carrier

CHEVROLET

CHEVROLET

SUBURBAN 1/2 TON, K10

81-86	Exc. Lift Kit	⊙	G63347	77355	⊙	G63349	61524 81164	77349	43111 ⁸
	Quad Suspension Long Shock; Exc. Lift Kit	⊙	G63906 ⁶	61522 ⁶ 81496 ⁶	58906 ⁶ 77355	⊙
	Quad Suspension Short Shock; Exc. Lift Kit	⊙	G63908 ⁶	61516 ⁶	58908 ⁶ 77355	⊙
	Standard Suspension; Exc. Lift Kit	⊙	81113 ⁶	58347 77355	43107 ⁸	⊙	58349	49155 ⁷
73-86	All	⊙	77355	⊙
	4" Lift Kit; Exc. Quad Suspension	⊙	G63437 ⁹⁰	58437 ⁹⁰ 77355	⊙	G63438 ⁹⁰	58438 ⁹⁰
75-80	Exc. Lift Kit	⊙	G63347	61516 ⁶ 81113 ⁶	58347 77355	43107 ⁸	⊙	G63349	61524 81164	58349 77349	43111 ⁸ 49155 ⁷
73-74	Exc. Lift Kit	⊙	G63347	61516 ⁶ 81113 ⁶	58347 77355	43107 ⁸	⊙	G63349	61524	58349 77349	43111 ⁸ 49155 ⁷
71-72	All	⊙	77355	⊙	G63371
	Exc. Lift Kit	⊙	G63347	61516 ⁶ 81113 ⁶	58347 77355	43107 ⁸	⊙	G63371
69-70	Exc. Lift Kit	⊙	G63347	61516 ⁶ 81113 ⁶	58347 77355	43107 ⁸	⊙
68-70	All	⊙	77355	⊙

SUBURBAN 1/2 TON, K10 STEERING STABILIZERS

		Front	Rear
73-86	All	14017
	Dual System Steering Stabilizer	6802SE ⁸⁴
	Single System Steering Stabilizer	6804SE ⁸⁰
68-72	Dual System Steering Stabilizer	6802SE ⁸⁴
	Single System Steering Stabilizer	6803SE ⁸⁴

SUBURBAN 1/2 TON, K15 / K1500

92-99	All	⊙	G63609	61542 81726	58609 77609	⊙	G63638	61565 81789	58638 77638	43180 ⁸ 49231 ⁷
-------	-----	---	--------	----------------	----------------	------	------	---	--------	----------------	----------------	------	--

SUBURBAN 1/2 TON, K15 / K1500 STEERING STABILIZERS

		Front	Rear
92-97	Single System Steering Stabilizer	6807SE ⁸⁰

SUBURBAN 1/2 TON, R10

87-88	All	⊙	G63355	61525 81039	58355 77355	34036 ⁸	⊙	G63349	61524 81164	58349 77349	43111 ⁸
	RWD	⊙	G63355	61525 81039	58355 77355	34036 ⁸	⊙	G63349	61524 81164	58349 77349	49155 ⁷ 43111 ⁸
	RWD, Exc. Quad Suspension and Lift Kit	⊙	G63355	61525 81039	58355 77355	43107 ⁸ 34036 ⁸	⊙	G63349	61524 81164	58349 77349	43111 ⁸

SUBURBAN 1/2 TON, R10 STEERING STABILIZERS

		Front	Rear
87-88	Dual System Steering Stabilizer	6802SE ⁸⁴
	Single System Steering Stabilizer	6804SE ⁸⁰
	RWD	14017

SUBURBAN 1/2 TON, R1500

89-91	All	⊙	G63355	61525 81039	58355 77355	34036 ⁸	⊙	G63349	61524 81164	58349 77349	43111 ⁸
	RWD	⊙	G63355	61525 81039	58355 77355	34036 ⁸	⊙	G63349	61524 81164	58349 77349	49155 ⁷ 43111 ⁸

SUBURBAN 1/2 TON, R1500 STEERING STABILIZERS

		Front	Rear
89-91	Single System Steering Stabilizer	6802SE ⁸⁴

6 It is recommended that when replacing shocks on vehicles with "quad shocks" all 4 shocks should be matched by series.

8 Pair Packs.

80 Mounting bracket not required, install on O.E. Shock Mounts. See Ref. C for optional Steering Stabilizer Boots.

7 Pair Packs, air hose kit included.

50 Bellows Kit No.141242 is recommended for use to protect piston rod from potentially harmful road debris.

84 Replacement damper for vehicles with the Gabriel Aftermarket mounting kit

APPLICATION GUIDE

Year	Fitment Notes										
		Ultra	ProGuard/ Guardian/ Classic	Max Control/ LTV	Strut Cushion/ Strut Mount	HiJackers/ Load Carrier	Ultra	ProGuard/ Guardian/ Classic	Max Control/ LTV	Strut Cushion/ Strut Mount	HiJackers/ Load Carrier

CHEVROLET

CHEVROLET

SUBURBAN 1/2 TON, V10

87-88	Exc. Lift Kit	58349
	Quad Suspension Long Shock; Exc. Lift Kit	...	61522 ⁶ 81496 ⁶
	Quad Suspension Short Shock; Exc. Lift Kit	...	61516 ⁶ 81113 ⁶

SUBURBAN 1/2 TON, V1500

89-91	All	49155 ⁷
	Exc. Lift Kit	43111 ⁸ 49155 ⁷
	Exc. Quad Suspension and Lift Kit	...	61516	49155 ⁷
	Quad Suspension Long Shock; Exc. Lift Kit	G63906 ⁶	49155 ⁷
	Quad Suspension Short Shock; Exc. Lift Kit	G63908 ⁶	49155 ⁷
	4WD, 4" Lift Kit; Exc. Quad Suspension	G63437 ⁵⁰	...	58437 ⁵⁰	49155 ⁷

SUBURBAN 3/4 TON, 2500

07-11	All	...	M51891
	Exc. Z55 Auto Ride Suspension and Quadrasteer	G63817	61663 81925 M51891	58817 77817	G63866	61675 81930	58930 77953
00-06	Exc. Z55 Auto Ride Suspension and Quadrasteer	G63817	61663 81925	58817 77817	G63866	61675 81930	58930 77953

SUBURBAN 3/4 TON, 2500 READYMOUNTS

		Front		Rear	
		Ultra Readymount	Guardian Readymount	Ultra Readymount	Guardian Readymount
07-11	All	...	M57125 ⁴⁰

SUBURBAN 3/4 TON, 2500 STEERING STABILIZERS

		Front	Rear
00-05	4WD, Exc. O.E. Steering Stabilizer	6853SE ⁸²	...

SUBURBAN 3/4 TON, C20

73-86	All	G63355	61525 81039	58355 77355	...	34036 ⁶	G63349	61524 81164	58349 77349	...	43111 ⁸ 49155 ⁷
68-72	All	G63355	61525 81039	58355 77355	...	34036 ⁶	...	82003	43062 ⁸ 49107 ⁷
67	All	...	61525	34036 ⁶

SUBURBAN 3/4 TON, C20 STEERING STABILIZERS

		Front	Rear
68-86	Single System Steering Stabilizer	6802SE ⁸⁴	...

SUBURBAN 3/4 TON, C25 / C2500

92-99	All	G63489	61544 81668	58489 77489	G63896	61565 81789	58638 77638	...	43180 ⁸ 49231 ⁷
-------	-----	--------	----------------	----------------	-----	-----	--------	----------------	----------------	-----	--

SUBURBAN 3/4 TON, C25 / C2500 STEERING STABILIZERS

		Front	Rear
92-99	RWD	6852SE ⁸²	...

SUBURBAN 3/4 TON, K20

81-86	Exc. Lift Kit	G63347	...	77355	G63349	61524 81164	77349	...	43111 ⁸
	Quad Suspension Long Shock; Exc. Lift Kit	G63906 ⁶	61522 ⁶ 81496 ⁶	58906 ⁶

6 It is recommended that when replacing shocks on vehicles with "quad shocks" all 4 shocks should be matched by series.

8 Pair Packs.

50 Bellows Kit No.141242 is recommended for use to protect piston rod from potentially harmful road debris.



84 Replacement damper for vehicles with the Gabriel Aftermarket mounting kit

7 Pair Packs, air hose kit included.

40 Complete Assembled Unit.

82 Use kit if listed, See Ref. C for optional Steering Stabilizer Boots.

APPLICATION GUIDE

Year	Fitment Notes										
		Ultra	ProGuard\ Guardian\ Classic	Max Control\ LTV	Strut Cushion\ Strut Mount	HiJackers\ Load Carrier	Ultra	ProGuard\ Guardian\ Classic	Max Control\ LTV	Strut Cushion\ Strut Mount	HiJackers\ Load Carrier

CHEVROLET

CHEVROLET

SUBURBAN 3/4 TON, K20 (cont)

81-86	Quad Suspension Short Shock; Exc. Lift Kit	○	G63908 ⁸	61516 ⁶	58908 ⁶
	Standard Suspension; Exc. Lift Kit	○	81113 ⁶	58347	58349	49155 ⁷
73-86	4" Lift Kit; Exc. Quad Suspension	○	G63437 ⁵⁰	58437 ⁵⁰	58438 ⁵⁰
73-80	Exc. Lift Kit	○	G63347	61516 ⁶	58347	43111 ⁸
		○	81113 ⁶	77355	77349	49155 ⁷
71-72	Exc. Lift Kit	○	G63347	61516 ⁶	58347
		○	81113 ⁶	77355
69-70	Exc. Lift Kit	○	G63347	61516 ⁶	58347
68	Exc. Lift Kit	○	77355
		○

SUBURBAN 3/4 TON, K20 STEERING STABILIZERS

		Front		Rear	
73-86	All	14017		
	Dual System Steering Stabilizer	6802SE ⁸⁴		
	Single System Steering Stabilizer	6804SE ⁸⁰		
68-72	Dual System Steering Stabilizer	6802SE ⁸⁴		
	Single System Steering Stabilizer	6803SE ⁸⁴		

SUBURBAN 3/4 TON, K25 / K2500

92-99	All	○	G63609	61542 81726	58609 77609	○	G63638	61565 81789	58638 77638	43180 ⁸ 49231 ⁷
-------	-----	---	--------	----------------	----------------	------	------	---	--------	----------------	----------------	------	--

SUBURBAN 3/4 TON, K25 / K2500 STEERING STABILIZERS

		Front		Rear	
95-99	Exc. O.E. Steering Stabilizer	6853SE ⁸²		
92-97	Single System Steering Stabilizer	6807SE ⁸⁰		

SUBURBAN 3/4 TON, R20

87-88	All	○	G63355	61525 81039	58355 77355	34036 ⁸	○	G63349	61524 81164	58349 77349	43111 ⁸
	RWD	○	G63355	61525 81039	58355 77355	34036 ⁸	○	G63349	61524 81164	58349 77349	49155 ⁷ 43111 ⁸

SUBURBAN 3/4 TON, R20 STEERING STABILIZERS

		Front		Rear	
87-88	Single System Steering Stabilizer	6802SE ⁸⁴		

SUBURBAN 3/4 TON, R2500

89-91	All	○	G63355	61525 81039	58355 77355	34036 ⁸	○	G63349	61524 81164	58349 77349	43111 ⁸
	RWD	○	G63355	61525 81039	58355 77355	34036 ⁸	○	G63349	61524 81164	58349 77349	49155 ⁷ 43111 ⁸

SUBURBAN 3/4 TON, R2500 STEERING STABILIZERS

		Front		Rear	
89-91	Single System Steering Stabilizer	6802SE ⁸⁴		

SUBURBAN 3/4 TON, V20

87-88	All	○	○	49155 ⁷
	4" Lift Kit; Exc. Quad Suspension	○	G63437 ⁵⁰	58437 ⁵⁰	○	G63438 ⁵⁰	58438 ⁵⁰	49155 ⁷
	Exc. Quad Suspension and Lift Kit	○	G63347	58347	○	G63349	61524 81164	58349 77349	43111 ⁸ 49155 ⁷
	Quad Suspension Long Shock; Exc. Lift Kit	○	G63906 ⁶	61522 ⁶ 81496 ⁶	58906 ⁶	○	49155 ⁷
	Quad Suspension Short Shock; Exc. Lift Kit	○	G63908 ⁸	61516 81113 ⁶	58908 ⁶	○	49155 ⁷

6 It is recommended that when replacing shocks on vehicles with "quad shocks" all 4 shocks should be matched by series.

8 Pair Packs.

80 Mounting bracket not required, install on O.E. Shock Mounts. See Ref. C for optional Steering Stabilizer Boots.

84 Replacement damper for vehicles with the Gabriel Aftermarket mounting kit

7 Pair Packs, air hose kit included.

50 Bellows Kit No.141242 is recommended for use to protect piston rod from potentially harmful road debris.

82 Use kit if listed, See Ref. C for optional Steering Stabilizer Boots.

APPLICATION GUIDE

Year	Fitment Notes										
		Ultra	ProGuard\ Guardian\ Classic	Max Control\ LTV	Strut Cushion\ Strut Mount	HiJackers\ Load Carrier	Ultra	ProGuard\ Guardian\ Classic	Max Control\ LTV	Strut Cushion\ Strut Mount	HiJackers\ Load Carrier

CHEVROLET

CHEVROLET

SUBURBAN 3/4 TON, V20 STEERING STABILIZERS

		Front	Rear
87-88	All	14017
	Dual System Steering Stabilizer	6802SE ⁸⁴
	Single System Steering Stabilizer	6804SE ⁸⁰

SUBURBAN 3/4 TON, V2500

89-91	All	49155 ⁷		
	4" Lift Kit; Exc. Quad Suspension	G63437 ⁵⁰	58437 ⁵⁰	G63438 ⁵⁰	58438 ⁵⁰	49155 ⁷
	Exc. Lift Kit	G63347	58347	G63349	61524 81164	58349 77349	43111 ⁸ 49155 ⁷
	Quad Suspension Long Shock; Exc. Lift Kit	G63906 ⁶	61522 ⁶ 81496 ⁶	58906 ⁵	49155 ⁷
	Quad Suspension Short Shock; Exc. Lift Kit	G63908 ⁶	61516 81113 ⁶	58908 ⁵	49155 ⁷

SUBURBAN 3/4 TON, V2500 STEERING STABILIZERS

		Front	Rear
89-91	All	14017
	Dual System Steering Stabilizer	6802SE ⁸⁴
	Single System Steering Stabilizer	6804SE ⁸⁰

TAHOE

16	Exc. Police Package	G64101
15	All	G51960	G64107
	Exc. Police Package	G51960	G64101 G64107
12-14	All	77975
	Exc. Police Package	G64101	77975
	Exc. Z55 or ZW7 Ride Suspension	G51891	143316 ⁵³	77975
07-11	All	M51891
	Exc. Z55 or ZW7 Ride Suspension	G51891	M51891	143316 ⁵³	G63866	61675 81930	58930 77953
11	Exc. Police Package	M51891	G64101
02-06	Exc. Z55 Auto Ride Suspension	G63803	61643 81922	58803 77803	G63866	61675 81930	58930 77953
00-01	New Body Style; Exc. Z55 Auto Ride Suspension	G63803	61643 81922	58803 77803	G63866	61675 81930	58930 77953
95-00	Old Body Style	61565 81789	58638 77638	43180 ⁸ 49231 ⁷
	4WD, Old Body Style	G63609	61542 81726	58901 77609	G63638
	RWD, Old Body Style	G63489	61544 81668	58489 77489	G63896

TAHOE READYMOUNTS

		Front		Rear	
		Ultra Readymount	Guardian Readymount	Ultra Readymount	Guardian Readymount
12-14	Exc. Z55 or ZW7 Ride Suspension	G57125 ⁴⁰
07-11	All	M57125⁴⁰
	Exc. Z55 or ZW7 Ride Suspension	G57125 ⁴⁰	M57125⁴⁰

6 It is recommended that when replacing shocks on vehicles with "quad shocks" all 4 shocks should be matched by series.

8 Pair Packs.

50 Bellows Kit No. 141242 is recommended for use to protect piston rod from potentially harmful road debris.

80 Mounting bracket not required, install on O.E. Shock Mounts. See Ref. C for optional Steering Stabilizer Boots.

7 Pair Packs, air hose kit included.

40 Complete Assembled Unit.

53 Strut Mount. Hardware from O.E. Part may need to be reused.

84 Replacement damper for vehicles with the Gabriel Aftermarket mounting kit

APPLICATION GUIDE

Year	Fitment Notes										
		Ultra	ProGuard\ Guardian\ Classic	Max Control\ LTV	Strut Cushion\ Strut Mount	HiJackers\ Load Carrier	Ultra	ProGuard\ Guardian\ Classic	Max Control\ LTV	Strut Cushion\ Strut Mount	HiJackers\ Load Carrier

CHEVROLET

CHEVROLET

TAHOE STEERING STABILIZERS

		Front	Rear
01-05	4WD, New Body Style; Exc. Z55 Auto Ride Suspension	6853SE ⁸²
95-00	4WD, Old Body Style	6853SE ⁸²
95-99	RWD	6852SE ⁸²

TORNADO

04-08	All
-------	-----	------	------	------	------	------	------	------	------	------

TOWNSMAN

71-72	All	69675 ⁵	81446	34073 ⁸	69604	81492
69-70	All	69675 ⁵	81446	34073 ⁸	69724	81514	43049 ⁶ 49131 ³⁰

TRACKER

99-04	All	143204 ⁵³
04	Non-ABS	G56518	M56518	143204 ⁵³	G63799	61560 81904	49613 ⁷
99-03	Non-ABS	G56518	M56518	142294 ⁵⁴ 143204 ⁵³	G63799	61560 81904	49613 ⁷
98	Non-ABS	G56518	M56518	142294 ⁵⁴	G63799	61560 81904	49613 ⁷

TRAILBLAZER

06-09	All	M51718 ⁴⁵	143241 ⁵³
	Air(RearSpringType)	M51718 ⁴⁵	143241 ⁵³	G64014	61717
	Coil(RearSpringType)	M51718 ⁴⁵	143241 ⁵³	G63842	77971
	Exc. SS Models	G51718 ⁴⁵	M51718 ⁴⁵	143241 ⁵³
02-05	All	G51718 ⁴⁵	M51718 ⁴⁵	143241 ⁵³
	Air(RearSpringType)	G51718 ⁴⁵	M51718 ⁴⁵	143241 ⁵³	G64014	61717
	Coil(RearSpringType)	G51718 ⁴⁵	M51718 ⁴⁵	143241 ⁵³	G63842	77971

TRAILBLAZER EXT

02-06	All	G51718	M51718	77971
-------	-----	--------	--------	------	------	------	------	------	-------	------	------

TRAILBLAZER EXT READYMOUNTS

		Front		Rear	
		Ultra Readymount	Guardian Readymount	Ultra Readymount	Guardian Readymount
02-06	All	G57022 ⁴⁰	M57022 ⁴⁰

TRAILBLAZER READYMOUNTS

		Front		Rear	
		Ultra Readymount	Guardian Readymount	Ultra Readymount	Guardian Readymount
06-09	Exc. SS Models	G57022 ⁴⁰	M57022 ⁴⁰
02-05	All	G57022 ⁴⁰	M57022 ⁴⁰

TRAVERSE

15-16	All	G64040
-------	-----	------	------	------	------	------	--------	------	------	------	------

5 Use kit No. 140719 to replace O.E. hardware for lower shock absorber mounting when studs break or self-tapping screws are not longer useable.

8 Pair Packs.

40 Complete Assembled Unit.

53 Strut Mount. Hardware from O.E. Part may need to be reused.

82 Use kit if listed, See Ref. C for optional Steering Stabilizer Boots.

Bold Type - New / Future Part



7 Pair Packs, air hose kit included.

30 For GM Vehicles equipped with factory installed leveling systems, see Ref A.

45 Strut must be rotated to align notch with lower control arm.

54 Kit with Mount and Bearing. Hardware from O.E. Part may need to be reused.

APPLICATION GUIDE

Year	Fitment Notes										
		Ultra	ProGuard\ Guardian\ Classic	Max Control\ LTV	Strut Cushion\ Strut Mount	HiJackers\ Load Carrier	Ultra	ProGuard\ Guardian\ Classic	Max Control\ LTV	Strut Cushion\ Strut Mount	HiJackers\ Load Carrier

CHEVROLET

CHEVROLET

TRAVERSE (cont)

13-14	All	143486 ⁶⁸	⊗ G64040
09-12	All	⊗ G52125	143366	⊗ G64040

TRAVERSE READYMOUNTS

		Front		Rear	
		Ultra Readymount	Guardian Readymount	Ultra Readymount	Guardian Readymount
12	All	G57109
09-11	All	G57109	M57314 ⁴⁰

TRAX

13-16	Left	⊗ G52494	⊗ G511030 ²
	Right	⊗ G52495	⊗ G511030 ²

TWO-TEN SERIES

55-57	All	⊗ 69625	82099	⊗	82066
53-54	All	⊗	82026	⊗	82155

UPLANDER

05-09	Exc. Air-Leveling Suspension	⊗ G52025	⊗
	FWD, Exc. Air-Leveling Suspension	⊗	142526	⊗ G63776
05-08	FWD, Exc. Air-Leveling Suspension & Independent Rear Suspension	⊗	⊗	49230

UPLANDER READYMOUNTS

		Front		Rear	
		Ultra Readymount	Guardian Readymount	Ultra Readymount	Guardian Readymount
05-09	FWD	G57142 ⁴⁰	M57142 ⁴⁰

VAN 1/2 TON, G / EXPRESS

12-14	AWD, Torsion Bar(FrontSpringType)	⊗ G63893	61683	⊗ G63896	81789	58638 77638	43180 ⁸ 49231 ⁷
03-14	All	⊗	⊗ G63896	81789	58638 77638	43180 ⁸ 49231 ⁷
	RWD, Coil(FrontSpringType)	⊗ G63894	61684	⊗ G63896	81789	58638 77638	43180 ⁸ 49231 ⁷
03-11	Exc. Upfitter Package and Cutaway Chassis	⊗	⊗ G63896	61565 81789	58638 77638	43180 ⁸ 49231 ⁷
	Upfitter Package and Cutaway Chassis	⊗	⊗ G63896	61686 81789	58638 77638	43180 ⁸ 49231 ⁷
	Torsion Bar (FrontSpringType)	⊗ G63893	61683	⊗ G63896	81789	58638 77638	43180 ⁸ 49231 ⁷
96-02	All	⊗ G63375 ⁵	61555 81713 ⁵	77375	⊗ G63896	61565 81789	58638 77638	43180 ⁸ 49231 ⁷
78-95	All	⊗ G63357 ⁵	61517 81108	58357 77357	⊗ G63413	61522 81496 ⁵	58413 77413	49212 ⁷
71-77	All	⊗ G63357 ⁵	61517 81108	58357 77357	⊗ G63306	82006	43093 ⁸ 49162 ⁷
70	All	⊗	⊗ G63306	82006	43093 ⁸ 49162 ⁷
	Independent Front Suspension	⊗ G63357 ⁵	61517 81108	58357 77357	⊗ G63306	82006	43093 ⁸ 49162 ⁷
	Solid Front Axle	⊗	82062	⊗ G63306	82006	43093 ⁸ 49162 ⁷

2 Future Part, available 2nd Quarter of 2017.

6 It is recommended that when replacing shocks on vehicles with "quad shocks" all 4 shocks should be matched by series.

8 Pair Packs.

53 Strut Mount. Hardware from O.E. Part may need to be reused.

68 Strut Mount Kit. Hardware from O.E. Part may need to be reused.



5 Use kit No. 140719 to replace O.E. hardware for lower shock absorber mounting when studs break or self-tapping screws are not longer useable.

7 Pair Packs, air hose kit included.

40 Complete Assembled Unit.

54 Kit with Mount and Bearing. Hardware from O.E. Part may need to be reused.

APPLICATION GUIDE

Year	Fitment Notes										
		Ultra	ProGuard\Guardian\Classic	Max Control\LTV	Strut Cushion\Strut Mount	HiJackers\Load Carrier	Ultra	ProGuard\Guardian\Classic	Max Control\LTV	Strut Cushion\Strut Mount	HiJackers\Load Carrier

CHEVROLET

CHEVROLET

VAN 1/2 TON, G / EXPRESS (cont)

67-69	All	○	82062	○	G63306	82006	43093 ⁸ 49162 ⁷
64-66	All	○	82062	○	82003

VAN 1/2 TON, G / EXPRESS STEERING STABILIZERS

		Front	Rear
70-95	Single System Steering Stabilizer	6802SE ⁸⁴

VAN 1/2 TON, P SERIES

74-80	All	○	G63355	61525 81039	58355 77355	34036 ⁸	○	G63366	61649 81174	58366 77662
73	All	○	G63355	61525 81039	58355 77355	34036 ⁸	○	G63349	61524 81164	58349 77349	43111 ⁸ 49155 ⁷
67-72	All	○	G63355	61525 81039	58355 77355	34036 ⁸	○	82003	43062 ⁸ 49107 ⁷
63-66	All	○	G63355	61525 81039	58355 77355	34036 ⁸	○	G63306	82006	43093 ⁸ 49162 ⁷
61-62	All	○	82035	○	82086

VAN 3/4 TON, G / EXPRESS

10-16	All	○	○	G63897	61687	77638
	Coil(FrontSpringType)	⊖	G63895	61685	⊖	G63897	61687	77638
10-12	Torsion Bar (FrontSpringType)	⊖	G63893	61683	⊖	G63897	61687	77638
07-09	All	○	○	G63897	61687 81789	58638 77638
	Coil(FrontSpringType)	⊖	G63895	61685	⊖	G63897	61687 81789	58638 77638
	Torsion Bar (FrontSpringType)	⊖	G63893	61683	⊖	G63897	61687 81789	58638 77638
03-06	All	○	○	G63897	61687	77638
	Coil(FrontSpringType)	⊖	G63895	61685	⊖	G63897	61687	77638
	Torsion Bar (FrontSpringType)	⊖	G63893	61683	⊖	G63897	61687	77638
96-02	Exc. 8600# GVW	⊖	G63375 ⁵	61555 81713 ⁵	77375	⊖	G63638	61565 81789	58638 77638	43180 ⁸ 49231 ⁷
78-95	All	○	G63357 ⁵	○
	Exc. 8600# GVW	○	G63357 ⁵	61517 81108	58357 77357	○	G63413	61522 81496 ⁶	58413 77413	49212 ⁷
71-77	All	○	G63357 ⁵	61517 81108	58357 77357	○	G63306	82006	43093 ⁸ 49162 ⁷
70	All	○	58357	○	G63306	82006	43093 ⁸ 49162 ⁷
	Independent Front Suspension	○	G63357 ⁵	61517 81108	77357 58357	○	G63306	82006	43093 ⁸ 49162 ⁷
	Solid Front Axle	○	82062	58357	○	G63306	82006	43093 ⁸ 49162 ⁷
67-69	All	○	82062	○	G63306	82006	43093 ⁸ 49162 ⁷

VAN 3/4 TON, G / EXPRESS STEERING STABILIZERS

		Front	Rear
78-95	Single System Steering Stabilizer	6802SE ⁸⁴
75-77	All	6802SE ⁸⁴
70-74	Single System Steering Stabilizer	6802SE ⁸⁴

VAN 3/4 TON, P SERIES

79-89	All	○	G63355	61525 81039	58355 77355	34036 ⁸	○	G63366	61649 81174	58366 77662
73-78	All	○	G63355	61525 81039	58355 77355	34036 ⁸	○	G63349	61524 81164	58349 77349	43111 ⁸ 49155 ⁷
68-72	All	○	G63355	61525 81039	58355 77355	34036 ⁸	○	G63306	82006	43093 ⁸ 49162 ⁷

5 Use kit No. 140719 to replace O.E. hardware for lower shock absorber mounting when studs break or self-tapping screws are not longer useable.



7 Pair Packs, air hose kit included.

84 Replacement damper for vehicles with the Gabriel Aftermarket mounting kit

6 It is recommended that when replacing shocks on vehicles with "quad shocks" all 4 shocks should be matched by series.

8 Pair Packs.

APPLICATION GUIDE

Year	Fitment Notes										
		Ultra	ProGuard/ Guardian/ Classic	Max Control/ LTV	Strut Cushion/ Strut Mount	HiJackers/ Load Carrier	Ultra	ProGuard/ Guardian/ Classic	Max Control/ LTV	Strut Cushion/ Strut Mount	HiJackers/ Load Carrier

CHEVROLET

CHEVROLET

VAN 3/4 TON, P SERIES (cont)

63-67	All	⊗	82047
61-62	All	⊗	82047

VAN 1 TON, G / EXPRESS

13-16	All	⊗	⊗	G63897	61687	77638
	Coil(FrontSpringType)	⊗	G63895	61685	⊗	G63897	61687	77638
10-12	All	⊗	⊗	81789	58638 77638
	Single Rear Wheels	⊗	⊗	G63897	61687 81789	58638 77638
	Torsion Bar (FrontSpringType)	⊗	G63893	⊗	81789	58638 77638
	Coil(FrontSpringType)	⊗	G63895	61685	⊗	81789	58638 77638
07-09	All	⊗	⊗	77638
	Single Rear Wheels	⊗	⊗	G63897	61687	77638
	Torsion Bar (FrontSpringType)	⊗	G63893	⊗	77638
	Coil(FrontSpringType)	⊗	G63895	61685	⊗	77638
03-06	All	⊗	⊗	81789	58638 77638
	Dual Rear Wheels	⊗	⊗	G63898	61688 81789	58638 77638
	Single Rear Wheels	⊗	⊗	G63897	61687 81789	58638 77638
	Torsion Bar (FrontSpringType)	⊗	G63893	⊗	81789	58638 77638
	Coil(FrontSpringType)	⊗	G63895	61685	⊗	81789	58638 77638
97-02	All	⊗	G63375 ⁵	61555 81713 ⁵	77375	⊗	61565 81789	43180 ⁸ 49231 ⁷
	Exc. 8600# GVW	⊗	G63375 ⁵	61555 81713 ⁵	77375	⊗	G63638	61565 81789	43180 ⁸ 49231 ⁷
96	All	⊗	G63357	61517 81108	58357 77357	⊗	43180 ⁸ 49231 ⁷
	Exc. 8600# GVW	⊗	G63357	61517 81108	58357 77357	⊗	61565	43180 ⁸ 49231 ⁷
	Cutaway Van	⊗	G63357	61517 81108	58357 77357	⊗	G63671	43180 ⁸ 49231 ⁷
92-95	9200# GVW	⊗	G63357	61517 81108	58357 77357	⊗	77403
	Cutaway Van	⊗	G63357	61517 81108	58357 77357	⊗	G63671	61522 81496 ⁸	58403	49212 ⁷
	Exc. Cutaway Van	⊗	G63357	61517 81108	58357 77357	⊗	G63413
78-95	All	⊗	G63357	61517 81108	58357 77357	⊗
79-91	9200# GVW	⊗	G63357	61517 81108	58357 77357	⊗	G63403	77403
	Cutaway Van	⊗	G63357	61517 81108	58357 77357	⊗	61522 81496 ⁸	58403	49212 ⁷
78-91	Exc. Chassis Cab	⊗	G63357	61517 81108	58357 77357	⊗	77413
	Exc. Cutaway Van	⊗	G63357	61517 81108	58357 77357	⊗	G63413	58413
78	Cutaway Van	⊗	G63357	61517 81108	58357 77357	⊗	61522 81496 ⁸	49212 ⁷
76-77	All	⊗	G63357	81108	⊗	G63306	82006	43093 ⁸ 49162 ⁷
75	110.0(WheelBase)	⊗	⊗	G63306	82006	43093 ⁸ 49162 ⁷
	125.0(WheelBase)	⊗	⊗	G63306	82006	43093 ⁸ 49162 ⁷

5 Use kit No. 140719 to replace O.E. hardware for lower shock absorber mounting when studs break or self-tapping screws are not longer useable.

6 It is recommended that when replacing shocks on vehicles with "quad shocks" all 4 shocks should be matched by series.

APPLICATION GUIDE

Year	Fitment Notes										
		Ultra	ProGuard\ Guardian\ Classic	Max Control\ LTV	Strut Cushion\ Strut Mount	HiJackers\ Load Carrier	Ultra	ProGuard\ Guardian\ Classic	Max Control\ LTV	Strut Cushion\ Strut Mount	HiJackers\ Load Carrier

CHEVROLET

CHEVROLET

VAN 1 TON, G / EXPRESS (cont)

75	146.0(WheelBase)	○	G63357	61517 81108	58357 77357			
71-74	All	○	G63357	61517 81108	58357 77357	○	G63306	82006	43093 ⁸ 49162 ⁷

VAN 1 TON, G / EXPRESS STEERING STABILIZERS

		Front	Rear
94-95	Single System Steering Stabilizer; HD with Straight Front Axle & Tilt Hood	6804SE ⁸⁰
71-95	Single System Steering Stabilizer	6802SE ⁸⁴

VAN 1 TON, P SERIES

86-99	Motorhome Chassis with I-Beam Front Suspension	○	G63625	○	G63366	61649 81174	58366
85-99	Motorhome Chassis with Independent Front Suspension	○	G63394	58394	○	G63366	61649 81174	58366
73-99	All	○	○	G63366	61649 81174	58366
73-90	Cutaway Chassis	○	G63355	61525 81039	58355 77355	34036 ⁸	○	G63366	61649 81174	58366
85	Motorhome Chassis with I-Beam Front Suspension	○	G63403	58403 77403	○	G63366	61649 81174	58366
74-84	Motorhome Chassis	○	G63394	58394	○	G63366	61649 81174	58366
68-72	All	○	58355 77355	34036 ⁸	○
	Cutaway Chassis	○	G63355	61525 81039	58355 77355	34036 ⁸	○
	Exc. 11,000# Rear Axle	○	58355 77355	34036 ⁸	○	G63306	82006	43093 ⁸ 49162 ⁷
63-67	All	○	82047	○
61-62	All	○	82047	○	82155

VAN 1 TON, P SERIES STEERING STABILIZERS

		Front	Rear
85-93	Single System Steering Stabilizer; with I-Beam Front Suspension	6804SE ⁸⁰
75-93	Motorhome Chassis	6805SE ⁸⁰

VEGA

72-77	All	⊖	82129	⊖	81438
71	All	⊖	82129	⊖

VENTURE

02-05	All	⊖	G55948	M55948	142524 ⁶⁷ 142525 ⁵³ 142526 ⁵⁴ 143060 ⁵¹	○	G63776	61659 81924
	FWD	⊖	G55948	M55948	142524 ⁶⁷ 142525 ⁵³ 142526 ⁵⁴ 143060 ⁵¹	○	G63776	61659 81924	49230 ⁷
97-01	FWD	⊖	G55948	M55948	142524 ⁶⁷ 142525 ⁵³ 142526 ⁵⁴ 143060 ⁵¹	○	G63776	61659 81924	49230 ⁷

VENTURE READYMOUNTS

		Front		Rear	
		Ultra Readymount	Guardian Readymount	Ultra Readymount	Guardian Readymount
02-05	All	G57060 ⁴⁰	M57060 ⁴⁰
97-01	FWD	G57060 ⁴⁰	M57060 ⁴⁰

7 Pair Packs, air hose kit included.

40 Complete Assembled Unit.

53 Strut Mount. Hardware from O.E. Part may need to be reused.

67 Strut Mount Kit. Hardware from O.E. Part may need to be reused.

84 Replacement damper for vehicles with the Gabriel Aftermarket mounting kit

Bold Type - New / Future Part



8 Pair Packs.

51 Strut Cushion for use with the Strut/Cartridge/Shocks.

84 Kit with Mount and Bearing. Hardware from O.E. Part may need to be reused.

50 Mounting bracket not required, install on O.E. Shock Mounts. See Ref. C for optional Steering Stabilizer Boots.

APPLICATION GUIDE

Year	Fitment Notes										
		Ultra	ProGuard\ Guardian\ Classic	Max Control\ LTV	Strut Cushion\ Strut Mount	HiJackers\ Load Carrier	Ultra	ProGuard\ Guardian\ Classic	Max Control\ LTV	Strut Cushion\ Strut Mount	HiJackers\ Load Carrier

CHRYSLER 200

CHRYSLER

14	Left	G52117	143336 ⁵⁴	G51863	143337 ⁶⁷
	Right	G52118	143336 ⁵⁴	G51863	143337 ⁶⁷
12-13	All	143336 ⁵³	143337 ⁶⁷
	Left	G52117	143336 ⁵³	143337 ⁶⁷
	Right Standard Suspension	G52118	143336 ⁵³	143337 ⁶⁷
	Standard Suspension	143336 ⁵³	G51863	143337 ⁶⁷
11	All	143336 ⁵³ 143336 ⁵⁴	143337 ⁶⁷
	Left	G52117	143336 ⁵³ 143336 ⁵⁴	143337 ⁶⁷
	Right Standard Suspension	G52118	143336 ⁵³ 143336 ⁵⁴	143337 ⁶⁷
	Standard Suspension	143336 ⁵³ 143336 ⁵⁴	G51863	143337 ⁶⁷

200 READYMOUNTS		Front		Rear	
		Ultra Readymount	Guardian Readymount	Ultra Readymount	Guardian Readymount
11-14	Convertible Left	G57577 ⁴⁰	G57579 ⁴⁰
	Convertible Right	G57578 ⁴⁰	G57579 ⁴⁰
	Sedan Left	G57465 ⁴⁰	G57447 ⁴⁰
	Sedan Right	G57466 ⁴⁰	G57447 ⁴⁰

300

14-16	RWD, Left	G511031
	RWD, Right	G511032
11-13	RWD, Left	G511031	143468 ⁶⁸
	RWD, Right	G511032	143468 ⁶⁸
05-10	All	70086	143335 ⁶⁷
	AWD	G51970	70086	143335 ⁶⁷
	RWD	143369 ⁵³	70086	143335 ⁶⁷
	RWD, Exc. Nivomat Suspension	G51721 70086	143335 ⁶⁷
	RWD, Left	M51761	70086	143335 ⁶⁷
	RWD, Left Exc. Performance Suspension	G51761	70086	143335 ⁶⁷
	RWD, Left Performance Suspension	G51947	70086	143335 ⁶⁷
	RWD, Right Exc. Performance Suspension	G51760	M51760	70086	143335 ⁶⁷
	RWD, Right Performance Suspension	G51948	70086	143335 ⁶⁷

40 Complete Assembled Unit.



54 Kit with Mount and Bearing. Hardware from O.E. Part may need to be reused.

68 Strut Mount Kit. Hardware from O.E. Part may need to be reused.

53 Strut Mount. Hardware from O.E. Part may need to be reused.

67 Strut Mount Kit. Hardware from O.E. Part may need to be reused.

APPLICATION GUIDE

Year	Fitment Notes										
		Ultra	ProGuard/ Guardian/ Classic	Max Control/ LTV	Strut Cushion/ Strut Mount	HiJackers/ Load Carrier	Ultra	ProGuard/ Guardian/ Classic	Max Control/ LTV	Strut Cushion/ Strut Mount	HiJackers/ Load Carrier

CHRYSLER

CHRYSLER

300 (cont)

70-71	All	○	82011	○	43067 ⁶ 49149 ⁷
65-69	All	○	82011	○	82131	43096 ⁶ 49106 ⁷
57-64	All	○	82072	○	81469	49110 ⁷

300 READYMOUNTS

		Front		Rear	
		Ultra Readymount	Guardian Readymount	Ultra Readymount	Guardian Readymount
05-10	RWD, Left	G57071 ⁴⁰	M57071 ⁴⁰
	RWD, Right	G57072 ⁴⁰	M57072 ⁴⁰

300M

99-04	Left	↑	G55663	M55663	142827 ⁵⁸ 143057 ⁵¹	↑	G55856	M55856	142828 ⁵³ 143058 ⁵¹
	Right	↓	G55664	M55664	142827 ⁵⁸ 143057 ⁵¹	↓	G55856	M55856	142828 ⁵³ 143058 ⁵¹

300M READYMOUNTS

		Front		Rear	
		Ultra Readymount	Guardian Readymount	Ultra Readymount	Guardian Readymount
99-04	Left	G56962 ⁴⁰	M56962 ⁴⁰	G56964 ⁴⁰	M56964 ⁴⁰
	Right	G56963 ⁴⁰	M56963 ⁴⁰	G56964 ⁴⁰	M56964 ⁴⁰

ASPEN

07-09	All	○	G64016	61720	○	G63892
-------	-----	---	--------	-------	-------	-------	-------	---	--------	-------	-------	-------	-------

CIRRUS

99-00	All	↑	143064 ⁵¹	↑	G51268	M51268	143063 ⁵¹ 143328 ⁵⁷
	J2(MfrBodyCode)	↑	G51267	M51267	143064 ⁵¹	↑	G51268	M51268	143063 ⁵¹ 143328 ⁵⁷
97-98	All	↑	143064 ⁵¹	↑	G51078	M51268	143063 ⁵¹
	JA(MfrBodyCode)	↑	G51796	143064 ⁵¹	↑	G51078	M51268	143063 ⁵¹
95-96	All	↑	G55818	M51267	143064 ⁵¹	↑	G51078	M51268	143063 ⁵¹

CIRRUS READYMOUNTS

		Front		Rear	
		Ultra Readymount	Guardian Readymount	Ultra Readymount	Guardian Readymount
99-00	All	G57025 ⁴⁰	M57025 ⁴⁰
	2.4L & 2.7L Left	G57431 ⁴⁰	G57025 ⁴⁰	M57025 ⁴⁰
	2.4L & 2.7L Right	G57432 ⁴⁰	G57025 ⁴⁰	M57025 ⁴⁰
95-98	All	G57422 ⁴⁰

CONCORDE

98-04	Left	↑	G55663	M55663	142827 ⁵⁸ 143057 ⁵¹	↑	G55856	M55856	142828 ⁵³ 143058 ⁵¹
	Right	↓	G55664	M55664	142827 ⁵⁸ 143057 ⁵¹	↓	G55856	M55856	142828 ⁵³ 143058 ⁵¹
93-97	Left	↑	G55663	M55663	142755 ⁵⁷ 142842 ⁵⁴ 143057 ⁵¹	↑	G55665	M55665
	Right	↓	G55664	M55664	142755 ⁵⁷ 142842 ⁵⁴ 143057 ⁵¹	↓	G55665	M55665

7 Pair Packs, air hose kit included.

40 Complete Assembled Unit.

53 Strut Mount. Hardware from O.E. Part may need to be reused.

67 Strut Mount Kit. Hardware from O.E. Part may need to be reused.

Bold Type - New / Future Part



8 Pair Packs.

51 Strut Cushion for use with the Strut/Cartridge/Shocks.

54 Kit with Mount and Bearing. Hardware from O.E. Part may need to be reused.

68 Strut Mount Kit. Hardware from O.E. Part may need to be reused.

APPLICATION GUIDE

Year	Fitment Notes										
		Ultra	ProGuard\ Guardian\ Classic	Max Control\ LTV	Strut Cushion\ Strut Mount	HiJackers\ Load Carrier	Ultra	ProGuard\ Guardian\ Classic	Max Control\ LTV	Strut Cushion\ Strut Mount	HiJackers\ Load Carrier

CHRYSLER

CHRYSLER

CONCORDE READYMOUNTS		Front		Rear	
		Ultra Readymount	Guardian Readymount	Ultra Readymount	Guardian Readymount
98-04	Left	G56962 ⁴⁰	M56962 ⁴⁰	G56964 ⁴⁰	M56964 ⁴⁰
	Right	G56963 ⁴⁰	M56963 ⁴⁰	G56964 ⁴⁰	M56964 ⁴⁰
93-97	Left	G56958 ⁴⁰	M56958 ⁴⁰	G56960 ⁴⁰	M56960 ⁴⁰
	Right	G56959 ⁴⁰	M56959 ⁴⁰	G56960 ⁴⁰	M56960 ⁴⁰

CONQUEST

87-89	Exc. Electronic Adjustable Suspension	G44937 ⁹⁸	143058 ⁵¹	143057 ⁵¹
-------	---------------------------------------	----------------------	------	------	----------------------	------	------	------	------	----------------------	------

CORDOBA

80-83	All	69704	81406	69703	81338
77-79	All	81153	69703	81338
75-76	All	81153	82131	43096 ⁸ 49106 ⁷

DAYTONA

87-93	All	G55526	M55526	142567 ⁶⁷ 142568 ⁶⁷ 142880 ⁵⁴ 142933 ⁶⁸ 142940 ⁶⁶	69632	81459	49369 ⁷
	CAN	G55526	M55526	143059 ⁵¹ 142567 ⁶⁷ 142568 ⁶⁷ 142880 ⁵⁴ 142933 ⁶⁸ 142940 ⁶⁶	69632	81459	49369 ⁷
86	All	G55526	M55526	142568 ⁶⁷ 142880 ⁵⁴ 142933 ⁶⁸ 142940 ⁶⁶	69632	81459	49369 ⁷
	CAN	G55526	M55526	142567 ⁶⁷ 143059 ⁵¹ 142568 ⁶⁷ 142880 ⁵⁴ 142933 ⁶⁸ 142940 ⁶⁶	69632	81459	49369 ⁷
84-85	All	G55511	69632	81459	49369 ⁷
	CAN	G55511	143060 ⁵¹	69632	81459	49369 ⁷

DYNASTY

89-93	All	M55526	142567 ⁶⁷ 142568 ⁶⁷ 142880 ⁵⁴ 142933 ⁶⁸ 142940 ⁶⁶
	Hydraulic Self Leveling System	M55526	142567 ⁶⁷ 142568 ⁶⁷ 142880 ⁵⁴ 142933 ⁶⁸ 142940 ⁶⁶	81793
	CAN	M55526	143059 ⁵¹ 142567 ⁶⁷ 142568 ⁶⁷ 142880 ⁵⁴ 142933 ⁶⁸ 142940 ⁶⁶
88-93	Exc. Hydraulic Self Leveling System	G55526	M55526	142567 ⁶⁷ 142568 ⁶⁷ 142880 ⁵⁴ 142933 ⁶⁸ 142940 ⁶⁶

7 Pair Packs, air hose kit included.

40 Complete Assembled Unit.

54 Kit with Mount and Bearing. Hardware from O.E. Part may need to be reused.

67 Strut Mount Kit. Hardware from O.E. Part may need to be reused.

98 Notice: The level of difficulty to install this product is moderately high. Please review the installation instructions carefully before proceeding.

8 Pair Packs.

51 Strut Cushion for use with the Strut/Cartridge/Shocks.

66 Upper Spring Seat with Spacer. Hardware from O.E. Part may need to be reused.

68 Strut Mount Kit. Hardware from O.E. Part may need to be reused.

APPLICATION GUIDE

Year	Fitment Notes	Front					Rear				
		Ultra	ProGuard\ Guardian\ Classic	Max Control\ LTV	Strut Cushion\ Strut Mount	HiJackers\ Load Carrier	Ultra	ProGuard\ Guardian\ Classic	Max Control\ LTV	Strut Cushion\ Strut Mount	HiJackers\ Load Carrier

CHRYSLER

CHRYSLER

DYNASTY (cont)

88	All	142567 ⁵⁷ 142568 ⁵⁷ 142880 ⁵⁴ 142933 ⁵⁸ 142940 ⁵⁶
	Hydraulic Self Leveling System	142567 ⁵⁷ 142568 ⁵⁷ 142880 ⁵⁴ 142933 ⁵⁸ 142940 ⁵⁶	81793
	CAN	143059 ⁵¹ 142567 ⁵⁷ 142568 ⁵⁷ 142880 ⁵⁴ 142933 ⁵⁸ 142940 ⁵⁶

E CLASS

84	All	G55511	143060 ⁵¹	69632	81459	49369 ⁷
83	All	G55507	143057 ⁵¹	69632	81459	49369 ⁷

EXECUTIVE LIMOUSINE

85	All	G55511	143060 ⁵¹	69632	81459	49369 ⁷
----	-----	--------	-------	-------	----------------------	-------	-------	-------	-------	-------	--------------------

EXECUTIVE SEDAN

84	All	G55511	143060 ⁵¹	69632	81459	49369 ⁷
83	All	G55507	143057 ⁵¹	69632	81459	49369 ⁷

FIFTH AVENUE

83-89	All	69704	81406	69703	81338	49346 ⁷
-------	-----	-------	-------	-------	-------	-------	-------	-------	-------	-------	--------------------

IMPERIAL

90-93	All	142880 ⁵⁴ 142933 ⁵⁸ 143059 ⁵¹	
	Exc. Hydraulic Self Leveling System	G55526	M55526	142567 ⁵⁷ 142568 ⁵⁷ 142940 ⁵⁶ 142880 ⁵⁴ 142933 ⁵⁸ 143059 ⁵¹	69632	81459	49369 ⁷
81-83	All	69704	81406	69703	81338	49346 ⁷
74-75	All	69704	81406	82131	43096 ⁸ 49106 ⁷
67-73	All	82011	81091	43067 ⁸ 49149 ⁷
57-66	All	82072	81469
55	All	81469

IMPERIAL READYMOUNTS

		Front		Rear	
		Ultra Readymount	Guardian Readymount	Ultra Readymount	Guardian Readymount
90-93	All	M56985 ⁴⁰
	Exc. Hydraulic Self Leveling System	G56985 ⁴⁰	M56985 ⁴⁰

INTREPID

98-04	Left	G55663	M55663	142827 ⁵⁸	G55856	M55856	142828 ⁵³
-------	------	--------	--------	-------	----------------------	-------	--------	--------	-------	----------------------	-------

7 Pair Packs, air hose kit included.

40 Complete Assembled Unit.

53 Strut Mount. Hardware from O.E. Part may need to be reused.

66 Upper Spring Seat with Spacer. Hardware from O.E. Part may need to be reused.

68 Strut Mount Kit. Hardware from O.E. Part may need to be reused.

Bold Type - New / Future Part



8 Pair Packs.

51 Strut Cushion for use with the Strut/Cartridge/Shocks.

54 Kit with Mount and Bearing. Hardware from O.E. Part may need to be reused.

67 Strut Mount Kit. Hardware from O.E. Part may need to be reused.

APPLICATION GUIDE

Year	Fitment Notes										
		Ultra	ProGuard/ Guardian/ Classic	Max Control/ LTV	Strut Cushion/ Strut Mount	HiJackers/ Load Carrier	Ultra	ProGuard/ Guardian/ Classic	Max Control/ LTV	Strut Cushion/ Strut Mount	HiJackers/ Load Carrier

CHRYSLER

CHRYSLER

INTREPID (cont)

98-04	Right	G55664	M55664	142827 ⁶⁸	G55856	M55856	142828 ⁵³
	CAN	143057 ⁵¹	143058 ⁵¹
94-97	Left	G55663	M55663
	Right	G55664	M55664
	CAN	142842 ⁵⁴ 143057 ⁵¹	G55665	M55665
93	Left	G55663	M55663	G55665	M55665
	Right	G55664	M55664	G55665	M55665
	CAN	142842 ⁵⁴ 143057 ⁵¹

INTREPID READYMOUNTS

		Front		Rear	
		Ultra Readymount	Guardian Readymount	Ultra Readymount	Guardian Readymount
98-04	Left	G56962 ⁴⁰	M56962 ⁴⁰
	Right	G56963 ⁴⁰	M56963 ⁴⁰

LASER

86	All	G55526	M55526	142567 ⁶⁷ 142568 ⁶⁷ 142880 ⁵⁴ 142933 ⁶⁸ 143060 ⁵¹	69632	81459	49369 ⁷
	Mfg. from 1/2/86	G55526	M55526	142940 ⁶⁶ 142567 ⁶⁷ 142568 ⁶⁷ 142880 ⁵⁴ 142933 ⁶⁸ 143060 ⁵¹	69632	81459	49369 ⁷
84-85	All	G55511	143060 ⁵¹	69632	81459	49369 ⁷

LEBARON

87-95	All	G55526	M55526	142567 ⁶⁷ 142568 ⁶⁷ 142880 ⁵⁴ 142933 ⁶⁸ 142940 ⁶⁶ 143059 ⁵¹	69632	81459	49369 ⁷
86	All	G55526	M55526	142567 ⁶⁷ 142568 ⁶⁷ 142880 ⁵⁴ 142933 ⁶⁸ 143059 ⁵¹	69632	81459	49369 ⁷
	Mfg. from 1/2/86	G55526	M55526	142940 ⁶⁶ 142567 ⁶⁷ 142568 ⁶⁷ 142880 ⁵⁴ 142933 ⁶⁸ 143059 ⁵¹	69632	81459	49369 ⁷
84-85	All	G55511	143060 ⁵¹	69632	81459	49369 ⁷
82-83	All	G55507	143057 ⁵¹	69632	81459	49369 ⁷
81	All	69704	81406	143057 ⁵¹	69632
	Exc. M Body	69704	81406	143057 ⁵¹	69632	81459	49369 ⁷
	M Body	69704	81406	143057 ⁵¹	69632	81338	49346 ⁷

7 Pair Packs, air hose kit included.

51 Strut Cushion for use with the Strut/Cartridge/Shocks.

54 Kit with Mount and Bearing. Hardware from O.E. Part may need to be reused.

67 Strut Mount Kit. Hardware from O.E. Part may need to be reused.





40 Complete Assembled Unit.

53 Strut Mount. Hardware from O.E. Part may need to be reused.

66 Upper Spring Seat with Spacer. Hardware from O.E. Part may need to be reused.

68 Strut Mount Kit. Hardware from O.E. Part may need to be reused.





APPLICATION GUIDE

Year	Fitment Notes										
			Ultra	ProGuard/ Guardian/ Classic	Max Control/ LTV	Strut Cushion/ Strut Mount	HiJackers/ Load Carrier		Ultra	ProGuard/ Guardian/ Classic	Max Control/ LTV

CHRYSLER

CHRYSLER









LEBARON (cont)

77-80	All		69704	81406		69703	81338
	M Body		69704	81406		69703	81338	49346 ⁷

LEBARON READYMOUNTS

		Front				Rear			
		Ultra Readymount	Guardian Readymount	Ultra Readymount	Guardian Readymount	Ultra Readymount	Guardian Readymount	Ultra Readymount	Guardian Readymount
89-94	All	G56985 ⁴⁰	M56985⁴⁰



LHS

99-01	Left		G55663	M55663	142827 ⁵⁸ 143057 ⁵¹		G55856	M55856	142828 ⁵³ 143058 ⁵¹
	Right		G55664	M55664	142827 ⁵⁸ 143057 ⁵¹		G55856	M55856	142828 ⁵³ 143058 ⁵¹
94-97	Left		G55663	M55663	142755 ⁵⁷ 142842 ⁵⁴ 143057 ⁵¹		G55665	M55665	143058 ⁵¹
	Right		G55664	M55664	142755 ⁵⁷ 142842 ⁵⁴ 143057 ⁵¹		G55665	M55665	143058 ⁵¹





LHS READYMOUNTS

		Front				Rear			
		Ultra Readymount	Guardian Readymount	Ultra Readymount	Guardian Readymount	Ultra Readymount	Guardian Readymount	Ultra Readymount	Guardian Readymount
99-01	Left	G56962 ⁴⁰	M56962⁴⁰	G56964 ⁴⁰	M56964⁴⁰	G56964 ⁴⁰	M56964⁴⁰	G56964 ⁴⁰	M56964⁴⁰
	Right	G56963 ⁴⁰	M56963⁴⁰	G56964 ⁴⁰	M56964⁴⁰	G56964 ⁴⁰	M56964⁴⁰	G56964 ⁴⁰	M56964⁴⁰
94-97	Left	G56958 ⁴⁰	M56958⁴⁰
	Right	G56959 ⁴⁰	M56959⁴⁰

NASSAU

55-56	All			81469	49110 ⁷
-------	-----	---	------	------	------	------	------	---	------	-------	------	------	--------------------









NEON

00-02	Left		G55892	M55892	142932 ⁵⁸ 143060 ⁵¹		G55894	M55894	143057 ⁵¹ 143256 ⁵³
	Right		G55892	M55892	142932 ⁵⁸ 143060 ⁵¹		G55893	M55893	143057 ⁵¹ 143256 ⁵³

NEON READYMOUNTS

		Front				Rear			
		Ultra Readymount	Guardian Readymount	Ultra Readymount	Guardian Readymount	Ultra Readymount	Guardian Readymount	Ultra Readymount	Guardian Readymount
00-02	Left	G56975 ⁴⁰	M56975⁴⁰	G56973 ⁴⁰	M56973⁴⁰	G56973 ⁴⁰	M56973⁴⁰	G56974 ⁴⁰	M56974⁴⁰
	Right	G56975 ⁴⁰	M56975⁴⁰	G56974 ⁴⁰	M56974⁴⁰	G56974 ⁴⁰	M56974⁴⁰	G56974 ⁴⁰	M56974⁴⁰

NEW YORKER

94-96	Left		G55663	M55663	142755 ⁵⁷ 142842 ⁵⁴ 143057 ⁵¹		G55665	M55665
	Right		G55664	M55664	142755 ⁵⁷ 142842 ⁵⁴ 143057 ⁵¹		G55665	M55665
88-93	All		G55526	M55526	142567 ⁵⁷ 142568 ⁵⁷ 142880 ⁵⁴ 142933 ⁵⁸ 142940 ⁵⁶ 143060 ⁵¹	
	Exc. Hydraulic Self Leveling System		G55526	M55526	142567 ⁵⁷ 142568 ⁵⁷ 142880 ⁵⁴ 142933 ⁵⁸ 142940 ⁵⁶ 143060 ⁵¹		69632	81459	49369 ⁷

7 Pair Packs, air hose kit included.

51 Strut Cushion for use with the Strut/Cartridge/Shocks.

54 Kit with Mount and Bearing. Hardware from O.E. Part may need to be reused.

67 Strut Mount Kit. Hardware from O.E. Part may need to be reused.

Bold Type - New / Future Part



40 Complete Assembled Unit.

53 Strut Mount. Hardware from O.E. Part may need to be reused.

66 Upper Spring Seat with Spacer. Hardware from O.E. Part may need to be reused.

68 Strut Mount Kit. Hardware from O.E. Part may need to be reused.

APPLICATION GUIDE

Year	Fitment Notes										
		Ultra	ProGuard/ Guardian/ Classic	Max Control/ LTV	Strut Cushion/ Strut Mount	HiJackers/ Load Carrier	Ultra	ProGuard/ Guardian/ Classic	Max Control/ LTV	Strut Cushion/ Strut Mount	HiJackers/ Load Carrier

CHRYSLER

CHRYSLER

NEW YORKER (cont)

87	All	G55526	M55526	142567 ⁶⁷ 142568 ⁶⁷ 142880 ⁵⁴ 142933 ⁶⁸ 142940 ⁶⁶ 143060 ⁵¹	69632	81459	49369 ⁷
86	All	G55526	M55526	142567 ⁶⁷ 142568 ⁶⁷ 142880 ⁵⁴ 142933 ⁶⁸ 143060 ⁵¹	69632	81459	49369 ⁷
	Mfg. from 1/2/86	G55526	M55526	142940 ⁶⁶ 142567 ⁶⁷ 142568 ⁶⁷ 142880 ⁵⁴ 142933 ⁶⁸ 143060 ⁵¹	69632	81459	49369 ⁷
84-85	All	G55511	143060 ⁵¹	69632	81459	49369 ⁷
83	All	G55507	143057 ⁵¹	69632	81459	49369 ⁷
79-82	All	69704	81406	69703	81338
74-78	All	69704	81406	82131	43096 ⁸ 49106 ⁷
70-73	All	82011	81091	43067 ⁸ 49149 ⁷
65-69	All	82011	82131	43096 ⁸ 49106 ⁷
57-64	All	82072	81469	49110 ⁷
51-56	All	81469	49110 ⁷

NEW YORKER READYMOUNTS

		Front		Rear	
		Ultra Readymount	Guardian Readymount	Ultra Readymount	Guardian Readymount
94-96	Left	G56958 ⁴⁰	M56958 ⁴⁰
	Right	G56959 ⁴⁰	M56959 ⁴⁰
90-93	All	M56985 ⁴⁰
	Exc. Hydraulic Self Leveling System	G56985 ⁴⁰	M56985 ⁴⁰

NEWPORT

79-81	All	81153	69703	81338
74-78	All	69704	81406	82131	43096 ⁸ 49106 ⁷
70-73	All	82011	81091	43067 ⁸ 49149 ⁷
65-69	All	82011	82131	43096 ⁸ 49106 ⁷
57-64	All	82072	81469	49110 ⁷
51-56	All	81469	49110 ⁷

PACIFICA

04-08	All	G56772	142931 ⁵⁴ 143059 ⁵¹
-------	-----	--------	------	------	--	------	------	------	------	------	------

PACIFICA READYMOUNTS

		Front		Rear	
		Ultra Readymount	Guardian Readymount	Ultra Readymount	Guardian Readymount
04-08	Left	G57112 ⁴⁰	M57112 ⁴⁰
	Right	G57113 ⁴⁰	M57113 ⁴⁰

7 Pair Packs, air hose kit included.

40 Complete Assembled Unit.

54 Kit with Mount and Bearing. Hardware from O.E. Part may need to be reused.

67 Strut Mount Kit. Hardware from O.E. Part may need to be reused.



8 Pair Packs.

51 Strut Cushion for use with the Strut/Cartridge/Shocks.

66 Upper Spring Seat with Spacer. Hardware from O.E. Part may need to be reused.

68 Strut Mount Kit. Hardware from O.E. Part may need to be reused.

APPLICATION GUIDE

Year	Fitment Notes										
		Ultra	ProGuard\ Guardian\ Classic	Max Control\ LTV	Strut Cushion\ Strut Mount	HiJackers\ Load Carrier	Ultra	ProGuard\ Guardian\ Classic	Max Control\ LTV	Strut Cushion\ Strut Mount	HiJackers\ Load Carrier

CHRYSLER

CHRYSLER

PT CRUISER

01-10	All	G55896	M55896	142932 ⁵⁸ 143060 ⁵¹	69473	143057 ⁵¹
-------	-----	--------	--------	------	--	------	-------	------	------	----------------------	------

PT CRUISER READYMOUNTS

		Front		Rear	
		Ultra Readymount	Guardian Readymount	Ultra Readymount	Guardian Readymount
01-10	All	G56965 ⁴⁰	M56965⁴⁰

SARATOGA

57-60	All	82072	81469	49110 ⁷
51-52	All	81469	49110 ⁷

SEBRING

08-10	Left	G52117	143336 ⁵³	G51863	143337 ⁶⁷
	Right	G52118	143336 ⁵³	G51863	143337 ⁶⁷
07	All	143336 ⁵³	G51863	143337 ⁶⁷
03-06	Sedan and Convertible; JR (MfrBodyCode)	G51267	M51267	143423 ⁵⁷	G51268	M51268	143321 ⁵³ 143423 ⁵⁷
01-05	Coupe Left	M52811
	Coupe Right	M52812
	Coupe, ST(MfrBodyCode) Left	G56552	143087 ⁵³	G51254	M51254	142419 ⁶⁸
	Coupe, ST(MfrBodyCode) Right	G56551	143087 ⁵³	G51254	M51254	142419 ⁶⁸
01-02	Sedan and Convertible; JR (MfrBodyCode)	G51267	M51267	143423 ⁵⁷	G51268	M51268	143321 ⁵³
99-00	Convertible	143064 ⁵¹	143063 ⁵¹
	Sedan and Convertible; JR (MfrBodyCode)	G51267	M51267	G51268	M51268
96-00	Coupe	G55820	M55820	142419 ⁶⁸ 143057 ⁵¹	G51254	M51254	142419 ⁶⁸ 143057 ⁵¹
97-98	Convertible	G51796	143064 ⁵¹	G51078	M51268	143063 ⁵¹
96	Convertible	G55818	M51267	143064 ⁵¹	G51078	M51268	143063 ⁵¹
95	All	142419 ⁶⁸ 143057 ⁵¹	142419 ⁶⁸ 143057 ⁵¹
	Coupe	G55820	M55820	142419 ⁶⁸ 143057 ⁵¹	G51254	M51254	142419 ⁶⁸ 143057 ⁵¹

SEBRING READYMOUNTS

		Front		Rear	
		Ultra Readymount	Guardian Readymount	Ultra Readymount	Guardian Readymount
01-06	Convertible	G57422⁴⁰
	Sedan, JR(MfrBodyCode)	G57026 ⁴⁰	M57026⁴⁰
01-05	Left	G57440⁴⁰
	Right	G57439⁴⁰
	Coupe, ST(MfrBodyCode) Left	G57073 ⁴⁰	G57075 ⁴⁰
	Coupe, ST(MfrBodyCode) Right	G57074 ⁴⁰	G57075 ⁴⁰
96-98	Convertible	G57556⁴⁰
	Coupe	G57438⁴⁰

7 Pair Packs, air hose kit included.

51 Strut Cushion for use with the Strut/Cartridge/Shocks.

67 Strut Mount Kit. Hardware from O.E. Part may need to be reused.



Bold Type - New / Future Part

40 Complete Assembled Unit.

53 Strut Mount. Hardware from O.E. Part may need to be reused.

68 Strut Mount Kit. Hardware from O.E. Part may need to be reused.

APPLICATION GUIDE

Year	Fitment Notes										
		Ultra	ProGuard\Guardian\Classic	Max Control\LTV	Strut Cushion\Strut Mount	HiJackers\Load Carrier	Ultra	ProGuard\Guardian\Classic	Max Control\LTV	Strut Cushion\Strut Mount	HiJackers\Load Carrier

CHRYSLER SPIRIT

CHRYSLER

92-95	All	69632
-------	-----	------	------	------	------	------	-------	------	------	------	------

ST REGIS

55-56	All	81469	49110 ⁷
-------	-----	------	------	------	------	------	------	-------	------	------	--------------------

TOWN & COUNTRY

08-16	All	143463 ⁶⁸
	Exc. Self-Leveling Suspension	143463 ⁶⁸	G64042
	Exc. S Models	G52131	143463 ⁶⁸
01-07	All	G56620	M56620	142931 ⁵⁴	61605 ³⁴ 81878	49236 ⁷
	Exc. Hydraulic Self Leveling System	G56620	M56620	142931 ⁵⁴	G63690 ¹⁰	61605 ³⁴ 81878	49236 ⁷
96-00	All	G55697	M55697	142753 ⁶⁷ 142841 ⁵⁴ 143059 ⁵¹	61605 ³⁴ 81878	49236 ⁷
	Exc. Hydraulic Self Leveling System	G55697	M55697	142753 ⁶⁷ 142841 ⁵⁴ 143059 ⁵¹	G63690 ¹⁰	61605 ³⁴ 81878	49236 ⁷
90-95	All	G55525	M55525	142567 ⁶⁷ 142568 ⁶⁷ 142880 ⁵⁴ 142933 ⁶⁸ 142940 ⁶⁶ 143059 ⁵¹	G63426	61538 81529
86-88	All	G55526	M55526	142567 ⁶⁷ 142568 ⁶⁷ 142880 ⁵⁴	69632	81459	49369 ⁷
79-81	All	81153	69703	81338
74-78	All	69704	81406	82131	43096 ⁶ 49106 ⁷
71-73	All	82011	81091	43067 ⁶ 49149 ⁷
65-70	All	82011	82131	43096 ⁶ 49106 ⁷
57-64	All	82072	81469	49110 ⁷
51-56	All	81469	49110 ⁷

TOWN & COUNTRY READYMOUNTS

		Front		Rear	
		Ultra Readymount	Guardian Readymount	Ultra Readymount	Guardian Readymount
11-16	Exc. S Models	M57206⁴⁰
08-10	All	G57206⁴⁰
	Exc. S Models	G57206⁴⁰	M57206⁴⁰
01-07	Left	G56956 ⁴⁰	M56956⁴⁰
	Right	G56957 ⁴⁰	M56957⁴⁰
96-00	All	G56910 ⁴⁰	M56910⁴⁰
90-95	All	G56907 ⁴⁰	M56907⁴⁰

VOYAGER / GRAND VOYAGER

01-07	All	G56620	M56620	142931 ⁵⁴ 143059 ⁵¹
01-03	Non-ABS Exc. Hydraulic Self Leveling System	G56620	M56620	142931 ⁵⁴ 143059 ⁵¹	G63690 ¹⁰

7 Pair Packs, air hose kit included.

10 The Nivomat leveling shocks are on the rear only. If suspension spring contacts units, rotate suspension spring 180 degrees.

40 Complete Assembled Unit.

54 Kit with Mount and Bearing. Hardware from O.E. Part may need to be reused.

67 Strut Mount Kit. Hardware from O.E. Part may need to be reused.

8 Pair Packs.



34 If suspension spring contacts this unit, rotate suspension spring 180 degrees.

51 Strut Cushion for use with the Strut/Cartridge/Shocks.

66 Upper Spring Seat with Spacer. Hardware from O.E. Part may need to be reused.

68 Strut Mount Kit. Hardware from O.E. Part may need to be reused.

APPLICATION GUIDE

Year	Fitment Notes										
		Ultra	ProGuard\Guardian\Classic	Max Control\LTV	Strut Cushion\Strut Mount	HiJackers\Load Carrier	Ultra	ProGuard\Guardian\Classic	Max Control\LTV	Strut Cushion\Strut Mount	HiJackers\Load Carrier

CHRYSLER

CHRYSLER

VOYAGER / GRAND VOYAGER (cont)

03	Exc. Hydraulic Self Leveling System	G56620	M56620	142931 ⁵⁴ 143059 ⁵¹	61605 ³⁴ 81878	49236 ⁷
01-02	Exc. Hydraulic Self Leveling System	G56620	M56620	142931 ⁵⁴ 143059 ⁵¹	G63690	61605 ³⁴ 81878	49236 ⁷
00	All	G55697	M55697	142753 ⁶⁷ 142841 ⁵⁴ 143059 ⁵¹	61605 ³⁴ 81878	49236 ⁷
	Exc. Hydraulic Self Leveling System	G55697	M55697	142753 ⁶⁷ 142841 ⁵⁴ 143059 ⁵¹	G63690	61605 ³⁴ 81878	49236 ⁷
	Non-ABS	G55697	M55697	142753 ⁶⁷ 142841 ⁵⁴ 143059 ⁵¹	81878 61605 ³⁴	49236 ⁷
	Non-ABS Exc. Hydraulic Self Leveling System	G55697	M55697	142753 ⁶⁷ 142841 ⁵⁴ 143059 ⁵¹	G63690 ¹⁰	61605 ³⁴ 81878	49236 ⁷

		Front		Rear	
		Ultra Readymount	Guardian Readymount	Ultra Readymount	Guardian Readymount
01-07	Left	G56956 ⁴⁰	M56956⁴⁰
	Right	G56957 ⁴⁰	M56957⁴⁰
00	All	G56910 ⁴⁰	M56910⁴⁰
	Exc. Hydraulic Self Leveling System	G56910 ⁴⁰	M56910⁴⁰

WINDSOR

57-61	All	82072	81469	49110 ⁷
51-56	All	81469	49110 ⁷

DAEWOO

DAEWOO

LANOS

99-02	All	G44903 ⁹⁸	69749
-------	-----	----------------------	------	------	------	------	-------	------	------	------	------

LEGANZA

99-02	Left	G56762	G56764
	Right	G56762	G56763

NUBIRA

99-02	Non-ABS Left	G56766
	Non-ABS Right	G56765	G56767

DAIHATSU

DAIHATSU

CHARADE

88-92	All	142626 ⁶³
-------	-----	------	------	------	------	------	------	------	------	----------------------	------

ROCKY

90-92	All	G63611	81872	81270
-------	-----	--------	-------	------	------	------	------	-------	------	------	------

7 Pair Packs, air hose kit included.

34 If suspension spring contacts this unit, rotate suspension spring 180 degrees.

51 Strut Cushion for use with the Strut/Cartridge/Shocks.

54 Kit with Mount and Bearing. Hardware from O.E. Part may need to be reused.

98 Notice: The level of difficulty to install this product is moderately high. Please review the installation instructions carefully before proceeding.

Bold Type - New / Future Part



10 The Nivomat leveling shocks are on the rear only. If suspension spring contacts units, rotate suspension spring 180 degrees.

40 Complete Assembled Unit.

53 Strut Mount. Hardware from O.E. Part may need to be reused.

67 Strut Mount Kit. Hardware from O.E. Part may need to be reused.

APPLICATION GUIDE

Year	Fitment Notes										
		Ultra	ProGuard\ Guardian\ Classic	Max Control\ LTV	Strut Cushion\ Strut Mount	HiJackers\ Load Carrier	Ultra	ProGuard\ Guardian\ Classic	Max Control\ LTV	Strut Cushion\ Strut Mount	HiJackers\ Load Carrier

DODGE

DODGE

330

63-64	All	○	82090	○	82131	49106 ⁷
-------	-----	---	-------	-------	-------	-------	-------	---	-------	-------	-------	-------	-------	--------------------

400

82-83	All	⌋	G55507	143057 ⁵¹	○	69632	81459	49369 ⁷
-------	-----	---	--------	-------	-------	----------------------	-------	---	-------	-------	-------	-------	-------	--------------------

440

63-64	All	○	82090	○	82131	49106 ⁷
-------	-----	---	-------	-------	-------	-------	-------	---	-------	-------	-------	-------	-------	--------------------

600

88	All	⌋	G55526	M55526	142567 ⁶⁷ 142568 ⁶⁷ 142880 ⁵⁴ 142933 ⁶⁸ 142940 ⁶⁶ 143060 ⁵¹	○	69632	81459	49369 ⁷
87	All	⌋	G55526	M55526	142567 ⁶⁷ 142568 ⁶⁷ 142880 ⁵⁴ 142933 ⁶⁸ 143060 ⁵¹	○	69632	81459	49369 ⁷
	Mfg. from 1/2/86	⌋	G55526	M55526	142940 ⁶⁶ 142567 ⁶⁷ 142568 ⁶⁷ 142880 ⁵⁴ 142933 ⁶⁸ 143060 ⁵¹	○	69632	81459	49369 ⁷
86	All	⌋	G55526	M55526	142567 ⁶⁷ 142568 ⁶⁷ 142880 ⁵⁴ 142933 ⁶⁸ 143060 ⁵¹	○	69632	49369 ⁷
	Mfg. from 1/2/86	⌋	G55526	M55526	142940 ⁶⁶ 142567 ⁶⁷ 142568 ⁶⁷ 142880 ⁵⁴ 142933 ⁶⁸ 143060 ⁵¹	○	69632	49369 ⁷
	Mfg. to 2/86	⌋	G55526	M55526	142567 ⁶⁷ 142568 ⁶⁷ 142880 ⁵⁴ 142933 ⁶⁸ 143060 ⁵¹	○	69632	81459	49369 ⁷
84-85	All	⌋	G55511	143060 ⁵¹	○	69632	81459	49369 ⁷
83	All	⌋	G55507	143057 ⁵¹	○	69632	81459	49369 ⁷

880

65	All	○	82011	○	82131	43096 ⁸ 49106 ⁷
62-64	All	○	82072	○	81469	49110 ⁷

2000 GTX

89-90	All	⌋	G55945	⌋	G51046
90	Exc. Auto-Leveling System	⌋	G55945	142219 ⁶³	⌋	G51046
89	Exc. Auto-Leveling System	⌋	G55945	142219 ⁶³	⌋	G51046	142419 ⁶⁸
	CAN	⌋	G55945	⌋	G51046	143064 ⁵¹

A100 TRUCK

64-70	All	○	○	81469
-------	-----	---	-------	-------	-------	-------	-------	---	-------	-------	-------	-------	-------	-------

7 Pair Packs, air hose kit included.

51 Strut Cushion for use with the Strut/Cartridge/Shocks.

54 Kit with Mount and Bearing. Hardware from O.E. Part may need to be reused.

67 Strut Mount Kit. Hardware from O.E. Part may need to be reused.



8 Pair Packs.

53 Strut Mount. Hardware from O.E. Part may need to be reused.

66 Upper Spring Seat with Spacer. Hardware from O.E. Part may need to be reused.

68 Strut Mount Kit. Hardware from O.E. Part may need to be reused.

APPLICATION GUIDE

Year	Fitment Notes										
		Ultra	ProGuard\ Guardian\ Classic	Max Control\ LTV	Strut Cushion\ Strut Mount	HiJackers\ Load Carrier	Ultra	ProGuard\ Guardian\ Classic	Max Control\ LTV	Strut Cushion\ Strut Mount	HiJackers\ Load Carrier

DODGE

DODGE

A100 TRUCK STEERING STABILIZERS

		Front	Rear
70	Dual System Steering Stabilizer; with I-Beam Axle	6802SE ⁸⁴
	Single System Steering Stabilizer; with I-Beam Axle	6803SE ⁸⁴
64-69	Dual System	6802SE ⁸⁴

ARIES

86-89	All	G55526	M55526	142567 ⁶⁷ 142568 ⁶⁷ 142880 ⁶⁴ 142933 ⁶⁸ 142940 ⁶⁶ 143060 ⁶¹	69632	81459	49369 ⁷
84-85	All	G55511	143060 ⁶¹	69632	81459	49369 ⁷
81-83	All	G55507	143057 ⁶¹	69632	81459	49369 ⁷

ASPEN

76-80	All	69704	81406	69703	81338	49346 ⁷
-------	-----	-------	-------	------	------	------	-------	-------	------	------	--------------------

ATTITUDE

12-14	Left	G52353	70095
	Right	G52354	70095
06-11	Left	G52154	70036
	Right	G52155	70036

AVENGER

08-14	Left	G52117	143336 ⁶³	G51863	143337 ⁶⁷
	Right	G52118	143336 ⁶³	G51863	143337 ⁶⁷
95-00	All	G55820	M55820	142419 ⁶⁸	G51254	M51254	142419 ⁶⁸

CALIBER

12	Left	G52081	143495 ⁶⁴	G51842	143337 ⁶⁷
	Right	G52082	143495 ⁶⁴	G51842	143337 ⁶⁷
07-11	Left	G52081	143495 ⁶⁴	G51842	M51842	143337 ⁶⁷ 143496 ⁶⁷
	Right	G52082	143495 ⁶⁴	G51842	M51842	143337 ⁶⁷ 143496 ⁶⁷

CALIBER READYMOUNTS

		Front		Rear	
		Ultra Readymount	Guardian Readymount	Ultra Readymount	Guardian Readymount
12	Left	G57176 ⁴⁰	G57178 ⁴⁰
	Right	G57177 ⁴⁰	G57178 ⁴⁰
07-11	Left	G57176 ⁴⁰	M57176 ⁴⁰	G57178 ⁴⁰	M57178 ⁴⁰
	Right	G57177 ⁴⁰	M57177 ⁴⁰	G57178 ⁴⁰	M57178 ⁴⁰

CARAVAN / GRAND CARAVAN

12-16	Exc. Self-Leveling Suspension	143463 ⁶⁸	G64042
-------	-------------------------------	------	------	------	----------------------	------	--------	------	------	------	------

7 Pair Packs, air hose kit included.

51 Strut Cushion for use with the Strut/Cartridge/Shocks.

54 Kit with Mount and Bearing. Hardware from O.E. Part may need to be reused.

67 Strut Mount Kit. Hardware from O.E. Part may need to be reused.

84 Replacement damper for vehicles with the Gabriel Aftermarket mounting kit

Bold Type - New / Future Part

40 Complete Assembled Unit.

53 Strut Mount. Hardware from O.E. Part may need to be reused.

66 Upper Spring Seat with Spacer. Hardware from O.E. Part may need to be reused.

68 Strut Mount Kit. Hardware from O.E. Part may need to be reused.

APPLICATION GUIDE

Year	Fitment Notes										
		Ultra	ProGuard/ Guardian/ Classic	Max Control/ LTV	Strut Cushion/ Strut Mount	HiJackers/ Load Carrier	Ultra	ProGuard/ Guardian/ Classic	Max Control/ LTV	Strut Cushion/ Strut Mount	HiJackers/ Load Carrier

DODGE

DODGE

CARAVAN / GRAND CARAVAN (cont)

12-16	Exc. RT Models	G52131	143463 ⁶⁸
08-16	All	143463 ⁶⁸
08-11	Exc. Self-Leveling Suspension	G52131	143463 ⁶⁸	G64042
06-07	All	G56620	M56620	142931 ⁵⁴
01-07	Exc. Hydraulic Self Leveling System	G56620	M56620	142931 ⁵⁴	G63690 ¹⁰	61605 ³⁴ 81878	49236 ⁷
05	All	G56620	M56620	142931 ⁵⁴	G63690 ¹⁰
01-04	All	G56620	M56620	142931 ⁵⁴
96-00	All	142753 ⁶⁷ 143059 ⁵¹
	Exc. Hydraulic Self Leveling System	G55697	M55697	142753 ⁶⁷ 142841 ⁵⁴ 143059 ⁵¹	G63690 ¹⁰	61605 ³⁴ 81878	49236 ⁷
89-95	Mfg. from 1/86	G55525	M55525	142568 ⁶⁷ 142567 ⁶⁷ 142880 ⁵⁴ 142933 ⁶⁸ 142940 ⁶⁶ 143059 ⁵¹	G63426	61538 81529
87-95	All	G55525	M55525	142567 ⁶⁷ 142568 ⁶⁷ 142880 ⁵⁴ 142933 ⁶⁸ 142940 ⁶⁶ 143059 ⁵¹	G63426	61538 81529
90	Mfg. from 1/2/86	G55525	M55525	142940 ⁶⁶ 142567 ⁶⁷ 142568 ⁶⁷ 142880 ⁵⁴ 142933 ⁶⁸ 143059 ⁵¹	G63426	61538 81529
86	All	142567 ⁶⁷ 142568 ⁶⁷ 142880 ⁵⁴ 142933 ⁶⁸ 142940 ⁶⁶ 143059 ⁵¹	G63426	61538 81529
	Mfg. from 1/86	G55525	M55525	142567 ⁶⁷ 142568 ⁶⁷ 142880 ⁵⁴ 142933 ⁶⁸ 142940 ⁶⁶ 143059 ⁵¹	G63426	61538 81529
	Mfg. to 2/86	G55509	142567 ⁶⁷ 142568 ⁶⁷ 142880 ⁵⁴ 142933 ⁶⁸ 142940 ⁶⁶ 143059 ⁵¹	G63426	61538 81529
84-85	All	G55509	143059 ⁵¹	G63426	61538 81529

CARAVAN / GRAND CARAVAN READYMOUNTS

	Fitment Notes	Front		Rear	
		Ultra Readymount	Guardian Readymount	Ultra Readymount	Guardian Readymount
11-16	Exc. RT Models	M57206 ⁴⁰
08-10	All	G57206 ⁴⁰
	Exc. RT Models	G57206 ⁴⁰	M57206 ⁴⁰
01-07	Left	G56956 ⁴⁰	M56956 ⁴⁰
	Right	G56957 ⁴⁰	M56957 ⁴⁰

7 Pair Packs, air hose kit included.

34 If suspension spring contacts this unit, rotate suspension spring 180 degrees.

51 Strut Cushion for use with the Strut/Cartridge/Shocks.

66 Upper Spring Seat with Spacer. Hardware from O.E. Part may need to be reused.

68 Strut Mount Kit. Hardware from O.E. Part may need to be reused.





10 The Nivomat leveling shocks are on the rear only. If suspension spring contacts units, rotate suspension spring 180 degrees.

40 Complete Assembled Unit.

54 Kit with Mount and Bearing. Hardware from O.E. Part may need to be reused.

67 Strut Mount Kit. Hardware from O.E. Part may need to be reused.

APPLICATION GUIDE







Year	Fitment Notes										
		 Ultra	ProGuard\ Guardian\ Classic	Max Control\ LTV	Strut Cushion\ Strut Mount	HiJackers\ Load Carrier	 Ultra	ProGuard\ Guardian\ Classic	Max Control\ LTV	Strut Cushion\ Strut Mount	HiJackers\ Load Carrier

DODGE

































DODGE

CARAVAN / GRAND CARAVAN READYMOUNTS (cont)		Front		Rear	
		Ultra Readymount	Guardian Readymount	Ultra Readymount	Guardian Readymount
96-00	Exc. Hydraulic Self Leveling System	G56910 ⁴⁰	M56910 ⁴⁰
87-95	All	G56907 ⁴⁰	M56907 ⁴⁰
86	Mfg. from 1/86	G56907 ⁴⁰	M56907 ⁴⁰

CHALLENGER

08-10	All		143369 ⁵³		143335 ⁵⁷
78-83	All		143059 ⁵¹	
70-74	All		82090		82131	43096 ⁸ 49106 ⁷

CHARGER

14-16	RWD, Left		G511031	
	RWD, Right		G511032	
11-13	RWD, Left		G511031	143468 ⁵⁸	
	RWD, Right		G511032	143468 ⁵⁸	
07-10	AWD		G51970		143335 ⁵⁷
06-10	All			143335 ⁵⁷
	Exc. Police Package w/Nivomat Suspension			G51721	143335 ⁵⁷
	RWD		143369 ⁵³		143335 ⁵⁷
	RWD, Left		M51761		143335 ⁵⁷
	RWD, Left Exc. Police Models		G51761		143335 ⁵⁷
	RWD, Left Police		G51947		143335 ⁵⁷
	RWD, Right Exc. Police Models		G51760	M51760		143335 ⁵⁷
83-87	All		G55507	143057 ⁵¹		G51047	142173 ⁵³
77-78	All		81153		69703	81338
73-76	All		81153		82131	43096 ⁸ 49106 ⁷
66-72	All		82090		82131	43096 ⁸ 49106 ⁷

CHARGER READYMOUNTS		Front		Rear	
		Ultra Readymount	Guardian Readymount	Ultra Readymount	Guardian Readymount
06-10	RWD, Left	G57071 ⁴⁰	M57071 ⁴⁰
	RWD, Right	G57072 ⁴⁰	M57072 ⁴⁰

7 Pair Packs, air hose kit included.

40 Complete Assembled Unit.

53 Strut Mount. Hardware from O.E. Part may need to be reused.

68 Strut Mount Kit. Hardware from O.E. Part may need to be reused.



Bold Type - New / Future Part

8 Pair Packs.

51 Strut Cushion for use with the Strut/Cartridge/Shocks.

67 Strut Mount Kit. Hardware from O.E. Part may need to be reused.

















APPLICATION GUIDE

Year	Fitment Notes										
		Ultra	ProGuard\ Guardian\ Classic	Max Control\ LTV	Strut Cushion\ Strut Mount	HiJackers\ Load Carrier	Ultra	ProGuard\ Guardian\ Classic	Max Control\ LTV	Strut Cushion\ Strut Mount	HiJackers\ Load Carrier



DODGE

DODGE









COLT

93-95	All		G55911	142329 ⁵³		G51063	142419 ⁶⁸ 143064 ⁵¹
	Exc. Wagon		G55911	143057 ⁵¹ 142329 ⁵³		G51063	142419 ⁶⁸ 143064 ⁵¹
92	All			142419 ⁶⁸ 143064 ⁵¹
	Exc. Wagon		143057 ⁵¹		142419 ⁶⁸ 143064 ⁵¹
	Hatchback		G55592		G51249	142419 ⁶⁸ 143064 ⁵¹
90-91	Exc. Wagon		143057 ⁵¹	
	Hatchback		G55592		G51249	142419 ⁶⁸ 143064 ⁵¹
86-91	Vista, 4WD, Wagon			81739
85-91	Vista, FWD, Wagon		143059 ⁵¹		69689	81464
89	Hatchback		G55592	143060 ⁵¹		G51249	142419 ⁶⁸ 143064 ⁵¹
87-88	Hatchback		G55561	143060 ⁵¹	
	Sedan		G55561	143060 ⁵¹	
85-86	Hatchback		143060 ⁵¹	
	Sedan		143060 ⁵¹	
84	Vista, FWD, Wagon			69689	81464
	Wagon		143059 ⁵¹	
79-83	Hatchback			69689	81464
75-80	Wagon		143059 ⁵¹		82156	43048 ⁸ 49151 ⁷
77-79	Exc. Wagon & Hatchback			81676
71-74	All			82156	43048 ⁸ 49151 ⁷
	Wagon		143059 ⁵¹		82156	43048 ⁸ 49151 ⁷





CONQUEST

84-86	All			143058 ⁵¹
-------	-----	---	------	------	------	------	------	---	------	------	------	----------------------	------

CORONET

73-76	All		81153		82131	43096 ⁸ 49106 ⁷
65-72	All		82090		82131	43096 ⁸ 49106 ⁷
57-59	All		82072		81469	49110 ⁷
51-56	All			81469	49110 ⁷

CUSTOM

57-61	All		82072		81469	49110 ⁷
54-56	All			81469	49110 ⁷





7 Pair Packs, air hose kit included.

51 Strut Cushion for use with the Strut/Cartridge/Shocks.

8 Pair Packs.

53 Strut Mount. Hardware from O.E. Part may need to be reused.





APPLICATION GUIDE

Year	Fitment Notes										
		 Ultra	ProGuard\ Guardian\ Classic	Max Control\ LTV	Strut Cushion\ Strut Mount	HiJackers\ Load Carrier	 Ultra	ProGuard\ Guardian\ Classic	Max Control\ LTV	Strut Cushion\ Strut Mount	HiJackers\ Load Carrier

DODGE

DODGE













D50

79-82	RWD		G63950	61556 81714		G63907	61500 81147	77907	43048 ⁸ 49310 ⁷
82	4WD		G63418	61529	77418		G63419	61532 81538

D50 STEERING STABILIZERS

		Front	Rear
79-82	RWD, Single System Steering Stabilizer	6802SE ⁸⁴

DAKOTA

10	4WD			G63891
	RWD			G63890
05-09	All		G51815	143385⁶⁸
	4WD		G51815	143385⁶⁸	G63891
	RWD		G51815	143385⁶⁸	G63890
97-04	All		G63403	61658 81923	58403 77403
	4WD		G63905	61601 81836	77905	G63403	61658 81923	58403 77403
	RWD		G63915	61512 81559	77915	G63403	61658 81923	58403 77403
87-96	4WD		G63881	61679 81902	77958	G63499	61584 81837
	RWD		G63915	61512 81559	77915	G63460	61511 81560





DAKOTA READYMOUNTS

		Front		Rear	
		Ultra Readymount	Guardian Readymount	Ultra Readymount	Guardian Readymount
05-09	4WD	G57146⁴⁰
	RWD	G57409⁴⁰



DAKOTA STEERING STABILIZERS

		Front	Rear
87-94	4WD, Single System Steering Stabilizer	6804SE ⁸⁰

DART

13-16	Left Touring Suspension		G52502		
	Right Touring Suspension		G52503		
63-76	All		82090	81469	49110 ⁷
62	All		82090	82131	49106 ⁷
60-61	All		82072	81469	49110 ⁷

DAYTONA

89-93	All		142567 ⁶⁷ 142568 ⁶⁷ 142880 ⁶⁴ 142933 ⁶⁸ 143059 ⁶¹	
	Exc. Shelby & Base Models		G55526	M55526	142940 ⁶⁶ 142567 ⁶⁷ 142568 ⁶⁷ 142880 ⁶⁴ 142933 ⁶⁸ 143059 ⁶¹		69632	81459

7 Pair Packs, air hose kit included.

40 Complete Assembled Unit.

54 Kit with Mount and Bearing. Hardware from O.E. Part may need to be reused.

67 Strut Mount Kit. Hardware from O.E. Part may need to be reused.

80 Mounting bracket not required, install on O.E. Shock Mounts. See Ref. C for optional Steering Stabilizer Boots.

Bold Type - New / Future Part

8 Pair Packs.



51 Strut Cushion for use with the Strut/Cartridge/Shocks.

66 Upper Spring Seat with Spacer. Hardware from O.E. Part may need to be reused.

68 Strut Mount Kit. Hardware from O.E. Part may need to be reused.

84 Replacement damper for vehicles with the Gabriel Aftermarket mounting kit

APPLICATION GUIDE

Year	Fitment Notes										
		Ultra	ProGuard\ Guardian\ Classic	Max Control\ LTV	Strut Cushion\ Strut Mount	HiJackers\ Load Carrier	Ultra	ProGuard\ Guardian\ Classic	Max Control\ LTV	Strut Cushion\ Strut Mount	HiJackers\ Load Carrier

DODGE

DODGE

DAYTONA (cont)

87-88	All	142567 ⁶⁷ 143059 ⁵¹
	Exc. Shelby & Base Models	G55526	M55526	142940 ⁶⁶ 142567 ⁶⁷ 143059 ⁵¹	69632	81459	49369 ⁷
	Pacifica	142568 ⁶⁷ 142880 ⁵⁴ 142933 ⁶⁸ 142567 ⁶⁷ 143059 ⁵¹
86	All	G55526	M55526	142567 ⁶⁷ 142568 ⁶⁷ 142880 ⁵⁴ 142933 ⁶⁸ 142940 ⁶⁶ 143059 ⁵¹
	Exc. Shelby & Base Models	G55526	M55526	142567 ⁶⁷ 142568 ⁶⁷ 142880 ⁵⁴ 142933 ⁶⁸ 142940 ⁶⁶ 143059 ⁵¹	69632	81459	49369 ⁷
84-85	All	G55511	143060 ⁵¹
	Exc. Shelby & Base Models	G55511	143060 ⁵¹	69632	81459	49369 ⁷

DIPLOMAT

77-89	All	69704	81406	69703	81338	49346 ⁷
-------	-----	-------	-------	-------	-------	-------	-------	-------	-------	--------------------

DURANGO

04-09	All	G64016	61720	G63892	61734
01-03	All	G63403	77403
	4WD	G63905	61601 81836	77905	G63403	77403
	RWD	G63915	61512 81559	77915	G63403	77403
98-03	4WD, RWD	G63403	61658 81923	58403 77403
99-00	RWD	G63915	61512 81559	77915	G63403	58403 77403
98-00	All	G63403	58403 77403
	4WD	G63905	61601 81836	77905	G63403	58403 77403

DYNASTY

88-93	All	142880 ⁵⁴ 142933 ⁶⁸ 143059 ⁵¹
	Exc. Hydraulic Self Leveling System	G55526	M55526	142567 ⁶⁷ 142568 ⁶⁷ 142940 ⁶⁶ 142880 ⁵⁴ 142933 ⁶⁸ 143059 ⁵¹
	Hydraulic Self Leveling System	142880 ⁵⁴ 142933 ⁶⁸ 143059 ⁵¹	81793

DYNASTY READYMOUNTS

		Front		Rear	
		Ultra Readymount	Guardian Readymount	Ultra Readymount	Guardian Readymount
88-93	All	M56985 ⁴⁰
	Exc. Hydraulic Self Leveling System	G56985 ⁴⁰	M56985 ⁴⁰

7 Pair Packs, air hose kit included.

51 Strut Cushion for use with the Strut/Cartridge/Shocks.

66 Upper Spring Seat with Spacer. Hardware from O.E. Part may need to be reused.

68 Strut Mount Kit. Hardware from O.E. Part may need to be reused.

40 Complete Assembled Unit.

54 Kit with Mount and Bearing. Hardware from O.E. Part may need to be reused.

67 Strut Mount Kit. Hardware from O.E. Part may need to be reused.

APPLICATION GUIDE

Year	Fitment Notes	Front					Rear				
		Ultra	ProGuard/ Guardian/ Classic	Max Control/ LTV	Strut Cushion/ Strut Mount	HiJackers/ Load Carrier	Ultra	ProGuard/ Guardian/ Classic	Max Control/ LTV	Strut Cushion/ Strut Mount	HiJackers/ Load Carrier

DODGE

DODGE

H100

11-13	Diesel	G64129'	G64128'
	Gas Left	G52459	G64130'
	Gas Right	G52460	G64130'
08-09	Diesel	G64129'	G64128'
	Gas Left	G52459	G64130'
	Gas Right	G52460	G64130'

H100 TRUCK

10	Diesel	G64129'	G64128'
	Gas Left	G52459	G64130'
	Gas Right	G52460	G64130'

H100 VAN

10	Diesel	G64129'	G64128'
	Gas Left	G52459	G64130'
	Gas Right	G52460	G64130'

INTREPID

98-04	Left	G55663	M55663	142827 ⁵⁸ 143057 ⁵¹	G55856	M55856	142828 ⁵³ 143058 ⁵¹
	Right	G55664	M55664	142827 ⁵⁸ 143057 ⁵¹	G55856	M55856	142828 ⁵³ 143058 ⁵¹
93-97	Left	G55663	M55663	142755 ⁵⁷ 142842 ⁵⁴ 143057 ⁵¹	G55665	M55665
	Right	G55664	M55664	142755 ⁵⁷ 142842 ⁵⁴ 143057 ⁵¹	G55665	M55665

INTREPID READYMOUNTS

		Front		Rear	
		Ultra Readymount	Guardian Readymount	Ultra Readymount	Guardian Readymount
98-04	Left	G56962 ⁴⁰	M56962 ⁴⁰	G56964 ⁴⁰	M56964 ⁴⁰
	Right	G56963 ⁴⁰	M56963 ⁴⁰	G56964 ⁴⁰	M56964 ⁴⁰
93-97	Left	G56958 ⁴⁰	M56958 ⁴⁰	G56960 ⁴⁰	M56960 ⁴⁰
	Right	G56959 ⁴⁰	M56959 ⁴⁰	G56960 ⁴⁰	M56960 ⁴⁰

JOURNEY

14-16	Right	G52149
09-16	Left	G52148
09-13	Right	G52149
09-12	FWD	G51848

1 Future Part, available 1st Quarter of 2017.

51 Strut Cushion for use with the Strut/Cartridge/Shocks.

54 Kit with Mount and Bearing. Hardware from O.E. Part may need to be reused.

68 Strut Mount Kit. Hardware from O.E. Part may need to be reused.



Bold Type - New / Future Part

40 Complete Assembled Unit.

53 Strut Mount. Hardware from O.E. Part may need to be reused.

67 Strut Mount Kit. Hardware from O.E. Part may need to be reused.

APPLICATION GUIDE

Year	Fitment Notes										
		Ultra	ProGuard/ Guardian/ Classic	Max Control/ LTV	Strut Cushion/ Strut Mount	HiJackers/ Load Carrier	Ultra	ProGuard/ Guardian/ Classic	Max Control/ LTV	Strut Cushion/ Strut Mount	HiJackers/ Load Carrier

DODGE

DODGE

JOURNEY READYMOUNTS		Front		Rear	
		Ultra Readymount	Guardian Readymount	Ultra Readymount	Guardian Readymount
09-13	Left	G57266 ⁴⁰

LANCER

87-89	All	G55526	M55526	142567 ⁶⁷ 142568 ⁶⁷ 142880 ⁵⁴ 142933 ⁶⁸ 142940 ⁶⁶ 143060 ⁵¹	69632	81459	49369 ⁷
86	All	G55526	M55526	142567 ⁶⁷ 142568 ⁶⁷ 142880 ⁵⁴ 142933 ⁶⁸ 143060 ⁵¹	69632	81459	49369 ⁷
	Mfg. from 1/2/86	G55526	M55526	142940 ⁶⁶ 142567 ⁶⁷ 142568 ⁶⁷ 142880 ⁵⁴ 142933 ⁶⁸ 143060 ⁵¹	69632	81459	49369 ⁷
85	All	G55511	143060 ⁵¹	69632	81459	49369 ⁷
61-62	All	82090	81469	49110 ⁷

M300

74	All	G63605	G63183
	H3, M3, M-375 H4, M4	G63605	G63183	82065

M350

74	All	G63605
	H3, M3, M-375 H4, M4	G63605	82065

MAGNUM

05-08	All	143335 ⁶⁷
	Exc. Nivomat Suspension	G51721	143335 ⁶⁷
	AWD	G51970	143335 ⁶⁷
	RWD	143369 ⁵³	143335 ⁶⁷
	RWD, Left Exc. Performance Suspension	G51761	M51761	143335 ⁶⁷
	RWD, Left Performance Suspension	G51947	143335 ⁶⁷
	RWD, Right Exc. Performance Suspension	G51760	M51760	143335 ⁶⁷
	RWD, Right Performance Suspension	G51948	143335 ⁶⁷
78-79	All	81153	69703	81338	

MAGNUM READYMOUNTS		Front		Rear	
		Ultra Readymount	Guardian Readymount	Ultra Readymount	Guardian Readymount
05-08	RWD, Left	G57071 ⁴⁰	M57071 ⁴⁰
	RWD, Right	G57072 ⁴⁰	M57072 ⁴⁰

7 Pair Packs, air hose kit included.

51 Strut Cushion for use with the Strut/Cartridge/Shocks.

54 Kit with Mount and Bearing. Hardware from O.E. Part may need to be reused.

67 Strut Mount Kit. Hardware from O.E. Part may need to be reused.



40 Complete Assembled Unit.

53 Strut Mount. Hardware from O.E. Part may need to be reused.

66 Upper Spring Seat with Spacer. Hardware from O.E. Part may need to be reused.

68 Strut Mount Kit. Hardware from O.E. Part may need to be reused.

APPLICATION GUIDE

Year	Fitment Notes										
		Ultra	ProGuard/ Guardian/ Classic	Max Control/ LTV	Strut Cushion/ Strut Mount	HiJackers/ Load Carrier	Ultra	ProGuard/ Guardian/ Classic	Max Control/ LTV	Strut Cushion/ Strut Mount	HiJackers/ Load Carrier





DODGE

DODGE

MEADOWBROOK

51-54	All	81469	49110 ⁷
-------	-----	-------	-------	-------	-------	-------	-------	-------	-------	-------	--------------------



MINI RAM

87-88	All	 G55525	M55525	143059 ⁵¹	 G63426	61538 81529
84-86	All	 G63359 ³⁵	61523 ³⁵ 81096 ³⁵	58359 ³⁵ 77359 ³⁵	34052 ⁸	 G63413 ³⁵	61522 ⁶ 81496	58413 77413	43085 ⁸ 49212 ⁷





















MINI RAM READYMOUNTS

		Front		Rear	
		Ultra Readymount	Guardian Readymount	Ultra Readymount	Guardian Readymount
87-88	All	G56907 ⁴⁰		M56907 ⁴⁰	









MIRADA

80-83	All	 69704	81406	 69703	81338	49346 ⁷
-------	-----	---	-------	-------	-------	-------	---	-------	-------	-------	--------------------

MONACO

77-78	All		81153	 69703	81338 82131	49106 ⁷
	Police Package		81153	 69703	81338 82131	43096 ⁸ 49106 ⁷
74-76	All	 69704	81406		82131	43096 ⁸ 49106 ⁷
73	All		82011		81091 82131	43096 ⁸
	Exc. Wagon		82011		81091 82131	49106 ⁷ 43096 ⁸
	Wagon		82011		81091 82131	49149 ⁷ 43096 ⁸
72	All		82011		82131	43096 ⁸ 49106 ⁷
71	All		82011		81091	43067 ⁸
	Wagon		82011		81091	49149 ⁷ 43067 ⁸
65-70	All		82011		82131	43096 ⁸ 49106 ⁷

NEON

00-05	All		142932 ⁵⁸ 143060 ⁵¹		143057 ⁵¹ 143256 ⁵³
	Exc. SRT4 Left	 G55892	M55892	142932 ⁵⁸ 143060 ⁵¹	 G55894	M55894	143057 ⁵¹ 143256 ⁵³
	Exc. SRT4 Right	 G55892	M55892	142932 ⁵⁸ 143060 ⁵¹	 G55893	M55893	143057 ⁵¹ 143256 ⁵³
95-99	All	 G55679	M55679	142840 ⁵⁴ 143057 ⁵¹	 G55680	M55680	142393 ⁵³ 143059 ⁵¹

NEON READYMOUNTS

		Front		Rear	
		Ultra Readymount	Guardian Readymount	Ultra Readymount	Guardian Readymount
00-05	Exc. SRT4 Left	G56975 ⁴¹		M56975 ⁴¹	
	Exc. SRT4 Right	G56975 ⁴¹		M56975 ⁴¹	
95-99	All	G56966 ⁴⁰		M56966 ⁴⁰	

NITRO

09-11	All	 G51728	M51728
-------	-----	--	--------	-------	-------	-------	-------	-------	-------	-------

6 It is recommended that when replacing shocks on vehicles with "quad shocks" all 4 shocks should be matched by series.

8 Pair Packs.

40 Complete Assembled Unit.

51 Strut Cushion for use with the Strut/Cartridge/Shocks.

54 Kit with Mount and Bearing. Hardware from O.E. Part may need to be reused.

7 Pair Packs, air hose kit included.



35 Slight grinding of control arm opening is required to install product made before Aug 1988.

41 Complete Assembled Unit. See Ref. D for procedures to replace Elec Adj Susp with non-adj product.

53 Strut Mount. Hardware from O.E. Part may need to be reused.

68 Strut Mount Kit. Hardware from O.E. Part may need to be reused.



APPLICATION GUIDE

Year	Fitment Notes										
		Ultra	ProGuard\ Guardian\ Classic	Max Control\ LTV	Strut Cushion\ Strut Mount	HiJackers\ Load Carrier	Ultra	ProGuard\ Guardian\ Classic	Max Control\ LTV	Strut Cushion\ Strut Mount	HiJackers\ Load Carrier

DODGE

DODGE







NITRO (cont)

07-08	All	 G51728	M51728	 G63844
-------	-----	--	--------	------	------	------	--	------	------	------	------











NITRO READYMOUNTS

		Front		Rear	
		Ultra Readymount	Guardian Readymount	Ultra Readymount	Guardian Readymount
07-11	Left	G57007 ⁴⁰	M57007 ⁴⁰
	Right	G57008 ⁴⁰	M57008 ⁴⁰

OMNI

90	All	 G55594	143059 ⁵¹	 G51047	142173 ⁵³
81-89	All	 G55507	143057 ⁵¹	 G51047	142173 ⁵³
78-80	All	 G55507	143057 ⁵¹		142173 ⁵³









PICKUP 1/2 TON, D100 SERIES

86-93	All	 G63359 ³⁵	61523 ³⁵ 81096 ³⁵	58359 ³⁵ 77359 ³⁵	34052 ⁸	 G63353	61526 81091	58353	43067 ⁸ 49149 ⁷
84-85	All	 G63359	61523 ³⁵ 81096 81096 ³⁵	58359 ³⁴ 58359 ³⁵ 77359 ³⁵	34052 ⁸	 G63353	61526 81091	58353	43067 ⁸ 49149 ⁷
72-83	All	 G63359 ³⁵	61523 ³⁵ 81096 ³⁵	58359 ³⁵ 77359 ³⁵	34052 ⁸	 G63353	61526 81091	58353	43067 ⁸ 49149 ⁷
61-71	All		82046		82054
60	All		82065		82054

PICKUP 1/2 TON, D100 SERIES STEERING STABILIZERS

		Front	Rear
86-89	Single System Steering Stabilizer	6802SE ⁸⁴
72-79	Single System Steering Stabilizer	6802SE ⁸⁴
60-71	Single System Steering Stabilizer; with I-Beam Axle	6802SE ⁸⁴









PICKUP 1/2 TON, W100 SERIES

81-93	Exc. Lift Kit	 G63183	61632 81825	58183 77183	 G63389	61633 81342	58389 77389
72-80	All	 G63183	61632 81825	58183 77183	 G63389	61633 81342	58389 77389
61-71	All	 G63183	61632 81825	58183 77183		82054
60	All		82065		82054

PICKUP 1/2 TON, W100 SERIES STEERING STABILIZERS

		Front	Rear
90-93	Single System Steering Stabilizer	6802SE ⁸⁴
60-89	Single System Steering Stabilizer	6803SE ⁸⁴
60-86	Dual System Steering Stabilizer; Exc. Vacuum Servo Mounted on Drivers Side of Axle	6802SE ⁸⁴

PICKUP 3/4 TON, D200 SERIES

90-93	All		 G63353	61526 81091	58353	43067 ⁸ 49149 ⁷
	HD Package	 G63360 ³⁵	61650 81834	58360	 G63353	61526 81091	58353	43067 ⁸ 49149 ⁷
82-93	Exc. HD Package	 G63359 ³⁵	61523 ³⁵ 81096 ³⁵	58359 ³⁵ 77359 ³⁵	34052 ⁸	 G63353	61526 81091	58353	43067 ⁸ 49149 ⁷
82-89	All		77359 ³⁵	 G63353	61526 81091	58353	43067 ⁸ 49149 ⁷

7 Pair Packs, air hose kit included.

34 If suspension spring contacts this unit, rotate suspension spring 180 degrees.

40 Complete Assembled Unit.

53 Strut Mount. Hardware from O.E. Part may need to be reused.



8 Pair Packs.

35 Sight grinding of control arm opening is required to install product made before Aug 1988.

51 Strut Cushion for use with the Strut/Cartridge/Shocks.

84 Replacement damper for vehicles with the Gabriel Aftermarket mounting kit

APPLICATION GUIDE

Year	Fitment Notes										
		Ultra	ProGuard/ Guardian/ Classic	Max Control/ LTV	Strut Cushion/ Strut Mount	HiJackers/ Load Carrier	Ultra	ProGuard/ Guardian/ Classic	Max Control/ LTV	Strut Cushion/ Strut Mount	HiJackers/ Load Carrier

DODGE

DODGE

PICKUP 3/4 TON, D200 SERIES (cont)

82-89	HD Package	⊥ ⊕	G63360 ³⁵	61650 81834	58360 77359 ³⁵	⊕ ⊕	G63353	61526 81091	58353	43067 ⁸ 49149 ⁷
81	All		⊕ ⊕	G63353	61526 81091	58353	43067 ⁸
	Exc. HD Package	⊥ ⊕	G63359 ³⁵	61523 ³⁵ 81096 ³⁵	58359 ³⁵ 77359 ³⁵	34052 ⁸	⊕ ⊕	G63353	61526 81091	58353	49149 ⁷ 43067 ⁸
	HD Package	⊥ ⊕	G63360 ³⁵	⊕ ⊕	G63353	61526 81091	58353	43067 ⁸
	165.0(WheelBase) HD Package	⊥ ⊕	61650 81834	58360	⊕ ⊕	G63353	61526 81091	58353	43067 ⁸
77-80	HD Package	⊥ ⊕	G63360 ³⁵	61650	58360	⊕ ⊕	G63353	61526 81091	58353	43067 ⁸ 49149 ⁷
	165.0(WheelBase) HD Package	⊥ ⊕	81834	⊕ ⊕	G63353	61526 81091	58353	43067 ⁸ 49149 ⁷
72-80	All		⊕ ⊕	G63353	61526 81091	58353	43067 ⁸ 49149 ⁷
	Exc. HD Package	⊥ ⊕	G63359 ³⁵	61523 ³⁵ 81096 ³⁵	58359 ³⁵ 77359 ³⁵	34052 ⁸	⊕ ⊕	G63353	61526 81091	58353	43067 ⁸ 49149 ⁷
75-76	HD Package	⊥ ⊕	G63360 ³⁵	⊕ ⊕	G63353	61526 81091	58353	43067 ⁸ 49149 ⁷
	165.0(WheelBase) HD Package	⊥ ⊕	61650 81834	58360	⊕ ⊕	G63353	61526 81091	58353	43067 ⁸ 49149 ⁷
72-74	HD Package	⊥ ⊕	G63360 ³⁵	61650 81834	58360	⊕ ⊕	G63353	61526 81091	58353	43067 ⁸ 49149 ⁷
61-71	All	⊕ ⊕	82046	⊕ ⊕	82054
60	All	⊕ ⊕	82065	⊕ ⊕	82054

PICKUP 3/4 TON, D200 SERIES STEERING STABILIZERS

		Front	Rear
73-93	Single System Steering Stabilizer	6802SE ⁸⁴
60-71	Single System Steering Stabilizer; with I-Beam Axle	6802SE ⁸⁴

PICKUP 3/4 TON, W200 SERIES

81-93	Exc. Crew Cab & Lift Kit	⊕ ⊕	G63183	61632 81825	58183 77183	⊕ ⊕	G63389	61633 81342	58389 77389
72-80	All	⊕ ⊕	G63183	61632 81825	58183 77183	⊕ ⊕	G63389	61633 81342	58389 77389
69-71	All	⊕ ⊕	G63183	61632 81825	58183 77183	⊕ ⊕	82054
61-67	All	⊕ ⊕	G63183	61632 81825	58183 77183	⊕ ⊕	82054
60	All	⊕ ⊕	82065	⊕ ⊕	82054

PICKUP 3/4 TON, W200 SERIES STEERING STABILIZERS

		Front	Rear
90-93	Single System Steering Stabilizer	6802SE ⁸⁴
69-89	Single System Steering Stabilizer	6803SE ⁸⁴
60-86	Dual System Steering Stabilizer; Exc. Vacuum Servo Mounted on Drivers Side of Axle	6802SE ⁸⁴
60-67	Single System Steering Stabilizer	6803SE ⁸⁴

PICKUP 1 TON, D300 SERIES

72-93	All	⊥ ⊕	58360	⊕ ⊕	G63353	61526 81091	58353	43067 ⁸ 49149 ⁷
	HD Package	⊥ ⊕	G63360 ³⁵	61650 81834	58360	⊕ ⊕	G63353	61526 81091	58353	43067 ⁸ 49149 ⁷
61-71	All	⊕ ⊕	82046	⊕ ⊕	82065

PICKUP 1 TON, D300 SERIES STEERING STABILIZERS

		Front	Rear
75-93	Single System Steering Stabilizer	6802SE ⁸⁴
72-74	Single System Steering Stabilizer; with Coil Spring Front Suspension	6802SE ⁸⁴
60-71	Single System Steering Stabilizer; with I-Beam Axle	6802SE ⁸⁴



7 Pair Packs, air hose kit included.

35 Sight grinding of control arm opening is required to install product made before Aug 1988.

8 Pair Packs.

84 Replacement damper for vehicles with the Gabriel Aftermarket mounting kit

APPLICATION GUIDE

Year	Fitment Notes										
		Ultra	ProGuard\ Guardian\ Classic	Max Control\ LTV	Strut Cushion\ Strut Mount	HiJackers\ Load Carrier	Ultra	ProGuard\ Guardian\ Classic	Max Control\ LTV	Strut Cushion\ Strut Mount	HiJackers\ Load Carrier

DODGE

DODGE

PICKUP 1 TON, W300 SERIES

81-93	Exc. Quad Suspension and Lift Kit	⊖	G63183	61632 81825	58183 77183	⊖	G63389	61633 81342	58389 77389
72-80	All	⊖	G63183	61632 81825	58183 77183	⊖	G63389	61633 81342	58389 77389
61-71	All	⊖	G63183	61632 81825	58183 77183	⊖	G63183	61632 81825	58183 77183

PICKUP 1 TON, W300 SERIES STEERING STABILIZERS

		Front	Rear
90-93	Single System Steering Stabilizer	6802SE ⁸⁴
60-89	Single System Steering Stabilizer	6803SE ⁸⁴
60-86	Dual System Steering Stabilizer; Exc. Vacuum Servo Mounted on Drivers Side of Axle	6802SE ⁸⁴

PICKUP 1/2 TON, RAM 1500 (SEE RAM 1500)

09-10	All	⊖	⊖	G64044
	4WD	⊖	G51856	143389 ⁸⁸	⊖	G64044
	RWD	⊖	G64043	⊖	G64044
06-08	4WD	⊖	M52808	⊖
	4WD w/5.7L	⊖	77980	⊖
	4WD, Mega Cab	⊖	61712	⊖
	4WD; Exc. Mega Cab	⊖	G51758	143324	⊖	G63961	61691 81931
	RWD; Exc. Mega Cab	⊖	G63958	81933	77954	⊖	G63962	61692
06-07	Exc. Mega Cab	⊖	⊖	58412 77412
02-05	All	⊖	⊖	G63675	58412 77412
	4WD	⊖	G63848	81932	77947	⊖	G63675	61691 81931	58412 77412
	RWD	⊖	G63958	81933	77954	⊖	G63675	61692	58412 77412
94-01	All	⊖	⊖	G63662	61600 81873	58662 77662	43181 ⁸ 49235 ⁷
	4WD	⊖	G63673	61634 81919	58673 77673	⊖	G63662	61600 81873	58662 77662	43181 ⁸ 49235 ⁷
	RWD	⊖	G63661	61599 81928	58661 77661	⊖	G63662	61600 81873	58662 77662	43181 ⁸ 49235 ⁷

PICKUP 1/2 TON, RAM 1500 (SEE RAM 1500) READYMOUNTS

		Front		Rear	
		Ultra Readymount	Guardian Readymount	Ultra Readymount	Guardian Readymount
09-10	All	M57147 ⁴⁰
	4WD	G57147 ⁴⁰	M57147 ⁴⁰
06-08	4WD; Exc. Mega Cab	G57053 ⁴⁰

PICKUP 1/2 TON, RAM 1500 (SEE RAM 1500) STEERING STABILIZERS

		Front	Rear
00-07	4WD, With OEM # 52106909AB, AC, AD	6847SE ⁸²
94-01	RWD, GAS Coil Spring Suspension Steering Stabilizer	6859SE ⁸²
97-99	4WD, With OEM 52039280	6846SE ⁸²
94-97	4WD, With OEM 52038276	6804SE ⁸⁰

PICKUP 3/4 TON, RAM 2500 (SEE RAM 2500)

09-10	4WD	⊖	77948	⊖	61716	77950
-------	-----	---	------	------	-------	------	------	---	------	-------	-------	------	------

7 Pair Packs, air hose kit included.

40 Complete Assembled Unit.

68 Strut Mount Kit. Hardware from O.E. Part may need to be reused.

82 Use kit if listed, See Ref. C for optional Steering Stabilizer Boots.

8 Pair Packs.

53 Strut Mount. Hardware from O.E. Part may need to be reused.

80 Mounting bracket not required, install on O.E. Shock Mounts. See Ref. C for optional Steering Stabilizer Boots.

84 Replacement damper for vehicles with the Gabriel Aftermarket mounting kit

APPLICATION GUIDE

Year	Fitment Notes										
		Ultra	ProGuard/ Guardian/ Classic	Max Control/ LTV	Strut Cushion/ Strut Mount	HiJackers/ Load Carrier	Ultra	ProGuard/ Guardian/ Classic	Max Control/ LTV	Strut Cushion/ Strut Mount	HiJackers/ Load Carrier

DODGE

DODGE

PICKUP 3/4 TON, RAM 2500 (SEE RAM 2500) (cont)

07-10	RWD, Standard Cab Pickup		G63970	77950
03-10	All		77950
	4WD, 8800# GVW		G64013	77950
	RWD	⊖	77949	77950
07-08	4WD	⊖	G64011	61714	77948	61716	77950
03-06	RWD, Crew Cab Pickup		G63971	61710	77950
	RWD, Standard Cab Pickup		G63970	61709	77950
06	4WD	⊖	G64011	61714	61716	77950
	4WD w/5.7L	⊖	77980	77950
	4WD, Exc. 5.9L	⊖	77948	77950
05	4WD	⊖	G64011	61714	77948	61716	77950
03-04	4WD	⊖	77948	61716	77950
03	4WD, GAS Exc. 8800# GVW		G63662	61600 81873	77950
99-02	4WD, Exc. 8800# GVW	⊖	81919
94-02	4WD, DIESEL 8800# GVW	⊖	G63674	61635	58674 77674	G63675	61642 81921	58675 77675
	4WD, GAS Exc. 8800# GVW	⊖	G63673	61634	58673 77673	G63662	61600 81873	58662 77662	49235 ⁷
	RWD	⊖	G63661	61599 81928	58661 77661	G63662	61600 81873	58662 77662	43181 ⁸ 49235 ⁷
95-96	4WD, CNG Exc. 8800# GVW	⊖	G63673	61634	58673	G63662	61600 81873	58662 77662	49235 ⁷
94-95	4WD, Exc. 8800# GVW	⊖	81919

PICKUP 3/4 TON, RAM 2500 (SEE RAM 2500) STEERING STABILIZERS

	Front	Rear
00-07 4WD, With OEM # 52106909AB, AC, AD	6847SE ⁸²
94-02 RWD, GAS Coil Spring Suspension Steering Stabilizer	6859SE ⁸²
97-99 4WD, With OEM 52039280	6846SE ⁸²
94-97 4WD, With OEM 52038276	6804SE ⁸⁰

PICKUP 1 TON, RAM 3500 (SEE RAM 3500)

07-10	4WD		77948	77950
03-10	All		77950
	RWD	⊖	77949	77950
03-07	RWD, Crew Cab Pickup		G63971	61710	77950
03-06	RWD, Standard Cab Pickup		G63970	61709	77950
06	4WD w/5.7L	⊖	77980	77950
	4WD, Exc. 5.9L	⊖	77948	77950
03-05	4WD	⊖	77948	77950
94-02	4WD	⊖	G63674	61635	58674 77674	G63675	61642 81921	58675 77675
	RWD, Exc. Solid Front Axle	⊖	G63661	61599 81928	58661 77661	G63662	61600 81873	58662 77662	43181 ⁸ 49235 ⁷
	RWD, Solid Front Axle	⊖	G63674	61635	58674 77674	G63675	61642 81921	58675 77675



7 Pair Packs, air hose kit included.

80 Mounting bracket not required, install on O.E. Shock Mounts. See Ref. C for optional Steering Stabilizer Boots.

8 Pair Packs.

82 Use kit if listed, See Ref. C for optional Steering Stabilizer Boots.

APPLICATION GUIDE

Year	Fitment Notes										
		Ultra	ProGuard\ Guardian\ Classic	Max Control\ LTV	Strut Cushion\ Strut Mount	HiJackers\ Load Carrier	Ultra	ProGuard\ Guardian\ Classic	Max Control\ LTV	Strut Cushion\ Strut Mount	HiJackers\ Load Carrier

DODGE

DODGE

PICKUP 1 TON, RAM 3500 (SEE RAM 3500) STEERING STABILIZERS

			Front	Rear
00-07	4WD, With OEM # 52106909AB, AC, AD		6847SE ⁸²
	RWD, With OEM # 52106909AB, AC, AD and Solid Front Axle		6847SE ⁸²
94-02	RWD, GAS Coil Spring Suspension Steering Stabilizer		6859SE ⁸²
97-99	4WD, With OEM 52039280		6846SE ⁸²
	RWD, w/ OEM 52039280 Solid Front Axle		6846SE ⁸²
94-97	4WD, With OEM 52038276		6804SE ⁸⁰
	RWD, w/ OEM 52038276 Solid Front Axle		6804SE ⁸⁰

PICKUP, RAM 50

87-93	4WD	⊕	61529	77418	⊕	G63419	61532 81538
	RWD	⊕	G63950	61556 81714	⊕	G63907	61500 81147	77907	43048 ⁸ 49310 ⁷
83-86	All	⊕	⊕	G63907	61500	77907	43048 ⁸ 49310 ⁷
	4WD	⊕	G63418	⊕	G63907	61500	77907	43048 ⁸ 49310 ⁷
	RWD	⊕	G63950	61556 81714	⊕	G63907	81147 61500	77907	43048 ⁸ 49310 ⁷

PICKUP, RAM 50 STEERING STABILIZERS

			Front	Rear
83-93	RWD, Single System Steering Stabilizer		6802SE ⁸⁴

POLARA

73	All	⊕	82011	⊕	81091
	Exc. Wagon	⊕	82011	⊕	82131 81091	43096 ⁸ 49106 ⁷
	Wagon	⊕	82011	⊕	81091	49149 ⁷ 43067 ⁸
72	All	⊕	82011	⊕	82131	43096 ⁸ 49106 ⁷
71	All	⊕	82011	⊕	81091	43067 ⁸
	Wagon	⊕	82011	⊕	81091	49149 ⁷ 43067 ⁸
65-70	All	⊕	82011	⊕	82131	43096 ⁸ 49106 ⁷
62-64	All	⊕	82090	⊕	82131	43096 ⁸ 49106 ⁷
60-61	All	⊕	82072	⊕	81469	49110 ⁷

RAIDER

87-89	All	⊕	G63418	61529	77418	⊕
	Exc. Sport Utility	⊕	G63418	61529	77418	⊕	G63492	81318	77492
	2.6L 4 Cyl	⊕	G63418	61529	77418	⊕	61506
89	3.0L 6 Cyl V	⊕	G63418	61529	77418	⊕	61568
	Sport Utility	⊕	G63418	61529	77418	⊕	G63604

RAIDER STEERING STABILIZERS

			Front	Rear
87-89	Single System Steering Stabilizer		6802SE ⁸⁴

RAMCHARGER

76-93	4WD	⊕	G63183	61632 81825	58183	⊕	G63389	61633 81342	58389
	RWD	⊕	G63359 ³⁵	61523 ³⁵ 81096 ³⁵	58359 ³⁵ 77359 ³⁵	34052 ⁸	⊕	G63353	61526 81091	58353	43067 ⁸ 49149 ⁷
75	All	⊕	⊕	61526	58353	43067 ⁸ 49149 ⁷

7 Pair Packs, air hose kit included.

35 Sight grinding of control arm opening is required to install product made before Aug 1988.

8 Pair Packs.

80 Mounting bracket not required, install on O.E. Shock Mounts. See Ref. C for optional Steering Stabilizer Boots.

84 Replacement damper for vehicles with the Gabriel Aftermarket mounting kit

APPLICATION GUIDE

Year	Fitment Notes	Front					Rear				
		Ultra	ProGuard\ Guardian\ Classic	Max Control\ LTV	Strut Cushion\ Strut Mount	HiJackers\ Load Carrier	Ultra	ProGuard\ Guardian\ Classic	Max Control\ LTV	Strut Cushion\ Strut Mount	HiJackers\ Load Carrier

DODGE

DODGE

RAMCHARGER (cont)

75	4WD	○	G63183	61632 81825	58183	○	61526	58353	43067 ⁸ 49149 ⁷
	RWD	○	G63359 ³⁵	61523 ³⁵ 81096 ³⁵	58359 ³⁵ 77359 ³⁵	34052 ⁸	○	G63353	81091 61526	58353	43067 ⁸ 49149 ⁷
74	All		○	G63353	61526	58353	43067 ⁸ 49149 ⁷
	4WD	○	G63183	61632 81825	58183	○	G63353	61526	58353	43067 ⁸ 49149 ⁷
	RWD		○	G63353	81091 61526	58353	43067 ⁸ 49149 ⁷

RAMCHARGER STEERING STABILIZERS

		Front	Rear
87-93	RWD, Single System Steering Stabilizer	6802SE ⁸⁴
75-93	4WD, Single System Steering Stabilizer	6803SE ⁸⁴
74-86	Dual System Steering Stabilizer; Exc. Vacuum Servo Mounted on Drivers Side of Axle	6802SE ⁸⁴
74	Single System Steering Stabilizer	6803SE ⁸⁴

RAMPAGE

82-84	All	○	G55507	143057 ⁵¹	○
-------	-----	---	--------	------	------	----------------------	------	---	------	------	------	------	------

RD200

78-80	All	○	G63183	81825	○	81342
-------	-----	---	--------	-------	------	------	------	---	------	-------	------	------	------

ROYAL MONACO

75-77	All	○	69704	81406	○	82131	43096 ⁸ 49106 ⁷
-------	-----	---	-------	-------	------	------	------	---	------	-------	------	------	--

SHADOW

87-94	All	○	G55526	M55526	142567 ⁶⁷ 142568 ⁶⁷ 142880 ⁶⁴ 142933 ⁶⁸ 142940 ⁶⁶ 143059 ⁵¹	○	69632	81459	49369 ⁷
-------	-----	---	--------	--------	------	--	------	---	-------	-------	------	------	--------------------

SHADOW READYMOUNTS

		Front		Rear	
		Ultra Readymount	Guardian Readymount	Ultra Readymount	Guardian Readymount
89-94	All	M56985 ⁴⁰
	Exc. Hydraulic Self Leveling System	G56985 ⁴⁰	M56985 ⁴⁰

SPIRIT

89-95	All	○	G55526	M55526	142567 ⁶⁷ 142568 ⁶⁷ 142880 ⁶⁴ 142933 ⁶⁸ 142940 ⁶⁶ 143059 ⁵¹	○	69632	81459	49369 ⁷
-------	-----	---	--------	--------	------	--	------	---	-------	-------	------	------	--------------------

SPIRIT READYMOUNTS

		Front		Rear	
		Ultra Readymount	Guardian Readymount	Ultra Readymount	Guardian Readymount
89-95	All	M56985 ⁴⁰
	Exc. Hydraulic Self Leveling System	G56985 ⁴⁰	M56985 ⁴⁰

SPRINTER 2500

03-06	All	○	G56778	○
	Exc. Dual Rear Wheels	○	G56778	○	G63918

7 Pair Packs, air hose kit included.

35 Sight grinding of control arm opening is required to install product made before Aug 1988.

51 Strut Cushion for use with the Strut/Cartridge/Shocks.

66 Upper Spring Seat with Spacer. Hardware from O.E. Part may need to be reused.

68 Strut Mount Kit. Hardware from O.E. Part may need to be reused.

Bold Type - New / Future Part

8 Pair Packs.



40 Complete Assembled Unit.

54 Kit with Mount and Bearing. Hardware from O.E. Part may need to be reused.

67 Strut Mount Kit. Hardware from O.E. Part may need to be reused.

84 Replacement damper for vehicles with the Gabriel Aftermarket mounting kit

APPLICATION GUIDE

Year	Fitment Notes										
		Ultra	ProGuard\Guardian\Classic	Max Control\LTV	Strut Cushion\Strut Mount	HiJackers\Load Carrier	Ultra	ProGuard\Guardian\Classic	Max Control\LTV	Strut Cushion\Strut Mount	HiJackers\Load Carrier

DODGE

DODGE

SPRINTER 3500

03-06	All	↑	G56778			
	Dual Rear Wheels	↑	G56778	○	G63919
	Exc. Dual Rear Wheels	↑	G56778	○	G63918

ST. REGIS

79-81	All	○	81153	○	69703	81338
-------	-----	---	------	-------	------	------	------	------	---	-------	-------	------	------	------

STEALTH

91-96	All	↑	↑	142419 ⁶⁸
-------	-----	---	------	------	------	------	------	------	---	------	------	------	----------------------	------

STRATUS

01-06	Sedan	↑	G51267	M51267	↑	G51268	M51268	143321 ⁵³
	Sedan and Convertible; JR (MfrBodyCode)	↑	143423 ⁶⁷	↑	143423 ⁶⁷
01-05	Coupe Left	↑	M52811	↑
	Coupe Right	↑	M52812	↑
	Coupe, ST(MfrBodyCode) Left	↑	G56552	143087 ⁵³	↑	G51254	M51254	142419 ⁶⁸
	Coupe, ST(MfrBodyCode) Right	↑	G56551	143087 ⁵³	↑	G51254	M51254	142419 ⁶⁸
99-00	All	↑	143064 ⁵¹	↑	143063 ⁵¹ 143328 ⁶⁷
	Sedan	↑	G51267	M51267	143064 ⁵¹	↑	G51268	M51268	143063 ⁵¹ 143328 ⁶⁷
	Sedan and Convertible; JR (MfrBodyCode)	↑	143064 ⁵¹	↑	143423 ⁶⁷ 143063 ⁵¹ 143328 ⁶⁷
97-98	All	↑	G51796	143064 ⁵¹	↑	G51078	M51268	143063 ⁵¹
95-96	All	↑	G55818	M51267	143064 ⁵¹	↑	G51078	M51268	143063 ⁵¹

STRATUS READYMOUNTS

		Front		Rear	
		Ultra Readymount	Guardian Readymount	Ultra Readymount	Guardian Readymount
01-06	2.4L & 2.7L Left	G57431 ⁴⁰
	2.4L & 2.7L Right	G57432 ⁴⁰
	Sedan	G57026 ⁴⁰	M57026 ⁴⁰
01-05	Coupe Left	G57073 ⁴⁰	G57075 ⁴⁰
	Coupe Right	G57074 ⁴⁰	G57075 ⁴⁰
99-00	All	G57025 ⁴⁰	M57025 ⁴⁰
	2.4L & 2.7L Left	G57431 ⁴⁰	G57025 ⁴⁰	M57025 ⁴⁰
	2.4L & 2.7L Right	G57432 ⁴⁰	G57025 ⁴⁰	M57025 ⁴⁰
95-98	All	G57422 ⁴⁰

TRUCK

59-60	All	○	82065	○	82054
53-58	All	○	82065	○	82065

40 Complete Assembled Unit.



53 Strut Mount. Hardware from O.E. Part may need to be reused.

68 Strut Mount Kit. Hardware from O.E. Part may need to be reused.

51 Strut Cushion for use with the Strut/Cartridge/Shocks.

67 Strut Mount Kit. Hardware from O.E. Part may need to be reused.

APPLICATION GUIDE

Year	Fitment Notes										
		Ultra	ProGuard/ Guardian/ Classic	Max Control/ LTV	Strut Cushion/ Strut Mount	HiJackers/ Load Carrier	Ultra	ProGuard/ Guardian/ Classic	Max Control/ LTV	Strut Cushion/ Strut Mount	HiJackers/ Load Carrier

DODGE

DODGE

VAN 1/2 TON, A / B SERIES / RAM

99-03	109.3(WheelBase) Exc. 7000# GVW	⊥ ⊕	G63359 ³⁵	61523 ³⁵ 81096 ³⁵	58359 ³⁵ 77359 ³⁵	34052 ⁸	⊕ ⊕	G63413	61522 ⁶ 81496	58413 77413	43085 ⁸ 49212 ⁷
82-98	109.6(WheelBase) Exc. 7000# GVW	⊥ ⊕	G63359 ³⁵	61523 ³⁵ 81096 ³⁵	58359 ³⁵ 77359 ³⁵	34052 ⁸	⊕ ⊕	G63413	61522 ⁶ 81496	58413 77413	43085 ⁸ 49212 ⁷
81	109.6(WheelBase) Exc. 7000# GVW	⊥ ⊕	G63359 ³⁵	61523 ³⁵ 81096 ³⁵	58359 ³⁵ 77359 ³⁵	⊕ ⊕	G63413	61522 ⁶ 81496	58413 77413	43085 ⁸
71-80	All	⊥ ⊕	61523 ³⁵ 81096 ³⁵	58359 ³⁵ 77359 ³⁵	34052 ⁸	⊕ ⊕	G63413	61522 ⁶ 81496	58413 77413	43085 ⁸ 49212 ⁷
	Exc. 4000# Front Axle	⊥ ⊕	G63359 ³⁵	61523 ³⁵ 81096 ³⁵	58359 ³⁵ 77359 ³⁵	34052 ⁸	⊕ ⊕	G63413	61522 ⁶ 81496	58413 77413	43085 ⁸ 49212 ⁷
64-70	All	⊥ ⊕	⊕ ⊕	81469
	Van	⊥ ⊕	⊕ ⊕	82065 81469

VAN 1/2 TON, A / B SERIES / RAM STEERING STABILIZERS

		Front	Rear
71-87	Single System Steering Stabilizer	6803SE ⁸⁴
71	Single System Steering Stabilizer; with I-Beam Axle	6802SE ⁸⁴

VAN 1/2 TON, P SERIES

68	All	⊥ ⊕	⊕ ⊕	82046
62-64	All	⊥ ⊕	⊕ ⊕	82046

VAN 3/4 TON, A / B SERIES / RAM

81-03	All	⊥ ⊕	G63359 ³⁵	61523 ³⁵ 81096 ³⁵	58359 ³⁵ 77359 ³⁵	34052 ⁸	⊕ ⊕	G63413	61522 ⁶ 81496	58413 77413	43085 ⁸ 49212 ⁷
71-80	All	⊥ ⊕	61523 ³⁵ 81096 ³⁵	58359 ³⁵ 77359 ³⁵	34052 ⁸	⊕ ⊕	G63413	61522 ⁶ 81496	58413 77413	43085 ⁸ 49212 ⁷
	Exc. 4000# Front Axle	⊥ ⊕	G63359 ³⁵	61523 ³⁵ 81096 ³⁵	58359 ³⁵ 77359 ³⁵	34052 ⁸	⊕ ⊕	G63413	61522 ⁶ 81496	58413 77413	43085 ⁸ 49212 ⁷

VAN 3/4 TON, A / B SERIES / RAM STEERING STABILIZERS

		Front	Rear
80-87	Single System Steering Stabilizer	6803SE ⁸⁴
78-79	Van Charger Special	6803SE ⁸⁴
71-77	Single System Steering Stabilizer	6803SE ⁸⁴
71	Single System Steering Stabilizer; with I-Beam Axle	6802SE ⁸⁴

VAN 3/4 TON, P SERIES

69-72	All	⊥ ⊕	⊕ ⊕	82054
-------	-----	--------	------	------	------	------	------	--------	------	-------	------	------	------

VAN 1 TON, A / B SERIES / RAM

99-03	All	⊥ ⊕	G63359 ³⁵	61523 ³⁵ 81096 ³⁵	58359 ³⁵ 77359 ³⁵	34052 ⁸	⊕ ⊕	G63413	61522 ⁶ 81496	58413 77413	43085 ⁸ 49212 ⁷
95-98	Exc. 4000# Front Axle	⊥ ⊕	G63359 ³⁵	61523 ³⁵ 81096 ³⁵	58359 ³⁵ 77359 ³⁵	34052 ⁸	⊕ ⊕	G63413	61522 ⁶ 81496	58413 77413	43085 ⁸ 49212 ⁷
94	All	⊥ ⊕	⊕ ⊕	61522 ⁶ 81496	58413	43085 ⁸ 49212 ⁷
	Exc. 4000# Front Axle	⊥ ⊕	G63359 ³⁵	61523 ³⁵ 81096 ³⁵	58359 ³⁵ 77359 ³⁵	34052 ⁸	⊕ ⊕	G63413	61522 ⁶ 81496	77413 58413	43085 ⁸ 49212 ⁷
71-93	All	⊥ ⊕	⊕ ⊕	G63413	61522 ⁶ 81496	58413 77413	43085 ⁸ 49212 ⁷
	4000# Front Axle	⊥ ⊕	G63360 ³⁵	61650 81834	58360	⊕ ⊕	G63413	61522 ⁶ 81496	58413 77413	43085 ⁸ 49212 ⁷
	Exc. 4000# Front Axle	⊥ ⊕	G63359 ³⁵	61523 ³⁵ 81096 ³⁵	58359 ³⁵ 77359 ³⁵	34052 ⁸	⊕ ⊕	G63413	61522 ⁶ 81496	58413 77413	43085 ⁸ 49212 ⁷

VAN 1 TON, A / B SERIES / RAM STEERING STABILIZERS

		Front	Rear
71-87	Single System Steering Stabilizer	6803SE ⁸⁴
71	Single System Steering Stabilizer; with I-Beam Axle	6802SE ⁸⁴

6 It is recommended that when replacing shocks on vehicles with "quad shocks" all 4 shocks should be replaced by series.



8 Pair Packs.

84 Replacement damper for vehicles with the Gabriel Aftermarket mounting kit

7 Pair Packs, air hose kit included.

35 Sight grinding of control arm opening is required to install product made before Aug 1988.

APPLICATION GUIDE

Year	Fitment Notes										
		Ultra	ProGuard/ Guardian/ Classic	Max Control/ LTV	Strut Cushion/ Strut Mount	HiJackers/ Load Carrier	Ultra	ProGuard/ Guardian/ Classic	Max Control/ LTV	Strut Cushion/ Strut Mount	HiJackers/ Load Carrier

DODGE

DODGE

VAN 1 TON, P SERIES

66-72	All	⊗	82065
61-64	All	⊗	82065

VAN, CB300

78-80	All	⊗	G63413	61522 ⁵ 81496	58413	43085 ⁸ 49212 ⁷		
	4000# Front Axle	⊥ ⊗	G63360 ³⁵	61650 81834	⊗	G63413	61522 ⁵ 81496	58413	43085 ⁸ 49212 ⁷	
	Exc. 4000# Front Axle	⊥ ⊗	G63359 ³⁵	61523 ³⁵ 81096 ³⁵	58359 ³⁵ 77359 ³⁵	34052 ⁸	⊗	G63413	61522 ⁵ 81496	58413	43085 ⁸ 49212 ⁷
	Over 8300# GVW	⊥ ⊗	58360	⊗	G63413	61522 ⁵ 81496	77413 58413	43085 ⁸ 49212 ⁷
77	All	⊗	G63413	61522 ⁵ 81496	58413	43085 ⁸		
	4000# Front Axle	⊥ ⊗	G63360 ³⁵	61650 81834	⊗	G63413	61522 ⁵ 81496	58413	43085 ⁸
	Exc. 4000# Front Axle	⊥ ⊗	G63359 ³⁵	61523 ³⁵ 81096 ³⁵	77359 ³⁵	⊗	G63413	61522 ⁵ 81496	58413	43085 ⁸
	Over 8300# GVW	⊥ ⊗	58360	⊗	G63413	61522 ⁵ 81496	77413 58413	49212 ⁷ 43085 ⁸
	Up through 8300# GVW	⊥ ⊗	58359 ³⁵	34052 ⁸	⊗	G63413	61522 ⁵ 81496	58413	43085 ⁸
75-76	All	⊗	G63413	61522 ⁵ 81496	58413	43085 ⁸ 49212 ⁷		
	4000# Front Axle	⊥ ⊗	G63360 ³⁵	61650 81834	⊗	G63413	61522 ⁵ 81496	58413	43085 ⁸ 49212 ⁷
	Exc. 4000# Front Axle	⊥ ⊗	G63359 ³⁵	61523 ³⁵ 81096 ³⁵	77359 ³⁵	⊗	G63413	61522 ⁵ 81496	58413	43085 ⁸ 49212 ⁷
	Over 8300# GVW	⊥ ⊗	58360	⊗	G63413	61522 ⁵ 81496	77413 58413	43085 ⁸ 49212 ⁷
	Up through 8300# GVW	⊥ ⊗	58359 ³⁵	34052 ⁸	⊗	G63413	61522 ⁵ 81496	58413	43085 ⁸ 49212 ⁷
74	All	⊗	G63413	61522 ⁵ 81496	58413	43085 ⁸		
	4000# Front Axle	⊥ ⊗	G63360 ³⁵	61650 81834	⊗	G63413	61522 ⁵ 81496	58413	43085 ⁸
	Exc. 4000# Front Axle	⊥ ⊗	G63359 ³⁵	61523 ³⁵ 81096 ³⁵	77359 ³⁵	⊗	G63413	61522 ⁵ 81496	58413	43085 ⁸
	Over 8300# GVW	⊥ ⊗	58360	⊗	G63413	61522 ⁵ 81496	77413 58413	49212 ⁷ 43085 ⁸
	Up through 8300# GVW	⊥ ⊗	58359 ³⁵	34052 ⁸	⊗	G63413	61522 ⁵ 81496	58413	43085 ⁸

EAGLE

EAGLE

2000 GTX

91-93	All	⊥	G55945	⊥	G51046	142419 ⁶⁸
	Exc. Auto-Leveling System	⊥	G55605	⊥	G51424 G51046	142419 ⁶⁸
	CAN	⊥	G55945	143057 ⁵¹	⊥	G51046	143064 ⁵¹ 142419 ⁶⁸

SUMMIT

93-96	All	⊥	143057 ⁵¹	⊥	142419 ⁶⁸
	Coupe	⊥	G55911	142329 ⁵³ 143057 ⁵¹	⊥	G51063	142419 ⁶⁸
	Sedan	⊥	G55911	142329 ⁵³ 143057 ⁵¹	⊥	G51063	142419 ⁶⁸
	Wagon	⊥	G55605	143057 ⁵¹	⊥	69462	142419 ⁶⁸

6 It is recommended that when replacing shocks on vehicles with "quad shocks" all 4 shocks should be matched by series.

8 Pair Packs.

51 Strut Cushion for use with the Strut/Cartridge/Shocks.

116 68 Strut Mount Kit. Hardware from O.E. Part may need to be reused.

7 Pair Packs, air hose kit included.

35 Sight grinding of control arm opening is required to install product made before Aug 1988.

53 Strut Mount. Hardware from O.E. Part may need to be reused.

APPLICATION GUIDE

Year	Fitment Notes										
		Ultra	ProGuard/ Guardian/ Classic	Max Control/ LTV	Strut Cushion/ Strut Mount	HiJackers/ Load Carrier	Ultra	ProGuard/ Guardian/ Classic	Max Control/ LTV	Strut Cushion/ Strut Mount	HiJackers/ Load Carrier

EAGLE

EAGLE

SUMMIT (cont)

89-92	Sedan	↓	G55592	143057 ⁵¹	↓	G51249	142419 ⁶⁸ 143064 ⁵¹
92	All	↓	143057 ⁵¹	↓
	Hatchback	↓	143057 ⁵¹	↓	G51249
	Wagon	↓	G55605	143057 ⁵¹	↓	69462	142419 ⁶⁸
91	All	↓	143057 ⁵¹	↓	G51249	143064 ⁵¹
89-90	All	↓	G55592	143057 ⁵¹	↓	G51249	143064 ⁵¹

TALON

95-98	All	↓	G55819	142419 ⁶⁸	↓	142419 ⁶⁸
	AWD	↓	G55819	142419 ⁶⁸	↓	G51712	142419 ⁶⁸
	FWD	↓	G55819	142419 ⁶⁸	↓	G51254	M51254	142419 ⁶⁸
91-94	All	↓	G55605	142219 ⁵³ 143057 ⁵¹	↓	142419 ⁶⁸ 143064 ⁵¹
	AWD, Auto-Leveling System	↓	G55605	142219 ⁵³ 143057 ⁵¹	↓	G51046	142419 ⁶⁸ 143064 ⁵¹
	FWD	↓	G55605	142219 ⁵³ 143057 ⁵¹	↓	G51184	142419 ⁶⁸ 143064 ⁵¹
90	All	↓	142219 ⁵³ 143057 ⁵¹	↓	142419 ⁶⁸ 143064 ⁵¹
	AWD, Auto-Leveling System	↓	142219 ⁵³ 143057 ⁵¹	↓	G51046	142419 ⁶⁸ 143064 ⁵¹
	AWD, FWD	↓	G55587	142219 ⁵³ 143057 ⁵¹	↓	142419 ⁶⁸ 143064 ⁵¹
	FWD	↓	142219 ⁵³ 143057 ⁵¹	↓	G51184	142419 ⁶⁸ 143064 ⁵¹

VISION

93-97	Left	↓	G55663	M55663	142755 ⁶⁷ 142842 ⁵⁴ 143057 ⁵¹	↓	G55665	M55665
	Right	↓	G55664	M55664	142755 ⁶⁷ 142842 ⁵⁴ 143057 ⁵¹	↓	G55665	M55665

VISION READYMOUNTS

		Front		Rear	
		Ultra Readymount	Guardian Readymount	Ultra Readymount	Guardian Readymount
93-97	Left	G56958 ⁴⁰	M56958⁴⁰	G56960 ⁴⁰	M56960⁴⁰
	Right	G56959 ⁴⁰	M56959⁴⁰	G56960 ⁴⁰	M56960⁴⁰

VISTA

89-92	Exc. Wagon	↓	G55561	143060 ⁵¹	↓	
89-91	4WD, Wagon	↓	↓	81739
	CAN, Wagon	↓	143059 ⁵¹	↓
	FWD, Wagon	↓	↓	69689	81464
91	CAN, Sedan	↓	143060 ⁵¹	↓

40 Complete Assembled Unit.

53 Strut Mount. Hardware from O.E. Part may need to be reused.

67 Strut Mount Kit. Hardware from O.E. Part may need to be reused.





Bold Type - New / Future Part

51 Strut Cushion for use with the Strut/Cartridge/Shocks.

54 Kit with Mount and Bearing. Hardware from O.E. Part may need to be reused.

68 Strut Mount Kit. Hardware from O.E. Part may need to be reused.



APPLICATION GUIDE

Year	Fitment Notes										
		 Ultra	ProGuard\ Guardian\ Classic	Max Control\ LTV	Strut Cushion\ Strut Mount	HiJackers\ Load Carrier	 Ultra	ProGuard\ Guardian\ Classic	Max Control\ LTV	Strut Cushion\ Strut Mount	HiJackers\ Load Carrier



EDSEL

EDSEL





BERMUDA

58	All		82099	
----	-----	---	-------	------	------	------	---	------	------	------	------



CITATION

58	All		82099	
----	-----	---	-------	------	------	------	---	------	------	------	------





CORSAIR

58-59	All		82099		82076
	Exc. Wagon		82099		81469 82076



PACER

58	All		82099	
----	-----	---	-------	------	------	------	---	------	------	------	------





RANGER

58-60	All		82099		82076
58-59	Exc. Wagon		82099		81469 82076

ROUNDUP

58	All		82099	
----	-----	---	-------	------	------	------	---	------	------	------	------









VILLAGER

58-60	All		82099		82076
58-59	Exc. Wagon		82099		81469 82076





FIAT

FIAT





124

76-79	Built after Serial #066.059		82614	
76	Wagon			82156
67-75	All		82614	
	Wagon		82614		82156





500

09-12	Left		G52491	
	Right		G52492	



1100

66-67	Exc. Wagon			82155
	Wagon			82156

1500

64-67	Exc. Wagon			82155
	Wagon			82156



PALIO

04-08	All			70004 ¹
-------	-----	---	------	------	------	------	---	--------------------	------	------	------

FORD

FORD



AEROSTAR

90-97	All			G63502	61557 81727	49221 ⁷
-------	-----	---	------	------	------	------	---	--------	----------------	------	------	--------------------

¹ Future Part, available 1st Quarter of 2017.

⁷ Pair Packs, air hose kit included.

APPLICATION GUIDE

Year	Fitment Notes										
		Ultra	ProGuard\Guardian\Classic	Max Control\LTV	Strut Cushion\Strut Mount	HiJackers\Load Carrier	Ultra	ProGuard\Guardian\Classic	Max Control\LTV	Strut Cushion\Strut Mount	HiJackers\Load Carrier

FORD

FORD

AEROSTAR (cont)

90-97	AWD	⊥ ⊕	G63621	61569 81826	⊕ ⊕	G63502	61557 81727	49221 ⁷
	RWD	⊥ ⊕	G63457	61540 81582	⊕ ⊕	G63502	61557 81727	49221 ⁷
89	RWD	⊥ ⊕	G63457	61540 81582	⊕ ⊕	G63502	61557 81727	49221 ⁷
86-88	RWD	⊥ ⊕	G63457	61540 81582	⊕ ⊕	G63490	61541 81583

ASPIRE

94-97	Non-ABS	⊥ ⊕	G55615	143057 ⁵¹	⊥ ⊕	G51039
-------	---------	--------	--------	------	------	----------------------	------	--------	--------	------	------	------	------	------

BRONCO

80-96	Exc. Lift Kit	⊥ ⊕	⊕ ⊕	G63409	61554 81710	58409 77409 ⁶	43142 ⁸ 49197 ⁷
	Quad & Non Quad Suspensions Rearward of Front Axle; Exc. Lift Kit	⊥ ⊕	G63414 ⁵	61520 ⁵ 81490	58414 ⁵ 77414 ⁵	34057 ⁸	⊕ ⊕
	Quad Suspension; Forward of Front Axle; Exc. Lift Kit	⊥ ⊕	G63410 ⁵	61546 ⁵	77410 ⁶	⊕ ⊕
80-88	3-4" Lift Kit	⊥ ⊕	⊕ ⊕	G63441 ⁵⁰
80-86	3-4" Lift Kit; Quad Suspension Forward of Front Axle	⊥ ⊕	G63446 ⁵	⊕ ⊕
	3-4" Lift Kit; Quad Suspension Rearward of Front Axle	⊥ ⊕	G63445 ⁵	⊕ ⊕
78-79	4" Lift Kit	⊥ ⊕	⊕ ⊕	G63441 ⁵⁰
	Exc. Lift Kit	⊥ ⊕	⊕ ⊕	G63377	61519 81484	58377 77377	43058 ⁸ 49127 ⁷
	Quad Suspension, Forward of Front Axle; Non Quad Suspension, Left Shock; Exc. Lift Kit	⊥ ⊕	61551 ⁶	⊕ ⊕
	Quad Suspension, Forward of Front Axle; Non Quad Suspension, Left Shock; 4" Lift Kit	⊥ ⊕	G63447 ⁵⁰	⊕ ⊕
	Quad Suspension, Forward of Front Axle; Non Quad Suspension, Left Shock; Exc. Lift Kit	⊥ ⊕	G63511 ⁶	⊕ ⊕
	Quad Suspension, Rearward of Front Axle; Non Quad Suspension, Right Shock; Exc. Lift Kit	⊥ ⊕	G63396 ⁵	⊕ ⊕
	Quad Suspension; Rearward of Front Axle; Non Quad Suspension, Right Shock; Exc. Lift Kit	⊥ ⊕	61521 ⁶ 81394	⊕ ⊕
	Right Quad Suspension, Rearward of Front Axle; Non Quad Suspension, Right Shock; 4" Lift Kit	⊥ ⊕	G63445 ⁵	⊕ ⊕
67-77	From Serial #830001; Exc. Lift Kit	⊥ ⊕	G63386	61521 ⁶ 81394	58386	34058 ⁸	⊕ ⊕	G63377	61519 81484	58377 77377	43058 ⁸ 49127 ⁷
66-77	4-5" Lift Kit	⊥ ⊕	G63445 ⁵	⊕ ⊕	G63441 ⁵⁰
66	From Serial #830001; Exc. Lift Kit	⊥ ⊕	G63386	61521 ⁶ 81394	58386	34058 ⁸	⊕ ⊕	G63377	61519 81484	58377 77377	43058 ⁸
	Thru Serial #830000	⊥ ⊕	⊕ ⊕	G63350	61518 81242	58350	43099 ⁸ 49173 ⁷

BRONCO II

90	All	⊥ ⊕	G63614	61561 81744	58929 77614	⊕ ⊕	G63525	61559 81730	77525	49223 ⁷
89	Mfg. from 2/89; Vehicles with 12mm bolt in rear lower mount	⊥ ⊕	77414 ⁵	⊕ ⊕	G63525	61559 81730	77525	49223 ⁷
	Mfg. to 2/89; Vehicles with 10mm & 12mm bolt in rear lower mount	⊥ ⊕	G63414 ⁵	61520 ⁵ 81490	34057 ⁸	⊕ ⊕	G63427	61533 81539	43165 ⁸ 49207 ⁷
84-88	With 10mm Bolt In Rear Lower Mount	⊥ ⊕	G63414 ⁵	61520 ⁵ 81490	77414 ⁶	34057 ⁸	⊕ ⊕	G63427	61533 81539	43165 ⁸ 49207 ⁷

6 It is recommended that when replacing shocks on vehicles with "quad shocks" all 4 shocks should be matched by series.



8 Pair Packs.

51 Strut Cushion for use with the Strut/Cartridge/Shocks.

7 Pair Packs, air hose kit included.

50 Bellows Kit No.141242 is recommended for use to protect piston rod from potentially harmful road debris.

APPLICATION GUIDE

Year	Fitment Notes										
		Ultra	ProGuard/ Guardian/ Classic	Max Control/ LTV	Strut Cushion/ Strut Mount	HiJackers/ Load Carrier	Ultra	ProGuard/ Guardian/ Classic	Max Control/ LTV	Strut Cushion/ Strut Mount	HiJackers/ Load Carrier

FORD

FORD







BRONCO II STEERING STABILIZERS

		Front	Rear
84-90	Single System Steering Stabilizer	6802SE ⁸⁴

BRONCO STEERING STABILIZERS

		Front	Rear
92-96	Single System Steering Stabilizer	6802SE ⁸⁴
80-91	All	6802SE ⁸⁴
78-79	Dual System Steering Stabilizer; Exc. Sway Bar	6802SE ⁸⁴
71-79	All	14016
	Single System Steering Stabilizer	6803SE ⁸⁴
70	Single System Steering Stabilizer	6803SE ⁸⁴
68-69	Single System Steering Stabilizer	6804SE ⁸⁰
67	All	14016
	Single System Steering Stabilizer	6804SE ⁸⁰
66	Single System Steering Stabilizer	6804SE ⁸⁰











CONTOUR

97-00	Mfg. from 3/97	 G56520	M56520	142843 ⁵⁴ 143061 ⁵¹	 G55693	M55693	142402 ⁵³ 143058 ⁵¹
95-00	All		142843 ⁵⁴ 143061 ⁵¹	 G55693	M55693	142402 ⁵³ 143058 ⁵¹
95-97	Mfg. to 3/97	 G55692	142843 ⁵⁴ 143061 ⁵¹	 G55693	M55693	142402 ⁵³ 143058 ⁵¹













CONTOUR READYMOUNTS

		Front		Rear	
		Ultra Readymount	Guardian Readymount	Ultra Readymount	Guardian Readymount
99-00	Base, LX	G57052 ⁴⁰	M57052 ⁴⁰
	Power, SE	G57052 ⁴⁰
96-98	Base, GL, LX	G57052 ⁴⁰	M57052 ⁴⁰
	Power, SE, Sport	G57052 ⁴⁰	M57052 ⁴⁰
95	GL, LX	G57052 ⁴⁰	M57052 ⁴⁰
	SE	G57052 ⁴⁰



COUNTRY SEDAN

65-74	All	 69675 ⁵	81446	34073 ⁸	 69606	81495	43140 ⁸ 49205 ⁷
60-64	All		82099		82076
57-59	All		82099		81270	49105 ⁷
52-56	All		82026		81270	49105 ⁷
50-51	All		82026		82156

COUNTRY SQUIRE

87-91	All	 69675 ⁵	81446	34073 ⁸	 69606	81495	43140 ⁸ 49205 ⁷
65-74	All	 69675 ⁵	81446	34073 ⁸	 69606	81495	43140 ⁸ 49205 ⁷
59-64	All		82099		82076
57-58	All		82099	
52-56	All		82026		81270	49105 ⁷
50-51	All		82026		82060

COURIER

72-82	All	 G63421	61504 81750	58421 77421		82125
-------	-----	--	----------------	----------------	------	------	--	-------	------	------	------

5 Use kit No. 140719 to replace O.E. hardware for lower shock absorber mounting when studs break or self-tapping screws are not longer useable.

8 Pair Packs.

51 Strut Cushion for use with the Strut/Cartridge/Shocks.

54 Kit with Mount and Bearing. Hardware from O.E. Part may need to be reused.

84 Replacement damper for vehicles with the Gabriel Aftermarket mounting kit



7 Pair Packs, air hose kit included.

40 Complete Assembled Unit.

53 Strut Mount. Hardware from O.E. Part may need to be reused.

80 Mounting bracket not required, install on O.E. Shock Mounts. See Ref. C for optional Steering Stabilizer Boots.

APPLICATION GUIDE

Year	Fitment Notes										
		Ultra	ProGuard\ Guardian\ Classic	Max Control\ LTV	Strut Cushion\ Strut Mount	HiJackers\ Load Carrier	Ultra	ProGuard\ Guardian\ Classic	Max Control\ LTV	Strut Cushion\ Strut Mount	HiJackers\ Load Carrier

FORD

FORD

COURIER SEDAN DELIVERY

59-60	All	⌋	82099	⌋	82076
57-58	All	⌋	82099	⌋
54-56	All	⌋	82026	⌋	81270	49105 ⁷

CRESTLINE

52-54	All	⌋	82026	⌋	81270	49105 ⁷
50-51	All	⌋	82026	⌋	82156

CROWN VICTORIA

07-11	All	⌋	143356 ⁵³ 143357 ⁵⁸	⌋
	Exc. Police and Taxi Models	⌋	G51887	M52817	143356 ⁵³ 143357 ⁵⁸	⌋	69575
	Police and Taxi Models	⌋	G51888	143356 ⁵³ 143357 ⁵⁸	⌋	69574	77955
03-06	All	⌋	143356 ⁵³	⌋
	Exc. Police and Taxi Models	⌋	G51887	M52817	143357 ⁵⁸ 143356 ⁵³	⌋	69575
	Police and Taxi Models	⌋	G51888	143356 ⁵³	⌋	69574	77955
94-02	All	⌋	69675 ⁵	⌋	69606	81495	43140 ⁸
	Exc. Hydraulic Self Leveling System	⌋	69675 ⁵	34073 ⁸	⌋	69606	81495	43140 ⁸
	Rear Air Springs	⌋	69675 ⁵	⌋	69606	81495	49205 ⁷ 43140 ⁸
	Exc. Police and Taxi Models	⌋	69675 ⁵	81446	⌋	69606	81495	43140 ⁸
	Police and Taxi Models	⌋	G63375 ⁵	61555 81713	77375	⌋	69606	81495
93	All	⌋	69675 ⁵	⌋	69606	81495
	Exc. Hydraulic Self Leveling System	⌋	69675 ⁵	34073 ⁸	⌋	69606	81495	43140 ⁸
	Rear Air Springs	⌋	69675 ⁵	⌋	69606	81495	49205 ⁷
	Exc. Police and Taxi Models	⌋	69675 ⁵	81446	⌋	69606	81495
	Police and Taxi Models	⌋	G63375 ⁵	61555 81713 ⁵	77375	⌋	69606	81495
92	All	⌋	69675 ⁵	⌋	69606	81495	43140 ⁸
	Exc. Hydraulic Self Leveling System	⌋	69675 ⁵	34073 ⁸	⌋	69606	81495	43140 ⁸
	Rear Air Springs	⌋	69675 ⁵	⌋	69606	81495	49205 ⁷ 43140 ⁸
	Exc. Police and Taxi Models	⌋	69675 ⁵	81446	⌋	69606	81495	43140 ⁸

CROWN VICTORIA READYMOUNTS

		Front			Rear		
		Ultra Readymount	Guardian Readymount	Ultra Readymount	Guardian Readymount	Ultra Readymount	Guardian Readymount
03-11	Exc. Police and Taxi Models	G57080 ⁴⁰	M57299 ⁴⁰

CUSTOM

67-72	All	⌋	69675 ⁵	81446	34073 ⁸	⌋	69606	81495	43140 ⁸ 49205 ⁷
65-66	All	⌋	69675 ⁵	81446 82099	34073 ⁸	⌋	69606	81495 82076	43140 ⁸ 49205 ⁷
64	All	⌋	82099	⌋	82076

5 Use kit No. 140719 to replace O.E. hardware for lower shock absorber mounting when studs break or self-tapping screws are not longer useable.

8 Pair Packs.

53 Strut Mount. Hardware from O.E. Part may need to be reused.



Bold Type - New / Future Part

7 Pair Packs, air hose kit included.

40 Complete Assembled Unit.

68 Strut Mount Kit. Hardware from O.E. Part may need to be reused.

APPLICATION GUIDE

Year	Fitment Notes										
		Ultra	ProGuard\ Guardian\ Classic	Max Control\ LTV	Strut Cushion\ Strut Mount	HiJackers\ Load Carrier	Ultra	ProGuard\ Guardian\ Classic	Max Control\ LTV	Strut Cushion\ Strut Mount	HiJackers\ Load Carrier

FORD

FORD

CUSTOM (cont)

57	All	⊕	82099	⊕	81270	49105 ⁷
52	All	⊕	82026	⊕	81270	49105 ⁷
50-51	All	⊕	82026	⊕	82156

CUSTOM 300

60	All	⊕	82099	⊕	82076
59	All	⊕	82099	⊕
58	All	⊕	82099	⊕	81270	49105 ⁷

CUSTOM 500

68-77	All	⊕	69675 ⁵	81446	34073 ⁸	⊕	69606	81495	43140 ⁹ 49205 ⁷
-------	-----	---	--------------------	-------	------	------	--------------------	---	-------	-------	------	------	--

CUSTOMLINE

52-56	All	⊕	82026	⊕	81270	49105 ⁷
-------	-----	---	------	-------	------	------	------	---	------	-------	------	------	--------------------

DEL RIO WAGON

57-58	All	⊕	82099	⊕
-------	-----	---	------	-------	------	------	------	---	------	------	------	------	------

DELUXE

49-51	All	⊕	82026	⊕	82156
47-48	Direct Acting Shocks	⊕	82007	⊕	82156

E-550 ECONOLINE SUPER DUTY

02	All	⊕	⊕	61655
----	-----	---	------	------	------	------	------	---	------	-------	------	------	------

E-550 SUPER DUTY

03	All	⊕	⊕	61655
----	-----	---	------	------	------	------	------	---	------	-------	------	------	------

ECONOLINE

61-67	All	⊕	G63492	61506 81318	77492	⊕	G63299	82007
-------	-----	---	--------	----------------	-------	------	------	---	--------	-------	------	------	------

ECONOLINE VAN STEERING STABILIZERS

61-67	Van										Front	Rear
										6802SE ⁸⁴	

EDGE

11-14	Left	⊕	G52351	⊕	G64111
	Right	⊕	G52352	⊕	G64111
07-10	Left	⊕	G56840	143415⁵³	⊕	G64037
	Right	⊕	G56841	143415⁵³	⊕	G64037

EDGE READYMOUNTS

		Front		Rear	
		Ultra Readymount	Guardian Readymount	Ultra Readymount	Guardian Readymount
12-14	Left 4 Cyl	G57582⁴⁰
	FWD, Right 4 Cyl	G57583⁴⁰
11-14	Left	G57491⁴⁰
	Right	G57492⁴⁰
	AWD, Left	G57580⁴⁰
	AWD, Right	G57581⁴⁰

5 Use kit No. 140719 to replace O.E. hardware for lower shock absorber mounting when studs break or self-tapping screws are not longer useable.

8 Pair Packs.



53 Strut Mount. Hardware from O.E. Part may need to be reused.

7 Pair Packs, air hose kit included.

40 Complete Assembled Unit.

84 Replacement damper for vehicles with the Gabriel Aftermarket mounting kit

APPLICATION GUIDE



Year	Fitment Notes										
		Ultra	ProGuard\ Guardian\ Classic	Max Control\ LTV	Strut Cushion\ Strut Mount	HiJackers\ Load Carrier	Ultra	ProGuard\ Guardian\ Classic	Max Control\ LTV	Strut Cushion\ Strut Mount	HiJackers\ Load Carrier

FORD



















FORD

EDGE READYMOUNTS (cont)		Front		Rear	
		Ultra Readymount	Guardian Readymount	Ultra Readymount	Guardian Readymount
11	FWD, Left 4 Cyl	G57582
	FWD, Right 4 cYL	G57583 ⁴⁰

ELITE















75-76	All		69675	81446		69606	81495
-------	-----	---	-------	-------	------	------	------	---	-------	-------	------	------	------

ESCAPE

14-16	All			G511001 ¹
13	Left		G52420		G511001 ¹
	Right		G52421		G511001 ¹
12	Left		G56601	M52806	143253 ⁶⁸		G511001 ² G64047
	Right		G56568	M52807	143253 ⁶⁸		G511001 ² G64047
08-11	Left		G56601	M52806	143253 ⁵³		G64047
	Right		G56568	M52807	143253 ⁵³		G64047
01-07	Left		G56601	M52806	143253 ⁵³		69900 G63862
	Right		G56568	M52807	143253 ⁵³		69900 G63862

ESCAPE READYMOUNTS		Front		Rear	
		Ultra Readymount	Guardian Readymount	Ultra Readymount	Guardian Readymount
13-16	Left	G57517 ⁴⁰
	Right	G57518 ⁴⁰
01-12	Left	G57045 ⁴⁰
	Right	G57046 ⁴⁰

ESCORT

98-03	Hot & Cool Coupe; Non-ABS		G56801	142744 ⁶⁷ 142832 ⁵⁴ 143061 ⁵¹		G55848	M55848	142190 ⁵³ 143060 ⁵¹
97-03	All		142744 ⁶⁷ 142832 ⁵⁴ 143061 ⁵¹		G55848	M55848	142190 ⁵³ 143060 ⁵¹
97-02	Exc. Hot & Cool Coupe		G56515	M56515	142744 ⁶⁷ 142832 ⁵⁴ 143061 ⁵¹		G55848	M55848	142190 ⁵³ 143060 ⁵¹
91-96	All		G55847	M55847	142744 ⁶⁷ 143057 ⁵¹		G55848	M55848	142190 ⁵³ 143058 ⁵¹
85-90	Mfg. from 3/85		G55714	143057 ⁵¹		G55705	143059 ⁵¹
81-90	All		143057 ⁵¹		G55705	143059 ⁵¹
83-85	Mfg. from 2/83 thru 2/85		G55712	143057 ⁵¹		G55705	143059 ⁵¹

ESCORT READYMOUNTS		Front		Rear	
		Ultra Readymount	Guardian Readymount	Ultra Readymount	Guardian Readymount
97-03	All	G56940 ⁴⁰	M56940 ⁴⁰
97-02	Exc. Hot & Cool Coupe	G56926 ⁴⁰	M56926 ⁴⁰	G56940 ⁴⁰	M56940 ⁴⁰

1 Future Part, available 1st Quarter of 2017.

40 Complete Assembled Unit.

53 Strut Mount. Hardware from O.E. Part may need to be reused.

67 Strut Mount Kit. Hardware from O.E. Part may need to be reused.

Bold Type - New / Future Part

2 Future Part, available 2nd Quarter of 2017.

51 Strut Cushion for use with the Strut/Cartridge/Shocks.

54 Kit with Mount and Bearing. Hardware from O.E. Part may need to be reused.

68 Strut Mount Kit. Hardware from O.E. Part may need to be reused.

APPLICATION GUIDE

Year	Fitment Notes										
		Ultra	ProGuard/ Guardian/ Classic	Max Control/ LTV	Strut Cushion/ Strut Mount	HiJackers/ Load Carrier	Ultra	ProGuard/ Guardian/ Classic	Max Control/ LTV	Strut Cushion/ Strut Mount	HiJackers/ Load Carrier

FORD

FORD

		Front				Rear	
		Ultra Readymount		Guardian Readymount		Ultra Readymount	Guardian Readymount
91-96	All	G56911 ⁴⁰		M56911 ⁴⁰		G56940 ⁴⁰	M56940 ⁴⁰

ESCORT READYMOUNTS (cont)

EXCURSION

00-05	4WD	G63809	77809	G63837	77837
		G63614	77614	G63607	77607

EXCURSION STEERING STABILIZERS

		Front	Rear
00-05	4WD, With O.E. Unit	6854SE ⁸⁰

EXP

85-88	Mfg. from 3/85	G55714	143057 ⁵¹	G55705	143059 ⁵¹
84-88	All	143057 ⁵¹	G55705	143059 ⁵¹
84-85	Mfg. from 2/83 thru 2/85	G55712	143057 ⁵¹	G55705	143059 ⁵¹
82-83	All	143057 ⁵¹	143059 ⁵¹
	Mfg. to 2/83	143057 ⁵¹	G55705	143059 ⁵¹
83	Mfg. from 2/83 thru 2/85	G55712	143057 ⁵¹	143059 ⁵¹

EXPEDITION

15-16	4WD, RWD, Exc. Air Suspension	143424 ⁶⁸	143393 ⁶⁸
14-16	Coil(RearSpringType) Exc. Air Suspension	143424 ⁶⁸	G51861
12-16	All	143424 ⁶⁸
12-14	Exc. Air Suspension	143424 ⁶⁸	143393 ⁶⁸
12-13	Coil(RearSpringType) Exc. Air Suspension	G51860	143424 ⁶⁸	G51861
10-11	All	M51860	143424 ⁶⁸	M51861
	Exc. Air Suspension	M51860	143424 ⁶⁸	M51861	143393 ⁶⁸
	Coil(RearSpringType) Exc. Air Suspension	G51860	M51860	143424 ⁶⁸	G51861	M51861
07-09	All	M51860	M51861
	Coil(RearSpringType) Exc. Air Suspension	G51860	M51860	G51861	M51861
	RWD	M51860	143424 ⁶⁸	M51861	143393 ⁶⁸
03-06	All	M51719	G51729	143317 ⁵³
	Exc. Adjustable Suspension	M51719	143244 ⁵³	G51729	143317 ⁵³
	4WD	G51720	M52804 M51719	G51729	143317 ⁵³
	RWD	G51719	M51719	G51729	143317 ⁵³

40 Complete Assembled Unit.



53 Strut Mount. Hardware from O.E. Part may need to be reused.

80 Mounting bracket not required, install on O.E. Shock Mounts. See Ref. C for optional Steering Stabilizer Boots.

51 Strut Cushion for use with the Strut/Cartridge/Shocks.

68 Strut Mount Kit. Hardware from O.E. Part may need to be reused.

APPLICATION GUIDE

Year	Fitment Notes										
		Ultra	ProGuard/ Guardian/ Classic	Max Control/ LTV	Strut Cushion/ Strut Mount	HiJackers/ Load Carrier	Ultra	ProGuard/ Guardian/ Classic	Max Control/ LTV	Strut Cushion/ Strut Mount	HiJackers/ Load Carrier

FORD

FORD

EXPEDITION (cont)

97-02	All	○	G63717	61614	58717 77717	
	4WD, Exc. Front Air- Leveling	○	G63716	61613 81914	58716 77716	○	G63717	61614	58717 77717
	RWD, Exc. Front Air- Leveling	⊖	G63714	61611 81912	58714 77714	○	G63717	61614	58717 77717

EXPEDITION READYMOUNTS

		Front		Rear	
		Ultra Readymount	Guardian Readymount	Ultra Readymount	Guardian Readymount
15-16	4WD, Exc. Air Suspension	G57173 ⁴⁰
	RWD, Exc. Suspension de Aire	G57173 ⁴⁰
14	Exc. Air Suspension	G57173 ⁴⁰
12-13	All	G57172 ⁴⁰
	Exc. Air Suspension	G57172 ⁴⁰	G57173 ⁴⁰
10-11	All	G57172 ⁴⁰	M57172 ⁴⁰	M57173 ⁴⁰
	Exc. Air Suspension	G57172 ⁴⁰	M57172 ⁴⁰	G57173 ⁴⁰	M57173 ⁴⁰
07-09	All	G57172 ⁴⁰	M57172 ⁴⁰	G57173 ⁴⁰	M57173 ⁴⁰
03-06	All	M57212 ⁴⁰	G57016 ⁴⁰	M57308 ⁴⁰
	4WD	G57015 ⁴⁰	M57212 ⁴⁰	G57016 ⁴⁰	M57308 ⁴⁰
	RWD	G57212 ⁴⁰	M57212 ⁴⁰	G57016 ⁴⁰	M57308 ⁴⁰

EXPEDITION STEERING STABILIZERS

		Front	Rear
97-02	4WD, Torsion Bar(FrontSpringType)	6861SE ⁸²

EXPLORER

15-16	All	⊖	G51980	
11-14	All	143475 ⁶⁸	⊖	G51980	143476 ⁶³	
06-10	All	⊖	G56838	G56839	143361 ⁵³ 143362 ²⁷	
04-05	Exc. All Sport & Sport Trac Models	⊖	G51723	M51723	G51724	M51724	143319 ⁵³	
02-05	All	⊖	143319 ⁵³	
02-03	Exc. All Sport & Sport Trac Models	⊖	G51722	M51722	G51724	M51724	143319 ⁵³	
95-01	Exc. Adjustable Suspension	⊖	G63678	61623 81893	77678	G63679	61624 81890	77679	43171 ⁸ 49232 ⁷
91-94	All	⊖	G63608	61591 81744	58929 77608	34076 ⁸	G63607	61590 81823	77607	43172 ⁸ 49225 ⁷

EXPLORER READYMOUNTS

		Front		Rear	
		Ultra Readymount	Guardian Readymount	Ultra Readymount	Guardian Readymount
06-10	All	G57095 ⁴⁰	M57095 ⁴⁰	G57096 ⁴⁰	M57096 ⁴⁰
04-05	Exc. All Sport & Sport Trac Models	G57019 ⁴⁰	M57019 ⁴⁰	G57018 ⁴⁰	M57018 ⁴⁰
02-03	Exc. All Sport & Sport Trac Models	G57017 ⁴⁰	M57017 ⁴⁰	G57018 ⁴⁰	M57018 ⁴⁰

EXPLORER SPORT TRAC

07-10	All	⊖	G52205	⊖	G52206
01-05	All	⊖	G63678	61623 81893	77678	G63679	61624 81890	77679	43171 ⁸ 49232 ⁷

EXPLORER STEERING STABILIZERS

		Front	Rear
95-02	4WD, Position Rear	14077
91-94	All	6802SE ⁸⁴

7 Pair Packs, air hose kit included.

40 Complete Assembled Unit.

67 Strut Mount Kit. Hardware from O.E. Part may need to be reused.

82 Use kit if listed, See Ref. C for optional Steering Stabilizer Boots.

Bold Type - New / Future Part



8 Pair Packs.

53 Strut Mount. Hardware from O.E. Part may need to be reused.

68 Strut Mount Kit. Hardware from O.E. Part may need to be reused.

84 Replacement damper for vehicles with the Gabriel Aftermarket mounting kit

APPLICATION GUIDE

Year	Fitment Notes										
		Ultra	ProGuard\Guardian\Classic	Max Control\LTV	Strut Cushion\Strut Mount	HiJackers\Load Carrier	Ultra	ProGuard\Guardian\Classic	Max Control\LTV	Strut Cushion\Strut Mount	HiJackers\Load Carrier

FORD

FORD

F-200

86	All	⊖	81490
----	-----	---	------	-------	------	------	------	------	------	------	------

F59 STEERING STABILIZERS

89-91	Single System Steering Stabilizer; Superduty Motorhome							6802SE ⁸⁴			
-------	--	--	--	--	--	--	--	----------------------	--	--	--

FAIRLANE

66-70	All	⊖	82126	49105 ⁷
	Wagon	⊖	82126	69606	81270	49105 ⁷
62-65	All	⊖	82075	81270	49105 ⁷
60-61	All	⊖	82099	82076
59	All	⊖	82099
57-58	All	⊖	82099	81270	49105 ⁷
55-56	All	⊖	82026	81270	49105 ⁷

FAIRMONT

78-83	All	⊖	G56504 ⁹	M56504⁹	142197 ⁵³	143059 ⁵¹	69633	81460	49199 ⁷
-------	-----	---	---------------------	---------------------------	------	----------------------	----------------------	------	-------	-------	------	------	--------------------

FALCON

66-70	All	⊖	82126	
	Exc. Wagon	⊖	82126	81270	
	Wagon	⊖	82126	69606	
	Exc. Wagon	⊖	82126	49105 ⁷	
	Wagon	⊖	82126	81495	
60-65	All	⊖	82126	81270	49105 ⁷

FESTIVA

88-93	All	⊖	G55615	143059 ⁵¹	G51039	143063 ⁵¹
-------	-----	---	--------	------	------	----------------------	------	------	--------	------	------	----------------------	------

FIESTA

14	All	⊖	143399⁵⁴	70052
13	Left	⊖	G52255	143399⁵⁴	70052
	Right	⊖	G52256	143399⁵⁴	70052
11-12	Left	⊖	G52255	143399⁵⁴	70052	143400⁵³
	Right	⊖	G52256	143399⁵⁴	70052	143400⁵³
03-05	All	⊖	G56742
98-01	All	⊖	G56742

FIESTA IKON

02-04	All	⊖	G56742
-------	-----	---	--------	------	------	------	------	------	------	------	------	------	------

7 Pair Packs, air hose kit included.

51 Strut Cushion for use with the Strut/Cartridge/Shocks.



54 Kit with Mount and Bearing. Hardware from O.E. Part may need to be reused.

9 See Ref. D for procedures to replace Elec Adj Susp with non-adj product.

53 Strut Mount. Hardware from O.E. Part may need to be reused.

84 Replacement damper for vehicles with the Gabriel Aftermarket mounting kit

APPLICATION GUIDE

Year	Fitment Notes										
		Ultra	ProGuard\Guardian\Classic	Max Control\LTV	Strut Cushion\Strut Mount	HiJackers\Load Carrier	Ultra	ProGuard\Guardian\Classic	Max Control\LTV	Strut Cushion\Strut Mount	HiJackers\Load Carrier

FORD

FORD

FIVE HUNDRED

05-07	AWD, Left	G52136
	AWD, Right	G52137
	FWD, Left	G52138	G51849	143390 ⁵³
	FWD, Right	G52139	G51849	143391 ⁵³

FLEX

13-16	All	G51996
10-12	Left	G52384	G51996
	Right	G52385	G51996
09	All	G51996

FLEX READYMOUNTS

		Front		Rear	
		Ultra Readymount	Guardian Readymount	Ultra Readymount	Guardian Readymount
09-12	Left	G57495 ⁴⁰
	Right	G57496 ⁴⁰

FOCUS

14	All	G511002 ²
12-13	Left	G52422	G511002 ²
	Right	G52423	G511002 ²
08-11	Left	G56836	M52818	142930 ⁵⁴	69464 ³⁷	81935 ³⁷	142992 ⁵³
	Right	G56837	M52819	142930 ⁵⁴	69464 ³⁷	81935 ³⁷	142992 ⁵³
06-07	Left	G56836	M52818	142930 ⁵⁴
	Right	G56837	M52819	142930 ⁵⁴
	Hatchback	69464 ³⁷	81935 ³⁷	142992 ⁵³
	Sedan	69464 ³⁷	81935 ³⁷	142992 ⁵³
00-07	Wagon	69465
00-05	Left	G56516	M56516	142930 ⁵⁴
	Right	G56517	M56517	142930 ⁵⁴
	Hatchback	143057 ⁵¹	69464 ³⁷	81935 ³⁷	142992 ⁵³
	Sedan	143057 ⁵¹	69464 ³⁷	81935 ³⁷	142992 ⁵³

FOCUS READYMOUNTS

		Front		Rear	
		Ultra Readymount	Guardian Readymount	Ultra Readymount	Guardian Readymount
06-11	Left	G57081 ⁴⁰
	Right	G57082 ⁴⁰

2 Future Part, available 2nd Quarter of 2017.

40 Complete Assembled Unit.



53 Strut Mount. Hardware from O.E. Part may need to be reused.

37 Reuse or replace O.E. bumper. It is not included with this shock. Use mount kit 142992 if upper hardware needs to be replaced.

51 Strut Cushion for use with the Strut/Cartridge/Shocks.

54 Kit with Mount and Bearing. Hardware from O.E. Part may need to be reused.

APPLICATION GUIDE



Year	Fitment Notes										
		Ultra	ProGuard/ Guardian/ Classic	Max Control/ LTV	Strut Cushion/ Strut Mount	HiJackers/ Load Carrier	Ultra	ProGuard/ Guardian/ Classic	Max Control/ LTV	Strut Cushion/ Strut Mount	HiJackers/ Load Carrier

FORD



FORD

FOCUS READYMOUNTS (cont)		Front		Rear	
		Ultra Readymount	Guardian Readymount	Ultra Readymount	Guardian Readymount
00-05	Left	G57063 ⁴⁰	M57063 ⁴⁰
	Right	G57064 ⁴⁰	M57064 ⁴⁰



FORD

49	All		82026		82060
----	-----	---	------	-------	------	------	------	---	------	-------	------	------	------













FORD 300

63	All		82099		82076
----	-----	---	------	-------	------	------	------	---	------	-------	------	------	------











FREESTAR

04-07	All		G56655	143246 ⁵³		G63873
-------	-----	---	--------	------	------	----------------------	------	---	--------	------	------	------	------

FREESTYLE

05-07	Left		G52110	143341 ⁵³	
	Right		G52111	143341 ⁵³	
	AWD			G51857
	FWD, Left			G51889
	FWD, Right			G51890
				







FUSION

10-12	Left		G51896	143392 ⁵⁴	
	Right		G51897	143392 ⁵⁴	
	FWD			G69591
06-09	All		G51859	M51859	143392 ⁵⁴	
	FWD		G51859	M51859	143392 ⁵⁴		G69591





FUSION READYMOUNTS

		Front		Rear	
		Ultra Readymount	Guardian Readymount	Ultra Readymount	Guardian Readymount
10-12	All	G57427 ⁴⁰
06-09	All	G57148 ⁴⁰	M57148 ⁴⁰

GALAXIE

65-67	All		69675 ⁵	81446	34073 ⁸		69606	81495	43140 ⁸ 49205 ⁷
60-64	All		82099		82076
59	All		82099	

GALAXIE 500

68-74	All		69675 ⁵	81446	34073 ⁸		69606	81495	43140 ⁸ 49205 ⁷
64-66	All		69675	81446		69606	81495

5 Use kit No. 140719 to replace O.E. hardware for lower shock absorber mounting when studs break or self-tapping screws are not longer useable.

8 Pair Packs.





53 Strut Mount. Hardware from O.E. Part may need to be reused.

7 Pair Packs, air hose kit included.

40 Complete Assembled Unit.

54 Kit with Mount and Bearing. Hardware from O.E. Part may need to be reused.





APPLICATION GUIDE

Year	Fitment Notes										
			Ultra	ProGuard\ Guardian\ Classic	Max Control\ LTV	Strut Cushion\ Strut Mount	HiJackers\ Load Carrier		Ultra	ProGuard\ Guardian\ Classic	Max Control\ LTV



FORD

FORD











GRANADA

81-82	All		G56504 ⁹	M56504⁹	142197 ⁵³ 143059 ⁵¹		69633	81460	49199 ⁷
75-80	All		81491		82130



GRAND MARQUIS

01-02	All		69675 ⁵	81446	34073 ⁸		69606	81495	43140 ⁸ 49205 ⁷
-------	-----	---	--------------------	-------	------	------	--------------------	---	-------	-------	------	------	--



LTD / COUNTRY SEDAN / COUNTRY SQUIRE / CROWN VICTORIA

87-91	All		69675 ⁵	81446	34073 ⁸		69606	81495	43140 ⁸ 49205 ⁷
85-86	Police and Taxi Models		G56504 ⁹	81446 M56504⁹	142197 ⁵³ 143059 ⁵¹		69633	81460	49199 ⁷
83-86	All		G56504 ⁹	M56504⁹	142197 ⁵³ 143059 ⁵¹		69633	81460	49199 ⁷
67-82	All		69675 ⁵	81446	34073 ⁸		69606	81495	43140 ⁸ 49205 ⁷
65-66	All		69675	81446		69606	81495



LTD II

77-79	All		69675 ⁵	81446	34073 ⁸		69606	81495	43140 ⁸ 49205 ⁷
-------	-----	---	--------------------	-------	------	------	--------------------	---	-------	-------	------	------	--

MAINLINE

52-56	All		82026		81270	49105 ⁷
-------	-----	--	------	-------	------	------	------	--	------	-------	------	------	--------------------























MAVERICK

70-77	All		81076		82130
-------	-----	---	------	-------	------	------	------	---	------	-------	------	------	------

MOTORHOME CHASSIS / F53 STEERING STABILIZERS

		Front		Rear	
89-91	Single System Steering Stabilizer; Motorhome	6802SE ⁸⁴		

MUSTANG / MUSTANG II

11-14	All		G52406	
	Convertible		G52406		69593
	Coupe		G52406		69592
05-10	All		G56817	143341 ⁵³	
	Convertible		G56817	143341 ⁵³		69593
	Coupe		G56817	143341 ⁵³		69592
03-04	SVT Cobra		G56790	142197 ⁵³ 143060 ⁵¹	
94-04	All		142197 ⁵³ 143060 ⁵¹	
	Base, Mach & GT Models Only		G55681	M55681	142197 ⁵³ 143060 ⁵¹		69898	81794	75898	49234 ⁷
01	SVT Cobra		G56790	142197 ⁵³ 143060 ⁵¹	
00	SVT Cobra R		G56790	142197 ⁵³ 143060 ⁵¹	

5 Use kit No. 140719 to replace O.E. hardware for lower shock absorber mounting when studs break or self-tapping screws are not longer useable.

8 Pair Packs.

51 Strut Cushion for use with the Strut/Cartridge/Shocks.

84 Replacement damper for vehicles with the Gabriel Aftermarket mounting kit



Bold Type - New / Future Part

7 Pair Packs, air hose kit included.

9 See Ref. D for procedures to replace Elec Adj Susp with non-adj product.

53 Strut Mount. Hardware from O.E. Part may need to be reused.

APPLICATION GUIDE

Year	Fitment Notes										
		Ultra	ProGuard\Guardian\Classic	Max Control\LTV	Strut Cushion\Strut Mount	HiJackers\Load Carrier	Ultra	ProGuard\Guardian\Classic	Max Control\LTV	Strut Cushion\Strut Mount	HiJackers\Load Carrier

FORD

FORD

MUSTANG / MUSTANG II (cont)

96-99	SVT Cobra	↓	G56790	142197 ⁵³ 143060 ⁵¹	↓	
95	SVT Cobra, SVT Cobra R	↓	G56790	142197 ⁵³ 143060 ⁵¹	↓	
94	SVT Cobra	↓	G56790	142197 ⁵³ 143060 ⁵¹	↓	
87-93	2.3L 4 Cyl L	↓	142197 ⁵³ 143059 ⁵¹	↓	81460	
	5.0l 8 Cyl V	↓	142197 ⁵³ 143059 ⁵¹	↓	81674	
	LX	↓	G56504 ⁹	M56504⁹	142197 ⁵³ 143059 ⁵¹	↓	69633	75755	49199 ⁷
84-93	All	↓	142197 ⁵³ 143059 ⁵¹	↓	
	GT	↓	G55551	M55551	142197 ⁵³ 143059 ⁵¹	↓	69755	81674	75755
84-86	LX	↓	G56504 ⁹	M56504⁹	142197 ⁵³ 143059 ⁵¹	↓	69633	81460
	LX Exc. 5.0L	↓	142197 ⁵³ 143059 ⁵¹	↓	49199 ⁷
	SVO	↓	142197 ⁵³ 143059 ⁵¹	↓	69755	81674	75755
84	L	↓	142197 ⁵³ 143059 ⁵¹	↓	69633	81460
82-83	All	↓	G56504 ⁹	M56504⁹	142197 ⁵³ 143059 ⁵¹	↓
	GL, GLX	↓	G56504 ⁹	M56504⁹	142197 ⁵³ 143059 ⁵¹	↓	69633	81460	49199 ⁷
	GT	↓	G56504 ⁹	M56504⁹	142197 ⁵³ 143059 ⁵¹	↓	69755	81674	75755
83	L	↓	G56504 ⁹	M56504⁹	142197 ⁵³ 143059 ⁵¹	↓	81460	49199 ⁷
82	Ghia, L	↓	G56504 ⁹	M56504⁹	142197 ⁵³ 143059 ⁵¹	↓	81460	49199 ⁷
79-81	All	↓	G56504 ⁹	M56504⁹	143059 ⁵¹	↓	69633	81460	49199 ⁷
78	All	↓	↓	82002
74-77	All	↓	82128	↓	82002
71-73	All	↓	81491	↓	81270	49105 ⁷
67-70	All	↓	81076	↓	81270	49105 ⁷
65-66	All	↓	82104	↓	81270	49105 ⁷

MUSTANG / MUSTANG II READYMOUNTS

		Front		Rear	
		Ultra Readymount	Guardian Readymount	Ultra Readymount	Guardian Readymount
05-10	All	G57271⁴⁰	

MUSTANG / MUSTANG II STEERING STABILIZERS

		Front	Rear
84-04	All	14039

PARK LANE WAGON

56	All	↓	82026	↓	81270
----	-----	---	------	-------	------	------	------	---	------	-------	------	------	------

7 Pair Packs, air hose kit included.

40 Complete Assembled Unit.

53 Strut Mount. Hardware from O.E. Part may need to be reused.

9 See Ref. D for procedures to replace Elec Adj Susp with non-adj product.

51 Strut Cushion for use with the Strut/Cartridge/Shocks.

APPLICATION GUIDE

Year	Fitment Notes										
		Ultra	ProGuard\ Guardian\ Classic	Max Control\ LTV	Strut Cushion\ Strut Mount	HiJackers\ Load Carrier	Ultra	ProGuard\ Guardian\ Classic	Max Control\ LTV	Strut Cushion\ Strut Mount	HiJackers\ Load Carrier

FORD

FORD

PICKUP 1/2 TON, F SUPERDUTY

93-97	Mfg. from 2/93	O	G63692	O	G63409	61554 81710	58409 77409 ⁶
90-97	All	O	O	G63409	61554 81710	58409 77409 ⁶
90-93	Mfg. to 2/93	O	G63617	O	G63409	61554 81710	58409 77409 ⁶

PICKUP 1/2 TON, F SUPERDUTY STEERING STABILIZERS

		Front	Rear
93-97	With O.E. Unit	6857SE ⁸²
90-92	All	6802SE ⁸⁴

PICKUP 1/2 TON, F-100

80-83	RWD	I O	G63414 ⁶	61520 81490	58414 77414 ⁶	34057 ⁸	O O	G63409	61554 81710	58409 77409 ⁶	43142 ³ 49197 ⁷
77-79	4WD; 3-4" Lift Kit, Exc. Quad Suspension	I O	G63445 ⁵⁰	I O	G63447 ⁵⁰
75-79	RWD	I O	G63386	61521 ⁶ 81394	58386	34058 ⁸	I O	G63350	61518 81242	58350	43099 ³ 49173 ⁷
75-76	4WD; Exc. Lift Kit	O O	82033	I O	G63387	81285	49178 ⁷
70-76	4WD; 3-4" Lift Kit, Exc. Quad Suspension	I O	I O	G63447 ⁵⁰
73-74	RWD	I O	G63386	61521	58386	I O	G63350	61518
	RWD	I O	81394	34058 ⁸	I O	81242
71-74	4WD; Lift Kit	I O	I O	81285
70-74	Exc. Lift Kit	I O	I O	49178 ⁷
	Exc. Supercab	I O	I O	43099 ³
	w/Lift Kit	I O	I O	49173 ⁷
	4WD; Exc. Lift Kit	O O	82033	I O	G63387
	Standard Cab Pickup RWD	I O	I O	58350
70-72	RWD	I O	G63386	61521	58386	34058 ⁸	I O	G63350	61518
	RWD	I O	81394	I O	81242
66-69	RWD	I O	G63386	61521	58386	34058 ⁸	O O	G63377	58377 77377	49127 ³
	4WD; Exc. Lift Kit	O O	82033	O O	82147
	RWD	I O	81394	O O	61519	43058 ³
	RWD; w/Front Coil Springs	I O	O O	81484
65	All	O O	81147	O O	61500
	RWD	I O	G63386	61521 81147	58386	34058 ⁸	O O	G63377	61500	58377 77377	49127 ³
	With Front Leaf Springs	I O	G63187	81147	O O	61500
	4WD; Exc. Lift Kit	O O	82033 81147	O O	82147 61500
	RWD	I O	81394 81147	O O	61519 61500	43058 ³
	RWD; w/Front Coil Springs	O O	81147	O O	81484 61500
61-64	All	O O	81147 82038	O O	G63405	61500	77405	43048 ³ 49310 ⁷
60	All	I I	I I	81270 82123
54-55	All	O O	O O	81676

6 It is recommended that when replacing shocks on vehicles with "quad shocks" all 4 shocks should be matched by series.

8 Pair Packs.

82 Use kit if listed, See Ref. C for optional Steering Stabilizer Boots.

7 Pair Packs, air hose kit included.

50 Bellows Kit No.141242 is recommended for use to protect piston rod from potentially harmful road debris.

84 Replacement damper for vehicles with the Gabriel Aftermarket mounting kit

APPLICATION GUIDE

Year	Fitment Notes										
		Ultra	ProGuard\ Guardian\ Classic	Max Control\ LTV	Strut Cushion\ Strut Mount	HiJackers\ Load Carrier	Ultra	ProGuard\ Guardian\ Classic	Max Control\ LTV	Strut Cushion\ Strut Mount	HiJackers\ Load Carrier

FORD

FORD

PICKUP 1/2 TON, F-100 (cont)

53	Exc. Heavy Duty	81676
----	-----------------	------	------	------	------	------	------	-------	------	------	------

PICKUP 1/2 TON, F-100 STEERING STABILIZERS

		Front	Rear
80-83	Single System Steering Stabilizer	6802SE ⁸⁴
77-79	Single System Steering Stabilizer; with Twin I-Beam Axle	6802SE ⁸⁴
75-79	4WD; Single System Steering Stabilizer	6803SE ⁸⁴
79	Dual System Steering Stabilizer; Exc. Sway Bar	6802SE ⁸⁴
	4WD; Single System	14016
77-78	4WD; Dual System Steering Stabilizer; Exc. Sway Bar	6802SE ⁸⁴
75-78	4WD	14016
75-76	4WD, Dual System Steering Stabilizer; Exc. Sway Bar	6802SE ⁸⁴
	RWD, Single System Steering Stabilizer; with Twin I-Beam Axle	6802SE ⁸⁴
73-74	RWD; Single System Steering Stabilizer with Twin I Beam Axle	6802SE ⁸⁴
60-74	4WD; Single System Steering Stabilizer	6803SE
65-72	RWD; Single System Steering Stabilizer with Twin I Beam Axle	6802SE
60-64	RWD; Single Steering Stabilizer; with I Beam Axle	6802SE ⁸⁴

PICKUP 1/2 TON, F-150

14-15	RWD	G64157 ¹
14	4WD	G64079
13	4WD	G51864	G64079
	RWD	G51865	G64157 ¹
11-12	All	143424 ⁶⁸
	4WD	G51864	143424 ⁶⁸	G64079
	RWD	G51865	143424 ⁶⁸	G64157 ¹
10	All	M51864	143424 ⁶⁸
	4WD	G51864	M51864	143424 ⁶⁸	G64079
	RWD	G51865	M51864	143424 ⁶⁸	G63867
09	All	M51864
	4WD	G51864	M51864	G64079
	RWD	G51865	M51864	G63867
05-08	RWD; Exc Lightning Model	G51703	M51703	143248 ⁵³	G63870
04-08	All	143248 ⁵³
	4WD	G51704	M51704	143248 ⁵³	G63867
04	4WD, Exc. 7000# GVW	G63716	61613 81914	58716 77716	143248 ⁵³	G63715	61612 81913	58715 77715
	RWD	G63714	61611 81912	58714 77714	143248 ⁵³	61638 81892	58778 77778	49237 ⁷
	RWD; Exc Lightning Model	G51703	M51703	143248 ⁵³	G63778 G63870

¹ Future Part, available 1st Quarter of 2017.





⁵³ Strut Mount. Hardware from O.E. Part may need to be reused.

⁸⁴ Replacement damper for vehicles with the Gabriel Aftermarket mounting kit

⁷ Pair Packs, air hose kit included.

⁶⁸ Strut Mount Kit. Hardware from O.E. Part may need to be reused.

APPLICATION GUIDE

Year	Fitment Notes										
			Ultra	ProGuard/ Guardian/ Classic	Max Control/ LTV	Strut Cushion/ Strut Mount	HiJackers/ Load Carrier		Ultra	ProGuard/ Guardian/ Classic	Max Control/ LTV

FORD

FORD

PICKUP 1/2 TON, F-150 (cont)

97-03	4WD	 O	G63716	61613 81914	58716 77716	 O	
	4WD, Exc. 7000# GVW	 O	 O	G63715	61612 81913	58715 77715
	RWD	 O	G63714	61611 81912	58714 77714	 O
	RWD; Exc Lightning Model	 O	 O	G63778	61638 81892	58778 77778	49237 ⁷
85-96	RWD	 O	G63414 ⁶	61520 ⁶ 81490	58414 ⁶ 77414 ⁶	34057 ⁸	 O	G63406	61547 81082	58406 77406	43167 ⁸
80-96	4WD, Exc. Lift Kit	 O	 O	G63461	61530 81510	58461 77461	49217 ⁷
	4WD, Quad & Non Quad Suspensions Rearward of Front Axle; Exc. Lift Kit	 O	G63414 ⁶	61520 ⁶ 81490	58414 ⁶ 77414 ⁶	34057 ⁸	 O
	4WD, Quad Suspension; Forward of Front Axle; Exc. Lift Kit	 O	G63410 ⁶	61546 ⁶	77410 ⁶	 O
80-86	3-4" Lift Kit	 O	G63445 ⁵⁰	 O	G63439 ⁵⁰
	4WD, Quad Suspension with 3-4" Lift Kit Forward of Front Axle	 O	G63446 ⁶	 O
80-84	RWD	 O	G63414 ⁶	61520 ⁶ 81490	58414 ⁶ 77414 ⁶	34057 ⁸	 O	G63409	61554 81710	58409 77409 ⁶	43142 ⁸ 49197 ⁷
78-79	4WD, Quad Suspension, Rearward of Front Axle; Non Quad Suspension, Right Shock; Exc. Lift Kit	 O	G63396	 O
	4WD, Extended Cab Pickup Exc. Lift Kit	 O	G63398	 O
	4WD; Quad Suspension, Forward of Front Axle; Non Quad Suspension, Left Shock; Exc. Lift Kit and Ranger XLT Model	 O	61551 ⁶	 O
	4WD; Quad Suspension, Forward of Front Axle; Non Quad Suspension, Left Shock; 4" Lift Kit; Exc. Extended Cab	 O	 O	G63447 ⁵⁰
	4WD; Quad Suspension, Forward of Front Axle; Non Quad Suspension, Left Shock; Exc. Lift Kit	 O	G63511 ⁶	 O
	4WD; Quad Suspension, Rearward of Front Axle; Non Quad Suspension, Right Shock; 4" Lift Kit; Exc. Extended Cab	 O	G63445 ⁵⁰	 O
	RWD	 O	G63386	58386	34058 ⁸	 O	G63350	61518 81242	58350
	RWD, Quad Suspension; Rearward of Front Axle; Non Quad Suspension, Right Shock; Exc. Lift Kit	 O	61521 ⁶ 81394	 O
77-79	4WD; Exc. Lift Kit	 O	 O	G63387	61647 81285	49178 ⁷
75-79	RWD, Standard Cab Pickup	 O	 O	43099 ⁸
75-77	RWD	 O	G63386	61521 ⁶ 81394	58386	34058 ⁸	 O	G63350	61518 81242	58350
77	4WD, Quad Suspension, Forward of Front Axle; Non Quad Suspension, Left Shock; Exc. Lift Kit	 O	G63396	 O
	4WD; 3-4" Lift Kit; Exc. Quad Suspension and Extended Cab	 O	G63445 ⁵⁰	 O	G63447 ⁵⁰
75-76	4WD; Exc. Lift Kit	 O	82033	 O	G63387	61647 81285	49178 ⁷
	4WD; Lift Kit	 O	 O	G63447 ⁵⁰

6 It is recommended that when replacing shocks on vehicles with "quad shocks" all 4 shocks should be matched by series.
8 Pair Packs.

7 Pair Packs, air hose kit included.
50 Bellows Kit No. 141242 is recommended for use to protect piston rod from potentially harmful road debris.

APPLICATION GUIDE

Year	Fitment Notes										
		Ultra	ProGuard/ Guardian/ Classic	Max Control/ LTV	Strut Cushion/ Strut Mount	HiJackers/ Load Carrier	Ultra	ProGuard/ Guardian/ Classic	Max Control/ LTV	Strut Cushion/ Strut Mount	HiJackers/ Load Carrier

FORD

FORD

		Front		Rear	
		Ultra Readymount	Guardian Readymount	Ultra Readymount	Guardian Readymount
PICKUP 1/2 TON, F-150 READYMOUNTS					
09-13	4WD, Extended Cab Pickup Exc. Sport Suspensions	G57103 ⁴⁰	M57103⁴⁰
	RWD	M57132⁴⁰
	RWD; Exc. Standard Cab	G57132 ⁴⁰
04-08	4WD	G57020 ⁴⁰	M57020⁴⁰
	RWD	G57021 ⁴⁰	M57021⁴⁰

		Front	Rear
		PICKUP 1/2 TON, F-150 STEERING STABILIZERS	
97-03	4WD	6861SE ⁸²
	RWD, Coil(FrontSpringType)	6860SE ⁸²
94-96	4WD, Single System Steering Stabilizer; with Twin Traction Beam	6802SE ⁸⁴
90-93	Single System Steering Stabilizer	6802SE ⁸⁴
80-89	All	6802SE ⁸⁴
77-79	Dual System Steering Stabilizer; Exc. Sway Bar	6802SE ⁸⁴
76-79	4WD	14016
	4WD, Single System Steering Stabilizer	6803SE ⁸⁴
75-76	RWD	6802SE ⁸⁴
75	4WD	14016

PICKUP 3/4 TON, F-250 / SUPERDUTY											
16	4WD	61682	77952
	RWD, w/Off Road Package	61682
13-15	4WD	G63886	61682	77952
	RWD	61713
12-15	4WD, RWD, w/Off Road Package	G63888
	RWD, w/Off Road Package	G63886	61682
11-15	RWD, Exc. Off Road Package	G63622	G64010
11-12	RWD	58807 77807	61713
12	4WD	G63886	61680	77951	61682	77952
05-11	4WD	G63886	61680	77951	G63888	61682	77952
05-10	RWD	G63622	58807 77807	G64010	61713
99-04	All	61732
	4WD	G63809	61655 61732	58809 77809	G63810	61656	58810 77810
	RWD	G63622	61732	58807 77807	G63808	61654	58808 77808
99	4WD, Up through 8500# GVW; Exc. Superduty	G63716	61613 81914 61732	58716 77716	G63715	61612 81913	58715 77715
	RWD, Up through 8500# GVW	G63714	61611 81912 61732	58714 77714	G63778	61638 81892	58778 77778
97-98	4WD, Up through 8500# GVW; Exc. Superduty	G63716	61613 81914	58716 77716	G63715	61612 81913	58715 77715
	RWD, Up through 8500# GVW	G63714	61611 81912	58714 77714	G63778	61638 81892	58778 77778
98	Over 8500# GVW	61614	58455
	4WD, Over 8500# GVW	G63455	77455
97	4WD, Over 8500# GVW	G63455	61614 81821	58455 77455	G63461	61530 81510	58461 77461



7 Pair Packs, air hose kit included.

82 Use kit if listed, See Ref. C for optional Steering Stabilizer Boots.

40 Complete Assembled Unit.

84 Replacement damper for vehicles with the Gabriel Aftermarket mounting kit

APPLICATION GUIDE

Year	Fitment Notes										
		Ultra	ProGuard/ Guardian/ Classic	Max Control/ LTV	Strut Cushion/ Strut Mount	HiJackers/ Load Carrier	Ultra	ProGuard/ Guardian/ Classic	Max Control/ LTV	Strut Cushion/ Strut Mount	HiJackers/ Load Carrier

FORD



FORD

PICKUP 3/4 TON, F-250 / SUPERDUTY (cont)

97	RWD, Over 8500# GVW	 O	G63414	61520 ⁶ 81490	58414 ⁶ 77414 ⁶	 O	G63406	61547 81082	58406 77406	43167 ⁸
87-96	4WD	 O	G63455	61614 81821	58455 77455	 O	G63461	61530 81510	58461 77461	49241 ⁷
80-96	RWD	 O	G63414	61520 ⁶ 81490	58414 ⁶ 77414 ⁶	 O	G63406	61547 81082	58406 77406	43167 ⁸
96	RWD, Up through 8500# GVW	 E	61611	58714 77714	 E
86	4WD	 O	 O	G63461	81510	58461	49217 ⁷
	4WD, Clevis Type Lower Front Mount; Exc. Dual Rear Wheels or Lift Kit	 O	G63416	 O	61530	77461
83-85	4WD, Clevis Type Lower Front Mount; Exc. Dual Rear Wheels or Lift Kit	 O	G63416	 O	G63461	61530 81510	58461 77461	49217 ⁷
80-82	4WD, Extended Cab Pickup	 O	G63416	 O
	4WD, Standard Cab Pickup	 O	G63410	 O
82	4WD	 O	61546 ⁶	77410 ⁶	 O
	4WD, Clevis Type Lower Front Mount; Exc. Dual Rear Wheels or Lift Kit	 O	 O	G63461	61530 81510	58461 77461	49217 ⁷
80-81	4WD	 O	61546 ⁶	77410 ⁶	 O	G63461	61530 81510	58461 77461	49217 ⁷
77-79	4WD; Standard Cab, Cab & Chassis; All From Serial No. Y20001	 T	G63398	 O	G63387	81285	49178 ⁷
75-79	RWD	 O	 O	77377
	RWD	 O	G63386	61521 81394	58386	34058 ⁸	 O
	RWD, Cab & Chassis	 O	 O	G63350	81242	43058 ⁸ 49127 ⁷
	RWD, Extended Cab Pickup	 O	 O	G63377	61519 81484	58377	43058 ⁸ 49127 ⁷
	RWD, Standard Cab Pickup	 O	 O	G63350	81242	43099 ⁸ 49173 ⁷
	RWD; Exc. Extended & Crew Cab	 O	 O	61518	58350
75-77	4WD; Up through Serial No. Y20000	 T	G63187	82034	 O	82147
71-74	RWD; Exc. Extended Cab & Chassis Cab	 O	 O	49173 ⁷
70-74	RWD	 O	G63386	61521	58386	 O	77377
	RWD; Exc. Supercab	 O	 O	G63350
	RWD; Extended Cab Pickup	 O	 O	58377
	RWD	 O	81394	34058 ⁸	 O	43058 ⁸
	RWD; Exc. Extended Cab	 O	 O	58350
	RWD; Exc. Supercab	 O	 O	81242
	RWD; Standard Cab	 O	 O	61518
	RWD; Standard Cab Pickup	 O	 O	43099 ⁸
68-74	4WD; Up through Serial No Y20000	 T	G63187	 O
66-74	4WD; Up through Serial No Y2000	 O	 O	82147
65-74	RWD; Supercab	 O	 O	G63377
	RWD; Supercab	 O	 O	61519 81484
74	4WD, Up through Serial No Y20000	 T	82034	 O

6 It is recommended that when replacing shocks on vehicles with "quad shocks" all 4 shocks 7 Pair Packs, air hose kit included. should be matched by series.
8 Pair Packs.

APPLICATION GUIDE

Year	Fitment Notes										
		Ultra	ProGuard/ Guardian/ Classic	Max Control/ LTV	Strut Cushion/ Strut Mount	HiJackers/ Load Carrier	Ultra	ProGuard/ Guardian/ Classic	Max Control/ LTV	Strut Cushion/ Strut Mount	HiJackers/ Load Carrier

FORD

FORD

PICKUP 3/4 TON, F-250 / SUPERDUTY (cont)

68-73	4WD; Up through Serial No Y20000		82034
65-69	RWD		G63386	61521	58386	58377 77377
	Supercab		49127 ⁷
	RWD		81394	43058 ⁸
66-67	4WD; Up through Serial No Y20000		G63187	82034
65	4WD		G63187	82034
61-64	All		81147	G63405	61500	77405	43048 ⁸
	4WD		G63187	82034 81147	G63405	61500	77405	43048 ⁸
61-62	RWD		82038 81147	G63405	61500	77405	43048 ⁸
60	All		81270 82123
53-55	All		81676

PICKUP 3/4 TON, F-250 / SUPERDUTY STEERING STABILIZERS

		Front	Rear
08-10	4WD	14072
05-07	4WD, Exc. O.E. Steering Stabilizer	6856SE ⁸²
99-06	RWD	6828SE ⁸⁰
99-04	4WD, Exc. O.E. Unit	6850SE ⁸²
	4WD, Replacement Kit	6855SE ⁸²
99-03	4WD, With O.E. Unit	6854SE ⁸⁰
97-99	4WD, Torsion Bar(FrontSpringType)	6861SE ⁸²
	RWD, Coil(FrontSpringType)	6860SE ⁸²
80-96	4WD, Single System Steering Stabilizer	6802SE ⁸⁴
77-79	4WD, Power Steering Single System Steering Stabilizer	6805SE ⁸⁰
75-79	RWD, Single System Steering Stabilizer	6802SE ⁸⁴
75-77	4WD, Manual Steering Single System Steering Stabilizer	6803SE ⁸⁴
60-74	Single System Steering Stabilizer	6803SE ⁸⁴

PICKUP 1 TON, F-350 / SUPERDUTY

05-12	4WD		G63886	61680	77951
	4WD; Single Rear Wheels; Exc. Cab & Chassis		G63888	61682	77952
	RWD		G63622	58807 77807	G64010	61713
05-07	4WD; Dual Rear Wheels; Exc. Cab & Chassis		G63887
05-06	4WD, Cab & Chassis		G63964
99-04	All		61732
	4WD		G63809	61655 61732	58809 77809	G63810	61656	58810 77810
	RWD		G63622	61732	58807 77807	G63808	61654	58808 77808
86-97	4WD		G63455	61614 81821	58455 77455
	4WD, Dual Rear Wheels		G63461	61530 81510	58461 77461
	4WD, Exc. Dual Rear Wheels		G63456	77456
80-97	RWD		G63414	61520 ⁶ 81490	58414 ⁶ 77414 ⁶



6 It is recommended that when replacing shocks on vehicles with "quad shocks" all 4 shocks should be matched by series.
8 Pair Packs.

7 Pair Packs, air hose kit included.

80 Mounting bracket not required, install on O.E. Shock Mounts. See Ref. C for optional Steering Stabilizer Boots.

84 Replacement damper for vehicles with the Gabriel Aftermarket mounting kit

APPLICATION GUIDE

Year	Fitment Notes										
		Ultra	ProGuard\ Guardian\ Classic	Max Control\ LTV	Strut Cushion\ Strut Mount	HiJackers\ Load Carrier	Ultra	ProGuard\ Guardian\ Classic	Max Control\ LTV	Strut Cushion\ Strut Mount	HiJackers\ Load Carrier

FORD

FORD

PICKUP 1 TON, F-350 / SUPERDUTY (cont)

80-97	RWD, Dual Rear Wheels	○	G63409	61554 81710	58409 77409 ⁶
	RWD, Exc. Dual Rear Wheels	○	G63406	61547 81082	58406 77406	43167 ⁶
82-85	4WD, Clevis Type Lower Front Mount; Exc. Dual Rear Wheels or Lift Kit	○	G63416	○	G63461	61530 81510	58461 77461	49217 ⁷
80-81	4WD	○	G63410	61546 ⁶	77410 ⁶	○	G63461	61530 81510	77461	49217 ⁷
	4WD, Dual Rear Wheels	○	○	58461
75-79	RWD	○	G63386	61521 ⁶	58386	○
	RWD, Cab & Chassis	○	○	43099 ⁸ 49173 ⁷
	RWD, Extended Cab Pickup	○	G63396	○	G63350	61518	58350	43099 ⁸ 49173 ⁷
	RWD, Standard Cab Pickup	○	○	G63377	61519 81484	58377 77377	43058 ⁸
	RWD; Supercab	○	○	81242
73-79	RWD; Standard Cab Pickup	○	○	49127 ⁷
67-79	RWD	○	81394	○
79	4WD	○	G63398	○	G63387	61647 81285	49178 ⁷
73-74	RWD; Exc. Supercab	○	○	77377
	RWD; Supercab	○	○	G63377
	RWD; Exc. Supercab	○	○	61519 81484
	RWD; Supercab	○	○	43058 ⁸
67-74	RWD	○	G63386	61521	○
74	RWD; Extended Cab	○	○	G63350
	RWD; Extended Cab & Chassis Cab	○	○	49173 ⁷
	RWD; Extended Cab Pickup	○	○	61518
	RWD; Super Cab	○	○	43099 ⁸
	Standard Cab Pickup RWD	○	58386	○	58350
73	Standard Cab Pickup RWD	○	58386	○
61-66	All	○	81147	○	G63405	61500	77405	43048 ⁸
60	All	○	○	81270
53-55	All	○	○	81676

PICKUP 1 TON, F-350 / SUPERDUTY STEERING STABILIZERS

		Front	Rear
08-10	4WD	14072
99-06	RWD	6828SE ⁸⁰
99-04	4WD, Exc. O.E. Unit	6850SE ⁸²
	4WD, Replacement Kit	6855SE ⁸²
99-03	4WD, With O.E. Unit	6854SE ⁸⁰
95-97	4WD	6826SE ⁸⁰
92-96	RWD, Dual System Steering Stabilizer	6802SE ⁸⁴
89-91	RWD, Single System Steering Stabilizer	6802SE ⁸⁴
82-88	Single System Steering Stabilizer; Exc. Anti-Sway Bar	6802SE ⁸⁴
79-81	RWD, Dual System Steering Stabilizer	6802SE ⁸⁴

6 It is recommended that when replacing shocks on vehicles with "quad shocks" all 4 shocks should be matched by series.

8 Pair Packs.



82 Use kit if listed, See Ref. C for optional Steering Stabilizer Boots.

7 Pair Packs, air hose kit included.

80 Mounting bracket not required, install on O.E. Shock Mounts. See Ref. C for optional Steering Stabilizer Boots.

84 Replacement damper for vehicles with the Gabriel Aftermarket mounting kit

APPLICATION GUIDE

Year	Fitment Notes										
		Ultra	ProGuard\ Guardian\ Classic	Max Control\ LTV	Strut Cushion\ Strut Mount	HiJackers\ Load Carrier	Ultra	ProGuard\ Guardian\ Classic	Max Control\ LTV	Strut Cushion\ Strut Mount	HiJackers\ Load Carrier

FORD

FORD

PICKUP 1 TON, F-350 / SUPERDUTY STEERING STABILIZERS (cont)

		Front	Rear
79	4WD, Power Steering Single System Steering Stabilizer	6805SE ⁸⁰
75-78	Dual System Steering Stabilizer	6802SE ⁸⁴
75-77	Manual Steering Single System Steering Stabilizer	6803SE ⁸⁴
65-74	Single System Steering Stabilizer; with Twin I Beam Axle	6802SE ⁸⁴
60-74	Single System Steering Stabilizer	6803SE ⁸⁴
60-64	Single System Steering Stabilizer with I Beam Axle	6802SE

PICKUP F SERIES

57-59	All	81270
	F-100, F-250	81270	82123
55	All	G63299
	F-100	G63299	G63405	61500	77405
	F-100 Heavy Duty	G63299	81147
	F250	G63299	81676
53-54	All	G63299	81676
48-52	F-1, F-2 & F-3	G63405	61500 81147	77405	43048 ⁸	G63299	81676

PICKUP F SERIES STEERING STABILIZERS

		Front	Rear
57-59	Single System Steering Stabilizer; with I-Beam Axle	6802SE ⁸⁴
59	Single System Steering Stabilizer; F-250, F-350; Exc. Power Steering	6803SE ⁸⁴
50-55	Single System Steering Stabilizer; with I-Beam Axle	6802SE ⁸⁴

PICKUP F550

10-12	All	58944
	Crew Cab	58944	58945

PICKUP P100 STEERING STABILIZERS

		Front	Rear
65-67	Single System Steering Stabilizer	6802SE ⁸⁴

PICKUP P350

76	Up through 8000# GVW	G63405	61500	77405	43048 ⁸
68-75	All	82123
	Up through 8000# GVW	G63405	61500 81147	77405	43048 ⁸	82123

PICKUP P350 STEERING STABILIZERS

		Front	Rear
68-73	Single System Steering Stabilizer	6802SE ⁸⁴

PICKUP P400

75-76	All	82123
	Up through 8000# GVW	G63405	61500 81147	77405	43048 ⁸	82123

PICKUP, F-450 SUPERDUTY

11-12	All	58944
	Crew Cab	58944	58945
09	All	58944





7 Pair Packs, air hose kit included.

80 Mounting bracket not required, install on O.E. Shock Mounts. See Ref. C for

8 Pair Packs.

84 Replacement damper for vehicles with the Gabriel Aftermarket mounting kit





















APPLICATION GUIDE

Year	Fitment Notes										
			Ultra	ProGuard\ Guardian\ Classic	Max Control\ LTV	Strut Cushion\ Strut Mount	HiJackers\ Load Carrier		Ultra	ProGuard\ Guardian\ Classic	Max Control\ LTV

FORD

FORD















PICKUP, F-450 SUPERDUTY (cont)

09	Crew Cab		58944		58945
07-08	All		G63969	58944 77967	
	Crew Cab		G63969	58944 77967		58945
07	4 X 2		G63969	58944 77967		77968
	4 X 4		G63969	58944 77967		77969
05-06	All		G63969	77967		G63963
	4 X 2		G63969	77967		G63963	77968
	4 X 4		G63969	77967		G63963	77969
99-04	All		G63809	61655	58809 77809		G63811	61657	58811 77461
97	All		G63692		G63409	61554	58409 77409 ⁹

PICKUP, F-450 SUPERDUTY STEERING STABILIZERS

		Front	Rear
08-10	4 X 4	14072
99-04	4 X 4	6854SE





PICKUP, F-550 SUPERDUTY

07	All		G63969	77967	
	4 X 2		G63969	77967		77968
	4 X 4		G63969	77967		77969
05-06	All		G63969	77967		G63963
	4 X 2		G63969	77967		G63963	77968
	4 X 4		G63969	77967		G63963	77969
99-04	All		G63809	61655	58809 77809		G63811	61657	58811 77461













PICKUP, F-550 SUPERDUTY STEERING STABILIZERS

		Front	Rear
08-10	4 X 4	14072
99-04	4 X 4	6854SE

PINTO

74-80	Exc. Wagon & Hatchback		82128		82004
71-73	Sedan		82128		82004

PROBE

93-97	Left		G55671	142856 ⁵⁴		G55672	143057 ⁵¹
	Right		G55670	142856 ⁵⁴		G55672	143057 ⁵¹
91-92	Base, GL, GT, Automatic		G55600 ⁹	142562 ⁵⁷ 143057 ⁵¹		G55601 ⁹	142196 ⁵³
89-92	All		G55600 ⁹	143057 ⁵¹		G55601 ⁹	142196 ⁵³
90	GL, GT, Automatic		G55600 ⁹	142562 ⁵⁷ 143057 ⁵¹		G55601 ⁹	142196 ⁵³
89	GL, LX, Automatic		G55600 ⁹	142562 ⁵⁷ 143057 ⁵¹		G55601 ⁹	142196 ⁵³

6 It is recommended that when replacing shocks on vehicles with "quad shocks" all 4 shocks should be matched by series.

51 Strut Cushion for use with the Strut/Cartridge/Shocks.

54 Kit with Mount and Bearing. Hardware from O.E. Part may need to be reused.

9 See Ref. D for procedures to replace Elec Adj Susp with non-adj product.

53 Strut Mount. Hardware from O.E. Part may need to be reused.

67 Strut Mount Kit. Hardware from O.E. Part may need to be reused.

APPLICATION GUIDE

Year	Fitment Notes										
		Ultra	ProGuard/ Guardian/ Classic	Max Control/ LTV	Strut Cushion/ Strut Mount	HiJackers/ Load Carrier	Ultra	ProGuard/ Guardian/ Classic	Max Control/ LTV	Strut Cushion/ Strut Mount	HiJackers/ Load Carrier

FORD

FORD

RANCH WAGON

65-74	All	⊥ ⊕	69675 ⁵	81446 82126	34073 ⁸	⊥ ⊕	69606	81495	43140 ⁸ 49205 ⁷
59-64	All	⊥ ⊕	82099	⊥ ⊕	82076
57-58	All	⊥ ⊕	82099	⊥ ⊕
52-56	All	⊥ ⊕	82026	⊥ ⊕	81270	49105 ⁷
50-51	All	⊥ ⊕	82026	⊥ ⊕	82060

RANCHERO

72-79	All	⊥ ⊕	81446	34073 ⁸	⊥ ⊕	69606	81495	43140 ⁸ 49205 ⁷
66-71	All	⊥ ⊕	82126	⊥ ⊕	69606	81495
60-65	All	⊥ ⊕	82126	⊥ ⊕	81270	49105 ⁷
59	All	⊥ ⊕	82099	⊥ ⊕	82076





RANGER

12-14	All	⊥ ⊕	⊥ ⊕	G64131¹
07-11	RWD, Coil(FrontSpringType)	⊥ ⊕	G63772	61626 81916	77772	⊥ ⊕	G63773	61627 81917	77525	43167 ⁸
06-11	4WD	⊥ ⊕	⊥ ⊕	G63775	61629 81918	77524
	RWD, Torsion Bar(FrontSpringType)	⊥ ⊕	⊥ ⊕	G63775	61629 81918	77524
	RWD: Exc. Sport w/ Torsion Bar (FrontSpringType)	⊥ ⊕	G63678	81893	77678	⊥ ⊕
05-11	4WD; w/ Torsion Bar (FrontSpringType)	⊥ ⊕	G63678	81893	77678	⊥ ⊕
06	RWD, Coil(FrontSpringType)	⊥ ⊕	G63772	61626 81916	77772	⊥ ⊕	G63773	61627 81917	77525	43167 ⁸ 49223 ⁷
01-05	Edge, 4WD, RWD	⊥ ⊕	⊥ ⊕	G63775	61629 81918	77524
	RWD, Coil (FrontSpringType); Exc. Sport, STX & Tremor models w/Torsion Bar	⊥ ⊕	G63772	61626 81916	77772	⊥ ⊕
	RWD: Exc. Edge, EV, Splash & Sport Models	⊥ ⊕	⊥ ⊕	81917
	RWD; w/ Torsion Bar (FrontSpringType) Exc. Edge	⊥ ⊕	G63678	61623 81893	77678	⊥ ⊕
98-05	Exc. Edge, EV, Splash & Sport Models	⊥ ⊕	⊥ ⊕	G63773	61627	77525
	RWD	⊥ ⊕	⊥ ⊕	43167 ⁸ 49223 ⁷
04	4WD; w/ Torsion Bar (FrontSpringType)	⊥ ⊕	81893	77678	⊥ ⊕
00-03	4WD; w/ Torsion Bar (FrontSpringType)	⊥ ⊕	G63678	81893	77678	⊥ ⊕
98-00	RWD: Exc. Edge, EV, Splash & Sport Models	⊥ ⊕	G63772	61626 81916	77772	⊥ ⊕	81917
00	4WD	⊥ ⊕	⊥ ⊕	G63775	61629 81918	77524
	4WD, Torsion Bar(FrontSpringType)	⊥ ⊕	61623	⊥ ⊕
98-99	4WD	⊥ ⊕	G63678	61623 81893	77678	⊥ ⊕	G63775	61629 81918	77524
90-97	All	⊥ ⊕	G63614	61561 81744	58929 77614	⊥ ⊕
	4WD	⊥ ⊕	G63614	61561 81744	58929 77614	⊥ ⊕	G63524	61573 81905	77524
	RWD	⊥ ⊕	G63614	61561 81744	58929 77614	⊥ ⊕	G63525	61559 81730	77525	43167 ⁸ 49223 ⁷

1 Future Part, available 1st Quarter of 2017.
7 Pair Packs, air hose kit included.

5 Use kit No. 140719 to replace O.E. hardware for lower shock absorber mounting when studs break or self-tapping screws are not longer useable.
8 Pair Packs.













APPLICATION GUIDE

Year	Fitment Notes										
		 Ultra	ProGuard/ Guardian/ Classic	Max Control/ LTV	Strut Cushion/ Strut Mount	HiJackers/ Load Carrier	 Ultra	ProGuard/ Guardian/ Classic	Max Control/ LTV	Strut Cushion/ Strut Mount	HiJackers/ Load Carrier

FORD

FORD







RANGER (cont)

87-89	Exc. High Ryder Option		G63414	61520 ⁶ 81490	77414 ⁶	34057 ⁸
89	4WD		G63524	61534 81540
	4WD, High Ryder Option		61573
	4WD, Mfg. from 2/89; Vehicles with 12mm bolt in rear lower mount		81905	77524
	RWD, Mfg. from 2/89; Vehicles with 12mm bolt in rear lower mount		G63525	61559 81730	77525
	RWD, Mfg. to 2/89; Vehicles with 10mm bolt in rear lower mount		G63427	61533 81539	43165 ⁶ 49207 ⁷
87-88	4WD		G63420	61534 81540
	RWD		G63427	61533 81539	43165 ⁶ 49207 ⁷
83-86	All		G63414	61520 ⁶ 81490	77414 ⁶	34057 ⁸
	4WD		G63414	61520 ⁶ 81490	77414 ⁶	34057 ⁸		G63420	61534 81540
	RWD		G63414	61520 ⁶ 81490	77414 ⁶	34057 ⁸		G63427	61533 81539



RANGER STEERING STABILIZERS

		Front	Rear
83-97	Single System Steering Stabilizer	6802SE ⁸⁴









SKYLINER

59	All		82099		82076
57-58	All		82099	
54-56	All		82026		81270	49105 ⁷



STARLINER

60	All		82099		82076
----	-----	---	------	-------	------	------	------	---	------	-------	------	------	------















SUNLINER

60	All		82099		82076
59	All		82099	
57-58	All		82099		81270	49105 ⁷
52-56	All		82026		81270	49105 ⁷

SUPER DELUXE

47-48	Direct Acting Shocks		82007		82156
-------	----------------------	---	------	-------	------	------	------	---	------	-------	------	------	------

TAURUS

15-16	Limited			70096
	w/ Suspension Code A and B Exc. SHO Models			70096
10-14	All			143476 ⁶³
	Limited			70096	143476 ⁶³
10-12	w/ Suspension Code A and B Exc. SHO Models			70096	143476 ⁶³
	Left w/ Suspension Code A and B		G52398		143476 ⁶³
	Right w/ Suspension Code A and B		G52399		143476 ⁶³

6 It is recommended that when replacing shocks on vehicles with "quad shocks" all 4 shocks should be matched by series.



8 Pair Packs.

84 Replacement damper for vehicles with the Gabriel Aftermarket mounting kit

7 Pair Packs, air hose kit included.
53 Strut Mount. Hardware from O.E. Part may need to be reused.

Bold Type - New / Future Part

APPLICATION GUIDE

Year	Fitment Notes										
		Ultra	ProGuard/ Guardian/ Classic	Max Control/ LTV	Strut Cushion/ Strut Mount	HiJackers/ Load Carrier	Ultra	ProGuard/ Guardian/ Classic	Max Control/ LTV	Strut Cushion/ Strut Mount	HiJackers/ Load Carrier

FORD

FORD

TAURUS (cont)

07-09	FWD; Mfg. from 06/07 Left	G51875
	FWD; Mfg. from 06/07 Right	G51876
09	FWD, Left	G52129
	FWD, Right	G52130
08	FWD, Left	G52129	143415 ⁵³
	FWD, Right	G52130	143415 ⁵³
96-07	Left	G55978	M55978	143059 ⁵¹
	Right	G55960	M55960	143059 ⁵¹
	Sedan	G55901	M55901	143057 ⁵¹
96-05	Wagon	69962	81927
94-95	All	G55616	M55616	142746 ⁶⁷ 143059 ⁵¹
	Sedan	G55616	M55616	142746 ⁶⁷ 143059 ⁵¹	G55901	M55901	143057 ⁵¹
	Wagon	G55616	M55616	142746 ⁶⁷ 143059 ⁵¹	69756	81693	49216 ⁷
86-93	All	G55616	M55616	142746 ⁶⁷
	Sedan	G55616	M55616	142746 ⁶⁷	G55518	M55518	143059 ⁵¹
	Wagon	G55616	M55616	143059 ⁵¹ 142746 ⁶⁷	69756	81693	49216 ⁷

TAURUS READYMOUNTS

		Front		Rear	
		Ultra Readymount	Guardian Readymount	Ultra Readymount	Guardian Readymount
10-12	Left	G57497 ⁴⁰
	Right	G57498 ⁴⁰
08-09	AWD, Left	G57553 ⁴⁰
	AWD, Right	G57554 ⁴⁰
09	Left	G57497 ⁴⁰	G57449 ⁴⁰
	Right	G57498 ⁴⁰	G57450 ⁴⁰
08	Left	G57449 ⁴⁰
	Right	G57450 ⁴⁰
96-07	Left	G56934 ⁴⁰	M56934 ⁴⁰
	Right	G56937 ⁴⁰	M56937 ⁴⁰
	Sedan	G56936 ⁴⁰	M56936 ⁴⁰
94-95	Sedan	G56912 ⁴⁰	M56912 ⁴⁰	G56936 ⁴⁰	M56936 ⁴⁰
86-95	All	G56912 ⁴⁰	M56912 ⁴⁰
86-93	Sedan	G56912 ⁴⁰	M56912 ⁴⁰	G56913 ⁴⁰	M56913 ⁴⁰

TAURUS X

08-09	AWD	G51857
	FWD, Left	G51889
	FWD, Right	G51890

7 Pair Packs, air hose kit included.



51 Strut Cushion for use with the Strut/Cartridge/Shocks.

67 Strut Mount Kit. Hardware from O.E. Part may need to be reused.

40 Complete Assembled Unit.

53 Strut Mount. Hardware from O.E. Part may need to be reused.

APPLICATION GUIDE

Year	Fitment Notes										
		Ultra	ProGuard/ Guardian/ Classic	Max Control/ LTV	Strut Cushion/ Strut Mount	HiJackers/ Load Carrier	Ultra	ProGuard/ Guardian/ Classic	Max Control/ LTV	Strut Cushion/ Strut Mount	HiJackers/ Load Carrier

FORD

FORD

TAURUS X (cont)

09	Left	G52400
	Right	G52401
08	Left	G52400	143415⁵³
	Right	G52401	143415⁵³

TAURUS X READYMOUNTS

		Front		Rear	
		Ultra Readymount	Guardian Readymount	Ultra Readymount	Guardian Readymount
08-09	Left	G57359⁴⁰
	Right	G57360⁴⁰

TEMPO

87-94	All	G55714	143059 ⁵¹
	FWD	G55714	G55733	M55733	143059 ⁵¹
87-91	AWD	G55714	G55722	143059 ⁵¹
86	All	143059 ⁵¹
	FWD	G55733	M55733	143059 ⁵¹
	FWD, Mfg. from 3/85	G55714	143059 ⁵¹
84-85	All	143057 ⁵¹	143059 ⁵¹
	FWD	143057 ⁵¹	G55733	M55733	143059 ⁵¹
85	FWD, Mfg. from 3/85	G55714	143057 ⁵¹	143059 ⁵¹

THUNDERBIRD

02-05	All	G51770	143242 ⁵³	G51771	143242 ⁵³
92-97	Exc. Electronic Adjustable Suspension	G55579	M55579	142222 ⁵³	69845	81795
89-91	Exc. Electronic Adjustable Suspension	G55579	M55579	142222 ⁵³	69820
87-88	Non-ABS	G56504 ⁹	M56504⁹	143059 ⁵¹	69709 ⁹	81461	49196 ⁷
80-86	All	G56503 ³⁹	143059 ⁵¹	69709 ⁹	81461	49196 ⁷
77-79	All	69675 ⁵	81446	34073 ⁸	69606	81495	43140 ⁸ 49205 ⁷
73-76	All	69675 ⁵	81446	34073 ⁸	69606	82603
67-72	All	69675 ⁵	81446	34073 ⁸	69606	81495	43140 ⁸ 49205 ⁷
64-66	All	82617
59-60	All	82099
55-57	All	82026	81270	49105 ⁷

5 Use kit No. 140719 to replace O.E. hardware for lower shock absorber mounting when studs break or self-tapping screws are not longer useable.

8 Pair Packs.

39 Conventional gas-charged strut can be used to replace O.E. air adjustable gas-charged strut. However, the self-leveling system must be deactivated. See Ref. A for instructions.

51 Strut Cushion for use with the Strut/Cartridge/Shocks.

Bold Type - New / Future Part



7 Pair Packs, air hose kit included.

9 See Ref. D for procedures to replace Elec Adj Susp with non-adj product.

40 Complete Assembled Unit.

53 Strut Mount. Hardware from O.E. Part may need to be reused.

APPLICATION GUIDE

Year	Fitment Notes										
		Ultra	ProGuard\ Guardian\ Classic	Max Control\ LTV	Strut Cushion\ Strut Mount	HiJackers\ Load Carrier	Ultra	ProGuard\ Guardian\ Classic	Max Control\ LTV	Strut Cushion\ Strut Mount	HiJackers\ Load Carrier

FORD

FORD

THUNDERBIRD READYMOUNTS		Front		Rear	
		Ultra Readymount	Guardian Readymount	Ultra Readymount	Guardian Readymount
89-97	Left Exc. Electronic Adjustable Suspension	G56976 ⁴⁰	M56976 ⁴⁰
	Right Exc. Electronic Adjustable Suspension	G56977 ⁴⁰	M56977 ⁴⁰

THUNDERBIRD STEERING STABILIZERS		Front	Rear
84-88	All	14039

TORINO

74-76	Wagon	⊥ ⊕	69675 ⁵	81446	34073 ⁸	⊥ ⊕	69606	81495	43140 ⁸ 49205 ⁷
72-76	All	⊥ ⊕	69675 ⁵	81446	34073 ⁸	⊥ ⊕	69606	43140 ⁸ 49205 ⁷
68-71	All	⊥ ⊕	82126	⊥ ⊕	69606	49105 ⁷
71	Wagon	⊥ ⊕	82126	⊥ ⊕	69606	81495	49105 ⁷
68-70	Exc. Wagon	⊥ ⊕	82126	⊥ ⊕	69606	81270	49105 ⁷

TRANSIT

07-10	All	⊕	⊕	G64063
-------	-----	---	------	------	------	------	------	---	--------	------	------	------	------

TRANSIT CONNECT

10-13	Left	⊥ ⊕	G52369	143564 ⁶⁸	⊥ ⊕	G64114
	Right	⊥ ⊕	G52370	143564 ⁶⁸	⊥ ⊕	G64114

VAN 1/2 TON, ECONOLINE / CLUB WAGON

12-14	All	⊥ ⊕	G63622	81744	⊥ ⊕	G63623	61646 81828	58623 77623	49178 ⁷
10-11	All	⊥ ⊕	G63622	61591 81744	58929 77608	⊥ ⊕	G63623	61595 81828	58623 77623	49178 ⁷
08-09	All	⊥ ⊕	G63622	61591 81744	58929 77608	⊥ ⊕	G63623	61595	58624	49178 ⁷
92-07	All	⊥ ⊕	G63929	61591 81744	58929 77608	⊥ ⊕	G63624	61595 81833	58624	49178 ⁷
75-91	All	⊥ ⊕	G63500	61553 81694	⊥ ⊕	G63350	61518 81242	58350	43099 ⁸ 49173 ⁷
69-74	All	⊕	82012	⊕	G63377	61519 81484	77377	43058 ⁸ 49127 ⁷

VAN 1/2 TON, ECONOLINE / CLUB WAGON STEERING STABILIZERS

		Front	Rear
95-01	Aftermarket Kit	6858SE
69-74	Single System Steering Stabilizer; with Twin I-Beam Axle	6802SE ⁸⁴

VAN 3/4 TON, ECONOLINE / CLUB WAGON / SUPERDUTY

03-14	All	⊥ ⊕	G63622	81744	58622 77614	⊥ ⊕	G63623	61646 81828	58623 77623	49178 ⁷
92-02	All	⊥ ⊕	G63622	61591 81744	58622 77614	⊥ ⊕	G63623	61646 81828	58623 77623	49178 ⁷
75-91	All	⊥ ⊕	G63386	61521 ⁶ 81394	58386	34058 ⁸	⊥ ⊕	G63387	61647 81285	49178 ⁷
69-74	All	⊕	82012	⊕	G63377	61519 81484	77377	43058 ⁸ 49127 ⁷

VAN 3/4 TON, ECONOLINE / CLUB WAGON / SUPERDUTY STEERING STABILIZERS

		Front	Rear
95-01	Aftermarket Kit	6858SE
74-79	QuadraVan Special	6803SE ⁸⁴

5 Use kit No. 140719 to replace O.E. hardware for lower shock absorber mounting when studs break or self-tapping screws are not longer useable.

7 Pair Packs, air hose kit included.

40 Complete Assembled Unit.



84 Replacement damper for vehicles with the Gabriel Aftermarket mounting kit

6 It is recommended that when replacing shocks on vehicles with "quad shocks" all 4 shocks should be matched by series.

8 Pair Packs.

68 Strut Mount Kit. Hardware from O.E. Part may need to be reused.

APPLICATION GUIDE

Year	Fitment Notes										
		Ultra	ProGuard\Guardian\Classic	Max Control\LTV	Strut Cushion\Strut Mount	HiJackers\Load Carrier	Ultra	ProGuard\Guardian\Classic	Max Control\LTV	Strut Cushion\Strut Mount	HiJackers\Load Carrier

FORD

FORD

VAN 3/4 TON, ECONOLINE / CLUB WAGON / SUPERDUTY STEERING STABILIZERS (cont)

		Front	Rear
69-74	Single System Steering Stabilizer; with Twin I-Beam Axle	6802SE ⁸⁴

VAN 1 TON, ECONOLINE / CLUB WAGON / SUPERDUTY

12-14	All	 ○	G63622	81744	58622 77614	 ○	G63623	61646 81828	58623	49178 ⁷
	Exc. Cutaway Chassis	 ○	G63622	81744	77614 58622	 ○	G63623	81828 61646	77623 58623	49178 ⁷
10-11	All	 ○	G63622	61591 81744	58622 77614	 ○	G63623	61646 81828	58623	49178 ⁷
08-11	Exc. Cutaway Chassis	 ○	G63622	61591 81744	58622 77614	 ○	G63623	61646 81828	58623 77623	49178 ⁷
09	All	 ○	G63622	61591 81744	77614	 ○	49178 ⁷
08	All	 ○	G63622	61591 81744	77614	 ○	77623	49178 ⁷
	Cutaway Chassis	 ○	G63622	61591 81744	58622 77614	 ○	58623 77623	49178 ⁷
07	All	 ○	61591	77614	 ○	77623	49178 ⁷
	Cutaway Chassis	 ○	61591	58622 77614	 ○	58623 77623	49178 ⁷
	Exc. Cutaway Chassis	 ○	G63622	81744 61591	58622 77614	 ○	G63623	61646 81828	58623 77623	49178 ⁷
04-06	Exc. Cutaway Chassis	 ○	G63622	61591 81744	58622 77614	 ○	G63623	61646 81828	58623 77623	49178 ⁷
06	All	 ○	G63622	61591 81744	77614	 ○	49178 ⁷
04-05	All	 ○	G63622	61591 81744	77614	 ○	61646 81828	49178 ⁷
92-05	Cutaway Chassis	 ○	G63622	61591 81744	58622 77614	 ○	G63623	61646 81828	58623 77623	49178 ⁷
01-03	All	 ○	G63622	61591 81744	58622 77614	 ○	G63623	61646 81828	58623 77623	49178 ⁷
03	Exc. Cutaway Chassis	 ○	G63622	61591 81744	58622 77614	 ○	G63623	61646 81828	77623 58623	49178 ⁷
92-00	All	 ○	61591 81744	 ○	61646 81828	49178 ⁷
77-91	All	 ○	58386	34058 ⁸	 ○	49178 ⁷
	Cutaway Chassis	 ○	G63386	58386	34058 ⁸	 ○	G63387	49178 ⁷
75-91	Exc. Cutaway Chassis	 ○	61521 ⁶ 81394	58386	34058 ⁸	 ○	61647 81285	49178 ⁷
75-76	Cutaway Chassis	 ○	G63386	 ○	G63387
69-74	All	 ○	82012	 ○	G63377	61519 81484	77377	43058 ⁸ 49127 ⁷

VAN 1 TON, ECONOLINE / CLUB WAGON / SUPERDUTY STEERING STABILIZERS

		Front	Rear
95-02	Aftermarket Kit	6858SE

VICTORIA

60	All	 ⊖	82099	 ⊖	82076
59	All	 ⊖	82099	 ⊖
57-58	All	 ⊖	82099	 ⊖	81270	49105 ⁷
52-56	All	 ⊖	82026	 ⊖	81270	49105 ⁷
51	All	 ⊖	82026	 ⊖	82156



6 It is recommended that when replacing shocks on vehicles with "quad shocks" all 4 shocks 7 Pair Packs, air hose kit included.

should be matched by series.

84 Replacement damper for vehicles with the Gabriel Aftermarket mounting kit

8 Pair Packs.

APPLICATION GUIDE

Year	Fitment Notes										
		Ultra	ProGuard\ Guardian\ Classic	Max Control\ LTV	Strut Cushion\ Strut Mount	HiJackers\ Load Carrier	Ultra	ProGuard\ Guardian\ Classic	Max Control\ LTV	Strut Cushion\ Strut Mount	HiJackers\ Load Carrier

FORD

FORD

WINDSTAR

95-03	All	↓	G55685	M55685	143059 ⁵¹	↓
	Coil(RearSpringType)	↓	G55685	M55685	143059 ⁵¹	○	G63676	61625 81882

WINDSTAR READYMOUNTS

		Front		Rear	
		Ultra Readymount	Guardian Readymount	Ultra Readymount	Guardian Readymount
95-03	All	G56935 ⁴⁰	M56935⁴⁰

GEO

GEO

METRO

89-97	Non-ABS	↓	G55891	142293 ⁵⁴ 143059 ⁵¹	↓	G55772	142295 ⁵³ 143057 ⁵¹
-------	---------	---	--------	------	------	--	------	---	--------	------	------	--	------

PRIZM

93-97	Left	↓	G55999	M55999	143059 ⁵¹ 143281 ⁵³	↓	G55661	M55661	143058 ⁵¹
	Right	↓	G55999	M55999	143059 ⁵¹ 143281 ⁵³	↓	G55662	M55662	142229 ⁵³
89-92	All	↓	G55591	M55591	143059 ⁵¹ 143281 ⁵³	↓	G55557	M55557	143061 ⁵¹
	Right	↓	G55591	M55591	143059 ⁵¹ 143281 ⁵³	↓	G55557	M55557	142229 ⁵³ 143061 ⁵¹

PRIZM READYMOUNTS

		Front		Rear	
		Ultra Readymount	Guardian Readymount	Ultra Readymount	Guardian Readymount
93-97	Left	G56947 ⁴⁰	M56947⁴⁰	G56949 ⁴⁰	M56949⁴⁰
	Right	G56947 ⁴⁰	M56947⁴⁰	G56950 ⁴⁰	M56950⁴⁰

SPECTRUM

89	All	↓	G5719	143058 ⁵¹	↓	81558
----	-----	---	-------	------	------	----------------------	------	---	------	-------	------	------	------

STORM

90-93	Non-ABS	↓	G55780	142317 ⁵³ 143058 ⁵¹	↓	G55776	143061 ⁵¹
-------	---------	---	--------	------	------	--	------	---	--------	------	------	----------------------	------

TRACKER

89-97	All	↓	M56518	142294 ⁵⁴	↓	G63799	61560 81904	49613 ⁷
	Non-ABS	↓	G56518	M56518	142294 ⁵⁴	↓	G63799	61560 81904	49613 ⁷

GMC

GMC

ACADIA

13-16	All	↓	↓	G64040
07-12	All	↓	G52125	143366 ⁵³	↓	G64040

ACADIA READYMOUNTS

		Front		Rear	
		Ultra Readymount	Guardian Readymount	Ultra Readymount	Guardian Readymount
12	All	G57109 ⁴⁰
10-11	All	G57109 ⁴⁰
07-09	All	G57109 ⁴⁰	M57314⁴⁰

7 Pair Packs, air hose kit included.

40 Complete Assembled Unit.



53 Strut Mount. Hardware from O.E. Part may need to be reused.

8 Pair Packs.

51 Strut Cushion for use with the Strut/Cartridge/Shocks.

54 Kit with Mount and Bearing. Hardware from O.E. Part may need to be reused.

APPLICATION GUIDE

Year	Fitment Notes										
		Ultra	ProGuard/ Guardian/ Classic	Max Control/ LTV	Strut Cushion/ Strut Mount	HiJackers/ Load Carrier	Ultra	ProGuard/ Guardian/ Classic	Max Control/ LTV	Strut Cushion/ Strut Mount	HiJackers/ Load Carrier

GMC

GMC

C3500HD

01-02	Solid Front Axle	61543
91-02	HD Solid Front Axle	58812	58488
91-00	HD Solid Front Axle	G63812

CANYON

04-12	RWD	77422	...	43162 49213
	RWD, Coil(FrontSpringType) D Standard Suspension; Exc. Z71 Off Road Package	G63882
09-11	Torsion Bar(FrontSpringType)	G63879
04-11	RWD, Coil(FrontSpringType) Exc. Z71 Off Road Package	G51850
04-08	Torsion Bar(FrontSpringType)	G63884	G63879

CANYON READYMOUNTS

		Front		Rear	
		Ultra Readymount	Guardian Readymount	Ultra Readymount	Guardian Readymount
04-11	All	G57282 ⁴⁰

ENVOY

02-09	All	G51718 ⁴⁵	M51718 ⁴⁵	...	143241 ⁵³	61717
	Coil(RearSpringType)	G51718 ⁴⁵	M51718 ⁴⁵	...	143241 ⁵³	...	G63842	61717	77971	...
03-06	Air(RearSpringType)	G51718 ⁴⁵	M51718 ⁴⁵	...	143241 ⁵³	...	G64014	61717

ENVOY READYMOUNTS

		Front		Rear	
		Ultra Readymount	Guardian Readymount	Ultra Readymount	Guardian Readymount
02-09	All	G57022 ⁴⁰	M57022 ⁴⁰

ENVOY XL

02-06	All	G51718	M51718	77971
-------	-----	--------	--------	-----	-----	-----	-----	-------	-----	-----

ENVOY XL READYMOUNTS

		Front		Rear	
		Ultra Readymount	Guardian Readymount	Ultra Readymount	Guardian Readymount
02-06	All	G57022 ⁴⁰	M57022 ⁴⁰

ENVOY XUV

04-05	All	G51718	M51718	77971
-------	-----	--------	--------	-----	-----	-----	-----	-------	-----	-----

ENVOY XUV READYMOUNTS

		Front		Rear	
		Ultra Readymount	Guardian Readymount	Ultra Readymount	Guardian Readymount
04-05	All	G57022 ⁴⁰	M57022 ⁴⁰

JIMMY

05	4WD	G63423	61531 81516	58423 ⁵⁰ 77423	142316 ⁵³	...	G63422	61528 81482	58422 77422	...	43162 ⁵ 49213 ⁷
92-04	All	142316 ⁵³	...	G63422	61528 81482	58422 77422	...	43162 ⁵ 49213 ⁷
	4WD	G63423	61531 81516	58423 ⁵⁰ 77423	142316 ⁵³	...	G63422	61528 81482	58422 77422	...	43162 ⁵ 49213 ⁷
	RWD	G63421	61504 81750	58421 77421	142316 ⁵³	34051 ⁸	G63422	61528 81482	58422 77422	...	43162 ⁵ 49213 ⁷

7 Pair Packs, air hose kit included.

40 Complete Assembled Unit.

50 Bellows Kit No.141242 is recommended for use to protect piston rod from potentially harmful road debris.



Bold Type - New / Future Part

8 Pair Packs.

45 Strut must be rotated to align notch with lower control arm.

53 Strut Mount. Hardware from O.E. Part may need to be reused.

APPLICATION GUIDE

Year	Fitment Notes										
		Ultra	ProGuard\Guardian\Classic	Max Control\LTV	Strut Cushion\Strut Mount	HiJackers\Load Carrier	Ultra	ProGuard\Guardian\Classic	Max Control\LTV	Strut Cushion\Strut Mount	HiJackers\Load Carrier

GMC

GMC

JIMMY (cont)

87-91	Exc. Lift Kit	⊗ G63349	61524 81164	77349	...	43111 ⁸
	Exc. Quad Suspension and Lift Kit	⊗	49155 ⁷
73-91	4WD w/ 4" Lift Kit; Exc. Quad Suspension	⊗ G63437 ⁵⁰	...	58437 ⁵⁰	⊗ G63438 ⁵⁰	...	58438 ⁵⁰
	4WD; Exc. Lift Kit	⊗ G63347 ⁵⁰	⊗	...	58349
	4WD; Quad Suspension Long Shock; Exc. Lift Kit	⊗ G63906 ⁶	61522 ⁶ 81496 ⁶	58906 ⁶	⊗
	4WD; Quad Suspension Short Shock; Exc. Lift Kit	⊗ G63908 ⁶	...	58908 ⁶	⊗
70-91	4WD; Exc. Quad Suspension and Lift Kit	⊗	61516 81113 ⁶	58347	...	43107 ⁸	⊗
73-86	Exc. Lift Kit	⊗ G63349	61524 81164	77349	...	43111 ⁸ 49155 ⁷
75-84	RWD	⊗ G63355	61525 81039	58355 77355	...	34036 ⁸	⊗
73-74	RWD	⊗ G63355	61525 81039	77355	...	34036 ⁸	⊗
70-74	RWD	⊗	...	58355	⊗
70-72	Coil(RearSpringType)	⊗	49107 ⁷
	RWD; Coil(RearSpringType)	⊗	43062 ⁸
	4WD	⊗ G63371
	4WD; Exc. Lift Kit	⊗ G63347 ⁵⁰	⊗
	RWD	⊗ G63355	61525 81039	77355	...	34036 ⁸	⊗ G63306	82003	43093 ⁸ 49162 ⁷

JIMMY STEERING STABILIZERS

		Front	Rear
83-04	4WD, Power Steering Single System Steering Stabilizer; without a factory mounting hole in the steering linkage.	6851SE	...
73-91	Heavy Duty replacement damper for vehicles with OE stabilizer	6804SE ⁸⁰	...
	Replacement damper for vehicles with OE stabilizer	14017	...
	Replacement damper for vehicles with the Gabriel aftermarket mounting kit	6802SE ⁸⁴	...
70-72	4WD; K-5 Single System Steering Stabilizer	6803SE ⁸⁴	...
	4WD; K5 Dual System Steering Stabilizer	6802SE ⁸⁴	...
	RWD; Steering Stabilizer	6802SE ⁸⁴	...

PICKUP

55-59	All	⊗	82047	⊗
	Series 100, 150	⊗	82047	⊗	82060
	Series 250	⊗	82047	⊗	82123
53-54	All	⊗	81270	⊗
	1/2 and 3/4 Ton	⊗	81270	⊗	82155

PICKUP 1/2 TON, C15 / C1500

88-99	All	⊗ G63489	61544 81668	58489 77489	⊗ G63488	61543 81667	58488 77488	...	43163 ⁸ 49218 ⁷
73-86	All	⊗ G63355	61525 81039	58355 77355	...	34036 ⁸	⊗ G63349	61524 81164	58349 77349	...	43111 ⁸ 49155 ⁷
68-72	RWD; Leaf(RearSpringType)	⊗ G63355	61525 81039	58355 77355	...	34036 ⁸	⊗ G63306
67-72	All	⊗ G63355	61525 81039	58355 77355	...	34036 ⁸	⊗
	Coil(RearSpringType)	⊗ G63355	61525 81039	58355 77355	...	34036 ⁸	⊗	82003	43062 ⁸ 49107 ⁷
	Leaf(RearSpringType)	⊗ G63355	61525 81039	58355 77355	...	34036 ⁸	⊗	82006	43093 ⁸ 49162 ⁷

6 It is recommended that when replacing shocks on vehicles with "quad shocks" all 4 shocks should be matched by series.

8 Pair Packs.

80 Mounting bracket not required, install on O.E. Shock Mounts. See Ref. C for

7 Pair Packs, air hose kit included.

50 Bellows Kit No. 141242 is recommended for use to protect piston rod from potentially harmful road debris.

84 Replacement damper for vehicles with the Gabriel Aftermarket mounting kit

APPLICATION GUIDE

Year	Fitment Notes										
		Ultra	ProGuard\ Guardian\ Classic	Max Control\ LTV	Strut Cushion\ Strut Mount	HiJackers\ Load Carrier	Ultra	ProGuard\ Guardian\ Classic	Max Control\ LTV	Strut Cushion\ Strut Mount	HiJackers\ Load Carrier

GMC

GMC

PICKUP 1/2 TON, C15 / C1500 (cont)

67	Leaf(RearSpringType)	<input type="radio"/>	G63355	61525 81039	58355 77355	34036 ⁸	<input type="radio"/>	G63306
----	----------------------	-----------------------	--------	----------------	----------------	------	--------------------	-----------------------	--------	------	------	------	------

PICKUP 1/2 TON, C15 / C1500 STEERING STABILIZERS

		Front	Rear
88-99	RWD	6852SE ⁸²
73-86	Single System Steering Stabilizer	6802SE ⁸⁴

PICKUP 1/2 TON, K15 / K1500

88-99	All	<input type="radio"/>	G63818	58901 77609	<input type="radio"/>	G63488	61543 81667	58488 ⁵⁰ 77488	43163 ⁸ 49218 ⁷
81-86	Quad Suspension Long Shock; Exc. Lift Kit	<input type="radio"/>	G63906 ⁶	61522 ² 81496 ⁶	58906 ⁶	<input type="radio"/>
	Quad Suspension Short Shock; Exc. Lift Kit	<input type="radio"/>	G63908 ⁶	58908 ⁶	<input type="radio"/>
79-86	Exc. Lift Kit	<input type="radio"/>	<input type="radio"/>	G63349	61524 81164	58349 77349	43111 ⁸
	Exc. Quad Suspension and Lift Kit	<input type="radio"/>	G63347	61516 81113 ⁶	58347	43107 ⁸	<input type="radio"/>	49155 ⁷
73-86	4" Lift Kit; Exc. Quad Suspension	<input type="radio"/>	G63437 ⁵⁰	58437 ⁵⁰	<input type="radio"/>	G63438 ⁵⁰	58438 ⁵⁰
78	Exc. Lift Kit	<input type="radio"/>	<input type="radio"/>	G63349	61524 81164	58349 77349
	Exc. Quad Suspension and Lift Kit	<input type="radio"/>	G63347	61516 81113 ⁶	58347	43107 ⁸	<input type="radio"/>	43111 ⁸ 49155 ⁷
75-77	Exc. Lift Kit	<input type="radio"/>	<input type="radio"/>	G63349	61524 81164	58349 77349	43111 ⁸
73-77	Exc. Quad Suspension and Lift Kit	<input type="radio"/>	G63347	61516 81113 ⁶	58347	43107 ⁸	<input type="radio"/>	49155 ⁷
73-74	Exc. Lift Kit	<input type="radio"/>	<input type="radio"/>	G63349	61524 81164	58349 77349
	Exc. Quad Suspension and Lift Kit	<input type="radio"/>	G63347	61516 81113 ⁶	58347	43107 ⁸	<input type="radio"/>	G63371
71-72	All	<input type="radio"/>	43107 ⁸	<input type="radio"/>	G63371
	Exc. Quad Suspension and Lift Kit	<input type="radio"/>	G63347	61516 81113 ⁶	58347	43107 ⁸	<input type="radio"/>	G63371
69-70	All	<input type="radio"/>	43107 ⁸	<input type="radio"/>
	Exc. Quad Suspension and Lift Kit	<input type="radio"/>	G63347	61516 81113 ⁶	58347	43107 ⁸	<input type="radio"/>

PICKUP 1/2 TON, K15 / K1500 STEERING STABILIZERS

		Front	Rear
88-99	Single System Steering Stabilizer	6807SE ⁸⁰
73-86	All	14017
	Dual System Steering Stabilizer	6802SE ⁸⁴
	Single System Steering Stabilizer	6804SE ⁸⁰
69-72	Dual System Steering Stabilizer	6802SE ⁸⁴
	Single System Steering Stabilizer	6803SE ⁸⁴

PICKUP 1/2 TON, R1500

87	All	<input type="radio"/>	G63355	61525 81039	58355 77355	34036 ⁸	<input type="radio"/>	G63349	61524 81164	58349 77349	43111 ⁸ 49155 ⁷
----	-----	-----------------------	--------	----------------	----------------	------	--------------------	-----------------------	--------	----------------	----------------	------	--

PICKUP 1/2 TON, R1500 STEERING STABILIZERS

		Front	Rear
87	Single System Steering Stabilizer	6802SE ⁸⁴

PICKUP 1/2 TON, V1500

87	4" Lift Kit; Exc. Quad Suspension	<input type="radio"/>	G63437 ⁵⁰	58437 ⁵⁰	<input type="radio"/>	G63438 ⁵⁰	58438 ⁵⁰
	Exc. Lift Kit	<input type="radio"/>	G63347	58347	43107 ⁸	<input type="radio"/>	G63349	61524 81164	58349 77349	43111 ⁸
	Quad Suspension Long Shock; Exc. Lift Kit	<input type="radio"/>	G63906 ⁶	61522 ² 81496 ⁶	58906 ⁶	<input type="radio"/>
	Quad Suspension Short Shock; Exc. Lift Kit	<input type="radio"/>	G63908 ⁶	61516 81113 ⁶	58908 ⁶	<input type="radio"/>

6 It is recommended that when replacing shocks on vehicles with "quad shocks" all 4 shocks should be matched by series.

8 Pair Packs.

80 Mounting bracket not required, install on O.E. Shock Mounts. See Ref. C for optional Steering Stabilizer Boots.



84 Replacement damper for vehicles with the Gabriel Aftermarket mounting kit

7 Pair Packs, air hose kit included.

50 Bellows Kit No.141242 is recommended for use to protect piston rod from potentially harmful road debris.

82 Use kit if listed, See Ref. C for optional Steering Stabilizer Boots.

APPLICATION GUIDE

Year	Fitment Notes										
		Ultra	ProGuard/ Guardian/ Classic	Max Control/ LTV	Strut Cushion/ Strut Mount	HiJackers/ Load Carrier	Ultra	ProGuard/ Guardian/ Classic	Max Control/ LTV	Strut Cushion/ Strut Mount	HiJackers/ Load Carrier

GMC

GMC

PICKUP 1/2 TON, V1500 (cont)

87	Quad Suspension; Exc. Lift Kit	⊗	49155 ⁷
----	--------------------------------	-------	-------	-------	-------	-------	---	-------	-------	-------	-------	-------	--------------------

PICKUP 1/2 TON, V1500 STEERING STABILIZERS

								Front	Rear	
87	All							⊗	14017
	Dual System Steering Stabilizer							⊗	6802SE ⁸⁴
	Single System Steering Stabilizer							⊗	6804SE ⁸⁰

PICKUP 3/4 TON, C25 / C2500

88-00	All	⊗	G63489	61544 81668	58489 77489	⊗	G63488	61543 81667	58488 77488	43163 ⁸ 49218 ⁷
85-86	Crew Cab Pickup	⊗	⊗	G63366	61649 81174	58366
79-86	Cab & Chassis	⊗	⊗	G63349	61524 81164	58349 77349	43111 ⁸ 49155 ⁷
	Exc. Extended Cab	⊗	G63355	61525 81039	58355 77355	34036 ⁸	⊗
	Standard Cab Pickup	⊗	⊗	G63349	61524 81164	58349 77349	43111 ⁸ 49155 ⁷
75-83	Crew Cab Pickup	⊗	⊗	G63366	61649 81174	58366
75-78	Cab & Chassis	⊗	⊗	81164	49155 ⁷
	Exc. Extended Cab	⊗	G63355	61525 81039	58355 77355	34036 ⁸	⊗	G63349	61524	58349 77349	43111 ⁸
	Standard Cab Pickup	⊗	⊗	81164	49155 ⁷
73-74	All	⊗	G63355	61525 81039	58355 77355	34036 ⁸	⊗	43111 ⁸ 49155 ⁷
	Crew Cab Pickup	⊗	G63355	61525 81039	58355 77355	34036 ⁸	⊗	G63366	61649	43111 ⁸ 49155 ⁷
	Exc. Crew Cab & Bonus Cab	⊗	G63355	61525 81039	58355 77355	34036 ⁸	⊗	G63349	61524	58349 77349	43111 ⁸ 49155 ⁷
67-72	Leaf(RearSpringType)	⊗	G63355	61525 81039	58355 77355	34036 ⁸	⊗	G63306	82006	43093 ⁸ 49162 ⁷
72	All	⊗	G63355	61525 81039	58355 77355	34036 ⁸	⊗
	Coil(RearSpringType)	⊗	G63355	61525 81039	58355 77355	34036 ⁸	⊗	82003	43062 ⁸ 49107 ⁷
71	All	⊗	G63355	61525 81039	58355 77355	34036 ⁸	⊗	G63306
	Coil(RearSpringType)	⊗	G63355	61525 81039	58355 77355	34036 ⁸	⊗	G63306	82003	43062 ⁸ 49107 ⁷
67-70	All	⊗	G63355	61525 81039	58355 77355	34036 ⁸	⊗
	Coil(RearSpringType)	⊗	G63355	61525 81039	58355 77355	34036 ⁸	⊗	82003	43062 ⁸ 49107 ⁷

PICKUP 3/4 TON, C25 / C2500 STEERING STABILIZERS

								Front	Rear	
92-99	RWD, Exc. O.E. Steering Stabilizer							⊗	6852SE ⁸²
88-91	RWD							⊗	6852SE ⁸²
67-86	Single System Steering Stabilizer							⊗	6802SE ⁸⁴

PICKUP 3/4 TON, K25 / K2500

88-00	All	⊗	G63609	61542 81726	58609 77609	⊗	G63488	61543 81667	58488 77488	43163 ⁸ 49218 ⁷
81-86	Quad Suspension Long Shock; Exc. Lift Kit	⊗	G63906 ⁶	61522 ⁶ 81496 ⁶	58906 ⁶	⊗
	Quad Suspension Short Shock; Exc. Lift Kit	⊗	G63908 ⁶	58908 ⁶	⊗
73-86	4" Lift Kit; Exc. Quad Suspension	⊗	G63437 ⁵⁰	58437 ⁵⁰	⊗	G63438 ⁵⁰	58438 ⁵⁰
	Exc. Lift Kit	⊗	⊗	G63349	61524 81164	58349 77349	43111 ⁸

6 It is recommended that when replacing shocks on vehicles with "quad shocks" all 4 shocks should be matched by series.

8 Pair Packs.



80 Mounting bracket not required, install on O.E. Shock Mounts. See Ref. C for optional Steering Stabilizer Boots.

7 Pair Packs, air hose kit included.

50 Bellows Kit No. 141242 is recommended for use to protect piston rod from potentially harmful road debris.

82 Use kit if listed, See Ref. C for optional Steering Stabilizer Boots.

APPLICATION GUIDE

Year	Fitment Notes										
		Ultra	ProGuard\ Guardian\ Classic	Max Control\ LTV	Strut Cushion\ Strut Mount	HiJackers\ Load Carrier	Ultra	ProGuard\ Guardian\ Classic	Max Control\ LTV	Strut Cushion\ Strut Mount	HiJackers\ Load Carrier

GMC

GMC

PICKUP 3/4 TON, K25 / K2500 (cont)

73-86	Exc. Quad Suspension and Lift Kit	○	G63347	61516 81113 ⁶	58347	43107 ⁸	○	49155 ⁷
71-72	All	○	○	G63371
	Exc. Quad Suspension and Lift Kit	○	G63347	61516 81113 ⁶	58347	43107 ⁸	○	G63371
69-70	Exc. Quad Suspension and Lift Kit	○	G63347	61516 81113 ⁶	58347	43107 ⁸	○

PICKUP 3/4 TON, K25 / K2500 STEERING STABILIZERS

		Front		Rear	
99-00	4WD, 9200# GVW with O.E. Unit - 15059138 15155638	6853SE ⁸²		
88-99	Single System Steering Stabilizer	6807SE ⁸⁰		
73-86	All	14017		
	Dual System Steering Stabilizer	6802SE ⁸⁴		
	Single System Steering Stabilizer	6804SE ⁸⁰		
67-72	Dual System Steering Stabilizer	6802SE ⁸⁴		
	Single System Steering Stabilizer	6803SE ⁸⁴		

PICKUP 3/4 TON, R2500

87-89	Crew Cab Pickup	○	○	G63366	61649 81174	58366
	Exc. Crew Cab & Bonus Cab	○	G63355	61525 81039	58355 77355	34036 ⁸	○	G63349	61524 81164	58349 77349	43111 ⁸ 49155 ⁷

PICKUP 3/4 TON, R2500 STEERING STABILIZERS

		Front		Rear	
87-89	Single System Steering Stabilizer	6802SE ⁸⁴		

PICKUP 3/4 TON, V2500

87	4" Lift Kit; Exc. Quad Suspension	○	G63437 ⁵⁰	58437 ⁵⁰	○	G63438 ⁵⁰	58438 ⁵⁰
	Exc. Lift Kit	○	G63347	58347	43107 ⁸	○	G63349	61524 81164	58349 77349	43111 ⁸ 49155 ⁷
	Quad Suspension Long Shock; Exc. Lift Kit	○	G63906 ⁶	61522 ⁶ 81496 ⁶	58906 ⁶	○
	Quad Suspension Short Shock; Exc. Lift Kit	○	G63908 ⁶	61516 81113 ⁶	58908 ⁶	○

PICKUP 3/4 TON, V2500 STEERING STABILIZERS

		Front		Rear	
87	All	14017		
	AN49	6802SE ⁸⁴		
	Single System Steering Stabilizer	6804SE ⁸⁰		

PICKUP 1 TON, C35/3500

99-00	Exc. HD Straight Front Axle	○	○	77488	49218 ⁷
92-00	Exc. HD Straight Front Axle	⊖	81668	⊖	77488
	Crew Cab Pickup Exc. HD Straight Front Axle	⊖	G63489	61544	58489 77489	⊖	G63488	77488
91-00	All	⊖	⊖	77488
	Extended Cab Pickup Exc. HD Straight Front Axle	⊖	G63489	61544	58489 77489	⊖	G63488	81667	77488
	Standard Cab Pickup Exc. HD Straight Front Axle	⊖	G63489	61544	58489 77489	⊖	G63488	81667	77488
00	HD Solid Front Axle	⊖	⊖	61543	77488	43163 ⁸
91-99	HD Solid Front Axle	⊖	⊖	61543	58488 77488	43163 ⁸
92-98	Cab & Chassis Exc. HD Straight Front Axle	⊖	⊖	77488	49218 ⁷
91	Exc. HD Straight Front Axle	⊖	81668	⊖	77488	49218 ⁷

6 It is recommended that when replacing shocks on vehicles with "quad shocks" all 4 shocks should be matched by series.

8 Pair Packs.

80 Mounting bracket not required, install on O.E. Shock Mounts. See Ref. C for optional Steering Stabilizer Boots.



84 Replacement damper for vehicles with the Gabriel Aftermarket mounting kit

7 Pair Packs, air hose kit included.

50 Bellows Kit No.141242 is recommended for use to protect piston rod from potentially harmful road debris.

82 Use kit if listed, See Ref. C for optional Steering Stabilizer Boots.

APPLICATION GUIDE

Year	Fitment Notes										
		Ultra	ProGuard\Guardian\Classic	Max Control\LTV	Strut Cushion\Strut Mount	HiJackers\Load Carrier	Ultra	ProGuard\Guardian\Classic	Max Control\LTV	Strut Cushion\Strut Mount	HiJackers\Load Carrier

GMC

GMC

PICKUP 1 TON, C35/3500 (cont)

91	Cab & Chassis	⊖	81039	77355	⊖	77488
	Cab & Chassis Exc. HD Solid Front Axle	⊖	⊖	G63366	61649 81174	58366 77488
	Cab & Chassis HD Solid Front Axle	⊖	61525	34036 ⁸	⊖	77488
89-90	Extended Cab Pickup Exc. HD Straight Front Axle	⊖	G63489	61544	58489 77489	⊖	G63488	81667	77488	43163 ⁸
88-90	Exc. HD Straight Front Axle	⊖	81668	⊖	61543	49218 ⁷
	Cab & Chassis	⊖	81039	77355	⊖
	Cab & Chassis Exc. HD Solid Front Axle	⊖	G63355	⊖	G63366	61649 81174	58366
	Cab & Chassis HD Solid Front Axle	⊖	61525	34036 ⁸	⊖
	HD Solid Front Axle	⊖	58355	⊖	58488
	Standard Cab Pickup Exc. HD Straight Front Axle	⊖	G63489	61544	58489 77489	⊖	G63488	81667	77488	43163 ⁸
88	Extended Cab Pickup Exc. HD Straight Front Axle	⊖	G63489	61544	58489 77489	⊖	G63488	77488	43163 ⁸
73-78	All	⊖	G63355	61525 81039	58355 77355	34036 ⁸	⊖	G63366	61649 81174	58366
67-72	All	⊖	G63355	61525 81039	58355 77355	34036 ⁸	⊖
	Exc. 11,000# Rear Axle	⊖	G63355	61525 81039	58355 77355	34036 ⁸	⊖	G63306	82006	43093 ⁸ 49162 ⁷

PICKUP 1 TON, C35/3500 STEERING STABILIZERS

		Front	Rear
91-93	HD Pick UP; O.E. Replacement Stabilizer Single System	6807SE ⁸⁰
75-86	Crew Cab Pickup	6802SE ⁸⁴
72-74	All	6802SE ⁸⁴

PICKUP 1 TON, K35 / K3500

88-00	All	⊖	G63609	61542 81726	58609 77609	⊖	G63488	61543 81667	58488 77488	43163 ⁸ 49218 ⁷
77-86	All	⊖	G63411	58411	⊖	G63675	61642 81921	58412 77412

PICKUP 1 TON, K35 / K3500 STEERING STABILIZERS

		Front	Rear
88-00	Single System Steering Stabilizer	6807SE ⁸⁰
77-86	All	14017
73-74	All	14017

PICKUP 1 TON, R3500

87-91	All	⊖	G63355	61525 81039	58355 77355	34036 ⁸	⊖	G63366	61649 81174	58366
-------	-----	---	--------	----------------	----------------	------	--------------------	---	--------	----------------	-------	------	------

PICKUP 1 TON, V3000 / V3500

87-91	All	⊖	G63411	58411	⊖	G63675	61642 81921	58412 77412
87-88	Quad Suspension Long Shock; Exc. Lift Kit	⊖	G63411	81496 ⁶	58411	⊖	G63675	61642 81921	58412 77412

PICKUP 1 TON, V3000 / V3500 STEERING STABILIZERS

		Front	Rear
87-91	All	14017

PICKUP 1000 SERIES

66	All	⊖	G63355	61525 81039	⊖
63-65	All	⊖	G63355	61525 81039	58355	34036 ⁸	⊖	G63306	82006	43093 ⁸ 49162 ⁷
61-62	All	⊖	82035	⊖	82086





6 It is recommended that when replacing shocks on vehicles with "quad shocks" all 4 shocks should be matched by series.

8 Pair Packs.

7 Pair Packs, air hose kit included.

80 Mounting bracket not required, install on O.E. Shock Mounts. See Ref. C for optional Steering Stabilizer Boots.



APPLICATION GUIDE

Year	Fitment Notes										
			ProGuard/ Guardian/ Classic	Max Control/ LTV	Strut Cushion/ Strut Mount	HiJackers/ Load Carrier		ProGuard/ Guardian/ Classic	Max Control/ LTV	Strut Cushion/ Strut Mount	HiJackers/ Load Carrier



GMC

GMC

PICKUP 1500 SERIES

66	All		G63355	61525 81039
63-65	All		G63355	61525 81039	58355 77355	43093 ⁸ 49162 ⁷
61-62	All		82035







PICKUP 2500 SERIES

66	All		G63355	61525 81039
61-62	All		82035

PICKUP STEERING STABILIZERS

		Front	Rear
57-59	Single System Steering Stabilizer; with I-Beam Axle	6802SE ⁸⁴
53-56	Truck Single System Steering Stabilizer; with I-Beam Axle	6802SE ⁸⁴









S15 JIMMY

83-91	All		142316 ⁵³		G63422	61528 81482	58422 77422	43162 ⁸ 49213 ⁷
	4WD		G63423	61531 81516	58423 77423	142316 ⁵³		G63422	61528 81482	58422 77422	43162 ⁸ 49213 ⁷
	RWD		G63421	61504 81750	58421 77421	142316 ⁵³	34051 ⁸		G63422	61528 81482	58422 77422	43162 ⁸ 49213 ⁷



S15 JIMMY STEERING STABILIZERS

		Front	Rear
83-91	Single System Steering Stabilizer; with a factory mounting hole in the steering linkage.	6801SE





















SAFARI

90-05	All			G63454	61539 81581	77454	43161 ⁸ 49215 ⁷
	AWD		G63818	61542 81726	58609 77609		G63454	61539 81581	77454	43161 ⁸ 49215 ⁷
	RWD		G63375 ⁵	61555 81713 ⁵	77375		G63454	61539 81581	77454	43161 ⁸ 49215 ⁷
85-89	RWD		G63375 ⁵	61555 81713 ⁵	77375		G63454	61539 81581	77454	43161 ⁸ 49215 ⁷

SAVANA 4500

10-15	All			G63897	61687
-------	-----	---	------	------	------	------	------	---	--------	-------	------	------	------	------

SIERRA 1500

16-17	All			77976
	Exc. Electronic Adjustable Suspension			61690	77976
	Exc. Classic Models and Electronic Adjustable Suspension			G63959	77976
14-15	All		G51949		77976
	Exc. Classic Models and Electronic Adjustable Suspension		G51949		G63959	61690	77976
07-13	All			77976
	Exc. AWD		M52803		77976
	Exc. Classic Models and Electronic Adjustable Suspension		G51870	143316 ⁵³		G63959	61690	77976
07	4WD; Classic and Old Body Style; Exc. Electronic Adjustable Suspension		G63803	61643 81922	58803 77803		G63675	61642 81921	58412 77412 77976
	RWD; Classic Models Only; Exc. Electronic Adjustable Suspension		G63783	61641 81920	58783 77783		G63662	61600 81873	58662 77662 77976	43181 ⁸ 49235 ⁷

5 Use kit No. 140719 to replace O.E. hardware for lower shock absorber mounting when studs break or self-tapping screws are not longer useable.

8 Pair Packs.

84 Replacement damper for vehicles with the Gabriel Aftermarket mounting kit

7 Pair Packs, air hose kit included.

53 Strut Mount. Hardware from O.E. Part may need to be reused.

APPLICATION GUIDE

Year	Fitment Notes										
		Ultra	ProGuard\ Guardian\ Classic	Max Control\ LTV	Strut Cushion\ Strut Mount	HiJackers\ Load Carrier	Ultra	ProGuard\ Guardian\ Classic	Max Control\ LTV	Strut Cushion\ Strut Mount	HiJackers\ Load Carrier

GMC

GMC

SIERRA 1500 (cont)

99-06	4WD; Classic and Old Body Style; Exc. Electronic Adjustable Suspension		G63803	61643 81922	58803 77803		G63675	61642 81921	58412 77412
	RWD; Classic Models Only; Exc. Electronic Adjustable Suspension		G63783	61641 81920	58783 77783		G63662	61600 81873	58662 77662	43181 ⁶ 49235 ⁷

SIERRA 1500 HD

05-06	All		G63817	61663 81925	58817 77817		G63675	61642 81921	58412 77412
01-03	All		G63817	61663 81925	58817 77817		G63675	61642 81921	58412 77412

SIERRA 1500 HD CLASSIC

07	All		G63817	61663 81925	58817 77817		G63675	61642 81921	58412 77412
----	-----	--	--------	----------------	----------------	------	------	--	--------	----------------	----------------	------	------

SIERRA 1500 READYMOUNTS

		Front		Rear	
		Ultra Readymount	Guardian Readymount	Ultra Readymount	Guardian Readymount
13-16	All	G57448⁴⁰	
13	RWD	G57448⁴⁰		M57023⁴⁰
	RWD; Exc. Classic Models and Electronic Ride	G57023 ⁴⁰	
	RWD; Exc. Standard Cab	G57000 ⁴⁰	
07-12	RWD		M57023⁴⁰
	RWD; Exc. Classic Models and Electronic Ride	G57023 ⁴⁰	
	RWD; Exc. Standard Cab	G57000 ⁴⁰	

SIERRA 1500 STEERING STABILIZERS

		Front	Rear
99-05	4WD, Exc. O.E. Steering Stabilizer	6853SE ⁸²

SIERRA 2500

99-04	All		58817		G63675	61642 81921	58412 77412
	4WD		G63817	61663 81925	77817 58817		G63675	61642 81921	58412 77412

SIERRA 2500 HD

14	All			G64121
11-13	All			G64121	58943
01-10	All		G63817	61663	58817 77817		G63675	61642 81921	58412 77412

SIERRA 2500 HD CLASSIC

07	All		58412
	4WD		77412 58412

SIERRA 2500 HD STEERING STABILIZERS

		Front	Rear
11-13	All	14075
01-09	4WD, 9200# GVW with O.E. Unit - 15059138 15155638	6853SE ⁸²

SIERRA 2500 STEERING STABILIZERS

		Front	Rear
99-04	4WD, Up through 8600# GVW; Exc. O.E. Steering Stabilizer	6853SE ⁸²

SIERRA 3500

01-06	All		G63817	61663	58817 77817		G63675	61642 81921	58412 77412
-------	-----	--	--------	-------	----------------	------	------	--	--------	----------------	----------------	------	------

SIERRA 3500 CLASSIC

07	All		61663	58817	61642	58412 77412
----	-----	--	------	-------	-------	------	------	--	------	-------	----------------	------	------

7 Pair Packs, air hose kit included.

40 Complete Assembled Unit.

8 Pair Packs.

82 Use kit if listed, See Ref. C for optional Steering Stabilizer Boots.

APPLICATION GUIDE

Year	Fitment Notes										
		Ultra	ProGuard/ Guardian/ Classic	Max Control/ LTV	Strut Cushion/ Strut Mount	HiJackers/ Load Carrier	Ultra	ProGuard/ Guardian/ Classic	Max Control/ LTV	Strut Cushion/ Strut Mount	HiJackers/ Load Carrier

GMC

GMC

SIERRA 3500 HD

14	All	⌚	⌚	G64121
11-13	All	⌚	⌚	G64121	58943
07-10	All	⌚	⌚	G63675	61642 81921	58412 77412
	Torsion Bar(FrontSpringType)	⌚	G63817	61663	58817 77817	G63675	61642 81921	58412 77412

SIERRA 3500 HD STEERING STABILIZERS

		Front	Rear
11-13	All	14075

SONOMA / S15 2WD

82-04	All	⌚	⌚	G63422	61528 81482	58422 77422	43162 ⁸ 49213 ⁷
	RWD	⌚	G63421	61504 81750	58421 77421	34051 ⁸	G63422	61528 81482	58422 77422	43162 ⁸ 49213 ⁷

SONOMA / S15 4WD

83-04	4WD	⌚	G63423	61531 81516	58423 77423	⌚	G63422	61528 81482	58422 77422	43162 ⁸ 49213 ⁷
82-04	All	⌚	⌚	G63422	61528 81482	58422 77422	43162 ⁸ 49213 ⁷
04	RWD	⌚	G63421	61504 81750	58421 77421	34051 ⁸	⌚	G63422	61528 81482	58422 77422	43162 ⁸ 49213 ⁷
88-94	4WD, Torsion Bar(FrontSpringType)	⌚	142316 ⁵³	⌚	G63422	61528 81482	58422 77422	43162 ⁸ 49213 ⁷
82	RWD	⌚	34051 ⁸	⌚	G63422	61528 81482	58422 77422	43162 ⁸ 49213 ⁷

SONOMA / S15 STEERING STABILIZERS 2WD

		Front	Rear
91-93	Single System Steering Stabilizer; with a factory mounting hole in the steering linkage.	6801SE ⁸⁰
82-93	RWD, Single System Steering Stabilizer	6802SE ⁸⁴
82-90	RWD, Single System Steering Stabilizer; with a factory mounting hole in the steering linkage.	6801SE

SONOMA / S15 STEERING STABILIZERS 4WD

		Front	Rear
91-93	Single System Steering Stabilizer; with a factory mounting hole in the steering linkage.	6801SE ⁸⁰
83-90	4WD, Power Steering Single System Steering Stabilizer; without a factory mounting hole in the steering linkage.	6851SE

SPRINT / CABALLERO

78-87	All	⌚	61504	34051 ⁸	⌚
	RWD	⌚	G63421	81750 61504	58421 77421	34051 ⁸	⌚	81492	43060 ⁸ 49334 ⁹⁰
71-77	All	⌚	G63421	61504 81750	58421 77421	⌚	81492	43060 ⁸ 49152 ⁹⁰
	RWD	⌚	G63421	61504 81750	58421 77421	34051 ⁸	⌚	81492	43060 ⁸ 49152 ⁹⁰

SPRINT / CABALLERO STEERING STABILIZERS

		Front	Rear
73-77	All	14019

SUBURBAN 1/2 TON, C15 / C1500

93-99	All	⌚	G63489	61544 81668	58489 77489	⌚	G63896	61565 81789	58638 77638	43180 ⁸ 49231 ⁷
92	All	⌚	G63489	61544 81668	58489 77489	⌚	61565 81789	58638 77638	43180 ⁸ 49231 ⁷
	Old Body Style	⌚	G63489	61544 81668	58489 77489	⌚	G63896	61565 81789	58638 77638	43180 ⁸ 49231 ⁷
75-86	All	⌚	G63355	61525 81039	58355 77355	34036 ⁸	⌚	G63349	61524 81164	58349 77349	43111 ⁸ 49155 ⁷
73-74	All	⌚	G63355	81039	58355 77355	34036 ⁸	⌚	G63349	61524 81164	58349 77349	43111 ⁸ 49155 ⁷

7 Pair Packs, air hose kit included.

30 For GM Vehicles equipped with factory installed leveling systems, see Ref A.



80 Mounting bracket not required, install on O.E. Shock Mounts. See Ref. C for optional Steering Stabilizer Boots.

8 Pair Packs.

53 Strut Mount. Hardware from O.E. Part may need to be reused.

84 Replacement damper for vehicles with the Gabriel Aftermarket mounting kit

APPLICATION GUIDE

Year	Fitment Notes										
		Ultra	ProGuard\ Guardian\ Classic	Max Control\ LTV	Strut Cushion\ Strut Mount	HiJackers\ Load Carrier	Ultra	ProGuard\ Guardian\ Classic	Max Control\ LTV	Strut Cushion\ Strut Mount	HiJackers\ Load Carrier

GMC

GMC

SUBURBAN 1/2 TON, C15 / C1500 (cont)

73-74	Coil (FrontSpringType)	○ G63355	61525 81039	58355 77355	34036 ⁶	○ G63349	61524 81164	58349 77349	43111 ⁸ 49155 ⁷
68-72	All	○ G63355	58355 77355	34036 ⁶	○	43062 ⁸
	Coil (FrontSpringType)	○ G63355	61525 81039	58355 77355	34036 ⁶	○	43062 ⁸
	Coil(RearSpringType)	○ G63355	58355 77355	34036 ⁶	○	82003	49107 ⁷ 43062 ⁸

SUBURBAN 1/2 TON, C15 / C1500 STEERING STABILIZERS

		Front	Rear
92-99	RWD, Exc. O.E. Steering Stabilizer	6852SE ⁸²
68-86	Single System Steering Stabilizer	6802SE ⁸⁴

SUBURBAN 1/2 TON, K15 / K1500

92-99	All	○ G63609	61542 81726	58609 ⁵⁰ 77609	○ G63638	61565 81789	58638 ⁵⁰ 77638	43180 ⁸ 49231 ⁷
81-86	Quad Suspension Long Shock; Exc. Lift Kit	○ G63906 ⁶	61522 ⁶ 81496 ⁶	58906 ⁵	○
	Quad Suspension Short Shock; Exc. Lift Kit	○ G63908 ⁶	58908 ⁵	○
73-86	4" Lift Kit; Exc. Quad Suspension	○ G63437 ⁵⁰	58437 ⁵⁰	○ G63438 ⁵⁰	58438 ⁵⁰
	Exc. Lift Kit	○	○ G63349	61524 81164	58349 77349	43111 ⁸
	Exc. Quad Suspension and Lift Kit	○ G63347	61516 81113 ⁶	58347	43107 ⁸	○	49155 ⁷
71-72	All	○	○ G63371
	Exc. Quad Suspension and Lift Kit	○ G63347	61516 81113 ⁶	58347	43107 ⁸	○ G63371
69-70	Exc. Quad Suspension and Lift Kit	○ G63347	61516 81113 ⁶	58347	43107 ⁸	○

SUBURBAN 1/2 TON, K15 / K1500 STEERING STABILIZERS

		Front	Rear
92-95	Single System Steering Stabilizer	6807SE ⁸⁰
73-86	All	14017
	Dual System Steering Stabilizer	6802SE ⁸⁴
	Single System Steering Stabilizer	6804SE ⁸⁰
68-72	Dual System Steering Stabilizer	6802SE ⁸⁴
	Single System Steering Stabilizer	6803SE ⁸⁴

SUBURBAN 1/2 TON, R1500

87-91	All	○ G63355	61525 81039	58355 77355	34036 ⁶	○ G63349	61524 81164	58349 77349	43111 ⁸ 49155 ⁷
-------	-----	----------	----------------	----------------	------	--------------------	----------	----------------	----------------	------	--

SUBURBAN 1/2 TON, R1500 STEERING STABILIZERS

		Front	Rear
87-91	Single System Steering Stabilizer	6802SE ⁸⁴

SUBURBAN 1/2 TON, V1500

87-91	4" Lift Kit; Exc. Quad Suspension	○ G63437 ⁵⁰	58437 ⁵⁰	○ G63438 ⁵⁰	58438 ⁵⁰
	Exc. Lift Kit	○ G63347	43107 ⁸	○ G63349	61524 81164	58349 77349	43111 ⁸ 49155 ⁷
	Exc. Quad Suspension and Lift Kit	○	58347	○
	Quad Suspension Long Shock; Exc. Lift Kit	○ G63906 ⁶	61522 ⁶ 81496 ⁶	58906 ⁵	○
	Quad Suspension Short Shock; Exc. Lift Kit	○ G63908 ⁶	61516 81113 ⁶	58908 ⁵	○

6 It is recommended that when replacing shocks on vehicles with "quad shocks" all 4 shocks should be matched by series.

8 Pair Packs.



80 Mounting bracket not required, install on O.E. Shock Mounts. See Ref. C for optional Steering Stabilizer Boots.

7 Pair Packs, air hose kit included.

50 Bellows Kit No. 141242 is recommended for use to protect piston rod from potentially harmful road debris.

82 Use kit if listed, See Ref. C for optional Steering Stabilizer Boots.

APPLICATION GUIDE

Year	Fitment Notes										
		Ultra	ProGuard\Guardian\Classic	Max Control\LTV	Strut Cushion\Strut Mount	HiJackers\Load Carrier	Ultra	ProGuard\Guardian\Classic	Max Control\LTV	Strut Cushion\Strut Mount	HiJackers\Load Carrier

GMC

GMC

SUBURBAN 1/2 TON, V1500 STEERING STABILIZERS

		Front	Rear
87-91	All	14017
	Dual System Steering Stabilizer	6802SE ⁸⁴
	Single System Steering Stabilizer	6804SE ⁸⁰

SUBURBAN 3/4 TON, C25 / C2500

92-99	All	⊕ G63489	61544 81668	58489 77489	⊖ G63896	61565 81789	58638 77638	43180 ⁸ 49231 ⁷
75-86	All	⊖ G63355	61525 81039	58355 77355	34036 ⁸	⊖ G63349	61524 81164	58349 77349	43111 ⁸ 49155 ⁷
73-74	All	⊖ G63355	61525 81039	58355 77355	34036 ⁸	⊖	58349	43111 ⁸ 49155 ⁷
	Exc. Crew Cab & Bonus Cab	⊖ G63355	61525 81039	58355 77355	34036 ⁸	⊖ G63349	61524 81164	58349 77349	43111 ⁸ 49155 ⁷
68-72	All	⊖ G63355	61525 81039	58355 77355	34036 ⁸	⊖	82003	49107 ⁷
	Coil(RearSpringType)	⊖ G63355	61525 81039	58355 77355	34036 ⁸	⊖	82003	43062 ⁸ 49107 ⁷

SUBURBAN 3/4 TON, C25 / C2500 STEERING STABILIZERS

		Front	Rear
68-86	Single System Steering Stabilizer	6802SE ⁸⁴

SUBURBAN 3/4 TON, K25 / K2500

92-99	All	⊖ G63609	61542 81726	58609 77609	⊖ G63638	61565 81789	58638 77638	43180 ⁸ 49231 ⁷
81-86	Quad Suspension Long Shock; Exc. Lift Kit	⊖ G63906 ⁶	61522 ⁶ 81496 ⁶	58906 ⁶	⊖
	Quad Suspension Short Shock; Exc. Lift Kit	⊖ G63908 ⁶	58908 ⁶	⊖
73-86	4" Lift Kit; Exc. Quad Suspension	⊖ G63437 ⁵⁰	58437 ⁵⁰	⊖ G63438 ⁵⁰	58438 ⁵⁰
	Exc. Lift Kit	⊖	⊖ G63349	61524 81164	58349 77349	43111 ⁸
	Exc. Quad Suspension and Lift Kit	⊖ G63347	61516 81113 ⁶	58347	43107 ⁸	⊖	49155 ⁷
71-72	All	⊖	⊖ G63371
	Exc. Quad Suspension and Lift Kit	⊖ G63347	61516 81113 ⁶	58347	43107 ⁸	⊖ G63371
69-70	Exc. Quad Suspension and Lift Kit	⊖ G63347	61516 81113 ⁶	58347	43107 ⁸	⊖

SUBURBAN 3/4 TON, K25 / K2500 STEERING STABILIZERS

		Front	Rear
92-97	Single System Steering Stabilizer	6807SE ⁸⁰
73-86	All	14017
	Dual System Steering Stabilizer	6802SE ⁸⁴
	Single System Steering Stabilizer	6804SE ⁸⁰
68-72	Dual System Steering Stabilizer	6802SE ⁸⁴
	Single System Steering Stabilizer	6803SE ⁸⁴

SUBURBAN 3/4 TON, R2500

87-91	All	⊖ G63355	61525 81039	58355 77355	34036 ⁸	⊖ G63349	61524 81164	58349 77349	43111 ⁸ 49155 ⁷
-------	-----	----------	----------------	----------------	------	--------------------	----------	----------------	----------------	------	--

SUBURBAN 3/4 TON, R2500 STEERING STABILIZERS

		Front	Rear
87-91	Single System Steering Stabilizer	6802SE ⁸⁴

SUBURBAN 3/4 TON, V2500

87-91	4" Lift Kit; Exc. Quad Suspension	⊖ G63437 ⁵⁰	58437 ⁵⁰	⊖ G63438 ⁵⁰	58438 ⁵⁰
	Exc. Lift Kit	⊖ G63347	43107 ⁸	⊖ G63349	61524 81164	58349 77349	43111 ⁸ 49155 ⁷

6 It is recommended that when replacing shocks on vehicles with "quad shocks" all 4 shocks should be matched by series.

8 Pair Packs.



80 Mounting bracket not required, install on O.E. Shock Mounts. See Ref. C for optional Steering Stabilizer Boots.

7 Pair Packs, air hose kit included.

50 Bellows Kit No.141242 is recommended for use to protect piston rod from potentially harmful road debris.

84 Replacement damper for vehicles with the Gabriel Aftermarket mounting kit

APPLICATION GUIDE

Year	Fitment Notes										
		Ultra	ProGuard\Guardian\Classic	Max Control\LTV	Strut Cushion\Strut Mount	HiJackers\Load Carrier	Ultra	ProGuard\Guardian\Classic	Max Control\LTV	Strut Cushion\Strut Mount	HiJackers\Load Carrier

GMC

GMC

SUBURBAN 3/4 TON, V2500 (cont)

87-91	Exc. Quad Suspension and Lift Kit	○	58347
	Quad Suspension Long Shock; Exc. Lift Kit	○	G63906 ⁶	61522 ⁶ 81496 ⁶	58906 ⁶
	Quad Suspension Short Shock; Exc. Lift Kit	○	G63908 ⁶	61516 81113 ⁶	58908 ⁶

SUBURBAN 3/4 TON, V2500 STEERING STABILIZERS

		Front	Rear
87-91	All	14017
	Dual System Steering Stabilizer	6802SE ⁸⁴
	Single System Steering Stabilizer	6804SE ⁸⁰

SYCLONE

91	All	○	G63423	61531 81516	58423 77423	○	G63422	61528 81482	58422 77422	43162 ⁶ 49213 ⁷
	Torsion Bar(FrontSpringType)	○	G63423	61531 81516	58423 77423	142316 ⁵³	○	G63422	61528 81482	58422 77422	43162 ⁶ 49213 ⁷

SYCLONE STEERING STABILIZERS

		Front	Rear
91	Single System Steering Stabilizer; with a factory mounting hole in the steering linkage.	6801SE ⁸⁰

TERRAIN

14-16	All	○	○	G64140
13	All	○	○	G64015	61718
12	Left	○	G52127	○	G64015	61718
	Right	○	G52128	○	G64015	61718
10-11	Left	○	G52127	143469 ⁶⁸	○	G64015	61718
	Right	○	G52128	143469 ⁶⁸	○	G64015	61718

TERRAIN READYMOUNTS

		Front		Rear	
		Ultra Readymount	Guardian Readymount	Ultra Readymount	Guardian Readymount
10-12	Left 19" Wheels	G57322 ⁴⁰
	Left Exc. 19" Wheels	G57197 ⁴⁰
	Right 19" Wheels	G57323 ⁴⁰
	Right Exc. 19" Wheels	G57198 ⁴⁰

TRACKER

89-91	All	○	○	81904
-------	-----	---	------	------	------	------	------	---	------	-------	------	------	------

TYPHOON

92-93	All	○	G63423	61531 81516	58423 77423	142316 ⁵³	○	G63422	61528 81482	58422 77422	43162 ⁶ 49213 ⁷
-------	-----	---	--------	----------------	----------------	----------------------	------	---	--------	----------------	----------------	------	--

TYPHOON STEERING STABILIZERS

		Front	Rear
92-93	Single System Steering Stabilizer; without a factory mounting hole in the steering linkage.	6851SE

VAN 1/2 TON, G / SAVANNA

12-14	AWD, Torsion Bar(FrontSpringType)	○	G63893	61683	○	G63896	58638	43180 ⁶ 49231 ⁷
08-14	All	○	○	G63896	58638	43180 ⁶ 49231 ⁷

6 It is recommended that when replacing shocks on vehicles with "quad shocks" all 4 shocks should be matched by series.

8 Pair Packs.

53 Strut Mount. Hardware from O.E. Part may need to be reused.

80 Mounting bracket not required, install on O.E. Shock Mounts. See Ref. C for optional Steering Stabilizer Boots.

7 Pair Packs, air hose kit included.

40 Complete Assembled Unit.

68 Strut Mount Kit. Hardware from O.E. Part may need to be reused.

84 Replacement damper for vehicles with the Gabriel Aftermarket mounting kit

APPLICATION GUIDE

Year	Fitment Notes										
		Ultra	ProGuard/ Guardian/ Classic	Max Control/ LTV	Strut Cushion/ Strut Mount	HiJackers/ Load Carrier	Ultra	ProGuard/ Guardian/ Classic	Max Control/ LTV	Strut Cushion/ Strut Mount	HiJackers/ Load Carrier

GMC

GMC

VAN 1/2 TON, G / SAVANNA (cont)

08-14	RWD		G63896	81789	77638 58638	43180 ⁸ 49231 ⁷
	RWD, Coil(FrontSpringType)	I E	G63894	61684	G63896	58638	43180 ⁸ 49231 ⁷
08-11	Exc. Upfitter Package and Cutaway Chassis		G63896	61565	58638	43180 ⁸ 49231 ⁷
	Upfitter Package and Cutaway Chassis		G63896	61686	58638	43180 ⁸ 49231 ⁷
	Torsion Bar (FrontSpringType)	I N	G63893	61683	G63896	58638	43180 ⁸ 49231 ⁷
07	All		G63896	43180 ⁸ 49231 ⁷
	Exc. Upfitter Package and Cutaway Chassis		G63896	61565	43180 ⁸ 49231 ⁷
	Upfitter Package and Cutaway Chassis		G63896	61686	43180 ⁸ 49231 ⁷
	RWD		G63896	81789	77638	43180 ⁸ 49231 ⁷
	RWD, Coil(FrontSpringType)	I E	G63894	61684	G63896	43180 ⁸ 49231 ⁷
	Torsion Bar (FrontSpringType)	I N	G63893	61683	G63896	43180 ⁸ 49231 ⁷
03-06	All		G63896	58638	43180 ⁸ 49231 ⁷
	Exc. Upfitter Package and Cutaway Chassis		G63896	61565	58638	43180 ⁸ 49231 ⁷
	Upfitter Package and Cutaway Chassis		G63896	61686	58638	43180 ⁸ 49231 ⁷
	RWD		G63896	81789	77638 58638	43180 ⁸ 49231 ⁷
	RWD, Coil(FrontSpringType)	I E	G63894	61684	G63896	58638	43180 ⁸ 49231 ⁷
	Torsion Bar (FrontSpringType)	I N	G63893	61683	G63896	58638	43180 ⁸ 49231 ⁷
96-02	All	I E	61555	G63896	61565	58638	43180 ⁸ 49231 ⁷
	RWD	I E	G63375 ⁵	81713 ⁵ 61555	77375	G63896	81789 61565	77638 58638	43180 ⁸ 49231 ⁷
78-95	All	O O	G63357	61517 81108	58357 77357	G63413	61522 81496	58413 77413	49212 ⁷
71-77	All	O O	G63357	61517 81108	58357 77357	G63306	82006	43093 ⁸ 49162 ⁷
70	All	O O	58357	G63306	82006	43093 ⁸ 49162 ⁷
	I-Beam Front Axle	O O	82062	58357	G63306	82006	43093 ⁸ 49162 ⁷
	Independent Front Suspension	O O	G63357	61517 81108	77357 58357	G63306	82006	43093 ⁸ 49162 ⁷
67-69	All	O O	82062	G63306	82006	43093 ⁸ 49162 ⁷
64-66	All	O O	82062	82003

VAN 1/2 TON, G / SAVANNA STEERING STABILIZERS

		Front	Rear
70-95	Single System Steering Stabilizer	6802SE ⁸⁴



VAN 1/2 TON, P SERIES

74-80	All		G63355	61525 81039	58355 77355	34036 ⁸		G63366	61649 81174	58366 77662
73	All	O O	G63355	61525 81039	58355 77355	34036 ⁸	O O	G63349	61524 81164	58349 77349	43111 ⁸ 49155 ⁷
68-72	All	O O	G63355	61525 81039	58355 77355	34036 ⁸	O O	82003	43062 ⁸
	Coil(RearSpringType)	O O	G63355	61525 81039	58355 77355	34036 ⁸	O O	82003	49107 ⁷ 43062 ⁸
67	All	O O	G63355	61525 81039	58355 77355	34036 ⁸	O O	G63306	82006	43093 ⁸ 49162 ⁷

5 Use kit No. 140719 to replace O.E. hardware for lower shock absorber mounting when studs break or self-tapping screws are not longer useable.
8 Pair Packs.

7 Pair Packs, air hose kit included.
84 Replacement damper for vehicles with the Gabriel Aftermarket mounting kit

APPLICATION GUIDE

Year	Fitment Notes										
		Ultra	ProGuard\Guardian\Classic	Max Control\LTV	Strut Cushion\Strut Mount	HiJackers\Load Carrier	Ultra	ProGuard\Guardian\Classic	Max Control\LTV	Strut Cushion\Strut Mount	HiJackers\Load Carrier

GMC

GMC

VAN 3/4 TON, G / SAVANNA

03-16	All	⊖	⊖	G63897	61687	77638
	Coil(FrontSpringType)	⊖	G63895	61685	G63897	61687	77638
03-12	Torsion Bar (FrontSpringType)	⊖	G63893	61683	G63897	61687	77638
96-02	Exc. 8600# GVW	⊖	G63375 ⁵	61555 81713 ⁵	77375	G63638	61565 81789	58638 77638	43180 ⁸ 49231 ⁷
78-95	Exc. 8600# GVW	⊖	G63357	61517 81108	58357 77357	G63413	61522 81496	58413 77413	49212 ⁷
71-77	All	⊖	G63357	61517 81108	58357 77357	G63306	82006	43093 ⁸ 49162 ⁷
70	All	⊖	G63306	82006	43093 ⁸ 49162 ⁷
	I-Beam Front Axle	⊖	82062	G63306	82006	43093 ⁸ 49162 ⁷
	Independent Front Suspension	⊖	G63357	61517 81108	58357 77357	G63306	82006	43093 ⁸ 49162 ⁷
67-69	All	⊖	82062	G63306	82006	43093 ⁸ 49162 ⁷

VAN 3/4 TON, G / SAVANNA STEERING STABILIZERS

		Front	Rear
70-95	Single System Steering Stabilizer	6802SE ⁸⁴

VAN 3/4 TON, P SERIES

79-89	All	⊖	G63355	61525 81039	58355 77355	34036 ⁸	⊖	G63366	61649 81174	58366
73-78	All	⊖	G63355	61525 81039	58355 77355	34036 ⁸	⊖	G63349	61524 81164	58349 77349	43111 ⁸ 49155 ⁷
68-72	All	⊖	G63355	61525 81039	58355 77355	34036 ⁸	⊖	G63306	82006	43093 ⁸ 49162 ⁷
67	All	⊖	82047	⊖

VAN 1 TON, G / SAVANNA



13-16	All	⊖	⊖	G63897	61687	77638
	Coil(FrontSpringType)	⊖	G63895	61685	G63897	61687	77638
04-12	All	⊖	⊖	77638
	Single Rear Wheels	⊖	⊖	G63897	61687	77638
	Torsion Bar (FrontSpringType)	⊖	G63893	⊖	77638
	Coil(FrontSpringType)	⊖	G63895	61685	⊖	77638
04-06	Dual Rear Wheels	⊖	⊖	G63898	61688	77638
03	Dual Rear Wheels	⊖	⊖	G63898	61688
	Single Rear Wheels	⊖	⊖	G63897	61687
	Torsion Bar (FrontSpringType)	⊖	G63893	⊖
	Coil(FrontSpringType)	⊖	G63895	61685	⊖
97-02	All	⊖	G63375 ⁵	61555 81713 ⁵	77375	⊖	81789	43180 ⁸ 49231 ⁷
	Exc. 8600# GVW	⊖	G63375 ⁵	61555 81713 ⁵	77375	⊖	G63638	61565 81789	58638 77638	43180 ⁸ 49231 ⁷
96	All	⊖	G63375 ⁵	61555 81713 ⁵	58357 77375	⊖	43180 ⁸ 49231 ⁷
	7100, 7400 and 8600# GVW	⊖	G63375 ⁵	61555 81713 ⁵	58357 77375	⊖	77638	43180 ⁸ 49231 ⁷
	Exc. 8600# GVW	⊖	G63375 ⁵	61555 81713 ⁵	58357 77375	⊖	G63638	61565	58638 77638	43180 ⁸ 49231 ⁷
	Cutaway Van	⊖	G63375 ⁵	61555 81713 ⁵	58357 77375	⊖	G63671	43180 ⁸ 49231 ⁷
	Cutaway Van 9200# GVW	⊖	G63375 ⁵	61555 81713 ⁵	58357 77375	⊖	G63403	43180 ⁸ 49231 ⁷

⁵ Use kit No. 140719 to replace O.E. hardware for lower shock absorber mounting when studs break or self-tapping screws are not longer useable.

⁷ Pair Packs, air hose kit included.

⁸⁴ Replacement damper for vehicles with the Gabriel Aftermarket mounting kit

APPLICATION GUIDE

Year	Fitment Notes										
		Ultra	ProGuard\ Guardian\ Classic	Max Control\ LTV	Strut Cushion\ Strut Mount	HiJackers\ Load Carrier	Ultra	ProGuard\ Guardian\ Classic	Max Control\ LTV	Strut Cushion\ Strut Mount	HiJackers\ Load Carrier

GMC

GMC

VAN 1 TON, G / SAVANNA (cont)

96	Exc. Cutaway Van	⊕	G63375 ⁵	61555 81713 ⁵	58357 77375	⊕	G63413	61522 ⁶ 81496	58413	43180 ⁸ 49231 ⁷
93-95	Cutaway Van 9200# GVW	⊕	G63357	61517 81108	58357 77357	⊕	G63403	77403
92-95	Cutaway Van	⊕	G63357	61517 81108	58357 77357	⊕	G63671	58403
79-95	Exc. Cutaway Van	⊕	G63357	61517 81108	58357 77357	⊕	G63413	61522 ⁶ 81496	58413	49212 ⁷
78-95	All	⊕	G63357	61517 81108	58357 77357	⊕
92	Cutaway Van 9200# GVW	⊕	G63357	61517 81108	58357 77357	⊕	77403
79-91	Cutaway Van	⊕	G63357	61517 81108	58357 77357	⊕	58403
	Cutaway Van 9200# GVW	⊕	G63357	61517 81108	58357 77357	⊕	G63403	77403
78	Cutaway Van	⊕	G63357	61517 81108	58357 77357	⊕	G63413	61522 ⁶ 81496	58413	49212 ⁷
76-77	All	⊕	G63357	61517 81108	58357 77357	⊕	G63306	82006	43093 ⁸ 49162 ⁷
75	All	⊕	77357	⊕
	110.0(WheelBase)	⊕	61517	58357 77357	⊕	G63306	82006	43093 ⁸ 49162 ⁷
	125.0(WheelBase)	⊕	61517	58357 77357	⊕	G63306	82006	43093 ⁸ 49162 ⁷
	146.0(WheelBase)	⊕	G63357	81108	77357	⊕
71-74	All	⊕	G63357	61517 81108	58357 77357	⊕	G63306	82006
	Exc. 146" Wheelbase	⊕	G63357	61517 81108	58357 77357	⊕	G63306	82006	43093 ⁸ 49162 ⁷

VAN 1 TON, G / SAVANNA STEERING STABILIZERS

		Front	Rear
94-95	Single System Steering Stabilizer; HD with Straight Front Axle & Tilt Hood	6804SE ⁸⁰
71-95	Single System Steering Stabilizer	6802SE ⁸⁴

VAN 1 TON, P SERIES

86-99	Motorhome Chassis with I-Beam Front Suspension	⊕	G63625	⊕	G63366	61649 81174	58366 77662
85-99	Motorhome Chassis with Independent Front Suspension	⊕	G63394	58394	⊕	G63366	61649 81174	58366 77662
75-99	All	⊕	⊕	G63366	61649 81174	58366 77662
75-90	Cutaway Chassis	⊕	G63355	61525 81039	58355 77355	34036 ⁸	⊕	G63366	61649 81174	58366 77662
85	Motorhome Chassis with I-Beam Front Suspension	⊕	G63403	58403 77403	⊕	G63366	61649 81174	58366 77662
75-84	Motorhome Chassis	⊕	G63394	58394	⊕	G63366	61649 81174	58366 77662
74	All	⊕	⊕	G63366	61649 81174	58366
	Cutaway Chassis	⊕	58355	34036 ⁸	⊕	G63366	61649 81174	58366
	Base, Cutaway Chassis	⊕	G63355	61525 81039	77355	⊕	G63366	61649 81174	77662 58366
	Motor Home	⊕	G63394	⊕	G63366	61649 81174	77662 58366
	Motor Home, Motorhome Chassis	⊕	58394	⊕	G63366	61649 81174	58366
73	All	⊕	⊕	G63366	61649
	Base, Cutaway Chassis	⊕	G63355	61525 81039	58355 77355	34036 ⁸	⊕	G63366	81174 61649	58366 77662
68-72	All	⊕	G63355	61525 81039	58355 77355	34036 ⁸	⊕

5 Use kit No. 140719 to replace O.E. hardware for lower shock absorber mounting when studs break or self-tapping screws are not longer useable.

7 Pair Packs, air hose kit included.



80 Mounting bracket not required, install on O.E. Shock Mounts. See Ref. C for optional Steering Stabilizer Boots.

6 It is recommended that when replacing shocks on vehicles with "quad shocks" all 4 shocks should be matched by series.

8 Pair Packs.

84 Replacement damper for vehicles with the Gabriel Aftermarket mounting kit

APPLICATION GUIDE

Year	Fitment Notes										
		Ultra	ProGuard\ Guardian\ Classic	Max Control\ LTV	Strut Cushion\ Strut Mount	HiJackers\ Load Carrier	Ultra	ProGuard\ Guardian\ Classic	Max Control\ LTV	Strut Cushion\ Strut Mount	HiJackers\ Load Carrier

GMC

GMC

VAN 1 TON, P SERIES (cont)

68-72	Exc. 11,000# Rear Axle	⊙	G63355	61525 81039	58355 77355	34036 ⁸	⊙	G63306	82006	43093 ⁸ 49162 ⁷
67	All	⊙	82047	⊙

VAN 1 TON, P SERIES STEERING STABILIZERS

		Front		Rear	
79-93	Step Van Forward Control & Motorhome	6805SE ⁸⁰		
75-78	Motorhome Chassis	6805SE ⁸⁰		

VAN, PB 1000 SERIES

63-65	All	⊙	G63355	61525 81039	58355 77355	34036 ⁸	⊙	G63306	82006	43093 ⁸ 49162 ⁷
-------	-----	---	--------	----------------	----------------	------	--------------------	---	--------	-------	------	------	--

YUKON

15	All	⊙	G51960	⊙	G64107
12-14	All	⊙	⊙	G64101	77975
	Exc. Electronic Adjustable Suspension	⊙	143316 ⁵³	⊙	G64101	77975
	Exc. Z55 or ZW7 Ride Suspension	⊙	G51891	⊙	G64101	77975
07-11	All	⊙	M51891	⊙
	Exc. Electronic Adjustable Suspension	⊙	M51891	143316 ⁵³	⊙
	Exc. Z55 or ZW7 Ride Suspension	⊙	G51891	M51891	⊙	G63866	61675 81930	58930 77953
00-06	Exc. Z55 Auto Ride Suspension	⊙	G63803	61643 81922	58803 77803	⊙	G63866	61675 81930	58930 77953
00	Denali	⊙	⊙	G63896
92-99	All	⊙	⊙	G63896	61565 81789	58638 77638	43180 ⁸ 49231 ⁷
	4WD	⊙	G63609	61542 81726	58901 77609	⊙	G63896	61565 81789	58638 77638	43180 ⁸ 49231 ⁷
	RWD	⊙	G63489	61544 81668	58489 77489	⊙	G63896	61565 81789	58638 77638	43180 ⁸ 49231 ⁷

YUKON READYMOUNTS

		Front		Rear	
		Ultra Readymount	Guardian Readymount	Ultra Readymount	Guardian Readymount
12-13	Exc. Z55 or ZW7 Ride Suspension	G57125 ⁴⁰	
07-11	All		M57125⁴⁰
	Exc. Z55 or ZW7 Ride Suspension	G57125 ⁴⁰		M57125⁴⁰

YUKON STEERING STABILIZERS

		Front	Rear
99-05	4WD	6853SE ⁸²
95-99	RWD	6852SE ⁸²

YUKON XL

15	All	⊙	G51960	⊙	G64107
----	-----	---	--------	------	------	------	------	---	--------	------	------	------	------

YUKON XL 1/2 TON

12-14	All	⊙	⊙	G64101
	Exc. Z55 Auto Ride Suspension	⊙	143316 ⁵³	⊙	G64101
	Exc. Z55 or ZW7 Ride Suspension	⊙	G51891	⊙	G64101

7 Pair Packs, air hose kit included.

40 Complete Assembled Unit.



80 Mounting bracket not required, install on O.E. Shock Mounts. See Ref. C for optional Steering Stabilizer Boots.

8 Pair Packs.

53 Strut Mount. Hardware from O.E. Part may need to be reused.

82 Use kit if listed, See Ref. C for optional Steering Stabilizer Boots.

APPLICATION GUIDE

Year	Fitment Notes										
		Ultra	ProGuard/ Guardian/ Classic	Max Control/ LTV	Strut Cushion/ Strut Mount	HiJackers/ Load Carrier	Ultra	ProGuard/ Guardian/ Classic	Max Control/ LTV	Strut Cushion/ Strut Mount	HiJackers/ Load Carrier

GMC

GMC

YUKON XL 1/2 TON (cont)

07-11	All	↓	M51891
	Exc. Z55 Auto Ride Suspension	↓	M51891	143316 ⁵³
	Exc. Z55 or ZW7 Ride Suspension	↓	G51891	M51891
00-06	Exc. Z55 Auto Ride Suspension	↓	G63803	61643 81922	58803 77803

YUKON XL 1/2 TON READYMOUNTS

		Front		Rear	
		Ultra Readymount	Guardian Readymount	Ultra Readymount	Guardian Readymount
12-14	Exc. Z55 or ZW7 Ride Suspension	G57125 ⁴⁰	
07-11	All	M57125⁴⁰
	Exc. Z55 or ZW7 Ride Suspension	G57125 ⁴⁰		M57125⁴⁰

YUKON XL 3/4 TON

07-11	All	↓	M51891
	Exc. Z55 Auto Ride Suspension and Quadrateer	↓	M51891
00-06	Exc. Hydraulic Self Leveling System	↓	G63817	61663 81925	58817 77817
	Exc. Z55 Auto Ride Suspension	↓	81922
	Exc. Z55 Auto Ride Suspension and Quadrateer	↓

YUKON XL 3/4 TON READYMOUNTS

		Front		Rear	
		Ultra Readymount	Guardian Readymount	Ultra Readymount	Guardian Readymount
07-11	All	M57125⁴⁰

HONDA

HONDA

ACCORD

13-17	All	↓	G51892
	Sedan Left	↓	G52428	G51892
	Sedan Right	↓	G52429	G51892
08-12	Left	↓	G51877	G51892
	Right	↓	G51878	G51892
03-12	Exc. Hybrid	↓	142230 ⁵³	142230 ⁵³
03-07	Exc. Hybrid Models	↓	G51737	M51737	G51738	M51738
98-02	All	↓	G55870	M55870	142230 ⁵³ 143064 ⁵¹	G55871	M55871	142230 ⁵³ 142300 ⁵⁷ 143063 ⁵¹
94-97	All	↓	G55877	M55877	142230 ⁵³ 143064 ⁵¹	G55786	M55786	142231 ⁵³ 143063 ⁵¹
90-93	All	↓	G55774	M55774	142230 ⁵³ 143064 ⁵¹	G55786	M55786	142231 ⁵³ 143063 ⁵¹
86-89	All	↓	G55742	142230 ⁵³	G55743	142231 ⁵³ 143064 ⁵¹
82-85	All	↓	G55515	G55516	142231 ⁵³ 143059 ⁵¹

40 Complete Assembled Unit.



53 Strut Mount. Hardware from O.E. Part may need to be reused.

Bold Type - New / Future Part

51 Strut Cushion for use with the Strut/Cartridge/Shocks.

67 Strut Mount Kit. Hardware from O.E. Part may need to be reused.

APPLICATION GUIDE

Year	Fitment Notes										
		Ultra	ProGuard\ Guardian\ Classic	Max Control\ LTV	Strut Cushion\ Strut Mount	HiJackers\ Load Carrier	Ultra	ProGuard\ Guardian\ Classic	Max Control\ LTV	Strut Cushion\ Strut Mount	HiJackers\ Load Carrier

HONDA

HONDA

ACCORD (cont)

79-81	All	143059 ⁵¹	142231 ⁵³
76-78	All	143059 ⁵¹

ACCORD CROSSTOUR READYMOUNTS

		Front		Rear	
		Ultra Readymount	Guardian Readymount	Ultra Readymount	Guardian Readymount
10-11	All	G57419 ⁴⁰

ACCORD READYMOUNTS

		Front		Rear	
		Ultra Readymount	Guardian Readymount	Ultra Readymount	Guardian Readymount
08-12	All	G57419 ⁴⁰
	4 Cy Left	M57207 ⁴⁰	G57419 ⁴⁰
	4 Cy Right	M57208 ⁴⁰	G57419 ⁴⁰
	Automatic Left	G57207 ⁴⁰	G57419 ⁴⁰
	Automatic Right	G57208 ⁴⁰	G57419 ⁴⁰
	Standard Left	G57417 ⁴⁰	G57419 ⁴⁰
	Standard Right	G57418 ⁴⁰	G57419 ⁴⁰
03-07	Exc. Hybrid Models Left	G57054 ⁴⁰	M57054 ⁴⁰	G57056 ⁴⁰	M57056 ⁴⁰
	Exc. Hybrid Models Right	G57055 ⁴⁰	M57055 ⁴⁰	G57056 ⁴⁰	M57056 ⁴⁰
98-02	All	G57284 ⁴⁰	G56943 ⁴⁰	M56943 ⁴⁰
	Left	G56991 ⁴⁰	M56991 ⁴⁰	G56943 ⁴⁰	M56943 ⁴⁰
	Right	G56992 ⁴⁰	M56992 ⁴⁰	G56943 ⁴⁰	M56943 ⁴⁰
94-97	Left	G56961 ⁴⁰	M56961 ⁴⁰	G56968 ⁴⁰	M56968 ⁴⁰
	Right	G56961 ⁴⁰	M56961 ⁴⁰	G56969 ⁴⁰	M56969 ⁴⁰
90-93	Left	G56981 ⁴⁰	M56981 ⁴⁰	G56968 ⁴⁰	M56968 ⁴⁰
	Right	G56981 ⁴⁰	M56981 ⁴⁰	G56969 ⁴⁰	M56969 ⁴⁰

CITY

10-12	Left	G52152	G51905
	Right	G52153	G51905

CIVIC

14-15	All	143528 ⁶⁸
12-13	All	143528 ⁶⁸	143530 ⁶⁷
06-11	All	143497 ⁶⁸	G51807	143498 ⁶⁸
	Exc. SI and GX Left	G52038	143497 ⁶⁸	G51807	143498 ⁶⁸
	Exc. SI and GX Right	G52039	143497 ⁶⁸	G51807	143498 ⁶⁸
03-05	All	M52810	142230 ⁵³
	Base and Type-S	143353 ⁵⁴	M52810	142230 ⁵³
	Coupe & Sedan Models Exc. Hybrid Left	G56677	M56677	143233 ⁶⁰	M52810	142230 ⁵³
	Coupe & Sedan Models Exc. Hybrid Right	G56678	M56678	143265 ⁶⁰	M52810	142230 ⁵³
	Exc. Hybrid Models	G51716	M52810	142230 ⁵³

40 Complete Assembled Unit.

53 Strut Mount. Hardware from O.E. Part may need to be reused.

60 Strut Mount Contains a Metal Bearing. Hardware from O.E. Part may need to be reused.



68 Strut Mount Kit. Hardware from O.E. Part may need to be reused.

51 Strut Cushion for use with the Strut/Cartridge/Shocks.

54 Kit with Mount and Bearing. Hardware from O.E. Part may need to be reused.

67 Strut Mount Kit. Hardware from O.E. Part may need to be reused.

APPLICATION GUIDE

Year	Fitment Notes										
		Ultra	ProGuard/ Guardian/ Classic	Max Control/ LTV	Strut Cushion/ Strut Mount	HiJackers/ Load Carrier	Ultra	ProGuard/ Guardian/ Classic	Max Control/ LTV	Strut Cushion/ Strut Mount	HiJackers/ Load Carrier

HONDA

HONDA

CIVIC (cont)

03-05	Hybrid, Left	G56621	M56621	M52810	142230 ⁵³
	Hybrid, Right	G56622	M56622	M52810	142230 ⁵³
02	All	G51700	M51700	142230 ⁵³
	Base and Type-S	143353 ⁵⁴	G51700	M51700	142230 ⁵³
	Coupe & Sedan Models Exc. Hybrid Left	143233 ⁶⁰	G51700	M51700	142230 ⁵³
	Coupe & Sedan Models Exc. Hybrid Right	143265 ⁶⁰	G51700	M51700	142230 ⁵³
	Exc. Hatchback Left	G56621	M56621	G51700	M51700	142230 ⁵³
	Exc. Hatchback Right	G56622	M56622	G51700	M51700	142230 ⁵³
01	Left	G56621	M56621	G51700	M51700	142230 ⁵³
	Right	G56622	M56622	G51700	M51700	142230 ⁵³
	Base and Type-S	143353 ⁵⁴
96-00	All	G55909	M55909	142230 ⁵³	G55910	M55910	142230 ⁵³ 143064 ⁵¹
92-95	All	G55802 ⁴⁶	M55802⁴⁶	142230 ⁵³	G55803	M55803	142230 ⁵³ 142300 ⁶⁷ 143064 ⁵¹
89-91	All	142230 ⁵³	142230 ⁵³ 142300 ⁶⁷
	Hatchback	G55773	142230 ⁵³	G55771	143064 ⁵¹ 142230 ⁵³ 142300 ⁶⁷
	Sedan	G55773	142230 ⁵³	G55771	143064 ⁵¹ 142230 ⁵³ 142300 ⁶⁷
	Wagon	G55781	142230 ⁵³	G55782	142230 ⁵³ 142300 ⁶⁷
88	Hatchback	G55763	142230 ⁵³	G55766	142230 ⁵³
	Sedan	G55763	142230 ⁵³	G55766	142230 ⁵³
85-87	All	142231 ⁵³
	4WD, Wagon	G55728	143057 ⁵¹	142231 ⁵³
84-87	FWD, Wagon	G55732	G51170	142231 ⁵³
	Hatchback	G55725	G51170	142231 ⁵³
	Sedan	G55725	G51170	142231 ⁵³
84	All	G51170	142231 ⁵³
80-83	All	G55706	142231 ⁵³
	Exc. Wagon	G55706	G55707	142231 ⁵³

46 Upper Mount orientation may be required.

53 Strut Mount. Hardware from O.E. Part may need to be reused.

60 Strut Mount Contains a Metal Bearing. Hardware from O.E. Part may need to be reused.



Bold Type - New / Future Part

51 Strut Cushion for use with the Strut/Cartridge/Shocks.

54 Kit with Mount and Bearing. Hardware from O.E. Part may need to be reused.

67 Strut Mount Kit. Hardware from O.E. Part may need to be reused.



APPLICATION GUIDE

Year	Fitment Notes										
		Ultra	ProGuard\ Guardian\ Classic	Max Control\ LTV	Strut Cushion\ Strut Mount	HiJackers\ Load Carrier	Ultra	ProGuard\ Guardian\ Classic	Max Control\ LTV	Strut Cushion\ Strut Mount	HiJackers\ Load Carrier



HONDA

HONDA

CIVIC (cont)

80-83	Wagon	 G55706	 69884	142231 ⁵³
75-79	Wagon	 69884























CIVIC DEL SOL

93-97	All	 G55802 ⁴⁶	M55802⁴⁶	142230 ⁵³	 G55803	M55803	142230 ⁵³ 142300 ⁶⁷ 143064 ⁵¹
-------	-----	--	----------------------------	------	----------------------	------	--	--------	------	--	------

CIVIC READYMOUNTS

		Front		Rear	
		Ultra Readymount	Guardian Readymount	Ultra Readymount	Guardian Readymount
06-11	Left	G57390⁴⁰
	Right	G57391⁴⁰
03-05	Hybrid, Si, Left	G57521⁴⁰
	Hybrid, Si, Right	G57522⁴⁰
01-05	Coupe & Sedan Models Left	G57049 ⁴⁰	M57049⁴⁰
	Coupe & Sedan Models Right	G57050 ⁴⁰	M57050⁴⁰
05	Left	G57390⁴⁰	G57061 ⁴⁰
	Right	G57391⁴⁰	G57062 ⁴⁰
03-04	Left	G57061 ⁴⁰
	Right	G57062 ⁴⁰
01-02	Left	G57032 ⁴⁰	M57033⁴⁰
	Right	G57033 ⁴⁰	M57032⁴⁰
96-00	Left	G56996 ⁴⁰	M56996⁴⁰	G56998 ⁴⁰	M56998⁴⁰
	Right	G56997 ⁴⁰	M56997⁴⁰	G56998 ⁴⁰	M56998⁴⁰
92-95	Left	G56993 ⁴⁰	M56993⁴⁰	G56995 ⁴⁰	M56995⁴⁰
	Right	G56994 ⁴⁰	M56994⁴⁰	G56995 ⁴⁰	M56995⁴⁰

CR-V

15-16	All	 G51972
13-14	Left	 G52187	 G51972²
	Right	 G52188	 G51972²
12	Left	 G52187	 G51972	142230 ⁵³
	Right	 G52188	 G51972	142230 ⁵³
07-11	Left	 G52187	 G51879	142230 ⁵³
	Right	 G52188	 G51879	142230 ⁵³
03-06	Left	 G56800	 G51286	142230 ⁵³
	Right	 G56799	 G51286	142230 ⁵³
02-06	Automatic Left		M52820
	Automatic Right		M52821
	Base and Type-S		143353 ⁵⁴
02	Left	 G56800	 G51286

2 Future Part, available 2nd Quarter of 2017.

46 Upper Mount orientation may be required.

53 Strut Mount. Hardware from O.E. Part may need to be reused.





67 Strut Mount Kit. Hardware from O.E. Part may need to be reused.

40 Complete Assembled Unit.

51 Strut Cushion for use with the Strut/Cartridge/Shocks.

54 Kit with Mount and Bearing. Hardware from O.E. Part may need to be reused.





APPLICATION GUIDE

Year	Fitment Notes										
		 Ultra	ProGuard\ Guardian\ Classic	Max Control\ LTV	Strut Cushion\ Strut Mount	HiJackers\ Load Carrier	 Ultra	ProGuard\ Guardian\ Classic	Max Control\ LTV	Strut Cushion\ Strut Mount	HiJackers\ Load Carrier

HONDA

HONDA

CR-V (cont)

02	Right	 G56799	 G51286
97-01	All	 G51255	142230 ⁵³ 143064 ⁵¹	 G51256	142230 ⁵³ 143064 ⁵¹





CR-V READYMOUNTS

		Front		Rear	
		Ultra Readymount	Guardian Readymount	Ultra Readymount	Guardian Readymount
12-14	AWD, Left	G57601 ⁴⁰	G57599 ⁴⁰
	AWD, Right	G57602 ⁴⁰	G57600 ⁴⁰
	FWD, Left	G57479 ⁴⁰	G57597 ⁴⁰
	FWD, Right	G57480 ⁴⁰	G57598 ⁴⁰
07-11	Left	G57331 ⁴⁰	G57416 ⁴⁰
	Right	G57332 ⁴⁰	G57416 ⁴⁰
02-06	Left	G57086 ⁴⁰	M57086 ⁴⁰
	Right	G57087 ⁴⁰	M57087 ⁴⁰
	Automatic Left	G57084 ⁴⁰
	Automatic Right	G57085 ⁴⁰
97-01	Left	G57116 ⁴⁰	M57315 ⁴⁰	G57104 ⁴⁰ G57313 ⁴⁰
	Right	G57117 ⁴⁰	M57316 ⁴⁰	G57104 ⁴⁰ G57313 ⁴⁰







CR-Z

11-14	All	 G511037 ²
-------	-----	------	------	------	------	------	--	------	------	------	------

CRX

89-91	All	 G55787	142230 ⁵³ 143064 ⁵¹	 G55803	M55803	142230 ⁵³
88	All	 G55763	142230 ⁵³	 G55766	142230 ⁵³ 143064 ⁵¹







ELEMENT

03-11	All	 G51858	142230 ⁵³
	Exc. SC Model Left	 G52112	 G51858	142230 ⁵³
	Exc. SC Model Right	 G52113	 G51858	142230 ⁵³
03-06	Base and Type-S		143353 ⁵⁴	 G51858	142230 ⁵³

ELEMENT READYMOUNTS

		Front		Rear	
		Ultra Readymount	Guardian Readymount	Ultra Readymount	Guardian Readymount
07-11	Left	G57424 ⁴⁰
	Right	G57425 ⁴⁰
03-06	Left	G57222 ⁴⁰	G57424 ⁴⁰
	Right	G57223 ⁴⁰	G57425 ⁴⁰

FIT

15-16	Exc. EV Left	 G52152
	Exc. EV Right	 G52153
09-14	Exc. EV Left	 G52152	 G51905
	Exc. EV Right	 G52153	 G51905

2 Future Part, available 2nd Quarter of 2017.

51 Strut Cushion for use with the Strut/Cartridge/Shocks.



54 Kit with Mount and Bearing. Hardware from O.E. Part may need to be reused.

Bold Type - New / Future Part

40 Complete Assembled Unit.

53 Strut Mount. Hardware from O.E. Part may need to be reused.

























APPLICATION GUIDE

Year	Fitment Notes										
		Ultra	ProGuard\Guardian\Classic	Max Control\LTV	Strut Cushion\Strut Mount	HiJackers\Load Carrier	Ultra	ProGuard\Guardian\Classic	Max Control\LTV	Strut Cushion\Strut Mount	HiJackers\Load Carrier

HONDA

HONDA

























FIT (cont)

07-08	All	 70060  G511062²
	CAN Left	 G52282	 70060  G511062²
	CAN Right	 G52283	 70060  G511062²
	MEX Left	 G52588	 70060  G511062²
	MEX Right	 G52589	 70060  G511062²
	USA Left	 G52282	 70060  G511062²
	USA Right	 G52283	 70060  G511062²
06	All	 G511062²
	MEX Left	 G52588	 G511062²
	MEX Right	 G52589	 G511062²

FIT READYMOUNTS

		Front		Rear	
		Ultra Readymount	Guardian Readymount	Ultra Readymount	Guardian Readymount
09-13	Left	G57603⁴⁰
	Right	G57604⁴⁰
06-08	Left	G57541⁴⁰
	Right	G57542⁴⁰

ODYSSEY

17	From Chassis/VIN CB088499		143305	
12-16	From Chassis/VIN CB088499		143305 ⁵⁴	
08-10	Left	 G52253	143305 ⁵⁴	 70010 
	Right	 G52254	143305 ⁵⁴	 70010 
05-07	Left	 G52030	143305 ⁵⁴	 70010 
	Right	 G52031	143305 ⁵⁴	 70010 
99-04	Left	 G56559	M56559	143061 ⁵¹ 143315 ⁵⁴	 69909 
	Right	 G56558	M56558	143061 ⁵¹ 143315 ⁵⁴	 69909 
95-98	All	 G55877	M55877	142230 ⁵³ 143064 ⁵¹	 G55821 	142230 ⁵³ 143063 ⁵¹

ODYSSEY READYMOUNTS

		Front		Rear	
		Ultra Readymount	Guardian Readymount	Ultra Readymount	Guardian Readymount
08-10	Left	G57564⁴⁰
	Right	G57565⁴⁰
05-07	Left	G57137 ⁴⁰	M57137⁴⁰
	Right	G57138 ⁴⁰	M57138⁴⁰
99-04	Left	G57011 ⁴⁰	M57011⁴⁰
	Right	G57012 ⁴⁰	M57012⁴⁰
95-98	All	G57557⁴⁰

2 Future Part, available 2nd Quarter of 2017.



51 Strut Cushion for use with the Strut/Cartridge/Shocks.

54 Kit with Mount and Bearing. Hardware from O.E. Part may need to be reused.

40 Complete Assembled Unit.

53 Strut Mount. Hardware from O.E. Part may need to be reused.

APPLICATION GUIDE

Year	Fitment Notes										
		Ultra	ProGuard\Guardian\Classic	Max Control\LTV	Strut Cushion\Strut Mount	HiJackers\Load Carrier	Ultra	ProGuard\Guardian\Classic	Max Control\LTV	Strut Cushion\Strut Mount	HiJackers\Load Carrier

HONDA

HONDA

PASSPORT

98-02	All	↓	G63611	61593 81872	↓	G63710	61610 81911
94-97	All	↓	G63611	61593 81872	↓	G63610	61592 81937

PILOT

09-15	Left	↓	G52360	↓
	Right	↓	G52361	↓
03-08	Left	↓	G56759	143315 ⁵⁴	↓	G64003	61704
	Right	↓	G56758	143315 ⁵⁴	↓	G64003	61704
	AWD, Left	↓	M56759	↓
	AWD, Right	↓	M56758	↓

PILOT READYMOUNTS

		Front		Rear	
		Ultra Readymount	Guardian Readymount	Ultra Readymount	Guardian Readymount
06-08	AWD, Left	G57119 ⁴⁰	M57119 ⁴⁰
	FWD, Right	G57606 ⁴⁰
03-08	AWD, Right	G57120 ⁴⁰	M57120 ⁴⁰
03-05	AWD, Left	G57119 ⁴⁰	M57119 ⁴⁰

PRELUDE

97-01	All	↓	G51264	142230 ⁵³ 143064 ⁵¹	↓	G55805	142231 ⁵³ 143064 ⁵¹
92-96	All	↓	G55795	142230 ⁵³ 143064 ⁵¹	↓	G55805	142231 ⁵³ 143064 ⁵¹
88-91	All	↓	G55742	142230 ⁵³ 143064 ⁵¹	↓	G55757
83-87	All	↓	142230 ⁵³ 143059 ⁵¹	↓	142231 ⁵³ 143059 ⁵¹
	Sealed Rear Struts	↓	142230 ⁵³ 143059 ⁵¹	↓	G55516	142231 ⁵³ 143059 ⁵¹
79-82	All	↓	143059 ⁵¹	↓	142231 ⁵³

RIDGELINE

13-14	Left	↓	G52150	↓	G51880	142230
	Right	↓	G52151	↓	G51880	142230
06-12	Left	↓	G52150	↓	G51880	142230 ⁵³
	Right	↓	G52151	↓	G51880	142230 ⁵³

RIDGELINE READYMOUNTS

		Front		Rear	
		Ultra Readymount	Guardian Readymount	Ultra Readymount	Guardian Readymount
06-14	Left	G57333 ⁴⁰	G57414 ⁴⁰
	Right	G57334 ⁴⁰	G57415 ⁴⁰

S2000



08-09	All	↓	↓	142230 ⁵³
-------	-----	---	------	------	------	------	------	---	------	------	------	----------------------	------

40 Complete Assembled Unit.
53 Strut Mount. Hardware from O.E. Part may need to be reused.

Bold Type - New / Future Part

51 Strut Cushion for use with the Strut/Cartridge/Shocks.
54 Kit with Mount and Bearing. Hardware from O.E. Part may need to be reused.

APPLICATION GUIDE

Year	Fitment Notes										
		Ultra	ProGuard\ Guardian\ Classic	Max Control\ LTV	Strut Cushion\ Strut Mount	HiJackers\ Load Carrier	Ultra	ProGuard\ Guardian\ Classic	Max Control\ LTV	Strut Cushion\ Strut Mount	HiJackers\ Load Carrier

HONDA

HONDA

S2000 (cont)

00-07	All	142230 ⁵³	142230 ⁵³
-------	-----	-------	-------	-------	----------------------	-------	-------	-------	-------	----------------------	-------

HUMMER

HUMMER

H2

03-09	All	G63817	61663	77817	G64000
-------	-----	--------	-------	-------	-------	-------	--------	-------	-------	-------	-------

H3

06-10	All	G64001	G63965
	w/Off Road package	G64001	G63965	77983

HYUNDAI

HYUNDAI

ACCENT

14-16	Left	G52353	G70095
	Right	G52354	G70095
06-11	Left	G52154	143409⁵⁴	G70036	142419 ⁶⁸	143411⁶⁸
	Right	G52155	143410⁵⁴	G70036	142419 ⁶⁸	143411⁶⁸
00-05	All	G56522	142935 ⁵³	143059 ⁵¹	142626 ⁵³	143060 ⁵¹
	Left Gas Charged Unit	G56522	142935 ⁵³	143059 ⁵¹	G52333	142626 ⁵³	143060 ⁵¹
	Left Non-Gas Charged Unit	G56522	142935 ⁵³	143059 ⁵¹	G56524 ⁴⁴	142626 ⁵³	143060 ⁵¹
	Right Gas Charged Unit	G56522	142935 ⁵³	143059 ⁵¹	G52334	142626 ⁵³	143060 ⁵¹
	Right Non-Gas Charged Unit	G56522	142935 ⁵³	143059 ⁵¹	G56523 ⁴⁴	142626 ⁵³	143060 ⁵¹
98-99	All	G55849	143059 ⁵¹	142626 ⁵³	143060 ⁵¹
	Left Gas Charged Unit	G55849	143059 ⁵¹	G52333	142626 ⁵³	143060 ⁵¹
	Right Gas Charged Unit	G55849	143059 ⁵¹	G52334	142626 ⁵³	143060 ⁵¹
	Mfg. from 6/97; Non Gas Charged Unit	G55849	143059 ⁵¹	G55890	142626 ⁵³	143060 ⁵¹
97	All	G55849	142626 ⁵³
	Left Gas Charged Unit	G55849	G52333	142626 ⁵³
	Mfg. from 6/97	G55849	143060 ⁵¹	142626 ⁵³
	Mfg. to 6/97	G55849	G55850	143059 ⁵¹	142626 ⁵³
	Right Gas Charged Unit	G55849	G52334	142626 ⁵³
	Mfg. from 6/97; Non Gas Charged Unit	G55849	G55890	142626 ⁵³
95-96	All	G55849	143059 ⁵¹	G55850	142626 ⁵³	143059 ⁵¹

44 This strut is not gas pressurized therefore the piston rod will not extend without assistance.



53 Strut Mount. Hardware from O.E. Part may need to be reused.

68 Strut Mount Kit. Hardware from O.E. Part may need to be reused.

51 Strut Cushion for use with the Strut/Cartridge/Shocks.

54 Kit with Mount and Bearing. Hardware from O.E. Part may need to be reused.

APPLICATION GUIDE

Year	Fitment Notes										
		Ultra	ProGuard\ Guardian\ Classic	Max Control\ LTV	Strut Cushion\ Strut Mount	HiJackers\ Load Carrier	Ultra	ProGuard\ Guardian\ Classic	Max Control\ LTV	Strut Cushion\ Strut Mount	HiJackers\ Load Carrier

HYUNDAI

HYUNDAI

ACCENT READYMOUNTS		Front		Rear	
		Ultra Readymount	Guardian Readymount	Ultra Readymount	Guardian Readymount
06-11	Left	G57275 ⁴⁰
	Right	G57276 ⁴⁰
00-05	Left	G57268 ⁴⁰	G57278 ⁴⁰
	Right	G57269 ⁴⁰	G57279 ⁴⁰

AZERA

14-15	Left	G52437
	Right	G52438
12-13	Left	G52437	70068
	Right	G52438	70068
11	All	143342 ⁶⁸	70013
06-10	All	G51806	143342 ⁶⁸	70013	143386 ⁵³

AZERA READYMOUNTS		Front		Rear	
		Ultra Readymount	Guardian Readymount	Ultra Readymount	Guardian Readymount
06-11	All	G57149 ⁴⁰

ELANTRA

14-16	All	70098
12-13	Exc. 16 & 17 inch Wheels	70098
	Left	G52439
	Right	G52440
11	All	143477 ⁶⁸
	Exc. 16 & 17 inch Wheels	143477 ⁶⁸	70098
07-10	Left	G52156	143477 ⁶⁸	70037
	Right	G52157	143477 ⁶⁸	70037
01-06	Left	G56539	M56539	142625 ⁵³	G56640	M56640	142535 ⁵³
	Right	G56540	M56540	142625 ⁵³	G56641	M56641	142536 ⁵³
96-00	All	142625 ⁵³
	Left Gas Charged Unit	142625 ⁵³	G52335
	Right Gas Charged Unit	142625 ⁵³	G52336
00	Left	142625 ⁵³	M56640	142535 ⁵³
	Left Mfg. from 5/00	G56539	M56539	142625 ⁵³	G56640
	Left Mfg. to 5/00	G56526	142625 ⁵³



40 Complete Assembled Unit.

53 Strut Mount. Hardware from O.E. Part may need to be reused.

68 Strut Mount Kit. Hardware from O.E. Part may need to be reused.

Bold Type - New / Future Part

APPLICATION GUIDE

Year	Fitment Notes										
		Ultra	ProGuard\ Guardian\ Classic	Max Control\ LTV	Strut Cushion\ Strut Mount	HiJackers\ Load Carrier	Ultra	ProGuard\ Guardian\ Classic	Max Control\ LTV	Strut Cushion\ Strut Mount	HiJackers\ Load Carrier

HYUNDAI

HYUNDAI

ELANTRA (cont)

00	Left Mfg. to 5/00; Non-Gas Charged Unit	↑	142625 ⁵³	↑	G56528 ⁴⁴
	Right	↑	142625 ⁵³	↑	M56641	142536 ⁵³
	Right Mfg. from 5/00	↑	G56540	M56540	142625 ⁵³	↑	G56641
	Right Mfg. to 5/00	↑	G56525	142625 ⁵³	↑
	Right Mfg. to 5/00; Non-Gas Charged Unit	↑	142625 ⁵³	↑	G56527 ⁴⁴
96-99	Left	↑	G56526	142625 ⁵³	↑	142535 ⁵³
	Left Non-Gas Charged Unit	↑	142625 ⁵³	↑	G56528 ⁴⁴
	Right	↑	G56525	142625 ⁵³	↑	142536 ⁵³
	Right Non-Gas Charged Unit	↑	142625 ⁵³	↑	G56527 ⁴⁴
92-95	Non-ABS	↑	G55592	143057 ⁵¹	↑	G51249	142419 ⁶⁸

ELANTRA COUPE

13	Exc. 16 & 17 inch Wheels	↑	↑	70098
	Left	↑	G52439	↑
	Right	↑	G52440	↑

ELANTRA READYMOUNTS

		Front		Rear	
		Ultra Readymount	Guardian Readymount	Ultra Readymount	Guardian Readymount
07-10	Left	G57393 ⁴⁰
	Right	G57394 ⁴⁰
00-06	Left	G57167 ⁴⁰	M57167 ⁴⁰
	Right	G57168 ⁴⁰	M57168 ⁴⁰
	Automatic Left	G57088 ⁴⁰	M57088 ⁴⁰
	Automatic Right	G57089 ⁴⁰	M57089 ⁴⁰

ENTOURAGE

09	All	↑	143416 ⁵⁴	↑
07-08	Left	↑	G52257	143416 ⁵⁴	⊕	G64071
	Right	↑	G52258	143416 ⁵⁴	⊕	G64071

EXCEL

90-94	All	↑	G55586	143057 ⁵¹	⊕	69689	81464
86-89	All	↑	143059 ⁵¹	⊕	69689	81464
	Rebuildable O.E. Front Struts	↑	G44944 ⁹⁸	143059 ⁵¹	⊕	69689	81464

40 Complete Assembled Unit.

51 Strut Cushion for use with the Strut/Cartridge/Shocks.

54 Kit with Mount and Bearing. Hardware from O.E. Part may need to be reused.



98 Notice: The level of difficulty to install this product is moderately high. Please review the installation instructions carefully before proceeding.

44 This strut is not gas pressurized therefore the piston rod will not extend without assistance.

53 Strut Mount. Hardware from O.E. Part may need to be reused.

68 Strut Mount Kit. Hardware from O.E. Part may need to be reused.

APPLICATION GUIDE

Year	Fitment Notes										
		Ultra	ProGuard\ Guardian\ Classic	Max Control\ LTV	Strut Cushion\ Strut Mount	HiJackers\ Load Carrier	Ultra	ProGuard\ Guardian\ Classic	Max Control\ LTV	Strut Cushion\ Strut Mount	HiJackers\ Load Carrier

HYUNDAI

HYUNDAI

PONY

84-87	All	○	69689	81464
-------	-----	-------	-------	-------	-------	-------	---	-------	-------	-------	-------	-------

SANTA FE

13-16	AWD	○	G64144 ¹
	Sport, FWD	○	G64143
10-11	All	143416 ⁵⁴	○
07-09	Left	G52158	143416 ⁵⁴	○	G64048
	Right	G52159	143416 ⁵⁴	○	G64048
05-06	Left	G56562	M56562	○	69907
	Right	G56561	M56561	○	69907
01-04	Left	G56562	M56562	143087 ⁵³	○	69907
	Right	G56561	M56561	143087 ⁵³	○	69907

SANTA FE READYMOUNTS

		Front		Rear	
		Ultra Readymount	Guardian Readymount	Ultra Readymount	Guardian Readymount
07-09	Left	G57471 ⁴⁰
	Right	G57472 ⁴⁰
01-06	Left	G57139 ⁴⁰	M57139 ⁴⁰
	Right	G57140 ⁴⁰	M57140 ⁴⁰

SCOUPE

91-95	All	G55586	○	69689	81464
-------	-----	--------	-------	-------	-------	-------	---	-------	-------	-------	-------	-------

SONATA

13-14	All	143532 ⁵⁴	○	70068
11-12	All	143532 ⁵⁴	○	70068	143533 ⁵³
11	Mfg. to 7/22/10 Exc. Hybrid Left	G52329	143532 ⁵⁴	○	70068	143533 ⁵³
	Mfg. to 7/22/10 Exc. Hybrid Right	G52330	143532 ⁵⁴	○	70068	143533 ⁵³
	SE, Left Mfg. to 7/22/10	G52329	143532 ⁵⁴	○	70068	143533 ⁵³
06-10	All	G51806	143342 ⁶⁸	○	70013	143386 ⁵³
01-05	All	G51714	M51714	142419 ⁶⁸	○	G51713	M51713	142419 ⁶⁸
00	All	G56565	142419 ⁶⁸	○	142419 ⁶⁸
	Mfg. from 4/00	G56565	142419 ⁶⁸	○	G51713	M51713	142419 ⁶⁸
	Mfg. from 8/00	G51714	M51714	142419 ⁶⁸	○	142419 ⁶⁸
	Mfg. to 4/00	G56565	142419 ⁶⁸	○	G56566	142419 ⁶⁸

1 Future Part, available 1st Quarter of 2017.

53 Strut Mount. Hardware from O.E. Part may need to be reused.



68 Strut Mount Kit. Hardware from O.E. Part may need to be reused.

Bold Type - New / Future Part

40 Complete Assembled Unit.

54 Kit with Mount and Bearing. Hardware from O.E. Part may need to be reused.







APPLICATION GUIDE

Year	Fitment Notes										
		Ultra	ProGuard\ Guardian\ Classic	Max Control\ LTV	Strut Cushion\ Strut Mount	HiJackers\ Load Carrier	Ultra	ProGuard\ Guardian\ Classic	Max Control\ LTV	Strut Cushion\ Strut Mount	HiJackers\ Load Carrier

HYUNDAI

HYUNDAI















SONATA (cont)

99	All	 G56565	 G56566
95-98	All	 G56577	
89-94	All		 G51186	143057 ⁵¹

SONATA READYMOUNTS

		Front		Rear	
		Ultra Readymount	Guardian Readymount	Ultra Readymount	Guardian Readymount
06-10	All	G57149 ⁴⁰
00-05	Left	G57059 ⁴⁰	M57059 ⁴⁰	G57090 ⁴⁰	M57090 ⁴⁰
	Right	G57059 ⁴⁰	M57059 ⁴⁰	G57091 ⁴⁰	M57091 ⁴⁰









TIBURON

03-08	Left	 G56642	143397 ⁶⁸	 G56644	142535 ⁵³
	Right	 G56643	143397 ⁶⁸	 G56645	142536 ⁵³
97-01	All		142625 ⁵³	
	Left	 G56526	142625 ⁵³		142535 ⁵³
	Left Non-Gas Charged Unit		142625 ⁵³	 G56528 ⁴⁴
	Right	 G56525	142625 ⁵³		142536 ⁵³
	Right Non-Gas Charged Unit		142625 ⁵³	 G56527 ⁴⁴

TIBURON READYMOUNTS

		Front		Rear	
		Ultra Readymount	Guardian Readymount	Ultra Readymount	Guardian Readymount
03-08	Left	G57398 ⁴⁰
	Right	G57399 ⁴⁰	G57401 ⁴⁰





TUCSON

10-12	Left			142535 ⁵³
	Right			142536 ⁵³
05-09	Left	 G56819	143087 ⁵³	 G56822	142535 ⁵³
	Right	 G56820	143087 ⁵³	 G56821	142536 ⁵³

TUCSON READYMOUNTS

		Front		Rear	
		Ultra Readymount	Guardian Readymount	Ultra Readymount	Guardian Readymount
05-09	Left	G57218 ⁴⁰	G57344 ⁴⁰
	Right	G57219 ⁴⁰	G57343 ⁴⁰

VERACRUZ

12	All		 G64048
07-11	All		143416 ⁵⁴	 G64048

40 Complete Assembled Unit.

51 Strut Cushion for use with the Strut/Cartridge/Shocks.





54 Kit with Mount and Bearing. Hardware from O.E. Part may need to be reused.

44 This strut is not gas pressurized therefore the piston rod will not extend without assistance.

53 Strut Mount. Hardware from O.E. Part may need to be reused.

68 Strut Mount Kit. Hardware from O.E. Part may need to be reused.



APPLICATION GUIDE

Year	Fitment Notes										
		 Ultra	ProGuard\ Guardian\ Classic	Max Control\ LTV	Strut Cushion\ Strut Mount	HiJackers\ Load Carrier	 Ultra	ProGuard\ Guardian\ Classic	Max Control\ LTV	Strut Cushion\ Strut Mount	HiJackers\ Load Carrier



HYUNDAI

HYUNDAI

XG300

01	All	 G51899	 G51713	M51713	142419 ⁶⁸
----	-----	--	------	------	------	------	--	--------	------	----------------------	------





XG350

02-05	All	 G51899	 G51713	M51713	142419 ⁶⁸
-------	-----	--	------	------	------	------	--	--------	------	----------------------	------





INFINITI

INFINITI





FX35

03-08	Left	 G52061	142937 ⁵⁴	 G51831
	Right	 G52062	142937 ⁵⁴	 G51831























FX45

03-08	Left	 G52061	142937 ⁵⁴	 G51831
	Right	 G52062	142937 ⁵⁴	 G51831





G20

91-96	Left	 G56591	143057 ⁵¹	 G56512
	Right	 G56591	143057 ⁵¹	 G56513



G35

08	AWD, Left Exc. 4 Wheel Steer	 G511019	 G511021
	AWD, Right Exc. 4 Wheel Steer	 G511020	 G511021
03-07	All		143455 ⁶⁸	
	Coupe Left Sport Suspension	 G51813	143455 ⁶⁸	
	Coupe Right Sport Suspension	 G51814	143455 ⁶⁸	
07	AWD, Left Exc. 4 Wheel Steer	 G511019	143455 ⁶⁸	 G511021
	AWD, Right Exc. 4 Wheel Steer	 G511020	143455 ⁶⁸	 G511021
05-06	AWD, Left	 G51979	143455 ⁶⁸	
	AWD, Right	 G51981	143455 ⁶⁸	
03-06	Exc. Sport Suspension		143455 ⁶⁸	 G51764
	Coupe Sport Suspension		143455 ⁶⁸	 G51812

G37

09-10	AWD, Left Exc. 4 Wheel Steer	 G511019	 G511021
	AWD, Right Exc. 4 Wheel Steer	 G511020	 G511021

I30

00-01	Left	 G56683	142937 ⁵⁴	 G51727
-------	------	--	------	------	----------------------	------	--	------	------	------	------



51 Strut Cushion for use with the Strut/Cartridge/Shocks.

54 Kit with Mount and Bearing. Hardware from O.E. Part may need to be reused.

68 Strut Mount Kit. Hardware from O.E. Part may need to be reused.

Bold Type - New / Future Part







APPLICATION GUIDE

Year	Fitment Notes										
		Ultra	ProGuard\ Guardian\ Classic	Max Control\ LTV	Strut Cushion\ Strut Mount	HiJackers\ Load Carrier	Ultra	ProGuard\ Guardian\ Classic	Max Control\ LTV	Strut Cushion\ Strut Mount	HiJackers\ Load Carrier

INFINITI

INFINITI





I30 (cont)

00-01	Right		G56684	142937 ⁵⁴		G51727
96-99	Left		G55913	M55913	142546 ⁵⁴		G51087	M51087
	Right		G55912	M55912	142546 ⁵⁴		G51087	M51087

I30 READYMOUNTS

		Front		Rear	
		Ultra Readymount	Guardian Readymount	Ultra Readymount	Guardian Readymount
00-01	Left	G57525⁴⁰	G57551⁴⁰
	Right	G57526⁴⁰	G57552⁴⁰
96-99	Left	G56970 ⁴⁰	M56970⁴⁰	G57057 ⁴⁰	M57057⁴⁰
	Right	G56971 ⁴⁰	M56971⁴⁰	G57058 ⁴⁰	M57058⁴⁰







I35

02-04	Left		G56685	142937 ⁵⁴		G51727
	Right		G56686	142937 ⁵⁴		G51727





I35 READYMOUNTS

		Front		Rear	
		Ultra Readymount	Guardian Readymount	Ultra Readymount	Guardian Readymount
04	Left	G57551⁴⁰
	Right	G57552⁴⁰
02-03	Left	G57527⁴⁰	G57551⁴⁰
	Right	G57528⁴⁰	G57552⁴⁰





M35

08-10	All			G51927
06-07	Left		G51925	143455⁶⁸		G51927
	Right		G51926	143455⁶⁸		G51927









M45

08-10	All			G51927
06-07	Left		G51925		G51927
	Right		G51926		G51927

Q45

97-01	All			G51930
	Exc. Active Suspension		143210 ⁵³		G51930

QX4

02-03	Left		G56687	M56687	142938 ⁵³	
	Right		G56688	M56688	142938 ⁵³	
99-03	Mfg. from 12/98		142938 ⁵³		G63845
98-03	All		142938 ⁵³	



40 Complete Assembled Unit.

54 Kit with Mount and Bearing. Hardware from O.E. Part may need to be reused.

53 Strut Mount. Hardware from O.E. Part may need to be reused.

68 Strut Mount Kit. Hardware from O.E. Part may need to be reused.









APPLICATION GUIDE

Year	Fitment Notes										
		Ultra	ProGuard\ Guardian\ Classic	Max Control\ LTV	Strut Cushion\ Strut Mount	HiJackers\ Load Carrier	Ultra	ProGuard\ Guardian\ Classic	Max Control\ LTV	Strut Cushion\ Strut Mount	HiJackers\ Load Carrier

INFINITI

INFINITI







QX4 (cont)

99-01	Left Mfg. from 12/98		G56615	142938 ⁵³
	Right Mfg. from 12/98		G56616	142938 ⁵³
98-99	Left Mfg. to 12/98		G56739	M56739	142938 ⁵³
	Right Mfg. to 12/98		G56736	M56736	142938 ⁵³
99	Mfg. to 12/98		142938 ⁵³	61609
97-98	Mfg. to 12/98		142938 ⁵³	G63712	61609 81910
97	All		142938 ⁵³	G63712	81910
	Left		G56739	M56739	142938 ⁵³	G63712	81910
	Right		G56736	M56736	142938 ⁵³	G63712	81910

QX4 READYMOUNTS

		Front		Rear	
		Ultra Readymount	Guardian Readymount	Ultra Readymount	Guardian Readymount
02-03	Left	G57144 ⁴⁰	M57144⁴⁰
	Right	G57145 ⁴⁰	M57145⁴⁰
97-99	Mfg. to 11/98 Left	G57037 ⁴⁰
	Mfg. to 11/98 Right	G57038 ⁴⁰

QX56

08-10	All		G51715	143358 ⁵³ 143359 ⁶⁷
	4WD		G51715	M51715	143358 ⁵³ 143359 ⁶⁷
05-07	All		G51715	143358 ⁵³ 143359 ⁶⁷	G63875
	4WD		G51715	M51715	143358 ⁵³ 143359 ⁶⁷	G63875
04	All		G51715	143358 ⁵³ 143359 ⁶⁷
	4WD		G51715	M51715	143358 ⁵³ 143359 ⁶⁷

QX56 READYMOUNTS

		Front		Rear	
		Ultra Readymount	Guardian Readymount	Ultra Readymount	Guardian Readymount
04-10	4WD	G57092 ⁴⁰	M57092⁴⁰

INTERNATIONAL

INTERNATIONAL

100

74	All		82030
----	-----	---	------	------	------	------	------	-------	------	------	------

100 STEERING STABILIZERS

		Front	Rear
74	All	6802SE ⁸⁴

150

75	RWD		82030
----	-----	---	------	------	------	------	------	-------	------	------	------

150 STEERING STABILIZERS

		Front	Rear
75	All	6802SE ⁸⁴

40 Complete Assembled Unit.



67 Strut Mount Kit. Hardware from O.E. Part may need to be reused.

Bold Type - New / Future Part

53 Strut Mount. Hardware from O.E. Part may need to be reused.

84 Replacement damper for vehicles with the Gabriel Aftermarket mounting kit

APPLICATION GUIDE

Year	Fitment Notes										
		Ultra	ProGuard\ Guardian\ Classic	Max Control\ LTV	Strut Cushion\ Strut Mount	HiJackers\ Load Carrier	Ultra	ProGuard\ Guardian\ Classic	Max Control\ LTV	Strut Cushion\ Strut Mount	HiJackers\ Load Carrier

INTERNATIONAL 200

74-75	All	○	82030	○	82030
-------	-----	---	-------	-------	-------	-------	-------	---	-------	-------	-------	-------	-------

200 STEERING STABILIZERS

74-75	All										Front	Rear
											6802SE ⁸⁴

INTERNATIONAL

908C

68	All	○	82007	○	G63405	61500 81147	77405	43048 ⁸ 49310 ⁷
----	-----	---	-------	-------	-------	-------	-------	---	--------	----------------	-------	-------	--

908C STEERING STABILIZERS

68-69	Single System Steering Stabilizer; 1/2 Ton, 3/4 Ton & Travelall										Front	Rear
											6802SE ⁸⁴

1000C

68	All		82049	○	61500 81147	43048 ⁸ 49310 ⁷
	Exc. Travelette with 166" Wheelbase		82049	○	G63405	61500 81147	77405	43048 ⁸ 49310 ⁷

1000C STEERING STABILIZERS

68	Single System Steering Stabilizer; 1/2 Ton, 3/4 Ton & Travelall										Front	Rear
											6802SE ⁸⁴

1000D

69-70	Before Chassis #H-205000		82049	○	82030
-------	--------------------------	--	-------	-------	-------	-------	-------	---	-------	-------	-------	-------	-------

1000D STEERING STABILIZERS

69-70	Single System Steering Stabilizer; 1/2 Ton, 3/4 Ton & Travelall										Front	Rear
											6802SE ⁸⁴

1010

71-73	All		82049	○
71-72	Before Chassis #H-205000		82049	○	82030

1010 STEERING STABILIZERS

71-73	Single System Steering Stabilizer; 1/2 Ton, 3/4 Ton & Travelall										Front	Rear
											6802SE ⁸⁴

1100C

68	All	○	82007	○
	Exc. Travelette with 166" Wheelbase	○	G63405	61500 81147 82007	77405	43048 ⁸	○	G63405	61500 81147	77405	43048 ⁸ 49310 ⁷

1100C STEERING STABILIZERS

68	Single System Steering Stabilizer; 1/2 Ton, 3/4 Ton & Travelall										Front	Rear
											6802SE ⁸⁴

1100D

69-70	All	○	82030	○	82030
-------	-----	---	-------	-------	-------	-------	-------	---	-------	-------	-------	-------	-------

1100D STEERING STABILIZERS

69-70	Single System Steering Stabilizer; 1/2 Ton, 3/4 Ton & Travelall										Front	Rear
											6802SE ⁸⁴

1110

71-73	All	○	82030	○	82030
-------	-----	---	-------	-------	-------	-------	-------	---	-------	-------	-------	-------	-------

1110 STEERING STABILIZERS

71-73	Single System Steering Stabilizer; 1/2 Ton, 3/4 Ton & Travelall										Front	Rear
											6802SE ⁸⁴

1200C

68	Exc. Travelette with 166" Wheelbase	○	G63405	61500 81147 82007	77405	43048 ⁸	○	G63405	61500 81147	77405	43048 ⁸ 49310 ⁷
----	-------------------------------------	---	--------	-------------------------	-------	-------	--------------------	---	--------	----------------	-------	-------	--

7 Pair Packs, air hose kit included.

8 Pair Packs.

178 84 Replacement damper for vehicles with the Gabriel Aftermarket mounting kit

APPLICATION GUIDE

Year	Fitment Notes	Front					Rear				
		Ultra	ProGuard\ Guardian\ Classic	Max Control\ LTV	Strut Cushion\ Strut Mount	HiJackers\ Load Carrier	Ultra	ProGuard\ Guardian\ Classic	Max Control\ LTV	Strut Cushion\ Strut Mount	HiJackers\ Load Carrier

INTERNATIONAL

INTERNATIONAL

1200C STEERING STABILIZERS

		Front	Rear
68	Single System Steering Stabilizer; 1/2 Ton, 3/4 Ton & Travelall	6802SE ⁸⁴

1200D

69-70	All	○ ○	82030	○ ○	82030
-------	-----	-----	------	-------	------	------	------	-----	------	-------	------	------	------

1200D STEERING STABILIZERS

		Front	Rear
69-70	Single System Steering Stabilizer; 1/2 Ton, 3/4 Ton & Travelall	6802SE ⁸⁴

1210

71-73	All	○ ○	82030	○ ○	82030
-------	-----	-----	------	-------	------	------	------	-----	------	-------	------	------	------

1210 STEERING STABILIZERS

		Front	Rear
71-73	Single System Steering Stabilizer; 1/2 Ton, 3/4 Ton & Travelall	6802SE ⁸⁴

1300C

68	Exc. Travelette with 166" Wheelbase	○ ○	G63405	61500 81147 82007	77405	43048 ⁸	○ ○	G63405	61500 81147	77405	43048 ⁸ 49310 ⁷
----	-------------------------------------	-----	--------	-------------------------	-------	------	--------------------	-----	--------	----------------	-------	------	--

1300C STEERING STABILIZERS

		Front	Rear
68	Single System Steering Stabilizer; 1/2 Ton, 3/4 Ton & Travelall	6802SE ⁸⁴

1300D

69-70	All	○ ○	82030	○ ○	82030
-------	-----	-----	------	-------	------	------	------	-----	------	-------	------	------	------

1300D STEERING STABILIZERS

		Front	Rear
69-70	Single System Steering Stabilizer; 1/2 Ton, 3/4 Ton & Travelall	6802SE ⁸⁴

1310

71-73	All	○ ○	82030	○ ○	82030
-------	-----	-----	------	-------	------	------	------	-----	------	-------	------	------	------

1310 STEERING STABILIZERS

		Front	Rear
71-73	Single System Steering Stabilizer; 1/2 Ton, 3/4 Ton & Travelall	6802SE ⁸⁴

M800 STEERING STABILIZERS

		Front	Rear
68-71	Single System Steering Stabilizer; 1/2 and 3/4 Ton I-Beam Axle	6802SE ⁸⁴

M1100 / M1200

68-72	All	○ ○	81318 82007	○ ○	G63405	61500 81147	77405	43048 ⁸ 49310 ⁷
-------	-----	-----	------	----------------	------	------	------	-----	--------	----------------	-------	------	--

M1100 / M1200 STEERING STABILIZERS

		Front	Rear
68-72	Single System Steering Stabilizer; 1/2 and 3/4 Ton I-Beam Axle	6802SE ⁸⁴

M1400

69	All	○ ○	82007	○ ○	G63405	61500 81147	77405	43048 ⁸ 49310 ⁷
----	-----	-----	------	-------	------	------	------	-----	--------	----------------	-------	------	--

M1400 STEERING STABILIZERS

		Front	Rear
69	Single System Steering Stabilizer; 1/2 and 3/4 Ton I-Beam Axle	6802SE ⁸⁴

SCOUT

61-71	All	○ ○	82007	○ ○	82039
-------	-----	-----	------	-------	------	------	------	-----	------	-------	------	------	------

SCOUT II

71-80	All	○ ○	G63350	61518 81242	58350	43099 ⁸	○ ○	82030
-------	-----	-----	--------	----------------	-------	------	--------------------	-----	------	-------	------	------	------

SCOUT II STEERING STABILIZERS



		Front	Rear
71-80	Single System Steering Stabilizer	6803SE ⁸⁴

7 Pair Packs, air hose kit included.

8 Pair Packs.

84 Replacement damper for vehicles with the Gabriel Aftermarket mounting kit

APPLICATION GUIDE

Year	Fitment Notes										
		Ultra	ProGuard\ Guardian\ Classic	Max Control\ LTV	Strut Cushion\ Strut Mount	HiJackers\ Load Carrier	Ultra	ProGuard\ Guardian\ Classic	Max Control\ LTV	Strut Cushion\ Strut Mount	HiJackers\ Load Carrier

INTERNATIONAL

INTERNATIONAL

SCOUT STEERING STABILIZERS

		Front	Rear
69-71	Single System Steering Stabilizer	6803SE ⁸⁴
61-68	Single System Steering Stabilizer; 4WD; Scout 80, 800	6802SE ⁸⁴

TRAVELALL

75	All	82030
----	-----	-------	-------	------	------	------	-------	------	------	------

TRAVELALL STEERING STABILIZERS

		Front	Rear
75	4WD, Single System Steering Stabilizer	6803SE ⁸⁴
	RWD	6802SE ⁸⁴

ISUZU

ISUZU

AMIGO

98-00	All	⊥ G63611	61593 81872	⊥ G63710	61610 81911
89-94	All	⊥ G63909	61508 81507	77909	⊥ G63928	61506 81318	49311 ⁷

ASCENDER

03-08	All	⊥ G51718 ⁴⁵	M51718⁴⁵	143241 ⁵³	⊥
	Coil(RearSpringType)	⊥ G51718 ⁴⁵	M51718⁴⁵	143241 ⁵³	⊥ G63842	61717

ASCENDER READYMOUNTS

		Front		Rear	
		Ultra Readymount	Guardian Readymount	Ultra Readymount	Guardian Readymount
07-08	All	G57022 ⁴⁰
	Exc. V8	G57022 ⁴⁰	M57022⁴⁰
03-06	All	G57022 ⁴⁰	M57022⁴⁰

AXIOM

02-04	All	⊥ G63611	61593 81872	⊥ G63710	61610 81911
-------	-----	----------	----------------	------	------	------	----------	----------------	------	------	------

HOMBRE

98-00	RWD, Exc. Sport Chassis	⊥ G63421	61504 81750	58421 77421	34051 ⁸	⊥ G63422	61528 81482	58422 77422	43162 ⁸ 49213 ⁷
96-00	All	⊥ G63422	61528 81482	58422 77422	43162 ⁸ 49213 ⁷
00	Sport Chassis	⊥	58423	⊥ G63422	61528 81482	58422 77422	43162 ⁸ 49213 ⁷
	4WD	⊥ G63423	61531 81516	77423	⊥ G63422	61528 81482	58422 77422	43162 ⁸ 49213 ⁷
99	Sport Chassis	⊥ G63423	58423	⊥ G63422	61528 81482	58422 77422	43162 ⁸ 49213 ⁷
	4WD	⊥	61531 81516	77423	⊥ G63422	61528 81482	58422 77422	43162 ⁸ 49213 ⁷
96-98	Sport Chassis	⊥ G63423	61531 81516	58423 77423	⊥ G63422	61528 81482	58422 77422	43162 ⁸ 49213 ⁷
96-97	RWD, Exc. Sport Chassis	⊥ G63421	61504 81750	58421 77421	⊥ G63422	61528 81482	58422 77422	43162 ⁸ 49213 ⁷
	RWD; Exc. Sport Chassis	⊥	34051 ⁸	⊥ G63422	61528 81482	58422 77422	43162 ⁸ 49213 ⁷

I-280

06	Coil(FrontSpringType)	⊥	⊥ G63882
	RWD, Coil(FrontSpringType) Exc. Z71 Off Road Package	⊥	G51850	⊥

I-290

07-08	Coil(FrontSpringType)	⊥	⊥ G63882
-------	-----------------------	---	------	------	------	------	----------	------	------	------	------

7 Pair Packs, air hose kit included.

40 Complete Assembled Unit.





53 Strut Mount. Hardware from O.E. Part may need to be reused.

8 Pair Packs.

45 Strut must be rotated to align notch with lower control arm.

84 Replacement damper for vehicles with the Gabriel Aftermarket mounting kit

APPLICATION GUIDE

Year	Fitment Notes										
			ProGuard/ Guardian/ Classic	Max Control/ LTV	Strut Cushion/ Strut Mount	HiJackers/ Load Carrier		ProGuard/ Guardian/ Classic	Max Control/ LTV	Strut Cushion/ Strut Mount	HiJackers/ Load Carrier



ISUZU

ISUZU





I-290 (cont)

07-08	RWD, Coil(FrontSpringType) Exc. Z71 Off Road Package		G51850
-------	--	---	--------	------	------	------	------	------	------	------	------	------	------









I-350

06	Torsion Bar(FrontSpringType)		G63884		G63879
----	------------------------------	---	--------	------	------	------	------	------	------	---	--------	------	------	------	------









I-370

08	Coil(FrontSpringType)			G63882
	RWD, Coil(FrontSpringType) Exc. Z71 Off Road Package		G51850	



I-MARK

88-89	All		G55719	
	XS		G55719		81558
85-87	All		G55719		81558
81-84	All		81322	







IMPULSE

90-92	All		G55780	143058 ⁵¹		143061 ⁵¹
	Exc. Lotus Suspension		G55780	142317 ⁵³ 143058 ⁵¹		143061 ⁵¹
	FWD		G55780	143058 ⁵¹		G55776	143061 ⁵¹
83-89	All		81322		81340





OASIS

96-99	All		G55877	M55877	142230 ⁵³ 143064 ⁵¹		G55821	142230 ⁵³ 143063 ⁵¹
-------	-----	---	--------	--------	------	--	------	------	------	---	--------	------	------	--	------





PICKUP

81-95	All			61506 81318	77492	49311 ⁷
	4WD		G63909	61508 81507	77909		G63928	61506 81318	77492	49311 ⁷
	RWD		G63902	61501 81478	77902		G63492	61506 81318	77492	49311 ⁷











RODEO

98-04	All		G63611	61593 81872		G63710	61610 81911
91-97	All		G63611	61593 81872		G63610	61592 81937

STYLUS

91-93	All		G55780	143058 ⁵¹		G55776	143061 ⁵¹
	Exc. Lotus Suspension		G55780	142317 ⁵³ 143058 ⁵¹		G55776	143061 ⁵¹

TROOPER



92-02	All		G63707	61607		G63708	61608 81909
89-91	All			61586
	4WD		G63495	61593 81553	77904		61586
87-88	4WD		G63495	61593 81553	77904		61558 82066
84-86	4WD		G63909	61508 81507	77909		G63928	61506 81318	49311 ⁷

7 Pair Packs, air hose kit included.

53 Strut Mount. Hardware from O.E. Part may need to be reused.

51 Strut Cushion for use with the Strut/Cartridge/Shocks.

APPLICATION GUIDE

Year	Fitment Notes										
		Ultra	ProGuard\Guardian\Classic	Max Control\LTV	Strut Cushion\Strut Mount	HiJackers\Load Carrier	Ultra	ProGuard\Guardian\Classic	Max Control\LTV	Strut Cushion\Strut Mount	HiJackers\Load Carrier



ISUZU

ISUZU

TROOPER STEERING STABILIZERS

						Front	Rear
84-91	4WD, Single System Steering Stabilizer					6802SE ⁸⁴







VEHICROSS

99-01	All		G63707	61607		G63708	61608 81909
-------	-----	---	--------	-------	------	------	------	---	--------	----------------	------	------	------



JAGUAR

JAGUAR







S TYPE

00-06	Exc. Computer Active Technology Suspension		143242 ⁵³		143242 ⁵³
03-05	Mfg. to 6/02 Exc. Computer Active Technology Suspension			G51773
00-02	Mfg. to 6/02 Exc. Computer Active Technology Suspension		G51769		G51773











X-TYPE

02-08	Exc. CATS Computer Active Technology Suspension		G52276	
-------	---	---	--------	------	------	------	------	---	------	------	------	------	------



XJ6

87-94	Exc. Auto-Leveling System		G51711	
72-86	All		69677	
	4 units required		69677		G51161



XJ12

94	Exc. Auto-Leveling System		G51711	
81-92	All		69677	
	4 units required		69677		G51161
73-79	All		69677	
	4 units required		69677		G51161



XJS

76-96	All		69677		G51161
-------	-----	---	-------	------	------	------	------	---	--------	------	------	------	------

XK150

58-61	All			82123
-------	-----	---	------	------	------	------	------	---	------	-------	------	------	------









XKE

62-64	All			81270	49105 ⁷
-------	-----	---	------	------	------	------	------	---	------	-------	------	------	--------------------

JEEP

JEEP

CHEROKEE

84-01	All		G63424	61535 81548	77424		G63425	61536 81549	77425	49226 ⁷
76-83	All		G63377	61519 81484	58377 77377	43058 ⁸		G63377	61519 81484	58377 77377	43058 ⁸ 49127 ⁷
75	All		G63377	61519 81484	58377 77377	43058 ⁸	
74	All		G63377	61519 81484	58377 77377	43058 ⁸		81676

CHEROKEE STEERING STABILIZERS

						Front	Rear
84-01	All					14040



7 Pair Packs, air hose kit included.

182 53 Strut Mount. Hardware from O.E. Part may need to be reused.

8 Pair Packs.

84 Replacement damper for vehicles with the Gabriel Aftermarket mounting kit

APPLICATION GUIDE

Year	Fitment Notes										
		Ultra	ProGuard/ Guardian/ Classic	Max Control/ LTV	Strut Cushion/ Strut Mount	HiJackers/ Load Carrier	Ultra	ProGuard/ Guardian/ Classic	Max Control/ LTV	Strut Cushion/ Strut Mount	HiJackers/ Load Carrier

JEEP

JEEP

CHEROKEE STEERING STABILIZERS (cont)

		Front	Rear
84-00	Single System Steering Stabilizer; with a factory mounting hole in the steering linkage.	6801SE ⁸⁰
75-83	4WD, Single System Steering Stabilizer	6804SE ⁸⁰
74	Single System Steering Stabilizer	6804SE ⁸⁰

CJ3

61-66	Exc. 5 Leaf Front Springs & Lift Kit	82007
65	2-4" Lift Kit	G63440 ⁵⁰
	Exc. Lift Kit	G63405

CJ5

82-83	2 - 4" Lift Kit	G63441 ⁵⁰		
	2" Lift Kit	G63443 ⁵⁰		
	3-4" Lift Kit	G63440 ⁵⁰		
	Exc. Lift Kit	G63377	61519 81484	77377	G63405	61500 81147	77405	43048 ⁸ 49310 ⁷
72-81	2-4" Lift Kit	G63443 ⁵⁰	G63440 ⁵⁰		
	Exc. Lift Kit	G63299	82007	G63405	61500 81147	77405	43048 ⁸ 49310 ⁷
66-71	All	61500	43048 ⁸ 49310 ⁷
	2-4" Lift Kit	G63443 ⁵⁰	G63440 ⁵⁰	61500	43048 ⁸ 49310 ⁷
	5 Leaf Front Springs; Exc. Lift Kit	81676	81676 61500	43048 ⁸ 49310 ⁷
	Exc. 5 Leaf Front Springs & Lift Kit	82007	81147 61500	43048 ⁸ 49310 ⁷
	Exc. Lift Kit	G63405	61500	77405	43048 ⁸ 49310 ⁷
61-65	Exc. 5 Leaf Front Springs & Lift Kit	82007
65	2-4" Lift Kit	G63440 ⁵⁰
	Exc. Lift Kit	G63405

CJ5 STEERING STABILIZERS

		Front	Rear
66-83	Single System Steering Stabilizer	6802SE ⁸⁴
59-60	Single System Steering Stabilizer	6802SE ⁸⁴

CJ6

72-75	2-4" Lift Kit	G63443 ⁵⁰	G63440 ⁵⁰		
	Exc. Lift Kit	G63299	82007	G63405	61500 81147	77405	43048 ⁸ 49310 ⁷
66-71	All	61500	43048 ⁸ 49310 ⁷
	2-4" Lift Kit	G63443 ⁵⁰	G63440 ⁵⁰	61500	43048 ⁸ 49310 ⁷
	5 Leaf Front Springs; Exc. Lift Kit	81676	81676 61500	43048 ⁸ 49310 ⁷
	Exc. 5 Leaf Front Springs & Lift Kit	82007	61500	43048 ⁸ 49310 ⁷
	Exc. Lift Kit	G63405	81147 61500	77405	43048 ⁸ 49310 ⁷
65	2-4" Lift Kit	G63440 ⁵⁰
	Exc. Lift Kit	G63405

CJ6 STEERING STABILIZERS

		Front	Rear
66-75	Single System Steering Stabilizer	6802SE ⁸⁴

7 Pair Packs, air hose kit included.



50 Bellows Kit No. 141242 is recommended for use to protect piston rod from potentially harmful road debris.

84 Replacement damper for vehicles with the Gabriel Aftermarket mounting kit

8 Pair Packs.

80 Mounting bracket not required, install on O.E. Shock Mounts. See Ref. C for optional Steering Stabilizer Boots.

APPLICATION GUIDE

Year	Fitment Notes										
		Ultra	ProGuard\ Guardian\ Classic	Max Control\ LTV	Strut Cushion\ Strut Mount	HiJackers\ Load Carrier	Ultra	ProGuard\ Guardian\ Classic	Max Control\ LTV	Strut Cushion\ Strut Mount	HiJackers\ Load Carrier









JEEP

JEEP

CJ6 STEERING STABILIZERS (cont)

		Front	Rear
59-60	Single System Steering Stabilizer	6802SE ⁸⁴



CJ7

82-86	2 - 4" Lift Kit	 G63441 ⁵⁰
	2" Lift Kit	 G63443 ⁵⁰
	3-4" Lift Kit	 G63440 ⁵⁰
	Exc. Lift Kit	 G63377	61519 81484	77377	 G63405	61500 81147	77405
76-81	2-4" Lift Kit	 G63443 ⁵⁰	 G63440 ⁵⁰
	Exc. Lift Kit	 G63299	82007	 G63405	61500 81147	77405

CJ7 STEERING STABILIZERS

		Front	Rear
76-86	Single System Steering Stabilizer	6802SE ⁸⁴



COMANCHE

86-92	All	 G63424	61535 81548	77424	 G63492	61506 81318	77492
-------	-----	--	----------------	-------	------	------	--	----------------	-------	------	------

COMANCHE STEERING STABILIZERS

		Front	Rear
86-92	All	14040
	Single System Steering Stabilizer; with a factory mounting hole in the steering linkage.	6801SE ⁸⁰



COMMANDER

06-10	All	 G56807	143364 ⁵³	 G64012	61715
-------	-----	--	------	------	----------------------	------	--	-------	------	------	------

COMMANDER READYMOUNTS

		Front		Rear	
		Ultra Readymount	Guardian Readymount	Ultra Readymount	Guardian Readymount
06-10	Exc. Performance	G57083 ⁴⁰
	8 Cyl Non Performance	M57083 ⁴⁰



COMPASS

11-12	All	143337 ⁶⁷
07-10	Left	 G52081	143495 ⁵⁴	 G51842	143337 ⁶⁷ 143496 ⁶⁷
	Right	 G52082	143495 ⁵⁴	 G51842	143337 ⁶⁷ 143496 ⁶⁷





COMPASS READYMOUNTS

		Front		Rear	
		Ultra Readymount	Guardian Readymount	Ultra Readymount	Guardian Readymount
07-10	Left	G57464 ⁴⁰	G57607 ⁴⁰
	Right	G57463 ⁴⁰	G57607 ⁴⁰

DISPATCHER

61-67	All	 G63443 ⁵⁰	81676	 G63443 ⁵⁰	81676
-------	-----	--	-------	------	------	------	--	-------	------	------	------

DJ5

66-74	2-4" Lift Kit	 G63443 ⁵⁰	 G63440 ⁵⁰
	Exc. Lift Kit	 G63299	82007	 G63405	61500 81147	77405	43048 ⁸ 49310 ⁷

7 Pair Packs, air hose kit included.

40 Complete Assembled Unit.

53 Strut Mount. Hardware from O.E. Part may need to be reused.

67 Strut Mount Kit. Hardware from O.E. Part may need to be reused.

84 Replacement damper for vehicles with the Gabriel Aftermarket mounting kit



8 Pair Packs.

50 Bellows Kit No.141242 is recommended for use to protect piston rod from potentially harmful road debris.

54 Kit with Mount and Bearing. Hardware from O.E. Part may need to be reused.

80 Mounting bracket not required, install on O.E. Shock Mounts. See Ref. C for optional Steering Stabilizer Boots.

APPLICATION GUIDE

Year	Fitment Notes										
		Ultra	ProGuard\ Guardian\ Classic	Max Control\ LTV	Strut Cushion\ Strut Mount	HiJackers\ Load Carrier	Ultra	ProGuard\ Guardian\ Classic	Max Control\ LTV	Strut Cushion\ Strut Mount	HiJackers\ Load Carrier

JEEP

JEEP

DJ6

66-68	All	○	82007	○	61500 81147	43048 ⁸ 49310 ⁷
	2-4" Lift Kit	○	G63443 ⁸⁰	82007	○	G63440 ⁸⁰	61500 81147	43048 ⁸ 49310 ⁷
	Exc. Lift Kit	○	82007	○	G63405	61500 81147	77405	43048 ⁸ 49310 ⁷

FC150

61-65	All	○	82007	○	81676
57-60	All	○	82007	○	G63405	61500 81147	77405	43048 ⁸ 49310 ⁷

FC170

63-65	All	○	G63405	61500 81147	77405	43048 ⁸	○	G63405	61500 81147	77405	43048 ⁸ 49310 ⁷
-------	-----	---	--------	----------------	-------	------	--------------------	---	--------	----------------	-------	------	------	--

GLADIATOR

67	All	○	81318	○	61519 81484	43058 ⁸ 49127 ⁷
66	All	○	81318	○	81147	49310 ⁷
	Independent Front Suspension	○	81318	○	G63405	61500 81147	77405	43048 ⁸ 49310 ⁷
64-65	All	○	○	81147	49310 ⁷
	Exc. Independent Front Suspension	○	81318	○	81147	49310 ⁷
63-65	Independent Front Suspension	○	○	G63405	61500 81147	77405	43048 ⁸ 49310 ⁷

GLADIATOR STEERING STABILIZERS

		Front	Rear
63-67	Single System Steering Stabilizer	6803SE ⁸⁴

GRAND CHEROKEE

11-15	All	○	○	G511000 ²
05-10	All	○	G56807	143364 ⁵³	○	G64012	61715
99-04	All	○	81869	○	G63829	61676 81926	77829
	Exc. Up Country Suspension	○	G63847	61664 81869	77847	○	G63829	61676 81926	77829
95-98	All	○	G63424	61535 81548	77424	○	G63683	61575 81891	77683
93-94	All	○	G63424	61535 81548	77424	○	G63626	61575 81891	77683

GRAND CHEROKEE READYMOUNTS

		Front		Rear	
		Ultra Readymount	Guardian Readymount	Ultra Readymount	Guardian Readymount
05-10	4WD; V8 Models	G57083 ⁴⁰
	8 Cyl Non Performance	M57083 ⁴⁰
	V6 Left	G57433 ⁴⁰
	V6 Right	G57434 ⁴⁰

GRAND CHEROKEE STEERING STABILIZERS

		Front	Rear
99-04	Single System Steering Damper	14071
93-98	All	6853SE ⁸²

GRAND WAGONEER

93	All	○	G63377	61519 81484	43058 ⁸	○	G63377	61519 81484	58377	43058 ⁸
----	-----	---	--------	----------------	------	------	--------------------	---	--------	----------------	-------	------	------	--------------------

2 Future Part, available 2nd Quarter of 2017.

8 Pair Packs.

50 Bellows Kit No.141242 is recommended for use to protect piston rod from potentially harmful road debris.

82 Use kit if listed, See Ref. C for optional Steering Stabilizer Boots.

Bold Type - New / Future Part



7 Pair Packs, air hose kit included.

40 Complete Assembled Unit.

53 Strut Mount. Hardware from O.E. Part may need to be reused.

84 Replacement damper for vehicles with the Gabriel Aftermarket mounting kit





APPLICATION GUIDE

Year	Fitment Notes										
		Ultra	ProGuard\ Guardian\ Classic	Max Control\ LTV	Strut Cushion\ Strut Mount	HiJackers\ Load Carrier	Ultra	ProGuard\ Guardian\ Classic	Max Control\ LTV	Strut Cushion\ Strut Mount	HiJackers\ Load Carrier

JEEP

JEEP





GRAND WAGONEER (cont)

84-91	All	 	G63377	61519 81484	58377 77377	43058 ⁸	 	G63377	61519 81484	58377 77377	43058 ⁸ 49127 ⁷
-------	-----	---	--------	----------------	----------------	------	--------------------	---	--------	----------------	----------------	------	--

GRAND WAGONEER STEERING STABILIZERS

84-91	Single System Steering Stabilizer	6804SE ⁸⁰
-------	-----------------------------------	----------------------	------





J10 PICKUP

74-88	All	 	G63377	61519 81484	77377	43058 ⁸	 	G63377	61519 81484	77377	43058 ⁸ 49127 ⁷
-------	-----	---	--------	----------------	-------	------	--------------------	---	--------	----------------	-------	------	--

J10 PICKUP STEERING STABILIZERS

74-88	Single System Steering Stabilizer	6804SE ⁸⁰
-------	-----------------------------------	----------------------	------





J20 PICKUP

74-88	All	 	G63377	61519 81484	77377	43058 ⁸	 	G63377	61519 81484	77377	43058 ⁸ 49127 ⁷
-------	-----	---	--------	----------------	-------	------	--------------------	---	--------	----------------	-------	------	--









J20 PICKUP STEERING STABILIZERS

74-88	Single System Steering Stabilizer	6804SE ⁸⁰
-------	-----------------------------------	----------------------	------

J2500 PICKUP

68-73	All	 	81318	 	61519 81484	43058 ⁸ 49127 ⁷
-------	-----	---	------	-------	------	------	------	---	------	----------------	------	------	--













JEEPSTER

70-73	All	 	82007	 	G63405	61500 81147	77405	43048 ⁸ 49310 ⁷
67-69	All	 	82007	 	82007

JEEPSTER STEERING STABILIZERS

66-73	Single System Steering Stabilizer	6802SE ⁸⁴
-------	-----------------------------------	----------------------	------





















LIBERTY

12	All	 	G51728	M51728	 	G63844
02-11	Left	 	G51728	M51728	143255 ⁵³	 	G63844
	Right	 	G51728	M51728	143266 ⁵³	 	G63844

LIBERTY READYMOUNTS

		Front		Rear	
		Ultra Readymount	Guardian Readymount	Ultra Readymount	Guardian Readymount
02-12	Gas Left	G57007 ⁴⁰	M57007⁴⁰
	Gas Right	G57008 ⁴⁰	M57008⁴⁰

PATRIOT

11-12	All	 	 	143337 ⁶⁷
10	Left	 	G52081	143495⁵⁴	 	G51842	143337 ⁶⁷
	Right	 	G52082	143495⁵⁴	 	G51842	143337 ⁶⁷
07-09	Left	 	G52081	143495⁵⁴	 	G51842	143337 ⁶⁷ 143496⁶⁷
	Right	 	G52082	143495⁵⁴	 	G51842	143337 ⁶⁷ 143496⁶⁷

7 Pair Packs, air hose kit included.

40 Complete Assembled Unit.

54 Kit with Mount and Bearing. Hardware from O.E. Part may need to be reused.

80 Mounting bracket not required, install on O.E. Shock Mounts. See Ref. C for optional Steering Stabilizer Boots.

8 Pair Packs.

53 Strut Mount. Hardware from O.E. Part may need to be reused.

67 Strut Mount Kit. Hardware from O.E. Part may need to be reused.

84 Replacement damper for vehicles with the Gabriel Aftermarket mounting kit

APPLICATION GUIDE

Year	Fitment Notes	Front					Rear				
		Ultra	ProGuard/ Guardian/ Classic	Max Control/ LTV	Strut Cushion/ Strut Mount	HiJackers/ Load Carrier	Ultra	ProGuard/ Guardian/ Classic	Max Control/ LTV	Strut Cushion/ Strut Mount	HiJackers/ Load Carrier

JEEP

JEEP

PATRIOT READYMOUNTS		Front		Rear	
		Ultra Readymount	Guardian Readymount	Ultra Readymount	Guardian Readymount
07-10	Left	G57464 ⁴⁰	G57607 ⁴⁰
	Right	G57463 ⁴⁰	G57607 ⁴⁰

SCRAMBLER / CJ8

82-85	All	⊖ ⊖ ⊖	G63377	61519 81484	77377	⊖ ⊖ ⊖	G63405	61500 81147	77405	43048 ⁸ 49310 ⁷
81	All	⊖ ⊖ ⊖	G63299	82007	⊖ ⊖ ⊖	G63405	61500 81147	77405	43048 ⁸ 49310 ⁷

SCRAMBLER / CJ8 STEERING STABILIZERS

		Front	Rear
81-85	Single System Steering Stabilizer	6802SE ⁸⁴

UNIVERSAL

66-67	All	⊖ ⊖ ⊖	82007	⊖ ⊖ ⊖	61500	43048 ⁸ 49310 ⁷
	2-4" Lift Kit	⊖ ⊖ ⊖	G63443 ⁵⁰	82007	⊖ ⊖ ⊖	G63440 ⁵⁰	61500	43048 ⁸ 49310 ⁷
	5 Leaf Front Springs; Exc. Lift Kit	⊖ ⊖ ⊖	81676 82007	⊖ ⊖ ⊖	81676 61500	43048 ⁸ 49310 ⁷
	Exc. CJ-3B	⊖ ⊖ ⊖	82007	⊖ ⊖ ⊖	81147 61500	43048 ⁸ 49310 ⁷
65-67	Exc. Lift Kit	⊖ ⊖ ⊖	82007	⊖ ⊖ ⊖	G63405	61500	77405	43048 ⁸ 49310 ⁷
65	All	⊖ ⊖ ⊖	82007	⊖ ⊖ ⊖	61500	77405	43048 ⁸ 49310 ⁷
	2-4" Lift Kit	⊖ ⊖ ⊖	G63443 ⁵⁰	82007	⊖ ⊖ ⊖	G63440 ⁵⁰	61500	77405	43048 ⁸ 49310 ⁷
	5 Leaf Front Springs; Exc. Lift Kit	⊖ ⊖ ⊖	81676 82007	⊖ ⊖ ⊖	81676 61500	77405	43048 ⁸ 49310 ⁷
	Exc. CJ-3B	⊖ ⊖ ⊖	82007	⊖ ⊖ ⊖	81147 61500	77405	43048 ⁸ 49310 ⁷
61-64	All	⊖ ⊖ ⊖	82007	⊖ ⊖ ⊖	G63405	61500	77405	43048 ⁸ 49310 ⁷
	5 Leaf Front Springs; Exc. Lift Kit	⊖ ⊖ ⊖	81676 82007	⊖ ⊖ ⊖	G63405	81676 61500	77405	43048 ⁸ 49310 ⁷
	Exc. CJ-3B	⊖ ⊖ ⊖	82007	⊖ ⊖ ⊖	G63405	81147 61500	77405	43048 ⁸ 49310 ⁷

UNIVERSAL STEERING STABILIZERS

		Front	Rear
61-67	Single System Steering Stabilizer	6802SE ⁸⁴

WAGONEER

84-90	All	⊖ ⊖ ⊖	G63424	61535 81548	77424	⊖ ⊖ ⊖	G63425	61536 81549	77425	49226 ⁷
76-83	All	⊖ ⊖ ⊖	G63377	61519 81484	58377 77377	43058 ⁸	⊖ ⊖ ⊖	G63377	61519 81484	58377 77377	43058 ⁸ 49127 ⁷
75	All	⊖ ⊖ ⊖	G63377	61519 81484	58377 77377	43058 ⁸	⊖ ⊖ ⊖
74	All	⊖ ⊖ ⊖	G63377	61519 81484	58377 77377	43058 ⁸	⊖ ⊖ ⊖	G63299	81676
71-73	All	⊖ ⊖ ⊖	G63492	81318	77492	⊖ ⊖ ⊖	G63299	81676
68-70	All	⊖ ⊖ ⊖	G63492	81318	77492	⊖ ⊖ ⊖	81676
66-67	All	⊖ ⊖ ⊖	G63492	81318	77492	⊖ ⊖ ⊖	G63299	81676
63-65	All	⊖ ⊖ ⊖	⊖ ⊖ ⊖	G63299	81676
	Exc. Independent Front Suspension	⊖ ⊖ ⊖	G63492	81318	77492	⊖ ⊖ ⊖	G63299	81676
	Independent Front Suspension	⊖ ⊖ ⊖	81676	⊖ ⊖ ⊖	G63299	81676

WAGONEER STEERING STABILIZERS

		Front	Rear
63-67	Exc. Independent Front Suspension	6802SE ⁸⁴

7 Pair Packs, air hose kit included.

40 Complete Assembled Unit.



84 Replacement damper for vehicles with the Gabriel Aftermarket mounting kit

Bold Type - New / Future Part

8 Pair Packs.

50 Bellows Kit No. 141242 is recommended for use to protect piston rod from potentially harmful road debris.

APPLICATION GUIDE

Year	Fitment Notes										
		Ultra	ProGuard\Guardian\Classic	Max Control\LTV	Strut Cushion\Strut Mount	HiJackers\Load Carrier	Ultra	ProGuard\Guardian\Classic	Max Control\LTV	Strut Cushion\Strut Mount	HiJackers\Load Carrier

JEEP

JEEP

WRANGLER

13-15	All	⊕	61711
	17" Wheels	⊕	61711
	17" Wheels; w/Heavy Duty Suspension	⊕	61711
	Exc. 17" Wheels	⊕	61711
13-14	Unlimited Sahara, 4WD	⊕	61711
07-12	All	⊕	G64008	61711	77981
	17" Wheels	⊕	G64008	61711	77981
	Exc. 17" Wheels	⊕	G64008	61711	77981
12	Unlimited Sahara, 4WD	⊕	G64008	61711	77981
07-11	Unlimited Sahara, Unlimited X, 4WD	⊕	G64008	61711	77981
	X	⊕	G64008	61711	77981
97-06	All	⊕	77978
	TJ(MfrBodyCode)	⊕	G63721	61615 81936	77978
87-95	YJ(MfrBodyCode)	⊕	G63511	61551 ⁶ 81691	49222 ⁷

WRANGLER STEERING STABILIZERS

		Front	Rear
07-13	4WD	14074
97-06	TJ(MfrBodyCode) Single System Steering Stabilizer; with a factory mounting hole in the steering linkage.	6801SE ⁸⁰
94-95	YJ(MfrBodyCode) Single System Steering Stabilizer; with a factory mounting hole in the steering linkage.	6801SE ⁸⁰
87-92	YJ(MfrBodyCode) Single System Steering Stabilizer; with a factory mounting hole in the steering linkage.	6801SE ⁸⁰

KIA

KIA

AMANTI

07-09	All	⊕	G511071	143342 ⁶⁸
04-06	All	⊕	G51774	143419 ⁶⁷	143419 ⁶⁷

CADENZA

14	All	⊕
----	-----	---	------	------	------	------	------	------	------	------	------

MAGENTIS

07-10	Left	⊕	G52247	143381 ⁶⁸
	Right	⊕	G52248	143382 ⁶⁸
06	Left	⊕	G51714	M51714	143381 ⁶⁸	142419 ⁶⁸
	Right	⊕	G51714	M51714	143382 ⁶⁸	142419 ⁶⁸
01-05	All	⊕	G51714	M51714	142419 ⁶⁸

MAGENTIS READYMOUNTS

		Front		Rear	
		Ultra Readymount	Guardian Readymount	Ultra Readymount	Guardian Readymount
01-06	Left	G57090 ⁴⁰	M57090⁴⁰
	Right	G57091 ⁴⁰	M57091⁴⁰

6 It is recommended that when replacing shocks on vehicles with "quad shocks" all 4 shocks should be matched by series.

40 Complete Assembled Unit.



68 Strut Mount Kit. Hardware from O.E. Part may need to be reused.

7 Pair Packs, air hose kit included.

67 Strut Mount Kit. Hardware from O.E. Part may need to be reused.

80 Mounting bracket not required, install on O.E. Shock Mounts. See Ref. C for optional Steering Stabilizer Boots.

APPLICATION GUIDE

Year	Fitment Notes										
		Ultra	ProGuard\ Guardian\ Classic	Max Control\ LTV	Strut Cushion\ Strut Mount	HiJackers\ Load Carrier	Ultra	ProGuard\ Guardian\ Classic	Max Control\ LTV	Strut Cushion\ Strut Mount	HiJackers\ Load Carrier

KIA

KIA

OPTIMA

11	All	70068
07-10	Left	G52247	143381 ⁶⁸	70049
	Right	G52248	143382 ⁶⁸	70049
06	All	G51714	G51713	M51713	142419 ⁶⁸
	Left	G51714	143381 ⁶⁸	G51713	M51713	142419 ⁶⁸
	Left New Style	G52247	G51713	M51713	142419 ⁶⁸
	Right	G51714	143382 ⁶⁸	G51713	M51713	142419 ⁶⁸
	Right New Style	G52248	G51713	M51713	142419 ⁶⁸
01-05	All	G51714	M51714	G51713	M51713	142419 ⁶⁸

OPTIMA READYMOUNTS

		Front		Rear	
		Ultra Readymount	Guardian Readymount	Ultra Readymount	Guardian Readymount
01-06	Left	G57090 ⁴⁰	M57090⁴⁰
	Right	G57091 ⁴⁰	M57091⁴⁰

RIO

12-15	Left	G52353	70095
	Right	G52354	70095
06-11	Left	G52154	143409⁵⁴	70036	142419 ⁶⁸	143411⁶⁸
	Right	G52155	143410⁵⁴	70036	142419 ⁶⁸	143411⁶⁸
04-05	Left	G52015	70001
	Right	G52016	70001
	Sedan Left	143456⁵³
	Sedan Right	143457⁵³
01-03	Left	G56782	69585 G63880
	Right	G56781	69585 G63880

RIO READYMOUNTS

		Front		Rear	
		Ultra Readymount	Guardian Readymount	Ultra Readymount	Guardian Readymount
06-11	Left	G57275⁴⁰
	Right	G57276⁴⁰
02-05	Left	G57608⁴⁰
	Standard Right	G57609⁴⁰

RONDO

07-11	Left	G52247	70049	143386⁶³
	Right	G52248	70049	143386⁶³

40 Complete Assembled Unit.



54 Kit with Mount and Bearing. Hardware from O.E. Part may need to be reused.

Bold Type - New / Future Part

53 Strut Mount. Hardware from O.E. Part may need to be reused.

68 Strut Mount Kit. Hardware from O.E. Part may need to be reused.

















APPLICATION GUIDE

Year	Fitment Notes										
		Ultra	ProGuard\ Guardian\ Classic	Max Control\ LTV	Strut Cushion\ Strut Mount	HiJackers\ Load Carrier	Ultra	ProGuard\ Guardian\ Classic	Max Control\ LTV	Strut Cushion\ Strut Mount	HiJackers\ Load Carrier

KIA

KIA

































SEDONA

14	Left	 G52257	 G64071
	Right	 G52258	 G64071
12	Left	 G52257	 G64071
	Right	 G52258	 G64071
06-11	Left	 G52257	143416⁵⁴	 G64071
	Right	 G52258	143416⁵⁴	 G64071
02-05	Left	 G52034	143458⁶⁸	 70000
	Right	 G52035	143458⁶⁸	 70000

SEDONA READYMOUNTS

		Front		Rear	
		Ultra Readymount	Guardian Readymount	Ultra Readymount	Guardian Readymount
08-10	Left	G57487⁴⁰
	Right	G57488⁴⁰
02-05	Left	G57489⁴⁰
	Right	G57490⁴⁰

SEPHIA

01	Left Mfg. to 6/01		 G56534
	Right Mfg. to 6/01		 G56533
	Mfg. to 6/01 Left		142856 ⁵³		142642 ⁵³
	Mfg. to 6/01 Right		142856 ⁵³		142641 ⁵³
	Mfg. to 6/01; Non-ABS Left	 G56532	
	Mfg. to 6/01; Non-ABS Right	 G56531	
00	All		142856 ⁵⁴	
	Left Mfg. to 6/01		142856 ⁵⁴	 G56534
	Right Mfg. to 6/01		142856 ⁵⁴	 G56533
	Mfg. to 6/01 Left		142856 ⁵⁴		142642 ⁵³
	Mfg. to 6/01 Right		142856 ⁵⁴		142641 ⁵³
	Mfg. to 6/01; Non-ABS Left	 G56532	142856 ⁵⁴	
	Mfg. to 6/01; Non-ABS Right	 G56531	142856 ⁵⁴	
98-99	Left		142856 ⁵⁴	 G56534
	Right		142856 ⁵⁴	 G56533
	Mfg. to 6/01; Non-ABS Left	 G56532	



40 Complete Assembled Unit.

54 Kit with Mount and Bearing. Hardware from O.E. Part may need to be reused.

53 Strut Mount. Hardware from O.E. Part may need to be reused.

68 Strut Mount Kit. Hardware from O.E. Part may need to be reused.

APPLICATION GUIDE

Year	Fitment Notes										
		Ultra	ProGuard\Guardian\Classic	Max Control\LTV	Strut Cushion\Strut Mount	HiJackers\Load Carrier	Ultra	ProGuard\Guardian\Classic	Max Control\LTV	Strut Cushion\Strut Mount	HiJackers\Load Carrier

KIA

KIA

SEPHIA (cont)

98-99	Mfg. to 6/01; Non-ABS Right	G56531
94-99	Mfg. to 6/01 Left	142642 ⁵³
	Mfg. to 6/01 Right	142641 ⁵³
94-97	Left	G56570	G56637
	Right	G56569	G56571

SORENTO

07-09	Left Exc. HPD (High Performance Dampers)	G511054	70078
	Right Exc. HPD (High Performance Dampers)	G511055	70078
03-06	All	143226 ⁵³
	Exc. Self-Leveling Suspension	143226 ⁵³	G64032
	Left	G52036	143226 ⁵³
	Right	G52037	143226 ⁵³

SORENTO READYMOUNTS

		Front		Rear	
		Ultra Readymount	Guardian Readymount	Ultra Readymount	Guardian Readymount
03-06	Left	G57457 ⁴⁰
	Right	G57458 ⁴⁰

SPECTRA

04-09	Left	G52160	G52162	142535 ⁵³
	Right	G52161	G52163	142536 ⁵³
02-03	Left	G56892	G52017
	Right	G56893	G52018
00-01	Left	G52063
	Left Mfg. to 6/01	G56534
	Right	G52064
	Right Mfg. to 6/01	G56533

SPORTAGE



05-10	Left	G56819	G56822	142535 ⁵³
	Right	G56820	G56821	142536 ⁵³
00-02	Left	G56787	143228 ⁶⁷	G63720
	Right	G56786	143228 ⁶⁷	G63720

40 Complete Assembled Unit.

67 Strut Mount Kit. Hardware from O.E. Part may need to be reused.

53 Strut Mount. Hardware from O.E. Part may need to be reused.

APPLICATION GUIDE

Year	Fitment Notes										
		Ultra	ProGuard\ Guardian\ Classic	Max Control\ LTV	Strut Cushion\ Strut Mount	HiJackers\ Load Carrier	Ultra	ProGuard\ Guardian\ Classic	Max Control\ LTV	Strut Cushion\ Strut Mount	HiJackers\ Load Carrier

KIA

KIA

SPORTAGE (cont)

95-99	All	G51227	143064 ⁵¹ 143228 ⁶⁷	G63720
-------	-----	--------	------	------	--	------	--------	------	------	------	------

SPORTAGE READYMOUNTS

		Front		Rear	
		Ultra Readymount	Guardian Readymount	Ultra Readymount	Guardian Readymount
05-10	Left	G57218 ⁴⁰	G57344 ⁴⁰
	Right	G57219 ⁴⁰	G57343 ⁴⁰

LAND ROVER

LAND ROVER

DISCOVERY

94-99	Exc. Series II	G63506	G63694
-------	----------------	--------	------	------	------	------	--------	------	------	------	------

FREELANDER

02-05	Left	G52638
	Right	G52639

RANGE ROVER

03-08	All	G64074
94-95	All	G63615
	Air(RearSpringType)	G63615	G63694
95	County Classic, Coil (FrontSpringType) & RearSpringType, Exc. Air-Leveling Suspension	G63506
	County Classic, Exc. Air-Leveling Suspension	G63615	G63434
94	Coil(RearSpringType)	G63615	G63434
	County, Coil(RearSpringType)	G63506

LEXUS

LEXUS

ES250

90-91	Left	G55590	M55590	143061 ⁵¹ 143281 ⁵³	G55589	M52573	143061 ⁵¹
	Right	G55590	M55590	143061 ⁵¹ 143281 ⁵³	G55589	M52574	143061 ⁵¹

ES300

03	Left Exc. Electronic Adjustable Suspension	G56673	M56673	143202 ⁵⁴	G56675	M56675
	Right Exc. Electronic Adjustable Suspension	G56674	M56674	143202 ⁵⁴	G56676	M56676
02	All	143057 ⁵¹
	Left Exc. Electronic Adjustable Suspension	G56673	M56673	143202 ⁵⁴ 143057 ⁵¹	G56675	M56675	142837 ⁵³ 143057 ⁵¹
	Right Exc. Electronic Adjustable Suspension	G56674	M56674	143202 ⁵⁴ 143057 ⁵¹	G56676	M56676	142837 ⁵³ 143057 ⁵¹
97-01	All	143057 ⁵¹	143057 ⁵¹
	Left Exc. Electronic Adjustable Suspension	G56506	M56506	142650 ⁵⁴ 143057 ⁵¹	G56675	M56675	142837 ⁵³ 143057 ⁵¹
	Right Exc. Electronic Adjustable Suspension	G56514	M56514	142649 ⁵⁴ 143057 ⁵¹	G56676	M56676	142837 ⁵³ 143057 ⁵¹

40 Complete Assembled Unit.



53 Strut Mount. Hardware from O.E. Part may need to be reused.

67 Strut Mount Kit. Hardware from O.E. Part may need to be reused.

51 Strut Cushion for use with the Strut/Cartridge/Shocks.

54 Kit with Mount and Bearing. Hardware from O.E. Part may need to be reused.

APPLICATION GUIDE

Year	Fitment Notes										
		Ultra	ProGuard/ Guardian/ Classic	Max Control/ LTV	Strut Cushion/ Strut Mount	HiJackers/ Load Carrier	Ultra	ProGuard/ Guardian/ Classic	Max Control/ LTV	Strut Cushion/ Strut Mount	HiJackers/ Load Carrier

LEXUS

LEXUS

ES300 (cont)

95-96	Left	G56502	M56502	142836 ⁵⁴ 143057 ⁵¹	G55675	M55675	143057 ⁵¹
	Right	G56502	M56502	142836 ⁵⁴ 143057 ⁵¹	G55676	M55676	143057 ⁵¹
92-94	All	143057 ⁵¹	143057 ⁵¹
	Left Sealed O.E. Struts	143057 ⁵¹	G55675	M55675	143057 ⁵¹
	Right Sealed O.E. Struts	143057 ⁵¹	G55676	M55676	143057 ⁵¹
	Sealed O.E. Struts	G55914	143057 ⁵¹	143057 ⁵¹

ES300 READYMOUNTS

		Front		Rear	
		Ultra Readymount	Guardian Readymount	Ultra Readymount	Guardian Readymount
02-03	Left	G57041 ⁴⁰	M57041 ⁴⁰	G57043 ⁴⁰	M57043 ⁴⁰
	Right	G57042 ⁴⁰	M57042 ⁴⁰	G57044 ⁴⁰	M57044 ⁴⁰
02	Left Exc. Electronic Adjustable Suspension	G56932 ⁴⁰	M56932 ⁴⁰
	Right Exc. Electronic Adjustable Suspension	G56933 ⁴⁰	M56933 ⁴⁰
97-01	Left Exc. Electronic Adjustable Suspension	G56930 ⁴⁰	M56930 ⁴⁰	G56932 ⁴⁰	M56932 ⁴⁰
	Right Exc. Electronic Adjustable Suspension	G56931 ⁴⁰	M56931 ⁴⁰	G56933 ⁴⁰	M56933 ⁴⁰
92-96	Left Exc. Electronic Adjustable Suspension	G56932 ⁴⁰	M56932 ⁴⁰
	Right Exc. Electronic Adjustable Suspension	G56933 ⁴⁰	M56933 ⁴⁰

ES330

04-06	Exc. Adaptive Variable Suspension	143202 ⁵⁴
	Left	M52815
	Left Exc. Adaptive Variable Suspension	G56721	G56728
	Right	M52816
	Right Exc. Adaptive Variable Suspension	G56722	G56729

ES330 READYMOUNTS

		Front		Rear	
		Ultra Readymount	Guardian Readymount	Ultra Readymount	Guardian Readymount
04-06	Left	G57529 ⁴⁰	G57078 ⁴⁰
	Right	G57530 ⁴⁰	G57079 ⁴⁰

ES350

12	Left	G52103
	Right	G52104
10-11	Left	143402 ⁶⁸	G52103
	Right	143402 ⁶⁸	G52104
07-09	Left	G56888	143402 ⁶⁸	G52103
	Right	G56889	143402 ⁶⁸	G52104

ES350 READYMOUNTS

		Front		Rear	
		Ultra Readymount	Guardian Readymount	Ultra Readymount	Guardian Readymount
07-11	Left	G57190 ⁴⁰

40 Complete Assembled Unit.



54 Kit with Mount and Bearing. Hardware from O.E. Part may need to be reused.

Bold Type - New / Future Part

51 Strut Cushion for use with the Strut/Cartridge/Shocks.

68 Strut Mount Kit. Hardware from O.E. Part may need to be reused.

APPLICATION GUIDE





Year	Fitment Notes										
		Ultra	ProGuard\ Guardian\ Classic	Max Control\ LTV	Strut Cushion\ Strut Mount	HiJackers\ Load Carrier	Ultra	ProGuard\ Guardian\ Classic	Max Control\ LTV	Strut Cushion\ Strut Mount	HiJackers\ Load Carrier

LEXUS



LEXUS

ES350 READYMOUNTS (cont)		Front				Rear			
		Ultra Readymount	Guardian Readymount	Ultra Readymount	Guardian Readymount				
07-11	Right	G57191 ⁴⁰				



GS300

98-05	All	 G56598	143200 ⁵³	 G56599	143408 ⁶⁸
93-97	All	 G56594	143200 ⁵³	 G56595





GS400

98-00	All	 G56598	143200 ⁵³	 G56599	143408 ⁶⁸
-------	-----	--	------	------	----------------------	------	--	------	------	-----------------------------	------



GS430

01-05	All	 G56598	143200 ⁵³	 G56599	143408 ⁶⁸
-------	-----	--	------	------	----------------------	------	--	------	------	-----------------------------	------









IS250

06-11	Left	 G51920	 G51922
	Right	 G51921	 G51922

IS300

05	All			143408 ⁶⁸
01-04	All	 G51834	 G51835	143408 ⁶⁸



LS400

95-00	Exc. Auto-Leveling System			143198 ⁵³
	Coil(RearSpringType)	 G56592	 G56600
90-94	Exc. Auto-Leveling System		143199 ⁵³		143197 ⁵³
	Coil(RearSpringType)	 G56592	 G56593



LS400 READYMOUNTS

		Front		Rear	
		Ultra Readymount	Guardian Readymount	Ultra Readymount	Guardian Readymount
90-00	All	G57421 ⁴⁰	G57420 ⁴⁰



LS430

01-06	All	 G51832	 G51833
-------	-----	--	------	------	------	------	--	------	------	------	------







LX450

96-97	All	 G63615	 G63616
-------	-----	--	------	------	------	------	--	------	------	------	------

LX470

98-06	Torsion Bar(FrontSpringType)	 G63832	 G63828
-------	------------------------------	--	------	------	------	------	--	------	------	------	------

RX300

99-03	Left	 G56548	142650 ⁵⁴		142837 ⁵³
	Right	 G56547	142649 ⁵⁴		142837 ⁵³
	AWD, Left		 G56681



40 Complete Assembled Unit.

54 Kit with Mount and Bearing. Hardware from O.E. Part may need to be reused.

53 Strut Mount. Hardware from O.E. Part may need to be reused.

68 Strut Mount Kit. Hardware from O.E. Part may need to be reused.



APPLICATION GUIDE

Year	Fitment Notes										
		Ultra	ProGuard/ Guardian/ Classic	Max Control/ LTV	Strut Cushion/ Strut Mount	HiJackers/ Load Carrier	Ultra	ProGuard/ Guardian/ Classic	Max Control/ LTV	Strut Cushion/ Strut Mount	HiJackers/ Load Carrier

LEXUS











LEXUS

RX300 (cont)

99-03	AWD, Right		G56682
	FWD, Left		G56554
	FWD, Right		G56553



















RX300 READYMOUNTS		Front		Rear	
		Ultra Readymount	Guardian Readymount	Ultra Readymount	Guardian Readymount
99-03	Left	G57610 ⁴⁰	G57612 ⁴⁰
	Right	G57613 ⁴⁰
	AWD, Left	G57614 ⁴⁰
	AWD, Right	G57615 ⁴⁰

RX330

04-06	All		143202 ⁵⁴	
	Left Exc. Air Suspension		G56730	143202 ⁵⁴	143387 ⁶⁸	
	Right Exc. Air Suspension		G56731	143202 ⁵⁴	143388 ⁶⁸	
	AWD, Left Exc. Air Suspension		143202 ⁵⁴		G56732
	AWD, Right Exc. Air Suspension		143202 ⁵⁴		G56733
	FWD, Left Exc. Air Suspension		143202 ⁵⁴		G56734
	FWD, Right Exc. Air Suspension		143202 ⁵⁴		G56735

RX330 READYMOUNTS		Front		Rear	
		Ultra Readymount	Guardian Readymount	Ultra Readymount	Guardian Readymount
04-06	Left	G57152 ⁴⁰
	Right	G57153 ⁴⁰
	AWD, Left	G57150 ⁴⁰
	AWD, Right	G57151 ⁴⁰

RX350

11-15	Left w/o Air Suspension		G52447		
	Right w/o Air Suspension		G52448		
10	All			G64163
	Left w/o Air Suspension		G52447		G64163
	Right w/o Air Suspension		G52448		G64163
07-09	FWD, Left Exc. Air Suspension			G56734
	FWD, Right Exc. Air Suspension			G56735
09	Left			143387 ⁶⁸
	Left Exc. Air Suspension		G56730	
	Right			143388 ⁶⁸



40 Complete Assembled Unit.

68 Strut Mount Kit. Hardware from O.E. Part may need to be reused.

Bold Type - New / Future Part

54 Kit with Mount and Bearing. Hardware from O.E. Part may need to be reused.









APPLICATION GUIDE

Year	Fitment Notes										
		Ultra	ProGuard\ Guardian\ Classic	Max Control\ LTV	Strut Cushion\ Strut Mount	HiJackers\ Load Carrier	Ultra	ProGuard\ Guardian\ Classic	Max Control\ LTV	Strut Cushion\ Strut Mount	HiJackers\ Load Carrier

LEXUS

LEXUS









RX350 (cont)

09	Right Exc. Air Suspension	 G56731		
07-08	Left Exc. Air Suspension	 G56730		143387 ⁶⁸
	Right Exc. Air Suspension	 G56731		143388 ⁶⁸
07	AWD, Left Exc. Air Suspension	 G56732
	AWD, Right Exc. Air Suspension	 G56733

RX350 READYMOUNTS

		Front		Rear	
		Ultra Readymount	Guardian Readymount	Ultra Readymount	Guardian Readymount
10-14	Left	G57562 ⁴⁰
	Right	G57563 ⁴⁰
07-09	FWD, Left	G57616 ⁴⁰	G57618 ⁴⁰
	FWD, Right	G57617 ⁴⁰	G57619 ⁴⁰



RX400H

08	Left			143387 ⁶⁸
	Right			143388 ⁶⁸
06-07	Left		143202 ⁵⁴		143387 ⁶⁸
	Right		143202 ⁵⁴		143388 ⁶⁸



RX400H READYMOUNTS

		Front		Rear	
		Ultra Readymount	Guardian Readymount	Ultra Readymount	Guardian Readymount
06-08	Left	G57584 ⁴⁰
	Right	G57585 ⁴⁰
07	FWD, Left	G57588 ⁴⁰
	FWD, Right	G57589 ⁴⁰
06	AWD, Left	G57590 ⁴⁰
	AWD, Right	G57591 ⁴⁰
	FWD, Left	G57586 ⁴⁰
	FWD, Right	G57587 ⁴⁰





SC300

92-00	All	 G51709	 G51710
-------	-----	--	------	------	------	------	--	------	------	------	------

SC400

92-00	All	 G51709	 G51710
-------	-----	--	------	------	------	------	--	------	------	------	------



SC430

06-07	All	 G56598	143200 ⁵³	
02-05	All	 G56598	143200 ⁵³	 G51995

LINCOLN

LINCOLN

AVIATOR

03-05	All	 G51836	 G51837
-------	-----	--	------	------	------	------	--	------	------	------	------



40 Complete Assembled Unit.

54 Kit with Mount and Bearing. Hardware from O.E. Part may need to be reused.

53 Strut Mount. Hardware from O.E. Part may need to be reused.

68 Strut Mount Kit. Hardware from O.E. Part may need to be reused.









APPLICATION GUIDE

Year	Fitment Notes										
		Ultra	ProGuard\ Guardian\ Classic	Max Control\ LTV	Strut Cushion\ Strut Mount	HiJackers\ Load Carrier	Ultra	ProGuard\ Guardian\ Classic	Max Control\ LTV	Strut Cushion\ Strut Mount	HiJackers\ Load Carrier





LINCOLN

LINCOLN



CONTINENTAL

82-87	All	 G55510 ³⁹	143059 ⁵¹	 69709 ⁹	81461	49196 ⁷
70-80	All	 69675 ⁵	81446	34073 ⁸	 69606	81495	43140 ⁸ 49205 ⁷
64-69	All		82615		82067
61-63	All		82615	





LS

05-06	All		143242 ⁵³	 G51757	143242 ⁵³
00-04	All	 G51756	143242 ⁵³	 G51757	143242 ⁵³











MARK III

68-71	All	 69675 ⁵	81446	34073 ⁸	 69606	81495	43140 ⁸ 49205 ⁷
-------	-----	--	-------	------	------	--------------------	---	-------	------	------	--

MARK IV

73-76	All	 69675 ⁵	81446	34073 ⁸		82603
72	All	 69675 ⁵	81446	34073 ⁸	 69606	81495	43140 ⁸ 49205 ⁷

MARK LT

10-12	All		 G64079
	AWD	 G51864	 G64079
06-08	All		143248 ⁵³	
	4WD	 G51704	M51704	143248 ⁵³	 G63867
	RWD	 G51703	M51703	143248 ⁵³	 G63870



MARK LT READYMOUNTS

		Front		Rear	
		Ultra Readymount	Guardian Readymount	Ultra Readymount	Guardian Readymount
06-08	4WD	G57020 ⁴⁰	M57020⁴⁰
	RWD	G57021 ⁴⁰	M57021⁴⁰



MARK V

77-79	All	 69675 ⁵	81446	34073 ⁸		82603
-------	-----	--	-------	------	------	--------------------	---	-------	------	------	------







MARK VI

80-83	All	 69675 ⁵	81446	34073 ⁸	 69606	81495	43140 ⁸ 49205 ⁷
-------	-----	--	-------	------	------	--------------------	---	-------	------	------	--

MARK VII

84-92	All	 G55510 ³⁹	143059 ⁵¹	 69709 ⁹	81461
-------	-----	--	------	------	----------------------	------	--	-------	------	------	------

MKS

09-12	All		 70096
	Left w/ Suspension Code A and B	 G52398	 70096
	Right w/ Suspension Code A and B	 G52399	 70096

5 Use kit No. 140719 to replace O.E. hardware for lower shock absorber mounting when studs break or self-tapping screws are not longer useable.

8 Pair Packs.

39 Conventional gas-charged strut can be used to replace O.E. air adjustable gas-charged strut. However, the self-leveling system must be deactivated. See Ref. A for instructions.

51 Strut Cushion for use with the Strut/Cartridge/Shocks.

7 Pair Packs, air hose kit included.

9 See Ref. D for procedures to replace Elec Adj Susp with non-adj product.

40 Complete Assembled Unit.

53 Strut Mount. Hardware from O.E. Part may need to be reused.

Bold Type - New / Future Part

APPLICATION GUIDE

Year	Fitment Notes										
			Ultra	ProGuard/ Guardian/ Classic	Max Control/ LTV	Strut Cushion/ Strut Mount	HiJackers/ Load Carrier		Ultra	ProGuard/ Guardian/ Classic	Max Control/ LTV

LINCOLN MKT

LINCOLN

13-16	All			G51996
10-12	Left		G52384		G51996
	Right		G52385		G51996

MKX

11-14	Left		G52351		G64111
	Right		G52352		G64111
10	Left		G56840	143415⁵³
	Right		G56841	143415⁵³
07-09	Left		G56840	143415⁵³		G64037
	Right		G56841	143415⁵³		G64037

MKX READYMOUNTS

		Front		Rear	
		Ultra Readymount	Guardian Readymount	Ultra Readymount	Guardian Readymount
11-14	Left	G57491⁴⁰	
	Right	G57492⁴⁰	

MKZ

10-12	Left		G51896	143392 ⁵⁴
	Right		G51897	143392 ⁵⁴
	FWD			69591
07-09	All		G51859	143392 ⁵⁴
	FWD		G51859	143392 ⁵⁴		69591

MKZ READYMOUNTS

		Front		Rear	
		Ultra Readymount	Guardian Readymount	Ultra Readymount	Guardian Readymount
10-12	All	G57427⁴⁰	

NAVIGATOR

16	All		143424⁶⁸		G51861
	4WD, RWD, Exc. Air Suspension		143424⁶⁸		G51861	143393⁶⁸
14-15	All		143424⁶⁸
	Exc. Air Suspension		143424⁶⁸		G51861
	4WD, RWD, Exc. Air Suspension		143424⁶⁸	143393⁶⁸
11-13	Exc. Air Suspension		G51860	143424⁶⁸		G51861
	4WD, RWD, Exc. Air Suspension		G51860	143424⁶⁸	143393⁶⁸
10-13	All		G51860	143424⁶⁸



40 Complete Assembled Unit.

54 Kit with Mount and Bearing. Hardware from O.E. Part may need to be reused.

53 Strut Mount. Hardware from O.E. Part may need to be reused.

68 Strut Mount Kit. Hardware from O.E. Part may need to be reused.

APPLICATION GUIDE

Year	Fitment Notes										
		Ultra	ProGuard\ Guardian\ Classic	Max Control\ LTV	Strut Cushion\ Strut Mount	HiJackers\ Load Carrier	Ultra	ProGuard\ Guardian\ Classic	Max Control\ LTV	Strut Cushion\ Strut Mount	HiJackers\ Load Carrier

LINCOLN

LINCOLN

NAVIGATOR (cont)

10	Exc. Air Suspension	↓	G51860	143424 ⁶⁸	↓	G51861	143393 ⁶⁸
07-09	All	↓	G51860	143424 ⁶⁸	↓	G51861	143393 ⁶⁸
06	All	↓	↓	G51729
	4WD	↓	G51720	M52804	↓	G51729
03-05	All	↓	143244 ⁵³	↓	G51729
	4WD	↓	G51720	M52804	143244 ⁵³	↓	G51729
98-02	4WD, Air(RearSpringType)	↓	↓	G64002	61703
	Coil(FrontSpringType)	↓	61611	↓
	RWD	↓	G63714	81912	58714 77714	↓	G63717	61614	77717
	RWD, Coil(FrontSpringType)	↓	↓	58717

NAVIGATOR READYMOUNTS

		Front		Rear	
		Ultra Readymount	Guardian Readymount	Ultra Readymount	Guardian Readymount
14-16	4WD, RWD, Exc. Air Suspension	G57173 ⁴⁰
10-13	All	G57172 ⁴⁰
	4WD, RWD, Exc. Air Suspension	G57172 ⁴⁰	G57173 ⁴⁰
03-06	All	G57015 ⁴⁰	G57016 ⁴⁰	M57308 ⁴⁰

TOWN CAR

03-11	Limo Models	↓	G51888	↓	69574	77955
	Exc. Limo	↓	G51887	M52817	143356 ⁵³ 143357 ⁶⁸	↓	69575
81-02	All	↓	69675 ⁵	81446	34073 ⁸	↓	69606	81495	43140 ⁹ 49205 ⁷

TOWN CAR READYMOUNTS

		Front		Rear	
		Ultra Readymount	Guardian Readymount	Ultra Readymount	Guardian Readymount
03-11	Exc. Limo	G57080 ⁴⁰	M57299 ⁴⁰

VERSAILLES

77-80	All	↓	81491	↓	82130
-------	-----	---	------	-------	------	------	------	---	------	-------	------	------	------

ZEPHYR

06	All	↓	G51859	143392 ⁵⁴	↓	69591
----	-----	---	--------	------	------	----------------------	------	---	-------	------	------	------	------

MAZDA

MAZDA

2

12-14	All	↓	143399 ⁵⁴	↓	70052
11	Left	↓	G52255	143399 ⁵⁴	↓	70052	143400 ⁵³
	Right	↓	G52256	143399 ⁵⁴	↓	70052	143400 ⁵³

5 Use kit No. 140719 to replace O.E. hardware for lower shock absorber mounting when studs break or self-tapping screws are not longer useable.

8 Pair Packs.

53 Strut Mount. Hardware from O.E. Part may need to be reused.

68 Strut Mount Kit. Hardware from O.E. Part may need to be reused.



Bold Type - New / Future Part

7 Pair Packs, air hose kit included.

40 Complete Assembled Unit.

54 Kit with Mount and Bearing. Hardware from O.E. Part may need to be reused.

APPLICATION GUIDE

Year	Fitment Notes										
		Ultra	ProGuard\ Guardian\ Classic	Max Control\ LTV	Strut Cushion\ Strut Mount	HiJackers\ Load Carrier	Ultra	ProGuard\ Guardian\ Classic	Max Control\ LTV	Strut Cushion\ Strut Mount	HiJackers\ Load Carrier

MAZDA

MAZDA

3

12-13	All	G51983
	Mazdaspeed, Left	G52449	G51983
	Mazdaspeed, Right	G52450	G51983
13	Exc. Mazdaspeed Left	G52005	G51983
	Exc. Mazdaspeed Right	G52006	G51983
12	Exc. Mazdaspeed Left	G52005	143365 ⁶⁸	G51983
	Exc. Mazdaspeed Right	G52006	143365 ⁶⁸	G51983
10-11	All	G51983	143531 ⁵³
	Exc. Mazdaspeed Left	G52005	143365 ⁵³	G51983	143531 ⁵³
	Exc. Mazdaspeed Right	G52006	143365 ⁵³	G51983	143531 ⁵³
	Mazdaspeed, Left	G52449	G51983	143531 ⁵³
	Mazdaspeed, Right	G52450	G51983	143531 ⁵³
07-09	All	143531 ⁵³
	Mazdaspeed, Left	G52449	143531 ⁵³
	Mazdaspeed, Right	G52450	143531 ⁵³
04-09	Exc. Mazdaspeed Left	G52005	143365 ⁵³	70003	143531 ⁵³
	Exc. Mazdaspeed Right	G52006	143365 ⁵³	70003	143531 ⁵³
04-06	All	70003	143531 ⁵³

3 READYMOUNTS

		Front		Rear	
		Ultra Readymount	Guardian Readymount	Ultra Readymount	Guardian Readymount
04-13	Exc. Mazdaspeed Left	G57093 ⁴⁰	M57309 ⁴⁰
	Exc. Mazdaspeed Right	G57094 ⁴⁰	M57310 ⁴⁰

5

12-13	Left	G52519	G511040 ¹
	Right	G52520	G511040 ¹
06-10	Left	G52005	143365 ⁶⁸	70003	143531 ⁵³
	Right	G52006	143365 ⁶⁸	70003	143531 ⁵³

5 READYMOUNTS

		Front		Rear	
		Ultra Readymount	Guardian Readymount	Ultra Readymount	Guardian Readymount
06-10	Left	G57093 ⁴⁰	M57309 ⁴⁰
	Right	G57094 ⁴⁰	M57310 ⁴⁰



1 Future Part, available 1st Quarter of 2017.

53 Strut Mount. Hardware from O.E. Part may need to be reused.

40 Complete Assembled Unit.

68 Strut Mount Kit. Hardware from O.E. Part may need to be reused.













APPLICATION GUIDE

Year	Fitment Notes										
		Ultra	ProGuard\ Guardian\ Classic	Max Control\ LTV	Strut Cushion\ Strut Mount	HiJackers\ Load Carrier	Ultra	ProGuard\ Guardian\ Classic	Max Control\ LTV	Strut Cushion\ Strut Mount	HiJackers\ Load Carrier

MAZDA

6









MAZDA

09-13	Left		G51984		70110
	Right		G51985		70110
05-08	Left		G51810	143392 ⁵⁴		69591
	Right		G51811	143392 ⁵⁴		69591
03-04	Left		G51810	143224 ⁵³		69591
	Right		G51811	143224 ⁵³		69591

6 READYMOUNTS

		Front		Rear	
		Ultra Readymount	Guardian Readymount	Ultra Readymount	Guardian Readymount
14-15	Left	G57455⁴⁰
	Right	G57456⁴⁰
09-13	Left	G57455⁴⁰
	Right	G57456⁴⁰
03-08	All	G57270⁴⁰



















323

90-94	All		G55847	M55847	143057 ⁵¹		G55848	M55848	142190 ⁵³
86-89	Exc. Electronic Adjustable Suspension		142183 ⁵³	
	FWD		143058 ⁵¹		143058 ⁵¹
	FWD, Exc. Electronic Adjustable Suspension		G55710		G55544

323 READYMOUNTS

		Front		Rear	
		Ultra Readymount	Guardian Readymount	Ultra Readymount	Guardian Readymount
95	All	G56940 ⁴⁰	M56940⁴⁰
91-94	All	G56911 ⁴⁰	M56911⁴⁰	G56940 ⁴⁰	M56940⁴⁰
90	All	G56911 ⁴⁰	M56911⁴⁰

626

98-02	Left		G56689	143218 ⁵³		G56691
	Right		G56690	143218 ⁵³		G56691	143112 ⁵³
93-97	Left		G55671	142856 ⁵⁴		G55672	143057 ⁵¹
	Right		G55670	142856 ⁵⁴		G55672	143057 ⁵¹
88-92	Exc. Electronic Adjustable Suspension or 4 Wheel Steer		G55600 ⁹	143060 ⁵¹		G55601 ⁹	142196 ⁵³ 143057 ⁵¹
	Automatic Exc. Electronic Adjustable Suspension or 4 Wheel Steer		142562 ⁵⁷	
86-87	Exc. Electronic Adjustable Suspension		G55727		G55729
	Automatic Exc. Electronic Adjustable Suspension		143057 ⁵¹		143057 ⁵¹
83-85	All		143057 ⁵¹		143057 ⁵¹

9 See Ref. D for procedures to replace Elec Adj Susp with non-adj product.

51 Strut Cushion for use with the Strut/Cartridge/Shocks.

54 Kit with Mount and Bearing. Hardware from O.E. Part may need to be reused.



Bold Type - New / Future Part

40 Complete Assembled Unit.

53 Strut Mount. Hardware from O.E. Part may need to be reused.

67 Strut Mount Kit. Hardware from O.E. Part may need to be reused.

APPLICATION GUIDE

Year	Fitment Notes										
		Ultra	ProGuard\ Guardian\ Classic	Max Control\ LTV	Strut Cushion\ Strut Mount	HiJackers\ Load Carrier	Ultra	ProGuard\ Guardian\ Classic	Max Control\ LTV	Strut Cushion\ Strut Mount	HiJackers\ Load Carrier

MAZDA

MAZDA

626 (cont)

83-85	Exc. Electronic Adjustable Suspension	↓	G55727	143057 ⁵¹	↓	G55729	143057 ⁵¹
-------	---------------------------------------	---	--------	------	------	----------------------	------	---	--------	------	------	----------------------	------

808

72-77	Wagon Exc. Vehicles with Tokico O.E. Struts	↓	↓	81270
-------	---	---	------	------	------	------	------	---	------	-------	------	------	------

929

90-91	Exc. Electronic Adjustable Suspension	↓	G56716	↓	G51192 ⁹
88-89	Exc. Electronic Adjustable Suspension	↓	G56713	142562 ⁶⁷	↓	G51192 ⁹

B1600

72-76	All	↓	G63421	61504 81750	58421 77421	↓	82125
-------	-----	---	--------	----------------	----------------	------	------	---	------	-------	------	------	------

B1800

77-78	All	↓	G63421	61504 81750	58421 77421	↓	82125
-------	-----	---	--------	----------------	----------------	------	------	---	------	-------	------	------	------

B2000

86-87	RWD	↓	G63495	61593 81553	↓	G63907	61500 81147	77907	43048 ⁸ 49310 ⁷
79-84	All	↓	G63421	61504 81750	58421 77421	↓	82125

B2200

87-93	RWD	↓	G63495	61593 81553	↓	G63907	61500 81147	77907	43048 ⁸ 49310 ⁷
82-84	All	↓	G63421	61504 81750	58421 77421	↓	82125

B2300

07-09	RWD	↓	G63772	61626 81916	77772	↓	61627	77525
01-06	RWD	↓	G63772	61626 81916	77772	↓	G63773	61627	77525
94-97	All	↓	G63614	61561 81744	58929 77614	↓
	RWD	↓	G63614	61561 81744	58929 77614	↓	G63525	61559 81730	77525	49223 ⁷
95-96	4WD	↓	G63614	61561 81744	58929 77614	↓	G63524	61573 81905	77524

B2500

98-01	All	↓	↓	G63773	81917
	RWD	↓	G63772	61626 81916	77772	↓	G63773	61627 81917	77525

B2600

87-93	4WD	↓	G63635	61596	↓	G63639	61597
	RWD	↓	G63495	61593 81553	↓	G63907	61500 81147	77907	43048 ⁸ 49310 ⁷

B3000

07	4WD	↓	G63678	61623 81893	77678	↓	G63775	61629	77524
	4WD	↓	↓	81918
	RWD	↓	G63772	61626 81916	77772	↓	61627 81917	77525
98-06	RWD	↓	G63772	61626 81916	77772	↓	G63773	61627 81917	77525
06	4WD	↓	G63678	↓	G63775

7 Pair Packs, air hose kit included.

9 See Ref. D for procedures to replace Elec Adj Susp with non-adj product.

8 Pair Packs.

51 Strut Cushion for use with the Strut/Cartridge/Shocks.

APPLICATION GUIDE

Year	Fitment Notes	Front					Rear				
		Ultra	ProGuard/ Guardian/ Classic	Max Control/ LTV	Strut Cushion/ Strut Mount	HiJackers/ Load Carrier	Ultra	ProGuard/ Guardian/ Classic	Max Control/ LTV	Strut Cushion/ Strut Mount	HiJackers/ Load Carrier

MAZDA

MAZDA

B3000 (cont)

06	4WD	⊥ ⊕	61623 81893	77678	⊕ ⊕	61629 81918	77524
05	4WD	⊥ ⊕	G63678	61623 81893	77678	⊕ ⊕	G63775	61629 81918	77524
03-04	4WD	⊥ ⊕	61623 81893	77678	⊕ ⊕	61629 81918	77524
03	4WD	⊥ ⊕	G63678	⊕ ⊕
98-02	4WD	⊥ ⊕	G63678	61623 81893	77678	⊕ ⊕	G63775	61629 81918	77524
94-97	All	⊥ ⊕	G63614	61561 81744	⊕ ⊕
	4WD	⊥ ⊕	G63614	61561 81744	⊕ ⊕	G63524	81905
	RWD	⊥ ⊕	G63614	61561 81744	77614	⊕ ⊕	G63525	61559 81730	77525

B4000

07-09	4WD	⊥ ⊕	G63678	61623 81893	77678	⊕ ⊕	G63775	61629 81918	77524
	RWD	⊥ ⊕	61626 81916	77772	⊕ ⊕	61627 81917	77525
05-06	4WD	⊥ ⊕	G63678	61623 81893	77678	⊕ ⊕	G63775	61629	77524
98-06	RWD	⊥ ⊕	G63772	61626 81916	77772	⊕ ⊕	G63773	61627 81917	77525
98-04	4WD	⊥ ⊕	G63678	61623 81893	77678	⊕ ⊕	G63775	61629 81918	77524
95-97	RWD	⊥ ⊕	G63614	61561 81744	77614	⊕ ⊕	G63525	77525
94-97	All	⊥ ⊕	G63614	81744	⊕ ⊕
	4WD	⊥ ⊕	G63614	81744	⊕ ⊕	G63524	81905
94	RWD	⊥ ⊕	G63614	61561 81744	77614	⊕ ⊕	G63525	61559	77525

CX-7

07-10	Left	⊥ ⊕	G52209	⊕ ⊕	G64056
	Right	⊥ ⊕	G52210	⊕ ⊕	G64056

CX-7 READYMOUNTS

		Front		Rear	
		Ultra Readymount	Guardian Readymount	Ultra Readymount	Guardian Readymount
07-12	Left	G57361 ⁴⁰
	Right	G57362 ⁴⁰

CX-9

07-13	Left	⊥ ⊕	G52260
	Right	⊥ ⊕	G52261

GLC

84-85	All	⊥ ⊕	G55710	⊥ ⊕	143057 ⁵¹
	Hatchback	⊥ ⊕	G55710	142183 ⁵³ 143059 ⁵¹	⊥ ⊕	G55544	143057 ⁵¹
	Sedan	⊥ ⊕	G55710	142183 ⁵³ 143059 ⁵¹	⊥ ⊕	G55544	143057 ⁵¹
81-83	Sedan	⊥ ⊕	G55710	142183 ⁵³ 143059 ⁵¹	⊥ ⊕	G55544	143057 ⁵¹
79-83	Wagon	⊥ ⊕	⊥ ⊕	81270	49105 ⁷

7 Pair Packs, air hose kit included.



51 Strut Cushion for use with the Strut/Cartridge/Shocks.

Bold Type - New / Future Part

40 Complete Assembled Unit.

53 Strut Mount. Hardware from O.E. Part may need to be reused.

APPLICATION GUIDE

Year	Fitment Notes										
		Ultra	ProGuard\Guardian\Classic	Max Control\LTV	Strut Cushion\Strut Mount	HiJackers\Load Carrier	Ultra	ProGuard\Guardian\Classic	Max Control\LTV	Strut Cushion\Strut Mount	HiJackers\Load Carrier

MAZDA

MAZDA

GLC (cont)

83	Hatchback	↑	142183 ⁵³ 143059 ⁵¹	↑	G55544	143057 ⁵¹
81-82	Hatchback	↑	G55710	142183 ⁵³ 143059 ⁵¹	↑	G55544	143057 ⁵¹
78	All	↑	↑	81270	49105 ⁷

MIATA

04-05	Base, LS	↑	G56596	↑	G56597
03	Base, LS, SE	↑	G56596	↑	G56597
99-02	All	↑	G56596	↑	G56597
90-97	Non-ABS	↑	G51195	142237 ⁵⁴	↑	G51196	142237 ⁵⁴ 143064 ⁵¹
90	All	↑	↑	143064 ⁵¹

MILLENNIA

97-02	Left	↑	G51827	↑	G51826
	Right	↑	G51828	↑	G51826
95-96	All	↑	↑	G51826

MPV

01-06	Left	↑	G56625	142562 ⁶⁷ 143061 ⁵¹ 143267 ⁵³	○	69782 G63864
	Right	↑	G56624	142562 ⁶⁷ 143061 ⁵¹ 143267 ⁵³	○	69782 G63864
00	All	↑	142562 ⁶⁷ 143061 ⁵¹ 143267 ⁵³	○	69782 G63864
	Left Mfg. from 8/00	↑	G56625	142562 ⁶⁷ 143061 ⁵¹ 143267 ⁵³	○	69782 G63864
	Left Mfg. to 8/00	↑	G56589	142562 ⁶⁷ 143061 ⁵¹ 143267 ⁵³	○	69782 G63864
	Right Mfg. from 8/00	↑	G56624	142562 ⁶⁷ 143061 ⁵¹ 143267 ⁵³	○	69782 G63864
	Right Mfg. to 8/00	↑	G56588	142562 ⁶⁷ 143061 ⁵¹ 143267 ⁵³	○	69782 G63864
95-98	4WD	↑	G56715	○	G63640	61598
89-98	RWD	↑	G56714	○	G63606	61589	49229 ⁷
89-94	4WD	↑	○	G63640	61598
	4WD, Exc. Hydraulic Self Leveling System	↑	G56715	○

MX-5

09-15	17" Wheels	↑	↑	G51907
06-08	All	↑	G51906	↑	G51907



7 Pair Packs, air hose kit included.

53 Strut Mount. Hardware from O.E. Part may need to be reused.

51 Strut Cushion for use with the Strut/Cartridge/Shocks.

54 Kit with Mount and Bearing. Hardware from O.E. Part may need to be reused.

APPLICATION GUIDE

Year	Fitment Notes										
		Ultra	ProGuard/ Guardian/ Classic	Max Control/ LTV	Strut Cushion/ Strut Mount	HiJackers/ Load Carrier	Ultra	ProGuard/ Guardian/ Classic	Max Control/ LTV	Strut Cushion/ Strut Mount	HiJackers/ Load Carrier

MAZDA

MAZDA

MX-5 MIATA

09-15	17" Wheels	G51907
06-08	All	G51906	143412⁶⁷	G51907	143412⁶⁷

MX6

93-97	All	142856 ⁵⁴	G55672	143057 ⁵¹
	Exc. Electronic Adjustable Suspension or 4 Wheel Steer	143060 ⁵¹ 142856 ⁵⁴	G55672	143057 ⁵¹
	Left	G55671	142856 ⁵⁴	G55672	143057 ⁵¹
	Right	G55670	142856 ⁵⁴	G55672	143057 ⁵¹
88-92	All	143057 ⁵¹
	Exc. Electronic Adjustable Suspension or 4 Wheel Steer	G55600 ⁹	143060 ⁵¹	G55601 ⁹	142196 ⁵³ 143057 ⁵¹
	Automatic Exc. Electronic Adjustable Suspension or 4 Wheel Steer	142562 ⁶⁷	143057 ⁵¹

NAVAJO

91-94	All	G63608	61591 81744	58929 77608	34076 ⁸	G63607	61590 81823	77607	43172 ⁸ 49225 ⁷
-------	-----	--------	----------------	----------------	-------	--------------------	--------	----------------	-------	-------	--

NAVAJO STEERING STABILIZERS

						Front	Rear
91-94	All					6802SE ⁸⁴

PROTÉGÉ / PROTÉGÉS

03	All	143057 ⁵¹	143058 ⁵¹
	Left	143057 ⁵¹	G56538	143221 ⁵³ 143058 ⁵¹
	Left Mfg. from 10/00	G56634	143057 ⁵¹	143058 ⁵¹
	Right	143057 ⁵¹	G56537	143223 ⁵³ 143058 ⁵¹
	Right Mfg. from 10/00	G56633	143057 ⁵¹	143058 ⁵¹
	DX, ES, LX, SE, Left	143219 ⁵³ 143057 ⁵¹	143221 ⁵³ 143058 ⁵¹
	DX, ES, LX, SE, Right	143219 ⁵³ 143057 ⁵¹	143223 ⁵³ 143058 ⁵¹
	Exc. MP3 and Mazdaspeed Models Left	143057 ⁵¹	G56538	143058 ⁵¹
	Exc. MP3 and Mazdaspeed Models Right	143057 ⁵¹	G56537	143058 ⁵¹
01-02	Exc. MP3 and Mazdaspeed Models Left	143057 ⁵¹ 143219 ⁵³	G56538	143058 ⁵¹
	Exc. MP3 and Mazdaspeed Models Right	143057 ⁵¹ 143219 ⁵³	G56537	143058 ⁵¹
00-02	Left Mfg. from 10/00	G56634	143057 ⁵¹ 143219 ⁵³	143058 ⁵¹
	Right Mfg. from 10/00	G56633	143057 ⁵¹ 143219 ⁵³	143058 ⁵¹
99-02	All	143057 ⁵¹ 143219 ⁵³	143058 ⁵¹

7 Pair Packs, air hose kit included.

9 See Ref. D for procedures to replace Elec Adj Susp with non-adj product.

53 Strut Mount. Hardware from O.E. Part may need to be reused.

67 Strut Mount Kit. Hardware from O.E. Part may need to be reused.

Bold Type - New / Future Part



8 Pair Packs.

51 Strut Cushion for use with the Strut/Cartridge/Shocks.

54 Kit with Mount and Bearing. Hardware from O.E. Part may need to be reused.

84 Replacement damper for vehicles with the Gabriel Aftermarket mounting kit

APPLICATION GUIDE

Year	Fitment Notes										
		Ultra	ProGuard\ Guardian\ Classic	Max Control\ LTV	Strut Cushion\ Strut Mount	HiJackers\ Load Carrier	Ultra	ProGuard\ Guardian\ Classic	Max Control\ LTV	Strut Cushion\ Strut Mount	HiJackers\ Load Carrier

MAZDA

MAZDA

PROTÉGÉ / PROTÉGÉ5 (cont)

02	Left	143057 ⁵¹ 143219 ⁵³	G56538	143221 ⁵³ 143058 ⁵¹
	Right	143057 ⁵¹ 143219 ⁵³	G56537	143223 ⁵³ 143058 ⁵¹
01	Left	143057 ⁵¹ 143219 ⁵³	143221 ⁵³ 143058 ⁵¹
	Right	143057 ⁵¹ 143219 ⁵³	143223 ⁵³ 143058 ⁵¹
99-00	Left	143057 ⁵¹ 143219 ⁵³	G56538	143221 ⁵³ 143058 ⁵¹
	Left Mfg. to 10/00	G56536	143057 ⁵¹ 143219 ⁵³	143058 ⁵¹
	Right	143057 ⁵¹ 143219 ⁵³	G56537	143223 ⁵³ 143058 ⁵¹
	Right Mfg. to 10/00	G56535	143057 ⁵¹ 143219 ⁵³	143058 ⁵¹
95-98	Left	G55882	142851 ⁵⁴ 143057 ⁵¹	G55884	143058 ⁵¹
	Right	G55881	142851 ⁵⁴ 143057 ⁵¹	G55883	143058 ⁵¹
92-94	All	143057 ⁵¹	143058 ⁵¹
	FWD, Non-ABS	G55847	M55847	143057 ⁵¹	G55848	M55848	142190 ⁵³ 143058 ⁵¹
90-91	All	143057 ⁵¹
	FWD	143057 ⁵¹	143058 ⁵¹
	FWD, Non-ABS	G55847	M55847	143057 ⁵¹	G55848	M55848	142190 ⁵³

PROTÉGÉ / PROTÉGÉ5 READYMOUNTS

		Front		Rear	
		Ultra Readymount	Guardian Readymount	Ultra Readymount	Guardian Readymount
02-03	Left	G57273 ⁴⁰	G57509 ⁴⁰
	Right	G57272 ⁴⁰	G57510 ⁴⁰
00-01	Left	G57273 ⁴⁰
	Right	G57272 ⁴⁰
90-94	All	G56911 ⁴⁰	M56911 ⁴⁰	G56940 ⁴⁰	M56940 ⁴⁰

RX3

75-76	Wagon	81270
	Wagon Exc. Models with Tokico O.E. Struts	49105 ⁷
74	All	49105 ⁷
	Wagon	81270	49105 ⁷
72-73	All	81270	49105 ⁷

RX4

74-78	All	81270	49105 ⁷
-------	-----	-------	-------	-------	-------	-------	-------	-------	-------	--------------------

RX7

86-91	All	143059 ⁵¹	143063 ⁵¹
	Exc. Electronic Adjustable Suspension	G55542 ⁹	143059 ⁵¹	G51031 ⁹	143063 ⁵¹

7 Pair Packs, air hose kit included.

40 Complete Assembled Unit.



53 Strut Mount. Hardware from O.E. Part may need to be reused.

9 See Ref. D for procedures to replace Elec Adj Susp with non-adj product.

51 Strut Cushion for use with the Strut/Cartridge/Shocks.

54 Kit with Mount and Bearing. Hardware from O.E. Part may need to be reused.





APPLICATION GUIDE

Year	Fitment Notes										
		Ultra	ProGuard\ Guardian\ Classic	Max Control\ LTV	Strut Cushion\ Strut Mount	HiJackers\ Load Carrier	Ultra	ProGuard\ Guardian\ Classic	Max Control\ LTV	Strut Cushion\ Strut Mount	HiJackers\ Load Carrier



MAZDA

MAZDA













RX7 (cont)

81-85	GS, S		G44735 ⁹⁸		69674
79-85	All			69674

RX8

04-08	All		G51923		G51924
-------	-----	---	--------	------	------	------	------	---	--------	------	------	------	------

TRIBUTE

10-11	Left		G56601	M52806	143253 ⁶⁸		G64047
	Right		G56568	M52807	143253 ⁶⁸		G64047
08-09	Left		G56601	M52806	143253 ⁵³		G64047
	Right		G56568	M52807	143253 ⁵³		G64047
01-06	Left		G56601	M52806	143253 ⁵³		69900 G63862
	Right		G56568	M52807	143253 ⁵³		69900 G63862



TRIBUTE READYMOUNTS

		Front		Rear	
		Ultra Readymount	Guardian Readymount	Ultra Readymount	Guardian Readymount
08-11	Left	G57045 ⁴⁰	
	Right	G57046 ⁴⁰	
01-06	Left	G57045 ⁴⁰	
	Right	G57046 ⁴⁰	



MERCEDES-BENZ

MERCEDES-BENZ



190D

84-89	All		G55527	142326 ⁵³		69995
-------	-----	---	--------	------	------	----------------------	------	---	-------	------	------	------	------





190E

84-93	All		G55527	142326 ⁵³		69995
-------	-----	---	--------	------	------	----------------------	------	---	-------	------	------	------	------







190SL

62-63	All			82069
-------	-----	---	------	------	------	------	------	---	------	-------	------	------	------







200D

69-73	All			69766
68	All		69661		69766

220 / 220D

69-73	All			69766
	W115		69661		69766
68	All		69661		69766

230

77-78	Exc. W115		69996		69766
74-78	All			69766
74-76	W115		69661		69766



40 Complete Assembled Unit.

68 Strut Mount Kit. Hardware from O.E. Part may need to be reused.

53 Strut Mount. Hardware from O.E. Part may need to be reused.

98 Notice: The level of difficulty to install this product is moderately high. Please review the installation instructions carefully before proceeding.

APPLICATION GUIDE

Year	Fitment Notes										
		Ultra	ProGuard\ Guardian\ Classic	Max Control\ LTV	Strut Cushion\ Strut Mount	HiJackers\ Load Carrier	Ultra	ProGuard\ Guardian\ Classic	Max Control\ LTV	Strut Cushion\ Strut Mount	HiJackers\ Load Carrier

MERCEDES-BENZ

230 (cont)

68-69	All	○	○	69766
69	W115	○	69661	○	69766

240D

76-83	W123	○	69996	○	69766
74-83	All	○	○	69766
74-76	W115	○	69661	○	69766

250

68-70	All	○	○	69766
-------	-----	---	-------	-------	-------	-------	---	-------	-------	-------	-------	-------

260E

87-89	4 Matic	○	○	69995
	Exc. 4 Matic 4x4	○	G55527	142326 ⁵³
	Exc. Hydromat Suspension	○	69996	○	69766

280

76	All	○	69996	○	69766
----	-----	---	-------	-------	-------	-------	---	-------	-------	-------	-------	-------

280C

73-76	All	○	○	69766
	W115	○	69661	○	69766
76	Exc. W115	○	69996	○	69766

280CE / 280E / 280S / 280SE / 280SEL

77-81	All	○	69996	○	69766
75-80	Exc. Hydromat Suspension	○	69996	○	69766
73	Exc. Hydromat Suspension	○	69996	○	69766
72	Mfg. from 9/72; Exc. Hydromat Suspension	○	69996	○	69766

300D

90-93	Exc. 4 Matic 4x4	○	G55527	142326 ⁵³
	W115 4 Matic	○	○	69995
87	Exc. 4 Matic 4x4	○	G55527
	W115 4 Matic	○	○	69995
84-85	W115 4 Matic	○	○	69995
76-84	W123	○	69996	○	69766
76	W115	○	69661	○
75	All	○	69661	○
	W123	○	69661	○	69766



300E

86-93	All	○	○	69995
	Exc. 4 Matic 4x4	○	G55527	142326 ⁵³	○	69995

300SD / 300SDL / 300SE / 300SEL / 300TD / 350SD / 350SDL / 350SL / 380SE / 380SEC / 380SEL

78-91	Exc. Hydromat Suspension	○	69996	○	69766
-------	--------------------------	---	-------	-------	-------	-------	-------	---	-------	-------	-------	-------

APPLICATION GUIDE

Year	Fitment Notes										
		Ultra	ProGuard\ Guardian\ Classic	Max Control\ LTV	Strut Cushion\ Strut Mount	HiJackers\ Load Carrier	Ultra	ProGuard\ Guardian\ Classic	Max Control\ LTV	Strut Cushion\ Strut Mount	HiJackers\ Load Carrier

MERCEDES-BENZ

MERCEDES-BENZ

300SD / 300SDL / 300SE / 300SEL / 300TD / 350SD / 350SDL / 350SL / 380SE / 380SEC / 380SEL
(cont)

79-85	All	69996
72	All	69661	69766

380SL / 380SLC

85	All	69766
81-84	All	69661	69766

400E / 400SE / 400SEL / 420SEL / 450SE / 450SEL

92-93	All	G55527	142326 ⁵³
86-91	Exc. Hydromat Suspension	69996	69766
73-80	Exc. Hydromat Suspension	69996	69766

450SL / 450SLC

74-80	All	69661	69766
-------	-----	-------	------	------	------	------	------	------	------	-------	------	------	------

500SEC / 500SEL / 500SEC / 560SEC / 560SEL

84-91	Exc. Hydromat Suspension	69996	69766
-------	--------------------------	-------	------	------	------	------	------	------	------	-------	------	------	------

500SL

90-93	All	142326 ⁵³
-------	-----	------	------	------	----------------------	------	------	------	------	------	------	------	------

600SL

93	All	142326 ⁵³
----	-----	------	------	------	----------------------	------	------	------	------	------	------	------	------

C220

94-96	All	69877	69878
-------	-----	-------	------	------	------	------	------	------	------	-------	------	------	------

C230

02-07	All	70033
	RWD; Exc. Sport Suspension	G56791	70033
	RWD; w/ Sport Suspension	G56792	70033
97-00	All	69877	69878

C240

01-05	RWD	70033
	RWD; Exc. Sport Suspension	G56791
	RWD; w/ Sport Suspension	G56792



C250

12	CGI(FuelDelSubType), Sedan	G52172	70038
10-11	All	G52172	70038

C280

08-09	All	G52172	70038
06-07	RWD	70033

APPLICATION GUIDE

Year	Fitment Notes										
		Ultra	ProGuard/ Guardian/ Classic	Max Control/ LTV	Strut Cushion/ Strut Mount	HiJackers/ Load Carrier	Ultra	ProGuard/ Guardian/ Classic	Max Control/ LTV	Strut Cushion/ Strut Mount	HiJackers/ Load Carrier

MERCEDES-BENZ

C280 (cont)

06-07	RWD; Exc. Sport Suspension	↓	G56791	
	RWD; w/ Sport Suspension	↓	G56792	
94-00	All	○	69877	○	69878

MERCEDES-BENZ

C300

11	All	↓	G52172	○	70038
10	All	↓	○	70038
	Exc. 4-Matic Models	↓	G52172	○	70038
08-09	All	↓	G52172	○	70038

C320

01-05	RWD	↓	○	70033
	RWD Sedan & Wagon; Exc. Sport Suspension	↓	G56791	○
	RWD; w/ Sport Suspension	↓	G56792	○

C350

12	CGI(FuelDelSubType)	↓	G52172	○	70038
08-11	All	↓	G52172	○	70038
06-07	Exc. AWD & Sport Suspension	↓	G56791	○
	RWD	↓	○	70033
	RWD; w/ Sport Suspension	↓	G56792	○

CLK320

03-05	All	↓	○	70033
	RWD; Exc. Sport Suspension	↓	G56791	○	70033
	RWD; w/ Sport Suspension	↓	G56792	○	70033
98-02	All	○	70064	○	70065
02	RWD; Exc. Sport Suspension	↓	G56791	○	70065
	RWD; w/ Sport Suspension	↓	G56792	○	70065





CLK350

06-09	All	↓	○	70033
	RWD; Exc. Sport Suspension	↓	G56791	○	70033
	RWD; w/ Sport Suspension	↓	G56792	○	70033

CLK430









03	All	↓	○	70033
	RWD; Exc. Sport Suspension	↓	G56791	○	70033
	RWD; w/ Sport Suspension	↓	G56792	○	70033
02	All	○	70064	○

APPLICATION GUIDE

Year	Fitment Notes										
		 Ultra	ProGuard\ Guardian\ Classic	Max Control\ LTV	Strut Cushion\ Strut Mount	HiJackers\ Load Carrier	 Ultra	ProGuard\ Guardian\ Classic	Max Control\ LTV	Strut Cushion\ Strut Mount	HiJackers\ Load Carrier





MERCEDES-BENZ

CLK430 (cont)



02	Mfg. from 4/02	 70064	 70033
	Mfg. to 4/02	 70064	 70065
	RWD; Exc. Sport Suspension	 G56791
	RWD; w/ Sport Suspension	 G56792
99-01	All	 70064	 70065

MERCEDES-BENZ

CLK500

03-06	All	 70033
	RWD; Exc. Sport Suspension	 G56791	 70033
	RWD; w/ Sport Suspension	 G56792	 70033

CLK550

07-09	All	 70033
	RWD; Exc. Sport Suspension	 G56791	 70033







E200

12-13	All	 G511041 ¹
-------	-----	------	------	------	------	------	--	------	------	------	------





E250

11-13	All	 G511041 ¹
-------	-----	------	------	------	------	------	---	------	------	------	------

E300

11-13	All	 G511041 ¹
99	Exc. 4 Matic	 69966
	Exc. Sport Suspension	 69952
96-98	All	 69966
	Exc. Sport Suspension	 69952	 69966
95	All	 G55527	142326 ⁵³

E320

96-06	Exc. 4 Matic		143086 ⁵³
96-02	Sedan	 69966
	Sedan Exc. Sport Suspension	 69952
94-95	All	 G55527	142326 ⁵³

E350

11-13	All	 G511041 ¹
-------	-----	------	------	------	------	------	---	------	------	------	------

E400

13	All	 G511041 ¹
----	-----	------	------	------	------	------	---	------	------	------	------



E420

97	All	 69966
----	-----	------	------	------	------	------	---	------	------	------	------

¹ Future Part, available 1st Quarter of 2017.

⁵³ Strut Mount. Hardware from O.E. Part may need to be reused.

APPLICATION GUIDE

Year	Fitment Notes										
		Ultra	ProGuard\ Guardian\ Classic	Max Control\ LTV	Strut Cushion\ Strut Mount	HiJackers\ Load Carrier	Ultra	ProGuard\ Guardian\ Classic	Max Control\ LTV	Strut Cushion\ Strut Mount	HiJackers\ Load Carrier

MERCEDES-BENZ

MERCEDES-BENZ

E420 (cont)

97	Exc. 4 Matic	↓	143086 ⁵³	↓	69966
	Exc. 4 Matic & Sport Suspension	○	69952	↓	69966
94-95	All	↓	G55527	142326 ⁵³	↓

E430

98-02	All	↓	↓	69966
	Exc. 4 Matic	↓	143086 ⁵³	↓	69966
	Exc. 4 Matic & Sport Suspension	○	69952	↓	69966

E500

11-13	All	↓	↓	G511041 ¹
94	All	↓	G55527	142326 ⁵³	↓

E550

11-13	All	↓	↓	G511041 ¹
-------	-----	---	------	------	------	------	------	---	----------------------	------	------	------	------

GL320 READYMOUNTS

		Front		Rear	
		Ultra Readymount	Guardian Readymount	Ultra Readymount	Guardian Readymount
07-09	All	G57555 ⁴⁰

GL450 READYMOUNTS

		Front		Rear	
		Ultra Readymount	Guardian Readymount	Ultra Readymount	Guardian Readymount
10-12	All	G57555 ⁴⁰

ML55 AMG

00-03	All	○	G64049	↓
-------	-----	---	--------	------	------	------	------	---	------	------	------	------

ML320

98-03	All	○	G64049	↓
-------	-----	---	--------	------	------	------	------	---	------	------	------	------

ML320 READYMOUNTS

		Front		Rear	
		Ultra Readymount	Guardian Readymount	Ultra Readymount	Guardian Readymount
98-03	All	G57596 ⁴⁰

ML350

03-05	All	○	G64049	↓
-------	-----	---	--------	------	------	------	------	---	------	------	------	------

ML430

99-01	All	○	G64049	↓
-------	-----	---	--------	------	------	------	------	---	------	------	------	------

ML500

02-05	All	○	G64049	↓
-------	-----	---	--------	------	------	------	------	---	------	------	------	------

S320 / S350 / S420 / S500 / S600

94-99	Exc. Electronic Ride Control	○	70023	○	70024
-------	------------------------------	---	-------	------	------	------	------	---	-------	------	------	------	------

SL320 / SL500 / SL600



94-02	All	↓	142326 ⁵³	↓
-------	-----	---	------	------	------	----------------------	------	---	------	------	------	------	------

1 Future Part, available 1st Quarter of 2017.

53 Strut Mount. Hardware from O.E. Part may need to be reused.



40 Complete Assembled Unit.

APPLICATION GUIDE





Year	Fitment Notes										
		Ultra	ProGuard\ Guardian\ Classic	Max Control\ LTV	Strut Cushion\ Strut Mount	HiJackers\ Load Carrier	Ultra	ProGuard\ Guardian\ Classic	Max Control\ LTV	Strut Cushion\ Strut Mount	HiJackers\ Load Carrier

MERCEDES-BENZ







SLK230

98-04	All		70064		70065
-------	-----	---	-------	------	------	------	------	---	-------	------	------	------	------

SLK320





03-04	All		70064		70065
01-02	170.465(MfrBodyCode)		70064		70065

SPRINTER



04-06	All		G56778	
	Dual Rear Wheels		G56778		G63919
	Exc. Dual Rear Wheels		G56778		G63918

MERCURY





BOBCAT

75-80	All		82128	
	Sedan		82128		82004

BROUGHAM

67	All		69675 ⁵	81446	34073 ⁸		69606	81495	43140 ⁸ 49205 ⁷
----	-----	---	--------------------	-------	------	------	--------------------	---	-------	-------	------	------	--











CAPRI

91-93	All		G55602	143057 ⁵¹		G55603	143059 ⁵¹
79-86	All		G56504 ⁹	M56504⁹	142197 ⁵³ 143059 ⁵¹		69633	81460	49199 ⁷













CAPRI STEERING STABILIZERS

84-86	All						Front	Rear
							14039



COLONY PARK

87-91	All		69675 ⁵	81446	34073 ⁸		69606	81495	43140 ⁸ 49205 ⁷
65-74	All		69675 ⁵	81446	34073 ⁸		69606	81495	43140 ⁸ 49205 ⁷
61-64	All		82099		82076
59-60	All		82099		81270	49105 ⁷
57-58	All		82099	

COMET

71-77	All		81076		82130
68-69	All		82126		81270	49105 ⁷
66-67	All		82126	
	Exc. Wagon		82126		81270	49105 ⁷
	Wagon		82126		69606	81495
60-65	All		82126		81270	49105 ⁷

COMMUTER

65-68	All		69675 ⁵	81446	34073 ⁸		69606	81495	43140 ⁸ 49205 ⁷
-------	-----	---	--------------------	-------	------	------	--------------------	---	-------	-------	------	------	--

5 Use kit No. 140719 to replace O.E. hardware for lower shock absorber mounting when studs break or self-tapping screws are not longer useable.

8 Pair Packs.

51 Strut Cushion for use with the Strut/Cartridge/Shocks.



Bold Type - New / Future Part

7 Pair Packs, air hose kit included.

9 See Ref. D for procedures to replace Elec Adj Susp with non-adj product.

53 Strut Mount. Hardware from O.E. Part may need to be reused.

APPLICATION GUIDE

Year	Fitment Notes										
		Ultra	ProGuard\ Guardian\ Classic	Max Control\ LTV	Strut Cushion\ Strut Mount	HiJackers\ Load Carrier	Ultra	ProGuard\ Guardian\ Classic	Max Control\ LTV	Strut Cushion\ Strut Mount	HiJackers\ Load Carrier

MERCURY

MERCURY

COMMUTER (cont)

64	All	⊕	82099	⊕	82076
61-62	All	⊕	82099	⊕	82076
59-60	All	⊕	82099	⊕	81270	49105 ⁷
57-58	All	⊕	82099	⊕

COUGAR

01-02	All	⊕	G56520	M56520	142843 ⁵⁴ 143061 ⁵¹	⊕	G55693	M55693	143058 ⁵¹
99-00	All	⊕	G56520	M56520	142843 ⁵⁴ 143061 ⁵¹	⊕	G55693	M55693	142402 ⁵³ 143058 ⁵¹
92-97	Exc. Electronic Adjustable Suspension	⊕	G55579	M55579	142222 ⁵³	⊕	69845	81795
89-91	Exc. Electronic Adjustable Suspension	⊕	G55579	M55579	142222 ⁵³	⊕	69820
87-88	All	⊕	G56504 ⁹	M56504⁹	143059 ⁵¹	⊕	69709 ⁹	81461	49196 ⁷
83-86	All	⊕	G56503 ³⁹	143059 ⁵¹	⊕	69709 ⁹	81461	49196 ⁷
81-82	Base, GS & LS Models	⊕	G56504 ⁹	M56504⁹	142197 ⁵³ 143059 ⁵¹	⊕	69633	81460	49199 ⁷
80-82	All	⊕	143059 ⁵¹	⊕
	XR-7	⊕	G56503 ³⁹	143059 ⁵¹	⊕	69709 ⁹	81461	49196 ⁷
74-79	All	⊕	69675 ⁵	81446	34073 ⁸	⊕	69606	81495	43140 ⁸ 49205 ⁷
71-73	All	⊕	81491	⊕	81270	49105 ⁷
67-70	All	⊕	81076	⊕	81270	49105 ⁷

COUGAR READYMOUNTS

		Front		Rear	
		Ultra Readymount	Guardian Readymount	Ultra Readymount	Guardian Readymount
99-01	All	G57052 ⁴⁰	M57052⁴⁰
89-97	Left Exc. Electronic Adjustable Suspension	G56976 ⁴⁰	M56976⁴⁰
	Right Exc. Electronic Adjustable Suspension	G56977 ⁴⁰	M56977⁴⁰

COUGAR STEERING STABILIZERS

		Front	Rear
84-88	All	14039

COUNTRY CRUISER

63	All	⊕	82099	⊕	82076
59-60	All	⊕	82099	⊕	81270	49105 ⁷

CUSTOM

52-56	All	⊕	82026	⊕
-------	-----	---	------	-------	------	------	------	---	------	------	------	------	------

CYCLONE

68-71	All	⊕	82126	⊕	81270
-------	-----	---	------	-------	------	------	------	---	------	-------	------	------	------

5 Use kit No. 140719 to replace O.E. hardware for lower shock absorber mounting when studs break or self-tapping screws are not longer useable.

8 Pair Packs.

39 Conventional gas-charged strut can be used to replace O.E. air adjustable gas-charged strut. However, the self-leveling system must be deactivated. See Ref. A for instructions.

51 Strut Cushion for use with the Strut/Cartridge/Shocks.

54 Kit with Mount and Bearing. Hardware from O.E. Part may need to be reused.

7 Pair Packs, air hose kit included.

9 See Ref. D for procedures to replace Elec Adj Susp with non-adj product.

40 Complete Assembled Unit.











53 Strut Mount. Hardware from O.E. Part may need to be reused.

APPLICATION GUIDE

Year	Fitment Notes	Front					Rear				
		Ultra	ProGuard\ Guardian\ Classic	Max Control\ LTV	Strut Cushion\ Strut Mount	HiJackers\ Load Carrier	Ultra	ProGuard\ Guardian\ Classic	Max Control\ LTV	Strut Cushion\ Strut Mount	HiJackers\ Load Carrier

MERCURY

GRAND MARQUIS





11	All		G51887	M52817	143356 ⁵³ 143357 ⁵⁷		69575
03-10	All		G51887	M52817	143356 ⁵³ 143357 ⁵⁸		69575
92-02	All		69675 ⁵	81446		69606	81495	43140 ⁸ 49205 ⁷
	Exc. Hydraulic Self Leveling System		69675 ⁵	81446	34073 ⁸		69606	81495	43140 ⁸ 49205 ⁷
75-91	All		69675 ⁵	81446	34073 ⁸		69606	81495	43140 ⁸ 49205 ⁷

MERCURY







GRAND MARQUIS READYMOUNTS

		Front		Rear	
		Ultra Readymount	Guardian Readymount	Ultra Readymount	Guardian Readymount
03-11	All	G57080 ⁴⁰		M57299 ⁴⁰	









LN7

82-83	All		143057 ⁵¹		G55705	143059 ⁵¹
83	Mfg. from 2/83 thru 2/85		G55712	143057 ⁵¹		G55705	143059 ⁵¹











LYNX

85-87	Mfg. from 3/85		G55714	143057 ⁵¹		G55705	143059 ⁵¹
81-87	All		143057 ⁵¹		G55705	143059 ⁵¹
83-85	Mfg. from 2/83 thru 2/85		G55712	143057 ⁵¹		G55705	143059 ⁵¹

MARAUDER

03-04	All		G51888		69575
69-70	All		69675 ⁵	81446	34073 ⁸		69606	81495	43140 ⁸ 49205 ⁷
65-67	All		69675 ⁵	81446	34073 ⁸		69606	81495	43140 ⁸ 49205 ⁷
63-64	All		82099		82076

MARINER

08-11	Left		G56601	M52806		G64047
	Right		G56568	M52807		G64047
05-11	FWD		143253 ⁵³	
05-07	Left		G56601	M52806		69900 G63862
	Right		G56568	M52807		69900 G63862

MARINER READYMOUNTS

		Front		Rear	
		Ultra Readymount	Guardian Readymount	Ultra Readymount	Guardian Readymount
05-11	Left	G57045 ⁴⁰		
	Right	G57046 ⁴⁰		

5 Use kit No. 140719 to replace O.E. hardware for lower shock absorber mounting when studs break or self-tapping screws are not longer useable.

8 Pair Packs.

51 Strut Cushion for use with the Strut/Cartridge/Shocks.

67 Strut Mount Kit. Hardware from O.E. Part may need to be reused.

Bold Type - New / Future Part



7 Pair Packs, air hose kit included.

40 Complete Assembled Unit.

53 Strut Mount. Hardware from O.E. Part may need to be reused.





68 Strut Mount Kit. Hardware from O.E. Part may need to be reused.

APPLICATION GUIDE

Year	Fitment Notes										
		Ultra	ProGuard\ Guardian\ Classic	Max Control\ LTV	Strut Cushion\ Strut Mount	HiJackers\ Load Carrier	Ultra	ProGuard\ Guardian\ Classic	Max Control\ LTV	Strut Cushion\ Strut Mount	HiJackers\ Load Carrier





MERCURY

MARQUIS



83-86	All	 G56504 ⁹	M56504⁹	142197 ⁵³ 143059 ⁵¹	 69633	81460	49199 ⁷
67-82	All	 69675 ⁵	81446	34073 ⁸	 69606	81495	43140 ⁸ 49205 ⁷

MERCURY



MEDALIST

58	All		82099	
56	All		82026	











MERCURY

49-51	All		82026		81318
-------	-----	--	-------	------	------	------	--	-------	------	------	------

METEOR

62-63	All		82075		81270	49105 ⁷
-------	-----	--	-------	------	------	------	--	-------	------	------	--------------------



MILAN

10-11	Left	 G51896	143392 ⁵⁴	
	Right	 G51897	143392 ⁵⁴	
	FWD		 69591
06-09	All	 G51859	M51859	143392 ⁵⁴	
	FWD	 G51859	M51859	143392 ⁵⁴	 69591











MILAN READYMOUNTS

		Front		Rear	
		Ultra Readymount	Guardian Readymount	Ultra Readymount	Guardian Readymount
10-11	All	G57427⁴⁰
07-09	AWD	G57446	M57148⁴⁰
06-09	All	M57148⁴⁰
	FWD	G57445⁴⁰	M57148⁴⁰









MONARCH

75-80	All		81491		82130
-------	-----	--	-------	------	------	------	--	-------	------	------	------

MONTCLAIR

65-68	All	 69675 ⁵	81446	34073 ⁸	 69606	81495	43140 ⁸ 49205 ⁷
64	All		82099		82076
59-60	All		82099		81270	49105 ⁷
57-58	All		82099	
55-56	All		82026	

MONTEGO

05-07	Left		143341 ⁵³		143390 ⁵³
	Right		143341 ⁵³		143391 ⁵³
	AWD, Left	 G52136	
	AWD, Right	 G52137	

5 Use kit No. 140719 to replace O.E. hardware for lower shock absorber mounting when studs break or self-tapping screws are not longer useable.

8 Pair Packs.

40 Complete Assembled Unit.

53 Strut Mount. Hardware from O.E. Part may need to be reused.



7 Pair Packs, air hose kit included.

9 See Ref. D for procedures to replace Elec Adj Susp with non-adj product.

51 Strut Cushion for use with the Strut/Cartridge/Shocks.

54 Kit with Mount and Bearing. Hardware from O.E. Part may need to be reused.















APPLICATION GUIDE

Year	Fitment Notes										
		Ultra	ProGuard\Guardian\Classic	Max Control\LTV	Strut Cushion\Strut Mount	HiJackers\Load Carrier	Ultra	ProGuard\Guardian\Classic	Max Control\LTV	Strut Cushion\Strut Mount	HiJackers\Load Carrier















MERCURY

MERCURY









MONTEGO (cont)

05-07	FWD, Left		G52138		G51849
	FWD, Right		G52139		G51849
72-76	All		69675 ⁵	81446	34073 ⁸		69606	43140 ⁹ 49205 ⁷
	Wagon		69675 ⁵	81446	34073 ⁸		69606	81495	43140 ⁹ 49205 ⁷
68-71	All		82126		69606
	Exc. Wagon		82126		69606	81270	49105 ⁷
	Wagon		82126		69606	81495

MONTEREY

04-07	Mini Passenger Van		G56655	143246 ⁵³		G63873
65-74	All		69675 ⁵	81446	34073 ⁸		69606	81495	43140 ⁹ 49205 ⁷
61-64	All		82099		82076
59-60	All		82099		81270	49105 ⁷
57-58	All		82099	
52-56	All		82026	
50-51	All		82026		81318







MOUNTAINEER

06-10	All		G56838	143330 ⁶⁷ 143360 ⁶³		G56839	143361 ⁵³ 143362 ⁶⁷
04-05	All		G51723	M51723	143318 ⁵³		G51724	M51724	143319 ⁵³
02-03	All		G51722	M51722	143318 ⁵³		G51724	M51724	143319 ⁵³
97-01	Exc. Electronic Adjustable Suspension		G63678	61623 81893	77678		G63679	61624 81890	77679	43171 ⁸ 49232 ⁷

MOUNTAINEER READYMOUNTS

		Front		Rear	
		Ultra Readymount	Guardian Readymount	Ultra Readymount	Guardian Readymount
06-10	All	G57095 ⁴⁰	M57095 ⁴⁰	G57096 ⁴⁰	M57096 ⁴⁰
04-05	All	G57019 ⁴⁰	M57019 ⁴⁰	G57018 ⁴⁰	M57018 ⁴⁰
02-03	All	G57017 ⁴⁰	M57017 ⁴⁰	G57018 ⁴⁰	M57018 ⁴⁰



MYSTIQUE

97-00	Mfg. from 3/97		G56520	M56520	142843 ⁵⁴		G55693	M55693	142402 ⁵³
95-00	All		142843 ⁵⁴		G55693	M55693	142402 ⁵³
95-97	Mfg. to 3/97		G55692	142843 ⁵⁴		G55693	M55693	142402 ⁵³

MYSTIQUE READYMOUNTS

		Front		Rear	
		Ultra Readymount	Guardian Readymount	Ultra Readymount	Guardian Readymount
95-00	All	G57052 ⁴⁰	M57052 ⁴⁰

PARKLANE

65-68	All		69675 ⁵	81446	34073 ⁸		69606	81495	43140 ⁹ 49205 ⁷
-------	-----	---	--------------------	-------	------	------	--------------------	---	-------	-------	------	------	--

5 Use kit No. 140719 to replace O.E. hardware for lower shock absorber mounting when studs break or self-tapping screws are not longer useable.

8 Pair Packs.

53 Strut Mount. Hardware from O.E. Part may need to be reused.

67 Strut Mount Kit. Hardware from O.E. Part may need to be reused.



Bold Type - New / Future Part

7 Pair Packs, air hose kit included.

40 Complete Assembled Unit.

54 Kit with Mount and Bearing. Hardware from O.E. Part may need to be reused.

APPLICATION GUIDE

Year	Fitment Notes										
		Ultra	ProGuard\ Guardian\ Classic	Max Control\ LTV	Strut Cushion\ Strut Mount	HiJackers\ Load Carrier	Ultra	ProGuard\ Guardian\ Classic	Max Control\ LTV	Strut Cushion\ Strut Mount	HiJackers\ Load Carrier

MERCURY

MERCURY

PARKLANE (cont)

64	All	⊕	82099	⊕	82076
59-60	All	⊕	82099	⊕	81270	49105 ⁷
58	All	⊕	82099	⊕

SABLE

08-09	FWD, Left	⊕	G52129	143415 ⁵³	⊕	G51875
	FWD, Right	⊕	G52130	143415 ⁵³	⊕	G51876
96-05	Left	⊕	G55978	M55978	143059 ⁵¹	⊕
	Right	⊕	G55960	M55960	143059 ⁵¹	⊕
	Sedan	⊕	⊕	G55901	M55901	143057 ⁵¹
	Wagon	⊕	⊕	69962	81927
94-95	Sedan	⊕	G55616	M55616	142746 ⁶⁷ 143059 ⁵¹	⊕	G55901	M55901	143057 ⁵¹
91-95	All	⊕	G55616	M55616	143059 ⁵¹	⊕
	Wagon	⊕	G55616	M55616	143059 ⁵¹	⊕	69756	81693	49216 ⁷
91-93	Sedan	⊕	G55616	M55616	142746 ⁶⁷ 143059 ⁵¹	⊕	G55518	M55518
86-90	All	⊕	G55616	M55616	142746 ⁶⁷ 143059 ⁵¹	⊕
	Sedan	⊕	G55616	M55616	142746 ⁶⁷ 143059 ⁵¹	⊕	G55518	M55518
	Wagon	⊕	G55616	M55616	142746 ⁶⁷ 143059 ⁵¹	⊕	69756	81693	49216 ⁷

SABLE READYMOUNTS

		Front		Rear	
		Ultra Readymount	Guardian Readymount	Ultra Readymount	Guardian Readymount
96-05	Left	G56934 ⁴⁰	M56934 ⁴⁰
	Right	G56937 ⁴⁰	M56937 ⁴⁰
	Sedan	G56936 ⁴⁰	M56936 ⁴⁰
94-95	Sedan	G56912 ⁴⁰	M56912 ⁴⁰	G56936 ⁴⁰	M56936 ⁴⁰
86-95	All	G56912 ⁴⁰	M56912 ⁴⁰
86-93	Sedan	G56912 ⁴⁰	M56912 ⁴⁰	G56913 ⁴⁰	M56913 ⁴⁰

TOPAZ

92-94	All	⊕	⊕	143059 ⁵¹
	FWD	⊕	⊕	G55733	M55733	143059 ⁵¹
	FWD, Mfg. from 3/85	⊕	G55714	⊕	143059 ⁵¹
87-91	All	⊕	143059 ⁵¹	⊕	143059 ⁵¹
	Mfg. from 3/85	⊕	G55714	143059 ⁵¹	⊕	143059 ⁵¹
	AWD	⊕	143059 ⁵¹	⊕	G55722	143059 ⁵¹
	FWD	⊕	143059 ⁵¹	⊕	G55733	M55733	143059 ⁵¹

7 Pair Packs, air hose kit included.

51 Strut Cushion for use with the Strut/Cartridge/Shocks.

67 Strut Mount Kit. Hardware from O.E. Part may need to be reused.

40 Complete Assembled Unit.

53 Strut Mount. Hardware from O.E. Part may need to be reused.

APPLICATION GUIDE

Year	Fitment Notes	Front					Rear				
		Ultra	ProGuard\ Guardian\ Classic	Max Control\ LTV	Strut Cushion\ Strut Mount	HiJackers\ Load Carrier	Ultra	ProGuard\ Guardian\ Classic	Max Control\ LTV	Strut Cushion\ Strut Mount	HiJackers\ Load Carrier

MERCURY

TOPAZ (cont)

MERCURY

86	All
	FWD	G55733	M55733	143059 ⁵¹
	FWD, Mfg. from 3/85	G55714	143059 ⁵¹
84-85	All	143057 ⁵¹	143059 ⁵¹
	FWD	143057 ⁵¹	G55733	M55733	143059 ⁵¹
85	FWD, Mfg. from 3/85	G55714	143057 ⁵¹	143059 ⁵¹

TRACER

97-99	FWD	G56515	M56515	142744 ⁵⁷ 142832 ⁵⁴ 143061 ⁵¹	G55848	M55848	142190 ⁵³ 143060 ⁵¹
91-96	FWD	G55847	M55847	142744 ⁵⁷ 143057 ⁵¹	G55848	M55848	142190 ⁵³ 143058 ⁵¹
87-89	FWD	G55710	142183 ⁵³	G55544	143058 ⁵¹

TRACER READYMOUNTS

		Front		Rear	
		Ultra Readymount	Guardian Readymount	Ultra Readymount	Guardian Readymount
97-99	FWD	G56926 ⁴⁰	M56926⁴⁰	G56940 ⁴⁰	M56940⁴⁰
91-96	FWD	G56911 ⁴⁰	M56911⁴⁰	G56940 ⁴⁰	M56940⁴⁰

TURNPIKE CRUISER

57	All	82099
----	-----	-------	-------	-------	-------	-------	-------	-------	-------	-------

VILLAGER

97-02	Non-ABS	G63299	61637
02	Left	G56785
	Right	G56784
99-01	Left	G56785	142860 ⁵⁴
	Right	G56784	142860 ⁵⁴
93-98	Left	G55920	M55920	142860 ⁵⁴ 143057 ⁵¹
	Right	G55921	M55921	142860 ⁵⁴ 143057 ⁵¹
93-96	4-Wheel ABS	G63299	61637
65-67	All	69675 ⁵	81446	34073 ⁸	69606	81495	43140 ⁹ 49205 ⁷
62-64	All	82099	82076

VILLAGER READYMOUNTS

		Front		Rear	
		Ultra Readymount	Guardian Readymount	Ultra Readymount	Guardian Readymount
93-98	Left	G56989 ⁴⁰	M56989⁴⁰
	Right	G56990 ⁴⁰	M56990⁴⁰

5 Use kit No. 140719 to replace O.E. hardware for lower shock absorber mounting when studs break or self-tapping screws are not longer useable.

8 Pair Packs.

51 Strut Cushion for use with the Strut/Cartridge/Shocks.

54 Kit with Mount and Bearing. Hardware from O.E. Part may need to be reused.

Bold Type - New / Future Part



7 Pair Packs, air hose kit included.

40 Complete Assembled Unit.

53 Strut Mount. Hardware from O.E. Part may need to be reused.







67 Strut Mount Kit. Hardware from O.E. Part may need to be reused.

APPLICATION GUIDE

Year	Fitment Notes										
		Ultra	ProGuard\ Guardian\ Classic	Max Control\ LTV	Strut Cushion\ Strut Mount	HiJackers\ Load Carrier	Ultra	ProGuard\ Guardian\ Classic	Max Control\ LTV	Strut Cushion\ Strut Mount	HiJackers\ Load Carrier



MERCURY

VOYAGER

66-67	All	 69675 ⁵	81446	34073 ⁸	 69606	81495	43140 ⁶ 49205 ⁷
59	All		82099		81270
57-58	All		82099	













MERCURY

ZEPHYR

78-83	All	 G56504 ⁹	M56504⁹	142197 ⁵³ 143059 ⁵¹	 69633	81460	49199 ⁷
-------	-----	---	---------------------------	------	--	------	---	-------	------	------	--------------------

MINI

COOPER

12	Left	 G52297	143491⁵³	 G51934
	Right	 G52298	143491⁵³	 G51934
07-11	Left	 G52297	143405⁶⁷ 143491⁵³	 G51934
	Right	 G52298	143405⁶⁷ 143491⁵³	 G51934
02-06	Left	 G52164	143404⁵³ 143405⁶⁷	 G51881
	Right	 G52165	143404⁵³ 143405⁶⁷	 G51881

MINI



MITSUBISHI

3000GT







91-99	All		142419 ⁶⁸
-------	-----	------	------	------	------	------	--	------	------	----------------------	------

MITSUBISHI













CORDIA

83-88	All		143059 ⁵¹	 69689	81464
-------	-----	--	------	------	----------------------	------	---	-------	------	------	------

DIAMANTE

04	All		143087 ⁵³		142419 ⁶⁸
97-03	Left	 G52227	143087 ⁵³	 G51772	142419 ⁶⁸
	Right	 G52228	143087 ⁵³	 G51772	142419 ⁶⁸

ECLIPSE

11-12	Left	 G52166	
	Right	 G52167	
06-10	Left	 G52166	 G51882
	Right	 G52167	 G51882
00-05	Left	 G56552	143059 ⁵¹ 143087 ⁵³	 G51712	142419 ⁶⁸ 143059 ⁵¹
	Right	 G56551	143059 ⁵¹ 143087 ⁵³	 G51712	142419 ⁶⁸ 143059 ⁵¹

5 Use kit No. 140719 to replace O.E. hardware for lower shock absorber mounting when studs break or self-tapping screws are not longer useable.

8 Pair Packs.

51 Strut Cushion for use with the Strut/Cartridge/Shocks.

67 Strut Mount Kit. Hardware from O.E. Part may need to be reused.



7 Pair Packs, air hose kit included.

9 See Ref. D for procedures to replace Elec Adj Susp with non-adj product.

53 Strut Mount. Hardware from O.E. Part may need to be reused.

68 Strut Mount Kit. Hardware from O.E. Part may need to be reused.

APPLICATION GUIDE

Year	Fitment Notes										
		Ultra	ProGuard\Guardian\Classic	Max Control\LTV	Strut Cushion\Strut Mount	HiJackers\Load Carrier	Ultra	ProGuard\Guardian\Classic	Max Control\LTV	Strut Cushion\Strut Mount	HiJackers\Load Carrier

MITSUBISHI

ECLIPSE (cont)

MITSUBISHI

95-99	All	G55819	142419 ⁹⁸ 143059 ⁵¹	142419 ⁹⁸ 143059 ⁵¹
	AWD	G55819	142419 ⁹⁸ 143059 ⁵¹	G51712	142419 ⁹⁸ 143059 ⁵¹
	FWD	G55819	142419 ⁹⁸ 143059 ⁵¹	G51254	M51254	142419 ⁹⁸ 143059 ⁵¹
91-94	All	G55605	142219 ⁵³ 143057 ⁵¹	142419 ⁹⁸ 143064 ⁵¹
	AWD	G55605	142219 ⁵³ 143057 ⁵¹	G51046	142419 ⁹⁸ 143064 ⁵¹
	FWD	G55605	142219 ⁵³ 143057 ⁵¹	G51184	142419 ⁹⁸ 143064 ⁵¹
90	All	G55587	142219 ⁵³ 143057 ⁵¹	142419 ⁹⁸ 143064 ⁵¹
	AWD	G55587	142219 ⁵³ 143057 ⁵¹	G51046	142419 ⁹⁸ 143064 ⁵¹
	FWD	G55587	142219 ⁵³ 143057 ⁵¹	G51184	142419 ⁹⁸ 143064 ⁵¹

ENDEAVOR

10-11	AWD	G51933
11	Left	G52293
	Right	G52294
10	Left	G52293	143398⁵⁴
	Right	G52294	143398⁵⁴
09	Left	G52293
	Right	G52294
04-08	Left	G52293	143398⁵⁴
	Right	G52294	143398⁵⁴
	AWD	G51933

EXPO

92-95	All	G55945	143057 ⁵¹	69462	142419 ⁹⁸
-------	-----	--------	------	------	----------------------	------	-------	------	------	----------------------

GALANT

11	Exc. GT, LS, Sport, Ralliart Models Left	G52168	G51883
	Exc. GT, LS, Sport, Ralliart Models Right	G52169	G51883
08-10	All	143398⁵⁴
	Exc. GT, LS, Sport, Ralliart Models Left	G52168	143398⁵⁴	G51883
	Exc. GT, LS, Sport, Ralliart Models Right	G52169	143398⁵⁴	G51883
04-07	All	143398⁵⁴	142419 ⁹⁸

51 Strut Cushion for use with the Strut/Cartridge/Shocks.



54 Kit with Mount and Bearing. Hardware from O.E. Part may need to be reused.

53 Strut Mount. Hardware from O.E. Part may need to be reused.

68 Strut Mount Kit. Hardware from O.E. Part may need to be reused.

Bold Type - New / Future Part

APPLICATION GUIDE

Year	Fitment Notes										
		Ultra	ProGuard\Guardian\Classic	Max Control\LTV	Strut Cushion\Strut Mount	HiJackers\Load Carrier	Ultra	ProGuard\Guardian\Classic	Max Control\LTV	Strut Cushion\Strut Mount	HiJackers\Load Carrier

MITSUBISHI

GALANT (cont)

MITSUBISHI

04-07	Exc. GT, LS, Sport, Ralliart Models Left	G52168	143398 ⁵⁴	G51883	142419 ⁶⁸
	Exc. GT, LS, Sport, Ralliart Models Right	G52169	143398 ⁵⁴	G51883	142419 ⁶⁸
04-06	LS, Left	G52362	143398 ⁵⁴	G51969	142419 ⁶⁸
	LS, Right	G52363	143398 ⁵⁴	G51969	142419 ⁶⁸
99-03	Left	G56636	143087 ⁵³	G51254	M51254	142419 ⁶⁸
	Right	G56635	143087 ⁵³	G51254	M51254	142419 ⁶⁸
	GTZ, Left	M52811
	GTZ, Right	M52812
94-98	All	G55820	M55820	142419 ⁶⁸ 143057 ⁵¹	G51253	142419 ⁶⁸ 143057 ⁵¹
93	All	143057 ⁵¹	142419 ⁶⁸ 143063 ⁵¹
	FWD	G55609	143057 ⁵¹	G51424	142419 ⁶⁸ 143063 ⁵¹
90-92	All	143057 ⁵¹	142419 ⁶⁸
	AWD	G55605	143057 ⁵¹	G51046	143063 ⁵¹ 142419 ⁶⁸
	FWD	G55609	143057 ⁵¹	G51424	142419 ⁶⁸
89	All	143057 ⁵¹	142419 ⁶⁸ 143063 ⁵¹
	FWD	G55609	143057 ⁵¹	G51424	142419 ⁶⁸ 143063 ⁵¹
85-88	All	143060 ⁵¹	143064 ⁵¹
	Exc. Electronic Adjustable Suspension	143060 ⁵¹	G51424	142419 ⁶⁸ 143064 ⁵¹

GALANT READYMOUNTS

		Front		Rear	
		Ultra Readymount	Guardian Readymount	Ultra Readymount	Guardian Readymount
99-03	GTZ	G57075 ⁴⁰

LANCER

11	DE, ES	G51908
08-10	All	143394 ⁶⁷
	DE, ES, Left	G52262	G51908	143394 ⁶⁷
	DE, ES, Right	G52263	G51908	143394 ⁶⁷
02-07	All	143088 ⁵³	143394 ⁶⁷
	Exc. ES & Evolution Series	G56894	143088 ⁵³	G51794	143394 ⁶⁷

40 Complete Assembled Unit.

53 Strut Mount. Hardware from O.E. Part may need to be reused.

67 Strut Mount Kit. Hardware from O.E. Part may need to be reused.

51 Strut Cushion for use with the Strut/Cartridge/Shocks.

54 Kit with Mount and Bearing. Hardware from O.E. Part may need to be reused.

68 Strut Mount Kit. Hardware from O.E. Part may need to be reused.

APPLICATION GUIDE

Year	Fitment Notes	Front					Rear				
		Ultra	ProGuard\Guardian\Classic	Max Control\LTV	Strut Cushion\Strut Mount	HiJackers\Load Carrier	Ultra	ProGuard\Guardian\Classic	Max Control\LTV	Strut Cushion\Strut Mount	HiJackers\Load Carrier

MITSUBISHI

MIGHTY MAX

MITSUBISHI

95-96	All	○	G63907	61500 81147	77907	43048 ⁸ 49310 ⁷
	RWD	⊥	G63950	61556 81714	77418	○	G63907	61500 81147	77907
83-94	4WD	⊥	G63418	61529	77418	○	G63419	61532 81538
	RWD	⊥	G63950	61556 81714	○	G63907	61500 81147	77907

MIGHTY MAX STEERING STABILIZERS

		Front	Rear
95-96	Single System Steering Stabilizer	6802SE ⁸⁴
83-94	RWD, Single System Steering Stabilizer	6802SE ⁸⁴

MIRAGE

97-02	All	⊥	143059 ⁵¹	⊥	G51063	142419 ⁹⁸ 143064 ⁵¹
	Mfg. from 4/97; with 6" or 7" Spring Left	⊥	G56530	143059 ⁵¹	⊥	G51063	142419 ⁹⁸ 143064 ⁵¹
	Mfg. from 4/97; with 6" or 7" Spring Right	⊥	G56529	143059 ⁵¹	⊥	G51063	142419 ⁹⁸ 143064 ⁵¹
96	All	⊥	143057 ⁵¹	⊥	143064 ⁵¹
	Mfg. to 5/96	⊥	G55911	142329 ⁵³ 143057 ⁵¹	⊥	G51063	142419 ⁹⁸ 143064 ⁵¹
95	All	⊥	G55911	143057 ⁵¹	⊥	G51063	143064 ⁵¹
	Sedan	⊥	G55911	142329 ⁵³ 143057 ⁵¹	⊥	G51063	142419 ⁹⁸ 143064 ⁵¹
93-94	All	⊥	G55911	142329 ⁵³ 143057 ⁵¹	⊥	G51063	142419 ⁹⁸ 143064 ⁵¹
89-92	All	⊥	G55592	143057 ⁵¹	⊥	G51249	142419 ⁹⁸ 143064 ⁵¹
87-88	All	⊥	G55561	143060 ⁵¹	⊥
85-86	All	⊥	143060 ⁵¹	⊥

MONTERO

08-11	All	⊥	⊥	G511066 ¹
08-10	Sport	⊥	G511063	⊥	G511066 ¹
05-06	All	⊥	⊥	G511066 ¹
04	Exc. Sport	⊥	G51839	○	G64036
01-03	All	⊥	143464 ⁶⁸	⊥
	Exc. Sport	⊥	G51839	143464 ⁶⁸	○	G64036
92-00	All	○	G63782 ⁹	77782 ⁹	○	G63781 ⁹	77781 ⁹
90-91	All	⊥	G63418	61529	77418	○	61568
	3.0L 6 Cyl V	⊥	G63418	61529	77418	○	G63604	61568
89	All	⊥	G63418	61529	77418	○	61568 81318	77492	49311 ⁷
	2.6L 4 Cyl	⊥	G63418	61529	77418	○	G63492	61568 81318	77492	49311 ⁷

1 Future Part, available 1st Quarter of 2017.

8 Pair Packs.

51 Strut Cushion for use with the Strut/Cartridge/Shocks.

68 Strut Mount Kit. Hardware from O.E. Part may need to be reused.

Bold Type - New / Future Part



7 Pair Packs, air hose kit included.

9 See Ref. D for procedures to replace Elec Adj Susp with non-adj product.

53 Strut Mount. Hardware from O.E. Part may need to be reused.

84 Replacement damper for vehicles with the Gabriel Aftermarket mounting kit

APPLICATION GUIDE

Year	Fitment Notes										
		Ultra	ProGuard\Guardian\Classic	Max Control\LTV	Strut Cushion\Strut Mount	HiJackers\Load Carrier	Ultra	ProGuard\Guardian\Classic	Max Control\LTV	Strut Cushion\Strut Mount	HiJackers\Load Carrier

MITSUBISHI

MITSUBISHI

MONTERO (cont)

89	3.0L 6 Cyl V	⊕	G63418	61529	77418	⊕	G63604	61568 81318	77492	49311 ⁷
83-88	All	⊕	G63418	61529	77418	⊕	81318	77492	49311 ⁷
	2.6L 4 Cyl	⊕	G63418	61529	77418	⊕	G63492	61506 81318	77492	49311 ⁷

MONTERO SPORT

00-04	All	⊕	G64027	⊕	G64028
97-99	All	⊕	G63782 ⁹	77782 ⁹	⊕	G63492	61506	77492	49311 ⁷

MONTERO STEERING STABILIZERS

		Front		Rear	
86-95	Single System Steering Stabilizer	6802SE ⁸⁴		

OUTLANDER

12-13	SE, XLS & GT Models w/ 3rd Row Seating Left	⊕	G52299	⊕	G511004 ²
	SE, XLS & GT Models w/ 3rd Row Seating Right	⊕	G52300	⊕	G511004 ²
09-11	SE, XLS & GT Models w/ 3rd Row Seating Left	⊕	G52299	⊕	G511004 ²	143394 ⁶⁷
	SE, XLS & GT Models w/ 3rd Row Seating Right	⊕	G52300	⊕	G511004 ²	143394 ⁶⁷
08-11	All	⊕	⊕	143394 ⁶⁷
08	XLS, Left	⊕	G52299	⊕	G511004 ²	143394 ⁶⁷
	XLS, Right	⊕	G52300	⊕	G511004 ²	143394 ⁶⁷
07	Left	⊕	G52299	⊕	G511004 ²	143394 ⁶⁷
	Right	⊕	G52300	⊕	G511004 ²	143394 ⁶⁷
05-06	All	⊕	G52065	143088 ⁵³	⊕	143394 ⁶⁷
03-04	All	⊕	G52065	143088 ⁵³	⊕	G51838	143394 ⁶⁷

PRECIS

90-94	All	⊕	G55586	143057 ⁵¹	⊕	69689	81464
87-89	All	⊕	143059 ⁵¹	⊕
	Rebuildable O.E. Front Struts	⊕	G44944 ⁹⁸	143059 ⁵¹	⊕	69689

RAIDER

06-09	All	⊕	G51815	143385 ⁶⁸	⊕
	4WD	⊕	G51815	143385 ⁶⁸	⊕	G63891
	RWD	⊕	G51815	143385 ⁶⁸	⊕	G63890

2 Future Part, available 2nd Quarter of 2017.

9 See Ref. D for procedures to replace Elec Adj Susp with non-adj product.

53 Strut Mount. Hardware from O.E. Part may need to be reused.

68 Strut Mount Kit. Hardware from O.E. Part may need to be reused.

98 Notice: The level of difficulty to install this product is moderately high. Please review the installation instructions carefully before proceeding.

7 Pair Packs, air hose kit included.

51 Strut Cushion for use with the Strut/Cartridge/Shocks.

67 Strut Mount Kit. Hardware from O.E. Part may need to be reused.

84 Replacement damper for vehicles with the Gabriel Aftermarket mounting kit

APPLICATION GUIDE

Year	Fitment Notes	Front					Rear				
		Ultra	ProGuard\ Guardian\ Classic	Max Control\ LTV	Strut Cushion\ Strut Mount	HiJackers\ Load Carrier	Ultra	ProGuard\ Guardian\ Classic	Max Control\ LTV	Strut Cushion\ Strut Mount	HiJackers\ Load Carrier

MITSUBISHI

MITSUBISHI

RAIDER READYMOUNTS		Front		Rear	
		Ultra Readymount	Guardian Readymount	Ultra Readymount	Guardian Readymount
06-09	All	G57146 ⁴⁰
	RWD	G57409 ⁴⁰

SIGMA

89-90	Non-ABS	143060 ⁵¹	143064 ⁵¹
	Non-ABS Exc. Auto-Leveling System	G51424	142419 ⁹⁸

STARION

87-89	All	143057 ⁵¹	143058 ⁵¹
	Exc. Electronic Adjustable Suspension	G44937 ⁹⁸	143057 ⁵¹	143058 ⁵¹
86	LE	143058 ⁵¹	143058 ⁵¹
84-85	LE, LS	143058 ⁵¹	143058 ⁵¹
83	All	143058 ⁵¹	143058 ⁵¹

TREDIA

83-88	All	143059 ⁵¹	69689	81464
-------	-----	------	------	------	----------------------	------	--------------	-------	------	------	------

VAN

87-90	All	G63904	61593 81872	77904	G63907	61500 81147	77907	43048 ⁸ 49310 ⁷
-------	-----	---------------	----------------	-------	------	------	---------------	----------------	-------	------	------	--

NISSAN

NISSAN

200SX

95-98	All	142623 ⁵⁴ 143057 ⁵¹
	Left B14 Solid Rear Axle	G55970	M55970	142623 ⁵⁴ 143057 ⁵¹	G51230	M51230
	Right B14 Solid Rear Axle	G55971	M55971	142623 ⁵⁴ 143057 ⁵¹	G51230	M51230
85-88	All	G44934 ⁹⁸	143059 ⁵¹	81671
84	All	143059 ⁵¹
	Solid Rear Axle	G44934 ⁹⁸	143059 ⁵¹	81501
80-83	All	G44752 ⁹⁸	143059 ⁵¹	81501
77-79	All	81501

210

79-82	All	G44752 ⁹⁸	143059 ⁵¹	81501
-------	-----	-----------------------------	------	------	----------------------	------	------	-------	------	------	------

240SX

89-94	All	143059 ⁵¹	143064 ⁵¹
-------	-----	------	------	------	----------------------	------	------	------	------	----------------------	------

7 Pair Packs, air hose kit included.

40 Complete Assembled Unit.

54 Kit with Mount and Bearing. Hardware from O.E. Part may need to be reused.

98 Notice: The level of difficulty to install this product is moderately high. Please review the installation instructions carefully before proceeding.



Bold Type - New / Future Part

8 Pair Packs.

51 Strut Cushion for use with the Strut/Cartridge/Shocks.

68 Strut Mount Kit. Hardware from O.E. Part may need to be reused.





APPLICATION GUIDE

Year	Fitment Notes										
		Ultra	ProGuard\ Guardian\ Classic	Max Control\ LTV	Strut Cushion\ Strut Mount	HiJackers\ Load Carrier	Ultra	ProGuard\ Guardian\ Classic	Max Control\ LTV	Strut Cushion\ Strut Mount	HiJackers\ Load Carrier



NISSAN

NISSAN









240SX (cont)

89-94	Left Exc. Active Suspension		G55903	142430 ⁵³ 143059 ⁵¹		G51191	143064 ⁵¹
	Right Exc. Active Suspension		G55904	142430 ⁵³ 143059 ⁵¹		G51191	143064 ⁵¹



240Z

70-73	All		G44869 ⁹⁸	142241 ⁶⁷		G44868 ⁹⁸	143059 ⁵¹
-------	-----	---	----------------------	------	------	----------------------	------	---	----------------------	------	------	----------------------	------





260Z

74-75	All		G44869 ⁹⁸		143059 ⁵¹
	2+2		G44869 ⁹⁸		G44867 ⁹⁸	143059 ⁵¹
74	Mfg. 9/74		G44869 ⁹⁸	142241 ⁶⁷		143059 ⁵¹
	Base		G44869 ⁹⁸		G44868 ⁹⁸	143059 ⁵¹





















280Z

75-78	All		G44869 ⁹⁸	142241 ⁶⁷		G44867 ⁹⁸	143059 ⁵¹
-------	-----	---	----------------------	------	------	----------------------	------	---	----------------------	------	------	----------------------	------



280ZX

83	All		G44869 ⁹⁸	142241 ⁶⁷ 143059 ⁵¹	
79-82	All		G44869 ⁹⁸	142241 ⁶⁷ 143059 ⁵¹		G51229





300ZX

94-96	2+2, Left Exc. model spec VG30DETT		G51188		G51190
	2+2, Right Exc. model spec VG30DETT		G51189		G51190
90-96	2+2		143057 ⁵¹		143064 ⁵¹
93	2+2, Exc. model spec VG30DETT			G51190
	2+2, Left		G51188	
	2+2, Right Exc. model spec VG30DETT		G51189	
90-92	2+2, Left Exc. model spec VG30DETT		G51188		G51190
	2+2, Right Exc. model spec VG30DETT		G51189		G51190
87-89	All		G44968 ⁹⁸	142241 ⁶⁷ 143060 ⁵¹		69757
84-86	All		G44936 ⁹⁸	142241 ⁶⁷ 143057 ⁵¹		69757

310

79-82	All		143059 ⁵¹	
-------	-----	---	------	------	------	----------------------	------	---	------	------	------	------	------

350Z

09	Left		G51953		G51955
	Right		G51954		G51955





51 Strut Cushion for use with the Strut/Cartridge/Shocks.

67 Strut Mount Kit. Hardware from O.E. Part may need to be reused.

53 Strut Mount. Hardware from O.E. Part may need to be reused.

98 Notice: The level of difficulty to install this product is moderately high. Please review the installation instructions carefully before proceeding.











APPLICATION GUIDE

Year	Fitment Notes										
		 Ultra	ProGuard\ Guardian\ Classic	Max Control\ LTV	Strut Cushion\ Strut Mount	HiJackers\ Load Carrier	 Ultra	ProGuard\ Guardian\ Classic	Max Control\ LTV	Strut Cushion\ Strut Mount	HiJackers\ Load Carrier



NISSAN

NISSAN



350Z (cont)

07-08	Left	 G51953	143455⁹⁸	 G51955
	Right	 G51954	143455⁹⁸	 G51955
03-06	Coupe Exc. Sport Suspension	 G51764
06	Left	 G51953	143455⁹⁸
	Right	 G51954	143455⁹⁸
	Convertible	 G51955
03-05	Left	 G51813	143455⁹⁸
	Right	 G51814	143455⁹⁸
	Sport Suspension	 G51812









410

64-65	All	 69600	81494	 82155
-------	-----	---	-------	------	------	------	---	------	------	------	------



411

64-67	All	 69600	81494	 82155
-------	-----	--	-------	------	------	------	--	------	------	------	------







510

78-81	All	 G44752 ⁹⁸	143059 ⁵¹
	Hatchback	 G44752 ⁹⁸	143059 ⁵¹	 81501
	Sedan	 G44752 ⁹⁸	143059 ⁵¹	 81501
	Wagon	 G44752 ⁹⁸	143059 ⁵¹	 82156	49310 ⁷
72	All	 81340



521 PICKUP

69-72	All	 G63902	61501 81478	77902	 G63491	61505 81097	49309 ⁷
-------	-----	--	----------------	-------	------	------	--	----------------	------	------	------	--------------------

610

75-76	All		142241 ⁶⁷	
	Wagon		142241 ⁶⁷	 69604	81492	49152 ⁷
73-74	All		142241 ⁶⁷	 69604	49152 ⁷
	Wagon		142241 ⁶⁷	 69604	81492	49152 ⁷

620 PICKUP

72-79	All	 G63902	61501 81478	77902	 G63491	61505 81097	49309 ⁷
-------	-----	--	----------------	-------	------	------	--	----------------	------	------	------	--------------------

710

74-77	Exc. Wagon	 81340
-------	------------	------	------	------	------	------	---	------	------	------	------

7 Pair Packs, air hose kit included.

67 Strut Mount Kit. Hardware from O.E. Part may need to be reused.



98 Notice: The level of difficulty to install this product is moderately high. Please review the installation instructions carefully before proceeding.

Bold Type - New / Future Part

51 Strut Cushion for use with the Strut/Cartridge/Shocks.

68 Strut Mount Kit. Hardware from O.E. Part may need to be reused.

APPLICATION GUIDE

Year	Fitment Notes										
		Ultra	ProGuard\ Guardian\ Classic	Max Control\ LTV	Strut Cushion\ Strut Mount	HiJackers\ Load Carrier	Ultra	ProGuard\ Guardian\ Classic	Max Control\ LTV	Strut Cushion\ Strut Mount	HiJackers\ Load Carrier

NISSAN

NISSAN

710 (cont)

74-77	Wagon	⊖ 69604	81492	43060 ⁸ 49152 ⁷
-------	-------	-------	-------	-------	-------	-------	---------	-------	-------	-------	-------	--

720 PICKUP

82-86	All	⊖ G63902	61501 81478	77902
	4WD	⊖ G63902	61501 81478	77902	⊖ G63492	61506 81318	77492	49311 ⁷
86	RWD	⊖ G63902	61501 81478	77902	⊖	49309 ⁷
	RWD, Mfg. to 8/86	⊖ G63902	61501 81478	77902	⊖ G63491	61505 81097
82-85	RWD	⊖ G63902	61501 81478	77902	⊖ G63491	61505 81097	49309 ⁷
80-81	All	⊖ G63902	61501 81478	77902	⊖ G63491	61505 81097	49309 ⁷

720 PICKUP STEERING STABILIZERS

							Front	Rear
82	Single System Steering Stabilizer						6802SE ⁸⁴

810

81	All	⊖ G44869 ⁹⁸	142241 ⁶⁷ 143059 ⁵¹
	Sedan	⊖ G44869 ⁹⁸	142241 ⁶⁷ 143059 ⁵¹	⊖ G51229
79-80	Hardtop	⊖	142241 ⁶⁷	⊖ G51229
78-80	Wagon	⊖	142241 ⁶⁷	⊖ 69604	81492	43060 ⁸ 49152 ⁷
77-80	All	⊖	142241 ⁶⁷
	Sedan	⊖	142241 ⁶⁷	⊖ G51229
77	Wagon	⊖	142241 ⁶⁷	⊖	81492

1200

71-73	All	⊖	81501 82020
-------	-----	-------	-------	-------	-------	-------	---	----------------	-------	-------	-------	-------

1600

66-70	All	⊖ 69704	⊖	82130
-------	-----	---------	-------	-------	-------	-------	---	-------	-------	-------	-------	-------

2000

68-70	All	⊖ 69704	⊖	82130
-------	-----	---------	-------	-------	-------	-------	---	-------	-------	-------	-------	-------

ALTIMA

16-17	All	⊖	143395 ⁶⁸
13-15	All	⊖	143395 ⁶⁸	⊖ G51874
13	Exc. Hybrid Model Left	⊖ G52121	143395 ⁶⁸	⊖ G51874
	Exc. Hybrid Model Right	⊖ G52122	143395 ⁶⁸	⊖ G51874
09-12	Left	⊖	M52121	143395 ⁶⁸	⊖ 70089 G51874

7 Pair Packs, air hose kit included.

51 Strut Cushion for use with the Strut/Cartridge/Shocks.

68 Strut Mount Kit. Hardware from O.E. Part may need to be reused.



98 Notice: The level of difficulty to install this product is moderately high. Please review the installation instructions carefully before proceeding.

8 Pair Packs.

67 Strut Mount Kit. Hardware from O.E. Part may need to be reused.

84 Replacement damper for vehicles with the Gabriel Aftermarket mounting kit

APPLICATION GUIDE

Year	Fitment Notes										
		Ultra	ProGuard\Guardian\Classic	Max Control\LTV	Strut Cushion\Strut Mount	HiJackers\Load Carrier	Ultra	ProGuard\Guardian\Classic	Max Control\LTV	Strut Cushion\Strut Mount	HiJackers\Load Carrier

NISSAN

NISSAN

ALTIMA (cont)

09-12	Right	M52122	143395 ⁶⁸	70089 G51874
07-12	Exc. Hybrid Model Left	G52121
	Exc. Hybrid Model Right	G52122
08	Left	M52121	143395 ⁶⁸	G51874
	Right	M52122	143395 ⁶⁸	G51874
07	Left	M52121	143395 ⁶⁸	G51874	143214 ⁵³
	Right	M52122	143395 ⁶⁸	G51874	143214 ⁵³
02-06	Left	G56671	M56671	142937 ⁵⁴	G51725	143214 ⁵³
	Right	G56672	M56672	142937 ⁵⁴	G51725	143214 ⁵³
00-01	Left	G55832	143057 ⁵¹	G55669	143059 ⁵¹
	Right	G55833	143057 ⁵¹	G55668	143059 ⁵¹
98-99	Left	G55832	G55669	143060 ⁵¹
	Right	G55833	G55668	143060 ⁵¹
93-97	Left	G55667	M55667	G55669	143060 ⁵¹
	Right	G55666	M55666	G55668	143060 ⁵¹

ALTIMA READYMOUNTS

		Front		Rear	
		Ultra Readymount	Guardian Readymount	Ultra Readymount	Guardian Readymount
14-16	Left	G57545 ⁴⁰
	Right	G57546 ⁴⁰
10-12	4 Cyl Left	G57210
	4 Cyl Right	G57211
07-12	Left	M57161 ⁴⁰
	Right	M57162 ⁴⁰
	Exc. Hybrid Models Left	G57161 ⁴⁰
	Exc. Hybrid Models Right	G57162 ⁴⁰
07-11	Hybrid, Left	G57367 ⁴⁰
	Hybrid, Right	G57368 ⁴⁰
02-06	Left	G57030 ⁴⁰	M57030 ⁴⁰
	Right	G57031 ⁴⁰	M57031 ⁴⁰
00-01	Left	G57558 ⁴⁰	G57003 ⁴⁰	M57003 ⁴⁰
	Right	G57559 ⁴⁰	G57004 ⁴⁰	M57004 ⁴⁰
93-99	Left	G57001 ⁴⁰	M57001 ⁴⁰	G57003 ⁴⁰	M57003 ⁴⁰
	Right	G57002 ⁴⁰	M57002 ⁴⁰	G57004 ⁴⁰	M57004 ⁴⁰

ARMADA

12-15	Exc. Auto-Leveling System	G51715	G63875
05-11	All	143358 ⁶³ 143359 ⁶⁷

40 Complete Assembled Unit.

53 Strut Mount. Hardware from O.E. Part may need to be reused.

67 Strut Mount Kit. Hardware from O.E. Part may need to be reused.



Bold Type - New / Future Part

51 Strut Cushion for use with the Strut/Cartridge/Shocks.

54 Kit with Mount and Bearing. Hardware from O.E. Part may need to be reused.

68 Strut Mount Kit. Hardware from O.E. Part may need to be reused.

APPLICATION GUIDE

Year	Fitment Notes										
		Ultra	ProGuard\ Guardian\ Classic	Max Control\ LTV	Strut Cushion\ Strut Mount	HiJackers\ Load Carrier	Ultra	ProGuard\ Guardian\ Classic	Max Control\ LTV	Strut Cushion\ Strut Mount	HiJackers\ Load Carrier

NISSAN

NISSAN

ARMADA (cont)

05-11	Exc. Auto-Leveling System	G51715	143358 ⁵³ 143359 ⁶⁷	G63875
-------	---------------------------	--------	------	------	--	------	--------	------	------	------	------

ARMADA READYMOUNTS

		Front		Rear	
		Ultra Readymount	Guardian Readymount	Ultra Readymount	Guardian Readymount
10-15	4WD	M57092 ⁴⁰
	4WD, Exc. Auto-Leveling System	G57092 ⁴⁰
05-09	4WD	G57092 ⁴⁰	M57092 ⁴⁰

AXCESS

91-94	All	142241 ⁶⁷ 143059 ⁵¹	G44776 ⁹⁸	143059 ⁵¹
	Left	142241 ⁶⁷ 143059 ⁵¹	G44776 ⁹⁸	142426 ⁵³ 143059 ⁵¹
	Right	142241 ⁶⁷ 143059 ⁵¹	G44776 ⁹⁸	142427 ⁵³ 143059 ⁵¹
90-94	FWD, Left	G55607 ⁹	M55607 ⁹	142241 ⁶⁷ 143059 ⁵¹	G44776 ⁹⁸	143059 ⁵¹
	FWD, Right	G55608 ⁹	M55608 ⁹	142241 ⁶⁷ 143059 ⁵¹	G44776 ⁹⁸	143059 ⁵¹
90	All	142241 ⁶⁷ 143059 ⁵¹	143059 ⁵¹
	Left	142241 ⁶⁷ 143059 ⁵¹	142426 ⁵³ 143059 ⁵¹
	Right	142241 ⁶⁷ 143059 ⁵¹	142427 ⁵³ 143059 ⁵¹

B210

76-78	All	G44752 ⁹⁸	143059 ⁵¹	81501
	Hatchback	G44752 ⁹⁸	143059 ⁵¹	8200 81501
75	All	G44752 ⁹⁸	143059 ⁵¹	81501 82020
74	All	G44752 ⁹⁸	143059 ⁵¹	81501
	Hatchback	G44752 ⁹⁸	143059 ⁵¹	8200 81501

CUBE

14	Left	G52193
	Right	G52194
13	Left	G52193	G51976
	Right	G52194	G51976
09-12	Left	G52193	143516 ⁶⁸	G51976
	Right	G52194	143517 ⁶⁸	G51976

CUBE READYMOUNTS

		Front		Rear	
		Ultra Readymount	Guardian Readymount	Ultra Readymount	Guardian Readymount
09-14	Left	G57202 ⁴⁰	M57202 ⁴⁰

9 See Ref. D for procedures to replace Elec Adj Susp with non-adj product.

51 Strut Cushion for use with the Strut/Cartridge/Shocks.

67 Strut Mount Kit. Hardware from O.E. Part may need to be reused.



98 Notice: The level of difficulty to install this product is moderately high. Please review the installation instructions carefully before proceeding.

40 Complete Assembled Unit.

53 Strut Mount. Hardware from O.E. Part may need to be reused.

68 Strut Mount Kit. Hardware from O.E. Part may need to be reused.

APPLICATION GUIDE





Year	Fitment Notes										
		Ultra	ProGuard\ Guardian\ Classic	Max Control\ LTV	Strut Cushion\ Strut Mount	HiJackers\ Load Carrier	Ultra	ProGuard\ Guardian\ Classic	Max Control\ LTV	Strut Cushion\ Strut Mount	HiJackers\ Load Carrier

NISSAN





















NISSAN

CUBE READYMOUNTS (cont)		Front		Rear	
		Ultra Readymount	Guardian Readymount	Ultra Readymount	Guardian Readymount
09-14	Right	G57203 ⁴⁰	M57203 ⁴⁰

F10

76-78	All		143059 ⁵¹	
	Wagon		143059 ⁵¹		82125

FRONTIER

13-17	Exc. Nismo Off-Road			G64031
	Mfg. to 12/12; Exc. Nismo Off-Road		G51766	
13	Mfg. to 12/12; Exc. Nismo Offroad		143522 ⁵⁸	
05-12	All		143379 ⁵⁸	
	Exc. Nismo Off-Road		143379 ⁵⁸		G64031
	Mfg. to 12/12; Exc. Nismo Off-Road		G51766	143379 ⁵⁸	
	Mfg. to 12/12; Exc. Nismo Offroad		143522 ⁵⁸ 143379 ⁵⁸	
98-04	4WD		G63813	61662		G63492	61506 81318	77492	49311 ⁷
	RWD, Exc. Desert Runner		G63909	61508 81507	77909		G63907	61500 81147	77907	43048 ⁸ 49310 ⁷
	RWD; Crew Cab with Desert Runner		G63813	61662		G63492	61506 81318	77492	49311 ⁷



FRONTIER READYMOUNTS

FRONTIER READYMOUNTS		Front		Rear	
		Ultra Readymount	Guardian Readymount	Ultra Readymount	Guardian Readymount
05-14	4WD	G57647 ⁴⁰
	RWD	G57646 ⁴⁰













FRONTIER STEERING STABILIZERS

		Front	Rear
98	4WD	6863SE ⁸²

LEAF

11-12	All			G511042 ¹
-------	-----	---	------	------	------	------	---	-----------------------------	------	------	------	------

MAXIMA

09-14	Left		G52382		70089
	Right		G52383		70089
04-08	Left		G56671	M56671	142937 ⁵⁴		G51802	143214 ⁵³
	Right		G56672	M56672	142937 ⁵⁴		G51802	143214 ⁵³
02-03	Left		G56685	M56685	142937 ⁵⁴		G51727	M51727	142949 ⁵³
	Right		G56686	M56686	142937 ⁵⁴		G51727	M51727	142949 ⁵³

1 Future Part, available 1st Quarter of 2017.

8 Pair Packs.

51 Strut Cushion for use with the Strut/Cartridge/Shocks.

54 Kit with Mount and Bearing. Hardware from O.E. Part may need to be reused.

82 Use kit if listed, See Ref. C for optional Steering Stabilizer Boots.

Bold Type - New / Future Part



7 Pair Packs, air hose kit included.

40 Complete Assembled Unit.

53 Strut Mount. Hardware from O.E. Part may need to be reused.

68 Strut Mount Kit. Hardware from O.E. Part may need to be reused.

APPLICATION GUIDE

Year	Fitment Notes										
		Ultra	ProGuard/ Guardian/ Classic	Max Control/ LTV	Strut Cushion/ Strut Mount	HiJackers/ Load Carrier	Ultra	ProGuard/ Guardian/ Classic	Max Control/ LTV	Strut Cushion/ Strut Mount	HiJackers/ Load Carrier

NISSAN

NISSAN

MAXIMA (cont)

00-01	Left	G56683	M56683	142937 ⁵⁴	G51727	142949 ⁵³
	Right	G56684	M56684	142937 ⁵⁴	G51727	142949 ⁵³
95-99	Left	G55913	M55913	142546 ⁵⁴	G51087	M51087
	Right	G55912	M55912	142546 ⁵⁴	G51087	M51087
89-94	All	143059 ⁵¹	143057 ⁵¹
	Exc. Electronic Adjustable Suspension	142241 ⁶⁷ 143059 ⁵¹	G44990 ⁹⁸	143057 ⁵¹
	Left	143059 ⁵¹	142426 ⁵³ 143057 ⁵¹
	Left Exc. Electronic Adjustable Suspension	G55607 ⁹	M55607 ⁹	143059 ⁵¹	143057 ⁵¹
	Right Exc. Electronic Adjustable Suspension	G55608 ⁹	M55608 ⁹	143059 ⁵¹	142427 ⁵³ 143057 ⁵¹
86-88	Sedan	143060 ⁵¹	143059 ⁵¹
	Sedan Exc. Electronic Adjustable Suspension	G55521	142242 ⁵³	G44776 ⁹⁸
	Sedan Left	142426 ⁵³
	Sedan Right Exc. Electronic Adjustable Suspension	142427 ⁵³
85	All	143060 ⁵¹	143059 ⁵¹
	Exc. Electronic Adjustable Suspension	142242 ⁵³ 143060 ⁵¹	G44776 ⁹⁸	143059 ⁵¹
	Left	143060 ⁵¹	142426 ⁵³ 143059 ⁵¹
	Right Exc. Electronic Adjustable Suspension	143060 ⁵¹	142427 ⁵³ 143059 ⁵¹
83-84	Wagon	G44869 ⁹⁸	142241 ⁶⁷ 143059 ⁵¹	82156	49310 ⁷
82-84	All	G44869 ⁹⁸	142241 ⁶⁷ 143059 ⁵¹
	Sedan	G44869 ⁹⁸	142241 ⁶⁷ 143059 ⁵¹	G51229

MAXIMA READYMOUNTS

		Front		Rear	
		Ultra Readymount	Guardian Readymount	Ultra Readymount	Guardian Readymount
09-15	Left	G57493 ⁴⁰
	Right	G57494 ⁴⁰
04-08	Left	G57030 ⁴⁰	M57030 ⁴⁰
	Right	G57031 ⁴⁰	M57031 ⁴⁰
02-03	Left	M57157 ⁴⁰	G57159 ⁴⁰	M57159 ⁴⁰
	Right	M57158 ⁴⁰	G57160 ⁴⁰	M57160 ⁴⁰
	Standard Left	G57157 ⁴⁰
	Standard Right	G57158 ⁴⁰
00-01	Left	M57165 ⁴⁰	G57159 ⁴⁰
	Right	M57166 ⁴⁰	G57160 ⁴⁰
	Standard Left	G57165 ⁴⁰

7 Pair Packs, air hose kit included.

40 Complete Assembled Unit.

53 Strut Mount. Hardware from O.E. Part may need to be reused.

67 Strut Mount Kit. Hardware from O.E. Part may need to be reused.



9 See Ref. D for procedures to replace Elec Adj Susp with non-adj product.

51 Strut Cushion for use with the Strut/Cartridge/Shocks.

54 Kit with Mount and Bearing. Hardware from O.E. Part may need to be reused.

98 Notice: The level of difficulty to install this product is moderately high. Please review the installation instructions carefully before proceeding.

APPLICATION GUIDE











Year	Fitment Notes										
		Ultra	ProGuard/ Guardian/ Classic	Max Control/ LTV	Strut Cushion/ Strut Mount	HiJackers/ Load Carrier	Ultra	ProGuard/ Guardian/ Classic	Max Control/ LTV	Strut Cushion/ Strut Mount	HiJackers/ Load Carrier

NISSAN













NISSAN

MAXIMA READYMOUNTS (cont)		Front		Rear	
		Ultra Readymount	Guardian Readymount	Ultra Readymount	Guardian Readymount
00-01	Standard Right	G57166 ⁴⁰
95-99	Left	G56970 ⁴⁰	M56970 ⁴⁰	G57057 ⁴⁰	M57057 ⁴⁰
	Right	G56971 ⁴⁰	M56971 ⁴⁰	G57058 ⁴⁰	M57058 ⁴⁰

MULTI

87-88	Left	 G44767 ⁹⁸	142242 ⁵³ 142861 ⁵⁴	 G44776 ⁹⁸	81554	142426 ⁵³
	Right	 G44767 ⁹⁸	142242 ⁵³ 142861 ⁵⁴	 G44776 ⁹⁸	81554	142427 ⁵³
	CAN		143060 ⁵¹		143057 ⁵¹
86	All	 G44767 ⁹⁸	142861 ⁵⁴	 G44766 ⁹⁸	81554
	CAN	 G44767 ⁹⁸	143060 ⁵¹ 142861 ⁵⁴	 G44766 ⁹⁸	81554





MURANO

14-17	Exc. CrossCabriolet		 G51884
08-13	Mfg. to 12/12 Left	 G52170	 G51884
	Mfg. to 12/12 Right	 G52171	 G51884
08-12	All		 G51884
03-07	Left	 G52008	M52008	142937 ⁵⁴	 G51798	143396 ⁹⁸
	Right	 G52009	M52009	142937 ⁵⁴	 G51798	143396 ⁹⁸





MURANO READYMOUNTS

		Front		Rear	
		Ultra Readymount	Guardian Readymount	Ultra Readymount	Guardian Readymount
03-07	Left	G57163 ⁴⁰	M57163 ⁴⁰
	Right	G57164 ⁴⁰	M57164 ⁴⁰





NOTE

14-16	Left	 G52453	 G51990
	Right	 G52454	 G51990

NV200

13-17	Left	 G52591	 G64146
	Right	 G52592	 G64146

NX

91-93	Left	 G55745	M55745	142623 ⁵⁴ 143057 ⁵¹	 G55977	M55977	142302 ⁵³
	Right	 G55745	M55745	142623 ⁵⁴ 143057 ⁵¹	 G55976	M55976	142302 ⁵³

40 Complete Assembled Unit.

53 Strut Mount. Hardware from O.E. Part may need to be reused.



68 Strut Mount Kit. Hardware from O.E. Part may need to be reused.

51 Strut Cushion for use with the Strut/Cartridge/Shocks.

54 Kit with Mount and Bearing. Hardware from O.E. Part may need to be reused.

98 Notice: The level of difficulty to install this product is moderately high. Please review the installation instructions carefully before proceeding.

APPLICATION GUIDE

Year	Fitment Notes										
		Ultra	ProGuard\ Guardian\ Classic	Max Control\ LTV	Strut Cushion\ Strut Mount	HiJackers\ Load Carrier	Ultra	ProGuard\ Guardian\ Classic	Max Control\ LTV	Strut Cushion\ Strut Mount	HiJackers\ Load Carrier

NISSAN

NISSAN

PATHFINDER

13-16	Left		G52524		G511043²
	Right		G52525		G511043²
12-13	Mfg. to 09/12			G64033
12	Mfg. to 8/12		G51765	
05-11	All		143379⁶⁸	
	Mfg. to 09/12		143379⁶⁸		G64033
	Mfg. to 8/12		G51765	143379⁶⁸	
04	All			G63845
	Left		M56687		G63845
	Left With OE 543034W925 or 543034W926		G56687		G63845
	Right		M56688		G63845
	Right With OE 543034W925 or 543034W926		G56688		G63845
02-03	All		142938 ⁵³		G63845
	Left		M56687	142938 ⁵³		G63845
	Left With OE 543034W925 or 543034W926		G56687	142938 ⁵³		G63845
	Right		M56688	142938 ⁵³		G63845
	Right With OE 543034W925 or 543034W926		G56688	142938 ⁵³		G63845
99-01	Left Mfg. from 12/98; with OE543034W985		G56615	142938 ⁵³	
	Mfg. from 12/98		142938 ⁵³		G63845
	Right Mfg. from 12/98; with OE543034W985		G56616	142938 ⁵³	
96-01	All		142938 ⁵³	
01	Left With OE 543034W925 or 543034W926		G56687	142938 ⁵³	
	Right With OE 543034W925 or 543034W926		G56688	142938 ⁵³	
96-99	Mfg. to 12/98		142938 ⁵³		G63712	61609 81910
	Mfg. to 12/98 Left		G56739	M56739	142938 ⁵³	
	Mfg. to 12/98 Right		G56736	M56736	142938 ⁵³	
87-95	All		81872	
	Exc. Electronic Adjustable Suspension		G63904 ⁹	61593 ⁹ 81872	77904 ⁹		G63492 ⁹	61506 ⁹ 81318 ⁹	77492 ⁹	49311 ⁷

2 Future Part, available 2nd Quarter of 2017.



9 See Ref. D for procedures to replace Elec Adj Susp with non-adj product.

68 Strut Mount Kit. Hardware from O.E. Part may need to be reused.

7 Pair Packs, air hose kit included.

53 Strut Mount. Hardware from O.E. Part may need to be reused.

APPLICATION GUIDE

Year	Fitment Notes										
		Ultra	ProGuard\ Guardian\ Classic	Max Control\ LTV	Strut Cushion\ Strut Mount	HiJackers\ Load Carrier	Ultra	ProGuard\ Guardian\ Classic	Max Control\ LTV	Strut Cushion\ Strut Mount	HiJackers\ Load Carrier

NISSAN

NISSAN

PATHFINDER ARMADA

04	Left	G56687
	Right	G56688









PATHFINDER READYMOUNTS

		Front		Rear	
		Ultra Readymount	Guardian Readymount	Ultra Readymount	Guardian Readymount
05-15	All	G57227 ⁴⁰
05-11	4WD	G57118 ⁴⁰	M57118 ⁴⁰
02-04	Left	G57144 ⁴⁰	M57144 ⁴⁰
	Right	G57145 ⁴⁰	M57145 ⁴⁰
96-99	Mfg. to 11/98 Left	G57037 ⁴⁰
	Mfg. to 11/98 Right	G57038 ⁴⁰

PATHFINDER STEERING STABILIZERS

		Front	Rear
87-95	4WD	6848SE ⁸²











PICKUP

87-97	4WD	 G63902	61501 81478	77902	 G63492	61506 81318	77492	49311 ⁷
	RWD	 G63909	61508 81507	77909	 G63907	61500 81147	77907	43048 ⁸ 49310 ⁷
86	4WD, Mfg. from 8/86	 G63902	61501 81478	77902	 G63492	61506 81318	77492	49311 ⁷
	RWD, Mfg. from 8/86	 G63909	61508 81507	77909	 G63907	61500 81147	77907	43048 ⁸ 49310 ⁷















PICKUP STEERING STABILIZERS

		Front	Rear
95-97	4WD	6848SE ⁸²

PULSAR / PULSAR NX

87-90	All	 G55745	M55745	142861 ⁵⁴ 143057 ⁵¹	 G55746	143059 ⁵¹
86	All		142861 ⁵⁴ 143057 ⁵¹		143059 ⁵¹
	Mfg. from 1/86	 G55745	M55745	142861 ⁵⁴ 143057 ⁵¹	 G55746	81508	143059 ⁵¹
	Mfg. to 1/86	 G55713 ³	142861 ⁵⁴ 143057 ⁵¹		143059 ⁵¹
83-85	All	 G55713 ³	142241 ⁶⁷ 143057 ⁵¹		81508

QUEST

14-16	All		 70077
11-13	Left	 G52355	 70077
	Right	 G52356	 70077
04-09	Left	 G52032	142937 ⁵⁴	 G51803	143396 ⁶⁸
	Right	 G52033	142937 ⁵⁴	 G51803	143396 ⁶⁸
99-02	Left	 G56785	142241 ⁶⁷ 142860 ⁵⁴	 G63299	61637
	Right	 G56784	142241 ⁶⁷ 142860 ⁵⁴	 G63299	61637

7 Pair Packs, air hose kit included.

9 See Ref. D for procedures to replace Elec Adj Susp with non-adj product.

51 Strut Cushion for use with the Strut/Cartridge/Shocks.

67 Strut Mount Kit. Hardware from O.E. Part may need to be reused.

82 Use kit if listed, See Ref. C for optional Steering Stabilizer Boots.

Bold Type - New / Future Part



8 Pair Packs.

40 Complete Assembled Unit.

54 Kit with Mount and Bearing. Hardware from O.E. Part may need to be reused.

68 Strut Mount Kit. Hardware from O.E. Part may need to be reused.

APPLICATION GUIDE

Year	Fitment Notes										
		Ultra	ProGuard\Guardian\Classic	Max Control\LTV	Strut Cushion\Strut Mount	HiJackers\Load Carrier	Ultra	ProGuard\Guardian\Classic	Max Control\LTV	Strut Cushion\Strut Mount	HiJackers\Load Carrier

NISSAN

NISSAN

QUEST (cont)

93-98	Left	G55920	M55920	142241 ⁶⁷ 142860 ⁵⁴ 143057 ⁵¹	G63299	61637
	Right	G55921	M55921	142241 ⁶⁷ 142860 ⁵⁴ 143057 ⁵¹	G63299	61637

QUEST READYMOUNTS

		Front		Rear	
		Ultra Readymount	Guardian Readymount	Ultra Readymount	Guardian Readymount
04-09	Left	G57184 ⁴⁰
	Right	G57185 ⁴⁰
93-98	Left	G56989 ⁴⁰	M56989 ⁴⁰
	Right	G56990 ⁴⁰	M56990 ⁴⁰

ROGUE

08-17	All	G64050
12-13	Left	G52418	G64050
13	S and SV Models Right	G52419	G64050
08-12	Left With OE# E4303JM00A	G52173	G64050
	Right With OE# E4302JM00A	G52174	G64050
12	Right	G52419	G64050

ROGUE READYMOUNTS

		Front		Rear	
		Ultra Readymount	Guardian Readymount	Ultra Readymount	Guardian Readymount
08-10	Left	G57473 ⁴⁰
	Right	G57474 ⁴⁰

ROGUE SELECT

14-15	Left	G52418
	Right	G52419

SENTRA

07-12	Base, S and SL Models Left	G52094	70027
	Base, S and SL Models Right	G52095	70027
07-10	Left	143377 ⁶⁸
	Right	143378 ⁶⁸
05-06	GXE, GXE Sport, XE, Left	G56806	M56806	143322 ⁵³	G51279	M51279	143209 ⁵³
	GXE, GXE Sport, XE, Right	G56805	M56805	143322 ⁵³	G51279	M51279	143209 ⁵³
02-06	SE-R, SE-R Spec V, Left	G52055
	SE-R, SE-R Spec V, Right	G52056
03-04	GXE, GXE Sport, LE, XE, Left	G56806	M56806	143322 ⁵³	G51279	M51279	143209 ⁵³

40 Complete Assembled Unit.

53 Strut Mount. Hardware from O.E. Part may need to be reused.



67 Strut Mount Kit. Hardware from O.E. Part may need to be reused.

51 Strut Cushion for use with the Strut/Cartridge/Shocks.

54 Kit with Mount and Bearing. Hardware from O.E. Part may need to be reused.

68 Strut Mount Kit. Hardware from O.E. Part may need to be reused.

APPLICATION GUIDE

Year	Fitment Notes										
		Ultra	ProGuard/ Guardian/ Classic	Max Control/ LTV	Strut Cushion/ Strut Mount	HiJackers/ Load Carrier	Ultra	ProGuard/ Guardian/ Classic	Max Control/ LTV	Strut Cushion/ Strut Mount	HiJackers/ Load Carrier

NISSAN

NISSAN

SENTRA (cont)

03-04	GXE, GXE Sport, LE, XE, Right	G56805	M56805	143322 ⁵³	G51279	M51279	143209 ⁵³
02	CA, GXE, GXE Sport, XE, Left	G56806	M56806	143322 ⁵³	G51279	M51279	143209 ⁵³
	CA, GXE, GXE Sport, XE, Right	G56805	M56805	143322 ⁵³	G51279	M51279	143209 ⁵³
00-01	Left	G56618	M56618	142936 ⁵³	G51279	M51279	143209 ⁵³
	Right	G56619	M56619	142936 ⁵³	G51279	M51279	143209 ⁵³
95-99	All	142623 ⁵⁴ 143057 ⁵¹
	Left B14 Solid Rear Axle	G55970	M55970	142623 ⁵⁴ 143057 ⁵¹	G51230	M51230
	Right B14 Solid Rear Axle	G55971	M55971	142623 ⁵⁴ 143057 ⁵¹	G51230	M51230
93-94	All	142623 ⁵⁴ 143057 ⁵¹	142302 ⁵³
	Left B13 Independent Rear Suspension	G55657	M55657	142623 ⁵⁴ 143057 ⁵¹	142302 ⁵³
	Right B13 Independent Rear Suspension	G55658	M55658	142623 ⁵⁴ 143057 ⁵¹	142302 ⁵³
	Non-ABS Left B13 Independent Rear Suspension	142623 ⁵⁴ 143057 ⁵¹	G55977	M55977	142302 ⁵³
	Non-ABS Right B13 Independent Rear Suspension	142623 ⁵⁴ 143057 ⁵¹	G55976	M55976	142302 ⁵³
91-92	All	143057 ⁵¹
	Classic, FWD	142861 ⁵⁴ 143057 ⁵¹
	FWD	143057 ⁵¹	G55746
	Non-ABS	G55745	M55745	142623 ⁵⁴ 143057 ⁵¹	142302 ⁵³
	Non-ABS Left B13 Independent Rear Suspension	143057 ⁵¹	G55977	M55977
	Non-ABS Right B13 Independent Rear Suspension	143057 ⁵¹	G55976	M55976
87-90	FWD	G55745	M55745	142861 ⁵⁴ 143057 ⁵¹	G55746
82-86	All	G55713 ⁹	143057 ⁵¹	81508

SENTRA READYMOUNTS

		Front		Rear	
		Ultra Readymount	Guardian Readymount	Ultra Readymount	Guardian Readymount
07-12	Exc. SE & SE-R Models Left	G57200 ⁴⁰
	Exc. SE & SE-R Models Right	G57201 ⁴⁰
	SE-R, Left	G57395 ⁴⁰
02-06	Left	M57034 ⁴⁰	G57036 ⁴⁰	M57036 ⁴⁰
	Right	M57035 ⁴⁰	G57036 ⁴⁰	M57036 ⁴⁰
	Exc. SE-R & SE-R Spec V Models Left	G57034 ⁴⁰
	Exc. SE-R & SE-R Spec V Models Right	G57035 ⁴⁰
00-01	Left	G57519 ⁴⁰
	Right	G57520 ⁴⁰
	Exc. GST; GSS & GSX Models Left	M57318 ⁴⁰
	Exc. GST; GSS & GSX Models Right	M57319 ⁴⁰

9 See Ref. D for procedures to replace Elec Adj Susp with non-adj product.

51 Strut Cushion for use with the Strut/Cartridge/Shocks.



54 Kit with Mount and Bearing. Hardware from O.E. Part may need to be reused.

Bold Type - New / Future Part

40 Complete Assembled Unit.

53 Strut Mount. Hardware from O.E. Part may need to be reused.

APPLICATION GUIDE

Year	Fitment Notes										
		Ultra	ProGuard\ Guardian\ Classic	Max Control\ LTV	Strut Cushion\ Strut Mount	HiJackers\ Load Carrier	Ultra	ProGuard\ Guardian\ Classic	Max Control\ LTV	Strut Cushion\ Strut Mount	HiJackers\ Load Carrier

NISSAN

NISSAN

STANZA

90-92	All	143059 ⁵¹	G44990 ⁹	143060 ⁵¹
	Left	G55610	143059 ⁵¹	G44990 ⁹	142426 ⁵³ 143060 ⁵¹
	Right	G55611	143059 ⁵¹	G44990 ⁹	142427 ⁵³ 143060 ⁵¹
87-89	Sedan	G55521	142242 ⁵³ 142861 ⁵⁴ 143060 ⁵¹	G44776 ⁹⁸	143057 ⁵¹
	Sedan Left	G55521	142242 ⁵³ 142861 ⁵⁴ 143060 ⁵¹	G44776 ⁹⁸	142426 ⁵³
	Sedan Right	G55521	142242 ⁵³ 142861 ⁵⁴ 143060 ⁵¹	G44776 ⁹⁸	142427 ⁵³
87-88	FWD, Wagon	81554
85-86	Sedan	G44767 ⁹⁸	142861 ⁵⁴ 143058 ⁵¹	G44766 ⁹⁸
86	All	G44767 ⁹⁸	G44766 ⁹⁸
	FWD, Wagon	G44767 ⁹⁸	143060 ⁵¹	G44766 ⁹⁸	81554
82-85	All	G44767 ⁹⁸	143058 ⁵¹	G44766 ⁹⁸

TIIDA

07-11	Left	143516 ⁶⁸
-------	------	-------	-------	-------	----------------------	-------	-------	-------	-------	-------	-------

TITAN

12-15	All	G51715
	4WD	G51715	M51715	G63878
	RWD	G51715	G63883
04-11	All	G51715	143358 ⁵³ 143359 ⁶⁷
	4WD	G51715	M51715	143358 ⁵³ 143359 ⁶⁷	G63878
	RWD	G51715	143358 ⁵³ 143359 ⁶⁷	G63883

TITAN READYMOUNTS

		Front		Rear	
		Ultra Readymount	Guardian Readymount	Ultra Readymount	Guardian Readymount
04-15	4WD	M57092 ⁴⁰
	4WD, Exc. Offroad Package	G57092 ⁴⁰

TITAN XD

17	4WD; Exc. Pro 4-X	G63878
16	4WD	G63878

VERSA

13-16	Left	G52453	G51990
	Right	G52454	G51990

9 See Ref. D for procedures to replace Elec Adj Susp with non-adj product.

51 Strut Cushion for use with the Strut/Cartridge/Shocks.

54 Kit with Mount and Bearing. Hardware from O.E. Part may need to be reused.

68 Strut Mount Kit. Hardware from O.E. Part may need to be reused.



40 Complete Assembled Unit.

53 Strut Mount. Hardware from O.E. Part may need to be reused.

67 Strut Mount Kit. Hardware from O.E. Part may need to be reused.

98 Notice: The level of difficulty to install this product is moderately high. Please review the installation instructions carefully before proceeding.

APPLICATION GUIDE

Year	Fitment Notes										
		Ultra	ProGuard\Guardian\Classic	Max Control\LTV	Strut Cushion\Strut Mount	HiJackers\Load Carrier	Ultra	ProGuard\Guardian\Classic	Max Control\LTV	Strut Cushion\Strut Mount	HiJackers\Load Carrier

NISSAN

NISSAN

VERSA (cont)

12	All	70041
	Models S and SL 1.8L Left	G52193	70041
	Models S and SL 1.8L Right	G52194	70041
09-11	Models S and SL	70041
	Models S and SL 1.8L Left	G52193
	Models S and SL 1.8L Right	G52194
07-11	Models S & SL Left	143516⁶⁸
	Models S & SL Right	143517⁶⁸
07-08	Models S and SL Left	G52193	70041
	Models S and SL Right	G52194	70041

VERSA READYMOUNTS

		Front		Rear	
		Ultra Readymount	Guardian Readymount	Ultra Readymount	Guardian Readymount
07-11	Left	M57202⁴⁰
	Right	M57203⁴⁰
	S & SL Models Left	G57202⁴⁰
	S & SL Models Right	G57203⁴⁰
09	Right	G57203⁴⁰

X-TRAIL

10-12	Left	G52173	G64050
	Right	G52174	G64050
08	Left	G52173	G64050
	Right	G52174	G64050
02-07	Left	G52000	143346 ⁵³	G52002
	Right	G52001	143346 ⁵³	G52003

XTERRA

14-15	All	G51765
	4WD; Mfg. to 12/12	G51765	69595
	RWD; Mfg. to 12/12	G51765	69594
13	4WD; Mfg. to 12/12	69595
	Mfg. to 12/12	G51765
	RWD; Mfg. to 12/12	69594
05-12	All	143379⁶⁸
	4WD; Mfg. to 12/12	143379⁶⁸	69595



40 Complete Assembled Unit.

53 Strut Mount. Hardware from O.E. Part may need to be reused.

68 Strut Mount Kit. Hardware from O.E. Part may need to be reused.

Bold Type - New / Future Part







APPLICATION GUIDE

Year	Fitment Notes										
		Ultra	ProGuard\ Guardian\ Classic	Max Control\ LTV	Strut Cushion\ Strut Mount	HiJackers\ Load Carrier	Ultra	ProGuard\ Guardian\ Classic	Max Control\ LTV	Strut Cushion\ Strut Mount	HiJackers\ Load Carrier

NISSAN

NISSAN

XTERRA (cont)

05-12	Mfg. to 12/12		G51765	143379 ⁶⁸	
	RWD; Mfg. to 12/12		143379 ⁶⁸		69594
00-04	All		G63813	61662		G63492	61506	77492



























XTERRA READYMOUNTS

		Front		Rear	
		Ultra Readymount	Guardian Readymount	Ultra Readymount	Guardian Readymount
05-15	4WD	G57413 ⁴⁰
	RWD	G57227 ⁴⁰

OLDSMOBILE

OLDSMOBILE

88 SERIES

97-99	All		G56718 ⁹	M56718⁹	142524 ⁶⁷ 142751 ⁶⁷ 143060 ⁵¹		142132 ⁵³ 143060 ⁵¹
	Conventional Type Replacement for Air Assist Rear Suspension		G56718 ⁹	M56718⁹	142524 ⁶⁷ 142751 ⁶⁷ 143060 ⁵¹		G56707 ⁹	M56707⁹	142132 ⁵³ 143060 ⁵¹
	Coil(RearSpringType), Coil(FrontSpringType) Optional O.E. Hydraulic Self Leveling System; Exc. Electronic Adjustable Suspension		G56718 ⁹	M56718⁹	142524 ⁶⁷ 142751 ⁶⁷ 143060 ⁵¹		G56903 ⁹	M56903⁹	142132 ⁵³ 143060 ⁵¹
94-96	All		G56718 ⁹	M56718⁹	142226 ⁵⁴ 142227 ⁶⁷ 142751 ⁶⁷ 143060 ⁵¹		142132 ⁵³ 143060 ⁵¹
	Conventional Type Replacement for Air Assist Rear Suspension		G56718 ⁹	M56718⁹	142226 ⁵⁴ 142227 ⁶⁷ 142751 ⁶⁷ 143060 ⁵¹		G56707 ⁹	M56707⁹	142132 ⁵³ 143060 ⁵¹
	Coil(RearSpringType), Coil(FrontSpringType) Optional O.E. Hydraulic Self Leveling System; Exc. Electronic Adjustable Suspension		G56718 ⁹	M56718⁹	142226 ⁵⁴ 142227 ⁶⁷ 142751 ⁶⁷ 143060 ⁵¹		G56903 ⁹	M56903⁹	142132 ⁵³ 143060 ⁵¹
92-93	All		G56718 ⁹	M56718⁹	142226 ⁵⁴ 142227 ⁶⁷ 142751 ⁶⁷ 143060 ⁵¹		142132 ⁵³
	Conventional Type Replacement for Air Assist Rear Suspension		G56718 ⁹	M56718⁹	142226 ⁵⁴ 142227 ⁶⁷ 142751 ⁶⁷ 143060 ⁵¹		G56707 ⁹	M56707⁹	142132 ⁵³
	Air(RearSpringType), Coil(FrontSpringType) Optional O.E. Hydraulic Self Leveling System; Exc. Electronic Adjustable Suspension		G56718 ⁹	M56718⁹	142226 ⁵⁴ 142227 ⁶⁷ 142751 ⁶⁷ 143060 ⁵¹		G56903 ⁹	M56903⁹	142132 ⁵³
90-91	All		142226 ⁵⁴ 142227 ⁶⁷ 142751 ⁶⁷ 143060 ⁵¹		143060 ⁵¹
	Late Design Front Strut without Spring Guard		G56718 ⁹	M56718⁹	142226 ⁵⁴ 142227 ⁶⁷ 142751 ⁶⁷ 143060 ⁵¹		143060 ⁵¹
	Optional O.E. Hydraulic Self Leveling System		142226 ⁵⁴ 142227 ⁶⁷ 142751 ⁶⁷ 143060 ⁵¹		142132 ⁵³ 143060 ⁵¹
	Air(RearSpringType) Optional O.E. Hydraulic Self Leveling System		142226 ⁵⁴ 142227 ⁶⁷ 142751 ⁶⁷ 143060 ⁵¹		G56903	M56903	143060 ⁵¹

9 See Ref. D for procedures to replace Elec Adj Susp with non-adj product.

51 Strut Cushion for use with the Strut/Cartridge/Shocks.

54 Kit with Mount and Bearing. Hardware from O.E. Part may need to be reused.



68 Strut Mount Kit. Hardware from O.E. Part may need to be reused.

40 Complete Assembled Unit.

53 Strut Mount. Hardware from O.E. Part may need to be reused.

67 Strut Mount Kit. Hardware from O.E. Part may need to be reused.

APPLICATION GUIDE

Year	Fitment Notes										
		Ultra	ProGuard/ Guardian/ Classic	Max Control/ LTV	Strut Cushion/ Strut Mount	HiJackers/ Load Carrier	Ultra	ProGuard/ Guardian/ Classic	Max Control/ LTV	Strut Cushion/ Strut Mount	HiJackers/ Load Carrier

OLDSMOBILE

88 SERIES (cont)

90-91	Coil(RearSpringType)	142226 ⁵⁴ 142227 ⁵⁷ 142751 ⁵⁷ 143060 ⁵¹	G56707 ⁹	M56707 ⁹	143060 ⁵¹
90	Early Design Front Strut with Spring Guard	G56701	143061 ⁵¹ 142226 ⁵⁴ 142227 ⁵⁷ 142751 ⁵⁷ 143060 ⁵¹	143060 ⁵¹
86-89	All	142227 ⁵⁷ 142752 ⁵⁷
	Early Design Front Strut with Spring Guard	G56701	143061 ⁵¹ 142227 ⁵⁷ 142752 ⁵⁷
	Optional O.E. Hydraulic Self Leveling System	142227 ⁵⁷ 142752 ⁵⁷	142132 ⁵³
	Air(RearSpringType) Optional O.E. Hydraulic Self Leveling System	142227 ⁵⁷ 142752 ⁵⁷	G56903	M56903
	Coil(RearSpringType)	142227 ⁵⁷ 142752 ⁵⁷	G56707 ⁹	M56707 ⁹
71-85	All	69675 ⁵	81446	34073 ⁸	69724	81514	43049 ⁹ 49131 ³⁰
65-70	All	82110	69724	81514	43049 ⁹ 49128 ³⁰
63-64	All	82079	82089
59-62	All	82079
58	Exc. '58 Air Suspension	82079
57	All	82079

88 SERIES READYMOUNTS

		Front		Rear	
		Ultra Readymount	Guardian Readymount	Ultra Readymount	Guardian Readymount
94-99	Coil(RearSpringType) Optional O.E. Hydraulic Self Leveling System; Exc. Electronic Adjustable Suspension	G56909 ⁴¹	M56909 ⁴¹	G56906 ⁴³	M56906 ⁴⁰
92-99	All	G56909 ⁴¹	M56909 ⁴¹	M56906 ⁴⁰
	Coil(RearSpringType) Exc. Electronic Adjustable Suspension	G56909 ⁴¹	M56909 ⁴¹	G56726 ⁴³	M56906 ⁴⁰
92-93	Air(RearSpringType) Optional O.E. Hydraulic Self Leveling System; Exc. Electronic Adjustable Suspension	G56909 ⁴¹	M56909 ⁴¹	G56906 ⁴³	M56906 ⁴⁰
90-91	Late Design Front Strut without Spring Guard	G56909 ⁴¹	M56909 ⁴¹	M56906 ⁴⁰
86-91	All	M56906 ⁴⁰
	Coil(RearSpringType)	G56726 ⁴³	M56906 ⁴⁰
91	Air(RearSpringType) Optional O.E. Hydraulic Self Leveling System; Exc. Electronic Adjustable Suspension	G56906 ⁴³	M56906 ⁴⁰
86-90	Early Design Front Strut with Spring Guard	G56914 ⁴⁰	M56914 ⁴⁰	M56906 ⁴⁰
	Air(RearSpringType) Optional O.E. Hydraulic Self Leveling System	G56906 ⁴³	M56906 ⁴⁰

98

91-96	All	142226 ⁵⁴ 143060 ⁵¹	142132 ⁵³ 143060 ⁵¹
	CCR Computer Command Ride	G56718 ⁹	M56718 ⁹	142226 ⁵⁴ 143060 ⁵¹	142132 ⁵³ 143060 ⁵¹
	Exc. Soft Ride Susp (FE1) and Elec. Ride & Handling (FW1)	142227 ⁵⁷ 142751 ⁵⁷ 142226 ⁵⁴ 143060 ⁵¹	142132 ⁵³ 143060 ⁵¹

5 Use kit No. 140719 to replace O.E. hardware for lower shock absorber mounting when studs break or self-tapping screws are not longer useable.

9 See Ref. D for procedures to replace Elec Adj Susp with non-adj product.

40 Complete Assembled Unit.

43 Does not include springs due to vehicle design. See Ref. D for procedures to replace Elec Adj Susp with non-adj product.

53 Strut Mount. Hardware from O.E. Part may need to be reused.

67 Strut Mount Kit. Hardware from O.E. Part may need to be reused.

Bold Type - New / Future Part

8 Pair Packs.



30 For GM Vehicles equipped with factory installed leveling systems, see Ref A.

41 Complete Assembled Unit. See Ref. D for procedures to replace Elec Adj Susp with non-adj product.

51 Strut Cushion for use with the Strut/Cartridge/Shocks.

54 Kit with Mount and Bearing. Hardware from O.E. Part may need to be reused.

APPLICATION GUIDE

Year	Fitment Notes										
		Ultra	ProGuard\Guardian\Classic	Max Control\LTV	Strut Cushion\Strut Mount	HiJackers\Load Carrier	Ultra	ProGuard\Guardian\Classic	Max Control\LTV	Strut Cushion\Strut Mount	HiJackers\Load Carrier

OLDSMOBILE

98 (cont)

OLDSMOBILE

91-96	Air(RearSpringType) CCR Computer Command Ride	↑	142226 ⁵⁴ 143060 ⁵¹	↑	G56903	M56903	142132 ⁵³ 143060 ⁵¹
	Air(RearSpringType) Conventional Type Replacement	↑	142226 ⁵⁴ 143060 ⁵¹	↑	G56707 ⁹	M56707⁹	142132 ⁵³ 143060 ⁵¹
	Air(RearSpringType), Coil(FrontSpringType) Standard Equipment; Exc. Electronic Adjustable Suspension	↑	142751 ⁶⁷ 142226 ⁵⁴ 143060 ⁵¹	↑	142132 ⁵³ 143060 ⁵¹
85-90	All	↑	G56701	142227 ⁶⁷ 142752 ⁶⁷ 143061 ⁵¹	↑	142132 ⁵³
	Air(RearSpringType)	↑	G56701	142227 ⁶⁷ 142752 ⁶⁷ 143061 ⁵¹	↑	G56903	M56903	142132 ⁵³
	Air(RearSpringType) Conventional Type Replacement	↑	G56701	142227 ⁶⁷ 142752 ⁶⁷ 143061 ⁵¹	↑	G56707 ⁹	M56707⁹	142132 ⁵³
71-84	All	⊕	69675 ⁵	81446	34073 ⁸	⊕	69724	81514	43049 ⁸ 49131 ³⁰
65-70	All	⊕	82110	⊕	69724	81514	49128 ³⁰
63-64	All	⊕	82079	⊕	82089
59-62	All	⊕	82079	⊕
58	Exc. '58 Air Suspension	⊕	82079	⊕
56	All	⊕	⊕	82156
55	All	⊕	82026	⊕	82156
51-54	All	⊕	⊕	82156

98 READYMOUNTS

		Front		Rear	
		Ultra Readymount	Guardian Readymount	Ultra Readymount	Guardian Readymount
91-96	All	G56909 ⁴¹	M56909⁴¹	M56906⁴⁰
	Air(RearSpringType) CCR Computer Command Ride	G56909 ⁴¹	M56909⁴¹	G56906 ⁴³	M56906⁴⁰
	Air(RearSpringType) Conventional Type Replacement	G56909 ⁴¹	M56909⁴¹	G56726 ⁴³	M56906⁴⁰
85-90	All	G56914 ⁴⁰	M56914⁴⁰	M56906⁴⁰
	Air(RearSpringType)	G56914 ⁴⁰	M56914⁴⁰	G56906 ⁴³	M56906⁴⁰
	Air(RearSpringType) Conventional Type Replacement	G56914 ⁴⁰	M56914⁴⁰	G56726 ⁴³	M56906⁴⁰

ACHIEVA

95-98	All	↑	143059 ⁵¹	↑
	Left Exc. Electronic Adjustable Suspension	↑	G56720	M56720	142227 ⁶⁷ 143059 ⁵¹	⊕	69407 ⁹	81790	141974 ⁶⁷	49614 ⁷
	Right Exc. Electronic Adjustable Suspension	↑	G56719	M56719	142227 ⁶⁷ 143059 ⁵¹	⊕	69407 ⁹	81790	141974 ⁶⁷	49614 ⁷
92-94	All	↑	143059 ⁵¹	⊕	49371 ⁷
	Exc. Electronic Adjustable Suspension	↑	143059 ⁵¹	↑	141974 ⁶⁷	49371 ⁷
	Exc. FE3 and Electronic Ride Control	↑	143059 ⁵¹	⊕	69749	81530	49371 ⁷
	FE3 Suspension	↑	142227 ⁶⁷ 143059 ⁵¹	⊕	49371 ⁷

5 Use kit No. 140719 to replace O.E. hardware for lower shock absorber mounting when studs break or self-tapping screws are not longer useable.

8 Pair Packs.

30 For GM Vehicles equipped with factory installed leveling systems, see Ref A.

41 Complete Assembled Unit. See Ref. D for procedures to replace Elec Adj Susp with non-adj product.

51 Strut Cushion for use with the Strut/Cartridge/Shocks.

54 Kit with Mount and Bearing. Hardware from O.E. Part may need to be reused.

7 Pair Packs, air hose kit included.

9 See Ref. D for procedures to replace Elec Adj Susp with non-adj product.



40 Complete Assembled Unit.

43 Does not include springs due to vehicle design. See Ref. D for procedures to replace Elec Adj Susp with non-adj product.

53 Strut Mount. Hardware from O.E. Part may need to be reused.

67 Strut Mount Kit. Hardware from O.E. Part may need to be reused.

APPLICATION GUIDE

Year	Fitment Notes										
		Ultra	ProGuard\Guardian\Classic	Max Control\LTV	Strut Cushion\Strut Mount	HiJackers\Load Carrier	Ultra	ProGuard\Guardian\Classic	Max Control\LTV	Strut Cushion\Strut Mount	HiJackers\Load Carrier

OLDSMOBILE

OLDSMOBILE

ACHIEVA (cont)

92-94	Left Exc. FE3 and Electronic Ride Control	G56720	M56720	143059 ⁵¹	49371 ⁷
	Left FE3 Suspension	G56723	143059 ⁵¹	49371 ⁷
	Right Exc. FE3 and Electronic Ride Control	G56719	M56719	143059 ⁵¹	49371 ⁷
	Right FE3 Suspension	G56724	143059 ⁵¹	49371 ⁷

ACHIEVA READYMOUNTS

		Front		Rear	
		Ultra Readymount	Guardian Readymount	Ultra Readymount	Guardian Readymount
97-98	Left	M56917 ⁴⁰
	Left Exc. Electronic Adjustable Suspension	G56917 ⁴⁰
	Right	M56916 ⁴⁰
	Right Exc. Electronic Adjustable Suspension	G56916 ⁴⁰
95-96	Left	G56917 ⁴⁰	M56917 ⁴⁰
	Right	G56916 ⁴⁰	M56916 ⁴⁰
92-94	Left	M56919 ⁴⁰
	Right	M56918 ⁴⁰

ALERO

99-04	All	G55974	M55974	143060 ⁵¹	G56501	M56501	142532 ⁵³ 143057 ⁵¹
-------	-----	--------	--------	------	----------------------	------	--------	--------	------	--	------

ALERO READYMOUNTS

		Front		Rear	
		Ultra Readymount	Guardian Readymount	Ultra Readymount	Guardian Readymount
99-04	All	G56927 ⁴⁰	M56927 ⁴⁰	G56928 ⁴⁰	M56928 ⁴⁰

AURORA

01-03	All	G56509	M56509	142640 ⁵⁴	142647 ⁵³
	All w/o OE Style air fitting	G56509	M56509	142640 ⁵⁴	142647 ⁵³	49228 ³⁰
	With OE Style air fitting	G56509	M56509	142640 ⁵⁴	142647 ⁵³	49255 ⁷
98-99	All	G56509	M56509	142640 ⁵⁴	142647 ⁵³
	All w/o OE Style air fitting	G56509	M56509	142640 ⁵⁴	142647 ⁵³	49228 ³⁰
	With OE Style air fitting	G56509	M56509	142640 ⁵⁴	142647 ⁵³	49255 ⁷
97	All	G55878	142524 ⁵⁷	142647 ⁵³
	All w/o OE Style air fitting	G55878	142524 ⁵⁷	142647 ⁵³	49228 ³⁰
	With OE Style air fitting	G55878	142524 ⁵⁷	142647 ⁵³	49255 ⁷
95-96	All	G56718 ⁹	M56718 ⁹	142227 ⁵⁷ 142751 ⁵⁷ 143060 ⁵¹	142647 ⁵³
	All w/o OE Style air fitting	G56718 ⁹	M56718 ⁹	142227 ⁵⁷ 142751 ⁵⁷ 143060 ⁵¹	142647 ⁵³	49228 ³⁰
	With OE Style air fitting	G56718 ⁹	M56718 ⁹	142227 ⁵⁷ 142751 ⁵⁷ 143060 ⁵¹	142647 ⁵³	49255 ⁷

7 Pair Packs, air hose kit included.

30 For GM Vehicles equipped with factory installed leveling systems, see Ref A.

51 Strut Cushion for use with the Strut/Cartridge/Shocks.

54 Kit with Mount and Bearing. Hardware from O.E. Part may need to be reused.

Bold Type - New / Future Part



9 See Ref. D for procedures to replace Elec Adj Susp with non-adj product.

40 Complete Assembled Unit.

53 Strut Mount. Hardware from O.E. Part may need to be reused.

67 Strut Mount Kit. Hardware from O.E. Part may need to be reused.

APPLICATION GUIDE

Year	Fitment Notes										
		Ultra	ProGuard/ Guardian/ Classic	Max Control/ LTV	Strut Cushion/ Strut Mount	HiJackers/ Load Carrier	Ultra	ProGuard/ Guardian/ Classic	Max Control/ LTV	Strut Cushion/ Strut Mount	HiJackers/ Load Carrier

OLDSMOBILE

OLDSMOBILE

AURORA READYMOUNTS		Front		Rear	
		Ultra Readymount	Guardian Readymount	Ultra Readymount	Guardian Readymount
01-03	Exc. Electronic Adjustable Suspension	G57051 ⁴⁰	M57051 ⁴⁰
98-99	Exc. Electronic Adjustable Suspension	G57051 ⁴⁰	M57051 ⁴⁰

BRAVADA

02-04	All	G51718 ⁴⁵	M51718 ⁴⁵	143241 ⁵³	61717
	Coil(RearSpringType)	G51718 ⁴⁵	M51718 ⁴⁵	143241 ⁵³	G63842	61717
96-01	All	G63423	61531 81516	58423 77423	G63422	61528 81482	58422 77422	43162 ⁶ 49213 ⁷
91-94	All	G63423	61531 81516	58423 77423	G63422	61528 81482	58422 77422	43162 ⁶ 49213 ⁷
	Torsion Bar(FrontSpringType)	G63423	61531 81516	58423 77423	142316 ⁵³	G63422	61528 81482	58422 77422	43162 ⁶ 49213 ⁷

BRAVADA READYMOUNTS

BRAVADA READYMOUNTS		Front		Rear	
		Ultra Readymount	Guardian Readymount	Ultra Readymount	Guardian Readymount
02-04	All	G57022 ⁴⁰	M57022 ⁴⁰

CALAIS

87	Left	G56706	142762 ⁶⁷ 143060 ⁵¹	G69749	81530	141974 ⁶⁷	49371 ⁷
	Right	G56705	142762 ⁶⁷ 143060 ⁵¹	G69749	81530	141974 ⁶⁷	49371 ⁷
85-86	All	142762 ⁶⁷ 143060 ⁵¹	G69749	81530	141974 ⁶⁷	49371 ⁷
	Left Non-Rebuildable O.E. Struts	G56706	142762 ⁶⁷ 143060 ⁵¹	G69749	81530	141974 ⁶⁷	49371 ⁷
	Rebuildable O.E. Struts	G44451 ⁹⁸	142762 ⁶⁷ 143060 ⁵¹	G69749	81530	141974 ⁶⁷	49371 ⁷
	Right Non-Rebuildable O.E. Struts	G56705	142762 ⁶⁷ 143060 ⁵¹	G69749	81530	141974 ⁶⁷	49371 ⁷

CALAIS READYMOUNTS

CALAIS READYMOUNTS		Front		Rear	
		Ultra Readymount	Guardian Readymount	Ultra Readymount	Guardian Readymount
85-87	Left	G57327 ⁴⁰
	Right	G57328 ⁴⁰

CIERA / CUTLASS CIERA

85-96	All	142749 ⁶⁷ 143060 ⁵¹
	Exc. Electronic Adjustable Suspension	G55514	M55514	142223 ⁵³ 142749 ⁶⁷ 143060 ⁵¹	G69723 ⁹	81517	141974 ⁶⁷	49370 ³⁰
84	All	142223 ⁵³ 142749 ⁶⁷ 143060 ⁵¹	141974 ⁶⁷	49370 ³⁰
	Exc. Electronic Adjustable Suspension	142223 ⁵³ 142749 ⁶⁷ 143060 ⁵¹	G69723 ⁹	81517	141974 ⁶⁷	49370 ³⁰
	Exc. HD Suspension	G55505	142223 ⁵³ 142749 ⁶⁷ 143060 ⁵¹	141974 ⁶⁷	49370 ³⁰
	HD Suspension	G55514	M55514	142223 ⁵³ 142749 ⁶⁷ 143060 ⁵¹	141974 ⁶⁷	49370 ³⁰

7 Pair Packs, air hose kit included.

9 See Ref. D for procedures to replace Elec Adj Susp with non-adj product.

40 Complete Assembled Unit.

51 Strut Cushion for use with the Strut/Cartridge/Shocks.

67 Strut Mount Kit. Hardware from O.E. Part may need to be reused.

8 Pair Packs.



30 For GM Vehicles equipped with factory installed leveling systems, see Ref A.

45 Strut must be rotated to align notch with lower control arm.

53 Strut Mount. Hardware from O.E. Part may need to be reused.

98 Notice: The level of difficulty to install this product is moderately high. Please review the installation instructions carefully before proceeding.





APPLICATION GUIDE

Year	Fitment Notes										
		Ultra	ProGuard\Guardian\Classic	Max Control\LTV	Strut Cushion\Strut Mount	HiJackers\Load Carrier	Ultra	ProGuard\Guardian\Classic	Max Control\LTV	Strut Cushion\Strut Mount	HiJackers\Load Carrier

OLDSMOBILE





OLDSMOBILE

CIERA / CUTLASS CIERA (cont)







































82-83	All		G55505	142223 ⁵³ 142749 ⁶⁷ 143060 ⁵¹		49370 ³⁰
	Exc. Electronic Adjustable Suspension		G55505	142223 ⁵³ 142749 ⁶⁷ 143060 ⁵¹		69723 ⁹	81517	49370 ³⁰

CIERA / CUTLASS CIERA READYMOUNTS		Front		Rear	
		Ultra Readymount	Guardian Readymount	Ultra Readymount	Guardian Readymount
85-96	Exc. Electronic Adjustable Suspension	G56908 ⁴⁰	M56908⁴⁰
84-96	All	M56908⁴⁰
84	HD Suspension	G56908 ⁴⁰	M56908⁴⁰

CUSTOM CRUISER

77-92	All		69675 ⁵	81446	34073 ⁸		69604	81492	43060 ⁹ 49152 ³⁰
71-76	All		69675 ⁵	81446	34073 ⁸		69604	81492

CUTLASS / CUTLASS SUPREME

99	All		G55974	M55974	143060 ⁵¹		G56501	M56501	142532 ⁵³ 143057 ⁵¹
98	All		143060 ⁵¹		142532 ⁵³ 143057 ⁵¹
	First Design with Rear Strut Lower Mounting Holes at 3.2" Apart		143060 ⁵¹		G55975	M55975	142532 ⁵³ 143057 ⁵¹
	Rear Strut Lower Mounting Holes at 2.4" & 3.2" Apart		G55974	M55974	143060 ⁵¹		142532 ⁵³ 143057 ⁵¹
	Second Design with Rear Strut Lower Mounting holes at 2.4" apart		143060 ⁵¹		G56501	M56501	142532 ⁵³ 143057 ⁵¹
97	All		G44459 ³⁶	M55974	142143 ⁵³ 143060 ⁵¹		142532 ⁵³ 143057 ⁵¹ 143062 ⁵¹
	Exc. Rear Strut Lower Mounting holes at 3.2" apart		G44459 ³⁶	M55974	142143 ⁵³ 143060 ⁵¹		G56708	M56708	142532 ⁵³ 143057 ⁵¹ 143062 ⁵¹
	First Design with Rear Strut Lower Mounting Holes at 3.2" Apart		G44459 ³⁶	M55974	142143 ⁵³ 143060 ⁵¹		G55975	M55975	142532 ⁵³ 143057 ⁵¹ 143062 ⁵¹
88-96	All		G44459 ³⁶	142143 ⁵³ 143060 ⁵¹		G56708	M56708	143062 ⁵¹
79-87	All		69600	81494	34051 ⁸		69604	81492	43060 ⁹ 49334 ³⁰
78-79	Vista Cruiser		69600	81494	34051 ⁸		69604	81492	49334 ³⁰ 43060 ⁹
76-78	All		69600	81494	34051 ⁸		69604	81492	43060 ⁹
76-77	Coupe		69600	81494	34051 ⁸		69604	81492	49152 ³⁰ 43060 ⁹
	Sedan		69600	81494	34051 ⁸		69604	81492	49152 ³⁰ 43060 ⁹
	Wagon		69600	81494	34051 ⁸		69604	81492	49334 ³⁰ 43060 ⁹
73-75	All		69600	81494	34051 ⁸		69604	81492	43060 ⁹ 49152 ³⁰
71-72	All		69600	81494	34051 ⁸		69604	81492	43060 ⁹
68-72	HD Suspension		69600	81494	34051 ⁸		69604	81492	43060 ⁹
72	Base, S		69600	81494	34051 ⁸		69604	81492	49152 ³⁰ 43060 ⁹

5 Use kit No. 140719 to replace O.E. hardware for lower shock absorber mounting when studs break or self-tapping screws are not longer useable.

9 See Ref. D for procedures to replace Elec Adj Susp with non-adj product.

36 Requires special strut installation tool.

51 Strut Cushion for use with the Strut/Cartridge/Shocks.

67 Strut Mount Kit. Hardware from O.E. Part may need to be reused.

8 Pair Packs.



30 For GM Vehicles equipped with factory installed leveling systems, see Ref A.

40 Complete Assembled Unit.

53 Strut Mount. Hardware from O.E. Part may need to be reused.

Bold Type - New / Future Part

APPLICATION GUIDE

Year	Fitment Notes										
		Ultra	ProGuard/ Guardian/ Classic	Max Control/ LTV	Strut Cushion/ Strut Mount	HiJackers/ Load Carrier	Ultra	ProGuard/ Guardian/ Classic	Max Control/ LTV	Strut Cushion/ Strut Mount	HiJackers/ Load Carrier

OLDSMOBILE

OLDSMOBILE

CUTLASS / CUTLASS SUPREME (cont)

72	Cruiser	⊥ ⊕	69600	81494	34051 ⁸	⊕ ⊕	69604	81492	49114 ⁷ 43060 ⁸
	Exc. Cruiser	⊥ ⊕	69600	81494	34051 ⁸	⊕ ⊕	69604	81492	43060 ⁸
71	Exc. Vista Cruiser	⊥ ⊕	69600	81494	34051 ⁸	⊕ ⊕	69604	81492	49152 ³⁰ 43060 ⁸
	All	⊥ ⊕	69600	81494	34051 ⁸	⊕ ⊕	81492	43060 ⁸
68-70	Exc. Vista Cruiser	⊥ ⊕	69600	81494	34051 ⁸	⊕ ⊕	81492	49152 ³⁰ 43060 ⁸
	Exc. HD Suspension	⊥ ⊕	⊕ ⊕	69724	81514	43049 ⁸
66-67	Base, Exc. HD Suspension	⊥ ⊕	⊕ ⊕	49131 ³⁰
	HD Suspension; Exc. Vista Cruiser	⊥ ⊕	⊕ ⊕	49152 ³⁰
64-67	Base, Holiday	⊥ ⊕	82138	⊕ ⊕
	HD Suspension	⊥ ⊕	⊕ ⊕	81492	43060 ⁸
67	Turnpike Cruiser	⊥ ⊕	82110	⊕ ⊕	49128 ⁷
	HD Suspension	⊥ ⊕	⊕ ⊕	69604	81492	43060 ⁸
64-66	Exc. HD Suspension	⊥ ⊕	⊕ ⊕	69724	81514	43049 ⁸ 49131 ³⁰

CUTLASS / CUTLASS SUPREME READYMOUNTS

		Front		Rear	
		Ultra Readymount	Guardian Readymount	Ultra Readymount	Guardian Readymount
98-99	All	G56927 ⁴⁰	M56927 ⁴⁰
97	All	G56927 ⁴⁰	M56927 ⁴⁰	G56727 ⁴²	M56727 ⁴²
88-96	All	G56727 ⁴²	M56727 ⁴²

CUTLASS CALAIS

88-91	Left	⊥ ⊕	G56706	142762 ⁶⁷ 143060 ⁵¹	⊥ ⊕	69749	81530	141974 ⁶⁷	49371 ⁷
	Right	⊥ ⊕	G56705	142762 ⁶⁷ 143060 ⁵¹	⊥ ⊕	69749	81530	141974 ⁶⁷	49371 ⁷

CUTLASS CALAIS READYMOUNTS

		Front		Rear	
		Ultra Readymount	Guardian Readymount	Ultra Readymount	Guardian Readymount
88-91	Left	G57327 ⁴⁰
	Right	G57328 ⁴⁰

CUTLASS CLASSIC / CUTLASS CRUISER

87-94	All	⊥ ⊕	142749 ⁶⁷ 143060 ⁵¹	⊥ ⊕
	Exc. Electronic Adjustable Suspension	⊥ ⊕	G55514	M55514	142223 ⁵³ 142749 ⁶⁷ 143060 ⁵¹	⊥ ⊕	69723 ⁹	81517	141974 ⁶⁷	49370 ³⁰
80-83	All	⊥ ⊕	69600	81494	34051 ⁸	⊕ ⊕	69604	81492	43060 ⁸ 49334 ³⁰

CUTLASS CLASSIC / CUTLASS CRUISER READYMOUNTS

		Front		Rear	
		Ultra Readymount	Guardian Readymount	Ultra Readymount	Guardian Readymount
87-94	All	M56908 ⁴⁰
	Exc. Electronic Adjustable Suspension	G56908 ⁴⁰	M56908 ⁴⁰

F85

68-72	All	⊥ ⊕	69600	81494	⊕ ⊕	69604	81492	43060 ⁸ 49152 ³⁰
-------	-----	--------	-------	-------	------	------	------	--------	-------	-------	------	------	---

7 Pair Packs, air hose kit included.

9 See Ref. D for procedures to replace Elec Adj Susp with non-adj product.

40 Complete Assembled Unit.

51 Strut Cushion for use with the Strut/Cartridge/Shocks.

67 Strut Mount Kit. Hardware from O.E. Part may need to be reused.



8 Pair Packs.

30 For GM Vehicles equipped with factory installed leveling systems, see Ref A.

42 Does not include springs due to vehicle design.

53 Strut Mount. Hardware from O.E. Part may need to be reused.

APPLICATION GUIDE





Year	Fitment Notes										
		Ultra	ProGuard/ Guardian/ Classic	Max Control/ LTV	Strut Cushion/ Strut Mount	HiJackers/ Load Carrier	Ultra	ProGuard/ Guardian/ Classic	Max Control/ LTV	Strut Cushion/ Strut Mount	HiJackers/ Load Carrier

OLDSMOBILE







OLDSMOBILE

INTRIGUE READYMOUNTS		Front		Rear	
		Ultra Readymount	Guardian Readymount	Ultra Readymount	Guardian Readymount
98-02	Left	G57060 ⁴⁰	M57060 ⁴⁰	G56924 ⁴⁰	M56924 ⁴⁰
	Right	G57060 ⁴⁰	M57060 ⁴⁰	G56925 ⁴⁰	M56925 ⁴⁰

JETFIRE















63	All		82079		82089
62	All		82079	

LSS

96-99	All		G56718 ⁹	M56718 ⁹	142524 ⁶⁷ 142751 ⁶⁷ 143060 ⁵¹		142132 ⁵³ 143060 ⁵¹
	Air(RearSpringType)		G56718 ⁹	M56718 ⁹	142524 ⁶⁷ 142751 ⁶⁷ 143060 ⁵¹		G56903	M56903	142132 ⁵³ 143060 ⁵¹
	Coil(RearSpringType) Conventional Type Replacement for Air Assist Rear Suspension		G56718 ⁹	M56718 ⁹	142524 ⁶⁷ 142751 ⁶⁷ 143060 ⁵¹		G56707 ⁹	M56707 ⁹	142132 ⁵³ 143060 ⁵¹







LSS READYMOUNTS		Front		Rear	
		Ultra Readymount	Guardian Readymount	Ultra Readymount	Guardian Readymount
96-99	All	G56909 ⁴¹	M56909 ⁴¹	M56906 ⁴⁰
	Air(RearSpringType)	G56909 ⁴¹	M56909 ⁴¹	G56906 ⁴³	M56906 ⁴⁰
	Coil(RearSpringType) Conventional Type Replacement for Air Assist Rear Suspension	G56909 ⁴¹	M56909 ⁴¹	G56726 ⁴³	M56906 ⁴⁰

OMEGA

84	All		143060 ⁵¹		69723	81517	49370 ³⁰
	Exc. HD Suspension		G55505	143060 ⁵¹		69723	81517	49370 ³⁰
	HD Suspension		G55514	M55514	143060 ⁵¹		69723	81517	49370 ³⁰
80-83	All		G55505	143060 ⁵¹		69723	81517	49370 ³⁰
78-79	All		69600	81494	34051 ⁸		82093
74-77	All		69600	81494		82093	49193 ⁷
73	Exc. HD Suspension		69600	81494		82093	49193 ⁷

OMEGA READYMOUNTS		Front		Rear	
		Ultra Readymount	Guardian Readymount	Ultra Readymount	Guardian Readymount
84	All	M56908 ⁴⁰
	HD Suspension	G56908 ⁴⁰	M56908 ⁴⁰

REGENCY

97-98	All		G56718 ⁹	M56718 ⁹	142524 ⁶⁷ 142751 ⁶⁷ 143060 ⁵¹		142132 ⁵³ 143060 ⁵¹
	Air(RearSpringType) Optional O.E. Hydraulic Self Leveling System		G56718 ⁹	M56718 ⁹	142524 ⁶⁷ 142751 ⁶⁷ 143060 ⁵¹		G56903	M56903	142132 ⁵³ 143060 ⁵¹
	Coil(RearSpringType)		G56718 ⁹	M56718 ⁹	142524 ⁶⁷ 142751 ⁶⁷ 143060 ⁵¹		G56707 ⁹	M56707 ⁹	142132 ⁵³ 143060 ⁵¹

7 Pair Packs, air hose kit included.

9 See Ref. D for procedures to replace Elec Adj Susp with non-adj product.

40 Complete Assembled Unit.

43 Does not include springs due to vehicle design. See Ref. D for procedures to replace Elec Adj Susp with non-adj product.

53 Strut Mount. Hardware from O.E. Part may need to be reused.

8 Pair Packs.



30 For GM Vehicles equipped with factory installed leveling systems, see Ref A.

41 Complete Assembled Unit. See Ref. D for procedures to replace Elec Adj Susp with non-adj product.

51 Strut Cushion for use with the Strut/Cartridge/Shocks.

67 Strut Mount Kit. Hardware from O.E. Part may need to be reused.

APPLICATION GUIDE



Year	Fitment Notes										
		Ultra	ProGuard\Guardian\Classic	Max Control\LTV	Strut Cushion\Strut Mount	HiJackers\Load Carrier	Ultra	ProGuard\Guardian\Classic	Max Control\LTV	Strut Cushion\Strut Mount	HiJackers\Load Carrier

OLDSMOBILE

OLDSMOBILE





REGENCY READYMOUNTS		Front		Rear	
		Ultra Readymount	Guardian Readymount	Ultra Readymount	Guardian Readymount
97-98	All	G56909 ⁴¹	M56909 ⁴¹	M56906 ⁴⁰
	Air(RearSpringType) Optional O.E. Hydraulic Self Leveling System	G56909 ⁴¹	M56909 ⁴¹	G56906 ⁴³	M56906 ⁴⁰
	Coil(RearSpringType)	G56909 ⁴¹	M56909 ⁴¹	G56726 ⁴³	M56906 ⁴⁰

SILHOUETTE







02-04	AWD, FWD	G55948	M55948	142524 ⁵⁷ 142525 ⁵³ 142526 ⁵⁴ 143060 ⁵¹		G63776	61659 81924
	FWD	G55948	M55948	142524 ⁵⁷ 142525 ⁵³ 142526 ⁵⁴ 143060 ⁵¹	49230 ⁷
97-04	All	G55948	M55948	142524 ⁵⁷ 142525 ⁵³ 142526 ⁵⁴ 143060 ⁵¹	
97-01	FWD	G55948	M55948	142524 ⁵⁷ 142525 ⁵³ 142526 ⁵⁴ 143060 ⁵¹		G63776	61659 81924	49230 ⁷
90-96	All	G55992	142223 ⁵³ 142749 ⁵⁷ 143060 ⁵¹		G63914	61503	141974 ⁵⁷	49370 ³⁰

SILHOUETTE READYMOUNTS		Front		Rear	
		Ultra Readymount	Guardian Readymount	Ultra Readymount	Guardian Readymount
97-04	All	G57060 ⁴⁰	M57060 ⁴⁰
90-96	All	G57389 ⁴⁰

STARFIRE

75-80	All	82129		81438
65-66	All	82110		69724	81514	43049 ⁸ 49128 ³⁰
63-64	All	82079		82089
61-62	All	82079	
57	All	82079	

TORONADO

90-92	All	G56717 ⁹	142227 ⁵⁷ 142297 ⁵⁴		G56704 ⁹	142405 ⁵³
86-89	All	G56703	142298 ⁵⁴		G56704 ⁹	142405 ⁵³
79-85	All	69706	81445		49345 ³⁰
71-78	All	82010		69604	81492	43060 ⁸ 49152 ³⁰
67-70	Vertically Mounted	82010		82034
66	Vertically Mounted	82010		82040	49122 ⁷

TORONADO STEERING STABILIZERS		Front	Rear
		79-85	All
71-78	All	14010
66	All	14010

7 Pair Packs, air hose kit included.

9 See Ref. D for procedures to replace Elec Adj Susp with non-adj product.

40 Complete Assembled Unit.

43 Does not include springs due to vehicle design. See Ref. D for procedures to replace Elec Adj Susp with non-adj product.

53 Strut Mount. Hardware from O.E. Part may need to be reused.

67 Strut Mount Kit. Hardware from O.E. Part may need to be reused.

Bold Type - New / Future Part

8 Pair Packs.



30 For GM Vehicles equipped with factory installed leveling systems, see Ref A.

41 Complete Assembled Unit. See Ref. D for procedures to replace Elec Adj Susp with non-adj product.

51 Strut Cushion for use with the Strut/Cartridge/Shocks.

54 Kit with Mount and Bearing. Hardware from O.E. Part may need to be reused.

APPLICATION GUIDE

Year	Fitment Notes										
		Ultra	ProGuard\ Guardian\ Classic	Max Control\ LTV	Strut Cushion\ Strut Mount	HiJackers\ Load Carrier	Ultra	ProGuard\ Guardian\ Classic	Max Control\ LTV	Strut Cushion\ Strut Mount	HiJackers\ Load Carrier

OLDSMOBILE

OLDSMOBILE

VISTA CRUISER

73-75	All	⊕	69600	
68-72	All	⊕	69600	⊕	69606	49114 ⁷
	Stud Upper Mount	⊕	69600	⊕	69606	81495	49114 ⁷
64-67	All	⊕	⊕	69606	49114 ⁷
	Stud Upper Mount	⊕	⊕	69606	81495	49114 ⁷

OPEL

OPEL

1900

71-75	All	⊕	82614	⊕
-------	-----	---	------	-------	------	------	------	------	------	---	------	------	------	------

KADETT

68-72	All	⊕	⊕	82123
-------	-----	---	------	------	------	------	------	------	------	---	------	-------	------	------

MANTA

71-75	All	⊕	82614	⊕
-------	-----	---	------	-------	------	------	------	------	------	---	------	------	------	------

OPEL

69-73	All	⊕	81322	⊕	82039
-------	-----	---	------	-------	------	------	------	------	------	---	------	-------	------	------

PEUGEOT

PEUGEOT

403

59-66	All	⊕	⊕	82125
-------	-----	---	------	------	------	------	------	------	------	---	------	-------	------	------

404

61-67	All	⊕	⊕	82125
-------	-----	---	------	------	------	------	------	------	------	---	------	-------	------	------

504 / 505 / 604

91	All	⊕	143061 ⁵¹	⊕
86-90	Sedan	⊕	143061 ⁵¹	⊕

PLYMOUTH

PLYMOUTH

ACCLAIM

89-95	All	⊕	G55526	M55526	142567 ⁶⁷ 142568 ⁶⁷ 142880 ⁵⁴ 142933 ⁶⁸ 142940 ⁶⁶ 143059 ⁵¹	⊕	69632	81459	49369 ⁷
-------	-----	---	--------	--------	------	--	------	------	------	---	-------	-------	------	------	--------------------

ACCLAIM READYMOUNTS

		Front		Rear	
		Ultra Readymount	Guardian Readymount	Ultra Readymount	Guardian Readymount
89-95	All	M56985 ⁴⁰
	Exc. Hydraulic Self Leveling System	G56985 ⁴⁰	M56985 ⁴⁰

ARROW

76-80	All	⊕	143059 ⁵¹	⊕	81676
-------	-----	---	------	------	------	----------------------	------	------	------	---	------	-------	------	------	------

BARRACUDA

70-74	All	⊕	82090	⊕	82131	43096
-------	-----	---	------	-------	------	------	------	------	------	---	------	-------	------	------	-------

7 Pair Packs, air hose kit included.

51 Strut Cushion for use with the Strut/Cartridge/Shocks.

66 Upper Spring Seat with Spacer. Hardware from O.E. Part may need to be reused.



68 Strut Mount Kit. Hardware from O.E. Part may need to be reused.

40 Complete Assembled Unit.

54 Kit with Mount and Bearing. Hardware from O.E. Part may need to be reused.

67 Strut Mount Kit. Hardware from O.E. Part may need to be reused.

APPLICATION GUIDE

Year	Fitment Notes										
		Ultra	ProGuard/ Guardian/ Classic	Max Control/ LTV	Strut Cushion/ Strut Mount	HiJackers/ Load Carrier	Ultra	ProGuard/ Guardian/ Classic	Max Control/ LTV	Strut Cushion/ Strut Mount	HiJackers/ Load Carrier

PLYMOUTH

PLYMOUTH

BARRACUDA (cont)

64-69	All	○	82090	○	81469	49110 ⁷
-------	-----	---	-------	-------	-------	-------	-------	---	-------	-------	-------	-------	-------	--------------------

BELVEDERE

62-70	All	○	82090	○	82131	43096 ⁸ 49106 ⁷
57-61	All	○	82072	○	81469	49110 ⁷
53-56	All	○	○	81469	49110 ⁷

BREEZE

99-00	All	⌋	143064 ⁵¹	⌋	G51268	M51268	143063 ⁵¹ 143328 ⁶⁷
	Exc. JA Mfr Body Code	⌋	G51267	M51267	143064 ⁵¹	⌋	G51268	M51268	143063 ⁵¹ 143328 ⁶⁷
97-98	All	⌋	143064 ⁵¹	⌋	G51078	M51268	143063 ⁵¹
	JA(MfrBodyCode)	⌋	G51796	143064 ⁵¹	⌋	G51078	M51268	143063 ⁵¹
96	All	⌋	G55818	M51267	143064 ⁵¹	⌋	G51078	M51268	143063 ⁵¹
	JA(MfrBodyCode)	⌋	G51796	M51267	143064 ⁵¹	⌋	G51078	M51268	143063 ⁵¹

BREEZE READYMOUNTS

		Front		Rear	
		Ultra Readymount	Guardian Readymount	Ultra Readymount	Guardian Readymount
99-00	Left	G57431 ⁴⁰	G57025 ⁴⁰	M57025 ⁴⁰
	Right	G57432 ⁴⁰	G57025 ⁴⁰	M57025 ⁴⁰
96-98	All	G57422 ⁴⁰

CAMBRIDGE

51-53	All	○	○	81469	49110 ⁷
-------	-----	---	-------	-------	-------	-------	-------	---	-------	-------	-------	-------	-------	--------------------

CARAVELLE

89	All	⌋	81406	⌋
	RWD	⌋	69704	81406	⌋	69703	81338	49346 ⁷
88	All	⌋	G55526	81406 M55526	142567 ⁶⁷ 142568 ⁶⁷ 142880 ⁶⁴ 142933 ⁶⁸ 142940 ⁶⁶ 143060 ⁵¹	⌋
	FWD	⌋	G55526	81406 M55526	142567 ⁶⁷ 142568 ⁶⁷ 142880 ⁶⁴ 142933 ⁶⁸ 142940 ⁶⁶ 143060 ⁵¹	⌋	69632	81459	49369 ⁷
	RWD	⌋	69704	81406 M55526	142567 ⁶⁷ 142568 ⁶⁷ 142880 ⁶⁴ 142933 ⁶⁸ 142940 ⁶⁶ 143060 ⁵¹	⌋	69703	81338	49346 ⁷
87	All	⌋	G55526	81406 M55526	142567 ⁶⁷ 142568 ⁶⁷ 142880 ⁶⁴ 142933 ⁶⁸ 142940 ⁶⁶ 143060 ⁵¹	⌋	69632	81459	49369 ⁷

7 Pair Packs, air hose kit included.

40 Complete Assembled Unit.

54 Kit with Mount and Bearing. Hardware from O.E. Part may need to be reused.

67 Strut Mount Kit. Hardware from O.E. Part may need to be reused.

Bold Type - New / Future Part



8 Pair Packs.

51 Strut Cushion for use with the Strut/Cartridge/Shocks.

66 Upper Spring Seat with Spacer. Hardware from O.E. Part may need to be reused.

68 Strut Mount Kit. Hardware from O.E. Part may need to be reused.

APPLICATION GUIDE

Year	Fitment Notes										
		Ultra	ProGuard\Guardian\Classic	Max Control\LTV	Strut Cushion\Strut Mount	HiJackers\Load Carrier	Ultra	ProGuard\Guardian\Classic	Max Control\LTV	Strut Cushion\Strut Mount	HiJackers\Load Carrier

PLYMOUTH

CARAVELLE (cont)

PLYMOUTH

86	All	↑	G55526	81406 M55526	142567 ⁶⁷ 142568 ⁶⁷ 142880 ⁵⁴ 142933 ⁶⁸ 143060 ⁵¹	↑	69632	81459	49369 ⁷
	Mfg. from 1/2/86	↑	G55526	81406 M55526	142940 ⁶⁶ 142567 ⁶⁷ 142568 ⁶⁷ 142880 ⁵⁴ 142933 ⁶⁸ 143060 ⁵¹	↑	69632	81459	49369 ⁷
85	All	↑	G55511	81406	143060 ⁵¹	↑	69632	81459	49369 ⁷
84	All	↑	G55511	143060 ⁵¹	↑	69632	81459	49369 ⁷
83	All	↑	G55507	143060 ⁵¹	↑	69632	81459	49369 ⁷
78-81	RWD	↑	69704	81406	↑	69703	81338	49346 ⁷

CHAMP

79-82	All	↑	143059 ⁵¹	↑	69689	81464
-------	-----	---	------	------	------	----------------------	------	---	-------	-------	------	------	------

COLT

94	All	↑	↑	142419 ⁶⁸
	Sedan	↑	G55911	142329 ⁵³	↑	69689 G51063	81464	142419 ⁶⁸
	Wagon	↑	G55605	↑	69462	142419 ⁶⁸
92-93	All	↑	143057 ⁵¹	↑	142419 ⁶⁸
	Wagon	↑	G55605	143057 ⁵¹	↑	69462	142419 ⁶⁸
93	Sedan	↑	G55911	142329 ⁵³ 143057 ⁵¹	↑	69689 G51063	81464	142419 ⁶⁸
92	FWD, Hatchback	↑	143057 ⁵¹	↑	81464	142419 ⁶⁸
	Hatchback	↑	143057 ⁵¹	↑	69689	142419 ⁶⁸
	Sedan	↑	143057 ⁵¹	↑	69689	81464	142419 ⁶⁸
90-91	FWD, Hatchback	↑	143057 ⁵¹	↑	G51249 69689	142419 ⁶⁸
	Hatchback	↑	G55592	↑	69689	142419 ⁶⁸
89-91	All	↑	↑	69689	142419 ⁶⁸
	Vista, 4WD, Wagon	↑	↑	69689	81739	142419 ⁶⁸
	Vista, FWD, Wagon	↑	↑	69689	81464	142419 ⁶⁸
	Vista, Wagon	↑	143059 ⁵¹	↑	69689	142419 ⁶⁸
89-90	DL, Wagon	↑	G55561	↑	69689	142419 ⁶⁸
	Exc. Vista Model	↑	143060 ⁵¹	↑	69689	142419 ⁶⁸
89	FWD, Hatchback	↑	143057 ⁵¹	↑	69689	142419 ⁶⁸

7 Pair Packs, air hose kit included.

53 Strut Mount. Hardware from O.E. Part may need to be reused.

66 Upper Spring Seat with Spacer. Hardware from O.E. Part may need to be reused.





252 68 Strut Mount Kit. Hardware from O.E. Part may need to be reused.

51 Strut Cushion for use with the Strut/Cartridge/Shocks.

54 Kit with Mount and Bearing. Hardware from O.E. Part may need to be reused.

67 Strut Mount Kit. Hardware from O.E. Part may need to be reused.







































APPLICATION GUIDE

Year	Fitment Notes										
			Ultra	ProGuard\ Guardian\ Classic	Max Control\ LTV	Strut Cushion\ Strut Mount	HiJackers\ Load Carrier		Ultra	ProGuard\ Guardian\ Classic	Max Control\ LTV



PLYMOUTH

COLT (cont)



PLYMOUTH

89	Hatchback		G55592		G51249 69689	142419 ⁹⁸
85-88	All			69689
	Vista, FWD, Wagon			69689	81464
	Vista, Wagon		143059 ⁵¹		69689
88	DL, Wagon		G55561		69689
	Hatchback		143060 ⁵¹		69689
	Sedan		143060 ⁵¹		69689
87	Hatchback		G55561	143060 ⁵¹		69689
	Sedan		G55561	143060 ⁵¹		69689
85-86	DL, E, Premier		143060 ⁵¹		69689
84	Hatchback			69689
	Vista, FWD, Wagon			81464
	Vista, Wagon		143059 ⁵¹	
81-83	Hatchback		143059 ⁵¹		69689	81464
80	All			82156	43048 ⁸ 49151 ⁷
	Hatchback		143059 ⁵¹		69689	81464 82156	43048 ⁸ 49151 ⁷
76-79	All			81676 82156	43048 ⁸ 49151 ⁷
	Sedan		143059 ⁵¹		81676 82156	43048 ⁸ 49151 ⁷
	Wagon		143059 ⁵¹		81676 82156	43048 ⁸ 49151 ⁷



CONCORD

51-52	All			81469	49110 ⁷
-------	-----	---	------	------	------	------	------	---	------	-------	------	------	--------------------



CRANBROOK

51-53	All			81469	49110 ⁷
-------	-----	---	------	------	------	------	------	---	------	-------	------	------	--------------------



CUSTOM

58-61	All		82072		81469	49110 ⁷
-------	-----	---	------	-------	------	------	------	---	------	-------	------	------	--------------------





DUSTER

70-76	All		82090		81469	49110 ⁷
-------	-----	---	------	-------	------	------	------	---	------	-------	------	------	--------------------

EXPO

87-89	All		G55507	143057 ⁵¹		G51047	142173 ⁹³ 143059 ⁵¹
-------	-----	---	--------	------	------	----------------------	------	---	--------	------	------	--	------

FLEET SPECIAL

62-63	All		82090		82131	49106 ⁷
60-61	All		82072		81469	49110 ⁷

7 Pair Packs, air hose kit included.





51 Strut Cushion for use with the Strut/Cartridge/Shocks.

68 Strut Mount Kit. Hardware from O.E. Part may need to be reused.

8 Pair Packs.



























53 Strut Mount. Hardware from O.E. Part may need to be reused.

APPLICATION GUIDE















Year	Fitment Notes										
		 Ultra	ProGuard\ Guardian\ Classic	Max Control\ LTV	Strut Cushion\ Strut Mount	HiJackers\ Load Carrier	 Ultra	ProGuard\ Guardian\ Classic	Max Control\ LTV	Strut Cushion\ Strut Mount	HiJackers\ Load Carrier

PLYMOUTH FURY







PLYMOUTH

77-78	All		81153		69703	81338
	Police Package		81153		69703	82131 81338	43096 ⁸ 49106 ⁷
75-76	All		81153		82131	43096 ⁸ 49106 ⁷
74	All		69704		82131	43096 ⁸ 49106 ⁷
73	All		82011		81091
	Exc. Wagon		82011		81091
	Exc. Wagon		82011		81091	49149 ⁷
	Wagon		82011		82131 81091	49106 ⁷ 43096 ⁸
70-72	All		82011		81091	49149 ⁷
65-69	All		82011		82131	43096 ⁸ 49106 ⁷
62-64	All		82090		82131	49106 ⁷
57-61	All		82072		81469	49110 ⁷
56	All			81469	49110 ⁷









GRAN FURY

82-89	All		69704	81406		69703	81338	49346 ⁷
80-81	All		69704	81153		69703	81338
74-77	All		69704	81406		82131	43096 ⁸ 49106 ⁷
73	All		82011	
	Hardtop		82011		81091	43067 ⁸ 49149 ⁷
	Wagon		82011		82131	49106 ⁷ 43096 ⁸
72	All		82011		81091	49149 ⁷







GTX

71	All			82131
68-70	All		82090		82131
67	All		82090		82131	43096 ⁸ 49106 ⁷

HORIZON

90	All		G55594		G51047	142173 ⁵³
	Hatchback		G55594	143059 ⁵¹		G51047	142173 ⁵³
81-89	All		G55507	143057 ⁵¹		G51047	142173 ⁵³
78-80	All		G55507	143057 ⁵¹		142173 ⁵³

LASER

92-94	AWD		G55605	142219 ⁵³ 143057 ⁵¹		G51046	142419 ⁶⁸ 143064 ⁵¹
90-94	All		142219 ⁵³ 143057 ⁵¹		142419 ⁶⁸ 143064 ⁵¹
	FWD		G55587	142219 ⁵³ 143057 ⁵¹		G51184	142419 ⁶⁸ 143064 ⁵¹





7 Pair Packs, air hose kit included.

51 Strut Cushion for use with the Strut/Cartridge/Shocks.

8 Pair Packs.







53 Strut Mount. Hardware from O.E. Part may need to be reused.

APPLICATION GUIDE

Year	Fitment Notes										
		 Ultra	ProGuard\ Guardian\ Classic	Max Control\ LTV	Strut Cushion\ Strut Mount	HiJackers\ Load Carrier	 Ultra	ProGuard\ Guardian\ Classic	Max Control\ LTV	Strut Cushion\ Strut Mount	HiJackers\ Load Carrier



PLYMOUTH NEON

PLYMOUTH

00-01	Left	 G55892	M55892	142932 ⁶⁸	 G55894	M55894	143256 ⁶³
	Right	 G55892	M55892	142932 ⁶⁸	 G55893	M55893	143256 ⁶³
95-99	All	 G55679	M55679	142840 ⁵⁴ 143057 ⁵¹	 G55680	M55680	142393 ⁵³ 143059 ⁵¹

NEON READYMOUNTS		Front		Rear	
		Ultra Readymount	Guardian Readymount	Ultra Readymount	Guardian Readymount
00-01	Left	G56975 ⁴⁰	M56975⁴⁰	G56973 ⁴⁰	M56973⁴⁰
	Right	G56975 ⁴⁰	M56975⁴⁰	G56974 ⁴⁰	M56974⁴⁰
95-99	All	G56966 ⁴⁰	M56966⁴⁰	G56967 ⁴⁰	M56967⁴⁰





PICKUP

79-82	All	 G63950	61556 81714	 G63907	61500 81147	77907	43048 ⁸ 49310 ⁷
-------	-----	--	----------------	------	------	------	--	----------------	-------	------	--







PICKUP STEERING STABILIZERS

		Front	Rear
79-82	All	6802SE ⁸⁴







PLAZA

57-58	All		82072		81469	49110 ⁷
54-56	All			81469	49110 ⁷



RELIANT

86-89	All	 G55526	M55526	142567 ⁵⁷ 142568 ⁵⁷ 142880 ⁵⁴ 142933 ⁶⁸ 142940 ⁵⁶ 143060 ⁵¹	 69632	81459	49369 ⁷
84-85	All	 G55511	143060 ⁵¹	 69632	81459	49369 ⁷
81-83	All	 G55507	143057 ⁵¹	 69632	81459	49369 ⁷







ROADRUNNER

73-75	All		81153		82131	43096 ⁸ 49106 ⁷
71-72	All		82090		82131	49106 ⁷
68-70	All		82090		82131	43096 ⁸ 49106 ⁷





SAPPORO

78-83	All		143059 ⁵¹	
-------	-----	--	------	------	----------------------	------	--	------	------	------	------

SATELLITE

73-74	All		81153		82131	43096 ⁸ 49106 ⁷
71-72	All		82090		82131	49106 ⁷
65-70	All		82090		82131	43096 ⁸ 49106 ⁷

SAVOY

62-64	All		82090		82131	49106 ⁷
57-61	All		82072		81469	49110 ⁷

7 Pair Packs, air hose kit included.

40 Complete Assembled Unit.

53 Strut Mount. Hardware from O.E. Part may need to be reused.

66 Upper Spring Seat with Spacer. Hardware from O.E. Part may need to be reused.

68 Strut Mount Kit. Hardware from O.E. Part may need to be reused.

Bold Type - New / Future Part

8 Pair Packs.



51 Strut Cushion for use with the Strut/Cartridge/Shocks.

54 Kit with Mount and Bearing. Hardware from O.E. Part may need to be reused.

67 Strut Mount Kit. Hardware from O.E. Part may need to be reused.

84 Replacement damper for vehicles with the Gabriel Aftermarket mounting kit

APPLICATION GUIDE

Year	Fitment Notes										
		Ultra	ProGuard\ Guardian\ Classic	Max Control\ LTV	Strut Cushion\ Strut Mount	HiJackers\ Load Carrier	Ultra	ProGuard\ Guardian\ Classic	Max Control\ LTV	Strut Cushion\ Strut Mount	HiJackers\ Load Carrier

PLYMOUTH

SAVOY (cont)

PLYMOUTH

53-56	All	81469	49110 ⁷
-------	-----	-------	-------	-------	-------	-------	-------	-------	-------	-------	--------------------

SCAMP

83	All	G55507	143057 ⁵¹
71-76	All	82090	81469	49110 ⁷

SPORT WAGON

60-61	All	82072	81469	49110 ⁷
-------	-----	-------	-------	-------	-------	-------	-------	-------	-------	-------	--------------------

SUBURBAN

57-61	All	82072	81469	49110 ⁷
51-56	All	81469	49110 ⁷

SUNDANCE

87-94	All	G55526	M55526	142567 ⁶⁷ 142568 ⁶⁷ 142880 ⁵⁴ 142933 ⁶⁸ 142940 ⁶⁶ 143060 ⁵¹	69632	81459	49369 ⁷
-------	-----	--------	--------	-------	--	-------	-------	-------	-------	-------	--------------------

SUNDANCE READYMOUNTS

		Front		Rear	
		Ultra Readymount	Guardian Readymount	Ultra Readymount	Guardian Readymount
89-94	All	M56985 ⁴⁰
	Exc. Hydraulic Self Leveling System	G56985 ⁴⁰	M56985 ⁴⁰

SUPERBIRD

70	All	82090	82131	43096 ⁸ 49106 ⁷
----	-----	-------	-------	-------	-------	-------	-------	-------	-------	-------	--

TRAILDUSTER

81	All	77359 ³⁵	34052 ⁸	43067 ⁸ 49149 ⁷
	4WD	G63183	61632 81825	58183 77359 ³⁵	34052 ⁸	G63389	61633 81342	58389 77389	43067 ⁸ 49149 ⁷
	RWD	G63359 ³⁵	61523 ³⁵ 81096 ³⁵	58359 ³⁵ 77359 ³⁵	34052 ⁸	G63353	61526 81091	58353	43067 ⁸ 49149 ⁷
76-80	All	43067 ⁸ 49149 ⁷
	4WD	G63183	61632 81825	58183	G63389	61633 81342	58389 77389	43067 ⁸ 49149 ⁷
	RWD	G63359 ³⁵	61523 ³⁵ 81096 ³⁵	58359 ³⁵ 77359 ³⁵	34052 ⁸	G63353	61526 81091	58353	43067 ⁸ 49149 ⁷
75	All	G63353	61526	43067 ⁸ 49149 ⁷
	4WD	G63183	61632 81825	58183	G63353	61526	43067 ⁸ 49149 ⁷
	RWD	G63359 ³⁵	61523 ³⁵ 81096 ³⁵	58359 ³⁵ 77359 ³⁵	34052 ⁸	G63353	81091 61526	58353	43067 ⁸ 49149 ⁷
74	All	G63183	61632 81825	58183	G63353	61526 81091	58353	43067 ⁸ 49149 ⁷

TRAILDUSTER STEERING STABILIZERS

		Front	Rear
75-81	4WD, Single System Steering Stabilizer	6803SE ⁸⁴
74-81	Dual System Steering Stabilizer; Exc. Vacuum Servo Mounted on Drivers Side of Axle	6802SE ⁸⁴
74	Single System Steering Stabilizer	6803SE ⁸⁴

7 Pair Packs, air hose kit included.

35 Sight grinding of control arm opening is required to install product made before Aug 1988.

51 Strut Cushion for use with the Strut/Cartridge/Shocks.

66 Upper Spring Seat with Spacer. Hardware from O.E. Part may need to be reused.

68 Strut Mount Kit. Hardware from O.E. Part may need to be reused.

8 Pair Packs.



40 Complete Assembled Unit.

54 Kit with Mount and Bearing. Hardware from O.E. Part may need to be reused.

67 Strut Mount Kit. Hardware from O.E. Part may need to be reused.

84 Replacement damper for vehicles with the Gabriel Aftermarket mounting kit

APPLICATION GUIDE

Year	Fitment Notes										
		Ultra	ProGuard/ Guardian/ Classic	Max Control/ LTV	Strut Cushion/ Strut Mount	HiJackers/ Load Carrier	Ultra	ProGuard/ Guardian/ Classic	Max Control/ LTV	Strut Cushion/ Strut Mount	HiJackers/ Load Carrier

PLYMOUTH

TURISMO

85	All	G55507	143057 ⁵¹	G51047	142173 ⁵³
83	All	G55507	143057 ⁵¹	G51047	142173 ⁵³

PLYMOUTH

VALIANT

60-76	All	82090	81469	49110 ⁷
-------	-----	------	-------	------	------	------	------	-------	------	------	--------------------

VAN 1/2 TON, PB SERIES

74-83	All	G63359 ³⁵	61523 ³⁵ 81096 ³⁵	58359 ³⁵ 77359 ³⁵	34052 ⁸	G63413	61522 ⁶ 81496	58413 77413	43085 ⁹ 49212 ⁷
-------	-----	----------------------	--	--	------	--------------------	--------	-----------------------------	----------------	------	--

VAN 3/4 TON, PB SERIES

74-83	All	G63359 ³⁵	61523 ³⁵ 81096 ³⁵	58359 ³⁵ 77359 ³⁵	34052 ⁸	G63413	61522 ⁶ 81496	58413 77413	43085 ⁹ 49212 ⁷
-------	-----	----------------------	--	--	------	--------------------	--------	-----------------------------	----------------	------	--

VAN 1 TON, PB SERIES

74-83	All	G63413	61522 ⁶ 81496	58413 77413	43085 ⁹ 49212 ⁷
	4000# Front Axle	G63360 ³⁵	61650 81834	58360	G63413	61522 ⁶ 81496	58413 77413	43085 ⁹ 49212 ⁷
	Exc. 4000# Front Axle	G63359 ³⁵	61523 ³⁵ 81096 ³⁵	58359 ³⁵ 77359 ³⁵	34052 ⁸	G63413	61522 ⁶ 81496	58413 77413	43085 ⁹ 49212 ⁷

VIP

67	All	82011	82131	43096 ⁹ 49106 ⁷
----	-----	------	-------	------	------	------	------	-------	------	------	--

VOLARE

76-80	All	69704	81406	69703	81338	49346 ⁷
-------	-----	-------	-------	------	------	------	-------	-------	------	------	--------------------

VOYAGER / GRAND VOYAGER

96-00	All	G55697	M55697	143059 ⁵¹	61605 ³⁴ 81878
	Exc. Hydraulic Self Leveling System	G55697	M55697	143059 ⁵¹	G63690 ¹⁰	61605 ³⁴ 81878
	Exc. Nivomat Self-Leveling Option	G55697	M55697	142753 ⁵⁷ 142841 ⁵⁴ 143059 ⁵¹	61605 ³⁴ 81878
	Non-ABS	G55697	M55697	143059 ⁵¹	61605 ³⁴ 81878	49236 ⁷
87-95	All	G55525	M55525	142567 ⁵⁷ 142568 ⁵⁷ 142880 ⁵⁴ 142933 ⁵⁸ 143059 ⁵¹	G63426	61538 81529
86	All	142567 ⁵⁷ 142568 ⁵⁷ 142880 ⁵⁴ 142933 ⁵⁸ 143059 ⁵¹	G63426	61538 81529
	Mfg. from 1/86	G55525	M55525	142567 ⁵⁷ 142568 ⁵⁷ 142880 ⁵⁴ 142933 ⁵⁸ 143059 ⁵¹	G63426	61538 81529
	Mfg. to 2/86	G55509	142567 ⁵⁷ 142568 ⁵⁷ 142880 ⁵⁴ 142933 ⁵⁸ 143059 ⁵¹	G63426	61538 81529
84-85	All	G55509	143059 ⁵¹	G63426	61538 81529

6 It is recommended that when replacing shocks on vehicles with "quad shocks" all 4 shocks should be matched by series.

8 Pair Packs.

34 If suspension spring contacts this unit, rotate suspension spring 180 degrees.

51 Strut Cushion for use with the Strut/Cartridge/Shocks.

54 Kit with Mount and Bearing. Hardware from O.E. Part may need to be reused.

68 Strut Mount Kit. Hardware from O.E. Part may need to be reused.

7 Pair Packs, air hose kit included.





10 The Nivomat leveling shocks are on the rear only. If suspension spring contacts units, rotate suspension spring 180 degrees.

35 Sight grinding of control arm opening is required to install product made before Aug 1988.

53 Strut Mount. Hardware from O.E. Part may need to be reused.

67 Strut Mount Kit. Hardware from O.E. Part may need to be reused.

APPLICATION GUIDE

Year	Fitment Notes										
		 Ultra	ProGuard\ Guardian\ Classic	Max Control\ LTV	Strut Cushion\ Strut Mount	HiJackers\ Load Carrier	 Ultra	ProGuard\ Guardian\ Classic	Max Control\ LTV	Strut Cushion\ Strut Mount	HiJackers\ Load Carrier

PLYMOUTH



















PLYMOUTH

VOYAGER / GRAND VOYAGER READYMOUNTS		Front		Rear	
		Ultra Readymount	Guardian Readymount	Ultra Readymount	Guardian Readymount
96-00	All	G56910 ⁴⁰	M56910 ⁴⁰
96	Exc. Hydraulic Self Leveling System	G56910 ⁴⁰	M56910 ⁴⁰
87-95	All	G56907 ⁴⁰	M56907 ⁴⁰
86	Mfg. from 1/86	G56907 ⁴⁰	M56907 ⁴⁰

PONTIAC

PONTIAC



6000

91	FWD		142223 ⁵³ 142749 ⁶⁷ 143060 ⁵¹		69723	81517	141974 ⁶⁷	49370 ³⁰
	FWD, HD Suspension		G55514	M55514	
89-90	All		142223 ⁵³ 142749 ⁶⁷ 143060 ⁵¹	
	HD Suspension		G55514	M55514	142223 ⁵³ 142749 ⁶⁷ 143060 ⁵¹	
	FWD		142223 ⁵³ 142749 ⁶⁷ 143060 ⁵¹		69723	81517	141974 ⁶⁷	49370 ³⁰
84-88	All		142223 ⁵³ 142749 ⁶⁷ 143060 ⁵¹		69723	81517	141974 ⁶⁷	49370 ³⁰
	HD Suspension		G55514	M55514	142223 ⁵³ 142749 ⁶⁷ 143060 ⁵¹		69723	81517	141974 ⁶⁷	49370 ³⁰
84	Exc. HD Suspension		G55505	142223 ⁵³ 142749 ⁶⁷ 143060 ⁵¹		69723	81517	141974 ⁶⁷	49370 ³⁰
82-83	All		G55505	142223 ⁵³ 143060 ⁵¹		69723	81517	49370 ³⁰



6000 READYMOUNTS

6000 READYMOUNTS		Front		Rear	
		Ultra Readymount	Guardian Readymount	Ultra Readymount	Guardian Readymount
91	FWD	G56908 ⁴⁰
84-90	All	G56908 ⁴⁰
	FWD	G56908 ⁴⁰	M56908 ⁴⁰







ACADIAN

76-87	All		81322		81340
-------	-----	---	------	-------	------	------	------	---	------	-------	------	------	------

ASTRE

75-77	All		82129		81438
-------	-----	---	------	-------	------	------	------	---	------	-------	------	------	------

AZTEK

01-05	All		G55834	142526 ⁵⁴	
	AWD		G55834	142526 ⁵⁴		G63868	61777
	FWD		G55834	142526 ⁵⁴		G63869

AZTEK READYMOUNTS

AZTEK READYMOUNTS		Front		Rear	
		Ultra Readymount	Guardian Readymount	Ultra Readymount	Guardian Readymount
01-05	All	G57274 ⁴⁰

30 For GM Vehicles equipped with factory installed leveling systems, see Ref A.

51 Strut Cushion for use with the Strut/Cartridge/Shocks.

54 Kit with Mount and Bearing. Hardware from O.E. Part may need to be reused.

40 Complete Assembled Unit.

53 Strut Mount. Hardware from O.E. Part may need to be reused.

67 Strut Mount Kit. Hardware from O.E. Part may need to be reused.

APPLICATION GUIDE

Year	Fitment Notes										
		Ultra	ProGuard\ Guardian\ Classic	Max Control\ LTV	Strut Cushion\ Strut Mount	HiJackers\ Load Carrier	Ultra	ProGuard\ Guardian\ Classic	Max Control\ LTV	Strut Cushion\ Strut Mount	HiJackers\ Load Carrier

PONTIAC

PONTIAC

BONNEVILLE

00-05	All	G56509	M56509	142640 ⁵⁴	142647 ⁵³
	All w/o OE Style air fitting	G56509	M56509	142640 ⁵⁴	142647 ⁵³	49228 ³⁰
00-04	With OE Style air fitting	G56509	M56509	142640 ⁵⁴	142647 ⁵³	49255⁷
98-99	Air(RearSpringType) CCR Computer Command Ride	142226 ⁵⁴ 142751 ⁵⁷ 143060 ⁵¹	142132 ⁵³ 143060 ⁵¹
97-99	All	142751 ⁵⁷ 143060 ⁵¹	142132 ⁵³ 143060 ⁵¹
	Exc. CCR Computer Command Ride	G56718 ⁹	M56718⁹	142751 ⁵⁷ 143060 ⁵¹	142132 ⁵³ 143060 ⁵¹
	Air(RearSpringType) Optional O.E. Hydraulic Self Leveling System; Exc. Electronic Adjustable Suspension	142751 ⁵⁷ 143060 ⁵¹	G56903	M56903	142132 ⁵³ 143060 ⁵¹
	Coil(RearSpringType) Exc. Electronic Adjustable Suspension	142751 ⁵⁷ 143060 ⁵¹	G56707 ⁹	M56707⁹	142132 ⁵³ 143060 ⁵¹
94-96	All	142227 ⁵⁷ 142751 ⁵⁷ 143060 ⁵¹	142132 ⁵³ 143060 ⁵¹
	CCR Computer Command Ride	142226 ⁵⁴ 142227 ⁵⁷ 142751 ⁵⁷ 143060 ⁵¹	142132 ⁵³ 143060 ⁵¹
	Exc. CCR Computer Command Ride	G56718 ⁹	M56718⁹	142227 ⁵⁷ 142751 ⁵⁷ 143060 ⁵¹	142132 ⁵³ 143060 ⁵¹
	Air(RearSpringType) Optional O.E. Hydraulic Self Leveling System; Exc. Electronic Adjustable Suspension	142227 ⁵⁷ 142751 ⁵⁷ 143060 ⁵¹	G56903	M56903	142132 ⁵³ 143060 ⁵¹
	Coil(RearSpringType) Exc. Electronic Adjustable Suspension	142227 ⁵⁷ 142751 ⁵⁷ 143060 ⁵¹	G56707 ⁹	M56707⁹	142132 ⁵³ 143060 ⁵¹
91-93	All	G56718 ⁹	M56718⁹	142226 ⁵⁴ 142227 ⁵⁷ 142751 ⁵⁷ 143060 ⁵¹	142132 ⁵³ 143060 ⁵¹
	Air(RearSpringType) Optional O.E. Hydraulic Self Leveling System; Exc. Electronic Adjustable Suspension	G56718 ⁹	M56718⁹	142226 ⁵⁴ 142227 ⁵⁷ 142751 ⁵⁷ 143060 ⁵¹	G56903	M56903	142132 ⁵³ 143060 ⁵¹
	Coil(RearSpringType) Exc. Electronic Adjustable Suspension	G56718 ⁹	M56718⁹	142226 ⁵⁴ 142227 ⁵⁷ 142751 ⁵⁷ 143060 ⁵¹	G56707 ⁹	M56707⁹	142132 ⁵³ 143060 ⁵¹
90	All	142227 ⁵⁷ 142751 ⁵⁷ 143060 ⁵¹	142132 ⁵³ 143060 ⁵¹
	Early Design Front Strut with Spring Guard	G56701	142227 ⁵⁷ 142751 ⁵⁷ 143060 ⁵¹	142132 ⁵³ 143060 ⁵¹
	Late Design Front Strut without Spring Guard	G56718 ⁹	M56718⁹	142226 ⁵⁴ 142227 ⁵⁷ 142751 ⁵⁷ 143060 ⁵¹	142132 ⁵³ 143060 ⁵¹
	Air(RearSpringType) Optional O.E. Hydraulic Self Leveling System	142227 ⁵⁷ 142751 ⁵⁷ 143060 ⁵¹	G56903	M56903	142132 ⁵³ 143060 ⁵¹
	Coil(RearSpringType)	142227 ⁵⁷ 142751 ⁵⁷ 143060 ⁵¹	G56707 ⁹	M56707⁹	142132 ⁵³ 143060 ⁵¹
88-89	Air(RearSpringType) Optional O.E. Hydraulic Self Leveling System	142227 ⁵⁷ 142752 ⁵⁷ 143061 ⁵¹	G56903	M56903	142132 ⁵³ 143060 ⁵¹

7 Pair Packs, air hose kit included.

30 For GM Vehicles equipped with factory installed leveling systems, see Ref A.

53 Strut Mount. Hardware from O.E. Part may need to be reused.

67 Strut Mount Kit. Hardware from O.E. Part may need to be reused.



Bold Type - New / Future Part

9 See Ref. D for procedures to replace Elec Adj Susp with non-adj product.

51 Strut Cushion for use with the Strut/Cartridge/Shocks.

54 Kit with Mount and Bearing. Hardware from O.E. Part may need to be reused.

APPLICATION GUIDE

Year	Fitment Notes										
		Ultra	ProGuard\ Guardian\ Classic	Max Control\ LTV	Strut Cushion\ Strut Mount	HiJackers\ Load Carrier	Ultra	ProGuard\ Guardian\ Classic	Max Control\ LTV	Strut Cushion\ Strut Mount	HiJackers\ Load Carrier

PONTIAC

PONTIAC

BONNEVILLE (cont)

87-89	All	142227 ⁶⁷ 142752 ⁶⁷ 143061 ⁵¹	142132 ⁵³ 143060 ⁵¹
	Early Design Front Strut with Spring Guard	G56701	142227 ⁶⁷ 142752 ⁶⁷ 143061 ⁵¹	142132 ⁵³ 143060 ⁵¹
	Coil(RearSpringType)	142227 ⁶⁷ 142752 ⁶⁷ 143061 ⁵¹	G56707 ⁹	M56707 ⁹	142132 ⁵³ 143060 ⁵¹
87	Optional O.E. Hydraulic Self Leveling System	142227 ⁶⁷ 142752 ⁶⁷ 143061 ⁵¹	G56903	M56903	142132 ⁵³ 143060 ⁵¹
82-86	All	⊖ 69600	81494	34051 ⁸	⊖ 69604	81492	43060 ⁸ 49334 ³⁰
71-81	All	⊖ 69675 ⁵	81446	34073 ⁸	⊖ 69724	81514	43049 ⁸ 49131 ³⁰
65-70	All	⊖ 69675 ⁵	82110	⊖ 69724	81514	43049 ⁸ 49128 ³⁰
63-64	All	⊖ 69675 ⁵	82099	⊖ 69724	81514	43049 ⁸ 49128 ³⁰
61-62	All	⊖ 69675 ⁵	82099
58-60	All	⊖ 69675 ⁵	82099	⊖ 69675 ⁵	81318 82156
57	All	⊖ 69675 ⁵	82026	⊖ 69675 ⁵	81318 82156

BONNEVILLE READYMOUNTS

		Front		Rear	
		Ultra Readymount	Guardian Readymount	Ultra Readymount	Guardian Readymount
00-05	Exc. Electronic Adjustable Suspension	G57051 ⁴⁰	M57051 ⁴⁰
94-99	All	M56906 ⁴⁰
	Air(RearSpringType) Exc. CCR Computer Command Ride	G56909 ⁴¹	M56909 ⁴¹	M56906 ⁴⁰
	Air(RearSpringType) Optional O.E. Hydraulic Self Leveling System; Exc. Electronic Adjustable Suspension	G56906 ⁴³	M56906 ⁴⁰
	Coil(RearSpringType) Exc. Electronic Adjustable Suspension	G56726 ⁴³	M56906 ⁴⁰
91-93	All	G56909 ⁴¹	M56909 ⁴¹	M56906 ⁴⁰
	Air(RearSpringType) Optional O.E. Hydraulic Self Leveling System; Exc. Electronic Adjustable Suspension	G56909 ⁴¹	M56909 ⁴¹	G56906 ⁴³	M56906 ⁴⁰
	Coil(RearSpringType) Exc. Electronic Adjustable Suspension	G56909 ⁴¹	M56909 ⁴¹	G56726 ⁴³	M56906 ⁴⁰
90	All	M56906 ⁴⁰
	Early Design Front Strut with Spring Guard	G56914 ⁴⁰	M56914 ⁴⁰	M56906 ⁴⁰
	Late Design Front Strut without Spring Guard	G56909 ⁴¹	M56909 ⁴¹	M56906 ⁴⁰
	Air(RearSpringType) Optional O.E. Hydraulic Self Leveling System	G56906 ⁴³	M56906 ⁴⁰
	Coil(RearSpringType)	G56726 ⁴³	M56906 ⁴⁰
88-89	Air(RearSpringType) Optional O.E. Hydraulic Self Leveling System	M56914 ⁴⁰	G56906 ⁴³	M56906 ⁴⁰
87-89	All	M56914 ⁴⁰	M56906 ⁴⁰
	Early Design Front Strut with Spring Guard	G56914 ⁴⁰	M56914 ⁴⁰	M56906 ⁴⁰
	Coil(RearSpringType)	M56914 ⁴⁰	G56726 ⁴³	M56906 ⁴⁰
87	Optional O.E. Hydraulic Self Leveling System	M56914 ⁴⁰	G56906 ⁴³	M56906 ⁴⁰

CATALINA

77-81	Wagon	⊖ 69675 ⁵	81446	34073 ⁸	⊖ 69604	81492	49152 ³⁰
71-81	All	⊖ 69675 ⁵	81446	34073 ⁸
	Exc. Wagon	⊖ 69675 ⁵	81446	34073 ⁸	⊖ 69724	81514	43049 ⁸ 49131 ³⁰

5 Use kit No. 140719 to replace O.E. hardware for lower shock absorber mounting when studs break or self-tapping screws are not longer useable.

9 See Ref. D for procedures to replace Elec Adj Susp with non-adj product.

40 Complete Assembled Unit.

43 Does not include springs due to vehicle design. See Ref. D for procedures to replace Elec Adj Susp with non-adj product.

53 Strut Mount. Hardware from O.E. Part may need to be reused.

8 Pair Packs.





30 For GM Vehicles equipped with factory installed leveling systems, see Ref. A.

41 Complete Assembled Unit. See Ref. D for procedures to replace Elec Adj Susp with non-adj product.

51 Strut Cushion for use with the Strut/Cartridge/Shocks.

67 Strut Mount Kit. Hardware from O.E. Part may need to be reused.

















APPLICATION GUIDE

Year	Fitment Notes	Front					Rear				
			ProGuard/ Guardian/ Classic	Max Control/ LTV	Strut Cushion/ Strut Mount	HiJackers/ Load Carrier		ProGuard/ Guardian/ Classic	Max Control/ LTV	Strut Cushion/ Strut Mount	HiJackers/ Load Carrier
											





PONTIAC

PONTIAC



CATALINA (cont)

74-75	Wagon		69675 ⁵	81446	34073 ⁸		69604	81492	49152 ³⁰
71-73	Wagon		69675 ⁵	81446	34073 ⁸		69604	81492
	Wagon Wagon		69675 ⁵	81446	34073 ⁸		49152 ³⁰
65-70	All		82110		69724	81514	43049 ⁹ 49128 ³⁰
63-64	All		82099		69724	81514	43049 ⁹ 49128 ³⁰
61-62	All		82099	
58-60	All		82099		81318 82156
50-57	All		82026		82156





CHIEFTAIN

58	All		82099		81318 82156
49-57	All		82026		82156











EXECUTIVE

67-70	All		82110		69724	81514	43049 ⁹ 49128 ³⁰
-------	-----	---	------	-------	------	------	------	---	-------	-------	------	------	---

FIERO

88	All		81670		143059 ⁵¹
84-87	All		69727		G55512	143059 ⁵¹











FIREBIRD

93-02	All		G51204	M51204	142412 ⁵⁷		69676	81481	75676	49203 ⁷
82-92	All		G56700	M56700		69676	81481	75676	49203 ⁷
70-81	All		69675 ⁵	81446	34073 ⁸		69624	81095	43084 ⁹ 49135 ³⁰
68-69	All		69600	81494		69606	81495
67	All		69600	81494		82040	49122 ⁷

FIREBIRD READYMOUNTS

		Front		Rear	
		Ultra Readymount	Guardian Readymount	Ultra Readymount	Guardian Readymount
93-02	Left	G57107 ⁴⁰	M57107⁴⁰
	Right	G57108 ⁴⁰	M57108⁴⁰

FIREFLY

95-99	CAN		143059 ⁵¹		143057 ⁵¹
	Non-ABS		G55891		G55772
94	All		142293 ⁵⁴		142295 ⁵³
	CAN		G55891	143059 ⁵¹ 142293 ⁵⁴		G55772	143057 ⁵¹ 142295 ⁵³
89-91	All		142293 ⁵⁴		142295 ⁵³

5 Use kit No. 140719 to replace O.E. hardware for lower shock absorber mounting when studs break or self-tapping screws are not longer useable.

8 Pair Packs.

40 Complete Assembled Unit.

53 Strut Mount. Hardware from O.E. Part may need to be reused.

67 Strut Mount Kit. Hardware from O.E. Part may need to be reused.

Bold Type - New / Future Part



7 Pair Packs, air hose kit included.

30 For GM Vehicles equipped with factory installed leveling systems, see Ref A.

51 Strut Cushion for use with the Strut/Cartridge/Shocks.

54 Kit with Mount and Bearing. Hardware from O.E. Part may need to be reused.

APPLICATION GUIDE

Year	Fitment Notes										
		Ultra	ProGuard\Guardian\Classic	Max Control\LTV	Strut Cushion\Strut Mount	HiJackers\Load Carrier	Ultra	ProGuard\Guardian\Classic	Max Control\LTV	Strut Cushion\Strut Mount	HiJackers\Load Carrier

PONTIAC

PONTIAC

FIREFLY (cont)

89-91	CAN	↓	G55891	143059 ⁵¹ 142293 ⁵⁴	↓	G55772	143057 ⁵¹ 142295 ⁵³
85-88	All	↓	G55749	↓

G3

09-10	Left	↓	G56886	M56886	143239 ⁵³	↓	G51747	143375 ⁵³
	Right	↓	G56887	M56887	143239 ⁵³	↓	G51747	143375 ⁵³
07-08	Left	↓	G56886	M56886	↓	143375 ⁵³
	Right	↓	G56887	M56887	↓	143375 ⁵³

G3 READYMOUNTS

		Front		Rear	
		Ultra Readymount	Guardian Readymount	Ultra Readymount	Guardian Readymount
09-10	Left	G57130 ⁴⁰	M57130 ⁴⁰
	Right	G57131 ⁴⁰	M57131 ⁴⁰

G5

07-09	All	↓	G56810	M56810	143323 ⁵³	○	69587
-------	-----	---	--------	--------	------	----------------------	------	---	-------	------	------	------	------

G5 READYMOUNTS

		Front		Rear	
		Ultra Readymount	Guardian Readymount	Ultra Readymount	Guardian Readymount
07-09	Left	G57047 ⁴⁰	M57047 ⁴⁰
	Right	G57048 ⁴⁰	M57048 ⁴⁰

G6

05-10	Left	↓	G52028	M52028	143354 ⁵³	○	69590
	Right	↓	G52029	M52029	143355 ⁵³	○	69590
	Maxx Models	↓	↓	143425 ⁶⁸

G6 READYMOUNTS

		Front		Rear	
		Ultra Readymount	Guardian Readymount	Ultra Readymount	Guardian Readymount
06-10	Left	G57121 ⁴⁰
	Right	G57122 ⁴⁰
	4cyl Left	M57121 ⁴⁰
	4cyl Right	M57122 ⁴⁰
05-10	Exc. Convertible and 4Cyl Left	G57069 ⁴⁰	M57069 ⁴⁰
	Exc. Convertible and 4Cyl Right	G57070 ⁴⁰	M57070 ⁴⁰

GRAND AM

99-05	All	↓	G55974	M55974	143060 ⁵¹	↓	G56501	M56501	142532 ⁵³ 143057 ⁵¹
96-98	Right Exc. Electronic Adjustable Suspension	↓	G56719 ⁹	M56719 ⁹	142227 ⁶⁷ 143059 ⁵¹	○	69407 ⁹	81790	141974 ⁶⁷	49614 ⁷
95-98	Left Exc. Electronic Adjustable Suspension	↓	G56720 ⁹	M56720 ⁹	142227 ⁶⁷ 143059 ⁵¹	○	69407 ⁹	81790	141974 ⁶⁷	49614 ⁷
95	SE, Right Exc. Electronic Adjustable Suspension	↓	G56719 ⁹	M56719 ⁹	142227 ⁶⁷ 143059 ⁵¹	○	69407 ⁹	81790	141974 ⁶⁷	49614 ⁷

7 Pair Packs, air hose kit included.

40 Complete Assembled Unit.

53 Strut Mount. Hardware from O.E. Part may need to be reused.

67 Strut Mount Kit. Hardware from O.E. Part may need to be reused.



9 See Ref. D for procedures to replace Elec Adj Susp with non-adj product.

51 Strut Cushion for use with the Strut/Cartridge/Shocks.

54 Kit with Mount and Bearing. Hardware from O.E. Part may need to be reused.

68 Strut Mount Kit. Hardware from O.E. Part may need to be reused.

APPLICATION GUIDE

Year	Fitment Notes										
		Ultra	ProGuard/ Guardian/ Classic	Max Control/ LTV	Strut Cushion/ Strut Mount	HiJackers/ Load Carrier	Ultra	ProGuard/ Guardian/ Classic	Max Control/ LTV	Strut Cushion/ Strut Mount	HiJackers/ Load Carrier

PONTIAC

PONTIAC

GRAND AM (cont)

92-94	All	69749	81530	...	141974 ⁶⁷	49371 ³⁰	
	Exc. Electronic Adjustable Suspension	143059 ⁵¹	...	69749	81530	...	141974 ⁶⁷	49371 ³⁰	
	GT, Left FE3 Suspension	G56723	69749	81530	...	141974 ⁶⁷	49371 ³⁰	
	GT, Right FE3 Suspension	G56724	69749	81530	...	141974 ⁶⁷	49371 ³⁰	
	SE, Left Exc. FE3 and Electronic Ride Control	G56720 ⁹	M56720⁹	142227 ⁶⁷	...	69749	81530	...	141974 ⁶⁷	49371 ³⁰
	SE, Right Exc. FE3 and Electronic Ride Control	G56719 ⁹	M56719⁹	142227 ⁶⁷	...	69749	81530	...	141974 ⁶⁷	49371 ³⁰
87-91	Left	G56706	143060 ⁵¹	...	69749	81530	...	141974 ⁶⁷	49371 ³⁰	
	Right	G56705	143060 ⁵¹	...	69749	81530	...	141974 ⁶⁷	49371 ³⁰	
	Standard Suspension	142762 ⁶⁷	
85-86	All	143060 ⁵¹	...	69749	81530	...	141974 ⁶⁷	49371 ³⁰	
	Left Non-Rebuildable O.E. Struts	G56706	143060 ⁵¹	...	69749	81530	...	141974 ⁶⁷	49371 ³⁰	
	Rebuildable O.E. Struts	G44451 ⁹⁸	143060 ⁵¹	...	69749	81530	...	141974 ⁶⁷	49371 ³⁰	
	Right Non-Rebuildable O.E. Struts	G56705	143060 ⁵¹	...	69749	81530	...	141974 ⁶⁷	49371 ³⁰	
	Standard Suspension	142762 ⁶⁷ 143060 ⁵¹	...	69749	81530	...	141974 ⁶⁷	49371 ³⁰	
78-80	All	69600	81494	34051 ⁸	69604	81492	43060 ⁸ 49334 ³⁰	
73-75	All	69600	81494	34051 ⁸	69604	81492	43060 ⁸ 49152 ³⁰	

GRAND AM READYMOUNTS

		Front		Rear	
		Ultra Readymount	Guardian Readymount	Ultra Readymount	Guardian Readymount
99-05	All	G56927 ⁴⁰	M56927⁴⁰	G56928 ⁴⁰	M56928⁴⁰
96-98	Right Exc. Electronic Adjustable Suspension	G56916 ⁴⁰
95-98	Left	...	M56917⁴⁰
	Left Exc. Electronic Adjustable Suspension	G56917 ⁴⁰
	Right	...	M56916⁴⁰
95	Right Exc. Electronic Adjustable Suspension	G56916 ⁴¹
92-94	Sedan Left	...	M56919⁴⁰
	Sedan Right	...	M56918⁴⁰
85-91	Left	G57327⁴⁰
	Right	G57328⁴⁰

GRAND LEMANS

78-83	All	69600	81494	34051 ⁸	69604	81492	43060 ⁸ 49334 ³⁰
75-77	All	69600	81494	34051 ⁸	69604	81492	43060 ⁸ 49152 ³⁰

GRAND PRIX

04-08	All	G56812	142524 ⁶⁷ 142525 ⁵³ 142526 ⁵⁴
-------	-----	--------	-----	-----	--	-----	-----	-----	-----	-----	-----

8 Pair Packs.

30 For GM Vehicles equipped with factory installed leveling systems, see Ref A.

41 Complete Assembled Unit. See Ref. D for procedures to replace Elec Adj Susp with non-adj product.

53 Strut Mount. Hardware from O.E. Part may need to be reused.

67 Strut Mount Kit. Hardware from O.E. Part may need to be reused.

9 See Ref. D for procedures to replace Elec Adj Susp with non-adj product.

40 Complete Assembled Unit.



51 Strut Cushion for use with the Strut/Cartridge/Shocks.

54 Kit with Mount and Bearing. Hardware from O.E. Part may need to be reused.

98 Notice: The level of difficulty to install this product is moderately high. Please review the installation instructions carefully before proceeding.

Bold Type - New / Future Part

APPLICATION GUIDE

Year	Fitment Notes										
		Ultra	ProGuard/ Guardian/ Classic	Max Control/ LTV	Strut Cushion/ Strut Mount	HiJackers/ Load Carrier	Ultra	ProGuard/ Guardian/ Classic	Max Control/ LTV	Strut Cushion/ Strut Mount	HiJackers/ Load Carrier

PONTIAC

PONTIAC

GRAND PRIX (cont)

04-08	Exc. Models with 17" or 18" Wheels	G56812	142524 ⁶⁷ 142525 ⁵³ 142526 ⁵⁴	G55949	M55949
	Left	G56812	142524 ⁶⁷ 142525 ⁵³ 142526 ⁵⁴	143073 ⁵³
	Models with 17" or 18" Wheels	G56812	142524 ⁶⁷ 142525 ⁵³ 142526 ⁵⁴	G52244
	Right	G56812	142524 ⁶⁷ 142525 ⁵³ 142526 ⁵⁴	143074 ⁵³
97-03	All	G55948	M55948	142524 ⁶⁷ 142525 ⁵³ 142526 ⁵⁴ 143060 ⁵¹
	Exc. Models with 17" or 18" Wheels	G55948	M55948	142524 ⁶⁷ 142525 ⁵³ 142526 ⁵⁴ 143060 ⁵¹	G55949	M55949
	Left	G55948	M55948	142524 ⁶⁷ 142525 ⁵³ 142526 ⁵⁴ 143060 ⁵¹	143073 ⁵³
	Right	G55948	M55948	142524 ⁶⁷ 142525 ⁵³ 142526 ⁵⁴ 143060 ⁵¹	143074 ⁵³
90-96	All	G44459 ³⁶	142143 ⁵³ 143060 ⁵¹	G56708	M56708	143062 ⁵¹
88-89	All	G44459 ³⁶	143060 ⁵¹	G56708	M56708	143062 ⁵¹
69-87	All	69600	81494	34051 ⁸	69604	81492	43060 ⁸ 49334 ³⁰
65-68	All	82110	69724	81514	49128 ³⁰
63-64	All	82099	69724	81514	49128 ³⁰
62	All	82099

GRAND PRIX READYMOUNTS

		Front		Rear	
		Ultra Readymount	Guardian Readymount	Ultra Readymount	Guardian Readymount
04-08	All	G57141 ⁴⁰	M57141 ⁴⁰
	Left Exc. Models with 17" or 18" Wheels	G57141 ⁴⁰	M57141 ⁴⁰	G56924 ⁴⁰	M56924 ⁴⁰
	Right Exc. Models with 17" or 18" Wheels	G57141 ⁴⁰	M57141 ⁴⁰	G56925 ⁴⁰	M56925 ⁴⁰
97-03	All	G57060 ⁴⁰	M57060 ⁴⁰
	Left Exc. Models with 17" or 18" Wheels	G57060 ⁴⁰	M57060 ⁴⁰	G56924 ⁴⁰	M56924 ⁴⁰
	Right Exc. Models with 17" or 18" Wheels	G57060 ⁴⁰	M57060 ⁴⁰	G56925 ⁴⁰	M56925 ⁴⁰
88-96	All	G56727 ⁴²	M56727 ⁴²

GRAND SAFARI

71-78	All	69675 ⁵	81446	34073 ⁸	69604	81492	43060 ⁸ 49152 ³⁰
-------	-----	--------------------	-------	------	------	--------------------	-------	-------	------	------	---

GRANDVILLE

71-75	All	69600	81494	34051 ⁸	69604	81492	43060 ⁸ 49152 ³⁰
-------	-----	-------	-------	------	------	--------------------	-------	-------	------	------	---

GTO

04-06	Left	G52123	143459 ⁶⁸	70032
-------	------	--------	------	------	-----------------------------	------	-------	------	------	------	------

5 Use kit No. 140719 to replace O.E. hardware for lower shock absorber mounting when studs break or self-tapping screws are not longer useable.

30 For GM Vehicles equipped with factory installed leveling systems, see Ref A.

40 Complete Assembled Unit.

51 Strut Cushion for use with the Strut/Cartridge/Shocks.

54 Kit with Mount and Bearing. Hardware from O.E. Part may need to be reused.

68 Strut Mount Kit. Hardware from O.E. Part may need to be reused.

8 Pair Packs.





36 Requires special strut installation tool.

42 Does not include springs due to vehicle design.

53 Strut Mount. Hardware from O.E. Part may need to be reused.

67 Strut Mount Kit. Hardware from O.E. Part may need to be reused.











APPLICATION GUIDE

Year	Fitment Notes										
			Ultra	ProGuard\ Guardian\ Classic	Max Control\ LTV	Strut Cushion\ Strut Mount	HiJackers\ Load Carrier		Ultra	ProGuard\ Guardian\ Classic	Max Control\ LTV



















PONTIAC

PONTIAC

GTO (cont)

04-06	Right		G52124	143459 ⁹⁸		70032
68-73	All		69600	81494		69604	81492	43060 ⁹ 49152 ³⁰
64-67	All		82138	
	Exc. HD Suspension		82138		69724	81514	43049 ⁹ 49131 ³⁰
	HD Suspension		82138		69604	81492	43060 ⁹ 49152 ³⁰





J2000 / SUNBIRD

85	All		143060 ⁵¹		69749	81530	141974 ⁶⁷	49371 ³⁰
	Left Non-Rebuildable O.E. Struts		G56706	143060 ⁵¹		69749	81530	141974 ⁶⁷	49371 ³⁰
	Rebuildable O.E. Struts		G44451 ⁹⁸	143060 ⁵¹		69749	81530	141974 ⁶⁷	49371 ³⁰
	Right Non-Rebuildable O.E. Struts		G56705	143060 ⁵¹		69749	81530	141974 ⁶⁷	49371 ³⁰
84	All		142762 ⁶⁷ 143060 ⁵¹		69749	81530	141974 ⁶⁷	49371 ³⁰
	Left Non-Rebuildable O.E. Struts		G56706	142762 ⁶⁷ 143060 ⁵¹		69749	81530	141974 ⁶⁷	49371 ³⁰
	Rebuildable O.E. Struts		G44451 ⁹⁸	142762 ⁶⁷ 143060 ⁵¹		69749	81530	141974 ⁶⁷	49371 ³⁰
	Right Non-Rebuildable O.E. Struts		G56705	142762 ⁶⁷ 143060 ⁵¹		69749	81530	141974 ⁶⁷	49371 ³⁰
82-83	All		142762 ⁶⁷ 143060 ⁵¹		69749	81530	49371 ³⁰













J2000 / SUNBIRD READYMOUNTS

		Front		Rear	
		Ultra Readymount	Guardian Readymount	Ultra Readymount	Guardian Readymount
83-85	Left	G57327⁴⁰	
	Right	G57328⁴⁰	

LAURENTIAN

76-81	All		69675 ⁵	81446	34073 ⁸		69724	43049 ⁹ 49131 ³⁰
	CAN		69675 ⁵	81446	34073 ⁸		69724	81514	43049 ⁹ 49131 ³⁰

LEMANS

88-93	All		G44903 ⁹⁸	143057 ⁵¹		81742
68-81	All		69600	81494	34051 ⁸		69604	81492	43060 ⁹ 49334 ³⁰
64-67	All		82138	
	Exc. HD Suspension		82138		69724	81514	43049 ⁹ 49131 ³⁰
	HD Suspension		82138		69604	81492	43060 ⁹ 49152 ³⁰
63	All		82129	

5 Use kit No. 140719 to replace O.E. hardware for lower shock absorber mounting when studs break or self-tapping screws are not longer useable.

30 For GM Vehicles equipped with factory installed leveling systems, see Ref A.

51 Strut Cushion for use with the Strut/Cartridge/Shocks.

68 Strut Mount Kit. Hardware from O.E. Part may need to be reused.

8 Pair Packs.

40 Complete Assembled Unit.

67 Strut Mount Kit. Hardware from O.E. Part may need to be reused.

98 Notice: The level of difficulty to install this product is moderately high. Please review the installation instructions carefully before proceeding.

Bold Type - New / Future Part

APPLICATION GUIDE

Year	Fitment Notes										
		Ultra	ProGuard\ Guardian\ Classic	Max Control\ LTV	Strut Cushion\ Strut Mount	HiJackers\ Load Carrier	Ultra	ProGuard\ Guardian\ Classic	Max Control\ LTV	Strut Cushion\ Strut Mount	HiJackers\ Load Carrier

PONTIAC

PONTIAC

MONTANA

07-09	CAN	⌘	142526 ⁵⁴	⊖	G63776
06-09	All	⌘	142526 ⁵⁴	⊖
	SV6, Exc. Self-Leveling Suspension	⌘	G52025	142526 ⁵⁴	⊖
06	FWD, Exc. Air-Leveling Suspension	⌘	142526 ⁵⁴	⊖	G63776
04-05	All	⌘	142524 ⁶⁷ 142525 ⁵³ 142526 ⁵⁴ 143060 ⁵¹	⊖	61659 81924
	Exc. Air-Leveling Suspension	⌘	142524 ⁶⁷ 142525 ⁵³ 142526 ⁵⁴ 143060 ⁵¹	⊖	G63776	61659 81924
	Base	⌘	G55948	M55948	142524 ⁶⁷ 142525 ⁵³ 142526 ⁵⁴ 143060 ⁵¹	⊖	61659 81924
	FWD, Exc. Air-Leveling Suspension & Independent Rear Suspension	⌘	142524 ⁶⁷ 142525 ⁵³ 142526 ⁵⁴ 143060 ⁵¹	⊖	61659 81924	49230 ⁷
05	SV6, Exc. Self-Leveling Suspension	⌘	G52025	142524 ⁶⁷ 142525 ⁵³ 142526 ⁵⁴ 143060 ⁵¹	⊖	61659 81924
02-03	All	⌘	142525 ⁵³ 142526 ⁵⁴ 143060 ⁵¹	⊖	61659 81924
	Exc. Air-Leveling Suspension	⌘	142525 ⁵³ 142526 ⁵⁴ 143060 ⁵¹	⊖	G63776	61659 81924
	Base	⌘	G55948	M55948	142525 ⁵³ 142526 ⁵⁴ 143060 ⁵¹	⊖	61659 81924
	FWD, Exc. Air-Leveling Suspension & Independent Rear Suspension	⌘	142525 ⁵³ 142526 ⁵⁴ 143060 ⁵¹	⊖	61659 81924	49230 ⁷
	Mini Passenger Van	⌘	142524 ⁶⁷ 142525 ⁵³ 142526 ⁵⁴ 143060 ⁵¹	⊖	61659 81924
99-01	All	⌘	142524 ⁶⁷ 142525 ⁵³ 142526 ⁵⁴ 143060 ⁵¹	⊖	61659 81924
	Exc. Air-Leveling Suspension	⌘	142524 ⁶⁷ 142525 ⁵³ 142526 ⁵⁴ 143060 ⁵¹	⊖	G63776	61659 81924
	Base	⌘	G55948	M55948	142524 ⁶⁷ 142525 ⁵³ 142526 ⁵⁴ 143060 ⁵¹	⊖	61659 81924
	FWD, Exc. Air-Leveling Suspension & Independent Rear Suspension	⌘	142524 ⁶⁷ 142525 ⁵³ 142526 ⁵⁴ 143060 ⁵¹	⊖	61659 81924	49230 ⁷

MONTANA READYMOUNTS

		Front		Rear	
		Ultra Readymount	Guardian Readymount	Ultra Readymount	Guardian Readymount
05-09	FWD	M57142⁴⁰
	SV6, FWD	G57142⁴⁰
99-05	Base	G57060 ⁴⁰	M57060⁴⁰

7 Pair Packs, air hose kit included.

51 Strut Cushion for use with the Strut/Cartridge/Shocks.



54 Kit with Mount and Bearing. Hardware from O.E. Part may need to be reused.

40 Complete Assembled Unit.

53 Strut Mount. Hardware from O.E. Part may need to be reused.

67 Strut Mount Kit. Hardware from O.E. Part may need to be reused.





APPLICATION GUIDE

Year	Fitment Notes										
		Ultra	ProGuard\ Guardian\ Classic	Max Control\ LTV	Strut Cushion\ Strut Mount	HiJackers\ Load Carrier	Ultra	ProGuard\ Guardian\ Classic	Max Control\ LTV	Strut Cushion\ Strut Mount	HiJackers\ Load Carrier











PONTIAC

PONTIAC

PARISIENNE

76-86	All		69675 ⁵	81446	34073 ⁸		
	Sedan		69675 ⁵	81446	34073 ⁸		69724	81514	43049 ⁸ 49131 ³⁰
	Wagon		69675 ⁵	81446	34073 ⁸		69604	81492	43060 ⁸ 49152 ³⁰



PHOENIX

84	All		142223 ⁵³ 142749 ⁵⁷ 143060 ⁵¹		69723	81517	141974 ⁶⁷	49370 ³⁰
	Exc. HD Suspension		G55505	142223 ⁵³ 142749 ⁵⁷ 143060 ⁵¹		69723	81517	141974 ⁶⁷	49370 ³⁰
	HD Suspension		G55514	M55514	142223 ⁵³ 142749 ⁵⁷ 143060 ⁵¹		69723	81517	141974 ⁶⁷	49370 ³⁰
80-83	All		G55505	142223 ⁵³ 143060 ⁵¹		69723	81517	49370 ³⁰
77-79	All		69600	81494	34051 ⁸		82093	49193 ⁷

PHOENIX READYMOUNTS

		Front		Rear	
		Ultra Readymount	Guardian Readymount	Ultra Readymount	Guardian Readymount
84	All	M56908 ⁴⁰
	HD Suspension	G56908 ⁴⁰	M56908 ⁴⁰



PURSUIT

05-06	All		G56810	M56810	143323 ⁵³		69587
-------	-----	---	--------	--------	------	----------------------	------	---	-------	------	------	------	------



PURSUIT READYMOUNTS

		Front		Rear	
		Ultra Readymount	Guardian Readymount	Ultra Readymount	Guardian Readymount
05-06	Left	G57047 ⁴⁰	M57047 ⁴⁰
	Right	G57048 ⁴⁰	M57048 ⁴⁰











SAFARI

87-89	All		69675 ⁵	81446	34073 ⁸		69604	81492	43060 ⁸ 49152 ³⁰
-------	-----	---	--------------------	-------	------	------	--------------------	---	-------	-------	------	------	---



SOLSTICE

06-09	All		G51935		G51936
-------	-----	---	--------	------	------	------	------	---	--------	------	------	------	------



STAR CHIEF

65-66	All		82110		69724	81514	49128 ³⁰
63-64	All		82099		69724	81514	49128 ³⁰
61-62	All		82099	
58-60	All		82099		81318 82156
54-57	All		82026		82156

STREAMLINER

49-52	All		82026		82156
-------	-----	---	------	-------	------	------	------	---	------	-------	------	------	------

SUNBIRD

94	Left		G56706	142762 ⁵⁷ 143060 ⁵¹		69749	81530	141974 ⁶⁷	49371 ³⁰
----	------	---	--------	------	------	--	------	---	-------	-------	------	----------------------	---------------------

5 Use kit No. 140719 to replace O.E. hardware for lower shock absorber mounting when studs break or self-tapping screws are not longer useable.

8 Pair Packs.

40 Complete Assembled Unit.

53 Strut Mount. Hardware from O.E. Part may need to be reused.

Bold Type - New / Future Part



7 Pair Packs, air hose kit included.

30 For GM Vehicles equipped with factory installed leveling systems, see Ref A.

51 Strut Cushion for use with the Strut/Cartridge/Shocks.

67 Strut Mount Kit. Hardware from O.E. Part may need to be reused.























APPLICATION GUIDE

Year	Fitment Notes										
		Ultra	ProGuard\ Guardian\ Classic	Max Control\ LTV	Strut Cushion\ Strut Mount	HiJackers\ Load Carrier	Ultra	ProGuard\ Guardian\ Classic	Max Control\ LTV	Strut Cushion\ Strut Mount	HiJackers\ Load Carrier

PONTIAC

PONTIAC





SUNBIRD (cont)

94	Right		G56705	142762 ⁶⁷ 143060 ⁵¹		69749	81530	141974 ⁶⁷	49371 ³⁰
91-93	Left		G56706	142762 ⁶⁷ 143060 ⁵¹		69749	81530	49371 ³⁰
	Right		G56705	142762 ⁶⁷ 143060 ⁵¹		69749	81530	49371 ³⁰
	Sport Suspension			141974 ⁶⁷
88-90	Left		G56706	142762 ⁶⁷ 143060 ⁵¹		69749	81530	141974 ⁶⁷	49371 ³⁰
	Right		G56705	142762 ⁶⁷ 143060 ⁵¹		69749	81530	141974 ⁶⁷	49371 ³⁰
86-87	All		142762 ⁶⁷ 143060 ⁵¹		69749	81530	141974 ⁶⁷	49371 ³⁰
	Left Non-Rebuildable O.E. Struts		G56706	142762 ⁶⁷ 143060 ⁵¹		69749	81530	141974 ⁶⁷	49371 ³⁰
	Rebuildable O.E. Struts		G44451 ⁹⁸	142762 ⁶⁷ 143060 ⁵¹		69749	81530	141974 ⁶⁷	49371 ³⁰
	Right Non-Rebuildable O.E. Struts		G56705	142762 ⁶⁷ 143060 ⁵¹		69749	81530	141974 ⁶⁷	49371 ³⁰
76-80	All		82129		81438





SUNBIRD READYMOUNTS

		Front		Rear	
		Ultra Readymount	Guardian Readymount	Ultra Readymount	Guardian Readymount
92-94	Left	G56921 ⁴⁰	M56921 ⁴⁰
	Right	G56920 ⁴⁰	M56920 ⁴⁰
86-91	Left	G57327 ⁴⁰
	Right	G57328 ⁴⁰

SUNBURST

85-88	All		G55719		81558
	CAN		G55719	143058 ⁵¹		81558





SUNFIRE

99-05	All		G55698	M55698	143035 ⁵⁴ 143057 ⁵¹		G55825	M55825	142413 ⁵³
95-98	All		G55698	M55698	142227 ⁶⁷ 143057 ⁵¹		G55825	M55825	142413 ⁵³



SUNFIRE READYMOUNTS

		Front		Rear	
		Ultra Readymount	Guardian Readymount	Ultra Readymount	Guardian Readymount
99-05	All	G56951 ⁴⁰	M56951 ⁴⁰	G56938 ⁴⁰	M56938 ⁴⁰
95-98	All	G56939 ⁴⁰	M56939 ⁴⁰	G56938 ⁴⁰	M56938 ⁴⁰

SUNRUNNER

94-97	All		M56518	142294 ⁵⁴		G63799	61560 81904	49613 ⁷
	CAN Non-ABS		G56518	M56518	142294 ⁵⁴		G63799	61560 81904	49613 ⁷

SUPER CHIEF

58	All		82099		81318 82156
----	-----	---	------	-------	------	------	------	---	------	----------------	------	------	------

7 Pair Packs, air hose kit included.

40 Complete Assembled Unit.

53 Strut Mount. Hardware from O.E. Part may need to be reused.

67 Strut Mount Kit. Hardware from O.E. Part may need to be reused.



30 For GM Vehicles equipped with factory installed leveling systems, see Ref A.

51 Strut Cushion for use with the Strut/Cartridge/Shocks.

54 Kit with Mount and Bearing. Hardware from O.E. Part may need to be reused.

98 Notice: The level of difficulty to install this product is moderately high. Please review the installation instructions carefully before proceeding.

APPLICATION GUIDE

Year	Fitment Notes										
		Ultra	ProGuard/ Guardian/ Classic	Max Control/ LTV	Strut Cushion/ Strut Mount	HiJackers/ Load Carrier	Ultra	ProGuard/ Guardian/ Classic	Max Control/ LTV	Strut Cushion/ Strut Mount	HiJackers/ Load Carrier

PONTIAC

PONTIAC

SUPER CHIEF (cont)

57	All		82026
----	-----	--	-------	-------	-------	-------	-------	-------	-------	-------	-------	-------	-------	-------

T1000

81-87	All		81322
-------	-----	--	-------	-------	-------	-------	-------	-------	-------	-------	-------	-------	-------	-------

TEMPEST

87-91	Left		G56706	143060 ⁵¹		69749	81530	141974 ⁶⁷	49371 ³⁰
	Right		G56705	143060 ⁵¹		69749	81530	141974 ⁶⁷	49371 ³⁰
68-70	All		69600	81494		69604	81492	43060 ⁶ 49152 ³⁰
64-67	All		82138
	Exc. HD Suspension		82138		69724	81514	43049 ⁶ 49131 ³⁰
	HD Suspension		82138		69604	81492	43060 ⁶ 49152 ³⁰
61-63	All		82129

TEMPEST READYMOUNTS

		Front		Rear	
		Ultra Readymount	Guardian Readymount	Ultra Readymount	Guardian Readymount
87-91	Left	G56921 ⁴⁰	M56921⁴⁰
	Right	G56920 ⁴⁰	M56920⁴⁰

TORRENT

07-09	All		143469⁶⁸		G64015	61718
	Left Exc. Sport Suspension		G52127	143469⁶⁸		G64015	61718
	Right Exc. Sport Suspension		G52128	143469⁶⁸		G64015	61718
06	Left		G56773	M52824	143363 ⁵³		G64015	61718
	Right		G56774	M52825	143363 ⁵³		G64015	61718

TORRENT READYMOUNTS

		Front		Rear	
		Ultra Readymount	Guardian Readymount	Ultra Readymount	Guardian Readymount
07-09	Left 19" Wheels	G57197⁴⁰
	Left Exc. 19" Wheels	G57322⁴⁰
	Right 19" Wheels	G57198⁴⁰
	Right Exc. 19" Wheels	G57323⁴⁰
06	Left	G57110 ⁴⁰
	Right	G57111 ⁴⁰

TRANSPORT

99	All			G63776
97-98	All		G55948	M55948	142524 ⁶⁷		G63776	61659 81924	49230 ⁷
						142525 ⁵³							
						142526 ⁵⁴							
						143060 ⁵¹							
96	All		G55992	142223 ⁵³ 142749 ⁶⁷ 143060 ⁵¹		G63914	61503	141974 ⁶⁷ 49370 ³⁰	
90-95	All		G55992	142223 ⁵³ 142749 ⁶⁷ 143060 ⁵¹		G63914	61503	141974 ⁶⁷ 49370 ³⁰	

7 Pair Packs, air hose kit included.

30 For GM Vehicles equipped with factory installed leveling systems, see Ref A.

51 Strut Cushion for use with the Strut/Cartridge/Shocks.

54 Kit with Mount and Bearing. Hardware from O.E. Part may need to be reused.

68 Strut Mount Kit. Hardware from O.E. Part may need to be reused.

Bold Type - New / Future Part



8 Pair Packs.

40 Complete Assembled Unit.

53 Strut Mount. Hardware from O.E. Part may need to be reused.

67 Strut Mount Kit. Hardware from O.E. Part may need to be reused.

APPLICATION GUIDE

Year	Fitment Notes										
		Ultra	ProGuard\ Guardian\ Classic	Max Control\ LTV	Strut Cushion\ Strut Mount	HiJackers\ Load Carrier	Ultra	ProGuard\ Guardian\ Classic	Max Control\ LTV	Strut Cushion\ Strut Mount	HiJackers\ Load Carrier

PONTIAC

PONTIAC

TRANS SPORT READYMOUNTS		Front		Rear	
		Ultra Readymount	Guardian Readymount	Ultra Readymount	Guardian Readymount
97-98	All	G57060 ⁴⁰	M57060 ⁴⁰
90-96	All	G57389 ⁴⁰

VENTURA

74-77	All	69600	81494	34051 ⁸	82093	49193 ⁷
73	All	69600	81494	34051 ⁸	82093
	Exc. HD Suspension	69600	81494	34051 ⁸	82093	49193 ⁷
	HD Suspension	69600	81494	34051 ⁸	69724	81514 82093	49157 ⁷
71-72	All	69600	81494
	Leaf(RearSpringType)	69600	81494	69724	81514
	Multi-Leaf Rear Spring	69600	81494	49157 ⁷
	Single Leaf Rear Springs	69600	81494	82093
	Single-Leaf Rear Spring	69600	81494	49193 ⁷
	Leaf(RearSpringType)	69600	81494	43049 ⁸
61	All	82099
60	All	82099	81318 82156

VIBE

09-10	Left	G52245
	Right	G52246
	FWD	G51898
03-08	Left	G52013	143209 ⁵³	143094 ⁵³
	Right	G52014	143093 ⁵³	143094 ⁵³
	FWD	G51736	M51736
03-06	AWD	G51768

VIBE READYMOUNTS

VIBE READYMOUNTS		Front		Rear	
		Ultra Readymount	Guardian Readymount	Ultra Readymount	Guardian Readymount
09-10	Left	G57329 ⁴⁰
	Right	G57330 ⁴⁰
03-08	FWD, Left	G57357 ⁴⁰	G57067 ⁴⁰
	FWD, Right	G57358 ⁴⁰	G57068 ⁴⁰
03-06	AWD, Left	G57183 ⁴⁰
	AWD, Right	G57182 ⁴⁰

WAVE

05-08	Left	G56886	M56886	143239 ⁵³	G51747	143375 ⁵³
	Right	G56887	M56887	143239 ⁵³	G51747	143375 ⁵³

WAVE READYMOUNTS

WAVE READYMOUNTS		Front		Rear	
		Ultra Readymount	Guardian Readymount	Ultra Readymount	Guardian Readymount
05-08	Left	G57130 ⁴⁰	M57130 ⁴⁰

7 Pair Packs, air hose kit included.
40 Complete Assembled Unit.

8 Pair Packs.
53 Strut Mount. Hardware from O.E. Part may need to be reused.

APPLICATION GUIDE

Year	Fitment Notes	Front					Rear				
		Ultra	ProGuard\ Guardian\ Classic	Max Control\ LTV	Strut Cushion\ Strut Mount	HiJackers\ Load Carrier	Ultra	ProGuard\ Guardian\ Classic	Max Control\ LTV	Strut Cushion\ Strut Mount	HiJackers\ Load Carrier

PONTIAC

PONTIAC

WAVE READYMOUNTS (cont)		Front		Rear	
		Ultra Readymount	Guardian Readymount	Ultra Readymount	Guardian Readymount
05-08	Right	G57131 ⁴⁰	M57131⁴⁰

PORSCHE

PORSCHE

924

87-88	All		G44850 ⁹⁸	143058 ⁵¹		69760
77-82	All		G44850 ⁹⁸	143058 ⁵¹		69616

944

89-91	All			69760
86-88	All		G44850 ⁹⁸	143058 ⁵¹		69760
83-85	All		G44850 ⁹⁸	143058 ⁵¹		69616

RAM

RAM

1500 (SEE DODGE RAM 1500)

13-15	4WD		G51856		G64044
11-13	RWD		G64043
11-12	4WD		G51856	143389⁶⁸		G64044
10	4WD			G64044

1500 (SEE DODGE RAM 1500) READYMOUNTS

1500 (SEE DODGE RAM 1500) READYMOUNTS		Front		Rear	
		Ultra Readymount	Guardian Readymount	Ultra Readymount	Guardian Readymount
11	4WD	G57147⁴⁰

2500 (SEE DODGE RAM 2500)

14-15	4WD		G64009
15	RWD, Standard Cab Pickup		G64043
14	RWD, Standard Cab Pickup		G64043		G63970
11-13	All		77950
	RWD		77949	77950
	RWD, Standard Cab Pickup		G64043		G63970	77950
13	4WD		G64009	77948		G64013	77950
11-12	4WD		G64009	77948	61716	77950
	4WD, 8800# GVW			G64013	77950
10	4WD		G64009
	RWD, Standard Cab Pickup		G64043

3500 (SEE DODGE RAM 3500)

14-15	4WD		G64009
15	RWD, Standard Cab Pickup		G64043
14	RWD, Standard Cab Pickup		G64043		G63970
11-13	All		77950

40 Complete Assembled Unit.

68 Strut Mount Kit. Hardware from O.E. Part may need to be reused.

51 Strut Cushion for use with the Strut/Cartridge/Shocks.

98 Notice: The level of difficulty to install this product is moderately high. Please review the installation instructions carefully before proceeding.

APPLICATION GUIDE

Year	Fitment Notes	Front					Rear				
		Ultra	ProGuard\ Guardian\ Classic	Max Control\ LTV	Strut Cushion\ Strut Mount	HiJackers\ Load Carrier	Ultra	ProGuard\ Guardian\ Classic	Max Control\ LTV	Strut Cushion\ Strut Mount	HiJackers\ Load Carrier

RAM

RAM

3500 (SEE DODGE RAM 3500) (cont)

11-13	4WD	⌄	G64009	77948	⌄	77950
	RWD	⌄	77949	⌄	77950
	RWD, Standard Cab Pickup	⌄	G64043	⌄	G63970	77950

SAAB

SAAB

9-2X

05-06	Left	⌄	G52087	⌄	G52083
	Right	⌄	G52088	⌄	G52084

9-3

04-11	Left	⌄	G52175	⌄	70039
	Right	⌄	G52176	⌄	70039
03	All	⌄	G244002 ⁹⁸	⌄	70039
	Left	⌄	G52175	⌄	70039
	Right	⌄	G52176	⌄	70039
99-02	All	⌄	G244002 ⁹⁸	⌄
	Exc. Viggen	⌄	G244002 ⁹⁸	143206 ⁵³	⌄	70020

9-5

02-06	All	⌄	G52066	⌄	G51885
99-01	All	⌄	⌄	G51885

9-7X

05-09	All	⌄	G51718 ⁴⁵	M51718⁴⁵	143241 ⁵³	⌄	G63842	61717
-------	-----	---	----------------------	----------------------------	------	----------------------	------	---	--------	-------	------	------	------

9-7X READYMOUNTS

		Front		Rear	
		Ultra Readymount	Guardian Readymount	Ultra Readymount	Guardian Readymount
05-09	All	G57022 ⁴⁰	M57022⁴⁰

93

56-57	All	⌄	82607	⌄	81676
-------	-----	---	------	-------	------	------	------	---	------	-------	------	------	------

93B

58-59	All	⌄	82607	⌄	81676
-------	-----	---	------	-------	------	------	------	---	------	-------	------	------	------

95

59-73	All	⌄	82607	⌄
-------	-----	---	------	-------	------	------	------	---	------	------	------	------	------

96

61-73	All	⌄	82607	⌄
-------	-----	---	------	-------	------	------	------	---	------	------	------	------	------

99

79-80	All	⌄	82607	⌄	69671
-------	-----	---	------	-------	------	------	------	---	-------	------	------	------	------





40 Complete Assembled Unit.

53 Strut Mount. Hardware from O.E. Part may need to be reused.

45 Strut must be rotated to align notch with lower control arm.

98 Notice: The level of difficulty to install this product is moderately high. Please review the installation instructions carefully before proceeding.



APPLICATION GUIDE

Year	Fitment Notes										
			Ultra	ProGuard\ Guardian\ Classic	Max Control\ LTV	Strut Cushion\ Strut Mount	HiJackers\ Load Carrier		Ultra	ProGuard\ Guardian\ Classic	Max Control\ LTV























SAAB

SAAB









99 (cont)

69-78	All		82607		81270	49105 ⁷
-------	-----	---	------	-------	------	------	------	---	------	-------	------	------	------	--------------------





900

94-98	All		143057 ⁵¹		69891
	Naturally Aspirated(Eng Asp)		G44495 ⁹⁸	143057 ⁵¹		69891
	Turbocharged(Eng Asp)		G44461 ⁹⁸	143057 ⁵¹		69891
93	All		69670	143057 ⁵¹	
	Mfg. from 6/30/93		69670	143057 ⁵¹		69891
	Mfg. to 7/93		69670	143057 ⁵¹		69671
	Naturally Aspirated(Eng Asp) Mfg. from 6/30/93		G44495 ⁹⁸	143057 ⁵¹	
	Turbocharged(Eng Asp) Mfg. from 6/30/93		G44461 ⁹⁸	143057 ⁵¹	
86-92	All		69670	143057 ⁵¹		69671
80-85	All		69670		69671
79	All		69670	



9000

88-98	All		143061 ⁵¹	
	Hydraulic Self Leveling System		143061 ⁵¹		69773
86-87	All		143058 ⁵¹	
	Hydraulic Self Leveling System		143058 ⁵¹		69773

GT750

60-62	All		82607	
58-59	All		82607		81676



GT850

63	All		82607		81676
----	-----	---	------	-------	------	------	------	---	------	-------	------	------	------	------









SATURN

SATURN

ASTRA

08-09	All			69587
-------	-----	---	------	------	------	------	------	---	-------	------	------	------	------	------

AURA

07-09	Left		G52028	M52028	143354 ⁵³	
	Right		G52029	M52029	143355 ⁵³	
	Exc. Hybrid			69590
	Maxx Models			143425 ⁹⁸

7 Pair Packs, air hose kit included.



53 Strut Mount. Hardware from O.E. Part may need to be reused.

98 Notice: The level of difficulty to install this product is moderately high. Please review the installation instructions carefully before proceeding.

51 Strut Cushion for use with the Strut/Cartridge/Shocks.

68 Strut Mount Kit. Hardware from O.E. Part may need to be reused.

APPLICATION GUIDE

Year	Fitment Notes										
		Ultra	ProGuard\ Guardian\ Classic	Max Control\ LTV	Strut Cushion\ Strut Mount	HiJackers\ Load Carrier	Ultra	ProGuard\ Guardian\ Classic	Max Control\ LTV	Strut Cushion\ Strut Mount	HiJackers\ Load Carrier

SATURN

SATURN

AURA READYMOUNTS		Front		Rear	
		Ultra Readymount	Guardian Readymount	Ultra Readymount	Guardian Readymount
07-09	4Cyl: Exc. Hybrid Models Left	G57121 ⁴⁰
	4Cyl: Exc. Hybrid Models Right	G57122 ⁴⁰
	Exc. Hybrid Models & 4Cyl Left	G57069 ⁴⁰	M57069⁴⁰
	Exc. Hybrid Models & 4Cyl Right	G57070 ⁴⁰	M57070⁴⁰
09	XE, XR, Left	M57121⁴⁰
	XE, XR, Right	M57122⁴⁰
08	Green Line, XE, Left	M57121⁴⁰
	Green Line, XE, Right	M57122⁴⁰
07	Green Line, Left	M57121⁴⁰
	Green Line, Right	M57122⁴⁰

ION

04-07	All	G56809	M56809	143089 ⁵³	G69587
03	All	G56809	143089 ⁵⁴	G69587

ION READYMOUNTS		Front		Rear	
		Ultra Readymount	Guardian Readymount	Ultra Readymount	Guardian Readymount
03-07	Left	G57099 ⁴⁰	M57099⁴⁰
	Right	G57100 ⁴⁰	M57100⁴⁰

L / LS / LW SERIES

03-05	Left	G56796	G51759
	Right	G56795	G51759
01-02	Left	G56796	142943 ⁵³	G51759
	Right	G56795	142943 ⁵³	G51759
00	Left	G56796	G51759
	Right	G56795	G51759

OUTLOOK

07-10	All	G52125	143366 ⁵³	G64040
-------	-----	--------	------	------	----------------------	------	--------	------	------	------	------

OUTLOOK READYMOUNTS		Front		Rear	
		Ultra Readymount	Guardian Readymount	Ultra Readymount	Guardian Readymount
07-10	All	G57109 ⁴⁰	M57314⁴⁰

RELAY

06-07	Air-Leveling Suspension, Exc. Independent Rear Suspension	49230 ⁷
05-07	Exc. Air-Leveling Suspension	G52025
	FWD	142526 ⁵⁴
	FWD, Exc. Air-Leveling Suspension	G63776
05	Exc. Air-Leveling Suspension & Independent Rear Suspension	49230 ⁷

7 Pair Packs, air hose kit included.

53 Strut Mount. Hardware from O.E. Part may need to be reused.

40 Complete Assembled Unit.

54 Kit with Mount and Bearing. Hardware from O.E. Part may need to be reused.

APPLICATION GUIDE

Year	Fitment Notes	Front					Rear				
		Ultra	ProGuard/ Guardian/ Classic	Max Control/ LTV	Strut Cushion/ Strut Mount	HiJackers/ Load Carrier	Ultra	ProGuard/ Guardian/ Classic	Max Control/ LTV	Strut Cushion/ Strut Mount	HiJackers/ Load Carrier

SATURN

SATURN

RELAY READYMOUNTS		Front		Rear	
		Ultra Readymount	Guardian Readymount	Ultra Readymount	Guardian Readymount
05-07	FWD	M57142 ⁴⁰
07	1, 2, 3, FWD	G57142 ⁴⁰
05-06	2, 3, FWD	G57142 ⁴⁰

SC / SL / SW SERIES

91-02	All		G55801	M55801	142244 ⁵⁴ 143057 ⁵¹		G55800	M55800	142245 ⁵³ 143059 ⁵¹
-------	-----	--	--------	--------	------	--	------	--	--------	--------	------	--	------

SC / SL / SW SERIES READYMOUNTS		Front		Rear	
		Ultra Readymount	Guardian Readymount	Ultra Readymount	Guardian Readymount
91-02	All	G57013 ⁴⁰	M57013 ⁴⁰	G57014 ⁴⁰	M57014 ⁴⁰

VUE

08-10	Left		G52127	143469 ⁶⁸		G63872	
	Right		G52128	143469 ⁶⁸		G63872	
02-07	All		143035 ⁵⁴		G63872	
	Left		G52026	143035 ⁵⁴		G63872	
	Replaces Mount in GM Service Kit 15269823			143368 ⁵³ 143035 ⁵⁴		G63872
	Right		G52027	143035 ⁵⁴		G63872	

VUE READYMOUNTS		Front		Rear	
		Ultra Readymount	Guardian Readymount	Ultra Readymount	Guardian Readymount
08-10	Left 19" Wheels	G57197 ⁴⁰
	Left Exc. 19" Wheels	G57322 ⁴⁰
	Right 19" Wheels	G57198 ⁴⁰
	Right Exc. 19" Wheels	G57323 ⁴⁰
02-07	Left	G57311 ⁴⁰	M57311 ⁴⁰
	Right	G57312 ⁴⁰	M57312 ⁴⁰
	4Cyl Left	G57101 ⁴⁰
	4Cyl Right	G57102 ⁴⁰

SCION

SCION

TC

08-10	Left		G52096	143406 ⁵³		G51852
	Right		G52097	143406 ⁵³		G51852
05-07	Left		G52096	143406 ⁵³		G51852	143094 ⁵³
	Right		G52097	143406 ⁵³		G51852	143094 ⁵³

TC READYMOUNTS		Front		Rear	
		Ultra Readymount	Guardian Readymount	Ultra Readymount	Guardian Readymount
05-10	Left	G57369 ⁴⁰	G57428 ⁴⁰
	Right	G57370 ⁴⁰	G57429 ⁴⁰

40 Complete Assembled Unit.

53 Strut Mount. Hardware from O.E. Part may need to be reused.



68 Strut Mount Kit. Hardware from O.E. Part may need to be reused.

Bold Type - New / Future Part

51 Strut Cushion for use with the Strut/Cartridge/Shocks.

54 Kit with Mount and Bearing. Hardware from O.E. Part may need to be reused.



APPLICATION GUIDE

Year	Fitment Notes										
		Ultra	ProGuard\ Guardian\ Classic	Max Control\ LTV	Strut Cushion\ Strut Mount	HiJackers\ Load Carrier	Ultra	ProGuard\ Guardian\ Classic	Max Control\ LTV	Strut Cushion\ Strut Mount	HiJackers\ Load Carrier







SCION

SCION









XA

04-06	All		G52098		70028
-------	-----	---	--------	------	------	------	------	---	-------	------	------	------	------

XB

08-12	Left		G52264		70053
	Right		G52265		70053
04-06	All		G52098		70028

XD

11-14	Left		G52268	143417⁶⁸	
	Right		G52269	143417⁶⁸	
08-10	Left		G52268	143417⁶⁸		70055
	Right		G52269	143417⁶⁸		70055



STUDEBAKER

STUDEBAKER



AVANTI

63-64	All		82087		82103
-------	-----	--	------	-------	------	------	------	--	------	-------	------	------	------

CHAMPION

57-58	All		82087		82151
-------	-----	---	------	-------	------	------	------	---	------	-------	------	------	------

COMMANDER

57-58	All		82087		82151
-------	-----	---	------	-------	------	------	------	---	------	-------	------	------	------



GOLDEN HAWK

57-58	All		82087		82151
-------	-----	---	------	-------	------	------	------	---	------	-------	------	------	------



HAWK

60-62	All		82087		82151
-------	-----	---	------	-------	------	------	------	---	------	-------	------	------	------





LARK

59-62	All		82087		82151
-------	-----	---	------	-------	------	------	------	---	------	-------	------	------	------





POWER HAWK

56	All		82026		82060
----	-----	---	------	-------	------	------	------	---	------	-------	------	------	------



PRESIDENT

57-58	All		82087		82151
55-56	All		82026		82060



R / E SERIES 1/2 / 3/4 TON

55-60	All		61500		81147
49-54	All		61500 81147		61500 81147

SILVER HAWK





57-59	All		82087		82151
-------	-----	---	------	-------	------	------	------	---	------	-------	------	------	------

SKY HAWK

56	All		82026		82060
----	-----	---	------	-------	------	------	------	---	------	-------	------	------	------

68 Strut Mount Kit. Hardware from O.E. Part may need to be reused.





APPLICATION GUIDE

Year	Fitment Notes										
			Ultra	ProGuard\ Guardian\ Classic	Max Control\ LTV	Strut Cushion\ Strut Mount	HiJackers\ Load Carrier		Ultra	ProGuard\ Guardian\ Classic	Max Control\ LTV



SUBARU

SUBARU





B9 TRIBECA

06-07	Left		G52270		G51909
	Right		G52271		G51909















BAJA

03-06	All			G51767	143140 ⁵³
-------	-----	---	------	------	------	------	------	---	--------	------	------	----------------------	------



























BRAT

82-87	All		G55726	143061 ⁵¹		69733	81450
80-81	All		143061 ⁵¹		69733	81450

DL

87-89	4WD; Exc. Hatchback, Sedan and Exc. Air Suspension Left		G55785	143061 ⁵¹	
	4WD; Exc. Hatchback, Sedan and Exc. Air Suspension Right		G55784	143061 ⁵¹	
85-89	All		143061 ⁵¹	
	FWD, Sedan Exc. Air Suspension		143061 ⁵¹		G51173
	FWD, Wagon Exc. Air Suspension		143061 ⁵¹		G51183
82-84	4WD		G55726		69733	81450
80-84	All			69733	81450



FORESTER

09-13	Left		G52374	143492 ⁵³		G51961
13	All		143492 ⁵³		G51961
09-12	Right		G52375	143492 ⁵³		G51961
07-08	Left		G52180	143492 ⁵³		G52182
	Right		G52181	143492 ⁵³		G52183
06	Left		G52180	143492 ⁵³		G52182	143205 ⁵³
	Right		G52181	143492 ⁵³		G52183	143205 ⁵³
04-05	Left		G52067	143492 ⁵³		G52178	143205 ⁵³
	Right		G52068	143492 ⁵³		G52179	143205 ⁵³
03	Left		G52069	143492 ⁵³		G52178	143205 ⁵³
	Right		G52070	143492 ⁵³		G52179	143205 ⁵³
98-02	All		142330 ⁵³ 143057 ⁵¹ 143492 ⁵³		143057 ⁵¹
	Left		G56544	142330 ⁵³ 143057 ⁵¹ 143492 ⁵³		143057 ⁵¹

51 Strut Cushion for use with the Strut/Cartridge/Shocks.

53 Strut Mount. Hardware from O.E. Part may need to be reused.

APPLICATION GUIDE

Year	Fitment Notes										
		Ultra	ProGuard\Guardian\Classic	Max Control\LTV	Strut Cushion\Strut Mount	HiJackers\Load Carrier	Ultra	ProGuard\Guardian\Classic	Max Control\LTV	Strut Cushion\Strut Mount	HiJackers\Load Carrier

SUBARU

SUBARU

FORESTER (cont)

98-02	Left Exc. Hydraulic Self Leveling System	↑	142330 ⁵³ 143057 ⁵¹ 143492 ⁵³	↑	G56546	143057 ⁵¹
	Right	↑	G56543	142330 ⁵³ 143057 ⁵¹ 143492 ⁵³	↑	143057 ⁵¹
	Right Exc. Hydraulic Self Leveling System	↑	142330 ⁵³ 143057 ⁵¹ 143492 ⁵³	↑	G56545	143057 ⁵¹

FORESTER READYMOUNTS

		Front		Rear	
		Ultra Readymount	Guardian Readymount	Ultra Readymount	Guardian Readymount
09-10	AWD, Wagon Left	G57628 ⁴⁰
	AWD, Wagon Right	G57629 ⁴⁰
06-08	Automatic Left	G57628 ⁴⁰
	Automatic Right	G57627 ⁴⁰
	Standard Left	G57477 ⁴⁰
	Standard Right	G57478 ⁴⁰
04-05	Left Exc. 2.5L	G57459 ⁴⁰
	Right Exc. 2.5L	G57460 ⁴⁰
	2.5L Left	G57622 ⁴⁰
	2.5L Right	G57623 ⁴⁰
03-05	Left w/o Sunroof	G57624 ⁴⁰
	Right w/o Sunroof	G57625 ⁴⁰
98-02	Left	G57513 ⁴⁰
	Right	G57514 ⁴⁰
	Automatic Left	G57511 ⁴⁰
	Automatic Right	G57512 ⁴⁰
	Standard Left	G57281 ⁴⁰
	Standard Right	G57280 ⁴⁰

GL

87-89	4WD; Exc. Hatchback, Sedan and Exc. Air Suspension Left	↑	G55785
	4WD; Exc. Hatchback, Sedan and Exc. Air Suspension Right	↑	G55784
85-89	4WD, Hatchback	↑	G55726
	FWD, Sedan Exc. Air Suspension	↑	G51173
	Hatchback	↑	143061 ⁵¹	⊗ 69733	81450
89	FWD, Wagon Exc. Air Suspension	↑	↑ G51183
85-87	FWD, Wagon Exc. Air Suspension	↑	↑ G51183
82-84	4WD	↑	G55726	⊗ 69733	81450
80-84	All	↑	⊗ 69733	81450

IMPREZA



08-13	Left	↑	G52594	143492 ⁵³
	Right	↑	G52595	143492 ⁵³
07	All	↑	143492 ⁵³
	AWD, Wagon Left	↑	143492 ⁵³	↑	G52085

40 Complete Assembled Unit.

53 Strut Mount. Hardware from O.E. Part may need to be reused.

51 Strut Cushion for use with the Strut/Cartridge/Shocks.

APPLICATION GUIDE

Year	Fitment Notes										
		Ultra	ProGuard\Guardian\Classic	Max Control\LTV	Strut Cushion\Strut Mount	HiJackers\Load Carrier	Ultra	ProGuard\Guardian\Classic	Max Control\LTV	Strut Cushion\Strut Mount	HiJackers\Load Carrier

SUBARU

SUBARU



IMPREZA (cont)

07	AWD, Wagon Right	143492 ⁵³	G52086
	Sedan Left	G52087	143492 ⁵³
	Sedan Right	G52088	143492 ⁵³
	Wagon Left	143492 ⁵³	G52083
	Wagon Right	143492 ⁵³	G52084
04-06	All	143492 ⁵³	143205 ⁵³
	AWD, Wagon Left	143492 ⁵³	G52085	143205 ⁵³
	AWD, Wagon Right	143492 ⁵³	G52086	143205 ⁵³
	Sedan Left	G52087	143492 ⁵³	143205 ⁵³
	Sedan Right	G52088	143492 ⁵³	143205 ⁵³
	Wagon Left	143492 ⁵³	G52083	143205 ⁵³
	Wagon Right	143492 ⁵³	G52084	143205 ⁵³
04	AWD, Sedan Left	143492 ⁵³	G52089	143205 ⁵³
	AWD, Sedan Right	143492 ⁵³	G52090	143205 ⁵³
02-03	Left	143492 ⁵³	143466 ⁵³
	Right	143492 ⁵³	143466 ⁵³
	RS, Sedan Left	G52073
	RS, Sedan Right	G52074
	TS, Left	G52073
	TS, Right	G52074
	Wagon Left	G52386
	Wagon Right	G52387
00-01	Outback, Right	143492 ⁵³	G56541
	Outback, AWD, Left Non-ABS	143492 ⁵³	G56542
98-01	L, AWD, Non-ABS Left	143492 ⁵³	G55930
	L, AWD, Non-ABS Right	143492 ⁵³	G55929
93-01	All	143492 ⁵³
	Non-ABS Left	G55926	142330 ⁵³ 143492 ⁵³
	Non-ABS Right	G55925	142330 ⁵³ 143492 ⁵³

53 Strut Mount. Hardware from O.E. Part may need to be reused.

Bold Type - New / Future Part

APPLICATION GUIDE

Year	Fitment Notes										
		Ultra	ProGuard\Guardian\Classic	Max Control\LTV	Strut Cushion\Strut Mount	HiJackers\Load Carrier	Ultra	ProGuard\Guardian\Classic	Max Control\LTV	Strut Cushion\Strut Mount	HiJackers\Load Carrier

SUBARU

SUBARU

IMPREZA (cont)

95-99	Outback, AWD, Non-ABS Left	↓	143492 ⁵³	↓	G56542
	Outback, Non-ABS Right	↓	143492 ⁵³	↓	G56541
96-97	Brighton, L, AWD, Non-ABS Left	↓	143492 ⁵³	↓	G55930
	Brighton, L, AWD, Non-ABS Right	↓	143492 ⁵³	↓	G55929
93-95	FWD, Non-ABS Left	↓	143492 ⁵³	↓	G55934
	FWD, Non-ABS Right	↓	143492 ⁵³	↓	G55933
95	Base, L, AWD, Non-ABS Left	↓	143492 ⁵³	↓	G55930
	Base, L, AWD, Non-ABS Right	↓	143492 ⁵³	↓	G55929
93-94	AWD, Non-ABS Left	↓	143492 ⁵³	↓	G55930
	AWD, Non-ABS Right	↓	143492 ⁵³	↓	G55929

IMPREZA READYMOUNTS

		Front		Rear	
		Ultra Readymount	Guardian Readymount	Ultra Readymount	Guardian Readymount
08-11	Left	G57644 ⁴⁰
	Right	G57645 ⁴⁰
04-07	Left	G57640 ⁴⁰	G57642 ⁴⁰
	Right	G57641 ⁴⁰	G57643 ⁴⁰
02-03	RS, Left	G57632 ⁴⁰	G57634 ⁴⁰
	RS, Right	G57633 ⁴⁰	G57635 ⁴⁰
	TS, Left	G57636 ⁴⁰	G57638 ⁴⁰
	TS, Right	G57637 ⁴⁰	G57639 ⁴⁰

LEGACY



10-13	All	↓	143492 ⁵³	↓
08-09	Left	↓	G52023	143492 ⁵³	↓	G51886
	Right	↓	G52024	143492 ⁵³	↓	G51886
05-07	Left	↓	G52023	143492 ⁵³	↓	G51886	143140 ⁵³
	Right	↓	G52024	143492 ⁵³	↓	G51886	143140 ⁵³
00-04	Left	↓	G56556	142330 ⁵³ 143492 ⁵³	↓	G56557	143140 ⁵³
	Right	↓	G56555	142330 ⁵³ 143492 ⁵³	↓	G56557	143140 ⁵³
95-99	Brighton, AWD, Left	↓	142330 ⁵³ 143057 ⁵¹ 143492 ⁵³	↓	G55860	143057 ⁵¹
	Brighton, AWD, Right	↓	142330 ⁵³ 143057 ⁵¹ 143492 ⁵³	↓	G55859	143057 ⁵¹
	Exc. Outback Left	↓	G55858	↓
	Exc. Outback Right	↓	G55857	↓
99	Outback, Outback Limited, Left	↓	G55866	↓	G55868

40 Complete Assembled Unit.

53 Strut Mount. Hardware from O.E. Part may need to be reused.

51 Strut Cushion for use with the Strut/Cartridge/Shocks.

APPLICATION GUIDE

Year	Fitment Notes										
		Ultra	ProGuard/ Guardian/ Classic	Max Control/ LTV	Strut Cushion/ Strut Mount	HiJackers/ Load Carrier	Ultra	ProGuard/ Guardian/ Classic	Max Control/ LTV	Strut Cushion/ Strut Mount	HiJackers/ Load Carrier

SUBARU

SUBARU

LEGACY (cont)

99	Outback, Outback Limited, Right	G55865	G55867
98	Outback, Left	G55866	G55868
	Outback, Right	G55865	G55867
97	Outback, Outback Limited, Left	G55866	G55868
	Outback, Outback Limited, Right	G55865	G55867
95-96	L, FWD, Right	G56579
	Outback, Left	G55866	G55868
	Outback, Right	G55865	G55867
92-94	AWD, Coil(RearSpringType) Left	142330 ⁵³ 143061 ⁵¹ 143492 ⁵³	G55930	143058 ⁵¹
	AWD, Coil(RearSpringType) Right	142330 ⁵³ 143061 ⁵¹ 143492 ⁵³	G55929	143058 ⁵¹
	Coil(RearSpringType) Left	G55926	142330 ⁵³ 143061 ⁵¹ 143492 ⁵³	143058 ⁵¹
	Coil(RearSpringType) Right	G55925	142330 ⁵³ 143061 ⁵¹ 143492 ⁵³	143058 ⁵¹
	FWD, Coil(RearSpringType) Left	142330 ⁵³ 143061 ⁵¹ 143492 ⁵³	G55934	143058 ⁵¹
	FWD, Coil(RearSpringType) Right	142330 ⁵³ 143061 ⁵¹ 143492 ⁵³	G55933	143058 ⁵¹
90-94	All	142330 ⁵³ 143061 ⁵¹ 143492 ⁵³	143058 ⁵¹
90-91	Coil(FrontSpringType) Left	G55924	142330 ⁵³ 143061 ⁵¹ 143492 ⁵³	143058 ⁵¹
	Coil(FrontSpringType) Right	G55923	142330 ⁵³ 143061 ⁵¹ 143492 ⁵³	143058 ⁵¹
91	AWD, Coil(RearSpringType) Right	142330 ⁵³ 143061 ⁵¹ 143492 ⁵³	G55927	143058 ⁵¹
90	AWD, Right Exc. Air Suspension	142330 ⁵³ 143061 ⁵¹ 143492 ⁵³	G55927	143058 ⁵¹

LEGACY READYMOUNTS

		Front		Rear	
		Ultra Readymount	Guardian Readymount	Ultra Readymount	Guardian Readymount
05-09	Left	G57345 ⁴⁰	G57423 ⁴⁰
	Right	G57346 ⁴⁰	G57423 ⁴⁰
03-04	Left FWD	G57515 ⁴⁰
	Right FWD	G57516 ⁴⁰
	AWD, Left	G57671 ⁴⁰
	AWD, Right	G57672 ⁴⁰
00-02	Left	G57366 ⁴⁰	G57430 ⁴⁰
	Right	G57365 ⁴⁰	G57430 ⁴⁰
98-99	Left FWD	G57501 ⁴⁰	G57503 ⁴⁰
	Right FWD	G57502 ⁴⁰	G57504 ⁴⁰
	AWD; Sedan Exc. Outback Left	G57667 ⁴⁰	G57669 ⁴⁰
	AWD; Sedan Exc. Outback Right	G57668 ⁴⁰	G57670 ⁴⁰



40 Complete Assembled Unit.

51 Strut Cushion for use with the Strut/Cartridge/Shocks.

53 Strut Mount. Hardware from O.E. Part may need to be reused.

Bold Type - New / Future Part

APPLICATION GUIDE

Year	Fitment Notes										
		Ultra	ProGuard\ Guardian\ Classic	Max Control\ LTV	Strut Cushion\ Strut Mount	HiJackers\ Load Carrier	Ultra	ProGuard\ Guardian\ Classic	Max Control\ LTV	Strut Cushion\ Strut Mount	HiJackers\ Load Carrier

SUBARU

SUBARU

LOYALE

90-94	All	↑	143061 ⁵¹	↑	143064 ⁵¹
94	Exc. Air Suspension	↑	143061 ⁵¹	↑	G51183	143064 ⁵¹
90-93	4WD, Left Exc. Air Suspension	↑	G55785	143061 ⁵¹	↑	143064 ⁵¹
	4WD, Right Exc. Air Suspension	↑	G55784	143061 ⁵¹	↑	143064 ⁵¹
	FWD, Sedan Exc. Air Suspension	↑	143061 ⁵¹	↑	G51173	143064 ⁵¹
	Wagon Exc. Air Suspension	↑	143061 ⁵¹	↑	G51183	143064 ⁵¹
90	FWD, Coupe Exc. Air Suspension	↑	143061 ⁵¹	↑	G51173	143064 ⁵¹

OUTBACK

13	All	↑	143492⁵³	↑
10-12	Left	↑	G52272	143492⁵³	↑
	Right	↑	G52273	143492⁵³	↑
06-09	Left	↑	G52272	143492⁵³	↑	G51910
	Right	↑	G52273	143492⁵³	↑	G51910
05	Left	↑	G52272	143492⁵³	↑	G51910	143140 ⁵³
	Right	↑	G52273	143492⁵³	↑	G51910	143140 ⁵³
00-04	AWD, Left	↑	G56813	143492⁵³	↑	G51767	143140 ⁵³
	AWD, Right	↑	G56814	143492⁵³	↑	G51767	143140 ⁵³

OUTBACK READYMOUNTS

		Front		Rear	
		Ultra Readymount	Guardian Readymount	Ultra Readymount	Guardian Readymount
10-12	Left	G57339⁴⁰	G57675⁴⁰
	Right	G57340⁴⁰	G57675⁴⁰
05-09	Left	G57339⁴⁰
	Right	G57340⁴⁰
02-04	Left	G57341⁴⁰
	Right	G57342⁴⁰

TRIBECA

14	Left	↑	G52270	↑
	Right	↑	G52271	↑
08-13	Left	↑	G52270	↑	G51909
	Right	↑	G52271	↑	G51909

XT



89-91	All	↑	↑	143064 ⁵¹
-------	-----	---	------	------	------	------	------	---	------	------	------	----------------------	------

40 Complete Assembled Unit.

53 Strut Mount. Hardware from O.E. Part may need to be reused.

51 Strut Cushion for use with the Strut/Cartridge/Shocks.

APPLICATION GUIDE

Year	Fitment Notes										
		Ultra	ProGuard\ Guardian\ Classic	Max Control\ LTV	Strut Cushion\ Strut Mount	HiJackers\ Load Carrier	Ultra	ProGuard\ Guardian\ Classic	Max Control\ LTV	Strut Cushion\ Strut Mount	HiJackers\ Load Carrier

SUBARU

SUBARU

XT (cont)

89-91	FWD, Coil(RearSpringType) Exc. Air Suspension	☑ G51173	143064 ⁵¹
85-88	FWD, Coil(RearSpringType)	☑	143064 ⁵¹
	FWD, Coil(RearSpringType) Exc. Air Suspension	☑ G51173

SUZUKI

SUZUKI

AERIO

04-07	Left	☑ G52075	143401 ⁶⁸	☑ G52021	143418 ⁵³
	Right	☑ G52076	143401 ⁶⁸	☑ G52022	143418 ⁵³
02-03	Left	☑ G52019	143401 ⁶⁸	☑ G52021	143418 ⁵³
	Right	☑ G52020	143401 ⁶⁸	☑ G52022	143418 ⁵³

EQUATOR

09-11	All	☑	143379 ⁶⁸	☑
-------	-----	---	------	------	----------------------	------	---	------	------	------	------

EQUATOR READYMOUNTS

		Front		Rear	
		Ultra Readymount	Guardian Readymount	Ultra Readymount	Guardian Readymount
09-12	All	☑ G57413 ⁴⁰

ESTEEM

95-02	Left	☑ G56627	143057 ⁵¹	☑ G56629	143057 ⁵¹
	Right	☑ G56626	143057 ⁵¹	☑ G56628	143057 ⁵¹

FORENZA

06-08	Left	☑ G56882	M56882	143349 ⁶⁸	☑ G56884	M56884	143350 ⁵³
	Right	☑ G56883	M56883	143349 ⁶⁸	☑ G56885	M56885	143350 ⁵³
04-05	Left	☑ G56882	M56882	☑ G56884	M56884
	Right	☑ G56883	M56883	☑ G56885	M56885

FORENZA READYMOUNTS

		Front		Rear	
		Ultra Readymount	Guardian Readymount	Ultra Readymount	Guardian Readymount
04-08	Left	G57126 ⁴⁰	M57126⁴⁰	G57128 ⁴⁰	M57128⁴⁰
	Right	G57127 ⁴⁰	M57127⁴⁰	G57129 ⁴⁰	M57129⁴⁰

FORSA

85-88	All	☑ G55749	☑
-------	-----	----------	------	------	------	------	---	------	------	------	------

GRAND VITARA

06-13	Left	☑ G52184	☑ G64052
	Right	☑ G52185	☑ G64052
99-05	All	☑	M56518	143204 ⁵³	☑ G63799	61560 81904	49613 ⁷

7 Pair Packs, air hose kit included.

51 Strut Cushion for use with the Strut/Cartridge/Shocks.



68 Strut Mount Kit. Hardware from O.E. Part may need to be reused.

Bold Type - New / Future Part

40 Complete Assembled Unit.

53 Strut Mount. Hardware from O.E. Part may need to be reused.

APPLICATION GUIDE

Year	Fitment Notes										
		Ultra	ProGuard\Guardian\Classic	Max Control\LTV	Strut Cushion\Strut Mount	HiJackers\Load Carrier	Ultra	ProGuard\Guardian\Classic	Max Control\LTV	Strut Cushion\Strut Mount	HiJackers\Load Carrier

SUZUKI

SUZUKI

GRAND VITARA (cont)

99-05	Non-ABS	G56518	M56518	143204 ⁵³	G63799	61560 81904	49613 ⁷
-------	---------	--------	--------	------	----------------------	------	--------	----------------	------	------	--------------------

RENO

06-08	Left	G56882	M56882	143349 ⁶⁸	G56884	M56884	143350 ⁵³
	Right	G56883	M56883	143349 ⁶⁸	G56885	M56885	143350 ⁵³
05	Left	G56882	M56882	G56884	M56884
	Right	G56883	M56883	G56885	M56885

RENO READYMOUNTS

		Front		Rear	
		Ultra Readymount	Guardian Readymount	Ultra Readymount	Guardian Readymount
05-08	Left	G57126 ⁴⁰	M57126⁴⁰	G57128 ⁴⁰	M57128⁴⁰
	Right	G57127 ⁴⁰	M57127⁴⁰	G57129 ⁴⁰	M57129⁴⁰

SAMURAI

86-95	All	G63798	61549 81675	G63949	61550 81676
-------	-----	--------	----------------	------	------	------	--------	----------------	------	------	------

SAMURAI STEERING STABILIZERS

		Front	Rear
86-95	Single System Steering Stabilizer	6802SE ⁸⁴

SIDEKICK

96-98	All	G63799	61560 81904	49613 ⁷
	Non-ABS	G56518	M56518	142294 ⁵⁴	G63799	61560 81904	49613 ⁷
89-95	All	G63799	61560	49613 ⁷
	Non-ABS	G56518	M56518	142294 ⁵⁴	G63799	81904 61560	49613 ⁷

SWIFT

12-15	Left	G52586	G511061¹
	Right	G52587	G511061¹
04-09	Left	G56886	M56886	143375 ⁵³
	Right	G56887	M56887	143375 ⁵³
89-01	All	G55891	142293 ⁵⁴ 143059 ⁵¹	G55772	142295 ⁵³ 143057 ⁵¹

SWIFT READYMOUNTS

		Front		Rear	
		Ultra Readymount	Guardian Readymount	Ultra Readymount	Guardian Readymount
04-09	Left	G57130 ⁴⁰	M57130⁴⁰
	Right	G57131 ⁴⁰	M57131⁴⁰

VERONA

04-06	Left	G52389	G51997
	Right	G52390	G51998

1 Future Part, available 1st Quarter of 2017.

40 Complete Assembled Unit.

53 Strut Mount. Hardware from O.E. Part may need to be reused.

68 Strut Mount Kit. Hardware from O.E. Part may need to be reused.



7 Pair Packs, air hose kit included.

51 Strut Cushion for use with the Strut/Cartridge/Shocks.

54 Kit with Mount and Bearing. Hardware from O.E. Part may need to be reused.

84 Replacement damper for vehicles with the Gabriel Aftermarket mounting kit

APPLICATION GUIDE

Year	Fitment Notes										
		Ultra	ProGuard\Guardian\Classic	Max Control\LTV	Strut Cushion\Strut Mount	HiJackers\Load Carrier	Ultra	ProGuard\Guardian\Classic	Max Control\LTV	Strut Cushion\Strut Mount	HiJackers\Load Carrier

SUZUKI

SUZUKI

VITARA

99-04	All	M56518	143204 ⁵³	⊥ ○	G63799	61560 81904	49613 ⁷
	Non-ABS	G56518	M56518	143204 ⁵³	⊥ ○	G63799	61560 81904	49613 ⁷

X-90

96-98	All	⊥ ○	G63799	61560 81904	49613 ⁷
-------	-----	-------	-------	-------	-------	-------	--------	--------	----------------	-------	-------	--------------------

XL-7

07-09	Left	⊥ ○	G52127	143469⁶⁸	⊥ ○	G64015	61718
	Right	⊥ ○	G52128	143469⁶⁸	⊥ ○	G64015	61718
02-06	All	⊥ ○	M56518	143204 ⁵³	⊥ ○	G64105
	Non-ABS	⊥ ○	G56518	M56518	143204 ⁵³	⊥ ○	G64105

XL-7 READYMOUNTS

		Front		Rear	
		Ultra Readymount	Guardian Readymount	Ultra Readymount	Guardian Readymount
07-09	Left 19" Wheels	G57197⁴⁰
	Left Exc. 19" Wheels	G57322⁴⁰
	Right 19" Wheels	G57198⁴⁰
	Right Exc. 19" Wheels	G57323⁴⁰

TOYOTA

TOYOTA

4RUNNER

13-16	All	⊥ ○	G51739	143383 ⁶⁸	⊥ ○	G63885
03-12	All	⊥ ○	143383 ⁶⁸	⊥ ○
	Exc. X-REAS Suspension; Exc. Sport Models	⊥ ○	G51739	143383 ⁶⁸	⊥ ○	G63885
96-02	All	⊥ ○	G51077	M51077	⊥ ○	G63726	77726	49387 ⁷
	Exc. HD	⊥ ○	G51077	M51077	142838 ⁵³	⊥ ○	G63726	77726	49387 ⁷
	HD	⊥ ○	G51077	M51077	143325 ⁵³	⊥ ○	G63726	77726	49387 ⁷
90-95	All	⊥ ○	G63547	61552 81870	77479	⊥ ○	G63548	61588 81906	77726	49388 ⁷
	Exc. HD	⊥ ○	G63547	61552 81870	77479	142838 ⁵³	⊥ ○	G63548	61588 81906	77726	49388 ⁷
86-89	All	⊥ ○	G63479	61552 81870	77479	⊥ ○	G63494	61510 81871	77494
84-85	All	⊥ ○	G63404	⊥ ○	G63494	61510 81871	77494

4RUNNER READYMOUNTS

		Front		Rear	
		Ultra Readymount	Guardian Readymount	Ultra Readymount	Guardian Readymount
03-16	Left	G57133⁴⁰	M57133⁴⁰
	Right	G57134⁴⁰	M57134⁴⁰
96-02	Left	G57065 ⁴⁰
	Right	G57066 ⁴⁰

4RUNNER STEERING STABILIZERS

		Front	Rear
84-85	Single System Steering Stabilizer	6803SE ⁸⁴

7 Pair Packs, air hose kit included.

53 Strut Mount. Hardware from O.E. Part may need to be reused.



84 Replacement damper for vehicles with the Gabriel Aftermarket mounting kit

Bold Type - New / Future Part

40 Complete Assembled Unit.

68 Strut Mount Kit. Hardware from O.E. Part may need to be reused.

APPLICATION GUIDE

Year	Fitment Notes										
		Ultra	ProGuard\Guardian\Classic	Max Control\LTV	Strut Cushion\Strut Mount	HiJackers\Load Carrier	Ultra	ProGuard\Guardian\Classic	Max Control\LTV	Strut Cushion\Strut Mount	HiJackers\Load Carrier

TOYOTA

TOYOTA

AVALON

07-11	Left	G56888	143402 ⁶⁸
	Left Mfg. from 01/06	143402 ⁶⁸	G52103
	Right	G56889	143402 ⁶⁸
	Right Mfg. from 01/06	143402 ⁶⁸	G52104
06-11	All	143402 ⁶⁸
06	Left	143402 ⁶⁸	G52367
	Left Mfg. from 01/06	G56888	143402 ⁶⁸	G52103
	Right	143402 ⁶⁸	G52368
	Right Mfg. from 01/06	G56889	143402 ⁶⁸	G52104
	Mfg. to 01/06 Left	G52365	143402 ⁶⁸
	Mfg. to 01/06 Right	G52366	143402 ⁶⁸
05	Left	G52367
	Right	G52368
	Mfg. to 01/06 Left	G52365
	Mfg. to 01/06 Right	G52366
04	All	142556 ⁶⁷	142837 ⁵³
	Left	G52376	142650 ⁵⁴ 142556 ⁶⁷	G52412	142837 ⁵³
	Right	G52377	142649 ⁵⁴ 142556 ⁶⁷	G52413	142837 ⁵³
97-03	All	142556 ⁶⁷ 143057 ⁵¹	142837 ⁵³ 143057 ⁵¹
	Left	G56506	M56506	142650 ⁵⁴ 142556 ⁶⁷ 143057 ⁵¹	G55675	M55675	142837 ⁵³ 143057 ⁵¹
	Right	G56514	M56514	142649 ⁵⁴ 142556 ⁶⁷ 143057 ⁵¹	G55676	M55676	142837 ⁵³ 143057 ⁵¹
95-96	All	G56502	M56502	142556 ⁶⁷ 142836 ⁵⁴ 143057 ⁵¹	142439 ⁵³ 143057 ⁵¹
	Left	G56502	M56502	142556 ⁶⁷ 142836 ⁵⁴ 143057 ⁵¹	G55675	M55675	142439 ⁵³ 143057 ⁵¹
	Rebuildable O.E. Struts	G44783 ⁹⁸	M56502	142556 ⁶⁷ 142836 ⁵⁴ 143057 ⁵¹	142439 ⁵³ 143057 ⁵¹
	Right	G56502	M56502	142556 ⁶⁷ 142836 ⁵⁴ 143057 ⁵¹	G55676	M55676	142439 ⁵³ 143057 ⁵¹

51 Strut Cushion for use with the Strut/Cartridge/Shocks.

54 Kit with Mount and Bearing. Hardware from O.E. Part may need to be reused.

68 Strut Mount Kit. Hardware from O.E. Part may need to be reused.

53 Strut Mount. Hardware from O.E. Part may need to be reused.

67 Strut Mount Kit. Hardware from O.E. Part may need to be reused.

98 Notice: The level of difficulty to install this product is moderately high. Please review the installation instructions carefully before proceeding.

APPLICATION GUIDE

Year	Fitment Notes	Front					Rear				
		Ultra	ProGuard\Guardian\Classic	Max Control\LTV	Strut Cushion\Strut Mount	HiJackers\Load Carrier	Ultra	ProGuard\Guardian\Classic	Max Control\LTV	Strut Cushion\Strut Mount	HiJackers\Load Carrier

TOYOTA

TOYOTA

AVALON READYMOUNTS		Front		Rear	
		Ultra Readymount	Guardian Readymount	Ultra Readymount	Guardian Readymount
12-16	Left	G57539 ⁴⁰
	Right	G57540 ⁴⁰
06-11	Left	G57539 ⁴⁰	G57192 ⁴⁰
	Right	G57540 ⁴⁰	G57193 ⁴⁰
97-03	Left	G56930 ⁴⁰	M56930 ⁴⁰	G56932 ⁴⁰	M56932 ⁴⁰
	Right	G56931 ⁴⁰	M56931 ⁴⁰	G56933 ⁴⁰	M56933 ⁴⁰
95-96	Left	G56932 ⁴⁰	M56932 ⁴⁰
	Right	G56933 ⁴⁰	M56933 ⁴⁰

CAMRY

15	SE, Left	G52425
	SE, Right	G52426
14	SE, SE Sport, Left	G52425
	SE, SE Sport, Right	G52426
12-13	Exc. LE & L SubModels Left	G52485
	Exc. LE & L SubModels Right	G52486
	SE, Left	G52425
	SE, Right	G52426
07-11	Left	G56888	143402 ⁶⁸	G52103	143413 ⁶⁸
	Right	G56889	143402 ⁶⁸	G52104	143414 ⁶⁸
06	Left	G56721	M52813	143202 ⁵⁴	G56728	M52815	143413 ⁶⁸
	Right	G56722	M52814	143202 ⁵⁴	G56729	M52816	143414 ⁶⁸
04-05	Left	G56721	M52813	143202 ⁵⁴	G56728	M52815
	Right	G56722	M52814	143202 ⁵⁴	G56729	M52816
02-03	Left	G56673	M56673	143202 ⁵⁴	G56675	M56675	142837 ⁵³
	Right	G56674	M56674	143202 ⁵⁴	G56676	M56676	142837 ⁵³
97-01	All	142556 ⁵⁷ 143057 ⁵¹	142837 ⁵³ 143057 ⁵¹
	Left	G56506	M56506	142650 ⁵⁴ 142556 ⁵⁷ 143057 ⁵¹	G55675	M55675	142837 ⁵³ 143057 ⁵¹
	Right	G56514	M56514	142649 ⁵⁴ 142556 ⁵⁷ 143057 ⁵¹	G55676	M55676	142837 ⁵³ 143057 ⁵¹
95-96	All	G56502	M56502	142556 ⁵⁷ 142836 ⁵⁴ 143057 ⁵¹	142439 ⁵³ 143057 ⁵¹
	Left	G56502	M56502	142556 ⁵⁷ 142836 ⁵⁴ 143057 ⁵¹	G55675	M55675	142439 ⁵³ 143057 ⁵¹

40 Complete Assembled Unit.

53 Strut Mount. Hardware from O.E. Part may need to be reused.

67 Strut Mount Kit. Hardware from O.E. Part may need to be reused.



Bold Type - New / Future Part

51 Strut Cushion for use with the Strut/Cartridge/Shocks.

54 Kit with Mount and Bearing. Hardware from O.E. Part may need to be reused.

68 Strut Mount Kit. Hardware from O.E. Part may need to be reused.

APPLICATION GUIDE

Year	Fitment Notes										
		Ultra	ProGuard/ Guardian/ Classic	Max Control/ LTV	Strut Cushion/ Strut Mount	HiJackers/ Load Carrier	Ultra	ProGuard/ Guardian/ Classic	Max Control/ LTV	Strut Cushion/ Strut Mount	HiJackers/ Load Carrier

TOYOTA

TOYOTA

CAMRY (cont)

95-96	Rebuildable O.E. Struts	G44783 ⁹⁸	M56502	142556 ⁶⁷ 142836 ⁵⁴ 143057 ⁵¹	142439 ⁵³ 143057 ⁵¹
	Right	G56502	M56502	142556 ⁶⁷ 142836 ⁵⁴ 143057 ⁵¹	G55676	M55676	142439 ⁵³ 143057 ⁵¹
92-94	All	143057 ⁵¹	142439 ⁵³ 143057 ⁵¹
	Left Sealed O.E. Struts	143057 ⁵¹	G55675	M55675	142439 ⁵³ 143057 ⁵¹
	Right Sealed O.E. Struts	143057 ⁵¹	G55676	M55676	142439 ⁵³ 143057 ⁵¹
	Sealed O.E. Struts	G55914	143057 ⁵¹	142439 ⁵³ 143057 ⁵¹
	FWD, Rebuildable O.E. Struts	G44999 ⁹⁸	143057 ⁵¹	G44477 ⁹⁸	142439 ⁵³ 143057 ⁵¹
87-91	All	G55590	143057 ⁵¹ 143278 ⁵³	143057 ⁵¹
	Rebuildable O.E. Front Struts	G44982 ⁹⁸	143057 ⁵¹ 143278 ⁵³	143057 ⁵¹
	FWD	G55590	M55590	143057 ⁵¹ 143278 ⁵³	143057 ⁵¹
	FWD Left	G55590	143057 ⁵¹ 143278 ⁵³	G55589	M52573	143057 ⁵¹
	FWD Right	G55590	143057 ⁵¹ 143278 ⁵³	G55589	M52574	143057 ⁵¹
	Wagon Left	G55590	143057 ⁵¹ 143278 ⁵³	G55588	M52573	143057 ⁵¹
	Wagon Right	G55590	143057 ⁵¹ 143278 ⁵³	G55588	M52574	143057 ⁵¹
83-86	All	G44940 ⁹⁸	143058 ⁵¹

CAMRY READYMOUNTS

		Front		Rear	
		Ultra Readymount	Guardian Readymount	Ultra Readymount	Guardian Readymount
12-13	Left	G57537 ⁴⁰	G57499 ⁴⁰
	Right	G57538 ⁴⁰	G57500 ⁴⁰
07-11	Left	G57190 ⁴⁰	G57192 ⁴⁰
	Right	G57191 ⁴⁰	G57193 ⁴⁰
04-06	Left	G57078 ⁴⁰
	Right	G57079 ⁴⁰
	4Cyl Left	G57076 ⁴⁰
	4Cyl Right	G57077 ⁴⁰
02-03	Left	G57041 ⁴⁰	M57041 ⁴⁰	G57043 ⁴⁰	M57043 ⁴⁰
	Right	G57042 ⁴⁰	M57042 ⁴⁰	G57044 ⁴⁰	M57044 ⁴⁰
97-01	Left	G56930 ⁴⁰	M56930 ⁴⁰	G56932 ⁴⁰	M56932 ⁴⁰
	Right	G56931 ⁴⁰	M56931 ⁴⁰	G56933 ⁴⁰	M56933 ⁴⁰
95-96	Left	G56942 ⁴⁰	M56942 ⁴⁰	G56932 ⁴⁰	M56932 ⁴⁰
	Right	G56942 ⁴⁰	M56942 ⁴⁰	G56933 ⁴⁰	M56933 ⁴⁰
92-94	Left	G57387 ⁴⁰
	Left Sealed O.E. Struts	G56932 ⁴⁰	M56932 ⁴⁰
	Right	G57388 ⁴⁰
	Right Sealed O.E. Struts	G56933 ⁴⁰	M56933 ⁴⁰

40 Complete Assembled Unit.

53 Strut Mount. Hardware from O.E. Part may need to be reused.





67 Strut Mount Kit. Hardware from O.E. Part may need to be reused.

51 Strut Cushion for use with the Strut/Cartridge/Shocks.

54 Kit with Mount and Bearing. Hardware from O.E. Part may need to be reused.

98 Notice: The level of difficulty to install this product is moderately high. Please review the installation instructions carefully before proceeding.



APPLICATION GUIDE

Year	Fitment Notes										
			ProGuard/ Guardian/ Classic	Max Control/ LTV	Strut Cushion/ Strut Mount	HiJackers/ Load Carrier		ProGuard/ Guardian/ Classic	Max Control/ LTV	Strut Cushion/ Strut Mount	HiJackers/ Load Carrier































TOYOTA

TOYOTA











CARINA

72-73	All		143059 ⁵¹	
-------	-----	---	------	------	------	----------------------	------	---	------	------	------	------	------

CELICA

00-05	Left		G56586	143201 ⁵³		G56587	143094 ⁵³
	Right		G56585	143201 ⁵³		G56587	143094 ⁵³
94-99	Left		G56573	142556 ⁶⁷		G56575
	Right		G56576	142556 ⁶⁷		G56574
92-93	All			143057 ⁵¹
	FWD			G55606	143057 ⁵¹
	GT, GTS, ST		G44995 ⁹⁸	143059 ⁵¹		143057 ⁵¹
90-91	All		G44995 ⁹⁸	
	AWD		G44995 ⁹⁸	143059 ⁵¹		143059 ⁵¹
	FWD		G44995 ⁹⁸		G55606
88-89	All		143059 ⁵¹	
	AWD		G44939 ⁹⁸	143059 ⁵¹	
	FWD; Exc. All-Trac		G44982 ⁹⁸	143059 ⁵¹	
	GT, GTS, ST		143059 ⁵¹		142249 ⁵³
86-87	All		143059 ⁵¹		G55529	142249 ⁵³
	Exc. All-Trac		G44939 ⁹⁸	143059 ⁵¹		G55529	142249 ⁵³
82-85	All		G44938 ⁹⁸	143057 ⁵¹		69713	81416
78-81	All		G44938 ⁹⁸	143057 ⁵¹		81416
76-77	All		G44938 ⁹⁸	143057 ⁵¹	
75	All		143057 ⁵¹	
	Mfg. from 10/75		G44938 ⁹⁸	143057 ⁵¹	

COROLLA

14-16	All			G51898
09-13	Left		G52245		G51898
	Right		G52246		G51898
03-08	Left		G56661	M56661	143201 ⁵³		G51736	M51736	143094 ⁵³
	Right		G56660	M56660	143201 ⁵³		G51736	M51736	143094 ⁵³



51 Strut Cushion for use with the Strut/Cartridge/Shocks.

67 Strut Mount Kit. Hardware from O.E. Part may need to be reused.

53 Strut Mount. Hardware from O.E. Part may need to be reused.

98 Notice: The level of difficulty to install this product is moderately high. Please review the installation instructions carefully before proceeding.

APPLICATION GUIDE

Year	Fitment Notes										
		Ultra	ProGuard\Guardian\Classic	Max Control\LTV	Strut Cushion\Strut Mount	HiJackers\Load Carrier	Ultra	ProGuard\Guardian\Classic	Max Control\LTV	Strut Cushion\Strut Mount	HiJackers\Load Carrier

TOYOTA

TOYOTA

COROLLA (cont)

97-02	LE	↑	143281 ⁵³	
93-02	Left	↑	G55999	M55999	143059 ⁵¹	↑	G55661	M55661	143057 ⁵¹
	Right	↑	G55999	M55999	143059 ⁵¹	↑	G55662	M55662	143057 ⁵¹
	Exc. Wagon Right	↑	↑	142229 ⁵³
93-97	Exc. LE Model	↑	143280 ⁵³	↑
93-95	LE	↑	143281 ⁵³	↑
89-92	All	↑	143059 ⁵¹	↑
	Exc. Wagon	↑	M55591	143059 ⁵¹	↑	G55557	M55557
	Exc. Wagon Right	↑	143059 ⁵¹	↑	142229 ⁵³
	FWD	↑	G55591	143059 ⁵¹	↑	143058 ⁵¹
92	DLX, DLX All Trac, LE, SR5	↑	143281 ⁵³ 143059 ⁵¹	↑
89-91	DLX, DLX All Trac, GTS, LE, SR5	↑	143281 ⁵³ 143059 ⁵¹	↑
	Wagon	↑	G44994 ⁹⁸	143059 ⁵¹	↑	81498
88	DLX All Trac	↑	143281 ⁵³	↑
	DLX, GTS, LE, SR5	↑	143059 ⁵¹ 143281 ⁵³	↑
	Exc. Wagon	↑	M55591	↑	G55557	M55557
	Exc. Wagon Right	↑	↑	142229 ⁵³
	FWD	↑	G55591	↑	143058 ⁵¹
	FX, FX16	↑	143057 ⁵¹	↑
	FX16, Rebuildable Front Struts	↑	G44939 ⁹⁸	↑
	Wagon	↑	G44994 ⁹⁸	↑	81498
86-87	FWD	↑	143057 ⁵¹	↑	G55752	143058 ⁵¹ 142249 ⁵³
	FWD, Sealed Front Struts	↑	G55715	143057 ⁵¹	↑	142249 ⁵³
84-87	All	↑	143057 ⁵¹	↑	142249 ⁵³
	Coupe	↑	143057 ⁵¹	↑	81498	142249 ⁵³
	Rack(SteeringType), Coupe, Standard	↑	G44938 ⁹⁸	143057 ⁵¹	↑	142249 ⁵³
87	Exc. FX16 Rebuildable Front Struts	↑	G44747 ⁹⁸	143057 ⁵¹	↑	142249 ⁵³
	FX16, Rebuildable Front Struts	↑	G44939 ⁹⁸	143057 ⁵¹	↑	142249 ⁵³



51 Strut Cushion for use with the Strut/Cartridge/Shocks.

53 Strut Mount. Hardware from O.E. Part may need to be reused.

98 Notice:The level of difficulty to install this product is moderately high. Please

290 review the installation instructions carefully before proceeding.

APPLICATION GUIDE

Year	Fitment Notes										
		Ultra	ProGuard\Guardian\Classic	Max Control\LTV	Strut Cushion\Strut Mount	HiJackers\Load Carrier	Ultra	ProGuard\Guardian\Classic	Max Control\LTV	Strut Cushion\Strut Mount	HiJackers\Load Carrier

TOYOTA

TOYOTA

COROLLA (cont)

86	FWD, Rebuildable Front Struts	G44747 ⁹⁸	143057 ⁵¹	142249 ⁹³
84-85	FWD	143057 ⁵¹	143058 ⁵¹ 142249 ⁹³
	FWD, DIESEL	G44939 ⁹⁸	143057 ⁵¹	142249 ⁹³
	FWD, GAS	143057 ⁵¹	G55752	142249 ⁹³
	FWD, GAS Rebuildable Front Struts	G44747 ⁹⁸	143057 ⁵¹	142249 ⁹³
	FWD, GAS Sealed Front Struts	G55715	143057 ⁵¹	142249 ⁹³
80-83	All	G44938 ⁹⁸	143057 ⁵¹
	Coupe	G44938 ⁹⁸	143057 ⁵¹	81498
	Hatchback	G44938 ⁹⁸	143057 ⁵¹	81498
	Sedan	G44938 ⁹⁸	143057 ⁵¹	81498
	Wagon	G44938 ⁹⁸	143057 ⁵¹	81416
83	Hardtop	G44938 ⁹⁸	143057 ⁵¹	81498
76-79	Coupe	G44938 ⁹⁸	81340
75-79	All	G44938 ⁹⁸
	Sedan	G44938 ⁹⁸	81340
	Wagon	G44938 ⁹⁸	143057 ⁵¹	81416
75-78	Hardtop	G44938 ⁹⁸	81340
72-74	Coupe	81340
	Sedan	81340
74	Mfg. from 8/74	G44938 ⁹⁸	143057 ⁵¹
	Mfg. from 8/74; Wagon	81416
	Mfg to 07/74 Wagon	82020
71-73	Wagon	82020

COROLLA READYMOUNTS

		Front		Rear	
		Ultra Readymount	Guardian Readymount	Ultra Readymount	Guardian Readymount
14-17	Left	G57543 ⁴⁰
14-16	Right	G57544 ⁴⁰
09-12	Left	G57329 ⁴⁰
	Right	G57330 ⁴⁰
03-08	Left	G57114 ⁴⁰	M57114 ⁴⁰	G57067 ⁴⁰	M57067 ⁴⁰
	Right	G57115 ⁴⁰	M57115 ⁴⁰	G57068 ⁴⁰	M57068 ⁴⁰
98-02	Left	G56948 ⁴⁰	M56948 ⁴⁰	G56949 ⁴⁰	M56949 ⁴⁰
	Right	G56948 ⁴⁰	M56948 ⁴⁰	G56950 ⁴⁰	M56950 ⁴⁰
93-97	Left	G56947 ⁴⁰	M56947 ⁴⁰	G56949 ⁴⁰	M56949 ⁴⁰

40 Complete Assembled Unit.



53 Strut Mount. Hardware from O.E. Part may need to be reused.

51 Strut Cushion for use with the Strut/Cartridge/Shocks.

98 Notice: The level of difficulty to install this product is moderately high. Please review the installation instructions carefully before proceeding.

Bold Type - New / Future Part

APPLICATION GUIDE

Year	Fitment Notes										
		Ultra	ProGuard/ Guardian/ Classic	Max Control/ LTV	Strut Cushion/ Strut Mount	HiJackers/ Load Carrier	Ultra	ProGuard/ Guardian/ Classic	Max Control/ LTV	Strut Cushion/ Strut Mount	HiJackers/ Load Carrier

TOYOTA

TOYOTA

COROLLA READYMOUNTS (cont)		Front		Rear	
		Ultra Readymount	Guardian Readymount	Ultra Readymount	Guardian Readymount
93-97	Right	G56947 ⁴⁰	M56947 ⁴⁰	G56950 ⁴⁰	M56950 ⁴⁰

CORONA

79-82	All	G44898 ⁹⁸	143059 ⁵¹
	Exc. Wagon	G44898 ⁹⁸	143059 ⁵¹	81416
79-81	Wagon	G44898 ⁹⁸	143059 ⁵¹	81340
78	All	69600	81494
	Wagon	69600	81494	82156	49310 ⁷
73-77	Mfg. from 8/73	69600	81494
67-77	All	81494
77	Wagon	81494	82156	49310 ⁷
74-76	Exc. Wagon	81494	81340	49151 ⁷
	Wagon	81494	82156
73	Exc. Wagon	81494	81340 82155	49151 ⁷
	Wagon Mfg. from 8/73	81494	82156
69-72	Mark II	69600	81494
72	Exc. Wagon	81494	81340 82155
69-71	Mark II, Sedan	81494	49151 ⁷
68-71	Exc. Wagon	81494	82155
71	Mark II, Wagon	81494	49309 ⁷
	Mark II, Wagon Exc. Wagon	81494	82156
69-70	Mark II, Wagon	81494	82156	49309 ⁷

CRESSIDA

89-92	Exc. Electronic Adjustable Suspension	G44926 ⁹⁸	142437 ⁵³ 143059 ⁵¹	G51060
81-92	All	143059 ⁵¹
85-88	Exc. Electronic Adjustable Suspension	G44926 ⁹⁸	142437 ⁵³ 143059 ⁵¹
	Sedan Exc. Electronic Adjustable Suspension	143059 ⁵¹	81440
81-87	Wagon	143059 ⁵¹	81416
83-84	Exc. Electronic Adjustable Suspension	G44926 ⁹⁸	143059 ⁵¹
	Sedan	143059 ⁵¹	81440
81-82	Exc. Electronic Adjustable Suspension	G44926 ⁹⁸	142242 ⁵³ 143059 ⁵¹
	Sedan Exc. Electronic Adjustable Suspension	143059 ⁵¹	81440
78-80	All	G44898 ⁹⁸	142242 ⁵³ 143059 ⁵¹

7 Pair Packs, air hose kit included.



51 Strut Cushion for use with the Strut/Cartridge/Shocks.

98 Notice: The level of difficulty to install this product is moderately high. Please review the installation instructions carefully before proceeding.

40 Complete Assembled Unit.

53 Strut Mount. Hardware from O.E. Part may need to be reused.



APPLICATION GUIDE

Year	Fitment Notes										
		Ultra	ProGuard\ Guardian\ Classic	Max Control\ LTV	Strut Cushion\ Strut Mount	HiJackers\ Load Carrier	Ultra	ProGuard\ Guardian\ Classic	Max Control\ LTV	Strut Cushion\ Strut Mount	HiJackers\ Load Carrier





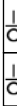

TOYOTA

TOYOTA





CRESSIDA (cont)

78-80	Sedan		G44898 ⁹⁸	142242 ⁵³ 143059 ⁵¹		81440
	Wagon		G44898 ⁹⁸	142242 ⁵³ 143059 ⁵¹		81340

CROWN

67	Mfg. to 9/67		82099	
65-66	All		82099	
	Wagon Wagon		82099		82156

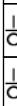



ECHO

00-05	All		G56572		69450
	Only fits O.E. P/N 48609-52021		G56572	143195 ⁵³		69450
	Only fits O.E. P/N's 48609-52011 & 48609-52050		G56572	143194 ⁵³		69450

ECHO READYMOUNTS

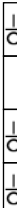
		Front		Rear	
		Ultra Readymount	Guardian Readymount	Ultra Readymount	Guardian Readymount
00-05	All	G57397 ⁴⁰











FJ CRUISER

11-12	4WD		G51739	143383 ⁶⁸		G64030
07-12	All		G51739	143383 ⁶⁸	
	RWD	G51739	143383 ⁶⁸		G64029	
07-09	4WD		G51739	143383 ⁶⁸		G64030

FJ CRUISER READYMOUNTS

		Front		Rear	
		Ultra Readymount	Guardian Readymount	Ultra Readymount	Guardian Readymount
12	Left	G57133 ⁴⁰
	Right	G57134 ⁴⁰
07-11	Left	G57133 ⁴⁰	M57133 ⁴⁰
	Right	G57134 ⁴⁰	M57134 ⁴⁰

HIGHLANDER

11-13	Left		G52201	143402 ⁶⁸		143509 ⁶⁸
	Right		G52202	143402 ⁶⁸		143510 ⁶⁸
08-13	AWD, Left			G52380
	AWD, Right			G52381
	FWD, Left			G52203
	FWD, Right			G52204
08-10	Left		G52201	143402 ⁶⁸		

40 Complete Assembled Unit.

53 Strut Mount. Hardware from O.E. Part may need to be reused.



98 Notice: The level of difficulty to install this product is moderately high. Please review the installation instructions carefully before proceeding.

Bold Type - New / Future Part

51 Strut Cushion for use with the Strut/Cartridge/Shocks.

68 Strut Mount Kit. Hardware from O.E. Part may need to be reused.

APPLICATION GUIDE

Year	Fitment Notes										
		Ultra	ProGuard\ Guardian\ Classic	Max Control\ LTV	Strut Cushion\ Strut Mount	HiJackers\ Load Carrier	Ultra	ProGuard\ Guardian\ Classic	Max Control\ LTV	Strut Cushion\ Strut Mount	HiJackers\ Load Carrier

TOYOTA

TOYOTA

HIGHLANDER (cont)

08-10	Right	G52202	143402 ⁶⁸
04-07	Left	G56730	143202 ⁵⁴	143387 ⁶⁸
	Right	G56731	143202 ⁵⁴	143388 ⁶⁸
	AWD, Left	G56732
	AWD, Right	G56733
	FWD, Left	G56734
	FWD, Right	G56735
01-03	Left	G56679	143202 ⁵⁴
	Right	G56680	143202 ⁵⁴
	AWD, Left	G56681
	AWD, Right	G56682
	FWD, Left	G56667
	FWD, Right	G56668

HIGHLANDER READYMOUNTS

		Front		Rear	
		Ultra Readymount	Guardian Readymount	Ultra Readymount	Guardian Readymount
08-10	AWD, Left w/o 3rd Seat	G57658 ⁴⁰
	AWD, Right w/o 3rd Seat	G57659 ⁴⁰
	AWD; 3.5L Left	G57656 ⁴⁰
	AWD; 3.5L Right	G57657 ⁴⁰
	AWD; Exc. 3.5L Left	G57481 ⁴⁰
	AWD; Exc. 3.5L Right	G57482 ⁴⁰
	FWD, Left	G57483 ⁴⁰
	FWD, Right	G57484 ⁴⁰
04-07	AWD, Left	G57652 ⁴⁰
	AWD, Left w/o 3rd Seat	G57654 ⁴⁰
	AWD, Right	G57653 ⁴⁰
	AWD, Right w/o 3rd Seat	G57655 ⁴⁰
	FWD, Left	G57531 ⁴⁰	G57533 ⁴⁰
	FWD, Right	G57532 ⁴⁰	G57534 ⁴⁰
01-03	AWD, Left	G57648 ⁴⁰	G57650 ⁴⁰
	AWD, Right	G57649 ⁴⁰	G57651 ⁴⁰

LAND CRUISER

98-07	All	G63832	G63828
93-97	All	G63615	G63616
91-92	All	G63615
	FJ80(MfrBodyCode)	G63615	G63616
88-90	All	G63432	61507	G63510
84-87	All	49311 ⁷

7 Pair Packs, air hose kit included.

54 Kit with Mount and Bearing. Hardware from O.E. Part may need to be reused.

40 Complete Assembled Unit.

68 Strut Mount Kit. Hardware from O.E. Part may need to be reused.

APPLICATION GUIDE

Year	Fitment Notes										
		Ultra	ProGuard/ Guardian/ Classic	Max Control/ LTV	Strut Cushion/ Strut Mount	HiJackers/ Load Carrier	Ultra	ProGuard/ Guardian/ Classic	Max Control/ LTV	Strut Cushion/ Strut Mount	HiJackers/ Load Carrier

TOYOTA

TOYOTA

LAND CRUISER (cont)

81-87	Sport Utility, FJ60(MfrBodyCode)	 ○	G63432	61507	○ ○	G63492	61506 81318	77492	49311 ⁷
81-83	All		○ ○	G63492	61506 81318	77492	49311 ⁷
	FJ40(MfrBodyCode)	○ ○	G63299	82007	○ ○	G63492	61506 81318	77492	49311 ⁷
80	All	 ○	61507	○ ○	G63492	61506 81318	77492	49311 ⁷
	FJ40(MfrBodyCode)	○ ○	G63299	82007 61507	○ ○	G63492	61506 81318	77492	49311 ⁷
76-79	FJ40(MfrBodyCode)	○ ○	G63299	82007	○ ○	G63492	61506 81318	77492	49311 ⁷
	Sport Utility, FJ55(MfrBodyCode)	 ○	81340	○ ○	G63492	61506 81318	77492	49311 ⁷
79	All		○ ○	G63492	81318	77492	49311 ⁷
76-78	All		○ ○	G63492	61506 81318	77492	49311 ⁷
75	All		○ ○	81318
	Mfg. from 1/75		○ ○	G63492	81318	49311 ⁷
	Mfg. to 2/75		○ ○	81318	77492
	FJ40(MfrBodyCode) Mfg. from 1/75		○ ○	61506 81318
	FJ40(MfrBodyCode) Mfg. to 2/75	○ ○	G63299	82007	○ ○	81318
	Sport Utility, FJ55(MfrBodyCode)	 ○	81340	○ ○	81318
69-74	All	○ ○	G63299	81340 82007	○ ○	G63492	77492
	Exc. Wagon	○ ○	G63299	81340 82007	○ ○	G63492	61500	77492	49310 ⁷
	Wagon	○ ○	G63299	81340 82007	○ ○	G63492	81318	77492	49311 ⁷
67-68	All	○ ○	G63299	82007	○ ○	61500 81147	49310 ⁷

LAND CRUISER STEERING STABILIZERS

		Front	Rear
80-95	All	14073

MATRIX

09-14	Left		G52245
	Right		G52246
	FWD			G51898
03-08	Left		G52013	143093 ⁵³	143094 ⁵³
	Right		G52014	143093 ⁵³	143094 ⁵³
	FWD			G51736	M51736
03-06	AWD			G51768

MATRIX READYMOUNTS

		Front		Rear	
		Ultra Readymount	Guardian Readymount	Ultra Readymount	Guardian Readymount
09-13	Left	G57329 ⁴⁰
	Right	G57330 ⁴⁰
03-08	FWD, Left	G57357 ⁴⁰	G57067 ⁴⁰	M57067 ⁴⁰



7 Pair Packs, air hose kit included.

40 Complete Assembled Unit.

53 Strut Mount. Hardware from O.E. Part may need to be reused.

Bold Type - New / Future Part

APPLICATION GUIDE









Year	Fitment Notes										
		Ultra	ProGuard\ Guardian\ Classic	Max Control\ LTV	Strut Cushion\ Strut Mount	HiJackers\ Load Carrier	Ultra	ProGuard\ Guardian\ Classic	Max Control\ LTV	Strut Cushion\ Strut Mount	HiJackers\ Load Carrier

TOYOTA





TOYOTA

MATRIX READYMOUNTS (cont)		Front		Rear	
		Ultra Readymount	Guardian Readymount	Ultra Readymount	Guardian Readymount
03-08	FWD, Right	G57358⁴⁰	G57068 ⁴⁰	M57068⁴⁰
03-06	AWD, Left	G57183⁴⁰
	AWD, Right	G57182⁴⁰























MR2

00-05	Left	 G52393	
	Right	 G52394	
92-95	All	 G44998⁹⁸	143059 ⁵¹	 G44997⁹⁸
91	All	 G44998
87-89	All	 G44802⁹⁸	143059 ⁵¹
85-86	All	 G44802⁹⁸	143059 ⁵¹	 G44803⁹⁸

PASEO

95-99	All	 G55879	M55879	142307 ⁵³ 143059 ⁵¹	 G51252	M51252	143064 ⁵¹
92-94	All	 G55828	142307 ⁵³ 143059 ⁵¹	 G55804	M55804	143064 ⁵¹

PICKUP

93-95	RWD, Exc. 1 Ton	 G63903	61509 81541	77903	 G63907	61500 81147	77907	49310 ⁷
86-95	4WD, Exc. Lift Kit	 G63479	61552 81870	77479	 G63494	61510 81871	77494
85-95	RWD	43048 ⁸
85-92	RWD, 1 Ton		61509	 G63492	61506 81318	77492	49311 ⁷
	RWD, Exc. 1 Ton	 G63903	81541	77903	 G63907	61500 81147	77907	49310 ⁷
84-85	4WD, Exc. Lift Kit	 G63404	 G63494	61510 81871	77494
84	RWD	 G63903	61509 81541	77903		77907	43048 ⁸ 49310 ⁷
	RWD, Exc. 1 Ton		81147
	RWD; Mojave	 G63907	61500
80-83	4WD, 2-3" Lift Kit	 G63444⁵⁰	 G63440⁵⁰
	4WD, Exc. Lift Kit	 G63404	 G63492	61506 81318	77492	49311 ⁷
73-83	RWD; Mojave		61504 81750	 G63907	61500 81147	77907	43048 ⁸ 49151 ⁷
70-72	RWD	43048 ⁸
	RWD	49151 ⁷
	RWD; Mojave		61504 81750	 G63907	61500 81147	77907

PICKUP STEERING STABILIZERS

		Front	Rear
86-95	Single System Steering Stabilizer	6802SE ⁸⁴

7 Pair Packs, air hose kit included.

40 Complete Assembled Unit.

51 Strut Cushion for use with the Strut/Cartridge/Shocks.

84 Replacement damper for vehicles with the Gabriel Aftermarket mounting kit



8 Pair Packs.

50 Bellows Kit No.141242 is recommended for use to protect piston rod from potentially harmful road debris.

53 Strut Mount. Hardware from O.E. Part may need to be reused.

98 Notice: The level of difficulty to install this product is moderately high. Please review the installation instructions carefully before proceeding.

APPLICATION GUIDE

Year	Fitment Notes										
		Ultra	ProGuard\ Guardian\ Classic	Max Control\ LTV	Strut Cushion\ Strut Mount	HiJackers\ Load Carrier	Ultra	ProGuard\ Guardian\ Classic	Max Control\ LTV	Strut Cushion\ Strut Mount	HiJackers\ Load Carrier

TOYOTA

TOYOTA

PICKUP STEERING STABILIZERS (cont)

		Front	Rear
86-95	4WD, Single System Steering Stabilizer; with OE Stock Mounts	6804SE ⁸⁰
80-85	4WD, Single System Steering Stabilizer; with OE Stock Mounts	6803SE ⁸⁴
79-85	RWD, Single System Steering Stabilizer	6802SE ⁸⁴

PREVIA

91-97	Left	G55652	143061 ⁵¹ 143278 ⁵³	G63620	61594
	Right	G55653	143061 ⁵¹ 143278 ⁵³	G63620	61594

PRIUS

13-15	17" Wheels	70053
	Mfg. to 12/11 Left	G52331
11-12	Mfg. to 12/11 Right	G52332	143553 ⁵³	143554 ⁶⁷
10-12	All	143553 ⁵³	143554 ⁶⁷
	17" Wheels	143553 ⁵³	70053	143554 ⁶⁷
	Mfg. to 12/11 Left	G52331	143553 ⁵³	143554 ⁶⁷
10	Right	G52332	143553 ⁵³	143554 ⁶⁷
04-09	Left	G56890	143201 ⁵³	G51795	143094 ⁵³
	Right	G56891	143201 ⁵³	G51795	143094 ⁵³
01-03	Left	G52077	143193 ⁵³	G51840	143094 ⁵³
	Right	G52078	143193 ⁵³	G51840	143094 ⁵³

PRIUS C

15-16	15" & 16" Wheels	70055
12-14	All	70055

PRIUS READYMOUNTS

		Front		Rear	
		Ultra Readymount	Guardian Readymount	Ultra Readymount	Guardian Readymount
04-09	Left	G57404 ⁴⁰	G57568 ⁴⁰
	Right	G57405 ⁴⁰	G57569 ⁴⁰
01-03	Left	G57462 ⁴⁰	G57444 ⁴⁰
	Right	G57461 ⁴⁰	G57444 ⁴⁰

RAV4

06-12	Left	G52004	G64026
	Right	G52007	G64026
06-11	4WD	143343 ⁵³
01-05	Left	G56582	143367 ⁵³	69813 G63860
	Right	G56581	143367 ⁵³	69813 G63860

40 Complete Assembled Unit.

53 Strut Mount. Hardware from O.E. Part may need to be reused.

80 Mounting bracket not required, install on O.E. Shock Mounts. See Ref. C for optional Steering Stabilizer Boots.



Bold Type - New / Future Part

51 Strut Cushion for use with the Strut/Cartridge/Shocks.

67 Strut Mount Kit. Hardware from O.E. Part may need to be reused.

84 Replacement damper for vehicles with the Gabriel Aftermarket mounting kit

APPLICATION GUIDE

Year	Fitment Notes										
		Ultra	ProGuard\ Guardian\ Classic	Max Control\ LTV	Strut Cushion\ Strut Mount	HiJackers\ Load Carrier	Ultra	ProGuard\ Guardian\ Classic	Max Control\ LTV	Strut Cushion\ Strut Mount	HiJackers\ Load Carrier

TOYOTA

TOYOTA

RAV4 (cont)

01-05	AWD, Automatic Left	↓	M52822		
	AWD, Automatic Right	↓	M52823		
00	All	↓	143367 ⁵³	↓	G63860
	Left Mfg. from 5/00	↓	G56582	143367 ⁵³	↓	G63860
	Left Mfg. to 5/00; Sealed Struts	↓	G56631	143367 ⁵³	↓	G63860
	Mfg. from 5/00	↓	143367 ⁵³	↓	G63860
	Mfg. to 5/00	↓	143367 ⁵³	↓	G63860	61651
	Right Mfg. from 5/00	↓	G56581	143367 ⁵³	↓	G63860
	Right Mfg. to 5/00; Sealed Struts	↓	G56632	143367 ⁵³	↓	G63860
	AWD, Automatic Left	↓	M52822	143367 ⁵³	↓	G63860
	AWD, Automatic Right	↓	M52823	143367 ⁵³	↓	G63860
96-99	All	↓	143367 ⁵³	↓	G63860	61651
	Left Sealed Struts	↓	G56631	143367 ⁵³	↓	G63860	61651
	Right Sealed Struts	↓	G56632	143367 ⁵³	↓	G63860	61651

RAV4 READYMOUNTS

		Front		Rear	
		Ultra Readymount	Guardian Readymount	Ultra Readymount	Guardian Readymount
09-12	Left	M57204 ⁴⁰
	Right	M57205 ⁴⁰
06-08	Left	G57204 ⁴⁰	M57204 ⁴⁰
	Right	G57205 ⁴⁰	M57205 ⁴⁰
01-05	FWD, Left	G57350 ⁴⁰
	FWD, Right	G57349 ⁴⁰
00-05	AWD, Automatic Left Mfg. from 5/00	G57105 ⁴⁰
	AWD, Automatic Right Mfg. from 5/00	G57106 ⁴⁰

SEQUOIA

17	Exc. Air Suspension	↓	G51937	143339 ⁶⁸	
12-16	All	↓	G51937	143339 ⁶⁸	
08-11	All	↓	G51937	143339 ⁶⁸	143340 ⁶⁷	
01-07	All	↓	G51477	M52805	143325 ⁵³	↓	G64087

SEQUOIA READYMOUNTS

		Front		Rear	
		Ultra Readymount	Guardian Readymount	Ultra Readymount	Guardian Readymount
08-15	Left	G57454 ⁴⁰
	Right	G57453 ⁴⁰
01-07	All	G57027 ⁴⁰

40 Complete Assembled Unit.

67 Strut Mount Kit. Hardware from O.E. Part may need to be reused.

53 Strut Mount. Hardware from O.E. Part may need to be reused.

68 Strut Mount Kit. Hardware from O.E. Part may need to be reused.

APPLICATION GUIDE

Year	Fitment Notes										
			Ultra	ProGuard/ Guardian/ Classic	Max Control/ LTV	Strut Cushion/ Strut Mount	HiJackers/ Load Carrier		Ultra	ProGuard/ Guardian/ Classic	Max Control/ LTV



TOYOTA

TOYOTA

SIENNA

15-16	FWD		G51804	143338 ⁶⁷
11-16	AWD		G51805	143338 ⁶⁷
09-16	All	143338 ⁶⁷
09-10	AWD, Left		G52105		G51805	143338 ⁶⁷
	AWD, Right		G52106		G51805	143338 ⁶⁷
	FWD, 7 Passenger		G51804	143338 ⁶⁷
	FWD, 8 Passenger		G51805	143338 ⁶⁷
	FWD, Left 8 Passenger		G52105	143338 ⁶⁷
	FWD, Left Mfg. from 7/05; 7 Passenger		G52107	143338 ⁶⁷
	FWD, Right 8 Passenger		G52106	143338 ⁶⁷
	FWD, Right Mfg. from 7/05; 7 Passenger		G52108	143338 ⁶⁷
06-08	AWD, Left		G52105	143202 ⁵⁴		G51805	143338 ⁶⁷
	AWD, Right		G52106	143202 ⁵⁴		G51805	143338 ⁶⁷
	FWD, Left 8 Passenger		G52105	143202 ⁵⁴		143338 ⁶⁷
	FWD, Right 8 Passenger		G52106	143202 ⁵⁴		143338 ⁶⁷
05-08	FWD, Left Mfg. from 7/05; 7 Passenger		G52107	143202 ⁵⁴		143338 ⁶⁷
	FWD, Right Mfg. from 7/05; 7 Passenger		G52108	143202 ⁵⁴		143338 ⁶⁷
04-08	All		143202 ⁵⁴		143338 ⁶⁷
	FWD, 7 Passenger		143202 ⁵⁴		G51804	143338 ⁶⁷
	FWD, 8 Passenger		143202 ⁵⁴		G51805	143338 ⁶⁷
04-05	AWD		143202 ⁵⁴		G51805	143338 ⁶⁷
05	AWD, Left Mfg. from 7/05		G52105	143202 ⁵⁴		143338 ⁶⁷
	AWD, Right Mfg. from 7/05		G52106	143202 ⁵⁴		143338 ⁶⁷
	FWD, Left Mfg. from 7/05; 8 Passenger		G52105	143202 ⁵⁴		143338 ⁶⁷
	FWD, Left Mfg. to 6/05; 7 Passenger		G56798	143202 ⁵⁴		143338 ⁶⁷
	FWD, Right Mfg. from 7/05; 8 Passenger		G52106	143202 ⁵⁴		143338 ⁶⁷
	FWD, Right Mfg. to 6/05; 7 Passenger		G56797	143202 ⁵⁴		143338 ⁶⁷
04	FWD, Left 7 Passenger		G56798	143202 ⁵⁴		143338 ⁶⁷
	FWD, Right 7 Passenger		G56797	143202 ⁵⁴		143338 ⁶⁷







APPLICATION GUIDE

Year	Fitment Notes										
		Ultra	ProGuard\ Guardian\ Classic	Max Control\ LTV	Strut Cushion\ Strut Mount	HiJackers\ Load Carrier	Ultra	ProGuard\ Guardian\ Classic	Max Control\ LTV	Strut Cushion\ Strut Mount	HiJackers\ Load Carrier

TOYOTA

TOYOTA















SIENNA (cont)

98-03	Left	 G55993	M55993	142650 ⁵⁴	 G63610	61592 81937
	Right	 G55994	M55994	 G63610	61592 81937
	Mfg. to 12/02 Right		142649 ⁵⁴	

SIENNA READYMOUNTS

		Front		Rear	
		Ultra Readymount	Guardian Readymount	Ultra Readymount	Guardian Readymount
07-10	Left 8 Passenger	G57665
	Right 8 Passenger	G57666
	AWD, Left 8 Passenger	G57375 ⁴⁰
	AWD, Right 8 Passenger	G57376 ⁴⁰
	FWD, Left 7 Passenger	G57663 ⁴⁰
	FWD, Right 7 Passenger	G57664
04-06	Left	G57373 ⁴⁰
	Right	G57372 ⁴⁰
98-03	Mfg. to 12/02 Left	G57097 ⁴⁰
	Mfg. to 12/02 Right	G57098 ⁴⁰



SOLARA

08	Left	 G56721	M52813	
	Right	 G56722	M52814	
07	Left	 G56721	M52813	143202 ⁵⁴	
	Right	 G56722	M52814	143202 ⁵⁴	
04-06	Left	 G56721	M52813	143202 ⁵⁴	 G56728	M52815
	Right	 G56722	M52814	143202 ⁵⁴	 G56729	M52816
99-03	All		143057 ⁵¹		142837 ⁵³
	Left	 G56506	M56506	142650 ⁵⁴ 143057 ⁵¹	 G55675	M55675	142837 ⁵³
	Right	 G56514	M56514	142649 ⁵⁴ 143057 ⁵¹	 G55676	M55676	142837 ⁵³



SOLARA READYMOUNTS

		Front		Rear	
		Ultra Readymount	Guardian Readymount	Ultra Readymount	Guardian Readymount
07-08	Left	G57076 ⁴⁰
	Right	G57077 ⁴⁰
04-06	Left	G57076 ⁴⁰	G57078 ⁴⁰
	Right	G57077 ⁴⁰	G57079 ⁴⁰
99-03	Left	G56930 ⁴⁰	M56930 ⁴⁰	G56932 ⁴⁰	M56932 ⁴⁰
	Right	G56931 ⁴⁰	M56931 ⁴⁰	G56933 ⁴⁰	M56933 ⁴⁰

STARLET

81-84	All	 G44724 ⁹⁸	143059 ⁵¹		81440
-------	-----	--	------	------	----------------------	------	---	-------	------	------	------

SUPRA

87-91	All			143057 ⁵¹
-------	-----	---	------	------	------	------	---	------	------	----------------------	------

40 Complete Assembled Unit.



53 Strut Mount. Hardware from O.E. Part may need to be reused.

98 Notice: The level of difficulty to install this product is moderately high. Please review the installation instructions carefully before proceeding.

51 Strut Cushion for use with the Strut/Cartridge/Shocks.

54 Kit with Mount and Bearing. Hardware from O.E. Part may need to be reused.

APPLICATION GUIDE

Year	Fitment Notes										
		Ultra	ProGuard\Guardian\Classic	Max Control\LTV	Strut Cushion\Strut Mount	HiJackers\Load Carrier	Ultra	ProGuard\Guardian\Classic	Max Control\LTV	Strut Cushion\Strut Mount	HiJackers\Load Carrier

TOYOTA

TOYOTA

SUPRA (cont)

87-91	Exc. Electronic Adjustable Suspension	↓	G51197 ⁹	↓	G51193 ⁹	143057 ⁵¹
86	All	↓	143057 ⁵¹	↓	143057 ⁵¹
	Exc. Electronic Adjustable Suspension	↓	G51197 ⁹	143057 ⁵¹	↓	143057 ⁵¹
	Mfg. from 3/86; Exc. Electronic Adjustable Suspension	↓	143057 ⁵¹	↓	G51193 ⁹	143057 ⁵¹
	Mfg. to 3/86	↓	G44938 ⁹⁸	142437 ⁵³ 143057 ⁵¹	↓	69713	143057 ⁵¹

T100

93-98	4WD	↓	G63479	61552 81870	77479	↓	G63660	61582
	RWD	↓	G63903	61509 81541	77903	↓	G63173	61506	77492

TACOMA

16	4WD	↓	↓	G64006
	4WD, Exc. Off Road	↓	G51739	↓
14-15	4WD, Exc. Off Road	↓	G51739	↓	G64006
13-15	Base, Pre Runner, RWD	↓	↓	G63889
	Base, Pre Runner, RWD, Left	↓	G51853	↓
13	4WD	↓	G51739	↓
	4WD, Exc. Off Road	↓	↓	G64006
10-12	Base, Pre Runner, RWD, Left	↓	G51853	143383 ⁶⁸	↓
05-12	All	↓	143383 ⁶⁸	↓
	4WD	↓	143383 ⁶⁸	↓	G64006
	Base, Pre Runner, RWD	↓	143383 ⁶⁸	↓	G63889
	Pre Runner	↓	143383 ⁶⁸	↓	G64007
	X-Runner, Left	↓	G51739	143383 ⁶⁸	↓	G64004
	X-Runner, Right	↓	G51739	143383 ⁶⁸	↓	G64005
05-09	Base and X-Runner Models Left	↓	G51853	143383 ⁶⁸	↓
	Base and X-Runner Models Right	↓	G51854	143383 ⁶⁸	↓
01-04	S-Runner	↓	G63937	↓	G63689	61510
	S-Runner, Exc. Offroad Package	↓	61606 81908	77937	↓
98-04	4WD	↓	143325 ⁵³	↓
	Pre Runner, Left	↓	↓	61699
	Pre Runner, Right	↓	↓	61700
	Pre Runner, 4WD, RWD, Exc. HD Upgrade	↓	↓	G63494

9 See Ref. D for procedures to replace Elec Adj Susp with non-adj product.



53 Strut Mount. Hardware from O.E. Part may need to be reused.

98 Notice: The level of difficulty to install this product is moderately high. Please review the installation instructions carefully before proceeding.

51 Strut Cushion for use with the Strut/Cartridge/Shocks.

68 Strut Mount Kit. Hardware from O.E. Part may need to be reused.

APPLICATION GUIDE

Year	Fitment Notes										
		Ultra	ProGuard/ Guardian/ Classic	Max Control/ LTV	Strut Cushion/ Strut Mount	HiJackers/ Load Carrier	Ultra	ProGuard/ Guardian/ Classic	Max Control/ LTV	Strut Cushion/ Strut Mount	HiJackers/ Load Carrier

TOYOTA

TOYOTA

TACOMA (cont)

04	Base, 4WD	61510	77494
	Base, RWD	G63937	G63689	61500
	Base, RWD, Exc. Offroad Package	61606 81908	77937
	Pre Runner, 4WD, RWD	G51077	M51077	81871
	Pre Runner, RWD	77494
98-03	Pre Runner, 4WD, RWD	G51077	M51077	81871	77494
95-03	DLX, 4WD	61510
	DLX, RWD	G63937	G63689	61500
	DLX, RWD, Exc. Offroad Package	61606 81908	77937
98-00	Limited	61510
	SR5, 4WD	61500
95-97	4WD	G51077	M51077	143325 ⁵³	81871	77494
	4WD, Exc. HD Upgrade	G63494

TACOMA READYMOUNTS

		Front		Rear	
		Ultra Readymount	Guardian Readymount	Ultra Readymount	Guardian Readymount
05-12	Left	G57133 ⁴⁰	M57133 ⁴⁰
	Right	G57134 ⁴⁰	M57134 ⁴⁰
98-04	Pre Runner, 4WD, RWD	G57010 ⁴⁰
95-97	4WD	G57010 ⁴⁰

TERCEL

95-99	All	G55879	M55879	142307 ⁵³ 143059 ⁵¹	G51252	M51252	143064 ⁵¹
91-94	All	G55828	142307 ⁵³ 143059 ⁵¹	G55804	M55804	143064 ⁵¹
89-90	All	G44743 ⁹⁸	143059 ⁵¹
	Hatchback	G44743 ⁹⁸	143059 ⁵¹	G51180	143064 ⁵¹
	Sedan	G44743 ⁹⁸	143059 ⁵¹	G51180	143064 ⁵¹
87-88	All	143059 ⁵¹
	4WD, Wagon	G44800 ⁹⁸	143059 ⁵¹	81498
	Hatchback	G44743 ⁹⁸	143059 ⁵¹	G51180	143064 ⁵¹
	Sedan	G44743 ⁹⁸	143059 ⁵¹	G51180	143064 ⁵¹
88	Wagon	142247 ⁵³ 143059 ⁵¹	143057 ⁵¹
87	FWD	G44748	143059 ⁵¹
	FWD, Wagon	143059 ⁵¹	G55752
	Wagon	142247 ⁵³ 143059 ⁵¹	142249 ⁵³ 143057 ⁵¹



40 Complete Assembled Unit.

53 Strut Mount. Hardware from O.E. Part may need to be reused.

51 Strut Cushion for use with the Strut/Cartridge/Shocks.

98 Notice: The level of difficulty to install this product is moderately high. Please review the installation instructions carefully before proceeding.

APPLICATION GUIDE

Year	Fitment Notes										
		Ultra	ProGuard\ Guardian\ Classic	Max Control\ LTV	Strut Cushion\ Strut Mount	HiJackers\ Load Carrier	Ultra	ProGuard\ Guardian\ Classic	Max Control\ LTV	Strut Cushion\ Strut Mount	HiJackers\ Load Carrier

TOYOTA

TOYOTA

TERCEL (cont)

83-86	All	143059 ⁵¹	G55752	142249 ⁵³
	4WD, Wagon	G44800 ⁹⁸	143059 ⁵¹	G55752	81498	142249 ⁵³
	FWD	G44748	143059 ⁵¹	G55752	142249 ⁵³
	Wagon	142247 ⁵³ 143059 ⁵¹	G55752	143057 ⁵¹ 142249 ⁵³
80-82	All	143059 ⁵¹
	AL1(MfrBodyCode)	143059 ⁵¹	82013

TUNDRA

17	Exc. Air Suspension	143339 ⁵³
	w/ Off Road Package	G51855	G64038
13-16	All	143339 ⁵³
	w/ Off Road Package	G51855	143339 ⁵³	G64038
	w/Off Road Package	143339 ⁵³	143340 ⁹⁷
07-12	All	G51855	143339 ⁵³	G64038
	w/Off Road Package	G51855	143339 ⁵³	G64038	143340 ⁹⁷
00-06	All	G51477	M52805	143325 ⁵³	G63815	77815

TUNDRA READYMOUNTS

		Front		Rear	
		Ultra Readymount	Guardian Readymount	Ultra Readymount	Guardian Readymount
07-16	RWD; Exc. Extended Cab; Offroad and Long bed Left	G57123 ⁴⁰
	RWD; Exc. Extended Cab; Offroad and Long bed Right	G57124 ⁴⁰
07-12	Left	G57220 ⁴⁰
	Right	G57221 ⁴⁰
	RWD, Left	M57123 ⁴⁰
	RWD, Right	M57124 ⁴⁰
00-06	All	G57027 ⁴⁰

VAN

87-89	4WD	G63612	
	Coil(RearSpringType)	G81542	
	RWD	G63900	61529	
	RWD; Coil(RearSpringType)	G63484	
87-88	Leaf(RearSpringType)	G63907	61500 81147	77907	43048 ⁸ 49310 ⁷
84-86	All	G63900	61529	
	Coil(RearSpringType)	G63900	61529	81542	
	Leaf(RearSpringType)	G63900	61529	G63907	61500 81147	77907	43048 ⁸ 49310 ⁷

7 Pair Packs, air hose kit included.

40 Complete Assembled Unit.

53 Strut Mount. Hardware from O.E. Part may need to be reused.

98 Notice: The level of difficulty to install this product is moderately high. Please review the installation instructions carefully before proceeding.



Bold Type - New / Future Part

8 Pair Packs.

51 Strut Cushion for use with the Strut/Cartridge/Shocks.

67 Strut Mount Kit. Hardware from O.E. Part may need to be reused.

APPLICATION GUIDE

Year	Fitment Notes										
		Ultra	ProGuard\ Guardian\ Classic	Max Control\ LTV	Strut Cushion\ Strut Mount	HiJackers\ Load Carrier	Ultra	ProGuard\ Guardian\ Classic	Max Control\ LTV	Strut Cushion\ Strut Mount	HiJackers\ Load Carrier

TOYOTA

TOYOTA

VAN (cont)

84-86	RWD; Coil(RearSpringType)	⌋ ⊖	G63900	61529	⌋ ⊖	G63484
-------	---------------------------	--------	--------	-------	------	------	------	--------	--------	------	------	------	------

VAN WAGON

88	All		⊖	43048 ⁸ 49310 ⁷	
	4WD	⌋ ⊖	G63612	⊖	43048 ⁸ 49310 ⁷	
	Leaf(RearSpringType)		⊖	61500	77907	43048 ⁸ 49310 ⁷	
	Leaf(RearSpringType) Leaf (RearSpringType)		⊖	G63907	43048 ⁸ 49310 ⁷	
	RWD	⌋ ⊖	G63900	61529	⊖	43048 ⁸ 49310 ⁷	
	RWD; Coil(RearSpringType)		⌋ ⊖	G63484	81542	43048 ⁸ 49310 ⁷
	RWD; Leaf(RearSpringType)		⊖	81147	43048 ⁸ 49310 ⁷

VENZA

09-11	All	⌋	143402⁶⁸	⌋
-------	-----	---	------	------	------	----------------------------	------	---	------	------	------	------	------

VENZA READYMOUNTS

		Front		Rear	
		Ultra Readymount	Guardian Readymount	Ultra Readymount	Guardian Readymount
09-14	Left Wagon	G57676⁴⁰	G57678⁴⁰
	Right Wagon	G57677⁴⁰	G57679⁴⁰

YARIS

12-14	All	⌋	143417⁶⁸	⌋ ⊖	70055
07-11	Left	⌋	G56842	143417⁶⁸	⌋ ⊖	70055 G51783
	Right	⌋	G56843	143417⁶⁸	⌋ ⊖	70055 G51783
06	All	⌋	143417⁶⁸	⌋ ⊖	70055

YARIS READYMOUNTS

		Front		Rear	
		Ultra Readymount	Guardian Readymount	Ultra Readymount	Guardian Readymount
07-11	Left	G57353⁴⁰
	Right	G57354⁴⁰

TRIUMPH

TRIUMPH

SPITFIRE

63-80	All		⊖	82139
-------	-----	--	------	------	------	------	------	---	------	-------	------	------	------

VOLKSWAGEN

VOLKSWAGEN

BEETLE

98-10	All	⌋	G56606	M56606	142651 ⁵⁴	⌋ ⊖	69945	81934	142654 ⁵³
67-77	All	⊖	82005	⊖	82001	49307 ⁷
66	All		⊖	82001	49307 ⁷
	1200	⊖	82001	⊖	82001	49307 ⁷
	1300 and 1500	⌋	82005	⊖	82001	49307 ⁷
52-65	All	⊖	82001	⊖	82001	49307 ⁷

7 Pair Packs, air hose kit included.

40 Complete Assembled Unit.

54 Kit with Mount and Bearing. Hardware from O.E. Part may need to be reused.

8 Pair Packs.

53 Strut Mount. Hardware from O.E. Part may need to be reused.

68 Strut Mount Kit. Hardware from O.E. Part may need to be reused.

APPLICATION GUIDE

Year	Fitment Notes	Front					Rear				
		Ultra	ProGuard\ Guardian\ Classic	Max Control\ LTV	Strut Cushion\ Strut Mount	HiJackers\ Load Carrier	Ultra	ProGuard\ Guardian\ Classic	Max Control\ LTV	Strut Cushion\ Strut Mount	HiJackers\ Load Carrier

VOLKSWAGEN

VOLKSWAGEN

BEETLE READYMOUNTS		Front		Rear	
		Ultra Readymount	Guardian Readymount	Ultra Readymount	Guardian Readymount
12-13	All	G57277 ⁴⁰
	4 Cyl	G57371 ⁴⁰
07-10	All	M57039 ⁴⁰
	GAS	G57039 ⁴⁰	M57039 ⁴⁰
98-06	All	G57039 ⁴⁰	M57039 ⁴⁰

BEETLE STEERING STABILIZERS		Front	Rear
59-77	All	14004

BORA

09	All	G56899	G51799
06-08	All	G56899	143552 ⁵⁴	G51799

CABRIO

95-02	All	G55989
-------	-----	--------	------	------	------	------	------	------	------	------	------

CABRIOLET

85-93	All	G44763 ⁹⁸	143058 ⁵¹	G51006
-------	-----	----------------------	------	------	----------------------	------	--------	------	------	------	------

CC

09-12	All	143344 ⁵³	143345 ⁵³
-------	-----	------	------	------	----------------------	------	------	------	------	----------------------	------

CORRADO

93-94	VR6	G55989
90-92	All	143061 ⁵¹	143063 ⁵¹
	Rebuildable Front Struts	G44774 ⁹⁸	143061 ⁵¹	143063 ⁵¹
92	VR6	G55989	143061 ⁵¹	143063 ⁵¹

EOS

12-14	All	G56899	G51799
12-13	Exc. Electronic Suspension	G56899	70061 G51799
11	All	G56899	143344 ⁵³	G51799	143345 ⁵³
	Exc. Electronic Suspension	G56899	143344 ⁵³	70061 G51799	143345 ⁵³
07-10	All	143344 ⁵³	143345 ⁵³
	Exc. Electronic Suspension	143344 ⁵³	70061	143345 ⁵³

EOS READYMOUNTS		Front		Rear	
		Ultra Readymount	Guardian Readymount	Ultra Readymount	Guardian Readymount
07-11	All	G57277 ⁴⁰
	4 Cyl	G57371 ⁴⁰

40 Complete Assembled Unit.

53 Strut Mount. Hardware from O.E. Part may need to be reused.

98 Notice: The level of difficulty to install this product is moderately high. Please review the installation instructions carefully before proceeding.

Bold Type - New / Future Part

51 Strut Cushion for use with the Strut/Cartridge/Shocks.

54 Kit with Mount and Bearing. Hardware from O.E. Part may need to be reused.

APPLICATION GUIDE

Year	Fitment Notes	Front					Rear				
		Ultra	ProGuard\Guardian\Classic	Max Control\LTV	Strut Cushion\Strut Mount	HiJackers\Load Carrier	Ultra	ProGuard\Guardian\Classic	Max Control\LTV	Strut Cushion\Strut Mount	HiJackers\Load Carrier

VOLKSWAGEN FASTBACK

VOLKSWAGEN

69-73	All	○	82001	○	82001	49307 ⁷
66-68	All	○	82001	○	82001

FOX

87-93	All	↓	G44902 ⁹⁸	143057 ⁵¹	↓	G51030 ⁵⁰	143063 ⁵¹
-------	-----	---	----------------------	------	------	----------------------	------	---	----------------------	------	------	----------------------	------

GOLF

12-14	Exc. R Model	↓	G56899	↓	G51799
10-11	All	↓	143344 ⁵³	↓	143345 ⁵³
11	Exc. R Model	↓	G56899	143344 ⁵³	↓	G51799	143345 ⁵³
99-06	A4(MfrBodyCode)	↓	G56606	M56606	142651 ⁵⁴	↓	69945	81934	142654 ⁵³
95-98	VR6 from Chassis # 08774; w/o 2.0L 4Cyl. L	↓	G55989	143058 ⁵¹	↓	G51022	M51022	142573 ⁶⁷ 143063 ⁵¹
93-98	All	↓	143058 ⁵¹	↓	G51022	M51022	142573 ⁶⁷ 143063 ⁵¹
	VR6 from Chassis # 08774	↓	G55991	M55991	143058 ⁵¹	↓	G51022	M51022	142573 ⁶⁷ 143063 ⁵¹
93-96	Up to Chassis # 08773	↓	G55990	M55990	143058 ⁵¹	↓	G51022	M51022	142573 ⁶⁷ 143063 ⁵¹
85-92	All	↓	143058 ⁵¹	↓	142573 ⁶⁷ 143063 ⁵¹
	Rebuildable Front Struts	↓	G44774 ⁹⁸	143058 ⁵¹	↓	G51022	M51022	142573 ⁶⁷ 143063 ⁵¹
	Sealed Struts	↓	G55990	M55990	143058 ⁵¹	↓	142573 ⁶⁷ 143063 ⁵¹

GOLF READYMOUNTS

		Front		Rear	
		Ultra Readymount	Guardian Readymount	Ultra Readymount	Guardian Readymount
10-12	All	G57277 ⁴⁰
	4 Cyl	G57371 ⁴⁰
99-06	All	G57039 ⁴⁰	M57039 ⁴⁰
97-98	All	G57006 ⁴⁰	G57024 ⁴⁰	M57024 ⁴⁰
85-96	All	G57005 ⁴⁰	G57024 ⁴⁰	M57024 ⁴⁰

GTI

06-14	All	↓	G56899	143344 ⁵³	↓	G51799	143345 ⁵³
-------	-----	---	--------	------	------	----------------------	------	---	--------	------	------	----------------------	------

GTI READYMOUNTS

		Front		Rear	
		Ultra Readymount	Guardian Readymount	Ultra Readymount	Guardian Readymount
10-14	All	G57680 ⁴⁰

JETTA

15-17	All	↓	143344 ⁵³	↓	143345 ⁵³
12-14	All	↓	M56899	143344 ⁵³	↓	143345 ⁵³
	Wagon	↓	G56899	M56899	143344 ⁵³	↓	143345 ⁵³

7 Pair Packs, air hose kit included.

50 Bellows Kit No. 141242 is recommended for use to protect piston rod from potentially harmful road debris.

53 Strut Mount. Hardware from O.E. Part may need to be reused.

67 Strut Mount Kit. Hardware from O.E. Part may need to be reused.



40 Complete Assembled Unit.

51 Strut Cushion for use with the Strut/Cartridge/Shocks.

54 Kit with Mount and Bearing. Hardware from O.E. Part may need to be reused.

98 Notice: The level of difficulty to install this product is moderately high. Please review the installation instructions carefully before proceeding.

APPLICATION GUIDE

Year	Fitment Notes										
		Ultra	ProGuard/ Guardian/ Classic	Max Control/ LTV	Strut Cushion/ Strut Mount	HiJackers/ Load Carrier	Ultra	ProGuard/ Guardian/ Classic	Max Control/ LTV	Strut Cushion/ Strut Mount	HiJackers/ Load Carrier

VOLKSWAGEN

JETTA (cont)

10-11	All	G56899	M56899	143344 ⁵³	143345 ⁵³
09	All	G56899	M56899	143344 ⁵³	G51799	143345 ⁵³
06-08	All	G56899	M56899	143344 ⁵³ 143552 ⁵⁴	G51799	143345 ⁵³
04-05	Wagon	M56899
01-05	Sedan	G56606	M56606	142651 ⁵⁴	69945	81934	142654 ⁵³
99-00	All	G56606	M56606	142651 ⁵⁴	69945	142654 ⁵³
96-98	2.0L & 1.9L from Chassis # 08774	G55989	143058 ⁵¹	G51022	M51022	142573 ⁵⁷ 143063 ⁵¹
93-98	VR6 from Chassis # 08774	G55991	M55991	143058 ⁵¹	G51022	M51022	142573 ⁵⁷ 143063 ⁵¹
	VR6 up to Chassis # 08773	G55990	M55990	143058 ⁵¹	G51022	M51022	142573 ⁵⁷ 143063 ⁵¹
85-98	All	143058 ⁵¹	G51022	M51022	142573 ⁵⁷ 143063 ⁵¹
85-92	Rebuildable Front Struts	G44774 ⁹⁸	143058 ⁵¹	G51022	M51022	142573 ⁵⁷ 143063 ⁵¹
	Sealed Struts	G55990	M55990	143058 ⁵¹	G51022	M51022	142573 ⁵⁷ 143063 ⁵¹
80-84	All	G44763 ⁹⁸	143058 ⁵¹	G51006

VOLKSWAGEN

JETTA READYMOUNTS

		Front		Rear	
		Ultra Readymount	Guardian Readymount	Ultra Readymount	Guardian Readymount
13-14	All	M57156 ⁴⁰
06-12	All	G57277 ⁴⁰	M57156 ⁴⁰
	Sedan; Exc. GLI	G57156 ⁴⁰	M57156 ⁴⁰
08-11	Wagon	G57156 ⁴⁰	M57156 ⁴⁰
06	Wagon	G57156 ⁴⁰	M57156 ⁴⁰
05	All	G57039 ⁴⁰
99-04	All	G57039 ⁴⁰	M57039 ⁴⁰
97-98	All	G57006 ⁴⁰	G57024 ⁴⁰	M57024 ⁴⁰
85-96	All	G57005 ⁴⁰	G57024 ⁴⁰	M57024 ⁴⁰

KARMANN GHIA

67-74	All	82005	82001
-------	-----	------	-------	------	------	------	------	-------	------	------	------

PASSAT

10	All	143344 ⁵³	143345 ⁵³
06-09	All	G56899	142652 ⁵⁴ 143344 ⁵³	G51799	143345 ⁵³
02-05	All	M51743	142652 ⁵⁴
	Exc. VIN# 3B300001 through VIN# 3B300000	G511057	M51743	142652 ⁵⁴
	AWD, Exc. VIN# 3B300001 through VIN# 3B300000	M51743	142652 ⁵⁴	G51742
	FWD	M51743	142652 ⁵⁴	143380 ⁵³

40 Complete Assembled Unit.

53 Strut Mount. Hardware from O.E. Part may need to be reused.

67 Strut Mount Kit. Hardware from O.E. Part may need to be reused.



51 Strut Cushion for use with the Strut/Cartridge/Shocks.

54 Kit with Mount and Bearing. Hardware from O.E. Part may need to be reused.

98 Notice: The level of difficulty to install this product is moderately high. Please review the installation instructions carefully before proceeding.

Bold Type - New / Future Part

APPLICATION GUIDE

Year	Fitment Notes										
		Ultra	ProGuard/ Guardian/ Classic	Max Control/ LTV	Strut Cushion/ Strut Mount	HiJackers/ Load Carrier	Ultra	ProGuard/ Guardian/ Classic	Max Control/ LTV	Strut Cushion/ Strut Mount	HiJackers/ Load Carrier

VOLKSWAGEN

PASSAT (cont)

VOLKSWAGEN

02-05	FWD, From VIN# 3B300001 through VIN# 3B300000	M51743	142652 ⁵⁴ 143058 ⁵¹	69946
01	All	M51743	142652 ⁵⁴ 143058 ⁵¹	143063 ⁵¹
	Exc. VIN# 3B300001 through VIN# 3B300000	G511057	M51743	142652 ⁵⁴ 143058 ⁵¹	143063 ⁵¹
	AWD, Exc. VIN# 3B300001 through VIN# 3B300000	M51743	142652 ⁵⁴ 143058 ⁵¹	G51742	143063 ⁵¹
	FWD, From VIN# 3B300001 through VIN# 3B300000	G51097	M51743	142652 ⁵⁴ 143058 ⁵¹	69946	143063 ⁵¹
99-00	AWD, Exc. VIN# 3B300001 through VIN# 3B300000	142652 ⁵⁴ 143058 ⁵¹	G51742	143063 ⁵¹
98-00	All	142652 ⁵⁴ 143058 ⁵¹	143063 ⁵¹
	FWD, From VIN# 3B300001 through VIN# 3B300000	G51097	142652 ⁵⁴ 143058 ⁵¹	69946	143063 ⁵¹
98	AWD; Exc. VIN# 3B300001 through VIN# 3B300000	142652 ⁵⁴ 143058 ⁵¹	G51742	143063 ⁵¹
90-97	All	143058 ⁵¹
	Rebuildable O.E. Front Struts	G44986 ⁹⁸	143058 ⁵¹	G51033

PASSAT READYMOUNTS

		Front		Rear	
		Ultra Readymount	Guardian Readymount	Ultra Readymount	Guardian Readymount
06-09	2.0T	G57156 ⁴⁰
01-05	Left	G57135 ⁴⁰	M57135 ⁴⁰
	Right	G57136 ⁴⁰	M57136 ⁴⁰

QUANTUM

82-88	All	G44902 ⁹⁸	142195 ⁵³ 143057 ⁵¹	143063 ⁵¹
-------	-----	----------------------	-------	-------	--	-------	-------	-------	----------------------	-------

R32

08	All	143344 ⁵³	143345 ⁵³
----	-----	-------	-------	-------	----------------------	-------	-------	-------	----------------------	-------

RABBIT

06-09	All	G56899	143344 ⁵³	G51799	143345 ⁵³
75-84	All	G44763 ⁹⁸	143058 ⁵¹	G51006

RABBIT PICKUP

80-83	All	G44763 ⁹⁸	143058 ⁵¹
-------	-----	----------------------	-------	-------	----------------------	-------	-------	-------	-------	-------	-------

ROUTAN

09-11	Exc. Self-Leveling Suspension	G52131	143463 ⁹⁸	G64042
11	All	143463 ⁹⁸	G64042
09-10	All	143463 ⁹⁸

40 Complete Assembled Unit.

53 Strut Mount. Hardware from O.E. Part may need to be reused.





68 Strut Mount Kit. Hardware from O.E. Part may need to be reused.

51 Strut Cushion for use with the Strut/Cartridge/Shocks.

54 Kit with Mount and Bearing. Hardware from O.E. Part may need to be reused.

98 Notice: The level of difficulty to install this product is moderately high. Please review the installation instructions carefully before proceeding.

APPLICATION GUIDE



Year	Fitment Notes										
		 Ultra	ProGuard\ Guardian\ Classic	Max Control\ LTV	Strut Cushion\ Strut Mount	HiJackers\ Load Carrier	 Ultra	ProGuard\ Guardian\ Classic	Max Control\ LTV	Strut Cushion\ Strut Mount	HiJackers\ Load Carrier

VOLKSWAGEN



VOLKSWAGEN

ROUTAN READYMOUNTS		Front		Rear	
		Ultra Readymount	Guardian Readymount	Ultra Readymount	Guardian Readymount
11-12	All	M57206 ⁴⁰
09-10	All	G57206 ⁴⁰	M57206 ⁴⁰













SCIROCCO

75-89	All	 G44763 ⁹⁸	143058 ⁵¹	 G51006	143063 ⁵¹
-------	-----	--	------	------	----------------------	------	--	------	------	----------------------	------

SQUAREBACK

66-73	All		82001		82001	49307 ⁷
-------	-----	--	-------	------	------	------	--	-------	------	------	--------------------



SUPER BEETLE

74-79	All	 G44850 ⁹⁸	82005	143057 ⁵¹		82001	49307 ⁷
73	All		82005	143057 ⁵¹	
	2 Bolt Flange-Type Lower Mount	 G44850 ⁹⁸	82005	143057 ⁵¹	
	3 Bolt Flange-Type Lower Mount	 G44862 ⁹⁸	82005	143057 ⁵¹		82001	49307 ⁷
71-72	All		143057 ⁵¹	
	3 Bolt Flange-Type Lower Mount	 G44862 ⁹⁸	143057 ⁵¹		82001	49307 ⁷

SUPER BEETLE STEERING STABILIZERS

		Front	Rear
71-75	All	14005





THING

73-74	All		82005		82001	49307 ⁷
-------	-----	--	-------	------	------	------	--	-------	------	------	--------------------





THING STEERING STABILIZERS

		Front	Rear
73-74	All	14004









TIGUAN

11	All	 G52301	143344 ⁵³	 G51993
09-10	All	 G52301	143344 ⁵³	 G51993	143345 ⁵³



TOUAREG

04-09	Left	 G52348	 G51928
	Right	 G52349	 G51928

TRANSPORTER

10-14	All		 70105
70-79	All		82031		82032
68-69	All		82001		82032
56-67	All		82001		82001

VANAGON

80-91	RWD	 69861	 69858
-------	-----	---	------	------	------	------	---	------	------	------	------

7 Pair Packs, air hose kit included.

51 Strut Cushion for use with the Strut/Cartridge/Shocks.



98 Notice: The level of difficulty to install this product is moderately high. Please review the installation instructions carefully before proceeding.

Bold Type - New / Future Part

40 Complete Assembled Unit.

53 Strut Mount. Hardware from O.E. Part may need to be reused.

APPLICATION GUIDE

Year	Fitment Notes										
		Ultra	ProGuard/ Guardian/ Classic	Max Control/ LTV	Strut Cushion/ Strut Mount	HiJackers/ Load Carrier	Ultra	ProGuard/ Guardian/ Classic	Max Control/ LTV	Strut Cushion/ Strut Mount	HiJackers/ Load Carrier

VOLKSWAGEN

VANAGON (cont)

86-89	4WD	○ G63454	61539 81581	49215 ⁷
-------	-----	------	------	------	------	------	----------	----------------	------	------	------	--------------------

VOLKSWAGEN

VOLVO

122

VOLVO

59-68	All		82026	81270	49105 ⁷
-------	-----	--	------	-------	------	------	--	------	-------	------	------	------	--------------------

142 / 144 / 145 / 164

75	All	⊖	69600	81494	⊖	69787 ³¹
68-74	All	⊖	69600	81494	⊖

240 / 242 / 244 / 245 / 262 / 264 / 265

75-93	All		G44856 ⁹⁸	143057 ⁵¹	⊖	69787 ³¹
-------	-----	--	----------------------	------	------	----------------------	------	---	---------------------	------	------	------	------

544

59-65	All		82123
-------	-----	--	------	------	------	------	--	------	-------	------	------	------	------

740 / 745 / 760 / 780

84-92	All		143058 ⁵¹
	Mfg. from 5/84; Exc. Hydraulic Self Leveling System		G44941 ⁹⁸	143058 ⁵¹	⊖	69805 ³²
89	Exc. Hydraulic Self Leveling System		G44941 ⁹⁸	143058 ⁵¹

850

93-97	Exc. Hydraulic Self Leveling System		G56612	M56612	143191 ⁵³		69901	142941 ⁵³
-------	-------------------------------------	--	--------	--------	------	----------------------	------	--	-------	------	------	----------------------	------

850 READYMOUNTS

		Front		Rear	
		Ultra Readymount	Guardian Readymount	Ultra Readymount	Guardian Readymount
93-97	Exc. Hydraulic Self Leveling System	G57040 ⁴⁰	M57040⁴⁰

940

91-95	Exc. Hydraulic Self Leveling System		G44941 ⁹⁸
	Exc. Hydraulic Self Leveling System		143058 ⁵¹	⊖	69805 ³²

960

96-97	Mfg. from 10/94; Exc. Hydraulic Self Leveling System		⊖	69417 ³²
94-95	Mfg. from 10/94; Exc. Hydraulic Self Leveling System		143058 ⁵¹	⊖	69417 ³²
92-95	All		143058 ⁵¹
95	Mfg. to 10/94; Exc. Hydraulic Self Leveling System		G44941 ⁹⁸	143058 ⁵¹
92-94	Mfg. to 10/94; Exc. Hydraulic Self Leveling System		G44941 ⁹⁸	143058 ⁵¹	⊖	69805 ³²

1800

61-73	All		82026
-------	-----	--	------	-------	------	------	------	--	------	------	------	------	------

7 Pair Packs, air hose kit included.

32 With Nivomat Self-Leveling Suspension replace spring with Volvo No. 1359710 or 1273977.

51 Strut Cushion for use with the Strut/Cartridge/Shocks.



98 Notice: The level of difficulty to install this product is moderately high. Please review the installation instructions carefully before proceeding.

31 With Nivomat Self-Leveling Suspension replace spring with Volvo No. 1229052/4.

40 Complete Assembled Unit.

53 Strut Mount. Hardware from O.E. Part may need to be reused.

APPLICATION GUIDE

Year	Fitment Notes										
		Ultra	ProGuard\ Guardian\ Classic	Max Control\ LTV	Strut Cushion\ Strut Mount	HiJackers\ Load Carrier	Ultra	ProGuard\ Guardian\ Classic	Max Control\ LTV	Strut Cushion\ Strut Mount	HiJackers\ Load Carrier

VOLVO

C30

07-13	Left	G52274	70056
	Right	G52275	70056

C70

08-13	Left	G52274
	Right	G52275
06-07	All	143191 ⁵³
98-04	All	G56612	M56612	143191 ⁵³	69901	142941 ⁵³

C70 READYMOUNTS

		Front		Rear	
		Ultra Readymount	Guardian Readymount	Ultra Readymount	Guardian Readymount
98-04	All	G57040 ⁴⁰	M57040 ⁴⁰

DL

84	Exc. Hydraulic Self Leveling System	G44856 ⁶⁸	69787 ³¹
----	-------------------------------------	----------------------	------	------	------	------	---------------------	------	------	------	------

GLE

84	Exc. Hydraulic Self Leveling System	G44856 ⁶⁸	69787 ³¹
----	-------------------------------------	----------------------	------	------	------	------	---------------------	------	------	------	------

PV 444

49	All	82123
----	-----	------	------	------	------	------	-------	------	------	------	------

S40

05-12	Left	G52274	70056
	Right	G52275	70056
04	All	143421 ⁵⁴	70056	143422 ⁵⁷
	Left Mfg. from 04/00	G52079	143421 ⁵⁴	70056	143422 ⁵⁷
	Mfg. from 04/00	143421 ⁵⁴	G51841 70056	143422 ⁵⁷
	Mfg. from 04/00 Right	G52080	143421 ⁵⁴	70056	143422 ⁵⁷
	T5, Left	G52274	143421 ⁵⁴	70056	143422 ⁵⁷
	T5, Right Mfg. to 04/00	G52275	143421 ⁵⁴	70056	143422 ⁵⁷
01-03	Left	G52079	143421 ⁵⁴	143422 ⁵⁷
	Right	G52080	143421 ⁵⁴	143422 ⁵⁷
	Mfg. from 04/00	G51841
00	All	143421 ⁵⁴	143422 ⁵⁷
	Left Mfg. from 04/00	G52079	143421 ⁵⁴	143422 ⁵⁷

31 With Nivomat Self-Leveling Suspension replace spring with Volvo No. 1229052/4.

53 Strut Mount. Hardware from O.E. Part may need to be reused.



67 Strut Mount Kit. Hardware from O.E. Part may need to be reused.

40 Complete Assembled Unit.

54 Kit with Mount and Bearing. Hardware from O.E. Part may need to be reused.

98 Notice: The level of difficulty to install this product is moderately high. Please review the installation instructions carefully before proceeding.





APPLICATION GUIDE

Year	Fitment Notes										
		Ultra	ProGuard\ Guardian\ Classic	Max Control\ LTV	Strut Cushion\ Strut Mount	HiJackers\ Load Carrier	Ultra	ProGuard\ Guardian\ Classic	Max Control\ LTV	Strut Cushion\ Strut Mount	HiJackers\ Load Carrier











VOLVO

VOLVO

S40 (cont)

00	Right Mfg. from 04/00	 G52080	143421 ⁵⁴		143422 ⁶⁷
	Mfg. from 04/00		143421 ⁵⁴	 G51841	143422 ⁶⁷



S60

08-09	All	 G56802	
	FWD	 G56802	 70040
04-07	All	 G56802	143191 ⁵³	
	FWD	 G56802	143191 ⁵³	 70040
01-03	All	 G56802	143191 ⁵³	 70040

S60 READYMOUNTS

		Front		Rear	
		Ultra Readymount	Guardian Readymount	Ultra Readymount	Guardian Readymount
01-06	FWD	G57171 ⁴⁰





S70

98-00	All	 G56612	M56612	143191 ⁵³	 69901	142941 ⁵³
-------	-----	---	--------	------	----------------------	------	--	------	------	----------------------	------

S70 READYMOUNTS

		Front		Rear	
		Ultra Readymount	Guardian Readymount	Ultra Readymount	Guardian Readymount
98-00	All	G57040 ⁴⁰	M57040 ⁴⁰

S80

99-06	All	 G56802	 70040
	Exc. Nivomat Rear Suspension	 G56802	143191 ⁵³	 70040







S80 READYMOUNTS

		Front		Rear	
		Ultra Readymount	Guardian Readymount	Ultra Readymount	Guardian Readymount
06-15	Left	G57337 ⁴⁰
	Right	G57338 ⁴⁰
04-05	Left	G57335 ⁴⁰
	Right	G57336 ⁴⁰
99-03	All	G57171 ⁴⁰
	Left	G57335 ⁴⁰
	Right	G57336 ⁴⁰

S90

97-98	Mfg. from 5/97; Exc. Hydraulic Self Leveling System	 69417 ³²
-------	---	------	------	------	------	------	---	------	------	------	------

V40

00-04	All		143421 ⁵⁴		143422 ⁶⁷
	Mfg. from 04/00 Left	 G52079	143421 ⁵⁴	 G51841	143422 ⁶⁷
	Mfg. from 04/00 Right	 G52080	143421 ⁵⁴	 G51841	143422 ⁶⁷

32 With Nivomat Self-Leveling Suspension replace spring with Volvo No. 1359710 or 1273977.

53 Strut Mount. Hardware from O.E. Part may need to be reused.

67 Strut Mount Kit. Hardware from O.E. Part may need to be reused.

40 Complete Assembled Unit.

54 Kit with Mount and Bearing. Hardware from O.E. Part may need to be reused.

APPLICATION GUIDE

Year	Fitment Notes	Front					Rear				
		Ultra	ProGuard\ Guardian\ Classic	Max Control\ LTV	Strut Cushion\ Strut Mount	HiJackers\ Load Carrier	Ultra	ProGuard\ Guardian\ Classic	Max Control\ LTV	Strut Cushion\ Strut Mount	HiJackers\ Load Carrier

VOLVO

VOLVO

V50

05-11	Left	↓	G52274	↓	70056
	Right	↓	G52275	↓	70056

V70

01-07	Exc. Electronic Suspension / Nivomat	↓	↓	70040
	Exc. XC70, XC Cross Country and Exc. Auto-Leveling System	↓	143191 ⁵³	↓
00-06	Mfg. from 3/00 and Exc. XC70, XC Cross Country and Auto Leveling	↓	G56802	↓
98-00	Exc. XC70, XC Cross Country and Exc. Auto-Leveling System	↓	143191 ⁵³	↓	142941 ⁵³
	Mfg. to 3/00 and Exc. XC70, XC Cross Country	↓	G56612	M56612	↓	69901

V70 READYMOUNTS

		Front		Rear	
		Ultra Readymount	Guardian Readymount	Ultra Readymount	Guardian Readymount
00-07	All	G57171 ⁴⁰
00	Mfg. to 3/00 and Exc. XC70, XC Cross Country	G57040 ⁴⁰	M57040 ⁴⁰
98-99	Mfg. to 3/00 and Exc. XC70, XC Cross Country	G57040 ⁴⁰	M57040 ⁴⁰

V90

97-98	Mfg. from 5/97; Exc. Hydraulic Self Leveling System	↓	↓	69417 ³²
-------	---	---	------	------	------	------	------	---	---------------------	------	------	------	------

XC90

07-08	All	↓	G52295	↓
04-06	All	↓	G52295	143191 ⁵³	↓
03	All	↓	G52295	↓
	AWD	↓	G52295	143191 ⁵³	↓

32 With Nivomat Self-Leveling Suspension replace spring with Volvo No. 1359710 or 1273977.

40 Complete Assembled Unit.

53 Strut Mount. Hardware from O.E. Part may need to be reused.

Bold Type - New / Future Part

Numerical listing

Shock	POP	Alternative No.	MTG Acc. Supplied
Pos.	Year	Application	

Steering Stabilizer

6801SE	A	500498,142037
F	83-94	CHEVROLET BLAZER, S MODELS All Single System Steering Stabilizer; with a factory mounting hole in the steering linkage.
F	79-82	LUV PICKUP 4WD Single System Steering Stabilizer; with a factory mounting hole in the steering linkage.
F	83-04	S10 4WD Single System Steering Stabilizer; with a factory mounting hole in the steering linkage.
F	83-91	GMC S15 JIMMY All Single System Steering Stabilizer; with a factory mounting hole in the steering linkage.
F	91-93	SONOMA / S15 All Single System Steering Stabilizer; with a factory mounting hole in the steering linkage.
F	82-90	SONOMA / S15 RWD Single System Steering Stabilizer; with a factory mounting hole in the steering linkage.
F	91	SYCLONE All Single System Steering Stabilizer; with a factory mounting hole in the steering linkage.
F	84-00	JEEP CHEROKEE All Single System Steering Stabilizer; with a factory mounting hole in the steering linkage.
F	86-92	COMANCHE All Single System Steering Stabilizer; with a factory mounting hole in the steering linkage.
F	97-06	WRANGLER TJ (MfrBodyCode) Single System Steering Stabilizer; with a factory mounting hole in the steering linkage.
F	94-95	WRANGLER YJ (MfrBodyCode) Single System Steering Stabilizer; with a factory mounting hole in the steering linkage.
F	87-92	WRANGLER YJ (MfrBodyCode) Single System Steering Stabilizer; with a factory mounting hole in the steering linkage.

6802SE	C	141998
F	79-86	CHEVROLET BLAZER 4WD Dual System Steering Stabilizer
F	79-84	BLAZER RWD Dual System Steering Stabilizer
F	50-58	PICKUP Truck Single System Steering Stabilizer; with I-Beam Axle
F	73-86	PICKUP 1/2 TON, C10 All Single System Steering Stabilizer
F	67-86	PICKUP 1/2 TON, K10 All Dual System Steering Stabilizer
F	87	PICKUP 1/2 TON, R10 All Single System Steering Stabilizer
F	87	PICKUP 1/2 TON, V10 All Dual System Steering Stabilizer
F	82-86	PICKUP 1 TON, C30 6.2L 8Cyl V (379) Single System Steering Stabilizer; with Cooler
F	73-86	PICKUP 1 TON, C30 4.8L 6Cyl L (292) Single System Steering Stabilizer; with Cooler
F	73-86	PICKUP 1 TON, C30 5.7L 8Cyl V (350) Single System Steering Stabilizer; with Cooler
F	78-80	PICKUP 1 TON, C30 4.1L 6Cyl L (250) Single System Steering Stabilizer; with Cooler
F	78-79	PICKUP 1 TON, C30 5.0L 8Cyl V (305) Single System Steering Stabilizer; with Cooler
F	76-79	PICKUP 1 TON, C30 6.6L 8Cyl V (400) Single System Steering Stabilizer; with Cooler
F	73-75	PICKUP 1 TON, C30 4.1L 6Cyl L (250) Single System Steering Stabilizer; with Cooler
F	73	PICKUP 1 TON, C30 5.0L 8Cyl V (307) Single System Steering Stabilizer; with Cooler
F	61-72	PICKUP 1 TON, C30 All Single System Steering Stabilizer
F	77-86	PICKUP 1 TON, K30 All Dual System Steering Stabilizer

Steering Stabilizer

Shock	POP	Alternative No.	MTG Acc. Supplied
Pos.	Year	Application	

6802SE	C	-continued	141998
F	87-88	PICKUP 1 TON, R30 4.8L 6Cyl L (292) Single System Steering Stabilizer; with Cooler	
F	87-88	PICKUP 1 TON, R30 5.7L 8Cyl V (350) Single System Steering Stabilizer; with Cooler	
F	87-88	PICKUP 1 TON, R30 6.2L 8Cyl V (379) Single System Steering Stabilizer; with Cooler	
F	89-91	PICKUP 1 TON, R3500 5.7L 8Cyl V (350) Single System Steering Stabilizer; with Cooler	
F	63-86	PICKUP 3/4 TON, C20 All Single System Steering Stabilizer	
F	67-86	PICKUP 3/4 TON, K20 All Dual System Steering Stabilizer	
F	87-88	PICKUP 3/4 TON, R20 All Single System Steering Stabilizer	
F	89	PICKUP 3/4 TON, R2500 All Single System Steering Stabilizer	
F	87	PICKUP 3/4 TON, V20 All Dual System Steering Stabilizer	
F	82-03	S10 RWD Single System Steering Stabilizer	
F	68-86	SUBURBAN 1/2 TON, C10 All Single System Steering Stabilizer	
F	68-86	SUBURBAN 1/2 TON, K10 All Dual System Steering Stabilizer	
F	87-88	SUBURBAN 1/2 TON, R10 All Dual System Steering Stabilizer	
F	89-91	SUBURBAN 1/2 TON, R1500 All Single System Steering Stabilizer	
F	68-86	SUBURBAN 3/4 TON, C20 All Single System Steering Stabilizer	
F	68-86	SUBURBAN 3/4 TON, K20 All Dual System Steering Stabilizer	
F	87-88	SUBURBAN 3/4 TON, R20 All Single System Steering Stabilizer	
F	89-91	SUBURBAN 3/4 TON, R2500 All Single System Steering Stabilizer	
F	87-88	SUBURBAN 3/4 TON, V20 All Dual System Steering Stabilizer	
F	89-91	SUBURBAN 3/4 TON, V2500 All Dual System Steering Stabilizer	
F	70-95	VAN 1/2 TON, G / EXPRESS All Single System Steering Stabilizer	
F	71-95	VAN 1 TON, G / EXPRESS All Single System Steering Stabilizer	
F	78-95	VAN 3/4 TON, G / EXPRESS All Single System Steering Stabilizer	
F	75-77	VAN 3/4 TON, G / EXPRESS All Single System Steering Stabilizer	
F	70-74	VAN 3/4 TON, G / EXPRESS All Single System Steering Stabilizer	
F	70	DODGE A100 TRUCK All Dual System Steering Stabilizer; with I-Beam Axle	
F	64-69	A100 TRUCK All Dual System Steering Stabilizer	
F	79-82	D50 RWD Single System Steering Stabilizer	
F	86-89	PICKUP 1/2 TON, D100 SERIES All Single System Steering Stabilizer	
F	72-79	PICKUP 1/2 TON, D100 SERIES All Single System Steering Stabilizer	
F	60-71	PICKUP 1/2 TON, D100 SERIES All Single System Steering Stabilizer; with I-Beam Axle	
F	90-93	PICKUP 1/2 TON, W100 SERIES All Single System Steering Stabilizer	
F	60-86	PICKUP 1/2 TON, W100 SERIES All Dual System Steering Stabilizer; Exc. Vacuum Servo Mounted on Drivers Side of Axle	
F	75-93	PICKUP 1 TON, D300 SERIES All Single System Steering Stabilizer	
F	72-74	PICKUP 1 TON, D300 SERIES All Single System Steering Stabilizer; with Coil Spring Front Suspension	
F	60-71	PICKUP 1 TON, D300 SERIES All Single System Steering Stabilizer; with I-Beam Axle	
F	90-93	PICKUP 1 TON, W300 SERIES All Single System Steering Stabilizer	
F	60-86	PICKUP 1 TON, W300 SERIES All Dual System Steering Stabilizer; Exc. Vacuum Servo Mounted on Drivers Side of Axle	
F	73-93	PICKUP 3/4 TON, D200 SERIES All Single System Steering Stabilizer	
F	60-71	PICKUP 3/4 TON, D200 SERIES All Single System Steering Stabilizer; with I-Beam Axle	
F	90-93	PICKUP 3/4 TON, W200 SERIES All Single System Steering Stabilizer	

Numerical listing

Shock	POP	Alternative No.	MTG Acc. Supplied
Pos.	Year	Application	

6802SE	C	-continued	141998
F	60-86	PICKUP 3/4 TON, W200 SERIES All Dual System Steering Stabilizer; Exc. Vacuum Servo Mounted on Drivers Side of Axle	
F	83-93	PICKUP, RAM 50 RWD Single System Steering Stabilizer	
F	87-89	RAIDER All Single System Steering Stabilizer	
F	87-93	RAMCHARGER RWD Single System Steering Stabilizer	
F	74-86	RAMCHARGER All Dual System Steering Stabilizer; Exc. Vacuum Servo Mounted on Drivers Side of Axle	
F	71	VAN 1/2 TON, A / B SERIES / RAM All Single System Steering Stabilizer; with I-Beam Axle	
F	71	VAN 1 TON, A / B SERIES / RAM All Single System Steering Stabilizer; with I-Beam Axle	
F	71	VAN 3/4 TON, A / B SERIES / RAM All Single System Steering Stabilizer; with I-Beam Axle	
F	92-96	FORD BRONCO All Single System Steering Stabilizer	
F	80-91	BRONCO All	
F	78-79	BRONCO All Dual System Steering Stabilizer; Exc. Sway Bar	
F	84-90	BRONCO II All Single System Steering Stabilizer	
F	61-67	ECONOLINE VAN Van	
F	91-94	EXPLORER All	
F	89-91	F59 All Single System Steering Stabilizer; Superduty Motorhome	
F	89-91	MOTORHOME CHASSIS / F53 All Single System Steering Stabilizer; Motorhome	
F	80-83	PICKUP 1/2 TON, F-100 All Single System Steering Stabilizer	
F	77-79	PICKUP 1/2 TON, F-100 All Dual System Steering Stabilizer; Exc. Sway Bar	
F	77-79	PICKUP 1/2 TON, F-100 All Single System Steering Stabilizer; with Twin I-Beam Axle	
F	75-76	PICKUP 1/2 TON, F-100 4WD Dual System Steering Stabilizer; Exc. Sway Bar	
F	75-76	PICKUP 1/2 TON, F-100 RWD Single System Steering Stabilizer; with Twin I-Beam Axle	
F	73-74	PICKUP 1/2 TON, F-100 RWD Single System Steering Stabilizer with Twin I Beam Axle	
F	65-72	PICKUP 1/2 TON, F-100 All RWD; Single System Steering Stabilizer with Twin I Beam Axle	
F	61-64	PICKUP 1/2 TON, F-100 All RWD; Single Steering Stabilizer; with I Beam Axle	
F	60	PICKUP 1/2 TON, F-100 All Single Steering Stabilizer; with I Beam Axle	
F	94-96	PICKUP 1/2 TON, F-150 4WD Single System Steering Stabilizer; with Twin Traction Beam	
F	90-93	PICKUP 1/2 TON, F-150 All Single System Steering Stabilizer	
F	80-89	PICKUP 1/2 TON, F-150 All	
F	77-79	PICKUP 1/2 TON, F-150 All Dual System Steering Stabilizer; Exc. Sway Bar	
F	75-76	PICKUP 1/2 TON, F-150 RWD	
F	90-92	PICKUP 1/2 TON, F SUPERDUTY All	
F	92-96	PICKUP 1 TON, F-350 / SUPERDUTY RWD Dual System Steering Stabilizer	
F	89-91	PICKUP 1 TON, F-350 / SUPERDUTY RWD Single System Steering Stabilizer	
F	82-88	PICKUP 1 TON, F-350 / SUPERDUTY All Single System Steering Stabilizer; Exc. Anti-Sway Bar	
F	79-81	PICKUP 1 TON, F-350 / SUPERDUTY RWD Dual System Steering Stabilizer	
F	75-78	PICKUP 1 TON, F-350 / SUPERDUTY All Dual System Steering Stabilizer	
F	65-74	PICKUP 1 TON, F-350 / SUPERDUTY All Single System Steering Stabilizer; with Twin I Beam Axle	

Numerical listing

Shock	POP	Alternative No.	MTG Acc. Supplied
Pos.	Year	Application	
6802SE	C	-continued	141998
F	60-64	PICKUP 1 TON, F-350 / SUPERDUTY All Single System Steering Stabilizer with I Beam Axle	
F	80-96	PICKUP 3/4 TON, F-250 / SUPERDUTY 4WD Single System Steering Stabilizer	
F	75-79	PICKUP 3/4 TON, F-250 / SUPERDUTY RWD Single System Steering Stabilizer	
F	57-59	PICKUP F SERIES All Single System Steering Stabilizer; with I-Beam Axle	
F	50-55	PICKUP F SERIES All Single System Steering Stabilizer; with I-Beam Axle	
F	65-67	PICKUP P100 All Single System Steering Stabilizer	
F	68-73	PICKUP P350 All Single System Steering Stabilizer	
F	83-97	RANGER All Single System Steering Stabilizer	
F	69-74	VAN 1/2 TON, ECONOLINE / CLUB WAGON All Single System Steering Stabilizer; with Twin I-Beam Axle	
F	69-74	VAN 3/4 TON, ECONOLINE / CLUB WAGON / SUPERDUTY All Single System Steering Stabilizer; with Twin I-Beam Axle	
F	73-91	GMC JIMMY All Replacement damper for vehicles with the Gabriel aftermarket mounting kit	
F	70-72	JIMMY 4WD K5 Dual System Steering Stabilizer	
F	70-72	JIMMY RWD	
F	57-59	PICKUP All Single System Steering Stabilizer; with I-Beam Axle	
F	53-56	PICKUP Truck Single System Steering Stabilizer; with I-Beam Axle	
F	73-86	PICKUP 1/2 TON, C15 / C1500 All Single System Steering Stabilizer	
F	69-86	PICKUP 1/2 TON, K15 / K1500 All Dual System Steering Stabilizer	
F	87	PICKUP 1/2 TON, R1500 All Single System Steering Stabilizer	
F	87	PICKUP 1/2 TON, V1500 All Dual System Steering Stabilizer	
F	75-86	PICKUP 1 TON, C35/3500 Crew Cab Pickup	
F	72-74	PICKUP 1 TON, C35/3500 All	
F	67-86	PICKUP 3/4 TON, C25 / C2500 All Single System Steering Stabilizer	
F	67-86	PICKUP 3/4 TON, K25 / K2500 All Dual System Steering Stabilizer	
F	87-89	PICKUP 3/4 TON, R2500 All Single System Steering Stabilizer	
F	87	PICKUP 3/4 TON, V2500 All AN49	
F	82-93	SONOMA / S15 RWD Single System Steering Stabilizer	
F	68-86	SUBURBAN 1/2 TON, C15 / C1500 All Single System Steering Stabilizer	
F	68-86	SUBURBAN 1/2 TON, K15 / K1500 All Dual System Steering Stabilizer	
F	87-91	SUBURBAN 1/2 TON, R1500 All Single System Steering Stabilizer	
F	87-91	SUBURBAN 1/2 TON, V1500 All Dual System Steering Stabilizer	
F	68-86	SUBURBAN 3/4 TON, C25 / C2500 All Single System Steering Stabilizer	
F	68-86	SUBURBAN 3/4 TON, K25 / K2500 All Dual System Steering Stabilizer	
F	87-91	SUBURBAN 3/4 TON, R2500 All Single System Steering Stabilizer	
F	87-91	SUBURBAN 3/4 TON, V2500 All Dual System Steering Stabilizer	
F	70-95	VAN 1/2 TON, G / SAVANNA All Single System Steering Stabilizer	
F	71-95	VAN 1 TON, G / SAVANNA All Single System Steering Stabilizer	
F	70-95	VAN 3/4 TON, G / SAVANNA All Single System Steering Stabilizer	
F	74	INTERNATIONAL 100 All	
F	75	150 All	
F	74-75	200 All	
F	68-69	908C All Single System Steering Stabilizer; 1/2 Ton, 3/4 Ton & Travelall	
F	68	1000C All Single System Steering Stabilizer; 1/2 Ton, 3/4 Ton & Travelall	
F	69-70	1000D All Single System Steering Stabilizer; 1/2 Ton, 3/4 Ton & Travelall	

Steering Stabilizer

Shock	POP	Alternative No.	MTG Acc. Supplied
Pos.	Year	Application	
6802SE	C	-continued	141998
F	71-73	1010 All Single System Steering Stabilizer; 1/2 Ton, 3/4 Ton & Travelall	
F	68	1100C All Single System Steering Stabilizer; 1/2 Ton, 3/4 Ton & Travelall	
F	69-70	1100D All Single System Steering Stabilizer; 1/2 Ton, 3/4 Ton & Travelall	
F	71-73	1110 All Single System Steering Stabilizer; 1/2 Ton, 3/4 Ton & Travelall	
F	68	1200C All Single System Steering Stabilizer; 1/2 Ton, 3/4 Ton & Travelall	
F	69-70	1200D All Single System Steering Stabilizer; 1/2 Ton, 3/4 Ton & Travelall	
F	71-73	1210 All Single System Steering Stabilizer; 1/2 Ton, 3/4 Ton & Travelall	
F	68	1300C All Single System Steering Stabilizer; 1/2 Ton, 3/4 Ton & Travelall	
F	69-70	1300D All Single System Steering Stabilizer; 1/2 Ton, 3/4 Ton & Travelall	
F	71-73	1310 All Single System Steering Stabilizer; 1/2 Ton, 3/4 Ton & Travelall	
F	68-71	M800 All Single System Steering Stabilizer; 1/2 and 3/4 Ton I-Beam Axle	
F	68-72	M1100 / M1200 All Single System Steering Stabilizer; 1/2 and 3/4 Ton I-Beam Axle	
F	69	M1400 All Single System Steering Stabilizer; 1/2 and 3/4 Ton I-Beam Axle	
F	61-68	SCOUT All Single System Steering Stabilizer; 4WD; Scout 80, 800	
F	75	TRAVELALL RWD	
F	84-91	ISUZU TROOPER 4WD Single System Steering Stabilizer	
F	66-83	JEEP CJ5 All Single System Steering Stabilizer	
F	59-60	CJ5 All Single System Steering Stabilizer	
F	66-75	CJ6 All Single System Steering Stabilizer	
F	59-60	CJ6 All Single System Steering Stabilizer	
F	76-86	CJ7 All Single System Steering Stabilizer	
F	66-73	JEEP STER All Single System Steering Stabilizer	
F	81-85	SCRAMBLER / CJ8 All Single System Steering Stabilizer	
F	61-67	UNIVERSAL All Single System Steering Stabilizer	
F	63-67	WAGONEER All Exc. Independent Front Suspension	
F	91-94	MAZDA NAVAJO All	
F	95-96	MINIBUS MIGHTY MAX All Single System Steering Stabilizer	
F	83-94	MIGHTY MAX RWD Single System Steering Stabilizer	
F	86-95	MONTERO All Single System Steering Stabilizer	
F	82	NISSAN 720 PICKUP All Single System Steering Stabilizer	
F	79-82	PLYMOUTH PICKUP All	
F	74-81	TRAILDUSTER All Dual System Steering Stabilizer; Exc. Vacuum Servo Mounted on Drivers Side of Axle	
F	86-95	SUZUKI SAMURAI All Single System Steering Stabilizer	
F	86-95	TOYOTA PICKUP All Single System Steering Stabilizer	
F	79-85	PICKUP RWD Single System Steering Stabilizer	
6803SE	D	-continued	141998
F	69-72	CHEVROLET BLAZER All Single System Steering Stabilizer	
F	60	PICKUP Truck Dana 60 Axle up to 3 1/2" O.D. or Napco axle up to 3 3/8" O.D.	
F	57-58	PICKUP Truck Dana 60 Axle up to 3 1/2" O.D. or Napco axle up to 3 3/8" O.D.	
F	61-72	PICKUP 1/2 TON, K10 All Single System Steering Stabilizer	

Numerical listing

Shock	POP	Alternative No.	MTG Acc. Supplied
Pos.	Year	Application	
6803SE	D	-continued	141998
F	61-72	PICKUP 3/4 TON, K20 All Single System Steering Stabilizer	
F	01-09	PICKUP 3/4 TON, SILVERADO 2500 HD All 9200# GVW w/o O.E. Unit - 15059138 15155638	
F	68-72	SUBURBAN 1/2 TON, K10 All Single System Steering Stabilizer	
F	68-72	SUBURBAN 3/4 TON, K20 All Single System Steering Stabilizer	
F	70	DODGE A100 TRUCK All Single System Steering Stabilizer; with I-Beam Axle	
F	60-89	PICKUP 1/2 TON, W100 SERIES All Single System Steering Stabilizer	
F	60-89	PICKUP 1 TON, W300 SERIES All Single System Steering Stabilizer	
F	69-89	PICKUP 3/4 TON, W200 SERIES All Single System Steering Stabilizer	
F	60-67	PICKUP 3/4 TON, W200 SERIES All Single System Steering Stabilizer	
F	75-93	RAMCHARGER 4WD Single System Steering Stabilizer	
F	74	RAMCHARGER All Single System Steering Stabilizer	
F	71-87	VAN 1/2 TON, A / B SERIES / RAM All Single System Steering Stabilizer	
F	71-87	VAN 1 TON, A / B SERIES / RAM All Single System Steering Stabilizer	
F	80-87	VAN 3/4 TON, A / B SERIES / RAM All Single System Steering Stabilizer	
F	78-79	VAN 3/4 TON, A / B SERIES / RAM All Van Charger Special	
F	71-77	VAN 3/4 TON, A / B SERIES / RAM All Single System Steering Stabilizer	
F	70-79	FORD BRONCO All Single System Steering Stabilizer	
F	77-79	PICKUP 1/2 TON, F-100 All 4WD; Single System Steering Stabilizer	
F	73-76	PICKUP 1/2 TON, F-100 4WD Single System Steering Stabilizer	
F	60-72	PICKUP 1/2 TON, F-100 All 4WD; Single System Steering Stabilizer	
F	76-79	PICKUP 1/2 TON, F-150 4WD Single System Steering Stabilizer	
F	75	PICKUP 1/2 TON, F-150 All 4WD	
F	75-77	PICKUP 1 TON, F-350 / SUPERDUTY Manual Steering Single System Steering Stabilizer	
F	60-74	PICKUP 1 TON, F-350 / SUPERDUTY All Single System Steering Stabilizer	
F	75-77	PICKUP 3/4 TON, F-250 / SUPERDUTY 4WD, Manual Steering Single System Steering Stabilizer	
F	60-74	PICKUP 3/4 TON, F-250 / SUPERDUTY All Single System Steering Stabilizer	
F	59	PICKUP F SERIES All Single System Steering Stabilizer; F-250, F-350; Exc. Power Steering	
F	74-79	VAN 3/4 TON, ECONOLINE / CLUB WAGON / SUPERDUTY All QuadraVan Special	
F	70-72	GMC JIMMY 4WD K-5 Single System Steering Stabilizer	
F	69-72	PICKUP 1/2 TON, K15 / K1500 All Single System Steering Stabilizer	
F	67-72	PICKUP 3/4 TON, K25 / K2500 All Single System Steering Stabilizer	
F	68-72	SUBURBAN 1/2 TON, K15 / K1500 All Single System Steering Stabilizer	
F	68-72	SUBURBAN 3/4 TON, K25 / K2500 All Single System Steering Stabilizer	
F	69-71	INTERNATIONAL SCOUT All Single System Steering Stabilizer	
F	71-80	SCOUT II All Single System Steering Stabilizer	
F	75	TRAVELALL 4WD Single System Steering Stabilizer	
F	63-67	JEEP GLADIATOR All Single System Steering Stabilizer	
F	75-81	PLYMOUTH TRAILDUSTER 4WD Single System Steering Stabilizer	
F	74	TRAILDUSTER All Single System Steering Stabilizer	
F	84-85	TOYOTA 4RUNNER All Single System Steering Stabilizer	
F	80-85	PICKUP 4WD Single System Steering Stabilizer; with OE Stock Mounts	

Numerical listing

Shock	POP	Alternative No.	MTG Acc. Supplied
Pos.	Year	Application	
6804SE	B	500498,141397	
F 80-88		AMERICAN MOTORS EAGLE All	
F 75-86		CHEVROLET BLAZER 4WD Single System Steering Stabilizer	
F 75-84		BLAZER RWD Single System Steering Stabilizer	
F 73-86		PICKUP 1/2 TON, K10 All Single System Steering Stabilizer	
F 87		PICKUP 1/2 TON, V10 All Single System Steering Stabilizer	
F 77-86		PICKUP 1 TON, K30 All Single System Steering Stabilizer	
F 73-86		PICKUP 3/4 TON, K20 All Single System Steering Stabilizer	
F 87		PICKUP 3/4 TON, V20 All Single System Steering Stabilizer	
F 73-86		SUBURBAN 1/2 TON, K10 All Single System Steering Stabilizer	
F 87-88		SUBURBAN 1/2 TON, R10 All Single System Steering Stabilizer	
F 73-86		SUBURBAN 3/4 TON, K20 All Single System Steering Stabilizer	
F 87-88		SUBURBAN 3/4 TON, V20 All Single System Steering Stabilizer	
F 89-91		SUBURBAN 3/4 TON, V2500 All Single System Steering Stabilizer	
F 94-95		VAN 1 TON, G / EXPRESS All Single System Steering Stabilizer; HD with Straight Front Axle & Tilt Hood	
F 85-93		VAN 1 TON, P SERIES All Single System Steering Stabilizer; with I-Beam Front Suspension	
F 87-94		DODGE DAKOTA 4WD Single System Steering Stabilizer	
F 94-97		PICKUP 1/2 TON, RAM 1500 (SEE RAM 1500) 4WD With OEM 52038276	
F 94-97		PICKUP 1 TON, RAM 3500 (SEE RAM 3500) 4WD With OEM 52038276	
F 94-97		PICKUP 1 TON, RAM 3500 (SEE RAM 3500) RWD w/ OEM 52038276 Solid Front Axle	
F 94-97		PICKUP 3/4 TON, RAM 2500 (SEE RAM 2500) 4WD With OEM 52038276	
F 66-69		FORD BRONCO All Single System Steering Stabilizer	
F 73-91		GMC JIMMY All Heavy Duty replacement damper for vehicles with OE stabilizer	
F 73-86		PICKUP 1/2 TON, K15 / K1500 All Single System Steering Stabilizer	
F 87		PICKUP 1/2 TON, V1500 All Single System Steering Stabilizer	
F 73-86		PICKUP 3/4 TON, K25 / K2500 All Single System Steering Stabilizer	
F 87		PICKUP 3/4 TON, V2500 All Single System Steering Stabilizer	
F 73-86		SUBURBAN 1/2 TON, K15 / K1500 All Single System Steering Stabilizer	
F 87-91		SUBURBAN 1/2 TON, V1500 All Single System Steering Stabilizer	
F 73-86		SUBURBAN 3/4 TON, K25 / K2500 All Single System Steering Stabilizer	
F 87-91		SUBURBAN 3/4 TON, V2500 All Single System Steering Stabilizer	
F 94-95		VAN 1 TON, G / SAVANNA All Single System Steering Stabilizer; HD with Straight Front Axle & Tilt Hood	
F 75-83		JEEP CHEROKEE 4WD Single System Steering Stabilizer	
F 74		CHEROKEE All Single System Steering Stabilizer	
F 84-91		GRAND WAGONEER All Single System Steering Stabilizer	
F 74-88		J10 PICKUP All Single System Steering Stabilizer	
F 74-88		J20 PICKUP All Single System Steering Stabilizer	
F 86-95		TOYOTA PICKUP 4WD Single System Steering Stabilizer; with OE Stock Mounts	

6805SE	W	141397,141998,142000	
F 75-93		CHEVROLET VAN 1 TON, P SERIES All Motorhome Chassis	
F 79		FORD PICKUP 1 TON, F-350 / SUPERDUTY 4WD, Power Steering Single System Steering Stabilizer	
F 77-79		PICKUP 3/4 TON, F-250 / SUPERDUTY 4WD, Power Steering Single System Steering Stabilizer	

Steering Stabilizer

Shock	POP	Alternative No.	MTG Acc. Supplied
Pos.	Year	Application	
6805SE	W	-continued 141397,141998,142000	
F 79-93		GMC VAN 1 TON, P SERIES All Step Van Forward Control & Motorhome	
F 75-78		VAN 1 TON, P SERIES All Motorhome Chassis	
6807SE	D	142038,500498	
F 91-02		CHEVROLET C3500HD All O.E. Replacement Stabilizer Single System	
F 88-99		PICKUP 1/2 TON, K15 / K1500 All Single System Steering Stabilizer	
F 03		PICKUP 1 TON, C35/3500 All HD Pick UP; O.E. Replacement Stabilizer Single System	
F 88-00		PICKUP 1 TON, K35 / K3500 All Single System Steering Stabilizer	
F 88-99		PICKUP 3/4 TON, K25 / K2500 All Single System Steering Stabilizer	
F 92-97		SUBURBAN 1/2 TON, K15 / K1500 All Single System Steering Stabilizer	
F 92-97		SUBURBAN 3/4 TON, K25 / K2500 All Single System Steering Stabilizer	
F 88-99		GMC PICKUP 1/2 TON, K15 / K1500 All Single System Steering Stabilizer	
F 91-93		PICKUP 1 TON, C35/3500 All HD Pick UP; O.E. Replacement Stabilizer Single System	
F 88-00		PICKUP 1 TON, K35 / K3500 All Single System Steering Stabilizer	
F 88-99		PICKUP 3/4 TON, K25 / K2500 All Single System Steering Stabilizer	
F 92-95		SUBURBAN 1/2 TON, K15 / K1500 All Single System Steering Stabilizer	
F 92-97		SUBURBAN 3/4 TON, K25 / K2500 All Single System Steering Stabilizer	
6826SE	D	141998 x 2	
F 95-97		FORD PICKUP 1 TON, F-350 / SUPERDUTY 4WD	
6828SE	D	142718	
F 99-06		FORD PICKUP 1 TON, F-350 / SUPERDUTY RWD	
F 99-06		PICKUP 3/4 TON, F-250 / SUPERDUTY RWD	
6846SE	C		
F 97-99		DODGE PICKUP 1/2 TON, RAM 1500 (SEE RAM 1500) 4WD With OEM 52039280	
F 97-99		PICKUP 1 TON, RAM 3500 (SEE RAM 3500) 4WD With OEM 52039280	
F 97-99		PICKUP 1 TON, RAM 3500 (SEE RAM 3500) RWD w/ OEM 52039280 Solid Front Axle	
F 97-99		PICKUP 3/4 TON, RAM 2500 (SEE RAM 2500) 4WD With OEM 52039280	
6847SE	A		
F 00-07		DODGE PICKUP 1/2 TON, RAM 1500 (SEE RAM 1500) 4WD With OEM # 52106909AB, AC, AD	
F 00-07		PICKUP 1 TON, RAM 3500 (SEE RAM 3500) 4WD With OEM # 52106909AB, AC, AD	
F 00-07		PICKUP 1 TON, RAM 3500 (SEE RAM 3500) RWD With OEM # 52106909AB, AC, AD and Solid Front Axle	
F 00-07		PICKUP 3/4 TON, RAM 2500 (SEE RAM 2500) 4WD With OEM # 52106909AB, AC, AD	
6848SE	W	143163	
F 87-95		NISSAN PATHFINDER 4WD	
F 95-97		PICKUP 4WD	
6850SE	C	143168	
F 99-04		FORD PICKUP 1 TON, F-350 / SUPERDUTY 4WD Exc. O.E. Unit	
F 99-04		PICKUP 3/4 TON, F-250 / SUPERDUTY 4WD Exc. O.E. Unit	
6851SE	W	143177, 140629	
F 83-04		CHEVROLET S10 4WD Single System Steering Stabilizer; without a factory mounting hole in the steering linkage.	
F 83-04		GMC JIMMY 4WD, Power Steering Single System Steering Stabilizer; without a factory mounting hole in the steering linkage.	

Numerical listing

Shock	POP	Alternative No.	MTG Acc. Supplied
Pos.	Year	Application	
6851SE	W	-continued 143177, 140629	
F 83-90		SONOMA / S15 4WD, Power Steering Single System Steering Stabilizer; without a factory mounting hole in the steering linkage.	
F 92-93		TYPHOON All Single System Steering Stabilizer; without a factory mounting hole in the steering linkage.	
6852SE	W	143165	
F 92-99		CHEVROLET SUBURBAN 1/2 TON, C15 / C1500 RWD	
F 92-99		SUBURBAN 3/4 TON, C25 / C2500 RWD	
F 95-99		TAHOE RWD	
F 88-99		GMC PICKUP 1/2 TON, C15 / C1500 RWD	
F 92-99		PICKUP 3/4 TON, C25 / C2500 RWD Exc. O.E. Steering Stabilizer	
F 88-91		PICKUP 3/4 TON, C25 / C2500 RWD	
F 92-99		SUBURBAN 1/2 TON, C15 / C1500 RWD Exc. O.E. Steering Stabilizer	
F 95-99		YUKON RWD	
6853SE	A	143155	
F 92-99		CHEVROLET PICKUP 1/2 TON, C15 / C1500 All Exc. O.E. Steering Stabilizer	
F 92-97		PICKUP 1/2 TON, K15 / K1500 All Exc. O.E. Steering Stabilizer	
F 95-00		PICKUP 1 TON, K35 / K3500 All Exc. O.E. Steering Stabilizer	
F 92-99		PICKUP 3/4 TON, C25 / C2500 All Exc. O.E. Steering Stabilizer	
F 99-00		PICKUP 3/4 TON, K25 / K2500 All Exc. O.E. Steering Stabilizer	
F 01-09		PICKUP 3/4 TON, SILVERADO 2500 HD 4WD 9200# GVW with O.E. Unit - 15059138 15155638	
F 00-05		SUBURBAN 1/2 TON, 1500 4WD Exc. O.E. Steering Stabilizer	
F 00-05		SUBURBAN 3/4 TON, 2500 4WD Exc. O.E. Steering Stabilizer	
F 95-99		SUBURBAN 3/4 TON, K25 / K2500 All Exc. O.E. Steering Stabilizer	
F 01-05		TAHOE 4WD New Body Style; Exc. Z55 Auto Ride Suspension	
F 95-00		TAHOE 4WD Old Body Style	
F 99-00		GMC PICKUP 3/4 TON, K25 / K2500 4WD 9200# GVW with O.E. Unit - 15059138 15155638	
F 99-05		SIERRA 1500 4WD Exc. O.E. Steering Stabilizer	
F 99-04		SIERRA 2500 4WD Up through 8600# GVW; Exc. O.E. Steering Stabilizer	
F 01-09		SIERRA 2500 HD 4WD 9200# GVW with O.E. Unit - 15059138 15155638	
F 99-05		YUKON 4WD	
F 93-98		JEEP GRAND CHEROKEE All	
6854SE	A	142718	
F 00-05		FORD EXCURSION 4WD With O.E. Unit	
F 99-03		PICKUP 1 TON, F-350 / SUPERDUTY 4WD With O.E. Unit	
F 99-03		PICKUP 3/4 TON, F-250 / SUPERDUTY 4WD With O.E. Unit	
F 99-04		PICKUP, F-450 SUPERDUTY 4 X 4	
F 99-04		PICKUP, F-550 SUPERDUTY 4 X 4	
6855SE	C	143154	
F 99-04		FORD PICKUP 1 TON, F-350 / SUPERDUTY 4WD Replacement Kit	
F 99-04		PICKUP 3/4 TON, F-250 / SUPERDUTY 4WD Replacement Kit	
6856SE	C	143156,143077	
F 05-07		FORD PICKUP 3/4 TON, F-250 / SUPERDUTY 4WD Exc. O.E. Steering Stabilizer	
6857SE	W	143157	
F 93-97		FORD PICKUP 1/2 TON, F SUPERDUTY All With O.E. Unit	
6858SE	D	143161	
F 95-01		FORD VAN 1/2 TON, ECONOLINE / CLUB WAGON All Aftermarket Kit	
F 95-02		VAN 1 TON, ECONOLINE / CLUB WAGON / SUPERDUTY All Aftermarket Kit	

Numerical listing

Steering Stabilizer, Steering Dampers, Front Load Carrier

Numerical listing

Shock	POP	Alternative No.	MTG Acc. Supplied
Pos.	Year	Application	
6858SE	D	-continued	143161
F	95-01	VAN 3/4 TON, ECONOLINE / CLUB WAGON / SUPERDUTY All Aftermarket Kit	
6859SE	D	-continued	143166
F	94-01	DODGE PICKUP 1/2 TON, RAM 1500 (SEE RAM 1500) RWD, GAS Coil Spring Suspension Steering Stabilizer	
F	94-02	PICKUP 1 TON, RAM 3500 (SEE RAM 3500) RWD, GAS Coil Spring Suspension Steering Stabilizer	
F	94-02	PICKUP 3/4 TON, RAM 2500 (SEE RAM 2500) RWD, GAS Coil Spring Suspension Steering Stabilizer	
6860SE	W	-continued	143162
F	97-03	FORD PICKUP 1/2 TON, F-150 RWD, Coil (FrontSpringType)	
F	97-99	PICKUP 3/4 TON, F-250 / SUPERDUTY RWD, Coil (FrontSpringType)	
6861SE	D	-continued	143160
F	97-02	FORD EXPEDITION 4WD, Torsion Bar (FrontSpringType)	
F	97-03	PICKUP 1/2 TON, F-150 4WD	
F	97-99	PICKUP 3/4 TON, F-250 / SUPERDUTY 4WD, Torsion Bar (FrontSpringType)	
6863SE	X	-continued	143164
F	98	NISSAN FRONTIER 4WD	

Steering Dampers

14004	C	-continued	
F	59-77	VOLKSWAGEN BEETLE All	
F	73-74	THING All	
14005	W	-continued	
F	71-75	VOLKSWAGEN SUPER BEETLE All	
14010	W	-continued	
F	67-78	CADILLAC ELDORADO All	
F	71-78	OLDSMOBILE TORONADO All	
F	66	TORONADO All	
14016	W	-continued	140126 x 2
F	71-79	FORD BRONCO All	
F	67	BRONCO All	
F	79	PICKUP 1/2 TON, F-100 All 4WD; Single System	
F	77-78	PICKUP 1/2 TON, F-100 All 4WD	
F	75-76	PICKUP 1/2 TON, F-100 4WD	
F	76-79	PICKUP 1/2 TON, F-150 4WD 4WD	
F	75	PICKUP 1/2 TON, F-150 All 4WD	
14017	D	-continued	142387
F	87-91	CHEVROLET BLAZER 4WD Full Size	
F	75-86	BLAZER 4WD	
F	75-84	BLAZER RWD	
F	73-86	PICKUP 1/2 TON, K10 All	
F	87	PICKUP 1/2 TON, V10 All	
F	77-86	PICKUP 1 TON, K30 All	
F	73-74	PICKUP 1 TON, K30 All	
F	89-91	PICKUP 1 TON, R3500 RWD	
F	87-88	PICKUP 1 TON, V30 All	
F	89-91	PICKUP 1 TON, V3000 / V3500 All	
F	73-86	PICKUP 3/4 TON, K20 All	
F	87	PICKUP 3/4 TON, V20 All	
F	73-86	SUBURBAN 1/2 TON, K10 All	
F	87-88	SUBURBAN 1/2 TON, R10 RWD	
F	73-86	SUBURBAN 3/4 TON, K20 All	
F	87-88	SUBURBAN 3/4 TON, V20 All	
F	89-91	SUBURBAN 3/4 TON, V2500 All	
F	73-91	GMC JIMMY All Replacement damper for vehicles with OE stabilizer	
F	73-86	PICKUP 1/2 TON, K15 / K1500 All	
F	87	PICKUP 1/2 TON, V1500 All	
F	77-86	PICKUP 1 TON, K35 / K3500 All	
F	73-74	PICKUP 1 TON, K35 / K3500 All	
F	87-91	PICKUP 1 TON, V3000 / V3500 All	
F	73-86	PICKUP 3/4 TON, K25 / K2500 All	
F	87	PICKUP 3/4 TON, V2500 All	
F	73-86	SUBURBAN 1/2 TON, K15 / K1500 All	
F	87-91	SUBURBAN 1/2 TON, V1500 All	
F	73-86	SUBURBAN 3/4 TON, K25 / K2500 All	
F	87-91	SUBURBAN 3/4 TON, V2500 All	

Shock	POP	Alternative No.	MTG Acc. Supplied
Pos.	Year	Application	
14018	D	-continued	141264
F	76-79	CADILLAC SEVILLE All	
14019	W	-continued	141264
F	87-92	CADILLAC BROUGHAM All	
F	92-96	COMMERCIAL CHASSIS RWD	
F	77-84	COMMERCIAL CHASSIS All	
F	93-96	FLEETWOOD RWD	
F	87-92	FLEETWOOD All	
F	85-86	FLEETWOOD RWD	
F	73-77	CHEVROLET EL CAMINO All	
F	73-77	MONTE CARLO All	
F	73-77	GMC SPRINT / CABALLERO All	
14020	X	-continued	141264
F	79-85	BUICK RIVIERA All	
F	79-85	CADILLAC ELDORADO All	
F	80-85	SEVILLE All	
F	79-85	OLDSMOBILE TORONADO All	
14039	C	-continued	
F	84-04	FORD MUSTANG / MUSTANG II All	
F	84-88	THUNDERBIRD All	
F	84-86	MERCURY CAPRI All	
F	84-88	COUGAR All	
14040	B	-continued	500498
F	84-01	JEEP CHEROKEE All	
F	86-92	COMANCHE All	
14071	A	-continued	
F	99-04	JEEP GRAND CHEROKEE All Single System Steering Damper	
14072	N	-continued	
F	08-10	FORD PICKUP 1 TON, F-350 / SUPERDUTY 4WD	
F	08-10	PICKUP 3/4 TON, F-250 / SUPERDUTY 4WD	
F	08-10	PICKUP, F-450 SUPERDUTY 4 X 4	
F	08-10	PICKUP, F-550 SUPERDUTY 4 X 4	
14073	A	-continued	
F	80-95	TOYOTA LAND CRUISER All	
14074	N	-continued	
F	07-13	JEEP WRANGLER 4WD	
14075	A	-continued	
F	11-13	CHEVROLET PICKUP 1 TON, SILVERADO 3500 HD All	
F	11-13	PICKUP 3/4 TON, SILVERADO 2500 HD All	
F	11-13	GMC SIERRA 2500 HD All	
F	11-13	SIERRA 3500 HD All	

Front Load Carrier

34036	W	-continued	140357
F	75-84	CHEVROLET BLAZER RWD	
F	69-74	BLAZER All RWD	
F	63-86	PICKUP 1/2 TON, C10 All	
F	87	PICKUP 1/2 TON, R10 All	
F	63-86	PICKUP 1 TON, C30 All	
F	88-91	PICKUP 1 TON, C35/3500 Cab & Chassis Exc. HD Solid Front Axle	
F	87-88	PICKUP 1 TON, R30 All	
F	89	PICKUP 1 TON, R3500 Standard Cab Pickup	
F	75-86	PICKUP 3/4 TON, C20 Crew Cab Pickup	
F	75-86	PICKUP 3/4 TON, C20 Standard Cab Pickup	
F	63-74	PICKUP 3/4 TON, C20 All	
F	88	PICKUP 3/4 TON, R20 Crew Cab Pickup	
F	87	PICKUP 3/4 TON, R20 All	
F	89	PICKUP 3/4 TON, R2500 All	
F	63-66	SUBURBAN 1/2 TON, 1500 All	
F	67-86	SUBURBAN 1/2 TON, C10 All	
F	87-88	SUBURBAN 1/2 TON, R10 All	
F	89-91	SUBURBAN 1/2 TON, R1500 All	
F	67-86	SUBURBAN 3/4 TON, C20 All	
F	87-88	SUBURBAN 3/4 TON, R20 All	
F	89-91	SUBURBAN 3/4 TON, R2500 All	
F	63-80	VAN 1/2 TON, P SERIES All	
F	73-90	VAN 1 TON, P SERIES All Cutaway Chassis	
F	68-72	VAN 1 TON, P SERIES All	
F	68-89	VAN 3/4 TON, P SERIES All	
F	75-84	GMC JIMMY RWD	
F	70-74	JIMMY All RWD	
F	67-86	PICKUP 1/2 TON, C15 / C1500 All	
F	87	PICKUP 1/2 TON, R1500 All	
F	88-91	PICKUP 1 TON, C35/3500 Cab & Chassis HD Solid Front Axle	
F	67-78	PICKUP 1 TON, C35/3500 All	

Shock	POP	Alternative No.	MTG Acc. Supplied
Pos.	Year	Application	
34036	W	-continued	140357
F	87-91	PICKUP 1 TON, R3500 All	
F	75-86	PICKUP 3/4 TON, C25 / C2500 Cab & Chassis	
F	75-86	PICKUP 3/4 TON, C25 / C2500 Crew Cab Pickup	
F	75-86	PICKUP 3/4 TON, C25 / C2500 Standard Cab Pickup	
F	67-74	PICKUP 3/4 TON, C25 / C2500 All	
F	87-89	PICKUP 3/4 TON, R2500 All Exc. Crew Cab & Bonus Cab	
F	63-65	PICKUP 1000 SERIES All	
F	63-65	PICKUP 1500 SERIES All	
F	68-86	SUBURBAN 1/2 TON, C15 / C1500 All	
F	87-91	SUBURBAN 1/2 TON, R1500 All	
F	68-86	SUBURBAN 3/4 TON, C25 / C2500 All	
F	87-91	SUBURBAN 3/4 TON, R2500 All	
F	67-80	VAN 1/2 TON, P SERIES All	
F	74-90	VAN 1 TON, P SERIES All Cutaway Chassis	
F	73	VAN 1 TON, P SERIES Base Cutaway Chassis	
F	68-72	VAN 1 TON, P SERIES All	
F	68-89	VAN 3/4 TON, P SERIES All	
F	63-65	VAN, PB 1000 SERIES All	

34051 D 140455

F	73-75	BUICK APOLLO All	
F	73-81	CENTURY All	
F	73-87	REGAL All	
F	75-79	SKYLARK All	
F	69-72	SKYLARK All	
F	68	SKYLARK All HD Suspension; Exc. Sportwagon	
F	68-69	SPECIAL All	
F	68-72	SPORTWAGON All	
F	76-79	CADILLAC SEVILLE All	
F	05	CHEVROLET BLAZER Base, RWD	
F	96-04	BLAZER LS, RWD	
F	95-02	BLAZER LT, RWD	
F	95-99	BLAZER Base, RWD	
F	95-97	BLAZER Deluxe, RWD	
F	83-94	BLAZER, S MODELS RWD	
F	68-73	CHEVELLE All	
F	68-87	EL CAMINO All	
F	73-83	MALIBU All	
F	70-88	MONTE CARLO All	
F	69-79	NOVA All	
F	94-03	S10 LS, RWD	
F	83-03	S10 Base, RWD	
F	92-93	S10 EL, RWD	
F	83-92	S10 Tahoe, RWD	
F	88-90	S10 Durango, RWD	
F	83-86	S10 Durango, RWD	
F	82	S10 Base	
F	82	S10 Durango	
F	92-04	GMC JIMMY RWD	
F	83-91	S15 JIMMY RWD	
F	04	SONOMA / S15 All RWD	
F	83-03	SONOMA / S15 RWD	
F	82	SONOMA / S15 All	
F	71-87	SPRINT / CABALLERO All	
F	98-00	ISUZU HOMBRE RWD Exc. Sport Chassis	
F	96-97	HOMBRE All Exc. Sport Chassis	
F	68-87	OLDSMOBILE CUTLASS / CUTLASS SUPREME All	
F	80-83	CUTLASS CLASSIC / CUTLASS CRUISER All	
F	78-79	OMEGA All	
F	82-86	PONTIAC BONNEVILLE All	
F	78-80	GRAND AM All	
F	73-75	GRAND AM All	
F	75-83	GRAND LEMANS All	
F	69-87	GRAND PRIX All	
F	71-75	GRANDVILLE All	
F	68-81	LEMANS All	
F	77-79	PHOENIX All	
F	73-77	VENTURA All	

34052 W 140126

F	84-86	DODGE MINI RAM All	
F	72-93	PICKUP 1/2 TON, D100 SERIES All	
F	72-93	PICKUP 3/4 TON, D200 SERIES All Exc. HD Package	
F	75-93	RAMCHARGER RWD	
F	99-03	VAN 1/2 TON, A / B SERIES / RAM 109.3 (WheelBase) Exc. 7000# GVW	
F	82-98	VAN 1/2 TON, A / B SERIES / RAM 109.6 (WheelBase) Exc. 7000# GVW	

Numerical listing

Shock	POP	Alternative No.	MTG Acc. Supplied
Pos.	Year	Application	
34052	W	-continued	140126
F	71-80	VAN 1/2 TON, A / B SERIES / RAM All	
F	99-03	VAN 1 TON, A / B SERIES / RAM All	
F	71-98	VAN 1 TON, A / B SERIES / RAM All Exc. 4000# Front Axle	
F	71-03	VAN 3/4 TON, A / B SERIES / RAM All	
F	78-80	VAN, CB300 All Exc. 4000# Front Axle	
F	74-77	VAN, CB300 All Up through 8300# GVW	
F	81	PLYMOUTH TRAILDUSTER All	
F	75-80	TRAILDUSTER RWD	
F	74-83	VAN 1/2 TON, PB SERIES All	
F	74-83	VAN 1 TON, PB SERIES All Exc. 4000# Front Axle	
F	74-83	VAN 3/4 TON, PB SERIES All	
34057	W	-continued	140780
F	80-96	FORD BRONCO All Quad & Non Quad Suspensions Rearward of Front Axle; Exc. Lift Kit	
F	89	BRONCO II All Mfg. to 2/89; Vehicles with 10mm & 12mm bolt in rear lower mount	
F	84-88	BRONCO II All With 10mm Bolt In Rear Lower Mount	
F	80-83	PICKUP 1/2 TON, F-100 RWD	
F	80-96	PICKUP 1/2 TON, F-150 4WD Quad & Non Quad Suspensions Rearward of Front Axle; Exc. Lift Kit	
F	80-96	PICKUP 1/2 TON, F-150 RWD	
F	87-89	RANGER All Exc. High Ryder Option	
F	83-86	RANGER All	
34058	W	-continued	140780
F	66-77	FORD BRONCO All From Serial #830001; Exc. Lift Kit	
F	73-79	PICKUP 1/2 TON, F-100 RWD	
F	65-72	PICKUP 1/2 TON, F-100 All RWD	
F	75-79	PICKUP 1/2 TON, F-150 RWD	
F	75-79	PICKUP 1 TON, F-350 / SUPERDUTY RWD	
F	73-74	PICKUP 1 TON, F-350 / SUPERDUTY All RWD; Exc. Supercab	
F	73-79	PICKUP 3/4 TON, F-250 / SUPERDUTY RWD	
F	70-72	PICKUP 3/4 TON, F-250 / SUPERDUTY All RWD	
F	77-91	VAN 1 TON, ECONOLINE / CLUB WAGON / SUPERDUTY All	
F	75-91	VAN 1 TON, ECONOLINE / CLUB WAGON / SUPERDUTY All Exc. Cutaway Chassis	
F	75-91	VAN 3/4 TON, ECONOLINE / CLUB WAGON / SUPERDUTY All	
34073	D	-continued	141041
F	71-73	BUICK CENTURION All	
F	85-89	ELECTRA Estate Wagon	
F	71-84	ELECTRA All	
F	71-83	ESTATE WAGON All	
F	88-89	LESABRE All	
F	71-85	LESABRE All	
F	71-78	RIVIERA All	
F	91-96	ROADMASTER All	
F	87-92	CADILLAC BROUGHAM All	
F	92-96	COMMERCIAL CHASSIS RWD	
F	77-84	COMMERCIAL CHASSIS All	
F	77-84	DEVILLE All	
F	93-96	FLEETWOOD All	
F	85-86	FLEETWOOD RWD	
F	77-84	FLEETWOOD All	
F	81	CHEVROLET BEL AIR Sedan	
F	75	BEL AIR Sedan	
F	65-74	BEL AIR All	
F	65-72	BISCAYNE All	
F	69-72	BROOKWOOD All	
F	70-81	CAMARO All	
F	66-96	CAPRICE All	
F	94-96	IMPALA All	
F	83-85	IMPALA All	
F	82	IMPALA Sedan	
F	65-81	IMPALA All	
F	69-72	KINGSWOOD All	
F	69-72	TOWNSMAN All	
F	65-74	FORD COUNTRY SEDAN All	
F	87-91	COUNTRY SQUIRE All	
F	65-74	COUNTRY SQUIRE All	
F	92-02	CROWN VICTORIA All Exc. Hydraulic Self Leveling System	
F	65-72	CUSTOM All	

Front Load Carrier, Rear Load Carrier

Shock	POP	Alternative No.	MTG Acc. Supplied
Pos.	Year	Application	
34073	D	-continued	141041
F	68-77	CUSTOM 500 All	
F	65-67	GALAXIE All	
F	68-74	GALAXIE 500 All	
F	01-02	GRAND MARQUIS All	
F	87-91	LTD / COUNTRY SEDAN / COUNTRY SQUIRE / CROWN VICTORIA All	
F	67-82	LTD / COUNTRY SEDAN / COUNTRY SQUIRE / CROWN VICTORIA All	
F	77-79	LTD II All	
F	72-79	RANCHERO All	
F	65-74	RANCH WAGON All	
F	67-79	THUNDERBIRD All	
F	72-76	TORINO All	
F	70-80	LINCOLN CONTINENTAL All	
F	68-71	MARK III All	
F	72-76	MARK IV All	
F	77-79	MARK V All	
F	80-83	MARK VI All	
F	81-02	TOWN CAR All	
F	67	MERCURY BROUGHAM All	
F	87-91	COLONY PARK All	
F	65-74	COLONY PARK All	
F	65-68	COMMUTER All	
F	74-79	COUGAR All	
F	92-02	GRAND MARQUIS All Exc. Hydraulic Self Leveling System	
F	75-91	GRAND MARQUIS All	
F	69-70	MARAUDER All	
F	65-67	MARAUDER All	
F	67-82	MARQUIS All	
F	65-68	MONTCLAIR All	
F	72-76	MONTEGO All	
F	65-74	MONTEREY All	
F	65-68	PARKLANE All	
F	65-67	VILLAGER All	
F	66-67	VOYAGER All	
F	71-85	OLDSMOBILE 88 SERIES All	
F	71-84	98 All	
F	71-92	CUSTOM CRUISER All	
F	71-81	PONTIAC BONNEVILLE All	
F	71-81	CATALINA All	
F	70-81	FIREBIRD All	
F	71-78	GRAND SAFARI All	
F	76-81	LAURENTIAN All	
F	76-86	PARISIENNE All	
F	87-89	SAFARI All	
34076	X	-continued	140780
F	91-94	FORD EXPLORER All	
F	91-94	MAZDA NAVAJO All	
43107	W	-continued	
F	87-91	CHEVROLET BLAZER 4WD Full Size; Exc. Quad Suspension and Lift Kit	
F	76-86	BLAZER 4WD Exc. Quad Suspension and Lift Kit	
F	75	BLAZER 4WD Exc. Lift Kit	
F	73-74	BLAZER All 4WD; Exc. Lift Kit	
F	69-72	BLAZER All 4WD	
F	81-86	PICKUP 1/2 TON, K10 All Standard Suspension; Exc. Lift Kit	
F	69-80	PICKUP 1/2 TON, K10 All Exc. Lift Kit	
F	87	PICKUP 1/2 TON, V10 All Exc. Lift Kit	
F	81-86	PICKUP 3/4 TON, K20 All Standard Suspension; Exc. Lift Kit	
F	73-80	PICKUP 3/4 TON, K20 All Exc. Lift Kit	
F	87	PICKUP 3/4 TON, V20 All Exc. Quad Suspension and Lift Kit	
F	81-86	SUBURBAN 1/2 TON, K10 All Standard Suspension; Exc. Lift Kit	
F	69-80	SUBURBAN 1/2 TON, K10 All Exc. Lift Kit	
F	87-88	SUBURBAN 1/2 TON, R10 RWD Exc. Quad Suspension and Lift Kit	
F	75-91	GMC JIMMY 4WD Exc. Quad Suspension and Lift Kit	
F	70-74	JIMMY All 4WD; Exc. Quad Suspension and Lift Kit	
F	73-86	PICKUP 1/2 TON, K15 / K1500 All Exc. Quad Suspension and Lift Kit	
F	69-72	PICKUP 1/2 TON, K15 / K1500 All	
F	87	PICKUP 1/2 TON, V1500 All Exc. Lift Kit	
F	69-86	PICKUP 3/4 TON, K25 / K2500 All Exc. Quad Suspension and Lift Kit	
F	87	PICKUP 3/4 TON, V2500 All Exc. Lift Kit	

Numerical listing

Shock	POP	Alternative No.	MTG Acc. Supplied
Pos.	Year	Application	
43107	W	-continued	
F	69-86	SUBURBAN 1/2 TON, K15 / K1500 All Exc. Quad Suspension and Lift Kit	
F	87-91	SUBURBAN 1/2 TON, V1500 All Exc. Lift Kit	
F	69-86	SUBURBAN 3/4 TON, K25 / K2500 All Exc. Quad Suspension and Lift Kit	
F	87-91	SUBURBAN 3/4 TON, V2500 All Exc. Lift Kit	
Rear Load Carrier			
43048	B	-continued	
R	75-80	CHEVROLET LUV PICKUP All	
R	72-74	LUV PICKUP All	
F	55-56	PICKUP 3800	
F	56	PICKUP All 3100	
F	55	PICKUP 3100	
R	75-80	DODGE COLT Wagon	
R	71-74	COLT All	
R	79-82	D50 RWD	
R	87-93	PICKUP, RAM 50 RWD	
R	83-86	PICKUP, RAM 50 All	
R	61-64	FORD PICKUP 1/2 TON, F-100 All	
R	61-66	PICKUP 1 TON, F-350 / SUPERDUTY All	
R	61-64	PICKUP 3/4 TON, F-250 / SUPERDUTY All	
R	55	PICKUP F SERIES All F-100	
F	48-52	PICKUP F SERIES All F-1, F-2 & F-3	
F	68-76	PICKUP P350 All Up through 8000# GVW	
F	75-76	PICKUP P400 All Up through 8000# GVW	
R	68	INTERNATIONAL 908C All	
R	68	1000C All	
F	68	1100C All Exc. Travelette with 166" Wheelbase	
R	68	1100C All Exc. Travelette with 166" Wheelbase	
F	68	1200C All Exc. Travelette with 166" Wheelbase	
R	68	1200C All Exc. Travelette with 166" Wheelbase	
F	68	1300C All Exc. Travelette with 166" Wheelbase	
R	68	1300C All Exc. Travelette with 166" Wheelbase	
R	68-72	M1100 / M1200 All	
R	69	M1400 All	
R	72-83	JEEP CJ5 All Exc. Lift Kit	
R	66-71	CJ5 All	
R	72-75	CJ6 All Exc. Lift Kit	
R	66-71	CJ6 All	
R	76-86	CJ7 All Exc. Lift Kit	
R	66-74	DJ5 All Exc. Lift Kit	
R	66-68	DJ6 All	
R	57-60	FC150 All	
F	63-65	FC170 All	
R	63-65	FC170 All	
R	63-66	GLADIATOR All Independent Front Suspension	
R	70-73	JEEPSTER All	
R	81-85	SCRAMBLER / CJ8 All	
R	61-67	UNIVERSAL All	
R	86-87	MAZDA B2000 RWD	
R	87-93	B2200 RWD	
R	87-93	B2600 RWD	
R	95-96	MITSUBISHI MIGHTY MAX All	
R	83-94	MIGHTY MAX RWD	
R	87-90	VAN All	
R	98-04	NISSAN FRONTIER RWD Exc. Desert Runner	
R	87-97	PICKUP RWD	
R	86	PICKUP RWD Mfg. from 8/86	
R	76-80	PLYMOUTH COLT All	
R	79-82	PICKUP All	
R	84-95	TOYOTA PICKUP RWD	
R	75-83	PICKUP RWD Mojave	
R	73-74	PICKUP All RWD; Mojave	
R	70-72	PICKUP All RWD	
R	84-88	VAN Leaf (RearSpringType)	
R	88	VAN WAGON All	
43049	C	-continued	140630
R	71-73	BUICK CENTURION All	
R	92-96	COMMERCIAL CHASSIS All	
R	71-84	ELECTRA All	
R	71-85	LESABRE All	
R	71-78	RIVIERA All	
R	92-96	ROADMASTER Sedan	
R	64-67	SKYLARK All Exc. HD Suspension	
R	64-67	SPECIAL All Exc. HD Suspension	

Numerical listing

Shock	POP	Alternative No.	MTG Acc. Supplied
Pos.	Year	Application	
43049	C	-continued	140630
R	87-92	CADILLAC	BROUGHAM All
R	92-96	COMMERCIAL CHASSIS	RWD
R	77-84	COMMERCIAL CHASSIS	All
R	77-84	DEVILLE	All
R	93-96	FLEETWOOD	RWD
R	77-86	FLEETWOOD	RWD
R	81	CHEVROLET	BEL AIR Sedan
R	75	BEL AIR	Sedan
R	65-74	BEL AIR	All
R	65-72	BISCAYNE	All
R	69-70	BROOKWOOD	All
R	81-96	CAPRICE	Sedan Police and Taxi Models
R	76-80	CAPRICE	Sedan Exc. Wagon
R	75-80	CAPRICE	Coupe Exc. Wagon
R	75	CAPRICE	Convertible Exc. Wagon
R	75	CAPRICE	Sedan
R	73-74	CAPRICE	Sedan Police and Taxi Models
R	71-72	CAPRICE	All Police and Taxi Models
R	66-70	CAPRICE	All
R	64-67	CHEVELLE	All Exc. HD Suspension
R	68	CHEVY II Leaf	(RearSpringType) Multi-Leaf Rear Spring
R	64-67	EL CAMINO	All
R	94-96	IMPALA	All
R	83-85	IMPALA	All
R	65-82	IMPALA	Sedan
R	74-81	IMPALA	Coupe
R	73	IMPALA	Hardtop
R	69-70	KINGSWOOD	All
R	64-67	MALIBU	All Exc. HD Suspension
R	69-72	NOVA	All Multi-Leaf Rear Spring
R	69-70	TOWNSMAN	All
R	65-85	OLDSMOBILE	88 SERIES All
R	71-84	98	All
R	64-67	CUTLASS / CUTLASS SUPREME	All Exc. HD Suspension
R	64-67	F85	All Exc. HD Suspension
R	65-66	STARFIRE	All
R	63-81	PONTIAC	BONNEVILLE All
R	75-81	CATALINA	Coupe
R	71-81	CATALINA	Sedan
R	71-74	CATALINA	Hardtop
R	63-70	CATALINA	All
R	67-70	EXECUTIVE	All
R	64-67	GTO	All Exc. HD Suspension
R	76-81	LAURENTIAN	All
R	64-67	LEMANS	All Exc. HD Suspension
R	76-86	PARISIENNE	Sedan
R	64-67	TEMPEST	All Exc. HD Suspension
R	71-72	VENTURA	Leaf (RearSpringType)
43058	D		140739
R	78-79	FORD	BRONCO All Exc. Lift Kit
R	66-77	BRONCO	All From Serial #830001; Exc. Lift Kit
R	65-69	PICKUP	1/2 TON, F-100 All RWD
R	75-79	PICKUP	1 TON, F-350 / SUPERDUTY Standard Cab Pickup, RWD
R	73-74	PICKUP	1 TON, F-350 / SUPERDUTY Standard Cab Pickup RWD
R	75-79	PICKUP	3/4 TON, F-250 / SUPERDUTY Cab & Chassis, RWD
R	75-79	PICKUP	3/4 TON, F-250 / SUPERDUTY Extended Cab Pickup, RWD
R	73-74	PICKUP	3/4 TON, F-250 / SUPERDUTY RWD
R	65-72	PICKUP	3/4 TON, F-250 / SUPERDUTY All RWD
R	69-74	VAN	1/2 TON, ECONOLINE / CLUB WAGON All
R	69-74	VAN	1 TON, ECONOLINE / CLUB WAGON / SUPERDUTY All
R	69-74	VAN	3/4 TON, ECONOLINE / CLUB WAGON / SUPERDUTY All
R	76-83	JEEP	CHEROKEE All
F	74-83	CHEROKEE	All
R	67	GLADIATOR	All
F	93	GRAND WAGONEER	All
R	93	GRAND WAGONEER	All
F	84-91	GRAND WAGONEER	All
R	84-91	GRAND WAGONEER	All
F	74-88	J10	PICKUP All
R	74-88	J10	PICKUP All
F	74-88	J20	PICKUP All
R	74-88	J20	PICKUP All
R	68-73	J2500	PICKUP All
R	76-83	WAGONEER	All
F	74-83	WAGONEER	All

Rear Load Carrier

Shock	POP	Alternative No.	MTG Acc. Supplied
Pos.	Year	Application	
43060	C		140630
R	73-81	BUICK	CENTURY All
R	71-83	ESTATE	WAGON All
R	65-67	GRAN SPORT	All
R	68-72	GS / GS350 / GS400 / GS455	All
R	73-87	REGAL	All
R	91-96	ROADMASTER	Wagon
R	68-72	SKYLARK	All
R	64-67	SKYLARK	All HD Suspension; Exc. Sportwagon
R	68-69	SPECIAL	All
R	64-67	SPECIAL	All HD Suspension; Exc. Sportwagon
R	70-72	SPORTWAGON	All
R	77-96	CHEVROLET	CAPRICE Wagon
R	68-73	CHEVELLE	All
R	64-67	CHEVELLE	All HD Suspension
R	68-87	EL CAMINO	All
R	71-82	IMPALA	Wagon
R	73-83	MALIBU	All
R	64-67	MALIBU	All HD Suspension
R	70-88	MONTE CARLO	All
R	78-87	GMC	SPRINT / CABALLERO RWD
R	71-77	SPRINT / CABALLERO	All
R	74-77	NISSAN	710 Wagon
R	78-80	810	Wagon
R	77-92	OLDSMOBILE	CUSTOM CRUISER All
R	68-87	CUTLASS / CUTLASS SUPREME	All
R	64-67	CUTLASS / CUTLASS SUPREME	All HD Suspension
R	80-83	CUTLASS CLASSIC / CUTLASS CRUISER	All
R	68-72	F85	All
R	64-67	F85	All HD Suspension
R	71-78	TORONADO	All
R	82-86	PONTIAC	BONNEVILLE All
R	78-80	GRAND AM	All
R	73-75	GRAND AM	All
R	75-83	GRAND LEMANS	All
R	69-87	GRAND PRIX	All
R	71-78	GRAND SAFARI	All
R	71-75	GRANDVILLE	All
R	68-73	GTO	All
R	64-67	GTO	All HD Suspension
R	68-81	LEMANS	All
R	64-67	LEMANS	All HD Suspension
R	80-86	PARISIENNE	Wagon
R	76-79	PARISIENNE	All Wagon
R	87-89	SAFARI	All
R	68-70	TEMPEST	All
R	64-67	TEMPEST	All HD Suspension
43062	W		
R	69-72	CHEVROLET	BLAZER All RWD; Coil(RearSpringType)
R	67-72	PICKUP	1/2 TON, C10 All Coil(RearSpringType)
R	67-72	PICKUP	3/4 TON, C20 All Coil(RearSpringType)
R	67-72	SUBURBAN	1/2 TON, C10 All
R	68-72	SUBURBAN	3/4 TON, C20 All
R	67-72	VAN	1/2 TON, P SERIES All
R	70-72	GMC	JIMMY All RWD; Coil(RearSpringType)
R	67-72	PICKUP	1/2 TON, C15 / C1500 All Coil(RearSpringType)
R	67-72	PICKUP	3/4 TON, C25 / C2500 All Coil(RearSpringType)
R	68-72	SUBURBAN	1/2 TON, C15 / C1500 All
R	68-72	SUBURBAN	3/4 TON, C25 / C2500 All Coil(RearSpringType)
R	68-72	VAN	1/2 TON, P SERIES All
43067	D		
R	70-71	CHRYSLER	300 All
R	67-73	IMPERIAL	All
R	70-73	NEWPORT	All
R	70-73	NEW YORKER	All
R	71-73	TOWN & COUNTRY	All
R	71	DODGE	MONACO All
R	72-93	PICKUP	1/2 TON, D100 SERIES All
R	72-93	PICKUP	1 TON, D300 SERIES All
R	72-93	PICKUP	3/4 TON, D200 SERIES All
R	73	POLARA	Wagon
R	71	POLARA	All
R	76-93	RAMCHARGER	RWD
R	74-75	RAMCHARGER	All
R	73	PLYMOUTH	GRAN FURY Hardtop
R	74-81	TRAILDUSTER	All
43084	W		140523
R	70-81	CHEVROLET	CAMARO All

Numerical listing

Shock	POP	Alternative No.	MTG Acc. Supplied
Pos.	Year	Application	
43084	W	-continued	140523
R	70-81	PONTIAC	FIREBIRD All
43085	D		140724
R	84-86	DODGE	MINI RAM All
R	99-03	VAN	1/2 TON, A / B SERIES / RAM 109.3 (WheelBase) Exc. 7000# GVW
R	81-98	VAN	1/2 TON, A / B SERIES / RAM 109.6 (WheelBase) Exc. 7000# GVW
R	71-80	VAN	1/2 TON, A / B SERIES / RAM All
R	99-03	VAN	1 TON, A / B SERIES / RAM All
R	95-98	VAN	1 TON, A / B SERIES / RAM All Exc. 4000# Front Axle
R	71-94	VAN	1 TON, A / B SERIES / RAM All
R	71-03	VAN	3/4 TON, A / B SERIES / RAM All
R	74-80	VAN	CB300 All
R	74-83	PLYMOUTH	VAN 1/2 TON, PB SERIES All
R	74-83	VAN	1 TON, PB SERIES All
R	74-83	VAN	3/4 TON, PB SERIES All
43093	W		141058
R	69-72	CHEVROLET	BLAZER All RWD; Leaf(RearSpringType)
R	63-72	PICKUP	1/2 TON, C10 All Leaf(RearSpringType)
R	67-72	PICKUP	1 TON, C30 All Exc. 11,000# Rear Axle
R	67-72	PICKUP	3/4 TON, C20 All Leaf(RearSpringType)
R	63-66	PICKUP	3/4 TON, C20 All
R	63-66	SUBURBAN	1/2 TON, 1500 All
R	67-77	VAN	1/2 TON, G / EXPRESS All
R	63-66	VAN	1/2 TON, P SERIES All
R	76-77	VAN	1 TON, G / EXPRESS All
R	75	VAN	1 TON, G / EXPRESS 110.0 (WheelBase)
R	75	VAN	1 TON, G / EXPRESS 125.0 (WheelBase)
R	71-74	VAN	1 TON, G / EXPRESS All
R	68-72	VAN	1 TON, P SERIES All Exc. 11,000# Rear Axle
R	67-77	VAN	3/4 TON, G / EXPRESS All
R	68-72	VAN	3/4 TON, P SERIES All
R	70-72	GMC	JIMMY RWD
R	67-72	PICKUP	1/2 TON, C15 / C1500 All Leaf(RearSpringType)
R	67-72	PICKUP	1 TON, C35/3500 All Exc. 11,000# Rear Axle
R	67-72	PICKUP	3/4 TON, C25 / C2500 All Leaf(RearSpringType)
R	63-65	PICKUP	1000 SERIES All
R	63-65	PICKUP	1500 SERIES All
R	67-77	VAN	1/2 TON, G / SAVANNA All
R	67	VAN	1/2 TON, P SERIES All
R	76-77	VAN	1 TON, G / SAVANNA All
R	75	VAN	1 TON, G / SAVANNA 110.0 (WheelBase)
R	75	VAN	1 TON, G / SAVANNA 125.0 (WheelBase)
R	71-74	VAN	1 TON, G / SAVANNA All Exc. 146" Wheelbase
R	68-72	VAN	1 TON, P SERIES All Exc. 11,000# Rear Axle
R	67-77	VAN	3/4 TON, G / SAVANNA All
R	68-72	VAN	3/4 TON, P SERIES All
R	63-65	VAN	1000 SERIES All
43096	D		
R	65-69	CHRYSLER	300 All
R	75-76	CORDOBA	All
R	74-75	IMPERIAL	All
R	74-78	NEWPORT	All
R	65-69	NEWPORT	All
R	74-78	NEW YORKER	All
R	65-69	NEW YORKER	All
R	74-78	TOWN & COUNTRY	All
R	65-70	TOWN & COUNTRY	All
R	65	DODGE	880 All
R	70-74	CHALLENGER	All
R	66-76	CHARGER	All
R	65-76	CORONET	All
R	77-78	MONACO	All Police Package
R	72-76	MONACO	All
R	65-70	MONACO	All
R	73	POLARA	All Exc. Wagon
R	72	POLARA	All
R	62-70	POLARA	All
R	75-77	ROYAL MONACO	All
R	70-74	PLYMOUTH	BARRACUDA All
R	62-70	BELVEDERE	All

Numerical listing

Shock	POP	Alternative No.	MTG Acc. Supplied
Pos.	Year	Application	
43096	D	-continued	
R	77-78	FURY All Police Package	
R	74-76	FURY All	
R	73	FURY Wagon	
R	65-69	FURY All	
R	74-77	GRAN FURY All	
R	73	GRAN FURY Wagon	
R	67	GTX All	
R	73-75	ROADRUNNER All	
R	68-70	ROADRUNNER All	
R	73-74	SATELLITE All	
R	65-70	SATELLITE All	
R	70	SUPERBIRD All	
R	67	VIP All	
43099	D		140126
R	66	FORD BRONCO All Thru Serial #830000	
R	75-79	PICKUP 1/2 TON, F-100 RWD	
R	70-74	PICKUP 1/2 TON, F-100 All Exc. Supercab	
R	75-79	PICKUP 1/2 TON, F-150 Standard Cab Pickup, RWD	
R	75-79	PICKUP 1 TON, F-350 / SUPERDUTY Cab & Chassis, RWD	
R	75-79	PICKUP 1 TON, F-350 / SUPERDUTY Extended Cab Pickup, RWD	
R	74	PICKUP 1 TON, F-350 / SUPERDUTY All RWD; Super Cab	
R	75-79	PICKUP 3/4 TON, F-250 / SUPERDUTY Standard Cab Pickup, RWD	
R	73-74	PICKUP 3/4 TON, F-250 / SUPERDUTY RWD Standard Cab Pickup	
R	70-72	PICKUP 3/4 TON, F-250 / SUPERDUTY All RWD; Standard Cab Pickup	
R	75-91	VAN 1/2 TON, ECONOLINE / CLUB WAGON All	
F	71-80	INTERNATIONAL SCOUT II All	
43111	D		140702
R	87-91	CHEVROLET BLAZER 4WD Full Size; Exc. Lift Kit	
R	85-86	BLAZER 4WD Exc. Lift Kit	
R	73-84	BLAZER All Exc. Lift Kit	
R	73-86	PICKUP 1/2 TON, C10 All	
R	73-86	PICKUP 1/2 TON, K10 All Exc. Lift Kit	
R	87	PICKUP 1/2 TON, R10 All	
R	87	PICKUP 1/2 TON, V10 All Exc. Lift Kit	
R	75-86	PICKUP 3/4 TON, C20 Standard Cab Pickup	
R	73-74	PICKUP 3/4 TON, C20 All Standard Cab Pickup	
R	73-86	PICKUP 3/4 TON, K20 All Exc. Lift Kit	
R	87	PICKUP 3/4 TON, R20 Standard Cab Pickup	
R	87	PICKUP 3/4 TON, V20 All Exc. Quad Suspension and Lift Kit	
R	73-86	SUBURBAN 1/2 TON, C10 All	
R	73-86	SUBURBAN 1/2 TON, K10 All Exc. Lift Kit	
R	87-88	SUBURBAN 1/2 TON, R10 All	
R	89-91	SUBURBAN 1/2 TON, R1500 All	
R	89-91	SUBURBAN 1/2 TON, V1500 All Exc. Lift Kit	
R	73-86	SUBURBAN 3/4 TON, C20 All	
R	73-86	SUBURBAN 3/4 TON, K20 All Exc. Lift Kit	
R	87-88	SUBURBAN 3/4 TON, R20 All	
R	89-91	SUBURBAN 3/4 TON, R2500 All	
R	87-88	SUBURBAN 3/4 TON, V20 All Exc. Quad Suspension and Lift Kit	
R	89-91	SUBURBAN 3/4 TON, V2500 All Exc. Lift Kit	
R	73	VAN 1/2 TON, P SERIES All	
R	73-78	VAN 3/4 TON, P SERIES All	
R	73-91	GMC JIMMY All Exc. Lift Kit	
R	73-86	PICKUP 1/2 TON, C15 / C1500 All	
R	79-86	PICKUP 1/2 TON, K15 / K1500 All Exc. Lift Kit	
R	78	PICKUP 1/2 TON, K15 / K1500 All Exc. Quad Suspension and Lift Kit	
R	75-77	PICKUP 1/2 TON, K15 / K1500 All Exc. Lift Kit	
R	87	PICKUP 1/2 TON, R1500 All	
R	87	PICKUP 1/2 TON, V1500 All Exc. Lift Kit	
R	75-86	PICKUP 3/4 TON, C25 / C2500 Cab & Chassis	

Rear Load Carrier

Shock	POP	Alternative No.	MTG Acc. Supplied
Pos.	Year	Application	
43111	D	-continued	140702
R	75-86	PICKUP 3/4 TON, C25 / C2500 Standard Cab Pickup	
R	73-74	PICKUP 3/4 TON, C25 / C2500 All	
R	73-86	PICKUP 3/4 TON, K25 / K2500 All Exc. Lift Kit	
R	88-89	PICKUP 3/4 TON, R2500 All Exc. Crew Cab & Bonus Cab	
R	87	PICKUP 3/4 TON, R2500 Cab & Chassis Exc. Crew Cab & Bonus Cab	
R	87	PICKUP 3/4 TON, R2500 Standard Cab Pickup Exc. Crew Cab & Bonus Cab	
R	87	PICKUP 3/4 TON, V2500 All Exc. Lift Kit	
R	73-86	SUBURBAN 1/2 TON, C15 / C1500 All	
R	73-86	SUBURBAN 1/2 TON, K15 / K1500 All Exc. Lift Kit	
R	87-91	SUBURBAN 1/2 TON, R1500 All	
R	87-91	SUBURBAN 1/2 TON, V1500 All Exc. Lift Kit	
R	73-86	SUBURBAN 3/4 TON, C25 / C2500 All	
R	73-86	SUBURBAN 3/4 TON, K25 / K2500 All Exc. Lift Kit	
R	87-91	SUBURBAN 3/4 TON, R2500 All	
R	87-91	SUBURBAN 3/4 TON, V2500 All Exc. Lift Kit	
R	73	VAN 1/2 TON, P SERIES All	
R	73-78	VAN 3/4 TON, P SERIES All	
43140	B		141150
R	65-74	FORD COUNTRY SEDAN All	
R	87-91	COUNTRY SQUIRE All	
R	65-74	COUNTRY SQUIRE All	
R	94-02	CROWN VICTORIA All	
R	93	CROWN VICTORIA All Exc. Hydraulic Self Leveling System	
R	92	CROWN VICTORIA All	
R	65-72	CUSTOM All	
R	68-77	CUSTOM 500 All	
R	65-67	GALAXIE All	
R	68-74	GALAXIE 500 All	
R	01-02	GRAND MARQUIS All	
R	87-91	LTD / COUNTRY SEDAN / COUNTRY SQUIRE / CROWN VICTORIA All	
R	67-82	LTD / COUNTRY SEDAN / COUNTRY SQUIRE / CROWN VICTORIA All	
R	77-79	LTD II All	
R	72-79	RANCHERO All	
R	65-74	RANCH WAGON All	
R	77-79	THUNDERBIRD All	
R	67-72	THUNDERBIRD All	
R	72-76	TORINO All	
R	70-80	LINCOLN CONTINENTAL All	
R	68-71	MARK III All	
R	72	MARK IV All	
R	80-83	MARK VI All	
R	81-02	TOWN CAR All	
R	67	MERCURY BROUGHAM All	
R	87-91	COLONY PARK All	
R	65-74	COLONY PARK All	
R	65-68	COMMUTER All	
R	74-79	COUGAR All	
R	75-02	GRAND MARQUIS All	
R	69-70	MARAUDER All	
R	65-67	MARAUDER All	
R	67-82	MARQUIS All	
R	65-68	MONTCLAIR All	
R	72-76	MONTEGO All	
R	65-74	MONTEREY All	
R	65-68	PARKLANE All	
R	65-67	VILLAGER All	
R	66-67	VOYAGER All	
43142	W		
R	80-96	FORD BRONCO All Exc. Lift Kit	
R	80-83	PICKUP 1/2 TON, F-100 RWD	
R	80-84	PICKUP 1/2 TON, F-150 RWD	
43161	C		
R	90-05	CHEVROLET ASTRO All	
R	85-89	ASTRO RWD	
R	90-05	GMC SAFARI All	
R	85-89	SAFARI RWD	
43162	C		140719
R	05	CHEVROLET BLAZER Base, 4WD	
R	05	BLAZER Base, RWD	
R	96-04	BLAZER LS, 4WD	
R	96-04	BLAZER LS, RWD	
R	95-02	BLAZER LT, RWD	

Numerical listing

Shock	POP	Alternative No.	MTG Acc. Supplied
Pos.	Year	Application	
43162	C	-continued	
R	95-01	BLAZER LT, 4WD	
R	95-99	BLAZER Base, 4WD	
R	95-99	BLAZER Base, RWD	
R	95-97	BLAZER Deluxe, RWD	
R	83-94	BLAZER, S MODELS All	
R	04-12	COLORADO RWD	
R	99-04	S10 LS, 4WD	
R	99-03	S10 Base, 4WD	
R	99-03	S10 Base, RWD	
R	99-03	S10 LS, RWD	
R	94-98	S10 LS	
R	82-98	S10 Base	
R	92-93	S10 EL	
R	83-92	S10 Tahoe	
R	88-90	S10 Durango	
R	82-86	S10 Durango	
R	04-12	GMC CANYON RWD	
R	05	JIMMY 4WD	
R	92-04	JIMMY All	
R	83-91	S15 JIMMY All	
R	82-04	SONOMA / S15 All	
R	91	SYCLONE All	
R	92-93	TYPHOON All	
R	96-00	ISUZU HOMBRE All	
R	96-01	OLDSMOBILE BRAVADA All	
R	91-94	BRAVADA All	
43163	B		
R	91-02	CHEVROLET C3500HD All Solid Front Axle	
R	88-99	PICKUP 1/2 TON, C15 / C1500 All	
R	88-99	PICKUP 1/2 TON, K15 / K1500 All	
R	88-90	PICKUP 1 TON, C35/3500 Extended Cab Pickup Exc. HD Straight Front Axle	
R	88-90	PICKUP 1 TON, C35/3500 Standard Cab Pickup Exc. HD Straight Front Axle	
R	88-00	PICKUP 1 TON, K35 / K3500 All	
R	88-00	PICKUP 3/4 TON, C25 / C2500 All	
R	88-00	PICKUP 3/4 TON, K25 / K2500 All	
R	88-99	GMC PICKUP 1/2 TON, C15 / C1500 All	
R	88-99	PICKUP 1/2 TON, K15 / K1500 All	
R	91-00	PICKUP 1 TON, C35/3500 All HD Solid Front Axle	
R	88-90	PICKUP 1 TON, C35/3500 Extended Cab Pickup Exc. HD Straight Front Axle	
R	88-90	PICKUP 1 TON, C35/3500 Standard Cab Pickup Exc. HD Straight Front Axle	
R	88-00	PICKUP 1 TON, K35 / K3500 All	
R	88-00	PICKUP 3/4 TON, C25 / C2500 All	
R	88-00	PICKUP 3/4 TON, K25 / K2500 All	
43165	W		
R	89	FORD BRONCO II All Mfg. to 2/89; Vehicles with 10mm & 12mm bolt in rear lower mount	
R	84-88	BRONCO II All With 10mm Bolt In Rear Lower Mount	
R	89	RANGER RWD Mfg. to 2/89; Vehicles with 10mm bolt in rear lower mount	
R	83-88	RANGER RWD	
43167	B		
R	85-96	FORD PICKUP 1/2 TON, F-150 RWD	
R	80-97	PICKUP 1 TON, F-350 / SUPERDUTY RWD Exc. Dual Rear Wheels	
R	97	PICKUP 3/4 TON, F-250 / SUPERDUTY RWD Over 8500# GVW	
R	80-96	PICKUP 3/4 TON, F-250 / SUPERDUTY RWD	
R	06-11	RANGER RWD, Coil (Front/SpringType)	
R	90-05	RANGER RWD	
43171	D		140719
R	95-01	FORD EXPLORER All Exc. Adjustable Suspension	
R	01-05	EXPLORER SPORT TRAC All	
R	97-01	MERCURY MOUNTAINEER All Exc. Electronic Adjustable Suspension	
43172	X		140719
R	91-94	FORD EXPLORER All	
R	91-94	MAZDA NAVAJO All	

Numerical listing

Shock	POP	Alternative No.	MTG Acc. Supplied
Pos.	Year	Application	
43173	D		
R	95-03	FORD WINDSTAR Coil (RearSpringType)	
43180	C		
R	99-00	CADILLAC ESCALADE All	
R	92-94	CHEVROLET BLAZER 4WD Full Size	
R	92-99	SUBURBAN 1/2 TON, C15 / C1500 All	
R	92-99	SUBURBAN 1/2 TON, K15 / K1500 All	
R	92-99	SUBURBAN 3/4 TON, C25 / C2500 All	
R	92-99	SUBURBAN 3/4 TON, K25 / K2500 All	
R	95-00	TAHOE All Old Body Style	
R	96-14	VAN 1/2 TON, G / EXPRESS All	
R	96-02	VAN 1 TON, G / EXPRESS All	
R	96-02	VAN 3/4 TON, G / EXPRESS All Exc. 8600# GVW	
R	92-99	GMC SUBURBAN 1/2 TON, C15 / C1500 All	
R	92-99	SUBURBAN 1/2 TON, K15 / K1500 All	
R	92-99	SUBURBAN 3/4 TON, C25 / C2500 All	
R	92-99	SUBURBAN 3/4 TON, K25 / K2500 All	
R	96-14	VAN 1/2 TON, G / SAVANNA All	
R	96-02	VAN 1 TON, G / SAVANNA All	
R	96-02	VAN 3/4 TON, G / SAVANNA All Exc. 8600# GVW	
R	92-99	YUKON All	
43181	B		
R	99-07	CHEVROLET PICKUP 1/2 TON, SILVERADO 1500 RWD Exc. Electronic Adjustable Suspension	
R	94-01	DODGE PICKUP 1/2 TON, RAM 1500 (SEE RAM 1500) All	
R	94-02	PICKUP 1 TON, RAM 3500 (SEE RAM 3500) RWD Exc. Solid Front Axle	
R	94-02	PICKUP 3/4 TON, RAM 2500 (SEE RAM 2500) RWD	
R	99-07	GMC SIERRA 1500 RWD Exc. Electronic Adjustable Suspension	
Ultra Cartridge			
G44450	W		141429
F	92-94	AUDI 100 All	
F	91	100 All Mfg. Late 91	
F	89-90	100 All	
F	89-94	100 QUATTRO All	
F	89-91	200 All	
F	89-91	200 QUATTRO Wagon	
F	78-88	5000 All	
F	95-97	A6 All	
F	95-97	A6 QUATTRO All	
F	84-86	QUATTRO All	
F	92-94	S4 All	
F	95-97	S6 All	
F	90-94	V8 QUATTRO All	
G44451	W		141860
F	84-86	BUICK SKYHAWK All Rebuildable O.E. Struts	
F	86-91	SKYLARK All Rebuildable O.E. Struts	
F	85-87	SOMERSET / SOMERSET REGAL All Rebuildable O.E. Struts	
F	84-86	CADILLAC CIMARRON All Rebuildable O.E. Struts	
F	84-86	CHEVROLET CAVALIER All Rebuildable O.E. Struts	
F	85-86	OLDSMOBILE CALAIS All Rebuildable O.E. Struts	
F	84-86	FIRENZA All Rebuildable O.E. Struts	
F	85-86	PONTIAC GRAND AM All Rebuildable O.E. Struts	
F	84-85	J2000 / SUNBIRD All Rebuildable O.E. Struts	
F	86-87	SUNBIRD All Rebuildable O.E. Struts	
G44459	C		141934
F	88-96	BUICK REGAL All	
F	90-01	CHEVROLET LUMINA All	
F	95-99	MONTE CARLO All	
F	88-97	OLDSMOBILE CUTLASS / CUTLASS SUPREME All	
F	88-96	PONTIAC GRAND PRIX All	

Rear Load Carrier, Ultra Cartridge

Shock	POP	Alternative No.	MTG Acc. Supplied
Pos.	Year	Application	
G44461	W		140804
F	94-98	SAAB 900 Turbocharged (Eng Asp)	
F	93	900 Turbocharged (Eng Asp) Mfg. from 6/30/93	
G44477	X		141039
R	92-94	TOYOTA CAMRY FWD Rebuildable O.E. Struts	
G44493	W		
F	92-95	BMW 525I All Exc. Electronic Adjustable Suspension	
G44495	W		141741
F	94-98	SAAB 900 Naturally Aspirated (Eng Asp)	
F	93	900 Naturally Aspirated (Eng Asp) Mfg. from 6/30/93	
G44497	W		
F	92	BMW 525I All Mfg. to 9/92	
F	91	525I All	
F	90	525I All Mfg. from 8/90	
F	94-95	530I Sedan	
F	91-93	535I All	
F	90	535I All Mfg. from 8/90	
F	94-95	540I All	
F	91	735I All	
F	93	740I All	
F	88-93	750IL All	
G44713	W		141422
F	77-83	BMW 320I All	
G44724	W		141028
F	81-84	TOYOTA STARLET All	
G44735	W		141028
F	81-85	MAZDA RX7 GS	
F	81-85	RX7 S	
G44743	D		141028
F	89-90	TOYOTA TERCEL All	
F	87-88	TERCEL Hatchback	
F	87-88	TERCEL Sedan	
G44745	W		141428
F	91	BMW 318I All	
F	84-85	318I All	
F	91	318IS All	
G44747	W		141867
F	87	TOYOTA COROLLA DLX, FWD Exc. FX16 Rebuildable Front Struts	
F	87	COROLLA LE Rebuildable Front Struts	
F	87	COROLLA Sport DLX Rebuildable Front Struts	
F	87	COROLLA Sport GTS Rebuildable Front Struts	
F	86	COROLLA FWD Rebuildable Front Struts	
F	84-85	COROLLA FWD, GAS Rebuildable Front Struts	
G44748	D		141028
F	83-87	TOYOTA TERCEL FWD	
G44752	D		141796
F	80-83	NISSAN 200SX All	
F	79-82	210 All	
F	78-81	510 All	
F	74-78	B210 All	
G44763	D		142730
F	85-93	VOLKSWAGEN CABRIOLET All	
F	80-84	JETTA All	
F	75-84	RABBIT All	
F	80-83	RABBIT PICKUP All	
F	75-89	SCIROCCO All	
G44766	W		141796
R	86	NISSAN MULTI All	
R	82-86	STANZA All	
G44767	W		141796
F	86-88	NISSAN MULTI All	
F	82-86	STANZA All	
G44774	W		142717
F	90-92	VOLKSWAGEN CORRADO 1.8L 4Cyl L (1780) Rebuildable Front Struts	
F	85-92	GOLF All Rebuildable Front Struts	
F	85-92	JETTA All Rebuildable Front Struts	

Numerical listing

Shock	POP	Alternative No.	MTG Acc. Supplied
Pos.	Year	Application	
G44775	D		141662
F	87-88	BMW 325 All Exc. Sport Suspension	
F	86	325 All	
F	84-87	325E All Exc. Sport Suspension	
F	87-92	325i E30 (MfrBodyCode) Exc. Sport Suspension	
F	87-92	325iS All Exc. Sport Suspension	
G44776	D		141923
R	91-94	NISSAN AXXESS All	
R	90	AXXESS FWD	
R	86-88	MAXIMA Sedan Exc. Electronic Adjustable Suspension	
R	85	MAXIMA All Exc. Electronic Adjustable Suspension	
R	87-88	MULTI All	
R	87-89	STANZA Sedan	
G44783	W		141039
F	95-96	TOYOTA AVALON All Rebuildable O.E. Struts	
F	95-96	CAMRY All Rebuildable O.E. Struts	
G44800	W		142167
F	83-88	TOYOTA TERCEL Wagon, 4WD	
G44802	W		141028
F	85-89	TOYOTA MR2 All	
G44803	W		141028
R	85-86	TOYOTA MR2 All	
G44850	D		141420
F	87-88	PORSCHE 924 All	
F	77-82	924 All	
F	83-88	944 All	
F	74-79	VOLKSWAGEN SUPER BEETLE All	
F	73	SUPER BEETLE All 2 Bolt Flange-Type Lower Mount	
G44856	D		142284
F	75-93	VOLVO 240 / 242 / 244 / 245 / 262 / 264 / 265 All	
F	84	DL All Exc. Hydraulic Self Leveling System	
F	84	GLE All Exc. Hydraulic Self Leveling System	
G44862	D		141748
F	71-73	VOLKSWAGEN SUPER BEETLE All 3 Bolt Flange-Type Lower Mount	
G44867	W		141800
R	74-75	NISSAN 260Z 2+2	
R	75-78	280Z All	
G44868	W		141760
R	70-73	NISSAN 240Z All	
R	74	260Z Base	
G44869	D		141762
F	70-73	NISSAN 240Z All	
F	74-75	260Z All	
F	75-78	280Z All	
F	79-83	280ZX All	
F	81	810 All	
F	82-84	MAXIMA All	
G44898	W		141039
F	79-82	TOYOTA CORONA All	
F	78-80	CRESSIDA All	
G44902	W		142717
F	88-92	AUDI 80 All	
F	88-92	80 QUATTRO All	
F	93-95	90 All	
F	88-91	90 All	
F	93-95	90 QUATTRO All	
F	88-91	90 QUATTRO All	
F	80-87	4000 All	
F	84-87	4000 QUATTRO All	
F	94-98	CABRIOLET All	
F	81-87	COUPE All	
F	90-91	COUPE QUATTRO All	
F	73-79	FOX All	
F	87-93	VOLKSWAGEN FOX All	
F	82-88	QUANTUM All	
G44903	D		141070
F	94	ASUNA GT	
F	92	GT	
F	93	GT, SE All	
F	94	SE	
F	92	SE	
F	99-02	DAEWOO LANOS All	

Numerical listing

Shock	POP	Alternative No.	MTG Acc. Supplied
Pos.	Year	Application	
G44903	D	-continued	141070
F	88-93	PONTIAC LEMANS All	
G44920	W		141769
F	82-88	BMW 528E All Auto-Leveling System	
F	83-84	533I All Auto-Leveling System	
F	85-88	535I All Auto-Leveling System	
F	88	535IS All Auto-Leveling System	
F	85-89	635CSI All Exc. Auto-Leveling System	
G44926	D		141845
F	81-92	TOYOTA CRESSIDA All Exc. Electronic Adjustable Suspension	
G44934	W		141796
F	85-88	NISSAN 200SX All	
F	84	200SX All Solid Rear Axle	
G44936	W		141039
F	84-86	NISSAN 300ZX All	
G44937	X		141070
F	87-89	CHRYSLER CONQUEST All Exc. Electronic Adjustable Suspension	
F	87-89	MITSUBISHI STARION All Exc. Electronic Adjustable Suspension	
G44938	D		142256
F	76-85	TOYOTA CELICA All	
F	75	CELICA All Mfg. from 10/75	
F	84-87	COROLLA Coupe, Standard, Rack (SteeringType)	
F	75-83	COROLLA All	
F	74	COROLLA All Mfg. from 8/74	
F	86	SUPRA All Mfg. to 3/86	
G44939	W		143011
F	88-89	TOYOTA CELICA AWD	
F	86-87	CELICA All Exc. All-Trac	
F	87-88	COROLLA FX16 Rebuildable Front Struts	
F	84-85	COROLLA FWD, DIESEL	
G44940	D		141768
F	83-86	TOYOTA CAMRY All	
G44941	D		142284
F	84-92	VOLVO 740 / 745 / 760 / 780 All Mfg. from 5/84; Exc. Hydraulic Self Leveling System	
F	89	740 / 745 / 760 / 780 All Exc. Hydraulic Self Leveling System	
F	91-95	940 All Exc. Hydraulic Self Leveling System	
F	92-95	960 All Mfg. to 10/94; Exc. Hydraulic Self Leveling System	
G44944	W		141975
F	86-89	HYUNDAI EXCEL All Rebuildable O.E. Front Struts	
F	87-89	MITSUBISHI PRECIS All Rebuildable O.E. Front Struts	
G44968	W		141039
F	87-89	NISSAN 300ZX All	
G44982	D		141039
F	87-91	TOYOTA CAMRY All Rebuildable O.E. Front Struts	
F	88-89	CELICA GT Exc. All-Trac	
F	88-89	CELICA GTS Exc. All-Trac	
F	88-89	CELICA ST Exc. All-Trac	
G44986	W		142717
F	90-97	VOLKSWAGEN PASSAT All Rebuildable O.E. Front Struts	
G44990	D		141923
R	89-94	NISSAN MAXIMA All Exc. Electronic Adjustable Suspension	
R	90-92	STANZA All	
G44991	X		141742
F	90	BMW 525I All Mfg. to 8/90	
F	89	525I All	
F	90	535I All Mfg. to 8/90	
F	89	535I All	
F	88	535I All Exc. Auto-Leveling System	
F	88	535IS All Exc. Auto-Leveling System	
G44994	W		141039
F	88-91	TOYOTA COROLLA Wagon	

Ultra Cartridge, HiJackers

Shock	POP	Alternative No.	MTG Acc. Supplied
Pos.	Year	Application	
G44995	D		141039
F	92-93	TOYOTA CELICA GT	
F	92-93	CELICA GTS	
F	92-93	CELICA ST	
F	90-91	CELICA All	
G44997	W		141039
R	92-95	TOYOTA MR2 All	
G44998	W		141039
F	91-95	TOYOTA MR2 All	
G44999	W		141039
F	92-94	TOYOTA CAMRY FWD Rebuildable O.E. Struts	
G244002	A		
F	99-03	SAAB 9-3 All	
HiJackers			
49105	W		140121,141099
R	75-80	AMERICAN MOTORS PACER All	
R	52-59	FORD COUNTRY SEDAN All	
R	52-56	COUNTRY SQUIRE All	
R	54-56	COURIER SEDAN DELIVERY All	
R	52-54	CRESTLINE All	
R	57	CUSTOM All	
R	52	CUSTOM All	
R	58	CUSTOM 300 All	
R	52-56	CUSTOMLINE All	
R	62-70	FAIRLANE All	
R	55-58	FAIRLANE All	
R	60-70	FALCON All	
R	52-56	MAINLINE All	
R	65-73	MUSTANG / MUSTANG II All	
R	60-65	RANCHERO All	
R	52-56	RANCH WAGON All	
R	54-56	SKYLINER All	
R	52-58	SUNLINER All	
R	55-57	THUNDERBIRD All	
R	68-71	TORINO All	
R	52-58	VICTORIA All	
R	62-64	JAGUAR XKE All	
R	79-83	MAZDA GLC Wagon	
R	78	GLC All	
R	75-76	RX3 Wagon Exc. Models with Tokico O.E. Struts	
R	72-74	RX3 All	
R	74-78	RX4 All	
R	59-60	MERCURY COLONY PARK All	
R	68-69	COMET All	
R	66-67	COMET Convertible	
R	66-67	COMET Hardtop	
R	66-67	COMET Sedan	
R	60-65	COMET All	
R	59-60	COMMUTER All	
R	67-73	COUGAR All	
R	59-60	COUNTRY CRUISER All	
R	62-63	METEOR All	
R	59-60	MONTCLAIR All	
R	68-71	MONTEGO All	
R	59-60	MONTEREY All	
R	59-60	PARLANE All	
R	69-78	SAAB 99 All	
R	59-68	VOLVO 122 All	
49106	D		141099
R	65-69	CHRYSLER 300 All	
R	75-76	CORDOBA All	
R	74-75	IMPERIAL All	
R	74-78	NEWPORT All	
R	65-69	NEWPORT All	
R	74-78	NEW YORKER All	
R	65-69	NEW YORKER All	
R	74-78	TOWN & COUNTRY All	
R	65-70	TOWN & COUNTRY All	
R	63-64	DODGE 330 All	
R	63-64	440 All	
R	65	880 All	
R	70-74	CHALLENGER All	
R	66-76	CHARGER All	
R	65-76	CORONET All	
R	62	DART All	
R	74-78	MONACO All	
R	73	MONACO All Exc. Wagon	
R	72	MONACO All	
R	65-70	MONACO All	
R	73	POLARA All Exc. Wagon	
R	72	POLARA All	
R	62-70	POLARA All	
R	75-77	ROYAL MONACO All	
R	62-70	PLYMOUTH BELVEDERE All	
R	62-63	FLEET SPECIAL All	
R	77-78	FURY All Police Package	
R	74-76	FURY All	

Numerical listing

Shock	POP	Alternative No.	MTG Acc. Supplied
Pos.	Year	Application	
49106	D	-continued	141099
R	73	FURY Wagon	
R	62-69	FURY All	
R	74-77	GRAN FURY All	
R	73	GRAN FURY Wagon	
R	67	GTX All	
R	68-75	ROADRUNNER All	
R	65-74	SATELLITE All	
R	62-64	SAVOY All	
R	70	SUPERBIRD All	
R	67	VIP All	
49107	W		141099
R	69-72	CHEVROLET BLAZER All Coil(RearSpringType)	
R	67-72	PICKUP 1/2 TON, C10 All Coil(RearSpringType)	
R	67-72	PICKUP 3/4 TON, C20 All Coil(RearSpringType)	
R	68-72	SUBURBAN 1/2 TON, C10 All	
R	68-72	SUBURBAN 3/4 TON, C20 All	
R	67-72	VAN 1/2 TON, P SERIES All	
R	70-72	GMC JIMMY All Coil(RearSpringType)	
R	67-72	PICKUP 1/2 TON, C15 / C1500 All Coil(RearSpringType)	
R	67-72	PICKUP 3/4 TON, C25 / C2500 All Coil(RearSpringType)	
R	68-72	SUBURBAN 1/2 TON, C15 / C1500 All Coil(RearSpringType)	
R	68-72	SUBURBAN 3/4 TON, C25 / C2500 All	
R	68-72	VAN 1/2 TON, P SERIES All Coil(RearSpringType)	
49110	W		140377,141099
R	57-64	CHRYSLER 300 All	
R	55-56	NASSAU All	
R	51-64	NEWPORT All	
R	51-64	NEW YORKER All	
R	57-60	SARATOGA All	
R	51-52	SARATOGA All	
R	55-56	ST REGIS All	
R	51-64	TOWN & COUNTRY All	
R	51-61	WINDSOR All	
R	62-64	DODGE 880 All	
R	51-59	CORONET All	
R	54-61	CUSTOM All	
R	63-76	DART All	
R	60-61	DART All	
R	61-62	LANCER All	
R	51-54	MEADOWBROOK All	
R	60-61	POLARA All	
R	64-69	PLYMOUTH BARRACUDA All	
R	53-61	BELVEDERE All	
R	51-53	CAMBRIDGE All	
R	51-52	CONCORD All	
R	51-53	CRANBROOK All	
R	58-61	CUSTOM All	
R	70-76	DUSTER All	
R	60-61	FLEET SPECIAL All	
R	56-61	FURY All	
R	54-58	PLAZA All	
R	53-61	SAVOY All	
R	71-76	SCAMP All	
R	60-61	SPORT WAGON All	
R	51-61	SUBURBAN All	
R	60-76	VALIANT All	
49114	W		141150,141099
R	64-69	BUICK SPORTWAGON All	
R	72	OLDSMOBILE CUTLASS / CUTLASS SUPREME Cruiser	
R	64-72	VISTA CRUISER All	
49122	W		140523,141099
R	68-70	CADILLAC ELDORADO All Vertically Mounted	
R	68-69	CHEVROLET CAMARO All Single Leaf Rear Springs	
R	67	CAMARO All	
R	66	OLDSMOBILE TORONADO All Vertically Mounted	
R	67	PONTIAC FIREBIRD All	
49127	D		140739,141137,141099
R	78-79	FORD BRONCO All Exc. Lift Kit	
R	67-77	BRONCO All From Serial #830001; Exc. Lift Kit	
R	65-69	PICKUP 1/2 TON, F-100 All RWD	
R	75-79	PICKUP 1 TON, F-350 / SUPERDUTY Standard Cab Pickup, RWD	
R	73-74	PICKUP 1 TON, F-350 / SUPERDUTY Standard Cab Pickup RWD	

Numerical listing

Shock	POP	Alternative No.	MTG Acc. Supplied
Pos.	Year	Application	
49127	D	-continued	140739,141137,141099
R	75-79	PICKUP 3/4 TON, F-250 / SUPERDUTY Cab & Chassis, RWD	
R	75-79	PICKUP 3/4 TON, F-250 / SUPERDUTY Extended Cab Pickup, RWD	
R	65-69	PICKUP 3/4 TON, F-250 / SUPERDUTY All Supercab	
R	69-74	VAN 1/2 TON, ECONOLINE / CLUB WAGON All	
R	69-74	VAN 1 TON, ECONOLINE / CLUB WAGON / SUPERDUTY All	
R	69-74	VAN 3/4 TON, ECONOLINE / CLUB WAGON / SUPERDUTY All	
R	76-83	JEEP CHEROKEE All	
R	67	GLADIATOR All	
R	84-91	GRAND WAGONEER All	
R	74-88	J10 PICKUP All	
R	74-88	J20 PICKUP All	
R	68-73	J2500 PICKUP All	
R	76-83	WAGONEER All	
49128	D		140644,141099
R	70	BUICK ESTATE WAGON All	
R	65-70	OLDSMOBILE 88 SERIES All	
R	65-70	98 All	
R	67	CUTLASS / CUTLASS SUPREME Turnpike Cruiser	
R	65-66	STARFIRE All	
R	63-70	PONTIAC BONNEVILLE All	
R	63-70	CATALINA All	
R	67-70	EXECUTIVE All	
R	63-68	GRAND PRIX All	
R	63-66	STAR CHIEF All	
49131	D		140630,141099
R	71-73	BUICK CENTURION All	
R	71-84	ELECTRA All	
R	71-85	LESABRE All	
R	71-78	RIVIERA All	
R	92-96	ROADMASTER Sedan	
R	64-67	SKYLARK All Exc. HD Suspension	
R	64-67	SPECIAL All Exc. HD Suspension	
R	87-92	CADILLAC BROUGHAM All	
R	92-96	COMMERCIAL CHASSIS RWD	
R	77-84	COMMERCIAL CHASSIS All	
R	77-84	DEVILLE All	
R	93-96	FLEETWOOD RWD	
R	77-86	FLEETWOOD RWD	
R	81	CHEVROLET BEL AIR Sedan	
R	75	BEL AIR Sedan	
R	65-74	BEL AIR All	
R	65-72	BISCAYNE All	
R	69-70	BROOKWOOD All	
R	81-96	CAPRICE Sedan Police and Taxi Models	
R	75-80	CAPRICE Coupe	
R	75-80	CAPRICE Sedan	
R	75	CAPRICE Convertible	
R	73-74	CAPRICE Sedan Police and Taxi Models	
R	71-72	CAPRICE Hardtop Police and Taxi Models	
R	66-70	CAPRICE All	
R	64-67	CHEVELLE All Exc. HD Suspension	
R	64-67	EL CAMINO All Exc. HD Suspension	
R	94-96	IMPALA All	
R	83-85	IMPALA All	
R	73-82	IMPALA Sedan Exc. Wagon	
R	74-81	IMPALA Coupe Exc. Wagon	
R	73	IMPALA Hardtop Exc. Wagon	
R	70-72	IMPALA Sedan	
R	65-69	IMPALA All	
R	69-70	KINGSWOOD All	
R	64-67	MALIBU All Exc. HD Suspension	
R	69-70	TOWNSMAN All	
R	71-85	OLDSMOBILE 88 SERIES All	
R	71-84	98 All	
R	66-67	CUTLASS / CUTLASS SUPREME Base Exc. HD Suspension	
R	64-65	CUTLASS / CUTLASS SUPREME All Exc. HD Suspension	
R	64-67	F85 All Exc. HD Suspension	
R	71-81	PONTIAC BONNEVILLE All	
R	75-81	CATALINA Coupe	
R	71-81	CATALINA Sedan	
R	72-74	CATALINA Hardtop	
R	64-67	GTO All Exc. HD Suspension	
R	76-81	LAURENTIAN All	
R	64-67	LEMANS All Exc. HD Suspension	
R	76-86	PARISIENNE Sedan	
R	64-67	TEMPEST All Exc. HD Suspension	

HiJackers

Shock	POP	Alternative No.	MTG Acc. Supplied
Pos.	Year	Application	
49135	W		140523,141099
R	70-81	CHEVROLET CAMARO All	
R	70-81	PONTIAC FIREBIRD All	
49149	D		141099
R	70-71	CHRYSLER 300 All	
R	67-73	IMPERIAL All	
R	70-73	NEWPORT All	
R	70-73	NEW YORKER All	
R	71-73	TOWN & COUNTRY All	
R	73	DODGE MONACO All	
R	71	MONACO All	
R	72-93	PICKUP 1/2 TON, D100 SERIES All	
R	72-93	PICKUP 1 TON, D300 SERIES All	
R	82-93	PICKUP 3/4 TON, D200 SERIES All	
R	81	PICKUP 3/4 TON, D200 SERIES All Exc. HD Package	
R	72-80	PICKUP 3/4 TON, D200 SERIES All	
R	73	POLARA All	
R	71	POLARA All	
R	76-93	RAMCHARGER RWD	
R	74-75	RAMCHARGER All	
R	73	PLYMOUTH FURY All Exc. Wagon	
R	70-72	FURY All	
R	73	GRAN FURY Hardtop	
R	72	GRAN FURY All	
R	74-81	TRAILDUSTER All	
49151	W		141099
R	75-80	CHEVROLET LUV PICKUP All	
R	72-74	LUV PICKUP All	
R	75-80	DODGE COLT Wagon	
R	71-74	COLT All	
R	76-80	PLYMOUTH COLT All	
R	74-76	TOYOTA CORONA Sedan	
R	73-76	CORONA Hardtop	
R	73	CORONA Sedan Mfg. from 8/73	
R	69-71	CORONA Mark II, Sedan	
R	73-83	PICKUP RWD Mojave	
R	70-72	PICKUP RWD	
49152	W		140630,141099
R	73-77	BUICK CENTURY All	
R	87	ESTATE WAGON	
R	71-83	ESTATE WAGON All	
R	65-67	GRAN SPORT All	
R	68-72	GS / GS350 / GS400 / GS455 All	
R	73-77	REGAL All	
R	91-96	ROADMASTER Wagon	
R	68-72	SKYLARK All	
R	64-67	SKYLARK All HD Suspension; Exc. Sportwagon	
R	68-69	SPECIAL All	
R	64-67	SPECIAL All HD Suspension; Exc. Sportwagon	
R	70-72	SPORTWAGON All	
R	71-96	CHEVROLET CAPRICE Wagon	
R	68-73	CHEVELLE All	
R	64-67	CHEVELLE All HD Suspension	
R	68-77	EL CAMINO All	
R	71-82	IMPALA Wagon	
R	73-77	MALIBU All	
R	64-67	MALIBU All HD Suspension	
R	70-72	MONTÉ CARLO All	
R	71-77	GMC SPRINT / CABALLERO All	
R	75-76	NISSAN 610 Wagon	
R	73-74	610 All	
R	74-77	710 Wagon	
R	78-80	810 Wagon	
R	77-92	OLDSMOBILE CUSTOM CRUISER All	
R	76-77	CUTLASS / CUTLASS SUPREME Coupe	
R	76-77	CUTLASS / CUTLASS SUPREME Sedan	
R	73-75	CUTLASS / CUTLASS SUPREME All	
R	72	CUTLASS / CUTLASS SUPREME Base	
R	72	CUTLASS / CUTLASS SUPREME S	
R	68-71	CUTLASS / CUTLASS SUPREME All Exc. Vista Cruiser	
R	64-67	CUTLASS / CUTLASS SUPREME All HD Suspension; Exc. Vista Cruiser	
R	68-72	F85 All	
R	64-67	F85 All HD Suspension	
R	71-78	TRONADO All	
R	77-81	PONTIAC CATALINA Wagon	
R	74-75	CATALINA Wagon	
R	71-73	CATALINA Wagon Wagon	
R	73-75	GRAND AM All	
R	75-77	GRAND LEMANS All	
R	71-78	GRAND SAFARI All	
R	71-75	GRANDVILLE All	

Numerical listing

Shock	POP	Alternative No.	MTG Acc. Supplied
Pos.	Year	Application	
49152	W	-continued	140630,141099
R	68-73	GTO All	
R	64-67	GTO All HD Suspension	
R	64-67	LEMANS All HD Suspension	
R	80-86	PARISIENNE Wagon	
R	76-79	PARISIENNE All Wagon	
R	87-89	SAFARI All	
R	68-70	TEMPEST All	
R	64-67	TEMPEST All HD Suspension	
49155	W		140702,141099
R	87-91	CHEVROLET BLAZER 4WD Full Size; Exc. Quad Suspension and Lift Kit	
R	81-86	BLAZER 4WD Exc. Lift Kit	
R	73-80	BLAZER All Exc. Lift Kit	
R	73-86	PICKUP 1/2 TON, C10 All	
R	81-86	PICKUP 1/2 TON, K10 All Standard Suspension; Exc. Lift Kit	
R	73-80	PICKUP 1/2 TON, K10 All Exc. Lift Kit	
R	87	PICKUP 1/2 TON, R10 RWD	
R	87	PICKUP 1/2 TON, V10 All	
R	75-86	PICKUP 3/4 TON, C20 Standard Cab Pickup	
R	73-74	PICKUP 3/4 TON, C20 All Standard Cab Pickup	
R	81-86	PICKUP 3/4 TON, K20 All Standard Suspension; Exc. Lift Kit	
R	73-80	PICKUP 3/4 TON, K20 All Exc. Lift Kit	
R	87	PICKUP 3/4 TON, R20 Standard Cab Pickup	
R	87	PICKUP 3/4 TON, V20 All	
R	73-86	SUBURBAN 1/2 TON, C10 All	
R	81-86	SUBURBAN 1/2 TON, K10 All Standard Suspension; Exc. Lift Kit	
R	73-80	SUBURBAN 1/2 TON, K10 All Exc. Lift Kit	
R	87-88	SUBURBAN 1/2 TON, R10 RWD	
R	89-91	SUBURBAN 1/2 TON, R1500 RWD	
R	89-91	SUBURBAN 1/2 TON, V1500 All	
R	73-86	SUBURBAN 3/4 TON, C20 All	
R	81-86	SUBURBAN 3/4 TON, K20 All Standard Suspension; Exc. Lift Kit	
R	73-80	SUBURBAN 3/4 TON, K20 All Exc. Lift Kit	
R	87-88	SUBURBAN 3/4 TON, R20 RWD	
R	89-91	SUBURBAN 3/4 TON, R2500 RWD	
R	87-88	SUBURBAN 3/4 TON, V20 All	
R	89-91	SUBURBAN 3/4 TON, V2500 All	
R	73	VAN 1/2 TON, P SERIES All	
R	73-78	VAN 3/4 TON, P SERIES All	
R	87-91	GMC JIMMY All Exc. Quad Suspension and Lift Kit	
R	73-86	JIMMY All Exc. Lift Kit	
R	73-86	PICKUP 1/2 TON, C15 / C1500 All	
R	73-86	PICKUP 1/2 TON, K15 / K1500 All Exc. Quad Suspension and Lift Kit	
R	87	PICKUP 1/2 TON, R1500 All	
R	87	PICKUP 1/2 TON, V1500 All Quad Suspension; Exc. Lift Kit	
R	75-86	PICKUP 3/4 TON, C25 / C2500 Cab & Chassis	
R	75-86	PICKUP 3/4 TON, C25 / C2500 Standard Cab Pickup	
R	73-74	PICKUP 3/4 TON, C25 / C2500 All	
R	73-86	PICKUP 3/4 TON, K25 / K2500 All Exc. Quad Suspension and Lift Kit	
R	88-89	PICKUP 3/4 TON, R2500 All Exc. Crew Cab & Bonus Cab	
R	87	PICKUP 3/4 TON, R2500 Cab & Chassis Exc. Crew Cab & Bonus Cab	
R	87	PICKUP 3/4 TON, R2500 Standard Cab Pickup Exc. Crew Cab & Bonus Cab	
R	87	PICKUP 3/4 TON, V2500 All Exc. Lift Kit	
R	73-86	SUBURBAN 1/2 TON, C15 / C1500 All	
R	73-86	SUBURBAN 1/2 TON, K15 / K1500 All Exc. Quad Suspension and Lift Kit	
R	87-91	SUBURBAN 1/2 TON, R1500 All	
R	87-91	SUBURBAN 1/2 TON, V1500 All Exc. Lift Kit	
R	73-86	SUBURBAN 3/4 TON, C25 / C2500 All	
R	73-86	SUBURBAN 3/4 TON, K25 / K2500 All Exc. Quad Suspension and Lift Kit	
R	87-91	SUBURBAN 3/4 TON, R2500 All	
R	87-91	SUBURBAN 3/4 TON, V2500 All Exc. Lift Kit	

Numerical listing

Shock	POP	Alternative No.	MTG Acc. Supplied
Pos.	Year	Application	
49155	W	-continued	140702,141099
R 73	VAN 1/2 TON, P SERIES All		
R 73-78	VAN 3/4 TON, P SERIES All		
49157	X		140629,141099
R 73	BUICK APOLLO All HD Suspension		
R 68	CHEVROLET CHEVY II All Multi-Leaf Rear Spring		
R 73	NOVA All HD Suspension		
R 69-72	NOVA All Multi-Leaf Rear Spring		
R 73	PONTIAC VENTURA All HD Suspension		
R 71-72	VENTURA All Multi-Leaf Rear Spring		
49162	D		141058,141099
R 69-72	CHEVROLET BLAZER All Leaf(RearSpringType)		
R 63-72	PICKUP 1/2 TON, C10 All Leaf(RearSpringType)		
R 67-72	PICKUP 1 TON, C30 All Exc. 11,000# Rear Axle		
R 67-72	PICKUP 3/4 TON, C20 All Leaf(RearSpringType)		
R 63-66	PICKUP 3/4 TON, C20 All		
R 63-66	SUBURBAN 1/2 TON, 1500 All		
R 67-77	VAN 1/2 TON, G / EXPRESS All		
R 63-66	VAN 1/2 TON, P SERIES All		
R 76-77	VAN 1 TON, G / EXPRESS All		
R 75	VAN 1 TON, G / EXPRESS 110.0 (WheelBase)		
R 75	VAN 1 TON, G / EXPRESS 125.0 (WheelBase)		
R 71-74	VAN 1 TON, G / EXPRESS All		
R 68-72	VAN 1 TON, P SERIES All Exc. 11,000# Rear Axle		
R 67-77	VAN 3/4 TON, G / EXPRESS All		
R 68-72	VAN 3/4 TON, P SERIES All		
R 70-72	GMC JIMMY RWD		
R 67-72	PICKUP 1/2 TON, C15 / C1500 All Leaf(RearSpringType)		
R 67-72	PICKUP 1 TON, C35/3500 All Exc. 11,000# Rear Axle		
R 67-72	PICKUP 3/4 TON, C25 / C2500 All Leaf(RearSpringType)		
R 63-65	PICKUP 1000 SERIES All		
R 63-65	PICKUP 1500 SERIES All		
R 67-77	VAN 1/2 TON, G / SAVANNA All		
R 67	VAN 1/2 TON, P SERIES All		
R 76-77	VAN 1 TON, G / SAVANNA All		
R 75	VAN 1 TON, G / SAVANNA 110.0 (WheelBase)		
R 75	VAN 1 TON, G / SAVANNA 125.0 (WheelBase)		
R 71-74	VAN 1 TON, G / SAVANNA All Exc. 146" Wheelbase		
R 68-72	VAN 1 TON, P SERIES All Exc. 11,000# Rear Axle		
R 67-77	VAN 3/4 TON, G / SAVANNA All		
R 68-72	VAN 3/4 TON, P SERIES All		
R 63-65	VAN, PB 1000 SERIES All		
49173	D		140126,141099
R 66	FORD BRONCO All Thru Serial #830000		
R 75-79	PICKUP 1/2 TON, F-100 RWD		
R 70-74	PICKUP 1/2 TON, F-100 All w/Lift Kit		
R 75-79	PICKUP 1 TON, F-350 / SUPERDUTY Cab & Chassis, RWD		
R 75-79	PICKUP 1 TON, F-350 / SUPERDUTY Extended Cab Pickup, RWD		
R 74	PICKUP 1 TON, F-350 / SUPERDUTY All RWD; Extended Cab & Chassis Cab		
R 75-79	PICKUP 3/4 TON, F-250 / SUPERDUTY Standard Cab Pickup, RWD		
R 71-74	PICKUP 3/4 TON, F-250 / SUPERDUTY All RWD; Exc. Extended Cab & Chassis Cab		
R 75-91	VAN 1/2 TON, ECONOLINE / CLUB WAGON All		
49178	D		140126,141099
R 75-76	FORD PICKUP 1/2 TON, F-100 4WD Exc. Lift Kit		
R 70-74	PICKUP 1/2 TON, F-100 All Exc. Lift Kit		
R 76-79	PICKUP 1/2 TON, F-150 4WD Exc. Lift Kit		
R 75	PICKUP 1/2 TON, F-150 All 4WD; Exc. Lift Kit		
R 79	PICKUP 1 TON, F-350 / SUPERDUTY 4WD		

HiJackers

Shock	POP	Alternative No.	MTG Acc. Supplied
Pos.	Year	Application	
49178	D	-continued	140126,141099
R 77-79	PICKUP 3/4 TON, F-250 / SUPERDUTY Cab & Chassis, 4WD All From Serial No. Y20001		
R 77-79	PICKUP 3/4 TON, F-250 / SUPERDUTY Standard Cab Pickup, 4WD All From Serial No. Y20001		
R 92-14	VAN 1/2 TON, ECONOLINE / CLUB WAGON All		
R 77-14	VAN 1 TON, ECONOLINE / CLUB WAGON / SUPERDUTY All		
R 07	VAN 1 TON, ECONOLINE / CLUB WAGON / SUPERDUTY All Exc. Cutaway Chassis		
R 75-91	VAN 1 TON, ECONOLINE / CLUB WAGON / SUPERDUTY All Exc. Cutaway Chassis		
R 75-14	VAN 3/4 TON, ECONOLINE / CLUB WAGON / SUPERDUTY All		
49193	W		141035,141099
R 74-75	BUICK APOLLO All		
R 73	APOLLO All Exc. HD Suspension		
R 75-79	SKYLARK All		
R 68	CHEVROLET CHEVY II All Single-Leaf Rear Spring		
R 73	NOVA All Exc. HD Suspension		
R 69-72	NOVA All Single-Leaf Rear Spring		
R 74-77	OLDSMOBILE OMEGA All		
R 73	OMEGA All Exc. HD Suspension		
R 77-79	PONTIAC PHOENIX All		
R 74-77	VENTURA All		
R 73	VENTURA All Exc. HD Suspension		
R 71-72	VENTURA All Single-Leaf Rear Spring		
49196	W		140126,141099
R 87-88	FORD THUNDERBIRD Non-ABS		
R 80-86	THUNDERBIRD All		
R 82-87	LINCOLN CONTINENTAL All		
R 83-88	MERCURY COUGAR All		
R 80-82	COUGAR XR-7		
49197	D		141099
R 80-96	FORD BRONCO All Exc. Lift Kit		
R 80-83	PICKUP 1/2 TON, F-100 RWD		
R 80-84	PICKUP 1/2 TON, F-150 RWD		
49199	X		141282,141099
R 78-83	FORD FAIRMONT All		
R 81-82	GRANADA All		
R 83-86	LTD / COUNTRY SEDAN / COUNTRY SQUIRE / CROWN VICTORIA All		
R 84-93	MUSTANG / MUSTANG II LX, 2.3L 4Cyl L (140)		
R 84-86	MUSTANG / MUSTANG II LX, 3.8L 6Cyl V (232)		
R 82-83	MUSTANG / MUSTANG II GL		
R 82-83	MUSTANG / MUSTANG II GLX		
R 82-83	MUSTANG / MUSTANG II L		
R 82	MUSTANG / MUSTANG II Ghia		
R 79-81	MUSTANG / MUSTANG II All		
R 79-86	MERCURY CAPRI All		
R 81-82	COUGAR Base		
R 82	COUGAR GS		
R 82	COUGAR LS		
R 83-86	MARQUIS All		
R 78-83	ZEPHYR All		
49203	C		142261,141099
R 82-02	CHEVROLET CAMARO All		
R 82-02	PONTIAC FIREBIRD All		
49205	W		141150,141099
R 65-74	FORD COUNTRY SEDAN All		
R 87-91	COUNTRY SQUIRE All		
R 65-74	COUNTRY SQUIRE All		
R 92-02	CROWN VICTORIA All Rear Air Springs		
R 65-72	CUSTOM All		
R 68-77	CUSTOM 500 All		
R 65-67	GALAXIE All		
R 68-74	GALAXIE 500 All		
R 01-02	GRAND MARQUIS All		
R 87-91	LTD / COUNTRY SEDAN / COUNTRY SQUIRE / CROWN VICTORIA All		
R 67-82	LTD / COUNTRY SEDAN / COUNTRY SQUIRE / CROWN VICTORIA All		
R 77-79	LTD II All		
R 72-79	RANCHERO All		
R 65-74	RANCH WAGON All		
R 77-79	THUNDERBIRD All		
R 67-72	THUNDERBIRD All		

Numerical listing

Shock	POP	Alternative No.	MTG Acc. Supplied
Pos.	Year	Application	
49205	W	-continued	141150,141099
R 72-76	TORINO All		
R 70-80	LINCOLN CONTINENTAL All		
R 68-71	MARK III All		
R 72	MARK IV All		
R 80-83	MARK VI All		
R 81-02	TOWN CAR All		
R 67	MERCURY BROUGHAM All		
R 87-91	COLONY PARK All		
R 65-74	COLONY PARK All		
R 65-68	COMMUTER All		
R 74-79	COUGAR All		
R 75-02	GRAND MARQUIS All		
R 69-70	MARAUDER All		
R 65-67	MARAUDER All		
R 67-82	MARQUIS All		
R 65-68	MONTCLAIR All		
R 72-76	MONTEGO All		
R 65-74	MONTEREY All		
R 65-68	PARKLANE All		
R 65-67	VILLAGER All		
R 66-67	VOYAGER All		
49207	X		141099
R 89	FORD BRONCO II All Mfg. to 2/89; Vehicles with 10mm & 12mm bolt in rear lower mount		
R 84-88	BRONCO II All With 10mm Bolt In Rear Lower Mount		
R 89	RANGER RWD Mfg. to 2/89; Vehicles with 10mm bolt in rear lower mount		
R 83-88	RANGER RWD		
49212	C		141099
R 78-95	CHEVROLET VAN 1/2 TON, G / EXPRESS All		
R 78-95	VAN 1 TON, G / EXPRESS Cutaway Van		
R 78-95	VAN 3/4 TON, G / EXPRESS All Exc. 8600# GVW		
R 84-86	DODGE MINI RAM All		
R 99-03	VAN 1/2 TON, A / B SERIES / RAM 109.3 (WheelBase) Exc. 7000# GVW		
R 82-98	VAN 1/2 TON, A / B SERIES / RAM 109.6 (WheelBase) Exc. 7000# GVW		
R 71-80	VAN 1/2 TON, A / B SERIES / RAM All		
R 99-03	VAN 1 TON, A / B SERIES / RAM All		
R 95-98	VAN 1 TON, A / B SERIES / RAM All Exc. 4000# Front Axle		
R 71-94	VAN 1 TON, A / B SERIES / RAM All		
R 71-03	VAN 3/4 TON, A / B SERIES / RAM All		
R 78-80	VAN, CB300 All		
R 77	VAN, CB300 All Over 8300# GVW		
R 75-76	VAN, CB300 All		
R 74	VAN, CB300 All Over 8300# GVW		
R 78-95	GMC VAN 1/2 TON, G / SAVANNA All		
R 85-95	VAN 1 TON, G / SAVANNA Extended Cargo Van		
R 85-95	VAN 1 TON, G / SAVANNA Extended Passenger Van		
R 79-95	VAN 1 TON, G / SAVANNA Standard Cargo Van		
R 79-95	VAN 1 TON, G / SAVANNA Standard Passenger Van		
R 78	VAN 1 TON, G / SAVANNA Cutaway Van		
R 78-95	VAN 3/4 TON, G / SAVANNA All Exc. 8600# GVW		
R 74-83	PLYMOUTH VAN 1/2 TON, PB SERIES All		
R 74-83	VAN 1 TON, PB SERIES All		
R 74-83	VAN 3/4 TON, PB SERIES All		
49213	W		141099
R 05	CHEVROLET BLAZER Base, 4WD		
R 05	BLAZER Base, RWD		
R 96-04	BLAZER LS, 4WD		
R 96-04	BLAZER LS, RWD		
R 95-02	BLAZER LT, RWD		
R 95-01	BLAZER LT, 4WD		
R 95-99	BLAZER Base, 4WD		
R 95-99	BLAZER Base, RWD		
R 95-97	BLAZER Deluxe, RWD		
R 83-94	BLAZER, S MODELS All		
R 04-12	COLORADO RWD		
R 99-04	S10 LS, 4WD		
R 99-03	S10 Base, 4WD		
R 99-03	S10 Base, RWD		
R 99-03	S10 LS, RWD		

Numerical listing

Shock	POP	Alternative No.	MTG Acc. Supplied
Pos.	Year	Application	
49213	W	-continued	141099
R	94-98	S10 LS	
R	82-98	S10 Base	
R	92-93	S10 EL	
R	83-92	S10 Tahoe	
R	88-90	S10 Durango	
R	82-86	S10 Durango	
R	04-12	GMC CANYON RWD	
R	05	JIMMY 4WD	
R	92-04	JIMMY All	
R	83-91	S15 JIMMY All	
R	82-04	SONOMA / S15 All	
R	91	SYCLONE All	
R	92-93	TYPHOON All	
R	96-00	ISUZU HOMBRE All	
R	96-01	OLDSMOBILE BRAVADA All	
R	91-94	BRAVADA All	
49215	W		141099
R	90-05	CHEVROLET ASTRO All	
R	85-89	ASTRO RWD	
R	90-05	GMC SAFARI All	
R	85-89	SAFARI RWD	
R	86-89	VOLKSWAGEN VANAGON 4WD	
49216	X		141665,140719,141099
R	86-95	FORD TAURUS Wagon	
R	86-95	MERCURY SABLE Wagon	
49217	W		141099
R	80-96	FORD PICKUP 1/2 TON, F-150 4WD Exc. Lift Kit	
R	82-85	PICKUP 1 TON, F-350 / SUPERDUTY 4WD Clevis Type Lower Front Mount; Exc. Dual Rear Wheels or Lift Kit	
R	80-81	PICKUP 1 TON, F-350 / SUPERDUTY 4WD	
R	86	PICKUP 3/4 TON, F-250 / SUPERDUTY 4WD	
R	82-85	PICKUP 3/4 TON, F-250 / SUPERDUTY 4WD Clevis Type Lower Front Mount; Exc. Dual Rear Wheels or Lift Kit	
R	80-81	PICKUP 3/4 TON, F-250 / SUPERDUTY 4WD	
49218	W		141099
R	88-99	CHEVROLET PICKUP 1/2 TON, C15 / C1500 All	
R	88-99	PICKUP 1/2 TON, K15 / K1500 All	
R	01-03	PICKUP 1 TON, C35/3500 Base Exc. HD Straight Front Axle	
R	97-00	PICKUP 1 TON, C35/3500 All Exc. HD Straight Front Axle	
R	96	PICKUP 1 TON, C35/3500 All	
R	91-95	PICKUP 1 TON, C35/3500 All Exc. HD Straight Front Axle	
R	88-90	PICKUP 1 TON, C35/3500 Extended Cab Pickup Exc. HD Straight Front Axle	
R	88-90	PICKUP 1 TON, C35/3500 Standard Cab Pickup Exc. HD Straight Front Axle	
R	88-00	PICKUP 1 TON, K35 / K3500 All	
R	88-00	PICKUP 3/4 TON, C25 / C2500 All	
R	88-00	PICKUP 3/4 TON, K25 / K2500 All	
R	88-99	GMC PICKUP 1/2 TON, C15 / C1500 All	
R	88-99	PICKUP 1/2 TON, K15 / K1500 All	
R	92-00	PICKUP 1 TON, C35/3500 Cab & Chassis Exc. HD Straight Front Axle	
R	88-91	PICKUP 1 TON, C35/3500 All Exc. HD Straight Front Axle	
R	88-00	PICKUP 1 TON, K35 / K3500 All	
R	88-00	PICKUP 3/4 TON, C25 / C2500 All	
R	88-00	PICKUP 3/4 TON, K25 / K2500 All	
49221	W		141099
R	90-97	FORD AEROSTAR All	
R	89	AEROSTAR RWD	
49222	C		141099
R	87-95	JEEP WRANGLER YJ (MfrBodyCode)	
49223	D		141099
R	90	FORD BRONCO II All	
R	89	BRONCO II All Mfg. from 2/89; Vehicles with 12mm bolt in rear lower mount	
R	06	RANGER RWD, Coil (FrontSpringType)	
R	90-05	RANGER RWD	

HiJackers

Shock	POP	Alternative No.	MTG Acc. Supplied
Pos.	Year	Application	
49223	D	-continued	141099
R	89	RANGER RWD Mfg. from 2/89; Vehicles with 12mm bolt in rear lower mount	
R	94-97	MAZDA B2300 RWD	
49225	X		140719,141099
R	91-94	FORD EXPLORER All	
R	91-94	MAZDA NAVAJO All	
49226	W		141099
R	84-01	JEEP CHEROKEE All	
R	84-90	WAGONEER All	
49228	W		143331,141248,141099
R	00-05	BUICK LESABRE All All w/o OE Style air fitting	
R	06-11	LUCERNE All Exc. Magnetic Ride Control System	
R	97-05	PARK AVENUE All All w/o OE Style air fitting	
R	98-99	RIVIERA All	
R	95-97	RIVIERA All All w/o OE Style air fitting	
R	00-05	CADILLAC DEVILLE All Exc. Electronic Adjustable Suspension	
R	06-11	DTS All	
R	98-04	SEVILLE All All w/o OE Style air fitting	
R	01-03	OLDSMOBILE AURORA All All w/o OE Style air fitting	
R	95-99	AURORA All All w/o OE Style air fitting	
R	00-05	PONTIAC BONNEVILLE All All w/o OE Style air fitting	
49229	W		141099
R	89-98	MAZDA MPV RWD	
49230	W		141099
R	05-07	BUICK TERRAZA FWD Exc. Air-Leveling Suspension & Independent Rear Suspension	
R	05-08	CHEVROLET UPLANDER FWD Exc. Air-Leveling Suspension & Independent Rear Suspension	
R	97-05	VENTURE FWD	
R	97-04	OLDSMOBILE SILHOUETTE FWD	
R	99-05	PONTIAC MONTANA FWD Exc. Air-Leveling Suspension & Independent Rear Suspension	
R	97-98	TRANS SPORT All	
R	06-07	SATURN RELAY All Air-Leveling Suspension, Exc. Independent Rear Suspension	
R	05	RELAY All Exc. Air-Leveling Suspension & Independent Rear Suspension	
49231	W		141099
R	99-00	CADILLAC ESCALADE All	
R	92-94	CHEVROLET BLAZER 4WD Full Size	
R	92-99	SUBURBAN 1/2 TON, C15 / C1500 All	
R	92-99	SUBURBAN 1/2 TON, K15 / K1500 All	
R	92-99	SUBURBAN 3/4 TON, C25 / C2500 All	
R	92-99	SUBURBAN 3/4 TON, K25 / K2500 All	
R	95-00	TAHOE All Old Body Style	
R	96-14	VAN 1/2 TON, G / EXPRESS All	
R	96-02	VAN 1 TON, G / EXPRESS All	
R	96-02	VAN 3/4 TON, G / EXPRESS All Exc. 8600# GVW	
R	92-99	GMC SUBURBAN 1/2 TON, C15 / C1500 All	
R	92-99	SUBURBAN 1/2 TON, K15 / K1500 All	
R	92-99	SUBURBAN 3/4 TON, C25 / C2500 All	
R	92-99	SUBURBAN 3/4 TON, K25 / K2500 All	
R	96-14	VAN 1/2 TON, G / SAVANNA All	
R	96-02	VAN 1 TON, G / SAVANNA All	
R	96-02	VAN 3/4 TON, G / SAVANNA All Exc. 8600# GVW	
R	92-99	YUKON All	
49232	W		140719,141099
R	95-01	FORD EXPLORER All Exc. Adjustable Suspension	
R	01-05	EXPLORER SPORT TRAC All	

Numerical listing

Shock	POP	Alternative No.	MTG Acc. Supplied
Pos.	Year	Application	
49232	W	-continued	140719,141099
R	97-01	MERCURY MOUNTAINEER All Exc. Electronic Adjustable Suspension	
49233	W		141099
R	95-03	FORD WINDSTAR Coil (RearSpringType)	
49234	C		140126,141099
R	03-04	FORD MUSTANG / MUSTANG II Mach I	
R	94-04	MUSTANG / MUSTANG II Base	
R	94-04	MUSTANG / MUSTANG II GT	
R	04	MUSTANG / MUSTANG II GT Base	
R	04	MUSTANG / MUSTANG II GT Equipado	
R	01	MUSTANG / MUSTANG II GT Bullitt	
R	95	MUSTANG / MUSTANG II GTS	
49235	W		141099
R	99-07	CHEVROLET PICKUP 1/2 TON, SILVERADO 1500 RWD Exc. Electronic Adjustable Suspension	
R	94-01	DODGE PICKUP 1/2 TON, RAM 1500 (SEE RAM 1500) All	
R	94-02	PICKUP 1 TON, RAM 3500 (SEE RAM 3500) RWD Exc. Solid Front Axle	
R	94-02	PICKUP 3/4 TON, RAM 2500 (SEE RAM 2500) 4WD, GAS Exc. 8800# GVW	
R	94-02	PICKUP 3/4 TON, RAM 2500 (SEE RAM 2500) RWD	
R	95-96	PICKUP 3/4 TON, RAM 2500 (SEE RAM 2500) 4WD, CNG Exc. 8800# GVW	
R	99-07	GMC SIERRA 1500 RWD Exc. Electronic Adjustable Suspension	
49236	W		141099
R	96-07	CHRYSLER TOWN & COUNTRY All	
R	01-03	VOYAGER / GRAND VOYAGER All Exc. Hydraulic Self Leveling System	
R	00	VOYAGER / GRAND VOYAGER All	
R	96-07	DODGE CARAVAN / GRAND CARAVAN All Exc. Hydraulic Self Leveling System	
R	96-00	PLYMOUTH VOYAGER / GRAND VOYAGER Non-ABS	
49237	W		142700,141099
R	04	FORD PICKUP 1/2 TON, F-150 RWD	
R	00-03	PICKUP 1/2 TON, F-150 Harley-Davidson Edition, RWD	
R	99-03	PICKUP 1/2 TON, F-150 Lariat, RWD	
R	99-03	PICKUP 1/2 TON, F-150 XL, RWD	
R	99-03	PICKUP 1/2 TON, F-150 XLT, RWD	
R	00	PICKUP 1/2 TON, F-150 Base, RWD	
R	97-98	PICKUP 1/2 TON, F-150 RWD	
R	97-99	PICKUP 3/4 TON, F-250 / SUPERDUTY RWD Up through 8500# GVW	
49241	W		141099
R	97	FORD PICKUP 3/4 TON, F-250 / SUPERDUTY 4WD Over 8500# GVW	
R	87-96	PICKUP 3/4 TON, F-250 / SUPERDUTY 4WD	
49254	D		141572
R	97-02	CADILLAC ELDORADO All Exc. Electronic Ride Control	
49255	N		141099,143331
R	00-05	BUICK LESABRE All With OE Style air fitting	
R	97-05	PARK AVENUE All With OE Style air fitting	
R	95-99	RIVIERA All With OE Style air fitting	
R	00-05	CADILLAC DEVILLE All With OE Style air fitting Exc. Electronic Adjustable Suspension	
R	98-04	SEVILLE All With OE Style air fitting Exc. Electronic Adjustable Suspension	
R	01-03	OLDSMOBILE AURORA All With OE Style air fitting	
R	95-99	AURORA All With OE Style air fitting	
R	00-04	PONTIAC BONNEVILLE All With OE Style air fitting	

Numerical listing

Shock	POP	Alternative No.	MTG Acc. Supplied
Pos.	Year	Application	
49304	B	140733,141099	
R	63-82	CHEVROLET CORVETTE All	
49307	W	141099	
R	52-77	VOLKSWAGEN BEETLE All	
R	69-73	FASTBACK All	
R	66-73	SQUAREBACK All	
R	74-79	SUPER BEETLE All	
R	71-73	SUPER BEETLE All 3 Bolt Flange-Type Lower Mount	
R	73-74	THING All	
49309	W	140523,141099	
R	69-72	NISSAN 521 PICKUP All	
R	72-79	620 PICKUP All	
R	82-86	720 PICKUP RWD	
R	80-81	720 PICKUP All	
R	69-71	TOYOTA CORONA Mark II, Wagon	
49310	D	140788,141099	
R	79-82	DODGE D50 RWD	
R	87-93	PICKUP, RAM 50 RWD	
R	83-86	PICKUP, RAM 50 All	
R	61-64	FORD PICKUP 1/2 TON, F-100 All	
R	55	PICKUP F SERIES All F-100	
R	68	INTERNATIONAL 908C All	
R	68	1000C All	
R	68	1100C All Exc. Travelette with 166" Wheelbase	
R	68	1200C All Exc. Travelette with 166" Wheelbase	
R	68	1300C All Exc. Travelette with 166" Wheelbase	
R	68-72	M1100 / M1200 All	
R	69	M1400 All	
R	72-83	JEEP CJ5 All Exc. Lift Kit	
R	66-71	CJ5 All	
R	72-75	CJ6 All Exc. Lift Kit	
R	66-71	CJ6 All	
R	76-86	CJ7 All Exc. Lift Kit	
R	66-74	DJ5 All Exc. Lift Kit	
R	66-68	DJ6 All	
R	57-60	FC150 All	
R	63-65	FC170 All	
R	64-66	GLADIATOR All	
R	63	GLADIATOR All Independent Front Suspension	
R	70-73	JEEP STER All	
R	81-85	SCRAMBLER / CJ8 All	
R	61-67	UNIVERSAL All	
R	86-87	MAZDA B2000 RWD	
R	87-93	B2200 RWD	
R	87-93	B2600 RWD	
R	95-96	MITSUBISHI MIGHTY MAX All	
R	83-94	MIGHTY MAX RWD	
R	87-90	VAN All	
R	78-81	NISSAN 510 Wagon	
R	98-04	FRONTIER RWD Exc. Desert Runner	
R	83-84	MAXIMA Wagon	
R	87-97	PICKUP RWD	
R	86	PICKUP RWD Mfg. from 8/86	
R	79-82	PLYMOUTH PICKUP All	
R	77-78	TOYOTA CORONA Wagon	
R	69-74	LAND CRUISER All Exc. Wagon	
R	67-68	LAND CRUISER All	
R	85-95	PICKUP RWD Exc. 1 Ton	
R	84	PICKUP RWD	
R	84-88	VAN Leaf (RearSpringType)	
R	88	VAN WAGON All	
49311	C	141099	
R	81-82	CHEVROLET LUV PICKUP All	
R	89-94	ISUZU AMIGO All	
R	81-95	PICKUP All	
R	84-86	TROOPER 4WD	
R	83-89	MITSUBISHI MONTERO All	
R	97-99	MONTERO SPORT All	
R	82-86	NISSAN 720 PICKUP 4WD	
R	00-04	FRONTIER Crew Cab Pickup, RWD with Desert Runner	
R	98-04	FRONTIER 4WD	
R	98-99	FRONTIER RWD Crew Cab with Desert Runner	
R	87-95	PATHFINDER All Exc. Electronic Adjustable Suspension	
R	87-97	PICKUP 4WD	
R	86	PICKUP 4WD Mfg. from 8/86	
R	76-87	TOYOTA LAND CRUISER All	
R	75	LAND CRUISER All Mfg. from 1/75	
R	69-74	LAND CRUISER All Wagon	
R	85-92	PICKUP RWD 1 Ton	
R	80-83	PICKUP 4WD Exc. Lift Kit	
49334	W	140630,141099	
R	78-81	BUICK CENTURY All	

HiJackers, Ultra Spring Seat, Ultra Struts

Shock	POP	Alternative No.	MTG Acc. Supplied
Pos.	Year	Application	
49334	W	-continued 140630,141099	
R	78-87	REGAL All	
R	78-87	CHEVROLET EL CAMINO All	
R	78-83	MALIBU All	
R	73-88	MONTE CARLO All	
R	78-87	GMC SPRINT / CABALLERO RWD	
R	79-87	OLDSMOBILE CUTLASS / CUTLASS SUPREME All	
R	78-79	CUTLASS / CUTLASS SUPREME Vista Cruiser	
R	76-77	CUTLASS / CUTLASS SUPREME Wagon	
R	80-83	CUTLASS CLASSIC / CUTLASS CRUISER All	
R	82-86	PONTIAC BONNEVILLE All	
R	78-80	GRAND AM All	
R	78-83	GRAND LEMANS All	
R	69-87	GRAND PRIX All	
R	68-81	LEMANS All	
49345	D	141248,141099	
R	79-85	BUICK RIVIERA All	
R	79-85	CADILLAC ELDORADO All	
R	80-85	SEVILLE All	
R	79-85	OLDSMOBILE TORONADO All	
49346	W	140873,141099	
R	83-89	CHRYSLER FIFTH AVENUE All	
R	81-83	IMPERIAL All	
R	77-81	LEBARON All M Body	
R	76-80	DODGE ASPEN All	
R	77-89	DIPLOMAT All	
R	80-83	MIRADA All	
R	88-89	PLYMOUTH CARAVELLE RWD	
R	78-81	CARAVELLE RWD	
R	82-89	GRAN FURY All	
R	76-80	VOLARE All	
49369	D	141099	
R	84-93	CHRYSLER DAYTONA All	
R	83-84	E CLASS All	
R	85	EXECUTIVE LIMOUSINE All	
R	83-84	EXECUTIVE SEDAN All	
R	90-93	IMPERIAL All Exc. Hydraulic Self Leveling System	
R	84-86	LASER All	
R	82-95	LEBARON All	
R	81	LEBARON All Exc. M Body	
R	88-93	NEW YORKER All Exc. Hydraulic Self Leveling System	
R	83-87	NEW YORKER All	
R	86-88	TOWN & COUNTRY All	
R	82-83	DODGE 400 All	
R	83-88	600 All	
R	81-89	ARIES All	
R	89-93	DAYTONA ES	
R	89-90	DAYTONA ES Turbo	
R	87-88	DAYTONA Pacifica	
R	86	DAYTONA Turbo Z	
R	84-85	DAYTONA Turbo	
R	85-89	LANCER All	
R	87-94	SHADOW All	
R	89-95	SPIRIT All	
R	89-95	PLYMOUTH ACCLAIM All	
R	88	CARAVELLE FWD	
R	83-87	CARAVELLE All	
R	81-89	RELIANT All	
R	87-94	SUNDANCE All	
49370	W	141277,141099	
R	82-96	BUICK CENTURY All	
R	80-85	SKYLARK All	
R	82-90	CHEVROLET CELEBRITY All	
R	80-85	CITATION / CITATION II All	
R	90-96	LUMINA APV All	
R	85-96	OLDSMOBILE CIERA / CUTLASS CIERA All Exc. Electronic Adjustable Suspension	
R	82-84	CIERA / CUTLASS CIERA All	
R	87-94	CUTLASS CLASSIC / CUTLASS CRUISER All Exc. Electronic Adjustable Suspension	
R	80-84	OMEGA All	
R	90-96	SILHOUETTE All	
R	89-91	PONTIAC 6000 FWD	
R	82-88	6000 All	
R	80-84	PHOENIX All	
R	90-96	TRANS SPORT All	
49371	W	141277,141099	
R	94	ASUNA GT	
R	92	GT	
R	93	GT, SE All	
R	94	SE	
R	92	SE	
R	82-89	BUICK SKYHAWK All	

Numerical listing

Shock	POP	Alternative No.	MTG Acc. Supplied
Pos.	Year	Application	
49371	W	-continued 141277,141099	
R	86-94	SKYLARK All	
R	85-87	SOMERSET / SOMERSET REGAL All	
R	82-88	CADILLAC CIMARRON All	
R	92-94	CHEVROLET BERETTA Base Exc. FE7 Suspension	
R	87-91	BERETTA All	
R	82-94	CAVALIER All	
R	94	CORSICA Base Exc. FE7 Suspension	
R	92-93	CORSICA All Exc. FE7 Suspension	
R	87-91	CORSICA All	
R	92-94	OLDSMOBILE ACHIEVA All	
R	85-87	CALAIS All	
R	88-91	CUTLASS CALAIS All	
R	87-88	FIRENZA All	
R	84-86	FIRENZA All Rebuildable O.E. Struts	
R	82-83	FIRENZA All	
R	85-94	PONTIAC GRAND AM All	
R	82-85	J2000 / SUNBIRD All	
R	86-94	SUNBIRD All	
R	87-91	TEMPEST All	
49387	D	140921,141099	
R	96-02	TOYOTA 4RUNNER All	
49388	D	140921,141099	
R	90-95	TOYOTA 4RUNNER All	
49613	W	141514,141099	
R	94-98	ASUNA SUNRUNNER	
R	92-93	SUNRUNNER All	
R	98-04	CHEVROLET TRACKER Non-ABS	
R	89-97	GEO TRACKER All	
R	94-97	PONTIAC SUNRUNNER All	
R	99-05	SUZUKI GRAND VITARA All	
R	89-98	SIDEKICK All	
R	99-04	VITARA All	
R	96-98	X-90 All	
49614	W	142369,141099	
R	95-98	BUICK SKYLARK All	
R	95-96	CHEVROLET BERETTA All	
R	95-96	CORSICA All	
R	95-98	OLDSMOBILE ACHIEVA All Exc. Electronic Adjustable Suspension	
R	95-98	PONTIAC GRAND AM All Exc. Electronic Adjustable Suspension	
Ultra Spring Seat			
G57267	FF	141544	
F	09-13	DODGE JOURNEY All Right	
Ultra Struts			
G51034	W	141544	
R	86-89	ACURA INTEGRA All	
G51039	D	142093	
R	94-97	FORD ASPIRE Non-ABS	
R	88-93	FESTIVA All	
G51060	W	142106	
R	89-92	TOYOTA CRESSIDA All Exc. Electronic Adjustable Suspension	
G51077	A	142106	
F	96-02	TOYOTA 4RUNNER All	
F	98-04	TACOMA Pre Runner, RWD	
F	95-04	TACOMA 4WD	
G51078	D	142106	
R	95-98	CHRYSLER CIRRUS All	
R	96-98	SEBRING Convertible	
R	95-98	DODGE STRATUS All	
R	96-98	PLYMOUTH BREEZE All	
G51087	B	142106	
R	96-99	INFINITI I30 All	
R	95-99	NISSAN MAXIMA All	
G51097	C	142106	
F	96-99	AUDI A4 Base Exc. Sport Suspension	
F	96-00	A4 QUATTRO Base Mfg. to 11/00; Exc. Sport Suspension	
F	98-01	VOLKSWAGEN PASSAT FWD From VIN# 3B300001 through VIN# 3B300000	
G51099	W	142106	
F	98-99	AUDI A4 Avant Sport Suspension	
F	96-97	A4 All Sport Suspension	
F	98-00	A4 QUATTRO Avant Sport Suspension	

Numerical listing

Shock	POP	Alternative No.	MTG Acc. Supplied
Pos.	Year	Application	
G51099 W -continued			
F	96-97	A4 QUATTRO	All Sport Suspension
F	99-00	A6 Avant	Sport Suspension
F	98	A6	Base Sport Suspension
G51100 D			
R	96-00	AUDI A4	All
G51161 D			
R	72-86	JAGUAR XJ6	All 4 units required
R	81-92	XJ12	All 4 units required
R	73-79	XJ12	All 4 units required
R	76-96	XJS	All
G51170 W 141544			
R	85-87	HONDA CIVIC	Hatchback
R	85-87	CIVIC	Sedan
R	85-87	CIVIC	Wagon, FWD
R	84	CIVIC	All
G51173 W 142094			
R	85-89	SUBARU DL	Sedan, FWD Exc. Air Suspension
R	85-89	GL	Sedan, FWD Exc. Air Suspension
R	90-93	LOYALE	Sedan, FWD Exc. Air Suspension
R	90	LOYALE	Coupe, FWD Exc. Air Suspension
R	85-91	XT	FWD, Coil (RearSpringType) Exc. Air Suspension
G51180 D 142099			
R	87-90	TOYOTA TERCEL	Hatchback
R	87-90	TERCEL	Sedan
G51183 W 142094			
R	85-89	SUBARU DL	Wagon, FWD Exc. Air Suspension
R	89	GL	Wagon, FWD Exc. Air Suspension
R	85-87	GL	Wagon, FWD Exc. Air Suspension
R	94	LOYALE	All Exc. Air Suspension
R	90-93	LOYALE	Wagon Exc. Air Suspension
G51184 W 142052			
R	90-94	EAGLE TALON	FWD
R	90-94	MIITSUBISHI ECLIPSE	FWD
R	90-94	PLYMOUTH LASER	FWD
G51186 W 142094			
R	89-94	HYUNDAI SONATA	All
G51188 W 142113			
F	94-96	NISSAN 300ZX	2+2 Left Exc. model spec VG30DETT
F	93	300ZX	2+2 Left
F	90-92	300ZX	2+2 Left Exc. model spec VG30DETT
G51189 W 142113			
F	90-96	NISSAN 300ZX	2+2 Right Exc. model spec VG30DETT
G51190 D 141716			
R	90-96	NISSAN 300ZX	2+2 Exc. model spec VG30DETT
G51191 W 141716			
R	89-94	NISSAN 240SX	All Exc. Active Suspension
G51192 X 142097			
R	88-91	MAZDA 929	All Exc. Electronic Adjustable Suspension
G51193 W 142113			
R	87-91	TOYOTA SUPRA	All Exc. Electronic Adjustable Suspension
R	86	SUPRA	All Mfg. from 3/86; Exc. Electronic Adjustable Suspension
G51195 D 141716			
F	90-97	MAZDA MIATA	Non-ABS
G51196 D 141716			
R	90-97	MAZDA MIATA	Non-ABS
G51197 W 142113			
F	86-91	TOYOTA SUPRA	All Exc. Electronic Adjustable Suspension
G51204 C			
F	93-02	CHEVROLET CAMARO	All
F	93-02	PONTIAC FIREBIRD	All

Ultra Struts

Shock	POP	Alternative No.	MTG Acc. Supplied
Pos.	Year	Application	
G51216 D			
R	01-03	BMW 525I	Sedan Exc. Electronic Adjustable Suspension
R	99-00	528I	Sedan
R	97-98	528I	All
R	01-03	530I	All Exc. Electronic Adjustable Suspension
R	97-03	540I	Sedan Exc. Electronic Adjustable Suspension
R	95	540I	Sedan Exc. Electronic Adjustable Suspension
G51227 D 142094			
F	95-99	KIA SPORTAGE	All
G51230 C 142106			
R	95-98	NISSAN 200SX	All B14 Solid Rear Axle
R	95-99	SENTRA	All B14 Solid Rear Axle
G51249 W 142052			
R	89-92	DODGE COLT	Hatchback
R	92	EAGLE SUMMIT	Hatchback
R	92	SUMMIT	Sedan
R	89-91	SUMMIT	All
R	92-95	HYUNDAI ELANTRA	Non-ABS
R	89-92	MIITSUBISHI MIRAGE	All
R	90-91	PLYMOUTH COLT	Hatchback, FWD
R	89	COLT	Hatchback
G51252 B 142094			
R	95-99	TOYOTA PASEO	All
R	95-99	TERCEL	All
G51253 W 142875			
R	94-98	MIITSUBISHI GALANT	All
G51255 B 141544			
F	97-01	HONDA CR-V	All
G51256 C 141544			
R	97-01	HONDA CR-V	All
G51264 D 142094			
F	97-01	HONDA PRELUDE	All
G51267 A			
F	99-00	CHRYSLER CIRRUS	J2 (MfrBodyCode)
F	01-06	SEBRING JR	(MfrBodyCode), Convertible
F	01-05	SEBRING JR	(MfrBodyCode), Sedan
F	99-00	SEBRING	Convertible
F	99-06	DODGE STRATUS	Sedan
F	99-00	PLYMOUTH BREEZE	All Exc. JA Mfr Body Code
G51268 A			
R	99-00	CHRYSLER CIRRUS	All
R	01-06	SEBRING JR	(MfrBodyCode), Convertible
R	01-06	SEBRING JR	(MfrBodyCode), Sedan
R	99-00	SEBRING	Convertible
R	99-06	DODGE STRATUS	Sedan
R	99-00	PLYMOUTH BREEZE	All
G51279 A 142094			
R	00-06	NISSAN SENTRA	All
G51286 C 141544			
R	02-06	HONDA CR-V	All
G51330 X			
R	85-86	BMW 524TD	All
R	82-88	528E	All Auto-Leveling System
R	83-84	533I	All Auto-Leveling System
R	85-88	535I	All Auto-Leveling System
R	88	535IS	All Auto-Leveling System
R	85-89	635CSI	All Exc. Auto-Leveling System
G51346 D			
R	91-95	BMW 525I	All
R	90	525I	All Mfg. from 8/90
R	89	525I	All
R	94-95	530I	Sedan
R	91-93	535I	All
R	90	535I	All Mfg. from 8/90
R	89	535I	All
R	88	535I	All Exc. Auto-Leveling System
R	88	535IS	All Exc. Auto-Leveling System

Numerical listing

Shock	POP	Alternative No.	MTG Acc. Supplied
Pos.	Year	Application	
G51424 W 142052			
R	91-93	EAGLE 2000 GTX	All Exc. Auto-Leveling System
R	89-93	MIITSUBISHI GALANT	FWD
R	85-88	GALANT	All Exc. Electronic Adjustable Suspension
R	89-90	SIGMA	Non-ABS Exc. Auto-Leveling System
G51477 A 143008			
F	01-07	TOYOTA SEQUOIA	All
F	00-06	TUNDRA	All
G51700 C 141544			
R	01-03	ACURA EL	All
R	01-02	HONDA CIVIC	All
G51703 A			
F	05-08	FORD PICKUP	1/2 TON, F-150 RWD
F	04	PICKUP	1/2 TON, F-150 Lariat, RWD
F	04	PICKUP	1/2 TON, F-150 STX, RWD
F	04	PICKUP	1/2 TON, F-150 XL, RWD
F	06-08	LINCOLN MARK LT	RWD
G51704 C			
F	04-08	FORD PICKUP	1/2 TON, F-150 4WD
F	06-08	LINCOLN MARK LT	4WD
G51709 D			
F	92-00	LEXUS SC300	All
F	92-00	SC400	All
G51710 D			
R	92-00	LEXUS SC300	All
R	92-00	SC400	All
G51712 D 142874			
R	95-98	EAGLE TALON	AWD
R	00-05	MIITSUBISHI ECLIPSE	All
R	95-99	ECLIPSE	AWD
G51713 B 142094			
R	01-05	HYUNDAI SONATA	All
R	00	SONATA	All Mfg. from 4/00
R	01	XG300	All
R	02-05	XG350	All
R	01-06	KIA MAGENTIS	All
R	01-06	OPTIMA	All
G51714 C 141544			
F	01-05	HYUNDAI SONATA	All
F	00	SONATA	All Mfg. from 8/00
F	01-06	KIA MAGENTIS	All
F	01-06	OPTIMA	All
G51715 A			
F	04-10	INFINITI QX56	All
F	05-15	NISSAN ARMADA	All Exc. Auto-Leveling System
F	04-15	TITAN	All
G51716 N 141544			
R	04-05	HONDA CIVIC	Value Package
R	03-05	CIVIC	DX
R	03-05	CIVIC	EX
R	03-05	CIVIC	GX
R	03-05	CIVIC	HX
R	03-05	CIVIC	LX
R	03-05	CIVIC	Si
R	05	CIVIC	EX Special Edition
R	05	CIVIC	LX Special Edition
R	05	CIVIC	Reverb
R	03-04	CIVIC	SiR
G51718 A			
F	04-07	BUICK RAINIER	All
F	03-06	CHEVROLET SSR	All
F	06-09	TRAILBLAZER	LT
F	06-08	TRAILBLAZER	Base
F	06-07	TRAILBLAZER	A
F	06-07	TRAILBLAZER	B
F	06-07	TRAILBLAZER	LS
F	06	TRAILBLAZER	EXT
F	06	TRAILBLAZER	EXT B
F	02-05	TRAILBLAZER	All
F	02-06	TRAILBLAZER	EXT All
F	02-09	GMC ENVOY	All
F	02-06	ENVOY XL	All
F	04-05	ENVOY XUV	All
F	03-08	ISUZU ASCENDER	All
F	02-04	OLDSMOBILE BRAVADA	All
F	05-09	SAAB 9-7X	All

Numerical listing

Shock	POP	Alternative No.	MTG Acc. Supplied
Pos.	Year	Application	
G51719 C			
F	03-06	FORD EXPEDITION RWD	
G51720 D			
F	03-06	FORD EXPEDITION 4WD	
F	03-06	LINCOLN NAVIGATOR 4WD	
G51722 C			
F	02-03	FORD EXPLORER Eddie Bauer	
F	02-03	EXPLORER Limited	
F	02-03	EXPLORER Postal	
F	02-03	EXPLORER XLS	
F	02-03	EXPLORER XLT	
F	02-03	MERCURY MOUNTAINEER All	
G51723 C			
F	04-05	FORD EXPLORER Eddie Bauer	
F	04-05	EXPLORER Limited	
F	04-05	EXPLORER XLS	
F	04-05	EXPLORER XLT	
F	04	EXPLORER NBX	
F	04-05	MERCURY MOUNTAINEER All	
G51724 B			
R	02-05	FORD EXPLORER Eddie Bauer	
R	02-05	EXPLORER Limited	
R	02-05	EXPLORER XLS	
R	02-05	EXPLORER XLT	
R	04	EXPLORER NBX	
R	02-03	EXPLORER Postal	
R	02-05	MERCURY MOUNTAINEER All	
G51727 B			
R	00-01	INFINITI I30 All	
R	02-04	I35 All	
R	00-03	NISSAN MAXIMA All	
G51728 A			
F	07-11	DODGE NITRO All	
F	02-12	JEEP LIBERTY All	
G51729 C			
R	03-06	FORD EXPEDITION All	
R	03-06	LINCOLN NAVIGATOR All	
G51736 A			
R	03-08	PONTIAC VIBE FWD	
R	03-08	TOYOTA COROLLA All	
R	03-08	MATRIX FWD	
G51737 A 141544			
F	04-08	ACURA TL All	
F	04-08	TSX All	
F	06-07	HONDA ACCORD Value Package	
F	03-07	ACCORD EX	
F	03-07	ACCORD LX	
F	03-05	ACCORD DX	
F	05	ACCORD SE	
F	03	ACCORD Coupe	
G51738 A			
R	04-08	ACURA TL All	
R	06-07	HONDA ACCORD Value Package	
R	03-07	ACCORD EX	
R	03-07	ACCORD LX	
R	03-05	ACCORD DX	
R	05	ACCORD SE	
R	03	ACCORD Coupe	
G51739 A			
F	13-16	TOYOTA 4RUNNER All	
F	12	4RUNNER All Exc. X-REAS Suspension; Exc. Sport Models	
F	10-11	4RUNNER Trail Exc. X-REAS Suspension	
F	03-11	4RUNNER Limited Exc. X-REAS Suspension	
F	03-11	4RUNNER SR5 Exc. X-REAS Suspension	
F	07-12	FJ CRUISER All	
F	14-16	TACOMA 4WD Exc. Off Road	
F	05-13	TACOMA 4WD	
F	05-12	TACOMA Pre Runner, RWD	
G51740 D			
F	00-08	AUDI A4 All	
F	05-08	A4 QUATTRO Elite Mfg. from 11/00; Exc. Sport Suspension	
F	04-08	A4 QUATTRO Cabriolet Mfg. from 11/00; Exc. Sport Suspension	
F	00-08	A4 QUATTRO Base Mfg. from 11/00; Exc. Sport Suspension	
F	08	A4 QUATTRO S Line Mfg. from 11/00; Exc. Sport Suspension	
F	08	A4 QUATTRO Trendy Mfg. from 11/00; Exc. Sport Suspension	

Ultra Struts

Shock	POP	Alternative No.	MTG Acc. Supplied
Pos.	Year	Application	
G51740 D -continued			
F	06-07	A4 QUATTRO DTM Mfg. from 11/00; Exc. Sport Suspension	
F	05-06	A4 QUATTRO S Line Mfg. from 11/00; Exc. Sport Suspension	
F	06	A4 QUATTRO Vanguard Mfg. from 11/00; Exc. Sport Suspension	
F	02-05	A4 QUATTRO Luxury Mfg. from 11/00; Exc. Sport Suspension	
F	01	A4 QUATTRO Confort Mfg. from 11/00; Exc. Sport Suspension	
G51742 D			
R	95-04	AUDI A6 QUATTRO All	
R	84-86	QUATTRO All	
R	99-05	VOLKSWAGEN PASSAT AWD Exc. VIN# 3B300001 through VIN# 3B300000	
R	98	PASSAT All AWD; Exc. VIN# 3B300001 through VIN# 3B300000	
G51744 D			
R	97-01	BMW 740I All Exc. Electronic Adjustable Suspension	
R	93-95	740I All Exc. Electronic Adjustable Suspension	
R	93-01	740IL All Exc. Electronic Adjustable Suspension	
R	94-96	750IL All	
G51746 C			
F	03-07	CADILLAC CTS All Exc. Magnetic Ride Control Suspension	
G51756 C			
F	00-04	LINCOLN LS All	
G51757 D			
R	00-06	LINCOLN LS All	
G51758 B			
F	06-08	DODGE PICKUP 1/2 TON, RAM 1500 (SEE RAM 1500) 4WD Exc. Mega Cab	
G51759 C			
R	00-05	SATURN L / LS / LW SERIES All	
G51760 A			
F	05-10	CHRYSLER 300 RWD Right Exc. Performance Suspension	
F	06-10	DODGE CHARGER RWD Right Exc. Police Models	
F	05-08	MAGNUM RWD Right Exc. Performance Suspension	
G51761 A			
F	05-10	CHRYSLER 300 RWD Left Exc. Performance Suspension	
F	06-10	DODGE CHARGER RWD Left Exc. Police Models	
F	05-08	MAGNUM RWD Left Exc. Performance Suspension	
G51765 A			
F	12	NISSAN PATHFINDER All Mfg. to 8/12	
F	05-11	PATHFINDER All	
F	13-15	XTERRA All	
F	12	XTERRA All Mfg. to 12/12	
F	05-11	XTERRA All	
G51766 A			
F	17	NISSAN FRONTIER All	
F	13-16	FRONTIER PRO-4X	
F	13-16	FRONTIER SL	
F	11-16	FRONTIER S	
F	11-16	FRONTIER SV	
F	13-15	FRONTIER LE	
F	05-15	FRONTIER XE	
F	12	FRONTIER LE Mfg. to 12/12	
F	12	FRONTIER PRO-4X Mfg. to 12/12	
F	12	FRONTIER SL Mfg. to 12/12	
F	09-11	FRONTIER PRO-4X	
F	05-11	FRONTIER LE	
F	11	FRONTIER SL	
F	05-10	FRONTIER SE	
G51767 C			
R	03-06	SUBARU BAJA All	
R	00-04	OUTBACK All	
G51768 W			
R	03-06	PONTIAC VIBE AWD	
R	03-06	TOYOTA MATRIX AWD	

Numerical listing

Shock	POP	Alternative No.	MTG Acc. Supplied
Pos.	Year	Application	
G51769 C			
F	00-02	JAGUAR S TYPE All Mfg. to 6/02 Exc. Computer Active Technology Suspension	
G51770 W			
F	02-05	FORD THUNDERBIRD All	
G51771 W			
R	02-05	FORD THUNDERBIRD All	
G51772 C			
R	97-03	MITSUBISHI DIAMANTE All	
G51773 D			
R	00-05	JAGUAR S TYPE All Mfg. to 6/02 Exc. Computer Active Technology Suspension	
G51774 C			
F	04-06	KIA AMANTI All	
G51794 C			
R	02-07	MITSUBISHI LANCER LS	
R	07	LANCER LS Diamond	
R	04-06	LANCER Ralliart	
R	02-06	LANCER OZ Rally	
R	06	LANCER DE	
R	06	LANCER SE	
R	04	LANCER DE	
R	04	LANCER Sportback	
G51795 C			
R	04-09	TOYOTA PRIUS All	
G51796 D			
F	97-98	CHRYSLER CIRRUS JA (MfrBodyCode)	
F	97-98	SEBRING Convertible	
F	97-98	DODGE STRATUS All	
F	96-98	PLYMOUTH BREEZE JA (MfrBodyCode)	
G51806 A			
F	06-10	HYUNDAI AZERA All	
F	06-10	SONATA All	
G51810 C			
F	03-08	MAZDA 6 All Left	
G51811 C			
F	03-08	MAZDA 6 All Right	
G51813 B			
F	03-07	INFINITI G35 Coupe Left Sport Suspension	
F	03-05	NISSAN 350Z All Left	
G51814 C			
F	03-07	INFINITI G35 Coupe Right Sport Suspension	
F	03-05	NISSAN 350Z All Right	
G51815 B			
F	05-09	DODGE DAKOTA All	
F	06-09	MITSUBISHI RAIDER All	
G51825 C			
R	04-06	KIA AMANTI All	
G51826 C			
R	95-02	MAZDA MILLENIA All	
G51827 D			
F	97-02	MAZDA MILLENIA All Left	
G51828 D			
F	97-02	MAZDA MILLENIA All Right	
G51829 D			
R	96-04	ACURA RL All	
G51830 N			
R	02-04	ACURA RSX All	
G51832 D			
F	01-06	LEXUS LS430 All	
G51833 D			
R	01-06	LEXUS LS430 All	
G51834 C			
F	01-04	LEXUS IS300 All	
G51835 D			
R	01-04	LEXUS IS300 All	
G51836 D			
F	03-05	LINCOLN AVIATOR All	

Numerical listing

Shock	POP	Alternative No.	MTG Acc. Supplied
Pos.	Year	Application	
G51837	D		
R	03-05	LINCOLN AVIATOR All	
G51838	C		
R	03-04	MITSUBISHI OUTLANDER All	
G51839	D		
F	01-04	MITSUBISHI MONTERO All Exc. Sport	
G51840	W		
R	01-03	TOYOTA PRIUS All	
G51842	A		
R	07-12	DODGE CALIBER All	
R	07-10	JEEP COMPASS All	
R	07-10	PATRIOT All	
G51847	D		
R	04-08	ACURA TSX All	
G51848	B		
R	09-12	DODGE JOURNEY FWD	
G51849	D		
R	05-07	FORD FIVE HUNDRED FWD	
R	05-07	MERCURY MONTEGO FWD	
G51850	A		
F	04-11	CHEVROLET COLORADO RWD, Coil (FrontSpringType) Exc. Z71 Off Road Package	
F	04-11	GMC CANYON RWD, Coil (FrontSpringType) Exc. Z71 Off Road Package	
F	06	ISUZU I-280 RWD, Coil (FrontSpringType) Exc. Z71 Off Road Package	
F	07-08	I-290 RWD, Coil (FrontSpringType) Exc. Z71 Off Road Package	
F	08	I-370 RWD, Coil (FrontSpringType) Exc. Z71 Off Road Package	
G51852	B		
R	05-10	SCION TC All	
G51853	D		
F	10-15	TOYOTA TACOMA Pre Runner, RWD Left	
F	05-15	TACOMA Base, RWD Left	
F	05-09	TACOMA X-Runner Left	
G51854	D		
F	05-09	TOYOTA TACOMA Base, RWD Right	
F	05-09	TACOMA X-Runner Right	
G51855	B		
F	13-17	TOYOTA TUNDRA All w/ Off Road Package	
F	07-12	TUNDRA All	
G51856	C		
F	09-10	DODGE PICKUP 1/2 TON, RAM 1500 (SEE RAM 1500) 4WD	
F	11-15	RAM 1500 (SEE DODGE RAM 1500) 4WD	
G51857	D		
R	05-07	FORD FREESTYLE AWD	
R	08-09	TAURUS X AWD	
G51858	A		
R	03-11	HONDA ELEMENT All	
G51859	B		
F	06-09	FORD FUSION All	
F	07-09	LINCOLN MKZ All	
F	06	ZEPHYR All	
F	06-09	MERCURY MILAN All	
G51860	C		
F	07-13	FORD EXPEDITION Coil (RearSpringType) Exc. Air Suspension	
F	07-13	LINCOLN NAVIGATOR All	
G51861	B		
R	07-16	FORD EXPEDITION Coil (RearSpringType) Exc. Air Suspension	
R	16	LINCOLN NAVIGATOR All	
R	10-15	NAVIGATOR All Exc. Air Suspension	
R	07-09	NAVIGATOR All	
G51863	A		
R	14	CHRYSLER 200 All	

Ultra Struts

Shock	POP	Alternative No.	MTG Acc. Supplied
Pos.	Year	Application	
G51863	A	-continued	
R	11-13	200 All Standard Suspension	
R	07-10	SEBRING All	
R	08-14	DODGE AVENGER All	
G51864	B		
F	09-13	FORD PICKUP 1/2 TON, F-150 4WD	
F	10-12	LINCOLN MARK LT AWD	
G51865	B		
F	09-13	FORD PICKUP 1/2 TON, F-150 RWD	
G51870	A		
F	08-13	CHEVROLET PICKUP 1/2 TON, SILVERADO 1500 All Exc. Electronic Adjustable Suspension	
F	07	PICKUP 1/2 TON, SILVERADO 1500 Base Exc. Electronic Adjustable Suspension	
F	07	PICKUP 1/2 TON, SILVERADO 1500 LT Exc. Electronic Adjustable Suspension	
F	07	PICKUP 1/2 TON, SILVERADO 1500 LTZ Exc. Electronic Adjustable Suspension	
F	07	PICKUP 1/2 TON, SILVERADO 1500 WT Exc. Electronic Adjustable Suspension	
F	08-13	GMC SIERRA 1500 All Exc. Electronic Adjustable Suspension	
F	07	SIERRA 1500 SLE Exc. Electronic Adjustable Suspension	
F	07	SIERRA 1500 SLT Exc. Electronic Adjustable Suspension	
F	07	SIERRA 1500 WT Exc. Electronic Adjustable Suspension	
G51875	D		
R	08-09	FORD TAURUS FWD Left	
R	07	TAURUS FWD Left Mfg. from 06/07	
R	08-09	MERCURY SABLE FWD Left	
G51876	D		
R	08-09	FORD TAURUS FWD Right	
R	07	TAURUS FWD Right Mfg. from 06/07	
R	08-09	MERCURY SABLE FWD Right	
G51877	B		
F	08-12	HONDA ACCORD All Left	
G51878	B		
F	08-12	HONDA ACCORD All Right	
G51879	B		
R	07-11	HONDA CR-V All	
G51880	D		
R	06-14	HONDA RIDGELINE All	
G51881	D		
R	02-06	MINI COOPER All	
G51882	D		
R	06-10	MITSUBISHI ECLIPSE All	
G51883	D		
R	10-11	MITSUBISHI GALANT SE	
R	04-11	GALANT ES	
R	04-08	GALANT DE	
R	05-07	GALANT SE	
G51885	D		
R	99-06	SAAB 9-5 All	
G51886	D		
R	05-09	SUBARU LEGACY All	
G51887	B		
F	10-11	FORD CROWN VICTORIA Base	
F	07-11	CROWN VICTORIA LX	
F	03-08	CROWN VICTORIA Base	
F	04-06	CROWN VICTORIA LX Sport	
F	05	CROWN VICTORIA Special Edition	
F	03	CROWN VICTORIA LWB	
F	03	CROWN VICTORIA S	
F	03-11	LINCOLN TOWN CAR All Exc. Limo	
F	03-11	MERCURY GRAND MARQUIS All	
G51888	C		
F	03-11	FORD CROWN VICTORIA Police Interceptor	
F	03-11	LINCOLN TOWN CAR All Limo Models	

Numerical listing

Shock	POP	Alternative No.	MTG Acc. Supplied
Pos.	Year	Application	
G51888	C	-continued	
F	03-04	MERCURY MARAUDER All	
G51889	W		
R	05-07	FORD FREESTYLE FWD Left	
R	08-09	TAURUS X FWD Left	
G51890	W		
R	05-07	FORD FREESTYLE FWD Right	
R	08-09	TAURUS X FWD Right	
G51891	A		
F	07-13	CHEVROLET AVALANCHE 1500 All Exc. Z55 or ZW7 Ride Suspension	
F	07-14	SUBURBAN 1/2 TON, 1500 All Exc. Z55 or ZW7 Ride Suspension	
F	07-14	TAHOE All Exc. Z55 or ZW7 Ride Suspension	
F	07-14	GMC YUKON All Exc. Z55 or ZW7 Ride Suspension	
F	07-14	YUKON XL 1/2 TON All Exc. Z55 or ZW7 Ride Suspension	
G51892	B		
R	08-17	HONDA ACCORD All	
G51896	C		
F	10-12	FORD FUSION All Left	
F	10-12	LINCOLN MKZ All Left	
F	10-11	MERCURY MILAN All Left	
G51897	C		
F	10-12	FORD FUSION All Right	
F	10-12	LINCOLN MKZ All Right	
F	10-11	MERCURY MILAN All Right	
G51898	A		
R	09-10	PONTIAC VIBE FWD	
R	09-16	TOYOTA COROLLA All	
R	09-14	MATRIX FWD	
G51899	A		
F	01	HYUNDAI XG300 All	
F	02-05	XG350 All	
G51900	A		
R	04-08	BMW 525i All	
R	04-08	530i All	
G51901	A		
F	09-11	CADILLAC CTS All Exc. Magnetic Ride Control Suspension	
G51906	A		
F	06-08	MAZDA MX-5 All	
F	06-08	MX-5 MIATA All	
G51907	A		
R	09-15	MAZDA MX-5 All 17" Wheels	
R	06-08	MX-5 All	
R	09-15	MX-5 MIATA All 17" Wheels	
R	06-08	MX-5 MIATA All	
G51908	A		
R	08-11	MITSUBISHI LANCER DE	
R	08-11	LANCER ES	
G51909	A		
R	06-07	SUBARU B9 TRIBECA All	
R	08-13	TRIBECA All	
G51910	A		
R	05-09	SUBARU OUTBACK All	
G51911	A		
F	05-12	ACURA RL All	
G51913	A		
R	05-12	ACURA RL All Right	
G51914	A		
R	05-06	ACURA RSX All	
G51915	A		
F	05-08	AUDI A6 QUATTRO All Exc. Air and Sport Suspension	
G51916	N		
R	14-15	CHEVROLET CAMARO All Exc. Electronic	
R	10-13	CAMARO 3.6L 6Cyl V (217)	
G51917	A		
F	09-14	ACURA TL All Left	
G51918	A		
F	09-14	ACURA TL All Right	

Numerical listing

Shock	POP	Alternative No.	MTG Acc. Supplied
Pos.	Year	Application	
G51919	A		
R	09-14	ACURA TL All	
R	09-14	TSX All	
G51920	A		
F	06-11	LEXUS IS250 All Left	
G51921	A		
F	06-11	LEXUS IS250 All Right	
G51922	A		
R	06-11	LEXUS IS250 All	
G51923	A		
F	04-08	MAZDA RX8 All	
G51924	A		
R	04-08	MAZDA RX8 All	
G51925	N		
F	06-07	INFINITI M35 All Left	
F	06-07	M45 All Left	
G51926	N		
F	06-07	INFINITI M35 All Right	
F	06-07	M45 All Right	
G51928	FF		
R	04-09	VOLKSWAGEN TOUAREG All	
G51933	N		
R	10-11	MITSUBISHI ENDEAVOR AWD	
R	04-08	ENDEAVOR AWD	
G51934	N		
R	07-12	MINI COOPER All	
G51935	A		
F	06-09	PONTIAC SOLSTICE All	
G51936	A		
R	06-09	PONTIAC SOLSTICE All	
G51937	N		
F	17	TOYOTA SEQUOIA All Exc. Air Suspension	
F	08-16	SEQUOIA All	
G51947	A		
F	05-10	CHRYSLER 300 RWD Left Performance Suspension	
F	06-10	DODGE CHARGER RWD Left Police	
F	05-08	MAGNUM RWD Left Performance Suspension	
G51948	A		
F	05-10	CHRYSLER 300 RWD Right Performance Suspension	
F	06-10	DODGE CHARGER RWD Right Police	
F	05-08	MAGNUM RWD Right Performance Suspension	
G51949	A		
F	14-15	CHEVROLET PICKUP 1/2 TON, SILVERADO 1500 All	
F	14-15	GMC SIERRA 1500 All	
G51953	A		
F	06-09	NISSAN 350Z All Left	
G51954	A		
F	06-09	NISSAN 350Z All Right	
G51960	FF		
F	15	CHEVROLET TAHOE All	
F	15	GMC YUKON All	
F	15	YUKON XL All	
G51961	N		
R	09-13	SUBARU FORESTER All	
G51969	N		
R	04-06	MITSUBISHI GALANT LS	
G51970	W		
F	05-10	CHRYSLER 300 AWD	
F	07-10	DODGE CHARGER AWD	
F	05-08	MAGNUM AWD	
G51979	N		
F	05-06	INFINITI G35 AWD Left	
G51981	N		
F	05-06	INFINITI G35 AWD Right	
G51984	N		
F	09-13	MAZDA 6 All Left	

Ultra Struts

Shock	POP	Alternative No.	MTG Acc. Supplied
Pos.	Year	Application	
G51985	N		
F	09-13	MAZDA 6 All Right	
G51995	N		
R	02-05	LEXUS SC430 All	
G51997	N		
R	04-06	SUZUKI VERONA All Left	
G51998	N		
R	04-06	SUZUKI VERONA All Right	
G52000	W		
F	02-07	NISSAN X-TRAIL All Left	
G52001	W		
F	02-07	NISSAN X-TRAIL All Right	
G52002	W		
R	02-07	NISSAN X-TRAIL All Left	
G52003	W		
R	02-07	NISSAN X-TRAIL All Right	
G52004	A		
F	06-12	TOYOTA RAV4 All Left	
G52005	A		
F	12-13	MAZDA 3 GS-SKY Left	
F	08-13	3 GT Left	
F	08-13	3 GX Left	
F	07-13	3 i Left	
F	07-13	3 S Left	
F	13	3 Grand Touring Left	
F	13	3 i Touring Left	
F	08-12	3 GS Left	
F	11	3 Sport GS Left	
F	11	3 Sport GT Left	
F	11	3 Sport GX Left	
F	04-06	3 All Left	
F	06-10	5 All Left	
G52006	A		
F	12-13	MAZDA 3 GS-SKY Right	
F	08-13	3 GT Right	
F	08-13	3 GX Right	
F	07-13	3 i Right	
F	07-13	3 S Right	
F	13	3 Grand Touring Right	
F	13	3 i Touring Right	
F	08-12	3 GS Right	
F	11	3 Sport GS Right	
F	11	3 Sport GT Right	
F	11	3 Sport GX Right	
F	04-06	3 All Right	
F	06-10	5 All Right	
G52007	A		
F	06-12	TOYOTA RAV4 All Right	
G52008	A		
F	03-07	NISSAN MURANO All Left	
G52009	A		
F	03-07	NISSAN MURANO All Right	
G52013	C		
F	03-08	PONTIAC VIBE All Left	
F	03-08	TOYOTA MATRIX All Left	
G52014	C		
F	03-08	PONTIAC VIBE All Right	
F	03-08	TOYOTA MATRIX All Right	
G52015	W		
F	04-05	KIA RIO All Left	
G52016	D		
F	04-05	KIA RIO All Right	
G52017	D		
R	02-03	KIA SPECTRA All Left	
G52018	D		
R	02-03	KIA SPECTRA All Right	
G52019	D		
F	02-03	SUZUKI AERIO All Left	
G52020	D		
F	02-03	SUZUKI AERIO All Right	
G52021	D		
R	02-07	SUZUKI AERIO All Left	
G52022	D		
R	02-07	SUZUKI AERIO All Right	

Numerical listing

Shock	POP	Alternative No.	MTG Acc. Supplied
Pos.	Year	Application	
G52023	D		
F	05-09	SUBARU LEGACY All Left	
G52024	D		
F	05-09	SUBARU LEGACY All Right	
G52025	B		
F	05-07	BUICK TERRAZA All Exc. Air-Leveling Suspension	
F	05-09	CHEVROLET UPLANDER All Exc. Air-Leveling Suspension	
F	05-09	PONTIAC MONTANA SV6 Exc. Self-Leveling Suspension	
F	05-07	SATURN RELAY All Exc. Air-Leveling Suspension	
G52026	B		
F	02-07	SATURN VUE All Left	
G52027	B		
F	02-07	SATURN VUE All Right	
G52028	A		
F	04-12	CHEVROLET MALIBU All Left	
F	05-10	PONTIAC G6 All Left	
F	07-09	SATURN AURA All Left	
G52029	A		
F	04-12	CHEVROLET MALIBU All Right	
F	05-10	PONTIAC G6 All Right	
F	07-09	SATURN AURA All Right	
G52030	C		
F	05-07	HONDA ODYSSEY All Left	
G52031	C		
F	05-07	HONDA ODYSSEY All Right	
G52032	B		
F	04-09	NISSAN QUEST All Left	
G52033	B		
F	04-09	NISSAN QUEST All Right	
G52034	D		
F	02-05	KIA SEDONA All Left	
G52035	D		
F	02-05	KIA SEDONA All Right	
G52036	C		
F	03-06	KIA SORENTO All Left	
G52037	C		
F	03-06	KIA SORENTO All Right	
G52038	A		
F	10-11	HONDA CIVIC EX-L Left	
F	10-11	CIVIC LX-S Left	
F	08-11	CIVIC DX-G Left	
F	06-11	CIVIC DX Left	
F	06-11	CIVIC EX Left	
F	06-11	CIVIC Hybrid Left	
F	06-11	CIVIC LX Left	
F	11	CIVIC Base Left	
F	09-10	CIVIC Sport Left	
F	08	CIVIC EX-L Left	
F	06-07	CIVIC EXS Left	
F	06-07	CIVIC LXS Left	
G52039	A		
F	10-11	HONDA CIVIC EX-L Right	
F	10-11	CIVIC Hybrid-L Right	
F	10-11	CIVIC LX-S Right	
F	08-11	CIVIC DX-G Right	
F	06-11	CIVIC DX Right	
F	06-11	CIVIC EX Right	
F	06-11	CIVIC Hybrid Right	
F	06-11	CIVIC LX Right	
F	11	CIVIC Base Right	
F	09-10	CIVIC Sport Right	
F	08	CIVIC EX-L Right	
F	06-07	CIVIC EXS Right	
F	06-07	CIVIC LXS Right	
G52055	D		
F	02-06	NISSAN SENTRA SE-R Left	
F	02-06	SENTRA SE-R Spec V Left	
G52056	D		
F	02-06	NISSAN SENTRA SE-R Right	
F	02-06	SENTRA SE-R Spec V Right	
G52057	D		
F	96-04	ACURA RL All Left	
G52058	D		
F	96-04	ACURA RL All Right	

Numerical listing

Shock	POP	Alternative No.	MTG Acc. Supplied
Pos.	Year	Application	
G52061	D		
F	03-08	INFINITI FX35 All Left	
F	03-08	FX45 All Left	
G52062	D		
F	03-08	INFINITI FX35 All Right	
F	03-08	FX45 All Right	
G52063	X		
F	00-01	KIA SPECTRA All Left	
G52064	X		
F	00-01	KIA SPECTRA All Right	
G52065	C		
F	03-06	MITSUBISHI OUTLANDER All	
G52066	W		
F	02-06	SAAB 9-5 All	
G52067	W		
F	04-05	SUBARU FORESTER All Left	
G52068	W		
F	04-05	SUBARU FORESTER All Right	
G52069	D		
F	03	SUBARU FORESTER All Left	
G52070	D		
F	03	SUBARU FORESTER All Right	
G52073	W		
R	02-03	SUBARU IMPREZA RS, Sedan Left	
R	02-03	IMPREZA TS Left	
G52074	W		
R	02-03	SUBARU IMPREZA RS, Sedan Right	
R	02-03	IMPREZA TS Right	
G52075	D		
F	04-07	SUZUKI AERIO All Left	
G52076	D		
F	04-07	SUZUKI AERIO All Right	
G52077	W		
F	01-03	TOYOTA PRIUS All Left	
G52078	W		
F	01-03	TOYOTA PRIUS All Right	
G52079	D		
F	04	VOLVO S40 All Left Mfg. from 04/00	
F	01-03	S40 All Left	
F	00	S40 All Left Mfg. from 04/00	
F	04	V40 All Left Mfg. from 04/00	
F	01-03	V40 All Left	
F	00	V40 All Left Mfg. from 04/00	
G52080	D		
F	01-04	VOLVO S40 All Right	
F	00	S40 All Right Mfg. from 04/00	
F	04	V40 All Right Mfg. from 04/00	
F	01-03	V40 All Right	
F	00	V40 All Right Mfg. from 04/00	
G52081	A		
F	07-12	DODGE CALIBER All Left	
F	07-10	JEEP COMPASS All Left	
F	07-10	PATRIOT All Left	
G52082	A		
F	07-12	DODGE CALIBER All Right	
F	07-10	JEEP COMPASS All Right	
F	07-10	PATRIOT All Right	
G52083	W		
R	05-06	SAAB 9-2X All Left	
R	04-07	SUBARU IMPREZA Wagon Left	
G52084	W		
R	05-06	SAAB 9-2X All Right	
R	04-07	SUBARU IMPREZA Wagon Right	
G52085	D		
R	04-07	SUBARU IMPREZA Wagon, AWD Left	
G52086	D		
R	04-07	SUBARU IMPREZA Wagon, AWD Right	
G52087	W		
F	05-06	SAAB 9-2X All Left	
F	04-07	SUBARU IMPREZA Sedan Left	

Ultra Struts

Shock	POP	Alternative No.	MTG Acc. Supplied
Pos.	Year	Application	
G52088	W		
F	05-06	SAAB 9-2X All Right	
F	04-07	SUBARU IMPREZA Sedan Right	
G52089	W		
R	04	SUBARU IMPREZA Sedan, AWD Left	
G52090	W		
R	04	SUBARU IMPREZA Sedan, AWD Right	
G52094	A		
F	07-12	NISSAN SENTRA Base Left	
F	07-12	SENTRA S Left	
F	07-12	SENTRA SL Left	
G52095	A		
F	07-12	NISSAN SENTRA Base Right	
F	07-12	SENTRA S Right	
F	07-12	SENTRA SL Right	
G52096	B		
F	05-10	SCION TC All Left	
G52097	B		
F	05-10	SCION TC All Right	
G52098	B		
F	04-06	SCION XA All	
F	04-06	XB All	
G52103	A		
R	07-12	LEXUS ES350 All Left	
R	06-11	TOYOTA AVALON All Left Mfg. from 01/06	
R	07-11	CAMRY All Left	
G52104	A		
R	07-12	LEXUS ES350 All Right	
R	06-11	TOYOTA AVALON All Right Mfg. from 01/06	
R	07-11	CAMRY All Right	
G52105	D		
F	06-10	TOYOTA SIENNA AWD Left	
F	06-10	SIENNA FWD Left 8 Passenger	
F	05	SIENNA AWD Left Mfg. from 7/05; 7 Passenger	
F	05	SIENNA FWD Left Mfg. from 7/05; 8 Passenger	
G52106	D		
F	06-10	TOYOTA SIENNA AWD Right	
F	06-10	SIENNA FWD Right 8 Passenger	
F	05	SIENNA AWD Right Mfg. from 7/05; 7 Passenger	
F	05	SIENNA FWD Right Mfg. from 7/05; 8 Passenger	
G52107	D		
F	05-10	TOYOTA SIENNA FWD Left Mfg. from 7/05; 7 Passenger	
G52108	D		
F	05-10	TOYOTA SIENNA FWD Right Mfg. from 7/05; 7 Passenger	
G52110	C		
F	05-07	FORD FREESTYLE All Left	
G52111	C		
F	05-07	FORD FREESTYLE All Right	
G52112	B		
F	04-11	HONDA ELEMENT LX Left	
F	03-11	ELEMENT EX Left	
F	03-04	ELEMENT DX Left	
G52113	B		
F	05-11	HONDA ELEMENT EX Right	
F	04-11	ELEMENT LX Right	
F	03-04	ELEMENT DX Right	
G52116	A		
F	06-11	BUICK LUCERNE All Exc. Magnetic Ride Control Suspension	
F	06-11	CADILLAC DTS All Exc. Magnetic Ride Control Suspension	
G52117	B		
F	11-14	CHRYSLER 200 All Left	
F	08-10	SEBRING All Left	
F	08-14	DODGE AVENGER All Left	
G52118	A		
F	14	CHRYSLER 200 All Right	
F	11-13	200 All Right Standard Suspension	
F	08-10	SEBRING All Right	
F	08-14	DODGE AVENGER All Right	

Numerical listing

Shock	POP	Alternative No.	MTG Acc. Supplied
Pos.	Year	Application	
G52121	A		
F	07-13	NISSAN ALTIMA Base Left	
F	07-13	ALTIMA S Left	
F	07-13	ALTIMA SL Left	
F	13	ALTIMA Advance Left	
F	13	ALTIMA Exclusive Left	
F	13	ALTIMA Sense Left	
F	13	ALTIMA SV Left	
F	10-12	ALTIMA SR Left	
F	08-09	ALTIMA Coupe Left	
F	07-09	ALTIMA SE Left	
G52122	A		
F	07-13	NISSAN ALTIMA Base Right	
F	07-13	ALTIMA S Right	
F	07-13	ALTIMA SL Right	
F	13	ALTIMA Advance Right	
F	13	ALTIMA Exclusive Right	
F	13	ALTIMA Sense Right	
F	13	ALTIMA SV Right	
F	10-12	ALTIMA SR Right	
F	08-09	ALTIMA Coupe Right	
F	07-09	ALTIMA SE Right	
G52123	A		
F	04-06	PONTIAC GTO All Left	
G52124	A		
F	04-06	PONTIAC GTO All Right	
G52125	A		
F	08-12	BUICK ENCLAVE All	
F	09-12	CHEVROLET TRAVERSE All	
F	07-12	GMC ACADIA All	
F	07-10	SATURN OUTLOOK All	
G52127	B		
F	07-12	CHEVROLET EQUINOX All Left Exc. Sport Suspension	
F	10-12	GMC TERRAIN All Left	
F	07-09	PONTIAC TORRENT All Left Exc. Sport Suspension	
F	08-10	SATURN VUE All Left	
F	07-09	SUZUKI XL-7 All Left	
G52128	A		
F	07-12	CHEVROLET EQUINOX All Right Exc. Sport Suspension	
F	10-12	GMC TERRAIN All Right	
F	07-09	PONTIAC TORRENT All Right Exc. Sport Suspension	
F	08-10	SATURN VUE All Right	
F	07-09	SUZUKI XL-7 All Right	
G52129	D		
F	08-09	FORD TAURUS FWD Left	
F	08-09	MERCURY SABLE FWD Left	
G52130	D		
F	08-09	FORD TAURUS FWD Right	
F	08-09	MERCURY SABLE FWD Right	
G52131	A		
F	15-16	CHRYSLER TOWN & COUNTRY Touring Piel	
F	13-16	TOWN & COUNTRY Li	
F	13-16	TOWN & COUNTRY Limited	
F	13-16	TOWN & COUNTRY LX	
F	13-16	TOWN & COUNTRY Touring	
F	13-16	TOWN & COUNTRY Touring L	
F	16	TOWN & COUNTRY Limited Platinum	
F	16	TOWN & COUNTRY Premium	
F	14	TOWN & COUNTRY 30th Anniversary Edition	
F	14	TOWN & COUNTRY Base	
F	08-12	TOWN & COUNTRY All Exc. Self-Leveling Suspension	
F	14-16	DODGE CARAVAN / GRAND CARAVAN American Value Package	
F	14-16	CARAVAN / GRAND CARAVAN SE Plus	
F	13-16	CARAVAN / GRAND CARAVAN SE	
F	12-16	CARAVAN / GRAND CARAVAN SXT	
F	12-14	CARAVAN / GRAND CARAVAN Crew	
F	12-14	CARAVAN / GRAND CARAVAN Crew Plus	
F	14	CARAVAN / GRAND CARAVAN 30th Anniversary Edition	
F	14	CARAVAN / GRAND CARAVAN SE 30th Anniversary Edition	
F	14	CARAVAN / GRAND CARAVAN SE Canada Value Package	

Numerical listing

Shock	POP	Alternative No.	MTG Acc. Supplied
Pos.	Year	Application	
G52131	A -continued		
F 14	CARAVAN / GRAND CARAVAN SXT 30th Anniversary Edition		
F 14	CARAVAN / GRAND CARAVAN SXT Plus		
F 13	CARAVAN / GRAND CARAVAN Canada Value Package		
F 12	CARAVAN / GRAND CARAVAN Canada Value Package Exc. Self-Leveling Suspension		
F 12	CARAVAN / GRAND CARAVAN SE Exc. Self-Leveling Suspension		
F 08-11	CARAVAN / GRAND CARAVAN All Exc. Self-Leveling Suspension		
F 09-11	VOLKSWAGEN ROUTAN All Exc. Self-Leveling Suspension		
G52136	D		
F 05-07	FORD FIVE HUNDRED AWD Left		
F 05-07	MERCURY MONTEGO AWD Left		
G52137	D		
F 05-07	FORD FIVE HUNDRED AWD Right		
F 05-07	MERCURY MONTEGO AWD Right		
G52138	C		
F 05-07	FORD FIVE HUNDRED FWD Left		
F 05-07	MERCURY MONTEGO FWD Left		
G52139	C		
F 05-07	FORD FIVE HUNDRED FWD Right		
F 05-07	MERCURY MONTEGO FWD Right		
G52140	C		
F 03-06	ACURA MDX All Left		
G52141	C		
F 03-06	ACURA MDX All Right		
G52142	C		
F 08-13	BMW 128i All Left		
F 08-11	135i All Left		
F 06	325i All Left		
F 07-13	328i All Left		
F 06	330i All Left		
F 07-13	335i All Left		
G52143	C		
F 08-13	BMW 128i All Right		
F 08-11	135i All Right		
F 06	325i All Right		
F 07-13	328i All Right		
F 06	330i All Right		
F 07-13	335i All Right		
G52144	W		
F 00-06	BMW X5 Coil (FrontSpringType) Left		
G52145	W		
F 00-06	BMW X5 Coil (FrontSpringType) Right		
G52148	C		
F 09-16	DODGE JOURNEY All Left		
G52149	C		
F 09-16	DODGE JOURNEY All Right		
G52150	D		
F 06-14	HONDA RIDGELINE All Left		
G52151	D		
F 06-14	HONDA RIDGELINE All Right		
G52152	D		
F 10-12	HONDA CITY All Left		
F 15-16	FIT All Left		
F 13-14	FIT DX Left		
F 13-14	FIT EX Left		
F 13-14	FIT LX Left		
F 13-14	FIT Sport Left		
F 13	FIT Base Left		
F 09-12	FIT All Left		
G52153	D		
F 10-12	HONDA CITY All Right		
F 15-16	FIT All Right		
F 13-14	FIT DX Right		
F 13-14	FIT EX Right		
F 13-14	FIT LX Right		
F 13-14	FIT Sport Right		
F 13	FIT Base Right		
F 09-12	FIT All Right		
G52154	B		
F 06-11	DODGE ATTITUDE All Left		

Ultra Struts

Shock	POP	Alternative No.	MTG Acc. Supplied
Pos.	Year	Application	
G52154	B -continued		
F 06-11	HYUNDAI ACCENT All Left		
F 06-11	KIA RIO All Left		
F 06-11	RIO All Left		
G52155	B		
F 06-11	DODGE ATTITUDE All Right		
F 06-11	HYUNDAI ACCENT All Right		
F 06-11	KIA RIO All Right		
F 06-11	RIO All Right		
G52156	B		
F 07-10	HYUNDAI ELANTRA All Left		
G52157	B		
F 07-10	HYUNDAI ELANTRA All Right		
G52158	C		
F 07-09	HYUNDAI SANTA FE All Left		
G52159	B		
F 07-09	HYUNDAI SANTA FE All Right		
G52160	C		
F 05-09	KIA SPECTRA All Left		
F 04-09	SPECTRA All Left		
G52161	C		
F 05-09	KIA SPECTRA All Right		
F 04-09	SPECTRA All Right		
G52162	D		
R 07-09	KIA SPECTRA All Left		
R 04-09	SPECTRA All Left		
G52163	D		
R 07-09	KIA SPECTRA All Right		
R 04-09	SPECTRA All Right		
G52164	D		
F 02-06	MINI COOPER All Left		
G52165	D		
F 02-06	MINI COOPER All Right		
G52166	D		
F 06-12	MITSUBISHI ECLIPSE All Left		
G52167	D		
F 06-12	MITSUBISHI ECLIPSE All Right		
G52168	D		
F 10-11	MITSUBISHI GALANT SE Left		
F 04-11	GALANT ES Left		
F 04-08	GALANT DE Left		
F 05-07	GALANT SE Left		
G52169	D		
F 10-11	MITSUBISHI GALANT SE Right		
F 04-11	GALANT ES Right		
F 04-08	GALANT DE Right		
F 05-07	GALANT SE Right		
G52170	D		
F 13	NISSAN MURANO All Left		
F 12	MURANO All Left Mfg. to 12/12		
F 08-11	MURANO All Left		
G52171	D		
F 13	NISSAN MURANO All Right		
F 12	MURANO All Right Mfg. to 12/12		
F 08-11	MURANO All Right		
G52172	D		
F 12	MERCEDES-BENZ C250 Sedan, CGI (FuelDelSubType)		
F 10-11	C250 All		
F 08-09	C280 All		
F 11	C300 All		
F 10	C300 All Exc. 4-Matic Models		
F 08-09	C300 All		
F 12	C350 CGI (FuelDelSubType)		
F 08-11	C350 All		
G52173	C		
F 08-12	NISSAN ROGUE All Left With OE# E4303JM00A		
F 10-12	X-TRAIL All Left		
F 08	X-TRAIL All Left		
G52174	C		
F 08-12	NISSAN ROGUE All Right With OE# E4302JM00A		
F 10-12	X-TRAIL All Right		
F 08	X-TRAIL All Right		
G52175	N		
F 03-11	SAAB 9-3 All Left		

Numerical listing

Shock	POP	Alternative No.	MTG Acc. Supplied
Pos.	Year	Application	
G52176	N		
F 03-11	SAAB 9-3 All Right		
G52178	D		
R 03-05	SUBARU FORESTER All Left		
G52179	D		
R 03-05	SUBARU FORESTER All Right		
G52180	W		
F 06-08	SUBARU FORESTER All Left		
G52181	W		
F 06-08	SUBARU FORESTER All Right		
G52182	D		
R 06-08	SUBARU FORESTER All Left		
G52183	D		
R 06-08	SUBARU FORESTER All Right		
G52184	D		
F 06-13	SUZUKI GRAND VITARA All Left		
G52185	D		
F 06-13	SUZUKI GRAND VITARA All Right		
G52187	A		
F 07-12	ACURA RDX All Left		
F 07-14	HONDA CR-V All Left		
G52188	A		
F 07-12	ACURA RDX All Right		
F 07-14	HONDA CR-V All Right		
G52193	B		
F 09-14	NISSAN CUBE All Left		
F 12	VERSA 1.8L 4Cyl L (1798) Left Models S and SL		
F 07-11	VERSA S Left		
F 07-11	VERSA SL Left		
G52194	B		
F 09-14	NISSAN CUBE All Right		
F 12	VERSA 1.8L 4Cyl L (1798) Right		
F 07-11	VERSA S Right		
F 07-11	VERSA SL Right		
G52199	D		
F 04-10	BMW X3 All Left		
G52200	D		
F 04-10	BMW X3 All Right		
G52201	D		
F 08-13	TOYOTA HIGHLANDER All Left		
G52202	D		
F 08-13	TOYOTA HIGHLANDER All Right		
G52203	D		
R 08-13	TOYOTA HIGHLANDER FWD Left		
G52204	D		
R 08-13	TOYOTA HIGHLANDER FWD Right		
G52205	D		
F 07-10	FORD EXPLORER SPORT TRAC All		
G52206	W		
R 07-10	FORD EXPLORER SPORT TRAC All		
G52209	D		
F 07-10	MAZDA CX-7 All Left		
G52210	D		
F 07-10	MAZDA CX-7 All Right		
G52227	D		
F 97-03	MITSUBISHI DIAMANTE All Left		
G52228	D		
F 97-03	MITSUBISHI DIAMANTE All Right		
G52235	N		
F 00	BMW 323Ci Coupe Left Sport Suspension		
F 06	323i Sedan Left Sport Suspension		
F 00-01	323i Sedan Left Sport Suspension		
F 01-06	325Ci All Left Sport Suspension		
F 00	328Ci All Left Sport Suspension		
F 02-06	330Ci All Left Sport Suspension		
F 01	330Ci Coupe Left Mfg. from 9/01; Sport Suspension		
F 01-05	330i All Left Sport Suspension		

Numerical listing

Shock	POP	Alternative No.	MTG Acc. Supplied
Pos.	Year	Application	
G52236 N			
F	00	BMW 323Ci Coupe Right Sport Suspension	
F	06	323i Sedan Right Sport Suspension	
F	00-01	323i Sedan Right Sport Suspension	
F	01-06	325Ci All Right Sport Suspension	
F	00	328Ci All Right Sport Suspension	
F	02-06	330Ci All Right Sport Suspension	
F	01	330Ci Coupe Right Sport Suspension	
F	01-05	330i All Right Sport Suspension	
G52237 A			
F	00	BMW 323Ci Coupe Left Exc. Sport Suspension	
F	00	323i Sedan Left Exc. Sport Suspension	
F	01-06	325Ci All Left Exc. Sport Suspension	
F	01-05	325i Sedan Left Exc. Sport Suspension	
F	00	328Ci Coupe Left Exc. Sport Suspension	
F	01-06	330Ci All Left Exc. Sport Suspension	
G52238 A			
F	00	BMW 323Ci Coupe Right Exc. Sport Suspension	
F	00	323i Sedan Right Exc. Sport Suspension	
F	01-06	325Ci All Right Exc. Sport Suspension	
F	01-05	325i Sedan Right Exc. Sport Suspension	
F	00	328Ci Coupe Right Exc. Sport Suspension	
F	01-06	330Ci All Right Exc. Sport Suspension	
G52244 B			
R	05-09	BUICK ALLURE All Models with 17" or 18" Wheels	
R	05-09	LACROSSE All Models with 17" or 18" Wheels	
R	04-11	CHEVROLET IMPALA All Models with 17" or 18" Wheels	
R	05-07	MONTE CARLO All Models with 17" or 18" Wheels	
R	04-08	PONTIAC GRAND PRIX All Models with 17" or 18" Wheels	
G52245 B			
F	09-10	PONTIAC VIBE All Left	
F	09-13	TOYOTA COROLLA All Left	
F	09-14	MATRIX All Left	
G52246 B			
F	09-10	PONTIAC VIBE All Right	
F	09-13	TOYOTA COROLLA All Right	
F	09-14	MATRIX All Right	
G52247 B			
F	07-10	KIA MAGENTIS All Left	
F	07-10	OPTIMA All Left	
F	06	OPTIMA All Left New Style	
F	07-11	RONDO All Left	
G52248 B			
F	07-10	KIA MAGENTIS All Right	
F	07-10	OPTIMA All Right	
F	06	OPTIMA All Right New Style	
F	07-11	RONDO All Right	
G52249 D			
F	07-13	ACURA MDX All Left Exc. Active Suspension	
G52250 D			
F	07-13	ACURA MDX All Right Exc. Active Suspension	
G52253 N			
F	08-10	HONDA ODYSSEY All Left	
G52254 N			
F	08-10	HONDA ODYSSEY All Right	
G52255 A			
F	11-13	FORD FIESTA All Left	
F	11	MAZDA 2 All Left	
G52256 A			
F	11-13	FORD FIESTA All Right	
F	11	MAZDA 2 All Right	

Ultra Struts

Shock	POP	Alternative No.	MTG Acc. Supplied
Pos.	Year	Application	
G52257 A			
F	07-08	HYUNDAI ENTOURAGE All Left	
F	14	KIA SEDONA All Left	
F	06-12	SEDONA All Left	
G52258 A			
F	07-08	HYUNDAI ENTOURAGE All Right	
F	14	KIA SEDONA All Right	
F	06-12	SEDONA All Right	
G52260 A			
F	07-13	MAZDA CX-9 All Left	
G52261 A			
F	07-13	MAZDA CX-9 All Right	
G52262 A			
F	08-10	MITSUBISHI LANCER DE Left	
F	08-10	LANCER ES Left	
G52263 A			
F	08-10	MITSUBISHI LANCER DE Right	
F	08-10	LANCER ES Right	
G52264 A			
F	08-12	SCION XB All Left	
G52265 A			
F	08-12	SCION XB All Right	
G52268 A			
F	08-14	SCION XD All Left	
G52269 A			
F	08-14	SCION XD All Right	
G52270 A			
F	06-07	SUBARU B9 TRIBECA All Left	
F	08-14	TRIBECA All Left	
G52271 A			
F	06-07	SUBARU B9 TRIBECA All Right	
F	08-14	TRIBECA All Right	
G52272 A			
F	05-12	SUBARU OUTBACK All Left	
G52273 A			
F	05-12	SUBARU OUTBACK All Right	
G52274 A			
F	07-13	VOLVO C30 All Left	
F	08-13	C70 All Left	
F	05-12	S40 All Left	
F	04	S40 T5 Left	
F	05-11	V50 All Left	
G52275 A			
F	07-13	VOLVO C30 All Right	
F	08-13	C70 All Right	
F	05-12	S40 All Right	
F	04	S40 T5 Right Mfg. to 04/00	
F	05-11	V50 All Right	
G52276 A			
F	02-08	JAGUAR X-TYPE All Exc. CATS Computer Active Technology Suspension	
G52278 A			
F	10	BUICK ALLURE FWD Left Exc. Electronic Suspension	
F	10-16	LACROSSE FWD Left Exc. Electronic Suspension	
G52279 A			
F	10	BUICK ALLURE FWD Right Exc. Electronic Suspension	
F	10-16	LACROSSE FWD Right Exc. Electronic Suspension	
G52280 A			
F	10-13	CHEVROLET CAMARO 3.6L 6Cyl V (217) Left	
G52281 A			
F	10-13	CHEVROLET CAMARO 3.6L 6Cyl V (217) Right	
G52282 A			
F	07-08	HONDA FIT CAN Left	
F	07-08	FIT USA Left	
G52283 A			
F	07-08	HONDA FIT CAN Right	
F	07-08	FIT USA Right	

Numerical listing

Shock	POP	Alternative No.	MTG Acc. Supplied
Pos.	Year	Application	
G52293 N			
F	04-11	MITSUBISHI ENDEAVOR All Left	
G52294 N			
F	04-11	MITSUBISHI ENDEAVOR All Right	
G52295 N			
F	03-08	VOLVO XC90 All	
G52297 A			
F	07-12	MINI COOPER All Left	
G52298 A			
F	07-12	MINI COOPER All Right	
G52299 N			
F	09-13	MITSUBISHI OUTLANDER SE Left w/ 3rd Row Seating	
F	09-13	OUTLANDER XLS Left w/ 3rd Row Seating	
F	10-12	OUTLANDER GT Left w/ 3rd Row Seating	
F	08	OUTLANDER XLS Left	
F	07	OUTLANDER All Left	
G52300 N			
F	10-13	MITSUBISHI OUTLANDER GT Right w/ 3rd Row Seating	
F	09-13	OUTLANDER SE Right w/ 3rd Row Seating	
F	09-13	OUTLANDER XLS Right w/ 3rd Row Seating	
F	08	OUTLANDER XLS Right	
F	07	OUTLANDER All Right	
G52301 N			
F	09-11	VOLKSWAGEN TIGUAN All	
G52314 A			
F	04-07	BMW 525i All	
F	08-10	528i All	
F	04-07	530i All	
F	08-10	535i All	
F	04-05	545i All	
F	06-10	550i All	
G52329 N			
F	11	HYUNDAI SONATA 2.0T Left Mfg. to 7/22/10	
F	11	SONATA 2.0T Limited Left Mfg. to 7/22/10	
F	11	SONATA GL Left Mfg. to 7/22/10	
F	11	SONATA GLS Left Mfg. to 7/22/10	
F	11	SONATA Limited Left Mfg. to 7/22/10	
F	11	SONATA SE Left Mfg. to 7/22/10	
G52330 N			
F	11	HYUNDAI SONATA 2.0T Limited Right Mfg. to 7/22/10	
F	11	SONATA 2.0T Right Mfg. to 7/22/10	
F	11	SONATA GL Right Mfg. to 7/22/10	
F	11	SONATA GLS Right Mfg. to 7/22/10	
F	11	SONATA Limited Right Mfg. to 7/22/10	
F	11	SONATA SE Right Mfg. to 7/22/10	
G52331 N			
F	12-15	TOYOTA PRIUS All Left	
F	11	PRIUS All Left Mfg. to 12/11	
F	10	PRIUS All Left	
G52332 N			
F	11-12	TOYOTA PRIUS All Right Mfg. to 12/11	
F	10	PRIUS All Right	
G52333 A			
R	97-05	HYUNDAI ACCENT All Left Gas Charged Unit	
G52334 A			
R	97-05	HYUNDAI ACCENT All Right Gas Charged Unit	
G52335 A			
R	96-00	HYUNDAI ELANTRA All Left Gas Charged Unit	
G52336 A			
R	96-00	HYUNDAI ELANTRA All Right Gas Charged Unit	
G52346 N			
F	05-06	ACURA RSX All Left	
G52347 A			
F	05-06	ACURA RSX All Right	

Numerical listing

Shock	POP	Alternative No.	MTG Acc. Supplied
Pos.	Year	Application	
G52348	N		
F	04-09	VOLKSWAGEN TOUAREG All Left	
G52349	N		
F	04-09	VOLKSWAGEN TOUAREG All Right	
G52351	N		
F	11-14	FORD EDGE All Left	
F	11-14	LINCOLN MKX All Left	
G52352	N		
F	11-14	FORD EDGE All Right	
F	11-14	LINCOLN MKX All Right	
G52353	N		
F	12-14	DODGE ATTITUDE All Left	
F	14-16	HYUNDAI ACCENT All Left	
F	12-15	KIA RIO All Left	
G52354	N		
F	12-14	DODGE ATTITUDE All Right	
F	14-16	HYUNDAI ACCENT All Right	
F	12-15	KIA RIO All Right	
G52355	N		
F	11-13	NISSAN QUEST All Left	
G52356	N		
F	11-13	NISSAN QUEST All Right	
G52360	N		
F	09-15	HONDA PILOT All Left	
G52361	N		
F	09-15	HONDA PILOT All Right	
G52362	N		
F	04-06	MITSUBISHI GALANT LS Left	
G52363	N		
F	04-06	MITSUBISHI GALANT LS Right	
G52365	N		
F	06	TOYOTA AVALON All Left Mfg. to 01/06	
F	05	AVALON All Left	
G52366	N		
F	06	TOYOTA AVALON All Right Mfg. to 01/06	
F	05	AVALON All Right	
G52367	N		
R	05-06	TOYOTA AVALON All Left	
G52368	N		
R	05-06	TOYOTA AVALON All Right	
G52369	N		
F	10-13	FORD TRANSIT CONNECT All Left	
G52370	N		
F	10-13	FORD TRANSIT CONNECT All Right	
G52374	N		
F	09-13	SUBARU FORESTER All Left	
G52375	N		
F	09-12	SUBARU FORESTER All Right	
G52376	N		
F	04	TOYOTA AVALON All Left	
G52377	N		
F	04	TOYOTA AVALON All Right	
G52380	N		
R	08-13	TOYOTA HIGHLANDER AWD Left	
G52381	N		
R	08-13	TOYOTA HIGHLANDER AWD Right	
G52382	N		
F	09-14	NISSAN MAXIMA All Left	
G52383	N		
F	09-14	NISSAN MAXIMA All Right	
G52384	N		
F	10-12	FORD FLEX All Left	
F	10-12	LINCOLN MKT All Left	
G52385	N		
F	10-12	FORD FLEX All Right	
F	10-12	LINCOLN MKT All Right	

Ultra Struts

Shock	POP	Alternative No.	MTG Acc. Supplied
Pos.	Year	Application	
G52386	N		
F	02-03	SUBARU IMPREZA Wagon Left	
G52387	N		
F	02-03	SUBARU IMPREZA Wagon Right	
G52389	N		
F	04-06	SUZUKI VERONA All Left	
G52390	N		
F	04-06	SUZUKI VERONA All Right	
G52393	A		
R	00-05	TOYOTA MR2 All Left	
G52394	A		
R	00-05	TOYOTA MR2 All Right	
G52395	N		
F	10-15	CHEVROLET CAMARO SS Left	
G52396	N		
F	10-15	CHEVROLET CAMARO SS Right	
G52398	N		
F	10-12	FORD TAURUS All Left w/ Suspension Code A and B	
F	09-12	LINCOLN MKS All Left w/ Suspension Code A and B	
G52399	N		
F	10-12	FORD TAURUS All Right w/ Suspension Code A and B	
F	09-12	LINCOLN MKS All Right w/ Suspension Code A and B	
G52400	N		
F	08-09	FORD TAURUS X All Left	
G52401	N		
F	08-09	FORD TAURUS X All Right	
G52406	N		
F	11-14	FORD MUSTANG / MUSTANG II All	
G52412	N		
R	04	TOYOTA AVALON All Left	
G52413	N		
R	04	TOYOTA AVALON All Right	
G52418	N		
F	12-13	NISSAN ROGUE All Left	
F	14-15	ROGUE SELECT All Left	
G52419	N		
F	12-13	NISSAN ROGUE All Right	
F	14-15	ROGUE SELECT All Right	
G52420	FF		
F	13	FORD ESCAPE All Left	
G52421	FF		
F	13	FORD ESCAPE All Right	
G52422	FF		
F	12-13	FORD FOCUS All Left	
G52423	FF		
F	12-13	FORD FOCUS All Right	
G52425	FF		
F	12-15	TOYOTA CAMRY SE Left	
F	14	CAMRY SE Sport Left	
G52426	FF		
F	12-15	TOYOTA CAMRY SE Right	
F	14	CAMRY SE Sport Right	
G52428	FF		
F	13-17	HONDA ACCORD Sedan Left	
G52429	FF		
F	13-17	HONDA ACCORD Sedan Right	
G52432	N		
F	12-16	BUICK VERANO All Left	
F	11-15	CHEVROLET CRUZE All Left	
F	16	CRUZE LIMITED All Left	
G52433	N		
F	12-16	BUICK VERANO All Right	
F	11-15	CHEVROLET CRUZE All Right	
F	16	CRUZE LIMITED All Right	
G52435	N		
F	11-13	BUICK REGAL All Left Exc. Active Suspension	

Numerical listing

Shock	POP	Alternative No.	MTG Acc. Supplied
Pos.	Year	Application	
G52436	N		
F	11-13	BUICK REGAL All Right Exc. Active Suspension	
G52437	N		
F	12-15	HYUNDAI AZERA All Left	
G52438	N		
F	12-15	HYUNDAI AZERA All Right	
G52439	N		
F	12-13	HYUNDAI ELANTRA All Left	
F	13	ELANTRA COUPE All Left	
G52440	N		
F	12-13	HYUNDAI ELANTRA All Right	
F	13	ELANTRA COUPE All Right	
G52447	N		
F	10-15	LEXUS RX350 All Left w/o Air Suspension	
G52448	N		
F	10-15	LEXUS RX350 All Right w/o Air Suspension	
G52449	FF		
F	07-13	MAZDA 3 Mazdaspeed Left	
G52450	FF		
F	07-13	MAZDA 3 Mazdaspeed Right	
G52453	N		
F	14-16	NISSAN NOTE All Left	
F	13-16	VERSA All Left	
G52454	N		
F	14-16	NISSAN NOTE All Right	
F	13-16	VERSA All Right	
G52459	FF		
F	12-13	DODGE H100 GAS Left	
F	11	H100 All Left Gas	
F	08-09	H100 All Left Gas	
F	10	H100 TRUCK Truck Left Gas	
F	10	H100 VAN Van Left Gas	
G52460	FF		
F	12-13	DODGE H100 GAS Right	
F	11	H100 All Right Gas	
F	08-09	H100 All Right Gas	
F	10	H100 TRUCK Truck Right Gas	
F	10	H100 VAN Van Right Gas	
G52485	FF		
R	12-13	TOYOTA CAMRY Hybrid LE Left	
R	12-13	CAMRY Hybrid XLE Left	
R	12-13	CAMRY SE Left	
R	12-13	CAMRY XLE Left	
G52486	FF		
R	12-13	TOYOTA CAMRY Hybrid LE Right	
R	12-13	CAMRY Hybrid XLE Right	
R	12-13	CAMRY SE Right	
R	12-13	CAMRY XLE Right	
G52491	FF		
F	09-12	FIAT 500 All Left	
G52492	FF		
F	09-12	FIAT 500 All Right	
G52494	FF		
F	13-16	BUICK ENCORE All Left	
F	13-16	CHEVROLET TRAX All Left	
G52495	FF		
F	13-16	BUICK ENCORE All Right	
F	13-16	CHEVROLET TRAX All Right	
G52502	FF		
F	13-16	DODGE DART All Left Touring Suspension	
G52503	FF		
F	13-16	DODGE DART All Right Touring Suspension	
G52519	FF		
F	12-13	MAZDA 5 All Left	
G52520	FF		
F	12-13	MAZDA 5 All Right	
G52524	N		
F	13-16	NISSAN PATHFINDER All Left	

Numerical listing

Shock	POP	Alternative No.	MTG Acc. Supplied
Pos.	Year	Application	
G52525	N		
F	13-16	NISSAN PATHFINDER All Right	
G52586	FF		
F	12-15	SUZUKI SWIFT All Left	
G52587	FF		
F	12-15	SUZUKI SWIFT All Right	
G52588	FF		
F	06-08	HONDA FIT MEX Left	
G52589	FF		
F	06-08	HONDA FIT MEX Right	
G52591	FF		
F	15-16	CHEVROLET CITY EXPRESS All Left	
F	13-17	NISSAN NV200 All Left	
G52592	N		
F	15-16	CHEVROLET CITY EXPRESS All Right	
F	13-17	NISSAN NV200 All Right	
G52594	FF		
F	08-13	SUBARU IMPREZA All Left	
G52595	FF		
F	08-13	SUBARU IMPREZA All Right	
G52600	FF		
F	10	BUICK ALLURE AWD Left Exc. Electronic Suspension	
F	10-12	LACROSSE AWD Left Exc. Electronic Suspension	
G52601	FF		
F	10	BUICK ALLURE AWD Right Exc. Electronic Suspension	
F	10-12	LACROSSE AWD Right Exc. Electronic Suspension	
G52622	FF		
F	13-16	CADILLAC ATS AWD Left	
G52623	FF		
F	13-16	CADILLAC ATS AWD Right	
G52638	FF		
R	02-05	LAND ROVER FREELANDER All Left	
G52639	FF		
R	02-05	LAND ROVER FREELANDER All Right	
G55505	W		
F	84	BUICK CENTURY All Exc. HD Suspension	
F	82-83	CENTURY All	
F	84	SKYLARK All Exc. HD Suspension	
F	80-83	SKYLARK All	
F	84	CHEVROLET CELEBRITY All Exc. HD Suspension	
F	82-83	CELEBRITY All	
F	84-85	CITATION / CITATION II All Exc. HD Suspension	
F	80-83	CITATION / CITATION II All	
F	84	OLDSMOBILE CIERA / CUTLASS CIERA All Exc. HD Suspension	
F	82-83	CIERA / CUTLASS CIERA All	
F	84	OMEGA All Exc. HD Suspension	
F	80-83	OMEGA All	
F	84	PONTIAC 6000 All Exc. HD Suspension	
F	82-83	6000 All	
F	84	PHOENIX All Exc. HD Suspension	
F	80-83	PHOENIX All	
G55507	W		
F	83	CHRYSLER E CLASS All	
F	83	EXECUTIVE SEDAN All	
F	81-83	LEBARON All	
F	83	NEW YORKER All	
F	82-83	DODGE 400 All	
F	83	600 All	
F	81-83	ARIES All	
F	83-87	CHARGER All	
F	78-89	OMNI All	
F	82-84	RAMPAGE All	
F	83	PLYMOUTH CARVELLE All	
F	87-89	EXPO All	
F	78-89	HORIZON All	
F	81-83	RELIANT All	
F	83	SCAMP All	
F	85	TURISMO All	

Ultra Struts

Shock	POP	Alternative No.	MTG Acc. Supplied
Pos.	Year	Application	
G55507	W	-continued	
F	83	TURISMO All	
G55509	X		
F	86	DODGE CARAVAN / GRAND CARAVAN All Mfg. to 2/86	
F	84-85	CARAVAN / GRAND CARAVAN All	
F	86	PLYMOUTH VOYAGER / GRAND VOYAGER All Mfg. to 2/86	
F	84-85	VOYAGER / GRAND VOYAGER All	
G55510	W		
F	82-87	LINCOLN CONTINENTAL All	
F	84-92	MARK VII All	
G55511	W		
F	84-85	CHRYSLER DAYTONA All	
F	84	E CLASS All	
F	85	EXECUTIVE LIMOUSINE All	
F	84	EXECUTIVE SEDAN All	
F	84-85	LASER All	
F	84-85	LEBARON All	
F	84-85	NEW YORKER All	
F	84-85	DODGE 600 All	
F	84-85	ARIES All	
F	84-85	DAYTONA All	
F	85	LANCER All	
F	84-85	PLYMOUTH CARVELLE All	
F	84-85	RELIANT All	
G55512	W		
R	84-87	PONTIAC FIERO All	
G55514	D		142699
F	85-96	BUICK CENTURY All	
F	84	CENTURY All HD Suspension	
F	85	SKYLARK All	
F	84	SKYLARK All HD Suspension	
F	85-90	CHEVROLET CELEBRITY All	
F	84	CELEBRITY All HD Suspension	
F	84-85	CITATION / CITATION II All HD Suspension	
F	85-96	OLDSMOBILE CIERA / CUTLASS CIERA All Exc. Electronic Adjustable Suspension	
F	84	CIERA / CUTLASS CIERA All HD Suspension	
F	87-94	CUTLASS CLASSIC / CUTLASS CRUISER All Exc. Electronic Adjustable Suspension	
F	84	OMEGA All HD Suspension	
F	91	PONTIAC 6000 FWD HD Suspension	
F	84-90	6000 All HD Suspension	
F	84	PHOENIX All HD Suspension	
G55515	W		
F	82-85	HONDA ACCORD All	
G55516	W		
R	82-85	HONDA ACCORD All	
R	83-87	PRELUDE All Sealed Rear Struts	
G55518	D		
R	86-93	FORD TAURUS Sedan	
R	86-93	MERCURY SABLE Sedan	
G55521	W		
F	86-88	NISSAN MAXIMA Sedan Exc. Electronic Adjustable Suspension	
F	87-89	STANZA Sedan	
G55525	D		
F	90-95	CHRYSLER TOWN & COUNTRY All	
F	87-95	DODGE CARAVAN / GRAND CARAVAN All	
F	86	CARAVAN / GRAND CARAVAN All Mfg. from 1/86	
F	87-88	MINI RAM All	
F	87-95	PLYMOUTH VOYAGER / GRAND VOYAGER All	
F	86	VOYAGER / GRAND VOYAGER All Mfg. from 1/86	
G55526	D		
F	86-93	CHRYSLER DAYTONA All	
F	88-93	DYNASTY All Exc. Hydraulic Self Leveling System	
F	90-93	IMPERIAL All Exc. Hydraulic Self Leveling System	
F	86	LASER All	
F	86-95	LEBARON All	
F	86-93	NEW YORKER All	
F	86-88	TOWN & COUNTRY All	
F	86-88	DODGE 600 All	
F	86-89	ARIES All	

Numerical listing

Shock	POP	Alternative No.	MTG Acc. Supplied
Pos.	Year	Application	
G55526	D	-continued	
F	89-93	DAYTONA ES	
F	91	DAYTONA Iroc	
F	89-90	DAYTONA ES Turbo	
F	87-88	DAYTONA Pacifica	
F	86	DAYTONA All	
F	88-93	DYNASTY All Exc. Hydraulic Self Leveling System	
F	86-89	LANCER All	
F	87-94	SHADOW All	
F	89-95	SPIRIT All	
F	89-95	PLYMOUTH ACCLAIM All	
F	86-88	CARAVELLE All	
F	86-89	RELIANT All	
F	87-94	SUNDANCE All	
G55527	D		
F	84-89	MERCEDES-BENZ 190D All	
F	84-93	190E All	
F	87-89	260E All Exc. 4 Matic 4x4	
F	90-93	300D All Exc. 4 Matic 4x4	
F	87	300D All Exc. 4 Matic 4x4	
F	86-93	300E All Exc. 4 Matic 4x4	
F	92-93	400E / 400SE / 400SEL / 420SEL / 450SE / 450SEL All	
F	95	E300 All	
F	94-95	E320 All	
F	94-95	E420 All	
F	94	E500 All	
G55529	W		141687
R	86-87	TOYOTA CELICA All	
G55542	W		141685
F	86-91	MAZDA RX7 All Exc. Electronic Adjustable Suspension	
G55544	D		141690
R	86-89	MAZDA 323 FWD Exc. Electronic Adjustable Suspension	
R	81-85	GLC Hatchback	
R	81-85	GLC Sedan	
R	87-89	MERCURY TRACER FWD	
G55551	C		141306
F	84-93	FORD MUSTANG / MUSTANG II GT, 5.0L 8Cyl V (302)	
G55557	C		141718
R	89-92	GEO PRIZM All	
R	88-92	TOYOTA COROLLA FWD	
G55561	W		
F	87-88	DODGE COLT Hatchback	
F	87-88	COLT Sedan	
F	89-92	EAGLE VISTA Sedan	
F	89-91	VISTA Hatchback	
F	87-88	MITSUBISHI MIRAGE All	
F	88-90	PLYMOUTH COLT DL, Wagon	
F	87	COLT Hatchback	
F	87	COLT Sedan	
G55579	C		141730
F	89-97	FORD THUNDERBIRD All Exc. Electronic Adjustable Suspension	
F	89-97	MERCURY COUGAR All Exc. Electronic Adjustable Suspension	
G55586	D		
F	90-94	HYUNDAI EXCEL All	
F	91-95	SCOUPE All	
F	90-94	MITSUBISHI PRECIS All	
G55587	W		
F	90	EAGLE TALON AWD	
F	90	TALON FWD	
F	90	MITSUBISHI ECLIPSE All	
F	90-94	PLYMOUTH LASER FWD	
G55588	W		142018
R	87-91	TOYOTA CAMRY Wagon	
G55589	D		142018
R	90-91	LEXUS ES250 All	
R	88-91	TOYOTA CAMRY Sedan, FWD	
R	87	CAMRY Sedan	
G55590	C		142597
F	90-91	LEXUS ES250 All	
F	87-91	TOYOTA CAMRY All	
G55591	B		142024
F	89-92	GEO PRIZM All	
F	88-92	TOYOTA COROLLA FWD	
G55592	W		
F	89-92	DODGE COLT Hatchback	

Numerical listing

Shock	POP	Alternative No.	MTG Acc. Supplied
Pos.	Year	Application	
G55592 W -continued			
F	91-92	EAGLE SUMMIT Sedan	
F	89-90	SUMMIT All	
F	92-95	HYUNDAI ELANTRA Non-ABS	
F	89-92	MINI COOPER All	
F	89-91	PLYMOUTH COLT Hatchback	
G55594 X			
F	90	DODGE OMNI All	
F	90	PLYMOUTH HORIZON All	
G55600 D 141715			
F	89-92	FORD PROBE All	
F	88-92	MAZDA 626 All Exc. Electronic Adjustable Suspension or 4 Wheel Steer	
F	88-92	MX6 All Exc. Electronic Adjustable Suspension or 4 Wheel Steer	
G55601 D			
R	89-92	FORD PROBE All	
R	88-92	MAZDA 626 All Exc. Electronic Adjustable Suspension or 4 Wheel Steer	
R	88-92	MX6 All Exc. Electronic Adjustable Suspension or 4 Wheel Steer	
G55602 W			
F	91-93	MERCURY CAPRI All	
G55603 W 141690			
R	91-93	MERCURY CAPRI All	
G55605 D 142174			
F	91-93	EAGLE 2000 GTX All Exc. Auto-Leveling System	
F	92-96	SUMMIT Wagon	
F	91-94	TALON All	
F	91-94	MINI COOPER All	
F	90-92	MINI COOPER All	
F	92-94	PLYMOUTH COLT Wagon	
F	92-94	LASER AWD	
G55606 D 141687			
R	90-93	TOYOTA CELICA FWD	
G55607 D			
F	90-94	NISSAN AXXESS FWD Left	
F	89-94	MAXIMA All Left Exc. Electronic Adjustable Suspension	
G55608 D			
F	90-94	NISSAN AXXESS FWD Right	
F	89-94	MAXIMA All Right Exc. Electronic Adjustable Suspension	
G55609 X 142174			
F	89-93	MINI COOPER All	
G55610 W			
F	90-92	NISSAN STANZA All Left	
G55611 W			
F	90-92	NISSAN STANZA All Right	
G55615 D 141711			
F	94-97	FORD ASPIRE Non-ABS	
F	88-93	FESTIVA All	
G55616 D			
F	86-95	FORD TAURUS All	
F	86-95	MERCURY SABLE All	
G55652 D			
F	91-97	TOYOTA PREVIA All Left	
G55653 D			
F	91-97	TOYOTA PREVIA All Right	
G55657 D			
F	93-94	NISSAN SENTRA All Left B13 Independent Rear Suspension	
G55658 D			
F	93-94	NISSAN SENTRA All Right B13 Independent Rear Suspension	
G55661 A			
R	98-02	CHEVROLET PRIZM All Left	
R	93-97	MINI COOPER All Left	
R	93-02	TOYOTA COROLLA All Left	
G55662 A			
R	98-02	CHEVROLET PRIZM All Right	
R	93-97	MINI COOPER All Right	
R	93-02	TOYOTA COROLLA All Right	

Ultra Struts

Shock	POP	Alternative No.	MTG Acc. Supplied
Pos.	Year	Application	
G55663 C			
F	99-04	CHRYSLER 300M All Left	
F	93-04	CONCORDE All Left	
F	93-04	INTREPID All Left	
F	99-01	LHS All Left	
F	94-97	LHS All Left	
F	94-96	NEW YORKER All Left	
F	93-04	DODGE INTREPID All Left	
F	93-97	EAGLE VISION All Left	
G55664 C			
F	99-04	CHRYSLER 300M All Right	
F	93-04	CONCORDE All Right	
F	93-04	INTREPID All Right	
F	99-01	LHS All Right	
F	94-97	LHS All Right	
F	94-96	NEW YORKER All Right	
F	93-04	DODGE INTREPID All Right	
F	93-97	EAGLE VISION All Right	
G55665 D			
R	93-97	CHRYSLER CONCORDE All	
R	94-97	INTREPID CAN	
R	93	INTREPID All	
R	94-97	LHS All	
R	94-96	NEW YORKER All	
R	93-97	DODGE INTREPID All	
R	93-97	EAGLE VISION All	
G55666 D			
F	93-97	NISSAN ALTIMA All Right	
G55667 D			
F	93-97	NISSAN ALTIMA All Left	
G55668 C 142868			
R	93-01	NISSAN ALTIMA All Right	
G55669 D 142868			
R	93-01	NISSAN ALTIMA All Left	
G55670 W			
F	93-97	FORD PROBE All Right	
F	93-97	MAZDA 626 All Right	
F	93-97	MX6 All Right	
G55671 W			
F	93-97	FORD PROBE All Left	
F	93-97	MAZDA 626 All Left	
F	93-97	MX6 All Left	
G55672 D			
R	93-97	FORD PROBE All	
R	93-97	MAZDA 626 All	
R	93-97	MX6 All	
G55675 A			
R	97-02	LEXUS ES300 All Left Exc. Electronic Adjustable Suspension	
R	95-96	ES300 All Left	
R	92-94	ES300 All Left Sealed O.E. Struts	
R	95-03	TOYOTA AVALON All Left	
R	95-01	CAMRY All Left	
R	92-94	CAMRY All Left Sealed O.E. Struts	
R	99-03	SOLARA All Left	
G55676 A			
R	97-02	LEXUS ES300 All Right Exc. Electronic Adjustable Suspension	
R	95-96	ES300 All Right	
R	92-94	ES300 All Right Sealed O.E. Struts	
R	95-03	TOYOTA AVALON All Right	
R	95-01	CAMRY All Right	
R	92-94	CAMRY All Right Sealed O.E. Struts	
R	99-03	SOLARA All Right	
G55679 D			
F	95-99	DODGE NEON All	
F	95-99	PLYMOUTH NEON All	
G55680 W			
R	95-99	DODGE NEON All	
R	95-99	PLYMOUTH NEON All	
G55681 A			
F	03-04	FORD MUSTANG / MUSTANG II Mach I	
F	94-04	MUSTANG / MUSTANG II Base	
F	94-04	MUSTANG / MUSTANG II GT	
F	04	MUSTANG / MUSTANG II GT Base	
F	04	MUSTANG / MUSTANG II GT Equipado	
F	01	MUSTANG / MUSTANG II GT Bullitt	
F	95	MUSTANG / MUSTANG II GTS	
G55685 A			
F	95-03	FORD WINDSTAR All	

Numerical listing

Shock	POP	Alternative No.	MTG Acc. Supplied
Pos.	Year	Application	
G55692 D			
F	95-97	FORD CONTOUR All Mfg. to 3/97	
F	95-97	MERCURY MYSTIQUE All Mfg. to 3/97	
G55693 C			
R	95-00	FORD CONTOUR All	
R	99-02	MERCURY COUGAR All	
R	95-00	MYSTIQUE All	
G55697 A 143004			
F	96-00	CHRYSLER TOWN & COUNTRY All	
F	00	VOYAGER / GRAND VOYAGER All	
F	00	VOYAGER / GRAND VOYAGER Non-ABS	
F	96-00	DODGE CARAVAN / GRAND CARAVAN All Exc. Hydraulic Self Leveling System	
F	96-00	PLYMOUTH VOYAGER / GRAND VOYAGER All	
G55698 A			
F	95-05	CHEVROLET CAVALIER All	
F	95-05	PONTIAC SUNFIRE All	
G55705 D			
R	81-90	FORD ESCORT All	
R	84-88	EXP All	
R	82-83	EXP All Mfg. to 2/83	
R	82-83	MERCURY LN7 All	
R	81-87	LYNX All	
G55706 W			
F	80-83	HONDA CIVIC All	
G55707 W 141505			
R	81-83	HONDA CIVIC Sedan	
R	80-83	CIVIC Hatchback	
G55710 D			
F	86-89	MAZDA 323 FWD Exc. Electronic Adjustable Suspension	
F	84-85	GLC All	
F	81-83	GLC Sedan	
F	81-82	GLC Hatchback	
F	87-89	MERCURY TRACER FWD	
G55712 W 141120			
F	83-85	FORD ESCORT All Mfg. from 2/83 thru 2/85	
F	83-85	EXP All Mfg. from 2/83 thru 2/85	
F	83	MERCURY LN7 All Mfg. from 2/83 thru 2/85	
F	83-85	LYNX All Mfg. from 2/83 thru 2/85	
G55713 D 141310			
F	86	NISSAN PULSAR / PULSAR NX All Mfg. to 1/86	
F	83-85	PULSAR / PULSAR NX All	
F	82-86	SENTRA All	
G55714 D 142449			
F	85-90	FORD ESCORT All Mfg. from 3/85	
F	85-88	EXP All Mfg. from 3/85	
F	87-94	TEMPO All	
F	85-86	TEMPO FWD Mfg. from 3/85	
F	85-87	MERCURY LYNX All Mfg. from 3/85	
F	92-94	TOPAZ FWD Mfg. from 3/85	
F	87-91	TOPAZ All Mfg. from 3/85	
F	85-86	TOPAZ FWD Mfg. from 3/85	
G55715 D 142024			
F	85-88	CHEVROLET NOVA All	
F	86-87	TOYOTA COROLLA FWD Sealed Front Struts	
F	84-85	COROLLA FWD, GAS Sealed Front Struts	
G55719 W			
F	85-88	CHEVROLET SPECTRUM All	
F	89	MINI COOPER All	
F	85-89	ISUZU I-MARK All	
F	85-88	PONTIAC SUNBURST All	
G55722 X			
R	87-91	FORD TEMPO AWD	
R	87-91	MERCURY TOPAZ AWD	
G55725 W			
F	84-87	HONDA CIVIC Hatchback	
F	84-87	CIVIC Sedan	
G55726 D 141701			
F	82-87	SUBARU BRAT All	
F	82-84	DL 4WD	
F	85-89	GL Hatchback, 4WD	

Numerical listing

Shock	POP	Alternative No.	MTG Acc. Supplied
Pos.	Year	Application	
G55726	D	-continued	141701
F	82-84	GL 4WD	
G55727	W		141982
F	83-87	MAZDA 626 All Exc. Electronic Adjustable Suspension	
G55728	W		
F	85-87	HONDA CIVIC Wagon, 4WD	
G55729	X		
R	83-87	MAZDA 626 All Exc. Electronic Adjustable Suspension	
G55731	W		
F	86-89	ACURA INTEGRA All	
G55732	W		
F	84-87	HONDA CIVIC Wagon, FWD	
G55733	D		
R	84-94	FORD TEMPO FWD	
R	84-94	MERCURY TOPAZ FWD	
G55742	D		141544
F	86-89	HONDA ACCORD All	
F	88-91	PRELUDE All	
G55743	W		141544
R	86-89	HONDA ACCORD All	
G55745	C		141709
F	91-93	NISSAN NX All	
F	87-90	PULSAR / PULSAR NX All	
F	86	PULSAR / PULSAR NX All Mfg. from 1/86	
F	91-92	SENTRA Non-ABS	
F	87-90	SENTRA FWD	
G55746	D		141682
R	87-90	NISSAN PULSAR / PULSAR NX All	
R	86	PULSAR / PULSAR NX All Mfg. from 1/86	
R	87-92	SENTRA FWD	
G55749	W		
F	85-88	CHEVROLET SPRINT All	
F	85-88	PONTIAC FIREFLY All	
F	85-88	SUZUKI FORSA All	
G55752	D		141689
R	85-88	CHEVROLET NOVA All	
R	86-87	TOYOTA COROLLA FWD	
R	84-85	COROLLA FWD, GAS	
R	87	TERCEL Wagon, FWD	
R	83-86	TERCEL All	
G55757	W		141699
R	88-91	HONDA PRELUDE All	
G55763	W		141720
F	88	HONDA CIVIC Hatchback	
F	88	CIVIC Sedan	
F	88	CRX All	
G55766	W		
R	88	HONDA CIVIC Hatchback	
R	88	CIVIC Sedan	
R	88	CRX All	
G55770	W		141544
F	89-90	ACURA LEGEND All Auto Leveling System	
F	87-88	LEGEND Coupe	
G55771	W		143427
R	89-91	HONDA CIVIC Hatchback	
R	89-91	CIVIC Sedan	
G55772	D		
R	98-01	CHEVROLET METRO Non-ABS	
R	89-91	SPRINT All	
R	89-97	GEO METRO Non-ABS	
R	95-99	PONTIAC FIREFLY Non-ABS	
R	94	FIREFLY CAN	
R	89-91	FIREFLY CAN	
R	89-01	SUZUKI SWIFT All	
G55773	D		141544
F	89-91	HONDA CIVIC Hatchback	
F	89-91	CIVIC Sedan	
G55774	C		141544
F	90-93	HONDA ACCORD All	
G55776	W		
R	93	ASUNA SUNFIRE (CANADIAN VEHICLE) All Exc. Lotus Suspension	

Ultra Struts

Shock	POP	Alternative No.	MTG Acc. Supplied
Pos.	Year	Application	
G55776	W	-continued	
R	90-93	GEO STORM Non-ABS	
R	90-92	ISUZU IMPULSE FWD	
R	91-93	STYLUS All	
G55780	W		142116
F	93	ASUNA SUNFIRE (CANADIAN VEHICLE) All	
F	90-93	GEO STORM Non-ABS	
F	90-92	ISUZU IMPULSE All	
F	91-93	STYLUS All	
G55781	W		141544
F	89-91	HONDA CIVIC Wagon	
G55782	W		141544
R	89-91	HONDA CIVIC Wagon	
G55784	X		
F	87-89	SUBARU DL Coupe, 4WD Right Exc. Air Suspension	
F	87-89	DL Wagon, 4WD Right Exc. Air Suspension	
F	87-89	GL Coupe, 4WD Right Exc. Air Suspension	
F	87-89	GL Wagon, 4WD Right Exc. Air Suspension	
F	90-93	LOYALE 4WD Right Exc. Air Suspension	
G55785	X		
F	87-89	SUBARU DL Coupe, 4WD Left Exc. Air Suspension	
F	87-89	DL Wagon, 4WD Left Exc. Air Suspension	
F	87-89	GL Coupe, 4WD Left Exc. Air Suspension	
F	87-89	GL Wagon, 4WD Left Exc. Air Suspension	
F	90-93	LOYALE 4WD Left Exc. Air Suspension	
G55786	B		141544
R	97-99	ACURA CL All	
R	90-97	HONDA ACCORD All	
G55787	D		141544
F	90-93	ACURA INTEGRA All	
F	89-91	HONDA CRX All	
G55788	W		141544
R	90-93	ACURA INTEGRA All	
G55795	D		141544
F	92-96	HONDA PRELUDE All	
G55800	W		142126
R	91-02	SATURN SC / SL / SW SERIES All	
G55801	W		142127
F	91-02	SATURN SC / SL / SW SERIES All	
G55802	C		141544
F	97-01	ACURA INTEGRA GS	
F	95-01	INTEGRA GS-R	
F	94-01	INTEGRA LS	
F	94-98	INTEGRA RS	
F	95-96	INTEGRA Special Edition	
F	92-95	HONDA CIVIC All	
F	93-97	CIVIC DEL SOL All	
G55803	B		142128
R	97-01	ACURA INTEGRA GS	
R	94-01	INTEGRA GS-R	
R	94-01	INTEGRA LS	
R	94-98	INTEGRA RS	
R	95-96	INTEGRA Special Edition	
R	92-95	HONDA CIVIC All	
R	93-97	CIVIC DEL SOL All	
R	89-91	CRX All	
G55804	D		142099
R	92-94	TOYOTA PASEO All	
R	91-94	TERCEL All	
G55805	D		142128
R	92-01	HONDA PRELUDE All	
G55817	D		
R	95-96	CHEVROLET LUMINA All	
R	95-96	MONTE CARLO All	
G55818	W		
F	95-96	CHRYSLER CIRRUS All	
F	96	SEBRING Convertible	
F	95-96	DODGE STRATUS All	
F	96	PLYMOUTH BREEZE All	

Numerical listing

Shock	POP	Alternative No.	MTG Acc. Supplied
Pos.	Year	Application	
G55819	D		142094
F	95-98	EAGLE TALON All	
F	95-99	MITSUBISHI ECLIPSE All	
G55820	D		142094
F	95-00	CHRYSLER SEBRING Coupe	
F	95-00	DODGE AVENGER All	
F	94-98	MITSUBISHI GALANT All	
G55821	D		142372
R	95-98	HONDA ODYSSEY All	
R	96-99	ISUZU OASIS All	
G55825	B		142609
R	95-05	CHEVROLET CAVALIER All	
R	95-05	PONTIAC SUNFIRE All	
G55828	C		142780
F	92-94	TOYOTA PASEO All	
F	91-94	TERCEL All	
G55831	B		
R	97-01	CHEVROLET LUMINA All	
R	97-99	MONTE CARLO All	
G55832	C		
F	98-01	NISSAN ALTIMA All Left	
G55833	C		
F	98-01	NISSAN ALTIMA All Right	
G55834	C		
F	02-07	BUICK RENDEZVOUS All Exc. Hydraulic Self Leveling System	
F	01-05	PONTIAC AZTEK All	
G55847	D		
F	91-96	FORD ESCORT All	
F	90-94	MAZDA 323 All	
F	90-94	PROTÉGÉ / PROTÉGÉ5 FWD, Non-ABS	
F	91-96	MERCURY TRACER FWD	
G55848	C		
R	91-03	FORD ESCORT All	
R	90-94	MAZDA 323 All	
R	90-94	PROTÉGÉ / PROTÉGÉ5 FWD, Non-ABS	
R	91-99	MERCURY TRACER FWD	
G55849	D		
F	95-99	HYUNDAI ACCENT All	
G55850	W		
R	97	HYUNDAI ACCENT All Mfg. to 6/97	
R	95-96	ACCENT All	
G55856	D		
R	99-04	CHRYSLER 300M All	
R	98-04	CONCORDE All	
R	98-04	INTREPID All	
R	99-01	LHS All	
R	98-04	DODGE INTREPID All	
G55857	D		
F	96-99	SUBARU LEGACY Brighton, AWD Right	
F	96-99	LEGACY GT, AWD Right	
F	95-99	LEGACY L, AWD Right	
F	95-98	LEGACY Postal, AWD Right	
F	98	LEGACY GT Limited, AWD Right	
F	95-97	LEGACY LSi, AWD Right	
F	95-96	LEGACY LS, AWD Right	
G55858	D		
F	96-99	SUBARU LEGACY Brighton, AWD Left	
F	96-99	LEGACY GT, AWD Left	
F	95-99	LEGACY L, AWD Left	
F	95-98	LEGACY Postal, AWD Left	
F	98	LEGACY GT Limited, AWD Left	
F	95-97	LEGACY LSi, AWD Left	
F	95-96	LEGACY LS, AWD Left	
G55859	W		
R	95-99	SUBARU LEGACY Brighton, AWD Right	
G55860	W		
R	95-99	SUBARU LEGACY Brighton, AWD Left	
G55865	D		
F	95-99	SUBARU LEGACY Outback Right	
F	99	LEGACY Outback Limited Right	
F	97	LEGACY Outback Limited Right	

Numerical listing

Shock	POP	Alternative No.	MTG Acc. Supplied
Pos.	Year	Application	
G55866	D		
F	95-99	SUBARU	LEGACY Outback Left
F	99		LEGACY Outback Limited Left
F	97		LEGACY Outback Limited Left
G55867	D		
R	95-99	SUBARU	LEGACY Outback Right
R	99		LEGACY Outback Limited Right
R	97		LEGACY Outback Limited Right
G55868	D		
R	95-99	SUBARU	LEGACY Outback Left
R	99		LEGACY Outback Limited Left
R	97		LEGACY Outback Limited Left
G55870	A		141544
F	01-03	ACURA	CL All
F	99-03		TL All
F	98-02	HONDA	ACCORD All
G55871	A		141544
R	01-03	ACURA	CL All
R	99-03		TL All
R	98-02	HONDA	ACCORD All
G55877	C		141544
F	97-99	ACURA	CL All
F	94-97	HONDA	ACCORD All
F	95-98		ODYSSEY All
F	96-99	ISUZU	OASIS All
G55878	W		141683
F	97	BUICK	PARK AVENUE All
F	97		RIVIERA All
F	97	OLDSMOBILE	AURORA All
G55879	C		142780
F	95-99	TOYOTA	PASEO All
F	95-99		TERCEL All
G55881	D		141682
F	95-98	MAZDA	PROTÉGÉ / PROTÉGÉ5 All Right
G55882	D		141682
F	95-98	MAZDA	PROTÉGÉ / PROTÉGÉ5 All Left
G55883	D		141682
R	95-98	MAZDA	PROTÉGÉ / PROTÉGÉ5 All Right
G55884	D		141682
R	95-98	MAZDA	PROTÉGÉ / PROTÉGÉ5 All Left
G55890	W		
R	98-99	HYUNDAI	ACCENT All Non Gas Charged Unit
R	97		ACCENT All Mfg. from 6/97; Non Gas Charged Unit
G55891	D		141682
F	98-01	CHEVROLET	METRO Non-ABS
F	89-91		SPRINT All
F	89-97	GEO	METRO Non-ABS
F	95-99	PONTIAC	FIREFLY Non-ABS
F	94		FIREFLY CAN
F	89-91		FIREFLY CAN
F	89-01	SUZUKI	SWIFT All
G55892	B		
F	00-02	CHRYSLER	NEON All
F	03-05	DODGE	NEON SXT
F	00-05		NEON SE
F	01-04		NEON R/T
F	00-03		NEON LE
F	01-02		NEON ACR
F	01-02		NEON Base
F	00-02		NEON ES
F	00-02		NEON LX
F	00		NEON High Line
F	00-01	PLYMOUTH	NEON All
G55893	D		
R	00-02	CHRYSLER	NEON All Right
R	03-05	DODGE	NEON SXT Right
R	00-05		NEON SE Right
R	01-04		NEON R/T Right
R	00-03		NEON LE Right
R	01-02		NEON ACR Right
R	01-02		NEON Base Right
R	00-02		NEON ES Right
R	00-02		NEON LX Right
R	00		NEON High Line Right
R	00-01	PLYMOUTH	NEON All Right

Ultra Struts

Shock	POP	Alternative No.	MTG Acc. Supplied
Pos.	Year	Application	
G55894	D		142098
R	00-02	CHRYSLER	NEON All Left
R	03-05	DODGE	NEON SXT Left
R	00-05		NEON SE Left
R	01-04		NEON R/T Left
R	00-03		NEON LE Left
R	01-02		NEON ACR Left
R	01-02		NEON Base Left
R	00-02		NEON ES Left
R	00-02		NEON LX Left
R	00		NEON High Line Left
R	00-01	PLYMOUTH	NEON All Left
G55896	A		
F	01-10	CHRYSLER	PT CRUISER All
G55901	A		142169
R	94-07	FORD	TAURUS Sedan
R	94-05	MERCURY	SABLE Sedan
G55903	W		141682
F	89-94	NISSAN	240SX All Left Exc. Active Suspension
G55904	W		141682
F	89-94	NISSAN	240SX All Right Exc. Active Suspension
G55909	B		141544
F	97-00	ACURA	EL All
F	96-00	HONDA	CIVIC All
G55910	A		141544
R	97-00	ACURA	EL All
R	96-00	HONDA	CIVIC All
G55911	D		142462
F	93-95	DODGE	COLT All
F	93-96	EAGLE	SUMMIT Coupe
F	93-96		SUMMIT Sedan
F	96	MITSUBISHI	MIRAGE All Mfg. to 5/96
F	93-95		MIRAGE All
F	93-94	PLYMOUTH	COLT Sedan
G55912	B		142081
F	96-99	INFINITI	I30 All Right
F	95-99	NISSAN	MAXIMA All Right
G55913	B		142081
F	96-99	INFINITI	I30 All Left
F	95-99	NISSAN	MAXIMA All Left
G55914	C		142215
F	92-94	LEXUS	ES300 All Sealed O.E. Struts
F	92-94	TOYOTA	CAMRY All Sealed O.E. Struts
G55920	C		142081
F	93-98	MERCURY	VILLAGER All Left
F	93-98	NISSAN	QUEST All Left
G55921	C		142081
F	93-98	MERCURY	VILLAGER All Right
F	93-98	NISSAN	QUEST All Right
G55923	X		141309
F	90-91	SUBARU	LEGACY Coil (FrontSpringType) Right
G55924	X		141309
F	90-91	SUBARU	LEGACY Coil (FrontSpringType) Left
G55925	D		141309
F	93-01	SUBARU	IMPREZA Non-ABS Right
F	92-94		LEGACY Coil (RearSpringType) Right
G55926	D		141309
F	93-01	SUBARU	IMPREZA Non-ABS Left
F	92-94		LEGACY Coil (RearSpringType) Left
G55927	X		141309
R	91	SUBARU	LEGACY AWD, Coil (RearSpringType) Right
R	90		LEGACY AWD Right Exc. Air Suspension
G55929	D		141309
R	95-01	SUBARU	IMPREZA L, AWD, Non-ABS Right
R	96-97		IMPREZA Brighton, AWD, Non-ABS Right
R	95		IMPREZA Base, AWD, Non-ABS Right

Numerical listing

Shock	POP	Alternative No.	MTG Acc. Supplied
Pos.	Year	Application	
G55929	D	-continued	141309
R	93-94		IMPREZA AWD, Non-ABS Right
R	92-94		LEGACY AWD, Coil (RearSpringType) Right
G55930	D		141309
R	95-01	SUBARU	IMPREZA L, AWD, Non-ABS Left
R	96-97		IMPREZA Brighton, AWD, Non-ABS Left
R	95		IMPREZA Base, AWD, Non-ABS Left
R	93-94		IMPREZA AWD, Non-ABS Left
R	92-94		LEGACY AWD, Coil (RearSpringType) Left
G55933	W		141309
R	93-95	SUBARU	IMPREZA FWD, Non-ABS Right
R	92-94		LEGACY FWD, Coil (RearSpringType) Right
G55934	W		
R	93-95	SUBARU	IMPREZA FWD, Non-ABS Left
R	92-94		LEGACY FWD, Coil (RearSpringType) Left
G55945	W		142174
F	89-90	DODGE	2000 GTX All
F	91-93	EAGLE	2000 GTX All
F	92-95	MITSUBISHI	EXPO All
G55948	A		142169
F	05-09	BUICK	ALLURE All
F	97-05		CENTURY All
F	05-09		LACROSSE All
F	97-04		REGAL All
F	05-06		TERRAZA AWD
F	00-16	CHEVROLET	IMPALA All
F	00-07		MONTE CARLO All
F	02-05		VENTURE All
F	97-01		VENTURE FWD
F	98-02	OLDSMOBILE	INTRIGUE All
F	97-04		SILHOUETTE All
F	97-03	PONTIAC	GRAND PRIX All
F	99-05		MONTANA Base
F	97-98		TRANS SPORT All
G55949	A		142169
R	05-09	BUICK	ALLURE All Exc. Models with 17" or 18" Wheels
R	97-05		CENTURY All
R	05-09		LACROSSE All Exc. Models with 17" or 18" Wheels
R	97-04		REGAL All
R	12-16	CHEVROLET	IMPALA All
R	00-11		IMPALA All Exc. Models with 17" or 18" Wheels
R	00-07		MONTE CARLO All Exc. Models with 17" or 18" Wheels
R	98-02	OLDSMOBILE	INTRIGUE All
R	97-08	PONTIAC	GRAND PRIX All Exc. Models with 17" or 18" Wheels
G55951	D		142723
F	91-95	ACURA	LEGEND All Right
G55952	D		141716
R	91-95	ACURA	LEGEND All
G55958	D		142723
F	91-95	ACURA	LEGEND All Left
G55960	A		142169
F	96-07	FORD	TAURUS All Right
F	96-05	MERCURY	SABLE All Right
G55970	C		141682
F	95-98	NISSAN	200SX All Left B14 Solid Rear Axle
F	95-99		SENTRA All Left B14 Solid Rear Axle
G55971	C		141682
F	95-98	NISSAN	200SX All Right B14 Solid Rear Axle
F	95-99		SENTRA All Right B14 Solid Rear Axle
G55974	A		142169
F	04-05	CHEVROLET	CLASSIC All
F	97-03		MALIBU All
F	99-04	OLDSMOBILE	ALERO All
F	99		CUTLASS / CUTLASS SUPREME All

Numerical listing

Shock	POP	Alternative No.	MTG Acc. Supplied
Pos.	Year	Application	
G55974	A	-continued	142169
F 98	CUTLASS / CUTLASS SUPREME	All Rear Strut Lower Mounting Holes at 2.4" & 3.2" Apart	
F 97	CUTLASS / CUTLASS SUPREME	All	
F 99-05	PONTIAC GRAND AM	All	
G55975	D	-continued	142169
R 97-98	CHEVROLET MALIBU	All Rear Strut Lower Mounting holes at 3.2" Apart	
R 97-98	OLDSMOBILE CUTLASS / CUTLASS SUPREME	All First Design with Rear Strut Lower Mounting Holes at 3.2" Apart	
G55976	C	-continued	142076
R 91-93	NISSAN NX	All Right	
R 91-94	SENTRA	Non-ABS Right B13 Independent Rear Suspension	
G55977	D	-continued	142076
R 91-93	NISSAN NX	All Left	
R 91-94	SENTRA	Non-ABS Left B13 Independent Rear Suspension	
G55978	A	-continued	142169
F 96-07	FORD TAURUS	All Left	
F 96-05	MERCURY SABLE	All Left	
G55989	D	-continued	
F 95-02	VOLKSWAGEN CABRIO	All	
F 92-94	CORRADO VR6	All	
F 98	GOLF 1.9L 4Cyl L (116)	VR6 from Chassis # 08774	
F 95-97	GOLF 1.8L 4Cyl L (109)	VR6 from Chassis # 08774	
F 97	GOLF 2.8L 6Cyl V (2792)	VR6 from Chassis # 08774	
F 96-98	JETTA VR6 2.0L & 1.9L	from Chassis # 08774	
G55990	D	-continued	
F 93-96	VOLKSWAGEN GOLF	All Up to Chassis # 08773	
F 85-92	GOLF	All Sealed Struts	
F 94-98	JETTA VR6 VR6	Up to Chassis # 08773	
F 93	JETTA	All VR6; Up to Chassis # 08773	
F 85-92	JETTA	All Sealed Struts	
G55991	W	-continued	
F 93-98	VOLKSWAGEN GOLF 2.0L 4Cyl L (121)	VR6 from Chassis # 08774	
F 96-98	JETTA 2.8L 6Cyl V (2792)	2.8L 6Cyl; VR6 from Chassis # 08774	
F 93-95	JETTA 2.0L 4Cyl L (121)	VR6 from Chassis # 08774	
G55992	D	-continued	141296
F 90-96	CHEVROLET LUMINA APV	All	
F 90-96	OLDSMOBILE SILHOUETTE	All	
F 90-96	PONTIAC TRANS SPORT	All	
G55993	B	-continued	
F 98-03	TOYOTA SIENNA	All Left	
G55994	B	-continued	
F 98-03	TOYOTA SIENNA	All Right	
G55999	A	-continued	141309
F 98-02	CHEVROLET PRIZM	All	
F 93-97	GEO PRIZM	All	
F 93-02	TOYOTA COROLLA	All	
G56501	A	-continued	142169
R 04-05	CHEVROLET CLASSIC	All	
R 98-03	MALIBU	All Rear Strut Lower Mounting holes at 2.4" Apart	
R 99-04	OLDSMOBILE ALERO	All	
R 99	CUTLASS / CUTLASS SUPREME	All	
R 98	CUTLASS / CUTLASS SUPREME	All Second Design with Rear Strut Lower Mounting holes at 2.4" apart	
R 99-05	PONTIAC GRAND AM	All	
G56502	B	-continued	
F 95-96	LEXUS ES300	All	
F 95-96	TOYOTA AVALON	All	
F 95-96	CAMRY	All	
G56503	W	-continued	141683
F 80-86	FORD THUNDERBIRD	All	
F 83-86	MERCURY COUGAR	All	

Ultra Struts

Shock	POP	Alternative No.	MTG Acc. Supplied
Pos.	Year	Application	
G56503	W	-continued	141683
F 80-82	COUGAR XR-7		
G56504	C	-continued	141306
F 78-83	FORD FAIRMONT	All	
F 81-82	GRANADA	All	
F 83-86	LTD / COUNTRY SEDAN / COUNTRY SQUIRE / CROWN VICTORIA	All	
F 84-93	MUSTANG / MUSTANG II LX, 2.3L 4Cyl L (140)		
F 84-86	MUSTANG / MUSTANG II LX, 5.0L 8Cyl V (302)		
F 82-83	MUSTANG / MUSTANG II 5.0L 8Cyl V (302)		
F 79-83	MUSTANG / MUSTANG II 2.3L 4Cyl L (140)		
F 80	MUSTANG / MUSTANG II 4.2L 8Cyl V (255)		
F 79	MUSTANG / MUSTANG II 5.0L 8Cyl V (302)		
F 87-88	THUNDERBIRD	Non-ABS	
F 79-86	MERCURY CAPRI	All	
F 87-88	COUGAR	All	
F 81-82	COUGAR Base		
F 82	COUGAR GS		
F 82	COUGAR LS		
F 83-86	MARQUIS	All	
F 78-83	ZEPHYR	All	
G56506	A	-continued	
F 97-01	LEXUS ES300	All Left Exc. Electronic Adjustable Suspension	
F 97-03	TOYOTA AVALON	All Left	
F 97-01	CAMRY	All Left	
F 99-03	SOLARA	All Left	
G56508	D	-continued	141572
F 98-05	BUICK PARK AVENUE	All	
F 98-99	RIVIERA	All	
G56509	A	-continued	141572
F 00-05	BUICK LESABRE	All	
F 00-05	CADILLAC DEVILLE	All Exc. Electronic Adjustable Suspension	
F 98-04	SEVILLE	All Exc. Electronic Adjustable Suspension	
F 01-03	OLDSMOBILE AURORA	All	
F 98-99	AURORA	All	
F 00-05	PONTIAC BONNEVILLE	All	
G56512	W	-continued	
R 91-96	INFINITI G20	All Left	
G56513	W	-continued	
R 91-96	INFINITI G20	All Right	
G56514	A	-continued	
F 97-01	LEXUS ES300	All Right Exc. Electronic Adjustable Suspension	
F 97-03	TOYOTA AVALON	All Right	
F 97-01	CAMRY	All Right	
F 99-03	SOLARA	All Right	
G56515	C	-continued	141682
F 01-02	FORD ESCORT SE	Exc. Hot & Cool Coupe	
F 00-02	ESCORT ZX2	Exc. Hot & Cool Coupe	
F 00	ESCORT LX	Exc. Hot & Cool Coupe	
F 00	ESCORT ZX2 S/R	Exc. Hot & Cool Coupe	
F 98-99	ESCORT LX		
F 98-99	ESCORT SE		
F 98-99	ESCORT SE	Equi	
F 98-99	ESCORT ZX2	Equi	
F 99	ESCORT ZX2 S/R		
F 99	ESCORT ZX2	Tipico	
F 97	ESCORT	All	
F 97-99	MERCURY TRACER	FWD	
G56516	B	-continued	
F 00-05	FORD FOCUS	All Left	
G56517	B	-continued	141682
F 00-05	FORD FOCUS	All Right	
G56518	B	-continued	141309
F 94-98	ASUNA SUNRUNNER		
F 92-93	SUNRUNNER	All Non-ABS	
F 98-04	CHEVROLET TRACKER	Non-ABS	
F 89-97	GEO TRACKER	Non-ABS	
F 94-97	PONTIAC SUNRUNNER	CAN Non-ABS	
F 99-05	SUZUKI GRAND VITARA	All Non-ABS	

Numerical listing

Shock	POP	Alternative No.	MTG Acc. Supplied
Pos.	Year	Application	
G56518	B	-continued	141309
F 89-98	SIDEKICK	Non-ABS	
F 99-04	VITARA	Non-ABS	
F 06	XL-7	All Non-ABS	
F 02-05	XL-7	Non-ABS	
G56520	D	-continued	141682
F 97-00	FORD CONTOUR	All Mfg. from 3/97	
F 99-02	MERCURY COUGAR	All	
F 97-00	MYSTIQUE	All Mfg. from 3/97	
G56522	C	-continued	141682
F 00-05	HYUNDAI ACCENT	All	
G56523	D	-continued	141682
R 00-05	HYUNDAI ACCENT	All Right Non-Gas Charged Unit	
G56524	D	-continued	141682
R 00-05	HYUNDAI ACCENT	All Left Non-Gas Charged Unit	
G56525	W	-continued	141682
F 00	HYUNDAI ELANTRA	All Right Mfg. to 5/00	
F 96-99	ELANTRA	All Right	
F 97-01	TIBURON	All Right	
G56526	W	-continued	141682
F 00	HYUNDAI ELANTRA	All Left Mfg. to 5/00	
F 96-99	ELANTRA	All Left	
F 97-01	TIBURON	All Left	
G56527	W	-continued	
R 00	HYUNDAI ELANTRA	All Right Mfg. to 5/00; Non-Gas Charged Unit	
R 96-99	ELANTRA	All Right Non-Gas Charged Unit	
R 97-01	TIBURON	All Right Non-Gas Charged Unit	
G56528	W	-continued	141682
R 00	HYUNDAI ELANTRA	All Left Mfg. to 5/00; Non-Gas Charged Unit	
R 96-99	ELANTRA	All Left Non-Gas Charged Unit	
R 97-01	TIBURON	All Left Non-Gas Charged Unit	
G56529	D	-continued	141682
F 98-02	MITSUBISHI MIRAGE 1.8L 4Cyl L (112)	Right With 6" or 7" Spring	
F 97	MIRAGE 1.8L 4Cyl L (112)	Right Mfg. from 4/97; with 6" or 7" Spring	
G56530	D	-continued	141682
F 98-02	MITSUBISHI MIRAGE 1.8L 4Cyl L (112)	Left With 6" or 7" Spring	
F 97	MIRAGE 1.8L 4Cyl L (112)	Left Mfg. from 4/97; with 6" or 7" Spring	
G56531	D	-continued	142078
F 00-01	KIA SEPHIA	Non-ABS Right Mfg. to 6/01	
F 98-99	SEPHIA	Non-ABS Right	
G56532	W	-continued	142078
F 00-01	KIA SEPHIA	Non-ABS Left Mfg. to 6/01	
F 98-99	SEPHIA	Non-ABS Left	
G56533	D	-continued	
R 00-01	KIA SEPHIA	All Right Mfg. to 6/01	
R 98-99	SEPHIA	All Right	
R 00-01	SPECTRA	All Right Mfg. to 6/01	
G56534	W	-continued	
R 00-01	KIA SEPHIA	All Left Mfg. to 6/01	
R 98-99	SEPHIA	All Left	
R 00-01	SPECTRA	All Left Mfg. to 6/01	
G56535	D	-continued	141682
F 99-00	MAZDA PROTÉGÉ / PROTÉGÉS	All Right Mfg. to 10/00	
G56536	D	-continued	141682
F 99-00	MAZDA PROTÉGÉ / PROTÉGÉS	All Left Mfg. to 10/00	
G56537	B	-continued	141682
R 02-03	MAZDA PROTÉGÉ / PROTÉGÉS	All Right	
R 02-03	PROTÉGÉ / PROTÉGÉS SE	Right	
R 01-03	PROTÉGÉ / PROTÉGÉS DX	Right	
R 01-03	PROTÉGÉ / PROTÉGÉS ES	Right	

Numerical listing

Shock	POP	Alternative No.	MTG Acc. Supplied
Pos.	Year	Application	
G56537	B	-continued	141682
R	01-03	PROTÉGÉ / PROTÉGÉS LX Right	
R	99-00	PROTÉGÉ / PROTÉGÉS All Right	
G56538	C		141682
R	02-03	MAZDA PROTÉGÉ / PROTÉGÉS All Left	
R	02-03	PROTÉGÉ / PROTÉGÉS SE Left	
R	01-03	PROTÉGÉ / PROTÉGÉS DX Left	
R	01-03	PROTÉGÉ / PROTÉGÉS ES Left	
R	01-03	PROTÉGÉ / PROTÉGÉS LX Left	
R	99-00	PROTÉGÉ / PROTÉGÉS All Left	
G56539	C		
F	01-06	HYUNDAI ELANTRA All Left	
F	00	ELANTRA All Left Mfg. from 5/00	
G56540	C		
F	01-06	HYUNDAI ELANTRA All Right	
F	00	ELANTRA All Right Mfg. from 5/00	
G56541	W		141682
R	00-01	SUBARU IMPREZA Outback Right	
R	95-99	IMPREZA Outback, Non-ABS Right	
G56542	W		141682
R	00-01	SUBARU IMPREZA Outback, AWD Left Non-ABS	
R	95-99	IMPREZA Outback, AWD, Non-ABS Left	
G56543	D		141682
F	98-02	SUBARU FORESTER All Right	
G56544	D		141682
F	98-02	SUBARU FORESTER All Left	
G56545	D		
R	98-02	SUBARU FORESTER All Right Exc. Hydraulic Self Leveling System	
G56546	D		
R	98-02	SUBARU FORESTER All Left Exc. Hydraulic Self Leveling System	
G56547	D		141309
F	99-03	LEXUS RX300 All Right	
G56548	D		
F	99-03	LEXUS RX300 All Left	
G56551	C		
F	01-05	CHRYSLER SEBRING ST (MfrBodyCode), Coupe Right	
F	01-05	DODGE STRATUS ST (MfrBodyCode), Coupe Right	
F	00-05	MITSUBISHI ECLIPSE All Right	
G56552	C		
F	01-05	CHRYSLER SEBRING ST (MfrBodyCode), Coupe Left	
F	01-05	DODGE STRATUS ST (MfrBodyCode), Coupe Left	
F	00-05	MITSUBISHI ECLIPSE All Left	
G56553	D		141309
R	99-03	LEXUS RX300 FWD Right	
G56554	D		141309
R	99-03	LEXUS RX300 FWD Left	
G56555	W		141682
F	00-04	SUBARU LEGACY All Right	
G56556	W		141682
F	00-04	SUBARU LEGACY All Left	
G56557	D		
R	00-04	SUBARU LEGACY All	
G56558	B		141682
F	99-04	HONDA ODYSSEY All Right	
G56559	B		141682
F	99-04	HONDA ODYSSEY All Left	
G56561	C		141682
F	01-06	HYUNDAI SANTA FE All Right	
G56562	C		141682
F	01-06	HYUNDAI SANTA FE All Left	
G56565	W		141716
F	99-00	HYUNDAI SONATA All	
G56566	W		141716
R	00	HYUNDAI SONATA All Mfg. to 4/00	
R	99	SONATA All	

Ultra Struts

Shock	POP	Alternative No.	MTG Acc. Supplied
Pos.	Year	Application	
G56568	A		
F	01-12	FORD ESCAPE All Right	
F	08-11	MAZDA TRIBUTE All Right	
F	01-06	TRIBUTE All Right	
F	05-11	MERCURY MARINER All Right	
G56569	W		
F	94-97	KIA SEPHIA All Right	
G56570	W		
F	94-97	KIA SEPHIA All Left	
G56571	X		
R	94-97	KIA SEPHIA All Right	
G56572	C		141682
F	00-05	TOYOTA ECHO All	
G56573	D		
F	94-99	TOYOTA CELICA All Left	
G56574	D		
R	94-99	TOYOTA CELICA All Right	
G56575	D		
R	94-99	TOYOTA CELICA All Left	
G56576	D		
F	94-99	TOYOTA CELICA All Right	
G56577	W		141682
F	95-98	HYUNDAI SONATA All	
G56579	X		
R	95-96	SUBARU LEGACY L, FWD Right	
G56581	B		141309
F	01-05	TOYOTA RAV4 All Right	
F	00	RAV4 All Right Mfg. from 5/00	
G56582	B		141309
F	01-05	TOYOTA RAV4 All Left	
F	00	RAV4 All Left Mfg. from 5/00	
G56585	C		
F	00-05	TOYOTA CELICA All Right	
G56586	C		
F	00-05	TOYOTA CELICA All Left	
G56587	C		
R	00-05	TOYOTA CELICA All	
G56588	D		141309
F	00	MAZDA MPV All Right Mfg. to 8/00	
G56589	W		141309
F	00	MAZDA MPV All Left Mfg. to 8/00	
G56591	W		
F	91-96	INFINITI G20 All	
G56592	D		
F	90-00	LEXUS LS400 Coil (RearSpringType)	
G56593	D		
R	90-94	LEXUS LS400 Coil (RearSpringType)	
G56594	W		141682
F	93-97	LEXUS GS300 All	
G56595	W		
R	93-97	LEXUS GS300 All	
G56596	W		
F	03-05	MAZDA MIATA Base	
F	03-05	MIATA LS	
F	03	MIATA SE	
F	99-02	MIATA All	
G56597	W		
R	03-05	MAZDA MIATA Base	
R	03-05	MIATA LS	
R	03	MIATA SE	
R	99-02	MIATA All	
G56598	C		
F	98-05	LEXUS GS300 All	
F	98-00	GS400 All	
F	01-05	GS430 All	
F	02-07	SC430 All	
G56599	D		141682
R	98-05	LEXUS GS300 All	
R	98-00	GS400 All	
R	01-05	GS430 All	

Numerical listing

Shock	POP	Alternative No.	MTG Acc. Supplied
Pos.	Year	Application	
G56600	D		
R	95-00	LEXUS LS400 Coil (RearSpringType)	
G56601	A		
F	01-12	FORD ESCAPE All Left	
F	08-11	MAZDA TRIBUTE All Left	
F	01-06	TRIBUTE All Left	
F	05-11	MERCURY MARINER All Left	
G56602	D		
F	92-99	BMW 318i All Left	
F	92-98	318IS All Left	
F	95-99	318TI All Left	
F	98-99	323IS All Left	
F	96-99	328IS All Left	
G56603	W		
F	92-99	BMW 318i All Right	
F	92-98	318IS All Right	
F	95-99	318TI All Right	
F	98-99	323IS All Right	
F	96-99	328IS All Right	
G56604	C		
F	98-99	BMW 323i E36 (MfrBodyCode) Left	
F	92-95	325i E36 (MfrBodyCode) Left	
F	96-98	328i All Left	
G56605	C		
F	98-99	BMW 323i E36 (MfrBodyCode) Right	
F	92-95	325i E36 (MfrBodyCode) Right	
F	96-98	328i All Right	
G56606	A		
F	98-10	VOLKSWAGEN BEETLE All	
F	99-06	GOLF A4 (MfrBodyCode)	
F	01-05	JETTA Sedan	
F	99-00	JETTA All	
G56607	D		
F	03	BMW 540i All Mfg. to 10/03; Exc. Electronic Adjustable Suspension	
F	97-02	540i All Exc. Electronic Adjustable Suspension	
F	95	540i All Exc. Electronic Adjustable Suspension	
G56608	D		
F	01-03	BMW 525i Sedan Exc. Electronic Adjustable Suspension	
F	97-00	528i Sedan	
F	01-03	530i All Exc. Electronic Adjustable Suspension	
G56611	D		
F	00-06	AUDI TT All	
F	00-06	TT QUATTRO All	
G56612	D		
F	93-97	VOLVO 850 All Exc. Hydraulic Self Leveling System	
F	98-04	C70 All	
F	98-00	S70 All	
F	98-00	V70 GLT Mfg. to 3/00 and Exc. XC70, XC Cross Country	
F	00	V70 GLT SE Mfg. to 3/00 and Exc. XC70, XC Cross Country	
F	98-99	V70 Base Mfg. to 3/00 and Exc. XC70, XC Cross Country	
F	98-99	V70 T5 Mfg. to 3/00 and Exc. XC70, XC Cross Country	
F	98	V70 R Mfg. to 3/00 and Exc. XC70, XC Cross Country	
G56615	A		141682
F	99-01	INFINITI QX4 All Left Mfg. from 12/98	
F	99-01	NISSAN PATHFINDER All Left Mfg. from 12/98; with OE543034W985	
G56616	B		141682
F	99-01	INFINITI QX4 All Right Mfg. from 12/98	
F	99-01	NISSAN PATHFINDER All Right Mfg. from 12/98; with OE543034W985	
G56618	C		141682
F	00-01	NISSAN SENTRA All Left	
G56619	C		
F	00-01	NISSAN SENTRA All Right	

Numerical listing

Shock	POP	Alternative No.	MTG Acc. Supplied
Pos.	Year	Application	
G56620	A		143004
F	01-07	CHRYSLER TOWN & COUNTRY All	
F	01-07	VOYAGER / GRAND VOYAGER All	
F	01-07	DODGE CARAVAN / GRAND CARAVAN All	
G56621	A		141682
F	01-03	ACURA EL All Left	
F	03-05	HONDA CIVIC Hybrid Left	
F	02	CIVIC Coupe Left	
F	02	CIVIC Sedan Left	
F	01	CIVIC All Left	
G56622	A		141682
F	01-03	ACURA EL All Right	
F	03-05	HONDA CIVIC Hybrid Right	
F	02	CIVIC Coupe Right	
F	02	CIVIC Sedan Right	
F	01	CIVIC All Right	
G56624	C		
F	01-06	MAZDA MPV All Right	
F	00	MPV All Right Mfg. from 8/00	
G56625	B		
F	01-06	MAZDA MPV All Left	
F	00	MPV All Left Mfg. from 8/00	
G56626	D		
F	95-02	SUZUKI ESTEEM All Right	
G56627	D		
F	95-02	SUZUKI ESTEEM All Left	
G56628	W		
R	95-02	SUZUKI ESTEEM All Right	
G56629	W		
R	95-02	SUZUKI ESTEEM All Left	
G56631	C		141309
F	00	TOYOTA RAV4 All Left Mfg. to 5/00; Sealed Struts	
F	96-99	RAV4 All Left Sealed Struts	
G56632	C		141309
F	00	TOYOTA RAV4 All Right Mfg. to 5/00; Sealed Struts	
F	96-99	RAV4 All Right Sealed Struts	
G56633	C		141682
F	00-03	MAZDA PROTÉGÉ / PROTÉGÉ5 All Right Mfg. from 10/00	
G56634	C		141682
F	00-03	MAZDA PROTÉGÉ / PROTÉGÉ5 All Left Mfg. from 10/00	
G56635	C		
F	99-03	MINISUBISHI GALANT All Right	
G56636	C		141682
F	99-03	MINISUBISHI GALANT All Left	
G56637	X		
R	94-97	KIA SEPHIA All Left	
G56640	N		141682
R	01-06	HYUNDAI ELANTRA All Left	
R	00	ELANTRA All Left Mfg. from 5/00	
G56641	N		141682
R	01-06	HYUNDAI ELANTRA All Right	
R	00	ELANTRA All Right Mfg. from 5/00	
G56642	D		141682
F	03-08	HYUNDAI TIBURON All Left	
G56643	C		141682
F	03-08	HYUNDAI TIBURON All Right	
G56644	C		141682
R	03-08	HYUNDAI TIBURON All Left	
G56645	C		141682
R	03-08	HYUNDAI TIBURON All Right	
G56655	D		142098
F	04-07	FORD FREESTAR All	
F	04-07	MERCURY MONTEREY Mini Passenger Van	
G56660	A		
F	03-08	TOYOTA COROLLA All Right	
G56661	A		141309
F	03-08	TOYOTA COROLLA All Left	

Ultra Struts

Shock	POP	Alternative No.	MTG Acc. Supplied
Pos.	Year	Application	
G56664	W		
R	98-99	CADILLAC DEVILLE Coil (RearSpringType) Exc. Electronic Adjustable Suspension	
R	94-97	DEVILLE Air (RearSpringType) Exc. Electronic Adjustable Suspension	
G56667	D		141309
R	01-03	TOYOTA HIGHLANDER FWD Left	
G56668	D		141309
R	01-03	TOYOTA HIGHLANDER FWD Right	
G56669	D		141038
F	94-95	CADILLAC DEVILLE All Left Exc. Electronic Adjustable Suspension	
G56670	D		141038
F	94-95	CADILLAC DEVILLE All Right Exc. Electronic Adjustable Suspension	
G56671	A		
F	02-06	NISSAN ALTIMA All Left	
F	04-08	MAXIMA All Left	
G56672	A		
F	02-06	NISSAN ALTIMA All Right	
F	04-08	MAXIMA All Right	
G56673	C		141309
F	02-03	LEXUS ES300 All Left Exc. Electronic Adjustable Suspension	
F	02-03	TOYOTA CAMRY All Left	
G56674	C		141309
F	02-03	LEXUS ES300 All Right Exc. Electronic Adjustable Suspension	
F	02-03	TOYOTA CAMRY All Right	
G56675	C		
R	03	LEXUS ES300 All Left Exc. Electronic Adjustable Suspension	
R	02-03	TOYOTA CAMRY All Left	
G56676	C		
R	03	LEXUS ES300 All Right Exc. Electronic Adjustable Suspension	
R	02-03	TOYOTA CAMRY All Right	
G56677	D		
F	04-05	HONDA CIVIC Value Package, Sedan Left	
F	03-05	CIVIC DX, Sedan Left	
F	03-05	CIVIC EX, Sedan Left	
F	03-05	CIVIC GX, Sedan Left	
F	03-05	CIVIC HX, Coupe Left	
F	03-05	CIVIC LX, Sedan Left	
F	03-05	CIVIC Si, Sedan Left	
F	05	CIVIC EX Special Edition, Sedan Left	
G56678	D		
F	04-05	HONDA CIVIC Value Package, Sedan Right	
F	03-05	CIVIC DX, Sedan Right	
F	03-05	CIVIC EX, Sedan Right	
F	03-05	CIVIC GX, Sedan Right	
F	03-05	CIVIC HX, Coupe Right	
F	03-05	CIVIC LX, Sedan Right	
F	03-05	CIVIC Si, Sedan Right	
F	05	CIVIC EX Special Edition Right	
F	05	CIVIC LX Special Edition, Sedan Right	
G56679	D		
F	01-03	TOYOTA HIGHLANDER All Left	
G56680	D		
F	01-03	TOYOTA HIGHLANDER All Right	
G56681	C		
R	99-03	LEXUS RX300 AWD Left	
R	01-03	TOYOTA HIGHLANDER AWD Left	
G56682	C		
R	99-03	LEXUS RX300 AWD Right	
R	01-03	TOYOTA HIGHLANDER AWD Right	
G56683	C		
F	00-01	INFINITI I30 All Left	
F	00-01	NISSAN MAXIMA All Left	
G56684	C		
F	00-01	INFINITI I30 All Right	
F	00-01	NISSAN MAXIMA All Right	

Numerical listing

Shock	POP	Alternative No.	MTG Acc. Supplied
Pos.	Year	Application	
G56685	C		
F	02-04	INFINITI I35 All Left	
F	02-03	NISSAN MAXIMA All Left	
G56686	C		
F	02-04	INFINITI I35 All Right	
F	02-03	NISSAN MAXIMA All Right	
G56687	C		141682
F	02-03	INFINITI QX4 All Left	
F	01-04	NISSAN PATHFINDER All Left With OE 543034W925 or 543034W926	
F	04	PATHFINDER ARMADA All Left	
G56688	C		141682
F	02-03	INFINITI QX4 All Right	
F	01-04	NISSAN PATHFINDER All Right With OE 543034W925 or 543034W926	
F	04	PATHFINDER ARMADA All Right	
G56689	D		
F	98-02	MAZDA 626 All Left	
G56690	D		
F	98-02	MAZDA 626 All Right	
G56691	D		
R	98-02	MAZDA 626 All	
G56700	C		141156
F	82-92	CHEVROLET CAMARO All	
F	82-92	PONTIAC FIREBIRD All	
G56701	D		141313
F	85-90	BUICK ELECTRA All	
F	90	LESABRE All Early Design Front Strut with Spring Guard	
F	86-89	LESABRE All	
F	85-90	CADILLAC COMMERCIAL CHASSIS All	
F	85-90	DEVILLE All	
F	85-90	FLEETWOOD All	
F	86-90	OLDSMOBILE 88 SERIES All Early Design Front Strut with Spring Guard	
F	85-90	98 All	
F	87-90	PONTIAC BONNEVILLE All Early Design Front Strut with Spring Guard	
G56703	W		141038
F	86-89	BUICK RIVIERA All	
F	87-88	CADILLAC ALLANTE All Exc. Electronic Adjustable Suspension	
F	86-89	ELDORADO All	
F	86-89	SEVILLE All	
F	86-89	OLDSMOBILE TORONADO All	
G56704	D		141572
R	86-93	BUICK RIVIERA All	
R	86-93	CADILLAC ELDORADO All	
R	90-93	SEVILLE All SSS Speed Sensitive Suspension or CCR Computer Command Ride; Non adjustable	
R	86-89	SEVILLE All	
R	86-92	OLDSMOBILE TORONADO All	
G56705	D		142607
F	87-89	BUICK SKYHAWK All Right	
F	84-86	SKYHAWK All Right Non-Rebuildable O.E. Struts	
F	86-91	SKYLARK All Right Non-Rebuildable O.E. Struts	
F	85-87	SOMERSET / SOMERSET REGAL All Right Non-Rebuildable O.E. Struts	
F	87-88	CADILLAC CIMARRON All Right	
F	84-86	CIMARRON All Right Non-Rebuildable O.E. Struts	
F	87-91	CHEVROLET BERETTA All Right	
F	87-94	CAVALIER All Right	
F	84-86	CAVALIER All Right Non-Rebuildable O.E. Struts	
F	87-91	CORSIKA All Right	
F	87	OLDSMOBILE CALAIS All Right	
F	85-86	CALAIS All Right Non-Rebuildable O.E. Struts	
F	88-91	CUTLASS CALAIS All Right	
F	87-88	FIRENZA All Right	
F	84-86	FIRENZA All Right Non-Rebuildable O.E. Struts	
F	87-91	PONTIAC GRAND AM All Right	
F	85-86	GRAND AM All Right Non-Rebuildable O.E. Struts	
F	84-85	J2000 / SUNBIRD All Right Non-Rebuildable O.E. Struts	
F	88-94	SUNBIRD All Right	

Numerical listing

Shock	POP	Alternative No.	MTG Acc. Supplied
Pos.	Year	Application	
G56705	D	-continued	142607
F	86-87	SUNBIRD All Right Non-Rebuildable O.E. Struts	
F	87-91	TEMPEST All Right	
G56706	D	-continued	142607
F	87-89	BUICK SKYHAWK All Left	
F	84-86	SKYHAWK All Left Non-Rebuildable O.E. Struts	
F	86-91	SKYLARK All Left Non-Rebuildable O.E. Struts	
F	85-87	SOMERSET / SOMERSET REGAL All Left Non-Rebuildable O.E. Struts	
F	87-88	CADILLAC CIMARRON All Left	
F	84-86	CIMARRON All Left Non-Rebuildable O.E. Struts	
F	87-91	CHEVROLET BERETTA All Left	
F	87-94	CAVALIER All Left	
F	84-86	CAVALIER All Left Non-Rebuildable O.E. Struts	
F	87-91	CORSICA All Left	
F	87	OLDSMOBILE CALAIS All Left	
F	85-86	CALAIS All Left Non-Rebuildable O.E. Struts	
F	88-91	CUTLASS CALAIS All Left	
F	87-88	FIRENZA All Left	
F	84-86	FIRENZA All Left Non-Rebuildable O.E. Struts	
F	87-91	PONTIAC GRAND AM All Left	
F	85-86	GRAND AM All Left Non-Rebuildable O.E. Struts	
F	84-85	J2000 / SUNBIRD All Left Non-Rebuildable O.E. Struts	
F	88-94	SUNBIRD All Left	
F	86-87	SUNBIRD All Left Non-Rebuildable O.E. Struts	
F	87-91	TEMPEST All Left	
G56707	B	-continued	142714
R	85-90	BUICK ELECTRA Air (RearSpringType) Conventional Replacement for Air Assist Rear Susp. Strut Only	
R	86-99	LESABRE Coil (RearSpringType)	
R	91-96	PARK AVENUE Air (RearSpringType) Conventional Replacement for Air Assist Susp; Exc. Elec. Adj. Susp	
R	93	CADILLAC 60 SPECIAL Coil (RearSpringType) Conventional Type Replacement for Air Assist Rear Suspension	
R	92-93	COMMERCIAL CHASSIS FWD Conventional Type Replacement for Air Assist Rear Suspension; Exc. Electronic Suspension	
R	85-91	COMMERCIAL CHASSIS All Conventional Type Replacement for Air Assist Rear Suspension; Exc. Electronic Suspension	
R	85-93	DEVILLE Air (RearSpringType) Conventional Type Replacement for Air Assist Rear Suspension	
R	85-93	FLEETWOOD All Conventional Type Replacement for Air Assist Rear Suspension	
R	92-99	OLDSMOBILE 88 SERIES All Conventional Type Replacement for Air Assist Rear Suspension	
R	86-91	88 SERIES Coil (RearSpringType)	
R	85-96	98 Air (RearSpringType) Conventional Type Replacement	
R	96-99	LSS Coil (RearSpringType) Conventional Type Replacement for Air Assist Rear Suspension	
R	97-98	REGENCY Coil (RearSpringType)	
R	91-99	PONTIAC BONNEVILLE Coil (RearSpringType) Exc. Electronic Adjustable Suspension	
R	87-90	BONNEVILLE Coil (RearSpringType)	
G56708	B	-continued	141693
R	88-96	BUICK REGAL All	
R	90-94	CHEVROLET LUMINA All	
R	97	OLDSMOBILE CUTLASS / CUTLASS SUPREME All Exc. Rear Strut Lower Mounting holes at 3.2" apart	
R	88-96	CUTLASS / CUTLASS SUPREME All	
R	88-96	PONTIAC GRAND PRIX All	
G56713	X	-continued	141309
F	88-89	MAZDA 929 All Exc. Electronic Adjustable Suspension	

Ultra Struts

Shock	POP	Alternative No.	MTG Acc. Supplied
Pos.	Year	Application	
G56714	D	-continued	141977
F	89-98	MAZDA MPV RWD	
G56715	W	-continued	141977
F	95-98	MAZDA MPV 4WD	
F	89-94	MPV 4WD Exc. Hydraulic Self Leveling System	
G56716	X	-continued	141309
F	90-91	MAZDA 929 All Exc. Electronic Adjustable Suspension	
G56717	C	-continued	141038
F	88-91	BUICK REATTA All	
F	90-93	RIVIERA All	
F	89-92	CADILLAC ALLANTE All Exc. Electronic Adjustable Suspension	
F	90-93	ELDORADO All	
F	90-93	SEVILLE All SSS Speed Sensitive Suspension or CCR Computer Command Ride; Non adjustable	
F	90-92	OLDSMOBILE TORONADO All	
G56718	D	-continued	141683
F	91-99	BUICK LESABRE All	
F	90	LESABRE All Late Design Front Strut without Spring Guard	
F	91-96	PARK AVENUE All	
F	95-96	RIVIERA All	
F	93	CADILLAC 60 SPECIAL All	
F	92-93	COMMERCIAL CHASSIS FWD	
F	91	COMMERCIAL CHASSIS All	
F	91-93	DEVILLE All Exc. Electronic Adjustable Suspension	
F	91-93	FLEETWOOD All	
F	92-99	OLDSMOBILE 88 SERIES All	
F	90-91	88 SERIES All Late Design Front Strut without Spring Guard	
F	91-96	98 All CCR Computer Command Ride	
F	95-96	AURORA All	
F	96-99	LSS All	
F	97-98	REGENCY All	
F	94-99	PONTIAC BONNEVILLE All Exc. CCR Computer Command Ride	
F	91-93	BONNEVILLE All	
F	90	BONNEVILLE All Late Design Front Strut without Spring Guard	
G56719	D	-continued	142607
F	95-98	BUICK SKYLARK All Right	
F	92-94	SKYLARK All Right Exc. FE3 and Electronic Ride Control	
F	95-96	CHEVROLET BERETTA All Right	
F	92-94	BERETTA Base Right Exc. FE7 Suspension	
F	95-96	CORSICA All Right	
F	94	CORSICA Base Right Exc. FE7 Suspension	
F	93	CORSICA All Right Exc. FE7 Suspension	
F	92	CORSICA LT Right Exc. FE7 Suspension	
F	95-98	OLDSMOBILE ACHIEVA All Right Exc. Electronic Adjustable Suspension	
F	92-94	ACHIEVA All Right Exc. FE3 and Electronic Ride Control	
F	96-98	PONTIAC GRAND AM All Right Exc. Electronic Adjustable Suspension	
F	95	GRAND AM SE Right Exc. Electronic Adjustable Suspension	
F	92-94	GRAND AM SE Right Exc. FE3 and Electronic Ride Control	
G56720	D	-continued	142607
F	95-98	BUICK SKYLARK All Left	
F	92-94	SKYLARK All Left Exc. FE3 and Electronic Ride Control	
F	95-96	CHEVROLET BERETTA All Left	
F	92-94	BERETTA Base Left Exc. FE7 Suspension	
F	95-96	CORSICA All Left	
F	94	CORSICA Base Left Exc. FE7 Suspension	
F	93	CORSICA All Left Exc. FE7 Suspension	
F	92	CORSICA LT Left Exc. FE7 Suspension	
F	95-98	OLDSMOBILE ACHIEVA All Left Exc. Electronic Adjustable Suspension	
F	92-94	ACHIEVA All Left Exc. FE3 and Electronic Ride Control	

Numerical listing

Shock	POP	Alternative No.	MTG Acc. Supplied
Pos.	Year	Application	
G56720	D	-continued	142607
F	95-98	PONTIAC GRAND AM All Left Exc. Electronic Adjustable Suspension	
F	92-94	GRAND AM SE Left Exc. FE3 and Electronic Ride Control	
G56721	B	-continued	141309
F	04-06	LEXUS ES330 All Left Exc. Adaptive Variable Suspension	
F	04-06	TOYOTA CAMRY All Left	
F	04-08	SOLARA All Left	
G56722	B	-continued	141309
F	04-06	LEXUS ES330 All Right Exc. Adaptive Variable Suspension	
F	04-06	TOYOTA CAMRY All Right	
F	04-08	SOLARA All Right	
G56723	W	-continued	142607
F	92-94	BUICK SKYLARK All Left FE3 Suspension	
F	94	CHEVROLET BERETTA Z26 Left FE7 Suspension	
F	92-93	BERETTA GT Left FE7 Suspension	
F	92-93	BERETTA GTZ Left FE7 Suspension	
F	94	CORSICA Base Left FE7 Suspension	
F	93	CORSICA All Left FE7 Suspension	
F	92	CORSICA LTZ Left FE7 Suspension	
F	92-94	OLDSMOBILE ACHIEVA All Left FE3 Suspension	
F	92-94	PONTIAC GRAND AM GT Left FE3 Suspension	
G56724	W	-continued	142607
F	92-94	BUICK SKYLARK All Right FE3 Suspension	
F	94	CHEVROLET BERETTA Z26 Right FE7 Suspension	
F	92-93	BERETTA GT Right FE7 Suspension	
F	92-93	BERETTA GTZ Right FE7 Suspension	
F	94	CORSICA Base Right FE7 Suspension	
F	93	CORSICA All Right FE7 Suspension	
F	92	CORSICA LTZ Right FE7 Suspension	
F	92-94	OLDSMOBILE ACHIEVA All Right FE3 Suspension	
F	92-94	PONTIAC GRAND AM GT Right FE3 Suspension	
G56728	B	-continued	
R	04-06	LEXUS ES330 All Left Exc. Adaptive Variable Suspension	
R	04-06	TOYOTA CAMRY All Left	
R	04-06	SOLARA All Left	
G56729	B	-continued	
R	04-06	LEXUS ES330 All Right Exc. Adaptive Variable Suspension	
R	04-06	TOYOTA CAMRY All Right	
R	04-06	SOLARA All Right	
G56730	B	-continued	
F	04-06	LEXUS RX330 All Left Exc. Air Suspension	
F	07-09	RX350 All Left Exc. Air Suspension	
F	04-07	TOYOTA HIGHLANDER All Left	
G56731	B	-continued	
F	04-06	LEXUS RX330 All Right Exc. Air Suspension	
F	07-09	RX350 All Right Exc. Air Suspension	
F	04-07	TOYOTA HIGHLANDER All Right	
G56732	C	-continued	
R	04-06	LEXUS RX330 AWD Left Exc. Air Suspension	
R	07	RX350 AWD Left Exc. Air Suspension	
R	04-07	TOYOTA HIGHLANDER AWD Left	
G56733	C	-continued	
R	04-06	LEXUS RX330 AWD Right Exc. Air Suspension	
R	07	RX350 AWD Right Exc. Air Suspension	
R	04-07	TOYOTA HIGHLANDER AWD Right	
G56734	C	-continued	
R	04-06	LEXUS RX330 FWD Left Exc. Air Suspension	

Numerical listing

Shock	POP	Alternative No.	MTG Acc. Supplied
Pos.	Year	Application	
G56734	C	-continued	
R	07-09	RX350 FWD Left Exc. Air Suspension	
R	04-07	TOYOTA HIGHLANDER FWD Left	
G56735	C		
R	04-06	LEXUS RX330 FWD Right Exc. Air Suspension	
R	07-09	RX350 FWD Right Exc. Air Suspension	
R	04-07	TOYOTA HIGHLANDER FWD Right	
G56736	B	141682	
F	98-99	INFINITI QX4 All Right Mfg. to 12/98	
F	97	QX4 All Right	
F	98-99	NISSAN PATHFINDER All Right Mfg. to 12/98	
F	96-97	PATHFINDER All Right	
G56739	B	141682	
F	98-99	INFINITI QX4 All Left Mfg. to 12/98	
F	97	QX4 All Left	
F	98-99	NISSAN PATHFINDER All Left Mfg. to 12/98	
F	96-97	PATHFINDER All Left	
G56742	FF		
F	03-05	FORD FIESTA All	
F	98-01	FIESTA All	
F	02-04	FIESTA IKON All	
G56750	W		
F	00	BMW 323i Wagon Left Sport Suspension	
F	02-05	325i Wagon Left Sport Suspension	
F	01	325i Wagon Left Mfg. to 9/01; Sport Suspension	
F	01	330Ci Convertible Left Sport Suspension	
G56751	W		
F	00	BMW 323i Wagon Right Sport Suspension	
F	01-05	325i Wagon Right Sport Suspension	
F	01	325i Wagon Right Mfg. to 9/01; Sport Suspension	
F	01	330Ci Convertible Right Sport Suspension	
G56758	B		
F	01-02	ACURA MDX All Right	
F	03-08	HONDA PILOT All Right	
G56759	B		
F	01-02	ACURA MDX All Left	
F	03-08	HONDA PILOT All Left	
G56760	W		
F	96-02	BMW Z3 All Right	
G56761	W		
F	96-02	BMW Z3 All Left	
G56762	W		
F	99-02	DAEWOO LEGANZA All	
G56763	W		
R	99-02	DAEWOO LEGANZA All Right	
G56764	W		
R	99-02	DAEWOO LEGANZA All Left	
G56765	X		
F	99-02	DAEWOO NUBIRA Non-ABS Right	
G56766	X		
F	99-02	DAEWOO NUBIRA Non-ABS Left	
G56767	X		
R	99-02	DAEWOO NUBIRA Non-ABS Right	
G56769	D		
F	97-01	CADILLAC CATERA All	
G56770	D		
F	97-01	BMW 740i All Right Exc. Electronic Adjustable Suspension	
F	94-95	740i All Right Exc. Electronic Adjustable Suspension	
F	94-01	740iL All Right Exc. Electronic Adjustable Suspension	
F	94-01	750iL All Right Exc. Electronic Adjustable Suspension	
G56771	D		
F	97-01	BMW 740i All Left Exc. Electronic Adjustable Suspension	

Ultra Struts

Shock	POP	Alternative No.	MTG Acc. Supplied
Pos.	Year	Application	
G56771	D	-continued	
F	94-95	740i All Left Exc. Electronic Adjustable Suspension	
F	94-01	740iL All Left Exc. Electronic Adjustable Suspension	
F	94-01	750iL All Left Exc. Electronic Adjustable Suspension	
G56772	B		
F	04-08	CHRYSLER PACIFICA All	
G56773	A	141309	
F	05-06	CHEVROLET EQUINOX All Left	
F	06	PONTIAC TORRENT All Left	
G56774	A		
F	05-06	CHEVROLET EQUINOX All Right	
F	06	PONTIAC TORRENT All Right	
G56775	D		
F	97-02	CADILLAC ELDORADO All Left Exc. Electronic Adjustable Suspension	
G56776	D		
F	97-02	CADILLAC ELDORADO All Right Exc. Electronic Adjustable Suspension	
G56778	C	143172	
F	03-06	DODGE SPRINTER 2500 All	
F	03-06	SPRINTER 3500 All	
F	04-06	MERCEDES-BENZ SPRINTER All	
G56781	D	141120	
F	01-03	KIA RIO All Right	
G56782	D		
F	01-03	KIA RIO All Left	
G56784	D		
F	99-02	MERCURY VILLAGER All Right	
F	99-02	NISSAN QUEST All Right	
G56785	D		
F	99-02	MERCURY VILLAGER All Left	
F	99-02	NISSAN QUEST All Left	
G56786	D		
F	00-02	KIA SPORTAGE All Right	
G56787	D		
F	00-02	KIA SPORTAGE All Left	
G56790	D		
F	03-04	FORD MUSTANG / MUSTANG II SVT Cobra	
F	01	MUSTANG / MUSTANG II SVT Cobra	
F	00	MUSTANG / MUSTANG II SVT Cobra R	
F	94-99	MUSTANG / MUSTANG II SVT Cobra	
F	95	MUSTANG / MUSTANG II SVT Cobra R	
G56791	C		
F	06-07	MERCEDES-BENZ C230 All Exc. Sport Suspension	
F	03-05	C230 Coupe Exc. Sport Suspension	
F	02	C230 Coupe, RWD Exc. Sport Suspension	
F	01-05	C240 RWD Exc. Sport Suspension	
F	06-07	C280 RWD Exc. Sport Suspension	
F	01-05	C320 Sedan, RWD Exc. Sport Suspension	
F	02-04	C320 Wagon, RWD Exc. Sport Suspension	
F	06-07	C350 RWD Exc. Sport Suspension	
F	02-05	CLK320 RWD Exc. Sport Suspension	
F	06-09	CLK350 RWD Exc. Sport Suspension	
F	02-03	CLK430 RWD Exc. Sport Suspension	
F	03-06	CLK500 RWD Exc. Sport Suspension	
F	07-09	CLK550 Coupe, RWD Exc. Sport Suspension	
G56792	C		
F	06-07	MERCEDES-BENZ C230 RWD Sport Suspension	
F	02-05	C230 Coupe Sport Suspension	
F	01-05	C240 RWD Sport Suspension	
F	06-07	C280 RWD Sport Suspension	
F	01-05	C320 RWD Sport Suspension	

Numerical listing

Shock	POP	Alternative No.	MTG Acc. Supplied
Pos.	Year	Application	
G56792	C	-continued	
F	06-07	C350 RWD Sport Suspension	
F	02-05	CLK320 RWD Sport Suspension	
F	06-09	CLK350 RWD Sport Suspension	
F	02-03	CLK430 RWD Sport Suspension	
F	03-06	CLK500 RWD Sport Suspension	
G56793	C		
F	02-04	ACURA RSX All Right	
G56794	D		
F	02-04	ACURA RSX All Left	
G56795	D	141198	
F	00-05	SATURN L / LS / LW SERIES All Right	
G56796	D	141198	
F	00-05	SATURN L / LS / LW SERIES All Left	
G56797	C	141118	
F	05	TOYOTA SIENNA FWD Right Mfg. to 6/05; 7 Passenger	
F	04	SIENNA FWD Right 7 Passenger	
G56798	C	141118	
F	05	TOYOTA SIENNA FWD Left Mfg. to 6/05; 7 Passenger	
F	04	SIENNA FWD Left 7 Passenger	
G56799	B	141198	
F	02-06	HONDA CR-V All Right	
G56800	B	141198	
F	02-06	HONDA CR-V All Left	
G56801	W	140953	
F	00-03	FORD ESCORT ZX2, Coupe, Non-ABS Hot & Cool Coupe; Non-ABS	
F	98-99	ESCORT ZX2 Cool Coupe, Non-ABS	
F	98-99	ESCORT ZX2 Hot Coupe, Non-ABS	
G56802	A	142098	
F	01-09	VOLVO S60 All	
F	99-06	S80 All	
F	05-06	V70 R Mfg. from 3/00 and Exc. XC70, XC Cross Country and Auto Leveling	
F	04-06	V70 2.4 Mfg. from 3/00 and Exc. XC70, XC Cross Country and Auto Leveling	
F	04-06	V70 2.5T Mfg. from 3/00 and Exc. XC70, XC Cross Country and Auto Leveling	
F	00-05	V70 T5 Mfg. from 3/00 and Exc. XC70, XC Cross Country and Auto Leveling	
F	04	V70 2.5T AWD Mfg. from 3/00 and Exc. XC70, XC Cross Country and Auto Leveling	
F	00-03	V70 2.4T Mfg. from 3/00 and Exc. XC70, XC Cross Country and Auto Leveling	
F	00-03	V70 Base Mfg. from 3/00 and Exc. XC70, XC Cross Country and Auto Leveling	
F	00	V70 2.4T SE Mfg. from 3/00 and Exc. XC70, XC Cross Country and Auto Leveling	
F	00	V70 GLT Mfg. from 3/00 and Exc. XC70, XC Cross Country and Auto Leveling	
F	00	V70 GLT SE Mfg. from 3/00 and Exc. XC70, XC Cross Country and Auto Leveling	
G56805	B		
F	02-06	NISSAN SENTRA GXE Right	
F	02-06	SENTRA GXE Sport Right	
F	02-06	SENTRA XE Right	
F	03-04	SENTRA LE Right	
F	02	SENTRA CA Right	
G56806	B		
F	02-06	NISSAN SENTRA GXE Left	
F	02-06	SENTRA GXE Sport Left	
F	02-06	SENTRA XE Left	
F	03-04	SENTRA LE Left	
F	02	SENTRA CA Left	
G56807	A	141727	
F	06-10	JEEP COMMANDER All	
F	05-10	GRAND CHEROKEE All	

Numerical listing

Shock	POP	Alternative No.	MTG Acc. Supplied
Pos.	Year	Application	
G56809	A		141156
F	03-07	SATURN ION All	
G56810	A		
F	05-10	CHEVROLET COBALT LS	
F	05-10	COBALT LT	
F	10	COBALT Base	
F	10	COBALT LT Team Canada	
F	06-07	COBALT LTZ	
F	05	COBALT Base	
F	11	HHR All	
F	08-10	HHR LS Panel	
F	08-10	HHR LT Panel	
F	06-10	HHR LS	
F	06-10	HHR LT	
F	06-08	HHR Comfort LT	
F	06-08	HHR Elegance LT	
F	07	HHR Edicion Especial	
F	07-09	PONTIAC G5 All	
F	05-06	PURSUIT All	
G56812	C		142169
F	04-08	PONTIAC GRAND PRIX All	
G56813	D		
F	00-04	SUBARU OUTBACK AWD Left	
G56814	D		
F	00-04	SUBARU OUTBACK AWD Right	
G56817	A		142169
F	05-10	FORD MUSTANG / MUSTANG II All	
G56819	B		
F	05-09	HYUNDAI TUCSON All Left	
F	05-10	KIA SPORTAGE All Left	
G56820	B		
F	05-09	HYUNDAI TUCSON All Right	
F	05-10	KIA SPORTAGE All Right	
G56821	B		
R	05-09	HYUNDAI TUCSON All Right	
R	05-10	KIA SPORTAGE All Right	
G56822	B		
R	05-09	HYUNDAI TUCSON All Left	
R	05-10	KIA SPORTAGE All Left	
G56836	B		142081
F	06-11	FORD FOCUS All Left	
G56837	C		142081
F	06-11	FORD FOCUS All Right	
G56838	C		141727
F	06-10	FORD EXPLORER All	
F	06-10	MERCURY MOUNTAINEER All	
G56839	C		141727
R	06-10	FORD EXPLORER All	
R	06-10	MERCURY MOUNTAINEER All	
G56840	B		142169
F	07-10	FORD EDGE All Left	
F	07-10	LINCOLN MKX All Left	
G56841	B		142169
F	07-10	FORD EDGE All Right	
F	07-10	LINCOLN MKX All Right	
G56842	C		
F	07-11	TOYOTA YARIS All Left	
G56843	C		
F	07-11	TOYOTA YARIS All Right	
G56882	D		141682
F	04-07	CHEVROLET OPTRA All Left	
F	04-08	SUZUKI FORENZA All Left	
F	05-08	RENO All Left	
G56883	D		141682
F	04-07	CHEVROLET OPTRA All Right	
F	04-08	SUZUKI FORENZA All Right	
F	05-08	RENO All Right	
G56884	D		141682
R	04-07	CHEVROLET OPTRA All Left	
R	04-08	SUZUKI FORENZA All Left	
R	05-08	RENO All Left	
G56885	D		141682
R	04-07	CHEVROLET OPTRA All Right	
R	04-08	SUZUKI FORENZA All Right	
R	05-08	RENO All Right	

Ultra Struts, Guardian Struts

Shock	POP	Alternative No.	MTG Acc. Supplied
Pos.	Year	Application	
G56886	B		
F	09-11	CHEVROLET AVEO All Left	
F	04-11	AVEO All Left	
F	07-10	PONTIAC G3 All Left	
F	05-08	WAVE All Left	
F	04-09	SUZUKI SWIFT All Left	
G56887	B		
F	09-11	CHEVROLET AVEO All Right	
F	04-11	AVEO All Right	
F	07-10	PONTIAC G3 All Right	
F	05-08	WAVE All Right	
F	04-09	SUZUKI SWIFT All Right	
G56888	A		
F	07-09	LEXUS ES350 All Left	
F	07-11	TOYOTA AVALON All Left	
F	06	AVALON All Left Mfg. from 01/06	
F	07-11	CAMRY All Left	
G56889	A		
F	07-09	LEXUS ES350 All Right	
F	07-11	TOYOTA AVALON All Right	
F	06	AVALON All Right Mfg. from 01/06	
F	07-11	CAMRY All Right	
G56890	C		
F	04-09	TOYOTA PRIUS All Left	
G56891	C		
F	04-09	TOYOTA PRIUS All Right	
G56892	D		
F	02-03	KIA SPECTRA All Left	
G56893	W		
F	02-03	KIA SPECTRA All Right	
G56894	B		
F	02-07	MITSUBISHI LANCER LS	
F	07	LANCER LS Diamond	
F	04-06	LANCER Ralliart	
F	02-06	LANCER OZ Rally	
F	06	LANCER DE	
F	06	LANCER SE	
F	04	LANCER DE	
F	04	LANCER Sportback	
G56899	A		
F	06-09	VOLKSWAGEN BORA All	
F	11-14	EOS All	
F	12-14	GOLF Comfortline TDI	
F	12-14	GOLF Highline TDI	
F	11-14	GOLF Base	
F	11-14	GOLF Comfortline	
F	11-14	GOLF TDI	
F	11-14	GOLF Trendline	
F	14	GOLF Trendline TDI	
F	11-13	GOLF Sportline	
F	13	GOLF GTI	
F	11-12	GOLF Highline	
F	11	GOLF TDI Comfortline	
F	06-14	GTI All	
F	12-14	JETTA Wagon	
F	06-11	JETTA All	
F	06-09	PASSAT All	
F	06-09	RABBIT All	
G56903	B		
R	85-90	BUICK ELECTRA Air (RearSpringType) w/Air assist Rear Susp. Std. Equip. Strut Only	
R	86-99	LESABRE Air (RearSpringType) Optional O.E. Hydraulic Self Leveling System	
R	91-96	PARK AVENUE Air (RearSpringType) Exc. Electronic Adjustable Suspension	
R	92-93	CADILLAC COMMERCIAL CHASSIS FWD Air Assist Rear Suspension; Exc. Electronic Adjustable Suspension	
R	91	COMMERCIAL CHASSIS All Air Assist Rear Suspension; Exc. Electronic Adjustable Suspension	
R	85-90	COMMERCIAL CHASSIS All Air Assist Rear Suspension Standard Equipment	
R	91-93	DEVILLE Air (RearSpringType) CCR Computer Command Ride	
R	85-90	DEVILLE Air (RearSpringType) Air Assist Rear Suspension Standard Equipment	
R	91-93	FLEETWOOD All Air Assist Rear Suspension; Exc. Electronic Adjustable Suspension	

Numerical listing

Shock	POP	Alternative No.	MTG Acc. Supplied
Pos.	Year	Application	
G56903	B	-continued	
R	85-90	FLEETWOOD All Air Assist Rear Suspension Standard Equipment	
R	94-99	OLDSMOBILE 88 SERIES Coil (FrontSpringType), Coil (RearSpringType) Optional O.E. Hydraulic Self Leveling System; Exc. Electronic Adjustable Suspension	
R	92-93	88 SERIES Coil (FrontSpringType), Air (RearSpringType) Optional O.E. Hydraulic Self Leveling System; Exc. Electronic Adjustable Suspension	
R	86-91	88 SERIES Air (RearSpringType) Optional O.E. Hydraulic Self Leveling System	
R	91-96	98 Air (RearSpringType) CCR Computer Command Ride	
R	85-90	98 Air (RearSpringType)	
R	96-99	LSS Air (RearSpringType)	
R	97-98	REGENCY Air (RearSpringType) Optional O.E. Hydraulic Self Leveling System	
R	91-99	PONTIAC BONNEVILLE Air (RearSpringType) Optional O.E. Hydraulic Self Leveling System; Exc. Electronic Adjustable Suspension	
R	88-90	BONNEVILLE Air (RearSpringType) Optional O.E. Hydraulic Self Leveling System	
R	87	BONNEVILLE All Optional O.E. Hydraulic Self Leveling System	
G511019	N		
F	07-08	INFINITI G35 AWD Left Exc. 4 Wheel Steer	
F	09-10	G37 AWD Left Exc. 4 Wheel Steer	
G511020	N		
F	07-08	INFINITI G35 AWD Right Exc. 4 Wheel Steer	
F	09-10	G37 AWD Right Exc. 4 Wheel Steer	
G511031	FF		
F	11-16	CHRYSLER 300 RWD Left	
F	11-16	DODGE CHARGER RWD Left	
G511032	FF		
F	11-16	CHRYSLER 300 RWD Right	
F	11-16	DODGE CHARGER RWD Right	
G511054	A		
F	07-09	KIA SORENTO All Left Exc. HPD (High Performance Dampers)	
G511055	A		
F	07-09	KIA SORENTO All Right Exc. HPD (High Performance Dampers)	
G511057	N		
F	03-04	AUDI A6 Comfort Exc. Sport Suspension	
F	02-04	A6 Luxury Exc. Sport Suspension	
F	98-04	A6 Base Exc. Sport Suspension	
F	02	A6 Premium Exc. Sport Suspension	
F	98-04	A6 QUATTRO All	
F	01-05	VOLKSWAGEN PASSAT All Exc. VIN# 3B300001 through VIN# 3B300000	
G511063	FF		
F	08-10	MITSUBISHI MONTERO All Sport	
G511070	FF		
R	02-05	BMW 745i All	
R	02-05	745Li All	
R	06-08	750i All	
R	06-08	750Li All	
R	04-06	760i All	
R	03-08	760Li All	
G511071	N		
F	07-09	KIA AMANTI All	
Guardian Struts			
M51077	N		
F	96-02	TOYOTA 4RUNNER All	
F	98-04	TACOMA Pre Runner, RWD	
F	95-04	TACOMA 4WD	
M51087	N		142106
R	96-99	INFINITI I30 All	
R	95-99	NISSAN MAXIMA All	
M51204	N		
F	93-02	CHEVROLET CAMARO All	
F	93-02	PONTIAC FIREBIRD All	

Numerical listing

Shock	POP	Alternative No.	MTG Acc. Supplied
Pos.	Year	Application	
M51230	N		142106
R	95-98	NISSAN 200SX All B14 Solid Rear Axle	
R	95-99	SENTRA All B14 Solid Rear Axle	
M51252	N		142094
R	95-99	TOYOTA PASEO All	
R	95-99	TERCEL All	
M51267	N		142154
F	99-00	CHRYSLER CIRRUS J2 (MfrBodyCode)	
F	95-96	CIRRUS All	
F	01-06	SEBRING JR (MfrBodyCode), Convertible	
F	01-05	SEBRING JR (MfrBodyCode), Sedan	
F	99-00	SEBRING Convertible	
F	96	SEBRING Convertible	
F	99-06	DODGE STRATUS Sedan	
F	95-96	STRATUS All	
F	99-00	PLYMOUTH BREEZE All Exc. JA Mfr Body Code	
F	96	BREEZE All	
M51268	N		142154
R	95-00	CHRYSLER CIRRUS All	
R	01-06	SEBRING JR (MfrBodyCode), Convertible	
R	01-06	SEBRING JR (MfrBodyCode), Sedan	
R	96-00	SEBRING Convertible	
R	99-06	DODGE STRATUS Sedan	
R	95-98	STRATUS All	
R	96-00	PLYMOUTH BREEZE All	
M51279	N		142094
R	00-06	NISSAN SENTRA All	
M51700	N		141544
R	01-03	ACURA EL All	
R	01-02	HONDA CIVIC All	
M51703	N		
F	05-08	FORD PICKUP 1/2 TON, F-150 RWD	
F	04	PICKUP 1/2 TON, F-150 Lariat, RWD	
F	04	PICKUP 1/2 TON, F-150 STX, RWD	
F	04	PICKUP 1/2 TON, F-150 XL, RWD	
F	04	PICKUP 1/2 TON, F-150 XLT, RWD	
F	06-08	LINCOLN MARK LT RWD	
M51704	N		
F	04-08	FORD PICKUP 1/2 TON, F-150 4WD	
F	06-08	LINCOLN MARK LT 4WD	
M51713	N		142094
R	01-05	HYUNDAI SONATA All	
R	00	SONATA All Mfg. from 4/00	
R	01	XG300 All	
R	02-05	XG350 All	
R	01-06	KIA MAGENTIS All	
R	01-06	OPTIMA All	
M51714	N		141544
F	01-05	HYUNDAI SONATA All	
F	00	SONATA All Mfg. from 8/00	
F	01-06	KIA MAGENTIS All	
F	01-05	OPTIMA All	
M51715	FF		
F	04-10	INFINITI QX56 4WD	
F	04-15	NISSAN TITAN 4WD	
M51718	N		
F	04-07	BUICK RAINIER All	
F	03-06	CHEVROLET SSR All	
F	02-09	TRAILBLAZER All	
F	02-06	TRAILBLAZER EXT All	
F	02-09	GMC ENVOY All	
F	02-06	ENVOY XL All	
F	04-05	ENVOY XUV All	
F	03-08	ISUZU ASCENDER All	
F	02-04	OLDSMOBILE BRAVADA All	
F	05-09	SAAB 9-7X All	
M51719	FF		
F	03-06	FORD EXPEDITION All	
M51722	N		
F	02-03	FORD EXPLORER Eddie Bauer	
F	02-03	EXPLORER Limited	
F	02-03	EXPLORER Postal	
F	02-03	EXPLORER XLS	
F	02-03	EXPLORER XLT	

Guardian Struts

Shock	POP	Alternative No.	MTG Acc. Supplied
Pos.	Year	Application	
M51722	N	-continued	
F	02-03	MERCURY MOUNTAINEER All	
M51723	N		
F	04-05	FORD EXPLORER Eddie Bauer	
F	04-05	EXPLORER Limited	
F	04-05	EXPLORER XLS	
F	04-05	EXPLORER XLT	
F	04	EXPLORER NBX	
F	04-05	MERCURY MOUNTAINEER All	
M51724	N		
R	02-05	FORD EXPLORER Eddie Bauer	
R	02-05	EXPLORER Limited	
R	02-05	EXPLORER XLS	
R	02-05	EXPLORER XLT	
R	04	EXPLORER NBX	
R	02-03	EXPLORER Postal	
R	02-05	MERCURY MOUNTAINEER All	
M51727	FF		
R	02-03	NISSAN MAXIMA All	
M51728	FF		
F	07-11	DODGE NITRO All	
F	02-12	JEEP LIBERTY All	
M51736	N		
R	03-08	PONTIAC VIBE FWD	
R	03-08	TOYOTA COROLLA All	
R	03-08	MATRIX FWD	
M51737	N		141544
F	04-08	ACURA TL All	
F	04-08	TSX All	
F	06-07	HONDA ACCORD Value Package	
F	03-07	ACCORD EX	
F	03-07	ACCORD LX	
F	03-05	ACCORD DX	
F	05	ACCORD SE	
F	03	ACCORD Coupe	
M51738	N		
R	04-08	ACURA TL All	
R	06-07	HONDA ACCORD Value Package	
R	03-07	ACCORD EX	
R	03-07	ACCORD LX	
R	03-05	ACCORD DX	
R	05	ACCORD SE	
R	03	ACCORD Coupe	
M51743	FF		
F	00-04	AUDI A6 All	
F	00-04	A6 QUATTRO All	
F	01-05	VOLKSWAGEN PASSAT All	
M51760	N		
F	05-10	CHRYSLER 300 RWD Right Exc. Performance Suspension	
F	06-10	DODGE CHARGER RWD Right Exc. Police Models	
F	05-08	MAGNUM RWD Right Exc. Performance Suspension	
M51761	N		
F	05-10	CHRYSLER 300 RWD Left	
F	06-10	DODGE CHARGER RWD Left	
F	05-08	MAGNUM RWD Left Exc. Performance Suspension	
M51842	FF		
R	07-11	DODGE CALIBER All	
M51859	FF		
F	06-09	FORD FUSION All	
F	06-09	MERCURY MILAN All	
M51860	FF		
F	07-11	FORD EXPEDITION All	
M51861	FF		
R	07-11	FORD EXPEDITION All	
M51864	FF		
F	09-10	FORD PICKUP 1/2 TON, F-150 All	
M51891	FF		
F	07-11	CHEVROLET AVALANCHE 1500 All	
F	07-11	SUBURBAN 1/2 TON, 1500 All	
F	07-11	SUBURBAN 3/4 TON, 2500 All	
F	07-11	TAHOE All	
F	07-11	GMC YUKON All	
F	07-11	YUKON XL 1/2 TON All	
F	07-11	YUKON XL 3/4 TON All	
M52008	FF		
F	03-07	NISSAN MURANO All Left	

Numerical listing

Shock	POP	Alternative No.	MTG Acc. Supplied
Pos.	Year	Application	
M52009	FF		
F	03-07	NISSAN MURANO All Right	
M52028	N		
F	04-12	CHEVROLET MALIBU All Left	
F	05-10	PONTIAC G6 All Left	
F	07-09	SATURN AURA All Left	
M52029	N		
F	04-12	CHEVROLET MALIBU All Right	
F	05-10	PONTIAC G6 All Right	
F	07-09	SATURN AURA All Right	
M52121	FF		
F	07-12	NISSAN ALTIMA All Left	
M52122	FF		
F	07-12	NISSAN ALTIMA All Right	
M52573	N		
R	90-91	LEXUS ES250 All Left	
R	88-91	TOYOTA CAMRY Sedan, FWD Left	
R	87-91	CAMRY Wagon Left	
R	87	CAMRY Sedan Left	
M52574	N		
R	90-91	LEXUS ES250 All Right	
R	88-91	TOYOTA CAMRY Sedan, FWD Right	
R	87-91	CAMRY Wagon Right	
R	87	CAMRY Sedan Right	
M52803	FF		
F	07-13	CHEVROLET PICKUP 1/2 TON, SILVERADO 1500 All	
F	07-13	GMC SIERRA 1500 4WD	
F	07-13	SIERRA 1500 RWD	
M52804	FF		
F	03-06	FORD EXPEDITION 4WD	
F	03-06	LINCOLN NAVIGATOR 4WD	
M52805	FF		
F	01-07	TOYOTA SEQUOIA All	
F	00-06	TUNDRA All	
M52806	FF		
F	01-12	FORD ESCAPE All Left	
F	08-11	MAZDA TRIBUTE All Left	
F	01-06	TRIBUTE All Left	
F	05-11	MERCURY MARINER All Left	
M52807	FF		
F	01-12	FORD ESCAPE All Right	
F	08-11	MAZDA TRIBUTE All Right	
F	01-06	TRIBUTE All Right	
F	05-11	MERCURY MARINER All Right	
M52808	FF		
F	06-08	DODGE PICKUP 1/2 TON, RAM 1500 (SEE RAM 1500) 4WD	
M52810	FF		
R	03-05	HONDA CIVIC All	
M52811	FF		
F	01-05	CHRYSLER SEBRING Coupe Left	
F	01-05	DODGE STRATUS Coupe Left	
F	99-03	MINI COOPER S All Left	
M52812	FF		
F	01-05	CHRYSLER SEBRING Coupe Right	
F	01-05	DODGE STRATUS Coupe Right	
F	99-03	MINI COOPER S All Right	
M52813	FF		
F	04-06	TOYOTA CAMRY All Left	
F	04-08	SOLARA All Left	
M52814	FF		
F	04-06	TOYOTA CAMRY All Right	
F	04-08	SOLARA All Right	
M52815	FF		
R	04-06	LEXUS ES330 All Left	
R	04-06	TOYOTA CAMRY All Left	
R	04-06	SOLARA All Left	
M52816	FF		
R	04-06	LEXUS ES330 All Right	
R	04-06	TOYOTA CAMRY All Right	
R	04-06	SOLARA All Right	
M52817	FF		
F	10-11	FORD CROWN VICTORIA Base	
F	03-11	CROWN VICTORIA LX	
F	03-08	CROWN VICTORIA Base	
F	04-06	CROWN VICTORIA LX Sport	

Numerical listing

Shock	POP	Alternative No.	MTG Acc. Supplied
Pos.	Year	Application	
M52817	FF	-continued	
F	05	CROWN VICTORIA S	
F	05	CROWN VICTORIA Special Edition	
F	03	CROWN VICTORIA LWB	
F	03	CROWN VICTORIA S	
F	03-11	LINCOLN TOWN CAR All Exc. Limo	
F	03-11	MERCURY GRAND MARQUIS All	
M52818	FF		
F	06-11	FORD FOCUS All Left	
M52819	FF		
F	06-11	FORD FOCUS All Right	
M52820	FF		
F	02-06	HONDA CR-V Automatic Left	
M52821	FF		
F	02-06	HONDA CR-V Automatic Right	
M52822	FF		
F	00-05	TOYOTA RAV4 AWD, Automatic Left	
M52823	FF		
F	00-05	TOYOTA RAV4 AWD, Automatic Right	
M52824	FF		
F	05-06	CHEVROLET EQUINOX All Left	
F	06	PONTIAC TORRENT All Left	
M52825	FF		
F	05-06	CHEVROLET EQUINOX All Right	
F	06	PONTIAC TORRENT All Right	
M55514	N	142699	
F	85-96	BUICK CENTURY All	
F	84	CENTURY All HD Suspension	
F	85	SKYLARK All	
F	84	SKYLARK All HD Suspension	
F	85-90	CHEVROLET CELEBRITY All	
F	84	CELEBRITY All HD Suspension	
F	84-85	CITATION / CITATION II All HD Suspension	
F	85-96	OLDSMOBILE CIERA / CUTLASS CIERA All Exc. Electronic Adjustable Suspension	
F	84	CIERA / CUTLASS CIERA All HD Suspension	
F	87-94	CUTLASS CLASSIC / CUTLASS CRUISER All Exc. Electronic Adjustable Suspension	
F	84	OMEGA All HD Suspension	
F	91	PONTIAC 6000 FWD HD Suspension	
F	84-90	6000 All HD Suspension	
F	84	PHOENIX All HD Suspension	
M55518	N		
R	86-93	FORD TAURUS Sedan	
R	86-93	MERCURY SABLE Sedan	
M55525	N		
F	90-95	CHRYSLER TOWN & COUNTRY All	
F	87-95	DODGE CARAVAN / GRAND CARAVAN All	
F	86	CARAVAN / GRAND CARAVAN All Mfg. from 1/86	
F	87-88	MINI RAM All	
F	87-95	PLYMOUTH VOYAGER / GRAND VOYAGER All	
F	86	VOYAGER / GRAND VOYAGER All Mfg. from 1/86	
M55526	N		
F	86-93	CHRYSLER DAYTONA All	
F	89-93	DYNASTY All	
F	88	DYNASTY All Exc. Hydraulic Self Leveling System	
F	90-93	IMPERIAL All Exc. Hydraulic Self Leveling System	
F	86	LASER All	
F	86-95	LEBARON All	
F	86-93	NEW YORKER All	
F	86-88	TOWN & COUNTRY All	
F	86-88	DODGE 600 All	
F	86-89	ARIES All	
F	89-93	DAYTONA ES	
F	87-88	DAYTONA Pacifica	
F	86	DAYTONA All	
F	88-93	DYNASTY All Exc. Hydraulic Self Leveling System	
F	86-89	LANCER All	
F	87-94	SHADOW All	

Guardian Struts

Shock	POP	Alternative No.	MTG Acc. Supplied
Pos.	Year	Application	
M55526	N	-continued	
F	89-95	SPIRIT All	
F	89-95	PLYMOUTH ACCLAIM All	
F	86-88	CARAVELLE All	
F	86-89	RELIANT All	
F	87-94	SUNDANCE All	
M55551	N	141306	
F	84-93	FORD MUSTANG / MUSTANG II GT, 5.0L 8Cyl V (302)	
M55557	N	141718	
R	89-92	GEO PRIZM All	
R	88-92	TOYOTA COROLLA FWD	
M55579	N	141730	
F	89-97	FORD THUNDERBIRD All Exc. Electronic Adjustable Suspension	
F	89-97	MERCURY COUGAR All Exc. Electronic Adjustable Suspension	
M55590	N	142597	
F	90-91	LEXUS ES250 All	
F	87-91	TOYOTA CAMRY FWD	
M55591	N	142024	
F	89-92	GEO PRIZM All	
F	88-92	TOYOTA COROLLA FWD	
M55607	N	142081	
F	90-94	NISSAN AXCESS FWD Left	
F	89-94	MAXIMA All Left Exc. Electronic Adjustable Suspension	
M55608	N	142081	
F	90-94	NISSAN AXCESS FWD Right	
F	89-94	MAXIMA All Right Exc. Electronic Adjustable Suspension	
M55616	N	141309	
F	86-95	FORD TAURUS All	
F	86-95	MERCURY SABLE All	
M55657	N	141682	
F	93-94	NISSAN SENTRA All Left B13 Independent Rear Suspension	
M55658	N	141682	
F	93-94	NISSAN SENTRA All Right B13 Independent Rear Suspension	
M55661	N	141309	
R	98-02	CHEVROLET PRIZM All Left	
R	93-97	GEO PRIZM All Left	
R	93-02	TOYOTA COROLLA All Left	
M55662	N	141309	
R	98-02	CHEVROLET PRIZM All Right	
R	93-97	GEO PRIZM All Right	
R	93-02	TOYOTA COROLLA All Right	
M55663	N	141309	
F	99-04	CHRYSLER 300M All Left	
F	93-04	CONCORDE All Left	
F	93-04	INTREPID All Left	
F	99-01	LHS All Left	
F	94-97	LHS All Left	
F	94-96	NEW YORKER All Left	
F	93-04	DODGE INTREPID All Left	
F	93-97	EAGLE VISION All Left	
M55664	N	141309	
F	99-04	CHRYSLER 300M All Right	
F	93-04	CONCORDE All Right	
F	93-04	INTREPID All Right	
F	99-01	LHS All Right	
F	94-97	LHS All Right	
F	94-96	NEW YORKER All Right	
F	93-04	DODGE INTREPID All Right	
F	93-97	EAGLE VISION All Right	
M55665	N	141309	
R	93-97	CHRYSLER CONCORDE All	
R	94-97	INTREPID CAN	
R	93	INTREPID All	
R	94-97	LHS All	
R	94-96	NEW YORKER All	
R	93-97	DODGE INTREPID All	
R	93-97	EAGLE VISION All	
M55666	N	142081	
F	93-97	NISSAN ALTIMA All Right	
M55667	N	142081	
F	93-97	NISSAN ALTIMA All Left	

Numerical listing

Shock	POP	Alternative No.	MTG Acc. Supplied
Pos.	Year	Application	
M55675	N	141309	
R	97-02	LEXUS ES300 All Left Exc. Electronic Adjustable Suspension	
R	95-96	ES300 All Left	
R	92-94	ES300 All Left Sealed O.E. Struts	
R	95-03	TOYOTA AVALON All Left	
R	95-01	CAMRY All Left	
R	92-94	CAMRY All Left Sealed O.E. Struts	
R	99-03	SOLARA All Left	
M55676	N	141309	
R	97-02	LEXUS ES300 All Right Exc. Electronic Adjustable Suspension	
R	95-96	ES300 All Right	
R	92-94	ES300 All Right Sealed O.E. Struts	
R	95-03	TOYOTA AVALON All Right	
R	95-01	CAMRY All Right	
R	92-94	CAMRY All Right Sealed O.E. Struts	
R	99-03	SOLARA All Right	
M55679	N		
F	95-99	DODGE NEON All	
F	95-99	PLYMOUTH NEON All	
M55680	N		
R	95-99	DODGE NEON All	
R	95-99	PLYMOUTH NEON All	
M55681	N		
F	03-04	FORD MUSTANG / MUSTANG II Mach I	
F	94-04	MUSTANG / MUSTANG II Base	
F	94-04	MUSTANG / MUSTANG II GT	
F	04	MUSTANG / MUSTANG II GT Base	
F	04	MUSTANG / MUSTANG II GT Equipado	
F	01	MUSTANG / MUSTANG II GT Bullitt	
F	95	MUSTANG / MUSTANG II GTS	
M55685	N	141309	
F	95-03	FORD WINDSTAR All	
M55693	N	141682	
R	95-00	FORD CONTOUR All	
R	99-02	MERCURY COUGAR All	
R	95-00	MYSTIQUE All	
M55697	N	143004	
F	96-00	CHRYSLER TOWN & COUNTRY All	
F	00	VOYAGER / GRAND VOYAGER All	
F	00	VOYAGER / GRAND VOYAGER Non-ABS	
F	96-00	DODGE CARAVAN / GRAND CARAVAN All Exc. Hydraulic Self Leveling System	
F	96-00	PLYMOUTH VOYAGER / GRAND VOYAGER All	
M55698	N		
F	95-05	CHEVROLET CAVALIER All	
F	95-05	PONTIAC SUNFIRE All	
M55733	N	141323	
R	84-94	FORD TEMPO FWD	
R	84-94	MERCURY TOPAZ FWD	
M55745	N	141709	
F	91-93	NISSAN NX All	
F	87-90	PULSAR / PULSAR NX All	
F	86	PULSAR / PULSAR NX All Mfg. from 1/86	
F	91-92	SENTRA Non-ABS	
F	87-90	SENTRA FWD	
M55774	N	141544	
F	90-93	HONDA ACCORD All	
M55786	N	141544	
R	97-99	ACURA CL All	
R	90-97	HONDA ACCORD All	
M55788	N	141544	
R	90-93	ACURA INTEGRA All	
M55800	N	142126	
R	91-02	SATURN SC / SL / SW SERIES All	
M55801	N		
F	91-02	SATURN SC / SL / SW SERIES All	
M55802	N	141544	
F	97-01	ACURA INTEGRA GS	
F	94-01	INTEGRA GS-R	
F	94-01	INTEGRA LS	
F	95-96	INTEGRA Special Edition	
F	92-95	HONDA CIVIC All	

Numerical listing

Shock	POP	Alternative No.	MTG Acc. Supplied
Pos.	Year	Application	
M55802	N	-continued	141544
F	93-97	CIVIC DEL SOL All	
M55803	N		142128
R	97-01	ACURA INTEGRA GS	
R	94-01	INTEGRA GS-R	
R	94-01	INTEGRA LS	
R	95-96	INTEGRA Special Edition	
R	92-95	HONDA CIVIC All	
R	93-97	CIVIC DEL SOL All	
R	89-91	CRX All	
M55804	N		142099
R	92-94	TOYOTA PASEO All	
R	91-94	TERCEL All	
M55817	N		141572
R	95-96	CHEVROLET LUMINA All	
R	95-96	MONTE CARLO All	
M55820	N		142094
F	95-00	CHRYSLER SEBRING Coupe	
F	95-00	DODGE AVENGER All	
F	94-98	MITSUBISHI GALANT All	
M55825	N		142609
R	95-05	CHEVROLET CAVALIER All	
R	95-05	PONTIAC SUNFIRE All	
M55831	N		141683
R	97-01	CHEVROLET LUMINA All	
R	97-99	MONTE CARLO All	
M55847	N		141682
F	91-96	FORD ESCORT All	
F	90-94	MAZDA 323 All	
F	90-94	PROTÉGÉ / PROTÉGÉ5 FWD, Non-ABS	
F	91-96	MERCURY TRACER FWD	
M55848	N		
R	91-03	FORD ESCORT All	
R	90-94	MAZDA 323 All	
R	90-94	PROTÉGÉ / PROTÉGÉ5 FWD, Non-ABS	
R	91-99	MERCURY TRACER FWD	
M55856	N		142169
R	99-04	CHRYSLER 300M All	
R	98-04	CONCORDE All	
R	98-04	INTREPID All	
R	99-01	LHS All	
R	98-04	DODGE INTREPID All	
M55870	N		141544
F	01-03	ACURA CL All	
F	99-03	TL All	
F	98-02	HONDA ACCORD All	
M55871	N		141544
R	01-03	ACURA CL All	
R	99-03	TL All	
R	98-02	HONDA ACCORD All	
M55877	N		141544
F	97-99	ACURA CL All	
F	94-97	HONDA ACCORD All	
F	95-98	ODYSSEY All	
F	96-99	ISUZU OASIS All	
M55879	N		142780
F	95-99	TOYOTA PASEO All	
F	95-99	TERCEL All	
M55892	N		
F	00-02	CHRYSLER NEON All	
F	03-05	DODGE NEON SXT	
F	00-05	NEON SE	
F	01-04	NEON R/T	
F	00-03	NEON LE	
F	01-02	NEON ACR	
F	01-02	NEON Base	
F	00-02	NEON ES	
F	00-02	NEON LX	
F	00	NEON High Line	
F	00-01	PLYMOUTH NEON All	
M55893	N		
R	00-02	CHRYSLER NEON All Right	
R	03-05	DODGE NEON SXT Right	
R	00-05	NEON SE Right	
R	01-04	NEON R/T Right	
R	00-03	NEON LE Right	
R	01-02	NEON ACR Right	
R	01-02	NEON Base Right	
R	00-02	NEON ES Right	
R	00-02	NEON LX Right	

Guardian Struts

Shock	POP	Alternative No.	MTG Acc. Supplied
Pos.	Year	Application	
M55893	N	-continued	
R	00	NEON High Line Right	
R	00-01	PLYMOUTH NEON All Right	
M55894	N		142098
R	00-02	CHRYSLER NEON All Left	
R	03-05	DODGE NEON SXT Left	
R	00-05	NEON SE Left	
R	01-04	NEON R/T Left	
R	00-03	NEON LE Left	
R	01-02	NEON ACR Left	
R	01-02	NEON Base Left	
R	00-02	NEON ES Left	
R	00-02	NEON LX Left	
R	00	NEON High Line Left	
R	00-01	PLYMOUTH NEON All Left	
M55896	N		
F	01-10	CHRYSLER PT CRUISER All	
M55901	N		142169
R	94-07	FORD TAURUS Sedan	
R	94-05	MERCURY SABLE Sedan	
M55909	N		141544
F	97-00	ACURA EL All	
F	96-00	HONDA CIVIC All	
M55910	N		141544
R	97-00	ACURA EL All	
R	96-00	HONDA CIVIC All	
M55912	N		142081
F	96-99	INFINITI I30 All Right	
F	95-99	NISSAN MAXIMA All Right	
M55913	N		142081
F	96-99	INFINITI I30 All Left	
F	95-99	NISSAN MAXIMA All Left	
M55920	N		142081
F	93-98	MERCURY VILLAGER All Left	
F	93-98	NISSAN QUEST All Left	
M55921	N		142081
F	93-98	MERCURY VILLAGER All Right	
F	93-98	NISSAN QUEST All Right	
M55948	N		142169
F	05-09	BUICK ALLURE All	
F	97-05	CENTURY All	
F	05-09	LACROSSE All	
F	97-04	REGAL All	
F	05-06	TERRAZA AWD	
F	00-16	CHEVROLET IMPALA All	
F	00-07	MONTE CARLO All	
F	02-05	VENTURE All	
F	97-01	VENTURE FWD	
F	98-02	OLDSMOBILE INTRIGUE All	
F	97-04	SILHOUETTE All	
F	97-03	PONTIAC GRAND PRIX All	
F	99-05	MONTANA Base	
F	97-98	TRANS SPORT All	
M55949	N		142169
R	05-09	BUICK ALLURE All Exc. Models with 17" or 18" Wheels	
R	97-05	CENTURY All	
R	05-09	LACROSSE All Exc. Models with 17" or 18" Wheels	
R	97-04	REGAL All	
R	00-11	CHEVROLET IMPALA All Exc. Models with 17" or 18" Wheels	
R	00-07	MONTE CARLO All Exc. Models with 17" or 18" Wheels	
R	98-02	OLDSMOBILE INTRIGUE All	
R	97-08	PONTIAC GRAND PRIX All Exc. Models with 17" or 18" Wheels	
M55960	N		142169
F	96-07	FORD TAURUS All Right	
F	96-05	MERCURY SABLE All Right	
M55970	N		141682
F	95-98	NISSAN 200SX All Left B14 Solid Rear Axle	
F	95-99	SENTRA All Left B14 Solid Rear Axle	
M55971	N		141682
F	95-98	NISSAN 200SX All Right B14 Solid Rear Axle	
F	95-99	SENTRA All Right B14 Solid Rear Axle	
M55974	N		142169
F	04-05	CHEVROLET CLASSIC All	

Numerical listing

Shock	POP	Alternative No.	MTG Acc. Supplied
Pos.	Year	Application	
M55974	N	-continued	142169
F	97-03	MALIBU All	
F	99-04	OLDSMOBILE ALERO All	
F	99	CUTLASS / CUTLASS SUPREME All	
F	98	CUTLASS / CUTLASS SUPREME All Rear Strut Lower Mounting Holes at 2.4" & 3.2" Apart	
F	97	CUTLASS / CUTLASS SUPREME All	
F	99-05	PONTIAC GRAND AM All	
M55975	N		142169
R	97-98	CHEVROLET MALIBU All Rear Strut Lower Mounting holes at 3.2" Apart	
R	97-98	OLDSMOBILE CUTLASS / CUTLASS SUPREME All First Design with Rear Strut Lower Mounting Holes at 3.2" Apart	
M55976	N		142076
R	91-93	NISSAN NX All Right	
R	91-94	SENTRA Non-ABS Right B13 Independent Rear Suspension	
M55977	N		142076
R	91-93	NISSAN NX All Left	
R	91-94	SENTRA Non-ABS Left B13 Independent Rear Suspension	
M55978	N		142169
F	96-07	FORD TAURUS All Left	
F	96-05	MERCURY SABLE All Left	
M55990	N		
F	93-96	VOLKSWAGEN GOLF All Up to Chassis # 08773	
F	85-92	GOLF All Sealed Struts	
F	94-98	JETTA VR6 VR6; Up to Chassis # 08773	
F	93	JETTA All VR6; Up to Chassis # 08773	
F	85-92	JETTA All Sealed Struts	
M55991	N		
F	93-98	VOLKSWAGEN GOLF 2.0L 4Cyl L (121) VR6 from Chassis # 08774	
F	97-98	JETTA VR6, 2.8L 6Cyl V (2792) from Chassis # 08774	
F	96	JETTA 2.8L 6Cyl V (2792) from Chassis # 08774	
F	93-95	JETTA 2.0L 4Cyl L (121) VR6 from Chassis # 08774	
M55993	N		
F	98-03	TOYOTA SIENNA All Left	
M55994	N		
F	98-03	TOYOTA SIENNA All Right	
M55999	N		141309
F	98-02	CHEVROLET PRIZM All	
F	93-97	GEO PRIZM All	
F	93-02	TOYOTA COROLLA All	
M5601	N		142169
R	04-05	CHEVROLET CLASSIC All	
R	98-03	MALIBU All Rear Strut Lower Mounting holes at 2.4" Apart	
R	99-04	OLDSMOBILE ALERO All	
R	99	CUTLASS / CUTLASS SUPREME All	
R	98	CUTLASS / CUTLASS SUPREME All Second Design with Rear Strut Lower Mounting holes at 2.4" apart	
R	99-05	PONTIAC GRAND AM All	
M5602	N		
F	95-96	LEXUS ES300 All	
F	95-96	TOYOTA AVALON All	
F	95-96	CAMRY All	
M5604	N		141306
F	78-83	FORD FAIRMONT All	
F	81-82	GRANADA All	
F	83-86	LTD / COUNTRY SEDAN / COUNTRY SQUIRE / CROWN VICTORIA All	
F	84-93	MUSTANG / MUSTANG II LX, 2.3L 4Cyl L (140)	
F	84-86	MUSTANG / MUSTANG II LX, 5.0L 8Cyl V (302)	
F	82-83	MUSTANG / MUSTANG II 5.0L 8Cyl V (302)	
F	79-83	MUSTANG / MUSTANG II 2.3L 4Cyl L (140)	

Numerical listing

Shock	POP	Alternative No.	MTG Acc. Supplied
Pos.	Year	Application	
M56504	N	-continued	141306
F 80	MUSTANG / MUSTANG II 4.2L 8Cyl V (255)		
F 79	MUSTANG / MUSTANG II 5.0L 8Cyl V (302)		
F 87-88	THUNDERBIRD Non-ABS		
F 79-86	MERCURY CAPRI All		
F 87-88	COUGAR All		
F 81-82	COUGAR Base		
F 82	COUGAR GS		
F 82	COUGAR LS		
F 83-86	MARQUIS All		
F 78-83	ZEPHYR All		
M56506	N		
F 97-01	LEXUS ES300 All Left Exc. Electronic Adjustable Suspension		
F 97-03	TOYOTA AVALON All Left		
F 97-01	CAMRY All Left		
F 99-03	SOLARA All Left		
M56509	N		141572
F 00-05	BUICK LESABRE All		
F 00-05	CADILLAC DEVILLE All Exc. Electronic Adjustable Suspension		
F 98-04	SEVILLE All Exc. Electronic Adjustable Suspension		
F 01-03	OLDSMOBILE AURORA All		
F 98-99	AURORA All		
F 00-05	PONTIAC BONNEVILLE All		
M56514	N		
F 97-01	LEXUS ES300 All Right Exc. Electronic Adjustable Suspension		
F 97-03	TOYOTA AVALON All Right		
F 97-01	CAMRY All Right		
F 99-03	SOLARA All Right		
M56515	N		141682
F 01-02	FORD ESCORT SE Exc. Hot & Cool Coupe		
F 00-02	ESCORT ZX2 Exc. Hot & Cool Coupe		
F 00	ESCORT LX Exc. Hot & Cool Coupe		
F 00	ESCORT ZX2 S/R Exc. Hot & Cool Coupe		
F 98-99	ESCORT LX		
F 98-99	ESCORT SE		
F 98-99	ESCORT SE Equi		
F 98-99	ESCORT ZX2 Equi		
F 99	ESCORT ZX2 S/R		
F 99	ESCORT ZX2 Tipico		
F 97	ESCORT All		
F 97-99	MERCURY TRACER FWD		
M56516	N		
F 00-05	FORD FOCUS All Left		
M56517	N		141682
F 00-05	FORD FOCUS All Right		
M56518	N		141309
F 94-98	ASUNA SUNRUNNER		
F 92-93	SUNRUNNER All Non-ABS		
F 98-04	CHEVROLET TRACKER Non-ABS		
F 89-97	GEO TRACKER All		
F 94-97	PONTIAC SUNRUNNER All		
F 99-05	SUZUKI GRAND VITARA All		
F 89-98	SIDEKICK Non-ABS		
F 99-04	VITARA All		
F 02-06	XL-7 All		
M56520	N		141682
F 97-00	FORD CONTOUR All Mfg. from 3/97		
F 99-02	MERCURY COUGAR All		
F 97-00	MYSTIQUE All Mfg. from 3/97		
M56539	N		
F 01-06	HYUNDAI ELANTRA All Left		
F 00	ELANTRA All Left Mfg. from 5/00		
M56540	N		
F 01-06	HYUNDAI ELANTRA All Right		
F 00	ELANTRA All Right Mfg. from 5/00		
M56558	N		
F 99-04	HONDA ODYSSEY All Right		
M56559	N		
F 99-04	HONDA ODYSSEY All Left		
M56561	FF		
F 01-06	HYUNDAI SANTA FE All Right		

Guardian Struts

Shock	POP	Alternative No.	MTG Acc. Supplied
Pos.	Year	Application	
M56562	FF		
F 01-06	HYUNDAI SANTA FE All Left		
M56606	N		
F 98-10	VOLKSWAGEN BEETLE All		
F 99-06	GOLF A4 (MfrBodyCode)		
F 01-05	JETTA Sedan		
F 99-00	JETTA All		
M56612	N		
F 93-97	VOLVO 850 All Exc. Hydraulic Self Leveling System		
F 98-04	C70 All		
F 98-00	S70 All		
F 98-00	V70 GLT Mfg. to 3/00 and Exc. XC70, XC Cross Country		
F 00	V70 GLT SE Mfg. to 3/00 and Exc. XC70, XC Cross Country		
F 98-99	V70 Base Mfg. to 3/00 and Exc. XC70, XC Cross Country		
F 98-99	V70 T5 Mfg. to 3/00 and Exc. XC70, XC Cross Country		
F 98	V70 R Mfg. to 3/00 and Exc. XC70, XC Cross Country		
M56618	N		
F 00-01	NISSAN SENTRA All Left		
M56619	N		
F 00-01	NISSAN SENTRA All Right		
M56620	N		
F 01-07	CHRYSLER TOWN & COUNTRY All		
F 01-07	VOYAGER / GRAND VOYAGER All		
F 01-07	DODGE CARAVAN / GRAND CARAVAN All		
M56621	N		
F 01-03	ACURA EL All Left		
F 03-05	HONDA CIVIC Hybrid Left		
F 02	CIVIC Coupe Left		
F 02	CIVIC Sedan Left		
F 01	CIVIC All Left		
M56622	N		
F 01-03	ACURA EL All Right		
F 03-05	HONDA CIVIC Hybrid Right		
F 02	CIVIC Coupe Right		
F 02	CIVIC Sedan Right		
F 01	CIVIC All Right		
M56640	FF		
R 00-06	HYUNDAI ELANTRA All Left		
M56641	FF		
R 00-06	HYUNDAI ELANTRA All Right		
M56660	N		
F 03-08	TOYOTA COROLLA All Right		
M56661	N		
F 03-08	TOYOTA COROLLA All Left		
M56671	N		
F 02-06	NISSAN ALTIMA All Left		
F 04-08	MAXIMA All Left		
M56672	N		
F 02-06	NISSAN ALTIMA All Right		
F 04-08	MAXIMA All Right		
M56673	N		
F 02-03	LEXUS ES300 All Left Exc. Electronic Adjustable Suspension		
F 02-03	TOYOTA CAMRY All Left		
M56674	N		
F 02-03	LEXUS ES300 All Right Exc. Electronic Adjustable Suspension		
F 02-03	TOYOTA CAMRY All Right		
M56675	N		
R 03	LEXUS ES300 All Left Exc. Electronic Adjustable Suspension		
R 02-03	TOYOTA CAMRY All Left		
M56676	N		
R 03	LEXUS ES300 All Right Exc. Electronic Adjustable Suspension		
R 02-03	TOYOTA CAMRY All Right		
M56677	N		
F 04-05	HONDA CIVIC Value Package, Coupe Left		
F 04-05	CIVIC Value Package, Sedan Left		
F 03-05	CIVIC DX, Sedan Left		
F 03-05	CIVIC EX, Coupe Left		

Numerical listing

Shock	POP	Alternative No.	MTG Acc. Supplied
Pos.	Year	Application	
M56677	N	-continued	
F 03-05	CIVIC EX, Sedan Left		
F 03-05	CIVIC GX, Sedan Left		
F 03-05	CIVIC HX, Coupe Left		
F 03-05	CIVIC LX, Coupe Left		
F 03-05	CIVIC LX, Sedan Left		
F 03-05	CIVIC Si, Coupe Left		
F 03-05	CIVIC Si, Sedan Left		
F 05	CIVIC EX Special Edition, Coupe Left		
F 05	CIVIC EX Special Edition, Sedan Left		
F 05	CIVIC LX Special Edition, Coupe Left		
F 05	CIVIC LX Special Edition, Sedan Left		
F 03-04	CIVIC DX, Coupe Left		
M56678	N		
F 04-05	HONDA CIVIC Value Package, Coupe Right		
F 04-05	CIVIC Value Package, Sedan Right		
F 03-05	CIVIC DX, Sedan Right		
F 03-05	CIVIC EX, Coupe Right		
F 03-05	CIVIC EX, Sedan Right		
F 03-05	CIVIC GX, Sedan Right		
F 03-05	CIVIC HX, Coupe Right		
F 03-05	CIVIC LX, Coupe Right		
F 03-05	CIVIC LX, Sedan Right		
F 03-05	CIVIC Si, Coupe Right		
F 03-05	CIVIC Si, Sedan Right		
F 05	CIVIC EX Special Edition, Coupe Right		
F 05	CIVIC EX Special Edition, Sedan Right		
F 05	CIVIC LX Special Edition, Coupe Right		
F 05	CIVIC LX Special Edition, Sedan Right		
M56683	FF		
F 00-01	NISSAN MAXIMA All Left		
M56684	FF		
F 00-01	NISSAN MAXIMA All Right		
M56685	FF		
F 02-03	NISSAN MAXIMA All Left		
M56686	FF		
F 02-03	NISSAN MAXIMA All Right		
M56687	FF		
F 02-03	INFINITI QX4 All Left		
F 02-04	NISSAN PATHFINDER All Left		
M56688	FF		
F 02-03	INFINITI QX4 All Right		
F 02-04	NISSAN PATHFINDER All Right		
M56700	N		
F 82-92	CHEVROLET CAMARO All		
F 82-92	PONTIAC FIREBIRD All		
M56707	N		142714
R 85-90	BUICK ELECTRA Air (RearSpringType) Conventional Replacement for Air Assist Rear Susp. Strut Only		
R 86-99	LESABRE Coil (RearSpringType)		
R 91-96	PARK AVENUE Air (RearSpringType) Conventional Replacement for Air Assist Susp; Exc. Elec. Adj. Susp.		
R 93	CADILLAC 60 SPECIAL Coil (RearSpringType) Conventional Type Replacement for Air Assist Rear Suspension		
R 92-93	COMMERCIAL CHASSIS FWD Conventional Type Replacement for Air Assist Rear Suspension; Exc. Electronic Suspension		
R 85-91	COMMERCIAL CHASSIS All Conventional Type Replacement for Air Assist Rear Suspension; Exc. Electronic Suspension		
R 85-93	DEVILLE Air (RearSpringType) Conventional Type Replacement for Air Assist Rear Suspension		
R 85-93	FLEETWOOD All Conventional Type Replacement for Air Assist Rear Suspension		
R 92-99	OLDSMOBILE 88 SERIES All Conventional Type Replacement for Air Assist Rear Suspension		
R 86-91	88 SERIES Coil (RearSpringType)		

Numerical listing

Shock	POP	Alternative No.	MTG Acc. Supplied
Pos.	Year	Application	
M56707 N -continued 142714			
R	85-96	98 Air (RearSpringType)	Conventional Type Replacement
R	96-99	LSS Coil (RearSpringType)	Conventional Type Replacement for Air Assist Rear Suspension
R	97-98	REGENCY Coil (RearSpringType)	
R	91-99	PONTIAC BONNEVILLE Coil (RearSpringType) Exc. Electronic Adjustable Suspension	
R	87-90	BONNEVILLE Coil (RearSpringType)	
M56708 N			
R	88-96	BUICK REGAL All	
R	90-94	CHEVROLET LUMINA All	
R	97	OLDSMOBILE CUTLASS / CUTLASS SUPREME All Exc. Rear Strut Lower Mounting holes at 3.2" apart	
R	88-96	CUTLASS / CUTLASS SUPREME All	
R	88-96	PONTIAC GRAND PRIX All	
M56718 N			
F	91-99	BUICK LESABRE All	
F	90	LESABRE All Late Design Front Strut without Spring Guard	
F	91-96	PARK AVENUE All	
F	95-96	RIVIERA All	
F	93	CADILLAC 60 SPECIAL All	
F	91-93	COMMERCIAL CHASSIS FWD	
F	91-93	DEVILLE All Exc. Electronic Adjustable Suspension	
F	91-93	FLEETWOOD All	
F	92-99	OLDSMOBILE 88 SERIES All	
F	90-91	88 SERIES All Late Design Front Strut without Spring Guard	
F	91-96	98 All CCR Computer Command Ride	
F	95-96	AURORA All	
F	96-99	LSS All	
F	97-98	REGENCY All	
F	94-99	PONTIAC BONNEVILLE All Exc. CCR Computer Command Ride	
F	91-93	BONNEVILLE All	
F	90	BONNEVILLE All Late Design Front Strut without Spring Guard	
M56719 N 142607			
F	95-98	BUICK SKYLARK All Right	
F	92-94	SKYLARK All Right Exc. FE3 and Electronic Ride Control	
F	95-96	CHEVROLET BERETTA All Right	
F	92-94	BERETTA Base Right Exc. FE7 Suspension	
F	95-96	CORSICA All Right	
F	94	CORSICA Base Right Exc. FE7 Suspension	
F	93	CORSICA All Right Exc. FE7 Suspension	
F	92	CORSICA LT Right Exc. FE7 Suspension	
F	95-98	OLDSMOBILE ACHIEVA All Right Exc. Electronic Adjustable Suspension	
F	92-94	ACHIEVA All Right Exc. FE3 and Electronic Ride Control	
F	96-98	PONTIAC GRAND AM All Right Exc. Electronic Adjustable Suspension	
F	95	GRAND AM SE Right Exc. Electronic Adjustable Suspension	
F	92-94	GRAND AM SE Right Exc. FE3 and Electronic Ride Control	
M56720 N 142607			
F	95-98	BUICK SKYLARK All Left	
F	92-94	SKYLARK All Left Exc. FE3 and Electronic Ride Control	
F	95-96	CHEVROLET BERETTA All Left	
F	92-94	BERETTA Base Left Exc. FE7 Suspension	
F	95-96	CORSICA All Left	
F	94	CORSICA Base Left Exc. FE7 Suspension	
F	93	CORSICA All Left Exc. FE7 Suspension	
F	92	CORSICA LT Left Exc. FE7 Suspension	
F	95-98	OLDSMOBILE ACHIEVA All Left Exc. Electronic Adjustable Suspension	
F	92-94	ACHIEVA All Left Exc. FE3 and Electronic Ride Control	

Guardian Struts, Ultra ReadyMount

Shock	POP	Alternative No.	MTG Acc. Supplied
Pos.	Year	Application	
M56720 N -continued 142607			
F	95-98	PONTIAC GRAND AM All Left Exc. Electronic Adjustable Suspension	
F	92-94	GRAND AM SE Left Exc. FE3 and Electronic Ride Control	
M56736 N			
F	98-99	INFINITI QX4 All Right Mfg. to 12/98	
F	97	QX4 All Right	
F	99	NISSAN PATHFINDER All Right	
F	98	PATHFINDER All Right Mfg. to 12/98	
F	96-97	PATHFINDER All Right	
M56739 N			
F	98-99	INFINITI QX4 All Left Mfg. to 12/98	
F	97	QX4 All Left	
F	99	NISSAN PATHFINDER All Left	
F	98	PATHFINDER All Left Mfg. to 12/98	
F	96-97	PATHFINDER All Left	
M56758 FF			
F	01-02	ACURA MDX All Right	
F	03-08	HONDA PILOT AWD Right	
M56759 FF			
F	01-02	ACURA MDX All Left	
F	03-08	HONDA PILOT AWD Left	
M56805 N			
F	02-06	NISSAN SENTRA GXE Right	
F	02-06	SENTRA GXE Sport Right	
F	02-06	SENTRA XE Right	
F	03-04	SENTRA LE Right	
F	02	SENTRA CA Right	
M56806 N			
F	02-06	NISSAN SENTRA GXE Left	
F	02-06	SENTRA GXE Sport Left	
F	02-06	SENTRA XE Left	
F	03-04	SENTRA LE Left	
F	02	SENTRA CA Left	
M56809 FF			
F	04-07	SATURN ION All	
M56810 N			
F	05-10	CHEVROLET COBALT LS	
F	05-10	COBALT LT	
F	10	COBALT Base	
F	10	COBALT LT Team Canada	
F	06-07	COBALT LTZ	
F	05	COBALT Base	
F	11	HHR All	
F	08-10	HHR LS Panel	
F	08-10	HHR LT Panel	
F	06-10	HHR LS	
F	06-10	HHR LT	
F	06-08	HHR Comfort LT	
F	06-08	HHR Elegance LT	
F	07	HHR Edicion Especial	
F	07-09	PONTIAC G5 All	
F	05-06	PURSUIT All	
M56882 FF			
F	04-08	SUZUKI FORENZA All Left	
F	05-08	RENO All Left	
M56883 FF			
F	04-08	SUZUKI FORENZA All Right	
F	05-08	RENO All Right	
M56884 FF			
R	04-08	SUZUKI FORENZA All Left	
R	05-08	RENO All Left	
M56885 FF			
R	04-08	SUZUKI FORENZA All Right	
R	05-08	RENO All Right	
M56886 FF			
F	06-11	CHEVROLET AVEO All Left	
F	04-11	AVEO All Left	
F	07-10	PONTIAC G3 All Left	
F	05-08	WAVE All Left	
F	04-09	SUZUKI SWIFT All Left	
M56887 FF			
F	06-11	CHEVROLET AVEO All Right	
F	04-11	AVEO All Right	
F	07-10	PONTIAC G3 All Right	
F	05-08	WAVE All Right	
F	04-09	SUZUKI SWIFT All Right	
M56899 FF			
F	06-14	VOLKSWAGEN JETTA All	
F	04-05	JETTA Wagon	

Numerical listing

Shock	POP	Alternative No.	MTG Acc. Supplied
Pos.	Year	Application	
M56903 N			
R	85-90	BUICK ELECTRA Air (RearSpringType) w/Air assist Rear Susp. Std. Equip. Strut Only	
R	86-99	LESABRE Air (RearSpringType) Optional O.E. Hydraulic Self Leveling System	
R	91-96	PARK AVENUE Air (RearSpringType) Exc. Electronic Adjustable Suspension	
R	92-93	CADILLAC COMMERCIAL CHASSIS FWD Air Assist Rear Suspension; Exc. Electronic Adjustable Suspension	
R	91	COMMERCIAL CHASSIS All Air Assist Rear Suspension; Exc. Electronic Adjustable Suspension	
R	85-90	COMMERCIAL CHASSIS All Air Assist Rear Suspension Standard Equipment	
R	91-93	DEVILLE Air (RearSpringType) CCR Computer Command Ride	
R	85-90	DEVILLE Air (RearSpringType) Air Assist Rear Suspension Standard Equipment	
R	91-93	FLEETWOOD All Air Assist Rear Suspension; Exc. Electronic Adjustable Suspension	
R	85-90	FLEETWOOD All Air Assist Rear Suspension Standard Equipment	
R	94-99	OLDSMOBILE 88 SERIES Coil (FrontSpringType), Coil (RearSpringType) Optional O.E. Hydraulic Self Leveling System; Exc. Electronic Adjustable Suspension	
R	92-93	88 SERIES Coil (FrontSpringType), Air (RearSpringType) Optional O.E. Hydraulic Self Leveling System; Exc. Electronic Adjustable Suspension	
R	86-91	88 SERIES Air (RearSpringType) Optional O.E. Hydraulic Self Leveling System	
R	91-96	98 Air (RearSpringType) CCR Computer Command Ride	
R	85-90	98 Air (RearSpringType)	
R	96-99	LSS Air (RearSpringType)	
R	97-98	REGENCY Air (RearSpringType) Optional O.E. Hydraulic Self Leveling System	
R	91-99	PONTIAC BONNEVILLE Air (RearSpringType) Optional O.E. Hydraulic Self Leveling System; Exc. Electronic Adjustable Suspension	
R	88-90	BONNEVILLE Air (RearSpringType) Optional O.E. Hydraulic Self Leveling System	
R	87	BONNEVILLE All Optional O.E. Hydraulic Self Leveling System	
Ultra ReadyMount			
G56726 D			
R	85-90	BUICK ELECTRA Air (RearSpringType) Conventional Replacement for Air Assist Rear Susp. Strut w/Upper Mount	
R	86-99	LESABRE Coil (RearSpringType)	
R	91-96	PARK AVENUE Air (RearSpringType) Conventional Replacement for Air Assist Susp; Exc. Elec. Adj. Susp.	
R	93	CADILLAC 60 SPECIAL Coil (RearSpringType) Conventional Type Replacement for Air Assist Rear Suspension	
R	85-93	DEVILLE Air (RearSpringType) Conventional Type Replacement for Air Assist Rear Suspension	
R	85-93	FLEETWOOD All Conventional Type Replacement for Air Assist Rear Suspension	
R	92-99	OLDSMOBILE 88 SERIES Coil (RearSpringType) Exc. Electronic Adjustable Suspension	
R	86-91	88 SERIES Coil (RearSpringType)	
R	85-96	98 Air (RearSpringType) Conventional Type Replacement LSS Coil (RearSpringType) Conventional Type Replacement for Air Assist Rear Suspension	
R	96-99	LSS Coil (RearSpringType) Conventional Type Replacement for Air Assist Rear Suspension	
R	97-98	REGENCY Coil (RearSpringType)	
R	91-99	PONTIAC BONNEVILLE Coil (RearSpringType) Exc. Electronic Adjustable Suspension	
R	87-90	BONNEVILLE Coil (RearSpringType)	

Numerical listing

Shock	POP	Alternative No.	MTG Acc. Supplied
Pos.	Year	Application	
G56727	C		142635
R	88-96	BUICK REGAL All	
R	90-94	CHEVROLET LUMINA All	
R	88-97	OLDSMOBILE CUTLASS / CUTLASS SUPREME All	
R	88-96	PONTIAC GRAND PRIX All	
G56906	D		
R	85-90	BUICK ELECTRA Air (RearSpringType) w/Air Assist Rear Susp. Std. Equip. Strut w/Upper Mount	
R	86-99	LESABRE Air (RearSpringType) Optional O.E. Hydraulic Self Leveling System	
R	91-96	PARK AVENUE Air (RearSpringType)	
R	93	CADILLAC 60 SPECIAL All Air Assist Rear Suspension; Exc. Electronic Adjustable Suspension	
R	91-93	DEVILLE Air (RearSpringType) CCR Computer Command Ride	
R	85-90	DEVILLE Air (RearSpringType) Air Assist Rear Suspension Standard Equipment	
R	91-93	FLEETWOOD All Air Assist Rear Suspension; Exc. Electronic Adjustable Suspension	
R	85-90	FLEETWOOD All Air Assist Rear Suspension Standard Equipment	
R	94-99	OLDSMOBILE 88 SERIES Coil (RearSpringType) Optional O.E. Hydraulic Self Leveling System; Exc. Electronic Adjustable Suspension	
R	91-93	88 SERIES Air (RearSpringType) Optional O.E. Hydraulic Self Leveling System; Exc. Electronic Adjustable Suspension	
R	86-90	88 SERIES Air (RearSpringType) Optional O.E. Hydraulic Self Leveling System	
R	91-96	98 Air (RearSpringType) CCR Computer Command Ride	
R	85-90	98 Air (RearSpringType)	
R	96-99	LSS Air (RearSpringType)	
R	97-98	REGENCY Air (RearSpringType) Optional O.E. Hydraulic Self Leveling System	
R	91-99	PONTIAC BONNEVILLE Air (RearSpringType) Optional O.E. Hydraulic Self Leveling System; Exc. Electronic Adjustable Suspension	
R	88-90	BONNEVILLE Air (RearSpringType) Optional O.E. Hydraulic Self Leveling System	
R	87	BONNEVILLE All Optional O.E. Hydraulic Self Leveling System	
G56907	C		
F	90-95	CHRYSLER TOWN & COUNTRY All	
F	87-95	DODGE CARAVAN / GRAND CARAVAN All	
F	86	CARAVAN / GRAND CARAVAN All Mfg. from 1/86	
F	87-88	MINI RAM All	
F	87-95	PLYMOUTH VOYAGER / GRAND VOYAGER All	
F	86	VOYAGER / GRAND VOYAGER All Mfg. from 1/86	
G56908	C		
F	85-96	BUICK CENTURY All	
F	84	CENTURY All HD Suspension	
F	85	SKYLARK All	
F	84	SKYLARK All HD Suspension	
F	85-90	CHEVROLET CELEBRITY All	
F	84	CELEBRITY All HD Suspension	
F	84-85	CITATION / CITATION II All HD Suspension	
F	85-96	OLDSMOBILE CIERA / CUTLASS CIERA All Exc. Electronic Adjustable Suspension	
F	84	CIERA / CUTLASS CIERA All HD Suspension	
F	87-94	CUTLASS CLASSIC / CUTLASS CRUISER All Exc. Electronic Adjustable Suspension	
F	84	OMEGA All HD Suspension	
F	91	PONTIAC 6000 FWD	
F	84-90	6000 All	
F	84	PHOENIX All HD Suspension	
G56909	B		
F	91-99	BUICK LESABRE All	

Ultra ReadyMount

Shock	POP	Alternative No.	MTG Acc. Supplied
Pos.	Year	Application	
G56909	B	-continued	
F	90	LESABRE All Late Design Front Strut without Spring Guard	
F	91-96	PARK AVENUE All CCR Computer Command Ride	
F	93	CADILLAC 60 SPECIAL All	
F	92-93	COMMERCIAL CHASSIS FWD	
F	91	COMMERCIAL CHASSIS All	
F	91-93	DEVILLE All Exc. Electronic Adjustable Suspension	
F	91-93	FLEETWOOD All	
F	92-99	OLDSMOBILE 88 SERIES All	
F	90-91	88 SERIES All Late Design Front Strut without Spring Guard	
F	91-96	98 All	
F	96-99	LSS All	
F	97-98	REGENCY All	
F	94-99	PONTIAC BONNEVILLE Air (RearSpringType) Exc. CCR Computer Command Ride	
F	91-93	BONNEVILLE All	
F	90	BONNEVILLE All Late Design Front Strut without Spring Guard	
G56910	A		
F	96-00	CHRYSLER TOWN & COUNTRY All	
F	00	VOYAGER / GRAND VOYAGER All	
F	00	VOYAGER / GRAND VOYAGER All Exc. Hydraulic Self Leveling System	
F	96-00	DODGE CARAVAN / GRAND CARAVAN All Exc. Hydraulic Self Leveling System	
F	96-00	PLYMOUTH VOYAGER / GRAND VOYAGER All	
F	96	VOYAGER / GRAND VOYAGER All Exc. Hydraulic Self Leveling System	
G56911	D		
F	91-96	FORD ESCORT All	
F	90-94	MAZDA 323 All	
F	90-94	PROTÉGÉ / PROTÉGÉ5 All	
F	91-96	MERCURY TRACER FWD	
G56912	D		
F	86-95	FORD TAURUS All	
F	86-95	MERCURY SABLE All	
G56913	D		
R	86-93	FORD TAURUS Sedan	
R	86-93	MERCURY SABLE Sedan	
G56914	C		
F	85-90	BUICK ELECTRA All	
F	90	LESABRE All Early Design Front Strut with Spring Guard	
F	86-89	LESABRE All	
F	85-90	CADILLAC COMMERCIAL CHASSIS All	
F	85-90	DEVILLE All	
F	85-90	FLEETWOOD All	
F	86-90	OLDSMOBILE 88 SERIES All Early Design Front Strut with Spring Guard	
F	85-90	98 All	
F	87-90	PONTIAC BONNEVILLE All Early Design Front Strut with Spring Guard	
G56916	C		143068
F	95-98	BUICK SKYLARK All Right	
F	95-96	CHEVROLET BERETTA All Right	
F	95-96	CORSICA All Right	
F	97-98	OLDSMOBILE ACHIEVA All Right Exc. Electronic Adjustable Suspension	
F	95-96	ACHIEVA All Right	
F	95-98	PONTIAC GRAND AM All Right Exc. Electronic Adjustable Suspension	
G56917	C		143068
F	95-98	BUICK SKYLARK All Left	
F	95-96	CHEVROLET BERETTA All Left	
F	95-96	CORSICA All Left	
F	97-98	OLDSMOBILE ACHIEVA All Left Exc. Electronic Adjustable Suspension	
F	95-96	ACHIEVA All Left	
F	95-98	PONTIAC GRAND AM All Left Exc. Electronic Adjustable Suspension	
G56920	D		143068
F	87-91	CHEVROLET BERETTA All Right	
F	92-94	CAVALIER All Right	
F	87-91	CORSICA All Right	
F	92-94	PONTIAC SUNBIRD All Right	
F	87-91	TEMPEST All Right	

Numerical listing

Shock	POP	Alternative No.	MTG Acc. Supplied
Pos.	Year	Application	
G56921	D		143068
F	87-91	CHEVROLET BERETTA All Left	
F	92-94	CAVALIER All Left	
F	87-91	CORSICA All Left	
F	92-94	PONTIAC SUNBIRD All Left	
F	87-91	TEMPEST All Left	
G56924	A		
R	05-09	BUICK ALLURE All Left Exc. Models with 17" or 18" Wheels	
R	97-05	CENTURY All Left	
R	05-09	LACROSSE All Left Exc. Models with 17" or 18" Wheels	
R	97-04	REGAL All Left	
R	12-16	CHEVROLET IMPALA All Left	
R	00-11	IMPALA All Left Exc. Models with 17" or 18" Wheels	
R	00-07	MONTE CARLO All Left Exc. Models with 17" or 18" Wheels	
R	98-02	OLDSMOBILE INTRIGUE All Left	
R	97-08	PONTIAC GRAND PRIX All Left Exc. Models with 17" or 18" Wheels	
G56925	A		
R	05-09	BUICK ALLURE All Right Exc. Models with 17" or 18" Wheels	
R	97-05	CENTURY All Right	
R	05-09	LACROSSE All Right Exc. Models with 17" or 18" Wheels	
R	97-04	REGAL All Right	
R	12-16	CHEVROLET IMPALA All Right	
R	00-11	IMPALA All Right Exc. Models with 17" or 18" Wheels	
R	00-07	MONTE CARLO All Right Exc. Models with 17" or 18" Wheels	
R	98-02	OLDSMOBILE INTRIGUE All Right	
R	97-08	PONTIAC GRAND PRIX All Right Exc. Models with 17" or 18" Wheels	
G56926	C		
F	01-02	FORD ESCORT SE	
F	00-02	ESCORT ZX2	
F	99-00	ESCORT ZX2 S/R	
F	98-00	ESCORT LX	
F	98-99	ESCORT SE	
F	98-99	ESCORT SE Equi	
F	98-99	ESCORT ZX2 Equi	
F	99	ESCORT ZX2 Tipico	
F	97	ESCORT All	
F	97-99	MERCURY TRACER FWD	
G56927	A		
F	04-05	CHEVROLET CLASSIC All	
F	97-03	MALIBU All	
F	99-04	OLDSMOBILE ALERO All	
F	97-99	CUTLASS / CUTLASS SUPREME All	
F	99-05	PONTIAC GRAND AM All	
G56928	A		
R	04-05	CHEVROLET CLASSIC All	
R	98-03	MALIBU All Rear Strut Lower Mounting holes at 2.4" Apart	
R	99-04	OLDSMOBILE ALERO All	
R	99-05	PONTIAC GRAND AM All	
G56929	B		
F	98-05	BUICK PARK AVENUE All	
F	98-99	RIVIERA All	
G56930	A		
F	97-01	LEXUS ES300 All Left Exc. Electronic Adjustable Suspension	
F	97-03	TOYOTA AVALON All Left	
F	97-01	CAMRY All Left	
F	99-03	SOLARA All Left	
G56931	A		
F	97-01	LEXUS ES300 All Right Exc. Electronic Adjustable Suspension	
F	97-03	TOYOTA AVALON All Right	
F	97-01	CAMRY All Right	
F	99-03	SOLARA All Right	
G56932	A		
R	92-02	LEXUS ES300 All Left Exc. Electronic Adjustable Suspension	
R	95-03	TOYOTA AVALON All Left	
R	95-01	CAMRY All Left	
R	92-94	CAMRY All Left Sealed O.E. Struts	
R	99-03	SOLARA All Left	
G56933	A		
R	92-02	LEXUS ES300 All Right Exc. Electronic Adjustable Suspension	
R	95-03	TOYOTA AVALON All Right	

Numerical listing

Shock	POP	Alternative No.	MTG Acc. Supplied
Pos.	Year	Application	
G56933 A -continued			
R	95-01	CAMRY	All Right
R	92-94	CAMRY	All Right Sealed O.E. Struts
R	99-03	SOLARA	All Right
G56934 A			
F	96-07	FORD TAURUS	All Left
F	96-05	MERCURY SABLE	All Left
G56935 B			
F	95-03	FORD WINDSTAR	All
G56936 A			
R	94-07	FORD TAURUS	Sedan
R	94-05	MERCURY SABLE	Sedan
G56937 A			
F	96-07	FORD TAURUS	All Right
F	96-05	MERCURY SABLE	All Right
G56938 A			
R	95-05	CHEVROLET CAVALIER	All
R	95-05	PONTIAC SUNFIRE	All
G56939 D			
F	95-98	CHEVROLET CAVALIER	All
F	95-98	PONTIAC SUNFIRE	All
G56940 B			
R	91-03	FORD ESCORT	All
R	91-95	MAZDA 323	All
R	90-94	PROTÉGÉ / PROTÉGÉS	All
R	91-99	MERCURY TRACER	FWD
G56942 C			
F	95-96	TOYOTA CAMRY	All
G56943 C			
R	98-02	HONDA ACCORD	All
G56947 A			
F	93-97	GEO PRIZM	All
F	93-97	TOYOTA COROLLA	All
G56948 A			
F	98-02	CHEVROLET PRIZM	All
F	98-02	TOYOTA COROLLA	All
G56949 B			
R	98-02	CHEVROLET PRIZM	All Left
R	93-97	GEO PRIZM	All Left
R	93-02	TOYOTA COROLLA	All Left
G56950 B			
R	98-02	CHEVROLET PRIZM	All Right
R	93-97	GEO PRIZM	All Right
R	93-02	TOYOTA COROLLA	All Right
G56951 A 143035			
F	99-05	CHEVROLET CAVALIER	All
F	99-05	PONTIAC SUNFIRE	All
G56952 D			
R	95-96	CHEVROLET LUMINA	All Left
G56953 D			
R	95-96	CHEVROLET LUMINA	All Right
G56956 A			
F	01-07	CHRYSLER TOWN & COUNTRY	All Left
F	01-07	VOYAGER / GRAND VOYAGER	All Left
F	01-07	DODGE CARAVAN / GRAND CARAVAN	All Left
G56957 A			
F	01-07	CHRYSLER TOWN & COUNTRY	All Right
F	01-07	VOYAGER / GRAND VOYAGER	All Right
F	01-07	DODGE CARAVAN / GRAND CARAVAN	All Right
G56958 D			
F	93-97	CHRYSLER CONCORDE	All Left
F	94-97	LHS	All Left
F	94-96	NEW YORKER	All Left
F	93-97	DODGE INTREPID	All Left
F	93-97	EAGLE VISION	All Left
G56959 D			
F	93-97	CHRYSLER CONCORDE	All Right
F	94-97	LHS	All Right
F	94-96	NEW YORKER	All Right
F	93-97	DODGE INTREPID	All Right
F	93-97	EAGLE VISION	All Right

Ultra ReadyMount

Shock	POP	Alternative No.	MTG Acc. Supplied
Pos.	Year	Application	
G56960 D			
R	93-97	CHRYSLER CONCORDE	All
R	93-97	DODGE INTREPID	All
R	93-97	EAGLE VISION	All
G56961 C			
F	94-97	HONDA ACCORD	All
G56962 B			
F	99-04	CHRYSLER 300M	All Left
F	98-04	CONCORDE	All Left
F	98-04	INTREPID	All Left
F	99-01	LHS	All Left
F	98-04	DODGE INTREPID	All Left
G56963 B			
F	99-04	CHRYSLER 300M	All Right
F	98-04	CONCORDE	All Right
F	98-04	INTREPID	All Right
F	99-01	LHS	All Right
F	98-04	DODGE INTREPID	All Right
G56964 C			
R	99-04	CHRYSLER 300M	All
R	98-04	CONCORDE	All
R	99-01	LHS	All
R	98-04	DODGE INTREPID	All
G56965 A			
F	01-10	CHRYSLER PT CRUISER	All
G56966 D			
F	95-99	DODGE NEON	All
F	95-99	PLYMOUTH NEON	All
G56967 D			
R	95-99	DODGE NEON	All
R	95-99	PLYMOUTH NEON	All
G56968 D			
R	90-97	HONDA ACCORD	All Left
G56969 D			
R	90-97	HONDA ACCORD	All Right
G56970 C			
F	96-99	INFINITI I30	All Left
F	95-99	NISSAN MAXIMA	All Left
G56971 C			
F	96-99	INFINITI I30	All Right
F	95-99	NISSAN MAXIMA	All Right
G56973 D			
R	00-02	CHRYSLER NEON	All Left
R	03-05	DODGE NEON SXT	Left
R	00-05	NEON SE	Left
R	01-04	NEON R/T	Left
R	00-03	NEON LE	Left
R	01-02	NEON ACR	Left
R	01-02	NEON Base	Left
R	00-02	NEON ES	Left
R	00-02	NEON LX	Left
R	00	NEON High Line	Left
R	00-01	PLYMOUTH NEON	All Left
G56974 D			
R	00-02	CHRYSLER NEON	All Right
R	03-05	DODGE NEON SXT	Right
R	00-05	NEON SE	Right
R	01-04	NEON R/T	Right
R	00-03	NEON LE	Right
R	01-02	NEON ACR	Right
R	01-02	NEON Base	Right
R	00-02	NEON ES	Right
R	00-02	NEON LX	Right
R	00	NEON High Line	Right
R	00-01	PLYMOUTH NEON	All Right
G56975 C			
F	00-02	CHRYSLER NEON	All
F	03-05	DODGE NEON SXT	All
F	00-05	NEON SE	All
F	01-04	NEON R/T	All
F	00-03	NEON LE	All
F	01-02	NEON ACR	All
F	01-02	NEON Base	All
F	00-02	NEON ES	All
F	00-02	NEON LX	All
F	00	NEON High Line	All
F	00-01	PLYMOUTH NEON	All
G56976 D			
F	89-97	FORD THUNDERBIRD	All Left Exc. Electronic Adjustable Suspension
F	89-97	MERCURY COUGAR	All Left Exc. Electronic Adjustable Suspension

Numerical listing

Shock	POP	Alternative No.	MTG Acc. Supplied
Pos.	Year	Application	
G56977 D			
F	89-97	FORD THUNDERBIRD	All Right Exc. Electronic Adjustable Suspension
F	89-97	MERCURY COUGAR	All Right Exc. Electronic Adjustable Suspension
G56981 C			
F	90-93	HONDA ACCORD	All
G56985 C			
F	90-93	CHRYSLER IMPERIAL	All Exc. Hydraulic Self Leveling System
F	89-94	LEBARON	All
F	90-93	NEW YORKER	All Exc. Hydraulic Self Leveling System
F	88-93	DODGE DYNASTY	All Exc. Hydraulic Self Leveling System
F	89-94	SHADOW	All Exc. Hydraulic Self Leveling System
F	89-95	SPIRIT	All Exc. Hydraulic Self Leveling System
F	89-95	PLYMOUTH ACCLAIM	All Exc. Hydraulic Self Leveling System
F	89-94	SUNDANCE	All Exc. Hydraulic Self Leveling System
G56989 D			
F	93-98	MERCURY VILLAGER	All Left
F	93-98	NISSAN QUEST	All Left
G56990 D			
F	93-98	MERCURY VILLAGER	All Right
F	93-98	NISSAN QUEST	All Right
G56991 C			
F	98-02	HONDA ACCORD 2.3L 4Cyl L	(2254) Left
G56992 C			
F	98-02	HONDA ACCORD 2.3L 4Cyl L	(2254) Right
G56993 C			
F	97-01	ACURA INTEGRA	GS Left
F	94-01	INTEGRA	GS-R Left
F	94-01	INTEGRA	LS Left
F	94-98	INTEGRA	RS Left
F	95-96	INTEGRA	Special Edition Left
F	92-95	HONDA CIVIC	All Left
G56994 C			
F	97-01	ACURA INTEGRA	GS Right
F	94-01	INTEGRA	GS-R Right
F	94-01	INTEGRA	LS Right
F	94-98	INTEGRA	RS Right
F	95-96	INTEGRA	Special Edition Right
F	92-95	HONDA CIVIC	All Right
G56995 C			
R	97-01	ACURA INTEGRA	GS
R	94-01	INTEGRA	GS-R
R	94-01	INTEGRA	LS
R	94-98	INTEGRA	RS
R	95-96	INTEGRA	Special Edition
R	92-95	HONDA CIVIC	All
G56996 C			
F	96-00	HONDA CIVIC	All Left
G56997 C			
F	96-00	HONDA CIVIC	All Right
G56998 C			
R	96-00	HONDA CIVIC	All
G57000 A			
F	07-13	CHEVROLET PICKUP 1/2 TON, SILVERADO 1500 Crew Cab	Pickup, RWD Exc. Electronic Ride Control
F	07-13	PICKUP 1/2 TON, SILVERADO 1500 Extended Cab Pickup, RWD	Exc. Electronic Ride Control
F	07-13	GMC SIERRA 1500 Crew Cab	Pickup, RWD Exc. Electronic Ride Control
F	07-13	SIERRA 1500 Extended Cab Pickup, RWD	Exc. Electronic Ride Control
G57001 C			
F	93-99	NISSAN ALTIMA	All Left
G57002 C			
F	93-99	NISSAN ALTIMA	All Right

Numerical listing

Shock	POP	Alternative No.	MTG Acc. Supplied
Pos.	Year	Application	
G57003	C		
R	93-01	NISSAN ALTIMA All Left	
G57004	C		
R	93-01	NISSAN ALTIMA All Right	
G57005	D		
F	85-96	VOLKSWAGEN GOLF All	
F	85-96	JETTA All	
G57006	D		
F	97-98	VOLKSWAGEN GOLF 2.0L 4Cyl L (121)	
F	97-98	JETTA 2.0L 4Cyl L (121)	
G57007	B		
F	07-11	DODGE NITRO All Left	
F	07-12	JEEP LIBERTY All Right	
F	05-06	LIBERTY GAS Left	
F	02-04	LIBERTY All Left	
G57008	B		
F	07-11	DODGE NITRO All Right	
F	07-12	JEEP LIBERTY All Right	
F	05-06	LIBERTY GAS Right	
F	02-04	LIBERTY All Right	
G57010	A		
F	98-04	TOYOTA TACOMA Pre Runner, RWD	
F	95-04	TACOMA 4WD	
G57011	A		
F	99-04	HONDA ODYSSEY All Left	
G57012	A		
F	99-04	HONDA ODYSSEY All Right	
G57013	C		
F	91-02	SATURN SC / SL / SW SERIES All	
G57014	D		
R	91-02	SATURN SC / SL / SW SERIES All	
G57015	C		
F	03-06	FORD EXPEDITION 4WD	
F	03-06	LINCOLN NAVIGATOR All	
G57016	C		
R	03-06	FORD EXPEDITION All	
R	03-06	LINCOLN NAVIGATOR All	
G57017	A		
F	02-03	FORD EXPLORER Eddie Bauer	
F	02-03	EXPLORER Limited	
F	02-03	EXPLORER Postal	
F	02-03	EXPLORER XLS	
F	02-03	EXPLORER XLT	
F	02-03	MERCURY MOUNTAINEER All	
G57018	A		
R	02-05	FORD EXPLORER Eddie Bauer	
R	02-05	EXPLORER Limited	
R	02-05	EXPLORER XLS	
R	02-05	EXPLORER XLT	
R	04	EXPLORER NBX	
R	02-03	EXPLORER Postal	
R	02-05	MERCURY MOUNTAINEER All	
G57019	B		
F	04-05	FORD EXPLORER Eddie Bauer	
F	04-05	EXPLORER Limited	
F	04-05	EXPLORER XLS	
F	04-05	EXPLORER XLT	
F	04	EXPLORER NBX	
F	04-05	MERCURY MOUNTAINEER All	
G57020	A		
F	04-08	FORD PICKUP 1/2 TON, F-150 4WD	
F	06-08	LINCOLN MARK LT 4WD	
G57021	A		143248
F	04-08	FORD PICKUP 1/2 TON, F-150 RWD	
F	06-08	LINCOLN MARK LT RWD	
G57022	A		
F	04-07	BUICK RAINIER All	
F	06-09	CHEVROLET TRAILBLAZER LT	
F	06-08	TRAILBLAZER Base	
F	06-07	TRAILBLAZER A	
F	06-07	TRAILBLAZER B	
F	06-07	TRAILBLAZER LS	
F	06	TRAILBLAZER EXT	
F	06	TRAILBLAZER EXT B	
F	02-05	TRAILBLAZER All	
F	02-06	TRAILBLAZER EXT All	

Ultra ReadyMount

Shock	POP	Alternative No.	MTG Acc. Supplied
Pos.	Year	Application	
G57022	A	-continued	
F	02-09	GMC ENVOY All	
F	02-06	ENVOY XL All	
F	04-05	ENVOY XUV All	
F	03-08	ISUZU ASCENDER All	
F	02-04	OLDSMOBILE BRAVADA All	
F	05-09	SAAB 9-7X All	
G57023	C		
F	10-13	CHEVROLET PICKUP 1/2 TON, SILVERADO 1500 Base, Standard Cab Pickup, RWD Exc. Classic Models and Electronic Ride	
F	07-13	PICKUP 1/2 TON, SILVERADO 1500 WT, Standard Cab Pickup, RWD Exc. Classic Models and Electronic Ride	
F	09	PICKUP 1/2 TON, SILVERADO 1500 LT, Standard Cab Pickup, RWD Exc. Classic Models and Electronic Ride	
F	07-08	PICKUP 1/2 TON, SILVERADO 1500 Base, Standard Cab Pickup, RWD Exc. Classic Models and Electronic Ride	
F	07	PICKUP 1/2 TON, SILVERADO 1500 LTZ, Standard Cab Pickup, RWD Exc. Classic Models and Electronic Ride	
F	07-13	GMC SIERRA 1500 SLE, Standard Cab Pickup, RWD Exc. Classic Models and Electronic Ride	
F	07-13	SIERRA 1500 WT, Standard Cab Pickup, RWD Exc. Classic Models and Electronic Ride	
G57024	D		
R	85-98	VOLKSWAGEN GOLF All	
R	94-98	JETTA 1.8L 4Cyl L (109)	
R	94-98	JETTA 1.9L 4Cyl L (116)	
R	94-98	JETTA 2.0L 4Cyl L (121)	
R	85-93	JETTA All	
G57025	C		
R	99-00	CHRYSLER CIRRUS All	
R	99-00	DODGE STRATUS All	
R	99-00	PLYMOUTH BREEZE All	
G57026	A		
R	01-06	CHRYSLER SEBRING JR (MfrBodyCode), Sedan	
R	01-06	DODGE STRATUS Sedan	
G57027	A		
F	01-07	TOYOTA SEQUOIA All	
F	00-06	TUNDRA All	
G57030	A		
F	02-06	NISSAN ALTIMA All Left	
F	04-08	MAXIMA All Left	
G57031	A		
F	02-06	NISSAN ALTIMA All Right	
F	04-08	MAXIMA All Right	
G57032	C		
R	01-02	HONDA CIVIC All Left	
G57033	C		
R	01-02	HONDA CIVIC All Right	
G57034	B		
F	04-06	NISSAN SENTRA Base Left	
F	04-06	SENTRA S Left	
F	02-06	SENTRA GXE Left	
F	02-06	SENTRA GXE Sport Left	
F	02-06	SENTRA XE Left	
F	06	SENTRA XE SE Edicion Especial Left	
F	06	SENTRA XE SE Left	
F	03-04	SENTRA LE Left	
F	03	SENTRA Limited Edition Left	
F	02	SENTRA CA Left	
G57035	B		
F	04-06	NISSAN SENTRA Base Right	
F	04-06	SENTRA GXE Right	
F	04-06	SENTRA S Right	
F	02-06	SENTRA GXE Sport Right	
F	02-06	SENTRA XE Right	
F	06	SENTRA XE SE Edicion Especial Right	
F	03-04	SENTRA LE Right	
F	03	SENTRA Limited Edition Right	
F	02	SENTRA CA Right	

Numerical listing

Shock	POP	Alternative No.	MTG Acc. Supplied
Pos.	Year	Application	
G57036	A		
R	02-06	NISSAN SENTRA All	
G57037	B		
F	99	INFINITI QX4 All Left	
F	98	QX4 All Left Mfg. to 11/98	
F	97	QX4 All Left	
F	99	NISSAN PATHFINDER All Left	
F	98	PATHFINDER All Left Mfg. to 11/98	
F	96-97	PATHFINDER All Left	
G57038	B		
F	99	INFINITI QX4 All Right	
F	98	QX4 All Right Mfg. to 11/98	
F	97	QX4 All Right	
F	99	NISSAN PATHFINDER All Right	
F	98	PATHFINDER All Right Mfg. to 11/98	
F	96-97	PATHFINDER All Right	
G57039	A		
F	07-10	VOLKSWAGEN BEETLE GAS	
F	98-06	BEETLE All	
F	99-06	GOLF All	
F	99-05	JETTA All	
G57040	A		
F	93-97	VOLVO 850 All Exc. Hydraulic Self Leveling System	
F	98-04	C70 All	
F	98-00	S70 All	
F	99-00	V70 R AWD Mfg. to 3/00 and Exc. XC70, XC Cross Country	
F	98-00	V70 Base Mfg. to 3/00 and Exc. XC70, XC Cross Country	
F	98-00	V70 GLT Mfg. to 3/00 and Exc. XC70, XC Cross Country	
F	98-00	V70 T5 Mfg. to 3/00 and Exc. XC70, XC Cross Country	
F	00	V70 2.4T Mfg. to 3/00 and Exc. XC70, XC Cross Country	
F	00	V70 GLT SE Mfg. to 3/00 and Exc. XC70, XC Cross Country	
F	98-99	V70 AWD Mfg. to 3/00 and Exc. XC70, XC Cross Country	
F	98	V70 R Mfg. to 3/00 and Exc. XC70, XC Cross Country	
G57041	B		
F	02-03	LEXUS ES300 All Left	
F	02-03	TOYOTA CAMRY All Left	
G57042	A		
F	02-03	LEXUS ES300 All Right	
F	02-03	TOYOTA CAMRY All Right	
G57043	B		
R	02-03	LEXUS ES300 All Left	
R	02-03	TOYOTA CAMRY All Left	
G57044	B		
R	02-03	LEXUS ES300 All Right	
R	02-03	TOYOTA CAMRY All Right	
G57045	A		
F	01-12	FORD ESCAPE All Left	
F	08-11	MAZDA TRIBUTE All Left	
F	01-06	TRIBUTE All Left	
F	05-11	MERCURY MARINER All Left	
G57046	A		
F	01-12	FORD ESCAPE All Right	
F	08-11	MAZDA TRIBUTE All Right	
F	01-06	TRIBUTE All Right	
F	05-11	MERCURY MARINER All Right	
G57047	A		
F	05-10	CHEVROLET COBALT LS Left	
F	05-10	COBALT LT Left	
F	10	COBALT Base Left	
F	10	COBALT LT Team Canada Left	
F	06-07	COBALT LTZ Left	
F	05	COBALT Base Left	
F	08-10	HHR LS Panel Left	
F	08-10	HHR LT Panel Left	
F	06-10	HHR LS Left	
F	06-10	HHR LT Left	
F	06-08	HHR Comfort LT Left	
F	06-08	HHR Elegance LT Left	
F	07	HHR Edicion Especial Left	
F	07-09	PONTIAC G5 All Left	
F	05-06	PURSUIT All Left	
G57048	A		
F	05-10	CHEVROLET COBALT LS Right	
F	05-10	COBALT LT Right	
F	10	COBALT Base Right	

Numerical listing

Shock	POP	Alternative No.	MTG Acc. Supplied
Pos.	Year	Application	
G57048 A -continued			
F	10	COBALT	LT Team Canada Right
F	06-07	COBALT	LTZ Right
F	05	COBALT	Base Right
F	11	HHR	All Right
F	08-10	HHR	LS Panel Right
F	08-10	HHR	LT Panel Right
F	06-10	HHR	LS Right
F	06-10	HHR	LT Right
F	06-08	HHR	Comfort LT Right
F	06-08	HHR	Elegance LT Right
F	07	HHR	Edicion Especial Right
F	07-09	PONTIAC	G5 All Right
F	05-06	PURSUIT	All Right
G57049 A			
F	01-05	HONDA	CIVIC Coupe Left
F	01-05	CIVIC	Sedan Left
G57050 A			
F	01-05	HONDA	CIVIC Coupe Right
F	01-05	CIVIC	Sedan Right
G57051 A			
F	00-05	BUICK	LESABRE All Exc. Electronic Adjustable Suspension
F	00-05	CADILLAC	DEVILLE All Exc. Electronic Adjustable Suspension
F	98-04	SEVILLE	All Exc. Electronic Adjustable Suspension
F	01-03	OLDSMOBILE	AURORA All Exc. Electronic Adjustable Suspension
F	98-99	AURORA	All Exc. Electronic Adjustable Suspension
F	00-05	PONTIAC	BONNEVILLE All Exc. Electronic Adjustable Suspension
G57052 B			
R	96-00	FORD	CONTOUR Base
R	96-00	CONTOUR	Power
R	95-00	CONTOUR	LX
R	95-00	CONTOUR	SE
R	96-98	CONTOUR	Sport
R	95-98	CONTOUR	GL
R	99-01	MERCURY	COUGAR All
R	95-00	MYSTIQUE	All
G57053 A			
F	06-08	DODGE	PICKUP 1/2 TON, RAM 1500 (SEE RAM 1500) 4WD Exc. Mega Cab
G57054 C			
F	04-07	HONDA	ACCORD 2.4L 4Cyl L (144) Left
F	03-07	ACCORD	2.4L 4Cyl L (2354) Left
G57055 C			
F	04-07	HONDA	ACCORD 2.4L 4Cyl L (144) Right
F	03-07	ACCORD	2.4L 4Cyl L (2354) Right
G57056 C			
R	04-08	ACURA	TL All
R	06-07	HONDA	ACCORD Value Package
R	05-07	ACCORD	EX
R	05-07	ACCORD	LX
R	07	ACCORD	LX SE
R	07	ACCORD	Special Edition
R	06	ACCORD	LX Special Edition
R	05	ACCORD	DX
R	05	ACCORD	SE
R	03-04	ACCORD	All
G57057 C			
R	96-99	INFINITI	I30 All Left
R	95-99	NISSAN	MAXIMA All Left
G57058 C			
R	96-99	INFINITI	I30 All Right
R	95-99	NISSAN	MAXIMA All Right
G57059 B			
F	00-05	HYUNDAI	SONATA All
G57060 A			
F	05-09	BUICK	ALLURE All
F	97-05	CENTURY	All
F	05-09	LACROSSE	All
F	97-04	REGAL	All
F	00-16	CHEVROLET	IMPALA All
F	00-07	MONTE CARLO	All
F	02-05	VENTURE	All
F	97-01	VENTURE	FWD
F	98-02	OLDSMOBILE	INTRIGUE All
F	97-04	SILHOUETTE	All
F	97-03	PONTIAC	GRAND PRIX All

Ultra ReadyMount

Shock	POP	Alternative No.	MTG Acc. Supplied
Pos.	Year	Application	
G57060 A -continued			
F	99-05	MONTANA	Base
F	97-98	TRANS SPORT	All
G57061 C			
R	03-05	HONDA	CIVIC All Left
G57062 C			
R	03-05	HONDA	CIVIC All Right
G57063 N			
F	00-05	FORD	FOCUS All Left
G57064 N			
F	00-05	FORD	FOCUS All Right
G57065 C			
F	96-02	TOYOTA	4RUNNER All Left
G57066 C			
F	96-02	TOYOTA	4RUNNER All Right
G57067 B			
R	03-08	PONTIAC	VIBE FWD Left
R	03-08	TOYOTA	COROLLA All Left
R	03-08	MATRIX	FWD Left
G57068 B			
R	03-08	PONTIAC	VIBE FWD Right
R	03-08	TOYOTA	COROLLA All Right
R	03-08	MATRIX	FWD Right
G57069 A			
F	11-12	CHEVROLET	MALIBU LS Left
F	11-12	MALIBU	LT Left
F	11-12	MALIBU	LTZ Left
F	08-10	MALIBU	LS, 3.5L 6Cyl V (213) Left
F	08-10	MALIBU	LTZ, 3.6L 6Cyl V (217) Left
F	10	MALIBU	LT, 3.6L 6Cyl V (217) Left
F	09	MALIBU	LT, 3.5L 6Cyl V (213) Left
F	04-08	MALIBU	Base Left
F	08	MALIBU	Classic LS, 3.5L 6Cyl V (213) Left
F	08	MALIBU	Classic LT Left
F	08	MALIBU	LT, 3.6L 6Cyl V (217) Left
F	06-07	MALIBU	LTZ Left
F	06-07	MALIBU	SS Left
F	04-07	MALIBU	LS Left
F	04-07	MALIBU	LT Left
F	04-07	MALIBU	Maxx LS Left
F	04-07	MALIBU	Maxx LT Left
F	04	MALIBU	Maxx Left
F	05-10	PONTIAC	G6 Sedan, 3.5L 6Cyl V (213) Left
F	07-09	G6	Coupe, 3.5L 6Cyl V (213) Left
F	07-09	G6	Coupe, 3.6L 6Cyl V (217) Left
F	07-09	G6	Sedan, 3.6L 6Cyl V (217) Left
F	06-09	G6	Coupe, 3.9L 6Cyl V (237) Left
F	06	G6	Coupe, 3.5L 6Cyl V (214) Left
F	06	G6	Sedan, 3.5L 6Cyl V (214) Left
F	05	G6	Sedan, 3.5L 6Cyl V (211) Left
F	07-09	SATURN	AURA XR, 3.6L 6Cyl V (217) Left
F	07-08	AURA	XE, 3.5L 6Cyl V (213) Left
G57070 A			
F	10-12	CHEVROLET	MALIBU LT, 3.6L 6Cyl V (217) Right
F	08-12	MALIBU	LTZ, 3.6L 6Cyl V (217) Right
F	08-10	MALIBU	LS, 3.5L 6Cyl V (213) Right
F	09	MALIBU	LT, 3.5L 6Cyl V (213) Right
F	04-08	MALIBU	Base Right
F	08	MALIBU	Classic LS Right
F	08	MALIBU	Classic LT Right
F	08	MALIBU	LT, 3.6L 6Cyl V (217) Right
F	06-07	MALIBU	LTZ Right
F	06-07	MALIBU	Maxx LTZ Right
F	06-07	MALIBU	SS Right
F	04-07	MALIBU	LS Right
F	04-07	MALIBU	LT Right
F	04-07	MALIBU	Maxx LS Right
F	04-07	MALIBU	Maxx LT Right
F	04	MALIBU	Maxx Right
F	05-10	PONTIAC	G6 Sedan, 3.5L 6Cyl V (213) Right
F	07-09	G6	Coupe, 3.5L 6Cyl V (213) Right
F	07-09	G6	Coupe, 3.6L 6Cyl V (217) Right
F	07-09	G6	Sedan, 3.6L 6Cyl V (217) Right
F	06-09	G6	Coupe, 3.9L 6Cyl V (237) Right
F	06	G6	Coupe, 3.5L 6Cyl V (214) Right
F	06	G6	Sedan, 3.5L 6Cyl V (214) Right
F	05	G6	Sedan, 3.5L 6Cyl V (211) Right
F	07-09	SATURN	AURA XR, 3.6L 6Cyl V (217) Right
F	07-08	AURA	XE, 3.5L 6Cyl V (213) Right

Numerical listing

Shock	POP	Alternative No.	MTG Acc. Supplied
Pos.	Year	Application	
G57071 B			
F	05-10	CHRYSLER	300 RWD, 5.7L 8Cyl V (345) Left
F	06-10	DODGE	CHARGER RWD, 5.7L 8Cyl V (345) Left
F	05-08	MAGNUM	RWD, 5.7L 8Cyl V (345) Left
G57072 B			
F	05-10	CHRYSLER	300 RWD, 5.7L 8Cyl V (345) Right
F	06-10	DODGE	CHARGER RWD, 5.7L 8Cyl V (345) Right
F	05-08	MAGNUM	RWD, 5.7L 8Cyl V (345) Right
G57073 C			
F	01-05	CHRYSLER	SEBRING ST (MfrBodyCode), Coupe Left
F	01-05	DODGE	STRATUS Coupe Left
G57074 C			
F	01-05	CHRYSLER	SEBRING ST (MfrBodyCode), Coupe Right
F	01-05	DODGE	STRATUS Coupe Right
G57075 A			
R	01-05	CHRYSLER	SEBRING ST (MfrBodyCode), Coupe
R	01-05	DODGE	STRATUS Coupe
R	99-03	MITSUBISHI	GALANT GTZ
G57076 C			
F	04-06	TOYOTA	CAMRY 2.4L 4Cyl L (2362) Left
F	04-05	CAMRY	2.4L 4Cyl L (144) Left
F	04-08	SOLARA	2.4L 4Cyl L (2362) Left
G57077 C			
F	04-06	TOYOTA	CAMRY 2.4L 4Cyl L (2362) Right
F	04-05	CAMRY	2.4L 4Cyl L (144) Right
F	04-08	SOLARA	2.4L 4Cyl L (2362) Right
G57078 B			
R	04-06	LEXUS	ES330 All Left
R	04-06	TOYOTA	CAMRY All Left
R	04-06	SOLARA	All Left
G57079 B			
R	04-06	LEXUS	ES330 All Right
R	04-06	TOYOTA	CAMRY All Right
R	04-06	SOLARA	All Right
G57080 B			
F	10-11	FORD	CROWN VICTORIA Base
F	03-11	CROWN	VICTORIA LX
F	03-08	CROWN	VICTORIA Base
F	06	CROWN	VICTORIA LX Sport
F	05	CROWN	VICTORIA S
F	03	CROWN	VICTORIA LWB
F	03	CROWN	VICTORIA S
F	03-11	LINCOLN	TOWN CAR All Exc. Limo
F	03-11	MERCURY	GRAND MARQUIS All
G57081 A			
F	06-11	FORD	FOCUS All Left
G57082 A			
F	06-11	FORD	FOCUS All Right
G57083 B			
F	06-10	JEEP	COMMANDER All Exc. Performance
F	06-10	GRAND CHEROKEE	4WD, 6.1L 8Cyl V (370)
F	05-10	GRAND CHEROKEE	4WD, 4.7L 8Cyl V (285)
F	05-10	GRAND CHEROKEE	4WD, 5.7L 8Cyl V (345)
G57084 B			
F	02-06	HONDA	CR-V Automatic Left
G57085 B			
F	02-06	HONDA	CR-V Automatic Right
G57086 C			
R	02-06	HONDA	CR-V All Left
G57087 C			
R	02-06	HONDA	CR-V All Right
G57088 B			
F	00-06	HYUNDAI	ELANTRA Automatic Left

Numerical listing

Shock	POP	Alternative No.	MTG Acc. Supplied
Pos.	Year	Application	
G57089	B		
F	00-06	HYUNDAI ELANTRA Automatic Right	
G57090	C		
R	00-05	HYUNDAI SONATA All Left	
R	01-06	KIA MAGENTIS All Left	
R	01-06	OPTIMA All Left	
G57091	B		
R	00-05	HYUNDAI SONATA All Right	
R	01-06	KIA MAGENTIS All Right	
R	01-06	OPTIMA All Right	
G57092	A		
F	04-10	INFINITI QX56 4WD	
F	10-15	NISSAN ARMADA 4WD Exc. Auto-Leveling System	
F	05-09	ARMADA 4WD	
F	04-15	TITAN 4WD Exc. Offroad Package	
G57093	A		
F	10-13	MAZDA 3 Grand Touring Left	
F	10-13	3 I Touring Left	
F	08-13	3 GT Left	
F	08-13	3 GX Left	
F	04-13	3 i Left	
F	04-13	3 S Left	
F	13	3 GS-SKY Left	
F	08-12	3 GS Left	
F	11	3 Sport GS Left	
F	11	3 Sport GT Left	
F	11	3 Sport GX Left	
F	05	3 SP23 Left	
F	06-10	5 All Left	
G57094	A		
F	10-13	MAZDA 3 I Touring Right	
F	08-13	3 GT Right	
F	08-13	3 GX Right	
F	04-13	3 i Right	
F	04-13	3 S Right	
F	13	3 Grand Touring Right	
F	13	3 GS-SKY Right	
F	08-12	3 GS Right	
F	11	3 Sport GS Right	
F	11	3 Sport GT Right	
F	05	3 SP23 Right	
F	06-10	5 All Right	
G57095	C		
F	06-10	FORD EXPLORER All	
F	06-10	MERCURY MOUNTAINEER All	
G57096	C		
R	06-10	FORD EXPLORER All	
R	06-10	MERCURY MOUNTAINEER All	
G57097	B		
F	03	TOYOTA SIENNA All Left	
F	02	SIENNA All Left Mfg. to 12/02	
F	98-01	SIENNA All Left	
G57098	B		
F	03	TOYOTA SIENNA All Right	
F	02	SIENNA All Right Mfg. to 12/02	
F	98-01	SIENNA All Right	
G57099	B		
F	03-07	SATURN ION All Left	
G57100	B		
F	03-07	SATURN ION All Right	
G57101	B		
F	02-07	SATURN VUE 2.2L 4Cyl L (134) Left	
G57102	B		
F	02-07	SATURN VUE 2.2L 4Cyl L (134) Right	
G57103	A		
F	09-13	FORD PICKUP 1/2 TON, F-150 Extended Cab Pickup, 4WD Exc. Sport Suspensions	
G57104	B		
R	97-01	HONDA CR-V All	
G57105	B		
F	00-05	TOYOTA RAV4 AWD, Automatic Left Mfg. from 5/00	
G57106	B		
F	00-05	TOYOTA RAV4 AWD, Automatic Right Mfg. from 5/00	

Ultra ReadyMount

Shock	POP	Alternative No.	MTG Acc. Supplied
Pos.	Year	Application	
G57107	A		
F	93-02	CHEVROLET CAMARO All Left	
F	93-02	PONTIAC FIREBIRD All Left	
G57108	A		
F	93-02	CHEVROLET CAMARO All Right	
F	93-02	PONTIAC FIREBIRD All Right	
G57109	A		
F	08-12	BUICK ENCLAVE All	
F	09-12	CHEVROLET TRAVERSE All	
F	07-12	GMC ACADIA All	
F	07-10	SATURN OUTLOOK All	
G57110	A		
F	05-06	CHEVROLET EQUINOX All Left	
F	06	PONTIAC TORRENT All Left	
G57111	A		
F	05-06	CHEVROLET EQUINOX All Right	
F	06	PONTIAC TORRENT All Right	
G57112	B		
F	04-08	CHRYSLER PACIFICA All Left	
G57113	B		
F	04-08	CHRYSLER PACIFICA All Right	
G57114	B		
F	03-08	TOYOTA COROLLA All Left	
G57115	B		
F	03-08	TOYOTA COROLLA All Right	
G57116	C		
F	97-01	HONDA CR-V All Left	
G57117	B		
F	97-01	HONDA CR-V All Right	
G57118	A		
F	05-11	NISSAN PATHFINDER 4WD, 4.0L 6Cyl V (3954)	
G57119	A		
F	01-02	ACURA MDX All Left	
F	03-08	HONDA PILOT AWD Left	
G57120	A		
F	01-02	ACURA MDX All Right	
F	03-08	HONDA PILOT AWD Right	
G57121	A		
F	08-10	CHEVROLET MALIBU LS, 2.4L 4Cyl L (145) Left	
F	08-10	MALIBU LT, 2.4L 4Cyl L (145) Left	
F	08-10	MALIBU LTZ, 2.4L 4Cyl L (145) Left	
F	09	MALIBU Base, 2.4L 4Cyl L (145) Left	
F	06-10	PONTIAC G6 2.4L 4Cyl L (145) Left	
F	08-09	SATURN AURA XE, 2.4L 4Cyl L (145) Left	
F	09	AURA XR, 2.4L 4Cyl L (145) Left	
F	07-08	AURA Green Line Left	
G57122	A		
F	08-10	CHEVROLET MALIBU LS, 2.4L 4Cyl L (145) Right	
F	08-10	MALIBU LT, 2.4L 4Cyl L (145) Right	
F	08-10	MALIBU LTZ, 2.4L 4Cyl L (145) Right	
F	06-10	PONTIAC G6 2.4L 4Cyl L (145) Right	
F	08-09	SATURN AURA XE, 2.4L 4Cyl L (145) Right	
F	09	AURA XR, 2.4L 4Cyl L (145) Right	
F	07-08	AURA Green Line Right	
G57123	N		
F	07-16	TOYOTA TUNDRA Crew Cab Pickup, RWD Left Exc. Offroad and Long bed	
F	07-16	TUNDRA Standard Cab Pickup, RWD Left Exc. Offroad and Long bed	
G57124	N		
F	14-16	TOYOTA TUNDRA Standard Cab Pickup, RWD Right	
F	07-16	TUNDRA Crew Cab Pickup, RWD Right Exc. Offroad and Long bed	
F	07-13	TUNDRA Standard Cab Pickup, RWD Right Exc. Offroad and Long bed	
G57125	A		
F	07-13	CHEVROLET AVALANCHE 1500 All Exc. Z55 or ZW7 Ride Suspension	

Numerical listing

Shock	POP	Alternative No.	MTG Acc. Supplied
Pos.	Year	Application	
G57125	A	-continued	
F	07-13	SUBURBAN 1/2 TON, 1500 All Exc. Z55 or ZW7 Ride Suspension	
F	07-14	TAHOE All Exc. Z55 or ZW7 Ride Suspension	
F	07-13	GMC YUKON All Exc. Z55 or ZW7 Ride Suspension	
F	07-14	YUKON XL 1/2 TON All Exc. Z55 or ZW7 Ride Suspension	
G57126	A		
F	04-08	SUZUKI FORENZA All Left	
F	05-08	RENO All Left	
G57127	A		
F	04-08	SUZUKI FORENZA All Right	
F	05-08	RENO All Right	
G57128	A		
R	04-08	SUZUKI FORENZA All Left	
R	05-08	RENO All Left	
G57129	A		
R	04-08	SUZUKI FORENZA All Right	
R	05-08	RENO All Right	
G57130	A		
F	06-11	CHEVROLET AVEO All Left	
F	04-11	AVEO All Left	
F	09-10	PONTIAC G3 All Left	
F	05-08	WAVE All Left	
F	04-09	SUZUKI SWIFT All Left	
G57131	A		
F	06-11	CHEVROLET AVEO All Right	
F	04-11	AVEO All Right	
F	09-10	PONTIAC G3 All Right	
F	05-08	WAVE All Right	
F	04-09	SUZUKI SWIFT All Right	
G57132	A		
F	11-13	FORD PICKUP 1/2 TON, F-150 Extended Cab Pickup, RWD	
F	09-13	PICKUP 1/2 TON, F-150 Crew Cab Pickup, RWD	
F	09-10	PICKUP 1/2 TON, F-150 Extended Cab Pickup, RWD, 4.6L 8Cyl V (281)	
G57133	N		
F	03-16	TOYOTA 4RUNNER All Left	
F	07-12	FJ CRUISER All Left	
F	05-12	TACOMA All Left	
G57134	N		
F	03-16	TOYOTA 4RUNNER All Right	
F	07-12	FJ CRUISER All Right	
F	05-12	TACOMA All Right	
G57135	A		
F	00-04	AUDI A6 All Left	
F	00-04	A6 QUATTRO All Left	
F	01-05	VOLKSWAGEN PASSAT All Left	
G57136	A		
F	00-04	AUDI A6 All Right	
F	00-04	A6 QUATTRO All Right	
F	01-05	VOLKSWAGEN PASSAT All Right	
G57137	A		
F	05-07	HONDA ODYSSEY All Left	
G57138	A		
F	05-07	HONDA ODYSSEY All Right	
G57139	A		
F	01-06	HYUNDAI SANTA FE All Left	
G57140	A		
F	01-06	HYUNDAI SANTA FE All Right	
G57141	N		
F	04-08	PONTIAC GRAND PRIX All	
G57142	N		
F	05-07	BUICK TERRAZA FWD	
F	05-09	CHEVROLET UPLANDER FWD	
F	05-09	PONTIAC MONTANA SV6, FWD	
F	05-07	SATURN RELAY 2, FWD	
F	05-07	RELAY 3, FWD	
F	07	RELAY 1, FWD	
G57144	A		
F	02-03	INFINITI QX4 All Left	
F	02-04	NISSAN PATHFINDER All Left	
G57145	A		
F	02-03	INFINITI QX4 All Right	
F	02-04	NISSAN PATHFINDER All Right	

Numerical listing

Shock	POP	Alternative No.	MTG Acc. Supplied
Pos.	Year	Application	
G57146	FF		
F	05-09	DODGE DAKOTA 4WD	
F	06-09	MITSUBISHI RAIDER All	
G57147	N		
F	09-10	DODGE PICKUP 1/2 TON, RAM 1500 (SEE RAM 1500) 4WD	
F	11	RAM 1500 (SEE DODGE RAM 1500) 4WD	
G57148	N		
F	06-09	FORD FUSION All	
G57149	FF		
F	06-11	HYUNDAI AZERA All	
F	06-10	SONATA All	
G57150	FF		
F	04-06	LEXUS RX330 AWD Left	
G57151	FF		
F	04-06	LEXUS RX330 AWD Right	
G57152	FF		
R	04-06	LEXUS RX330 All Left	
G57153	FF		
R	04-06	LEXUS RX330 All Right	
G57156	N		
F	11-12	VOLKSWAGEN JETTA Active, Sedan	
F	11-12	JETTA Sport, Sedan	
F	11-12	JETTA Sportline, Sedan	
F	11-12	JETTA Style, Sedan	
F	09-12	JETTA Comfortline, Sedan	
F	09-12	JETTA Highline, Sedan	
F	09-12	JETTA S, Sedan	
F	09-12	JETTA SE, Sedan	
F	08-12	JETTA SEL, Sedan	
F	08-12	JETTA Trendline, Sedan	
F	06-12	JETTA TDI, Sedan	
F	12	JETTA Comfortline TDI, Sedan	
F	12	JETTA Highline TDI, Sedan	
F	12	JETTA TDI Premium, Sedan	
F	10-11	JETTA Base, Sedan	
F	08-11	JETTA Wagon	
F	11	JETTA Bicentenario, Sedan	
F	11	JETTA TDI Comfortline, Sedan	
F	11	JETTA TDI Highline, Sedan	
F	07-10	JETTA Wolfsburg Edition, Sedan	
F	06-10	JETTA Europa, Sedan	
F	10	JETTA City, Sedan	
F	10	JETTA Clasico, Sedan	
F	10	JETTA TDI Cup Edition, Sedan	
F	06-08	JETTA 2.0T, Sedan	
F	06-08	JETTA 2.5, Sedan	
F	06	JETTA 475 Aniversario, Sedan	
F	06	JETTA Soccer 1, Sedan	
F	06	JETTA Soccer 2, Sedan	
F	06	JETTA Value Edition, Sedan	
F	06	JETTA Wagon	
F	06	JETTA Winter 1, Sedan	
F	06	JETTA Winter 2, Sedan	
F	06-09	PASSAT 2.0T	
G57157	FF		
F	02-03	NISSAN MAXIMA Standard Left	
G57158	FF		
F	02-03	NISSAN MAXIMA Standard Right	
G57159	N		
R	00-03	NISSAN MAXIMA All Left	
G57160	N		
R	00-03	NISSAN MAXIMA All Right	
G57161	N		
F	10-12	NISSAN ALTIMA SR Left	
F	07-12	ALTIMA Base Left	
F	07-12	ALTIMA S Left	
F	07-12	ALTIMA SL Left	
F	08-09	ALTIMA Coupe Left	
F	07-09	ALTIMA SE Left	
G57162	N		
F	10-12	NISSAN ALTIMA SR Right	
F	07-12	ALTIMA Base Right	
F	07-12	ALTIMA S Right	
F	07-12	ALTIMA SL Right	
F	08-09	ALTIMA Coupe Right	
F	07-09	ALTIMA SE Right	
G57163	N		
F	03-07	NISSAN MURANO All Left	

Ultra ReadyMount

Shock	POP	Alternative No.	MTG Acc. Supplied
Pos.	Year	Application	
G57164	N		
F	03-07	NISSAN MURANO All Right	
G57165	N		
F	00-01	NISSAN MAXIMA Standard Left	
G57166	N		
F	00-01	NISSAN MAXIMA Standard Right	
G57167	N		
R	00-06	HYUNDAI ELANTRA All Left	
G57168	N		
R	00-06	HYUNDAI ELANTRA All Right	
G57171	FF		
F	01-06	VOLVO S60 FWD	
F	99-03	S80 All	
F	00-07	V70 All	
G57172	N		
F	07-13	FORD EXPEDITION All	
F	10-13	LINCOLN NAVIGATOR All	
G57173	N		
R	15-16	FORD EXPEDITION 4WD Exc. Air Suspension	
R	15-16	EXPEDITION RWD Exc. Suspension de Aire	
R	10-14	EXPEDITION All Exc. Air Suspension	
R	07-09	EXPEDITION All	
R	10-16	LINCOLN NAVIGATOR 4WD Exc. Air Suspension	
R	10-16	NAVIGATOR RWD Exc. Air Suspension	
G57176	N		
F	07-12	DODGE CALIBER All Left	
G57177	N		
F	07-12	DODGE CALIBER All Right	
G57178	N		
R	07-12	DODGE CALIBER All	
G57182	FF		
F	03-06	PONTIAC VIBE AWD Right	
F	03-06	TOYOTA MATRIX AWD Right	
G57183	FF		
F	03-06	PONTIAC VIBE AWD Left	
F	03-06	TOYOTA MATRIX AWD Left	
G57184	FF		
F	04-09	NISSAN QUEST All Left	
G57185	FF		
F	04-09	NISSAN QUEST All Right	
G57190	FF		
F	07-11	LEXUS ES350 All Left	
F	07-11	TOYOTA CAMRY All Left	
G57191	FF		
F	07-11	LEXUS ES350 All Right	
F	07-11	TOYOTA CAMRY All Right	
G57192	FF		
R	06-11	TOYOTA AVALON All Left	
R	07-11	CAMRY All Left	
G57193	FF		
R	06-11	TOYOTA AVALON All Right	
R	07-11	CAMRY All Right	
G57197	FF		
F	07-12	CHEVROLET EQUINOX All Left Exc. 19" Wheels	
F	10-12	GMC TERRAIN All Left Exc. 19" Wheels	
F	07-09	PONTIAC TORRENT All Left 19" Wheels	
F	08-10	SATURN VUE All Left 19" Wheels	
F	07-09	SUZUKI XL-7 All Left 19" Wheels	
G57198	FF		
F	07-12	CHEVROLET EQUINOX All Right Exc. 19" Wheels	
F	10-12	GMC TERRAIN All Right Exc. 19" Wheels	
F	07-09	PONTIAC TORRENT All Right 19" Wheels	
F	08-10	SATURN VUE All Right 19" Wheels	
F	07-09	SUZUKI XL-7 All Right 19" Wheels	
G57200	FF		
F	11-12	NISSAN SENTRA Elite Left	

Numerical listing

Shock	POP	Alternative No.	MTG Acc. Supplied
Pos.	Year	Application	
G57200	FF -continued		
F	09-12	SENTRA SR Left	
F	07-12	SENTRA Base Left	
F	07-12	SENTRA Custom Left	
F	07-12	SENTRA Emotion Left	
F	07-12	SENTRA S Left	
F	07-12	SENTRA SL Left	
F	08-10	SENTRA Luxury Left	
F	08-10	SENTRA Premium Left	
G57201	FF		
F	11-12	NISSAN SENTRA Elite Right	
F	09-12	SENTRA SR Right	
F	07-12	SENTRA Base Right	
F	07-12	SENTRA Custom Right	
F	07-12	SENTRA Emotion Right	
F	07-12	SENTRA S Right	
F	07-12	SENTRA SL Right	
F	08-10	SENTRA Luxury Right	
F	08-10	SENTRA Premium Right	
G57202	N		
F	09-14	NISSAN CUBE All Left	
F	09-11	VERSA S Left	
F	09-11	VERSA SL Left	
F	07-08	VERSA All Left	
G57203	N		
F	09-14	NISSAN CUBE All Right	
F	09-11	VERSA S Right	
F	09-11	VERSA SL Right	
F	07-08	VERSA All Right	
G57204	N		
F	06-08	TOYOTA RAV4 All Left	
G57205	N		
F	06-08	TOYOTA RAV4 All Right	
G57206	FF		
F	08-10	CHRYSLER TOWN & COUNTRY All	
F	08-10	DODGE CARAVAN / GRAND CARAVAN All	
F	09-10	VOLKSWAGEN ROUTAN All	
G57207	N		
F	08-12	HONDA ACCORD Automatic Left	
G57208	N		
F	08-12	HONDA ACCORD Automatic Right	
G57210	FF		
F	10-12	NISSAN ALTIMA 2.5L 4Cyl L (152) Left	
F	10-12	ALTIMA 2.5L 4Cyl L (2500) Left	
G57211	FF		
F	10-12	NISSAN ALTIMA 2.5L 4Cyl L (152) Right	
F	10-12	ALTIMA 2.5L 4Cyl L (2500) Right	
G57212	FF		
F	03-06	FORD EXPEDITION RWD	
G57218	FF		
F	05-09	HYUNDAI TUCSON All Left	
F	05-10	KIA SPORTAGE All Left	
G57219	FF		
F	05-09	HYUNDAI TUCSON All Right	
F	05-10	KIA SPORTAGE All Right	
G57220	FF		
F	07-12	TOYOTA TUNDRA All Left	
G57221	FF		
F	07-12	TOYOTA TUNDRA All Right	
G57222	FF		
F	03-06	HONDA ELEMENT All Left	
G57223	FF		
F	03-06	HONDA ELEMENT All Right	
G57227	FF		
F	05-15	NISSAN PATHFINDER All	
F	05-15	XTERRA RWD	
G57266	FF		
F	09-13	DODGE JOURNEY All Left	
G57268	FF		
F	00-05	HYUNDAI ACCENT All Left	
G57269	FF		
F	00-05	HYUNDAI ACCENT All Right	

Numerical listing

Shock	POP	Alternative No.	MTG Acc. Supplied
Pos.	Year	Application	
G57270	FF		
F	03-08	MAZDA 6 All	
G57271	FF		
F	05-10	FORD MUSTANG / MUSTANG II All	
G57272	FF		
F	00-03	MAZDA PROTÉGÉ / PROTÉGÉ5 All Right	
G57273	FF		
F	00-03	MAZDA PROTÉGÉ / PROTÉGÉ5 All Left	
G57274	FF		
F	02-07	BUICK RENDEZVOUS All	
F	01-05	PONTIAC AZTEK All	
G57275	FF		
F	06-11	HYUNDAI ACCENT All Left	
F	06-11	KIA RIO All Left	
G57276	FF		
F	06-11	HYUNDAI ACCENT All Right	
F	06-11	KIA RIO All Right	
G57277	FF		
F	12-13	VOLKSWAGEN BEETLE All	
F	07-11	EOS All	
F	10-12	GOLF All	
F	05-12	JETTA All	
G57278	FF		
R	00-05	HYUNDAI ACCENT All Left	
G57279	FF		
R	00-05	HYUNDAI ACCENT All Right	
G57280	FF		
F	98-02	SUBARU FORESTER Standard Right	
G57281	FF		
F	98-02	SUBARU FORESTER Standard Left	
G57282	FF		
F	04-11	CHEVROLET COLORADO All	
F	04-11	GMC CANYON All	
G57284	FF		
F	01-03	ACURA CL All	
F	99-03	TL All	
F	98-02	HONDA ACCORD All	
G57311	FF		
F	02-07	SATURN VUE All Left	
G57312	FF		
F	02-07	SATURN VUE All Right	
G57313	FF		
R	97-01	HONDA CR-V All	
G57314	FF		
F	08-11	BUICK ENCLAVE All	
F	09-11	CHEVROLET TRAVERSE All	
F	07-11	GMC ACADIA All	
F	07-10	SATURN OUTLOOK All	
G57315	FF		
F	97-01	HONDA CR-V All Left	
G57316	FF		
F	97-01	HONDA CR-V All Right	
G57322	FF		
F	07-12	CHEVROLET EQUINOX All Left 19" Wheels	
F	10-12	GMC TERRAIN All Left 19" Wheels	
F	07-09	PONTIAC TORRENT All Left Exc. 19" Wheels	
F	08-10	SATURN VUE All Left Exc. 19" Wheels	
F	07-09	SUZUKI XL-7 All Left Exc. 19" Wheels	
G57323	FF		
F	07-12	CHEVROLET EQUINOX All Right 19" Wheels	
F	10-12	GMC TERRAIN All Right 19" Wheels	
F	07-09	PONTIAC TORRENT All Right Exc. 19" Wheels	
F	08-10	SATURN VUE All Right Exc. 19" Wheels	
F	07-09	SUZUKI XL-7 All Right Exc. 19" Wheels	

Ultra ReadyMount

Shock	POP	Alternative No.	MTG Acc. Supplied
Pos.	Year	Application	
G57324	FF		
F	06-11	BUICK LUCERNE All	
F	06-11	CADILLAC DTS All	
G57327	FF		
F	83-89	BUICK SKYHAWK All Left	
F	86-91	SKYLARK All Left	
F	85	SOMERSET / SOMERSET REGAL All Left	
F	83-88	CADILLAC CIMARRON All Left	
F	83-91	CHEVROLET CAVALIER All Left	
F	85-87	OLDSMOBILE CALAIS All Left	
F	88-91	CUTLASS CALAIS All Left	
F	83-88	FIRENZA All Left	
F	85-91	PONTIAC GRAND AM All Left	
F	83-85	J2000 / SUNBIRD All Left	
F	86-91	SUNBIRD All Left	
G57328	FF		
F	83-89	BUICK SKYHAWK All Right	
F	86-91	SKYLARK All Right	
F	85	SOMERSET / SOMERSET REGAL All Right	
F	83-88	CADILLAC CIMARRON All Right	
F	83-91	CHEVROLET CAVALIER All Right	
F	85-87	OLDSMOBILE CALAIS All Right	
F	88-91	CUTLASS CALAIS All Right	
F	83-88	FIRENZA All Right	
F	85-91	PONTIAC GRAND AM All Right	
F	83-85	J2000 / SUNBIRD All Right	
F	86-91	SUNBIRD All Right	
G57329	FF		
F	09-10	PONTIAC VIBE All Left	
F	09-12	TOYOTA COROLLA All Left	
F	09-13	MATRIX All Left	
G57330	FF		
F	09-10	PONTIAC VIBE All Right	
F	09-12	TOYOTA COROLLA All Right	
F	09-13	MATRIX All Right	
G57331	FF		
F	07-11	HONDA CR-V All Left	
G57332	FF		
F	07-11	HONDA CR-V All Right	
G57333	FF		
F	06-14	HONDA RIDGELINE All Left	
G57334	FF		
F	06-14	HONDA RIDGELINE All Right	
G57335	FF		
F	99-05	VOLVO S80 All Left	
G57336	FF		
F	99-05	VOLVO S80 All Right	
G57337	FF		
F	06-15	VOLVO S80 All Left	
G57338	FF		
F	06-15	VOLVO S80 All Right	
G57339	FF		
F	05-12	SUBARU OUTBACK All Left	
G57340	FF		
F	05-12	SUBARU OUTBACK All Right	
G57341	FF		
F	02-04	SUBARU OUTBACK All Left	
G57342	FF		
F	02-04	SUBARU OUTBACK All Right	
G57343	FF		
R	05-09	HYUNDAI TUCSON All Right	
R	05-10	KIA SPORTAGE All Right	
G57344	FF		
R	05-09	HYUNDAI TUCSON All Left	
R	05-10	KIA SPORTAGE All Left	
G57345	FF		
F	05-09	SUBARU LEGACY All Left	
G57346	FF		
F	05-09	SUBARU LEGACY All Right	
G57349	FF		
F	01-05	TOYOTA RAV4 FWD Right	
G57350	FF		
F	01-05	TOYOTA RAV4 FWD Left	

Numerical listing

Shock	POP	Alternative No.	MTG Acc. Supplied
Pos.	Year	Application	
G57353	FF		
F	07-11	TOYOTA YARIS All Left	
G57354	FF		
F	07-11	TOYOTA YARIS All Right	
G57357	FF		
F	03-08	PONTIAC VIBE FWD Left	
F	03-08	TOYOTA MATRIX FWD Left	
G57358	FF		
F	03-08	PONTIAC VIBE FWD Right	
F	03-08	TOYOTA MATRIX FWD Right	
G57359	FF		
F	08-09	FORD TAURUS X All Left	
G57360	FF		
F	08-09	FORD TAURUS X All Right	
G57361	FF		
F	07-12	MAZDA CX-7 All Left	
G57362	FF		
F	07-12	MAZDA CX-7 All Right	
G57363	FF		
F	08-11	BMW 128i All Left	
F	08-11	135i All Left	
F	06	325i All Left w/o Sport Suspension	
F	07-13	328i All Left	
F	06	330i All Left	
F	07-13	335i All Left	
G57364	FF		
F	08-11	BMW 128i All Right	
F	08-11	135i All Right	
F	06	325i All Right w/o Sport Suspension	
F	07-13	328i All Right	
F	06	330i All Right	
F	07-13	335i All Right	
G57365	FF		
F	00-02	SUBARU LEGACY All Right	
G57366	FF		
F	00-02	SUBARU LEGACY All Left	
G57367	FF		
F	07-11	NISSAN ALTIMA Hybrid Left	
G57368	FF		
F	07-11	NISSAN ALTIMA Hybrid Right	
G57369	FF		
F	05-10	SCION TC All Left	
G57370	FF		
F	05-10	SCION TC All Right	
G57371	FF		
F	06-13	AUDI A3 All	
F	12-13	VOLKSWAGEN BEETLE 2.0L 4Cyl L (121)	
F	13	BEETLE 2.0L 4Cyl L (120)	
F	07-11	EOS 2.0L 4Cyl L (121)	
F	10-12	GOLF 2.0L 4Cyl L (120)	
F	12	GOLF 2.0L 4Cyl L (121)	
G57372	FF		
F	04-06	TOYOTA SIENNA All Right	
G57373	FF		
F	04-06	TOYOTA SIENNA All Left	
G57375	FF		
F	07-10	TOYOTA SIENNA AWD Left 8 Passenger	
G57376	FF		
F	07-10	TOYOTA SIENNA AWD Right 8 Passenger	
G57377	FF		
F	12-15	BUICK VERANO All Left	
F	11-16	CHEVROLET CRUZE All Left	
F	16	CRUZE LIMITED All Left	
G57378	FF		
F	12-15	BUICK VERANO All Right	
F	11-16	CHEVROLET CRUZE All Right	
F	16	CRUZE LIMITED All Right	
G57379	FF		
F	00	BMW 323Ci All Left	
F	00	328Ci All Left	

Numerical listing

Shock	POP	Alternative No.	MTG Acc. Supplied
Pos.	Year	Application	
G57380	FF		
F 00		BMW 323Ci All Right	
F 00		328Ci All Right	
G57381	FF		
F 01-05		BMW 320i All Left	
G57382	FF		
F 02-05		BMW 320i All Right	
G57387	FF		
F 92-94		TOYOTA CAMRY All Left	
G57388	FF		
F 92-94		TOYOTA CAMRY All Right	
G57389	FF		
F 90-96		CHEVROLET LUMINA APV All	
F 90-96		OLDSMOBILE SILHOUETTE All	
F 90-96		PONTIAC TRANS SPORT All	
G57390	FF		
F 05-11		HONDA CIVIC All Left	
G57391	FF		
F 05-11		HONDA CIVIC All Right	
G57392	FF		
F 97-98		VOLKSWAGEN JETTA All	
G57393	FF		
F 07-10		HYUNDAI ELANTRA All Left	
G57394	FF		
F 07-10		HYUNDAI ELANTRA All Right	
G57395	FF		
F 07-12		NISSAN SENTRA SE-R Left	
G57397	FF		
F 00-05		TOYOTA ECHO All	
G57398	FF		
F 03-08		HYUNDAI TIBURON All Left	
G57399	FF		
F 03-08		HYUNDAI TIBURON All Right	
G57400	FF		
F 03-08		HYUNDAI TIBURON All Left	
G57401	FF		
R 03-08		HYUNDAI TIBURON All Right	
G57402	FF		
F 00-05		HYUNDAI ACCENT All Left	
G57403	FF		
F 00-05		HYUNDAI ACCENT All Right	
G57404	FF		
F 04-09		TOYOTA PRIUS All Left	
G57405	FF		
F 04-09		TOYOTA PRIUS All Right	
G57409	FF		
F 05-09		DODGE DAKOTA RWD	
F 06-09		MITSUBISHI RAIDER RWD	
G57413	FF		
F 05-15		NISSAN XTERRA 4WD	
F 09-12		SUZUKI EQUATOR All	
G57414	FF		
R 06-14		HONDA RIDGELINE All Left	
G57415	FF		
R 06-14		HONDA RIDGELINE All Right	
G57416	FF		
R 07-11		HONDA CR-V All	
G57417	FF		
F 08-12		HONDA ACCORD Standard Left	
G57418	FF		
F 08-12		HONDA ACCORD Standard Right	
G57419	FF		
R 08-12		HONDA ACCORD All	
R 10-11		ACCORD CROSSTOUR All	
G57420	FF		
R 90-00		LEXUS LS400 All	
G57421	FF		
F 90-00		LEXUS LS400 All	

Ultra ReadyMount

Shock	POP	Alternative No.	MTG Acc. Supplied
Pos.	Year	Application	
G57422	FF		
R 95-98		CHRYSLER CIRRUS All	
R 01-06		SEBRING Convertible	
R 95-98		DODGE STRATUS All	
R 96-98		PLYMOUTH BREEZE All	
G57423	FF		
R 05-09		SUBARU LEGACY All	
G57424	FF		
R 03-11		HONDA ELEMENT All Left	
G57425	FF		
R 03-11		HONDA ELEMENT All Right	
G57427	FF		
F 10-12		FORD FUSION All	
F 10-12		LINCOLN MKZ All	
F 10-11		MERCURY MILAN All	
G57428	FF		
R 05-10		SCION TC All Left	
G57429	FF		
R 05-10		SCION TC All Right	
G57430	FF		
R 00-02		SUBARU LEGACY All	
G57431	FF		
F 99-00		CHRYSLER CIRRUS 2.4L 4Cyl L (148) Left	
F 99-06		DODGE STRATUS 2.4L 4Cyl L (148) Left	
F 01-05		STRATUS 2.4L 4Cyl L (2351) Left	
F 99-00		PLYMOUTH BREEZE All Left	
G57432	FF		
F 99-00		CHRYSLER CIRRUS 2.4L 4Cyl L (148) Right	
F 99-06		DODGE STRATUS 2.4L 4Cyl L (148) Right	
F 01-05		STRATUS 2.4L 4Cyl L (2351) Right	
F 99-00		PLYMOUTH BREEZE All Right	
G57433	FF		
F 07-10		JEEP GRAND CHEROKEE 3.0L 6Cyl V (182) Left	
F 05-10		GRAND CHEROKEE 3.7L 6Cyl V (226) Left	
G57434	FF		
F 07-10		JEEP GRAND CHEROKEE 3.0L 6Cyl V (182) Right	
F 05-10		GRAND CHEROKEE 3.7L 6Cyl V (226) Right	
G57438	FF		
R 96-98		CHRYSLER SEBRING Coupe	
G57439	FF		
F 01-05		CHRYSLER SEBRING All Right	
G57440	FF		
F 01-05		CHRYSLER SEBRING All Left	
G57441	FF		
R 02-05		ACURA RSX All Right	
G57442	FF		
R 02-05		ACURA RSX All Left	
G57443	FF		
F 06-10		HYUNDAI SONATA All	
G57444	FF		
R 01-03		TOYOTA PRIUS All	
G57445	FF		
F 06-09		MERCURY MILAN FWD	
G57446	FF		
F 07-09		MERCURY MILAN AWD	
G57447	FF		
R 11-14		CHRYSLER 200 Sedan	
G57448	FF		
F 13-16		CHEVROLET PICKUP 1/2 TON, SILVERADO 1500 All	
F 13-16		GMC SIERRA 1500 All	
G57449	FF		
R 08-09		FORD TAURUS All Left	
G57450	FF		
R 08-09		FORD TAURUS All Right	

Numerical listing

Shock	POP	Alternative No.	MTG Acc. Supplied
Pos.	Year	Application	
G57453	FF		
F 08-15		TOYOTA SEQUOIA All Right	
G57454	FF		
F 08-15		TOYOTA SEQUOIA All Left	
G57455	FF		
F 09-15		MAZDA 6 All Left	
G57456	FF		
F 09-15		MAZDA 6 All Right	
G57457	FF		
F 03-06		KIA SORENTO All Left	
G57458	FF		
F 03-06		KIA SORENTO All Right	
G57459	FF		
F 04-05		SUBARU FORESTER All Left Exc. 2.5L	
G57460	FF		
F 04-05		SUBARU FORESTER All Right Exc. 2.5L	
G57461	FF		
F 01-03		TOYOTA PRIUS All Right	
G57462	FF		
F 01-03		TOYOTA PRIUS All Left	
G57463	FF		
F 07-10		JEEP COMPASS All Right	
F 07-10		PATRIOT All Right	
G57464	FF		
F 07-10		JEEP COMPASS All Left	
F 07-10		PATRIOT All Left	
G57465	FF		
F 11-14		CHRYSLER 200 Sedan Left	
G57466	FF		
F 11-14		CHRYSLER 200 Sedan Right	
G57471	FF		
F 07-09		HYUNDAI SANTA FE All Left	
G57472	FF		
F 07-09		HYUNDAI SANTA FE All Right	
G57473	FF		
F 08-10		NISSAN ROGUE All Left	
G57474	FF		
F 08-10		NISSAN ROGUE All Right	
G57477	FF		
F 06-08		SUBARU FORESTER Standard Left	
G57478	FF		
F 06-08		SUBARU FORESTER Standard Right	
G57479	FF		
F 12-14		HONDA CR-V FWD Left	
G57480	FF		
F 12-14		HONDA CR-V FWD Right	
G57481	FF		
F 09-10		TOYOTA HIGHLANDER AWD, 2.7L 4Cyl L (163) Left	
F 08-10		HIGHLANDER 3.3L 6Cyl V (202) Left	
G57482	FF		
F 09-10		TOYOTA HIGHLANDER AWD, 2.7L 4Cyl L (163) Right	
F 08-10		HIGHLANDER AWD, 3.3L 6Cyl V (202) Right	
G57483	FF		
R 08-10		TOYOTA HIGHLANDER FWD Left	
G57484	FF		
R 08-10		TOYOTA HIGHLANDER FWD Right	
G57487	FF		
F 08-10		KIA SEDONA All Left	
G57488	FF		
F 08-10		KIA SEDONA All Right	
G57489	FF		
F 02-05		KIA SEDONA All Left	

Numerical listing

Shock	POP	Alternative No.	MTG Acc. Supplied
Pos.	Year	Application	
G57490	FF		
F	02-05	KIA SEDONA All Right	
G57491	FF		
F	11-14	FORD EDGE All Left	
F	11-14	LINCOLN MKX All Left	
G57492	FF		
F	11-14	FORD EDGE All Right	
F	11-14	LINCOLN MKX All Right	
G57493	FF		
F	09-15	NISSAN MAXIMA All Left	
G57494	FF		
F	09-15	NISSAN MAXIMA All Right	
G57495	FF		
F	09-12	FORD FLEX All Left	
G57496	FF		
F	09-12	FORD FLEX All Right	
G57497	FF		
F	09-12	FORD TAURUS All Left	
G57498	FF		
F	09-12	FORD TAURUS All Right	
G57499	FF		
R	12-13	TOYOTA CAMRY All Left	
G57500	FF		
R	12-13	TOYOTA CAMRY All Right	
G57501	FF		
F	98-99	SUBARU LEGACY All Left FWD	
G57502	FF		
F	98-99	SUBARU LEGACY All Right FWD	
G57503	FF		
R	98-99	SUBARU LEGACY All Left FWD	
G57504	FF		
R	98-99	SUBARU LEGACY All Right FWD	
G57509	FF		
R	02-03	MAZDA PROTÉGÉ / PROTÉGÉ5 All Left	
G57510	FF		
R	02-03	MAZDA PROTÉGÉ / PROTÉGÉ5 All Right	
G57511	FF		
F	98-02	SUBARU FORESTER Automatic Left	
G57512	FF		
F	98-02	SUBARU FORESTER Automatic Right	
G57513	FF		
R	98-02	SUBARU FORESTER All Left	
G57514	FF		
R	98-02	SUBARU FORESTER All Right	
G57515	FF		
F	03-04	SUBARU LEGACY All Left FWD	
G57516	FF		
F	03-04	SUBARU LEGACY All Right FWD	
G57517	FF		
F	13-16	FORD ESCAPE All Left	
G57518	FF		
F	13-16	FORD ESCAPE All Right	
G57519	FF		
F	00-01	NISSAN SENTRA All Left	
G57520	FF		
F	00-01	NISSAN SENTRA All Right	
G57521	FF		
F	03-05	HONDA CIVIC Hybrid Left	
F	03-05	HONDA CIVIC Si Left	
G57522	FF		
F	03-05	HONDA CIVIC Hybrid Right	
F	03-05	HONDA CIVIC Si Right	
G57523	FF		
F	02-05	ACURA RSX All Left	

Ultra ReadyMount

Shock	POP	Alternative No.	MTG Acc. Supplied
Pos.	Year	Application	
G57524	FF		
F	02-05	ACURA RSX All Right	
G57525	FF		
F	00-01	INFINITI I30 All Left	
G57526	FF		
F	00-01	INFINITI I30 All Right	
G57527	FF		
F	02-03	INFINITI I35 All Left	
G57528	FF		
F	02-03	INFINITI I35 All Right	
G57529	FF		
F	04-06	LEXUS ES330 All Left	
G57530	FF		
F	04-06	LEXUS ES330 All Right	
G57531	FF		
F	04-07	TOYOTA HIGHLANDER FWD Left	
G57532	FF		
F	04-07	TOYOTA HIGHLANDER FWD Right	
G57533	FF		
R	04-07	TOYOTA HIGHLANDER FWD Left	
G57534	FF		
R	04-07	TOYOTA HIGHLANDER FWD Right	
G57535	FF		
F	06	PONTIAC TORRENT All Left	
G57536	FF		
F	06	PONTIAC TORRENT All Right	
G57537	FF		
F	12-13	TOYOTA CAMRY All Left	
G57538	FF		
F	12-13	TOYOTA CAMRY All Right	
G57539	FF		
F	06-16	TOYOTA AVALON All Left	
G57540	FF		
F	06-16	TOYOTA AVALON All Right	
G57541	FF		
F	06-08	HONDA FIT All Left	
G57542	FF		
F	06-08	HONDA FIT All Right	
G57543	FF		
F	14-17	TOYOTA COROLLA All Left	
G57544	FF		
F	14-16	TOYOTA COROLLA All Right	
G57545	FF		
F	14-16	NISSAN ALTIMA All Left	
G57546	FF		
F	14-16	NISSAN ALTIMA All Right	
G57549	FF		
F	12-13	CHEVROLET CAPTIVA SPORT All Left	
G57550	FF		
F	12-13	CHEVROLET CAPTIVA SPORT All Right	
G57551	FF		
R	00-01	INFINITI I30 All Left	
R	02-04	I35 All Left	
G57552	FF		
R	00-01	INFINITI I30 All Right	
R	02-04	I35 All Right	
G57553	FF		
R	08-09	FORD TAURUS AWD Left	
G57554	FF		
R	08-09	FORD TAURUS AWD Right	
G57555	FF		
R	07-09	MERCEDES-BENZ GL320 All	
R	10-12	GL450 All	
G57556	FF		
R	96-98	CHRYSLER SEBRING Convertible	

Numerical listing

Shock	POP	Alternative No.	MTG Acc. Supplied
Pos.	Year	Application	
G57557	FF		
F	95-98	HONDA ODYSSEY All	
G57558	FF		
F	00-01	NISSAN ALTIMA All Left	
G57559	FF		
F	00-01	NISSAN ALTIMA All Right	
G57560	FF		
F	07-13	ACURA MDX All Left	
G57561	FF		
F	07-13	ACURA MDX All Right	
G57562	FF		
F	10-14	LEXUS RX350 All Left	
G57563	FF		
F	10-14	LEXUS RX350 All Right	
G57564	FF		
F	08-10	HONDA ODYSSEY All Left	
G57565	FF		
F	08-10	HONDA ODYSSEY All Right	
G57568	FF		
R	04-09	TOYOTA PRIUS All Left	
G57569	FF		
R	04-09	TOYOTA PRIUS All Right	
G57574	FF		
F	07-12	ACURA RDX All Left	
G57575	FF		
F	07-12	ACURA RDX All Right	
G57576	FF		
R	99-03	ACURA TL All	
G57577	FF		
F	11-14	CHRYSLER 200 Convertible Left	
G57578	FF		
F	11-14	CHRYSLER 200 Convertible Right	
G57579	FF		
R	11-14	CHRYSLER 200 Convertible	
G57580	FF		
F	11-14	FORD EDGE AWD, 3.5L 6Cyl V (213) Left	
F	11-14	EDGE AWD, 3.7L 6Cyl V (227) Left	
G57581	FF		
F	12-14	FORD EDGE AWD, 3.5L 6Cyl V (213) Right	
F	11-14	EDGE AWD, 3.7L 6Cyl V (227) Right	
G57582	FF		
F	12-14	FORD EDGE 2.0L 4Cyl L (122) Left 4 Cyl	
F	11	EDGE FWD Left 4 Cyl	
G57583	FF		
F	12-14	FORD EDGE FWD, 2.0L 4Cyl L (122) Right 4 Cyl	
F	11	EDGE FWD Right 4 cYL	
G57584	FF		
F	06-08	LEXUS RX400H All Left	
G57585	FF		
F	06-08	LEXUS RX400H All Right	
G57586	FF		
R	06	LEXUS RX400H FWD Left	
G57587	FF		
R	06	LEXUS RX400H FWD Right	
G57588	FF		
R	07	LEXUS RX400H FWD Left	
G57589	FF		
R	07	LEXUS RX400H FWD Right	
G57590	FF		
R	06	LEXUS RX400H AWD Left	
G57591	FF		
R	06	LEXUS RX400H AWD Right	
G57594	FF		
F	09-13	MAZDA 6 All Left	

Numerical listing

Shock	POP	Alternative No.	MTG Acc. Supplied
Pos.	Year	Application	
G57595	FF		
F	09-13	MAZDA 6 All Right	
G57596	FF		
R	98-03	MERCEDES-BENZ ML320 All	
G57597	FF		
R	12-14	HONDA CR-V FWD Left	
G57598	FF		
R	12-14	HONDA CR-V FWD Right	
G57599	FF		
R	12-14	HONDA CR-V AWD Left	
G57600	FF		
R	12-14	HONDA CR-V AWD Right	
G57601	FF		
F	12-14	HONDA CR-V AWD Left	
G57602	FF		
F	12-14	HONDA CR-V AWD Right	
G57603	FF		
F	09-13	HONDA FIT All Left	
G57604	FF		
F	09-13	HONDA FIT All Right	
G57605	FF		
F	06-08	HONDA PILOT AWD Left	
G57606	FF		
F	06-08	HONDA PILOT FWD Right	
G57607	FF		
R	07-10	JEEP COMPASS All	
R	07-10	PATRIOT All	
G57608	FF		
F	02-05	KIA RIO All Left	
G57609	FF		
F	02-05	KIA RIO Standard Right	
G57610	FF		
F	99-03	LEXUS RX300 All Left	
G57612	FF		
R	99-03	LEXUS RX300 All Left	
G57613	FF		
R	99-03	LEXUS RX300 All Right	
G57614	FF		
F	99-03	LEXUS RX300 AWD Left	
G57615	FF		
F	99-03	LEXUS RX300 AWD Right	
G57616	FF		
F	07-09	LEXUS RX350 FWD Left	
G57617	FF		
F	07-09	LEXUS RX350 FWD Right	
G57618	FF		
R	07-09	LEXUS RX350 FWD Left	
G57619	FF		
R	07-09	LEXUS RX350 FWD Right	
G57622	FF		
F	04-05	SUBARU FORESTER All Left	
G57623	FF		
F	04-05	SUBARU FORESTER All Right	
G57624	FF		
R	03-05	SUBARU FORESTER All Left w/o Sunroof	
G57625	FF		
R	03-05	SUBARU FORESTER All Right w/o Sunroof	
G57626	FF		
F	06-08	SUBARU FORESTER Automatic Left	
G57627	FF		
F	06-08	SUBARU FORESTER Automatic Right	
G57628	FF		
F	09-10	SUBARU FORESTER Wagon, AWD Left	

Ultra ReadyMount, Guardian ReadyMount

Shock	POP	Alternative No.	MTG Acc. Supplied
Pos.	Year	Application	
G57629	FF		
F	09-10	SUBARU FORESTER Wagon, AWD Right	
G57632	FF		
F	02-03	SUBARU IMPREZA RS Left	
G57633	FF		
F	02-03	SUBARU IMPREZA RS Right	
G57634	FF		
R	02-03	SUBARU IMPREZA RS Left	
G57635	FF		
R	02-03	SUBARU IMPREZA RS Right	
G57636	FF		
F	02-03	SUBARU IMPREZA TS Left	
G57637	FF		
F	02-03	SUBARU IMPREZA TS Right	
G57638	FF		
R	02-03	SUBARU IMPREZA TS Left	
G57639	FF		
R	02-03	SUBARU IMPREZA TS Right	
G57640	FF		
F	04-07	SUBARU IMPREZA All Left	
G57641	FF		
F	04-07	SUBARU IMPREZA All Right	
G57642	FF		
R	04-07	SUBARU IMPREZA All Left	
G57643	FF		
R	04-07	SUBARU IMPREZA All Right	
G57644	FF		
F	08-11	SUBARU IMPREZA All Left	
G57645	FF		
F	08-11	SUBARU IMPREZA All Right	
G57646	FF		
F	05-14	NISSAN FRONTIER RWD	
G57647	FF		
F	05-14	NISSAN FRONTIER 4WD	
G57648	FF		
F	01-03	TOYOTA HIGHLANDER AWD Left	
G57649	FF		
F	01-03	TOYOTA HIGHLANDER AWD Right	
G57650	FF		
R	01-03	TOYOTA HIGHLANDER AWD Left	
G57651	FF		
R	01-03	TOYOTA HIGHLANDER AWD Right	
G57652	FF		
F	04-07	TOYOTA HIGHLANDER AWD Left	
G57653	FF		
F	04-07	TOYOTA HIGHLANDER AWD Right	
G57654	FF		
R	04-07	TOYOTA HIGHLANDER AWD Left w/o 3rd Seat	
G57655	FF		
R	04-07	TOYOTA HIGHLANDER AWD Right w/o 3rd Seat	
G57656	FF		
F	08-10	TOYOTA HIGHLANDER AWD, 3.5L 6Cyl V (3456) Left	
F	10	HIGHLANDER AWD, 3.5L 6Cyl V (214) Left	
G57657	FF		
F	08-10	TOYOTA HIGHLANDER AWD Right	
F	10	HIGHLANDER AWD, 3.5L 6Cyl V (214) Right	
G57658	FF		
R	08-10	TOYOTA HIGHLANDER AWD Left w/o 3rd Seat	

Numerical listing

Shock	POP	Alternative No.	MTG Acc. Supplied
Pos.	Year	Application	
G57659	FF		
R	08-10	TOYOTA HIGHLANDER AWD Right w/o 3rd Seat	
G57663	FF		
F	07-10	TOYOTA SIENNA FWD Left 7 Passenger	
G57664	FF		
F	07-10	TOYOTA SIENNA FWD Right 7 Passenger	
G57665	FF		
F	07-10	TOYOTA SIENNA All Left 8 Passenger	
G57666	FF		
F	07-10	TOYOTA SIENNA All Right 8 Passenger	
G57667	FF		
F	98-99	SUBARU LEGACY Sedan, AWD Left	
G57668	FF		
F	98-99	SUBARU LEGACY Sedan, AWD Right	
G57669	FF		
R	98-99	SUBARU LEGACY Sedan, AWD Left	
G57670	FF		
R	98-99	SUBARU LEGACY Sedan, AWD Right	
G57671	FF		
F	03-04	SUBARU LEGACY AWD Left	
G57672	FF		
F	03-04	SUBARU LEGACY AWD Right	
G57673	FF		
F	10-12	SUBARU OUTBACK All Left	
G57674	FF		
F	10-12	SUBARU OUTBACK All Right	
G57675	FF		
R	10-12	SUBARU OUTBACK All	
G57676	FF		
F	09-14	TOYOTA VENZA All Left Wagon	
G57677	FF		
F	09-14	TOYOTA VENZA All Right Wagon	
G57678	FF		
R	09-14	TOYOTA VENZA All Left Wagon	
G57679	FF		
R	09-14	TOYOTA VENZA All Right Wagon	
G57680	FF		
F	10-14	VOLKSWAGEN GTI All	
Guardian ReadyMount			
M56727	N		
R	88-96	BUICK REGAL All	
R	90-94	CHEVROLET LUMINA All	
R	88-97	OLDSMOBILE CUTLASS / CUTLASS SUPREME All	
R	88-96	PONTIAC GRAND PRIX All	
M56906	FF		
R	85-90	BUICK ELECTRA Air (RearSpringType)	
R	86-99	LESABRE Air (RearSpringType)	
R	91-96	PARK AVENUE All	
R	93	CADILLAC 60 SPECIAL All	
R	85-93	DEVILLE All	
R	85-93	FLEETWOOD All	
R	86-99	OLDSMOBILE 88 SERIES All	
R	85-96	98 All	
R	96-99	LSS All	
R	97-98	REGENCY All	
R	87-99	PONTIAC BONNEVILLE All	
M56907	N		
F	90-95	CHRYSLER TOWN & COUNTRY All	
F	87-95	DODGE CARAVAN / GRAND CARAVAN All	
F	86	CARAVAN / GRAND CARAVAN All Mfg. from 1/86	
F	87-88	MINI RAM All	

Numerical listing

Shock	POP	Alternative No.	MTG Acc. Supplied
Pos.	Year	Application	
M56907 N -continued			
F	87-95	PLYMOUTH VOYAGER / GRAND VOYAGER All	
F	86	VOYAGER / GRAND VOYAGER All Mfg. from 1/86	
M56908 FF			
F	84-96	BUICK CENTURY All	
F	84-96	SKYLARK All	
F	84-90	CHEVROLET CELEBRITY All	
F	84-85	CITATION / CITATION II All	
F	84-96	OLDSMOBILE CIERA / CUTLASS CIERA All	
F	87-94	CUTLASS CLASSIC / CUTLASS CRUISER All	
F	84	OMEGA All	
F	84-90	PONTIAC 6000 FWD	
F	84	PHOENIX All	
M56909 N			
F	91-99	BUICK LESABRE All	
F	90	LESABRE All Late Design Front Strut without Spring Guard	
F	91-96	PARK AVENUE All CCR Computer Command Ride	
F	93	CADILLAC 60 SPECIAL All	
F	92-93	COMMERCIAL CHASSIS FWD	
F	91	COMMERCIAL CHASSIS All	
F	91-93	DEVILLE All Exc. Electronic Adjustable Suspension	
F	91-93	FLEETWOOD All	
F	92-99	OLDSMOBILE 88 SERIES All	
F	90-91	88 SERIES All Late Design Front Strut without Spring Guard	
F	91-96	98 All	
F	96-99	LSS All	
F	97-98	REGENCY All	
F	94-99	PONTIAC BONNEVILLE Air (RearSpringType) Exc. CCR Computer Command Ride	
F	91-93	BONNEVILLE All	
F	90	BONNEVILLE All Late Design Front Strut without Spring Guard	
M56910 N			
F	96-00	CHRYSLER TOWN & COUNTRY All	
F	00	VOYAGER / GRAND VOYAGER All	
F	00	VOYAGER / GRAND VOYAGER All Exc. Hydraulic Self Leveling System	
F	96-00	DODGE CARAVAN / GRAND CARAVAN All Exc. Hydraulic Self Leveling System	
F	96-00	PLYMOUTH VOYAGER / GRAND VOYAGER All	
F	96	VOYAGER / GRAND VOYAGER All Exc. Hydraulic Self Leveling System	
M56911 N			
F	91-96	FORD ESCORT All	
F	90-94	MAZDA 323 All	
F	90-94	PROTÉGÉ / PROTÉGÉ5 All	
F	91-96	MERCURY TRACER FWD	
M56912 N			
F	86-95	FORD TAURUS All	
F	86-95	MERCURY SABLE All	
M56913 FF			
R	86-93	FORD TAURUS Sedan	
R	86-93	MERCURY SABLE Sedan	
M56914 FF			
F	85-90	BUICK ELECTRA All	
F	86-90	LESABRE All	
F	85-90	CADILLAC COMMERCIAL CHASSIS All	
F	85-90	DEVILLE All	
F	85-90	FLEETWOOD All	
F	86-90	OLDSMOBILE 88 SERIES All Early Design Front Strut with Spring Guard	
F	85-90	98 All	
F	90	PONTIAC BONNEVILLE All Early Design Front Strut with Spring Guard	
F	87-89	BONNEVILLE All	
M56916 FF			
F	95-98	BUICK SKYLARK All Right	
F	95-96	CHEVROLET BERETTA All Right	
F	95-96	CORSICA All Right	
F	95-98	OLDSMOBILE ACHIEVA All Right	
F	95-98	PONTIAC GRAND AM All Right	
M56917 FF			
F	95-98	BUICK SKYLARK All Left	
F	95-96	CHEVROLET BERETTA All Left	

Guardian ReadyMount

Shock	POP	Alternative No.	MTG Acc. Supplied
Pos.	Year	Application	
M56917 FF -continued			
F	95-96	CORSICA All Left	
F	95-98	OLDSMOBILE ACHIEVA All Left	
F	95-98	PONTIAC GRAND AM All Left	
M56918 FF			
F	92-94	BUICK SKYLARK All Right	
F	92-94	CHEVROLET BERETTA Base Right	
F	93-94	CORSICA All Right	
F	92	CORSICA LT Right	
F	92-94	OLDSMOBILE ACHIEVA All Right	
F	92-94	PONTIAC GRAND AM Sedan Right	
M56919 FF			
F	92-94	BUICK SKYLARK All Left	
F	92-94	CHEVROLET BERETTA Base Left	
F	94	CORSICA All Left	
F	92-93	CORSICA LT Left	
F	92-94	OLDSMOBILE ACHIEVA All Left	
F	92-94	PONTIAC GRAND AM Sedan Left	
M56920 FF			
F	87-91	CHEVROLET BERETTA All Right	
F	92-94	CAVALIER All Right	
F	90-91	CORSICA All Right	
F	87-88	CORSICA All Right	
F	92-94	PONTIAC SUNBIRD All Right	
F	87-91	TEMPEST All Right	
M56921 FF			
F	87-91	CHEVROLET BERETTA All Left	
F	92-94	CAVALIER All Left	
F	90-91	CORSICA All Left	
F	87-88	CORSICA All Left	
F	92-94	PONTIAC SUNBIRD All Left	
F	87-91	TEMPEST All Left	
M56924 N			
R	05-09	BUICK ALLURE All Left Exc. Models with 17" or 18" Wheels	
R	97-05	CENTURY All Left	
R	05-09	LACROSSE All Left Exc. Models with 17" or 18" Wheels	
R	97-04	REGAL All Left	
R	12-16	CHEVROLET IMPALA All Left	
R	00-11	IMPALA All Left Exc. Models with 17" or 18" Wheels	
R	00-07	MONTE CARLO All Left Exc. Models with 17" or 18" Wheels	
R	98-02	OLDSMOBILE INTRIGUE All Left	
R	97-08	PONTIAC GRAND PRIX All Left Exc. Models with 17" or 18" Wheels	
M56925 N			
R	05-09	BUICK ALLURE All Right Exc. Models with 17" or 18" Wheels	
R	97-05	CENTURY All Right	
R	05-09	LACROSSE All Right Exc. Models with 17" or 18" Wheels	
R	97-04	REGAL All Right	
R	12-16	CHEVROLET IMPALA All Right	
R	00-11	IMPALA All Right Exc. Models with 17" or 18" Wheels	
R	00-07	MONTE CARLO All Right Exc. Models with 17" or 18" Wheels	
R	98-02	OLDSMOBILE INTRIGUE All Right	
R	97-08	PONTIAC GRAND PRIX All Right Exc. Models with 17" or 18" Wheels	
M56926 N			
F	01-02	FORD ESCORT SE	
F	00-02	ESCORT ZX2	
F	99-00	ESCORT ZX2 S/R	
F	98-00	ESCORT LX	
F	98-99	ESCORT SE	
F	98-99	ESCORT SE Equi	
F	98-99	ESCORT ZX2 Equi	
F	99	ESCORT ZX2 Tipico	
F	97	ESCORT All	
F	97-99	MERCURY TRACER FWD	
M56927 N			
F	04-05	CHEVROLET CLASSIC All	
F	97-03	MALIBU All	
F	99-04	OLDSMOBILE ALERO All	
F	97-99	CUTLASS / CUTLASS SUPREME All	
F	99-05	PONTIAC GRAND AM All	
M56928 N			
R	04-05	CHEVROLET CLASSIC All	
R	98-03	MALIBU All Rear Strut Lower Mounting holes at 2.4" Apart	
R	99-04	OLDSMOBILE ALERO All	
R	99-05	PONTIAC GRAND AM All	

Numerical listing

Shock	POP	Alternative No.	MTG Acc. Supplied
Pos.	Year	Application	
M56929 N			
F	98-05	BUICK PARK AVENUE All	
F	98-99	RIVIERA All	
M56930 N			
F	97-01	LEXUS ES300 All Left Exc. Electronic Adjustable Suspension	
F	97-03	TOYOTA AVALON All Left	
F	97-01	CAMRY All Left	
F	99-03	SOLARA All Left	
M56931 N			
F	97-01	LEXUS ES300 All Right Exc. Electronic Adjustable Suspension	
F	97-03	TOYOTA AVALON All Right	
F	97-01	CAMRY All Right	
F	99-03	SOLARA All Right	
M56932 N			
R	92-02	LEXUS ES300 All Left Exc. Electronic Adjustable Suspension	
R	95-03	TOYOTA AVALON All Left	
R	95-01	CAMRY All Left	
R	92-94	CAMRY All Left Sealed O.E. Struts	
R	99-03	SOLARA All Left	
M56933 N			
R	92-02	LEXUS ES300 All Right Exc. Electronic Adjustable Suspension	
R	95-03	TOYOTA AVALON All Right	
R	95-01	CAMRY All Right	
R	92-94	CAMRY All Right Sealed O.E. Struts	
R	99-03	SOLARA All Right	
M56934 N			
F	96-07	FORD TAURUS All Left	
F	96-05	MERCURY SABLE All Left	
M56935 N			
F	95-03	FORD WINDSTAR All	
M56936 N			
R	94-07	FORD TAURUS Sedan	
R	94-05	MERCURY SABLE Sedan	
M56937 N			
F	96-07	FORD TAURUS All Right	
F	96-05	MERCURY SABLE All Right	
M56938 N			
R	95-05	CHEVROLET CAVALIER All	
R	95-05	PONTIAC SUNFIRE All	
M56939 N			
F	95-98	CHEVROLET CAVALIER All	
F	95-98	PONTIAC SUNFIRE All	
M56940 N			
R	91-03	FORD ESCORT All	
R	91-95	MAZDA 323 All	
R	90-94	PROTÉGÉ / PROTÉGÉ5 All	
R	91-99	MERCURY TRACER FWD	
M56942 FF			
F	95-96	TOYOTA CAMRY All	
M56943 N			
R	98-02	HONDA ACCORD All	
M56947 N			
F	93-97	GEO PRIZM All	
F	93-97	TOYOTA COROLLA All	
M56948 N			
F	98-02	CHEVROLET PRIZM All	
F	98-02	TOYOTA COROLLA All	
M56949 N			
R	98-02	CHEVROLET PRIZM All Left	
R	93-97	GEO PRIZM All Left	
R	93-02	TOYOTA COROLLA All Left	
M56950 N			
R	98-02	CHEVROLET PRIZM All Right	
R	93-97	GEO PRIZM All Right	
R	93-02	TOYOTA COROLLA All Right	
M56951 N			
F	99-05	CHEVROLET CAVALIER All	
F	99-05	PONTIAC SUNFIRE All	
M56956 N			
F	01-07	CHRYSLER TOWN & COUNTRY All Left	
F	01-07	VOYAGER / GRAND VOYAGER All Left	
F	01-07	DODGE CARAVAN / GRAND CARAVAN All Left	

Numerical listing

Shock	POP	Alternative No.	MTG Acc. Supplied
Pos.	Year	Application	
M56957 N			
F	01-07	CHRYSLER TOWN & COUNTRY All Right	
F	01-07	VOYAGER / GRAND VOYAGER All Right	
F	01-07	DODGE CARAVAN / GRAND CARAVAN All Right	
M56958 FF			
F	93-97	CHRYSLER CONCORDE All Left	
F	94-97	LHS All Left	
F	94-96	NEW YORKER All Left	
F	93-97	DODGE INTREPID All Left	
F	93-97	EAGLE VISION All Left	
M56959 FF			
F	93-97	CHRYSLER CONCORDE All Right	
F	94-97	LHS All Right	
F	94-96	NEW YORKER All Right	
F	93-97	DODGE INTREPID All Right	
F	93-97	EAGLE VISION All Right	
M56960 FF			
R	93-97	CHRYSLER CONCORDE All	
R	93-97	DODGE INTREPID All	
R	93-97	EAGLE VISION All	
M56961 N			
F	94-97	HONDA ACCORD All	
M56962 N			
F	99-04	CHRYSLER 300M All Left	
F	98-04	CONCORDE All Left	
F	98-04	INTREPID All Left	
F	99-01	LHS All Left	
F	98-04	DODGE INTREPID All Left	
M56963 N			
F	99-04	CHRYSLER 300M All Right	
F	98-04	CONCORDE All Right	
F	98-04	INTREPID All Right	
F	99-01	LHS All Right	
F	98-04	DODGE INTREPID All Right	
M56964 N			
R	99-04	CHRYSLER 300M All	
R	98-04	CONCORDE All	
R	99-01	LHS All	
R	98-04	DODGE INTREPID All	
M56965 N			
F	01-10	CHRYSLER PT CRUISER All	
M56966 FF			
F	95-99	DODGE NEON All	
F	95-99	PLYMOUTH NEON All	
M56967 N			
R	95-99	DODGE NEON All	
R	95-99	PLYMOUTH NEON All	
M56968 FF			
R	90-97	HONDA ACCORD All Left	
M56969 FF			
R	90-97	HONDA ACCORD All Right	
M56970 N			
F	96-99	INFINITI I30 All Left	
F	95-99	NISSAN MAXIMA All Left	
M56971 N			
F	96-99	INFINITI I30 All Right	
F	95-99	NISSAN MAXIMA All Right	
M56973 N			
R	00-02	CHRYSLER NEON All Left	
R	03-05	DODGE NEON SXT Left	
R	00-05	NEON SE Left	
R	01-04	NEON R/T Left	
R	00-03	NEON LE Left	
R	01-02	NEON ACR Left	
R	01-02	NEON Base Left	
R	00-02	NEON ES Left	
R	00-02	NEON LX Left	
R	00	NEON High Line Left	
R	00-01	PLYMOUTH NEON All Left	
M56974 N			
R	00-02	CHRYSLER NEON All Right	
R	03-05	DODGE NEON SXT Right	
R	00-05	NEON SE Right	
R	01-04	NEON R/T Right	
R	00-03	NEON LE Right	
R	01-02	NEON ACR Right	
R	01-02	NEON Base Right	
R	00-02	NEON ES Right	

Guardian ReadyMount

Shock	POP	Alternative No.	MTG Acc. Supplied
Pos.	Year	Application	
M56974 N -continued			
R	00-02	NEON LX Right	
R	00	NEON High Line Right	
R	00-01	PLYMOUTH NEON All Right	
M56975 N			
F	00-02	CHRYSLER NEON All	
F	03-05	DODGE NEON SXT	
F	00-05	NEON SE	
F	01-04	NEON R/T	
F	00-03	NEON LE	
F	01-02	NEON ACR	
F	01-02	NEON Base	
F	00-02	NEON ES	
F	00-02	NEON LX	
F	00	NEON High Line	
F	00-01	PLYMOUTH NEON All	
M56976 N			
F	89-97	FORD THUNDERBIRD All Left Exc. Electronic Adjustable Suspension	
F	89-97	MERCURY COUGAR All Left Exc. Electronic Adjustable Suspension	
M56977 N			
F	89-97	FORD THUNDERBIRD All Right Exc. Electronic Adjustable Suspension	
F	89-97	MERCURY COUGAR All Right Exc. Electronic Adjustable Suspension	
M56981 N			
F	90-93	HONDA ACCORD All	
M56985 FF			
F	90-93	CHRYSLER IMPERIAL All	
F	89-94	LEBARON All	
F	90-93	NEW YORKER All	
F	88-93	DODGE DYNASTY All	
F	89-94	SHADOW All	
F	89-95	SPIRIT All	
F	89-95	PLYMOUTH ACCLAIM All	
F	89-94	SUNDANCE All	
M56989 FF			
F	93-98	MERCURY VILLAGER All Right	
F	93-98	NISSAN QUEST All Right	
M56990 FF			
F	93-98	MERCURY VILLAGER All Right	
F	93-98	NISSAN QUEST All Right	
M56991 N			
F	98-02	HONDA ACCORD 2.3L 4Cyl L (2254) Left	
M56992 N			
F	98-02	HONDA ACCORD 2.3L 4Cyl L (2254) Right	
M56993 FF			
F	97-01	ACURA INTEGRA GS Left	
F	94-01	INTEGRA GS-R Left	
F	95-96	INTEGRA Special Edition Left	
F	92-95	HONDA CIVIC All Left	
M56994 FF			
F	97-01	ACURA INTEGRA GS Right	
F	94-01	INTEGRA GS-R Right	
F	95-96	INTEGRA All Right	
F	92-95	HONDA CIVIC All Right	
M56995 FF			
R	97-01	ACURA INTEGRA GS	
R	94-01	INTEGRA GS-R	
R	95-96	INTEGRA Special Edition	
R	92-95	HONDA CIVIC All	
M56996 N			
F	96-00	HONDA CIVIC All Left	
M56997 N			
F	96-00	HONDA CIVIC All Right	
M56998 N			
R	96-00	HONDA CIVIC All	
M57001 FF			
F	93-99	NISSAN ALTIMA All Left	
M57002 FF			
F	93-99	NISSAN ALTIMA All Right	
M57003 FF			
R	93-01	NISSAN ALTIMA All Left	
M57004 FF			
R	93-01	NISSAN ALTIMA All Right	

Numerical listing

Shock	POP	Alternative No.	MTG Acc. Supplied
Pos.	Year	Application	
M57007 N			
F	07-11	DODGE NITRO All Left	
F	07-12	JEEP LIBERTY All Left	
F	05-06	LIBERTY GAS Left	
F	02-04	LIBERTY All Left	
M57008 N			
F	07-11	DODGE NITRO All Right	
F	07-12	JEEP LIBERTY All Right	
F	05-06	LIBERTY GAS Right	
F	02-04	LIBERTY All Right	
M57011 N			
F	99-04	HONDA ODYSSEY All Left	
M57012 N			
F	99-04	HONDA ODYSSEY All Right	
M57013 N			
F	91-02	SATURN SC / SL / SW SERIES All	
M57014 N			
R	91-02	SATURN SC / SL / SW SERIES All	
M57017 N			
F	02-03	FORD EXPLORER Eddie Bauer	
F	02-03	EXPLORER Limited	
F	02-03	EXPLORER Postal	
F	02-03	EXPLORER XLS	
F	02-03	EXPLORER XLT	
F	02-03	MERCURY MOUNTAINEER All	
M57018 N			
R	04-05	FORD EXPLORER All	
R	02-05	EXPLORER XLS	
R	02-05	EXPLORER XLT	
R	04	EXPLORER NBX	
R	02-03	EXPLORER Eddie Bauer	
R	02-03	EXPLORER Limited	
R	02-03	EXPLORER Postal	
R	02-05	MERCURY MOUNTAINEER All	
M57019 N			
F	04-05	FORD EXPLORER Eddie Bauer	
F	04-05	EXPLORER Limited	
F	04-05	EXPLORER XLS	
F	04-05	EXPLORER XLT	
F	04	EXPLORER NBX	
F	04-05	MERCURY MOUNTAINEER All	
M57020 N			
F	04-08	FORD PICKUP 1/2 TON, F-150 4WD	
F	06-08	LINCOLN MARK LT 4WD	
M57021 N			
F	04-08	FORD PICKUP 1/2 TON, F-150 RWD	
F	06-08	LINCOLN MARK LT RWD	
M57022 N			
F	04-07	BUICK RAINIER 4.2L 6Cyl L (256)	
F	06-09	CHEVROLET TRAILBLAZER LT	
F	06-08	TRAILBLAZER Base	
F	06-07	TRAILBLAZER A	
F	06-07	TRAILBLAZER B	
F	06-07	TRAILBLAZER LS	
F	06	TRAILBLAZER EXT	
F	06	TRAILBLAZER EXT B	
F	02-05	TRAILBLAZER All	
F	03-06	TRAILBLAZER EXT 4.2L 6Cyl L (256)	
F	02	TRAILBLAZER EXT All	
F	05-09	GMC ENVOY 4.2L 6Cyl L (256)	
F	02-04	ENVOY All	
F	03-06	ENVOY XL 4.2L 6Cyl L (256)	
F	02	ENVOY XL All	
F	04-05	ENVOY XUV 4.2L 6Cyl L (256)	
F	07-08	ISUZU ASCENDER All	
F	03-06	ASCENDER 4.2L 6Cyl L (256)	
F	02-04	OLDSMOBILE BRAVADA All	
F	05-09	SAAB 9-7X All	
M57023 N			
F	07-13	CHEVROLET PICKUP 1/2 TON, SILVERADO 1500 RWD	
F	07-13	GMC SIERRA 1500 RWD	
M57024 N			
R	85-98	VOLKSWAGEN GOLF All	
R	94-98	JETTA 1.8L 4Cyl L (109)	
R	94-98	JETTA 1.9L 4Cyl L (116)	
R	94-98	JETTA 2.0L 4Cyl L (121)	
R	85-93	JETTA All	
M57025 N			
R	99-00	CHRYSLER CIRRUS All	

Numerical listing

Shock	POP	Alternative No.	MTG Acc. Supplied
Pos.	Year	Application	
M57025	N	-continued	
R	99-00	DODGE STRATUS All	
R	99-00	PLYMOUTH BREEZE All	
M57026	N		
R	01-06	CHRYSLER SEBRING JR (MfrBodyCode), Sedan	
R	01-06	DODGE STRATUS Sedan	
M57030	N		
F	02-06	NISSAN ALTIMA All Left	
F	04-08	MAXIMA All Left	
M57031	N		
F	02-06	NISSAN ALTIMA All Right	
F	04-08	MAXIMA All Right	
M57032	FF		
R	01-02	HONDA CIVIC All Right	
M57033	FF		
R	01-02	HONDA CIVIC All Left	
M57034	N		
F	02-06	NISSAN SENTRA All Left	
M57035	N		
F	02-06	NISSAN SENTRA All Right	
M57036	N		
R	02-06	NISSAN SENTRA All	
M57039	N		
F	98-10	VOLKSWAGEN BEETLE All	
F	99-06	GOLF All	
F	99-04	JETTA All	
M57040	N		
F	93-97	VOLVO 850 All Exc. Hydraulic Self Leveling System	
F	98-04	C70 All	
F	98-00	S70 All	
F	99-00	V70 R AWD Mfg. to 3/00 and Exc. XC70, XC Cross Country	
F	98-00	V70 Base Mfg. to 3/00 and Exc. XC70, XC Cross Country	
F	98-00	V70 GLT Mfg. to 3/00 and Exc. XC70, XC Cross Country	
F	98-00	V70 T5 Mfg. to 3/00 and Exc. XC70, XC Cross Country	
F	00	V70 2.4T Mfg. to 3/00 and Exc. XC70, XC Cross Country	
F	00	V70 GLT SE Mfg. to 3/00 and Exc. XC70, XC Cross Country	
F	98-99	V70 AWD Mfg. to 3/00 and Exc. XC70, XC Cross Country	
F	98	V70 R Mfg. to 3/00 and Exc. XC70, XC Cross Country	
M57041	N		
F	02-03	LEXUS ES300 All Left	
F	02-03	TOYOTA CAMRY All Left	
M57042	N		
F	02-03	LEXUS ES300 All Right	
F	02-03	TOYOTA CAMRY All Right	
M57043	N		
R	02-03	LEXUS ES300 All Left	
R	02-03	TOYOTA CAMRY All Left	
M57044	N		
R	02-03	LEXUS ES300 All Right	
R	02-03	TOYOTA CAMRY All Right	
M57047	N		
F	05-10	CHEVROLET COBALT All Left	
F	06-11	HHR All Left	
F	07-09	PONTIAC G5 All Left	
F	05-06	PURSUIT All Left	
M57048	N		
F	05-10	CHEVROLET COBALT All Right	
F	06-11	HHR All Right	
F	07-09	PONTIAC G5 All Right	
F	05-06	PURSUIT All Right	
M57049	N		
F	01-05	HONDA CIVIC Coupe Left	
F	01-05	CIVIC Sedan Left	
M57050	N		
F	01-05	HONDA CIVIC Coupe Right	
F	01-05	CIVIC Sedan Right	
M57051	N		
F	00-05	BUICK LESABRE All Exc. Electronic Adjustable Suspension	

Guardian ReadyMount

Shock	POP	Alternative No.	MTG Acc. Supplied
Pos.	Year	Application	
M57051	N	-continued	
F	00-05	CADILLAC DEVILLE All Exc. Electronic Adjustable Suspension	
F	98-04	SEVILLE All Exc. Electronic Adjustable Suspension	
F	01-03	OLDSMOBILE AURORA All Exc. Electronic Adjustable Suspension	
F	98-99	AURORA All Exc. Electronic Adjustable Suspension	
F	00-05	PONTIAC BONNEVILLE All Exc. Electronic Adjustable Suspension	
M57052	FF		
R	96-00	FORD CONTOUR Base	
R	95-00	CONTOUR LX	
R	96-98	CONTOUR Sport	
R	95-98	CONTOUR GL	
R	99-01	MERCURY COUGAR All	
R	95-00	MYSTIQUE All	
M57054	N		
F	04-07	HONDA ACCORD 2.4L 4Cyl L (144) Left	
F	03-07	ACCORD 2.4L 4Cyl L (2354) Left	
M57055	N		
F	04-07	HONDA ACCORD 2.4L 4Cyl L (144) Right	
F	03-07	ACCORD 2.4L 4Cyl L (2354) Right	
M57056	N		
R	04-08	ACURA TL All	
R	06-07	HONDA ACCORD Value Package	
R	05-07	ACCORD EX	
R	05-07	ACCORD LX	
R	07	ACCORD LX SE	
R	07	ACCORD Special Edition	
R	06	ACCORD LX Special Edition	
R	05	ACCORD DX	
R	05	ACCORD SE	
R	03-04	ACCORD All	
M57057	N		
R	96-99	INFINITI I30 All Left	
R	95-99	NISSAN MAXIMA All Left	
M57058	N		
R	96-99	INFINITI I30 All Right	
R	95-99	NISSAN MAXIMA All Right	
M57059	N		
F	00-05	HYUNDAI SONATA All	
M57060	N		
F	05-09	BUICK ALLURE All	
F	97-05	CENTURY All	
F	05-09	LACROSSE All	
F	97-04	REGAL All	
F	00-16	CHEVROLET IMPALA All	
F	00-07	MONTE CARLO All	
F	02-05	VENTURE All	
F	97-01	VENTURE FWD	
F	98-02	OLDSMOBILE INTRIGUE All	
F	97-04	SILHOUETTE All	
F	97-03	PONTIAC GRAND PRIX All	
F	99-05	MONTANA Base	
F	97-98	TRANS SPORT All	
M57063	N		
F	00-05	FORD FOCUS All Left	
M57064	N		
F	00-05	FORD FOCUS All Right	
M57067	N		
R	03-08	TOYOTA COROLLA All Left	
R	03-08	MATRIX FWD Left	
M57068	N		
R	03-08	TOYOTA COROLLA All Right	
R	03-08	MATRIX FWD Right	
M57069	N		
F	11-12	CHEVROLET MALIBU All Left	
F	06-10	MALIBU LTZ Left	
F	04-10	MALIBU LS Left	
F	04-10	MALIBU LT Left	
F	04-08	MALIBU Base Left	
F	08	MALIBU Classic LS Left	
F	08	MALIBU Classic LT Left	
F	06-07	MALIBU Maxx LTZ Left	
F	06-07	MALIBU SS Left	
F	04-07	MALIBU Maxx LS Left	
F	04-07	MALIBU Maxx LT Left	
F	04	MALIBU Maxx Left	
F	05-10	PONTIAC G6 Sedan, 3.5L 6Cyl V (213) Left	

Numerical listing

Shock	POP	Alternative No.	MTG Acc. Supplied
Pos.	Year	Application	
M57069	N	-continued	
F	07-09	G6 Coupe , 3.5L 6Cyl V (213) Left	
F	07-09	G6 Coupe , 3.6L 6Cyl V (217) Left	
F	07-09	G6 Sedan , 3.6L 6Cyl V (217) Left	
F	06-09	G6 Coupe , 3.9L 6Cyl V (237) Left	
F	06	G6 Coupe , 3.5L 6Cyl V (214) Left	
F	06	G6 Sedan , 3.5L 6Cyl V (214) Left	
F	05	G6 Sedan , 3.5L 6Cyl V (211) Left	
F	07-09	SATURN AURA XR , 3.6L 6Cyl V (217) Left	
F	07-08	AURA XE , 3.5L 6Cyl V (213) Left	
M57070	N		
F	11-12	CHEVROLET MALIBU All Right	
F	06-10	MALIBU LTZ Right	
F	04-10	MALIBU LS Right	
F	04-10	MALIBU LT Right	
F	04-08	MALIBU Base Right	
F	08	MALIBU Classic LS Right	
F	08	MALIBU Classic LT Right	
F	06-07	MALIBU Maxx LTZ Right	
F	06-07	MALIBU SS Right	
F	04-07	MALIBU Maxx LS Right	
F	04-07	MALIBU Maxx LT Right	
F	04	MALIBU Maxx Right	
F	05-10	PONTIAC G6 Sedan, 3.5L 6Cyl V (213) Right	
F	07-09	G6 Coupe , 3.5L 6Cyl V (213) Right	
F	07-09	G6 Coupe , 3.6L 6Cyl V (217) Right	
F	07-09	G6 Sedan , 3.6L 6Cyl V (217) Right	
F	06-09	G6 Coupe , 3.9L 6Cyl V (237) Right	
F	06	G6 Coupe , 3.5L 6Cyl V (214) Right	
F	06	G6 Sedan , 3.5L 6Cyl V (214) Right	
F	05	G6 Sedan , 3.5L 6Cyl V (211) Right	
F	07-09	SATURN AURA XR , 3.6L 6Cyl V (217) Right	
F	07-08	AURA XE , 3.5L 6Cyl V (213) Right	
M57071	N		
F	05-10	CHRYSLER 300 RWD Left	
F	06-10	DODGE CHARGER RWD Left	
F	05-08	MAGNUM RWD Left	
M57072	N		
F	05-10	CHRYSLER 300 RWD Right	
F	06-10	DODGE CHARGER RWD Right	
F	05-08	MAGNUM RWD Right	
M57083	N		
F	06-10	JEEP COMMANDER All	
F	05-10	GRAND CHEROKEE All	
M57086	N		
R	02-06	HONDA CR-V All Left	
M57087	FF		
R	02-06	HONDA CR-V All Right	
M57088	N		
F	00-06	HYUNDAI ELANTRA Automatic Left	
M57089	N		
F	00-06	HYUNDAI ELANTRA Automatic Right	
M57090	N		
R	00-05	HYUNDAI SONATA All Left	
R	01-06	KIA MAGENTIS All Left	
R	01-06	OPTIMA All Left	
M57091	N		
R	00-05	HYUNDAI SONATA All Right	
R	01-06	KIA MAGENTIS All Right	
R	01-06	OPTIMA All Right	
M57092	N		
F	04-10	INFINITI QX56 4WD	
F	05-15	NISSAN ARMADA 4WD	
F	04-15	TITAN 4WD	
M57095	N		
F	06-10	FORD EXPLORER All	
F	06-10	MERCURY MOUNTAINEER All	
M57096	N		
R	06-10	FORD EXPLORER All	
R	06-10	MERCURY MOUNTAINEER All	
M57099	N		
F	03-07	SATURN ION All Left	
M57100	N		
F	03-07	SATURN ION All Right	

Numerical listing

Shock	POP	Alternative No.	MTG Acc. Supplied
Pos.	Year	Application	
M57103	FF		
F	09-13	FORD PICKUP 1/2 TON, F-150 Extended Cab Pickup, 4WD Exc. Sport Suspensions	
M57107	FF		
F	93-02	CHEVROLET CAMARO All Left	
F	93-02	PONTIAC FIREBIRD All Left	
M57108	FF		
F	93-02	CHEVROLET CAMARO All Right	
F	93-02	PONTIAC FIREBIRD All Right	
M57112	FF		
F	04-08	CHRYSLER PACIFICA All Left	
M57113	FF		
F	04-08	CHRYSLER PACIFICA All Right	
M57114	N		
F	03-08	TOYOTA COROLLA All Left	
M57115	N		
F	03-08	TOYOTA COROLLA All Right	
M57118	FF		
F	05-11	NISSAN PATHFINDER 4WD	
M57119	N		
F	01-02	ACURA MDX All Left	
F	03-08	HONDA PILOT AWD Left	
M57120	N		
F	01-02	ACURA MDX All Right	
F	03-08	HONDA PILOT AWD Right	
M57121	FF		
F	08-10	CHEVROLET MALIBU LS, 2.4L 4Cyl L (145) Left	
F	08-10	MALIBU LT, 2.4L 4Cyl L (145) Left	
F	08-10	MALIBU LTZ, 2.4L 4Cyl L (145) Left	
F	09	MALIBU Base, 2.4L 4Cyl L (145) Left	
F	06-10	PONTIAC G6 2.4L 4Cyl L (145) Left	
F	08-09	SATURN AURA XE Left	
F	09	AURA XR Left	
F	07-08	AURA Green Line Left	
M57122	FF		
F	08-10	CHEVROLET MALIBU LS, 2.4L 4Cyl L (145) Right	
F	08-10	MALIBU LT, 2.4L 4Cyl L (145) Right	
F	08-10	MALIBU LTZ, 2.4L 4Cyl L (145) Right	
F	09	MALIBU Base, 2.4L 4Cyl L (145) Right	
F	06-10	PONTIAC G6 2.4L 4Cyl L (145) Right	
F	08-09	SATURN AURA XE Right	
F	09	AURA XR Right	
F	07-08	AURA Green Line Right	
M57123	FF		
F	07-12	TOYOTA TUNDRA RWD Left	
M57124	FF		
F	07-12	TOYOTA TUNDRA RWD Right	
M57125	N		
F	07-11	CHEVROLET AVALANCHE 1500 All Exc. Z55 or ZW7 Ride Suspension	
F	07-11	SUBURBAN 1/2 TON, 1500 All	
F	07-11	SUBURBAN 3/4 TON, 2500 All	
F	07-11	TAHOE All	
F	07-11	GMC YUKON All	
F	07-11	YUKON XL 1/2 TON All	
F	07-11	YUKON XL 3/4 TON All	
M57126	N		
F	04-08	SUZUKI FORENZA All Left	
F	05-08	RENO All Left	
M57127	N		
F	04-08	SUZUKI FORENZA All Right	
F	05-08	RENO All Right	
M57128	N		
R	04-08	SUZUKI FORENZA All Left	
R	05-08	RENO All Left	
M57129	FF		
R	04-08	SUZUKI FORENZA All Right	
R	05-08	RENO All Right	
M57130	N		
F	06-11	CHEVROLET AVEO All Left	
F	04-11	AVEO All Left	
F	09-10	PONTIAC G3 All Left	

Guardian ReadyMount

Shock	POP	Alternative No.	MTG Acc. Supplied
Pos.	Year	Application	
M57130	N	-continued	
F	05-08	WAVE All Left	
F	04-09	SUZUKI SWIFT All Left	
M57131	N		
F	06-11	CHEVROLET AVEO All Right	
F	04-11	AVEO All Right	
F	09-10	PONTIAC G3 All Right	
F	05-08	WAVE All Right	
F	04-09	SUZUKI SWIFT All Right	
M57132	N		
F	09-13	FORD PICKUP 1/2 TON, F-150 RWD	
M57133	FF		
F	03-16	TOYOTA 4RUNNER All Left	
F	07-11	FJ CRUISER All Left	
F	05-12	TACOMA All Left	
M57134	FF		
F	03-16	TOYOTA 4RUNNER All Right	
F	07-11	FJ CRUISER All Right	
F	05-12	TACOMA All Right	
M57135	N		
F	00-04	AUDI A6 All Left	
F	00-04	A6 QUATTRO All Left	
F	01-05	VOLKSWAGEN PASSAT All Left	
M57136	N		
F	00-04	AUDI A6 All Right	
F	00-04	A6 QUATTRO All Right	
F	01-05	VOLKSWAGEN PASSAT All Right	
M57137	FF		
F	05-07	HONDA ODYSSEY All Left	
M57138	FF		
F	05-07	HONDA ODYSSEY All Right	
M57139	N		
F	01-06	HYUNDAI SANTA FE All Left	
M57140	N		
F	01-06	HYUNDAI SANTA FE All Right	
M57141	FF		
F	04-08	PONTIAC GRAND PRIX All	
M57142	FF		
F	05-07	BUICK TERRAZA FWD	
F	05-09	CHEVROLET UPLANDER FWD	
F	05-09	PONTIAC MONTANA FWD	
F	05-07	SATURN RELAY FWD	
M57144	N		
F	02-03	INFINITI QX4 All Left	
F	02-04	NISSAN PATHFINDER All Left	
M57145	N		
F	02-03	INFINITI QX4 All Right	
F	02-04	NISSAN PATHFINDER All Right	
M57147	FF		
F	09-10	DODGE PICKUP 1/2 TON, RAM 1500 (SEE RAM 1500) All	
M57148	FF		
F	06-09	FORD FUSION All	
F	06-09	MERCURY MILAN All	
M57156	N		
F	06-14	VOLKSWAGEN JETTA All	
M57157	FF		
F	02-03	NISSAN MAXIMA All Left	
M57158	FF		
F	02-03	NISSAN MAXIMA All Right	
M57159	N		
R	02-03	NISSAN MAXIMA All Left	
M57160	N		
R	02-03	NISSAN MAXIMA All Right	
M57161	N		
F	07-12	NISSAN ALTIMA All Left	
M57162	N		
F	07-12	NISSAN ALTIMA All Right	
M57163	N		
F	03-07	NISSAN MURANO All Left	
M57164	N		
F	03-07	NISSAN MURANO All Right	

Numerical listing

Shock	POP	Alternative No.	MTG Acc. Supplied
Pos.	Year	Application	
M57165	FF		
F	00-01	NISSAN MAXIMA All Left	
M57166	FF		
F	00-01	NISSAN MAXIMA All Right	
M57167	N		
R	00-06	HYUNDAI ELANTRA All Left	
M57168	N		
R	00-06	HYUNDAI ELANTRA All Right	
M57172	FF		
F	07-11	FORD EXPEDITION All	
M57173	N		
R	07-11	FORD EXPEDITION All	
M57176	N		
F	07-11	DODGE CALIBER All Left	
M57177	N		
F	07-11	DODGE CALIBER All Right	
M57178	N		
R	07-11	DODGE CALIBER All	
M57202	N		
F	09-14	NISSAN CUBE All Left	
F	07-11	VERSA All Left	
M57203	N		
F	09-14	NISSAN CUBE All Right	
F	07-11	VERSA All Right	
M57204	FF		
F	06-12	TOYOTA RAV4 All Left	
M57205	FF		
F	06-12	TOYOTA RAV4 All Right	
M57206	N		
F	15-16	CHRYSLER TOWN & COUNTRY Touring Piel	
F	13-16	TOWN & COUNTRY Li	
F	13-16	TOWN & COUNTRY Limited	
F	13-16	TOWN & COUNTRY LX	
F	13-16	TOWN & COUNTRY Touring	
F	13-16	TOWN & COUNTRY Touring L	
F	16	TOWN & COUNTRY Limited Platinum	
F	16	TOWN & COUNTRY Premium	
F	14	TOWN & COUNTRY 30th Anniversary Edition	
F	14	TOWN & COUNTRY Base	
F	08-12	TOWN & COUNTRY All	
F	14-16	DODGE CARAVAN / GRAND CARAVAN American Value Package	
F	14-16	CARAVAN / GRAND CARAVAN SE Plus	
F	12-16	CARAVAN / GRAND CARAVAN SE	
F	12-16	CARAVAN / GRAND CARAVAN SXT	
F	12-14	CARAVAN / GRAND CARAVAN Crew	
F	12-14	CARAVAN / GRAND CARAVAN Crew Plus	
F	14	CARAVAN / GRAND CARAVAN 30th Anniversary Edition	
F	14	CARAVAN / GRAND CARAVAN SE 30th Anniversary Edition	
F	14	CARAVAN / GRAND CARAVAN SE Canada Value Package	
F	14	CARAVAN / GRAND CARAVAN SXT 30th Anniversary Edition	
F	14	CARAVAN / GRAND CARAVAN SXT Plus	
F	12-13	CARAVAN / GRAND CARAVAN Canada Value Package	
F	08-11	CARAVAN / GRAND CARAVAN All	
F	09-12	VOLKSWAGEN ROUTAN All	
M57207	N		
F	08-12	HONDA ACCORD 2.4L 4Cyl L (144) Left 4 Cyl	
M57208	N		
F	08-12	HONDA ACCORD 2.4L 4Cyl L (2354) Right 4 Cy	
M57212	FF		
F	03-06	FORD EXPEDITION All	
M57285	S		
F	07-13	CHEVROLET PICKUP 1/2 TON, SILVERADO 1500 4WD	
F	07-13	GMC SIERRA 1500 4WD	

Numerical listing

Shock	POP	Alternative No.	MTG Acc. Supplied
Pos.	Year	Application	
M57286	S		
F	03-06	FORD EXPEDITION 4WD	
F	03-06	LINCOLN NAVIGATOR 4WD	
M57287	S		
F	01-07	TOYOTA SEQUOIA All	
F	00-06	TUNDRA All	
M57288	S		
F	01-12	FORD ESCAPE All Left	
F	08-11	MAZDA TRIBUTE All Left	
F	01-06	TRIBUTE All Left	
F	05-11	MERCURY MARINER All Left	
M57289	S		
F	01-12	FORD ESCAPE All Right	
F	08-11	MAZDA TRIBUTE All Right	
F	01-06	TRIBUTE All Right	
F	05-11	MERCURY MARINER All Right	
M57290	S		
F	06-08	DODGE PICKUP 1/2 TON, RAM 1500 (SEE RAM 1500) 4WD	
M57291	S		
R	03-05	HONDA CIVIC All Left	
M57292	S		
R	03-05	HONDA CIVIC All Right	
M57293	S		
F	01-05	CHRYSLER SEBRING Coupe Left	
F	01-05	DODGE STRATUS Coupe Left	
F	99-03	MITSUBISHI GALANT GTZ Left	
M57294	S		
F	01-05	CHRYSLER SEBRING Coupe Right	
F	01-05	DODGE STRATUS Coupe Right	
F	99-03	MITSUBISHI GALANT GTZ Right	
M57295	S		
F	04-06	TOYOTA CAMRY All Left	
F	04-08	SOLARA All Left	
M57296	S		
F	04-06	TOYOTA CAMRY All Right	
F	04-08	SOLARA All Right	
M57297	S		
R	04-06	LEXUS ES330 All Left	
R	04-06	TOYOTA CAMRY All Left	
R	04-06	SOLARA All Left	
M57298	S		
R	04-06	LEXUS ES330 All Right	
R	04-06	TOYOTA CAMRY All Right	
R	04-06	SOLARA All Right	
M57299	N		
F	10-11	FORD CROWN VICTORIA Base	
F	03-11	CROWN VICTORIA LX	
F	03-08	CROWN VICTORIA Base	
F	04-06	CROWN VICTORIA LX Sport	
F	05	CROWN VICTORIA S	
F	03	CROWN VICTORIA LWB	
F	03-11	LINCOLN TOWN CAR All Exc. Limo	
F	03-11	MERCURY GRAND MARQUIS All	
M57300	S		
F	06-11	FORD FOCUS All Left	
M57301	S		
F	06-11	FORD FOCUS All Right	
M57302	S		
F	02-06	HONDA CR-V Automatic Left	
M57303	S		
F	02-06	HONDA CR-V Automatic Right	
M57304	S		
F	00-05	TOYOTA RAV4 AWD, Automatic Left	
M57305	S		
F	00-05	TOYOTA RAV4 AWD, Automatic Right	
M57306	S		
F	05-06	CHEVROLET EQUINOX All Left	
F	06	PONTIAC TORRENT All Left	
M57307	S		
F	05-06	CHEVROLET EQUINOX All Right	
F	06	PONTIAC TORRENT All Right	

Guardian ReadyMount, LTV

Shock	POP	Alternative No.	MTG Acc. Supplied
Pos.	Year	Application	
M57308	FF		
R	03-06	FORD EXPEDITION All	
R	03-06	LINCOLN NAVIGATOR All	
M57309	FF		
F	12-13	MAZDA 3 GS-SKY Left	
F	10-13 3	Grand Touring Left	
F	10-13 3	I Touring Left	
F	08-13 3	GT Left	
F	08-13 3	GX Left	
F	04-13 3	i Left	
F	04-13 3	S Left	
F	10-12 3	GS Left	
F	04-06 3	GT Left	
F	04-06 3	GX Left	
F	06-10 5	All Left	
M57310	FF		
F	12-13	MAZDA 3 GS-SKY Right	
F	12-13 3	GT Right	
F	10-13 3	Grand Touring Right	
F	10-13 3	I Touring Right	
F	08-13 3	GX Right	
F	04-13 3	i Right	
F	04-13 3	S Right	
F	08-12 3	GS Right	
F	04-06 3	GS Right	
F	04-06 3	GX Right	
F	06-10 5	All Right	
M57311	FF		
F	02-07	SATURN VUE All Left	
M57312	FF		
F	02-07	SATURN VUE All Right	
M57313	FF		
R	97-01	HONDA CR-V All	
M57314	FF		
F	08-11	BUICK ENCLAVE All	
F	09-11	CHEVROLET TRAVERSE All	
F	07-09	GMC ACADIA All	
F	07-10	SATURN OUTLOOK All	
M57315	FF		
F	97-01	HONDA CR-V All Left	
M57316	N		
F	97-01	HONDA CR-V All Right	
M57318	FF		
F	01	NISSAN SENTRA All Left	
F	00	SENTRA GXE Left	
F	00	SENTRA SE Left	
F	00	SENTRA XE Left	
M57319	FF		
F	01	NISSAN SENTRA All Right	
F	00	SENTRA GXE Right	
F	00	SENTRA SE Right	
F	00	SENTRA XE Right	
M57335	S		
F	06	VOLVO S80 All Left Mfg. to 3/06	
F	99-05	S80 All Left	
M57336	S		
F	06	VOLVO S80 All Right Mfg. to 3/06	
F	99-05	S80 All Right	
LTV			
58183	W		
F	81-93	DODGE PICKUP 1/2 TON, W100 SERIES All Exc. Lift Kit	
F	61-80	PICKUP 1/2 TON, W100 SERIES All	
F	81-93	PICKUP 1 TON, W300 SERIES All Exc. Quad Suspension and Lift Kit	
F	61-80	PICKUP 1 TON, W300 SERIES All	
R	61-71	PICKUP 1 TON, W300 SERIES All	
F	90-93	PICKUP 3/4 TON, W200 SERIES Extended Cab Pickup Exc. Lift Kit	
F	88-93	PICKUP 3/4 TON, W200 SERIES Cab & Chassis Exc. Lift Kit	
F	81-93	PICKUP 3/4 TON, W200 SERIES Standard Cab Pickup Exc. Lift Kit	
F	86	PICKUP 3/4 TON, W200 SERIES Cab & Chassis Exc. Lift Kit	
F	81-83	PICKUP 3/4 TON, W200 SERIES Cab & Chassis Exc. Lift Kit	
F	81-82	PICKUP 3/4 TON, W200 SERIES Extended Cab Pickup Exc. Lift Kit	
F	69-80	PICKUP 3/4 TON, W200 SERIES All	
F	61-67	PICKUP 3/4 TON, W200 SERIES All	
F	75-93	RAMCHARGER 4WD	
F	74	RAMCHARGER All 4WD	

Numerical listing

Shock	POP	Alternative No.	MTG Acc. Supplied
Pos.	Year	Application	
58183	W	-continued	
F	75-81	PLYMOUTH TRAILDUSTER 4WD	
F	74	TRAILDUSTER All	
58347	W		
F	87-91	CHEVROLET BLAZER 4WD Full Size; Exc. Quad Suspension and Lift Kit	
F	75-86	BLAZER 4WD Exc. Quad Suspension and Lift Kit	
F	73-74	BLAZER All 4WD; Exc. Lift Kit	
F	69-72	BLAZER All 4WD	
F	81-86	PICKUP 1/2 TON, K10 All Standard Suspension; Exc. Lift Kit	
F	69-80	PICKUP 1/2 TON, K10 All Exc. Lift Kit	
F	87	PICKUP 1/2 TON, V10 All Exc. Lift Kit	
F	81-86	PICKUP 3/4 TON, K20 All Standard Suspension; Exc. Lift Kit	
F	69-80	PICKUP 3/4 TON, K20 All Exc. Lift Kit	
F	87	PICKUP 3/4 TON, V20 All Exc. Quad Suspension and Lift Kit	
F	81-86	SUBURBAN 1/2 TON, K10 All Standard Suspension; Exc. Lift Kit	
F	69-80	SUBURBAN 1/2 TON, K10 All Exc. Lift Kit	
F	81-86	SUBURBAN 3/4 TON, K20 All Standard Suspension; Exc. Lift Kit	
F	69-80	SUBURBAN 3/4 TON, K20 All Exc. Lift Kit	
F	87-88	SUBURBAN 3/4 TON, V20 All Exc. Quad Suspension and Lift Kit	
F	89-91	SUBURBAN 3/4 TON, V2500 All Exc. Lift Kit	
F	75-91	GMC JIMMY 4WD Exc. Quad Suspension and Lift Kit	
F	70-74	JIMMY All 4WD; Exc. Quad Suspension and Lift Kit	
F	69-86	PICKUP 1/2 TON, K15 / K1500 All Exc. Quad Suspension and Lift Kit	
F	87	PICKUP 1/2 TON, V1500 All Exc. Lift Kit	
F	69-86	PICKUP 3/4 TON, K25 / K2500 All Exc. Quad Suspension and Lift Kit	
F	87	PICKUP 3/4 TON, V2500 All Exc. Lift Kit	
F	69-86	SUBURBAN 1/2 TON, K15 / K1500 All Exc. Quad Suspension and Lift Kit	
F	87-91	SUBURBAN 1/2 TON, V1500 All Exc. Quad Suspension and Lift Kit	
F	69-86	SUBURBAN 3/4 TON, K25 / K2500 All Exc. Quad Suspension and Lift Kit	
F	87-91	SUBURBAN 3/4 TON, V2500 All Exc. Quad Suspension and Lift Kit	
58349	W	140357	
R	87-91	CHEVROLET BLAZER 4WD Full Size; Exc. Lift Kit	
R	85-86	BLAZER 4WD Exc. Lift Kit	
R	73-84	BLAZER All Exc. Lift Kit	
R	73-86	PICKUP 1/2 TON, C10 All	
R	81-86	PICKUP 1/2 TON, K10 All Standard Suspension; Exc. Lift Kit	
R	73-80	PICKUP 1/2 TON, K10 All Exc. Lift Kit	
R	87	PICKUP 1/2 TON, R10 All	
R	87	PICKUP 1/2 TON, V10 All Exc. Lift Kit	
R	75-86	PICKUP 3/4 TON, C20 Standard Cab Pickup	
R	73-74	PICKUP 3/4 TON, C20 All Standard Cab Pickup	
R	81-86	PICKUP 3/4 TON, K20 All Standard Suspension; Exc. Lift Kit	
R	73-80	PICKUP 3/4 TON, K20 All Exc. Lift Kit	
R	87	PICKUP 3/4 TON, R20 Standard Cab Pickup	
R	87	PICKUP 3/4 TON, V20 All Exc. Quad Suspension and Lift Kit	
R	73-86	SUBURBAN 1/2 TON, C10 All	
R	81-86	SUBURBAN 1/2 TON, K10 All Standard Suspension; Exc. Lift Kit	
R	73-80	SUBURBAN 1/2 TON, K10 All Exc. Lift Kit	
R	87-88	SUBURBAN 1/2 TON, R10 All	
R	89-91	SUBURBAN 1/2 TON, R1500 All	
R	87-88	SUBURBAN 1/2 TON, V10 All Exc. Lift Kit	
R	89-91	SUBURBAN 1/2 TON, V1500 All Exc. Lift Kit	

Numerical listing

Shock	POP	Alternative No.	MTG Acc. Supplied
Pos.	Year	Application	
58349	W	-continued	140357
R	73-86	SUBURBAN 3/4 TON, C20 All	
R	81-86	SUBURBAN 3/4 TON, K20 All Standard Suspension; Exc. Lift Kit	
R	73-80	SUBURBAN 3/4 TON, K20 All Exc. Lift Kit	
R	87-88	SUBURBAN 3/4 TON, R20 All	
R	89-91	SUBURBAN 3/4 TON, R2500 All	
R	87-88	SUBURBAN 3/4 TON, V20 All Exc. Quad Suspension and Lift Kit	
R	89-91	SUBURBAN 3/4 TON, V2500 All Exc. Lift Kit	
R	73	VAN 1/2 TON, P SERIES All	
R	73-78	VAN 3/4 TON, P SERIES All	
R	73-91	GMC JIMMY All Exc. Lift Kit	
R	73-86	PICKUP 1/2 TON, C15 / C1500 All	
R	73-86	PICKUP 1/2 TON, K15 / K1500 All Exc. Lift Kit	
R	87	PICKUP 1/2 TON, R1500 All	
R	87	PICKUP 1/2 TON, V1500 All Exc. Lift Kit	
R	75-86	PICKUP 3/4 TON, C25 / C2500 Cab & Chassis	
R	75-86	PICKUP 3/4 TON, C25 / C2500 Standard Cab Pickup	
R	73-74	PICKUP 3/4 TON, C25 / C2500 All Exc. Crew Cab & Bonus Cab	
R	73-86	PICKUP 3/4 TON, K25 / K2500 All Exc. Lift Kit	
R	88-89	PICKUP 3/4 TON, R2500 All Exc. Crew Cab & Bonus Cab	
R	87	PICKUP 3/4 TON, R2500 Cab & Chassis Exc. Crew Cab & Bonus Cab	
R	87	PICKUP 3/4 TON, R2500 Standard Cab Pickup Exc. Crew Cab & Bonus Cab	
R	87	PICKUP 3/4 TON, V2500 All Exc. Lift Kit	
R	73-86	SUBURBAN 1/2 TON, C15 / C1500 All	
R	73-86	SUBURBAN 1/2 TON, K15 / K1500 All Exc. Lift Kit	
R	87-91	SUBURBAN 1/2 TON, R1500 All	
R	87-91	SUBURBAN 1/2 TON, V1500 All Exc. Lift Kit	
R	73-86	SUBURBAN 3/4 TON, C25 / C2500 All	
R	73-86	SUBURBAN 3/4 TON, K25 / K2500 All Exc. Lift Kit	
R	87-91	SUBURBAN 3/4 TON, R2500 All	
R	87-91	SUBURBAN 3/4 TON, V2500 All Exc. Lift Kit	
R	73	VAN 1/2 TON, P SERIES All	
R	73-78	VAN 3/4 TON, P SERIES All	
58350	W		140126
R	66	FORD BRONCO All Thru Serial #830000	
R	75-79	PICKUP 1/2 TON, F-100 RWD	
R	70-74	PICKUP 1/2 TON, F-100 Standard Cab Pickup RWD	
R	75-79	PICKUP 1/2 TON, F-150 RWD	
R	75-79	PICKUP 1 TON, F-350 / SUPERDUTY Extended Cab Pickup, RWD	
R	74	PICKUP 1 TON, F-350 / SUPERDUTY Standard Cab Pickup RWD	
R	75-79	PICKUP 3/4 TON, F-250 / SUPERDUTY Cab & Chassis, RWD	
R	75-79	PICKUP 3/4 TON, F-250 / SUPERDUTY Standard Cab Pickup, RWD	
R	70-74	PICKUP 3/4 TON, F-250 / SUPERDUTY Standard Cab Pickup RWD	
R	75-91	VAN 1/2 TON, ECONOLINE / CLUB WAGON All	
F	71-80	INTERNATIONAL SCOUT II All	
58353	X		
R	72-93	DODGE PICKUP 1/2 TON, D100 SERIES All	
R	72-93	PICKUP 1 TON, D300 SERIES All	
R	72-93	PICKUP 3/4 TON, D200 SERIES All	
R	76-93	RAMCHARGER RWD	
R	74-75	RAMCHARGER All	
R	75-81	PLYMOUTH TRAILDUSTER RWD	
R	74	TRAILDUSTER All	
58355	W		140702
F	75-84	CHEVROLET BLAZER RWD	
F	69-74	BLAZER All RWD	
F	63-86	PICKUP 1/2 TON, C10 All	

LTV

Shock	POP	Alternative No.	MTG Acc. Supplied
Pos.	Year	Application	
58355	W	-continued	140702
F	87	PICKUP 1/2 TON, R10 All	
F	63-86	PICKUP 1 TON, C30 All	
F	88-91	PICKUP 1 TON, C35/3500 Cab & Chassis Exc. HD Solid Front Axle	
F	87-88	PICKUP 1 TON, R30 All	
F	89	PICKUP 1 TON, R3500 Standard Cab Pickup	
F	75-86	PICKUP 3/4 TON, C20 Crew Cab Pickup	
F	75-86	PICKUP 3/4 TON, C20 Standard Cab Pickup	
F	63-74	PICKUP 3/4 TON, C20 All	
F	87-88	PICKUP 3/4 TON, R20 Crew Cab Pickup	
F	87	PICKUP 3/4 TON, R20 Standard Cab Pickup	
F	89	PICKUP 3/4 TON, R2500 All	
F	63-66	SUBURBAN 1/2 TON, 1500 All	
F	67-86	SUBURBAN 1/2 TON, C10 All	
F	87-88	SUBURBAN 1/2 TON, R10 All	
F	89-91	SUBURBAN 1/2 TON, R1500 All	
F	68-86	SUBURBAN 3/4 TON, C20 All	
F	87-88	SUBURBAN 3/4 TON, R20 All	
F	89-91	SUBURBAN 3/4 TON, R2500 All	
F	63-80	VAN 1/2 TON, P SERIES All	
F	73-90	VAN 1 TON, P SERIES All Cutaway Chassis	
F	68-72	VAN 1 TON, P SERIES All	
F	68-89	VAN 3/4 TON, P SERIES All	
F	75-84	GMC JIMMY RWD	
F	70-74	JIMMY All RWD	
F	67-86	PICKUP 1/2 TON, C15 / C1500 All	
F	87	PICKUP 1/2 TON, R1500 All	
F	88-90	PICKUP 1 TON, C35/3500 Cab & Chassis HD Solid Front Axle	
F	67-78	PICKUP 1 TON, C35/3500 All	
F	87-91	PICKUP 1 TON, R3500 All	
F	85-86	PICKUP 3/4 TON, C25 / C2500 Crew Cab Pickup	
F	75-86	PICKUP 3/4 TON, C25 / C2500 Cab & Chassis	
F	75-86	PICKUP 3/4 TON, C25 / C2500 Standard Cab Pickup	
F	75-83	PICKUP 3/4 TON, C25 / C2500 Crew Cab Pickup	
F	67-74	PICKUP 3/4 TON, C25 / C2500 All	
F	87-89	PICKUP 3/4 TON, R2500 All Exc. Crew Cab & Bonus Cab	
F	63-65	PICKUP 1000 SERIES All	
F	63-65	PICKUP 1500 SERIES All	
F	68-86	SUBURBAN 1/2 TON, C15 / C1500 All	
F	87-91	SUBURBAN 1/2 TON, R1500 All	
F	68-86	SUBURBAN 3/4 TON, C25 / C2500 All	
F	87-91	SUBURBAN 3/4 TON, R2500 All	
F	67-80	VAN 1/2 TON, P SERIES All	
F	74-90	VAN 1 TON, P SERIES All Cutaway Chassis	
F	73	VAN 1 TON, P SERIES Base Cutaway Chassis	
F	68-72	VAN 1 TON, P SERIES All	
F	68-89	VAN 3/4 TON, P SERIES All	
F	63-65	VAN, PB 1000 SERIES All	
58357	W		
F	71-95	CHEVROLET VAN 1/2 TON, G / EXPRESS All	
F	70	VAN 1/2 TON, G / EXPRESS All Independent Front Suspension	
F	78-96	VAN 1 TON, G / EXPRESS All	
F	96	VAN 1 TON, G / EXPRESS Cutaway Van	
F	75	VAN 1 TON, G / EXPRESS 146.0 (WheelBase)	
F	71-74	VAN 1 TON, G / EXPRESS All	
F	78-95	VAN 3/4 TON, G / EXPRESS All Exc. 8600# GVW	
F	70-77	VAN 3/4 TON, G / EXPRESS All	
F	70-95	GMC VAN 1/2 TON, G / SAVANNA All	
F	76-96	VAN 1 TON, G / SAVANNA All	
F	75	VAN 1 TON, G / SAVANNA 110.0 (WheelBase)	
F	75	VAN 1 TON, G / SAVANNA 125.0 (WheelBase)	
F	71-74	VAN 1 TON, G / SAVANNA All	
F	78-95	VAN 3/4 TON, G / SAVANNA All Exc. 8600# GVW	
F	71-77	VAN 3/4 TON, G / SAVANNA All	
F	70	VAN 3/4 TON, G / SAVANNA All Independent Front Suspension	

Numerical listing

Shock	POP	Alternative No.	MTG Acc. Supplied
Pos.	Year	Application	
58359	W		140126
F	84-86	DODGE MINI RAM All	
F	72-93	PICKUP 1/2 TON, D100 SERIES All	
F	72-93	PICKUP 3/4 TON, D200 SERIES All Exc. HD Package	
F	75-93	RAMCHARGER RWD	
F	99-03	VAN 1/2 TON, A / B SERIES / RAM 109.3 (WheelBase) Exc. 7000# GVW	
F	81-98	VAN 1/2 TON, A / B SERIES / RAM 109.6 (WheelBase) Exc. 7000# GVW	
F	71-80	VAN 1/2 TON, A / B SERIES / RAM All	
F	99-03	VAN 1 TON, A / B SERIES / RAM All	
F	71-98	VAN 1 TON, A / B SERIES / RAM All Exc. 4000# Front Axle	
F	71-03	VAN 3/4 TON, A / B SERIES / RAM All	
F	78-80	VAN, CB300 All Exc. 4000# Front Axle	
F	74-77	VAN, CB300 All Up through 8300# GVW	
F	75-81	PLYMOUTH TRAILDUSTER RWD	
F	74-83	VAN 1/2 TON, PB SERIES All	
F	74-83	VAN 1 TON, PB SERIES All Exc. 4000# Front Axle	
F	74-83	VAN 3/4 TON, PB SERIES All	
58360	W		140126
F	72-93	DODGE PICKUP 1 TON, D300 SERIES All	
F	82-93	PICKUP 3/4 TON, D200 SERIES All HD Package	
F	81	PICKUP 3/4 TON, D200 SERIES 165.0 (WheelBase) HD Package	
F	77-80	PICKUP 3/4 TON, D200 SERIES All HD Package	
F	75-76	PICKUP 3/4 TON, D200 SERIES 165.0 (WheelBase) HD Package	
F	72-74	PICKUP 3/4 TON, D200 SERIES All HD Package	
F	71-93	VAN 1 TON, A / B SERIES / RAM All 4000# Front Axle	
F	74-80	VAN, CB300 All Over 8300# GVW	
F	74-83	PLYMOUTH VAN 1 TON, PB SERIES All 4000# Front Axle	
58366	W		
R	73-86	CHEVROLET PICKUP 1 TON, C30 All	
R	88-91	PICKUP 1 TON, C35/3500 Cab & Chassis Exc. HD Solid Front Axle	
R	87-88	PICKUP 1 TON, R30 All	
R	89	PICKUP 1 TON, R3500 Standard Cab Pickup	
R	75-86	PICKUP 3/4 TON, C20 Crew Cab Pickup	
R	73-74	PICKUP 3/4 TON, C20 All Crew Cab Pickup	
R	87-88	PICKUP 3/4 TON, R20 Crew Cab Pickup	
R	89	PICKUP 3/4 TON, R2500 All	
R	74-80	VAN 1/2 TON, P SERIES All	
R	73-99	VAN 1 TON, P SERIES All	
R	79-89	VAN 3/4 TON, P SERIES All	
R	88-91	GMC PICKUP 1 TON, C35/3500 Cab & Chassis Exc. HD Solid Front Axle	
R	73-78	PICKUP 1 TON, C35/3500 All	
R	87-91	PICKUP 1 TON, R3500 All	
R	85-86	PICKUP 3/4 TON, C25 / C2500 Crew Cab Pickup	
R	75-83	PICKUP 3/4 TON, C25 / C2500 Crew Cab Pickup	
R	87-89	PICKUP 3/4 TON, R2500 Crew Cab Pickup	
R	74-80	VAN 1/2 TON, P SERIES All	
R	74-99	VAN 1 TON, P SERIES All	
R	73	VAN 1 TON, P SERIES Base Cutaway Chassis	
R	79-89	VAN 3/4 TON, P SERIES All	
58377	X		
R	78-79	FORD BRONCO All Exc. Lift Kit	
R	66-77	BRONCO All From Serial #830001; Exc. Lift Kit	
R	65-69	PICKUP 1/2 TON, F-100 All RWD	
R	75-79	PICKUP 1 TON, F-350 / SUPERDUTY Standard Cab Pickup, RWD	
R	75-79	PICKUP 3/4 TON, F-250 / SUPERDUTY Extended Cab Pickup, RWD	

Numerical listing

Shock	POP	Alternative No.	MTG Acc. Supplied
Pos.	Year	Application	
58377	X	-continued	
R	70-74	PICKUP 3/4 TON, F-250 / SUPERDUTY All RWD; Extended Cab Pickup	
R	65-69	PICKUP 3/4 TON, F-250 / SUPERDUTY All RWD	
R	76-83	JEEP CHEROKEE All	
F	74-83	CHEROKEE All	
R	93	GRAND WAGONEER All	
F	84-91	GRAND WAGONEER All	
R	84-91	GRAND WAGONEER All	
R	76-83	WAGONEER All	
F	74-83	WAGONEER All	
58386	W	140780	
F	66-77	FORD BRONCO All From Serial #830001; Exc. Lift Kit	
F	75-79	PICKUP 1/2 TON, F-100 RWD	
F	65-74	PICKUP 1/2 TON, F-100 All RWD	
F	75-79	PICKUP 1/2 TON, F-150 RWD	
F	75-79	PICKUP 1 TON, F-350 / SUPERDUTY RWD	
F	73-74	PICKUP 1 TON, F-350 / SUPERDUTY Standard Cab Pickup RWD	
F	75-79	PICKUP 3/4 TON, F-250 / SUPERDUTY RWD	
F	65-74	PICKUP 3/4 TON, F-250 / SUPERDUTY All RWD	
F	77-91	VAN 1 TON, ECONOLINE / CLUB WAGON / SUPERDUTY All	
F	75-91	VAN 1 TON, ECONOLINE / CLUB WAGON / SUPERDUTY All Exc. Cutaway Chassis	
F	75-91	VAN 3/4 TON, ECONOLINE / CLUB WAGON / SUPERDUTY All	
58389	W		
R	81-93	DODGE PICKUP 1/2 TON, W100 SERIES All Exc. Lift Kit	
R	72-80	PICKUP 1/2 TON, W100 SERIES All	
R	81-93	PICKUP 1 TON, W300 SERIES All Exc. Quad Suspension and Lift Kit	
R	72-80	PICKUP 1 TON, W300 SERIES All	
R	90-93	PICKUP 3/4 TON, W200 SERIES Extended Cab Pickup Exc. Lift Kit	
R	88-93	PICKUP 3/4 TON, W200 SERIES Cab & Chassis Exc. Lift Kit	
R	81-93	PICKUP 3/4 TON, W200 SERIES Standard Cab Pickup Exc. Lift Kit	
R	86	PICKUP 3/4 TON, W200 SERIES Cab & Chassis Exc. Lift Kit	
R	81-83	PICKUP 3/4 TON, W200 SERIES Cab & Chassis Exc. Lift Kit	
R	81-82	PICKUP 3/4 TON, W200 SERIES Extended Cab Pickup Exc. Lift Kit	
R	72-80	PICKUP 3/4 TON, W200 SERIES All	
R	76-93	RAMCHARGER 4WD	
R	76-81	PLYMOUTH TRAILDUSTER 4WD	
58394	W	140702	
F	85-99	CHEVROLET VAN 1 TON, P SERIES All Motorhome Chassis with Independent Front Suspension	
F	74-84	VAN 1 TON, P SERIES All Motorhome Chassis	
F	85-99	GMC VAN 1 TON, P SERIES All Motorhome Chassis with Independent Front Suspension	
F	75-84	VAN 1 TON, P SERIES All Motorhome Chassis	
F	74	VAN 1 TON, P SERIES Motor Home Motorhome Chassis	
58403	W		
R	79-95	CHEVROLET VAN 1 TON, G / EXPRESS Cutaway Van	
F	85	VAN 1 TON, P SERIES All Motorhome Chassis with I-Beam Front Suspension	
R	97-04	DODGE DAKOTA All	
R	01-03	DURANGO 4WD	
R	01-03	DURANGO RWD	
R	98-00	DURANGO All	
R	79-95	GMC VAN 1 TON, G / SAVANNA Cutaway Van	
F	85	VAN 1 TON, P SERIES All Motorhome Chassis with I-Beam Front Suspension	
58406	W		
R	85-96	FORD PICKUP 1/2 TON, F-150 RWD	
R	80-97	PICKUP 1 TON, F-350 / SUPERDUTY RWD Exc. Dual Rear Wheels	

LTV

Shock	POP	Alternative No.	MTG Acc. Supplied
Pos.	Year	Application	
58406	W	-continued	
R	97	PICKUP 3/4 TON, F-250 / SUPERDUTY RWD Over 8500# GVW	
R	80-96	PICKUP 3/4 TON, F-250 / SUPERDUTY RWD	
58409	W		
R	80-96	FORD BRONCO All Exc. Lift Kit	
R	80-83	PICKUP 1/2 TON, F-100 RWD	
R	80-84	PICKUP 1/2 TON, F-150 RWD	
R	90-97	PICKUP 1/2 TON, F SUPERDUTY All	
R	80-97	PICKUP 1 TON, F-350 / SUPERDUTY RWD Dual Rear Wheels	
R	97	PICKUP, F-450 SUPERDUTY All	
58411	W		
F	77-86	CHEVROLET PICKUP 1 TON, K30 All	
F	90-91	PICKUP 1 TON, R3500 All	
F	89	PICKUP 1 TON, R3500 Cab & Chassis	
F	89	PICKUP 1 TON, R3500 Crew Cab Pickup	
F	87-88	PICKUP 1 TON, V30 All	
F	89-91	PICKUP 1 TON, V3000 / V3500 All	
F	77-86	GMC PICKUP 1 TON, K35 / K3500 All	
F	87-91	PICKUP 1 TON, V3000 / V3500 All	
58412	D		
R	07	CHEVROLET PICKUP 1/2 TON, SILVERADO 1500 4WD Old Body Style; Exc. Electronic Adjustable Suspension	
R	99-06	PICKUP 1/2 TON, SILVERADO 1500 4WD Exc. Electronic Adjustable Suspension	
R	05-06	PICKUP 1/2 TON, SILVERADO 1500 HD All	
R	01-03	PICKUP 1/2 TON, SILVERADO 1500 HD All	
R	77-86	PICKUP 1 TON, K30 All	
R	90-91	PICKUP 1 TON, R3500 All	
R	89	PICKUP 1 TON, R3500 Cab & Chassis	
R	89	PICKUP 1 TON, R3500 Crew Cab Pickup	
R	08-09	PICKUP 1 TON, SILVERADO 3500 All	
R	01-06	PICKUP 1 TON, SILVERADO 3500 All	
R	07-10	PICKUP 1 TON, SILVERADO 3500 HD All	
R	87-88	PICKUP 1 TON, V30 All	
R	89-91	PICKUP 1 TON, V3000 / V3500 All	
R	99-08	PICKUP 3/4 TON, SILVERADO 2500 All	
R	08-10	PICKUP 3/4 TON, SILVERADO 2500 HD All	
R	01-06	PICKUP 3/4 TON, SILVERADO 2500 HD All	
R	07	SILVERADO 1500 HD CLASSIC All	
R	07	SILVERADO 2500 HD CLASSIC All	
R	07	SILVERADO 3500 CLASSIC All	
R	06-07	DODGE PICKUP 1/2 TON, RAM 1500 (SEE RAM 1500) All Exc. Mega Cab	
R	02-05	PICKUP 1/2 TON, RAM 1500 (SEE RAM 1500) All	
R	77-86	GMC PICKUP 1 TON, K35 / K3500 All	
R	87-91	PICKUP 1 TON, V3000 / V3500 All	
R	07	SIERRA 1500 4WD Old Body Style; Exc. Electronic Adjustable Suspension	
R	99-06	SIERRA 1500 4WD Exc. Electronic Adjustable Suspension	
R	05-06	SIERRA 1500 HD All	
R	01-03	SIERRA 1500 HD All	
R	07	SIERRA 1500 HD CLASSIC All	
R	99-04	SIERRA 2500 All	
R	01-10	SIERRA 2500 HD All	
R	07	SIERRA 2500 HD CLASSIC All	
R	01-06	SIERRA 3500 All	
R	07	SIERRA 3500 CLASSIC All	
R	07-10	SIERRA 3500 HD All	
58413	W		
R	78-95	CHEVROLET VAN 1/2 TON, G / EXPRESS All	
R	78-91	VAN 1 TON, G / EXPRESS Standard Cargo Van	

Numerical listing

Shock	POP	Alternative No.	MTG Acc. Supplied
Pos.	Year	Application	
58413	W	-continued	
R	78-91	VAN 1 TON, G / EXPRESS Standard Passenger Van	
R	78-95	VAN 3/4 TON, G / EXPRESS All Exc. 8600# GVW	
R	84-86	DODGE MINI RAM All	
R	99-03	VAN 1/2 TON, A / B SERIES / RAM 109.3 (WheelBase) Exc. 7000# GVW	
R	81-98	VAN 1/2 TON, A / B SERIES / RAM 109.6 (WheelBase) Exc. 7000# GVW	
R	71-80	VAN 1/2 TON, A / B SERIES / RAM All	
R	99-03	VAN 1 TON, A / B SERIES / RAM All	
R	95-98	VAN 1 TON, A / B SERIES / RAM All Exc. 4000# Front Axle	
R	71-94	VAN 1 TON, A / B SERIES / RAM All	
R	71-03	VAN 3/4 TON, A / B SERIES / RAM All	
R	74-80	VAN, CB300 All	
R	78-95	GMC VAN 1/2 TON, G / SAVANNA All	
R	85-96	VAN 1 TON, G / SAVANNA Extended Cargo Van	
R	85-96	VAN 1 TON, G / SAVANNA Extended Passenger Van	
R	79-96	VAN 1 TON, G / SAVANNA Standard Cargo Van	
R	79-96	VAN 1 TON, G / SAVANNA Standard Passenger Van	
R	78	VAN 1 TON, G / SAVANNA Cutaway Van	
R	78-95	VAN 3/4 TON, G / SAVANNA All Exc. 8600# GVW	
R	74-83	PLYMOUTH VAN 1/2 TON, PB SERIES All	
R	74-83	VAN 1 TON, PB SERIES All	
R	74-83	VAN 3/4 TON, PB SERIES All	
58414	W	140780	
F	80-96	FORD BRONCO All Quad & Non Quad Suspensions Rearward of Front Axle; Exc. Lift Kit	
F	80-83	PICKUP 1/2 TON, F-100 RWD	
F	80-96	PICKUP 1/2 TON, F-150 4WD Quad & Non Quad Suspensions Rearward of Front Axle; Exc. Lift Kit	
F	80-96	PICKUP 1/2 TON, F-150 RWD	
F	80-97	PICKUP 1 TON, F-350 / SUPERDUTY RWD	
F	97	PICKUP 3/4 TON, F-250 / SUPERDUTY RWD Over 8500# GVW	
F	80-96	PICKUP 3/4 TON, F-250 / SUPERDUTY RWD	
58421	W	140455	
F	05	CHEVROLET BLAZER Base, RWD	
F	96-04	BLAZER LS, RWD	
F	95-02	BLAZER LT, RWD	
F	95-99	BLAZER Base, RWD	
F	95-97	BLAZER Deluxe, RWD	
F	83-94	BLAZER, S MODELS RWD	
F	94-03	S10 LS, RWD	
F	82-03	S10 Base, RWD	
F	92-93	S10 EL, RWD	
F	83-92	S10 Tahoe, RWD	
F	88-90	S10 Durango, RWD	
F	82-86	S10 Durango, RWD	
F	72-82	FORD COURIER All	
F	92-04	GMC JIMMY RWD	
F	83-91	S15 JIMMY RWD	
F	04	SONOMA / S15 All RWD	
F	82-03	SONOMA / S15 RWD	
F	78-87	SPRINT / CABALLERO RWD	
F	71-77	SPRINT / CABALLERO All	
F	96-00	ISUZU HOMBRE RWD Exc. Sport Chassis	
F	72-76	MAZDA B1600 All	
F	77-78	B1800 All	
F	79-84	B2000 All	
F	82-84	B2200 All	
58422	W		
R	05	CHEVROLET BLAZER Base, 4WD	
R	05	BLAZER Base, RWD	
R	96-04	BLAZER LS, 4WD	
R	96-04	BLAZER LS, RWD	
R	95-02	BLAZER LT, RWD	
R	95-01	BLAZER LT, 4WD	
R	95-99	BLAZER Base, 4WD	
R	95-99	BLAZER Base, RWD	
R	95-97	BLAZER Deluxe, RWD	
R	83-94	BLAZER, S MODELS All	

Numerical listing

Shock	POP	Alternative No.	MTG Acc. Supplied
Pos.	Year	Application	
58422	W	-continued	
R	99-04	S10 LS, 4WD	
R	99-03	S10 Base, 4WD	
R	99-03	S10 Base, RWD	
R	99-03	S10 LS, RWD	
R	94-98	S10 LS	
R	82-98	S10 Base	
R	92-93	S10 EL	
R	83-92	S10 Tahoe	
R	88-90	S10 Durango	
R	82-86	S10 Durango	
R	05	GMC JIMMY 4WD	
R	92-04	JIMMY All	
R	83-91	S15 JIMMY All	
R	82-04	SONOMA / S15 All	
R	91	SYCLONE All	
R	92-93	TYPHOON All	
R	96-00	ISUZU HOMBRE All	
R	96-01	OLDSMOBILE BRAVADA All	
R	91-94	BRAVADA All	
58423	W		
F	05	CHEVROLET BLAZER Base, 4WD	
F	96-04	BLAZER LS, 4WD	
F	95-01	BLAZER LT, 4WD	
F	95-99	BLAZER Base, 4WD	
F	83-94	BLAZER, S MODELS 4WD	
F	94-04	S10 LS, 4WD	
F	83-03	S10 Base, 4WD	
F	92-93	S10 EL, 4WD	
F	83-92	S10 Tahoe, 4WD	
F	88-90	S10 Durango, 4WD	
F	88	S10 Sport, 4WD	
F	83-86	S10 Durango, 4WD	
F	92-05	GMC JIMMY 4WD	
F	83-91	S15 JIMMY 4WD	
F	83-04	SONOMA / S15 4WD	
F	91	SYCLONE All	
F	92-93	TYPHOON All	
F	96-00	ISUZU HOMBRE All Sport Chassis	
F	96-01	OLDSMOBILE BRAVADA All	
F	91-94	BRAVADA All	
58437	W		
F	87-91	CHEVROLET BLAZER 4WD Full Size; 4" Lift Kit; Exc. Quad Suspension	
F	75-86	BLAZER 4WD 4" Lift Kit; Exc. Quad Suspension	
F	73-74	BLAZER All 4WD; 4" Lift Kit; Exc. Quad Suspension	
F	73-86	PICKUP 1/2 TON, K10 All 4" Lift Kit; Exc. Quad Suspension	
F	87	PICKUP 1/2 TON, V10 All 4" Lift Kit; Exc. Quad Suspension	
F	73-86	PICKUP 3/4 TON, K20 All 4" Lift Kit; Exc. Quad Suspension	
F	87	PICKUP 3/4 TON, V20 All 4" Lift Kit; Exc. Quad Suspension	
F	73-86	SUBURBAN 1/2 TON, K10 All 4" Lift Kit; Exc. Quad Suspension	
F	89-91	SUBURBAN 1/2 TON, V1500 4WD 4" Lift Kit; Exc. Quad Suspension	
F	73-86	SUBURBAN 3/4 TON, K20 All 4" Lift Kit; Exc. Quad Suspension	
F	87-88	SUBURBAN 3/4 TON, V20 All 4" Lift Kit; Exc. Quad Suspension	
F	89-91	SUBURBAN 3/4 TON, V2500 All 4" Lift Kit; Exc. Quad Suspension	
F	75-91	GMC JIMMY 4WD 4" Lift Kit; Exc. Quad Suspension	
F	73-74	JIMMY All 4" Lift Kit; Exc. Quad Suspension	
F	73-86	PICKUP 1/2 TON, K15 / K1500 All 4" Lift Kit; Exc. Quad Suspension	
F	87	PICKUP 1/2 TON, V1500 All 4" Lift Kit; Exc. Quad Suspension	
F	73-86	PICKUP 3/4 TON, K25 / K2500 All 4" Lift Kit; Exc. Quad Suspension	
F	87	PICKUP 3/4 TON, V2500 All 4" Lift Kit; Exc. Quad Suspension	
F	73-86	SUBURBAN 1/2 TON, K15 / K1500 All 4" Lift Kit; Exc. Quad Suspension	
F	87-91	SUBURBAN 1/2 TON, V1500 All 4" Lift Kit; Exc. Quad Suspension	
F	73-86	SUBURBAN 3/4 TON, K25 / K2500 All 4" Lift Kit; Exc. Quad Suspension	
F	87-91	SUBURBAN 3/4 TON, V2500 All 4" Lift Kit; Exc. Quad Suspension	
58438	W	140357	
R	87-90	CHEVROLET BLAZER 4WD Full Size; 4" Lift Kit; Exc. Quad Suspension	

LTV

Shock	POP	Alternative No.	MTG Acc. Supplied
Pos.	Year	Application	
58438	W	-continued 140357	
R	75-86	BLAZER 4WD 4" Lift Kit; Exc. Quad Suspension	
R	73-74	BLAZER All 4WD; 4" Lift Kit; Exc. Quad Suspension	
R	73-86	PICKUP 1/2 TON, K10 All 4" Lift Kit; Exc. Quad Suspension	
R	87	PICKUP 1/2 TON, V10 All 4" Lift Kit; Exc. Quad Suspension	
R	73-86	PICKUP 3/4 TON, K20 All 4" Lift Kit; Exc. Quad Suspension	
R	87	PICKUP 3/4 TON, V20 All 4" Lift Kit; Exc. Quad Suspension	
R	73-86	SUBURBAN 1/2 TON, K10 All 4" Lift Kit; Exc. Quad Suspension	
R	73-86	SUBURBAN 3/4 TON, K20 All 4" Lift Kit; Exc. Quad Suspension	
R	87-88	SUBURBAN 3/4 TON, V20 All 4" Lift Kit; Exc. Quad Suspension	
R	89-91	SUBURBAN 3/4 TON, V2500 All 4" Lift Kit; Exc. Quad Suspension	
R	85-91	GMC JIMMY All 4" Lift Kit	
R	75-84	JIMMY 4WD 4" Lift Kit	
R	73-74	JIMMY All 4WD w/ 4" Lift Kit	
R	73-86	PICKUP 1/2 TON, K15 / K1500 All 4" Lift Kit; Exc. Quad Suspension	
R	87	PICKUP 1/2 TON, V1500 All 4" Lift Kit; Exc. Quad Suspension	
R	73-86	PICKUP 3/4 TON, K25 / K2500 All 4" Lift Kit; Exc. Quad Suspension	
R	87	PICKUP 3/4 TON, V2500 All 4" Lift Kit; Exc. Quad Suspension	
R	73-86	SUBURBAN 1/2 TON, K15 / K1500 All 4" Lift Kit; Exc. Quad Suspension	
R	87-91	SUBURBAN 1/2 TON, V1500 All 4" Lift Kit; Exc. Quad Suspension	
R	73-86	SUBURBAN 3/4 TON, K25 / K2500 All 4" Lift Kit; Exc. Quad Suspension	
R	87-91	SUBURBAN 3/4 TON, V2500 All 4" Lift Kit; Exc. Quad Suspension	
58455	W		
F	86-97	FORD PICKUP 1 TON, F-350 / SUPERDUTY 4WD	
F	98	PICKUP 3/4 TON, F-250 / SUPERDUTY All Over 8500# GVW	
F	97	PICKUP 3/4 TON, F-250 / SUPERDUTY 4WD Over 8500# GVW	
F	87-96	PICKUP 3/4 TON, F-250 / SUPERDUTY 4WD	
58461	W		
R	80-96	FORD PICKUP 1/2 TON, F-150 4WD Exc. Lift Kit	
R	86-97	PICKUP 1 TON, F-350 / SUPERDUTY 4WD Dual Rear Wheels	
R	82-85	PICKUP 1 TON, F-350 / SUPERDUTY 4WD Clevis Type Lower Front Mount; Exc. Dual Rear Wheels or Lift Kit	
R	80-81	PICKUP 1 TON, F-350 / SUPERDUTY 4WD Dual Rear Wheels	
R	97	PICKUP 3/4 TON, F-250 / SUPERDUTY 4WD Over 8500# GVW	
R	86-96	PICKUP 3/4 TON, F-250 / SUPERDUTY 4WD	
R	82-85	PICKUP 3/4 TON, F-250 / SUPERDUTY 4WD Clevis Type Lower Front Mount; Exc. Dual Rear Wheels or Lift Kit	
R	80-81	PICKUP 3/4 TON, F-250 / SUPERDUTY 4WD	
58488	W		
R	91-02	CHEVROLET C3500HD All Solid Front Axle	
R	88-99	PICKUP 1/2 TON, C15 / C1500 All	
R	88-99	PICKUP 1/2 TON, K15 / K1500 All	
R	01-03	PICKUP 1 TON, C35/3500 HD, Standard Cab Pickup HD Solid Front Axle	
R	88-90	PICKUP 1 TON, C35/3500 Extended Cab Pickup Exc. HD Straight Front Axle	
R	88-90	PICKUP 1 TON, C35/3500 Standard Cab Pickup Exc. HD Straight Front Axle	
R	88-00	PICKUP 1 TON, K35 / K3500 All	
R	88-00	PICKUP 3/4 TON, C25 / C2500 All	
R	88-00	PICKUP 3/4 TON, K25 / K2500 All	
R	91-02	GMC C3500HD All Solid Front Axle	

Numerical listing

Shock	POP	Alternative No.	MTG Acc. Supplied
Pos.	Year	Application	
58488	W	-continued	
R	88-99	PICKUP 1/2 TON, C15 / C1500 All	
R	88-99	PICKUP 1/2 TON, K15 / K1500 All	
R	98-99	PICKUP 1 TON, C35/3500 Cab & Chassis HD Solid Front Axle	
R	88-97	PICKUP 1 TON, C35/3500 All HD Solid Front Axle	
R	88-00	PICKUP 1 TON, K35 / K3500 All	
R	88-00	PICKUP 3/4 TON, C25 / C2500 All	
R	88-00	PICKUP 3/4 TON, K25 / K2500 All	
58489	W	141537	
F	88-99	CHEVROLET PICKUP 1/2 TON, C15 / C1500 All	
F	92-00	PICKUP 1 TON, C35/3500 Crew Cab Pickup Exc. HD Straight Front Axle	
F	88-00	PICKUP 1 TON, C35/3500 Extended Cab Pickup Exc. HD Straight Front Axle	
F	88-00	PICKUP 1 TON, C35/3500 Standard Cab Pickup Exc. HD Straight Front Axle	
F	88-00	PICKUP 3/4 TON, C25 / C2500 All	
F	92-99	SUBURBAN 1/2 TON, C15 / C1500 All	
F	92-99	SUBURBAN 3/4 TON, C25 / C2500 All	
F	95-00	TAHOE RWD Old Body Style	
F	88-99	GMC PICKUP 1/2 TON, C15 / C1500 All	
F	92-00	PICKUP 1 TON, C35/3500 Crew Cab Pickup Exc. HD Straight Front Axle	
F	88-00	PICKUP 1 TON, C35/3500 Extended Cab Pickup Exc. HD Straight Front Axle	
F	88-00	PICKUP 1 TON, C35/3500 Standard Cab Pickup Exc. HD Straight Front Axle	
F	88-00	PICKUP 3/4 TON, C25 / C2500 All	
F	92-99	SUBURBAN 1/2 TON, C15 / C1500 All	
F	92-99	SUBURBAN 3/4 TON, C25 / C2500 All	
F	92-99	YUKON RWD	
58609	W	140780	
F	99-00	CADILLAC ESCALADE All	
F	90-05	CHEVROLET ASTRO AWD	
F	92-94	BLAZER 4WD Full Size	
F	88-00	PICKUP 1 TON, K35 / K3500 All	
F	88-00	PICKUP 3/4 TON, K25 / K2500 All	
F	92-99	SUBURBAN 1/2 TON, K15 / K1500 All	
F	92-99	SUBURBAN 3/4 TON, K25 / K2500 All	
F	88-00	GMC PICKUP 1 TON, K35 / K3500 All	
F	88-00	PICKUP 3/4 TON, K25 / K2500 All	
F	90-05	SAFARI AWD	
F	92-99	SUBURBAN 1/2 TON, K15 / K1500 All	
F	92-99	SUBURBAN 3/4 TON, K25 / K2500 All	
58622	W	142617	
F	10-14	FORD VAN 1 TON, ECONOLINE / CLUB WAGON / SUPERDUTY All	
F	04-11	VAN 1 TON, ECONOLINE / CLUB WAGON / SUPERDUTY All Exc. Cutaway Chassis	
F	07-08	VAN 1 TON, ECONOLINE / CLUB WAGON / SUPERDUTY All Cutaway Chassis	
F	92-05	VAN 1 TON, ECONOLINE / CLUB WAGON / SUPERDUTY All Cutaway Chassis	
F	01-03	VAN 1 TON, ECONOLINE / CLUB WAGON / SUPERDUTY All	
F	92-14	VAN 3/4 TON, ECONOLINE / CLUB WAGON / SUPERDUTY All	
58623	D	142617	
R	10-14	FORD VAN 1/2 TON, ECONOLINE / CLUB WAGON All	
R	10-14	VAN 1 TON, ECONOLINE / CLUB WAGON / SUPERDUTY All	
R	04-11	VAN 1 TON, ECONOLINE / CLUB WAGON / SUPERDUTY All Exc. Cutaway Chassis	
R	07-08	VAN 1 TON, ECONOLINE / CLUB WAGON / SUPERDUTY All Cutaway Chassis	

Numerical listing

Shock	POP	Alternative No.	MTG Acc. Supplied
Pos.	Year	Application	
58623	D	-continued	142617
R	92-05	VAN 1 TON, ECONOLINE / CLUB WAGON / SUPERDUTY All Cutaway Chassis	
R	01-03	VAN 1 TON, ECONOLINE / CLUB WAGON / SUPERDUTY All	
R	92-14	VAN 3/4 TON, ECONOLINE / CLUB WAGON / SUPERDUTY All	
58624	D	-continued	140780
R	92-09	FORD VAN 1/2 TON, ECONOLINE / CLUB WAGON All	
58638	W		
R	99-00	CADILLAC ESCALADE All	
R	92-94	CHEVROLET BLAZER 4WD Full Size	
R	92-99	SUBURBAN 1/2 TON, C15 / C1500 All	
R	92-99	SUBURBAN 1/2 TON, K15 / K1500 All	
R	92-99	SUBURBAN 3/4 TON, C25 / C2500 All	
R	92-99	SUBURBAN 3/4 TON, K25 / K2500 All	
R	95-00	TAHOE All Old Body Style	
R	96-14	VAN 1/2 TON, G / EXPRESS All	
R	10-12	VAN 1 TON, G / EXPRESS All	
R	03-06	VAN 1 TON, G / EXPRESS All	
R	07-09	VAN 3/4 TON, G / EXPRESS All	
R	96-02	VAN 3/4 TON, G / EXPRESS All Exc. 8600# GVW	
R	92-99	GMC SUBURBAN 1/2 TON, C15 / C1500 All	
R	92-99	SUBURBAN 1/2 TON, K15 / K1500 All	
R	92-99	SUBURBAN 3/4 TON, C25 / C2500 All	
R	92-99	SUBURBAN 3/4 TON, K25 / K2500 All	
R	08-14	VAN 1/2 TON, G / SAVANNA All	
R	96-06	VAN 1/2 TON, G / SAVANNA All	
R	96-02	VAN 1 TON, G / SAVANNA All Exc. 8600# GVW	
R	96-02	VAN 3/4 TON, G / SAVANNA All Exc. 8600# GVW	
R	92-99	YUKON All	
58661	W		143000
F	94-01	DODGE PICKUP 1/2 TON, RAM 1500 (SEE RAM 1500) RWD	
F	94-02	PICKUP 1 TON, RAM 3500 (SEE RAM 3500) RWD Exc. Solid Front Axle	
F	94-02	PICKUP 3/4 TON, RAM 2500 (SEE RAM 2500) RWD	
58662	W		
R	99-07	CHEVROLET PICKUP 1/2 TON, SILVERADO 1500 RWD Exc. Electronic Adjustable Suspension	
R	94-01	DODGE PICKUP 1/2 TON, RAM 1500 (SEE RAM 1500) All	
R	94-02	PICKUP 1 TON, RAM 3500 (SEE RAM 3500) RWD Exc. Solid Front Axle	
R	94-02	PICKUP 3/4 TON, RAM 2500 (SEE RAM 2500) 4WD, GAS Exc. 8800# GVW	
R	94-02	PICKUP 3/4 TON, RAM 2500 (SEE RAM 2500) RWD	
R	95-96	PICKUP 3/4 TON, RAM 2500 (SEE RAM 2500) 4WD, CNG Exc. 8800# GVW	
R	99-07	GMC SIERRA 1500 RWD Exc. Electronic Adjustable Suspension	
58673	W		142731
F	94-01	DODGE PICKUP 1/2 TON, RAM 1500 (SEE RAM 1500) 4WD	
F	94-02	PICKUP 3/4 TON, RAM 2500 (SEE RAM 2500) 4WD, GAS Exc. 8800# GVW	
F	95-96	PICKUP 3/4 TON, RAM 2500 (SEE RAM 2500) 4WD, CNG Exc. 8800# GVW	
58674	D		142731
F	94-02	DODGE PICKUP 1 TON, RAM 3500 (SEE RAM 3500) 4WD	
F	94-02	PICKUP 1 TON, RAM 3500 (SEE RAM 3500) RWD Solid Front Axle	
F	94-02	PICKUP 3/4 TON, RAM 2500 (SEE RAM 2500) 4WD, DIESEL 8800# GVW	

LTV

Shock	POP	Alternative No.	MTG Acc. Supplied
Pos.	Year	Application	
58675	W		
R	94-02	DODGE PICKUP 1 TON, RAM 3500 (SEE RAM 3500) 4WD	
R	94-02	PICKUP 1 TON, RAM 3500 (SEE RAM 3500) RWD Solid Front Axle	
R	94-02	PICKUP 3/4 TON, RAM 2500 (SEE RAM 2500) 4WD, DIESEL 8800# GVW	
58714	D		142731
F	97-02	FORD EXPEDITION RWD Exc. Front Air- Leveling	
F	97-04	PICKUP 1/2 TON, F-150 RWD	
F	96-99	PICKUP 3/4 TON, F-250 / SUPERDUTY RWD Up through 8500# GVW	
F	98-02	LINCOLN NAVIGATOR RWD	
58715	D		142700
R	97-04	FORD PICKUP 1/2 TON, F-150 4WD Exc. 7000# GVW	
R	97-99	PICKUP 3/4 TON, F-250 / SUPERDUTY 4WD Up through 8500# GVW; Exc. Superduty	
58716	D		142731
F	97-02	FORD EXPEDITION 4WD Exc. Front Air- Leveling	
F	04	PICKUP 1/2 TON, F-150 4WD Exc. 7000# GVW	
F	97-03	PICKUP 1/2 TON, F-150 4WD	
F	97-99	PICKUP 3/4 TON, F-250 / SUPERDUTY 4WD Up through 8500# GVW; Exc. Superduty	
58717	W		
R	97-02	FORD EXPEDITION All	
R	98-02	LINCOLN NAVIGATOR RWD, Coil (FrontSpringType)	
58778	W		142700
R	04	FORD PICKUP 1/2 TON, F-150 RWD	
R	00-03	PICKUP 1/2 TON, F-150 Harley-Davidson Edition. RWD	
R	99-03	PICKUP 1/2 TON, F-150 Lariat, RWD	
R	99-03	PICKUP 1/2 TON, F-150 XL, RWD	
R	99-03	PICKUP 1/2 TON, F-150 XLT, RWD	
R	00	PICKUP 1/2 TON, F-150 Base, RWD	
R	97-98	PICKUP 1/2 TON, F-150 RWD	
R	97-99	PICKUP 3/4 TON, F-250 / SUPERDUTY RWD Up through 8500# GVW	
58783	D		141665
F	07	CHEVROLET PICKUP 1/2 TON, SILVERADO 1500 RWD Exc. Electronic Adjustable Suspension	
F	99-06	PICKUP 1/2 TON, SILVERADO 1500 RWD Electronic Adjustable Suspension	
F	99-07	GMC SIERRA 1500 RWD Exc. Electronic Adjustable Suspension	
58803	W		141665
F	02-06	CADILLAC ESCALADE All	
F	02-04	ESCALADE EXT All	
F	02-06	CHEVROLET AVALANCHE 1500 All Exc. Electronic Ride Control	
F	07	PICKUP 1/2 TON, SILVERADO 1500 4WD Old Body Style; Exc. Electronic Adjustable Suspension	
F	99-06	PICKUP 1/2 TON, SILVERADO 1500 4WD Exc. Electronic Adjustable Suspension	
F	00-06	SUBURBAN 1/2 TON, 1500 All Exc. Z55 Auto Ride Suspension	
F	02-06	TAHOE All Exc. Z55 Auto Ride Suspension	
F	00-01	TAHOE All New Body Style; Exc. Z55 Auto Ride Suspension	
F	07	GMC SIERRA 1500 4WD Old Body Style; Exc. Electronic Adjustable Suspension	
F	99-06	SIERRA 1500 4WD Exc. Electronic Adjustable Suspension	
F	00-06	YUKON All Exc. Z55 Auto Ride Suspension	
F	00-06	YUKON XL 1/2 TON All Exc. Z55 Auto Ride Suspension	
58807	D		142617
F	99-12	FORD PICKUP 1 TON, F-350 / SUPERDUTY RWD	

Numerical listing

Shock	POP	Alternative No.	MTG Acc. Supplied
Pos.	Year	Application	
58807	D	-continued	142617
F	99-12	PICKUP 3/4 TON, F-250 / SUPERDUTY RWD	
58808	W		
R	99-04	FORD PICKUP 1 TON, F-350 / SUPERDUTY RWD	
R	99-04	PICKUP 3/4 TON, F-250 / SUPERDUTY RWD	
58809	W		
F	99-04	FORD PICKUP 1 TON, F-350 / SUPERDUTY 4WD	
F	99-04	PICKUP 3/4 TON, F-250 / SUPERDUTY 4WD	
F	99-04	PICKUP, F-450 SUPERDUTY All	
F	99-04	PICKUP, F-550 SUPERDUTY All	
58810	W		
R	99-04	FORD PICKUP 1 TON, F-350 / SUPERDUTY 4WD	
R	99-04	PICKUP 3/4 TON, F-250 / SUPERDUTY 4WD	
58811	W		
R	99-04	FORD PICKUP, F-450 SUPERDUTY All	
R	99-04	PICKUP, F-550 SUPERDUTY All	
58812	D		
F	91-02	CHEVROLET C3500HD All Solid Front Axle	
F	91-02	GMC C3500HD All Solid Front Axle	
58817	W		141665
F	02-06	CHEVROLET AVALANCHE 2500 All Exc. Electronic Ride Control	
F	05-06	PICKUP 1/2 TON, SILVERADO 1500 HD All	
F	01-03	PICKUP 1/2 TON, SILVERADO 1500 HD All	
F	01-09	PICKUP 1 TON, SILVERADO 3500 All	
F	07-10	PICKUP 1 TON, SILVERADO 3500 HD All	
F	05-08	PICKUP 3/4 TON, SILVERADO 2500 All	
F	99-04	PICKUP 3/4 TON, SILVERADO 2500 4WD	
F	01-10	PICKUP 3/4 TON, SILVERADO 2500 HD All 9200# GVW	
F	07	SILVERADO 1500 HD CLASSIC All	
F	07	SILVERADO 2500 HD CLASSIC All 9200# GVW	
F	00-11	SUBURBAN 3/4 TON, 2500 All Exc. Z55 Auto Ride Suspension and QuadraSteer	
F	05-06	GMC SIERRA 1500 HD All	
F	01-03	SIERRA 1500 HD All	
F	07	SIERRA 1500 HD CLASSIC All	
F	99-04	SIERRA 2500 All	
F	01-10	SIERRA 2500 HD All	
F	01-06	SIERRA 3500 All	
F	07	SIERRA 3500 CLASSIC All	
F	07-10	SIERRA 3500 HD Torsion Bar (FrontSpringType)	
F	00-06	YUKON XL 3/4 TON All Exc. Hydraulic Self Leveling System	
58901	W		
F	88-99	CHEVROLET PICKUP 1/2 TON, K15 / K1500 All	
F	95-00	TAHOE 4WD Old Body Style	
F	88-99	GMC PICKUP 1/2 TON, K15 / K1500 All	
F	92-99	YUKON 4WD	
58906	W		
F	87-91	CHEVROLET BLAZER 4WD Full Size; Quad Suspension Long Shock; Exc. Lift Kit	
F	81-86	BLAZER 4WD Quad Suspension Long Shock; Exc. Lift Kit	
F	81-86	PICKUP 1/2 TON, K10 All Quad Suspension Long Shock; Exc. Lift Kit	
F	87	PICKUP 1/2 TON, V10 All Quad Suspension Long Shock; Exc. Lift Kit	
F	81-86	PICKUP 3/4 TON, K20 All Quad Suspension Long Shock; Exc. Lift Kit	
F	87	PICKUP 3/4 TON, V20 All Quad Suspension Long Shock; Exc. Lift Kit	
F	81-86	SUBURBAN 1/2 TON, K10 All Quad Suspension Long Shock; Exc. Lift Kit	
F	81-86	SUBURBAN 3/4 TON, K20 All Quad Suspension Long Shock; Exc. Lift Kit	

Numerical listing

Shock	POP	Alternative No.	MTG Acc. Supplied
Pos.	Year	Application	
58906	W	-continued	
F	87-88	SUBURBAN 3/4 TON, V20 All Quad Suspension Long Shock; Exc. Lift Kit	
F	89-91	SUBURBAN 3/4 TON, V2500 All Quad Suspension Long Shock; Exc. Lift Kit	
F	73-91	GMC JIMMY 4WD Quad Suspension Long Shock; Exc. Lift Kit	
F	81-86	PICKUP 1/2 TON, K15 / K1500 All Quad Suspension Long Shock; Exc. Lift Kit	
F	87	PICKUP 1/2 TON, V1500 All Quad Suspension Long Shock; Exc. Lift Kit	
F	81-86	PICKUP 3/4 TON, K25 / K2500 All Quad Suspension Long Shock; Exc. Lift Kit	
F	87	PICKUP 3/4 TON, V2500 All Quad Suspension Long Shock; Exc. Lift Kit	
F	81-86	SUBURBAN 1/2 TON, K15 / K1500 All Quad Suspension Long Shock; Exc. Lift Kit	
F	87-91	SUBURBAN 1/2 TON, V1500 All Quad Suspension Long Shock; Exc. Lift Kit	
F	81-86	SUBURBAN 3/4 TON, K25 / K2500 All Quad Suspension Long Shock; Exc. Lift Kit	
F	87-91	SUBURBAN 3/4 TON, V2500 All Quad Suspension Long Shock; Exc. Lift Kit	
58908	W	-continued	
F	87-91	CHEVROLET BLAZER 4WD Full Size; Quad Suspension Short Shock; Exc. Lift Kit	
F	81-86	BLAZER 4WD Quad Suspension Short Shock; Exc. Lift Kit	
F	81-86	PICKUP 1/2 TON, K10 All Quad Suspension Short Shock; Exc. Lift Kit	
F	87	PICKUP 1/2 TON, V10 All Quad Suspension Short Shock; Exc. Lift Kit	
F	81-86	PICKUP 3/4 TON, K20 All Quad Suspension Short Shock; Exc. Lift Kit	
F	87	PICKUP 3/4 TON, V20 All Quad Suspension Short Shock; Exc. Lift Kit	
F	81-86	SUBURBAN 1/2 TON, K10 All Quad Suspension Short Shock; Exc. Lift Kit	
F	81-86	SUBURBAN 3/4 TON, K20 All Quad Suspension Short Shock; Exc. Lift Kit	
F	87-88	SUBURBAN 3/4 TON, V20 All Quad Suspension Short Shock; Exc. Lift Kit	
F	89-91	SUBURBAN 3/4 TON, V2500 All Quad Suspension Short Shock; Exc. Lift Kit	
F	73-91	GMC JIMMY 4WD Quad Suspension Short Shock; Exc. Lift Kit	
F	81-86	PICKUP 1/2 TON, K15 / K1500 All Quad Suspension Short Shock; Exc. Lift Kit	
F	87	PICKUP 1/2 TON, V1500 All Quad Suspension Short Shock; Exc. Lift Kit	
F	81-86	PICKUP 3/4 TON, K25 / K2500 All Quad Suspension Short Shock; Exc. Lift Kit	
F	87	PICKUP 3/4 TON, V2500 All Quad Suspension Short Shock; Exc. Lift Kit	
F	81-86	SUBURBAN 1/2 TON, K15 / K1500 All Quad Suspension Short Shock; Exc. Lift Kit	
F	87-91	SUBURBAN 1/2 TON, V1500 All Quad Suspension Short Shock; Exc. Lift Kit	
F	81-86	SUBURBAN 3/4 TON, K25 / K2500 All Quad Suspension Short Shock; Exc. Lift Kit	
F	87-91	SUBURBAN 3/4 TON, V2500 All Quad Suspension Short Shock; Exc. Lift Kit	
58929	W	140780	
F	90	FORD BRONCO II All	
F	91-94	EXPLORER All	
F	90-97	RANGER All	
F	92-11	VAN 1/2 TON, ECONOLINE / CLUB WAGON All	

LTV, ProGuard

Shock	POP	Alternative No.	MTG Acc. Supplied
Pos.	Year	Application	
58929	W	-continued 140780	
F	94-97	MAZDA B2300 All	
F	91-94	NAVAJO All	
58930	D	-continued	
R	02-13	CADILLAC ESCALADE All	
R	07-11	CHEVROLET AVALANCHE 1500 All Exc. Z55 or ZW7 Ride Suspension	
R	02-06	AVALANCHE 1500 All Exc. Electronic Ride Control	
R	02-06	AVALANCHE 2500 All Exc. Electronic Ride Control	
R	07-11	SUBURBAN 1/2 TON, 1500 All Exc. Z55 or ZW7 Ride Suspension	
R	00-06	SUBURBAN 1/2 TON, 1500 All Exc. Z55 Auto Ride Suspension	
R	00-11	SUBURBAN 3/4 TON, 2500 All Exc. Z55 Auto Ride Suspension and Quadrasteer	
R	07-11	TAHOE All Exc. Z55 or ZW7 Ride Suspension	
R	02-06	TAHOE All Exc. Z55 Auto Ride Suspension	
R	00-01	TAHOE All New Body Style; Exc. Z55 Auto Ride Suspension	
R	07-11	GMC YUKON All Exc. Z55 or ZW7 Ride Suspension	
R	00-06	YUKON All Exc. Z55 Auto Ride Suspension	
R	07-11	YUKON XL 1/2 TON All Exc. Z55 or ZW7 Ride Suspension	
R	00-06	YUKON XL 1/2 TON All Exc. Z55 Auto Ride Suspension	
R	00-11	YUKON XL 3/4 TON All Exc. Z55 Auto Ride Suspension and Quadrasteer	
58943	FF	-continued	
R	11-13	CHEVROLET PICKUP 1 TON, SILVERADO 3500 All	
R	11-13	PICKUP 1 TON, SILVERADO 3500 HD All	
R	11-13	PICKUP 3/4 TON, SILVERADO 2500 All	
R	11-13	PICKUP 3/4 TON, SILVERADO 2500 HD All	
R	11-13	GMC SIERRA 2500 HD All	
R	11-13	SIERRA 3500 HD All	
58944	FF	-continued	
F	11-12	FORD PICKUP, F-450 SUPERDUTY All	
F	07-09	PICKUP, F-450 SUPERDUTY All	
F	10-12	PICKUP F550 All	
58945	FF	-continued	
R	11-12	FORD PICKUP, F-450 SUPERDUTY All Crew Cab	
R	07-09	PICKUP, F-450 SUPERDUTY All Crew Cab	
R	10-12	PICKUP F550 All Crew Cab	
ProGuard			
61500	A	-continued	
R	75-80	CHEVROLET LUV PICKUP All	
R	72-74	LUV PICKUP All	
F	55-56	PICKUP 3800	
F	56	PICKUP All 3100	
F	55	PICKUP 3100	
R	79-82	DODGE D50 RWD	
R	87-93	PICKUP, RAM 50 RWD	
R	83-86	PICKUP, RAM 50 All	
R	61-65	FORD PICKUP 1/2 TON, F-100 All	
R	61-66	PICKUP 1 TON, F-350 / SUPERDUTY All	
R	61-64	PICKUP 3/4 TON, F-250 / SUPERDUTY All	
R	55	PICKUP F SERIES All F-100	
F	48-52	PICKUP F SERIES All F-1, F-2 & F-3	
F	68-76	PICKUP P350 All Up through 8000# GVW	
F	75-76	PICKUP P400 All Up through 8000# GVW	
R	68	INTERNATIONAL 908C All	
R	68	1000C All	
F	68	1100C All Exc. Travelette with 166" Wheelbase	
R	68	1100C All Exc. Travelette with 166" Wheelbase	
F	68	1200C All Exc. Travelette with 166" Wheelbase	
R	68	1200C All Exc. Travelette with 166" Wheelbase	

Numerical listing

Shock	POP	Alternative No.	MTG Acc. Supplied
Pos.	Year	Application	
61500	A	-continued	
F	68	1300C All Exc. Travelette with 166" Wheelbase	
R	68	1300C All Exc. Travelette with 166" Wheelbase	
R	68-72	M1100 / M1200 All	
R	69	M1400 All	
R	72-83	JEEP CJ5 All Exc. Lift Kit	
R	66-71	CJ5 All	
R	72-75	CJ6 All Exc. Lift Kit	
R	66-71	CJ6 All	
R	76-86	CJ7 All Exc. Lift Kit	
R	66-74	DJ5 All Exc. Lift Kit	
R	66-68	DJ6 All	
R	57-60	FC150 All	
F	63-65	FC170 All	
R	63-65	FC170 All	
R	63-66	GLADIATOR All Independent Front Suspension	
R	70-73	JEEPSTER All	
R	81-85	SCRAMBLER / CJ8 All	
R	61-67	UNIVERSAL All	
R	86-87	MAZDA B2000 RWD	
R	87-93	B2200 RWD	
R	87-93	B2600 RWD	
R	95-96	MITSUBISHI MIGHTY MAX All	
R	83-94	MIGHTY MAX RWD	
R	87-90	VAN All	
R	98-04	NISSAN FRONTIER RWD Exc. Desert Runner	
R	87-97	PICKUP RWD	
R	86	PICKUP RWD Mfg. from 8/86	
R	79-82	PLYMOUTH PICKUP All	
F	49-60	STUDEBAKER R / E SERIES 1/2 / 3/4 TON	
R	49-54	R / E SERIES 1/2 / 3/4 TON	
R	69-74	TOYOTA LAND CRUISER All Exc. Wagon	
R	67-68	LAND CRUISER All	
R	85-95	PICKUP RWD Exc. 1 Ton	
R	84	PICKUP RWD	
R	75-83	PICKUP RWD Mojave	
R	70-74	PICKUP All RWD; Mojave	
R	04	TACOMA Base, RWD	
R	95-03	TACOMA DLX RWD	
R	98-00	TACOMA SR5, 4WD	
R	84-88	VAN Leaf (RearSpringType)	
R	88	VAN WAGON All Leaf(RearSpringType)	
61501	D	140857	
F	81-82	CHEVROLET LUV PICKUP RWD	
F	81-95	ISUZU PICKUP RWD	
F	69-72	NISSAN 521 PICKUP All	
F	72-79	620 PICKUP All	
F	80-86	720 PICKUP All	
F	87-97	PICKUP 4WD	
F	86	PICKUP 4WD Mfg. from 8/86	
61503	W	141277	
R	90-96	CHEVROLET LUMINA APV All	
R	90-96	OLDSMOBILE SILHOUETTE All	
R	90-96	PONTIAC TRANS SPORT All	
61504	A	140455	
F	05	CHEVROLET BLAZER Base, RWD	
F	96-04	BLAZER LS, RWD	
F	95-02	BLAZER LT, RWD	
F	95-99	BLAZER Base, RWD	
F	95-97	BLAZER Deluxe, RWD	
F	83-94	BLAZER, S MODELS RWD	
F	68-87	EL CAMINO All	
F	94-03	S10 LS, RWD	
F	82-03	S10 Base, RWD	
F	92-93	S10 EL, RWD	
F	83-92	S10 Tahoe, RWD	
F	88-90	S10 Durango, RWD	
F	82-86	S10 Durango, RWD	
F	72-82	FORD COURIER All	
F	92-04	GMC JIMMY RWD	
F	83-91	S15 JIMMY RWD	
F	04	SONOMA / S15 All RWD	
F	82-03	SONOMA / S15 RWD	
F	71-87	SPRINT / CABALLERO All	
F	96-00	ISUZU HOMBRE RWD Exc. Sport Chassis	
F	72-76	MAZDA B1600 All	
F	77-78	B1800 All	
F	79-84	B2000 All	
F	82-84	B2200 All	
F	75-83	TOYOTA PICKUP RWD Mojave	
F	70-74	PICKUP All RWD; Mojave	
61505	W	140524	
R	69-72	NISSAN 521 PICKUP All	
R	72-79	620 PICKUP All	

Numerical listing

Shock	POP	Alternative No.	MTG Acc. Supplied
Pos.	Year	Application	
61505	W	-continued	140524
R 86	720	PICKUP RWD Mfg. to 8/86	
R 82-85	720	PICKUP RWD	
R 80-81	720	PICKUP All	
61506	A		141137
R 81-82	CHEVROLET	LUV PICKUP All	
R 87-89	DODGE	RAIDER 2.6L 4Cyl L (156)	
F 61-67	FORD	ECONOLINE All	
R 89-94	ISUZU	AMIGO All	
R 81-95	PICKUP	All	
R 84-86	TROOPER	4WD	
R 86-92	JEEP	COMANCHE All	
R 83-88	MITSUBISHI	MONTERO 2.6L 4Cyl L (156)	
R 97-99	MONTERO	SPORT All	
R 82-86	NISSAN	720 PICKUP 4WD	
R 00-04	FRONTIER	Crew Cab Pickup, RWD with Desert Runner	
R 98-04	FRONTIER	4WD	
R 98-99	FRONTIER	RWD Crew Cab with Desert Runner	
R 87-95	PATHFINDER	All Exc. Electronic Adjustable Suspension	
R 87-97	PICKUP	4WD	
R 86	PICKUP	4WD Mfg. from 8/86	
R 00-04	XTERRA	All	
R 84-87	TOYOTA	LAND CRUISER FJ60 (MfrBodyCode), Sport Utility	
R 80-83	LAND CRUISER	All	
R 79	LAND CRUISER	FJ40 (MfrBodyCode)	
R 79	LAND CRUISER	FJ55 (MfrBodyCode), Sport Utility	
R 76-78	LAND CRUISER	All	
R 75	LAND CRUISER	FJ40 (MfrBodyCode) Mfg. from 1/75	
R 75	LAND CRUISER	FJ55 (MfrBodyCode), Sport Utility Mfg. from 1/75	
R 85-92	PICKUP	RWD 1 Ton	
R 80-83	PICKUP	4WD Exc. Lift Kit	
R 93-98	T100	RWD	
61507	X		141349,140169
F 88-90	TOYOTA	LAND CRUISER All	
F 81-87	LAND CRUISER	FJ60 (MfrBodyCode), Sport Utility	
F 80	LAND CRUISER	All	
61508	C		140857
F 81-82	CHEVROLET	LUV PICKUP 4WD	
F 75-80	LUV	PICKUP All	
F 72-74	LUV	PICKUP All	
F 89-94	ISUZU	AMIGO All	
F 81-95	PICKUP	4WD	
F 84-86	TROOPER	4WD	
F 98-04	NISSAN	FRONTIER RWD Exc. Desert Runner	
F 87-97	PICKUP	RWD	
F 86	PICKUP	RWD Mfg. from 8/86	
61509	C		140455
F 93-95	TOYOTA	PICKUP RWD Exc. 1 Ton	
F 85-92	PICKUP	RWD 1 Ton	
F 84	PICKUP	RWD	
F 93-98	T100	RWD	
61510	B		140149
R 84-89	TOYOTA	4RUNNER All	
R 84-95	PICKUP	4WD Exc. Lift Kit	
R 01-04	TACOMA	S-Runner	
R 04	TACOMA	Base, 4WD	
R 95-03	TACOMA	DLX, 4WD	
R 98-00	TACOMA	Limited	
61511	D		
R 87-96	DODGE	DAKOTA RWD	
61512	A		140126
F 87-04	DODGE	DAKOTA RWD	
F 99-03	DURANGO	RWD	
61516	D		
F 87-91	CHEVROLET	BLAZER 4WD Full Size; Quad Suspension Short Shock; Exc. Lift Kit	
F 81-86	BLAZER	4WD Quad Suspension Short Shock; Exc. Lift Kit	
F 75-80	BLAZER	4WD Exc. Quad Suspension and Lift Kit	
F 73-74	BLAZER	All 4WD; Exc. Lift Kit	
F 69-72	BLAZER	All 4WD	
F 81-86	PICKUP	1/2 TON, K10 All Quad Suspension Short Shock; Exc. Lift Kit	

ProGuard

Shock	POP	Alternative No.	MTG Acc. Supplied
Pos.	Year	Application	
61516	D	-continued	
F 69-80	PICKUP	1/2 TON, K10 All Exc. Lift Kit	
F 88	PICKUP	1/2 TON, K15 / K1500 All Quad Suspension Short Shock; Exc. Lift Kit	
F 87	PICKUP	1/2 TON, V10 All Quad Suspension Short Shock; Exc. Lift Kit	
F 81-86	PICKUP	3/4 TON, K20 All Quad Suspension Short Shock; Exc. Lift Kit	
F 69-80	PICKUP	3/4 TON, K20 All Exc. Lift Kit	
F 87	PICKUP	3/4 TON, V20 All Exc. Quad Suspension and Lift Kit	
F 81-86	SUBURBAN	1/2 TON, K10 All Quad Suspension Short Shock; Exc. Lift Kit	
F 69-80	SUBURBAN	1/2 TON, K10 All Exc. Lift Kit	
F 87-88	SUBURBAN	1/2 TON, V10 All Quad Suspension Short Shock; Exc. Lift Kit	
F 89-91	SUBURBAN	1/2 TON, V1500 All Exc. Quad Suspension and Lift Kit	
F 81-86	SUBURBAN	3/4 TON, K20 All Quad Suspension Short Shock; Exc. Lift Kit	
F 69-80	SUBURBAN	3/4 TON, K20 All Exc. Lift Kit	
F 87-88	SUBURBAN	3/4 TON, V20 All Quad Suspension Short Shock; Exc. Lift Kit	
F 89-91	SUBURBAN	3/4 TON, V2500 All Quad Suspension Short Shock; Exc. Lift Kit	
F 75-91	GMC	JIMMY 4WD Exc. Quad Suspension and Lift Kit	
F 70-74	JIMMY	All 4WD; Exc. Quad Suspension and Lift Kit	
F 69-86	PICKUP	1/2 TON, K15 / K1500 All Exc. Quad Suspension and Lift Kit	
F 87	PICKUP	1/2 TON, V1500 All Quad Suspension Short Shock; Exc. Lift Kit	
F 69-86	PICKUP	3/4 TON, K25 / K2500 All Exc. Quad Suspension and Lift Kit	
F 87	PICKUP	3/4 TON, V2500 All Quad Suspension Short Shock; Exc. Lift Kit	
F 69-86	SUBURBAN	1/2 TON, K15 / K1500 All Exc. Quad Suspension and Lift Kit	
F 87-91	SUBURBAN	1/2 TON, V1500 All Quad Suspension Short Shock; Exc. Lift Kit	
F 69-86	SUBURBAN	3/4 TON, K25 / K2500 All Exc. Quad Suspension and Lift Kit	
F 87-91	SUBURBAN	3/4 TON, V2500 All Quad Suspension Short Shock; Exc. Lift Kit	
61517	C		
F 71-95	CHEVROLET	VAN 1/2 TON, G / EXPRESS All	
F 70	VAN	1/2 TON, G / EXPRESS All Independent Front Suspension	
F 78-96	VAN	1 TON, G / EXPRESS All	
F 75	VAN	1 TON, G / EXPRESS 146.0 (WheelBase)	
F 71-74	VAN	1 TON, G / EXPRESS All	
F 78-95	VAN	3/4 TON, G / EXPRESS All Exc. 8600# GVW	
F 71-77	VAN	3/4 TON, G / EXPRESS All	
F 70	VAN	3/4 TON, G / EXPRESS All Independent Front Suspension	
F 71-95	GMC	VAN 1/2 TON, G / SAVANNA All	
F 70	VAN	1/2 TON, G / SAVANNA All Independent Front Suspension	
F 76-95	VAN	1 TON, G / SAVANNA All	
F 75	VAN	1 TON, G / SAVANNA 110.0 (WheelBase)	
F 75	VAN	1 TON, G / SAVANNA 125.0 (WheelBase)	
F 71-74	VAN	1 TON, G / SAVANNA All	
F 78-95	VAN	3/4 TON, G / SAVANNA All Exc. 8600# GVW	
F 71-77	VAN	3/4 TON, G / SAVANNA All	
F 70	VAN	3/4 TON, G / SAVANNA All Independent Front Suspension	

Numerical listing

Shock	POP	Alternative No.	MTG Acc. Supplied
Pos.	Year	Application	
61518	D		140126
R 66	FORD	BRONCO All Thru Serial #830000	
R 75-79	PICKUP	1/2 TON, F-100 RWD	
R 70-74	PICKUP	1/2 TON, F-100 All RWD	
R 75-79	PICKUP	1/2 TON, F-150 RWD	
R 75-79	PICKUP	1 TON, F-350 / SUPERDUTY Extended Cab Pickup, RWD	
R 74	PICKUP	1 TON, F-350 / SUPERDUTY All RWD; Extended Cab Pickup	
R 75-79	PICKUP	3/4 TON, F-250 / SUPERDUTY Cab & Chassis, RWD	
R 73-79	PICKUP	3/4 TON, F-250 / SUPERDUTY Standard Cab Pickup, RWD	
R 70-72	PICKUP	3/4 TON, F-250 / SUPERDUTY Standard Cab Pickup RWD	
R 75-91	VAN	1/2 TON, ECONOLINE / CLUB WAGON All	
F 71-80	INTERNATIONAL	SCOUT II All	
61519	D		141137
R 78-79	FORD	BRONCO All Exc. Lift Kit	
R 66-77	BRONCO	All From Serial #830001; Exc. Lift Kit	
R 65-69	PICKUP	1/2 TON, F-100 All RWD	
R 75-79	PICKUP	1 TON, F-350 / SUPERDUTY Standard Cab Pickup, RWD	
R 73-74	PICKUP	1 TON, F-350 / SUPERDUTY All RWD; Exc. Supercab	
R 75-79	PICKUP	3/4 TON, F-250 / SUPERDUTY Extended Cab Pickup, RWD	
R 73-74	PICKUP	3/4 TON, F-250 / SUPERDUTY RWD Supercab	
R 65-72	PICKUP	3/4 TON, F-250 / SUPERDUTY All RWD; Supercab	
R 69-74	VAN	1/2 TON, ECONOLINE / CLUB WAGON All	
R 69-74	VAN	1 TON, ECONOLINE / CLUB WAGON / SUPERDUTY All	
R 69-74	VAN	3/4 TON, ECONOLINE / CLUB WAGON / SUPERDUTY All	
R 76-83	JEEP	CHEROKEE All	
F 74-83	CHEROKEE	All	
F 82-83	CJ5	All Exc. Lift Kit	
F 82-86	CJ7	All Exc. Lift Kit	
R 67	GLADIATOR	All	
F 93	GRAND WAGONEER	All	
R 93	GRAND WAGONEER	All	
F 84-91	GRAND WAGONEER	All	
R 84-91	GRAND WAGONEER	All	
F 74-88	J10	PICKUP All	
R 74-88	J10	PICKUP All	
F 74-88	J20	PICKUP All	
R 74-88	J20	PICKUP All	
R 68-73	J2500	PICKUP All	
F 82-85	SCRAMBLER	/ CJ8 All	
R 76-83	WAGONEER	All	
F 74-83	WAGONEER	All	
61520	A		140780
F 80-96	FORD	BRONCO All Quad & Non Quad Suspensions Rearward of Front Axle; Exc. Lift Kit	
F 89	BRONCO	II All Mfg. to 2/89; Vehicles with 10mm & 12mm bolt in rear lower mount	
F 84-88	BRONCO	II All With 10mm Bolt In Rear Lower Mount	
F 80-83	PICKUP	1/2 TON, F-100 RWD	
F 80-96	PICKUP	1/2 TON, F-150 4WD Quad & Non Quad Suspensions Rearward of Front Axle; Exc. Lift Kit	
F 80-96	PICKUP	1/2 TON, F-150 RWD	
F 80-97	PICKUP	1 TON, F-350 / SUPERDUTY RWD	
F 97	PICKUP	3/4 TON, F-250 / SUPERDUTY RWD Over 8500# GVW	
F 80-96	PICKUP	3/4 TON, F-250 / SUPERDUTY RWD	
F 87-89	RANGER	All Exc. High Ryder Option	
F 83-86	RANGER	All	

Numerical listing

Shock	POP	Alternative No.	MTG Acc. Supplied
Pos.	Year	Application	
61521	C		140780
F	78-79	FORD BRONCO All Quad Suspension; Rearward of Front Axle; Non Quad Suspension, Right Shock; Exc. Lift Kit	
F	66-77	BRONCO All From Serial #830001; Exc. Lift Kit	
F	75-79	PICKUP 1/2 TON, F-100 RWD	
F	65-74	PICKUP 1/2 TON, F-100 All RWD	
F	78-79	PICKUP 1/2 TON, F-150 RWD Quad Suspension; Rearward of Front Axle; Non Quad Suspension, Right Shock; Exc. Lift Kit	
F	75-77	PICKUP 1/2 TON, F-150 RWD	
F	75-79	PICKUP 1 TON, F-350 / SUPERDUTY RWD	
F	67-74	PICKUP 1 TON, F-350 / SUPERDUTY All RWD	
F	75-79	PICKUP 3/4 TON, F-250 / SUPERDUTY RWD	
F	65-74	PICKUP 3/4 TON, F-250 / SUPERDUTY All RWD	
F	75-91	VAN 1 TON, ECONOLINE / CLUB WAGON / SUPERDUTY All Exc. Cutaway Chassis	
F	75-91	VAN 3/4 TON, ECONOLINE / CLUB WAGON / SUPERDUTY All	
61522	C		
F	87-91	CHEVROLET BLAZER 4WD Full Size; Quad Suspension Long Shock; Exc. Lift Kit	
F	81-86	BLAZER 4WD Quad Suspension Long Shock; Exc. Lift Kit	
F	81-86	PICKUP 1/2 TON, K10 All Quad Suspension Long Shock; Exc. Lift Kit	
F	88	PICKUP 1/2 TON, K15 / K1500 All Quad Suspension Long Shock; Exc. Lift Kit	
F	87	PICKUP 1/2 TON, V10 All Quad Suspension Long Shock; Exc. Lift Kit	
F	81-86	PICKUP 3/4 TON, K20 All Quad Suspension Long Shock; Exc. Lift Kit	
F	87	PICKUP 3/4 TON, V20 All Quad Suspension Long Shock; Exc. Lift Kit	
F	81-86	SUBURBAN 1/2 TON, K10 All Quad Suspension Long Shock; Exc. Lift Kit	
F	87-88	SUBURBAN 1/2 TON, V10 All Quad Suspension Long Shock; Exc. Lift Kit	
F	81-86	SUBURBAN 3/4 TON, K20 All Quad Suspension Long Shock; Exc. Lift Kit	
F	87-88	SUBURBAN 3/4 TON, V20 All Quad Suspension Long Shock; Exc. Lift Kit	
F	89-91	SUBURBAN 3/4 TON, V2500 All Quad Suspension Long Shock; Exc. Lift Kit	
R	78-95	VAN 1/2 TON, G / EXPRESS All	
R	78-95	VAN 1 TON, G / EXPRESS Cutaway Van	
R	78-95	VAN 3/4 TON, G / EXPRESS All Exc. 8600# GVW	
R	84-86	DODGE MINI RAM All	
R	99-03	VAN 1/2 TON, A / B SERIES / RAM 109.3 (WheelBase) Exc. 7000# GVW	
R	81-98	VAN 1/2 TON, A / B SERIES / RAM 109.6 (WheelBase) Exc. 7000# GVW	
R	71-80	VAN 1/2 TON, A / B SERIES / RAM All	
R	99-03	VAN 1 TON, A / B SERIES / RAM All	
R	95-98	VAN 1 TON, A / B SERIES / RAM All Exc. 4000# Front Axle	
R	71-94	VAN 1 TON, A / B SERIES / RAM All	
R	71-03	VAN 3/4 TON, A / B SERIES / RAM All	
R	74-80	VAN, CB300 All	
F	73-91	GMC JIMMY 4WD Quad Suspension Long Shock; Exc. Lift Kit	
F	81-86	PICKUP 1/2 TON, K15 / K1500 All Quad Suspension Long Shock; Exc. Lift Kit	
F	87	PICKUP 1/2 TON, V1500 All Quad Suspension Long Shock; Exc. Lift Kit	
F	81-86	PICKUP 3/4 TON, K25 / K2500 All Quad Suspension Long Shock; Exc. Lift Kit	
F	87	PICKUP 3/4 TON, V2500 All Quad Suspension Long Shock; Exc. Lift Kit	
F	81-86	SUBURBAN 1/2 TON, K15 / K1500 All Quad Suspension Long Shock; Exc. Lift Kit	
F	87-91	SUBURBAN 1/2 TON, V1500 All Quad Suspension Long Shock; Exc. Lift Kit	

ProGuard

Shock	POP	Alternative No.	MTG Acc. Supplied
Pos.	Year	Application	
61522	C		-continued
F	81-86	SUBURBAN 3/4 TON, K25 / K2500 All Quad Suspension Long Shock; Exc. Lift Kit	
F	87-91	SUBURBAN 3/4 TON, V2500 All Quad Suspension Long Shock; Exc. Lift Kit	
R	78-95	VAN 1/2 TON, G / SAVANNA All	
R	85-96	VAN 1 TON, G / SAVANNA Extended Cargo Van	
R	85-96	VAN 1 TON, G / SAVANNA Extended Passenger Van	
R	79-96	VAN 1 TON, G / SAVANNA Standard Cargo Van	
R	79-96	VAN 1 TON, G / SAVANNA Standard Passenger Van	
R	78	VAN 1 TON, G / SAVANNA Cutaway Van	
R	78-95	VAN 3/4 TON, G / SAVANNA All Exc. 8600# GVW	
R	74-83	PLYMOUTH VAN 1/2 TON, PB SERIES All	
R	74-83	VAN 1 TON, PB SERIES All	
R	74-83	VAN 3/4 TON, PB SERIES All	
61523	C		140126
F	84-86	DODGE MINI RAM All	
F	72-93	PICKUP 1/2 TON, D100 SERIES All	
F	72-93	PICKUP 3/4 TON, D200 SERIES All Exc. HD Package	
F	75-93	RAMCHARGER RWD	
F	99-03	VAN 1/2 TON, A / B SERIES / RAM 109.3 (WheelBase) Exc. 7000# GVW	
F	81-98	VAN 1/2 TON, A / B SERIES / RAM 109.6 (WheelBase) Exc. 7000# GVW	
F	71-80	VAN 1/2 TON, A / B SERIES / RAM All	
F	99-03	VAN 1 TON, A / B SERIES / RAM All	
F	71-98	VAN 1 TON, A / B SERIES / RAM All Exc. 4000# Front Axle	
F	71-03	VAN 3/4 TON, A / B SERIES / RAM All	
F	74-80	VAN, CB300 All Exc. 4000# Front Axle	
F	75-81	PLYMOUTH TRAILDUSTER RWD	
F	74-83	VAN 1/2 TON, PB SERIES All	
F	74-83	VAN 1 TON, PB SERIES All Exc. 4000# Front Axle	
F	74-83	VAN 3/4 TON, PB SERIES All	
61524	C		140357
R	87-91	CHEVROLET BLAZER 4WD Full Size; Exc. Lift Kit	
R	85-86	BLAZER 4WD Exc. Lift Kit	
R	73-84	BLAZER All Exc. Lift Kit	
R	73-86	PICKUP 1/2 TON, C10 All	
R	73-86	PICKUP 1/2 TON, K10 All Exc. Lift Kit	
R	87	PICKUP 1/2 TON, R10 All	
R	87	PICKUP 1/2 TON, V10 All Exc. Lift Kit	
R	75-86	PICKUP 3/4 TON, C20 Standard Cab Pickup	
R	73-74	PICKUP 3/4 TON, C20 All Standard Cab Pickup	
R	73-86	PICKUP 3/4 TON, K20 All Exc. Lift Kit	
R	87	PICKUP 3/4 TON, R20 Standard Cab Pickup	
R	87	PICKUP 3/4 TON, V20 All Exc. Quad Suspension and Lift Kit	
R	73-86	SUBURBAN 1/2 TON, C10 All	
R	73-86	SUBURBAN 1/2 TON, K10 All Exc. Lift Kit	
R	87-88	SUBURBAN 1/2 TON, R10 All	
R	89-91	SUBURBAN 1/2 TON, R1500 All	
R	89-91	SUBURBAN 1/2 TON, V1500 All Exc. Lift Kit	
R	73-86	SUBURBAN 3/4 TON, C20 All	
R	73-86	SUBURBAN 3/4 TON, K20 All Exc. Lift Kit	
R	87-88	SUBURBAN 3/4 TON, R20 All	
R	89-91	SUBURBAN 3/4 TON, R2500 All	
R	87-88	SUBURBAN 3/4 TON, V20 All Exc. Quad Suspension and Lift Kit	
R	89-91	SUBURBAN 3/4 TON, V2500 All Exc. Lift Kit	
R	73	VAN 1/2 TON, P SERIES All	
R	73-78	VAN 3/4 TON, P SERIES All	
R	73-91	GMC JIMMY All Exc. Lift Kit	
R	73-86	PICKUP 1/2 TON, C15 / C1500 All	
R	73-86	PICKUP 1/2 TON, K15 / K1500 All Exc. Lift Kit	

Numerical listing

Shock	POP	Alternative No.	MTG Acc. Supplied
Pos.	Year	Application	
61524	C		-continued
R	87	PICKUP 1/2 TON, R1500 All	
R	87	PICKUP 1/2 TON, V1500 All Exc. Lift Kit	
R	75-86	PICKUP 3/4 TON, C25 / C2500 Cab & Chassis	
R	75-86	PICKUP 3/4 TON, C25 / C2500 Standard Cab Pickup	
R	73-74	PICKUP 3/4 TON, C25 / C2500 All Exc. Crew Cab & Bonus Cab	
R	73-86	PICKUP 3/4 TON, K25 / K2500 All Exc. Lift Kit	
R	88-89	PICKUP 3/4 TON, R2500 All Exc. Crew Cab & Bonus Cab	
R	87	PICKUP 3/4 TON, R2500 Cab & Chassis Exc. Crew Cab & Bonus Cab	
R	87	PICKUP 3/4 TON, R2500 Standard Cab Pickup Exc. Crew Cab & Bonus Cab	
R	87	PICKUP 3/4 TON, V2500 All Exc. Lift Kit	
R	73-86	SUBURBAN 1/2 TON, C15 / C1500 All	
R	73-86	SUBURBAN 1/2 TON, K15 / K1500 All Exc. Lift Kit	
R	87-91	SUBURBAN 1/2 TON, R1500 All	
R	87-91	SUBURBAN 1/2 TON, V1500 All Exc. Lift Kit	
R	75-86	SUBURBAN 3/4 TON, C25 / C2500 All	
R	73-74	SUBURBAN 3/4 TON, C25 / C2500 All Exc. Crew Cab & Bonus Cab	
R	73-86	SUBURBAN 3/4 TON, K25 / K2500 All Exc. Lift Kit	
R	87-91	SUBURBAN 3/4 TON, R2500 All	
R	87-91	SUBURBAN 3/4 TON, V2500 All Exc. Lift Kit	
R	73	VAN 1/2 TON, P SERIES All	
R	73-78	VAN 3/4 TON, P SERIES All	
61525	B		140702
F	75-84	CHEVROLET BLAZER RWD	
F	69-74	BLAZER All RWD	
F	63-86	PICKUP 1/2 TON, C10 All	
F	87	PICKUP 1/2 TON, R10 All	
F	63-86	PICKUP 1 TON, C30 All	
F	88-91	PICKUP 1 TON, C35/3500 Cab & Chassis Exc. HD Solid Front Axle	
F	87-88	PICKUP 1 TON, R30 All	
F	89	PICKUP 1 TON, R3500 Standard Cab Pickup	
F	75-86	PICKUP 3/4 TON, C20 Crew Cab Pickup	
F	75-86	PICKUP 3/4 TON, C20 Standard Cab Pickup	
F	63-74	PICKUP 3/4 TON, C20 All	
F	87-88	PICKUP 3/4 TON, R20 All	
F	89	PICKUP 3/4 TON, R2500 All	
F	63-66	SUBURBAN 1/2 TON, 1500 All	
F	67-86	SUBURBAN 1/2 TON, C10 All	
F	87-88	SUBURBAN 1/2 TON, R10 All	
F	89-91	SUBURBAN 1/2 TON, R1500 All	
F	67-86	SUBURBAN 3/4 TON, C20 All	
F	87-88	SUBURBAN 3/4 TON, R20 All	
F	89-91	SUBURBAN 3/4 TON, R2500 All	
F	63-80	VAN 1/2 TON, P SERIES All	
F	68-90	VAN 1 TON, P SERIES All Cutaway Chassis	
F	68-89	VAN 3/4 TON, P SERIES All	
F	75-84	GMC JIMMY RWD	
F	70-74	JIMMY All RWD	
F	67-86	PICKUP 1/2 TON, C15 / C1500 All	
F	87	PICKUP 1/2 TON, R1500 All	
F	88-91	PICKUP 1 TON, C35/3500 Cab & Chassis HD Solid Front Axle	
F	67-78	PICKUP 1 TON, C35/3500 All	
F	87-91	PICKUP 1 TON, R3500 All	
F	85-86	PICKUP 3/4 TON, C25 / C2500 Crew Cab Pickup	
F	75-86	PICKUP 3/4 TON, C25 / C2500 Cab & Chassis	
F	75-86	PICKUP 3/4 TON, C25 / C2500 Standard Cab Pickup	
F	75-83	PICKUP 3/4 TON, C25 / C2500 Crew Cab Pickup	
F	67-74	PICKUP 3/4 TON, C25 / C2500 All	
F	87-89	PICKUP 3/4 TON, R2500 All Exc. Crew Cab & Bonus Cab	
F	63-66	PICKUP 1000 SERIES All	
F	63-66	PICKUP 1500 SERIES All	
F	66	PICKUP 2500 SERIES All	
F	75-86	SUBURBAN 1/2 TON, C15 / C1500 All	

Numerical listing

Shock	POP	Alternative No.	MTG Acc. Supplied
Pos.	Year	Application	
61525	B	-continued	140702
F	68-74	SUBURBAN 1/2 TON, C15 / C1500 All Coil (FrontSpringType)	
F	87-91	SUBURBAN 1/2 TON, R1500 All	
F	68-86	SUBURBAN 3/4 TON, C25 / C2500 All	
F	87-91	SUBURBAN 3/4 TON, R2500 All	
F	67-80	VAN 1/2 TON, P SERIES All	
F	75-90	VAN 1 TON, P SERIES All Cutaway Chassis	
F	73-74	VAN 1 TON, P SERIES Base Cutaway Chassis	
F	68-72	VAN 1 TON, P SERIES All	
F	68-89	VAN 3/4 TON, P SERIES All	
F	63-65	VAN, PB 1000 SERIES All	
61526	D		
R	72-93	DODGE PICKUP 1/2 TON, D100 SERIES All	
R	72-93	PICKUP 1 TON, D300 SERIES All	
R	72-93	PICKUP 3/4 TON, D200 SERIES All	
R	76-93	RAMCHARGER RWD	
R	74-75	RAMCHARGER All	
R	76-81	PLYMOUTH TRAILDUSTER RWD	
R	74-75	TRAILDUSTER All	
61528	A		
R	05	CHEVROLET BLAZER Base, 4WD	
R	05	BLAZER Base, RWD	
R	96-04	BLAZER LS, 4WD	
R	96-04	BLAZER LS, RWD	
R	95-02	BLAZER LT, RWD	
R	95-01	BLAZER LT, 4WD	
R	95-99	BLAZER Base, 4WD	
R	95-99	BLAZER Base, RWD	
R	95-97	BLAZER Deluxe, RWD	
R	83-94	BLAZER, S MODELS All	
R	99-04	S10 LS, 4WD	
R	99-03	S10 Base, 4WD	
R	99-03	S10 Base, RWD	
R	99-03	S10 LS, RWD	
R	94-98	S10 LS	
R	82-98	S10 Base	
R	92-93	S10 EL	
R	83-92	S10 Tahoe	
R	88-90	S10 Durango	
R	82-86	S10 Durango	
R	05	GMC JIMMY 4WD	
R	92-04	JIMMY All	
R	83-91	S15 JIMMY All	
R	82-04	SONOMA / S15 All	
R	91	SYCLONE All	
R	92-93	TYPHOON All	
R	96-00	ISUZU HOMBRE All	
R	96-01	OLDSMOBILE BRAVADA All	
R	91-94	BRAVADA All	
61529	D		140673
F	82	DODGE D50 4WD	
F	87-93	PICKUP, RAM 50 4WD	
F	87-89	RAIDER All	
F	83-94	MITSUBISHI MIGHTY MAX 4WD	
F	83-91	MONTERO All	
F	87-89	TOYOTA VAN RWD	
F	84-86	VAN All	
F	88	VAN WAGON RWD	
61530	B		
R	80-96	FORD PICKUP 1/2 TON, F-150 4WD Exc. Lift Kit	
R	86-97	PICKUP 1 TON, F-350 / SUPERDUTY 4WD Dual Rear Wheels	
R	82-85	PICKUP 1 TON, F-350 / SUPERDUTY 4WD Clevis Type Lower Front Mount; Exc. Dual Rear Wheels or Lift Kit	
R	80-81	PICKUP 1 TON, F-350 / SUPERDUTY 4WD	
R	97	PICKUP 3/4 TON, F-250 / SUPERDUTY 4WD Over 8500# GVW	
R	87-96	PICKUP 3/4 TON, F-250 / SUPERDUTY 4WD	
R	82-86	PICKUP 3/4 TON, F-250 / SUPERDUTY 4WD Clevis Type Lower Front Mount; Exc. Dual Rear Wheels or Lift Kit	
R	80-81	PICKUP 3/4 TON, F-250 / SUPERDUTY 4WD	
61531	A		
F	05	CHEVROLET BLAZER Base, 4WD	
F	96-04	BLAZER LS, 4WD	
F	95-01	BLAZER LT, 4WD	
F	95-99	BLAZER Base, 4WD	

ProGuard

Shock	POP	Alternative No.	MTG Acc. Supplied
Pos.	Year	Application	
61531	A	-continued	
F	83-94	BLAZER, S MODELS 4WD	
F	94-04	S10 LS, 4WD	
F	83-03	S10 Base, 4WD	
F	92-93	S10 EL, 4WD	
F	83-92	S10 Tahoe, 4WD	
F	88-90	S10 Durango, 4WD	
F	83-86	S10 Durango, 4WD	
F	92-05	GMC JIMMY 4WD	
F	83-91	S15 JIMMY 4WD	
F	83-04	SONOMA / S15 4WD	
F	91	SYCLONE All	
F	92-93	TYPHOON All	
F	99-00	ISUZU HOMBRE 4WD	
F	96-98	HOMBRE All Sport Chassis	
F	96-01	OLDSMOBILE BRAVADA All	
F	91-94	BRAVADA All	
61532	W		
R	82	DODGE D50 4WD	
R	87-93	PICKUP, RAM 50 4WD	
R	83-94	MITSUBISHI MIGHTY MAX 4WD	
61533	W		
R	89	FORD BRONCO II All Mfg. to 2/89; Vehicles with 10mm & 12mm bolt in rear lower mount	
R	84-88	BRONCO II All With 10mm Bolt In Rear Lower Mount	
R	89	RANGER RWD Mfg. to 2/89; Vehicles with 10mm bolt in rear lower mount	
R	83-88	RANGER RWD	
61534	X		
R	83-89	FORD RANGER 4WD	
61535	A		141353
F	84-01	JEEP CHEROKEE All	
F	86-92	COMANCHE All	
F	93-98	GRAND CHEROKEE All	
F	84-90	WAGONEER All	
61536	B		
R	84-01	JEEP CHEROKEE All	
R	84-90	WAGONEER All	
61538	W		
R	90-95	CHRYSLER TOWN & COUNTRY All	
R	84-95	DODGE CARAVAN / GRAND CARAVAN All	
R	87-88	MINI RAM All	
R	84-95	PLYMOUTH VOYAGER / GRAND VOYAGER All	
61539	B		
R	90-05	CHEVROLET ASTRO All	
R	85-89	ASTRO RWD	
R	90-05	GMC SAFARI All	
R	85-89	SAFARI RWD	
R	86-89	VOLKSWAGEN VANAGON 4WD	
61540	W		140126
F	86-97	FORD AEROSTAR RWD	
61541	D		
R	86-88	FORD AEROSTAR RWD	
R	87-95	JEEP WRANGLER YJ (MfrBodyCode)	
61542	A		
F	99-00	CADILLAC ESCALADE All	
F	90-05	CHEVROLET ASTRO 4WD	
F	92-94	BLAZER 4WD Full Size	
F	88-00	PICKUP 1 TON, K35 / K3500 All	
F	88-00	PICKUP 3/4 TON, K25 / K2500 All	
F	92-99	SUBURBAN 1/2 TON, K15 / K1500 All	
F	92-99	SUBURBAN 3/4 TON, K25 / K2500 All	
F	95-00	TAHOE 4WD Old Body Style	
F	88-00	GMC PICKUP 1 TON, K35 / K3500 All	
F	88-00	PICKUP 3/4 TON, K25 / K2500 All	
F	90-05	SAFARI 4WD	
F	92-99	SUBURBAN 1/2 TON, K15 / K1500 All	
F	92-99	SUBURBAN 3/4 TON, K25 / K2500 All	
F	92-99	YUKON 4WD	
61543	A		
R	91-02	CHEVROLET C3500HD All Solid Front Axle	
R	88-99	PICKUP 1/2 TON, C15 / C1500 All	
R	88-99	PICKUP 1/2 TON, K15 / K1500 All	

Numerical listing

Shock	POP	Alternative No.	MTG Acc. Supplied
Pos.	Year	Application	
61543	A	-continued	
R	03	PICKUP 1 TON, C35/3500 All HD Solid Front Axle	
R	88-90	PICKUP 1 TON, C35/3500 Extended Cab Pickup Exc. HD Straight Front Axle	
R	88-90	PICKUP 1 TON, C35/3500 Standard Cab Pickup Exc. HD Straight Front Axle	
R	88-00	PICKUP 1 TON, K35 / K3500 All	
R	88-00	PICKUP 3/4 TON, C25 / C2500 All	
R	88-00	PICKUP 3/4 TON, K25 / K2500 All	
R	01-02	GMC C3500HD All Solid Front Axle	
R	88-99	PICKUP 1/2 TON, C15 / C1500 All	
R	88-99	PICKUP 1/2 TON, K15 / K1500 All	
R	91-00	PICKUP 1 TON, C35/3500 All HD Solid Front Axle	
R	88-90	PICKUP 1 TON, C35/3500 All Exc. HD Straight Front Axle	
R	88-00	PICKUP 1 TON, K35 / K3500 All	
R	88-00	PICKUP 3/4 TON, C25 / C2500 All	
R	88-00	PICKUP 3/4 TON, K25 / K2500 All	
61544	A		141277
F	88-99	CHEVROLET PICKUP 1/2 TON, C15 / C1500 All	
F	92-00	PICKUP 1 TON, C35/3500 Crew Cab Pickup Exc. HD Straight Front Axle	
F	88-00	PICKUP 1 TON, C35/3500 Extended Cab Pickup Exc. HD Straight Front Axle	
F	88-00	PICKUP 1 TON, C35/3500 Standard Cab Pickup Exc. HD Straight Front Axle	
F	88-00	PICKUP 3/4 TON, C25 / C2500 All	
F	92-99	SUBURBAN 1/2 TON, C15 / C1500 All	
F	92-99	SUBURBAN 3/4 TON, C25 / C2500 All	
F	95-00	TAHOE RWD Old Body Style	
F	88-99	GMC PICKUP 1/2 TON, C15 / C1500 All	
F	92-00	PICKUP 1 TON, C35/3500 Crew Cab Pickup Exc. HD Straight Front Axle	
F	88-00	PICKUP 1 TON, C35/3500 Extended Cab Pickup Exc. HD Straight Front Axle	
F	88-00	PICKUP 1 TON, C35/3500 Standard Cab Pickup Exc. HD Straight Front Axle	
F	88-00	PICKUP 3/4 TON, C25 / C2500 All	
F	92-99	SUBURBAN 1/2 TON, C15 / C1500 All	
F	92-99	SUBURBAN 3/4 TON, C25 / C2500 All	
F	92-99	YUKON RWD	
61546	D		141047
F	80-96	FORD BRONCO All Quad Suspension; Forward of Front Axle; Exc. Lift Kit	
F	80-96	PICKUP 1/2 TON, F-150 4WD Quad Suspension; Forward of Front Axle; Exc. Lift Kit	
F	80-81	PICKUP 1 TON, F-350 / SUPERDUTY 4WD	
F	80-82	PICKUP 3/4 TON, F-250 / SUPERDUTY 4WD	
61547	C		
R	85-96	FORD PICKUP 1/2 TON, F-150 RWD	
R	80-97	PICKUP 1 TON, F-350 / SUPERDUTY RWD Exc. Dual Rear Wheels	
R	97	PICKUP 3/4 TON, F-250 / SUPERDUTY RWD Over 8500# GVW	
R	80-96	PICKUP 3/4 TON, F-250 / SUPERDUTY RWD	
61549	W		140455
F	86-95	SUZUKI SAMURAI All	
61550	W		
R	86-95	SUZUKI SAMURAI All	
61551	D		141353
F	78-79	FORD BRONCO All Quad Suspension; Forward of Front Axle; Non Quad Suspension, Left Shock; Exc. Lift Kit	

Numerical listing

Shock	POP	Alternative No.	MTG Acc. Supplied
Pos.	Year	Application	
61551	D	-continued	141353
F	78-79	PICKUP 1/2 TON, F-150 Custom, 4WD Quad Suspension, Forward of Front Axle; Non Quad Suspension, Left Shock; Exc. Lift Kit	
F	78-79	PICKUP 1/2 TON, F-150 Ranger Lariat, 4WD Quad Suspension, Forward of Front Axle; Non Quad Suspension, Left Shock; Exc. Lift Kit	
F	78-79	PICKUP 1/2 TON, F-150 Ranger, 4WD Quad Suspension, Forward of Front Axle; Non Quad Suspension, Left Shock; Exc. Lift Kit	
F	78	PICKUP 1/2 TON, F-150 Base, 4WD Quad Suspension, Forward of Front Axle; Non Quad Suspension, Left Shock; Exc. Lift Kit	
F	78	PICKUP 1/2 TON, F-150 Northland, 4WD Quad Suspension, Forward of Front Axle; Non Quad Suspension, Left Shock; Exc. Lift Kit	
F	87-95	JEEP WRANGLER YJ (MfrBodyCode)	
61552	B		140524
F	86-95	TOYOTA 4RUNNER All	
F	86-95	PICKUP 4WD Exc. Lift Kit	
F	93-98	T100 4WD	
61553	W		140780
F	75-91	FORD VAN 1/2 TON, ECONOLINE / CLUB WAGON All	
61554	D		
R	80-96	FORD BRONCO All Exc. Lift Kit	
R	80-83	PICKUP 1/2 TON, F-100 RWD	
R	80-84	PICKUP 1/2 TON, F-150 RWD	
R	90-97	PICKUP 1/2 TON, F SUPERDUTY All	
R	80-97	PICKUP 1 TON, F-350 / SUPERDUTY RWD Dual Rear Wheels	
R	97	PICKUP, F-450 SUPERDUTY All	
61555	A		142615
F	85-05	CHEVROLET ASTRO RWD	
F	81	BEL AIR Sedan Police and Taxi Models	
F	71-75	BEL AIR Sedan Police and Taxi Models	
F	71-72	BISCAYNE All Police and Taxi Models	
F	73-96	CAPRICE Sedan Police and Taxi Models	
F	71-72	CAPRICE All Police and Taxi Models	
F	83-85	IMPALA All Police and Taxi Models	
F	71-82	IMPALA Sedan Police and Taxi Models	
F	96-02	VAN 1/2 TON, G / EXPRESS All	
F	97-02	VAN 1 TON, G / EXPRESS All	
F	96-02	VAN 3/4 TON, G / EXPRESS All Exc. 8600# GVW	
F	93-02	FORD CROWN VICTORIA Police Interceptor	
F	85-05	GMC SAFARI RWD	
F	96-02	VAN 1/2 TON, G / SAVANNA All	
F	96-02	VAN 1 TON, G / SAVANNA All	
F	96-02	VAN 3/4 TON, G / SAVANNA All Exc. 8600# GVW	
61556	W		140455
F	79-82	DODGE D50 RWD	
F	83-93	PICKUP, RAM 50 RWD	
F	83-96	PLYMOUTH MIGHTY MAX RWD	
F	79-82	PLYMOUTH PICKUP All	
61557	W		
R	90-97	FORD AEROSTAR All	
R	89	AEROSTAR RWD	
61558	W		140524
R	87-88	ISUZU TROOPER 4WD	
61559	B		
R	90	FORD BRONCO II All	
R	89	BRONCO II All Mfg. from 2/89; Vehicles with 12mm bolt in rear lower mount	
R	90-97	RANGER RWD	
R	89	RANGER RWD Mfg. from 2/89; Vehicles with 12mm bolt in rear lower mount	
R	94-97	MAZDA B2300 RWD	
R	94-97	B3000 RWD	
R	94	B4000 RWD	

ProGuard

Shock	POP	Alternative No.	MTG Acc. Supplied
Pos.	Year	Application	
61560	C		141514
R	94-98	ASUNA SUNRUNNER	
R	92-93	SUNRUNNER All	
R	98-04	CHEVROLET TRACKER Non-ABS	
R	89-97	GEO TRACKER All	
R	94-97	PONTIAC SUNRUNNER All	
R	99-05	SUZUKI GRAND VITARA All	
R	89-98	SIDEKICK All	
R	99-04	VITARA All	
R	96-98	X-90 All	
61561	B		140780
F	90	FORD BRONCO II All	
F	90-97	RANGER All	
F	94-97	MAZDA B2300 All	
F	94-97	B3000 All	
F	94-97	B4000 RWD	
61565	A		
R	99-00	CADILLAC ESCALADE All	
R	92-94	CHEVROLET BLAZER 4WD Full Size	
R	92-99	SUBURBAN 1/2 TON, C15 / C1500 All	
R	92-99	SUBURBAN 1/2 TON, K15 / K1500 All	
R	92-99	SUBURBAN 3/4 TON, C25 / C2500 All	
R	92-99	SUBURBAN 3/4 TON, K25 / K2500 All	
R	95-00	TAHOE All Old Body Style	
R	03-11	VAN 1/2 TON, G / EXPRESS All Exc. Upfitter Package and Cutaway Chassis	
R	96-02	VAN 1/2 TON, G / EXPRESS All	
R	97-02	VAN 1 TON, G / EXPRESS All	
R	96	VAN 1 TON, G / EXPRESS All Exc. 8600# GVW	
R	96-02	VAN 3/4 TON, G / EXPRESS All Exc. 8600# GVW	
R	92-99	GMC SUBURBAN 1/2 TON, C15 / C1500 All	
R	92-99	SUBURBAN 1/2 TON, K15 / K1500 All	
R	92-99	SUBURBAN 3/4 TON, C25 / C2500 All	
R	92-99	SUBURBAN 3/4 TON, K25 / K2500 All	
R	03-11	VAN 1/2 TON, G / SAVANNA All Exc. Upfitter Package and Cutaway Chassis	
R	96-02	VAN 1/2 TON, G / SAVANNA All	
R	96-02	VAN 1 TON, G / SAVANNA All Exc. 8600# GVW	
R	96-02	VAN 3/4 TON, G / SAVANNA All Exc. 8600# GVW	
R	92-99	YUKON All	
61568	X		
R	89	DODGE RAIDER 3.0L 6Cyl V (181)	
R	89-91	MINI COOPER MONTERO 3.0L 6Cyl V (181)	
61569	W		140780
F	90-97	FORD AEROSTAR AWD	
61573	D		
R	90-97	FORD RANGER 4WD	
R	89	RANGER 4WD High Ryder Option	
R	95-96	MAZDA B2300 4WD	
61575	C		
R	93-98	JEEP GRAND CHEROKEE All	
61582	W		
R	93-98	TOYOTA T100 4WD	
61584	D		
R	87-96	DODGE DAKOTA 4WD	
61586	W		141350
R	89-91	ISUZU TROOPER All	
61588	D		140921
R	90-95	TOYOTA 4RUNNER All	
61589	W		
R	89-98	MAZDA MPV RWD	
61590	D		140719
R	91-94	FORD EXPLORER All	
R	91-94	MAZDA NAVAJA All	
61591	A		140780
F	91-94	FORD EXPLORER All	
F	92-11	VAN 1/2 TON, ECONOLINE / CLUB WAGON All	

Numerical listing

Shock	POP	Alternative No.	MTG Acc. Supplied
Pos.	Year	Application	
61591	A	-continued	140780
F	92-11	VAN 1 TON, ECONOLINE / CLUB WAGON / SUPERDUTY All	
F	92-02	VAN 3/4 TON, ECONOLINE / CLUB WAGON / SUPERDUTY All	
F	91-94	MAZDA NAVAJA All	
61592	B		142389
R	94-97	HONDA PASSPORT All	
R	91-97	ISUZU RODEO All	
R	98-03	TOYOTA SIENNA All	
61593	B		140524
F	94-02	HONDA PASSPORT All	
F	98-00	ISUZU AMIGO All	
F	02-04	AXIOM All	
F	91-04	RODEO All	
F	87-91	TROOPER 4WD	
F	86-87	MAZDA B2000 RWD	
F	87-93	B2200 RWD	
F	87-93	B2600 RWD	
F	87-90	MINI COOPER VAN All	
F	87-95	NISSAN PATHFINDER All Exc. Electronic Adjustable Suspension	
61594	W		141405
R	91-97	TOYOTA PREVIA All	
61595	C		140780
R	92-11	FORD VAN 1/2 TON, ECONOLINE / CLUB WAGON All	
61596	W		140524
F	87-93	MAZDA B2600 4WD	
61597	W		140169
R	87-93	MAZDA B2600 4WD	
61598	X		
R	89-98	MAZDA MPV 4WD	
61599	A		143000
F	94-01	DODGE PICKUP 1/2 TON, RAM 1500 (SEE RAM 1500) RWD	
F	94-02	PICKUP 1 TON, RAM 3500 (SEE RAM 3500) RWD Exc. Solid Front Axle	
F	94-02	PICKUP 3/4 TON, RAM 2500 (SEE RAM 2500) RWD	
61600	A		
R	99-07	CHEVROLET PICKUP 1/2 TON, SILVERADO 1500 RWD Exc. Electronic Adjustable Suspension	
R	94-01	DODGE PICKUP 1/2 TON, RAM 1500 (SEE RAM 1500) All	
R	94-02	PICKUP 1 TON, RAM 3500 (SEE RAM 3500) RWD Exc. Solid Front Axle	
R	94-03	PICKUP 3/4 TON, RAM 2500 (SEE RAM 2500) 4WD, GAS Exc. 8800# GVW	
R	94-02	PICKUP 3/4 TON, RAM 2500 (SEE RAM 2500) RWD	
R	95-96	PICKUP 3/4 TON, RAM 2500 (SEE RAM 2500) 4WD, CNG Exc. 8800# GVW	
R	99-07	GMC SIERRA 1500 RWD Exc. Electronic Adjustable Suspension	
61601	A		140126
F	97-04	DODGE DAKOTA 4WD	
F	98-03	DURANGO 4WD	
61605	A		
R	96-07	CHRYSLER TOWN & COUNTRY All	
R	01-03	VOYAGER / GRAND VOYAGER All Exc. Hydraulic Self Leveling System	
R	00	VOYAGER / GRAND VOYAGER All	
R	00	VOYAGER / GRAND VOYAGER Non-ABS Exc. Hydraulic Self Leveling System	
R	96-07	DODGE CARAVAN / GRAND CARAVAN All Exc. Hydraulic Self Leveling System	
R	96-00	PLYMOUTH VOYAGER / GRAND VOYAGER All	
61606	B		140673
F	01-04	TOYOTA TACOMA S-Runner Exc. Offroad Package	
F	04	TACOMA Base, RWD Exc. Offroad Package	
F	95-03	TACOMA DLX, RWD Exc. Offroad Package	

Numerical listing

Shock	POP	Alternative No.	MTG Acc. Supplied
Pos.	Year	Application	
61607	D		141354
F	96-99	ACURA SLX All	
F	92-02	ISUZU TROOPER All	
F	99-01	VEHICROSS All	
61608	D		140169
R	96-99	ACURA SLX All	
R	92-02	ISUZU TROOPER All	
R	99-01	VEHICROSS All	
61609	C		141137
R	97-99	INFINITI QX4 All Mfg. to 12/98	
R	96-99	NISSAN PATHFINDER All Mfg. to 12/98	
61610	C		140524
R	98-02	HONDA PASSPORT All	
R	98-00	ISUZU AMIGO All	
R	02-04	AXIOM All	
R	98-04	RODEO All	
61611	A		142731
F	97-02	FORD EXPEDITION RWD Exc. Front Air- Leveling	
F	97-04	PICKUP 1/2 TON, F-150 RWD	
F	96-99	PICKUP 3/4 TON, F-250 / SUPERDUTY RWD Up through 8500# GVW	
F	98-02	LINCOLN NAVIGATOR Coil (FrontSpringType)	
61612	B		142700
R	97-04	FORD PICKUP 1/2 TON, F-150 4WD Exc. 7000# GVW	
R	97-99	PICKUP 3/4 TON, F-250 / SUPERDUTY 4WD Up through 8500# GVW; Exc. Superduty	
61613	A		142731
F	97-02	FORD EXPEDITION 4WD Exc. Front Air- Leveling	
F	04	PICKUP 1/2 TON, F-150 4WD Exc. 7000# GVW	
F	97-03	PICKUP 1/2 TON, F-150 4WD	
F	97-99	PICKUP 3/4 TON, F-250 / SUPERDUTY 4WD Up through 8500# GVW; Exc. Superduty	
61614	A		
R	97-02	FORD EXPEDITION All	
F	86-97	PICKUP 1 TON, F-350 / SUPERDUTY 4WD	
F	98	PICKUP 3/4 TON, F-250 / SUPERDUTY All Over 8500# GVW	
F	97	PICKUP 3/4 TON, F-250 / SUPERDUTY 4WD Over 8500# GVW	
F	87-96	PICKUP 3/4 TON, F-250 / SUPERDUTY 4WD	
R	98-02	LINCOLN NAVIGATOR RWD	
61615	C		141665
F	97-06	JEEP WRANGLER TJ (MfrBodyCode)	
61616	B		
R	97-06	JEEP WRANGLER TJ (MfrBodyCode)	
61623	A		142277
F	95-01	FORD EXPLORER All Exc. Adjustable Suspension	
F	01-05	EXPLORER SPORT TRAC All	
F	01-05	RANGER XL, RWD, Torsion Bar (FrontSpringType)	
F	01-05	RANGER XLT, RWD, Torsion Bar (FrontSpringType)	
F	05	RANGER STX, RWD w/ Torsion Bar (FrontSpringType)	
F	04	RANGER Tremor, RWD, Torsion Bar (FrontSpringType)	
F	01-02	RANGER EV, RWD, Torsion Bar (FrontSpringType)	
F	02	RANGER Sport, RWD w/ Torsion Bar (FrontSpringType)	
F	00	RANGER 4WD, Torsion Bar (FrontSpringType)	
F	98-99	RANGER 4WD	
F	03-07	MAZDA B3000 All 4WD	
F	98-02	B3000 4WD	
F	98-09	B4000 4WD	
F	97-01	MERCURY MOUNTAINEER All Exc. Electronic Adjustable Suspension	

ProGuard

Shock	POP	Alternative No.	MTG Acc. Supplied
Pos.	Year	Application	
61624	A		140719
R	95-01	FORD EXPLORER All Exc. Adjustable Suspension	
R	01-05	EXPLORER SPORT TRAC All	
R	97-01	MERCURY MOUNTAINEER All Exc. Electronic Adjustable Suspension	
61625	C		
R	95-03	FORD WINDSTAR Coil (RearSpringType)	
61626	A		141665
F	06-11	FORD RANGER RWD, Coil (FrontSpringType)	
F	01-05	RANGER XL, RWD, Coil (FrontSpringType)	
F	01-05	RANGER XLT, RWD, Coil (FrontSpringType)	
F	01-02	RANGER EV, RWD Coil Front Spring Type	
F	98-00	RANGER XL, RWD	
F	98-00	RANGER XLT, RWD	
F	01-09	MAZDA B2300 RWD	
F	98-01	B2500 RWD	
F	98-07	B3000 RWD	
F	98-09	B4000 RWD	
61627	A		
R	06-11	FORD RANGER RWD, Coil (FrontSpringType)	
R	98-05	RANGER XL, RWD	
R	98-05	RANGER XLT, RWD	
R	05	RANGER STX, RWD	
R	04	RANGER Tremor, RWD	
R	01-09	MAZDA B2300 RWD	
R	98-01	B2500 RWD	
R	98-07	B3000 RWD	
R	98-09	B4000 RWD	
61629	B		
R	06-11	FORD RANGER RWD, Torsion Bar (FrontSpringType)	
R	98-11	RANGER 4WD	
R	01-05	RANGER Edge, RWD	
R	03-07	MAZDA B3000 All 4WD	
R	98-02	B3000 4WD	
R	98-09	B4000 4WD	
61632	W		
F	81-93	DODGE PICKUP 1/2 TON, W100 SERIES All Exc. Lift Kit	
F	61-80	PICKUP 1/2 TON, W100 SERIES All	
F	81-93	PICKUP 1 TON, W300 SERIES All Exc. Quad Suspension and Lift Kit	
F	61-80	PICKUP 1 TON, W300 SERIES All	
R	61-71	PICKUP 1 TON, W300 SERIES All	
F	90-93	PICKUP 3/4 TON, W200 SERIES Extended Cab Pickup Exc. Lift Kit	
F	88-93	PICKUP 3/4 TON, W200 SERIES Cab & Chassis Exc. Lift Kit	
F	81-93	PICKUP 3/4 TON, W200 SERIES Standard Cab Pickup Exc. Lift Kit	
F	86	PICKUP 3/4 TON, W200 SERIES Cab & Chassis Exc. Lift Kit	
F	81-83	PICKUP 3/4 TON, W200 SERIES Cab & Chassis Exc. Lift Kit	
F	81-82	PICKUP 3/4 TON, W200 SERIES Extended Cab Pickup Exc. Lift Kit	
F	69-80	PICKUP 3/4 TON, W200 SERIES All	
F	61-67	PICKUP 3/4 TON, W200 SERIES All	
F	75-93	RAMCHARGER 4WD	
F	74	RAMCHARGER All 4WD	
F	75-81	PLYMOUTH TRAILDUSTER 4WD	
F	74	TRAILDUSTER All	
61633	W		
R	81-93	DODGE PICKUP 1/2 TON, W100 SERIES All Exc. Lift Kit	
R	72-80	PICKUP 1/2 TON, W100 SERIES All	
R	81-93	PICKUP 1 TON, W300 SERIES All Exc. Quad Suspension and Lift Kit	
R	72-80	PICKUP 1 TON, W300 SERIES All	
R	90-93	PICKUP 3/4 TON, W200 SERIES Extended Cab Pickup Exc. Lift Kit	
R	88-93	PICKUP 3/4 TON, W200 SERIES Cab & Chassis Exc. Lift Kit	
R	81-93	PICKUP 3/4 TON, W200 SERIES Standard Cab Pickup Exc. Lift Kit	
R	86	PICKUP 3/4 TON, W200 SERIES Cab & Chassis Exc. Lift Kit	
R	81-83	PICKUP 3/4 TON, W200 SERIES Cab & Chassis Exc. Lift Kit	
R	81-82	PICKUP 3/4 TON, W200 SERIES Extended Cab Pickup Exc. Lift Kit	
R	72-80	PICKUP 3/4 TON, W200 SERIES All	

Numerical listing

Shock	POP	Alternative No.	MTG Acc. Supplied
Pos.	Year	Application	
61633	W	-continued	
R	76-93	RAMCHARGER 4WD	
R	76-81	PLYMOUTH TRAILDUSTER 4WD	
61634	B		142731
F	94-01	DODGE PICKUP 1/2 TON, RAM 1500 (SEE RAM 1500) 4WD	
F	94-02	PICKUP 3/4 TON, RAM 2500 (SEE RAM 2500) 4WD, GAS Exc. 8800# GVW	
F	95-96	PICKUP 3/4 TON, RAM 2500 (SEE RAM 2500) 4WD, CNG Exc. 8800# GVW	
61635	D		142731
F	94-02	DODGE PICKUP 1 TON, RAM 3500 (SEE RAM 3500) 4WD	
F	94-02	PICKUP 1 TON, RAM 3500 (SEE RAM 3500) RWD Solid Front Axle	
F	94-02	PICKUP 3/4 TON, RAM 2500 (SEE RAM 2500) 4WD, DIESEL 8800# GVW	
61637	D		140885
R	97-02	MERCURY VILLAGER Non-ABS	
R	93-96	VILLAGER 4-Wheel ABS	
R	93-02	NISSAN QUEST All	
61638	A		142700
R	04	FORD PICKUP 1/2 TON, F-150 RWD	
R	00-03	PICKUP 1/2 TON, F-150 Harley-Davidson Edition, RWD	
R	99-03	PICKUP 1/2 TON, F-150 Lariat, RWD	
R	99-03	PICKUP 1/2 TON, F-150 XL, RWD	
R	99-03	PICKUP 1/2 TON, F-150 XLT, RWD	
R	00	PICKUP 1/2 TON, F-150 Base, RWD	
R	97-98	PICKUP 1/2 TON, F-150 RWD	
R	97-99	PICKUP 3/4 TON, F-250 / SUPERDUTY RWD Up through 8500# GVW	
61641	A		141665
F	99-07	CHEVROLET PICKUP 1/2 TON, SILVERADO 1500 RWD Exc. Electronic Adjustable Suspension	
F	99-07	GMC SIERRA 1500 RWD Exc. Electronic Adjustable Suspension	
61642	A		
R	07	CHEVROLET PICKUP 1/2 TON, SILVERADO 1500 4WD Old Body Style; Exc. Electronic Adjustable Suspension	
R	99-06	PICKUP 1/2 TON, SILVERADO 1500 4WD Exc. Electronic Adjustable Suspension	
R	05-06	PICKUP 1/2 TON, SILVERADO 1500 HD All	
R	01-03	PICKUP 1/2 TON, SILVERADO 1500 HD All	
R	77-86	PICKUP 1 TON, K30 All	
R	90-91	PICKUP 1 TON, R3500 All	
R	89	PICKUP 1 TON, R3500 Cab & Chassis, RWD	
R	89	PICKUP 1 TON, R3500 Crew Cab Pickup, RWD	
R	01-09	PICKUP 1 TON, SILVERADO 3500 All	
R	07-10	PICKUP 1 TON, SILVERADO 3500 HD All	
R	87-88	PICKUP 1 TON, V30 All	
R	89-91	PICKUP 1 TON, V3000 / V3500 All	
R	99-08	PICKUP 3/4 TON, SILVERADO 2500 All	
R	01-10	PICKUP 3/4 TON, SILVERADO 2500 HD All	
R	07	SILVERADO 1500 HD CLASSIC 4WD	
R	94-02	DODGE PICKUP 1 TON, RAM 3500 (SEE RAM 3500) 4WD	
R	94-02	PICKUP 1 TON, RAM 3500 (SEE RAM 3500) RWD Solid Front Axle	
R	94-02	PICKUP 3/4 TON, RAM 2500 (SEE RAM 2500) 4WD, DIESEL 8800# GVW	
R	77-86	GMC PICKUP 1 TON, K35 / K3500 All	
R	87-91	PICKUP 1 TON, V3000 / V3500 All	
R	07	SIERRA 1500 4WD Old Body Style; Exc. Electronic Adjustable Suspension	
R	99-06	SIERRA 1500 4WD Exc. Electronic Adjustable Suspension	
R	05-06	SIERRA 1500 HD All	

Numerical listing

Shock	POP	Alternative No.	MTG Acc. Supplied
Pos.	Year	Application	
61642	A	-continued	
R	01-03	SIERRA 1500 HD All	
R	07	SIERRA 1500 HD CLASSIC All	
R	99-04	SIERRA 2500 All	
R	01-10	SIERRA 2500 HD All	
R	01-06	SIERRA 3500 All	
R	07	SIERRA 3500 CLASSIC All	
R	07-10	SIERRA 3500 HD All	
61643	A	141665	
F	02-06	CHEVROLET AVALANCHE 1500 All Exc. Electronic Ride Control	
F	07	PICKUP 1/2 TON, SILVERADO 1500 4WD Old Body Style; Exc. Electronic Adjustable Suspension	
F	99-06	PICKUP 1/2 TON, SILVERADO 1500 4WD Exc. Electronic Adjustable Suspension	
F	00-06	SUBURBAN 1/2 TON, 1500 All Exc. Z55 Auto Ride Suspension	
F	02-06	TAHOE All Exc. Z55 Auto Ride Suspension	
F	00-01	TAHOE All New Body Style; Exc. Z55 Auto Ride Suspension	
F	07	GMC SIERRA 1500 4WD Old Body Style; Exc. Electronic Adjustable Suspension	
F	99-06	SIERRA 1500 4WD Exc. Electronic Adjustable Suspension	
F	00-06	YUKON All Exc. Z55 Auto Ride Suspension	
F	00-06	YUKON XL 1/2 TON All Exc. Z55 Auto Ride Suspension	
61646	C	142617	
R	12-14	FORD VAN 1/2 TON, ECONOLINE / CLUB WAGON All	
R	10-14	VAN 1 TON, ECONOLINE / CLUB WAGON / SUPERDUTY All	
R	04-11	VAN 1 TON, ECONOLINE / CLUB WAGON / SUPERDUTY All Exc. Cutaway Chassis	
R	92-05	VAN 1 TON, ECONOLINE / CLUB WAGON / SUPERDUTY All	
R	92-14	VAN 3/4 TON, ECONOLINE / CLUB WAGON / SUPERDUTY All	
61647	W	140126	
R	76-79	FORD PICKUP 1/2 TON, F-150 4WD Exc. Lift Kit	
R	75	PICKUP 1/2 TON, F-150 All 4WD; Exc. Lift Kit	
R	79	PICKUP 1 TON, F-350 / SUPERDUTY 4WD	
R	75-91	VAN 1 TON, ECONOLINE / CLUB WAGON / SUPERDUTY All Exc. Cutaway Chassis	
R	75-91	VAN 3/4 TON, ECONOLINE / CLUB WAGON / SUPERDUTY All	
61649	W		
R	73-86	CHEVROLET PICKUP 1 TON, C30 All	
R	88-91	PICKUP 1 TON, C35/3500 Cab & Chassis Exc. HD Solid Front Axle	
R	87-88	PICKUP 1 TON, R30 All	
R	89	PICKUP 1 TON, R3500 Standard Cab Pickup	
R	75-86	PICKUP 3/4 TON, C20 Crew Cab Pickup	
R	73-74	PICKUP 3/4 TON, C20 All Crew Cab Pickup	
R	87-88	PICKUP 3/4 TON, R20 Crew Cab Pickup	
R	89	PICKUP 3/4 TON, R2500 All	
R	74-80	VAN 1/2 TON, P SERIES All	
R	73-99	VAN 1 TON, P SERIES All	
R	79-89	VAN 3/4 TON, P SERIES All	
R	88-91	GMC PICKUP 1 TON, C35/3500 Cab & Chassis Exc. HD Solid Front Axle	
R	73-78	PICKUP 1 TON, C35/3500 All	
R	87-91	PICKUP 1 TON, R3500 All	
R	85-86	PICKUP 3/4 TON, C25 / C2500 Crew Cab Pickup	
R	75-83	PICKUP 3/4 TON, C25 / C2500 Crew Cab Pickup	
R	73-74	PICKUP 3/4 TON, C25 / C2500 All Crew Cab Pickup	
R	87-89	PICKUP 3/4 TON, R2500 Crew Cab Pickup	
R	74-80	VAN 1/2 TON, P SERIES All	
R	73-99	VAN 1 TON, P SERIES All	
R	79-89	VAN 3/4 TON, P SERIES All	

ProGuard

Shock	POP	Alternative No.	MTG Acc. Supplied
Pos.	Year	Application	
61650	W	140126	
F	72-93	DODGE PICKUP 1 TON, D300 SERIES All HD Package	
F	82-93	PICKUP 3/4 TON, D200 SERIES All HD Package	
F	81	PICKUP 3/4 TON, D200 SERIES 165.0 (WheelBase) HD Package	
F	77-80	PICKUP 3/4 TON, D200 SERIES All HD Package	
F	75-76	PICKUP 3/4 TON, D200 SERIES 165.0 (WheelBase) HD Package	
F	72-74	PICKUP 3/4 TON, D200 SERIES All HD Package	
F	71-93	VAN 1 TON, A / B SERIES / RAM All 4000# Front Axle	
F	74-80	VAN, CB300 All 4000# Front Axle	
F	74-83	PLYMOUTH VAN 1 TON, PB SERIES All 4000# Front Axle	
61651	C	142389	
R	00	TOYOTA RAV4 All Mfg. to 5/00	
R	96-99	RAV4 All	
61654	W		
R	99-04	FORD PICKUP 1 TON, F-350 / SUPERDUTY RWD	
R	99-04	PICKUP 3/4 TON, F-250 / SUPERDUTY RWD	
61655	B		
R	02	FORD E-550 ECONOLINE SUPER DUTY All	
R	03	E-550 SUPER DUTY All	
F	99-04	PICKUP 1 TON, F-350 / SUPERDUTY 4WD	
F	99-04	PICKUP 3/4 TON, F-250 / SUPERDUTY 4WD	
F	99-04	PICKUP, F-450 SUPERDUTY All	
F	99-04	PICKUP, F-550 SUPERDUTY All	
61656	C		
R	99-04	FORD PICKUP 1 TON, F-350 / SUPERDUTY 4WD	
R	99-04	PICKUP 3/4 TON, F-250 / SUPERDUTY 4WD	
61657	W		
R	99-04	FORD PICKUP, F-450 SUPERDUTY All	
R	99-04	PICKUP, F-550 SUPERDUTY All	
61658	A		
R	97-04	DODGE DAKOTA All	
R	98-03	DURANGO 4WD	
R	98-03	DURANGO RWD	
61659	B		
R	02-05	CHEVROLET VENTURE All	
R	97-01	VENTURE FWD	
R	02-04	OLDSMOBILE SILHOUETTE AWD	
R	97-04	SILHOUETTE FWD	
R	99-05	PONTIAC MONTANA All	
R	97-98	TRANS SPORT All	
61662	A	142389	
F	00-04	NISSAN FRONTIER Crew Cab Pickup, RWD with Desert Runner	
F	98-04	FRONTIER 4WD	
F	98-99	FRONTIER RWD Crew Cab with Desert Runner	
F	00-04	XTERRA All	
61663	A	141665	
F	02-06	CHEVROLET AVALANCHE 2500 All Exc. Electronic Ride Control	
F	05-06	PICKUP 1/2 TON, SILVERADO 1500 HD All	
F	01-03	PICKUP 1/2 TON, SILVERADO 1500 HD All	
F	01-09	PICKUP 1 TON, SILVERADO 3500 All	
F	07-10	PICKUP 1 TON, SILVERADO 3500 HD All	
F	05-08	PICKUP 3/4 TON, SILVERADO 2500 All	
F	99-04	PICKUP 3/4 TON, SILVERADO 2500 4WD	
F	01-10	PICKUP 3/4 TON, SILVERADO 2500 HD All 9200# GVW	
F	07	SILVERADO 1500 HD CLASSIC All	
F	00-11	SUBURBAN 3/4 TON, 2500 All Exc. Z55 Auto Ride Suspension and Quadrateer	
F	05-06	GMC SIERRA 1500 HD All	
F	01-03	SIERRA 1500 HD All	
F	07	SIERRA 1500 HD CLASSIC All	

Numerical listing

Shock	POP	Alternative No.	MTG Acc. Supplied
Pos.	Year	Application	
61663	A	-continued	
F	99-04	SIERRA 2500 4WD	141665
F	01-10	SIERRA 2500 HD All	
F	01-06	SIERRA 3500 All	
F	07	SIERRA 3500 CLASSIC All	
F	07-10	SIERRA 3500 HD Torsion Bar (FrontSpringType)	
F	00-06	YUKON XL 3/4 TON All Exc. Hydraulic Self Leveling System	
F	03-09	HUMMER H2 All	
61664	A	141353	
F	99-04	JEEP GRAND CHEROKEE All Exc. Up Country Suspension	
61675	A		
R	02-13	CADILLAC ESCALADE All Exc. Electronic Ride Control	
R	03-10	ESCALADE ESV All Exc. Electronic Ride Control	
R	02-10	ESCALADE EXT All Exc. Electronic Ride Control	
R	07-11	CHEVROLET AVALANCHE 1500 All Exc. Z55 or ZW7 Ride Suspension	
R	02-06	AVALANCHE 1500 All Exc. Electronic Ride Control	
R	02-06	AVALANCHE 2500 All Exc. Electronic Ride Control	
R	07-11	SUBURBAN 1/2 TON, 1500 All Exc. Z55 or ZW7 Ride Suspension	
R	00-06	SUBURBAN 1/2 TON, 1500 All Exc. Z55 Auto Ride Suspension	
R	00-11	SUBURBAN 3/4 TON, 2500 All Exc. Z55 Auto Ride Suspension and Quadrateer	
R	07-11	TAHOE All Exc. Z55 or ZW7 Ride Suspension	
R	02-06	TAHOE All Exc. Z55 Auto Ride Suspension	
R	00-01	TAHOE All New Body Style; Exc. Z55 Auto Ride Suspension	
R	07-11	GMC YUKON All Exc. Z55 or ZW7 Ride Suspension	
R	00-06	YUKON All Exc. Z55 Auto Ride Suspension	
R	07-11	YUKON XL 1/2 TON All Exc. Z55 or ZW7 Ride Suspension	
R	00-06	YUKON XL 1/2 TON All Exc. Z55 Auto Ride Suspension	
R	00-11	YUKON XL 3/4 TON All Exc. Z55 Auto Ride Suspension and Quadrateer	
61676	A		
R	99-04	JEEP GRAND CHEROKEE All	
61679	D	140126	
F	87-96	DODGE DAKOTA 4WD	
61680	C	142731	
F	05-12	FORD PICKUP 1 TON, F-350 / SUPERDUTY 4WD	
F	05-12	PICKUP 3/4 TON, F-250 / SUPERDUTY 4WD	
61682	D		
R	05-12	FORD PICKUP 1 TON, F-350 / SUPERDUTY Crew Cab Pickup, 4WD Single Rear Wheels	
R	05-12	PICKUP 1 TON, F-350 / SUPERDUTY Extended Cab Pickup, 4WD Single Rear Wheels	
R	05-12	PICKUP 1 TON, F-350 / SUPERDUTY Standard Cab Pickup, 4WD Single Rear Wheels	
R	12-16	PICKUP 3/4 TON, F-250 / SUPERDUTY RWD w/Off Road Package	
R	05-16	PICKUP 3/4 TON, F-250 / SUPERDUTY 4WD	
61683	W	143276	
F	10-14	CHEVROLET VAN 1/2 TON, G / EXPRESS AWD, Torsion Bar (FrontSpringType)	
F	03-09	VAN 1/2 TON, G / EXPRESS Torsion Bar (FrontSpringType)	
F	06-12	VAN 3/4 TON, G / EXPRESS All Torsion Bar (FrontSpringType)	
F	03-05	VAN 3/4 TON, G / EXPRESS Torsion Bar (FrontSpringType)	
F	10-14	GMC VAN 1/2 TON, G / SAVANNA AWD, Torsion Bar (FrontSpringType)	
F	04-09	VAN 1/2 TON, G / SAVANNA Torsion Bar (FrontSpringType)	

Numerical listing

Shock	POP	Alternative No.	MTG Acc. Supplied
Pos.	Year	Application	
61683	W	-continued	143276
F	03	VAN 1/2 TON, G / SAVANNA Torsion Bar (FrontSpringType)	
F	06-12	VAN 3/4 TON, G / SAVANNA All Torsion Bar (FrontSpringType)	
F	03-05	VAN 3/4 TON, G / SAVANNA AWD, Torsion Bar (FrontSpringType)	
61684	W	-continued	143276
F	03-14	CHEVROLET VAN 1/2 TON, G / EXPRESS RWD, Coil (FrontSpringType)	
F	03-14	GMC VAN 1/2 TON, G / SAVANNA RWD, Coil (FrontSpringType)	
61685	C	-continued	143078
F	03-16	CHEVROLET VAN 1 TON, G / EXPRESS Coil (FrontSpringType)	
F	03-16	VAN 3/4 TON, G / EXPRESS Coil (FrontSpringType)	
F	03-16	GMC VAN 1 TON, G / SAVANNA Coil (FrontSpringType)	
F	03-16	VAN 3/4 TON, G / SAVANNA Coil (FrontSpringType)	
61686	W	-continued	
R	03-11	CHEVROLET VAN 1/2 TON, G / EXPRESS All Uppitter Package and Cutaway Chassis	
R	03-11	GMC VAN 1/2 TON, G / SAVANNA All Uppitter Package and Cutaway Chassis	
61687	D	-continued	
R	10-15	CHEVROLET EXPRESS 4500 All	
R	13-16	VAN 1 TON, G / EXPRESS All	
R	03-12	VAN 1 TON, G / EXPRESS All Single Rear Wheels	
R	03-16	VAN 3/4 TON, G / EXPRESS All	
R	10-15	GMC SAVANA 4500 All	
R	13-16	VAN 1 TON, G / SAVANNA All	
R	03-12	VAN 1 TON, G / SAVANNA All Single Rear Wheels	
R	03-16	VAN 3/4 TON, G / SAVANNA All	
61688	W	-continued	
R	03-06	CHEVROLET VAN 1 TON, G / EXPRESS All Dual Rear Wheels	
R	03-06	GMC VAN 1 TON, G / SAVANNA All Dual Rear Wheels	
61690	B	-continued	
R	08-17	CHEVROLET PICKUP 1/2 TON, SILVERADO 1500 All Exc. Electronic Adjustable Suspension	
R	07	PICKUP 1/2 TON, SILVERADO 1500 Base Exc. Electronic Adjustable Suspension	
R	07	PICKUP 1/2 TON, SILVERADO 1500 LT Exc. Electronic Adjustable Suspension	
R	07	PICKUP 1/2 TON, SILVERADO 1500 LTZ Exc. Electronic Adjustable Suspension	
R	07	PICKUP 1/2 TON, SILVERADO 1500 WT Exc. Electronic Adjustable Suspension	
R	14-17	GMC SIERRA 1500 All Exc. Electronic Adjustable Suspension	
R	08-13	SIERRA 1500 All Exc. Electronic Adjustable Suspension	
R	07	SIERRA 1500 Denali Exc. Electronic Adjustable Suspension	
R	07	SIERRA 1500 SLE Exc. Electronic Adjustable Suspension	
R	07	SIERRA 1500 SLT Exc. Electronic Adjustable Suspension	
R	07	SIERRA 1500 WT Exc. Electronic Adjustable Suspension	
61691	C	-continued	
R	06-08	DODGE PICKUP 1/2 TON, RAM 1500 (SEE RAM 1500) Crew Cab Pickup, 4WD	
R	06-08	PICKUP 1/2 TON, RAM 1500 (SEE RAM 1500) Standard Cab Pickup, 4WD	
R	02-05	PICKUP 1/2 TON, RAM 1500 (SEE RAM 1500) 4WD	
61692	C	-continued	
R	06-08	PICKUP 1/2 TON, RAM 1500 (SEE RAM 1500) Standard Cab Pickup, RWD	
R	02-05	PICKUP 1/2 TON, RAM 1500 (SEE RAM 1500) RWD	

ProGuard, Ultra Truck Shock

Shock	POP	Alternative No.	MTG Acc. Supplied
Pos.	Year	Application	
61692	C	-continued	
R	06-08	PICKUP 1/2 TON, RAM 1500 (SEE RAM 1500) Standard Cab Pickup, RWD	
R	02-05	PICKUP 1/2 TON, RAM 1500 (SEE RAM 1500) RWD	
61696	W	-continued	
R	07-15	JEEP WRANGLER All Exc. 17" Wheels	
61697	W	-continued	
R	07-15	JEEP WRANGLER All 17" Wheels	
61699	W	-continued	140149
R	98-04	TOYOTA TACOMA Pre Runner Left	
61700	W	-continued	140149
R	98-04	TOYOTA TACOMA Pre Runner Right	
61703	W	-continued	
R	98-02	LINCOLN NAVIGATOR 4WD, Air (RearSpringType)	
61704	C	-continued	
R	01-06	ACURA MDX All	
R	03-08	HONDA PILOT All	
61709	W	-continued	
R	03-06	DODGE PICKUP 1 TON, RAM 3500 (SEE RAM 3500) Standard Cab Pickup, RWD	
R	03-06	PICKUP 3/4 TON, RAM 2500 (SEE RAM 2500) Standard Cab Pickup, RWD	
61710	W	-continued	
R	03-07	DODGE PICKUP 1 TON, RAM 3500 (SEE RAM 3500) Crew Cab Pickup, RWD	
R	03-06	PICKUP 3/4 TON, RAM 2500 (SEE RAM 2500) Crew Cab Pickup, RWD	
61711	D	-continued	142973
F	07-15	JEEP WRANGLER All	
61712	W	-continued	142731
F	06-08	DODGE PICKUP 1/2 TON, RAM 1500 (SEE RAM 1500) 4WD Mega Cab	
61713	W	-continued	
R	05-12	FORD PICKUP 1 TON, F-350 / SUPERDUTY RWD	
R	05-15	PICKUP 3/4 TON, F-250 / SUPERDUTY RWD	
61714	W	-continued	142731
F	05-08	DODGE PICKUP 3/4 TON, RAM 2500 (SEE RAM 2500) 4WD	
61715	C	-continued	
R	06-10	JEEP COMMANDER All	
R	05-10	GRAND CHEROKEE All	
61716	W	-continued	
R	03-10	DODGE PICKUP 3/4 TON, RAM 2500 (SEE RAM 2500) 4WD	
R	11-12	RAM 2500 (SEE DODGE RAM 2500) 4WD	
61717	B	-continued	
R	04-07	BUICK RAINIER All	
R	06-09	CHEVROLET TRAILBLAZER Air (RearSpringType)	
R	02-05	TRAILBLAZER All Air (RearSpringType)	
R	02-09	GMC ENVOY All	
R	03-08	ISUZU ASCENDER Coil (RearSpringType)	
R	02-04	OLDSMOBILE BRAVADA All	
R	05-09	SAAB 9-7X All	
61718	C	-continued	
R	05-13	CHEVROLET EQUINOX All	
R	10-13	GMC TERRAIN All	
R	06-09	PONTIAC TORRENT All	
R	07-09	SUZUKI XL-7 All	
61720	C	-continued	
F	07-09	CHRYSLER ASPEN All	
F	04-09	DODGE DURANGO All	
61732	N	-continued	142617
F	99-04	FORD PICKUP 1 TON, F-350 / SUPERDUTY All	

Numerical listing

Shock	POP	Alternative No.	MTG Acc. Supplied
Pos.	Year	Application	
61732	N	-continued	142617
F	99-04	PICKUP 3/4 TON, F-250 / SUPERDUTY All	
61734	N	-continued	
R	04-09	DODGE DURANGO All	
61777	C	-continued	
R	02-07	BUICK RENDEZVOUS All Exc. Hydraulic Self Leveling System	
R	01-05	PONTIAC AZTEK AWD	
Ultra Truck Shock			
G63173	C	-continued	
R	93-98	TOYOTA T100 RWD	
G63183	D	-continued	
R	74	DODGE M300 All	
F	81-93	PICKUP 1/2 TON, W100 SERIES All Exc. Lift Kit	
F	61-80	PICKUP 1/2 TON, W100 SERIES All	
F	81-93	PICKUP 1 TON, W300 SERIES All Exc. Quad Suspension and Lift Kit	
F	61-80	PICKUP 1 TON, W300 SERIES All	
R	61-71	PICKUP 1 TON, W300 SERIES All	
F	90-93	PICKUP 3/4 TON, W200 SERIES Extended Cab Pickup Exc. Lift Kit	
F	88-93	PICKUP 3/4 TON, W200 SERIES Cab & Chassis Exc. Lift Kit	
F	81-93	PICKUP 3/4 TON, W200 SERIES Standard Cab Pickup Exc. Lift Kit	
F	86	PICKUP 3/4 TON, W200 SERIES Cab & Chassis Exc. Lift Kit	
F	81-83	PICKUP 3/4 TON, W200 SERIES Cab & Chassis Exc. Lift Kit	
F	81-82	PICKUP 3/4 TON, W200 SERIES Extended Cab Pickup Exc. Lift Kit	
F	69-80	PICKUP 3/4 TON, W200 SERIES All	
F	61-67	PICKUP 3/4 TON, W200 SERIES All	
F	75-93	RAMCHARGER 4WD	
F	74	RAMCHARGER All 4WD	
F	78-80	RD200 All	
F	75-81	PLYMOUTH TRAILDUSTER 4WD	
F	74	TRAILDUSTER All	
G63187	W	-continued	141138
F	65	FORD PICKUP 1/2 TON, F-100 All With Front Leaf Springs	
F	75-77	PICKUP 3/4 TON, F-250 / SUPERDUTY 4WD Up through Serial No. Y20000	
F	66-74	PICKUP 3/4 TON, F-250 / SUPERDUTY All 4WD; Up through Serial No Y20000	
F	61-65	PICKUP 3/4 TON, F-250 / SUPERDUTY All 4WD	
G63299	C	-continued	140885
R	61-67	FORD ECONOLINE All	
F	53-55	PICKUP F SERIES All	
R	48-52	PICKUP F SERIES All F-1, F-2 & F-3	
F	72-81	JEEP CJ5 All Exc. Lift Kit	
F	72-75	CJ6 All Exc. Lift Kit	
F	76-81	CJ7 All Exc. Lift Kit	
F	66-74	DJ5 All Exc. Lift Kit	
F	81	SCRAMBLER / CJ8 All	
R	71-74	WAGONEER All	
R	63-67	WAGONEER All	
R	97-02	MERCURY VILLAGER Non-ABS	
R	93-96	VILLAGER 4-Wheel ABS	
R	93-02	NISSAN QUEST All	
F	76-83	TOYOTA LAND CRUISER FJ40 (MfrBodyCode)	
F	75	LAND CRUISER FJ40 (MfrBodyCode) Mfg. to 2/75	
F	67-74	LAND CRUISER All	
G63306	D	-continued	
R	69-72	CHEVROLET BLAZER RWD	
R	63-72	PICKUP 1/2 TON, C10 All Leaf (RearSpringType)	
R	67-72	PICKUP 1 TON, C30 All Exc. 11,000# Rear Axle	
R	63-72	PICKUP 3/4 TON, C20 All	
R	63-66	SUBURBAN 1/2 TON, 1500 All	
R	67-77	VAN 1/2 TON, G / EXPRESS All	
R	63-66	VAN 1/2 TON, P SERIES All	
R	76-77	VAN 1 TON, G / EXPRESS All	
R	75	VAN 1 TON, G / EXPRESS 110.0 (WheelBase)	
R	75	VAN 1 TON, G / EXPRESS 125.0 (WheelBase)	
R	71-74	VAN 1 TON, G / EXPRESS All	

Numerical listing

Shock	POP	Alternative No.	MTG Acc. Supplied
Pos.	Year	Application	
G63306 D -continued			
R	68-72	VAN 1 TON, P SERIES All Exc. 11,000# Rear Axle	
R	67-77	VAN 3/4 TON, G / EXPRESS All	
R	68-72	VAN 3/4 TON, P SERIES All	
R	70-72	GMC JIMMY All RWD	
R	68-72	PICKUP 1/2 TON, C15 / C1500 All RWD	
R	67	PICKUP 1/2 TON, C15 / C1500 All	
R	67-72	PICKUP 1 TON, C35/3500 All Exc. 11,000# Rear Axle	
R	72	PICKUP 3/4 TON, C25 / C2500 All Leaf(RearSpringType)	
R	71	PICKUP 3/4 TON, C25 / C2500 All	
R	67-70	PICKUP 3/4 TON, C25 / C2500 All Leaf(RearSpringType)	
R	63-65	PICKUP 1000 SERIES All	
R	63-65	PICKUP 1500 SERIES All	
R	67-77	VAN 1/2 TON, G / SAVANNA All	
R	67	VAN 1/2 TON, P SERIES All	
R	76-77	VAN 1 TON, G / SAVANNA All	
R	75	VAN 1 TON, G / SAVANNA 110.0 (WheelBase)	
R	75	VAN 1 TON, G / SAVANNA 125.0 (WheelBase)	
R	71-74	VAN 1 TON, G / SAVANNA All	
R	68-72	VAN 1 TON, P SERIES All Exc. 11,000# Rear Axle	
R	67-77	VAN 3/4 TON, G / SAVANNA All	
R	68-72	VAN 3/4 TON, P SERIES All	
R	63-65	VAN, PB 1000 SERIES All	
G63347 D			
F	87-91	CHEVROLET BLAZER 4WD Full Size; Exc. Quad Suspension and Lift Kit	
F	81-86	BLAZER 4WD Exc. Quad Suspension and Lift Kit	
F	79-80	BLAZER 4WD Exc. Lift Kit	
F	78	BLAZER 4WD Exc. Quad Suspension and Lift Kit	
F	75-77	BLAZER 4WD Exc. Lift Kit	
F	73-74	BLAZER All 4WD; Exc. Quad Suspension and Lift Kit	
F	69-72	BLAZER All 4WD Exc. Lift Kit	
F	73-86	PICKUP 1/2 TON, K10 All Exc. Lift Kit	
F	69-72	PICKUP 1/2 TON, K10 All	
F	87	PICKUP 1/2 TON, V10 All Exc. Lift Kit	
F	69-86	PICKUP 3/4 TON, K20 All Exc. Lift Kit	
F	87	PICKUP 3/4 TON, V20 All Exc. Quad Suspension and Lift Kit	
F	69-86	SUBURBAN 1/2 TON, K10 All Exc. Lift Kit	
F	69-86	SUBURBAN 3/4 TON, K20 All Exc. Lift Kit	
F	87-88	SUBURBAN 3/4 TON, V20 All Exc. Quad Suspension and Lift Kit	
F	89-91	SUBURBAN 3/4 TON, V2500 All Exc. Lift Kit	
F	75-91	GMC JIMMY 4WD Exc. Lift Kit	
F	70-74	JIMMY All 4WD; Exc. Lift Kit	
F	69-86	PICKUP 1/2 TON, K15 / K1500 All Exc. Quad Suspension and Lift Kit	
F	87	PICKUP 1/2 TON, V1500 All Exc. Lift Kit	
F	69-86	PICKUP 3/4 TON, K25 / K2500 All Exc. Quad Suspension and Lift Kit	
F	87	PICKUP 3/4 TON, V2500 All Exc. Lift Kit	
F	69-86	SUBURBAN 1/2 TON, K15 / K1500 All Exc. Quad Suspension and Lift Kit	
F	87-91	SUBURBAN 1/2 TON, V1500 All Exc. Lift Kit	
F	69-86	SUBURBAN 3/4 TON, K25 / K2500 All Exc. Quad Suspension and Lift Kit	
F	87-91	SUBURBAN 3/4 TON, V2500 All Exc. Lift Kit	
G63349 C 140357			
R	87-91	CHEVROLET BLAZER 4WD Full Size; Exc. Lift Kit	
R	85-86	BLAZER 4WD Exc. Lift Kit	
R	73-84	BLAZER All Exc. Lift Kit	
R	75-86	PICKUP 1/2 TON, C10 All	
R	73-86	PICKUP 1/2 TON, K10 All Exc. Lift Kit	
R	87	PICKUP 1/2 TON, R10 All	
R	87	PICKUP 1/2 TON, V10 All Exc. Lift Kit	

Ultra Truck Shock

Shock	POP	Alternative No.	MTG Acc. Supplied
Pos.	Year	Application	
G63349 C -continued 140357			
R	75-86	PICKUP 3/4 TON, C20 Standard Cab Pickup	
R	75-86	PICKUP 3/4 TON, K20 All Exc. Lift Kit	
R	87	PICKUP 3/4 TON, R20 Standard Cab Pickup	
R	87	PICKUP 3/4 TON, V20 All Exc. Quad Suspension and Lift Kit	
R	73-86	SUBURBAN 1/2 TON, C10 All	
R	73-86	SUBURBAN 1/2 TON, K10 All Exc. Lift Kit	
R	87-88	SUBURBAN 1/2 TON, R10 All	
R	89-91	SUBURBAN 1/2 TON, R1500 All	
R	89-91	SUBURBAN 1/2 TON, V1500 All Exc. Lift Kit	
R	73-86	SUBURBAN 3/4 TON, C20 All	
R	73-86	SUBURBAN 3/4 TON, K20 All Exc. Lift Kit	
R	87-88	SUBURBAN 3/4 TON, R20 All	
R	89-91	SUBURBAN 3/4 TON, R2500 All	
R	87-88	SUBURBAN 3/4 TON, V20 All Exc. Quad Suspension and Lift Kit	
R	89-91	SUBURBAN 3/4 TON, V2500 All Exc. Lift Kit	
R	73	VAN 1/2 TON, P SERIES All	
R	73-78	VAN 3/4 TON, P SERIES All	
R	73-91	GMC JIMMY All Exc. Lift Kit	
R	73-86	PICKUP 1/2 TON, C15 / C1500 All	
R	73-86	PICKUP 1/2 TON, K15 / K1500 All Exc. Lift Kit	
R	87	PICKUP 1/2 TON, R1500 All	
R	87	PICKUP 1/2 TON, V1500 All Exc. Lift Kit	
R	75-86	PICKUP 3/4 TON, C25 / C2500 Cab & Chassis	
R	75-86	PICKUP 3/4 TON, C25 / C2500 Standard Cab Pickup	
R	73-74	PICKUP 3/4 TON, C25 / C2500 All Exc. Crew Cab & Bonus Cab	
R	73-86	PICKUP 3/4 TON, K25 / K2500 All Exc. Lift Kit	
R	88-89	SUBURBAN 3/4 TON, R2500 All Exc. Crew Cab & Bonus Cab	
R	87	PICKUP 3/4 TON, R2500 Cab & Chassis Exc. Crew Cab & Bonus Cab	
R	87	PICKUP 3/4 TON, R2500 Standard Cab Pickup Exc. Crew Cab & Bonus Cab	
R	87	PICKUP 3/4 TON, V2500 All Exc. Lift Kit	
R	73-86	SUBURBAN 1/2 TON, C15 / C1500 All	
R	73-86	SUBURBAN 1/2 TON, K15 / K1500 All Exc. Lift Kit	
R	87-91	SUBURBAN 1/2 TON, R1500 All	
R	87-91	SUBURBAN 1/2 TON, V1500 All Exc. Lift Kit	
R	75-86	SUBURBAN 3/4 TON, C25 / C2500 All	
R	73-74	SUBURBAN 3/4 TON, C25 / C2500 All Exc. Crew Cab & Bonus Cab	
R	73-86	SUBURBAN 3/4 TON, K25 / K2500 All Exc. Lift Kit	
R	87-91	SUBURBAN 3/4 TON, R2500 All	
R	87-91	SUBURBAN 3/4 TON, V2500 All Exc. Lift Kit	
R	73	VAN 1/2 TON, P SERIES All	
R	73-78	VAN 3/4 TON, P SERIES All	
G63350 D 140126			
R	66	FORD BRONCO All Thru Serial #830000	
R	75-79	PICKUP 1/2 TON, F-100 RWD	
R	70-74	PICKUP 1/2 TON, F-100 All RWD	
R	75-79	PICKUP 1/2 TON, F-150 RWD	
R	75-79	PICKUP 1 TON, F-350 / SUPERDUTY Extended Cab Pickup, RWD	
R	74	PICKUP 1 TON, F-350 / SUPERDUTY All RWD; Extended Cab	
R	75-79	PICKUP 3/4 TON, F-250 / SUPERDUTY Cab & Chassis, RWD	
R	75-79	PICKUP 3/4 TON, F-250 / SUPERDUTY Standard Cab Pickup, RWD	
R	70-74	PICKUP 3/4 TON, F-250 / SUPERDUTY All RWD; Exc. Supercab	
R	75-91	VAN 1/2 TON, ECONOLINE / CLUB WAGON All	
F	71-80	INTERNATIONAL SCOUT II All	

Numerical listing

Shock	POP	Alternative No.	MTG Acc. Supplied
Pos.	Year	Application	
G63353 D			
R	72-93	DODGE PICKUP 1/2 TON, D100 SERIES All	
R	72-93	PICKUP 1 TON, D300 SERIES All	
R	72-93	PICKUP 3/4 TON, D200 SERIES All	
R	75-93	RAMCHARGER RWD	
R	74	RAMCHARGER All	
R	76-81	PLYMOUTH TRAILDUSTER RWD	
R	74-75	TRAILDUSTER All	
G63355 B 140702			
F	75-84	CHEVROLET BLAZER RWD	
F	69-74	BLAZER All	
F	63-86	PICKUP 1/2 TON, C10 All	
F	87	PICKUP 1/2 TON, R10 All	
F	63-86	PICKUP 1 TON, C30 All	
F	88-91	PICKUP 1 TON, C35/3500 Cab & Chassis Exc. HD Solid Front Axle	
F	87-88	PICKUP 1 TON, R30 All	
F	89	PICKUP 1 TON, R3500 Standard Cab Pickup	
F	75-86	PICKUP 3/4 TON, C20 Crew Cab Pickup	
F	75-86	PICKUP 3/4 TON, C20 Standard Cab Pickup	
F	63-74	PICKUP 3/4 TON, C20 All	
F	87-88	PICKUP 3/4 TON, R20 All	
F	89	PICKUP 3/4 TON, R2500 All	
F	63-66	SUBURBAN 1/2 TON, 1500 All	
F	67-86	SUBURBAN 1/2 TON, C10 All	
F	87-88	SUBURBAN 1/2 TON, R10 All	
F	89-91	SUBURBAN 1/2 TON, R1500 All	
F	68-86	SUBURBAN 3/4 TON, C20 All	
F	87-88	SUBURBAN 3/4 TON, R20 All	
F	89-91	SUBURBAN 3/4 TON, R2500 All	
F	63-80	VAN 1/2 TON, P SERIES All	
F	68-90	VAN 1 TON, P SERIES All Cutaway Chassis	
F	68-89	VAN 3/4 TON, P SERIES All	
F	75-84	GMC JIMMY RWD	
F	70-74	JIMMY All RWD	
F	67-86	PICKUP 1/2 TON, C15 / C1500 All	
F	87	PICKUP 1/2 TON, R1500 All	
F	88-90	PICKUP 1 TON, C35/3500 Cab & Chassis Exc. HD Solid Front Axle	
F	67-78	PICKUP 1 TON, C35/3500 All	
F	87-91	PICKUP 1 TON, R3500 All	
F	85-86	PICKUP 3/4 TON, C25 / C2500 Crew Cab Pickup	
F	75-86	PICKUP 3/4 TON, C25 / C2500 Cab & Chassis	
F	75-86	PICKUP 3/4 TON, C25 / C2500 Standard Cab Pickup	
F	75-83	PICKUP 3/4 TON, C25 / C2500 Crew Cab Pickup	
F	67-74	PICKUP 3/4 TON, C25 / C2500 All	
F	87-89	PICKUP 3/4 TON, R2500 All Exc. Crew Cab & Bonus Cab	
F	63-66	PICKUP 1000 SERIES All	
F	63-66	PICKUP 1500 SERIES All	
F	66	PICKUP 2500 SERIES All	
F	68-86	SUBURBAN 1/2 TON, C15 / C1500 All	
F	87-91	SUBURBAN 1/2 TON, R1500 All	
F	68-86	SUBURBAN 3/4 TON, C25 / C2500 All	
F	87-91	SUBURBAN 3/4 TON, R2500 All	
F	67-80	VAN 1/2 TON, P SERIES All	
F	75-90	VAN 1 TON, P SERIES All Cutaway Chassis	
F	73-74	VAN 1 TON, P SERIES Base Cutaway Chassis	
F	68-72	VAN 1 TON, P SERIES All	
F	68-89	VAN 3/4 TON, P SERIES All	
F	63-65	VAN, PB 1000 SERIES All	
G63357 D			
F	71-95	CHEVROLET VAN 1/2 TON, G / EXPRESS All	
F	70	VAN 1/2 TON, G / EXPRESS All Independent Front Suspension	
F	76-96	VAN 1 TON, G / EXPRESS All	
F	75	VAN 1 TON, G / EXPRESS 146.0 (WheelBase)	
F	71-74	VAN 1 TON, G / EXPRESS All	
F	71-95	VAN 3/4 TON, G / EXPRESS All	
F	70	VAN 3/4 TON, G / EXPRESS All Independent Front Suspension	
F	71-95	GMC VAN 1/2 TON, G / SAVANNA All	
F	70	VAN 1/2 TON, G / SAVANNA All Independent Front Suspension	
F	76-95	VAN 1 TON, G / SAVANNA All	
F	75	VAN 1 TON, G / SAVANNA 146.0 (WheelBase)	

Numerical listing

Shock	POP	Alternative No.	MTG Acc. Supplied
Pos.	Year	Application	
G63357	D	-continued	
F	71-74	VAN 1 TON, G / SAVANNA All	
F	78-95	VAN 3/4 TON, G / SAVANNA All Exc. 8600# GVW	
F	71-77	VAN 3/4 TON, G / SAVANNA All	
F	70	VAN 3/4 TON, G / SAVANNA All Independent Front Suspension	
G63359	C		140126
F	84-86	DODGE MINI RAM All	
F	72-93	PICKUP 1/2 TON, D100 SERIES All	
F	72-93	PICKUP 3/4 TON, D200 SERIES All Exc. HD Package	
F	75-93	RAMCHARGER RWD	
F	99-03	VAN 1/2 TON, A / B SERIES / RAM 109.3 (WheelBase) Exc. 7000# GVW	
F	81-98	VAN 1/2 TON, A / B SERIES / RAM 109.6 (WheelBase) Exc. 7000# GVW	
F	71-80	VAN 1/2 TON, A / B SERIES / RAM All Exc. 4000# Front Axle	
F	99-03	VAN 1 TON, A / B SERIES / RAM All	
F	71-98	VAN 1 TON, A / B SERIES / RAM All Exc. 4000# Front Axle	
F	81-03	VAN 3/4 TON, A / B SERIES / RAM All	
F	71-80	VAN 3/4 TON, A / B SERIES / RAM All Exc. 4000# Front Axle	
F	74-80	VAN, CB300 All Exc. 4000# Front Axle	
F	75-81	PLYMOUTH TRAILDUSTER RWD	
F	74-83	VAN 1/2 TON, PB SERIES All	
F	74-83	VAN 1 TON, PB SERIES All Exc. 4000# Front Axle	
F	74-83	VAN 3/4 TON, PB SERIES All	
G63360	D		140126
F	72-93	DODGE PICKUP 1 TON, D300 SERIES All HD Package	
F	72-93	PICKUP 3/4 TON, D200 SERIES All HD Package	
F	71-93	VAN 1 TON, A / B SERIES / RAM All 4000# Front Axle	
F	74-80	VAN, CB300 All 4000# Front Axle	
F	74-83	PLYMOUTH VAN 1 TON, PB SERIES All 4000# Front Axle	
G63366	C		
R	75-86	CHEVROLET PICKUP 1 TON, C30 All	
R	88-91	PICKUP 1 TON, C35/3500 Cab & Chassis Exc. HD Solid Front Axle	
R	87-88	PICKUP 1 TON, R30 All	
R	89	PICKUP 1 TON, R3500 Standard Cab Pickup	
R	75-86	PICKUP 3/4 TON, C20 Crew Cab Pickup	
R	87-88	PICKUP 3/4 TON, R20 Crew Cab Pickup	
R	89	PICKUP 3/4 TON, R2500 All	
R	74-80	VAN 1/2 TON, P SERIES All	
R	73-99	VAN 1 TON, P SERIES All	
R	79-89	VAN 3/4 TON, P SERIES All	
R	88-91	GMC PICKUP 1 TON, C35/3500 Cab & Chassis Exc. HD Solid Front Axle	
R	73-78	PICKUP 1 TON, C35/3500 All	
R	87-91	PICKUP 1 TON, R3500 All	
R	85-86	PICKUP 3/4 TON, C25 / C2500 Crew Cab Pickup	
R	73-83	PICKUP 3/4 TON, C25 / C2500 Crew Cab Pickup	
R	87-89	PICKUP 3/4 TON, R2500 Crew Cab Pickup	
R	74-80	VAN 1/2 TON, P SERIES All	
R	73-99	VAN 1 TON, P SERIES All	
R	79-89	VAN 3/4 TON, P SERIES All	
G63371	W		
R	69-72	CHEVROLET BLAZER 4WD	
R	69-72	PICKUP 1/2 TON, K10 All	
R	71-72	PICKUP 3/4 TON, K20 All	
R	71-72	SUBURBAN 1/2 TON, K10 All	
R	71-72	SUBURBAN 3/4 TON, K20 All Exc. Lift Kit	
R	70-72	GMC JIMMY 4WD	
R	71-72	PICKUP 1/2 TON, K15 / K1500 All	
R	71-72	PICKUP 3/4 TON, K25 / K2500 All	
R	71-72	SUBURBAN 1/2 TON, K15 / K1500 All	
R	71-72	SUBURBAN 3/4 TON, K25 / K2500 All	
G63375	A		140780,142615
F	85-05	CHEVROLET ASTRO RWD	

Ultra Truck Shock

Shock	POP	Alternative No.	MTG Acc. Supplied
Pos.	Year	Application	
G63375	A	-continued	140780,142615
F	81	BEL AIR Sedan Police and Taxi Models	
F	71-75	BEL AIR Sedan Police and Taxi Models	
F	71-72	BISCAYNE All	
F	73-96	CAPRICE Sedan Police and Taxi Models	
F	71-72	CAPRICE All Police and Taxi Models	
F	83-85	IMPALA All Police and Taxi Models	
F	71-82	IMPALA Sedan Police and Taxi Models	
F	96-02	VAN 1/2 TON, G / EXPRESS All	
F	97-02	VAN 1 TON, G / EXPRESS All	
F	96-02	VAN 3/4 TON, G / EXPRESS All Exc. 8600# GVW	
F	93-02	FORD CROWN VICTORIA Police Interceptor	
F	85-05	GMC SAFARI RWD	
F	96-02	VAN 1/2 TON, G / SAVANNA RWD	
F	96-02	VAN 1 TON, G / SAVANNA All	
F	96-02	VAN 3/4 TON, G / SAVANNA All Exc. 8600# GVW	
G63377	D		141137
R	78-79	FORD BRONCO All Exc. Lift Kit	
R	66-77	BRONCO All From Serial #830001; Exc. Lift Kit	
R	65-69	PICKUP 1/2 TON, F-100 All RWD	
R	75-79	PICKUP 1 TON, F-350 / SUPERDUTY Standard Cab Pickup, RWD	
R	73-74	PICKUP 1 TON, F-350 / SUPERDUTY All RWD; Supercab	
R	75-79	PICKUP 3/4 TON, F-250 / SUPERDUTY Extended Cab Pickup, RWD	
R	65-74	PICKUP 3/4 TON, F-250 / SUPERDUTY All RWD; Supercab	
R	69-74	VAN 1/2 TON, ECONOLINE / CLUB WAGON All	
R	69-74	VAN 1 TON, ECONOLINE / CLUB WAGON / SUPERDUTY All	
R	69-74	VAN 3/4 TON, ECONOLINE / CLUB WAGON / SUPERDUTY All	
R	76-83	JEEP CHEROKEE All	
F	74-83	CHEROKEE All	
F	82-83	CJ5 All Exc. Lift Kit	
F	82-86	CJ7 All Exc. Lift Kit	
F	93	GRAND WAGONEER All	
F	93	GRAND WAGONEER All	
F	84-91	GRAND WAGONEER All	
F	84-91	GRAND WAGONEER All	
F	74-88	J10 PICKUP All	
F	74-88	J10 PICKUP All	
F	74-88	J20 PICKUP All	
F	74-88	J20 PICKUP All	
F	82-85	SCRAMBLER / CJ8 All	
F	76-83	WAGONEER All	
F	74-83	WAGONEER All	
G63386	C		140780
F	66-77	FORD BRONCO All From Serial #830001; Exc. Lift Kit	
F	75-79	PICKUP 1/2 TON, F-100 RWD	
F	65-74	PICKUP 1/2 TON, F-100 All RWD	
F	75-79	PICKUP 1/2 TON, F-150 RWD	
F	75-79	PICKUP 1 TON, F-350 / SUPERDUTY RWD	
F	67-74	PICKUP 1 TON, F-350 / SUPERDUTY All RWD	
F	75-79	PICKUP 3/4 TON, F-250 / SUPERDUTY RWD	
F	65-74	PICKUP 3/4 TON, F-250 / SUPERDUTY All RWD	
F	75-91	VAN 1 TON, ECONOLINE / CLUB WAGON / SUPERDUTY All Cutaway Chassis	
F	75-91	VAN 3/4 TON, ECONOLINE / CLUB WAGON / SUPERDUTY All	
G63387	D		140126
R	75-76	FORD PICKUP 1/2 TON, F-100 4WD Exc. Lift Kit	
R	70-74	PICKUP 1/2 TON, F-100 All 4WD; Exc. Lift Kit	
R	76-79	PICKUP 1/2 TON, F-150 4WD Exc. Lift Kit	
R	75	PICKUP 1/2 TON, F-150 All 4WD; Exc. Lift Kit	
R	79	PICKUP 1 TON, F-350 / SUPERDUTY 4WD	
R	77-79	PICKUP 3/4 TON, F-250 / SUPERDUTY Cab & Chassis, 4WD All From Serial No. Y20001	

Numerical listing

Shock	POP	Alternative No.	MTG Acc. Supplied
Pos.	Year	Application	
G63387	D	-continued	140126
R	77-79	PICKUP 3/4 TON, F-250 / SUPERDUTY Standard Cab Pickup, 4WD All From Serial No. Y20001	
R	75-91	VAN 1 TON, ECONOLINE / CLUB WAGON / SUPERDUTY All Cutaway Chassis	
R	75-91	VAN 3/4 TON, ECONOLINE / CLUB WAGON / SUPERDUTY All	
G63389	D		
R	81-93	DODGE PICKUP 1/2 TON, W100 SERIES All Exc. Lift Kit	
R	72-80	PICKUP 1/2 TON, W100 SERIES All	
R	81-93	PICKUP 1 TON, W300 SERIES All Exc. Quad Suspension and Lift Kit	
R	72-80	PICKUP 1 TON, W300 SERIES All	
R	90-93	PICKUP 3/4 TON, W200 SERIES Extended Cab Pickup Exc. Lift Kit	
R	88-93	PICKUP 3/4 TON, W200 SERIES Cab & Chassis Exc. Lift Kit	
R	81-93	PICKUP 3/4 TON, W200 SERIES Standard Cab Pickup Exc. Lift Kit	
R	86	PICKUP 3/4 TON, W200 SERIES Cab & Chassis Exc. Lift Kit	
R	81-83	PICKUP 3/4 TON, W200 SERIES Cab & Chassis Exc. Lift Kit	
R	81-82	PICKUP 3/4 TON, W200 SERIES Extended Cab Pickup Exc. Lift Kit	
R	72-80	PICKUP 3/4 TON, W200 SERIES All	
R	76-93	RAMCHARGER 4WD	
R	76-81	PLYMOUTH TRAILDUSTER 4WD	
G63394	D		140702
F	85-99	CHEVROLET VAN 1 TON, P SERIES All Motorhome Chassis with Independent Front Suspension	
F	74-84	VAN 1 TON, P SERIES All Motorhome Chassis	
F	85-99	GMC VAN 1 TON, P SERIES All Motorhome Chassis with Independent Front Suspension	
F	75-84	VAN 1 TON, P SERIES All Motorhome Chassis	
F	74	VAN 1 TON, P SERIES Motor Home	
G63396	W		140780
F	78-79	FORD BRONCO All Quad Suspension, Rearward of Front Axle; Non Quad Suspension, Right Shock; Exc. Lift Kit	
F	78-79	PICKUP 1/2 TON, F-150 4WD Quad Suspension, Rearward of Front Axle; Non Quad Suspension, Right Shock; Exc. Lift Kit	
F	77	PICKUP 1/2 TON, F-150 4WD Quad Suspension, Forward of Front Axle; Non Quad Suspension, Left Shock; Exc. Lift Kit	
F	75-79	PICKUP 1 TON, F-350 / SUPERDUTY Extended Cab Pickup, RWD	
G63398	W		141138
F	78-79	FORD PICKUP 1/2 TON, F-150 Extended Cab Pickup, 4WD Exc. Lift Kit	
F	79	PICKUP 1 TON, F-350 / SUPERDUTY 4WD	
F	77-79	PICKUP 3/4 TON, F-250 / SUPERDUTY Cab & Chassis, 4WD All From Serial No. Y20001	
F	77-79	PICKUP 3/4 TON, F-250 / SUPERDUTY Standard Cab Pickup, 4WD All From Serial No. Y20001	
G63403	B		
R	79-91	CHEVROLET VAN 1 TON, G / EXPRESS All 9200# GVW	
F	85	VAN 1 TON, P SERIES All Motorhome Chassis with I-Beam Front Suspension	
R	97-04	DODGE DAKOTA All	
R	98-03	DURANGO All	
R	93-96	GMC VAN 1 TON, G / SAVANNA Cutaway Van 9200# GVW	
R	79-91	VAN 1 TON, G / SAVANNA Cutaway Van 9200# GVW	
F	85	VAN 1 TON, P SERIES All Motorhome Chassis with I-Beam Front Suspension	
G63404	W		141349
F	84-85	TOYOTA 4RUNNER All	
F	80-85	PICKUP 4WD Exc. Lift Kit	

Numerical listing

Shock	POP	Alternative No.	MTG Acc. Supplied
Pos.	Year	Application	
G63405 C 140884			
F	55-56	CHEVROLET PICKUP All	
R	61-64	FORD PICKUP 1/2 TON, F-100 All	
R	61-66	PICKUP 1 TON, F-350 / SUPERDUTY All	
R	61-64	PICKUP 3/4 TON, F-250 / SUPERDUTY All	
R	55	PICKUP F SERIES All F-100	
F	48-52	PICKUP F SERIES All F-1, F-2 & F-3	
F	68-76	PICKUP P350 All Up through 8000# GVW	
F	75-76	PICKUP P400 All Up through 8000# GVW	
R	68	INTERNATIONAL 908C All	
R	68	1000C All Exc. Travelette with 166" Wheelbase	
F	68	1100C All Exc. Travelette with 166" Wheelbase	
R	68	1100C All Exc. Travelette with 166" Wheelbase	
F	68	1200C All Exc. Travelette with 166" Wheelbase	
R	68	1200C All Exc. Travelette with 166" Wheelbase	
F	68	1300C All Exc. Travelette with 166" Wheelbase	
R	68	1300C All Exc. Travelette with 166" Wheelbase	
R	68-72	M1100 / M1200 All	
R	69	M1400 All	
R	65	JEEP CJ3 All Exc. Lift Kit	
R	65-83	CJ5 All Exc. Lift Kit	
R	65-75	CJ6 All Exc. Lift Kit	
R	76-86	CJ7 All Exc. Lift Kit	
R	66-74	DJ5 All Exc. Lift Kit	
R	66-68	DJ6 All Exc. Lift Kit	
R	57-60	FC150 All	
F	63-65	FC170 All	
R	63-65	FC170 All	
R	63-66	GLADIATOR All Independent Front Suspension	
R	70-73	JEEPSTER All	
R	81-85	SCRAMBLER / CJ8 All	
R	65-67	UNIVERSAL All Exc. Lift Kit	
R	61-64	UNIVERSAL All	
G63406 D			
R	85-96	FORD PICKUP 1/2 TON, F-150 RWD	
R	80-97	PICKUP 1 TON, F-350 / SUPERDUTY RWD Exc. Dual Rear Wheels	
R	97	PICKUP 3/4 TON, F-250 / SUPERDUTY RWD Over 8500# GVW	
R	80-96	PICKUP 3/4 TON, F-250 / SUPERDUTY RWD	
G63409 D			
R	80-96	FORD BRONCO All Exc. Lift Kit	
R	80-83	PICKUP 1/2 TON, F-100 RWD	
R	80-84	PICKUP 1/2 TON, F-150 RWD	
R	90-97	PICKUP 1/2 TON, F SUPERDUTY All	
R	80-97	PICKUP 1 TON, F-350 / SUPERDUTY RWD Dual Rear Wheels	
R	97	PICKUP, F-450 SUPERDUTY All	
G63410 C 141047			
F	80-96	FORD BRONCO All Quad Suspension; Forward of Front Axle; Exc. Lift Kit	
F	80-96	PICKUP 1/2 TON, F-150 4WD Quad Suspension; Forward of Front Axle; Exc. Lift Kit	
F	80-81	PICKUP 1 TON, F-350 / SUPERDUTY 4WD	
F	80-82	PICKUP 3/4 TON, F-250 / SUPERDUTY Standard Cab Pickup, 4WD	
G63411 W			
F	77-86	CHEVROLET PICKUP 1 TON, K30 All	
F	90-91	PICKUP 1 TON, R3500 All	
F	89	PICKUP 1 TON, R3500 Cab & Chassis	
F	89	PICKUP 1 TON, R3500 Crew Cab Pickup	
F	87-88	PICKUP 1 TON, V30 All	
F	89-91	PICKUP 1 TON, V3000 / V3500 All	
F	77-86	GMC PICKUP 1 TON, K35 / K3500 All	
F	87-91	PICKUP 1 TON, V3000 / V3500 All	

Ultra Truck Shock

Shock	POP	Alternative No.	MTG Acc. Supplied
Pos.	Year	Application	
G63413 C			
R	78-95	CHEVROLET VAN 1/2 TON, G / EXPRESS All	
R	85-95	VAN 1 TON, G / EXPRESS Extended Cargo Van	
R	85-95	VAN 1 TON, G / EXPRESS Extended Passenger Van	
R	78-95	VAN 1 TON, G / EXPRESS Standard Cargo Van	
R	78-95	VAN 1 TON, G / EXPRESS Standard Passenger Van	
R	78	VAN 1 TON, G / EXPRESS Extended Cargo Van	
R	78-95	VAN 3/4 TON, G / EXPRESS All Exc. 8600# GVW	
R	84-86	DODGE MINI RAM All	
R	99-03	VAN 1/2 TON, A / B SERIES / RAM 109.3 (WheelBase) Exc. 7000# GVW	
R	81-98	VAN 1/2 TON, A / B SERIES / RAM 109.6 (WheelBase) Exc. 7000# GVW	
R	71-80	VAN 1/2 TON, A / B SERIES / RAM All	
R	99-03	VAN 1 TON, A / B SERIES / RAM All	
R	94-98	VAN 1 TON, A / B SERIES / RAM All Exc. 4000# Front Axle	
R	71-93	VAN 1 TON, A / B SERIES / RAM All	
R	71-03	VAN 3/4 TON, A / B SERIES / RAM All	
R	74-80	VAN, CB300 All	
R	78-95	GMC VAN 1/2 TON, G / SAVANNA All	
R	85-96	VAN 1 TON, G / SAVANNA Extended Cargo Van	
R	85-96	VAN 1 TON, G / SAVANNA Extended Passenger Van	
R	79-96	VAN 1 TON, G / SAVANNA Standard Cargo Van	
R	79-96	VAN 1 TON, G / SAVANNA Standard Passenger Van	
R	78	VAN 1 TON, G / SAVANNA Cutaway Van	
R	78-95	VAN 3/4 TON, G / SAVANNA All Exc. 8600# GVW	
R	74-83	PLYMOUTH VAN 1/2 TON, PB SERIES All	
R	74-83	VAN 1 TON, PB SERIES All	
R	74-83	VAN 3/4 TON, PB SERIES All	
G63414 B 140780			
F	80-96	FORD BRONCO All Quad & Non Quad Suspensions Rearward of Front Axle; Exc. Lift Kit	
F	89	BRONCO II All Mfg. to 2/89; Vehicles with 10mm & 12mm bolt in rear lower mount	
F	84-88	BRONCO II All With 10mm Bolt In Rear Lower Mount	
F	80-83	PICKUP 1/2 TON, F-100 RWD	
F	80-96	PICKUP 1/2 TON, F-150 4WD Quad & Non Quad Suspensions Rearward of Front Axle; Exc. Lift Kit	
F	80-96	PICKUP 1/2 TON, F-150 RWD	
F	80-97	PICKUP 1 TON, F-350 / SUPERDUTY RWD	
F	97	PICKUP 3/4 TON, F-250 / SUPERDUTY RWD Over 8500# GVW	
F	80-96	PICKUP 3/4 TON, F-250 / SUPERDUTY RWD	
F	87-89	RANGER All Exc. High Ryder Option	
F	83-86	RANGER All	
G63416 W 140780			
F	82-85	FORD PICKUP 1 TON, F-350 / SUPERDUTY 4WD Clevis Type Lower Front Mount; Exc. Dual Rear Wheels or Lift Kit	
F	83-86	PICKUP 3/4 TON, F-250 / SUPERDUTY 4WD Clevis Type Lower Front Mount; Exc. Dual Rear Wheels or Lift Kit	
F	80-82	PICKUP 3/4 TON, F-250 / SUPERDUTY Extended Cab Pickup, 4WD	
G63418 D 141356			
F	82	DODGE D50 4WD	
F	83-86	PICKUP, RAM 50 4WD	
F	87-89	RAIDER All	
F	83-94	MITSUBISHI MIGHTY MAX 4WD	
F	83-91	MONTERO All	

Numerical listing

Shock	POP	Alternative No.	MTG Acc. Supplied
Pos.	Year	Application	
G63419 D			
R	82	DODGE D50 4WD	
R	87-93	PICKUP, RAM 50 4WD	
R	83-94	MITSUBISHI MIGHTY MAX 4WD	
G63420 W			
R	83-88	FORD RANGER 4WD	
G63421 B 140455			
F	05	CHEVROLET BLAZER Base, RWD	
F	96-04	BLAZER LS, RWD	
F	95-02	BLAZER LT, RWD	
F	95-99	BLAZER Base, RWD	
F	95-97	BLAZER Deluxe, RWD	
F	83-94	BLAZER, S MODELS RWD	
F	94-03	S10 LS, RWD	
F	82-03	S10 Base, RWD	
F	99	S10 Xtreme, RWD	
F	92-93	S10 EL, RWD	
F	83-92	S10 Tahoe, RWD	
F	88-90	S10 Durango, RWD	
F	82-86	S10 Durango, RWD	
F	72-82	FORD COURIER All	
F	92-04	GMC JIMMY RWD	
F	83-91	S15 JIMMY RWD	
F	04	SONOMA / S15 All RWD	
F	82-03	SONOMA / S15 LERO	
F	78-87	SPRINT / CABALLERO RWD	
F	71-77	SPRINT / CABALLERO All	
F	96-00	ISUZU HOMBRE RWD Exc. Sport Chassis	
F	72-76	MAZDA B1600 All	
F	77-78	B1800 All	
F	79-84	B2000 All	
F	82-84	B2200 All	
G63422 A			
R	05	CHEVROLET BLAZER Base, 4WD	
R	05	BLAZER Base, RWD	
R	96-04	BLAZER LS, 4WD	
R	96-04	BLAZER LS, RWD	
R	95-02	BLAZER LT, RWD	
R	95-01	BLAZER LT, 4WD	
R	95-99	BLAZER Base, 4WD	
R	95-99	BLAZER Base, RWD	
R	95-97	BLAZER Deluxe, RWD	
R	83-94	BLAZER, S MODELS All	
R	99-04	S10 LS, 4WD	
R	99-03	S10 Base, 4WD	
R	99-03	S10 Base, RWD	
R	99-03	S10 LS, RWD	
R	94-98	S10 LS	
R	82-98	S10 Base	
R	92-93	S10 EL	
R	83-92	S10 Tahoe	
R	88-90	S10 Durango	
R	82-86	S10 Durango	
R	05	GMC JIMMY 4WD	
R	92-04	JIMMY All	
R	83-91	S15 JIMMY All	
R	82-04	SONOMA / S15 All	
R	91	SYCLONE All	
R	92-93	TYPHOON All	
R	96-00	ISUZU HOMBRE All	
R	96-01	OLDSMOBILE BRAVADA All	
R	91-94	BRAVADA All	
G63423 B			
F	05	CHEVROLET BLAZER Base, 4WD	
F	96-04	BLAZER LS, 4WD	
F	95-01	BLAZER LT, 4WD	
F	95-99	BLAZER Base, 4WD	
F	83-94	BLAZER, S MODELS 4WD	
F	94-04	S10 LS, 4WD	
F	83-03	S10 Base, 4WD	
F	92-93	S10 EL, 4WD	
F	83-92	S10 Tahoe, 4WD	
F	88-90	S10 Durango, 4WD	
F	83-86	S10 Durango, 4WD	
F	92-05	GMC JIMMY 4WD	
F	83-91	S15 JIMMY 4WD	
F	83-04	SONOMA / S15 4WD	
F	91	SYCLONE All	
F	92-93	TYPHOON All	
F	00	ISUZU HOMBRE 4WD	
F	96-99	HOMBRE All Sport Chassis	
F	96-01	OLDSMOBILE BRAVADA All	
F	91-94	BRAVADA All	
G63424 A 141353,142592			
F	84-01	JEEP CHEROKEE All	
F	86-92	COMANCHE All	
F	93-98	GRAND CHEROKEE All	
F	84-90	WAGONEER All	

Numerical listing

Shock	POP	Alternative No.	MTG Acc. Supplied
Pos.	Year	Application	
G63425	B		140357
R 84-01		JEEP CHEROKEE All	
R 84-90		WAGONEER All	
G63426	D		
R 90-95		CHRYSLER TOWN & COUNTRY All	
R 84-95		DODGE CARAVAN / GRAND CARAVAN All	
R 87-88		MINI RAM All	
R 84-95		PLYMOUTH VOYAGER / GRAND VOYAGER All	
G63427	W		
R 89		FORD BRONCO II All Mfg. to 2/89; Vehicles with 10mm & 12mm bolt in rear lower mount	
R 84-88		BRONCO II All With 10mm Bolt In Rear Lower Mount	
R 89		RANGER RWD Mfg. to 2/89; Vehicles with 10mm bolt in rear lower mount	
R 83-88		RANGER RWD	
G63432	C		141349,140169
F 88-90		TOYOTA LAND CRUISER All	
F 81-87		LAND CRUISER FJ60 (MfrBodyCode), Sport Utility	
G63434	W		141439
R 95		LAND ROVER RANGE ROVER County Classic Exc. Air-Leveling Suspension	
R 94		RANGE ROVER Coil (RearSpringType)	
G63437	D		
F 87-91		CHEVROLET BLAZER 4WD Full Size; 4" Lift Kit; Exc. Quad Suspension	
F 75-86		BLAZER 4WD 4" Lift Kit; Exc. Quad Suspension	
F 73-74		BLAZER All 4WD; 4" Lift Kit; Exc. Quad Suspension	
F 73-86		PICKUP 1/2 TON, K10 All 4" Lift Kit; Exc. Quad Suspension	
F 87		PICKUP 1/2 TON, V10 All 4" Lift Kit; Exc. Quad Suspension	
F 73-86		PICKUP 3/4 TON, K20 All 4" Lift Kit; Exc. Quad Suspension	
F 87		PICKUP 3/4 TON, V20 All 4" Lift Kit; Exc. Quad Suspension	
F 73-86		SUBURBAN 1/2 TON, K10 All 4" Lift Kit; Exc. Quad Suspension	
F 89-91		SUBURBAN 1/2 TON, V1500 4WD 4" Lift Kit; Exc. Quad Suspension	
F 73-86		SUBURBAN 3/4 TON, K20 All 4" Lift Kit; Exc. Quad Suspension	
F 87-88		SUBURBAN 3/4 TON, V20 All 4" Lift Kit; Exc. Quad Suspension	
F 89-91		SUBURBAN 3/4 TON, V2500 All 4" Lift Kit; Exc. Quad Suspension	
F 75-91		GMC JIMMY 4WD 4" Lift Kit; Exc. Quad Suspension	
F 73-74		JIMMY All 4" Lift Kit; Exc. Quad Suspension	
F 73-86		PICKUP 1/2 TON, K15 / K1500 All 4" Lift Kit; Exc. Quad Suspension	
F 87		PICKUP 1/2 TON, V1500 All 4" Lift Kit; Exc. Quad Suspension	
F 73-86		PICKUP 3/4 TON, K25 / K2500 All 4" Lift Kit; Exc. Quad Suspension	
F 87		PICKUP 3/4 TON, V2500 All 4" Lift Kit; Exc. Quad Suspension	
F 73-86		SUBURBAN 1/2 TON, K15 / K1500 All 4" Lift Kit; Exc. Quad Suspension	
F 87-91		SUBURBAN 1/2 TON, V1500 All 4" Lift Kit; Exc. Quad Suspension	
F 73-86		SUBURBAN 3/4 TON, K25 / K2500 All 4" Lift Kit; Exc. Quad Suspension	
F 87-91		SUBURBAN 3/4 TON, V2500 All 4" Lift Kit; Exc. Quad Suspension	
G63438	D		140357
R 87-90		CHEVROLET BLAZER 4WD Full Size; 4" Lift Kit; Exc. Quad Suspension	
R 75-86		BLAZER 4WD 4" Lift Kit; Exc. Quad Suspension	
R 73-74		BLAZER All 4WD; 4" Lift Kit; Exc. Quad Suspension	
R 73-86		PICKUP 1/2 TON, K10 All 4" Lift Kit; Exc. Quad Suspension	
R 87		PICKUP 1/2 TON, V10 All 4" Lift Kit; Exc. Quad Suspension	

Ultra Truck Shock

Shock	POP	Alternative No.	MTG Acc. Supplied
Pos.	Year	Application	
G63438	D	-continued	140357
R 73-86		PICKUP 3/4 TON, K20 All 4" Lift Kit; Exc. Quad Suspension	
R 87		PICKUP 3/4 TON, V20 All 4" Lift Kit; Exc. Quad Suspension	
R 73-86		SUBURBAN 1/2 TON, K10 All 4" Lift Kit; Exc. Quad Suspension	
R 73-86		SUBURBAN 3/4 TON, K20 All 4" Lift Kit; Exc. Quad Suspension	
R 87-88		SUBURBAN 3/4 TON, V20 All 4" Lift Kit; Exc. Quad Suspension	
R 89-91		SUBURBAN 3/4 TON, V2500 All 4" Lift Kit; Exc. Quad Suspension	
R 73-91		GMC JIMMY All 4" Lift Kit; Exc. Quad Suspension	
R 73-86		PICKUP 1/2 TON, K15 / K1500 All 4" Lift Kit; Exc. Quad Suspension	
R 87		PICKUP 1/2 TON, V1500 All 4" Lift Kit; Exc. Quad Suspension	
R 73-86		PICKUP 3/4 TON, K25 / K2500 All 4" Lift Kit; Exc. Quad Suspension	
R 87		PICKUP 3/4 TON, V2500 All 4" Lift Kit; Exc. Quad Suspension	
R 73-86		SUBURBAN 1/2 TON, K15 / K1500 All 4" Lift Kit; Exc. Quad Suspension	
R 87-91		SUBURBAN 1/2 TON, V1500 All 4" Lift Kit; Exc. Quad Suspension	
R 73-86		SUBURBAN 3/4 TON, K25 / K2500 All 4" Lift Kit; Exc. Quad Suspension	
R 87-91		SUBURBAN 3/4 TON, V2500 All 4" Lift Kit; Exc. Quad Suspension	
G63439	W		
R 80-86		FORD PICKUP 1/2 TON, F-150 All 3-4" Lift Kit	
G63440	W		
R 65		JEEP CJ3 All 2-4" Lift Kit	
R 82-83		CJ5 All 3-4" Lift Kit	
R 65-81		CJ5 All 2-4" Lift Kit	
R 65-75		CJ6 All 2-4" Lift Kit	
R 82-86		CJ7 All 3-4" Lift Kit	
R 76-81		CJ7 All 2-4" Lift Kit	
R 66-74		DJ5 All 2-4" Lift Kit	
R 66-68		DJ6 All 2-4" Lift Kit	
R 65-67		UNIVERSAL All 2-4" Lift Kit	
R 80-83		TOYOTA PICKUP 4WD 2-3" Lift Kit	
G63441	W		
R 80-88		FORD BRONCO All 3-4" Lift Kit	
R 78-79		BRONCO All 4" Lift Kit	
R 66-77		BRONCO All 4-5" Lift Kit	
F 82-83		JEEP CJ5 All 2 - 4" Lift Kit	
F 82-86		CJ7 All 2 - 4" Lift Kit	
G63443	W		
R 82-83		JEEP CJ5 All 2" Lift Kit	
F 66-81		CJ5 All 2-4" Lift Kit	
F 66-75		CJ6 All 2-4" Lift Kit	
R 82-86		CJ7 All 2" Lift Kit	
F 76-81		CJ7 All 2-4" Lift Kit	
F 66-74		DJ5 All 2-4" Lift Kit	
F 66-68		DJ6 All 2-4" Lift Kit	
F 65-67		UNIVERSAL All 2-4" Lift Kit	
G63444	W		141041
F 80-83		TOYOTA PICKUP 4WD 2-3" Lift Kit	
G63445	W		140780
F 80-86		FORD BRONCO All 3-4" Lift Kit; Quad Suspension Rearward of Front Axle	
F 78-79		BRONCO All Right Quad Suspension, Rearward of Front Axle; Non Quad Suspension, Right Shock; 4" Lift Kit	
F 66-77		BRONCO All 4-5" Lift Kit	
F 77-79		PICKUP 1/2 TON, F-100 All 3-4" Lift Kit; Exc. Quad Suspension	
F 80-86		PICKUP 1/2 TON, F-150 All 3-4" Lift Kit	
F 78-79		PICKUP 1/2 TON, F-150 Cab & Chassis, 4WD Quad Suspension, Rearward of Front Axle; Non Quad Suspension, Right Shock; 4" Lift Kit	
F 78-79		PICKUP 1/2 TON, F-150 Standard Cab Pickup, 4WD Quad Suspension, Rearward of Front Axle; Non Quad Suspension, Right Shock; 4" Lift Kit	
F 77		PICKUP 1/2 TON, F-150 Cab & Chassis, 4WD 3-4" Lift Kit; Exc. Quad Suspension	
F 77		PICKUP 1/2 TON, F-150 Standard Cab Pickup, 4WD 3-4" Lift Kit; Exc. Quad Suspension	

Numerical listing

Shock	POP	Alternative No.	MTG Acc. Supplied
Pos.	Year	Application	
G63446	W		141047
F 80-86		FORD BRONCO All 3-4" Lift Kit; Quad Suspension Forward of Front Axle	
F 80-86		PICKUP 1/2 TON, F-150 4WD Quad Suspension with 3-4" Lift Kit Forward of Front Axle	
G63447	W		140780
F 78-79		FORD BRONCO All Quad Suspension, Forward of Front Axle; Non Quad Suspension, Left Shock; 4" Lift Kit	
R 77-79		PICKUP 1/2 TON, F-100 All 4WD; 3-4" Lift Kit; Exc. Quad Suspension	
R 75-76		PICKUP 1/2 TON, F-100 4WD 3 1/2-4" Lift Kit	
R 70-74		PICKUP 1/2 TON, F-100 All 4WD; Lift Kit	
R 78-79		PICKUP 1/2 TON, F-150 Cab & Chassis, 4WD Quad Suspension, Forward of Front Axle; Non Quad Suspension, Left Shock; 4" Lift Kit	
R 78-79		PICKUP 1/2 TON, F-150 Standard Cab Pickup, 4WD Quad Suspension, Forward of Front Axle; Non Quad Suspension, Left Shock; 4" Lift Kit	
R 77		PICKUP 1/2 TON, F-150 Cab & Chassis, 4WD 3-4" Lift Kit; Exc. Quad Suspension	
R 77		PICKUP 1/2 TON, F-150 Standard Cab Pickup, 4WD 3-4" Lift Kit; Exc. Quad Suspension	
R 76		PICKUP 1/2 TON, F-150 Cab & Chassis, 4WD Lift Kit	
R 76		PICKUP 1/2 TON, F-150 Standard Cab Pickup, 4WD Lift Kit	
R 75		PICKUP 1/2 TON, F-150 Cab & Chassis 4WD; Lift Kit	
R 75		PICKUP 1/2 TON, F-150 Standard Cab Pickup 4WD; Lift Kit	
G63454	B		
R 90-05		CHEVROLET ASTRO All	
R 85-89		ASTRO RWD	
R 90-05		GMC SAFARI All	
R 85-89		SAFARI RWD	
R 86-89		VOLKSWAGEN VANAGON 4WD	
G63455	D		
F 86-97		FORD PICKUP 1 TON, F-350 / SUPERDUTY 4WD	
F 97-98		PICKUP 3/4 TON, F-250 / SUPERDUTY 4WD Over 8500# GVW	
F 87-96		PICKUP 3/4 TON, F-250 / SUPERDUTY 4WD	
G63456	D		
R 86-97		FORD PICKUP 1 TON, F-350 / SUPERDUTY 4WD Exc. Dual Rear Wheels	
G63457	W		140126
F 86-97		FORD AEROSTAR RWD	
G63460	D		
R 87-96		DODGE DAKOTA RWD	
G63461	C		
R 80-96		FORD PICKUP 1/2 TON, F-150 4WD Exc. Lift Kit	
R 86-97		PICKUP 1 TON, F-350 / SUPERDUTY 4WD Dual Rear Wheels	
R 82-85		PICKUP 1 TON, F-350 / SUPERDUTY 4WD Clevis Type Lower Front Mount; Exc. Dual Rear Wheels or Lift Kit	
R 80-81		PICKUP 1 TON, F-350 / SUPERDUTY 4WD	
R 97		PICKUP 3/4 TON, F-250 / SUPERDUTY 4WD Over 8500# GVW	
R 86-96		PICKUP 3/4 TON, F-250 / SUPERDUTY 4WD	
R 82-85		PICKUP 3/4 TON, F-250 / SUPERDUTY 4WD Clevis Type Lower Front Mount; Exc. Dual Rear Wheels or Lift Kit	
R 80-81		PICKUP 3/4 TON, F-250 / SUPERDUTY 4WD	
G63479	C		140524
F 86-89		TOYOTA 4RUNNER All	
F 86-95		PICKUP 4WD Exc. Lift Kit	

Numerical listing

Shock	POP	Alternative No.	MTG Acc. Supplied
Pos.	Year	Application	
G63479	C	-continued	140524
F	93-98	T100 4WD	
G63484	W		140524
R	84-89	TOYOTA VAN Coil (RearSpringType)	
R	88	VAN WAGON RWD Coil(RearSpringType)	
G63488	A		
R	88-99	CHEVROLET PICKUP 1/2 TON, C15 / C1500 All	
R	88-99	PICKUP 1/2 TON, K15 / K1500 All	
R	01-03	PICKUP 1 TON, C35/3500 Base Exc. HD Straight Front Axle	
R	92-00	PICKUP 1 TON, C35/3500 Crew Cab Pickup Exc. HD Straight Front Axle	
R	92-00	PICKUP 1 TON, C35/3500 Standard Cab Pickup Exc. HD Straight Front Axle	
R	88-00	PICKUP 1 TON, C35/3500 Extended Cab Pickup Exc. HD Straight Front Axle	
R	88-99	PICKUP 1 TON, C35/3500 Standard Cab Pickup Exc. HD Straight Front Axle	
R	88-00	PICKUP 1 TON, K35 / K3500 All	
R	88-00	PICKUP 3/4 TON, C25 / C2500 All	
R	88-00	PICKUP 3/4 TON, K25 / K2500 All	
R	88-99	GMC PICKUP 1/2 TON, C15 / C1500 All	
R	88-99	PICKUP 1/2 TON, K15 / K1500 All	
R	92-00	PICKUP 1 TON, C35/3500 Crew Cab Pickup Exc. HD Straight Front Axle	
R	88-00	PICKUP 1 TON, C35/3500 Extended Cab Pickup Exc. HD Straight Front Axle	
R	88-00	PICKUP 1 TON, C35/3500 Standard Cab Pickup Exc. HD Straight Front Axle	
R	88-00	PICKUP 1 TON, K35 / K3500 All	
R	88-00	PICKUP 3/4 TON, C25 / C2500 All	
R	88-00	PICKUP 3/4 TON, K25 / K2500 All	
G63489	A		141277
F	88-99	CHEVROLET PICKUP 1/2 TON, C15 / C1500 All	
F	92-00	PICKUP 1 TON, C35/3500 Crew Cab Pickup Exc. HD Straight Front Axle	
F	88-00	PICKUP 1 TON, C35/3500 Extended Cab Pickup Exc. HD Straight Front Axle	
F	88-00	PICKUP 1 TON, C35/3500 Standard Cab Pickup Exc. HD Straight Front Axle	
F	88-00	PICKUP 3/4 TON, C25 / C2500 All	
F	92-99	SUBURBAN 1/2 TON, C15 / C1500 All	
F	92-99	SUBURBAN 3/4 TON, C25 / C2500 All	
F	95-00	TAHOE RWD Old Body Style	
F	88-99	GMC PICKUP 1/2 TON, C15 / C1500 All	
F	92-00	PICKUP 1 TON, C35/3500 Crew Cab Pickup Exc. HD Straight Front Axle	
F	88-00	PICKUP 1 TON, C35/3500 Extended Cab Pickup Exc. HD Straight Front Axle	
F	88-00	PICKUP 1 TON, C35/3500 Standard Cab Pickup Exc. HD Straight Front Axle	
F	88-00	PICKUP 3/4 TON, C25 / C2500 All	
F	92-99	SUBURBAN 1/2 TON, C15 / C1500 All	
F	92-99	SUBURBAN 3/4 TON, C25 / C2500 All	
F	92-99	YUKON RWD	
G63490	D		
R	86-88	FORD AEROSTAR RWD	
R	87-95	JEEP WRANGLER YJ (MfrBodyCode)	
G63491	W		140524
R	69-72	NISSAN 521 PICKUP All	
R	72-79	620 PICKUP All	
R	86	720 PICKUP RWD Mfg. to 8/86	
R	82-85	720 PICKUP RWD	
R	80-81	720 PICKUP All	
G63492	A		141137
R	81-82	CHEVROLET LUV PICKUP All	

Ultra Truck Shock

Shock	POP	Alternative No.	MTG Acc. Supplied
Pos.	Year	Application	
G63492	A	-continued	141137
R	87-89	DODGE RAIDER 2.6L 4Cyl L (156) Exc. Sport Utility	
F	61-67	FORD ECONOLINE All	
R	81-95	ISUZU PICKUP RWD	
R	86-92	JEEP COMANCHE All	
F	66-73	WAGONEER All	
F	63-65	WAGONEER All Exc. Independent Front Suspension	
R	83-89	MITSUBISHI MONTERO 2.6L 4Cyl L (156)	
R	97-99	MONTERO SPORT All	
R	82-86	NISSAN 720 PICKUP 4WD	
R	00-04	FRONTIER Crew Cab Pickup, RWD with Desert Runner	
R	98-04	FRONTIER 4WD	
R	98-99	FRONTIER RWD Crew Cab with Desert Runner	
R	87-95	PATHFINDER All Exc. Electronic Adjustable Suspension	
R	87-97	PICKUP 4WD	
R	86	PICKUP 4WD Mfg. from 8/86	
R	00-04	XTERRA All	
R	84-87	TOYOTA LAND CRUISER FJ60 (MfrBodyCode), Sport Utility	
R	76-83	LAND CRUISER All	
R	75	LAND CRUISER All Mfg. from 1/75	
R	69-74	LAND CRUISER All	
R	85-92	PICKUP RWD 1 Ton	
R	80-83	PICKUP 4WD Exc. Lift Kit	
G63494	A		140149
R	84-89	TOYOTA 4RUNNER All	
R	84-95	PICKUP 4WD Exc. Lift Kit	
R	98-04	TACOMA Pre Runner, RWD Exc. HD Upgrade	
R	95-04	TACOMA 4WD Exc. HD Upgrade	
G63495	W		141350
F	87-91	ISUZU TROOPER 4WD	
F	86-87	MAZDA B2000 RWD	
F	87-93	B2200 RWD	
F	87-93	B2600 RWD	
G63499	W		
R	87-96	DODGE DAKOTA 4WD	
G63500	W		140780
F	75-91	FORD VAN 1/2 TON, ECONOLINE / CLUB WAGON All	
G63502	W		
R	90-97	FORD AEROSTAR All	
R	89	AEROSTAR RWD	
G63506	D		141448
F	99	LAND ROVER DISCOVERY SD	
F	99	DISCOVERY SE7	
F	94-98	DISCOVERY All	
F	95	RANGE ROVER County Classic Coil (FrontSpringType) & RearSpringType, Exc. Air-Leveling Suspension	
F	94	RANGE ROVER County, Coil (RearSpringType)	
G63510	D		140149
R	88-90	TOYOTA LAND CRUISER All	
G63511	D		141353
F	78-79	FORD BRONCO All Quad Suspension, Forward of Front Axle; Non Quad Suspension, Left Shock; Exc. Lift Kit	
F	78-79	PICKUP 1/2 TON, F-150 Custom, 4WD Quad Suspension, Forward of Front Axle; Non Quad Suspension, Left Shock; Exc. Lift Kit	
F	78-79	PICKUP 1/2 TON, F-150 Ranger Lariat, 4WD Quad Suspension, Forward of Front Axle; Non Quad Suspension, Left Shock; Exc. Lift Kit	
F	78-79	PICKUP 1/2 TON, F-150 Ranger, 4WD Quad Suspension, Forward of Front Axle; Non Quad Suspension, Left Shock; Exc. Lift Kit	
F	78	PICKUP 1/2 TON, F-150 Base, 4WD Quad Suspension, Forward of Front Axle; Non Quad Suspension, Left Shock; Exc. Lift Kit	
F	78	PICKUP 1/2 TON, F-150 Northland, 4WD Quad Suspension, Forward of Front Axle; Non Quad Suspension, Left Shock; Exc. Lift Kit	
F	87-95	JEEP WRANGLER YJ (MfrBodyCode)	

Numerical listing

Shock	POP	Alternative No.	MTG Acc. Supplied
Pos.	Year	Application	
G63524	D		
R	89-97	FORD RANGER 4WD	
R	95-96	MAZDA B2300 4WD	
R	94-97	B3000 4WD	
R	94-97	B4000 4WD	
G63525	D		
R	90	FORD BRONCO II All	
R	89	BRONCO II All Mfg. from 2/89; Vehicles with 12mm bolt in rear lower mount	
R	90-97	RANGER RWD	
R	89	RANGER RWD Mfg. from 2/89; Vehicles with 12mm bolt in rear lower mount	
R	94-97	MAZDA B2300 RWD	
R	94-97	B3000 RWD	
R	94-97	B4000 RWD	
G63547	D		141350
F	90-95	TOYOTA 4RUNNER All	
G63548	D		140921
R	90-95	TOYOTA 4RUNNER All	
G63604	W		
R	89	DODGE RAIDER Sport Utility, 3.0L 6Cyl V (181)	
R	89-91	MITSUBISHI MONTERO 3.0L 6Cyl V (181)	
G63605	W		140169
F	74	DODGE M300 All	
F	74	M350 All	
G63606	W		
R	89-98	MAZDA MPV RWD	
G63607	D		140719
R	00-05	FORD EXCURSION RWD	
R	91-94	EXPLORER All	
R	91-94	MAZDA NAVAJO All	
G63608	W		140780
F	91-94	FORD EXPLORER All	
F	91-94	MAZDA NAVAJO All	
G63609	B		
F	99-00	CADILLAC ESCALADE All	
F	92-94	CHEVROLET BLAZER 4WD Full Size	
F	88-00	PICKUP 1 TON, K35 / K3500 All	
F	88-00	PICKUP 3/4 TON, K25 / K2500 All	
F	92-99	SUBURBAN 1/2 TON, K15 / K1500 All	
F	92-99	SUBURBAN 3/4 TON, K25 / K2500 All	
F	95-00	TAHOE 4WD Old Body Style	
F	88-00	GMC PICKUP 1 TON, K35 / K3500 All	
F	88-00	PICKUP 3/4 TON, K25 / K2500 All	
F	92-99	SUBURBAN 1/2 TON, K15 / K1500 All	
F	92-99	SUBURBAN 3/4 TON, K25 / K2500 All	
F	92-99	YUKON 4WD	
G63610	B		142389
R	94-97	HONDA PASSPORT All	
R	91-97	ISUZU RODEO All	
R	98-03	TOYOTA SIENNA All	
G63611	C		140524
F	90-92	DAIHATSU ROCKY All	
F	94-02	HONDA PASSPORT All	
F	98-00	ISUZU AMIGO All	
F	02-04	AXIOM All	
F	91-04	RODEO All	
G63612	W		141349
F	87-89	TOYOTA VAN 4WD	
F	88	VAN WAGON All 4WD	
G63614	C		140780
F	90	FORD BRONCO II All	
F	00-05	EXCURSION RWD	
F	90-97	RANGER All	
F	94-97	MAZDA B2300 All	
F	94-97	B3000 All	
F	94-97	B4000 All	
G63615	C		142657
F	94-95	LAND ROVER RANGE ROVER All	
F	96-97	LEXUS LX450 All	
F	91-97	TOYOTA LAND CRUISER All	

Numerical listing

Shock	POP	Alternative No.	MTG Acc. Supplied
Pos.	Year	Application	
G63616	C		140169,142656
R	96-97	LEXUS LX450 All	
R	93-97	TOYOTA LAND CRUISER All	
R	91-92	LAND CRUISER FJ80 (MfrBodyCode)	
G63617	W		
F	90-93	FORD PICKUP 1/2 TON, F SUPERDUTY All Mfg. to 2/93	
G63620	D		141405
R	91-97	TOYOTA PREVIA All	
G63621	W		140780
F	90-97	FORD AEROSTAR AWD	
G63622	A		142617
F	99-12	FORD PICKUP 1 TON, F-350 / SUPERDUTY RWD	
F	11-15	PICKUP 3/4 TON, F-250 / SUPERDUTY RWD Exc. Off Road Package	
F	99-10	PICKUP 3/4 TON, F-250 / SUPERDUTY RWD	
F	08-14	VAN 1/2 TON, ECONOLINE / CLUB WAGON All	
F	08-14	VAN 1 TON, ECONOLINE / CLUB WAGON / SUPERDUTY All	
F	07	VAN 1 TON, ECONOLINE / CLUB WAGON / SUPERDUTY All Exc. Cutaway Chassis	
F	01-06	VAN 1 TON, ECONOLINE / CLUB WAGON / SUPERDUTY All	
F	92-05	VAN 1 TON, ECONOLINE / CLUB WAGON / SUPERDUTY All Cutaway Chassis	
F	92-14	VAN 3/4 TON, ECONOLINE / CLUB WAGON / SUPERDUTY All	
G63623	B		142617
R	08-14	FORD VAN 1/2 TON, ECONOLINE / CLUB WAGON All	
R	10-14	VAN 1 TON, ECONOLINE / CLUB WAGON / SUPERDUTY All	
R	04-11	VAN 1 TON, ECONOLINE / CLUB WAGON / SUPERDUTY All Exc. Cutaway Chassis	
R	92-05	VAN 1 TON, ECONOLINE / CLUB WAGON / SUPERDUTY All Cutaway Chassis	
R	01-03	VAN 1 TON, ECONOLINE / CLUB WAGON / SUPERDUTY All	
R	92-14	VAN 3/4 TON, ECONOLINE / CLUB WAGON / SUPERDUTY All	
G63624	C		140780
R	92-07	FORD VAN 1/2 TON, ECONOLINE / CLUB WAGON All	
G63625	D		140702
F	86-99	CHEVROLET VAN 1 TON, P SERIES All Motorhome Chassis with I-Beam Front Suspension	
F	86-99	GMC VAN 1 TON, P SERIES All Motorhome Chassis with I-Beam Front Suspension	
G63626	W		
R	93-94	JEEP GRAND CHEROKEE All	
G63635	D		140524
F	87-93	MAZDA B2600 4WD	
G63638	B		
R	99-00	CADILLAC ESCALADE All	
R	92-94	CHEVROLET BLAZER 4WD Full Size	
R	92-99	SUBURBAN 1/2 TON, K15 / K1500 All	
R	92-99	SUBURBAN 3/4 TON, K25 / K2500 All	
R	95-00	TAHOE 4WD Old Body Style	
R	97-02	VAN 1 TON, G / EXPRESS All Exc. 8600# GVW	
R	96-02	VAN 3/4 TON, G / EXPRESS All Exc. 8600# GVW	
R	92-99	GMC SUBURBAN 1/2 TON, K15 / K1500 All	
R	92-99	SUBURBAN 3/4 TON, K25 / K2500 All	
R	96-02	VAN 1 TON, G / SAVANNA All Exc. 8600# GVW	
R	96-02	VAN 3/4 TON, G / SAVANNA All Exc. 8600# GVW	
G63639	D		140169
R	87-93	MAZDA B2600 4WD	

Ultra Truck Shock

Shock	POP	Alternative No.	MTG Acc. Supplied
Pos.	Year	Application	
G63640	W		
R	89-98	MAZDA MPV 4WD	
G63660	W		
R	93-98	TOYOTA T100 4WD	
G63661	B		143000
F	94-01	DODGE PICKUP 1/2 TON, RAM 1500 (SEE RAM 1500) RWD	
F	94-02	PICKUP 1 TON, RAM 3500 (SEE RAM 3500) RWD Exc. Solid Front Axle	
F	94-02	PICKUP 3/4 TON, RAM 2500 (SEE RAM 2500) RWD	
G63662	A		
R	99-07	CHEVROLET PICKUP 1/2 TON, SILVERADO 1500 RWD Exc. Electronic Adjustable Suspension	
R	94-01	DODGE PICKUP 1/2 TON, RAM 1500 (SEE RAM 1500) All	
R	94-02	PICKUP 1 TON, RAM 3500 (SEE RAM 3500) RWD Exc. Solid Front Axle	
R	94-03	PICKUP 3/4 TON, RAM 2500 (SEE RAM 2500) 4WD, GAS Exc. 8800# GVW	
R	94-02	PICKUP 3/4 TON, RAM 2500 (SEE RAM 2500) RWD	
R	95-96	PICKUP 3/4 TON, RAM 2500 (SEE RAM 2500) 4WD, CNG Exc. 8800# GVW	
R	99-07	GMC SIERRA 1500 RWD Exc. Electronic Adjustable Suspension	
G63671	W		
R	92-96	CHEVROLET VAN 1 TON, G / EXPRESS Cutaway Van	
R	92-96	GMC VAN 1 TON, G / SAVANNA Cutaway Van	
G63673	C		143000
F	94-01	DODGE PICKUP 1/2 TON, RAM 1500 (SEE RAM 1500) 4WD	
F	94-02	PICKUP 3/4 TON, RAM 2500 (SEE RAM 2500) 4WD, GAS Exc. 8800# GVW	
F	95-96	PICKUP 3/4 TON, RAM 2500 (SEE RAM 2500) 4WD, CNG Exc. 8800# GVW	
G63674	C		142731
F	94-02	DODGE PICKUP 1 TON, RAM 3500 (SEE RAM 3500) 4WD	
F	94-02	PICKUP 1 TON, RAM 3500 (SEE RAM 3500) RWD Solid Front Axle	
F	94-02	PICKUP 3/4 TON, RAM 2500 (SEE RAM 2500) 4WD, DIESEL 8800# GVW	
G63675	A		
R	07	CHEVROLET PICKUP 1/2 TON, SILVERADO 1500 4WD Old Body Style; Exc. Electronic Adjustable Suspension	
R	99-06	PICKUP 1/2 TON, SILVERADO 1500 4WD Exc. Electronic Adjustable Suspension	
R	05-06	PICKUP 1/2 TON, SILVERADO 1500 HD All	
R	01-03	PICKUP 1/2 TON, SILVERADO 1500 HD All	
R	77-86	PICKUP 1 TON, K30 All	
R	90-91	PICKUP 1 TON, R3500 All	
R	89	PICKUP 1 TON, R3500 Cab & Chassis, RWD	
R	89	PICKUP 1 TON, R3500 Crew Cab Pickup, RWD	
R	01-09	PICKUP 1 TON, SILVERADO 3500 All	
R	07-10	PICKUP 1 TON, SILVERADO 3500 HD All	
R	87-88	PICKUP 1 TON, V30 All	
R	89-91	PICKUP 1 TON, V3000 / V3500 All	
R	99-08	PICKUP 3/4 TON, SILVERADO 2500 All	
R	01-10	PICKUP 3/4 TON, SILVERADO 2500 HD All	
R	07	SILVERADO 1500 HD CLASSIC All	
R	02-05	DODGE PICKUP 1/2 TON, RAM 1500 (SEE RAM 1500) All	
R	94-02	PICKUP 1 TON, RAM 3500 (SEE RAM 3500) 4WD	
R	94-02	PICKUP 1 TON, RAM 3500 (SEE RAM 3500) RWD Solid Front Axle	

Numerical listing

Shock	POP	Alternative No.	MTG Acc. Supplied
Pos.	Year	Application	
G63675	A	-continued	
R	94-02	PICKUP 3/4 TON, RAM 2500 (SEE RAM 2500) 4WD, DIESEL 8800# GVW	
R	77-86	GMC PICKUP 1 TON, K35 / K3500 All	
R	87-91	PICKUP 1 TON, V3000 / V3500 All	
R	07	SIERRA 1500 4WD Old Body Style; Exc. Electronic Adjustable Suspension	
R	99-06	SIERRA 1500 4WD Exc. Electronic Adjustable Suspension	
R	05-06	SIERRA 1500 HD All	
R	01-03	SIERRA 1500 HD All	
R	07	SIERRA 1500 HD CLASSIC All	
R	99-04	SIERRA 2500 All	
R	01-10	SIERRA 2500 HD All	
R	01-06	SIERRA 3500 All	
R	07-10	SIERRA 3500 HD All	
G63676	C		
R	95-03	FORD WINDSTAR Coil (RearSpringType)	
G63678	A		142277
F	95-01	FORD EXPLORER All Exc. Adjustable Suspension	
F	01-05	EXPLORER SPORT TRAC All	
F	05-11	RANGER 4WD, Torsion Bar (FrontSpringType)	
F	01-11	RANGER XLT, RWD, Torsion Bar (FrontSpringType)	
F	01-09	RANGER XL, RWD, Torsion Bar (FrontSpringType)	
F	05	RANGER STX, RWD w/ Torsion Bar (FrontSpringType)	
F	04	RANGER Tremor, RWD, Torsion Bar (FrontSpringType)	
F	00-03	RANGER 4WD, Torsion Bar (FrontSpringType)	
F	01-02	RANGER EV, RWD, Torsion Bar (FrontSpringType)	
F	02	RANGER Sport, RWD w/ Torsion Bar (FrontSpringType)	
F	98-99	RANGER 4WD	
F	06-07	MAZDA B3000 All 4WD	
F	05	B3000 4WD	
F	03	B3000 All 4WD	
F	98-02	B3000 4WD	
F	98-09	B4000 4WD	
F	97-01	MERCURY MOUNTAINEER All Exc. Electronic Adjustable Suspension	
G63679	B		140719
R	95-01	FORD EXPLORER All Exc. Adjustable Suspension	
R	01-05	EXPLORER SPORT TRAC All	
R	97-01	MERCURY MOUNTAINEER All Exc. Electronic Adjustable Suspension	
G63683	D		
R	95-98	JEEP GRAND CHEROKEE All	
G63689	C		
R	01-04	TOYOTA TACOMA S-Runner	
R	04	TACOMA Base, RWD	
R	95-03	TACOMA DLX, RWD	
G63690	A		
R	96-07	CHRYSLER TOWN & COUNTRY All Exc. Hydraulic Self Leveling System	
R	00-03	VOYAGER / GRAND VOYAGER Non-ABS Exc. Hydraulic Self Leveling System	
R	00-02	VOYAGER / GRAND VOYAGER All Exc. Hydraulic Self Leveling System	
R	96-07	DODGE CARAVAN / GRAND CARAVAN All Exc. Hydraulic Self Leveling System	
R	05	CARAVAN / GRAND CARAVAN All	
R	96-00	PLYMOUTH VOYAGER / GRAND VOYAGER All Exc. Hydraulic Self Leveling System	
G63692	D		
F	93-97	FORD PICKUP 1/2 TON, F SUPERDUTY All Mfg. from 2/93	
F	97	PICKUP, F-450 SUPERDUTY All	
G63694	D		141448
R	99	LAND ROVER DISCOVERY SD	
R	99	DISCOVERY SE7	
R	94-98	DISCOVERY All	

Numerical listing

Shock	POP	Alternative No.	MTG Acc. Supplied
Pos.	Year	Application	
G63694	D	-continued	141448
R	94-95	RANGE ROVER Air (RearSpringType)	
G63707	D		141354
F	96-99	ACURA SLX All	
F	92-02	ISUZU TROOPER All	
F	99-01	VEHICROSS All	
G63708	D		140169
R	96-99	ACURA SLX All	
R	92-02	ISUZU TROOPER All	
R	99-01	VEHICROSS All	
G63710	D		140524
R	98-02	HONDA PASSPORT All	
R	98-00	ISUZU AMIGO All	
R	02-04	AXIOM All	
R	98-04	RODEO All	
G63712	C		141137
R	98	INFINITI QX4 All Mfg. to 12/98	
R	97	QX4 All	
R	96-99	NISSAN PATHFINDER All Mfg. to 12/98	
G63714	A		142731
F	97-02	FORD EXPEDITION RWD Exc. Front Air- Leveling	
F	97-04	PICKUP 1/2 TON, F-150 RWD	
F	97-99	PICKUP 3/4 TON, F-250 / SUPERDUTY RWD Up through 8500# GVW	
F	98-02	LINCOLN NAVIGATOR RWD	
G63715	C		142700
R	97-04	FORD PICKUP 1/2 TON, F-150 4WD Exc. 7000# GVW	
R	97-99	PICKUP 3/4 TON, F-250 / SUPERDUTY 4WD Up through 8500# GVW; Exc. Superduty	
G63716	A		142731
F	97-02	FORD EXPEDITION 4WD Exc. Front Air- Leveling	
F	04	PICKUP 1/2 TON, F-150 4WD Exc. 7000# GVW	
F	97-03	PICKUP 1/2 TON, F-150 4WD	
F	97-99	PICKUP 3/4 TON, F-250 / SUPERDUTY 4WD Up through 8500# GVW; Exc. Superduty	
G63717	B		
R	97-02	FORD EXPEDITION All	
R	98-02	LINCOLN NAVIGATOR RWD	
G63720	D		140800
R	95-02	KIA SPORTAGE All	
G63721	D		141665
F	97-06	JEEP WRANGLER TJ (MfrBodyCode)	
G63722	C		
R	97-06	JEEP WRANGLER TJ (MfrBodyCode)	
G63726	B		140921
R	96-02	TOYOTA 4RUNNER All	
G63772	B		141665
F	06-11	FORD RANGER RWD, Coil (FrontSpringType)	
F	01-05	RANGER XL, RWD, Coil (FrontSpringType)	
F	01-05	RANGER XLT, RWD, Coil (FrontSpringType)	
F	02	RANGER EV, Torsion Bar (FrontSpringType) 4WD	
F	01	RANGER EV Coil Front Spring Type	
F	98-00	RANGER XL, RWD	
F	98-00	RANGER XLT, RWD	
F	01-09	MAZDA B2300 RWD	
F	98-01	B2500 RWD	
F	98-07	B3000 RWD	
F	98-06	B4000 RWD	
G63773	C		
R	06-11	FORD RANGER RWD, Coil (FrontSpringType)	
R	98-05	RANGER XL, RWD	
R	98-05	RANGER XLT, RWD	
R	05	RANGER STX, RWD	
R	04	RANGER Tremor, RWD	
R	01-06	MAZDA B2300 RWD	
R	98-01	B2500 All	
R	98-06	B3000 RWD	

Ultra Truck Shock

Shock	POP	Alternative No.	MTG Acc. Supplied
Pos.	Year	Application	
G63773	C	-continued	
R	98-06	B4000 RWD	
G63775	B		
R	06-11	FORD RANGER RWD, Torsion Bar (FrontSpringType)	
R	98-11	RANGER 4WD	
R	01-05	RANGER Edge, RWD	
R	06-07	MAZDA B3000 All 4WD	
R	05	B3000 4WD	
R	98-02	B3000 4WD	
R	98-09	B4000 4WD	
G63776	A		
R	05-07	BUICK TERRAZA FWD Exc. Air-Leveling Suspension	
R	05-09	CHEVROLET UPLANDER FWD Exc. Air-Leveling Suspension	
R	02-05	VENTURE All	
R	97-01	VENTURE FWD	
R	02-04	OLDSMOBILE SILHOUETTE AWD	
R	97-04	SILHOUETTE FWD	
R	07-09	PONTIAC MONTANA CAN	
R	06	MONTANA FWD Exc. Air-Leveling Suspension	
R	99-05	MONTANA All Exc. Air-Leveling Suspension	
R	97-99	TRANS SPORT All	
R	05-07	SATURN RELAY FWD Exc. Air-Leveling Suspension	
G63778	A		142700
R	04	FORD PICKUP 1/2 TON, F-150 RWD	
R	00-03	PICKUP 1/2 TON, F-150 Harley-Davidson Edition, RWD	
R	99-03	PICKUP 1/2 TON, F-150 Lariat, RWD	
R	99-03	PICKUP 1/2 TON, F-150 XL, RWD	
R	99-03	PICKUP 1/2 TON, F-150 XLT, RWD	
R	00	PICKUP 1/2 TON, F-150 Base, RWD	
R	97-98	PICKUP 1/2 TON, F-150 RWD	
R	97-99	PICKUP 3/4 TON, F-250 / SUPERDUTY RWD Up through 8500# GVW	
G63781	D		141350
R	92-00	MITSUBISHI MONTERO All	
G63782	C		141350
F	92-00	MITSUBISHI MONTERO All	
F	97-99	MONTERO SPORT All	
G63783	A		141665
F	99-07	CHEVROLET PICKUP 1/2 TON, SILVERADO 1500 RWD Exc. Electronic Adjustable Suspension	
F	99-07	GMC SIERRA 1500 RWD Exc. Electronic Adjustable Suspension	
G63798	W		140455
F	86-95	SUZUKI SAMURAI All	
G63799	D		141514
R	94-98	ASUNA SUNRUNNER	
R	92-93	SUNRUNNER All	
R	98-04	CHEVROLET TRACKER Non-ABS	
R	89-97	GEO TRACKER All	
R	94-97	PONTIAC SUNRUNNER All	
R	99-05	SUZUKI GRAND VITARA All	
R	89-98	SIDEKICK All	
R	99-04	VITARA All	
R	96-98	X-90 All	
G63803	A		141665
F	02-06	CHEVROLET AVALANCHE 1500 All Exc. Electronic Ride Control	
F	07	PICKUP 1/2 TON, SILVERADO 1500 4WD Old Body Style; Exc. Electronic Adjustable Suspension	
F	99-06	PICKUP 1/2 TON, SILVERADO 1500 4WD Exc. Electronic Adjustable Suspension	
F	00-06	SUBURBAN 1/2 TON, 1500 All Exc. Z55 Auto Ride Suspension	
F	02-06	TAHOE All Exc. Z55 Auto Ride Suspension	
F	00-01	TAHOE All New Body Style; Exc. Z55 Auto Ride Suspension	
F	07	GMC SIERRA 1500 4WD Old Body Style; Exc. Electronic Adjustable Suspension	
F	99-06	SIERRA 1500 4WD Exc. Electronic Adjustable Suspension	
F	00-06	YUKON All Exc. Z55 Auto Ride Suspension	

Numerical listing

Shock	POP	Alternative No.	MTG Acc. Supplied
Pos.	Year	Application	
G63803	A	-continued	141665
F	00-06	YUKON XL 1/2 TON All Exc. Z55 Auto Ride Suspension	
G63808	C		
R	99-04	FORD PICKUP 1 TON, F-350 / SUPERDUTY RWD	
R	99-04	PICKUP 3/4 TON, F-250 / SUPERDUTY RWD	
G63809	A		
F	00-05	FORD EXCURSION 4WD	
F	99-04	PICKUP 1 TON, F-350 / SUPERDUTY 4WD	
F	99-04	PICKUP 3/4 TON, F-250 / SUPERDUTY 4WD	
F	99-04	PICKUP, F-450 SUPERDUTY All	
F	99-04	PICKUP, F-550 SUPERDUTY All	
G63810	B		
R	99-04	FORD PICKUP 1 TON, F-350 / SUPERDUTY 4WD	
R	99-04	PICKUP 3/4 TON, F-250 / SUPERDUTY 4WD	
G63811	D		
R	99-04	FORD PICKUP, F-450 SUPERDUTY All	
R	99-04	PICKUP, F-550 SUPERDUTY All	
G63812	W		
F	91-00	CHEVROLET C3500HD All HD Solid Front Axle	
F	01-02	PICKUP 1 TON, C35/3500 HD Solid Front Axle	
F	91-00	GMC C3500HD All HD Solid Front Axle	
G63813	A		142389
F	00-04	NISSAN FRONTIER Crew Cab Pickup, RWD with Desert Runner	
F	98-04	FRONTIER 4WD	
F	98-99	FRONTIER RWD Crew Cab with Desert Runner	
F	00-04	XTERRA All	
G63815	B		142389
R	00-06	TOYOTA TUNDRA All	
G63817	A		141665
F	02-06	CHEVROLET AVALANCHE 2500 All Exc. Electronic Ride Control	
F	05-06	PICKUP 1/2 TON, SILVERADO 1500 HD All	
F	01-03	PICKUP 1/2 TON, SILVERADO 1500 HD All	
F	01-09	PICKUP 1 TON, SILVERADO 3500 All	
F	07-10	PICKUP 1 TON, SILVERADO 3500 HD All	
F	05-08	PICKUP 3/4 TON, SILVERADO 2500 All	
F	99-04	PICKUP 3/4 TON, SILVERADO 2500 4WD	
F	01-10	PICKUP 3/4 TON, SILVERADO 2500 HD All 9200# GVW	
F	07	SILVERADO 1500 HD CLASSIC All	
F	00-11	SUBURBAN 3/4 TON, 2500 All Exc. Z55 Auto Ride Suspension and Quadrateer	
F	05-06	GMC SIERRA 1500 HD All	
F	01-03	SIERRA 1500 HD All	
F	07	SIERRA 1500 HD CLASSIC All	
F	99-04	SIERRA 2500 4WD	
F	01-10	SIERRA 2500 HD All	
F	01-06	SIERRA 3500 All	
F	07-10	SIERRA 3500 HD Torsion Bar (FrontSpringType)	
F	00-06	YUKON XL 3/4 TON All Exc. Hydraulic Self Leveling System	
F	03-09	HUMMER H2 All	
G63818	A		
F	90-05	CHEVROLET ASTRO AWD	
F	88-99	PICKUP 1/2 TON, K15 / K1500 All	
F	88-99	GMC PICKUP 1/2 TON, K15 / K1500 All	
F	90-05	SAFARI AWD	
G63828	A		142976
R	98-06	LEXUS LX470 Torsion Bar (FrontSpringType)	
R	98-07	TOYOTA LAND CRUISER All	
G63829	B		
R	99-04	JEEP GRAND CHEROKEE All	

Numerical listing

Shock	POP	Alternative No.	MTG Acc. Supplied
Pos.	Year	Application	
G63832	A		142976
F	98-06	LEXUS LX470 Torsion Bar (FrontSpringType)	
F	98-07	TOYOTA LAND CRUISER All	
G63837	W		
R	00-05	FORD EXCURSION 4WD	
G63842	A		
R	04-07	BUICK RAINIER Coil (FrontSpringType)	
R	03-06	CHEVROLET SSR All	
R	02-09	TRAILBLAZER Coil (RearSpringType)	
R	02-09	GMC ENVOY Coil (RearSpringType)	
R	03-08	ISUZU ASCENDER Coil (RearSpringType)	
R	02-04	OLDSMOBILE BRAVADA Coil (RearSpringType)	
R	05-09	SAAB 9-7X All	
G63844	A		
R	07-08	DODGE NITRO All	
R	02-12	JEEP LIBERTY All	
G63845	A		
R	99-03	INFINITI QX4 All Mfg. from 12/98	
R	02-04	NISSAN PATHFINDER All	
R	99-01	NISSAN PATHFINDER All Mfg. from 12/98	
G63847	B		141353,142592
F	99-04	JEEP GRAND CHEROKEE All Exc. Up Country Suspension	
G63848	B		142731
F	02-05	DODGE PICKUP 1/2 TON, RAM 1500 (SEE RAM 1500) 4WD	
G63860	B		140455
R	96-05	TOYOTA RAV4 All	
G63862	B		141041
R	01-07	FORD ESCAPE All	
R	01-06	MAZDA TRIBUTE All	
R	05-07	MERCURY MARINER All	
G63864	C		
R	00-06	MAZDA MPV All	
G63866	A		
R	02-13	CADILLAC ESCALADE All	
R	07-11	CHEVROLET AVALANCHE 1500 All Exc. Z55 or ZW7 Ride Suspension	
R	02-06	AVALANCHE 1500 All Exc. Electronic Ride Control	
R	02-06	AVALANCHE 2500 All Exc. Electronic Ride Control	
R	07-11	SUBURBAN 1/2 TON, 1500 All Exc. Z55 or ZW7 Ride Suspension	
R	00-06	SUBURBAN 1/2 TON, 1500 All Exc. Z55 Auto Ride Suspension	
R	00-11	SUBURBAN 3/4 TON, 2500 All Exc. Z55 Auto Ride Suspension and Quadrasteer	
R	07-11	TAHOE All Exc. Z55 or ZW7 Ride Suspension	
R	02-06	TAHOE All Exc. Z55 Auto Ride Suspension	
R	00-01	TAHOE All New Body Style; Exc. Z55 Auto Ride Suspension	
R	07-11	GMC YUKON All Exc. Z55 or ZW7 Ride Suspension	
R	00-06	YUKON All Exc. Z55 Auto Ride Suspension	
R	07-11	YUKON XL 1/2 TON All Exc. Z55 or ZW7 Ride Suspension	
R	00-06	YUKON XL 1/2 TON All Exc. Z55 Auto Ride Suspension	
R	00-11	YUKON XL 3/4 TON All Exc. Z55 Auto Ride Suspension and Quadrasteer	
G63867	B		
R	09-10	FORD PICKUP 1/2 TON, F-150 RWD	
R	04-08	PICKUP 1/2 TON, F-150 4WD	
R	06-08	LINCOLN MARK LT 4WD	
G63868	X		
R	02-07	BUICK RENDEZVOUS All Exc. Hydraulic Self Leveling System	
R	01-05	PONTIAC AZTEK AWD	
G63869	W		
R	01-05	PONTIAC AZTEK FWD	

Ultra Truck Shock

Shock	POP	Alternative No.	MTG Acc. Supplied
Pos.	Year	Application	
G63870	B		
R	05-08	FORD PICKUP 1/2 TON, F-150 RWD	
R	04	PICKUP 1/2 TON, F-150 Lariat, RWD	
R	04	PICKUP 1/2 TON, F-150 STX, RWD	
R	04	PICKUP 1/2 TON, F-150 XL, RWD	
R	04	PICKUP 1/2 TON, F-150 XLT, RWD	
R	06-08	LINCOLN MARK LT RWD	
G63872	C		
R	02-10	SATURN VUE All	
G63873	D		
R	04-07	FORD FREESTAR All	
R	04-07	MERCURY MONTEREY Mini Passenger Van	
G63875	C		
R	04-08	CHEVROLET TORNADO All	
R	05-07	INFINITI QX56 All	
R	05-15	NISSAN ARMADA All Exc. Auto-Leveling System	
G63877	S		
R	99-04	HONDA ODYSSEY All	
G63878	C		
R	04-15	NISSAN TITAN 4WD	
R	17	TITAN XD Platinum Reserve, 4WD	
R	17	TITAN XD S, 4WD	
R	17	TITAN XD SL, 4WD	
R	17	TITAN XD SV, 4WD	
R	16	TITAN XD 4WD	
G63879	C		
R	04-11	CHEVROLET COLORADO Torsion Bar (FrontSpringType)	
R	04-11	GMC CANYON Torsion Bar (FrontSpringType)	
R	06	ISUZU I-350 Torsion Bar (FrontSpringType)	
G63880	W		
R	01-03	KIA RIO All	
G63881	W		140126
F	87-96	DODGE DAKOTA 4WD	
G63882	D		
R	04-12	CHEVROLET COLORADO RWD, Coil (FrontSpringType) D Standard Suspension; Exc. Z71 Off Road Package	
R	04-12	GMC CANYON RWD, Coil (FrontSpringType) D Standard Suspension; Exc. Z71 Off Road Package	
R	06	ISUZU I-280 Coil (FrontSpringType)	
R	07-08	I-290 Coil (FrontSpringType)	
R	08	I-370 Coil (FrontSpringType)	
G63883	C		
R	04-15	NISSAN TITAN RWD	
G63884	C		143312
F	04-08	CHEVROLET COLORADO Torsion Bar (FrontSpringType)	
F	04-08	GMC CANYON Torsion Bar (FrontSpringType)	
F	06	ISUZU I-350 Torsion Bar (FrontSpringType)	
G63885	C		142280
R	10-16	TOYOTA 4RUNNER All	
R	03-09	4RUNNER Limited	
R	03-09	4RUNNER SR5	
G63886	B		142731
F	05-12	FORD PICKUP 1 TON, F-350 / SUPERDUTY 4WD	
F	12-15	PICKUP 3/4 TON, F-250 / SUPERDUTY RWD w/Off Road Package	
F	05-15	PICKUP 3/4 TON, F-250 / SUPERDUTY 4WD	
G63887	W		
R	05-07	FORD PICKUP 1 TON, F-350 / SUPERDUTY Crew Cab Pickup, 4WD Dual Rear Wheels	
R	05-07	PICKUP 1 TON, F-350 / SUPERDUTY Extended Cab Pickup, 4WD Dual Rear Wheels	
R	05-07	PICKUP 1 TON, F-350 / SUPERDUTY Standard Cab Pickup, 4WD Dual Rear Wheels	

Numerical listing

Shock	POP	Alternative No.	MTG Acc. Supplied
Pos.	Year	Application	
G63888	B		
R	05-12	FORD PICKUP 1 TON, F-350 / SUPERDUTY Crew Cab Pickup, 4WD Single Rear Wheels	
R	05-12	PICKUP 1 TON, F-350 / SUPERDUTY Extended Cab Pickup, 4WD Single Rear Wheels	
R	05-12	PICKUP 1 TON, F-350 / SUPERDUTY Standard Cab Pickup, 4WD Single Rear Wheels	
R	12-15	PICKUP 3/4 TON, F-250 / SUPERDUTY 4WD w/Off Road Package	
R	12-15	PICKUP 3/4 TON, F-250 / SUPERDUTY RWD w/Off Road Package	
R	05-11	PICKUP 3/4 TON, F-250 / SUPERDUTY 4WD	
G63889	C		141041
R	05-15	TOYOTA TACOMA Base, RWD	
R	05-15	TACOMA Pre Runner, RWD	
G63890	D		
R	05-10	DODGE DAKOTA RWD	
R	06-09	NISSAN RAIDER RWD	
G63891	D		
R	05-10	DODGE DAKOTA 4WD	
R	06-09	NISSAN RAIDER 4WD	
G63892	B		
R	07-09	CHRYSLER ASPEN All	
R	04-09	DODGE DURANGO All	
G63893	W		143276
F	10-14	CHEVROLET VAN 1/2 TON, G / EXPRESS AWD, Torsion Bar (FrontSpringType)	
F	03-09	VAN 1/2 TON, G / EXPRESS Torsion Bar (FrontSpringType)	
F	03-12	VAN 1 TON, G / EXPRESS All Torsion Bar (FrontSpringType)	
F	06-12	VAN 3/4 TON, G / EXPRESS All Torsion Bar (FrontSpringType)	
F	03-05	VAN 3/4 TON, G / EXPRESS Torsion Bar (FrontSpringType)	
F	10-14	GMC VAN 1/2 TON, G / SAVANNA AWD, Torsion Bar (FrontSpringType)	
F	03-09	VAN 1/2 TON, G / SAVANNA Torsion Bar (FrontSpringType)	
F	03-12	VAN 1 TON, G / SAVANNA All Torsion Bar (FrontSpringType)	
F	04-12	VAN 3/4 TON, G / SAVANNA All Torsion Bar (FrontSpringType)	
F	03	VAN 3/4 TON, G / SAVANNA Torsion Bar (FrontSpringType)	
G63894	B		143276
F	03-14	CHEVROLET VAN 1/2 TON, G / EXPRESS RWD, Coil (FrontSpringType)	
F	03-14	GMC VAN 1/2 TON, G / SAVANNA RWD, Coil (FrontSpringType)	
G63895	A		143276
F	03-16	CHEVROLET VAN 1 TON, G / EXPRESS Coil (FrontSpringType)	
F	03-16	VAN 3/4 TON, G / EXPRESS Coil (FrontSpringType)	
F	03-16	GMC VAN 1 TON, G / SAVANNA Coil (FrontSpringType)	
F	03-16	VAN 3/4 TON, G / SAVANNA Coil (FrontSpringType)	
G63896	B		
R	92-99	CHEVROLET SUBURBAN 1/2 TON, C15 / C1500 All	
R	92-99	SUBURBAN 3/4 TON, C25 / C2500 All	
R	95-00	TAHOE RWD Old Body Style	
R	96-14	VAN 1/2 TON, G / EXPRESS All	
R	93-99	GMC SUBURBAN 1/2 TON, C15 / C1500 All	
R	92	SUBURBAN 1/2 TON, C15 / C1500 All Old Body Style	
R	92-99	SUBURBAN 3/4 TON, C25 / C2500 All	
R	96-14	VAN 1/2 TON, G / SAVANNA All	
R	00	YUKON Denali	
R	92-99	YUKON All	
G63897	C		
R	10-15	CHEVROLET EXPRESS 4500 All	
R	13-16	VAN 1 TON, G / EXPRESS All	

Numerical listing

Shock	POP	Alternative No.	MTG Acc. Supplied
Pos.	Year	Application	
G63897 C -continued			
R	03-12	VAN 1 TON, G / EXPRESS All Single Rear Wheels	
R	03-16	VAN 3/4 TON, G / EXPRESS All	
R	10-15	GMC SAVANA 4500 All	
R	13-16	VAN 1 TON, G / SAVANNA All	
R	03-12	VAN 1 TON, G / SAVANNA All Single Rear Wheels	
R	03-16	VAN 3/4 TON, G / SAVANNA All	
G63898 W			
R	03-06	CHEVROLET VAN 1 TON, G / EXPRESS All Dual Rear Wheels	
R	03-06	GMC VAN 1 TON, G / SAVANNA All Dual Rear Wheels	
G63900 W 140673			
F	87-89	TOYOTA VAN RWD	
F	84-86	VAN All	
F	88	VAN WAGON RWD	
G63902 D 140857			
F	81-82	CHEVROLET LUV PICKUP RWD	
F	81-95	ISUZU PICKUP RWD	
F	69-72	NISSAN 521 PICKUP All	
F	72-79	620 PICKUP All	
F	80-86	720 PICKUP All	
F	87-97	PICKUP 4WD	
F	86	PICKUP 4WD Mfg. from 8/86	
G63903 C 141376			
F	85-95	TOYOTA PICKUP RWD Exc. 1 Ton	
F	84	PICKUP RWD	
F	93-98	T100 RWD	
G63904 C 141356			
F	87-90	MITSUBISHI VAN All	
F	87-95	NISSAN PATHFINDER All Exc. Electronic Adjustable Suspension	
G63905 B 140126			
F	97-04	DODGE DAKOTA 4WD	
F	98-03	DURANGO 4WD	
G63906 W			
F	87-91	CHEVROLET BLAZER 4WD Full Size; Quad Suspension Long Shock; Exc. Lift Kit	
F	81-86	BLAZER 4WD Quad Suspension Long Shock; Exc. Lift Kit	
F	81-86	PICKUP 1/2 TON, K10 All Quad Suspension Long Shock; Exc. Lift Kit	
F	87	PICKUP 1/2 TON, V10 All Quad Suspension Long Shock; Exc. Lift Kit	
F	81-86	PICKUP 3/4 TON, K20 All Quad Suspension Long Shock; Exc. Lift Kit	
F	87	PICKUP 3/4 TON, V20 All Quad Suspension Long Shock; Exc. Lift Kit	
F	81-86	SUBURBAN 1/2 TON, K10 All Quad Suspension Long Shock; Exc. Lift Kit	
F	89-91	SUBURBAN 1/2 TON, V1500 All Quad Suspension Long Shock; Exc. Lift Kit	
F	81-86	SUBURBAN 3/4 TON, K20 All Quad Suspension Long Shock; Exc. Lift Kit	
F	87-88	SUBURBAN 3/4 TON, V20 All Quad Suspension Long Shock; Exc. Lift Kit	
F	89-91	SUBURBAN 3/4 TON, V2500 All Quad Suspension Long Shock; Exc. Lift Kit	
F	73-91	GMC JIMMY 4WD Quad Suspension Long Shock; Exc. Lift Kit	
F	81-86	PICKUP 1/2 TON, K15 / K1500 All Quad Suspension Long Shock; Exc. Lift Kit	
F	87	PICKUP 1/2 TON, V1500 All Quad Suspension Long Shock; Exc. Lift Kit	
F	81-86	PICKUP 3/4 TON, K25 / K2500 All Quad Suspension Long Shock; Exc. Lift Kit	
F	87	PICKUP 3/4 TON, V2500 All Quad Suspension Long Shock; Exc. Lift Kit	
F	81-86	SUBURBAN 1/2 TON, K15 / K1500 All Quad Suspension Long Shock; Exc. Lift Kit	
F	87-91	SUBURBAN 1/2 TON, V1500 All Quad Suspension Long Shock; Exc. Lift Kit	
F	81-86	SUBURBAN 3/4 TON, K25 / K2500 All Quad Suspension Long Shock; Exc. Lift Kit	
F	87-91	SUBURBAN 3/4 TON, V2500 All Quad Suspension Long Shock; Exc. Lift Kit	

Ultra Truck Shock

Shock	POP	Alternative No.	MTG Acc. Supplied
Pos.	Year	Application	
G63907 B			
R	75-80	CHEVROLET LUV PICKUP All	
R	72-74	LUV PICKUP All	
R	79-82	DODGE D50 RWD	
R	87-93	PICKUP, RAM 50 RWD	
R	83-86	PICKUP, RAM 50 All	
R	86-87	MAZDA B2000 RWD	
R	87-93	B2200 RWD	
R	87-93	B2600 RWD	
R	95-96	MITSUBISHI MIGHTY MAX All	
R	83-94	MIGHTY MAX RWD	
R	87-90	VAN All	
R	98-04	NISSAN FRONTIER RWD Exc. Desert Runner	
R	87-97	PICKUP RWD	
R	86	PICKUP RWD Mfg. from 8/86	
R	79-82	PLYMOUTH PICKUP All	
R	85-95	TOYOTA PICKUP RWD Exc. 1 Ton	
R	75-84	PICKUP RWD Mojave	
R	70-74	PICKUP All RWD; Mojave	
R	84-88	VAN Leaf (RearSpringType)	
R	88	VAN WAGON Leaf (RearSpringType)	
G63908 W			
F	87-91	CHEVROLET BLAZER 4WD Full Size; Quad Suspension Short Shock; Exc. Lift Kit	
F	81-86	BLAZER 4WD Quad Suspension Short Shock; Exc. Lift Kit	
F	81-86	PICKUP 1/2 TON, K10 All Quad Suspension Short Shock; Exc. Lift Kit	
F	87	PICKUP 1/2 TON, V10 All Quad Suspension Short Shock; Exc. Lift Kit	
F	81-86	PICKUP 3/4 TON, K20 All Quad Suspension Short Shock; Exc. Lift Kit	
F	87	PICKUP 3/4 TON, V20 All Quad Suspension Short Shock; Exc. Lift Kit	
F	81-86	SUBURBAN 1/2 TON, K10 All Quad Suspension Short Shock; Exc. Lift Kit	
F	89-91	SUBURBAN 1/2 TON, V1500 All Quad Suspension Short Shock; Exc. Lift Kit	
F	81-86	SUBURBAN 3/4 TON, K20 All Quad Suspension Short Shock; Exc. Lift Kit	
F	87-88	SUBURBAN 3/4 TON, V20 All Quad Suspension Short Shock; Exc. Lift Kit	
F	89-91	SUBURBAN 3/4 TON, V2500 All Quad Suspension Short Shock; Exc. Lift Kit	
F	73-91	GMC JIMMY 4WD Quad Suspension Short Shock; Exc. Lift Kit	
F	81-86	PICKUP 1/2 TON, K15 / K1500 All Quad Suspension Short Shock; Exc. Lift Kit	
F	87	PICKUP 1/2 TON, V1500 All Quad Suspension Short Shock; Exc. Lift Kit	
F	81-86	SUBURBAN 1/2 TON, K15 / K1500 All Quad Suspension Short Shock; Exc. Lift Kit	
F	87-91	SUBURBAN 1/2 TON, V1500 All Quad Suspension Short Shock; Exc. Lift Kit	
F	81-86	SUBURBAN 3/4 TON, K25 / K2500 All Quad Suspension Short Shock; Exc. Lift Kit	
F	87-91	SUBURBAN 3/4 TON, V2500 All Quad Suspension Short Shock; Exc. Lift Kit	
F	81-86	SUBURBAN 3/4 TON, K25 / K2500 All Quad Suspension Short Shock; Exc. Lift Kit	
F	87-91	SUBURBAN 3/4 TON, V2500 All Quad Suspension Short Shock; Exc. Lift Kit	
G63909 B 141368			
F	81-82	CHEVROLET LUV PICKUP 4WD	
F	75-80	LUV PICKUP All	
F	72-74	LUV PICKUP All	
F	89-94	ISUZU AMIGO All	
F	81-95	PICKUP 4WD	
F	84-86	TROOPER 4WD	
F	98-04	NISSAN FRONTIER RWD Exc. Desert Runner	

Numerical listing

Shock	POP	Alternative No.	MTG Acc. Supplied
Pos.	Year	Application	
G63909 B -continued 141368			
F	87-97	PICKUP RWD	
F	86	PICKUP RWD Mfg. from 8/86	
G63914 W 141277			
R	90-96	CHEVROLET LUMINA APV All	
R	90-96	OLDSMOBILE SILHOUETTE All	
R	90-96	PONTIAC TRANS SPORT All	
G63915 C 140126			
F	87-04	DODGE DAKOTA RWD	
F	99-03	DURANGO RWD	
G63918 D			
R	03-06	DODGE SPRINTER 2500 All Exc. Dual Rear Wheels	
R	03-06	SPRINTER 3500 All Exc. Dual Rear Wheels	
R	04-06	MERCEDES-BENZ SPRINTER All Exc. Dual Rear Wheels	
G63919 W			
R	03-06	DODGE SPRINTER 3500 All Dual Rear Wheels	
R	04-06	MERCEDES-BENZ SPRINTER All Dual Rear Wheels	
G63928 D			
R	89-94	ISUZU AMIGO All	
R	81-95	PICKUP 4WD	
R	84-86	TROOPER 4WD	
G63929 C 140780			
F	92-07	FORD VAN 1/2 TON, ECONOLINE / CLUB WAGON All	
G63937 C 140673			
F	01-04	TOYOTA TACOMA S-Runner	
F	04	TACOMA Base, RWD	
F	95-03	TACOMA DLX, RWD	
G63949 W			
R	86-95	SUZUKI SAMURAI All	
G63950 W 140455			
F	79-82	DODGE D50 RWD	
F	83-93	PICKUP, RAM 50 RWD	
F	83-96	MITSUBISHI MIGHTY MAX RWD	
F	79-82	PLYMOUTH PICKUP All	
G63958 A 143276			
F	06-08	DODGE PICKUP 1/2 TON, RAM 1500 (SEE RAM 1500) Crew Cab Pickup, RWD	
F	06-08	PICKUP 1/2 TON, RAM 1500 (SEE RAM 1500) Standard Cab Pickup, RWD	
F	02-05	PICKUP 1/2 TON, RAM 1500 (SEE RAM 1500) RWD	
G63959 A			
R	16-17	CHEVROLET PICKUP 1/2 TON, SILVERADO 1500 All Exc. Electronic Adjustable Suspension	
R	15	PICKUP 1/2 TON, SILVERADO 1500 All Exc. Electronic Adjustable Suspension	
R	08-14	PICKUP 1/2 TON, SILVERADO 1500 All Exc. Electronic Adjustable Suspension	
R	07	PICKUP 1/2 TON, SILVERADO 1500 Base Exc. Electronic Adjustable Suspension	
R	07	PICKUP 1/2 TON, SILVERADO 1500 LT Exc. Electronic Adjustable Suspension	
R	07	PICKUP 1/2 TON, SILVERADO 1500 LTZ Exc. Electronic Adjustable Suspension	
R	07	PICKUP 1/2 TON, SILVERADO 1500 WT Exc. Electronic Adjustable Suspension	
R	08-17	GMC SIERRA 1500 All Exc. Electronic Adjustable Suspension	
R	07	SIERRA 1500 SLE Exc. Electronic Adjustable Suspension	
R	07	SIERRA 1500 SLT Exc. Electronic Adjustable Suspension	
R	07	SIERRA 1500 WT Exc. Electronic Adjustable Suspension	
G63961 D			
R	06-08	DODGE PICKUP 1/2 TON, RAM 1500 (SEE RAM 1500) 4WD Exc. Mega Cab	

Numerical listing

Shock	POP	Alternative No.	MTG Acc. Supplied
Pos.	Year	Application	
G63962	C		
R	06-08	DODGE PICKUP 1/2 TON, RAM 1500 (SEE RAM 1500) RWD Exc. Mega Cab	
G63963	W		
R	05-06	FORD PICKUP, F-450 SUPERDUTY All	
R	05-06	PICKUP, F-550 SUPERDUTY All	
G63964	W		
R	05-06	FORD PICKUP 1 TON, F-350 / SUPERDUTY Cab & Chassis, 4WD	
G63965	D		
R	09-10	HUMMER H3 All	
R	06-10	H3 All	
G63966	C		
R	07-15	JEEP WRANGLER All Exc. 17" Wheels	
G63967	C		
R	13-15	JEEP WRANGLER All 17" Wheels; w/Heavy Duty Suspension	
R	07-12	WRANGLER All 17" Wheels	
G63969	W	143146	
F	05-08	FORD PICKUP, F-450 SUPERDUTY All	
F	05-07	PICKUP, F-550 SUPERDUTY All	
G63970	W		
R	03-06	DODGE PICKUP 1 TON, RAM 3500 (SEE RAM 3500) Standard Cab Pickup, RWD	
R	03-10	PICKUP 3/4 TON, RAM 2500 (SEE RAM 2500) Standard Cab Pickup, RWD	
R	11-14	RAM 2500 (SEE DODGE RAM 2500) Standard Cab Pickup, RWD	
R	11-14	3500 (SEE DODGE RAM 3500) Standard Cab Pickup, RWD	
G63971	W		
R	03-07	DODGE PICKUP 1 TON, RAM 3500 (SEE RAM 3500) Crew Cab Pickup, RWD	
R	03-06	PICKUP 3/4 TON, RAM 2500 (SEE RAM 2500) Crew Cab Pickup, RWD	
G64000	D		
R	03-09	HUMMER H2 All	
G64001	C	143276	
F	09-10	HUMMER H3 All	
F	06-10	H3 All	
G64002	W		
R	98-02	LINCOLN NAVIGATOR 4WD, Air (RearSpringType)	
G64003	B		
R	01-06	ACURA MDX All	
R	03-08	HONDA PILOT All	
G64004	W	141041	
R	05-12	TOYOTA TACOMA X-Runner Left	
G64005	W	141041	
R	05-12	TOYOTA TACOMA X-Runner Right	
G64006	C	141041	
R	16	TOYOTA TACOMA 4WD	
R	13-15	TACOMA 4WD Exc. Off Road	
R	05-12	TACOMA 4WD	
G64007	C	141041	
R	05-12	TOYOTA TACOMA Pre Runner	
G64008	C	142973	
F	07-12	JEEP WRANGLER All	
G64009	W	142731	
F	10-15	RAM 2500 (SEE DODGE RAM 2500) 4WD	
F	11-15	3500 (SEE DODGE RAM 3500) 4WD	
G64010	C		
R	05-12	FORD PICKUP 1 TON, F-350 / SUPERDUTY RWD	
R	11-15	PICKUP 3/4 TON, F-250 / SUPERDUTY RWD Exc. Off Road Package	
R	05-10	PICKUP 3/4 TON, F-250 / SUPERDUTY RWD	

Ultra Truck Shock

Shock	POP	Alternative No.	MTG Acc. Supplied
Pos.	Year	Application	
G64011	D		142731
F	05-08	DODGE PICKUP 3/4 TON, RAM 2500 (SEE RAM 2500) 4WD	
G64012	B		
R	06-10	JEEP COMMANDER All	
R	05-10	GRAND CHEROKEE All	
G64013	D		
R	03-10	DODGE PICKUP 3/4 TON, RAM 2500 (SEE RAM 2500) 4WD 8800# GVW	
R	13	RAM 2500 (SEE DODGE RAM 2500) 4WD	
R	11-12	2500 (SEE DODGE RAM 2500) 4WD 8800# GVW	
G64014	D		
R	06-09	CHEVROLET TRAILBLAZER Air (RearSpringType)	
R	02-05	TRAILBLAZER All Air(RearSpringType)	
R	03-06	GMC ENVOY Air (RearSpringType)	
G64015	B		
R	05-13	CHEVROLET EQUINOX All	
R	10-13	GMC TERRAIN All	
R	06-09	PONTIAC TORRENT All	
R	07-09	SUZUKI XL-7 All	
G64016	B		
F	07-09	CHRYSLER ASPEN All	
F	04-09	DODGE DURANGO All	
G64026	B		
R	06-12	TOYOTA RAV4 All	
G64027	D		
F	00-04	MINI COOPER All	
G64028	D		
R	00-04	MINI COOPER All	
G64029	D	142731	
R	07-12	TOYOTA FJ CRUISER RWD	
G64030	D	142731	
R	11-12	TOYOTA FJ CRUISER 4WD	
R	07-09	FJ CRUISER 4WD	
G64031	C		
R	14-17	NISSAN FRONTIER All	
R	09-13	FRONTIER All Exc. Nismo Off-Road	
R	05-08	FRONTIER LE	
R	05-08	FRONTIER SE	
R	05-08	FRONTIER XE	
G64032	D		
R	03-06	KIA SORENTO All Exc. Self-Leveling Suspension	
G64033	B		
R	12-13	NISSAN PATHFINDER All Mfg. to 09/12	
R	05-11	PATHFINDER All	
G64036	D	141716	
R	01-04	MINI COOPER All Exc. Sport	
G64037	C		
R	07-10	FORD EDGE All	
R	07-09	LINCOLN MKX All	
G64038	C	143340	
R	13-17	TOYOTA TUNDRA All w/ Off Road Package	
R	07-12	TUNDRA All	
G64040	A		
R	08-16	BUICK ENCLAVE All	
R	09-16	CHEVROLET TRAVERSE All	
R	07-16	GMC ACADIA All	
R	07-10	SATURN OUTLOOK All	
G64042	B		
R	08-16	CHRYSLER TOWN & COUNTRY All Exc. Self-Leveling Suspension	
R	08-16	DODGE CARAVAN / GRAND CARAVAN All Exc. Self-Leveling Suspension	
R	11	VOLKSWAGEN ROUTAN All	
R	09-10	ROUTAN All Exc. Self-Leveling Suspension	
G64043	D		
F	09-10	DODGE PICKUP 1/2 TON, RAM 1500 (SEE RAM 1500) RWD	

Numerical listing

Shock	POP	Alternative No.	MTG Acc. Supplied
Pos.	Year	Application	
G64043	D	-continued	
F	11-13	RAM 1500 (SEE DODGE RAM 1500) RWD	
F	10-15	2500 (SEE DODGE RAM 2500) Standard Cab Pickup, RWD	
F	11-15	3500 (SEE DODGE RAM 3500) Standard Cab Pickup, RWD	
G64044	D		
R	09-10	DODGE PICKUP 1/2 TON, RAM 1500 (SEE RAM 1500) All	
R	10-15	RAM 1500 (SEE DODGE RAM 1500) 4WD	
G64046	D		
R	00-06	BMW X5 All	
G64047	B		
R	08-12	FORD ESCAPE All	
R	08-11	MAZDA TRIBUTE All	
R	08-11	MERCUY MARINER All	
G64048	C		
R	07-09	HYUNDAI SANTA FE All	
R	07-12	VERACRUZ All	
G64049	D		
F	00-03	MERCEDES-BENZ ML55 AMG All	
F	98-03	ML320 All	
F	03-05	ML350 All	
F	99-01	ML430 All	
F	02-05	ML500 All	
G64050	B		
R	08-17	NISSAN ROGUE All	
R	10-12	X-TRAIL All	
R	08	X-TRAIL All	
G64052	D		
R	06-13	SUZUKI GRAND VITARA All	
G64056	D		
R	07-10	MAZDA CX-7 All	
G64063	N		
R	07-10	FORD TRANSIT All	
G64071	A		
R	07-08	HYUNDAI ENTOURAGE All	
R	14	KIA SEDONA All	
R	06-12	SEDONA All	
G64074	N		
R	03-08	LAND ROVER RANGE ROVER All	
G64079	B		
R	09-14	FORD PICKUP 1/2 TON, F-150 4WD	
R	10-12	LINCOLN MARK LT All	
G64080	A		
R	07-13	ACURA MDX All Exc. Active Suspension	
G64087	A	143426	
R	01-07	TOYOTA SEQUOIA All	
G64101	A		
R	12-16	CHEVROLET SUBURBAN 1/2 TON, 1500 All	
R	11-16	TAHOE All Exc. Police Package	
R	12-14	GMC YUKON All	
R	12-14	YUKON XL 1/2 TON All	
G64105	N		
R	02-06	SUZUKI XL-7 All	
G64107	FF		
R	15	CHEVROLET TAHOE All	
R	15	GMC YUKON All	
R	15	YUKON XL All	
G64111	N		
R	11-14	FORD EDGE All	
R	11-14	LINCOLN MKX All	
G64114	N		
R	10-13	FORD TRANSIT CONNECT All	
G64121	FF		
R	11-13	CHEVROLET PICKUP 1 TON, SILVERADO 3500 All	
R	11-14	PICKUP 3/4 TON, SILVERADO 2500 All	
R	11-14	GMC SIERRA 2500 HD All	
R	11-14	SIERRA 3500 HD All	

Numerical listing

Shock	POP	Alternative No.	MTG Acc. Supplied
Pos.	Year	Application	
G64128	FF		
R	11-13	DODGE	H100 DIESEL
R	08-09	H100	All
R	10	H100	TRUCK Truck
R	10	H100	VAN Van, DIESEL
G64129	FF		
F	11-13	DODGE	H100 All
F	08-09	H100	All
F	10	H100	TRUCK Truck
F	10	H100	VAN Van
G64130	FF		
R	12-13	DODGE	H100 GAS
R	11	H100	All Gas
R	08-09	H100	All Gas
R	10	H100	TRUCK Truck Gas
R	10	H100	VAN Van Gas
G64131	FF		
R	12-14	FORD	RANGER All
G64140	FF		
R	14-16	CHEVROLET	EQUINOX All
R	14-16	GMC	TERRAIN All
G64143	FF		
R	13-16	HYUNDAI	SANTA FE Sport, FWD
G64144	FF		
R	13-16	HYUNDAI	SANTA FE AWD
G64146	N		
R	15-16	CHEVROLET	CITY EXPRESS All
R	13-17	NISSAN	NV200 All
G64157	FF		
R	11-15	FORD	PICKUP 1/2 TON, F-150 RWD
G64163	FF		
R	10	LEXUS	RX350 All
Ultra Shock			
69407	W		142369
R	95-98	BUICK	SKYLARK All
R	95-96	CHEVROLET	BERETTA All
R	95-96	CORSICA	All
R	95-98	OLDSMOBILE	ACHIEVA All Exc. Electronic Adjustable Suspension
R	95-98	PONTIAC	GRAND AM All Exc. Electronic Adjustable Suspension
69416	W		
R	00-06	AUDI	TT QUATTRO All
69417	W		
R	94-97	VOLVO	960 All Mfg. from 10/94; Exc. Hydraulic Self Leveling System
R	97-98	S90	All Mfg. from 5/97; Exc. Hydraulic Self Leveling System
R	97-98	V90	All Mfg. from 5/97; Exc. Hydraulic Self Leveling System
69420	W		
R	00-06	AUDI	TT All
69450	C		
R	00-05	TOYOTA	ECHO All
69462	W		
R	92-96	EAGLE	SUMMIT Wagon
R	92-95	MITSUBISHI	EXPO All
R	92-94	PLYMOUTH	COLT Wagon
69464	A		142950
R	08-11	FORD	FOCUS All
R	00-07	FOCUS	Hatchback
R	00-07	FOCUS	Sedan
69465	D		
R	00-07	FORD	FOCUS Wagon
69473	A		
R	01-10	CHRYSLER	PT CRUISER All
69574	D		140505
R	03-11	FORD	CROWN VICTORIA Police Interceptor
R	03-11	LINCOLN	TOWN CAR All Limo Models
69575	B		140505
R	10-11	FORD	CROWN VICTORIA Base Exc. Police and Taxi Models
R	03-11	CROWN VICTORIA	LX Exc. Police and Taxi Models

Ultra Truck Shock, Ultra Shock

Shock	POP	Alternative No.	MTG Acc. Supplied
Pos.	Year	Application	
69575	B	-continued	140505
R	03-08	CROWN VICTORIA	Base Exc. Police and Taxi Models
R	04-06	CROWN VICTORIA	LX Sport Exc. Police and Taxi Models
R	05	CROWN VICTORIA	S Exc. Police and Taxi Models
R	05	CROWN VICTORIA	Special Edition Exc. Police and Taxi Models
R	03	CROWN VICTORIA	LWB Exc. Police and Taxi Models
R	03	CROWN VICTORIA	S Exc. Police and Taxi Models
R	03-11	LINCOLN	TOWN CAR All
R	03-11	MERCURY	GRAND MARQUIS All
R	03-04	MARAUDER	All
69585	D		
R	01-03	KIA	RIO All
69586	D		142155
R	01-08	AUDI	A4 All
R	02-08	A4	QUATTRO All
69587	N		
R	05-10	CHEVROLET	COBALT LS
R	05-10	COBALT	LT
R	10	COBALT	Base
R	10	COBALT	LT Team Canada
R	06-07	COBALT	LTZ
R	05	COBALT	Base
R	11	HHR	All
R	08-10	HHR	LS Panel
R	08-10	HHR	LT Panel
R	06-10	HHR	LS
R	06-10	HHR	LT
R	06-08	HHR	Comfort LT
R	06-08	HHR	Elegance LT
R	07	HHR	Edicion Especial
R	07-09	PONTIAC	G5 All
R	05-06	PURSUIT	All
R	08-09	SATURN	ASTRA All
R	03-07	ION	All
69589	B		
R	08	CHEVROLET	MALIBU Classic LS
R	08	MALIBU	Classic LT
R	06-07	MALIBU	LTZ
R	06-07	MALIBU	SS
R	04-07	MALIBU	LS
R	04-07	MALIBU	LT
R	04-05	MALIBU	Base
69590	N		143269
R	09-12	CHEVROLET	MALIBU All
R	08	MALIBU	Base
R	08	MALIBU	Hybrid
R	08	MALIBU	LS
R	08	MALIBU	LT
R	08	MALIBU	LTZ
R	04-07	MALIBU	Maxx LS
R	04-07	MALIBU	Maxx LT
R	04	MALIBU	Maxx
R	05-10	PONTIAC	G6 All
R	07-09	SATURN	AURA XE
R	07-09	AURA	XR
69591	B		
R	06-12	FORD	FUSION FWD
R	07-12	LINCOLN	MKZ FWD
R	06	ZEPHYR	All
R	03-08	MAZDA	6 All
R	06-11	MERCURY	MILAN FWD
69592	C		140524
R	05-14	FORD	MUSTANG / MUSTANG II Coupe
69593	D		140524
R	05-14	FORD	MUSTANG / MUSTANG II Convertible
69594	C		
R	13-15	NISSAN	XTERRA RWD
R	12	XTERRA	RWD Mfg. to 12/12
R	05-11	XTERRA	RWD
69595	D		
R	13-15	NISSAN	XTERRA 4WD
R	12	XTERRA	4WD Mfg. to 12/12
R	05-11	XTERRA	4WD
69600	B		140455
F	87-91	AVANTI	II All
F	73-75	BUICK	APOLLO All
F	73-81	CENTURY	All
F	68-72	GS / GS350 / GS400 / GS455	All

Numerical listing

Shock	POP	Alternative No.	MTG Acc. Supplied
Pos.	Year	Application	
69600	B	-continued	140455
F	73-87	REGAL	All
F	75-79	SKYLARK	All
F	68-72	SKYLARK	All
F	68-69	SPECIAL	All
F	68-72	SPORTWAGON	All
F	76-79	CADILLAC	SEVILLE All
F	67-69	CHEVROLET	CAMARO All
F	68-73	CHEVELLE	All
F	68	CHEVY	II All
F	73-83	MALIBU	All
F	70-88	MONTE CARLO	All
F	69-79	NOVA	All
F	64-65	NISSAN	410 All
F	64-67	411	All
F	68-87	OLDSMOBILE	CUTLASS / CUTLASS SUPREME All
F	80-83	CUTLASS	CLASSIC / CUTLASS CRUISER All
F	68-72	F85	All
F	74-79	OMEGA	All
F	73	OMEGA	All Exc. HD Suspension
F	68-75	VISTA	CRUISER All
F	82-86	PONTIAC	BONNEVILLE All
F	67-69	FIREBIRD	All
F	78-80	GRAND AM	All
F	73-75	GRAND AM	All
F	75-83	GRAND LEMANS	All
F	69-87	GRAND PRIX	All
F	71-75	GRANDVILLE	All
F	68-73	GTO	All
F	68-81	LEMANS	All
F	77-79	PHOENIX	All
F	68-70	TEMPEST	All
F	71-77	VENTURA	All
F	78	TOYOTA	CORONA All
F	73-77	CORONA	All Mfg. from 8/73
F	69-72	CORONA	Mark II
F	68-75	VOLVO	142 / 144 / 145 / 164 All
69604	C		140629
R	87-88	AVANTI	II All
R	73-81	BUICK	CENTURY All
R	87	ESTATE	WAGON
R	71-83	ESTATE	WAGON All
R	65-67	GRAN	SPORT All
R	68-72	GS / GS350 / GS400 / GS455	All
R	73-87	REGAL	All
R	91-96	ROADMASTER	Wagon
R	68-72	SKYLARK	All
R	64-67	SKYLARK	All HD Suspension; Exc. Sportwagon
R	68-69	SPECIAL	All
R	64-67	SPECIAL	All HD Suspension; Exc. Sportwagon
R	70-72	SPORTWAGON	All
R	71-72	CHEVROLET	BROOKWOOD All
R	71-96	CAPRICE	Wagon
R	68-73	CHEVELLE	All
R	64-67	CHEVELLE	All HD Suspension
R	71-82	IMPALA	Wagon
R	71-72	KINGSWOOD	All
R	73-83	MALIBU	All
R	64-67	MALIBU	All HD Suspension
R	70-88	MONTE CARLO	All
R	71-72	TOWNSMAN	All
R	75-76	NISSAN	610 Wagon
R	73-74	610	All
R	74-77	710	Wagon
R	78-80	810	Wagon
R	71-92	OLDSMOBILE	CUSTOM CRUISER All
R	71-87	CUTLASS / CUTLASS SUPREME	All
R	68-72	CUTLASS / CUTLASS SUPREME	All HD Suspension
R	64-66	CUTLASS / CUTLASS SUPREME	All HD Suspension
R	80-83	CUTLASS	CLASSIC / CUTLASS CRUISER All
R	68-72	F85	All
R	61-67	F85	All HD Suspension
R	71-78	TORONADO	All
R	82-86	PONTIAC	BONNEVILLE All
R	77-81	CATALINA	Wagon
R	71-75	CATALINA	Wagon
R	78-80	GRAND AM	All
R	73-75	GRAND AM	All
R	75-83	GRAND LEMANS	All
R	69-87	GRAND PRIX	All
R	71-78	GRAND SAFARI	All
R	71-75	GRANDVILLE	All
R	68-73	GTO	All
R	64-67	GTO	All HD Suspension
R	68-81	LEMANS	All

Numerical listing

Shock	POP	Alternative No.	MTG Acc. Supplied
Pos.	Year	Application	
69604	C	-continued	140629
R	64-67	LEMANS All HD Suspension	
R	80-86	PARISIENNE Wagon	
R	76-79	PARISIENNE All Wagon	
R	87-89	SAFARI All	
R	68-70	TEMPEST All	
R	64-67	TEMPEST All HD Suspension	
69606	A		141150
R	64-69	BUICK SPORTWAGON All	
R	68-69	CHEVROLET CAMARO All Leaf(RearSpringType)	
R	65-74	FORD COUNTRY SEDAN All	
R	87-91	COUNTRY SQUIRE All	
R	65-74	COUNTRY SQUIRE All	
R	92-02	CROWN VICTORIA All	
R	65-72	CUSTOM All	
R	68-77	CUSTOM 500 All	
R	75-76	ELITE All	
R	66-70	FAIRLANE All Wagon	
R	66-70	FALCON All Wagon	
R	65-67	GALAXIE All	
R	68-74	GALAXIE 500 All	
R	64-66	GALAXIE 500 All	
R	01-02	GRAND MARQUIS All	
R	87-91	LTD / COUNTRY SEDAN / COUNTRY SQUIRE / CROWN VICTORIA All	
R	65-82	LTD / COUNTRY SEDAN / COUNTRY SQUIRE / CROWN VICTORIA All	
R	77-79	LTD II All	
R	66-79	RANCHERO All	
R	65-74	RANCH WAGON All	
R	77-79	THUNDERBIRD All	
R	67-72	THUNDERBIRD All	
R	68-76	TORINO All	
R	70-80	LINCOLN CONTINENTAL All	
R	68-71	MARK III All	
R	72	MARK IV All	
R	80-83	MARK VI All	
R	81-02	TOWN CAR All	
R	67	MERCURY BROUGHAM All	
R	87-91	COLONY PARK All	
R	65-74	COLONY PARK All	
R	66-67	COMET Wagon	
R	65-68	COMMUTER All	
R	74-79	COUGAR All	
R	75-02	GRAND MARQUIS All	
R	69-70	MARAUDER All	
R	65-67	MARAUDER All	
R	67-82	MARQUIS All	
R	65-68	MONTCLAIR All	
R	68-76	MONTEGO All	
R	65-74	MONTEREY All	
R	65-68	PARKLANE All	
R	65-67	VILLAGER All	
R	66-67	VOYAGER All	
R	64-72	OLDSMOBILE VISTA CRUISER All	
R	68-69	PONTIAC FIREBIRD All	
69616	W		
R	77-82	PORSCHE 924 All	
R	83-85	944 All	
69622	C		
R	63-82	CHEVROLET CORVETTE All	
69624	D		140524
R	70-81	CHEVROLET CAMARO All	
R	70-81	PONTIAC FIREBIRD All	
69625	C		140877
F	55-57	CHEVROLET BEL AIR All	
F	63-82	CORVETTE All	
F	55-57	ONE-FIFTY SERIES All	
F	55-57	TWO-TEN SERIES All	
69632	D		
R	84-93	CHRYSLER DAYTONA All	
R	83-84	E CLASS All	
R	85	EXECUTIVE LIMOUSINE All	
R	83-84	EXECUTIVE SEDAN All	
R	90-93	IMPERIAL All Exc. Hydraulic Self Leveling System	
R	84-86	LASER All	
R	81-95	LEBARON All	
R	88-93	NEW YORKER All Exc. Hydraulic Self Leveling System	
R	83-87	NEW YORKER All	
R	92-95	SPIRIT All	
R	86-88	TOWN & COUNTRY All	
R	82-83	DODGE 400 All	
R	83-88	600 All	
R	81-89	ARIES All	
R	92-93	DAYTONA Iroc R/T	

Ultra Shock

Shock	POP	Alternative No.	MTG Acc. Supplied
Pos.	Year	Application	
69632	D	-continued	
R	91-93	DAYTONA Iroc	
R	89-93	DAYTONA ES	
R	89-90	DAYTONA ES Turbo	
R	87-88	DAYTONA Pacifica	
R	86	DAYTONA Turbo Z	
R	84-85	DAYTONA Turbo	
R	85-89	LANCER All	
R	87-94	SHADOW All	
R	89-95	SPIRIT All	
R	89-95	PLYMOUTH ACCLAIM All	
R	88	CARAVELLE FWD	
R	83-87	CARAVELLE All	
R	81-89	RELIANT All	
R	87-94	SUNDANCE All	
69633	D		141282
R	78-83	FORD FAIRMONT All	
R	81-82	GRANADA All	
R	83-86	LTD / COUNTRY SEDAN / COUNTRY SQUIRE / CROWN VICTORIA All	
R	84-93	MUSTANG / MUSTANG II LX	
R	84	MUSTANG / MUSTANG II L	
R	82-83	MUSTANG / MUSTANG II GL	
R	82-83	MUSTANG / MUSTANG II GLX	
R	79-81	MUSTANG / MUSTANG II All	
R	79-86	MERCURY CAPRI All	
R	81-82	COUGAR Base	
R	82	COUGAR GS	
R	82	COUGAR LS	
R	83-86	MARQUIS All	
R	78-83	ZEPHYR All	
69661	W		140793
F	68	MERCEDES-BENZ 200D All	
F	69-73	220 / 220D All W115	
F	68	220 / 220D All	
F	74-76	230 All W115	
F	69	230 All W115	
F	74-76	240D All W115	
F	73-76	280C All W115	
F	76	300D All W115	
F	75	300D All	
F	72	300SD / 300SDL / 300SE / 300SEL / 300TD / 350SD / 350SDL / 350SL / 380SE / 380SEC / 380SEL All	
F	81-84	380SL / 380SLC All	
F	74-80	450SL / 450SLC All	
69670	W		141349
F	79-93	SAAB 900 All	
69671	W		141349
R	79-80	SAAB 99 All	
R	93	900 All Mfg. to 7/93	
R	80-92	900 All	
69674	W		140524
R	79-85	MAZDA RX7 All	
69675	A		141041
F	71-73	BUICK CENTURION All	
F	71-84	ELECTRA All	
F	87	ESTATE WAGON	
F	71-83	ESTATE WAGON All	
F	71-85	LESABRE All	
F	71-78	RIVIERA All	
F	92-96	ROADMASTER All	
F	91	ROADMASTER Wagon	
F	87-92	CADILLAC BROUGHAM All	
F	92-96	COMMERCIAL CHASSIS RWD	
F	77-84	COMMERCIAL CHASSIS All	
F	77-84	DEVILLE All	
F	93-96	FLEETWOOD RWD	
F	77-86	FLEETWOOD RWD	
F	81	CHEVROLET BEL AIR Sedan Exc. Police and Taxi Models	
F	71-75	BEL AIR Sedan Exc. Police and Taxi Models	
F	65-70	BEL AIR All	
F	71-72	BISCAYNE All	
F	69-72	BROOKWOOD All	
F	70-81	CAMARO All	
F	66-96	CAPRICE All	
F	94-96	IMPALA All	
F	65-85	IMPALA All	
F	69-72	KINGSWOOD All	
F	69-72	TOWNSMAN All	
F	65-74	FORD COUNTRY SEDAN All	
F	87-91	COUNTRY SQUIRE All	
F	65-74	COUNTRY SQUIRE All	
F	92-02	CROWN VICTORIA All	
F	65-72	CUSTOM All	
F	68-77	CUSTOM 500 All	
F	75-76	ELITE All	

Numerical listing

Shock	POP	Alternative No.	MTG Acc. Supplied
Pos.	Year	Application	
69675	A	-continued	141041
F	65-67	GALAXIE All	
F	68-74	GALAXIE 500 All	
F	64-66	GALAXIE 500 All	
F	01-02	GRAND MARQUIS All	
F	87-91	LTD / COUNTRY SEDAN / COUNTRY SQUIRE / CROWN VICTORIA All	
F	65-82	LTD / COUNTRY SEDAN / COUNTRY SQUIRE / CROWN VICTORIA All	
F	77-79	LTD II All	
F	65-74	RANCH WAGON All	
F	67-79	THUNDERBIRD All	
F	72-76	TORINO All	
F	70-80	LINCOLN CONTINENTAL All	
F	68-71	MARK III All	
F	72-76	MARK IV All	
F	77-79	MARK V All	
F	80-83	MARK VI All	
F	81-02	TOWN CAR All	
F	67	MERCURY BROUGHAM All	
F	87-91	COLONY PARK All	
F	65-74	COLONY PARK All	
F	65-68	COMMUTER All	
F	74-79	COUGAR All	
F	75-02	GRAND MARQUIS All	
F	69-70	MARAUDER All	
F	65-67	MARAUDER All	
F	67-82	MARQUIS All	
F	65-68	MONTCLAIR All	
F	72-76	MONTEGO All	
F	65-74	MONTEREY All	
F	65-68	PARKLANE All	
F	65-67	VILLAGER All	
F	66-67	VOYAGER All	
F	71-85	OLDSMOBILE 88 SERIES All	
F	71-84	98 All	
F	71-92	CUSTOM CRUISER All	
F	71-81	PONTIAC BONNEVILLE All	
F	71-81	CATALINA All	
F	70-81	FIREBIRD All	
F	71-78	GRAND SAFARI All	
F	76-81	LAURENTIAN All	
F	76-86	PARISIENNE All	
F	87-89	SAFARI All	
69676	B		142261
R	82-02	CHEVROLET CAMARO All	
R	82-02	PONTIAC FIREBIRD All	
69677	W		141350
F	72-86	JAGUAR XJ6 All	
F	81-92	XJ12 All	
F	73-79	XJ12 All	
F	76-96	XJS All	
69689	W		
R	84-91	DODGE COLT Vista, Wagon, FWD	
R	79-83	COLT Hatchback	
R	89-91	EAGLE VISTA Wagon, FWD	
R	86-94	HYUNDAI EXCEL All	
R	84-87	PONY All	
R	91-95	SCOUPE All	
R	83-88	MITSUBISHI CORDIA All	
R	90-94	PRECIS All	
R	87-89	PRECIS All Rebuildable O.E. Front Struts	
R	83-88	TREDIA All	
R	79-82	PLYMOUTH CHAMP All	
R	92-94	COLT Sedan	
R	92	COLT Hatchback	
R	85-91	COLT All	
R	80-84	COLT Hatchback	
69703	W		140873
R	77-83	CHRYSLER CORDOBA All	
R	83-89	FIFTH AVENUE All	
R	81-83	IMPERIAL All	
R	77-80	LEBARON All	
R	79-81	NEWPORT All	
R	79-82	NEW YORKER All	
R	79-81	TOWN & COUNTRY All	
R	76-80	DODGE ASPEN All	
R	77-78	CHARGER All	
R	77-89	DIPLOMAT All	
R	78-79	MAGNUM All	
R	80-83	MIRADA All	
R	77-78	MONACO All	
R	79-81	ST. REGIS All	
R	88-89	PLYMOUTH CARAVELLE RWD	
R	78-81	CARAVELLE RWD	
R	77-78	FURY All	
R	80-89	GRAN FURY All	
R	76-80	VOLARE All	

Numerical listing

Shock	POP	Alternative No.	MTG Acc. Supplied
Pos.	Year	Application	
69704	W		140873
F	80-83	CHRYSLER	CORDOBA All
F	83-89	FIFTH AVENUE	All
F	81-83	IMPERIAL	All
F	74-75	IMPERIAL	All
F	77-81	LEBARON	All
F	74-78	NEWPORT	All
F	74-82	NEW YORKER	All
F	74-78	TOWN & COUNTRY	All
F	76-80	DODGE	ASPEN All
F	77-89	DIPLOMAT	All
F	80-83	MIRADA	All
F	74-76	MONACO	All
F	75-77	ROYAL MONACO	All
F	66-70	NISSAN	1600 All
F	68-70	2000	All
F	88-89	PLYMOUTH	CARAVELLE RWD
F	78-81	CARAVELLE	RWD
F	74	FURY	All
F	80-89	GRAN FURY	All
F	74-77	GRAN FURY	All
F	76-80	VOLARE	All
69706	W		141073
F	79-85	BUICK	RIVIERA All
F	79-85	CADILLAC	ELDORADO All
F	80-85	SEVILLE	All
F	79-85	OLDSMOBILE	TORONADO All
69709	W		140126
R	87-88	FORD	THUNDERBIRD Non-ABS
R	80-86	THUNDERBIRD	All
R	82-87	LINCOLN	CONTINENTAL All
R	84-92	MARK VII	All
R	83-88	MERCURY	COUGAR All
R	80-82	COUGAR XR-7	
69713	W		141045
R	82-85	TOYOTA	CELICA All
R	86	SUPRA	All Mfg. to 3/86
69714	D		141147
F	84-87	CHEVROLET	CORVETTE All
69715	D		
R	84-87	CHEVROLET	CORVETTE All
69723	W		141277
R	82-96	BUICK	CENTURY All
R	80-85	SKYLARK	All
R	82-90	CHEVROLET	CELEBRITY All
R	80-85	CITATION / CITATION II	All
R	82-96	OLDSMOBILE	CIERA / CUTLASS CIERA All Exc. Electronic Adjustable Suspension
R	87-94	CUTLASS CLASSIC / CUTLASS CRUISER	All Exc. Electronic Adjustable Suspension
R	80-84	OMEGA	All
R	89-91	PONTIAC	6000 FWD
R	82-88	6000	All
R	80-84	PHOENIX	All
69724	C		140629
R	89-91	AVANTI	II All
R	73	BUICK	APOLLO All HD Suspension
R	71-73	CENTURION	All
R	71-84	ELECTRA	All
R	70	ESTATE WAGON	All
R	71-85	LESABRE	All
R	71-78	RIVIERA	All
R	92-96	ROADMASTER	Sedan
R	64-67	SKYLARK	All Exc. HD Suspension
R	64-67	SPECIAL	All Exc. HD Suspension
R	87-92	CADILLAC	BROUGHAM All
R	92-96	COMMERCIAL CHASSIS	RWD
R	77-84	COMMERCIAL CHASSIS	All
R	77-84	DEVILLE	All
R	93-96	FLEETWOOD	RWD
R	77-86	FLEETWOOD	RWD
R	81	CHEVROLET	BEL AIR Sedan
R	65-75	BEL AIR	All
R	65-72	BISCAYNE	All
R	69-70	BROOKWOOD	All
R	73-96	CAPRICE	Sedan Police and Taxi Models
R	71-72	CAPRICE	Hardtop Police and Taxi Models
R	66-70	CAPRICE	All
R	64-67	CHEVELLE	All Exc. HD Suspension
R	68	CHEVY II	All Multi-Leaf Rear Spring
R	64-67	EL CAMINO	All Exc. HD Suspension
R	94-96	IMPALA	All
R	83-85	IMPALA	All
R	81-82	IMPALA	Sedan

Ultra Shock

Shock	POP	Alternative No.	MTG Acc. Supplied
Pos.	Year	Application	
69724	C	-continued	140629
R	81	IMPALA	Coupe
R	74-80	IMPALA	Coupe Exc. Wagon
R	74-80	IMPALA	Sedan Exc. Wagon
R	71-73	IMPALA	Sedan
R	73	IMPALA	Hardtop
R	65-70	IMPALA	All
R	69-70	KINGSWOOD	All
R	64-67	MALIBU	All Exc. HD Suspension
R	73	NOVA	All HD Suspension
R	69-72	NOVA	All Multi-Leaf Rear Spring
R	69-70	TOWNSMAN	All
R	65-85	OLDSMOBILE	88 SERIES All
R	65-84	98	All
R	64-67	CUTLASS / CUTLASS SUPREME	All Exc. HD Suspension
R	61-67	F85	All Exc. HD Suspension
R	65-66	STARFIRE	All
R	63-81	PONTIAC	BONNEVILLE All
R	75-81	CATALINA	Coupe
R	71-81	CATALINA	Sedan
R	71-74	CATALINA	Hardtop
R	63-70	CATALINA	All
R	67-70	EXECUTIVE	All
R	63-68	GRAND PRIX	All
R	64-67	GTO	All Exc. HD Suspension
R	76-81	LAURENTIAN	All
R	64-67	LEMANS	All Exc. HD Suspension
R	76-86	PARISIENNE	Sedan
R	63-66	STAR CHIEF	All
R	64-67	TEMPEST	All Exc. HD Suspension
R	73	VENTURA	All HD Suspension
R	71-72	VENTURA	All Leaf(RearSpringType)
69725	W		140814
R	91	BMW	318I All
R	84-85	318I	All
R	91	318IS	All
R	86-88	325	All
R	84-87	325E	All
R	87-92	325i E30 (MfrBodyCode)	Exc. Sport Suspension
R	87-92	325S	All
R	88-91	M3	All
69727	W		
F	84-87	PONTIAC	FIERO All
69733	W		
R	80-87	SUBARU	BRAT All
R	80-84	DL	All
R	85-89	GL	Hatchback
R	80-84	GL	All
69749	D		141277
R	94	ASUNA	GT
R	92	GT	
R	93	GT, SE	All
R	94	SE	
R	92	SE	
R	82-89	BUICK	SKYHAWK All
R	86-94	SKYLARK	All
R	85-87	SOMERSET / SOMERSET REGAL	All
R	82-88	CADILLAC	CIMARRON All
R	92-94	CHEVROLET	BERETTA Base Exc. FE7 Suspension
R	87-91	BERETTA	All
R	82-94	CAVALIER	All
R	87-94	CORSICA	All
R	99-02	DAEWOO	LANOS All
R	92-94	OLDSMOBILE	ACHIEVA All Exc. FE3 and Electronic Ride Control
R	85-87	CALAIS	All
R	88-91	CUTLASS CALAIS	All
R	87-88	FIRENZA	All
R	84-86	FIRENZA	All Rebuildable O.E. Struts
R	82-83	FIRENZA	All
R	85-94	PONTIAC	GRAND AM All
R	82-85	J2000 / SUNBIRD	All
R	86-94	SUNBIRD	All
R	87-91	TEMPEST	All
69755	D		141301
R	87-93	FORD	MUSTANG / MUSTANG II GT, 5.0L 8Cyl V (302)
R	84-86	MUSTANG / MUSTANG II SVO	
R	82-86	MUSTANG / MUSTANG II GT	
69756	W		141665,140719
R	86-95	FORD	TAURUS Wagon
R	86-95	MERCURY	SABLE Wagon

Numerical listing

Shock	POP	Alternative No.	MTG Acc. Supplied
Pos.	Year	Application	
69757	D		140045
R	84-89	NISSAN	300ZX All
69760	W		
R	87-88	PORSCHE	924 All
R	86-91	944	All
69766	D		140800
R	68-73	MERCEDES-BENZ	200D All
R	68-73	220 / 220D	All
R	74-78	230	All
R	68-69	230	All
R	74-83	240D	All
R	68-70	250	All
R	87-89	260E	All Exc. Hydromat Suspension
R	76	280	All
R	73-76	280C	All
R	77-81	280CE / 280E / 280S / 280SE / 280SEL	All
R	75-80	280CE / 280E / 280S / 280SE / 280SEL	All Exc. Hydromat Suspension
R	72	280CE / 280E / 280S / 280SE / 280SEL	All Mfg. from 9/72; Exc. Hydromat Suspension
R	75-84	300D	All W123
R	78-91	300SD / 300SDL / 300SE / 300SEL / 300TD / 350SD / 350SDL / 350SL / 380SE / 380SEC / 380SEL	All Exc. Hydromat Suspension
R	72	300SD / 300SDL / 300SE / 300SEL / 300TD / 350SD / 350SDL / 350SL / 380SE / 380SEC / 380SEL	All
R	81-85	380SL / 380SLC	All
R	86-91	400E / 400SE / 400SEL / 420SEL / 450SE / 450SEL	All Exc. Hydromat Suspension
R	73-80	400E / 400SE / 400SEL / 420SEL / 450SE / 450SEL	All Exc. Hydromat Suspension
R	74-80	450SL / 450SLC	All
R	84-91	500SEC / 500SEL / 500SEC / 560SEC / 560SEL	All Exc. Hydromat Suspension
69773	X		142155
R	86-98	SAAB	9000 All Hydraulic Self Leveling System
69782	W		
R	00-06	MAZDA	MPV All
69787	D		
R	75	VOLVO	142 / 144 / 145 / 164 All
R	75-93	240 / 242 / 244 / 245 / 262 / 264 / 265	All
R	84	DL	All Exc. Hydraulic Self Leveling System
R	84	GLE	All Exc. Hydraulic Self Leveling System
69794	W		141665
F	88	CHEVROLET	CORVETTE All
69795	D		141666
R	89-96	CHEVROLET	CORVETTE All Exc. Electronic Adjustable Suspension
R	88	CORVETTE	All
69805	D		
R	84-92	VOLVO	740 / 745 / 760 / 780 All Mfg. from 5/84; Exc. Hydraulic Self Leveling System
R	91-95	940	All Exc. Hydraulic Self Leveling System
R	92-94	960	All Mfg. to 10/94; Exc. Hydraulic Self Leveling System
69811	D		141665
F	89-96	CHEVROLET	CORVETTE All Exc. Electronic Adjustable Suspension
69813	W		140455
R	01-05	TOYOTA	RAV4 All
R	00	RAV4	All Mfg. from 5/00
69820	W		141743
R	89-91	FORD	THUNDERBIRD All Exc. Electronic Adjustable Suspension
R	89-91	MERCURY	COUGAR All Exc. Electronic Adjustable Suspension

Numerical listing

Shock	POP	Alternative No.	MTG Acc. Supplied
Pos.	Year	Application	
69845	D		141743
R	92-97	FORD THUNDERBIRD All Exc. Electronic Adjustable Suspension	
R	92-97	MERCURY COUGAR All Exc. Electronic Adjustable Suspension	
69858	W		
R	80-91	VOLKSWAGEN VANAGON RWD	
69861	W		141191
F	80-91	VOLKSWAGEN VANAGON RWD	
69863	B		142155
R	92-99	BMW 318i All	
R	92-98	318IS All	
R	00	323CI All	
R	00	323i Wagon	
R	98-99	323i All	
R	98-99	323IS All	
R	01-06	325CI All	
R	01-05	325i All	
R	92-95	325i E36 (MfrBodyCode)	
R	00	328CI All	
R	96-00	328i All	
R	96-99	328IS All	
R	01-06	330CI All	
R	01-05	330i All	
69877	D		142155
F	94-96	MERCEDES-BENZ C220 All	
F	97-00	C230 All	
F	94-00	C280 All	
69878	D		144151
R	94-96	MERCEDES-BENZ C220 All	
R	97-00	C230 All	
R	94-00	C280 All	
69884	X		140981
R	75-83	HONDA CIVIC Wagon	
69891	W		140780
R	94-98	SAAB 900 All	
R	93	900 All Mfg. from 6/30/93	
69898	B		140126
R	03-04	FORD MUSTANG / MUSTANG II Mach I	
R	94-04	MUSTANG / MUSTANG II Base	
R	94-04	MUSTANG / MUSTANG II GT	
R	04	MUSTANG / MUSTANG II GT Base	
R	04	MUSTANG / MUSTANG II GT Equipado	
R	01	MUSTANG / MUSTANG II GT Bullitt	
R	95	MUSTANG / MUSTANG II GTS	
69900	A		140455
R	01-07	FORD ESCAPE All	
R	01-06	MAZDA TRIBUTE All	
R	05-07	MERCURY MARINER All	
69901	D		
R	93-97	VOLVO 850 All Exc. Hydraulic Self Leveling System	
R	98-04	C70 All	
R	98-00	S70 All	
R	98-00	V70 All Mfg. to 3/00 and Exc. XC70, XC Cross Country	
69903	W		
R	95-99	BMW 318TI All	
69907	B		141716
R	01-06	HYUNDAI SANTA FE All	
69909	B		
R	99-04	HONDA ODYSSEY All	
69945	B		142155
R	98-10	VOLKSWAGEN BEETLE All	
R	99-06	GOLF A4 (MfrBodyCode)	
R	01-05	JETTA Sedan	
R	99-00	JETTA All	
69946	D		141191
R	98-04	AUDI A6 All	
R	98-05	VOLKSWAGEN PASSAT FWD From VIN# 3B300001 through VIN# 3B300000	
69952	D		
F	96-99	MERCEDES-BENZ E300 All Exc. Sport Suspension	
F	96-02	E320 Sedan Exc. Sport Suspension	
F	97	E420 All Exc. 4 Matic & Sport Suspension	

Ultra Shock

Shock	POP	Alternative No.	MTG Acc. Supplied
Pos.	Year	Application	
69952	D	-continued	
F	98-02	E430 All Exc. 4 Matic & Sport Suspension	
69962	D		141727,141354
R	96-05	FORD TAURUS Wagon	
R	96-05	MERCURY SABLE Wagon	
69966	D		
R	99	MERCEDES-BENZ E300 All Exc. 4 Matic	
R	96-98	E300 All	
R	96-02	E320 Sedan	
R	97	E420 All	
R	98-02	E430 All	
69995	D		144151
R	84-89	MERCEDES-BENZ 190D All	
R	84-93	190E All	
R	87-89	260E All 4 Matic	
R	90-93	300D All W115 4 Matic	
R	87	300D All W115 4 Matic	
R	84-85	300D All W115 4 Matic	
R	86-93	300E All	
69996	D		140800,142628
F	77-78	MERCEDES-BENZ 230 All Exc. W115	
F	76-83	240D All W123	
F	87-89	260E All Exc. Hydromat Suspension	
F	76	280 All	
F	76	280C All Exc. W115	
F	77-81	280CE / 280E / 280S / 280SE / 280SEL All	
F	75-80	280CE / 280E / 280S / 280SE / 280SEL All Exc. Hydromat Suspension	
F	73	280CE / 280E / 280S / 280SE / 280SEL All Exc. Hydromat Suspension	
F	72	280CE / 280E / 280S / 280SE / 280SEL All Mfg. from 9/72; Exc. Hydromat Suspension	
F	77-84	300D All	
F	76	300D All W123	
F	78-91	300SD / 300SDL / 300SE / 300SEL / 300TD / 350SD / 350SDL / 350SL / 380SE / 380SEC / 380SEL All Exc. Hydromat Suspension	
F	79-85	300SD / 300SDL / 300SE / 300SEL / 300TD / 350SD / 350SDL / 350SL / 380SE / 380SEC / 380SEL All	
F	86-91	400E / 400SE / 400SEL / 420SEL / 450SE / 450SEL All Exc. Hydromat Suspension	
F	73-80	400E / 400SE / 400SEL / 420SEL / 450SE / 450SEL All Exc. Hydromat Suspension	
F	84-91	500SEC / 500SEL / 500SEC / 560SEC / 560SEL All Exc. Hydromat Suspension	
69998	W		
R	01-03	BMW 525i Wagon Exc. Electronic Adjustable Suspension	
R	99-00	528i Wagon	
R	00-03	540i Wagon Exc. Electronic Adjustable Suspension	
70000	B		
R	02-05	KIA SEDONA All	
70001	D		
R	04-05	KIA RIO All	
70003	A		
R	08-09	MAZDA 3 GS	
R	08-09	3 GT	
R	08-09	3 GX	
R	07-09	3 i	
R	07-09	3 S	
R	04-06	3 All	
R	06-10	5 All	
70004	FF		
R	04-08	FIAT PALIO All	
70010	A		
R	05-10	HONDA ODYSSEY All	
70013	B		
R	06-11	HYUNDAI AZERA All	
R	06-10	SONATA All	
70020	W		142154
R	01-02	SAAB 9-3 Turbo	
R	99-02	9-3 SE	

Numerical listing

Shock	POP	Alternative No.	MTG Acc. Supplied
Pos.	Year	Application	
70020	W	-continued	142154
R	99-01	9-3 Base	
70023	D		
F	94-99	MERCEDES-BENZ S320 / S350 / S420 / S500 / S600 All Exc. Electronic Ride Control	
70024	D		
R	94-99	MERCEDES-BENZ S320 / S350 / S420 / S500 / S600 All Exc. Electronic Ride Control	
70027	B		
R	07-12	NISSAN SENTRA Base	
R	07-12	SENTRA S	
R	07-12	SENTRA SE-R	
R	07-12	SENTRA SL	
70028	C		
R	04-06	SCION XA All	
R	04-06	XB All	
70031	B		
R	03-07	CADILLAC CTS All Exc. Magnetic Ride Control Suspension	
70032	W		
R	04-06	PONTIAC GTO All	
70033	D		
R	02-07	MERCEDES-BENZ C230 All	
R	03-05	C240 RWD	
R	01-02	C240 All	
R	06-07	C280 RWD	
R	03-05	C320 RWD	
R	01-02	C320 All	
R	06-07	C350 RWD	
R	03-05	CLK320 All	
R	06-09	CLK350 All	
R	03	CLK430 All	
R	02	CLK430 All Mfg. from 4/02	
R	03-06	CLK500 All	
R	07-09	CLK550 All	
70034	D		
R	04-10	BMW X3 All	
70036	C		
R	06-11	DODGE ATTITUDE All	
R	06-11	HYUNDAI ACCENT All	
R	06-11	KIA RIO All	
R	06-11	RIO All	
70037	B		
R	07-10	HYUNDAI ELANTRA All	
70038	D		
R	12	MERCEDES-BENZ C250 Sedan, CGI (FuelDelSubType)	
R	10-11	C250 All	
R	08-09	C280 All	
R	08-11	C300 All	
R	12	C350 CGI (FuelDelSubType)	
R	08-11	C350 All	
70039	D		
R	03-11	SAAB 9-3 All	
70040	D		
R	04-09	VOLVO S60 FWD	
R	01-03	S60 All	
R	99-06	S80 All	
R	01-07	V70 All Exc. Electronic Suspension / Nivomat	
70041	B		
R	12	NISSAN VERSA All	
R	07-11	VERSA S	
R	07-11	VERSA SL	
70045	C		
R	08-13	BMW 128i All	
R	08-11	135i All	
R	06	325i All	
R	07-13	328i All	
R	06	330i All	
R	07-13	335i All	
70049	A		
R	07-10	KIA MAGENTIS All	
R	07-10	OPTIMA All	
R	07-11	RONDO All	
70052	A		
R	11-14	FORD FIESTA All	
R	11-14	MAZDA 2 All	

Numerical listing

Shock	POP	Alternative No.	MTG Acc. Supplied
Pos.	Year	Application	
70053	A		
R	08-12	SCION XB All	
R	10-15	TOYOTA PRIUS All 17" Wheels	
70055	A		
R	08-10	SCION XD All	
R	15-16	TOYOTA PRIUS C All 15" & 16" Wheels	
R	12-14	PRIUS C All	
R	06-14	YARIS All	
70056	A		
R	07-13	VOLVO C30 All	
R	04-12	S40 All	
R	05-11	V50 All	
70059	A		
R	10	BUICK ALLURE FWD Exc. Electronic Suspension	
R	10-16	LACROSSE FWD Exc. Electronic Suspension	
70060	A		
R	07-08	HONDA FIT All	
70061	A		
R	07-13	VOLKSWAGEN EOS All Exc. Electronic Suspension	
70064	N		
F	98-02	MERCEDES-BENZ CLK320 All	
F	99-02	CLK430 All	
F	98-04	SLK230 All	
F	03-04	SLK320 All	
F	01-02	SLK320 170.465 (MfrBodyCode)	
70065	N		
R	98-02	MERCEDES-BENZ CLK320 All	
R	02	CLK430 All Mfg. to 4/02	
R	99-01	CLK430 All	
R	98-04	SLK230 All	
R	03-04	SLK320 All	
R	01-02	SLK320 170.465 (MfrBodyCode)	
70068	A		
R	12-13	HYUNDAI AZERA All	
R	11-14	SONATA All	
R	14	KIA CADENZA All	
R	11	OPTIMA All	
70077	N		
R	11-16	NISSAN QUEST All	
70078	W		
R	07-09	KIA SORENTO All Exc. HPD (High Performance Dampers)	
70086	N		
R	05-10	CHRYSLER 300 All	
70089	N		
R	09-12	NISSAN ALTIMA All	
R	09-14	MAXIMA All	
70095	N		
R	12-14	DODGE ATTITUDE All	
R	14-16	HYUNDAI ACCENT All	
R	12-15	KIA RIO All	
70096	N		
R	10-16	FORD TAURUS Limited	
R	10-16	TAURUS SE w/ Suspension Code A and B	
R	10-16	TAURUS SEL w/ Suspension Code A and B	
R	09-12	LINCOLN MKS All	
70098	N		
R	14-16	HYUNDAI ELANTRA All	
R	11-13	ELANTRA All Exc. 16 & 17 inch Wheels	
R	13	ELANTRA COUPE All Exc. 16 & 17 inch Wheels	
70105	FF		
R	10-14	VOLKSWAGEN TRANSPORTER All	
70110	FF		
R	09-13	MAZDA 6 All	
G51006	W		142137,141947
R	85-93	VOLKSWAGEN CABRIOLET All	
R	80-84	JETTA All	
R	75-84	RABBIT All	
R	75-89	SCIROCCO All	

Ultra Shock

Shock	POP	Alternative No.	MTG Acc. Supplied
Pos.	Year	Application	
G51007	X		141191,141946
R	77-83	BMW 320i All	
G51022	W		142386
R	93-98	VOLKSWAGEN GOLF 2.0L 4Cyl L (121)	
R	85-92	GOLF All Rebuildable Front Struts	
R	95-98	JETTA 1.9L 4Cyl L (116)	
R	94-98	JETTA 2.0L 4Cyl L (121)	
R	95	JETTA 1.8L 4Cyl L (109)	
R	85-93	JETTA All	
G51030	X		141352,142386
R	87-93	VOLKSWAGEN FOX All	
G51031	X		
R	86-91	MAZDA RX7 All Exc. Electronic Adjustable Suspension	
G51033	W		141265,142386
R	90-97	VOLKSWAGEN PASSAT All Rebuildable O.E. Front Struts	
G51046	W		142052
R	89-90	DODGE 2000 GTX All	
R	91-93	EAGLE 2000 GTX All	
R	90-94	TALON AWD Auto-Leveling System	
R	90-94	MITSUBISHI ECLIPSE AWD	
R	90-92	GALANT AWD	
R	92-94	PLYMOUTH LASER AWD	
G51047	W		142101
R	83-87	DODGE CHARGER All	
R	81-90	OMNI All	
R	87-89	PLYMOUTH EXPO All	
R	81-90	HORIZON All	
R	85	TURISMO All	
R	83	TURISMO All	
G51063	B		142487
R	93-95	DODGE COLT All	
R	93-96	EAGLE SUMMIT Coupe	
R	93-96	SUMMIT Sedan	
R	97-02	MITSUBISHI MIRAGE All	
R	96	MIRAGE All Mfg. to 5/96	
R	93-95	MIRAGE All	
R	93-94	PLYMOUTH COLT Sedan	
G51229	W		142721,141065
R	79-82	NISSAN 280ZX All	
R	77-81	810 Sedan	
R	79-80	810 Hardtop	
R	82-84	MAXIMA Sedan	
G51254	B		142874
R	01-05	CHRYSLER SEBRING ST (MfrBodyCode), Coupe	
R	95-00	SEBRING Coupe	
R	95-00	DODGE AVENGER All	
R	01-05	STRATUS ST (MfrBodyCode), Coupe	
R	95-98	EAGLE TALON FWD	
R	95-99	MITSUBISHI ECLIPSE FWD	
R	99-03	GALANT All	
G51711	W		
F	87-94	JAGUAR XJ6 All Exc. Auto-Leveling System	
F	94	XJ12 All Exc. Auto-Leveling System	
G51721	A		
R	05-10	CHRYSLER 300 RWD Exc. Nivomat Suspension	
R	06-10	DODGE CHARGER All Exc. Police Package w/Nivomat Suspension	
R	05-08	MAGNUM All Exc. Nivomat Suspension	
G51725	A		
R	02-06	NISSAN ALTIMA All	
G51747	B		
R	06-11	CHEVROLET AVEO All	
R	04-11	AVEO All	
R	09-10	PONTIAC G3 All	
R	05-08	WAVE All	
G51764	W		142106
R	03-06	INFINITI G35 All Exc. Sport Suspension	
R	03-06	NISSAN 350Z Coupe Exc. Sport Suspension	
G51783	B		
R	07-11	TOYOTA YARIS All	

Numerical listing

Shock	POP	Alternative No.	MTG Acc. Supplied
Pos.	Year	Application	
G51798	B		
R	03-07	NISSAN MURANO All	
G51799	C		
R	06-09	VOLKSWAGEN BORA All	
R	11-14	EOS All	
R	12-14	GOLF Comfortline TDI	
R	12-14	GOLF Highline TDI	
R	11-14	GOLF Base	
R	11-14	GOLF Comfortline	
R	11-14	GOLF TDI	
R	11-14	GOLF Trendline	
R	14	GOLF Trendline TDI	
R	11-13	GOLF Sportline	
R	13	GOLF GTI	
R	11-12	GOLF Highline	
R	11	GOLF TDI Comfortline	
R	11	GOLF TDI Highline	
R	06-14	GTI All	
R	06-09	JETTA All	
R	06-09	PASSAT All	
R	06-09	RABBIT All	
G51802	B		
R	04-08	NISSAN MAXIMA All	
G51803	B		
R	04-09	NISSAN QUEST All	
G51804	D		
R	15-16	TOYOTA SIENNA FWD	
R	04-10	SIENNA FWD 7 Passenger	
G51805	B		
R	04-16	TOYOTA SIENNA AWD	
R	04-10	SIENNA FWD 8 Passenger	
G51807	A		
R	06-11	HONDA CIVIC All	
G51812	C		
R	03-06	INFINITI G35 Coupe Sport Suspension	
R	03-05	NISSAN 350Z All Sport Suspension	
G51831	D		
R	03-08	INFINITI FX35 All	
R	03-08	FX45 All	
G51841	D		
R	01-04	VOLVO S40 All	
R	00	S40 All Mfg. from 04/00	
R	01-04	V40 All	
R	00	V40 All Mfg. from 04/00	
G51871	D		
R	97-04	CHEVROLET CORVETTE All Exc. Electronic Adjustable Suspension	
G51874	A		
R	07-15	NISSAN ALTIMA All	
G51884	D		
R	17	NISSAN MURANO All	
R	15-16	MURANO Platinum	
R	14-16	MURANO S	
R	14-16	MURANO SL	
R	14-16	MURANO SV	
R	14	MURANO Exclusive	
R	14	MURANO LE	
R	08-13	MURANO All	
G51904	D		
F	97-04	CHEVROLET CORVETTE All Exc. Electronic Adjustable Suspension	
G51905	D		
R	10-12	HONDA CITY All	
R	13-14	FIT DX	
R	13-14	FIT EX	
R	13-14	FIT LX	
R	13-14	FIT Sport	
R	13	FIT Base	
R	09-12	FIT All	
G51912	A		
R	05-12	ACURA RL All Left	
G51927	N		
R	06-10	INFINITI M35 All	
R	06-10	M45 All	
G51930	N		
R	97-01	INFINITI Q45 All	
G51955	A		
R	07-09	NISSAN 350Z All	
R	06	350Z Convertible	

Numerical listing

Shock	POP	Alternative No.	MTG Acc. Supplied
Pos.	Year	Application	
G51966	N		
R	07-12	ACURA RDX	All
G51968	A		
R	05-08	AUDI A6 QUATTRO	All Exc. Air and Sport Suspension
G51971	FF		
R	11-15	CHEVROLET CRUZE	All
R	16	CRUZE LIMITED	All
G51972	FF		
R	12-16	HONDA CR-V	All
G51975	N		
R	10-12	CHEVROLET CAMARO SS	
G51976	N		
R	09-13	NISSAN CUBE	All
G51980	N		
R	11-16	FORD EXPLORER	All
G51982	N		
R	11-12	BUICK REGAL	All Exc. Active Suspension
G51983	N		
R	10-13	MAZDA 3	All
G51990	N		
R	14-16	NISSAN NOTE	All
R	13-16	VERSA	All
G51993	A		
R	09-11	VOLKSWAGEN TIGUAN	All
G51994	N		
R	07-09	KIA AMANTI	All
G51996	N		
R	09-16	FORD FLEX	All
R	10-16	LINCOLN MKT	All
G511000	FF		
R	11-15	JEEP GRAND CHEROKEE	All
G511001	FF		
R	12-16	FORD ESCAPE	All
G511002	FF		
R	12-14	FORD FOCUS	All
G511004	N		
R	12-13	MITSUBISHI OUTLANDER GT	
R	12-13	OUTLANDER SE	
R	12-13	OUTLANDER XLS	
R	10-11	OUTLANDER GT w/ 3rd Row Seating	
R	09-11	OUTLANDER SE w/ 3rd Row Seating	
R	09-11	OUTLANDER XLS w/ 3rd Row Seating	
R	08	OUTLANDER XLS	
R	07	OUTLANDER	All
G511021	N		
R	07-08	INFINITI G35 AWD	Exc. 4 Wheel Steer
R	09-10	G37 AWD	Exc. 4 Wheel Steer
G511030	FF		
R	13-16	BUICK ENCORE	All
R	13-16	CHEVROLET TRAX	All
G511037	FF		
R	11-14	HONDA CR-Z	All
G511040	FF		
R	12-13	MAZDA 5	All
G511041	FF		
R	12-13	MERCEDES-BENZ E200	All
R	11-13	E250	All
R	11-13	E300	All
R	11-13	E350	All
R	13	E400	All
R	11-13	E500	All
R	11-13	E550	All
G511042	FF		
R	11-12	NISSAN LEAF	All
G511043	N		
R	13-16	NISSAN PATHFINDER	All
G511061	FF		
R	12-15	SUZUKI SWIFT	All

Ultra Shock, Max Control

Shock	POP	Alternative No.	MTG Acc. Supplied
Pos.	Year	Application	
G511062	FF		
R	08	AUDI A4 QUATTRO	All
R	06-08	HONDA FIT	All
G511066	FF		
R	08-11	MITSUBISHI MONTERO	All
R	05-06	MONTERO	All
G511074	FF		
R	10	BUICK ALLURE AWD	Exc. Electronic Suspension
R	10-12	LACROSSE AWD	Exc. Electronic Suspension
G511076	FF		
R	09-12	AUDI A4	All Sport Suspension
R	09-12	A4 QUATTRO	All Sport Suspension
Max Control			
75676	C		142261
R	82-02	CHEVROLET CAMARO	All
R	82-02	PONTIAC FIREBIRD	All
75755	X		141301
R	87-93	FORD MUSTANG / MUSTANG II GT, 5.0L 8Cyl V (302)	
R	87-93	MUSTANG / MUSTANG II LX, 5.0L 8Cyl V (302)	
R	84-86	MUSTANG / MUSTANG II SVO	
R	82-86	MUSTANG / MUSTANG II GT	
75795	X		141666
R	89-96	CHEVROLET CORVETTE	All Exc. Electronic Adjustable Suspension
R	88	CORVETTE	All
75811	W		141665
F	89-96	CHEVROLET CORVETTE	All Exc. Electronic Adjustable Suspension
F	84-87	CORVETTE	All
75898	D		140126
R	03-04	FORD MUSTANG / MUSTANG II Mach I	
R	94-04	MUSTANG / MUSTANG II Base	
R	94-04	MUSTANG / MUSTANG II GT	
R	04	MUSTANG / MUSTANG II GT Base	
R	04	MUSTANG / MUSTANG II GT Equipado	
R	01	MUSTANG / MUSTANG II GT Bullitt	
R	95	MUSTANG / MUSTANG II GTS	
77183	W		
F	81-93	DODGE PICKUP 1/2 TON, W100 SERIES	All Exc. Lift Kit
F	61-80	PICKUP 1/2 TON, W100 SERIES	All
F	81-93	PICKUP 1 TON, W300 SERIES	All Exc. Quad Suspension and Lift Kit
F	61-80	PICKUP 1 TON, W300 SERIES	All
R	61-71	PICKUP 1 TON, W300 SERIES	All
F	90-93	PICKUP 3/4 TON, W200 SERIES	Extended Cab Pickup Exc. Lift Kit
F	88-93	PICKUP 3/4 TON, W200 SERIES	Cab & Chassis Exc. Lift Kit
F	81-93	PICKUP 3/4 TON, W200 SERIES	Standard Cab Pickup Exc. Lift Kit
F	86	PICKUP 3/4 TON, W200 SERIES	Cab & Chassis Exc. Lift Kit
F	81-83	PICKUP 3/4 TON, W200 SERIES	Cab & Chassis Exc. Lift Kit
F	81-82	PICKUP 3/4 TON, W200 SERIES	Extended Cab Pickup Exc. Lift Kit
F	69-80	PICKUP 3/4 TON, W200 SERIES	All
F	61-67	PICKUP 3/4 TON, W200 SERIES	All
77349	W		140357
R	87-91	CHEVROLET BLAZER 4WD	Full Size; Exc. Quad Suspension and Lift Kit
R	85-86	BLAZER 4WD	Exc. Lift Kit
R	73-84	BLAZER	All Exc. Lift Kit
R	73-86	PICKUP 1/2 TON, C10	All
R	73-86	PICKUP 1/2 TON, K10	All Exc. Lift Kit
R	87	PICKUP 1/2 TON, R10	All
R	87	PICKUP 1/2 TON, V10	All Exc. Lift Kit
R	75-86	PICKUP 3/4 TON, C20	Standard Cab Pickup
R	73-74	PICKUP 3/4 TON, C20	All Standard Cab Pickup
R	73-86	PICKUP 3/4 TON, K20	All Exc. Lift Kit
R	87	PICKUP 3/4 TON, R20	Standard Cab Pickup

Numerical listing

Shock	POP	Alternative No.	MTG Acc. Supplied
Pos.	Year	Application	
77349	W	-continued	140357
R	87	PICKUP 3/4 TON, V20	All Exc. Quad Suspension and Lift Kit
R	73-86	SUBURBAN 1/2 TON, C10	All
R	73-86	SUBURBAN 1/2 TON, K10	All Exc. Lift Kit
R	87-88	SUBURBAN 1/2 TON, R10	All
R	89-91	SUBURBAN 1/2 TON, R1500	All
R	89-91	SUBURBAN 1/2 TON, V1500	All Exc. Lift Kit
R	73-86	SUBURBAN 3/4 TON, C20	All
R	73-86	SUBURBAN 3/4 TON, K20	All Exc. Lift Kit
R	87-88	SUBURBAN 3/4 TON, R20	All
R	89-91	SUBURBAN 3/4 TON, R2500	All
R	87-88	SUBURBAN 3/4 TON, V20	All Exc. Quad Suspension and Lift Kit
R	89-91	SUBURBAN 3/4 TON, V2500	All Exc. Lift Kit
R	73	VAN 1/2 TON, P SERIES	All
R	73-78	VAN 3/4 TON, P SERIES	All
R	73-91	GMC JIMMY	All Exc. Lift Kit
R	73-86	PICKUP 1/2 TON, C15 / C1500	All
R	73-86	PICKUP 1/2 TON, K15 / K1500	All Exc. Lift Kit
R	87	PICKUP 1/2 TON, R1500	All
R	87	PICKUP 1/2 TON, V1500	All Exc. Lift Kit
R	75-86	PICKUP 3/4 TON, C25 / C2500	Cab & Chassis
R	75-86	PICKUP 3/4 TON, C25 / C2500	Standard Cab Pickup
R	73-74	PICKUP 3/4 TON, C25 / C2500	All Exc. Crew Cab & Bonus Cab
R	73-86	PICKUP 3/4 TON, K25 / K2500	All Exc. Lift Kit
R	88-89	PICKUP 3/4 TON, R2500	All Exc. Crew Cab & Bonus Cab
R	87	PICKUP 3/4 TON, R2500	Cab & Chassis Exc. Crew Cab & Bonus Cab
R	87	PICKUP 3/4 TON, R2500	Standard Cab Pickup Exc. Crew Cab & Bonus Cab
R	87	PICKUP 3/4 TON, V2500	All Exc. Lift Kit
R	73-86	SUBURBAN 1/2 TON, C15 / C1500	All
R	73-86	SUBURBAN 1/2 TON, K15 / K1500	All Exc. Lift Kit
R	87-91	SUBURBAN 1/2 TON, R1500	All
R	87-91	SUBURBAN 1/2 TON, V1500	All Exc. Lift Kit
R	75-86	SUBURBAN 3/4 TON, C25 / C2500	All
R	73-74	SUBURBAN 3/4 TON, C25 / C2500	All Exc. Crew Cab & Bonus Cab
R	73-86	SUBURBAN 3/4 TON, K25 / K2500	All Exc. Lift Kit
R	87-91	SUBURBAN 3/4 TON, R2500	All
R	87-91	SUBURBAN 3/4 TON, V2500	All Exc. Lift Kit
R	73	VAN 1/2 TON, P SERIES	All
R	73-78	VAN 3/4 TON, P SERIES	All
77355	D		140702
F	75-84	CHEVROLET BLAZER RWD	
F	69-74	BLAZER	All RWD
F	63-86	PICKUP 1/2 TON, C10	All
F	87	PICKUP 1/2 TON, R10	All
F	63-86	PICKUP 1 TON, C30	All
F	88-91	PICKUP 1 TON, C35/3500	Cab & Chassis Exc. HD Solid Front Axle
F	87-88	PICKUP 1 TON, R30	All
F	89	PICKUP 1 TON, R3500	Standard Cab Pickup
F	75-86	PICKUP 3/4 TON, C20	Crew Cab Pickup
F	75-86	PICKUP 3/4 TON, C20	Standard Cab Pickup
F	63-74	PICKUP 3/4 TON, C20	All
F	87-88	PICKUP 3/4 TON, R20	Crew Cab Pickup
F	89	PICKUP 3/4 TON, R2500	All
F	63-66	SUBURBAN 1/2 TON, 1500	All
F	67-86	SUBURBAN 1/2 TON, C10	All
F	68-86	SUBURBAN 1/2 TON, K10	All
F	87-88	SUBURBAN 1/2 TON, R10	All
F	89-91	SUBURBAN 1/2 TON, R1500	All
F	68-86	SUBURBAN 3/4 TON, C20	All
F	68-86	SUBURBAN 3/4 TON, K20	All Exc. Lift Kit
F	87-88	SUBURBAN 3/4 TON, R20	All
F	89-91	SUBURBAN 3/4 TON, R2500	All
F	63-80	VAN 1/2 TON, P SERIES	All

Numerical listing

Shock	POP	Alternative No.	MTG Acc. Supplied
Pos.	Year	Application	
77355 D -continued 140702			
F	73-90	VAN 1 TON, P SERIES All Cutaway Chassis	
F	68-72	VAN 1 TON, P SERIES All	
F	68-89	VAN 3/4 TON, P SERIES All	
F	75-84	GMC JIMMY RWD	
F	70-74	JIMMY All RWD	
F	67-86	PICKUP 1/2 TON, C15 / C1500 All	
F	87	PICKUP 1/2 TON, R1500 All	
F	88-91	PICKUP 1 TON, C35/3500 Cab & Chassis	
F	67-78	PICKUP 1 TON, C35/3500 All	
F	87-91	PICKUP 1 TON, R3500 All	
F	85-86	PICKUP 3/4 TON, C25 / C2500 Crew Cab Pickup	
F	75-86	PICKUP 3/4 TON, C25 / C2500 Cab & Chassis	
F	75-86	PICKUP 3/4 TON, C25 / C2500 Standard Cab Pickup	
F	75-83	PICKUP 3/4 TON, C25 / C2500 Crew Cab Pickup	
F	67-74	PICKUP 3/4 TON, C25 / C2500 All	
F	87-89	PICKUP 3/4 TON, R2500 All Exc. Crew Cab & Bonus Cab	
F	63-65	PICKUP 1500 SERIES All	
F	68-86	SUBURBAN 1/2 TON, C15 / C1500 All	
F	87-91	SUBURBAN 1/2 TON, R1500 All	
F	68-86	SUBURBAN 3/4 TON, C25 / C2500 All	
F	87-91	SUBURBAN 3/4 TON, R2500 All	
F	67-80	VAN 1/2 TON, P SERIES All	
F	75-90	VAN 1 TON, P SERIES All Cutaway Chassis	
F	73-74	VAN 1 TON, P SERIES Base Cutaway Chassis	
F	68-72	VAN 1 TON, P SERIES All	
F	68-89	VAN 3/4 TON, P SERIES All	
F	63-65	VAN, PB 1000 SERIES All	
77357 W			
F	71-95	CHEVROLET VAN 1/2 TON, G / EXPRESS All	
F	70	VAN 1/2 TON, G / EXPRESS All Independent Front Suspension	
F	78-96	VAN 1 TON, G / EXPRESS All	
F	75	VAN 1 TON, G / EXPRESS 146.0 (WheelBase)	
F	71-74	VAN 1 TON, G / EXPRESS All	
F	78-95	VAN 3/4 TON, G / EXPRESS All Exc. 8600# GVW	
F	71-77	VAN 3/4 TON, G / EXPRESS All	
F	70	VAN 3/4 TON, G / EXPRESS All Independent Front Suspension	
F	71-95	GMC VAN 1/2 TON, G / SAVANNA All	
F	70	VAN 1/2 TON, G / SAVANNA All Independent Front Suspension	
F	71-95	VAN 1 TON, G / SAVANNA All	
F	78-95	VAN 3/4 TON, G / SAVANNA All Exc. 8600# GVW	
F	71-77	VAN 3/4 TON, G / SAVANNA All	
F	70	VAN 3/4 TON, G / SAVANNA All Independent Front Suspension	
77359 D 140126			
F	84-86	DODGE MINI RAM All	
F	72-93	PICKUP 1/2 TON, D100 SERIES All	
F	90-93	PICKUP 3/4 TON, D200 SERIES All Exc. HD Package	
F	82-89	PICKUP 3/4 TON, D200 SERIES All	
F	72-81	PICKUP 3/4 TON, D200 SERIES All Exc. HD Package	
F	75-93	RAMCHARGER RWD	
F	99-03	VAN 1/2 TON, A / B SERIES / RAM 109.3 (WheelBase) Exc. 7000# GVW	
F	81-98	VAN 1/2 TON, A / B SERIES / RAM 109.6 (WheelBase) Exc. 7000# GVW	
F	71-80	VAN 1/2 TON, A / B SERIES / RAM All	
F	99-03	VAN 1 TON, A / B SERIES / RAM All	
F	71-98	VAN 1 TON, A / B SERIES / RAM All Exc. 4000# Front Axle	
F	71-03	VAN 3/4 TON, A / B SERIES / RAM All	
F	74-80	VAN, CB300 All Exc. 4000# Front Axle	
F	81	PLYMOUTH TRAILDUSTER All	
F	75-80	TRAILDUSTER RWD	
F	74-83	VAN 1/2 TON, PB SERIES All	
F	74-83	VAN 1 TON, PB SERIES All Exc. 4000# Front Axle	
F	74-83	VAN 3/4 TON, PB SERIES All	

Max Control

Shock	POP	Alternative No.	MTG Acc. Supplied
Pos.	Year	Application	
77375 B 140780			
F	85-05	CHEVROLET ASTRO RWD	
F	81	BEL AIR All	
F	71-75	BEL AIR All	
F	71-72	BISCAYNE All	
F	73-96	CAPRICE Sedan Police and Taxi Models	
F	71-72	CAPRICE All Sedan; Police and Taxi Models	
F	83-85	IMPALA All Police and Taxi Models	
F	71-82	IMPALA Sedan Police and Taxi Models	
F	96-02	VAN 1/2 TON, G / EXPRESS All	
F	97-02	VAN 1 TON, G / EXPRESS All	
F	96-02	VAN 3/4 TON, G / EXPRESS All Exc. 8600# GVW	
F	93-02	FORD CROWN VICTORIA Police Interceptor	
F	85-05	GMC SAFARI RWD	
F	96-02	VAN 1/2 TON, G / SAVANNA RWD	
F	96-02	VAN 1 TON, G / SAVANNA All	
F	96-02	VAN 3/4 TON, G / SAVANNA All Exc. 8600# GVW	
77377 W 141137			
R	78-79	FORD BRONCO All Exc. Lift Kit	
R	66-77	BRONCO All From Serial #830001; Exc. Lift Kit	
R	65-69	PICKUP 1/2 TON, F-100 All RWD	
R	75-79	PICKUP 1 TON, F-350 / SUPERDUTY Standard Cab Pickup, RWD	
R	73-74	PICKUP 1 TON, F-350 / SUPERDUTY All RWD; Exc. Supercab	
R	75-79	PICKUP 3/4 TON, F-250 / SUPERDUTY RWD	
R	65-74	PICKUP 3/4 TON, F-250 / SUPERDUTY All RWD	
R	69-74	VAN 1/2 TON, ECONOLINE / CLUB WAGON All	
R	69-74	VAN 1 TON, ECONOLINE / CLUB WAGON / SUPERDUTY All	
R	69-74	VAN 3/4 TON, ECONOLINE / CLUB WAGON / SUPERDUTY All	
R	76-83	JEEP CHEROKEE All	
F	74-83	CHEROKEE All	
F	82-83	CJ5 All Exc. Lift Kit	
F	82-86	CJ7 All Exc. Lift Kit	
F	84-91	GRAND WAGONEER All	
F	84-91	GRAND WAGONEER All	
F	74-88	J10 PICKUP All	
F	74-88	J10 PICKUP All	
F	74-88	J20 PICKUP All	
F	74-88	J20 PICKUP All	
F	82-85	SCRAMBLER / CJ8 All	
R	76-83	WAGONEER All	
F	74-83	WAGONEER All	
77389 W			
R	81-93	DODGE PICKUP 1/2 TON, W100 SERIES All Exc. Lift Kit	
R	72-80	PICKUP 1/2 TON, W100 SERIES All	
R	81-93	PICKUP 1 TON, W300 SERIES All Exc. Quad Suspension and Lift Kit	
R	72-80	PICKUP 1 TON, W300 SERIES All	
R	90-93	PICKUP 3/4 TON, W200 SERIES Extended Cab Pickup Exc. Lift Kit	
R	88-93	PICKUP 3/4 TON, W200 SERIES Cab & Chassis Exc. Lift Kit	
R	81-93	PICKUP 3/4 TON, W200 SERIES Standard Cab Pickup Exc. Lift Kit	
R	86	PICKUP 3/4 TON, W200 SERIES Cab & Chassis Exc. Lift Kit	
R	81-83	PICKUP 3/4 TON, W200 SERIES Cab & Chassis Exc. Lift Kit	
R	81-82	PICKUP 3/4 TON, W200 SERIES Extended Cab Pickup Exc. Lift Kit	
R	72-80	PICKUP 3/4 TON, W200 SERIES All	
R	76-81	PLYMOUTH TRAILDUSTER 4WD	
77403 C			
R	79-95	CHEVROLET VAN 1 TON, G / EXPRESS All 9200# GVW	
F	85	VAN 1 TON, P SERIES All Motorhome Chassis with I-Beam Front Suspension	
R	97-04	DODGE DAKOTA All	
R	98-03	DURANGO All	
R	79-95	GMC VAN 1 TON, G / SAVANNA Cutaway Van 9200# GVW	
F	85	VAN 1 TON, P SERIES All Motorhome Chassis with I-Beam Front Suspension	

Numerical listing

Shock	POP	Alternative No.	MTG Acc. Supplied
Pos.	Year	Application	
77405 W 140884			
F	55-56	CHEVROLET PICKUP 3200	
F	55-56	PICKUP 3800	
F	56	PICKUP All 3100	
F	55	PICKUP 3100	
R	61-64	FORD PICKUP 1/2 TON, F-100 All	
R	61-66	PICKUP 1 TON, F-350 / SUPERDUTY All	
R	61-64	PICKUP 3/4 TON, F-250 / SUPERDUTY All	
R	55	PICKUP F SERIES All F-100	
F	48-52	PICKUP F SERIES All F-1, F-2 & F-3	
F	68-76	PICKUP P350 All Up through 8000# GVW	
F	75-76	PICKUP P400 All Up through 8000# GVW	
R	68	INTERNATIONAL 908C All	
R	68	1000C All Exc. Travelette with 166" Wheelbase	
F	68	1100C All Exc. Travelette with 166" Wheelbase	
R	68	1100C All Exc. Travelette with 166" Wheelbase	
F	68	1200C All Exc. Travelette with 166" Wheelbase	
R	68	1200C All Exc. Travelette with 166" Wheelbase	
R	68	1200C All Exc. Travelette with 166" Wheelbase	
F	68	1300C All Exc. Travelette with 166" Wheelbase	
R	68	1300C All Exc. Travelette with 166" Wheelbase	
R	68-72	M1100 / M1200 All	
R	69	M1400 All	
R	66-83	JEEP CJ5 All Exc. Lift Kit	
R	66-75	CJ6 All Exc. Lift Kit	
R	76-86	CJ7 All Exc. Lift Kit	
R	66-74	DJ5 All Exc. Lift Kit	
R	66-68	DJ6 All Exc. Lift Kit	
R	57-60	FC150 All	
F	63-65	FC170 All	
R	63-65	FC170 All	
R	63-66	GLADIATOR All Independent Front Suspension	
R	70-73	JEEPSTER All	
R	81-85	SCRAMBLER / CJ8 All	
R	66-67	UNIVERSAL All Exc. Lift Kit	
R	61-65	UNIVERSAL All	
77406 D			
R	85-96	FORD PICKUP 1/2 TON, F-150 RWD	
R	80-97	PICKUP 1 TON, F-350 / SUPERDUTY RWD Exc. Dual Rear Wheels	
R	97	PICKUP 3/4 TON, F-250 / SUPERDUTY RWD Over 8500# GVW	
R	80-96	PICKUP 3/4 TON, F-250 / SUPERDUTY RWD	
77409 D			
R	80-96	FORD BRONCO All Exc. Lift Kit	
R	80-83	PICKUP 1/2 TON, F-100 RWD	
R	80-84	PICKUP 1/2 TON, F-150 RWD	
R	90-97	PICKUP 1/2 TON, F SUPERDUTY All	
R	80-97	PICKUP 1 TON, F-350 / SUPERDUTY RWD Dual Rear Wheels	
R	97	PICKUP, F-450 SUPERDUTY All	
77410 W 141047			
F	80-96	FORD BRONCO All Quad Suspension; Forward of Front Axle; Exc. Lift Kit	
F	80-96	PICKUP 1/2 TON, F-150 4WD Quad Suspension; Forward of Front Axle; Exc. Lift Kit	
F	80-81	PICKUP 1 TON, F-350 / SUPERDUTY 4WD	
F	80-82	PICKUP 3/4 TON, F-250 / SUPERDUTY 4WD	
77412 A			
R	07	CHEVROLET PICKUP 1/2 TON, SILVERADO 1500 4WD Old Body Style; Exc. Electronic Adjustable Suspension	
R	99-06	PICKUP 1/2 TON, SILVERADO 1500 4WD Exc. Electronic Adjustable Suspension	
R	05-06	PICKUP 1/2 TON, SILVERADO 1500 HD All	
R	01-03	PICKUP 1/2 TON, SILVERADO 1500 HD All	

Numerical listing

Shock	POP	Alternative No.	MTG Acc. Supplied
Pos.	Year	Application	
77412	A	-continued	
R	77-86	PICKUP 1 TON, K30 All	
R	90-91	PICKUP 1 TON, R3500 All	
R	89	PICKUP 1 TON, R3500 Cab & Chassis, RWD	
R	89	PICKUP 1 TON, R3500 Crew Cab Pickup, RWD	
R	01-09	PICKUP 1 TON, SILVERADO 3500 All	
R	07-10	PICKUP 1 TON, SILVERADO 3500 HD All	
R	87-88	PICKUP 1 TON, V30 All	
R	89-91	PICKUP 1 TON, V3000 / V3500 All	
R	99-08	PICKUP 3/4 TON, SILVERADO 2500 All	
R	01-10	PICKUP 3/4 TON, SILVERADO 2500 HD All	
R	07	SILVERADO 1500 HD CLASSIC 4WD	
R	07	SILVERADO 2500 HD CLASSIC All	
R	06-07	DODGE PICKUP 1/2 TON, RAM 1500 (SEE RAM 1500) All Exc. Mega Cab	
R	02-05	PICKUP 1/2 TON, RAM 1500 (SEE RAM 1500) All	
R	77-86	GMC PICKUP 1 TON, K35 / K3500 All	
R	87-91	PICKUP 1 TON, V3000 / V3500 All	
R	07	SIERRA 1500 4WD Old Body Style; Exc. Electronic Adjustable Suspension	
R	99-06	SIERRA 1500 4WD Exc. Electronic Adjustable Suspension	
R	05-06	SIERRA 1500 HD All	
R	01-03	SIERRA 1500 HD All	
R	07	SIERRA 1500 HD CLASSIC All	
R	99-04	SIERRA 2500 All	
R	01-10	SIERRA 2500 HD All	
R	07	SIERRA 2500 HD CLASSIC 4WD	
R	01-06	SIERRA 3500 All	
R	07	SIERRA 3500 CLASSIC All	
R	07-10	SIERRA 3500 HD All	
77413	D		
R	78-95	CHEVROLET VAN 1/2 TON, G / EXPRESS All	
R	85-91	VAN 1 TON, G / EXPRESS Extended Cargo Van	
R	85-91	VAN 1 TON, G / EXPRESS Extended Passenger Van	
R	78-91	VAN 1 TON, G / EXPRESS Standard Cargo Van	
R	78-91	VAN 1 TON, G / EXPRESS Standard Passenger Van	
R	78-95	VAN 3/4 TON, G / EXPRESS All Exc. 8600# GVW	
R	84-86	DODGE MINI RAM All	
R	99-03	VAN 1/2 TON, A / B SERIES / RAM 109.3 (WheelBase) Exc. 7000# GVW	
R	81-98	VAN 1/2 TON, A / B SERIES / RAM 109.6 (WheelBase) Exc. 7000# GVW	
R	71-80	VAN 1/2 TON, A / B SERIES / RAM All	
R	99-03	VAN 1 TON, A / B SERIES / RAM All	
R	94-98	VAN 1 TON, A / B SERIES / RAM All Exc. 4000# Front Axle	
R	71-93	VAN 1 TON, A / B SERIES / RAM All	
R	71-03	VAN 3/4 TON, A / B SERIES / RAM All	
R	74-80	VAN, CB300 All Over 8300# GVW	
R	78-95	GMC VAN 1/2 TON, G / SAVANNA All	
R	78-95	VAN 3/4 TON, G / SAVANNA All Exc. 8600# GVW	
R	74-83	PLYMOUTH VAN 1/2 TON, PB SERIES All	
R	74-83	VAN 1 TON, PB SERIES All	
R	74-83	VAN 3/4 TON, PB SERIES All	
77414	C	140780	
F	80-96	FORD BRONCO All Quad & Non Quad Suspensions Rearward of Front Axle; Exc. Lift Kit	
F	89	BRONCO II All Mfg. from 2/89; Vehicles with 12mm bolt in rear lower mount	
F	84-88	BRONCO II All With 10mm Bolt In Rear Lower Mount	
F	80-83	PICKUP 1/2 TON, F-100 RWD	
F	80-96	PICKUP 1/2 TON, F-150 4WD Quad & Non Quad Suspensions Rearward of Front Axle; Exc. Lift Kit	
F	80-96	PICKUP 1/2 TON, F-150 RWD	

Max Control

Shock	POP	Alternative No.	MTG Acc. Supplied
Pos.	Year	Application	
77414	C	-continued 140780	
F	80-97	PICKUP 1 TON, F-350 / SUPERDUTY RWD	
F	97	PICKUP 3/4 TON, F-250 / SUPERDUTY RWD Over 8500# GVW	
F	80-96	PICKUP 3/4 TON, F-250 / SUPERDUTY RWD	
F	87-89	RANGER All Exc. High Ryder Option	
F	83-86	RANGER All	
77418	W	141356	
F	82	DODGE D50 4WD	
F	87-93	PICKUP, RAM 50 4WD	
F	87-89	RAIDER All	
F	95-96	MINI MIGHTY MAX RWD	
F	83-94	MIGHTY MAX 4WD	
F	83-91	MONTERO All	
77421	C	140455	
F	05	CHEVROLET BLAZER Base, RWD	
F	96-04	BLAZER LS, RWD	
F	95-02	BLAZER LT, RWD	
F	95-99	BLAZER Base, RWD	
F	95-97	BLAZER Deluxe, RWD	
F	83-94	BLAZER, S MODELS RWD	
F	94-03	S10 LS, RWD	
F	82-03	S10 Base, RWD	
F	92-93	S10 EL, RWD	
F	83-92	S10 Tahoe, RWD	
F	88-90	S10 Durango, RWD	
F	82-86	S10 Durango, RWD	
F	72-82	FORD COURIER All	
F	92-04	GMC JIMMY RWD	
F	83-91	S15 JIMMY RWD	
F	04	SONOMA / S15 All RWD	
F	82-03	SONOMA / S15 RWD	
F	78-87	SPRINT / CABALLERO RWD	
F	71-77	SPRINT / CABALLERO All	
F	96-00	ISUZU HOMBRE RWD Exc. Sport Chassis	
F	72-76	MAZDA B1600 All	
F	77-78	B1800 All	
F	79-84	B2000 All	
F	82-84	B2200 All	
77422	C		
R	05	CHEVROLET BLAZER Base, 4WD	
R	05	BLAZER Base, RWD	
R	96-04	BLAZER LS, 4WD	
R	96-04	BLAZER LS, RWD	
R	95-02	BLAZER LT, RWD	
R	95-01	BLAZER LT, 4WD	
R	95-99	BLAZER Base, 4WD	
R	95-99	BLAZER Base, RWD	
R	95-97	BLAZER Deluxe, RWD	
R	83-94	BLAZER, S MODELS All	
R	04-12	COLORADO RWD	
R	99-04	S10 LS, 4WD	
R	99-03	S10 Base, 4WD	
R	99-03	S10 Base, RWD	
R	99-03	S10 LS, RWD	
R	94-98	S10 LS	
R	82-98	S10 Base	
R	92-93	S10 EL	
R	83-92	S10 Tahoe	
R	88-90	S10 Durango	
R	82-86	S10 Durango	
R	04-12	GMC CANYON RWD	
R	05	JIMMY 4WD	
R	92-04	JIMMY All	
R	83-91	S15 JIMMY All	
R	82-04	SONOMA / S15 All	
R	91	SYCLONE All	
R	92-93	TYPHOON All	
R	96-00	ISUZU HOMBRE All	
R	96-01	OLDSMOBILE BRAVADA All	
R	91-94	BRAVADA All	
77423	C		
F	05	CHEVROLET BLAZER Base, 4WD Exc. ZR2	
F	03-04	BLAZER LS, 4WD Exc. ZR2	
F	02	BLAZER LS, 4WD	
F	96-01	BLAZER LS, 4WD Exc. ZR2	
F	01	BLAZER LT, 4WD	
F	95-00	BLAZER LT, 4WD Exc. ZR2	
F	98-99	BLAZER Base, 4WD Exc. ZR2	
F	97	BLAZER Base, 4WD	
F	95-96	BLAZER Base, 4WD Exc. ZR2	
F	83-94	BLAZER, S MODELS 4WD	
F	94-04	S10 LS, 4WD Exc. ZR2, ZR5 or Sport Chassis	
F	83-03	S10 Base, 4WD Exc. ZR2, ZR5 or Sport Chassis	

Numerical listing

Shock	POP	Alternative No.	MTG Acc. Supplied
Pos.	Year	Application	
77423	C	-continued	
F	92-93	S10 EL, 4WD Exc. ZR2, ZR5 or Sport Chassis	
F	83-92	S10 Tahoe, 4WD Exc. ZR2, ZR5 or Sport Chassis	
F	88-90	S10 Durango, 4WD Exc. ZR2, ZR5 or Sport Chassis	
F	83-86	S10 Durango, 4WD Exc. ZR2, ZR5 or Sport Chassis	
F	92-05	GMC JIMMY 4WD	
F	83-91	S15 JIMMY 4WD	
F	83-04	SONOMA / S15 4WD	
F	91	SYCLONE All	
F	92-93	TYPHOON All	
F	99-00	ISUZU HOMBRE 4WD	
F	96-98	HOMBRE All Sport Chassis	
F	96-01	OLDSMOBILE BRAVADA All	
F	91-94	BRAVADA All	
77424	C	141353	
F	84-01	JEEP CHEROKEE All	
F	86-92	COMANCHE All	
F	93-98	GRAND CHEROKEE All	
F	84-90	WAGONEER All	
77425	D		
R	84-01	JEEP CHEROKEE All	
R	84-90	WAGONEER All	
77454	C		
R	90-05	CHEVROLET ASTRO All	
R	85-89	ASTRO RWD	
R	90-05	GMC SAFARI All	
R	85-89	SAFARI RWD	
77455	D		
F	86-97	FORD PICKUP 1 TON, F-350 / SUPERDUTY 4WD	
F	97-98	PICKUP 3/4 TON, F-250 / SUPERDUTY 4WD Over 8500# GVW	
F	87-96	PICKUP 3/4 TON, F-250 / SUPERDUTY 4WD	
77456	W		
R	86-97	FORD PICKUP 1 TON, F-350 / SUPERDUTY 4WD Exc. Dual Rear Wheels	
77461	C		
R	80-96	FORD PICKUP 1/2 TON, F-150 4WD Exc. Lift Kit	
R	86-97	PICKUP 1 TON, F-350 / SUPERDUTY 4WD Dual Rear Wheels	
R	82-85	PICKUP 1 TON, F-350 / SUPERDUTY 4WD Clevis Type Lower Front Mount; Exc. Dual Rear Wheels or Lift Kit	
R	80-81	PICKUP 1 TON, F-350 / SUPERDUTY 4WD	
R	97	PICKUP 3/4 TON, F-250 / SUPERDUTY 4WD Over 8500# GVW	
R	87-96	PICKUP 3/4 TON, F-250 / SUPERDUTY 4WD	
R	82-86	PICKUP 3/4 TON, F-250 / SUPERDUTY 4WD Clevis Type Lower Front Mount; Exc. Dual Rear Wheels or Lift Kit	
R	80-81	PICKUP 3/4 TON, F-250 / SUPERDUTY 4WD	
R	99-04	PICKUP, F-450 SUPERDUTY All	
R	99-04	PICKUP, F-550 SUPERDUTY All	
77479	D	140524	
F	86-95	TOYOTA 4RUNNER All	
F	86-95	PICKUP 4WD Exc. Lift Kit	
F	93-98	T100 4WD	
77488	A		
R	88-99	CHEVROLET PICKUP 1/2 TON, C15 / C1500 All	
R	88-99	PICKUP 1/2 TON, K15 / K1500 All	
R	91-03	PICKUP 1 TON, C35/3500 All	
R	88-90	PICKUP 1 TON, C35/3500 Extended Cab Pickup Exc. HD Straight Front Axle	
R	88-90	PICKUP 1 TON, C35/3500 Standard Cab Pickup Exc. HD Straight Front Axle	
R	88-00	PICKUP 1 TON, K35 / K3500 All	
R	88-00	PICKUP 3/4 TON, C25 / C2500 All	
R	88-00	PICKUP 3/4 TON, K25 / K2500 All	
R	88-99	GMC PICKUP 1/2 TON, C15 / C1500 All	

Numerical listing

Shock	POP	Alternative No.	MTG Acc. Supplied
Pos.	Year	Application	
77488 A -continued			
R	88-99	PICKUP 1/2 TON, K15 / K1500 All	
R	91-00	PICKUP 1 TON, C35/3500 All	
R	88-90	PICKUP 1 TON, C35/3500 Extended Cab Pickup Exc. HD Straight Front Axle	
R	88-90	PICKUP 1 TON, C35/3500 Standard Cab Pickup Exc. HD Straight Front Axle	
R	88-00	PICKUP 1 TON, K35 / K3500 All	
R	88-00	PICKUP 3/4 TON, C25 / C2500 All	
R	88-00	PICKUP 3/4 TON, K25 / K2500 All	
77489 B			
F	88-99	CHEVROLET PICKUP 1/2 TON, C15 / C1500 All	
F	01-03	PICKUP 1 TON, C35/3500 Base Exc. HD Straight Front Axle	
F	98-00	PICKUP 1 TON, C35/3500 All Exc. HD Straight Front Axle	
F	92-97	PICKUP 1 TON, C35/3500 Crew Cab Pickup Exc. HD Straight Front Axle	
F	88-97	PICKUP 1 TON, C35/3500 Extended Cab Pickup Exc. HD Straight Front Axle	
F	88-97	PICKUP 1 TON, C35/3500 Standard Cab Pickup Exc. HD Straight Front Axle	
F	88-00	PICKUP 3/4 TON, C25 / C2500 All	
F	92-99	SUBURBAN 1/2 TON, C15 / C1500 All	
F	92-99	SUBURBAN 3/4 TON, C25 / C2500 All	
F	95-00	TAHOE RWD Old Body Style	
F	88-99	GMC PICKUP 1/2 TON, C15 / C1500 All	
F	92-00	PICKUP 1 TON, C35/3500 Crew Cab Pickup Exc. HD Straight Front Axle	
F	88-00	PICKUP 1 TON, C35/3500 Extended Cab Pickup Exc. HD Straight Front Axle	
F	88-00	PICKUP 1 TON, C35/3500 Standard Cab Pickup Exc. HD Straight Front Axle	
F	88-00	PICKUP 3/4 TON, C25 / C2500 All	
F	92-99	SUBURBAN 1/2 TON, C15 / C1500 All	
F	92-99	SUBURBAN 3/4 TON, C25 / C2500 All	
F	92-99	YUKON RWD	
77492 B 141137			
R	81-82	CHEVROLET LUV PICKUP All	
R	87-89	DODGE RAIDER 2.6L 4Cyl L (156) Exc. Sport Utility	
F	61-67	FORD ECONOLINE All	
R	81-95	ISUZU PICKUP All	
R	86-92	JEEP COMANCHE All	
F	66-73	WAGONEER All	
F	63-65	WAGONEER All Exc. Independent Front Suspension	
R	83-89	MINI MONTERO 2.6L 4Cyl L (156)	
R	97-99	MONTERO SPORT All	
R	82-86	NISSAN 720 PICKUP 4WD	
R	00-04	FRONTIER Crew Cab Pickup, RWD with Desert Runner	
R	98-04	FRONTIER 4WD	
R	98-99	FRONTIER RWD Crew Cab with Desert Runner	
R	87-95	PATHFINDER All Exc. Electronic Adjustable Suspension	
R	87-97	PICKUP 4WD	
R	86	PICKUP 4WD Mfg. from 8/86	
R	00-04	XTERRA All	
R	84-87	TOYOTA LAND CRUISER FJ60 (MfrBodyCode), Sport Utility	
R	76-83	LAND CRUISER All	
R	75	LAND CRUISER All Mfg. to 2/75	
R	69-74	LAND CRUISER All	
R	85-92	PICKUP RWD 1 Ton	
R	80-83	PICKUP 4WD Exc. Lift Kit	
R	93-98	T100 RWD	
77494 C 140149			
R	84-89	TOYOTA 4RUNNER All	
R	84-95	PICKUP 4WD Exc. Lift Kit	
R	98-04	TACOMA Pre Runner, RWD	
R	04	TACOMA Base, 4WD	
R	95-03	TACOMA 4WD	
77524 B			
R	06-11	FORD RANGER RWD, Torsion Bar (FrontSpringType)	

Max Control

Shock	POP	Alternative No.	MTG Acc. Supplied
Pos.	Year	Application	
77524 B -continued			
R	90-11	RANGER 4WD	
R	01-05	RANGER Edge, RWD	
R	89	RANGER 4WD Mfg. from 2/89; Vehicles with 12mm bolt in rear lower mount	
R	95-96	MAZDA B2300 4WD	
R	03-07	B3000 All 4WD	
R	98-02	B3000 4WD	
R	98-09	B4000 4WD	
77525 C			
R	90	FORD BRONCO II All	
R	89	BRONCO II All Mfg. from 2/89; Vehicles with 12mm bolt in rear lower mount	
R	06-11	RANGER RWD, Coil (FrontSpringType)	
R	98-05	RANGER XL, RWD	
R	98-05	RANGER XLT, RWD	
R	05	RANGER STX, RWD	
R	04	RANGER Tremor, RWD	
R	90-97	RANGER RWD	
R	89	RANGER RWD Mfg. from 2/89; Vehicles with 12mm bolt in rear lower mount	
R	01-09	MAZDA B2300 RWD	
R	94-97	B2300 RWD	
R	98-01	B2500 RWD	
R	94-07	B3000 RWD	
R	94-09	B4000 RWD	
77607 D 140719			
R	00-05	FORD EXCURSION RWD	
R	91-94	EXPLORER All	
R	91-94	MAZDA NAVAJO All	
77608 D 140780			
F	91-94	FORD EXPLORER All	
F	92-11	VAN 1/2 TON, ECONOLINE / CLUB WAGON All	
F	91-94	MAZDA NAVAJO All	
77609 A			
F	99-00	CADILLAC ESCALADE All	
F	90-05	CHEVROLET ASTRO 4WD	
F	92-94	BLAZER 4WD Full Size	
F	88-99	PICKUP 1/2 TON, K15 / K1500 All	
F	88-00	PICKUP 1 TON, K35 / K3500 All	
F	88-00	PICKUP 3/4 TON, K25 / K2500 All	
F	92-99	SUBURBAN 1/2 TON, K15 / K1500 All	
F	92-99	SUBURBAN 3/4 TON, K25 / K2500 All	
F	95-00	TAHOE 4WD Old Body Style	
F	88-99	GMC PICKUP 1/2 TON, K15 / K1500 All	
F	88-00	PICKUP 1 TON, K35 / K3500 All	
F	88-00	PICKUP 3/4 TON, K25 / K2500 All	
F	92-99	SUBURBAN 1/2 TON, K15 / K1500 All	
F	92-99	SUBURBAN 3/4 TON, K25 / K2500 All	
F	92-99	YUKON 4WD	
77614 A 140780			
F	90	FORD BRONCO II All	
F	00-05	EXCURSION RWD	
F	90-97	RANGER All	
F	07-14	VAN 1 TON, ECONOLINE / CLUB WAGON / SUPERDUTY All Exc. Cutaway Chassis	
F	01-14	VAN 1 TON, ECONOLINE / CLUB WAGON / SUPERDUTY All	
F	92-05	VAN 1 TON, ECONOLINE / CLUB WAGON / SUPERDUTY All Cutaway Chassis	
F	92-14	VAN 3/4 TON, ECONOLINE / CLUB WAGON / SUPERDUTY All	
F	94-97	MAZDA B2300 All	
F	94-97	B3000 RWD	
F	94-97	B4000 RWD	
77623 C 142731			
R	10-14	FORD VAN 1/2 TON, ECONOLINE / CLUB WAGON All	
R	03-14	VAN 1 TON, ECONOLINE / CLUB WAGON / SUPERDUTY All Exc. Cutaway Chassis	
R	07-08	VAN 1 TON, ECONOLINE / CLUB WAGON / SUPERDUTY All	
R	92-05	VAN 1 TON, ECONOLINE / CLUB WAGON / SUPERDUTY All Cutaway Chassis	

Numerical listing

Shock	POP	Alternative No.	MTG Acc. Supplied
Pos.	Year	Application	
77623 C -continued 142731			
R	01-03	VAN 1 TON, ECONOLINE / CLUB WAGON / SUPERDUTY All	
R	92-14	VAN 3/4 TON, ECONOLINE / CLUB WAGON / SUPERDUTY All	
77638 A			
R	99-00	CADILLAC ESCALADE All	
R	92-94	CHEVROLET BLAZER 4WD Full Size	
R	92-99	SUBURBAN 1/2 TON, C15 / C1500 All	
R	92-99	SUBURBAN 1/2 TON, K15 / K1500 All	
R	92-99	SUBURBAN 3/4 TON, C25 / C2500 All	
R	92-99	SUBURBAN 3/4 TON, K25 / K2500 All	
R	95-00	TAHOE All Old Body Style	
R	96-14	VAN 1/2 TON, G / EXPRESS All	
R	03-16	VAN 1 TON, G / EXPRESS All	
R	03-16	VAN 3/4 TON, G / EXPRESS All	
R	96-02	VAN 3/4 TON, G / EXPRESS All Exc. 8600# GVW	
R	92-99	GMC SUBURBAN 1/2 TON, C15 / C1500 All	
R	92-99	SUBURBAN 1/2 TON, K15 / K1500 All	
R	92-99	SUBURBAN 3/4 TON, C25 / C2500 All	
R	92-99	SUBURBAN 3/4 TON, K25 / K2500 All	
R	96-14	VAN 1/2 TON, G / SAVANNA RWD	
R	04-16	VAN 1 TON, G / SAVANNA All	
R	96-02	VAN 1 TON, G / SAVANNA All Exc. 8600# GVW	
R	96	VAN 1 TON, G / SAVANNA All 7100, 7400 and 8600# GVW	
R	03-16	VAN 3/4 TON, G / SAVANNA All	
R	96-02	VAN 3/4 TON, G / SAVANNA All Exc. 8600# GVW	
R	92-99	YUKON All	
77661 B			
F	94-01	DODGE PICKUP 1/2 TON, RAM 1500 (SEE RAM 1500) RWD	
F	94-02	PICKUP 1 TON, RAM 3500 (SEE RAM 3500) RWD Exc. Solid Front Axle	
F	94-02	PICKUP 3/4 TON, RAM 2500 (SEE RAM 2500) RWD	
77662 A			
R	07	CHEVROLET PICKUP 1/2 TON, SILVERADO 1500 RWD Old Body Style, Exc. Electronic Adjustable Suspension	
R	99-06	PICKUP 1/2 TON, SILVERADO 1500 RWD Exc. Electronic Adjustable Suspension	
R	74-80	VAN 1/2 TON, P SERIES All	
R	79-89	VAN 3/4 TON, P SERIES All	
R	94-01	DODGE PICKUP 1/2 TON, RAM 1500 (SEE RAM 1500) All	
R	94-02	PICKUP 1 TON, RAM 3500 (SEE RAM 3500) RWD Exc. Solid Front Axle	
R	94-02	PICKUP 3/4 TON, RAM 2500 (SEE RAM 2500) 4WD, GAS Exc. 8800# GVW	
R	94-02	PICKUP 3/4 TON, RAM 2500 (SEE RAM 2500) RWD	
R	95-96	PICKUP 3/4 TON, RAM 2500 (SEE RAM 2500) 4WD, CNG Exc. 8800# GVW	
R	99-07	GMC SIERRA 1500 RWD Exc. Electronic Adjustable Suspension	
R	74-80	VAN 1/2 TON, P SERIES All	
R	75-99	VAN 1 TON, P SERIES All	
R	73-74	VAN 1 TON, P SERIES Base Cutaway Chassis	
R	74	VAN 1 TON, P SERIES Motor Home	
77673 C 142731			
F	94-01	DODGE PICKUP 1/2 TON, RAM 1500 (SEE RAM 1500) 4WD	
F	94-02	PICKUP 3/4 TON, RAM 2500 (SEE RAM 2500) 4WD, GAS Exc. 8800# GVW	
77674 C 142731			
F	94-02	DODGE PICKUP 1 TON, RAM 3500 (SEE RAM 3500) 4WD	
F	94-02	PICKUP 1 TON, RAM 3500 (SEE RAM 3500) RWD Solid Front Axle	

Numerical listing

Shock	POP	Alternative No.	MTG Acc. Supplied
Pos.	Year	Application	
77674	C	-continued	142731
F	94-02	PICKUP 3/4 TON, RAM 2500 (SEE RAM 2500) 4WD, DIESEL 8800# GVW	
77675	C		
R	94-02	DODGE PICKUP 1 TON, RAM 3500 (SEE RAM 3500) 4WD	
R	94-02	PICKUP 1 TON, RAM 3500 (SEE RAM 3500) RWD Solid Front Axle	
R	94-02	PICKUP 3/4 TON, RAM 2500 (SEE RAM 2500) 4WD, DIESEL 8800# GVW	
77678	B		
F	95-01	FORD EXPLORER All Exc. Adjustable Suspension	
F	01-05	EXPLORER SPORT TRAC All	
F	10-11	RANGER RWD , Torsion Bar (FrontSpringType)	
F	00-11	RANGER 4WD , Torsion Bar (FrontSpringType)	
F	01-09	RANGER XL, RWD , Torsion Bar (FrontSpringType)	
F	01-09	RANGER XLT, RWD , Torsion Bar (FrontSpringType)	
F	05	RANGER STX, RWD w/ Torsion Bar (FrontSpringType)	
F	04	RANGER Tremor, RWD , Torsion Bar (FrontSpringType)	
F	01-02	RANGER EV, RWD , Torsion Bar (FrontSpringType)	
F	02	RANGER Sport, RWD w/ Torsion Bar (FrontSpringType)	
F	98-99	RANGER 4WD	
F	03-07	MAZDA B3000 All 4WD	
F	98-02	B3000 4WD	
F	98-09	B4000 4WD	
F	97-01	MERCURY MOUNTAINEER All Exc. Electronic Adjustable Suspension	
77679	C		140719
R	95-01	FORD EXPLORER All Exc. Adjustable Suspension	
R	01-05	EXPLORER SPORT TRAC All	
R	97-01	MERCURY MOUNTAINEER All Exc. Electronic Adjustable Suspension	
77683	D		
R	93-98	JEEP GRAND CHEROKEE All	
77714	B		142731
F	97-02	FORD EXPEDITION RWD Exc. Front Air- Leveling	
F	97-04	PICKUP 1/2 TON, F-150 RWD	
F	96-99	PICKUP 3/4 TON, F-250 / SUPERDUTY RWD Up through 8500# GVW	
F	98-02	LINCOLN NAVIGATOR RWD	
77715	B		142700
R	97-04	FORD PICKUP 1/2 TON, F-150 4WD Exc. 7000# GVW	
R	97-99	PICKUP 3/4 TON, F-250 / SUPERDUTY 4WD Up through 8500# GVW; Exc. Superduty	
77716	B		142731
F	97-02	FORD EXPEDITION 4WD Exc. Front Air- Leveling	
F	04	PICKUP 1/2 TON, F-150 4WD Exc. 7000# GVW	
F	97-03	PICKUP 1/2 TON, F-150 4WD	
F	97-99	PICKUP 3/4 TON, F-250 / SUPERDUTY 4WD Up through 8500# GVW; Exc. Superduty	
77717	C		
R	97-02	FORD EXPEDITION All	
R	98-02	LINCOLN NAVIGATOR RWD	
77726	B		140921
R	90-02	TOYOTA 4RUNNER All	
77772	D		140780
F	06-11	FORD RANGER RWD , Coil (FrontSpringType)	
F	01-05	RANGER XL, RWD , Coil (FrontSpringType)	
F	01-05	RANGER XLT, RWD , Coil (FrontSpringType)	
F	01-02	RANGER EV Coil Front Spring Type	
F	02	RANGER Sport, RWD , Coil (FrontSpringType)	

Max Control

Shock	POP	Alternative No.	MTG Acc. Supplied
Pos.	Year	Application	
77772	D	-continued	140780
F	98-00	RANGER XL, RWD	
F	98-00	RANGER XLT, RWD	
F	01-09	MAZDA B2300 RWD	
F	98-01	B2500 RWD	
F	98-07	B3000 RWD	
F	98-09	B4000 RWD	
77778	C		142700
R	04	FORD PICKUP 1/2 TON, F-150 RWD	
R	00-03	PICKUP 1/2 TON, F-150 Harley-Davidson Edition, RWD	
R	99-03	PICKUP 1/2 TON, F-150 Lariat, RWD	
R	99-03	PICKUP 1/2 TON, F-150 XL, RWD	
R	99-03	PICKUP 1/2 TON, F-150 XLT, RWD	
R	00	PICKUP 1/2 TON, F-150 Base, RWD	
R	97-98	PICKUP 1/2 TON, F-150 RWD	
R	97-99	PICKUP 3/4 TON, F-250 / SUPERDUTY RWD Up through 8500# GVW	
77781	W		141350
R	92-00	MITSUBISHI MONTERO All	
77782	W		141350
F	92-00	MITSUBISHI MONTERO All	
F	97-99	MONTERO SPORT All	
77783	A		141665
F	99-07	CHEVROLET PICKUP 1/2 TON, SILVERADO 1500 RWD Exc. Electronic Adjustable Suspension	
F	99-07	GMC SIERRA 1500 RWD Exc. Electronic Adjustable Suspension	
77803	A		143276
F	02-06	CADILLAC ESCALADE All	
F	02-04	ESCALADE EXT All	
F	02-06	CHEVROLET AVALANCHE 1500 All Exc. Electronic Ride Control	
F	07	PICKUP 1/2 TON, SILVERADO 1500 All Old Body Style; Exc. Electronic Adjustable Suspension	
F	99-06	PICKUP 1/2 TON, SILVERADO 1500 4WD Exc. Electronic Adjustable Suspension	
F	00-06	SUBURBAN 1/2 TON, 1500 All Exc. Z55 Auto Ride Suspension	
F	02-06	TAHOE All Exc. Z55 Auto Ride Suspension	
F	00-01	TAHOE All New Body Style; Exc. Z55 Auto Ride Suspension	
F	07	GMC SIERRA 1500 4WD Old Body Style; Exc. Electronic Adjustable Suspension	
F	99-06	SIERRA 1500 4WD Exc. Electronic Adjustable Suspension	
F	00-06	YUKON All Exc. Z55 Auto Ride Suspension	
F	00-06	YUKON XL 1/2 TON All Exc. Z55 Auto Ride Suspension	
77807	A		142617
F	99-12	FORD PICKUP 1 TON, F-350 / SUPERDUTY RWD	
F	99-12	PICKUP 3/4 TON, F-250 / SUPERDUTY RWD	
77808	B		
R	99-04	FORD PICKUP 1 TON, F-350 / SUPERDUTY RWD	
R	99-04	PICKUP 3/4 TON, F-250 / SUPERDUTY RWD	
77809	A		
F	00-05	FORD EXCURSION 4WD	
F	99-04	PICKUP 1 TON, F-350 / SUPERDUTY 4WD	
F	99-04	PICKUP 3/4 TON, F-250 / SUPERDUTY 4WD	
F	99-04	PICKUP, F-450 SUPERDUTY All	
F	99-04	PICKUP, F-550 SUPERDUTY All	
77810	A		
R	99-04	FORD PICKUP 1 TON, F-350 / SUPERDUTY 4WD	
R	99-04	PICKUP 3/4 TON, F-250 / SUPERDUTY 4WD	
77815	B		142389
R	00-06	TOYOTA TUNDRA All	
77817	A		141665
F	02-06	CHEVROLET AVALANCHE 2500 All Exc. Electronic Ride Control	

Numerical listing

Shock	POP	Alternative No.	MTG Acc. Supplied
Pos.	Year	Application	
77817	A	-continued	141665
F	05-06	PICKUP 1/2 TON, SILVERADO 1500 HD All	
F	01-03	PICKUP 1/2 TON, SILVERADO 1500 HD All	
F	01-09	PICKUP 1 TON, SILVERADO 3500 All	
F	07-10	PICKUP 1 TON, SILVERADO 3500 HD All	
F	05-08	PICKUP 3/4 TON, SILVERADO 2500 All	
F	99-04	PICKUP 3/4 TON, SILVERADO 2500 4WD	
F	01-10	PICKUP 3/4 TON, SILVERADO 2500 HD All 9200# GVW	
F	07	SILVERADO 1500 HD CLASSIC All	
F	00-11	SUBURBAN 3/4 TON, 2500 All Exc. Z55 Auto Ride Suspension and Quadrateer	
F	05-06	GMC SIERRA 1500 HD All	
F	01-03	SIERRA 1500 HD All	
F	07	SIERRA 1500 HD CLASSIC All	
F	99-04	SIERRA 2500 4WD	
F	01-10	SIERRA 2500 HD All	
F	01-06	SIERRA 3500 All	
F	07-10	SIERRA 3500 HD Torsion Bar (FrontSpringType)	
F	00-06	YUKON XL 3/4 TON All Exc. Hydraulic Self Leveling System	
F	03-09	HUMMER H2 All	
77829	C		
R	99-04	JEEP GRAND CHEROKEE All	
77837	C		
R	00-05	FORD EXCURSION 4WD	
77847	C		142592,141353
F	99-04	JEEP GRAND CHEROKEE All Exc. Up Country Suspension	
77902	W		140857
F	81-82	CHEVROLET LUV PICKUP RWD	
F	81-95	ISUZU PICKUP RWD	
F	69-72	NISSAN 521 PICKUP All	
F	72-79	620 PICKUP All	
F	80-86	720 PICKUP All	
F	87-97	PICKUP 4WD	
F	86	PICKUP 4WD Mfg. from 8/86	
77903	W		141376
F	85-95	TOYOTA PICKUP RWD Exc. 1 Ton	
F	84	PICKUP RWD	
F	93-98	T100 RWD	
77904	W		141356
F	87-91	ISUZU TROOPER 4WD	
F	87-90	MITSUBISHI VAN All	
F	87-95	NISSAN PATHFINDER All Exc. Electronic Adjustable Suspension	
77905	C		140126
F	97-04	DODGE DAKOTA 4WD	
F	98-03	DURANGO 4WD	
77907	D		
R	75-80	CHEVROLET LUV PICKUP All	
R	72-74	LUV PICKUP All	
R	79-82	DODGE D50 RWD	
R	87-93	PICKUP, RAM 50 RWD	
R	83-86	PICKUP, RAM 50 All	
R	86-87	MAZDA B2000 RWD	
R	87-93	B2200 RWD	
R	87-93	B2600 RWD	
R	95-96	MITSUBISHI MIGHTY MAX All	
R	83-94	MIGHTY MAX RWD	
R	87-90	VAN All	
R	98-04	NISSAN FRONTIER RWD Exc. Desert Runner	
R	87-97	PICKUP RWD	
R	86	PICKUP RWD Mfg. from 8/86	
R	79-82	PLYMOUTH PICKUP All	
R	85-95	TOYOTA PICKUP RWD Exc. 1 Ton	
R	84	PICKUP RWD	
R	75-83	PICKUP RWD Mojave	
R	70-74	PICKUP All RWD; Mojave	
R	84-88	VAN Leaf (RearSpringType)	
R	88	VAN WAGON Leaf (RearSpringType)	
77909	D		141368
F	81-82	CHEVROLET LUV PICKUP 4WD	
F	75-80	LUV PICKUP All	
F	72-74	LUV PICKUP All	
F	89-94	ISUZU AMIGO All	
F	81-95	PICKUP 4WD	

Numerical listing

Shock	POP	Alternative No.	MTG Acc. Supplied
Pos.	Year	Application	
77909	D	-continued	141368
F	84-86	TROOPER 4WD	
F	98-04	NISSAN FRONTIER RWD Exc. Desert Runner	
F	87-97	PICKUP RWD	
F	86	PICKUP RWD Mfg. from 8/86	
77915	D		141349
F	87-04	DODGE DAKOTA RWD	
F	99-03	DURANGO RWD	
77937	W		140673
F	01-04	TOYOTA TACOMA S-Runner Exc. Offroad Package	
F	04	TACOMA Base, RWD Exc. Offroad Package	
F	95-03	TACOMA DLX , RWD Exc. Offroad Package	
77947	B		142731
F	02-05	DODGE PICKUP 1/2 TON, RAM 1500 (SEE RAM 1500) 4WD	
77948	A		142731
F	07-10	DODGE PICKUP 1 TON, RAM 3500 (SEE RAM 3500) 4WD	
F	06	PICKUP 1 TON, RAM 3500 (SEE RAM 3500) 4WD Exc. 5.9L	
F	03-05	PICKUP 1 TON, RAM 3500 (SEE RAM 3500) 4WD	
F	07-10	PICKUP 3/4 TON, RAM 2500 (SEE RAM 2500) 4WD	
F	06	PICKUP 3/4 TON, RAM 2500 (SEE RAM 2500) 4WD Exc. 5.9L	
F	03-05	PICKUP 3/4 TON, RAM 2500 (SEE RAM 2500) 4WD	
F	11-13	RAM 2500 (SEE DODGE RAM 2500) 4WD	
F	11-13	3500 (SEE DODGE RAM 3500) 4WD	
77949	A		143000
F	03-10	DODGE PICKUP 1 TON, RAM 3500 (SEE RAM 3500) RWD	
F	03-10	PICKUP 3/4 TON, RAM 2500 (SEE RAM 2500) RWD	
F	11-13	RAM 2500 (SEE DODGE RAM 2500) RWD	
F	11-13	3500 (SEE DODGE RAM 3500) RWD	
77950	A		
R	03-10	DODGE PICKUP 1 TON, RAM 3500 (SEE RAM 3500) All	
R	03-10	PICKUP 3/4 TON, RAM 2500 (SEE RAM 2500) All	
R	11-13	RAM 2500 (SEE DODGE RAM 2500) All	
R	11-13	3500 (SEE DODGE RAM 3500) All	
77951	A		142731
F	05-12	FORD PICKUP 1 TON, F-350 / SUPERDUTY 4WD	
F	05-12	PICKUP 3/4 TON, F-250 / SUPERDUTY 4WD	
77952	B		
R	05-12	FORD PICKUP 1 TON, F-350 / SUPERDUTY Crew Cab Pickup, 4WD Single Rear Wheels	
R	05-12	PICKUP 1 TON, F-350 / SUPERDUTY Extended Cab Pickup, 4WD Single Rear Wheels	
R	05-12	PICKUP 1 TON, F-350 / SUPERDUTY Standard Cab Pickup, 4WD Single Rear Wheels	
R	05-16	PICKUP 3/4 TON, F-250 / SUPERDUTY 4WD	
77953	A		
R	02-13	CADILLAC ESCALADE All	
R	07-11	CHEVROLET AVALANCHE 1500 All Exc. Z55 or ZW7 Ride Suspension	
R	02-06	AVALANCHE 1500 All Exc. Electronic Ride Control	
R	02-06	AVALANCHE 2500 All Exc. Electronic Ride Control	
R	07-11	SUBURBAN 1/2 TON, 1500 All Exc. Z55 or ZW7 Ride Suspension	
R	00-06	SUBURBAN 1/2 TON, 1500 All Exc. Z55 Auto Ride Suspension	
R	00-11	SUBURBAN 3/4 TON, 2500 All Exc. Z55 Auto Ride Suspension and Quadrasteer	
R	07-11	TAHOE All Exc. Z55 or ZW7 Ride Suspension	

Max Control, Guardian Shock

Shock	POP	Alternative No.	MTG Acc. Supplied
Pos.	Year	Application	
77953	A	-continued	
R	02-06	TAHOE All Exc. Z55 Auto Ride Suspension	
R	00-01	TAHOE All New Body Style; Exc. Z55 Auto Ride Suspension	
R	07-11	GMC YUKON All Exc. Z55 or ZW7 Ride Suspension	
R	00-06	YUKON All Exc. Z55 Auto Ride Suspension	
R	07-11	YUKON XL 1/2 TON All Exc. Z55 or ZW7 Ride Suspension	
R	00-06	YUKON XL 1/2 TON All Exc. Z55 Auto Ride Suspension	
R	00-11	YUKON XL 3/4 TON All Exc. Z55 Auto Ride Suspension and Quadrasteer	
77954	A		143276
F	06-08	DODGE PICKUP 1/2 TON, RAM 1500 (SEE RAM 1500) Crew Cab Pickup, RWD	
F	06-08	PICKUP 1/2 TON, RAM 1500 (SEE RAM 1500) Standard Cab Pickup, RWD	
F	02-05	PICKUP 1/2 TON, RAM 1500 (SEE RAM 1500) RWD	
77955	W		142486
R	03-11	FORD CROWN VICTORIA Police Interceptor	
R	03-11	LINCOLN TOWN CAR All Limo Models	
77958	W		140126
F	87-96	DODGE DAKOTA 4WD	
77967	D		143146
F	05-08	FORD PICKUP, F-450 SUPERDUTY All	
F	05-07	PICKUP, F-550 SUPERDUTY All	
77968	W		
R	05-07	FORD PICKUP, F-450 SUPERDUTY 4 X 2	
R	05-07	PICKUP, F-550 SUPERDUTY 4 X 2	
77969	W		
R	05-07	FORD PICKUP, F-450 SUPERDUTY 4 X 4	
R	05-07	PICKUP, F-550 SUPERDUTY 4 X 4	
77971	A		
R	02-09	CHEVROLET TRAILBLAZER Coil (RearSpringType)	
R	02-06	TRAILBLAZER EXT All	
R	02-09	GMC ENVOY Coil (RearSpringType)	
R	02-06	ENVOY XL All	
R	04-05	ENVOY XUV All	
77973	A		
R	07-14	JEEP WRANGLER Unlimited Sahara, 4WD	
R	07-11	WRANGLER Unlimited X, 4WD	
R	07-11	WRANGLER X	
77975	FF		
R	14	CHEVROLET SUBURBAN 1/2 TON, 1500 All	
R	12-14	TAHOE All	
R	12-14	GMC YUKON All	
77976	FF		
R	07-17	CHEVROLET PICKUP 1/2 TON, SILVERADO 1500 All	
R	07-17	GMC SIERRA 1500 All	
77978	FF		141665
F	97-06	JEEP WRANGLER All	
77979	W		
R	97-06	JEEP WRANGLER All	
77980	N		142731
F	06-08	DODGE PICKUP 1/2 TON, RAM 1500 (SEE RAM 1500) 4WD, 5.7L 8Cyl V (345)	
F	06	PICKUP 1 TON, RAM 3500 (SEE RAM 3500) 4WD, 5.9L 6Cyl L (359)	
F	06	PICKUP 3/4 TON, RAM 2500 (SEE RAM 2500) 4WD, 5.9L 6Cyl L (359)	
77981	N		142973
F	07-12	JEEP WRANGLER All	
77983	N		
R	06-10	HUMMER H3 All w/Off Road package	

Numerical listing

Shock	POP	Alternative No.	MTG Acc. Supplied
Pos.	Year	Application	
Guardian Shock			
81039	B		140357
F	75-84	CHEVROLET BLAZER RWD	
F	69-74	BLAZER All RWD	
F	63-86	PICKUP 1/2 TON, C10 All	
F	87	PICKUP 1/2 TON, R10 All	
F	63-86	PICKUP 1 TON, C30 All	
F	88-91	PICKUP 1 TON, C35/3500 Cab & Chassis Exc. HD Solid Front Axle	
F	87-88	PICKUP 1 TON, R30 All	
F	89-91	PICKUP 1 TON, R3500 All	
F	75-86	PICKUP 3/4 TON, C20 Crew Cab Pickup	
F	75-86	PICKUP 3/4 TON, C20 Standard Cab Pickup	
F	63-74	PICKUP 3/4 TON, C20 All	
F	87-88	PICKUP 3/4 TON, R20 All	
F	89	PICKUP 3/4 TON, R2500 All	
F	63-66	SUBURBAN 1/2 TON, 1500 All	
F	67-86	SUBURBAN 1/2 TON, C10 All	
F	87-88	SUBURBAN 1/2 TON, R10 All	
F	89-91	SUBURBAN 1/2 TON, R1500 All	
F	68-86	SUBURBAN 3/4 TON, C20 All	
F	87-88	SUBURBAN 3/4 TON, R20 All	
F	89-91	SUBURBAN 3/4 TON, R2500 All	
F	63-80	VAN 1/2 TON, P SERIES All	
F	68-90	VAN 1 TON, P SERIES All Cutaway Chassis	
F	68-89	VAN 3/4 TON, P SERIES All	
F	75-84	GMC JIMMY RWD	
F	70-74	JIMMY All RWD	
F	67-86	PICKUP 1/2 TON, C15 / C1500 All	
F	87	PICKUP 1/2 TON, R1500 All	
F	88-91	PICKUP 1 TON, C35/3500 Cab & Chassis	
F	67-78	PICKUP 1 TON, C35/3500 All	
F	87-91	PICKUP 1 TON, R3500 All	
F	75-86	PICKUP 3/4 TON, C25 / C2500 Cab & Chassis	
F	75-86	PICKUP 3/4 TON, C25 / C2500 Crew Cab Pickup	
F	75-86	PICKUP 3/4 TON, C25 / C2500 Standard Cab Pickup	
F	67-74	PICKUP 3/4 TON, C25 / C2500 All	
F	87-89	PICKUP 3/4 TON, R2500 All Exc. Crew Cab & Bonus Cab	
F	63-66	PICKUP 1000 SERIES All	
F	63-66	PICKUP 1500 SERIES All	
F	66	PICKUP 2500 SERIES All	
F	73-86	SUBURBAN 1/2 TON, C15 / C1500 All	
F	68-72	SUBURBAN 1/2 TON, C15 / C1500 All Coil (FrontSpringType)	
F	87-91	SUBURBAN 1/2 TON, R1500 All	
F	68-86	SUBURBAN 3/4 TON, C25 / C2500 All	
F	87-91	SUBURBAN 3/4 TON, R2500 All	
F	67-80	VAN 1/2 TON, P SERIES All	
F	75-90	VAN 1 TON, P SERIES All Cutaway Chassis	
F	73-74	VAN 1 TON, P SERIES Base Cutaway Chassis	
F	68-72	VAN 1 TON, P SERIES All	
F	68-89	VAN 3/4 TON, P SERIES All	
F	63-65	VAN, PB 1000 SERIES All	
81076	D		140496
F	70-77	FORD MAVERICK All	
F	67-70	MUSTANG / MUSTANG II All	
F	71-77	MERCURY COMET All	
F	67-70	COUGAR All	
81082	D		
R	85-96	FORD PICKUP 1/2 TON, F-150 RWD	
R	80-97	PICKUP 1 TON, F-350 / SUPERDUTY RWD Exc. Dual Rear Wheels	
R	97	PICKUP 3/4 TON, F-250 / SUPERDUTY RWD Over 8500# GVW	
R	80-96	PICKUP 3/4 TON, F-250 / SUPERDUTY RWD	
81091	W		
R	67-73	CHRYSLER IMPERIAL All	
R	70-73	NEWPORT All	
R	70-73	NEW YORKER All	
R	71-73	TOWN & COUNTRY All	
R	73	DODGE MONACO All	
R	71	MONACO All	
R	72-93	PICKUP 1/2 TON, D100 SERIES All	
R	72-93	PICKUP 1 TON, D300 SERIES All	
R	72-93	PICKUP 3/4 TON, D200 SERIES All	
R	73	POLARA All	

Numerical listing

Shock	POP	Alternative No.	MTG Acc. Supplied
Pos.	Year	Application	
81091	W	-continued	
R	71	POLARA All	
R	74-93	RAMCHARGER RWD	
R	70-73	PLYMOUTH FURY All	
R	73	FURY All Exc. Wagon	
R	73	GRAN FURY Hardtop	
R	72	GRAN FURY All	
R	75-81	TRAILDUSTER RWD	
R	74	TRAILDUSTER All	
81095	D	140524	
R	70-81	CHEVROLET CAMARO All	
R	70-81	PONTIAC FIREBIRD All	
81096	C	140126	
F	84-86	DODGE MINI RAM All	
F	72-93	PICKUP 1/2 TON, D100 SERIES All	
F	72-93	PICKUP 3/4 TON, D200 SERIES All	
F		Exc. HD Package	
F	75-93	RAMCHARGER RWD	
F	99-03	VAN 1/2 TON, A / B SERIES / RAM	
F		109.3 (WheelBase) Exc. 7000#	
F		GVW	
F	81-98	VAN 1/2 TON, A / B SERIES / RAM	
F		109.6 (WheelBase) Exc. 7000#	
F		GVW	
F	71-80	VAN 1/2 TON, A / B SERIES / RAM	
F		All	
F	99-03	VAN 1 TON, A / B SERIES / RAM All	
F	71-98	VAN 1 TON, A / B SERIES / RAM All	
F		Exc. 4000# Front Axle	
F	71-03	VAN 3/4 TON, A / B SERIES / RAM	
F		All	
F	74-80	VAN, CB300 All Exc. 4000# Front	
F		Axle	
F	75-81	PLYMOUTH TRAILDUSTER RWD	
F	74-83	VAN 1/2 TON, PB SERIES All	
F	74-83	VAN 1 TON, PB SERIES All Exc.	
F		4000# Front Axle	
F	74-83	VAN 3/4 TON, PB SERIES All	
81097	D	140524	
R	69-72	NISSAN 521 PICKUP All	
R	72-79	620 PICKUP All	
R	86	720 PICKUP RWD Mfg. to 8/86	
R	82-85	720 PICKUP RWD	
R	80-81	720 PICKUP All	
81108	D		
F	71-95	CHEVROLET VAN 1/2 TON, G /	
F		EXPRESS All	
F	70	VAN 1/2 TON, G / EXPRESS All	
F		Independent Front Suspension	
F	76-96	VAN 1 TON, G / EXPRESS All	
F	75	VAN 1 TON, G / EXPRESS 146.0	
F		(WheelBase)	
F	71-74	VAN 1 TON, G / EXPRESS All	
F	78-95	VAN 3/4 TON, G / EXPRESS All	
F		Exc. 8600# GVW	
F	71-77	VAN 3/4 TON, G / EXPRESS All	
F	70	VAN 3/4 TON, G / EXPRESS All	
F		Independent Front Suspension	
F	71-95	GMC VAN 1/2 TON, G / SAVANNA	
F		All	
F	70	VAN 1/2 TON, G / SAVANNA All	
F		Independent Front Suspension	
F	76-95	VAN 1 TON, G / SAVANNA All	
F	75	VAN 1 TON, G / SAVANNA 146.0	
F		(WheelBase)	
F	71-74	VAN 1 TON, G / SAVANNA All	
F	78-95	VAN 3/4 TON, G / SAVANNA All	
F		Exc. 8600# GVW	
F	71-77	VAN 3/4 TON, G / SAVANNA All	
F	70	VAN 3/4 TON, G / SAVANNA All	
F		Independent Front Suspension	
81113	W		
F	87-91	CHEVROLET BLAZER 4WD Full	
F		Size; Quad Suspension Short Shock;	
F		Exc. Lift Kit	
F	81-86	BLAZER 4WD Quad Suspension	
F		Short Shock; Exc. Lift Kit	
F	75-80	BLAZER 4WD Exc. Quad	
F		Suspension and Lift Kit	
F	73-74	BLAZER All 4WD; Exc. Lift Kit	
F	72	BLAZER All	
F	69-71	BLAZER All 4WD	
F	81-86	PICKUP 1/2 TON, K10 All Standard	
F		Suspension; Exc. Lift Kit	
F	69-80	PICKUP 1/2 TON, K10 All Exc. Lift	
F		Kit	
F	87	PICKUP 1/2 TON, V10 All Quad	
F		Suspension Short Shock; Exc. Lift	
F		Kit	
F	81-86	PICKUP 3/4 TON, K20 All Standard	
F		Suspension; Exc. Lift Kit	

Guardian Shock

Shock	POP	Alternative No.	MTG Acc. Supplied
Pos.	Year	Application	
81113	W	-continued	
F	69-80	PICKUP 3/4 TON, K20 All Exc. Lift	
F		Kit	
F	81-86	SUBURBAN 1/2 TON, K10 All	
F		Standard Suspension; Exc. Lift Kit	
F	69-80	SUBURBAN 1/2 TON, K10 All Exc.	
F		Lift Kit	
F	87-88	SUBURBAN 1/2 TON, V10 All Quad	
F		Suspension Short Shock; Exc. Lift	
F		Kit	
F	81-86	SUBURBAN 3/4 TON, K20 All	
F		Standard Suspension; Exc. Lift Kit	
F	69-80	SUBURBAN 3/4 TON, K20 All Exc.	
F		Lift Kit	
F	87-88	SUBURBAN 3/4 TON, V20 All Quad	
F		Suspension Short Shock; Exc. Lift	
F		Kit	
F	89-91	SUBURBAN 3/4 TON, V2500 All	
F		Quad Suspension Short Shock; Exc.	
F		Lift Kit	
F	75-91	GMC JIMMY 4WD Exc. Quad	
F		Suspension and Lift Kit	
F	70-74	JIMMY All 4WD; Exc. Quad	
F		Suspension and Lift Kit	
F	69-86	PICKUP 1/2 TON, K15 / K1500 All	
F		Exc. Quad Suspension and Lift Kit	
F	87	PICKUP 1/2 TON, V1500 All Quad	
F		Suspension Short Shock; Exc. Lift	
F		Kit	
F	69-86	PICKUP 3/4 TON, K25 / K2500 All	
F		Exc. Quad Suspension and Lift Kit	
F	87	PICKUP 3/4 TON, V2500 All Quad	
F		Suspension Short Shock; Exc. Lift	
F		Kit	
F	69-86	SUBURBAN 1/2 TON, K15 / K1500	
F		All Exc. Quad Suspension and Lift	
F		Kit	
F	87-91	SUBURBAN 1/2 TON, V1500 All	
F		Quad Suspension Short Shock; Exc.	
F		Lift Kit	
F	69-86	SUBURBAN 3/4 TON, K25 / K2500	
F		All Exc. Quad Suspension and Lift	
F		Kit	
F	87-91	SUBURBAN 3/4 TON, V2500 All	
F		Quad Suspension Short Shock; Exc.	
F		Lift Kit	
81147	B		
R	56	BUICK ROADMASTER All Exc. Air	
R		Suspension	
R	56	SPECIAL All	
R	56	SUPER All	
R	75-80	CHEVROLET LUV PICKUP All	
R	72-74	LUV PICKUP All	
F	55-56	PICKUP 3200	
F	55-56	PICKUP 3600	
F	55-56	PICKUP 3800	
F	56	PICKUP All 3100	
F	55	PICKUP 3100	
R	79-82	DODGE D50 RWD	
R	83-93	PICKUP, RAM 50 RWD	
F	61-65	FORD PICKUP 1/2 TON, F-100 All	
F	61-66	PICKUP 1 TON, F-350 /	
F		SUPERDUTY All	
F	61-64	PICKUP 3/4 TON, F-250 /	
F		SUPERDUTY All	
R	55	PICKUP F SERIES All F-100 Heavy	
R		Duty	
F	48-52	PICKUP F SERIES All F-1, F-2 & F-	
F		3	
F	68-75	PICKUP P350 All Up through 8000#	
F		GVW	
F	75-76	PICKUP P400 All Up through 8000#	
F		GVW	
R	68	INTERNATIONAL 908C All	
R	68	1000C All	
F	68	1100C All Exc. Travelette with 166"	
R		Wheelbase	
R	68	1100C All Exc. Travelette with 166"	
R		Wheelbase	
F	68	1200C All Exc. Travelette with 166"	
R		Wheelbase	
R	68	1200C All Exc. Travelette with 166"	
R		Wheelbase	
F	68	1300C All Exc. Travelette with 166"	
R		Wheelbase	
R	68	1300C All Exc. Travelette with 166"	
R		Wheelbase	
R	68-72	M1100 / M1200 All	
R	69	M1400 All	
R	72-83	JEEP CJ5 All Exc. Lift Kit	
R	66-71	CJ5 All Exc. 5 Leaf Front Springs &	
R		Lift Kit	
R	66-75	CJ6 All Exc. Lift Kit	
R	76-86	CJ7 All Exc. Lift Kit	

Numerical listing

Shock	POP	Alternative No.	MTG Acc. Supplied
Pos.	Year	Application	
81147	B	-continued	
R	66-74	DJ5 All Exc. Lift Kit	
R	66-68	DJ6 All	
R	57-60	FC150 All	
F	63-65	FC170 All	
R	63-65	FC170 All	
R	64-66	GLADIATOR All	
R	63	GLADIATOR All Independent Front	
R		Suspension	
R	70-73	JEEPSTER All	
R	81-85	SCRAMBLER / CJ8 All	
R	61-67	UNIVERSAL All Exc. CJ-3B	
R	86-87	MAZDA B2000 RWD	
R	87-93	B2200 RWD	
R	87-93	B2600 RWD	
R	95-96	MITSUBISHI MIGHTY MAX All	
R	83-94	MIGHTY MAX RWD	
R	87-90	VAN All	
R	98-04	NISSAN FRONTIER RWD Exc.	
R		Desert Runner	
R	87-97	PICKUP RWD	
R	86	PICKUP RWD Mfg. from 8/86	
R	79-82	PLYMOUTH PICKUP All	
R	49-60	STUDEBAKER R / E SERIES 1/2 /	
R		3/4 TON	
F	49-54	R / E SERIES 1/2 / 3/4 TON	
R	67-68	TOYOTA LAND CRUISER All	
R	84-95	PICKUP RWD Exc. 1 Ton	
R	75-83	PICKUP RWD Mojave	
R	70-74	PICKUP All RWD; Mojave	
R	84-88	VAN Leaf (RearSpringType)	
R	88	VAN WAGON All	
R		Leaf(RearSpringType)	
81153	W	140126	
F	75-79	CHRYSLER CORDOBA All	
F	79-81	NEWPORT All	
F	79-81	TOWN & COUNTRY All	
F	73-78	DODGE CHARGER All	
F	73-76	CORONET All	
F	78-79	MAGNUM All	
F	77-78	MONACO All	
F	79-81	ST. REGIS All	
F	75-78	PLYMOUTH FURY All	
F	80-81	GRAN FURY All	
F	73-75	ROADRUNNER All	
F	73-74	SATELLITE All	
81164	C	140357	
R	87-91	CHEVROLET BLAZER 4WD Full	
R		Size; Exc. Quad Suspension and Lift	
R		Kit	
R	85-86	BLAZER 4WD Exc. Lift Kit	
R	73-84	BLAZER All Exc. Lift Kit	
R	73-86	PICKUP 1/2 TON, C10 All	
R	73-86	PICKUP 1/2 TON, K10 All Exc. Lift	
R		Kit	
R	87	PICKUP 1/2 TON, R10 All	
R	87	PICKUP 1/2 TON, V10 All Exc. Lift	
R		Kit	
R	75-86	PICKUP 3/4 TON, C20 Standard	
R		Cab Pickup	
R	73-74	PICKUP 3/4 TON, C20 All Standard	
R		Cab Pickup	
R	73-86	PICKUP 3/4 TON, K20 All Exc. Lift	
R		Kit	
R	87	PICKUP 3/4 TON, R20 Standard	
R		Cab Pickup	
R	87	PICKUP 3/4 TON, V20 All Exc. Quad	
R		Suspension and Lift Kit	
R	73-86	SUBURBAN 1/2 TON, R1500 All	
R	75-86	SUBURBAN 1/2 TON, K10 All Exc.	
R		Lift Kit	
R	87-88	SUBURBAN 1/2 TON, R10 All	
R	89-91	SUBURBAN 1/2 TON, R1500 All	
R		Exc. Lift Kit	
R	73-86	SUBURBAN 3/4 TON, C20 All	
R	73-86	SUBURBAN 3/4 TON, K20 All Exc.	
R		Lift Kit	
R	87-88	SUBURBAN 3/4 TON, R20 All	
R	89-91	SUBURBAN 3/4 TON, R2500 All	
R	87-88	SUBURBAN 3/4 TON, V20 All Exc.	
R		Quad Suspension and Lift Kit	
R	89-91	SUBURBAN 3/4 TON, V2500 All	
R		Exc. Lift Kit	
R	73	VAN 1/2 TON, P SERIES All	
R	73-78	VAN 3/4 TON, P SERIES All	
R	73-91	GMC JIMMY All Exc. Lift Kit	
R	73-86	PICKUP 1/2 TON, C15 / C1500 All	
R	73-86	PICKUP 1/2 TON, K15 / K1500 All	
R		Exc. Lift Kit	
R	87	PICKUP 1/2 TON, R1500 All	
R	87	PICKUP 1/2 TON, V1500 All Exc. Lift	
R		Kit	

Numerical listing

Shock	POP	Alternative No.	MTG Acc. Supplied
Pos.	Year	Application	
81164	C	-continued	140357
R	75-86	PICKUP 3/4 TON, C25 / C2500 Cab & Chassis	
R	75-86	PICKUP 3/4 TON, C25 / C2500 Standard Cab Pickup	
R	73-86	PICKUP 3/4 TON, K25 / K2500 All Exc. Lift Kit	
R	88-89	PICKUP 3/4 TON, R2500 All Exc. Crew Cab & Bonus Cab	
R	87	PICKUP 3/4 TON, R2500 Cab & Chassis Exc. Crew Cab & Bonus Cab	
R	87	PICKUP 3/4 TON, R2500 Standard Cab Pickup Exc. Crew Cab & Bonus Cab	
R	87	PICKUP 3/4 TON, V2500 All Exc. Lift Kit	
R	73-86	SUBURBAN 1/2 TON, C15 / C1500 All	
R	73-86	SUBURBAN 1/2 TON, K15 / K1500 All Exc. Lift Kit	
R	87-91	SUBURBAN 1/2 TON, R1500 All	
R	87-91	SUBURBAN 1/2 TON, V1500 All Exc. Lift Kit	
R	75-86	SUBURBAN 3/4 TON, C25 / C2500 All	
R	73-74	SUBURBAN 3/4 TON, C25 / C2500 All Exc. Crew Cab & Bonus Cab	
R	73-86	SUBURBAN 3/4 TON, K25 / K2500 All Exc. Lift Kit	
R	87-91	SUBURBAN 3/4 TON, R2500 All	
R	87-91	SUBURBAN 3/4 TON, V2500 All Exc. Lift Kit	
R	73	VAN 1/2 TON, P SERIES All	
R	73-78	VAN 3/4 TON, P SERIES All	
81174	W		
R	73-86	CHEVROLET PICKUP 1 TON, C30 All	
R	88-91	PICKUP 1 TON, C35/3500 Cab & Chassis Exc. HD Solid Front Axle	
R	87-88	PICKUP 1 TON, R30 RWD	
R	89	PICKUP 1 TON, R3500 Standard Cab Pickup	
R	75-86	PICKUP 3/4 TON, C20 Crew Cab Pickup	
R	73-74	PICKUP 3/4 TON, C20 All Crew Cab Pickup	
R	87-88	PICKUP 3/4 TON, R20 Crew Cab Pickup	
R	89	PICKUP 3/4 TON, R2500 RWD	
R	74-80	VAN 1/2 TON, P SERIES All	
R	73-99	VAN 1 TON, P SERIES All	
R	79-89	VAN 3/4 TON, P SERIES All	
R	88-91	GMC PICKUP 1 TON, C35/3500 Cab & Chassis Exc. HD Solid Front Axle	
R	73-78	PICKUP 1 TON, C35/3500 All	
R	87-91	PICKUP 1 TON, R3500 All	
R	85-86	PICKUP 3/4 TON, C25 / C2500 Crew Cab Pickup	
R	75-83	PICKUP 3/4 TON, C25 / C2500 Crew Cab Pickup	
R	87-89	PICKUP 3/4 TON, R2500 Crew Cab Pickup	
R	74-80	VAN 1/2 TON, P SERIES All	
R	74-99	VAN 1 TON, P SERIES All	
R	73	VAN 1 TON, P SERIES Base Cutaway Chassis	
R	79-89	VAN 3/4 TON, P SERIES All	
81242	W		140126
R	66	FORD BRONCO All Thru Serial #830000	
R	73-79	PICKUP 1/2 TON, F-100 RWD	
R	70-72	PICKUP 1/2 TON, F-100 All RWD	
R	75-79	PICKUP 1/2 TON, F-150 RWD	
R	75-79	PICKUP 1 TON, F-350 / SUPERDUTY Extended Cab Pickup, RWD	
R	75-79	PICKUP 3/4 TON, F-250 / SUPERDUTY Cab & Chassis, RWD	
R	75-79	PICKUP 3/4 TON, F-250 / SUPERDUTY Standard Cab Pickup, RWD	
R	73-74	PICKUP 3/4 TON, F-250 / SUPERDUTY RWD Exc. Supercab	
R	70-72	PICKUP 3/4 TON, F-250 / SUPERDUTY All RWD; Exc. Supercab	
R	75-91	VAN 1/2 TON, ECONOLINE / CLUB WAGON All	
F	71-80	INTERNATIONAL SCOUT II All	

Guardian Shock

Shock	POP	Alternative No.	MTG Acc. Supplied
Pos.	Year	Application	
81270	C		140523
R	75-80	AMERICAN MOTORS PACER All	
F	58	BUICK CENTURY All	
F	58	LIMITED All	
F	58	ROADMASTER All Exc. Air Suspension	
F	58	SPECIAL All Exc. Air Suspension	
F	58	SUPER All Exc. Air Suspension	
F	55	CHEVROLET PICKUP All 1st Series	
F	54	PICKUP All	
F	50-53	PICKUP 3100	
F	50-53	PICKUP 3600	
F	50-53	PICKUP 3800	
R	90-92	DAIHATSU ROCKY All	
R	52-59	FORD COUNTRY SEDAN All	
R	52-56	COUNTRY SQUIRE All	
R	54-56	COURIER SEDAN DELIVERY All	
R	52-54	CRESTLINE All	
R	57	CUSTOM All	
R	52	CUSTOM All	
R	58	CUSTOM 300 All	
R	52-56	CUSTOMLINE All	
R	62-70	FAIRLANE All	
R	55-58	FAIRLANE All	
R	66-70	FALCON All Exc. Wagon	
R	60-65	FALCON All	
R	52-56	MAINLINE All	
R	65-73	MUSTANG / MUSTANG II All	
R	56	PARK LANE WAGON All	
R	60	PICKUP 1/2 TON, F-100 All	
R	60	PICKUP 1 TON, F-350 / SUPERDUTY All	
R	60	PICKUP 3/4 TON, F-250 / SUPERDUTY All	
F	57-59	PICKUP F SERIES All	
R	60-65	RANCHERO All	
R	52-56	RANCH WAGON All	
R	54-56	SKYLINER All	
R	52-58	SUNLINER All	
R	55-57	THUNDERBIRD All	
R	68-70	TORINO All Exc. Wagon	
R	52-58	VICTORIA All	
F	53-54	GMC PICKUP All	
R	62-64	JAGUAR XKE All	
R	72-77	MAZDA 808 Wagon Exc. Vehicles with Tokico O.E. Struts	
R	79-83	GLC Wagon	
R	78	GLC All	
R	74-76	RX3 Wagon	
R	72-73	RX3 All	
R	74-78	RX4 All	
R	59-60	MERCURY COLONY PARK All	
R	68-69	COMET All	
R	66-67	COMET Convertible	
R	66-67	COMET Hardtop	
R	66-67	COMET Sedan	
R	60-65	COMET All	
R	59-60	COMMUTER All	
R	67-73	COUGAR All	
R	59-60	COUNTRY CRUISER All	
R	68-71	CYCLONE All	
R	62-63	METEOR All	
R	59-60	MONTCLAIR All	
R	68-71	MONTGO All Exc. Wagon	
R	59-60	MONTEREY All	
R	59-60	PARKLANE All	
R	59	VOYAGER All	
R	69-78	SAAB 99 All	
R	59-68	VOLVO 122 All	
81285	W		140126
R	75-76	FORD PICKUP 1/2 TON, F-100 4WD Exc. Lift Kit	
R	71-74	PICKUP 1/2 TON, F-100 All 4WD; Lift Kit	
R	76-79	PICKUP 1/2 TON, F-150 4WD Exc. Lift Kit	
R	75	PICKUP 1/2 TON, F-150 All 4WD; Exc. Lift Kit	
R	79	PICKUP 1 TON, F-350 / SUPERDUTY 4WD	
R	77-79	PICKUP 3/4 TON, F-250 / SUPERDUTY Cab & Chassis, 4WD All From Serial No. Y20001	
R	77-79	PICKUP 3/4 TON, F-250 / SUPERDUTY Standard Cab Pickup, 4WD All From Serial No. Y20001	
R	75-91	VAN 1 TON, ECONOLINE / CLUB WAGON / SUPERDUTY All Exc. Cutaway Chassis	
R	75-91	VAN 3/4 TON, ECONOLINE / CLUB WAGON / SUPERDUTY All	
81318	C		141137
R	81-82	CHEVROLET LUV PICKUP All	

Numerical listing

Shock	POP	Alternative No.	MTG Acc. Supplied
Pos.	Year	Application	
81318	C	-continued	141137
R	55	PICKUP 3100	
R	87-89	DODGE RAIDER 2.6L 4Cyl L (156) Exc. Sport Utility	
F	61-67	FORD ECONOLINE All	
F	68-72	INTERNATIONAL M1100 / M1200 All	
R	89-94	ISUZU AMIGO All	
R	81-95	PICKUP All	
R	84-86	TROOPER 4WD	
R	86-92	JEEP COMANCHE All	
F	66-67	GLADIATOR All	
F	64-65	GLADIATOR All Exc. Independent Front Suspension	
F	68-73	J2500 PICKUP All	
F	66-73	WAGONEER All	
F	63-65	WAGONEER All Exc. Independent Front Suspension	
R	49-51	MERCURY MERCURY All	
R	50-51	MONTEREY All	
R	83-89	MITSUBISHI MONTERO 2.6L 4Cyl L (156)	
R	82-86	NISSAN 720 PICKUP 4WD	
R	00-04	FRONTIER Crew Cab Pickup, RWD with Desert Runner	
R	98-04	FRONTIER 4WD	
R	98-99	FRONTIER RWD Crew Cab with Desert Runner	
R	87-95	PATHFINDER All Exc. Electronic Adjustable Suspension	
R	87-97	PICKUP 4WD	
R	86	PICKUP 4WD Mfg. from 8/86	
R	57-60	PONTIAC BONNEVILLE All	
R	58-60	CATALINA All	
R	58	CHIEFTAIN All	
R	58-60	STAR CHIEF All	
R	58	SUPER CHIEF All	
R	60	VENTURA All	
R	84-87	TOYOTA LAND CRUISER FJ60 (MfrBodyCode), Sport Utility	
R	75-83	LAND CRUISER All	
R	69-74	LAND CRUISER All Wagon	
R	85-92	PICKUP RWD 1 Ton	
R	80-83	PICKUP 4WD Exc. Lift Kit	
81322	W		141041
F	76-87	CHEVROLET CHEVETTE All	
F	81-84	ISUZU I-MARK All	
F	83-89	IMPULSE All	
F	69-73	OPEL OPEL All	
F	76-87	PONTIAC ACADIAN All	
F	81-87	T1000 All	
81338	W		140873
R	77-83	CHRYSLER CORDOBA All	
R	83-89	FIFTH AVENUE All	
R	81-83	IMPERIAL All	
R	81	LEBARON All M Body	
R	77-80	LEBARON All	
R	79-81	NEWPORT All	
R	79-82	NEW YORKER All	
R	79-81	TOWN & COUNTRY All	
R	76-80	DODGE ASPEN All	
R	77-78	CHARGER All	
R	77-89	DIPLOMAT All	
R	78-79	MAGNUM All	
R	80-83	MIRADA All	
R	77-78	MONACO All	
R	79-81	ST. REGIS All	
R	88-89	PLYMOUTH CARAVELLE RWD	
R	78-81	CARAVELLE RWD	
R	77-78	FURY All	
R	80-89	GRAN FURY All	
R	76-80	VOLARE All	
81340	D		141041
R	70-74	AMERICAN MOTORS AMBASSADOR All	
R	70	AMX All	
R	80-88	EAGLE All	
R	70-74	JAVELIN All	
R	71-78	MATADOR All	
R	76-87	CHEVROLET CHEVETTE All	
R	83-89	ISUZU IMPULSE All	
R	72	NISSAN 510 All	
R	74-77	710 Hardtop	
R	74-77	710 Sedan	
R	76-87	PONTIAC ACADIAN All	
R	81-87	T1000 All	
R	76-79	TOYOTA COROLLA Coupe	
R	72-79	COROLLA Sedan	
R	75-78	COROLLA Hardtop	
R	72-74	COROLLA Coupe	
R	79-81	CORONA Wagon	
R	73-76	CORONA Sedan	

Numerical listing

Shock	POP	Alternative No.	MTG Acc. Supplied
Pos.	Year	Application	
81340	D	-continued	141041
R	73-74	CORONA Hardtop	
R	72	CORONA Mark II Exc. Wagon	
R	78-80	CRESSIDA Wagon	
F	75-79	LAND CRUISER FJ55 (MfrBodyCode), Sport Utility	
F	69-74	LAND CRUISER All	
81342	W		
R	81-93	DODGE PICKUP 1/2 TON, W100 SERIES All Exc. Lift Kit	
R	72-80	PICKUP 1/2 TON, W100 SERIES All	
R	81-93	PICKUP 1 TON, W300 SERIES All Exc. Quad Suspension and Lift Kit	
R	72-80	PICKUP 1 TON, W300 SERIES All	
R	90-93	PICKUP 3/4 TON, W200 SERIES Extended Cab Pickup Exc. Lift Kit	
R	88-93	PICKUP 3/4 TON, W200 SERIES Cab & Chassis Exc. Lift Kit	
R	81-93	PICKUP 3/4 TON, W200 SERIES Standard Cab Pickup Exc. Lift Kit	
R	86	PICKUP 3/4 TON, W200 SERIES Cab & Chassis Exc. Lift Kit	
R	81-83	PICKUP 3/4 TON, W200 SERIES Cab & Chassis Exc. Lift Kit	
R	81-82	PICKUP 3/4 TON, W200 SERIES Extended Cab Pickup Exc. Lift Kit	
R	72-80	PICKUP 3/4 TON, W200 SERIES All	
R	76-93	RAMCHARGER 4WD	
R	78-80	RD200 All	
R	76-81	PLYMOUTH TRAILDUSTER 4WD	
81394	D		140780
F	78-79	FORD BRONCO All Quad Suspension; Rearward of Front Axle; Non Quad Suspension, Right Shock; Exc. Lift Kit	
F	66-77	BRONCO All From Serial #830001; Exc. Lift Kit	
F	73-79	PICKUP 1/2 TON, F-100 RWD	
F	65-72	PICKUP 1/2 TON, F-100 All RWD	
F	78-79	PICKUP 1/2 TON, F-150 RWD Quad Suspension; Rearward of Front Axle; Non Quad Suspension, Right Shock; Exc. Lift Kit	
F	75-77	PICKUP 1/2 TON, F-150 RWD	
F	75-79	PICKUP 1 TON, F-350 / SUPERDUTY RWD	
F	67-74	PICKUP 1 TON, F-350 / SUPERDUTY All RWD	
F	73-79	PICKUP 3/4 TON, F-250 / SUPERDUTY RWD	
F	65-72	PICKUP 3/4 TON, F-250 / SUPERDUTY All RWD	
F	75-91	VAN 1 TON, ECONOLINE / CLUB WAGON / SUPERDUTY All Exc. Cutaway Chassis	
F	75-91	VAN 3/4 TON, ECONOLINE / CLUB WAGON / SUPERDUTY All	
81406	W		140873,140126
F	80-83	CHRYSLER CORDOBA All	
F	83-89	FIFTH AVENUE All	
F	81-83	IMPERIAL All	
F	74-75	IMPERIAL All	
F	77-81	LEBARON All	
F	74-78	NEWPORT All	
F	74-82	NEW YORKER All	
F	74-78	TOWN & COUNTRY All	
F	76-80	DODGE ASPEN All	
F	77-89	DIPLOMAT All	
F	80-83	MIRADA All	
F	74-76	MONACO All	
F	75-77	ROYAL MONACO All	
F	85-89	PLYMOUTH CARAVELLE All	
F	78-81	CARAVELLE RWD	
F	82-89	GRAN FURY All	
F	74-77	GRAN FURY All	
F	76-80	VOLARE All	
81416	D		141045
R	78-85	TOYOTA CELICA All	
R	75-83	COROLLA Wagon	
R	74	COROLLA All Mfg. from 8/74; Wagon	
R	79-82	CORONA Hatchback	
R	79-82	CORONA Sedan	
R	81-87	CRESSIDA Wagon	
81438	W		141184
R	75-80	BUICK SKYHAWK All	
R	75-80	CHEVROLET MONZA All	
R	72-77	VEGA All	
R	75-80	OLDSMOBILE STARFIRE All	
R	75-77	PONTIAC ASTRE All	
R	76-80	SUNBIRD All	

Guardian Shock

Shock	POP	Alternative No.	MTG Acc. Supplied
Pos.	Year	Application	
81440	W		141045
R	85-88	TOYOTA CRESSIDA Sedan Exc. Electronic Adjustable Suspension	
R	83-84	CRESSIDA Sedan	
R	81-82	CRESSIDA Sedan Exc. Electronic Adjustable Suspension	
R	78-80	CRESSIDA Sedan	
R	81-84	STARLET All	
81445	W		141073
F	79-85	BUICK RIVIERA All	
F	79-85	CADILLAC ELDORADO All	
F	80-85	SEVILLE All	
F	79-85	OLDSMOBILE TORONADO All	
81446	A		141041
F	71-73	BUICK CENTURION All	
F	71-84	ELECTRA All	
F	87	ESTATE WAGON	
F	71-83	ESTATE WAGON All	
F	71-85	LESABRE All	
F	71-78	RIVIERA All	
F	92-96	ROADMASTER All	
F	91	ROADMASTER Wagon	
F	87-92	CADILLAC BROUGHAM All	
F	92-96	COMMERCIAL CHASSIS RWD	
F	77-84	COMMERCIAL CHASSIS All	
F	77-84	DEVILLE All	
F	93-96	FLEETWOOD RWD	
F	77-86	FLEETWOOD RWD	
F	81	CHEVROLET BEL AIR Sedan	
F	71-75	BEL AIR Sedan	
F	65-70	BEL AIR All	
F	65-72	BISCAYNE All Exc. Police and Taxi Models	
F	69-72	BROOKWOOD All	
F	70-81	CAMARO All	
F	73-96	CAPRICE Wagon	
F	71-72	CAPRICE Hardtop Exc. Police and Taxi Models	
F	70	CAPRICE Hardtop	
F	66-69	CAPRICE All	
F	94-96	IMPALA All	
F	83-85	IMPALA All	
F	67-82	IMPALA Wagon	
F	66	IMPALA Wagon Exc. Police and Taxi Models	
F	65	IMPALA Wagon	
F	69-72	KINGSWOOD All	
F	69-72	TOWNSMAN All	
F	65-74	FORD COUNTRY SEDAN All	
F	87-91	COUNTRY SQUIRE All	
F	65-74	COUNTRY SQUIRE All	
F	93-02	CROWN VICTORIA Base	
F	93-02	CROWN VICTORIA LX	
F	93-02	CROWN VICTORIA S	
F	02	CROWN VICTORIA LWB	
F	92	CROWN VICTORIA All	
F	65-72	CUSTOM All	
F	68-77	CUSTOM 500 All	
F	75-76	ELITE All	
F	65-67	GALAXIE All	
F	68-74	GALAXIE 500 All	
F	64-66	GALAXIE 500 All	
F	01-02	GRAND MARQUIS All	
F	87-91	LTD / COUNTRY SEDAN / COUNTRY SQUIRE / CROWN VICTORIA All	
F	85-86	LTD / COUNTRY SEDAN / COUNTRY SQUIRE / CROWN VICTORIA Crown Victoria	
F	65-82	LTD / COUNTRY SEDAN / COUNTRY SQUIRE / CROWN VICTORIA All	
F	77-79	LTD II All	
F	72-79	RANCHERO All	
F	65-74	RANCH WAGON All	
F	67-79	THUNDERBIRD All	
F	72-76	TORINO All	
F	70-80	LINCOLN CONTINENTAL All	
F	68-71	MARK III All	
F	72-76	MARK IV All	
F	77-79	MARK V All	
F	80-83	MARK VI All	
F	81-02	TOWN CAR All	
F	67	MERCURY BROUGHAM All	
F	87-91	COLONY PARK All	
F	65-74	COLONY PARK All	
F	65-68	COMMUTER All	
F	74-79	COUGAR All	
F	75-02	GRAND MARQUIS All	
F	69-70	MARAUDER All	
F	65-67	MARAUDER All	
F	67-82	MARQUIS All	
F	65-68	MONTCLAIR All	

Numerical listing

Shock	POP	Alternative No.	MTG Acc. Supplied
Pos.	Year	Application	
81446	A	-continued	141041
F	72-76	MONTEGO All	
F	65-74	MONTEREY All	
F	65-68	PARKLANE All	
F	65-67	VILLAGER All	
F	66-67	VOYAGER All	
F	71-85	OLDSMOBILE 88 SERIES All	
F	71-84	98 All	
F	71-92	CUSTOM CRUISER All	
F	71-81	PONTIAC BONNEVILLE All	
F	71-81	CATALINA All	
F	70-81	FIREBIRD All	
F	71-78	GRAND SAFARI All	
F	76-81	LAURENTIAN All	
F	76-86	PARISIENNE All	
F	87-89	SAFARI All	
81450	W		
R	80-87	SUBARU BRAT All	
R	80-84	DL All	
R	85-89	GL Hatchback	
R	80-84	GL All	
81459	W		
R	84-93	CHRYSLER DAYTONA All	
R	83-84	E CLASS All	
R	85	EXECUTIVE LIMOUSINE All	
R	83-84	EXECUTIVE SEDAN All	
R	90-93	IMPERIAL All Exc. Hydraulic Self Leveling System	
R	84-86	LASER All	
R	82-95	LEBARON All	
R	81	LEBARON All Exc. M Body	
R	88-93	NEW YORKER All Exc. Hydraulic Self Leveling System	
R	83-87	NEW YORKER All	
R	86-88	TOWN & COUNTRY All	
R	82-83	DODGE 400 All	
R	87-88	600 All	
R	86	600 All Mfg. to 2/86	
R	83-85	600 All	
R	81-89	ARIES All	
R	92-93	DAYTONA Iroc R/T	
R	91-93	DAYTONA Iroc	
R	89-93	DAYTONA ES	
R	89-90	DAYTONA ES Turbo	
R	87-88	DAYTONA Pacifica	
R	86	DAYTONA Turbo Z	
R	84-85	DAYTONA Turbo	
R	85-89	LANCER All	
R	87-94	SHADOW All	
R	89-95	SPIRIT All	
R	89-95	PLYMOUTH ACCLAIM All	
R	88	CARAVELLE FWD	
R	83-87	CARAVELLE All	
R	81-89	RELIANT All	
R	87-94	SUNDANCE All	
81460	W		141282
R	78-83	FORD FAIRMONT All	
R	81-82	GRANADA All	
R	83-86	LTD / COUNTRY SEDAN / COUNTRY SQUIRE / CROWN VICTORIA All	
R	87-93	MUSTANG / MUSTANG II LX, 2.3L 4Cyl (140)	
R	84-86	MUSTANG / MUSTANG II LX	
R	82-84	MUSTANG / MUSTANG II L	
R	82-83	MUSTANG / MUSTANG II GL	
R	82-83	MUSTANG / MUSTANG II GLX	
R	82	MUSTANG / MUSTANG II Ghia	
R	79-81	MUSTANG / MUSTANG II All	
R	79-86	MERCURY CAPRI All	
R	81-82	COUGAR Base	
R	82	COUGAR GS	
R	82	COUGAR LS	
R	83-86	MARQUIS All	
R	78-83	ZEPHYR All	
81461	W		140126
R	87-88	FORD THUNDERBIRD Non-ABS	
R	80-86	THUNDERBIRD All	
R	82-87	LINCOLN CONTINENTAL All	
R	84-92	MARK VII All	
R	83-88	MERCURY COUGAR All	
R	80-82	COUGAR XR-7	
81464	D		
R	84-91	DODGE COLT Vista, Wagon, FWD	
R	79-83	COLT Hatchback	
R	89-91	EAGLE VISTA Wagon, FWD	
R	86-94	HYUNDAI EXCEL All	
R	84-87	PONY All	
R	91-95	SCOUPÉ All	
R	83-88	MIITSUBISHI CORDIA All	
R	90-94	PRECIS All	

Numerical listing

Shock	POP	Alternative No.	MTG Acc. Supplied
Pos.	Year	Application	
81464	D	-continued	
R	83-88	TREDIA All	
R	79-82	PLYMOUTH CHAMP All	
R	92-94	COLT Sedan	
R	92	COLT Hatchback, FWD	
R	84-91	COLT Vista, Wagon, FWD	
R	80-83	COLT Hatchback	
81469	D		
R	57-64	CHRYSLER 300 All	
R	57-66	IMPERIAL All	
R	55	IMPERIAL All	
R	55-56	NASSAU All	
R	51-64	NEWPORT All	
R	51-64	NEW YORKER All	
R	57-60	SARATOGA All	
R	51-52	SARATOGA All	
R	55-56	ST REGIS All	
R	51-64	TOWN & COUNTRY All	
R	51-61	WINDSOR All	
R	62-64	DODGE 880 All	
R	64-70	A100 TRUCK All	
R	51-59	CORONET All	
R	54-61	CUSTOM All	
R	63-76	DART All	
R	60-61	DART All	
R	61-62	LANCER All	
R	51-54	MEADOWBROOK All	
R	60-61	POLARA All	
R	64-70	VAN 1/2 TON, A / B SERIES / RAM All	
R	58-59	EDSEL CORSAIR All Exc. Wagon	
R	58-59	RANGER All Exc. Wagon	
R	58-59	VILLAGER All Exc. Wagon	
R	64-69	PLYMOUTH BARRACUDA All	
R	53-61	BELVEDERE All	
R	51-53	CAMBRIDGE All	
R	51-52	CONCORD All	
R	51-53	CRANBROOK All	
R	58-61	CUSTOM All	
R	70-76	DUSTER All	
R	60-61	FLEET SPECIAL All	
R	56-61	FURY All	
R	54-58	PLAZA All	
R	53-61	SAVOY All	
R	71-76	SCAMP All	
R	60-61	SPORT WAGON All	
R	51-61	SUBURBAN All	
R	60-76	VALIANT All	
81478	D		140857
F	81-82	CHEVROLET LUV PICKUP RWD	
F	81-95	ISUZU PICKUP RWD	
F	69-72	NISSAN 521 PICKUP All	
F	72-79	620 PICKUP All	
F	80-86	720 PICKUP All	
F	87-97	PICKUP 4WD	
F	86	PICKUP 4WD Mfg. from 8/86	
81481	D		142261
R	82-02	CHEVROLET CAMARO All	
R	82-02	PONTIAC FIREBIRD All	
81482	A		
R	05	CHEVROLET BLAZER Base, 4WD	
R	05	BLAZER Base, RWD	
R	96-04	BLAZER LS, 4WD	
R	96-04	BLAZER LS, RWD	
R	95-02	BLAZER LT, RWD	
R	95-01	BLAZER LT, 4WD	
R	95-99	BLAZER Base, 4WD	
R	95-99	BLAZER Base, RWD	
R	95-97	BLAZER Deluxe, RWD	
R	83-94	BLAZER, S MODELS All	
R	98-04	S10 LS, 4WD	
R	99-03	S10 Base, 4WD	
R	99-03	S10 LS, RWD	
R	98-03	S10 Base, RWD	
R	94-97	S10 LS	
R	82-97	S10 Base	
R	92-93	S10 EL	
R	83-92	S10 Tahoe	
R	88-90	S10 Durango	
R	82-86	S10 Durango	
R	05	GMC JIMMY 4WD	
R	92-04	JIMMY All	
R	83-91	S15 JIMMY All	
R	82-04	SONOMA / S15 All	
R	91	SYCLONE All	
R	92-93	TYPHOON All	
R	96-00	ISUZU HOMBRE All	
R	96-01	OLDSMOBILE BRAVADA All	
R	91-94	BRAVADA All	
81484	D		141137
R	78-79	FORD BRONCO All Exc. Lift Kit	

Guardian Shock

Shock	POP	Alternative No.	MTG Acc. Supplied
Pos.	Year	Application	
81484	D	-continued	141137
R	66-77	BRONCO All From Serial #830001; Exc. Lift Kit	
R	65-69	PICKUP 1/2 TON, F-100 All RWD; w/Front Coil Springs	
R	75-79	PICKUP 1 TON, F-350 / SUPERDUTY Standard Cab Pickup, RWD	
R	73-74	PICKUP 1 TON, F-350 / SUPERDUTY All RWD; Exc. Supercab	
R	75-79	PICKUP 3/4 TON, F-250 / SUPERDUTY Extended Cab Pickup, RWD	
R	73-74	PICKUP 3/4 TON, F-250 / SUPERDUTY RWD Supercab	
R	65-72	PICKUP 3/4 TON, F-250 / SUPERDUTY All RWD; Supercab	
R	69-74	VAN 1/2 TON, ECONOLINE / CLUB WAGON All	
R	69-74	VAN 1 TON, ECONOLINE / CLUB WAGON / SUPERDUTY All	
R	69-74	VAN 3/4 TON, ECONOLINE / CLUB WAGON / SUPERDUTY All	
R	76-83	JEEP CHEROKEE All	
F	74-83	CHEROKEE All	
F	82-83	CJ5 All Exc. Lift Kit	
F	82-86	CJ7 All Exc. Lift Kit	
R	67	GLADIATOR All	
F	93	GRAND WAGONEER All	
R	93	GRAND WAGONEER All	
F	84-91	GRAND WAGONEER All	
R	84-91	GRAND WAGONEER All	
F	74-88	J10 PICKUP All	
R	74-88	J10 PICKUP All	
F	74-88	J20 PICKUP All	
R	74-88	J20 PICKUP All	
R	68-73	J2500 PICKUP All	
F	82-85	SCRAMBLER / CJ8 All	
R	76-83	WAGONEER All	
F	74-83	WAGONEER All	
81490	B		140780
F	80-96	FORD BRONCO All Quad & Non Quad Suspensions Rearward of Front Axle; Exc. Lift Kit	
F	89	BRONCO II All Mfg. to 2/89; Vehicles with 10mm & 12mm bolt in rear lower mount	
F	84-88	BRONCO II All With 10mm Bolt In Rear Lower Mount	
F	86	F-200 All	
F	80-83	PICKUP 1/2 TON, F-100 RWD	
F	80-96	PICKUP 1/2 TON, F-150 4WD Quad & Non Quad Suspensions Rearward of Front Axle; Exc. Lift Kit	
F	80-96	PICKUP 1/2 TON, F-150 RWD	
F	80-97	PICKUP 1 TON, F-350 / SUPERDUTY RWD	
F	97	PICKUP 3/4 TON, F-250 / SUPERDUTY RWD Over 8500# GVW	
F	80-96	PICKUP 3/4 TON, F-250 / SUPERDUTY RWD	
F	87-89	RANGER All Exc. High Ryder Option	
F	83-86	RANGER All	
81491	D		141164
F	80-88	AMERICAN MOTORS EAGLE All	
F	75-80	FORD GRANADA All	
F	71-73	MUSTANG / MUSTANG II All	
F	77-80	LINCOLN VERSAILLES All	
F	71-73	MERCURY COUGAR All	
F	75-80	MONARCH All	
81492	C		140629
R	73-81	BUICK CENTURY All	
R	87	ESTATE WAGON	
R	71-83	ESTATE WAGON All	
R	65-67	GRAN SPORT All	
R	68-72	GS / GS350 / GS400 / GS455 All	
R	73-87	REGAL All	
R	91-96	ROADMASTER Wagon	
R	68-72	SKYLARK All	
R	64-67	SKYLARK All HD Suspension; Exc. Sportwagon	
R	68-69	SPECIAL All	
R	64-67	SPECIAL All HD Suspension; Exc. Sportwagon	
R	70-72	SPORTWAGON All	
R	71-72	CHEVROLET BROOKWOOD All	
R	71-96	CAPRICE Wagon	
R	68-73	CHEVELLE All	
R	64-67	CHEVELLE All HD Suspension	

Numerical listing

Shock	POP	Alternative No.	MTG Acc. Supplied
Pos.	Year	Application	
81492	C	-continued	140629
R	68-87	EL CAMINO All	
R	71-82	IMPALA Wagon	
R	71-72	KINGSWOOD All	
R	73-83	MALIBU All	
R	64-67	MALIBU All HD Suspension	
R	70-88	MONTE CARLO All	
R	71-72	TOWNSMAN All	
R	78-87	GMC SPRINT / CABALLERO RWD	
R	71-77	SPRINT / CABALLERO All	
R	73-76	NISSAN 610 Wagon	
R	74-77	710 Wagon	
R	77-80	810 Wagon	
R	71-92	OLDSMOBILE CUSTOM CRUISER All	
R	68-87	CUTLASS / CUTLASS SUPREME All	
R	72	CUTLASS / CUTLASS SUPREME Base	
R	72	CUTLASS / CUTLASS SUPREME S	
R	64-67	CUTLASS / CUTLASS SUPREME All HD Suspension	
R	80-83	CUTLASS CLASSIC / CUTLASS CRUISER All	
R	68-72	F85 All	
R	61-67	F85 All HD Suspension	
R	71-78	TORONADO All	
R	82-86	PONTIAC BONNEVILLE All	
R	77-81	CATALINA Wagon	
R	71-75	CATALINA Wagon	
R	78-80	GRAND AM All	
R	73-75	GRAND AM All	
R	75-83	GRAND LEMANS All	
R	69-87	GRAND PRIX All	
R	71-78	GRAND SAFARI All	
R	71-75	GRANDVILLE All	
R	68-73	GTO All	
R	64-67	GTO All HD Suspension	
R	68-81	LEMANS All	
R	64-67	LEMANS All HD Suspension	
R	80-86	PARISIENNE Wagon	
R	76-79	PARISIENNE All Wagon	
R	87-89	SAFARI All	
R	68-70	TEMPEST All	
R	64-67	TEMPEST All HD Suspension	
81494	C		140455
F	73-75	BUICK APOLLO All	
F	73-81	CENTURY All	
F	68-72	GS / GS350 / GS400 / GS455 All	
F	73-87	REGAL All	
F	75-79	SKYLARK All	
F	68-72	SKYLARK All	
F	68-69	SPECIAL All	
F	68-72	SPORTWAGON All	
F	76-79	CADILLAC SEVILLE All	
F	67-69	CHEVROLET CAMARO All	
F	68-73	CHEVELLE All	
F	68	CHEVY II All	
F	73-83	MALIBU All	
F	70-88	MONTE CARLO All	
F	69-79	NOVA All	
F	64-65	NISSAN 410 All	
F	64-67	411 All	
F	68-87	OLDSMOBILE CUTLASS / CUTLASS SUPREME All	
F	80-83	CUTLASS CLASSIC / CUTLASS CRUISER All	
F	68-72	F85 All	
F	74-79	OMEGA All	
F	73	OMEGA All Exc. HD Suspension	
F	82-86	PONTIAC BONNEVILLE All	
F	67-69	FIREBIRD All	
F	78-80	GRAND AM All	
F	73-75	GRAND AM All	
F	75-83	GRAND LEMANS All	
F	69-87	GRAND PRIX All	
F	71-75	GRANDVILLE All	
F	68-73	GTO All	
F	68-81	LEMANS All	
F	77-79	PHOENIX All	
F	68-70	TEMPEST All	
F	71-77	VENTURA All	
F	67-78	TOYOTA CORONA All	
F	68-75	VOLVO 142 / 144 / 145 / 164 All	
81495	B		141150
R	61-63	BUICK SKYLARK All	
R	61-63	SPECIAL All	
R	64-69	SPORTWAGON All	
R	68-69	CHEVROLET CAMARO All Multi-Leaf Rear Spring	
R	65-74	FORD COUNTRY SEDAN All	
R	87-91	COUNTRY SQUIRE All	
R	65-74	COUNTRY SQUIRE All	

Numerical listing

Shock	POP	Alternative No.	MTG Acc. Supplied
Pos.	Year	Application	
81495	B	-continued	141150
R	92-02	CROWN VICTORIA All	
R	65-72	CUSTOM All	
R	68-77	CUSTOM 500 All	
R	75-76	ELITE All	
R	66-70	FALCON All Wagon	
R	65-67	GALAXIE All	
R	68-74	GALAXIE 500 All	
R	64-66	GALAXIE 500 All	
R	01-02	GRAND MARQUIS All	
R	87-91	LTD / COUNTRY SEDAN / COUNTRY SQUIRE / CROWN VICTORIA All	
R	65-82	LTD / COUNTRY SEDAN / COUNTRY SQUIRE / CROWN VICTORIA All	
R	77-79	LTD II All	
R	66-79	RANCHERO All	
R	65-74	RANCH WAGON All	
R	77-79	THUNDERBIRD All	
R	67-72	THUNDERBIRD All	
R	74-76	TORINO Wagon	
R	71	TORINO Wagon	
R	70-80	LINCOLN CONTINENTAL All	
R	68-71	MARK III All	
R	72	MARK IV All	
R	80-83	MARK VI All	
R	81-02	TOWN CAR All	
R	67	MERCURY BROUGHAM All	
R	87-91	COLONY PARK All	
R	65-74	COLONY PARK All	
R	66-67	COMET Wagon	
R	65-68	COMMUTER All	
R	74-79	COUGAR All	
R	75-02	GRAND MARQUIS All	
R	69-70	MARAUDER All	
R	65-67	MARAUDER All	
R	67-82	MARQUIS All	
R	65-68	MONTECLAIR All	
R	74-76	MONTEGO Wagon	
R	68-73	MONTEGO All Wagon	
R	65-74	MONTEREY All	
R	65-68	PARKLANE All	
R	65-67	VILLAGER All	
R	66-67	VOYAGER All	
R	64-72	OLDSMOBILE VISTA CRUISER All Stud Upper Mount	
R	68-69	PONTIAC FIREBIRD All	
81496	D		
F	87-91	CHEVROLET BLAZER 4WD Full Size; Quad Suspension Long Shock; Exc. Lift Kit	
F	81-86	BLAZER 4WD Quad Suspension Long Shock; Exc. Lift Kit	
F	81-86	PICKUP 1/2 TON, K10 All Quad Suspension Long Shock; Exc. Lift Kit	
F	87	PICKUP 1/2 TON, V10 All Quad Suspension Long Shock; Exc. Lift Kit	
F	81-86	PICKUP 3/4 TON, K20 All Quad Suspension Long Shock; Exc. Lift Kit	
F	87	PICKUP 3/4 TON, V20 All Quad Suspension Long Shock; Exc. Lift Kit	
F	81-86	SUBURBAN 1/2 TON, K10 All Quad Suspension Long Shock; Exc. Lift Kit	
F	87-88	SUBURBAN 1/2 TON, V10 All Quad Suspension Long Shock; Exc. Lift Kit	
F	81-86	SUBURBAN 3/4 TON, K20 All Quad Suspension Long Shock; Exc. Lift Kit	
F	87-88	SUBURBAN 3/4 TON, V20 All Quad Suspension Long Shock; Exc. Lift Kit	
F	89-91	SUBURBAN 3/4 TON, V2500 All Quad Suspension Long Shock; Exc. Lift Kit	
R	78-95	VAN 1/2 TON, G / EXPRESS All	
R	78-95	VAN 1 TON, G / EXPRESS Cutaway Van	
R	78-95	VAN 3/4 TON, G / EXPRESS All Exc. 8600# GVW	
R	84-86	DODGE MINI RAM All	
R	99-03	VAN 1/2 TON, A / B SERIES / RAM 109.3 (WheelBase) Exc. 7000# GVW	
R	81-98	VAN 1/2 TON, A / B SERIES / RAM 109.6 (WheelBase) Exc. 7000# GVW	
R	71-80	VAN 1/2 TON, A / B SERIES / RAM All	
R	99-03	VAN 1 TON, A / B SERIES / RAM All	
R	95-98	VAN 1 TON, A / B SERIES / RAM All Exc. 4000# Front Axle	
R	71-94	VAN 1 TON, A / B SERIES / RAM All	
R	71-03	VAN 3/4 TON, A / B SERIES / RAM All	
R	74-80	VAN, CB300 All	

Guardian Shock

Shock	POP	Alternative No.	MTG Acc. Supplied
Pos.	Year	Application	
81496	D	-continued	
F	73-91	GMC JIMMY 4WD Quad Suspension Long Shock; Exc. Lift Kit	
F	81-86	PICKUP 1/2 TON, K15 / K1500 All Quad Suspension Long Shock; Exc. Lift Kit	
F	87	PICKUP 1/2 TON, V1500 All Quad Suspension Long Shock; Exc. Lift Kit	
F	87-88	PICKUP 1 TON, V3000 / V3500 All Quad Suspension Long Shock; Exc. Lift Kit	
F	81-86	PICKUP 3/4 TON, K25 / K2500 All Quad Suspension Long Shock; Exc. Lift Kit	
F	87	PICKUP 3/4 TON, V2500 All Quad Suspension Long Shock; Exc. Lift Kit	
F	81-86	SUBURBAN 1/2 TON, K15 / K1500 All Quad Suspension Long Shock; Exc. Lift Kit	
F	87-91	SUBURBAN 1/2 TON, V1500 All Quad Suspension Long Shock; Exc. Lift Kit	
F	81-86	SUBURBAN 3/4 TON, K25 / K2500 All Quad Suspension Long Shock; Exc. Lift Kit	
F	87-91	SUBURBAN 3/4 TON, V2500 All Quad Suspension Long Shock; Exc. Lift Kit	
R	78-95	VAN 1/2 TON, G / SAVANNA All	
R	85-96	VAN 1 TON, G / SAVANNA Extended Cargo Van	
R	85-96	VAN 1 TON, G / SAVANNA Extended Passenger Van	
R	79-96	VAN 1 TON, G / SAVANNA Standard Cargo Van	
R	79-96	VAN 1 TON, G / SAVANNA Standard Passenger Van	
R	78	VAN 1 TON, G / SAVANNA Cutaway Van	
R	78-95	VAN 3/4 TON, G / SAVANNA All Exc. 8600# GVW	
R	74-83	PLYMOUTH VAN 1/2 TON, PB SERIES All	
R	74-83	VAN 1 TON, PB SERIES All	
R	74-83	VAN 3/4 TON, PB SERIES All	
81498	D		141045
R	88-91	TOYOTA COROLLA Wagon	
R	80-87	COROLLA Coupe	
R	80-83	COROLLA Hatchback	
R	80-83	COROLLA Sedan	
R	83	COROLLA Hardtop	
R	83-88	TERCEL Wagon, 4WD	
81501	W		140862
R	84	NISSAN 200SX All Solid Rear Axle	
R	77-83	200SX All	
R	79-82	210 All	
R	78-81	510 Hatchback	
R	78-81	510 Sedan	
R	71-73	1200 All	
R	74-78	B210 All	
81507	B		140857
F	81-82	CHEVROLET LUV PICKUP 4WD	
F	75-80	LUV PICKUP All	
F	72-74	LUV PICKUP All	
F	89-94	ISUZU AMIGO All	
F	81-95	PICKUP 4WD	
F	84-86	TROOPER 4WD	
F	98-04	NISSAN FRONTIER RWD Exc. Desert Runner	
F	87-97	PICKUP RWD	
F	86	PICKUP RWD Mfg. from 8/86	
81508	W		140812
R	86	NISSAN PULSAR / PULSAR NX All Mfg. from 1/86	
R	83-85	PULSAR / PULSAR NX All	
R	82-86	SENTRA All	
81510	D		
R	80-96	FORD PICKUP 1/2 TON, F-150 4WD Exc. Lift Kit	
R	86-97	PICKUP 1 TON, F-350 / SUPERDUTY 4WD Dual Rear Wheels	
R	82-85	PICKUP 1 TON, F-350 / SUPERDUTY 4WD Clevis Type Lower Front Mount; Exc. Dual Rear Wheels or Lift Kit	
R	80-81	PICKUP 1 TON, F-350 / SUPERDUTY 4WD	
R	97	PICKUP 3/4 TON, F-250 / SUPERDUTY 4WD Over 8500# GVW	

Numerical listing

Shock	POP	Alternative No.	MTG Acc. Supplied
Pos.	Year	Application	
81510	D	-continued	
R	86-96	PICKUP 3/4 TON, F-250 / SUPERDUTY 4WD	
R	82-85	PICKUP 3/4 TON, F-250 / SUPERDUTY 4WD Clevis Type Lower Front Mount; Exc. Dual Rear Wheels or Lift Kit	
R	80-81	PICKUP 3/4 TON, F-250 / SUPERDUTY 4WD	
81514	C		140629
R	73	BUICK APOLLO All HD Suspension	
R	71-73	CENTURION All	
R	71-84	ELECTRA All	
R	70	ESTATE WAGON All	
R	71-85	LESABRE All	
R	71-78	RIVIERA All	
R	92-96	ROADMASTER Sedan	
R	64-67	SKYLARK All Exc. HD Suspension	
R	64-67	SPECIAL All Exc. HD Suspension	
R	87-92	CADILLAC BROUGHAM All	
R	92-96	COMMERCIAL CHASSIS RWD	
R	77-84	COMMERCIAL CHASSIS All	
R	77-84	DEVILLE All	
R	93-96	FLEETWOOD RWD	
R	77-86	FLEETWOOD RWD	
R	81	CHEVROLET BEL AIR Sedan	
R	65-75	BEL AIR All	
R	65-72	BISCAYNE All	
R	69-70	BROOKWOOD All	
R	73-96	CAPRICE Sedan Police and Taxi Models	
R	71-72	CAPRICE Hardtop Police and Taxi Models	
R	66-70	CAPRICE All	
R	64-67	CHEVELLE All Exc. HD Suspension	
R	68	CHEVY II All Multi-Leaf Rear Spring	
R	64-67	EL CAMINO All	
R	94-96	IMPALA All	
R	83-85	IMPALA All	
R	65-82	IMPALA Sedan	
R	74-81	IMPALA Coupe	
R	73	IMPALA Hardtop	
R	69-70	KINGSWOOD All	
R	64-67	MALIBU All Exc. HD Suspension	
R	73	NOVA All HD Suspension	
R	69-72	NOVA All Multi-Leaf Rear Spring	
R	69-70	TOWNSMAN All	
R	65-85	OLDSMOBILE 88 SERIES All	
R	65-84	98 All	
R	64-67	CUTLASS / CUTLASS SUPREME All Exc. HD Suspension	
R	61-67	F85 All Exc. HD Suspension	
R	65-66	STARFIRE All	
R	63-81	PONTIAC BONNEVILLE All	
R	75-81	CATALINA Coupe	
R	71-81	CATALINA Sedan	
R	71-74	CATALINA Hardtop	
R	63-70	CATALINA All	
R	67-70	EXECUTIVE All	
R	63-68	GRAND PRIX All	
R	64-67	GTO All Exc. HD Suspension	
R	76-81	LAURENTIAN CAN	
R	64-67	LEMANS All Exc. HD Suspension	
R	76-86	PARISIENNE Sedan	
R	63-66	STAR CHIEF All	
R	64-67	TEMPEST All Exc. HD Suspension	
R	73	VENTURA All HD Suspension	
R	71-72	VENTURA All Leaf(RearSpringType)	
81516	B		
F	05	CHEVROLET BLAZER Base, 4WD	
F	96-04	BLAZER LS, 4WD	
F	95-01	BLAZER LT, 4WD	
F	95-99	BLAZER Base, 4WD	
F	83-94	BLAZER, S MODELS 4WD	
F	94-04	S10 LS, 4WD	
F	83-03	S10 Base, 4WD	
F	92-93	S10 EL, 4WD	
F	83-92	S10 Tahoe, 4WD	
F	88-90	S10 Durango, 4WD	
F	83-86	S10 Durango, 4WD	
F	92-05	GMC JIMMY 4WD	
F	83-91	S15 JIMMY 4WD	
F	83-04	SONOMA / S15 4WD	
F	91	SYCLONE All	
F	92-93	TYPHOON All	
F	99-00	ISUZU HOMBRE 4WD	
F	96-98	HOMBRE All Sport Chassis	
F	96-01	OLDSMOBILE BRAVADA All	
F	91-94	BRAVADA All	
81517	D		141277
R	82-96	BUICK CENTURY All	

Numerical listing

Shock	POP	Alternative No.	MTG Acc. Supplied
Pos.	Year	Application	
81517	D	-continued	141277
R	80-85	SKYLARK All	
R	82-90	CHEVROLET CELEBRITY All	
R	80-85	CITATION / CITATION II All	
R	82-96	OLDSMOBILE CIERA / CUTLASS CIERA All Exc. Electronic Adjustable Suspension	
R	87-94	CUTLASS CLASSIC / CUTLASS CRUISER All Exc. Electronic Adjustable Suspension	
R	80-84	OMEGA All	
R	89-91	PONTIAC 6000 FWD	
R	82-88	6000 All	
R	80-84	PHOENIX All	
81529	W		
R	90-95	CHRYSLER TOWN & COUNTRY All	
R	84-95	DODGE CARAVAN / GRAND CARAVAN All	
R	87-88	MINI RAM All	
R	84-95	PLYMOUTH VOYAGER / GRAND VOYAGER All	
81530	W		141277
R	94	ASUNA GT	
R	92	GT	
R	93	GT, SE All	
R	94	SE	
R	92	SE	
R	82-89	BUICK SKYHAWK All	
R	86-94	SKYLARK All	
R	85-87	SOMERSET / SOMERSET REGAL All	
R	82-88	CADILLAC CIMARRON All	
R	92-94	CHEVROLET BERETTA Base Exc. FE7 Suspension	
R	87-91	BERETTA All	
R	82-94	CAVALIER All	
R	87-94	CORSICA All	
R	92-94	OLDSMOBILE ACHIEVA All Exc. FE3 and Electronic Ride Control	
R	85-87	CALAIS All	
R	88-91	CUTLASS CALAIS All	
R	87-88	FIRENZA All	
R	84-86	FIRENZA All Rebuildable O.E. Struts	
R	82-83	FIRENZA All	
R	85-94	PONTIAC GRAND AM All	
R	82-85	J2000 / SUNBIRD All	
R	86-94	SUNBIRD All	
R	87-91	TEMPEST All	
81538	W		
R	82	DODGE D50 4WD	
R	87-93	PICKUP, RAM 50 4WD	
R	83-94	MINI MITSUBISHI MIGHTY MAX 4WD	
81539	W		
R	89	FORD BRONCO II All Mfg. to 2/89; Vehicles with 10mm & 12mm bolt in rear lower mount	
R	84-88	BRONCO II All With 10mm Bolt In Rear Lower Mount	
R	89	RANGER RWD Mfg. to 2/89; Vehicles with 10mm bolt in rear lower mount	
R	83-88	RANGER RWD	
81540	W		
R	83-89	FORD RANGER 4WD	
81541	C		140455
F	85-95	TOYOTA PICKUP RWD Exc. 1 Ton	
F	84	PICKUP RWD	
F	93-98	T100 RWD	
81542	X		140524
R	84-89	TOYOTA VAN Coil (RearSpringType)	
R	88	VAN WAGON All Coil(RearSpringType)	
81548	B		141353
F	84-01	JEEP CHEROKEE All	
F	86-92	COMANCHE All	
F	93-98	GRAND CHEROKEE All	
F	84-90	WAGONEER All	
81549	C		
R	84-01	JEEP CHEROKEE All	
R	84-90	WAGONEER All	
81553	W		140524
F	87-91	ISUZU TROOPER 4WD	
F	86-87	MAZDA B2000 RWD	

Guardian Shock

Shock	POP	Alternative No.	MTG Acc. Supplied
Pos.	Year	Application	
81553	W	-continued	140524
F	87-93	B2200 RWD	
F	87-93	B2600 RWD	
81554	X		
R	86-88	NISSAN MULTI All	
R	86-88	STANZA Wagon, FWD	
81558	W		140673
R	85-88	CHEVROLET SPECTRUM All	
R	89	GEO SPECTRUM All	
R	88-89	ISUZU I-MARK XS	
R	85-87	I-MARK All	
R	85-88	PONTIAC SUNBURST All	
81559	B		140126
F	87-04	DODGE DAKOTA RWD	
F	99-03	DURANGO RWD	
81560	W		
R	87-96	DODGE DAKOTA RWD	
81581	D		
R	90-05	CHEVROLET ASTRO All	
R	85-89	ASTRO RWD	
R	90-05	GMC SAFARI All	
R	85-89	SAFARI RWD	
R	86-89	VOLKSWAGEN VANAGON 4WD	
81582	W		140126
F	86-97	FORD AEROSTAR RWD	
81583	D		
R	86-88	FORD AEROSTAR RWD	
R	87-95	JEEP WRANGLER YJ (MfrBodyCode)	
81667	A		
R	88-99	CHEVROLET PICKUP 1/2 TON, C15 / C1500 All	
R	88-99	PICKUP 1/2 TON, K15 / K1500 All	
R	01-03	PICKUP 1 TON, C35/3500 Base Exc. HD Straight Front Axle	
R	88-00	PICKUP 1 TON, C35/3500 Extended Cab Pickup Exc. HD Straight Front Axle	
R	88-00	PICKUP 1 TON, C35/3500 Standard Cab Pickup Exc. HD Straight Front Axle	
R	88-00	PICKUP 1 TON, K35 / K3500 All	
R	88-00	PICKUP 3/4 TON, C25 / C2500 All	
R	88-00	PICKUP 3/4 TON, K25 / K2500 All	
R	88-99	GMC PICKUP 1/2 TON, C15 / C1500 All	
R	88-99	PICKUP 1/2 TON, K15 / K1500 All	
R	89-00	PICKUP 1 TON, C35/3500 Extended Cab Pickup Exc. HD Straight Front Axle	
R	88-00	PICKUP 1 TON, C35/3500 Standard Cab Pickup Exc. HD Straight Front Axle	
R	88-00	PICKUP 1 TON, K35 / K3500 All	
R	88-00	PICKUP 3/4 TON, C25 / C2500 All	
R	88-00	PICKUP 3/4 TON, K25 / K2500 All	
81668	A		141277
F	88-99	CHEVROLET PICKUP 1/2 TON, C15 / C1500 All	
F	92-00	PICKUP 1 TON, C35/3500 All Exc. HD Straight Front Axle	
F	88-91	PICKUP 1 TON, C35/3500 Extended Cab Pickup Exc. HD Straight Front Axle	
F	88-91	PICKUP 1 TON, C35/3500 Standard Cab Pickup Exc. HD Straight Front Axle	
F	88-00	PICKUP 3/4 TON, C25 / C2500 All	
F	92-99	SUBURBAN 1/2 TON, C15 / C1500 All	
F	92-99	SUBURBAN 3/4 TON, C25 / C2500 All	
F	95-00	TAHOE RWD Old Body Style	
F	88-99	GMC PICKUP 1/2 TON, C15 / C1500 All	
F	88-00	PICKUP 1 TON, C35/3500 All Exc. HD Straight Front Axle	
F	88-00	PICKUP 3/4 TON, C25 / C2500 All	
F	92-99	SUBURBAN 1/2 TON, C15 / C1500 All	
F	92-99	SUBURBAN 3/4 TON, C25 / C2500 All	
F	92-99	YUKON RWD	
81670	W		140524
F	88	PONTIAC FIERO All	

Numerical listing

Shock	POP	Alternative No.	MTG Acc. Supplied
Pos.	Year	Application	
81671	W		141714
R	85-88	NISSAN 200SX All	
81674	X		141301
R	87-93	FORD MUSTANG / MUSTANG II GT, 5.0L 8Cyl V (302)	
R	87-93	MUSTANG / MUSTANG II LX, 5.0L 8Cyl V (302)	
R	84-86	MUSTANG / MUSTANG II SVO	
R	82-86	MUSTANG / MUSTANG II GT	
81675	D		140455
F	86-95	SUZUKI SAMURAI All	
81676	D		
R	77-79	DODGE COLT Coupe	
R	77-79	COLT Sedan	
R	77	COLT Hardtop	
R	54-55	FORD PICKUP 1/2 TON, F-100 All	
R	53	PICKUP 1/2 TON, F-100 All Exc. Heavy Duty	
R	53-55	PICKUP 1 TON, F-350 / SUPERDUTY All	
R	53-55	PICKUP 3/4 TON, F-250 / SUPERDUTY All	
R	55	PICKUP F SERIES All F250	
R	53-54	PICKUP F SERIES All	
R	48-52	PICKUP F SERIES All F-1, F-2 & F-3	
R	74	JEEP CHEROKEE All	
F	66-71	CJ5 All 5 Leaf Front Springs; Exc. Lift Kit	
R	66-71	CJ5 All 5 Leaf Front Springs; Exc. Lift Kit	
F	66-71	CJ6 All 5 Leaf Front Springs; Exc. Lift Kit	
R	66-71	CJ6 All 5 Leaf Front Springs; Exc. Lift Kit	
F	61-67	DISPATCHER All	
R	61-67	DISPATCHER All	
R	61-65	FC150 All	
F	61-67	UNIVERSAL All 5 Leaf Front Springs; Exc. Lift Kit	
R	61-67	UNIVERSAL All 5 Leaf Front Springs; Exc. Lift Kit	
R	63-74	WAGONEER All	
F	63-65	WAGONEER All Independent Front Suspension	
R	76-80	PLYMOUTH ARROW All	
R	76-79	COLT All	
R	56-57	SAAB 93 All	
R	58-59	93B All	
R	58-59	GT750 All	
R	63	GT850 All	
R	86-95	SUZUKI SAMURAI All	
81691	D		141353
F	87-95	JEEP WRANGLER YJ (MfrBodyCode)	
81693	W		141665,140719
R	86-95	FORD TAURUS Wagon	
R	86-95	MERCURY SABLE Wagon	
81694	W		140780
F	75-91	FORD VAN 1/2 TON, ECONOLINE / CLUB WAGON All	
81710	W		
R	80-96	FORD BRONCO All Exc. Lift Kit	
R	80-83	PICKUP 1/2 TON, F-100 RWD	
R	80-84	PICKUP 1/2 TON, F-150 RWD	
R	90-97	PICKUP 1/2 TON, F SUPERDUTY All	
R	80-97	PICKUP 1 TON, F-350 / SUPERDUTY RWD Dual Rear Wheels	
81713	C		140800
F	85-05	CHEVROLET ASTRO RWD	
F	71-75	BEL AIR Wagon	
F	71-72	BISCAYNE All Police and Taxi Models	
F	73-96	CAPRICE Sedan Police and Taxi Models	
F	71-72	CAPRICE Hardtop Police and Taxi Models	
F	83-85	IMPALA All Police and Taxi Models	
F	71-82	IMPALA Sedan Police and Taxi Models	
F	96-02	VAN 1/2 TON, G / EXPRESS All	
F	97-02	VAN 1 TON, G / EXPRESS All	
F	96-02	VAN 3/4 TON, G / EXPRESS All Exc. 8600# GVW	
F	93-02	FORD CROWN VICTORIA Police Interceptor	

Numerical listing

Shock	POP	Alternative No.	MTG Acc. Supplied
Pos.	Year	Application	
81713	C	-continued	140800
F	85-05	GMC SAFARI RWD	
F	96-02	VAN 1/2 TON, G / SAVANNA RWD	
F	96-02	VAN 1 TON, G / SAVANNA All	
F	96-02	VAN 3/4 TON, G / SAVANNA All	
		Exc. 8600# GVW	
81714	W		140455
F	79-82	DODGE D50 RWD	
F	83-93	PICKUP, RAM 50 RWD	
F	83-96	MITSUBISHI MIGHTY MAX RWD	
F	79-82	PLYMOUTH PICKUP All	
81726	C		
F	99-00	CADILLAC ESCALADE All	
F	90-05	CHEVROLET ASTRO AWD	
F	92-94	BLAZER 4WD Full Size	
F	88-00	PICKUP 1 TON, K35 / K3500 All	
F	88-00	PICKUP 3/4 TON, K25 / K2500 All	
F	92-99	SUBURBAN 1/2 TON, K15 / K1500 All	
F	92-99	SUBURBAN 3/4 TON, K25 / K2500 All	
F	95-00	TAHOE 4WD Old Body Style	
F	88-00	GMC PICKUP 1 TON, K35 / K3500 All	
F	88-00	PICKUP 3/4 TON, K25 / K2500 All	
F	90-05	SAFARI AWD	
F	92-99	SUBURBAN 1/2 TON, K15 / K1500 All	
F	92-99	SUBURBAN 3/4 TON, K25 / K2500 All	
F	92-99	YUKON 4WD	
81727	W		
R	90-97	FORD AEROSTAR All	
R	89	AEROSTAR RWD	
81730	B		
R	90	FORD BRONCO II All	
R	89	BRONCO II All Mfg. from 2/89; Vehicles with 12mm bolt in rear lower mount	
R	90-97	RANGER RWD	
R	89	RANGER RWD Mfg. from 2/89; Vehicles with 12mm bolt in rear lower mount	
R	94-97	MAZDA B2300 RWD	
R	94-97	B3000 RWD	
81739	X		
R	86-91	DODGE COLT Vista, Wagon, 4WD	
R	89-91	EAGLE VISTA Wagon, 4WD	
R	89-91	PLYMOUTH COLT Vista, Wagon, 4WD	
81742	W		141665
R	88-93	PONTIAC LEMANS All	
81744	A		140780
F	90	FORD BRONCO II All	
F	91-94	EXPLORER All	
F	90-97	RANGER All	
F	92-14	VAN 1/2 TON, ECONOLINE / CLUB WAGON All	
F	08-14	VAN 1 TON, ECONOLINE / CLUB WAGON / SUPERDUTY All	
F	07	VAN 1 TON, ECONOLINE / CLUB WAGON / SUPERDUTY All Exc. Cutaway Chassis	
F	92-06	VAN 1 TON, ECONOLINE / CLUB WAGON / SUPERDUTY All	
F	92-14	VAN 3/4 TON, ECONOLINE / CLUB WAGON / SUPERDUTY All	
F	94-97	MAZDA B2300 All	
F	94-97	B3000 All	
F	94-97	B4000 All	
F	91-94	NAVAJO All	
81750	A		140455
F	05	CHEVROLET BLAZER Base, RWD	
F	96-04	BLAZER LS, RWD	
F	95-02	BLAZER LT, RWD	
F	95-99	BLAZER Base, RWD	
F	95-97	BLAZER Deluxe, RWD	
F	83-94	BLAZER, S MODELS RWD	
F	68-87	EL CAMINO All	
F	94-03	S10 LS, RWD	
F	82-03	S10 Base, RWD	
F	92-93	S10 EL, RWD	
F	83-92	S10 Tahoe, RWD	
F	88-90	S10 Durango, RWD	
F	82-86	S10 Durango, RWD	
F	72-82	FORD COURIER All	
F	92-04	GMC JIMMY RWD	
F	83-91	S15 JIMMY RWD	

Guardian Shock

Shock	POP	Alternative No.	MTG Acc. Supplied
Pos.	Year	Application	
81750	A	-continued	140455
F	04	SONOMA / S15 All RWD	
F	82-03	SONOMA / S15 RWD	
F	78-87	SPRINT / CABALLERO RWD	
F	71-77	SPRINT / CABALLERO All	
F	96-00	ISUZU HOMBRE RWD Exc. Sport Chassis	
F	72-76	MAZDA B1600 All	
F	77-78	B1800 All	
F	79-84	B2000 All	
F	82-84	B2200 All	
F	75-83	TOYOTA PICKUP RWD Mojave	
F	70-74	PICKUP All RWD; Mojave	
81789	C		
R	99-00	CADILLAC ESCALADE All	
R	92-94	CHEVROLET BLAZER 4WD Full Size	
R	92-99	SUBURBAN 1/2 TON, C15 / C1500 All	
R	92-99	SUBURBAN 1/2 TON, K15 / K1500 All	
R	92-99	SUBURBAN 3/4 TON, C25 / C2500 All	
R	92-99	SUBURBAN 3/4 TON, K25 / K2500 All	
R	95-00	TAHOE All Old Body Style	
R	96-14	VAN 1/2 TON, G / EXPRESS All	
R	10-12	VAN 1 TON, G / EXPRESS All	
R	97-06	VAN 1 TON, G / EXPRESS All	
R	07-09	VAN 3/4 TON, G / EXPRESS All	
R	96-02	VAN 3/4 TON, G / EXPRESS All	
		Exc. 8600# GVW	
R	92-99	GMC SUBURBAN 1/2 TON, C15 / C1500 All	
R	92-99	SUBURBAN 1/2 TON, K15 / K1500 All	
R	92-99	SUBURBAN 3/4 TON, C25 / C2500 All	
R	92-99	SUBURBAN 3/4 TON, K25 / K2500 All	
R	96-14	VAN 1/2 TON, G / SAVANNA RWD	
R	97-02	VAN 1 TON, G / SAVANNA All	
R	96-02	VAN 3/4 TON, G / SAVANNA All	
		Exc. 8600# GVW	
R	92-99	YUKON All	
81790	W		142369
R	95-98	BUICK SKYLARK All	
R	95-96	CHEVROLET BERETTA All	
R	95-96	CORSICA All	
R	95-98	OLDSMOBILE ACHIEVA All Exc. Electronic Adjustable Suspension	
R	95-98	PONTIAC GRAND AM All Exc. Electronic Adjustable Suspension	
81791	W		141666
R	89-96	CHEVROLET CORVETTE All Exc. Electronic Adjustable Suspension	
R	88	CORVETTE All	
81792	W		141665
F	89-96	CHEVROLET CORVETTE All Exc. Electronic Adjustable Suspension	
81793	W		
R	88-93	CHRYSLER DYNASTY All Hydraulic Self Leveling System	
R	88-93	DODGE DYNASTY All Hydraulic Self Leveling System	
81794	C		140126
R	03-04	FORD MUSTANG / MUSTANG II Mach I	
R	94-04	MUSTANG / MUSTANG II Base	
R	94-04	MUSTANG / MUSTANG II GT	
R	04	MUSTANG / MUSTANG II GT Base	
R	04	MUSTANG / MUSTANG II GT Equipado	
R	01	MUSTANG / MUSTANG II GT Bullitt	
R	95	MUSTANG / MUSTANG II GTS	
81795	W		141743
R	92-97	FORD THUNDERBIRD All Exc. Electronic Adjustable Suspension	
R	92-97	MERCURY COUGAR All Exc. Electronic Adjustable Suspension	
81821	W		
F	86-97	FORD PICKUP 1 TON, F-350 / SUPERDUTY 4WD	
F	97	PICKUP 3/4 TON, F-250 / SUPERDUTY 4WD Over 8500# GVW	
F	87-96	PICKUP 3/4 TON, F-250 / SUPERDUTY 4WD	

Numerical listing

Shock	POP	Alternative No.	MTG Acc. Supplied
Pos.	Year	Application	
81823	W		140719
R	91-94	FORD EXPLORER All	
R	91-94	MAZDA NAVAJO All	
81825	W		
F	81-93	DODGE PICKUP 1/2 TON, W100 SERIES All Exc. Lift Kit	
F	61-80	PICKUP 1/2 TON, W100 SERIES All	
F	81-93	PICKUP 1 TON, W300 SERIES All Exc. Quad Suspension and Lift Kit	
F	61-80	PICKUP 1 TON, W300 SERIES All	
R	61-71	PICKUP 1 TON, W300 SERIES All	
F	90-93	PICKUP 3/4 TON, W200 SERIES Extended Cab Pickup Exc. Lift Kit	
F	88-93	PICKUP 3/4 TON, W200 SERIES Cab & Chassis Exc. Lift Kit	
F	81-93	PICKUP 3/4 TON, W200 SERIES Standard Cab Pickup Exc. Lift Kit	
F	86	PICKUP 3/4 TON, W200 SERIES Cab & Chassis Exc. Lift Kit	
F	81-83	PICKUP 3/4 TON, W200 SERIES Cab & Chassis Exc. Lift Kit	
F	81-82	PICKUP 3/4 TON, W200 SERIES Extended Cab Pickup Exc. Lift Kit	
F	69-80	PICKUP 3/4 TON, W200 SERIES All	
F	61-67	PICKUP 3/4 TON, W200 SERIES All	
F	75-93	RAMCHARGER 4WD	
F	74	RAMCHARGER All	
F	78-80	RD200 All	
F	75-81	PLYMOUTH TRAILDUSTER 4WD	
F	74	TRAILDUSTER All	
81826	W		140780
F	90-97	FORD AEROSTAR AWD	
81828	D		142617
R	10-14	FORD VAN 1/2 TON, ECONOLINE / CLUB WAGON All	
R	10-14	VAN 1 TON, ECONOLINE / CLUB WAGON / SUPERDUTY All	
R	04-14	VAN 1 TON, ECONOLINE / CLUB WAGON / SUPERDUTY All Exc. Cutaway Chassis	
R	92-05	VAN 1 TON, ECONOLINE / CLUB WAGON / SUPERDUTY All	
R	92-14	VAN 3/4 TON, ECONOLINE / CLUB WAGON / SUPERDUTY All	
81833	W		140780
R	92-07	FORD VAN 1/2 TON, ECONOLINE / CLUB WAGON All	
81834	W		140126
F	72-93	DODGE PICKUP 1 TON, D300 SERIES All HD Package	
F	82-93	PICKUP 3/4 TON, D200 SERIES All HD Package	
F	75-81	PICKUP 3/4 TON, D200 SERIES 165.0 (WheelBase) HD Package	
F	72-74	PICKUP 3/4 TON, D200 SERIES All HD Package	
F	71-93	VAN 1 TON, A / B SERIES / RAM All 4000# Front Axle	
F	74-80	VAN, CB300 All 4000# Front Axle	
F	74-83	PLYMOUTH VAN 1 TON, PB SERIES All 4000# Front Axle	
81836	B		140126
F	97-04	DODGE DAKOTA 4WD	
F	98-03	DURANGO 4WD	
81837	W		
R	87-96	DODGE DAKOTA 4WD	
81869	B		141353,142592
F	99-04	JEEP GRAND CHEROKEE All	
81870	C		141350
F	86-95	TOYOTA 4RUNNER All	
F	86-95	PICKUP 4WD Exc. Lift Kit	
F	93-98	T100 4WD	
81871	C		140149
R	84-89	TOYOTA 4RUNNER All	
R	84-95	PICKUP 4WD Exc. Lift Kit	
R	98-04	TACOMA Pre Runner, RWD	
R	95-04	TACOMA 4WD	
81872	C		140524
F	90-92	DAIHATSU ROCKY All	
F	94-02	HONDA PASSPORT All	
F	98-00	ISUZU AMIGO All	
F	02-04	AXIOM All	
F	91-04	RODEO All	
F	87-90	MITSUBISHI VAN All	
F	87-95	NISSAN PATHFINDER All	

Numerical listing

Shock	POP	Alternative No.	MTG Acc. Supplied
Pos.	Year	Application	
81873 B			
R	99-07	CHEVROLET PICKUP 1/2 TON, SILVERADO 1500 RWD Exc. Electronic Adjustable Suspension	
R	94-01	DODGE PICKUP 1/2 TON, RAM 1500 (SEE RAM 1500) All	
R	94-02	PICKUP 1 TON, RAM 3500 (SEE RAM 3500) RWD Exc. Solid Front Axle	
R	94-03	PICKUP 3/4 TON, RAM 2500 (SEE RAM 2500) 4WD, GAS Exc. 8800# GVW	
R	94-02	PICKUP 3/4 TON, RAM 2500 (SEE RAM 2500) RWD	
R	95-96	PICKUP 3/4 TON, RAM 2500 (SEE RAM 2500) 4WD, CNG Exc. 8800# GVW	
R	99-07	GMC SIERRA 1500 RWD Exc. Electronic Adjustable Suspension	
81878 A			
R	96-07	CHRYSLER TOWN & COUNTRY All	
R	01-03	VOYAGER / GRAND VOYAGER All Exc. Hydraulic Self Leveling System	
R	00	VOYAGER / GRAND VOYAGER All	
R	00	VOYAGER / GRAND VOYAGER Non-ABS	
R	96-07	DODGE CARAVAN / GRAND CARAVAN All Exc. Hydraulic Self Leveling System	
R	96-00	PLYMOUTH VOYAGER / GRAND VOYAGER All	
81880 W			
R	63-82	CHEVROLET CORVETTE All	
81882 D			
R	95-03	FORD WINDSTAR Coil (RearSpringType)	
81890 B 140719			
R	95-01	FORD EXPLORER All Exc. Adjustable Suspension	
R	01-05	EXPLORER SPORT TRAC All	
R	97-01	MERCURY MOUNTAINEER All Exc. Electronic Adjustable Suspension	
81891 D			
R	93-98	JEEP GRAND CHEROKEE All	
81892 C 142700			
R	04	FORD PICKUP 1/2 TON, F-150 RWD	
R	00-03	PICKUP 1/2 TON, F-150 Harley-Davidson Edition, RWD	
R	99-03	PICKUP 1/2 TON, F-150 Lariat, RWD	
R	99-03	PICKUP 1/2 TON, F-150 XL, RWD	
R	99-03	PICKUP 1/2 TON, F-150 XLT, RWD	
R	00	PICKUP 1/2 TON, F-150 Base, RWD	
R	97-98	PICKUP 1/2 TON, F-150 RWD	
R	97-99	PICKUP 3/4 TON, F-250 / SUPERDUTY RWD Up through 8500# GVW	
81893 A 142277			
F	95-01	FORD EXPLORER All Exc. Adjustable Suspension	
F	01-05	EXPLORER SPORT TRAC All	
F	10-11	RANGER RWD, Torsion Bar (FrontSpringType)	
F	00-11	RANGER 4WD, Torsion Bar (FrontSpringType)	
F	01-09	RANGER XL, RWD, Torsion Bar (FrontSpringType)	
F	01-09	RANGER XLT, RWD, Torsion Bar (FrontSpringType)	
F	05	RANGER STX, RWD w/ Torsion Bar (FrontSpringType)	
F	04	RANGER Tremor, RWD, Torsion Bar (FrontSpringType)	
F	01-02	RANGER EV, RWD, Torsion Bar (FrontSpringType)	
F	02	RANGER Sport, RWD w/ Torsion Bar (FrontSpringType)	
F	98-99	RANGER 4WD	
F	03-07	MAZDA B3000 All 4WD	
F	98-02	B3000 4WD	
F	98-09	B4000 4WD	
F	97-01	MERCURY MOUNTAINEER All Exc. Electronic Adjustable Suspension	

Guardian Shock

Shock	POP	Alternative No.	MTG Acc. Supplied
Pos.	Year	Application	
81902 W 140126			
F	87-96	DODGE DAKOTA 4WD	
81904 D 141514			
R	94-98	ASUNA SUNRUNNER	
R	92-93	SUNRUNNER All	
R	98-04	CHEVROLET TRACKER Non-ABS	
R	89-97	GEO TRACKER All	
R	89-91	GMC TRACKER All	
R	94-97	PONTIAC SUNRUNNER All	
R	99-05	SUZUKI GRAND VITARA All	
R	96-98	SIDEKICK All	
R	89-95	SIDEKICK Non-ABS	
R	99-04	VITARA All	
R	96-98	X-90 All	
81905 W			
R	90-97	FORD RANGER 4WD	
R	89	RANGER 4WD Mfg. from 2/89; Vehicles with 12mm bolt in rear lower mount	
R	95-96	MAZDA B2300 4WD	
R	94-97	B3000 4WD	
R	94-97	B4000 4WD	
81906 W 140921			
R	90-95	TOYOTA 4RUNNER All	
81908 W 140673			
F	01-04	TOYOTA TACOMA S-Runner Exc. Offroad Package	
F	04	TACOMA Base, RWD Exc. Offroad Package	
F	95-03	TACOMA DLX, RWD Exc. Offroad Package	
81909 W 140169			
R	96-99	ACURA SLX All	
R	92-02	ISUZU TROOPER All	
R	99-01	VEHICROSS All	
81910 W 141137			
R	98	INFINITI QX4 All Mfg. to 12/98	
R	97	QX4 All	
R	96-99	NISSAN PATHFINDER All Mfg. to 12/98	
81911 W 140524			
R	98-02	HONDA PASSPORT All	
R	98-00	ISUZU AMIGO All	
R	02-04	AXIOM All	
R	98-04	RODEO All	
81912 B 142731			
F	97-02	FORD EXPEDITION RWD Exc. Front Air- Leveling	
F	97-04	PICKUP 1/2 TON, F-150 RWD	
F	97-99	PICKUP 3/4 TON, F-250 / SUPERDUTY RWD Up through 8500# GVW	
F	98-02	LINCOLN NAVIGATOR RWD	
81913 W 142700			
R	97-04	FORD PICKUP 1/2 TON, F-150 4WD Exc. 7000# GVW	
R	97-99	PICKUP 3/4 TON, F-250 / SUPERDUTY 4WD Up through 8500# GVW; Exc. Superduty	
81914 D 142731			
F	97-02	FORD EXPEDITION 4WD Exc. Front Air- Leveling	
F	04	PICKUP 1/2 TON, F-150 4WD Exc. 7000# GVW	
F	97-03	PICKUP 1/2 TON, F-150 4WD	
F	97-99	PICKUP 3/4 TON, F-250 / SUPERDUTY 4WD Up through 8500# GVW; Exc. Superduty	
81916 B 141665			
F	06-11	FORD RANGER RWD, Coil (FrontSpringType)	
F	01-05	RANGER XL, RWD, Coil (FrontSpringType)	
F	01-05	RANGER XLT, RWD, Coil (FrontSpringType)	
F	01-02	RANGER EV, RWD Coil Front Spring Type	
F	98-00	RANGER XL, RWD	
F	98-00	RANGER XLT, RWD	
F	01-09	MAZDA B2300 RWD	
F	98-01	B2500 RWD	
F	98-07	B3000 RWD	
F	98-09	B4000 RWD	

Numerical listing

Shock	POP	Alternative No.	MTG Acc. Supplied
Pos.	Year	Application	
81917 C			
R	06-11	FORD RANGER RWD, Coil (FrontSpringType)	
R	98-05	RANGER XL, RWD	
R	98-05	RANGER XLT, RWD	
R	05	RANGER STX, RWD	
R	04	RANGER Tremor, RWD	
R	98-01	MAZDA B2500 All	
R	98-07	B3000 RWD	
R	98-09	B4000 RWD	
81918 D			
R	06-11	FORD RANGER RWD, Torsion Bar (FrontSpringType)	
R	98-11	RANGER 4WD	
R	01-05	RANGER Edge, RWD	
R	03-07	MAZDA B3000 All 4WD	
R	98-02	B3000 4WD	
R	07-09	B4000 4WD	
R	98-04	B4000 4WD	
81919 D 142731			
F	94-01	DODGE PICKUP 1/2 TON, RAM 1500 (SEE RAM 1500) 4WD	
F	99-02	PICKUP 3/4 TON, RAM 2500 (SEE RAM 2500) 4WD Exc. 8800# GVW	
F	94-95	PICKUP 3/4 TON, RAM 2500 (SEE RAM 2500) 4WD Exc. 8800# GVW	
81920 B 141665			
F	99-07	CHEVROLET PICKUP 1/2 TON, SILVERADO 1500 RWD Exc. Electronic Adjustable Suspension	
F	99-07	GMC SIERRA 1500 RWD Exc. Electronic Adjustable Suspension	
81921 D			
R	07	CHEVROLET PICKUP 1/2 TON, SILVERADO 1500 4WD Old Body Style; Exc. Electronic Adjustable Suspension	
R	99-06	PICKUP 1/2 TON, SILVERADO 1500 4WD Exc. Electronic Adjustable Suspension	
R	05-06	PICKUP 1/2 TON, SILVERADO 1500 HD All	
R	01-03	PICKUP 1/2 TON, SILVERADO 1500 HD All	
R	77-86	PICKUP 1 TON, K30 All	
R	90-91	PICKUP 1 TON, R3500 All	
R	89	PICKUP 1 TON, R3500 Cab & Chassis, RWD	
R	89	PICKUP 1 TON, R3500 Crew Cab Pickup, RWD	
R	01-09	PICKUP 1 TON, SILVERADO 3500 All	
R	07-10	PICKUP 1 TON, SILVERADO 3500 HD All	
R	87-88	PICKUP 1 TON, V30 All	
R	89-91	PICKUP 1 TON, V3000 / V3500 All	
R	99-08	PICKUP 3/4 TON, SILVERADO 2500 All	
R	01-10	PICKUP 3/4 TON, SILVERADO 2500 HD All	
R	07	SILVERADO 1500 HD CLASSIC All	
R	94-02	DODGE PICKUP 1 TON, RAM 3500 (SEE RAM 3500) 4WD	
R	94-02	PICKUP 1 TON, RAM 3500 (SEE RAM 3500) RWD Solid Front Axle	
R	94-02	PICKUP 3/4 TON, RAM 2500 (SEE RAM 2500) 4WD, DIESEL 8800# GVW	
R	77-86	GMC PICKUP 1 TON, K35 / K3500 All	
R	87-91	PICKUP 1 TON, V3000 / V3500 All	
R	07	SIERRA 1500 4WD Old Body Style; Exc. Electronic Adjustable Suspension	
R	99-06	SIERRA 1500 4WD Exc. Electronic Adjustable Suspension	
R	05-06	SIERRA 1500 HD All	
R	01-03	SIERRA 1500 HD All	
R	07	SIERRA 1500 HD CLASSIC All	
R	99-04	SIERRA 2500 All	
R	01-10	SIERRA 2500 HD All	
R	01-06	SIERRA 3500 All	
R	07-10	SIERRA 3500 HD All	
81922 B 141665			
F	02-06	CHEVROLET AVALANCHE 1500 All Exc. Electronic Ride Control	
F	07	PICKUP 1/2 TON, SILVERADO 1500 4WD Old Body Style; Exc. Electronic Adjustable Suspension	

Numerical listing

Shock	POP	Alternative No.	MTG Acc. Supplied
Pos.	Year	Application	
81922	B	-continued	141665
F	99-06	PICKUP 1/2 TON, SILVERADO 1500 4WD Exc. Electronic Adjustable Suspension	
F	00-06	SUBURBAN 1/2 TON, 1500 All Exc. Z55 Auto Ride Suspension	
F	02-06	TAHOE All Exc. Z55 Auto Ride Suspension	
F	00-01	TAHOE All New Body Style; Exc. Z55 Auto Ride Suspension	
F	07	GMC SIERRA 1500 4WD Old Body Style; Exc. Electronic Adjustable Suspension	
F	99-06	SIERRA 1500 4WD Exc. Electronic Adjustable Suspension	
F	00-06	YUKON All Exc. Z55 Auto Ride Suspension	
F	00-06	YUKON XL 1/2 TON All Exc. Z55 Auto Ride Suspension	
F	00-06	YUKON XL 3/4 TON All Exc. Z55 Auto Ride Suspension	
81923	D		
R	97-04	DODGE DAKOTA All	
R	98-03	DURANGO 4WD	
R	98-03	DURANGO RWD	
81924	D		
R	02-05	CHEVROLET VENTURE All	
R	97-01	VENTURE FWD	
R	02-04	OLDSMOBILE SILHOUETTE AWD	
R	97-04	SILHOUETTE FWD	
R	99-05	PONTIAC MONTANA All	
R	97-98	TRANS SPORT All	
81925	W		141665
F	02-06	CHEVROLET AVALANCHE 2500 All Exc. Electronic Ride Control	
F	05-06	PICKUP 1/2 TON, SILVERADO 1500 HD All	
F	01-03	PICKUP 1/2 TON, SILVERADO 1500 HD All	
F	05-08	PICKUP 3/4 TON, SILVERADO 2500 All	
F	99-04	PICKUP 3/4 TON, SILVERADO 2500 4WD	
F	07	SILVERADO 1500 HD CLASSIC All	
F	00-11	SUBURBAN 3/4 TON, 2500 All Exc. Z55 Auto Ride Suspension and Quadrasteer	
F	05-06	GMC SIERRA 1500 HD All	
F	01-03	SIERRA 1500 HD All	
F	07	SIERRA 1500 HD CLASSIC All	
F	99-04	SIERRA 2500 4WD	
F	00-06	YUKON XL 3/4 TON All Exc. Hydraulic Self Leveling System	
81926	D		
R	99-04	JEEP GRAND CHEROKEE All	
81927	W		141727,141354
R	96-05	FORD TAURUS Wagon	
R	96-05	MERCURY SABLE Wagon	
81928	C		143000
F	94-01	DODGE PICKUP 1/2 TON, RAM 1500 (SEE RAM 1500) RWD	
F	94-02	PICKUP 1 TON, RAM 3500 (SEE RAM 3500) RWD Exc. Solid Front Axle	
F	94-02	PICKUP 3/4 TON, RAM 2500 (SEE RAM 2500) RWD	
81929	D		
R	97-06	JEEP WRANGLER TJ (MfrBodyCode)	
81930	B		
R	07-11	CHEVROLET AVALANCHE 1500 All Exc. Z55 or ZW7 Ride Suspension	
R	02-06	AVALANCHE 1500 All Exc. Electronic Ride Control	
R	02-06	AVALANCHE 2500 All Exc. Electronic Ride Control	
R	07-11	SUBURBAN 1/2 TON, 1500 All Exc. Z55 or ZW7 Ride Suspension	
R	00-06	SUBURBAN 1/2 TON, 1500 All Exc. Z55 Auto Ride Suspension	
R	00-11	SUBURBAN 3/4 TON, 2500 All Exc. Z55 Auto Ride Suspension and Quadrasteer	
R	07-11	TAHOE All Exc. Z55 or ZW7 Ride Suspension	
R	02-06	TAHOE All Exc. Z55 Auto Ride Suspension	

Guardian Shock, Classic Shock Absorbers

Shock	POP	Alternative No.	MTG Acc. Supplied
Pos.	Year	Application	
81930	B	-continued	
R	00-01	TAHOE All New Body Style; Exc. Z55 Auto Ride Suspension	
R	07-11	GMC YUKON All Exc. Z55 or ZW7 Ride Suspension	
R	00-06	YUKON All Exc. Z55 Auto Ride Suspension	
R	07-11	YUKON XL 1/2 TON All Exc. Z55 or ZW7 Ride Suspension	
R	00-06	YUKON XL 1/2 TON All Exc. Z55 Auto Ride Suspension	
R	00-11	YUKON XL 3/4 TON All Exc. Z55 Auto Ride Suspension and Quadrasteer	
81931	C		
R	06-08	DODGE PICKUP 1/2 TON, RAM 1500 (SEE RAM 1500) Crew Cab Pickup, 4WD	
R	06-08	PICKUP 1/2 TON, RAM 1500 (SEE RAM 1500) Standard Cab Pickup, 4WD	
R	02-05	PICKUP 1/2 TON, RAM 1500 (SEE RAM 1500) 4WD	
81932	D		
F	02-05	DODGE PICKUP 1/2 TON, RAM 1500 (SEE RAM 1500) 4WD	
81933	B		
F	06-08	DODGE PICKUP 1/2 TON, RAM 1500 (SEE RAM 1500) Crew Cab Pickup, RWD	
F	06-08	PICKUP 1/2 TON, RAM 1500 (SEE RAM 1500) Standard Cab Pickup, RWD	
F	02-05	PICKUP 1/2 TON, RAM 1500 (SEE RAM 1500) RWD	
81934	B		142155
R	98-10	VOLKSWAGEN BEETLE All	
R	99-06	GOLF A4 (MfrBodyCode)	
R	01-05	JETTA Sedan	
81935	B		142950
R	08-11	FORD FOCUS All	
R	00-07	FOCUS Hatchback	
R	00-07	FOCUS Sedan	
81936	D		
F	97-06	JEEP WRANGLER TJ (MfrBodyCode)	
81937	D		142389
R	94-97	HONDA PASSPORT All	
R	91-97	ISUZU RODEO All	
R	98-03	TOYOTA SIENNA All	
M51022	N		
R	93-98	VOLKSWAGEN GOLF 2.0L 4Cyl L (121)	
R	85-92	GOLF All Rebuildable Front Struts	
R	95-98	JETTA 1.9L 4Cyl L (116)	
R	94-98	JETTA 2.0L 4Cyl L (121)	
R	95	JETTA 1.8L 4Cyl L (109)	
R	85-93	JETTA All	
M51254	N		142874
R	01-05	CHRYSLER SEBRING ST (MfrBodyCode), Coupe	
R	95-00	SEBRING Coupe	
R	95-00	DODGE AVENGER All	
R	01-05	STRATUS ST (MfrBodyCode), Coupe	
R	95-98	EAGLE TALON FWD	
R	95-99	MITSUBISHI ECLIPSE FWD	
R	99-03	GALANT All	
Classic Shock Absorbers			
82001	C		141229
R	52-77	VOLKSWAGEN BEETLE All	
F	66	BEETLE All 1200	
F	52-65	BEETLE All	
F	66-73	FASTBACK All	
F	66-73	FASTBACK All	
F	67-74	KARMANN GHIA All	
R	66-73	SQUAREBACK All	
R	66-73	SQUAREBACK All	
R	74-79	SUPER BEETLE All	
R	71-73	SUPER BEETLE All 3 Bolt Flange-Type Lower Mount	
R	73-74	THING All	
F	56-69	TRANSPORTER All	
R	56-67	TRANSPORTER All	

Numerical listing

Shock	POP	Alternative No.	MTG Acc. Supplied
Pos.	Year	Application	
82002	W		140916
R	74-78	FORD MUSTANG / MUSTANG II All	
82003	D		
R	69-72	CHEVROLET BLAZER All Coil(RearSpringType)	
R	67-72	PICKUP 1/2 TON, C10 All Coil(RearSpringType)	
R	67-72	PICKUP 3/4 TON, C20 All Coil(RearSpringType)	
R	68-72	SUBURBAN 1/2 TON, C10 All	
R	68-72	SUBURBAN 3/4 TON, C20 All	
R	64-66	VAN 1/2 TON, G / EXPRESS All	
R	67-72	VAN 1/2 TON, P SERIES All	
R	70-72	GMC JIMMY All RWD	
R	67-72	PICKUP 1/2 TON, C15 / C1500 All Coil(RearSpringType)	
R	67-72	PICKUP 3/4 TON, C25 / C2500 All Coil(RearSpringType)	
R	68-72	SUBURBAN 1/2 TON, C15 / C1500 All Coil(RearSpringType)	
R	68-72	SUBURBAN 3/4 TON, C25 / C2500 All	
R	64-66	VAN 1/2 TON, G / SAVANNA All	
R	68-72	VAN 1/2 TON, P SERIES All	
82004	W		140918
R	71-80	FORD PINTO Sedan	
R	75-80	MERCURY BOBCAT Sedan	
82005	D		141147
F	67-77	VOLKSWAGEN BEETLE All	
F	66	BEETLE All 1300 and 1500	
F	67-74	KARMANN GHIA All	
F	73-79	SUPER BEETLE All	
F	73-74	THING All	
82006	D		
R	69-72	CHEVROLET BLAZER All Leaf(RearSpringType)	
R	63-72	PICKUP 1/2 TON, C10 All Leaf(RearSpringType)	
R	67-72	PICKUP 1 TON, C30 All Exc. 11,000# Rear Axle	
R	67-72	PICKUP 3/4 TON, C20 All Leaf(RearSpringType)	
R	63-66	SUBURBAN 1/2 TON, 1500 All	
R	67-77	VAN 1/2 TON, G / EXPRESS All	
R	63-66	VAN 1/2 TON, P SERIES All	
R	76-77	VAN 1 TON, G / EXPRESS All	
R	75	VAN 1 TON, G / EXPRESS 110.0 (WheelBase)	
R	75	VAN 1 TON, G / EXPRESS 125.0 (WheelBase)	
R	71-74	VAN 1 TON, G / EXPRESS All	
R	68-72	VAN 1 TON, P SERIES All Exc. 11,000# Rear Axle	
R	67-77	VAN 3/4 TON, G / EXPRESS All	
R	68-72	VAN 3/4 TON, P SERIES All	
R	67-72	GMC PICKUP 1/2 TON, C15 / C1500 All Leaf(RearSpringType)	
R	67-72	PICKUP 1 TON, C35/3500 All Exc. 11,000# Rear Axle	
R	67-72	PICKUP 3/4 TON, C25 / C2500 All Leaf(RearSpringType)	
R	63-65	PICKUP 1000 SERIES All	
R	63-65	PICKUP 1500 SERIES All	
R	67-77	VAN 1/2 TON, G / SAVANNA All	
R	67	VAN 1/2 TON, P SERIES All	
R	76-77	VAN 1 TON, G / SAVANNA All	
R	75	VAN 1 TON, G / SAVANNA 110.0 (WheelBase)	
R	75	VAN 1 TON, G / SAVANNA 125.0 (WheelBase)	
R	71-74	VAN 1 TON, G / SAVANNA All	
R	68-72	VAN 1 TON, P SERIES All Exc. 11,000# Rear Axle	
R	67-77	VAN 3/4 TON, G / SAVANNA All	
R	68-72	VAN 3/4 TON, P SERIES All	
R	63-65	VAN, PB 1000 SERIES All	
82007	D		140349
F	47-48	FORD DELUXE All Direct Acting Shocks	
R	61-67	ECONOLINE All	
F	47-48	SUPER DELUXE All Direct Acting Shocks	
F	68	INTERNATIONAL 908C All	
F	68	1100C All	
F	68	1200C All Exc. Travelette with 166" Wheelbase	
F	68	1300C All Exc. Travelette with 166" Wheelbase	
F	68-72	M1100 / M1200 All	
F	69	M1400 All	
F	61-71	SCOUT All	

Numerical listing

Shock	POP	Alternative No.	MTG Acc. Supplied
Pos.	Year	Application	
82007		D -continued	140349
F	61-66	JEEP CJ3 All Exc. 5 Leaf Front Springs & Lift Kit	
F	72-81	CJ5 All Exc. Lift Kit	
F	61-71	CJ5 All Exc. 5 Leaf Front Springs & Lift Kit	
F	72-75	CJ6 All Exc. Lift Kit	
F	66-71	CJ6 All Exc. 5 Leaf Front Springs & Lift Kit	
F	76-81	CJ7 All Exc. Lift Kit	
F	66-74	DJ5 All Exc. Lift Kit	
F	66-68	DJ6 All	
F	57-65	FC150 All	
F	67-73	JEEPSTER All	
R	67-69	JEEPSTER All	
F	81	SCRAMBLER / CJ8 All	
F	61-67	UNIVERSAL All	
F	76-83	TOYOTA LAND CRUISER FJ40 (MfrBodyCode)	
F	75	LAND CRUISER FJ40 (MfrBodyCode) Mfg. to 2/75	
F	67-74	LAND CRUISER All	
82010		D	
F	71-78	CADILLAC ELDORADO All	
F	67-70	ELDORADO All Vertically Mounted	
F	71-78	OLDSMOBILE TORONADO All	
F	66-70	TORONADO All Vertically Mounted	
82011		D	140126
F	65-71	CHRYSLER 300 All	
F	67-73	IMPERIAL All	
F	65-73	NEWPORT All	
F	65-73	NEW YORKER All	
F	65-73	TOWN & COUNTRY All	
F	65	DODGE 880 All	
F	65-73	MONACO All	
F	65-73	POLARA All	
F	65-73	PLYMOUTH FURY All	
F	72-73	GRAN FURY All	
F	67	VIP All	
82012		W	
F	69-74	FORD VAN 1/2 TON, ECONOLINE / CLUB WAGON All	
F	69-74	VAN 1 TON, ECONOLINE / CLUB WAGON / SUPERDUTY All	
F	69-74	VAN 3/4 TON, ECONOLINE / CLUB WAGON / SUPERDUTY All	
82013		W	141705
R	80-82	TOYOTA TERCEL AL1 (MfrBodyCode)	
82020		X	140673
R	71-73	NISSAN 1200 All	
R	76-78	B210 All Hatchback	
R	75	B210 All	
R	74	B210 All Hatchback	
R	74	TOYOTA COROLLA Wagon Mfg to 7/74	
R	71-73	COROLLA Wagon	
82025		W	140873
F	75-80	AMERICAN MOTORS PACER All	
82026		C	140455
F	53	CADILLAC DEVILLE All	
F	50-53	FLEETWOOD / 60 SERIES / 70 SERIES All	
F	50-54	CHEVROLET BEL AIR All	
F	53-62	CORVETTE All	
F	53-54	ONE-FIFTY SERIES All	
F	49-52	STYLELINE DELUXE All	
F	49-52	STYLELINE SPECIAL All	
F	53-54	TWO-TEN SERIES All	
F	50-56	FORD COUNTRY SEDAN All	
F	50-56	COUNTRY SQUIRE All	
F	54-56	COURIER SEDAN DELIVERY All	
F	50-54	CRESTLINE All	
F	50-52	CUSTOM All	
F	52-56	CUSTOMLINE All	
F	49-51	DELUXE All	
F	55-56	FAIRLANE All	
F	49	FORD All	
F	52-56	MAINLINE All	
F	56	PARK LANE WAGON All	
F	50-56	RANCH WAGON All	
F	54-56	SKYLINER All	
F	52-56	SUNLINER All	
F	55-57	THUNDERBIRD All	
F	51-56	VICTORIA All	
F	52-56	MERCURY CUSTOM All	
F	56	MEDALIST All	
F	49-51	MERCURY All	
F	55-56	MONTCLAIR All	

Classic Shock Absorbers

Shock	POP	Alternative No.	MTG Acc. Supplied
Pos.	Year	Application	
82026		C -continued	140455
F	50-56	MONTEREY All	
F	55	OLDSMOBILE 98 All	
F	57	PONTIAC BONNEVILLE All	
F	50-57	CATALINA All	
F	49-57	CHIEFTAIN All	
F	54-57	STAR CHIEF All	
F	49-52	STREAMLINER All	
F	57	SUPER CHIEF All	
F	56	STUDEBAKER POWER HAWK All	
F	55-56	PRESIDENT All	
F	56	SKY HAWK All	
F	59-68	VOLVO 122 All	
F	61-73	1800 All	
82030		W	
R	74	INTERNATIONAL 100 All	
R	75	150 RWD	
F	74-75	200 All	
R	74-75	200 All	
R	69-70	1000D All Before Chassis #H-205000	
R	71-72	1010 All Before Chassis #H-205000	
F	69-70	1100D All	
R	69-70	1100D All	
F	71-73	1110 All	
R	71-73	1110 All	
F	69-70	1200D All	
R	69-70	1200D All	
F	71-73	1210 All	
R	71-73	1210 All	
F	69-70	1300D All	
R	69-70	1300D All	
F	71-73	1310 All	
R	71-73	1310 All	
R	71-80	SCOUT II All	
F	75	TRAVELALL All	
82031		W	
F	70-79	VOLKSWAGEN TRANSPORTER All	
82032		W	
R	68-79	VOLKSWAGEN TRANSPORTER All	
82033		W	140169
F	75-76	FORD PICKUP 1/2 TON, F-100 4WD Exc. Lift Kit	
F	65-74	PICKUP 1/2 TON, F-100 All 4WD; Exc. Lift Kit	
F	76	PICKUP 1/2 TON, F-150 4WD Exc. Lift Kit	
F	75	PICKUP 1/2 TON, F-150 All 4WD; Exc. Lift Kit	
82034		W	141138
R	55-56	CADILLAC DEVILLE All	
R	67	ELDORADO All Vertically Mounted	
R	55-56	FLEETWOOD / 60 SERIES / 70 SERIES All	
F	75-77	FORD PICKUP 3/4 TON, F-250 / SUPERDUTY 4WD Up through Serial No. Y20000	
F	73-74	PICKUP 3/4 TON, F-250 / SUPERDUTY 4WD Up through Serial No Y20000	
F	66-72	PICKUP 3/4 TON, F-250 / SUPERDUTY All 4WD; Up through Serial No Y20000	
F	61-65	PICKUP 3/4 TON, F-250 / SUPERDUTY All 4WD	
R	67-70	OLDSMOBILE TORONADO All Vertically Mounted	
82035		W	140357
F	60	CHEVROLET PICKUP All	
F	60-62	PICKUP 1/2 TON, C10 All	
F	61-62	PICKUP 1 TON, C30 All	
F	60-62	PICKUP 3/4 TON, C20 All	
F	61-62	SUBURBAN 1/2 TON, 1500 All	
F	61-62	VAN 1/2 TON, P SERIES All	
F	61-62	GMC PICKUP 1000 SERIES All	
F	61-62	PICKUP 1500 SERIES All	
F	61-62	PICKUP 2500 SERIES All	
82038		W	141138
F	61-64	FORD PICKUP 1/2 TON, F-100 All	
F	61-62	PICKUP 3/4 TON, F-250 / SUPERDUTY All RWD	
82039		W	140455
R	53-59	CHEVROLET CORVETTE All	
R	61-71	INTERNATIONAL SCOUT All	
R	69-73	OPEL OPEL All	

Numerical listing

Shock	POP	Alternative No.	MTG Acc. Supplied
Pos.	Year	Application	
82040		W	140455
R	68-70	CADILLAC ELDORADO All Vertically Mounted	
R	68-69	CHEVROLET CAMARO Leaf (RearSpringType) Single Leaf Rear Springs	
R	67	CAMARO All	
R	66	OLDSMOBILE TORONADO All Vertically Mounted	
R	67	PONTIAC FIREBIRD All	
82046		W	
F	61-71	DODGE PICKUP 1/2 TON, D100 SERIES All	
F	61-71	PICKUP 1 TON, D300 SERIES All	
F	61-71	PICKUP 3/4 TON, D200 SERIES All	
R	68	VAN 1/2 TON, P SERIES All	
R	62-64	VAN 1/2 TON, P SERIES All	
82047		D	140630
F	57-58	CHEVROLET PICKUP All	
F	61-67	VAN 1 TON, P SERIES All	
F	61-67	VAN 3/4 TON, P SERIES All	
F	55-59	GMC PICKUP All	
F	67	VAN 1 TON, P SERIES All	
F	67	VAN 3/4 TON, P SERIES All	
82049		W	140121
F	68	INTERNATIONAL 1000C All	
F	69-70	1000D All Before Chassis #H-205000	
F	71-73	1010 All	
82051		D	
R	70	AMERICAN MOTORS GREMLIN All	
R	70	HORNET All	
R	58-64	CHEVROLET BEL AIR All	
R	58-64	BISCAYNE All	
R	58	DEL RAY All	
R	59-60	EL CAMINO All	
R	59-64	IMPALA All	
82054		W	
R	60-71	DODGE PICKUP 1/2 TON, D100 SERIES All	
R	60-71	PICKUP 1/2 TON, W100 SERIES All	
R	60-71	PICKUP 3/4 TON, D200 SERIES All	
R	69-71	PICKUP 3/4 TON, W200 SERIES All	
R	60-67	PICKUP 3/4 TON, W200 SERIES All	
R	59-60	TRUCK All	
R	69-72	VAN 3/4 TON, P SERIES All	
82060		D	140630
R	65-68	CADILLAC CALAIS All	
R	65-68	DEVILLE All	
R	65-68	FLEETWOOD All	
R	50-51	FLEETWOOD / 60 SERIES / 70 SERIES All	
R	57-58	CHEVROLET PICKUP Truck, 3200 PICKUP Truck, 3600	
R	50-51	FORD COUNTRY SQUIRE All	
R	49	FORD All	
R	50-51	RANCH WAGON All	
R	55-59	GMC PICKUP All Series 100, 150	
R	56	STUDEBAKER POWER HAWK All	
R	55-56	PRESIDENT All	
R	56	SKY HAWK All	
82062		X	
F	70	CHEVROLET VAN 1/2 TON, G / EXPRESS All Solid Front Axle	
F	64-69	VAN 1/2 TON, G / EXPRESS All	
F	70	VAN 3/4 TON, G / EXPRESS All Solid Front Axle	
F	67-69	VAN 3/4 TON, G / EXPRESS All	
F	70	GMC VAN 1/2 TON, G / SAVANNA All I-Beam Front Axle	
F	64-69	VAN 1/2 TON, G / SAVANNA All	
F	70	VAN 3/4 TON, G / SAVANNA All I-Beam Front Axle	
F	67-69	VAN 3/4 TON, G / SAVANNA All	
82065		W	140478
R	74	DODGE M300 All H3, M3, M-375 H4, M4	
R	74	M350 All H3, M3, M-375 H4, M4	
F	60	PICKUP 1/2 TON, D100 SERIES All	
F	60	PICKUP 1/2 TON, W100 SERIES All	
R	61-71	PICKUP 1 TON, D300 SERIES All	
F	60	PICKUP 3/4 TON, D200 SERIES All	
F	60	PICKUP 3/4 TON, W200 SERIES All	
F	53-60	TRUCK All	
R	53-58	TRUCK All	
R	64-70	VAN 1/2 TON, A / B SERIES / RAM Van	

Numerical listing

Shock	POP	Alternative No.	MTG Acc. Supplied
Pos.	Year	Application	
82065	W	-continued	140478
R	66-72	VAN 1 TON, P SERIES All	
R	61-64	VAN 1 TON, P SERIES All	
82066	D		140455
R	60-66	AMERICAN MOTORS AMBASSADOR All	
R	61-66	CLASSIC All	
R	65-66	MARLIN All	
R	53-54	CADILLAC DEVILLE All	
R	52-54	FLEETWOOD / 60 SERIES / 70 SERIES All	
R	55-57	CHEVROLET BEL AIR All	
R	55-57	ONE-FIFTY SERIES All	
R	50-53	PICKUP Truck, 3100	
R	50-53	PICKUP Truck, 3600	
R	50-53	PICKUP Truck, 3800	
R	55-57	TWO-TEN SERIES All	
R	87-88	ISUZU TROOPER 4WD	
82067	W		140126
R	64-69	LINCOLN CONTINENTAL All	
82069	D		140435
F	64-68	AMERICAN MOTORS AMERICAN All	
F	68-69	AMX All	
F	68-69	JAVELIN All	
F	69	RAMBLER All	
R	62-63	MERCEDES-BENZ 190SL All	
82070	W		140494
F	62-67	CHEVROLET CHEVY II All	
82072	D		140126
F	57-64	CHRYSLER 300 All	
F	57-66	IMPERIAL All	
F	57-64	NEWPORT All	
F	57-64	NEW YORKER All	
F	57-60	SARATOGA All	
F	57-64	TOWN & COUNTRY All	
F	57-61	WINDSOR All	
F	62-64	DODGE 880 All	
F	57-59	CORONET All	
F	57-61	CUSTOM All	
F	60-61	DART All	
F	60-61	POLARA All	
F	57-61	PLYMOUTH BELVEDERE All	
F	58-61	CUSTOM All	
F	60-61	FLEET SPECIAL All	
F	57-61	FURY All	
F	57-58	PLAZA All	
F	57-61	SAVOY All	
F	60-61	SPORT WAGON All	
F	57-61	SUBURBAN All	
82074	W		140455
R	62-67	CHEVROLET CHEVY II All	
82075	D		140689
F	62-65	FORD FAIRLANE All	
F	62-63	MERCURY METEOR All	
82076	D		140524
R	58-59	EDSEL CORSAIR All	
R	58-60	RANGER All	
R	58-60	VILLAGER All	
R	60-64	FORD COUNTRY SEDAN All	
R	59-64	COUNTRY SQUIRE All	
R	59-60	COURIER SEDAN DELIVERY All	
R	64-66	CUSTOM All	
R	60	CUSTOM 300 All	
R	60-61	FAIRLANE All	
R	63	FORD 300 All	
R	60-64	GALAXIE All	
R	59	RANCHERO All	
R	59-64	RANCH WAGON All	
R	59	SKYLINER All	
R	60	STARLINER All	
R	60	SUNLINER All	
R	60	VICTORIA All	
R	61-64	MERCURY COLONY PARK All	
R	64	COMMUTER All	
R	61-62	COMMUTER All	
R	63	COUNTRY CRUISER All	
R	63-64	MARAUDER All	
R	64	MONTCLAIR All	
R	61-64	MONTEREY All	
R	64	PARKLANE All	
R	62-64	VILLAGER All	
82079	D		140877
F	59-64	OLDSMOBILE 88 SERIES All	
F	58	88 SERIES All Exc. '58 Air Suspension	
F	57	88 SERIES All	

Classic Shock Absorbers

Shock	POP	Alternative No.	MTG Acc. Supplied
Pos.	Year	Application	
82079	D	-continued	140877
F	59-64	98 All	
F	58	98 All Exc. '58 Air Suspension	
F	59-63	FIESTA All	
F	58	FIESTA All Exc. '58 Air Suspension	
F	57	FIESTA All	
F	62-63	JETFIRE All	
F	61-64	STARFIRE All	
F	57	STARFIRE All	
82086	W		140455
R	60	CHEVROLET PICKUP All	
R	60-62	PICKUP 1/2 TON, C10 All	
R	60-62	PICKUP 3/4 TON, C20 All	
R	61-62	SUBURBAN 1/2 TON, 1500 All	
R	61-62	VAN 1/2 TON, P SERIES All	
R	61-62	GMC PICKUP 1000 SERIES All	
R	61-62	PICKUP 1500 SERIES All	
82087	D		140455
F	56	BUICK CENTURY All	
F	61-64	ELECTRA All	
F	61-63	INVICTA All	
F	61-64	LESABRE All	
F	63-65	RIVIERA All	
F	56	ROADMASTER All Exc. Air Suspension	
F	56	SPECIAL All	
F	56	SUPER All Exc. Air Suspension	
F	63-64	WILDCAT All	
F	63-64	STUDEBAKER AVANTI All	
F	57-58	CHAMPION All	
F	57-58	COMMANDER All	
F	57-58	GOLDEN HAWK All	
F	60-62	HAWK All	
F	59-62	LARK All	
F	57-58	PRESIDENT All	
F	57-59	SILVER HAWK All	
82089	W		140629
R	63-64	OLDSMOBILE 88 SERIES All	
R	63-64	98 All	
R	63	FIESTA All	
R	63	JETFIRE All	
R	63-64	STARFIRE All	
82090	C		140126
F	63-64	DODGE 330 All	
F	63-64	440 All	
F	70-74	CHALLENGER All	
F	66-72	CHARGER All	
F	65-72	CORONET All	
F	62-76	DART All	
F	61-62	LANCER All	
F	62-64	POLARA All	
F	64-74	PLYMOUTH BARRACUDA All	
F	62-70	BELVEDERE All	
F	70-76	DUSTER All	
F	62-63	FLEET SPECIAL All	
F	62-64	FURY All	
F	67-70	GTX All	
F	68-72	ROADRUNNER All	
F	65-72	SATELLITE All	
F	62-64	SAVOY All	
F	71-76	SCAMP All	
F	70	SUPERBIRD All	
F	60-76	VALIANT All	
82093	D		140877
R	74-75	BUICK APOLLO All	
R	73	APOLLO All Exc. HD Suspension	
R	75-79	SKYLARK All	
R	76-79	CADILLAC SEVILLE All	
R	68	CHEVROLET CHEVY II All Single Leaf Rear Springs	
R	74-79	NOVA All	
R	73	NOVA All Exc. HD Suspension	
R	69-72	NOVA All Single Leaf Rear Springs	
R	74-79	OLDSMOBILE OMEGA All	
R	73	OMEGA All Exc. HD Suspension	
R	77-79	PONTIAC PHOENIX All	
R	73-77	VENTURA All	
R	71-72	VENTURA All Single Leaf Rear Springs	
82099	D		140877
F	58-60	CADILLAC DEVILLE All	
F	56	DEVILLE All	
F	56-60	FLEETWOOD / 60 SERIES / 70 SERIES All	
F	55-57	CHEVROLET BEL AIR All	
F	60-64	CORVAIR All	
F	61-64	CORVAIR TRUCK All	
F	55-57	ONE-FIFTY SERIES All	
F	55-57	TWO-TEN SERIES All	
F	58	EDSEL BERMUDA All	

Numerical listing

Shock	POP	Alternative No.	MTG Acc. Supplied
Pos.	Year	Application	
82099	D	-continued	140877
F	58	CITATION All	
F	58-59	CORSAIR All	
F	58	PACER All	
F	58-60	RANGER All	
F	58	ROUNDUP All	
F	58-60	VILLAGER All	
F	57-64	FORD COUNTRY SEDAN All	
F	57-64	COUNTRY SQUIRE All	
F	57-60	COURIER SEDAN DELIVERY All	
F	64-66	CUSTOM All	
F	57	CUSTOM All	
F	58-60	CUSTOM 300 All	
F	57-58	DEL RIO WAGON All	
F	57-61	FAIRLANE All	
F	63	FORD 300 All	
F	59-64	GALAXIE All	
F	59	RANCHERO All	
F	57-64	RANCH WAGON All	
F	57-59	SKYLINER All	
F	60	STARLINER All	
F	57-60	SUNLINER All	
F	59-60	THUNDERBIRD All	
F	57-60	VICTORIA All	
F	57-64	MERCURY COLONY PARK All	
F	64	COMMUTER All	
F	57-62	COMMUTER All	
F	63	COUNTRY CRUISER All	
F	59-60	COUNTRY CRUISER All	
F	63-64	MARAUDER All	
F	58	MEDALIST All	
F	64	MONTCLAIR All	
F	57-60	MONTCLAIR All	
F	57-64	MONTEREY All	
F	64	PARKLANE All	
F	58-60	PARKLANE All	
F	57	TURNPIKE CRUISER All	
F	62-64	VILLAGER All	
F	57-59	VOYAGER All	
F	58-64	PONTIAC BONNEVILLE All	
F	58-64	CATALINA All	
F	58	CHIEFTAIN All	
F	62-64	GRAND PRIX All	
F	58-64	STAR CHIEF All	
F	58	SUPER CHIEF All	
F	60-61	VENTURA All	
F	67	TOYOTA CROWN All Mfg. to 9/67	
F	65-66	CROWN All	
82103	W		140455
R	63-64	STUDEBAKER AVANTI All	
82104	D		140496
F	65-66	FORD MUSTANG / MUSTANG II All	
82109	D		140455
F	61-64	CADILLAC DEVILLE All	
F	61-64	FLEETWOOD / 60 SERIES / 70 SERIES All	
82110	W		140455
F	65-70	OLDSMOBILE 88 SERIES All	
F	65-70	98 All	
F	67	CUTLASS / CUTLASS SUPREME Turnpike Cruiser	
F	65-66	STARFIRE All	
F	65-70	PONTIAC BONNEVILLE All	
F	65-70	CATALINA All	
F	67-70	EXECUTIVE All	
F	65-68	GRAND PRIX All	
F	65-66	STAR CHIEF All	
82118	D		141983
F	58-64	CHEVROLET BEL AIR All	
F	58-64	BISCAYNE All	
F	58	DEL RAY All	
F	59-60	EL CAMINO All	
F	59-64	IMPALA All	
82123	W		141045
R	60	FORD PICKUP 1/2 TON, F-100 All	
R	60	PICKUP 3/4 TON, F-250 / SUPERDUTY All	
R	57-59	PICKUP F SERIES All F-100, F-250	
R	68-75	PICKUP P350 All	
R	75-76	PICKUP P400 All	
R	55-59	GMC PICKUP All Series 250	
R	58-61	JAGUAR XK150 All	
R	68-72	OPEL KADETT All	
R	59-65	VOLVO 544 All	
R	49	PV 444 All	
82125	D		140523
R	78-80	AMERICAN MOTORS AMX All	
R	78-83	CONCORD All	
R	71-78	GREMLIN All	

Numerical listing

Shock	POP	Alternative No.	MTG Acc. Supplied
Pos.	Year	Application	
82125	D	-continued	140523
R	71-77	HORNET All	
R	79-83	SPIRIT All	
R	75-76	CADILLAC COMMERCIAL CHASSIS All	
R	58-64	DEVILLE All	
R	57-64	FLEETWOOD / 60 SERIES / 70 SERIES All	
R	72-82	FORD COURIER All	
R	72-76	MAZDA B1600 All	
R	77-78	B1800 All	
R	79-84	B2000 All	
R	82-84	B2200 All	
R	76-78	NISSAN F10 Wagon	
R	59-66	PEUGEOT 403 All	
R	61-67	404 All	
82126	D		141164
F	70-74	AMERICAN MOTORS AMBASSADOR All	
F	78-80	AMX All	
F	70	AMX All	
F	78-83	CONCORD All	
F	70-78	GREMLIN All	
F	70-77	HORNET All	
F	70-74	JAVELIN All	
F	71-78	MATADOR All	
F	79-83	SPIRIT All	
F	66-70	FORD FAIRLANE All	
F	60-70	FALCON All	
F	60-71	RANCHERO All	
F	65-74	RANCH WAGON All	
F	68-71	TORINO All	
F	60-69	MERCURY COMET All	
F	68-71	CYCLONE All	
F	68-71	MONTEGO All	
82128	D		140873
F	74-77	FORD MUSTANG / MUSTANG II All	
F	71-80	PINTO Sedan	
F	75-80	MERCURY BOBCAT All	
82129	W		140455
F	75-80	BUICK SKYHAWK All	
F	75-80	CHEVROLET MONZA All	
F	71-77	VEGA All	
F	75-80	OLDSMOBILE STARFIRE All	
F	75-77	PONTIAC ASTRE All	
F	63	LEMANS All	
F	76-80	SUNBIRD All	
F	61-63	TEMPEST All	
82130	W		141132
R	75-80	FORD GRANADA All	
R	70-77	MAVERICK All	
R	77-80	LINCOLN VERSAILLES All	
R	71-77	MERCURY COMET All	
R	75-80	MONARCH All	
R	66-70	NISSAN 1600 All	
R	68-70	2000 All	
82131	D		
R	65-69	CHRYSLER 300 All	
R	75-76	CORDOBA All	
R	74-75	IMPERIAL All	
R	74-78	NEWPORT All	
R	65-69	NEWPORT All	
R	74-78	NEW YORKER All	
R	65-69	NEW YORKER All	
R	74-78	TOWN & COUNTRY All	
R	65-70	TOWN & COUNTRY All	
R	63-64	DODGE 330 All	
R	63-64	440 All	
R	65	880 All	
R	70-74	CHALLENGER All	
R	66-76	CHARGER All	
R	65-76	CORONET All	
R	62	DART All	
R	72-78	MONACO All	
R	65-70	MONACO All	
R	73	POLARA All Exc. Wagon	
R	72	POLARA All	
R	62-70	POLARA All	
R	75-77	ROYAL MONACO All	
R	70-74	PLYMOUTH BARRACUDA All	
R	62-70	BELVEDERE All	
R	62-63	FLEET SPECIAL All	
R	77-78	FURY All Police Package	
R	73-76	FURY All	
R	73	FURY Wagon	
R	62-69	FURY All	
R	74-77	GRAN FURY All	
R	73	GRAN FURY Wagon Wagon	
R	67-71	GTX All	
R	68-75	ROADRUNNER All	
R	65-74	SATELLITE All	

Classic Shock Absorbers, Suspension Mounts

Shock	POP	Alternative No.	MTG Acc. Supplied
Pos.	Year	Application	
82131	D	-continued	
R	62-64	SAVOY All	
R	70	SUPERBIRD All	
R	67	VIP All	
82138	D		140455
F	65-67	BUICK GRAN SPORT All Sportwagon	
F	64-67	SKYLARK All HD Suspension; Exc. Sportwagon	
F	64-67	SPECIAL All HD Suspension; Exc. Sportwagon	
F	64-67	SPORTWAGON All	
F	64-67	CHEVROLET CHEVELLE All	
F	64-67	EL CAMINO All	
F	64-67	MALIBU All	
F	64-67	OLDSMOBILE CUTLASS / CUTLASS SUPREME Base	
F	64-67	CUTLASS / CUTLASS SUPREME Holiday	
F	61-67	F85 All	
F	64-67	PONTIAC GTO All	
F	64-67	LEMANS All	
F	64-67	TEMPEST All	
82139	W		
R	63-80	TRIUMPH SPITFIRE All	
82147	W		
R	65-69	FORD PICKUP 1/2 TON, F-100 All 4WD; Exc. Lift Kit	
R	75-77	PICKUP 3/4 TON, F-250 / SUPERDUTY 4WD Up through Serial No. Y2000	
R	66-74	PICKUP 3/4 TON, F-250 / SUPERDUTY All 4WD; Up through Serial No Y2000	
82151	W		
R	57-58	STUDEBAKER CHAMPION All	
R	57-58	COMMANDER All	
R	57-58	GOLDEN HAWK All	
R	60-62	HAWK All	
R	59-62	LARK All	
R	57-58	PRESIDENT All	
R	57-59	SILVER HAWK All	
82155	D		141041
R	67-69	AMERICAN MOTORS AMBASSADOR All	
R	59-68	AMERICAN All	
R	68-69	AMX All	
R	68-69	JAVELIN All	
R	67	MARLIN All	
R	69	RAMBLER All	
R	59-60	RAMBLER All	
R	59-60	BUICK ELECTRA All Exc. Air Suspension	
R	59-60	INVICTA All Exc. Air Suspension	
R	60	LESABRE All	
R	59	LESABRE All Exc. Air Suspension	
R	51-54	CHEVROLET BEL AIR All	
R	50	BEL AIR All Exc. Air Suspension	
R	60-62	CORVETTE All	
R	53-54	ONE-FIFTY SERIES All	
R	55-58	PICKUP 3800	
R	54	PICKUP All	
R	49-52	STYLELINE DELUXE All	
R	49-52	STYLELINE SPECIAL All	
R	53-54	TWO-TEN SERIES All	
R	61-62	VAN 1 TON, P SERIES All	
R	61-62	VAN 3/4 TON, P SERIES All	
R	66-67	FIAT 1100 All Exc. Wagon	
R	64-67	1500 All Exc. Wagon	
R	53-54	GMC PICKUP All 1/2 and 3/4 Ton	
R	64-65	NISSAN 410 All	
R	64-67	411 All	
R	73	TOYOTA CORONA Base, Hardtop Mfg. to 6/73	
R	73	CORONA Base, Sedan Mfg. to 6/73	
R	68-72	CORONA Base, Hardtop	
R	68-72	CORONA Base, Sedan	
82156	D		
R	57-58	BUICK CENTURY All	
R	58	LIMITED All	
R	57-58	ROADMASTER All Exc. Air Suspension	
R	57-58	SPECIAL All Exc. Air Suspension	
R	57-58	SUPER All Exc. Air Suspension	
R	75-80	DODGE COLT Wagon	
R	71-74	COLT All	
R	75-76	FIAT 124 All Wagon	
R	67-74	124 Wagon Wagon	
R	66-67	1100 All Wagon	
R	64-67	1500 All Wagon	
R	50-51	FORD COUNTRY SEDAN All	

Numerical listing

Shock	POP	Alternative No.	MTG Acc. Supplied
Pos.	Year	Application	
82156	D	-continued	
R	50-51	CRESTLINE All	
R	50-51	CUSTOM All	
R	49-51	DELUXE All	
R	47-48	DELUXE All Direct Acting Shocks	
R	47-48	SUPER DELUXE All Direct Acting Shocks	
R	51	VICTORIA All	
R	78-81	NISSAN 510 Wagon	
R	83-84	MAXIMA Wagon	
R	51-56	OLDSMOBILE 98 All	
R	76-80	PLYMOUTH COLT All	
R	57-60	PONTIAC BONNEVILLE All	
R	50-60	CATALINA All	
R	49-58	CHIEFTAIN All	
R	54-60	STAR CHIEF All	
R	49-52	STREAMLINER All	
R	57-58	SUPER CHIEF All	
R	60	VENTURA All	
R	74-78	TOYOTA CORONA Wagon	
R	73	CORONA Wagon Mfg. from 8/73	
R	71	CORONA Mark II, Wagon Exc. Wagon	
R	69-70	CORONA Mark II, Wagon	
R	65-66	CROWN Wagon Wagon	
82601	D		140455
F	65-70	BUICK ELECTRA All	
F	70	ESTATE WAGON All	
F	65-70	LESABRE All	
F	66-70	RIVIERA All	
F	65-70	WILDCAT All	
F	65-76	CADILLAC CALAIS All	
F	75-76	COMMERCIAL CHASSIS All	
F	65-76	DEVILLE All	
F	65-76	FLEETWOOD All	
82602	W		140629
R	65-70	BUICK ELECTRA All	
R	65-70	LESABRE All	
R	65-70	WILDCAT All	
R	71-76	CADILLAC CALAIS All	
R	71-76	DEVILLE All	
R	71-76	FLEETWOOD All	
82603	W		140633
R	73-76	FORD THUNDERBIRD All	
R	73-76	LINCOLN MARK IV All	
R	77-79	MARK V All	
82607	W		
F	56-57	SAAB 93 All	
F	58-59	93B All	
F	59-73	95 All	
F	61-73	96 All	
F	69-80	99 All	
F	58-62	GT750 All	
F	63	GT850 All	
82609	W		
R	61-64	BUICK ELECTRA All	
R	61-63	INVICTA All	
R	61-64	LESABRE All	
R	63-65	RIVIERA All	
R	63-64	WILDCAT All	
82610	W		140645
R	69-70	CADILLAC CALAIS All	
R	69-70	DEVILLE All	
R	69-70	FLEETWOOD All	
82614	X		141142
F	76-79	FIAT 124 All Built after Serial #066.059	
F	67-75	124 All	
F	71-75	OPEL 1900 All	
F	71-75	MANTA All	
82615	W		
F	61-69	LINCOLN CONTINENTAL All	
82617	W		140126
R	64-66	FORD THUNDERBIRD All	
82618	W		140629
R	66-70	BUICK RIVIERA All	
Suspension Mounts			
141974	X		
R	94	ASUNA GT	
R	92	GT	
R	93	GT, SE All	
R	94	SE	
R	92	SE	
R	82-96	BUICK CENTURY All	
R	82-89	SKYHAWK All	

Numerical listing

Shock	POP	Alternative No.	MTG Acc. Supplied
Pos.	Year	Application	
141974	X	-continued	
R	84-98	SKYLARK	All
R	85-87	SOMERSET / SOMERSET REGAL	All
R	84-88	CADILLAC C/MARRON	All
R	95-96	CHEVROLET BERETTA	All
R	92-94	BERETTA Base Exc. FE7 Suspension	
R	87-91	BERETTA	All
R	87-94	CAVALIER	All
R	84-86	CAVALIER	All Rebuildable O.E. Struts
R	82-83	CAVALIER	All
R	82-90	CELEBRITY	All
R	84-85	CITATION / CITATION II	All
R	87-96	CORSICA	All
R	90-96	LUMINA APV	All
R	92-98	OLDSMOBILE ACHIEVA	All Exc. Electronic Adjustable Suspension
R	85-87	CALAIS	All
R	85-96	CIERA / CUTLASS CIERA	All Exc. Electronic Adjustable Suspension
R	84	CIERA / CUTLASS CIERA	All
R	88-91	CUTLASS CALAIS	All
R	87-94	CUTLASS CLASSIC / CUTLASS CRUISER	All Exc. Electronic Adjustable Suspension
R	84-88	FIRENZA	All
R	90-96	SILHOUETTE	All
R	89-91	PONTIAC 6000	FWD
R	84-88	6000	All
R	95-98	GRAND AM	All Exc. Electronic Adjustable Suspension
R	85-94	GRAND AM	All
R	84-85	J2000 / SUNBIRD	All
R	84	PHOENIX	All
R	94	SUNBIRD	All
R	91-93	SUNBIRD	All Sport Suspension
R	86-90	SUNBIRD	All
R	87-91	TEMPEST	All
R	90-96	TRANS SPORT	All
142132	X		
R	85-90	BUICK ELECTRA	All
R	86-99	LESABRE	All
R	91-96	PARK AVENUE	All
R	93	CADILLAC 60 SPECIAL	All
R	92-93	COMMERCIAL CHASSIS FWD	Air Assist Rear Suspension; Exc. Electronic Adjustable Suspension
R	91	COMMERCIAL CHASSIS	All Air Assist Rear Suspension; Exc. Electronic Adjustable Suspension
R	85-90	COMMERCIAL CHASSIS	All Air Assist Rear Suspension Standard Equipment
R	85-93	DEVILLE	All
R	91-93	FLEETWOOD	All Air Assist Rear Suspension; Exc. Electronic Adjustable Suspension
R	87-90	FLEETWOOD	All Air Assist Rear Suspension Standard Equipment
R	85-86	FLEETWOOD	All Air Assist Rear Suspension; Exc. Electronic Adjustable Suspension
R	92-99	OLDSMOBILE 88 SERIES	All
R	86-91	88 SERIES	All Optional O.E. Hydraulic Self Leveling System
R	85-96	98	All
R	96-99	LSS	All
R	97-98	REGENCY	All
R	87-99	PONTIAC BONNEVILLE	All
142135	X		
R	91-98	BMW 318i	All
R	84-85	318i	All
R	91-98	318iS	All
R	95-99	318Ti	All
R	98-99	323i	All
R	87-88	325	All
R	84-87	325E	All
R	92-95	325i E36	(MfrBodyCode)
R	87-91	325i	All
R	87-92	325iS	All
R	88-91	325iX	All
R	96-98	328i	All
R	88-91	M3	All
142143	W		
F	88-96	BUICK REGAL	All
F	90-01	CHEVROLET LUMINA	All
F	95-99	MONTE CARLO	All Exc. HD Suspension
F	88-97	OLDSMOBILE CUTLASS / CUTLASS SUPREME	All

Suspension Mounts

Shock	POP	Alternative No.	MTG Acc. Supplied
Pos.	Year	Application	
142143	W	-continued	
F	90-96	PONTIAC GRAND PRIX	All
142173	X		
R	83-87	DODGE CHARGER	All
R	78-90	OMNI	All
R	87-89	PLYMOUTH EXPO	All
R	78-90	HORIZON	All
R	85	TURISMO	All
R	83	TURISMO	All
142183	X		
F	86-89	MAZDA 323	All Exc. Electronic Adjustable Suspension
F	81-85	GLC Hatchback	
F	81-85	GLC Sedan	
F	87-89	MERCURY TRACER	FWD
142190	X		
R	91-03	FORD ESCORT	All
R	90-94	MAZDA 323	All
R	90-94	PROTÉGÉ / PROTÉGÉ5 FWD, Non-ABS	
R	91-99	MERCURY TRACER	FWD
142195	X		
F	88-92	AUDI 80	All
F	88-92	80 QUATTRO	All
F	93-95	90	All
F	88-91	90 All	
F	93-95	90 QUATTRO	All
F	88-91	90 QUATTRO	All
F	80-87	4000	All
F	84-87	4000 QUATTRO	All
F	83-87	COUPE	All
F	90-91	COUPE QUATTRO	All
F	82-88	VOLKSWAGEN QUANTUM	All
142196	X		
R	89-92	FORD PROBE	All
R	88-92	MAZDA 626	All Exc. Electronic Adjustable Suspension or 4 Wheel Steer
R	88-92	MX6	All Exc. Electronic Adjustable Suspension or 4 Wheel Steer
142197	X		
F	78-83	FORD FAIRMONT	All
F	81-82	GRANADA	All
F	83-86	LTD / COUNTRY SEDAN / COUNTRY SQUIRE / CROWN VICTORIA	All
F	82-04	MUSTANG / MUSTANG II	All
F	79-86	MERCURY CAPRI	All
F	81-82	COUGAR Base	
F	82	COUGAR GS	
F	82	COUGAR LS	
F	83-86	MARQUIS	All
F	78-83	ZEPHYR	All
142219	X		
F	89-90	DODGE 2000 GTX	All Exc. Auto-Leveling System
F	90-94	EAGLE TALON	All
F	90-94	MITSUBISHI ECLIPSE	All
F	90-94	PLYMOUTH LASER	All
142222	W		
F	89-97	FORD THUNDERBIRD	All Exc. Electronic Adjustable Suspension
F	89-97	MERCURY COUGAR	All Exc. Electronic Adjustable Suspension
142223	X		
F	82-96	BUICK CENTURY	All
F	80-85	SKYLARK	All
F	82-90	CHEVROLET CELEBRITY	All
F	80-85	CITATION / CITATION II	All
F	90-96	LUMINA APV	All
F	85-96	OLDSMOBILE CIERA / CUTLASS CIERA	All Exc. Electronic Adjustable Suspension
F	82-84	CIERA / CUTLASS CIERA	All
F	87-94	CUTLASS CLASSIC / CUTLASS CRUISER	All Exc. Electronic Adjustable Suspension
F	90-96	SILHOUETTE	All
F	91	PONTIAC 6000	FWD
F	82-90	6000	All
F	80-84	PHOENIX	All
F	90-96	TRANS SPORT	All
142226	X		
F	90-96	BUICK LESABRE	All
F	91-96	PARK AVENUE	All
F	93	CADILLAC 60 SPECIAL	All

Numerical listing

Shock	POP	Alternative No.	MTG Acc. Supplied
Pos.	Year	Application	
142226	X	-continued	
F	91-92	BROUGHAM	All
F	92-93	COMMERCIAL CHASSIS FWD	
F	91	COMMERCIAL CHASSIS	All
F	91-93	DEVILLE	All Exc. Electronic Adjustable Suspension
F	91-93	FLEETWOOD	All
F	90-96	OLDSMOBILE 88 SERIES	All
F	91-96	98	All
F	98-99	PONTIAC BONNEVILLE	Air (RearSpringType) CCR Computer Command Ride
F	94-96	BONNEVILLE	All CCR Computer Command Ride
F	91-93	BONNEVILLE	All
F	90	BONNEVILLE	All Late Design Front Strut without Spring Guard
142227	X		
F	85-90	BUICK ELECTRA	All
F	86-90	LESABRE	All
F	91-96	PARK AVENUE	All
F	95-98	SKYLARK	All
F	92-94	SKYLARK	All Exc. FE3 and Electronic Ride Control
F	93	CADILLAC 60 SPECIAL	All
F	87-93	ALLANTE	All
F	92-93	COMMERCIAL CHASSIS FWD	
F	85-91	COMMERCIAL CHASSIS	All
F	85-93	DEVILLE	All
F	91-02	ELDORADO	All
F	85-93	FLEETWOOD	All
F	87-97	SEVILLE	All
F	92-96	CHEVROLET BERETTA	All
F	95-98	CAVALIER	All
F	92-96	CORSICA	All
F	86-96	OLDSMOBILE 88 SERIES	All
F	91-96	98	All Exc. Soft Ride Susp (FE1) and Elec. Ride & Handling (FW1)
F	85-90	98	All
F	95-98	ACHIEVA	All Exc. Electronic Adjustable Suspension
F	92-94	ACHIEVA	All FE3 Suspension
F	95-96	AURORA	All
F	90-92	TORONADO	All
F	87-96	PONTIAC BONNEVILLE	All
F	95-98	GRAND AM	All Exc. Electronic Adjustable Suspension
F	92-94	GRAND AM	SE Exc. FE3 and Electronic Ride Control
F	95-98	SUNFIRE	All
142229	X		
R	98-02	CHEVROLET PRIZM	All Right
R	89-97	GEO PRIZM	All Right
R	88-02	TOYOTA COROLLA	FWD Right
142230	D		
F	01-03	ACURA CL	All
F	97-99	CL	All
F	97-03	EL	All
F	90-01	INTEGRA	All
R	90-93	INTEGRA	All
F	89-90	LEGEND	All Auto Leveling System
F	86-88	LEGEND	All
R	02-06	RSX	All
F	95-14	TL	All
R	99-12	TL	All
F	92-94	VIGOR	All
F	08-12	HONDA ACCORD	All
R	98-12	ACCORD	All
F	03-07	ACCORD 2.4L 4Cyl L (2354)	
F	86-02	ACCORD	All
R	89-05	CIVIC	All
F	89-00	CIVIC	All
F	88	CIVIC Hatchback	
R	88	CIVIC Hatchback	
F	88	CIVIC Sedan	
R	88	CIVIC Sedan	
F	93-97	CIVIC DEL SOL	All
R	93-97	CIVIC DEL SOL	All
R	03-12	CR-V	All
F	97-01	CR-V	All
R	97-01	CR-V	All
F	88-91	CRX	All
R	88-91	CRX	All
R	03-11	ELEMENT	All
F	95-98	ODYSSEY	All
R	95-98	ODYSSEY	All
F	83-01	PRELUDE	All
R	06-14	RIDGELINE	All
R	00-09	S2000	All
F	00-07	S2000	All
F	96-99	ISUZU OASIS	All
R	96-99	OASIS	All

Numerical listing

Shock	POP	Alternative No.	MTG Acc. Supplied
Pos.	Year	Application	
142231 X			
R	01-03	ACURA	CL All
R	97-99	CL	All
R	86-89	INTEGRA	All
R	89-90	LEGEND	All Auto Leveling System
R	87-88	LEGEND	Coupe
R	92-94	VIGOR	All
R	79-97	HONDA	ACCORD All
R	80-87	CIVIC	All
R	92-01	PRELUDE	All
R	79-87	PRELUDE	All
142237 W			
F	90-97	MAZDA	MIATA Non-ABS
R	90-97	MIATA	Non-ABS
142241 X			
F	70-73	NISSAN	240Z All
F	74	260Z	All Mfg. 9/74
F	75-78	280Z	All
F	79-83	280ZX	All
F	84-89	300ZX	All
F	73-76	610	All
F	77-81	810	All
F	90-94	AXXESS	All
F	89-94	MAXIMA	All Exc. Electronic Adjustable Suspension
F	82-84	MAXIMA	All
F	83-85	PULSAR / PULSAR NX	All
F	93-02	QUEST	All
142242 X			
F	86-88	NISSAN	MAXIMA Sedan Exc. Electronic Adjustable Suspension
F	85	MAXIMA	All Exc. Electronic Adjustable Suspension
F	87-88	MULTI	All
F	87-89	STANZA	Sedan
F	81-82	TOYOTA	CRESSIDA All Exc. Electronic Adjustable Suspension
F	78-80	CRESSIDA	All
142244 X			
F	91-02	SATURN	SC / SL / SW SERIES All
142245 X			
R	91-02	SATURN	SC / SL / SW SERIES All
142247 X			
F	83-88	TOYOTA	TERCEL Wagon
142249 X			
R	85-88	CHEVROLET	NOVA All
R	88-89	TOYOTA	CELICA GT
R	88-89	CELICA	GTS
R	88-89	CELICA	ST
R	86-87	CELICA	All
R	84-87	COROLLA	All
R	87	TERCEL	Wagon
R	83-86	TERCEL	All
142293 C			
F	98-01	CHEVROLET	METRO Non-ABS
F	89-91	SPRINT	All
F	89-97	GEO	METRO Non-ABS
F	94	PONTIAC	FIREFLY All
F	89-91	FIREFLY	All
F	89-01	SUZUKI	SWIFT All
142294 W			
F	94-98	ASUNA	SUNRUNNER
F	92-93	SUNRUNNER	All
F	98-03	CHEVROLET	TRACKER Non-ABS
F	89-97	GEO	TRACKER All
F	94-97	PONTIAC	SUNRUNNER All
F	89-98	SUZUKI	SIDEKICK Non-ABS
142295 X			
R	98-01	CHEVROLET	METRO Non-ABS
R	89-91	SPRINT	All
R	89-97	GEO	METRO Non-ABS
R	94	PONTIAC	FIREFLY All
R	89-91	FIREFLY	All
R	89-01	SUZUKI	SWIFT All
142297 W			
F	90-91	BUICK	REATA All
F	90-93	RIVIERA	All
F	87-92	CADILLAC	ALLANTE All Exc. Electronic Adjustable Suspension
F	87-02	ELDORADO	All
F	87-92	SEVILLE	All
F	90-92	OLDSMOBILE	TORONADO All
142298 X			
F	88-89	BUICK	REATA All
F	86-89	RIVIERA	All

Suspension Mounts

Shock	POP	Alternative No.	MTG Acc. Supplied
Pos.	Year	Application	
142298 X -continued			
F	86	CADILLAC	ELDORADO All
F	86	SEVILLE	All
F	86-89	OLDSMOBILE	TORONADO All
142300 X			
R	90-93	ACURA	INTEGRA All
R	98-02	HONDA	ACCORD All
R	89-95	CIVIC	All
R	93-97	CIVIC DEL SOL	All
142302 X			
R	91-93	NISSAN	NX All
R	93-94	SENTRA	All
R	91-92	SENTRA	Non-ABS
142307 W			
F	92-99	TOYOTA	PASEO All
F	91-99	TERCEL	All
142316 X			
F	88-94	CHEVROLET	BLAZER, S MODELS 4WD, Torsion Bar (FrontSpringType)
F	88-04	S10 4WD	Torsion Bar (FrontSpringType)
F	05	GMC	JIMMY 4WD
F	92-04	JIMMY	All
F	83-91	S15	JIMMY All
F	88-94	SONOMA / S15	4WD, Torsion Bar (FrontSpringType)
F	91	SYCLONE	Torsion Bar (FrontSpringType)
F	92-93	TYPHOON	All
F	91-94	OLDSMOBILE	BRAVADA Torsion Bar (FrontSpringType)
142317 X			
F	93	ASUNA	SUNFIRE (CANADIAN VEHICLE) All
F	90-93	GEO	STORM Non-ABS
F	90-92	ISUZU	IMPULSE All Exc. Lotus Suspension
F	91-93	STYLUS	All Exc. Lotus Suspension
142326 C			
F	84-89	MERCEDES-BENZ	190D All
F	84-93	190E	All
F	87-89	260E	All Exc. 4 Matic 4x4
F	90-93	300D	All Exc. 4 Matic 4x4
F	86-93	300E	All Exc. 4 Matic 4x4
F	92-93	400E / 400SE / 400SEL / 420SEL / 450SE / 450SEL	All
F	90-93	500SL	All
F	93	600SL	All
F	95	E300	All
F	94-95	E320	All
F	94-95	E420	All
F	94	E500	All
F	94-02	SL320 / SL500 / SL600	All
142329 X			
F	93-95	DODGE	COLT All
F	93-96	EAGLE	SUMMIT Coupe
F	93-96	SUMMIT	Sedan
F	96	MITSUBISHI	MIRAGE All Mfg. to 5/96
F	95	MIRAGE	Sedan
F	93-94	MIRAGE	All
F	93-94	PLYMOUTH	COLT Sedan
142330 D			
F	98-02	SUBARU	FORESTER All
F	93-01	IMPREZA	Non-ABS
F	90-04	LEGACY	All
142393 X			
R	95-99	DODGE	NEON All
R	95-99	PLYMOUTH	NEON All
142402 X			
R	95-00	FORD	CONTOUR All
R	99-00	MERCURY	COUGAR All
R	95-00	MYSTIQUE	All
142405 X			
R	88-91	BUICK	REATA All
R	86-93	RIVIERA	All
R	87-92	CADILLAC	ALLANTE All Exc. Electronic Adjustable Suspension
R	86-93	ELDORADO	All
R	86-93	SEVILLE	All
R	86-92	OLDSMOBILE	TORONADO All
142412 X			
F	93-02	CHEVROLET	CAMARO All
F	93-02	PONTIAC	FIREBIRD All

Numerical listing

Shock	POP	Alternative No.	MTG Acc. Supplied
Pos.	Year	Application	
142413 W			
R	95-05	CHEVROLET	CAVALIER All
R	95-05	PONTIAC	SUNFIRE All
142419 C			
R	01-05	CHRYSLER	SEBRING ST (MfrBodyCode), Coupe
F	96-00	SEBRING	Coupe
R	96-00	SEBRING	Coupe
F	95	SEBRING	All
R	95	SEBRING	All
R	89	DODGE	2000 GTX All Exc. Auto-Leveling System
F	95-00	AVENGER	All
R	95-00	AVENGER	All
R	92-95	COLT	All
R	89-91	COLT	Hatchback
R	91-96	STEALTH	All
R	01-05	STRATUS	ST (MfrBodyCode), Coupe
R	91-93	EAGLE	2000 GTX All
R	93-96	SUMMIT	All
R	89-92	SUMMIT	Sedan
R	92	SUMMIT	Wagon
F	95-98	TALON	All
R	90-98	TALON	All
R	06-11	HYUNDAI	ACCENT All
R	92-95	ELANTRA	Non-ABS
F	00-05	SONATA	All
R	00-05	SONATA	All
R	01	XG300	All
R	02-05	XG350	All
R	01-06	KIA	MAGENTIS All
R	01-06	OPTIMA	All
R	06-11	RIO	All
R	06-11	RIO	All
R	91-99	MITSUBISHI	3000GT All
R	97-04	DIAMANTE	All
R	90-05	ECLIPSE	All
F	95-99	ECLIPSE	All
R	92-95	EXPO	All
R	89-07	GALANT	All
F	94-98	GALANT	All
R	85-88	GALANT	All Exc. Electronic Adjustable Suspension
R	97-02	MIRAGE	All
R	96	MIRAGE	All Mfg. to 5/96
R	95	MIRAGE	Sedan
R	89-94	MIRAGE	All
R	89-90	SIGMA	Non-ABS Exc. Auto-Leveling System
R	89-94	PLYMOUTH	COLT All
R	90-94	LASER	All
142426 X			
R	90-94	NISSAN	AXXESS All Left
R	89-94	MAXIMA	All Left
R	86-88	MAXIMA	Sedan Left
R	85	MAXIMA	All Left
R	87-88	MULTI	All Left
R	90-92	STANZA	All Left
R	87-89	STANZA	Sedan Left
142427 X			
R	90-94	NISSAN	AXXESS All Right
R	89-94	MAXIMA	All Right Exc. Electronic Adjustable Suspension
R	86-88	MAXIMA	Sedan Right Exc. Electronic Adjustable Suspension
R	85	MAXIMA	All Right Exc. Electronic Adjustable Suspension
R	87-88	MULTI	All Right
R	90-92	STANZA	All Right
R	87-89	STANZA	Sedan Right
142430 X			
F	89-94	NISSAN	240SX All Exc. Active Suspension
142437 X			
F	85-92	TOYOTA	CRESSIDA All Exc. Electronic Adjustable Suspension
F	86	SUPRA	All Mfg. to 3/86
142439 W			
R	95-96	TOYOTA	AVALON All
R	92-96	CAMRY	All
142524 X			
F	05-09	BUICK	ALLURE All
F	97-05	CENTURY	All
F	05-09	LACROSSE	All
F	97-05	LESABRE	All
F	97-05	PARK AVENUE	All
F	97-04	REGAL	All
F	98-99	RIVIERA	All

Numerical listing

Shock	POP	Alternative No.	MTG Acc. Supplied
Pos.	Year	Application	
142524 X -continued			
F	98-04	CADILLAC	SEVILLE All
F	00-11	CHEVROLET	IMPALA All
F	00-06		MONTE CARLO All
F	02-05		VENTURE All
F	97-01		VENTURE FWD
F	97-99	OLDSMOBILE	88 SERIES All
F	97		AURORA All
F	98-02		INTRIGUE All
F	96-99		LSS All
F	97-98		REGENCY All
F	97-04		SILHOUETTE All
F	97-08	PONTIAC	GRAND PRIX All
F	04-05		MONTANA All
F	02-03		MONTANA Mini Passenger Van
F	99-01		MONTANA All
F	97-98		TRANS SPORT All
142525 W			
F	05-09	BUICK	ALLURE All
F	97-05		CENTURY All
F	05-09		LACROSSE All
F	97-04		REGAL All
F	00-16	CHEVROLET	IMPALA All
F	00-06		MONTE CARLO All
F	02-05		VENTURE All
F	97-01		VENTURE FWD
F	98-02	OLDSMOBILE	INTRIGUE All
F	97-04		SILHOUETTE All
F	97-08	PONTIAC	GRAND PRIX All
F	99-05		MONTANA All
F	97-98		TRANS SPORT All
142526 D			
F	05-09	BUICK	ALLURE All
F	97-05		CENTURY All
F	05-09		LACROSSE All
F	97-04		REGAL All
F	05-07		TERRAZA FWD
F	00-16	CHEVROLET	IMPALA All
F	00-07		MONTE CARLO All
F	05-09		UPLANDER FWD Exc. Air-Leveling Suspension
F	02-05		VENTURE All
F	97-01		VENTURE FWD
F	98-02	OLDSMOBILE	INTRIGUE All
F	97-04		SILHOUETTE All
F	01-05	PONTIAC	AZTEK All
F	97-08		GRAND PRIX All
F	99-09		MONTANA All
F	97-98		TRANS SPORT All
F	05-07	SATURN	RELAY FWD
142527 X			
F	97-99	CADILLAC	DEVILLE All Electronic Ride Control
F	97-02		ELDORADO All Electronic Ride Control
F	93-97		SEVILLE All
142532 X			
R	04-05	CHEVROLET	CLASSIC All
R	97-03		MALIBU All
R	99-04	OLDSMOBILE	ALERO All
R	97-99		CUTLASS / CUTLASS SUPREME All
R	99-05	PONTIAC	GRAND AM All
142535 C			
R	96-06	HYUNDAI	ELANTRA All Left
R	03-08		TIBURON All Left
R	97-01		TIBURON All Left
R	05-12		TUCSON All Left
R	05-09	KIA	SPECTRA All Left
R	04-09		SPECTRA All Left
R	05-10		SPORTAGE All Left
142536 C			
R	96-06	HYUNDAI	ELANTRA All Right
R	03-08		TIBURON All Right
R	97-01		TIBURON All Right
R	05-12		TUCSON All Right
R	05-09	KIA	SPECTRA All Right
R	04-09		SPECTRA All Right
R	05-10		SPORTAGE All Right
142546 D			
F	96-99	INFINITI	I30 All
F	95-99	NISSAN	MAXIMA All
142556 X			
F	95-04	TOYOTA	AVALON All
F	95-01		CAMRY All
F	94-99		CELICA All

Suspension Mounts

Shock	POP	Alternative No.	MTG Acc. Supplied
Pos.	Year	Application	
142562 X			
F	91-92	FORD	PROBE Base, 2.2L 4Cyl L (133), Automatic
F	90-92		PROBE GT, 2.2L 4Cyl L (133), Automatic
F	89-92		PROBE GL, 2.2L 4Cyl L (133), Automatic
F	89		PROBE LX, 2.2L 4Cyl L (133), Automatic
F	88-92	MAZDA	626 Automatic Exc. Electronic Adjustable Suspension or 4 Wheel Steer
F	88-89		929 All Exc. Electronic Adjustable Suspension
F	00-06		MPV All
F	88-92		MX6 Automatic Exc. Electronic Adjustable Suspension or 4 Wheel Steer
142567 W			
F	87-93	CHRYSLER	DAYTONA All
F	86		DAYTONA CAN
F	88-93		DYNASTY All
F	90-93		IMPERIAL All Exc. Hydraulic Self Leveling System
F	86		LASER All
F	86-95		LEBARON All
F	86-93		NEW YORKER All
F	90-95		TOWN & COUNTRY All
F	86-88		TOWN & COUNTRY All
F	86-88	DODGE	600 All
F	86-89		ARIES All
F	86-95		CARAVAN / GRAND CARAVAN All
F	86-93		DAYTONA All
F	88-93		DYNASTY All Exc. Hydraulic Self Leveling System
F	86-89		LANCER All
F	87-94		SHADOW All
F	89-95		SPIRIT All
F	89-95	PLYMOUTH	ACCLAIM All
F	86-88		CARAVELLE All
F	86-89		RELIANT All
F	87-94		SUNDANCE All
F	86-95		VOYAGER / GRAND VOYAGER All
142568 W			
F	86-93	CHRYSLER	DAYTONA All
F	88-93		DYNASTY All
F	90-93		IMPERIAL All Exc. Hydraulic Self Leveling System
F	86		LASER All
F	86-95		LEBARON All
F	86-93		NEW YORKER All
F	90-95		TOWN & COUNTRY All
F	86-88		TOWN & COUNTRY All
F	86-88	DODGE	600 All
F	86-89		ARIES All
F	89-95		CARAVAN / GRAND CARAVAN All Mfg. from 1/86
F	86-95		CARAVAN / GRAND CARAVAN All
F	89-93		DAYTONA All
F	87-88		DAYTONA Pacifica
F	86		DAYTONA All
F	88-93		DYNASTY All Exc. Hydraulic Self Leveling System
F	86-89		LANCER All
F	87-94		SHADOW All
F	89-95		SPIRIT All
F	89-95	PLYMOUTH	ACCLAIM All
F	86-88		CARAVELLE All
F	86-89		RELIANT All
F	87-94		SUNDANCE All
F	86-95		VOYAGER / GRAND VOYAGER All
142573 X			
R	85-98	VOLKSWAGEN	GOLF All
R	85-98		JETTA All
142623 W			
F	95-98	NISSAN	200SX All
F	91-93		NX All
F	93-99		SENTRA All
F	91-92		SENTRA Non-ABS
142625 D			
F	96-06	HYUNDAI	ELANTRA All
F	97-01		TIBURON All
142626 X			
R	88-92	DAIHATSU	CHARADE All
R	95-05	HYUNDAI	ACCENT All
142640 X			
F	00-05	BUICK	LESABRE All
F	98-05		PARK AVENUE All
F	98-99		RIVIERA All

Numerical listing

Shock	POP	Alternative No.	MTG Acc. Supplied
Pos.	Year	Application	
142640 X -continued			
F	97-05	CADILLAC	DEVILLE All Exc. Electronic Adjustable Suspension
F	98-04		SEVILLE All Exc. Electronic Adjustable Suspension
F	01-03	OLDSMOBILE	AURORA All
F	98-99		AURORA All
F	00-05	PONTIAC	BONNEVILLE All
142641 X			
R	94-01	KIA	SEPHIA All Right
142642 X			
R	94-01	KIA	SEPHIA All Left
142647 X			
R	00-05	BUICK	LESABRE All
R	06-11		LUCERNE All
R	97-05		PARK AVENUE All
R	95-99		RIVIERA All
R	00-05	CADILLAC	DEVILLE All Exc. Electronic Adjustable Suspension
R	98-04		SEVILLE All Exc. Electronic Adjustable Suspension
R	01-03	OLDSMOBILE	AURORA All
R	95-99		AURORA All
R	00-05	PONTIAC	BONNEVILLE All
142649 X			
F	97-01	LEXUS	ES300 All Right Exc. Electronic Adjustable Suspension
F	99-03		RX300 All Right
F	97-04	TOYOTA	AVALON All Right
F	97-01		CAMRY All Right
F	03		SIENNA All Right
F	02		SIENNA All Right Mfg. to 12/02
F	98-01		SIENNA All Right
F	99-03		SOLARA All Right
142650 X			
F	97-01	LEXUS	ES300 All Left Exc. Electronic Adjustable Suspension
F	99-03		RX300 All Left
F	97-04	TOYOTA	AVALON All Left
F	97-01		CAMRY All Left
F	98-03		SIENNA All Left
F	99-03		SOLARA All Left
142651 C			
F	00-06	AUDI	TT All
F	00-06		TT QUATTRO All
F	98-10	VOLKSWAGEN	BETLE All
F	99-06		GOLF A4 (MfrBodyCode)
F	01-05		JETTA Sedan
F	99-00		JETTA All
142652 C			
F	96-08	AUDI	A4 All
F	98-04		A6 All
F	98-07		A6 QUATTRO All
F	97-99		A8 All
F	00-02		S4 All
F	98-09	VOLKSWAGEN	PASSAT All
142654 C			
R	00-06	AUDI	TT All
R	98-10	VOLKSWAGEN	BETLE All
R	99-06		GOLF A4 (MfrBodyCode)
R	01-05		JETTA Sedan
R	99-00		JETTA All
142735 X			
R	92-95	BMW	525i All Exc. Electronic Adjustable Suspension
R	89-91		525i All
R	94-95		530i Sedan
R	88-93		535i All
R	88		535iS All
142744 X			
F	91-03	FORD	ESCORT All
F	91-99	MERCURY	TRACER FWD
142746 X			
F	86-95	FORD	TAURUS All
F	91-95	MERCURY	SABLE Sedan
F	86-90		SABLE All
142749 X			
F	85-96	BUICK	CENTURY All
F	85		SKYLARK All
F	84-90	CHEVROLET	CELEBRITY All
F	84-85		CITATION / CITATION II All
F	90-96		LUMINA APV All
F	82-96	OLDSMOBILE	CIERA / CUTLASS CIERA All

Numerical listing

Shock	POP	Alternative No.	MTG Acc. Supplied
Pos.	Year	Application	
142749 X -continued			
F	87-94	CUTLASS CLASSIC / CUTLASS CRUISER All	
F	90-96	SILHOUETTE All	
F	91	PONTIAC 6000 FWD	
F	84-90	6000 All	
F	84	PHOENIX All	
F	90-96	TRANS SPORT All	
142751 X			
F	91-99	BUICK LESABRE All	
F	91-96	PARK AVENUE All	
F	95-97	RIVIERA All	
F	93	CADILLAC 60 SPECIAL All	
F	92-93	COMMERCIAL CHASSIS FWD	
F	91	COMMERCIAL CHASSIS All	
F	91-93	DEVILLE All	
F	91-93	FLEETWOOD All	
F	90-99	OLDSMOBILE 88 SERIES All	
F	91-96	98 All Exc. Soft Ride Susp (FE1) and Elec. Ride & Handling (FW1)	
F	91-96	98 Coil (FrontSpringType), Air (RearSpringType) Standard Equipment; Exc. Electronic Adjustable Suspension	
F	95-96	AURORA All	
F	96-99	LSS All	
F	97-98	REGENCY All	
F	90-99	PONTIAC BONNEVILLE All	
142752 X			
F	86-90	BUICK LESABRE All	
F	85-90	CADILLAC COMMERCIAL CHASSIS All	
F	85-90	DEVILLE All	
F	87-90	FLEETWOOD All	
F	86-89	OLDSMOBILE 88 SERIES All	
F	85-90	98 All	
F	87-89	PONTIAC BONNEVILLE All	
142753 X			
F	96-00	CHRYSLER TOWN & COUNTRY All	
F	00	VOYAGER / GRAND VOYAGER All	
F	96-00	DODGE CARAVAN / GRAND CARAVAN All	
F	96-00	CARAVAN / GRAND CARAVAN All Exc. Hydraulic Self Leveling System	
F	96-00	PLYMOUTH VOYAGER / GRAND VOYAGER All Exc. Nivomat Self-Leveling Option	
142755 X			
F	93-97	CHRYSLER CONCORDE All	
F	94-97	LHS All	
F	94-96	NEW YORKER All	
F	93-97	DODGE INTREPID All	
F	93-97	EAGLE VISION All	
142762 X			
F	82-89	BUICK SKYHAWK All	
F	86-91	SKYLARK All	
F	85-87	SOMERSET / SOMERSET REGAL All	
F	82-88	CADILLAC CIMARRON All	
F	87-91	CHEVROLET BERETTA All	
F	82-94	CAVALIER All	
F	87-91	CORSIKA All	
F	85-87	OLDSMOBILE CALAIS All	
F	88-91	CUTLASS CALAIS All	
F	82-87	FIRENZA All	
F	85-91	PONTIAC GRAND AM All Standard Suspension	
F	82-84	J2000 / SUNBIRD All	
F	86-94	SUNBIRD All	
142825 X			
F	95-99	BMW M3 All Right	
142826 X			
F	95-99	BMW M3 All Left	
142827 W			
F	99-04	CHRYSLER 300M All	
F	98-04	CONCORDE All	
F	98-04	INTREPID All	
F	99-01	LHS All	
F	98-04	DODGE INTREPID All	
142828 X			
R	99-04	CHRYSLER 300M All	
R	98-04	CONCORDE All	
R	98-04	INTREPID All	
R	99-01	LHS All	
R	98-04	DODGE INTREPID All	

Suspension Mounts

Shock	POP	Alternative No.	MTG Acc. Supplied
Pos.	Year	Application	
142832 X			
F	97-03	FORD ESCORT All	
F	97-99	MERCURY TRACER FWD	
142836 X			
F	95-96	LEXUS ES300 All	
F	95-96	TOYOTA AVALON All	
F	95-96	CAMRY All	
142837 C			
R	97-02	LEXUS ES300 All Exc. Electronic Adjustable Suspension	
R	99-03	RX300 All	
R	97-04	TOYOTA AVALON All	
R	97-03	CAMRY All	
R	99-03	SOLARA All	
142838 W			
F	90-02	TOYOTA 4RUNNER All Exc. HD	
142840 X			
F	95-99	DODGE NEON All	
F	95-99	PLYMOUTH NEON All	
142841 W			
F	96-00	CHRYSLER TOWN & COUNTRY All	
F	00	VOYAGER / GRAND VOYAGER All	
F	96-00	DODGE CARAVAN / GRAND CARAVAN All Exc. Hydraulic Self Leveling System	
F	96-00	PLYMOUTH VOYAGER / GRAND VOYAGER All Exc. Nivomat Self-Leveling Option	
142842 X			
F	93-97	CHRYSLER CONCORDE All	
F	93-97	INTREPID CAN	
F	94-97	LHS All	
F	94-96	NEW YORKER All	
F	93-97	DODGE INTREPID All	
F	93-97	EAGLE VISION All	
142843 W			
F	95-00	FORD CONTOUR All	
F	99-02	MERCURY COUGAR All	
F	95-00	MYSTIQUE All	
142851 X			
F	95-98	MAZDA PROTÉGÉ / PROTÉGÉ5 All	
142856 X			
F	93-97	FORD PROBE All	
F	98-01	KIA SEPHIA All	
F	93-97	MAZDA 626 All	
F	93-97	MX6 All	
142860 X			
F	93-01	MERCURY VILLAGER All	
F	93-02	NISSAN QUEST All	
142861 X			
F	86-88	NISSAN MULTI All	
F	86-90	PULSAR / PULSAR NX All	
F	91-92	SENTRA Classic, FWD	
F	87-90	SENTRA FWD	
F	85-89	STANZA Sedan	
142880 X			
F	86-93	CHRYSLER DAYTONA All	
F	88-93	DYNASTY All	
F	90-93	IMPERIAL All	
F	86	LASER All	
F	86-95	LEBARON All	
F	86-93	NEW YORKER All	
F	90-95	TOWN & COUNTRY All	
F	86-88	TOWN & COUNTRY All	
F	86-88	DODGE 600 All	
F	86-89	ARIES All	
F	86-95	CARAVAN / GRAND CARAVAN All	
F	89-93	DAYTONA All	
F	87-88	DAYTONA Pacifica	
F	86	DAYTONA All	
F	88-93	DYNASTY All	
F	86-89	LANCER All	
F	87-94	SHADOW All	
F	89-95	SPIRIT All	
F	89-95	PLYMOUTH ACCLAIM All	
F	86-88	CARAVELLE All	
F	86-89	RELIANT All	
F	87-94	SUNDANCE All	
F	86-95	VOYAGER / GRAND VOYAGER All	
142930 C			
F	00-11	FORD FOCUS All	

Numerical listing

Shock	POP	Alternative No.	MTG Acc. Supplied
Pos.	Year	Application	
142931 W			
F	04-08	CHRYSLER PACIFICA All	
F	01-07	TOWN & COUNTRY All	
F	01-07	VOYAGER / GRAND VOYAGER All	
F	01-07	DODGE CARAVAN / GRAND CARAVAN All	
142932 D			
F	00-02	CHRYSLER NEON All	
F	01-10	PT CRUISER All	
F	00-05	DODGE NEON All	
F	00-01	PLYMOUTH NEON All	
142933 X			
F	86-93	CHRYSLER DAYTONA All	
F	88-93	DYNASTY All	
F	90-93	IMPERIAL All	
F	86	LASER All	
F	86-95	LEBARON All	
F	86-93	NEW YORKER All	
F	90-95	TOWN & COUNTRY All	
F	86-88	DODGE 600 All	
F	86-89	ARIES All	
F	86-95	CARAVAN / GRAND CARAVAN All	
F	89-93	DAYTONA All	
F	87-88	DAYTONA Pacifica	
F	86	DAYTONA All	
F	88-93	DYNASTY All	
F	86-89	LANCER All	
F	87-94	SHADOW All	
F	89-95	SPIRIT All	
F	89-95	PLYMOUTH ACCLAIM All	
F	86-88	CARAVELLE All	
F	86-89	RELIANT All	
F	87-94	SUNDANCE All	
F	86-95	VOYAGER / GRAND VOYAGER All	
142935 D			
F	00-05	HYUNDAI ACCENT All	
142936 X			
F	00-01	NISSAN SENTRA All	
142937 B			
F	03-08	INFINITI FX35 All	
F	03-08	FX45 All	
F	00-01	i30 All	
F	02-04	i35 All	
F	02-06	NISSAN ALTIMA All	
F	00-08	MAXIMA All	
F	03-07	MURANO All	
F	04-09	QUEST All	
142938 D			
F	97-03	INFINITI QX4 All	
F	96-03	NISSAN PATHFINDER All	
142940 X			
F	86-93	CHRYSLER DAYTONA All	
F	88-93	DYNASTY All	
F	90-93	IMPERIAL All Exc. Hydraulic Self Leveling System	
F	86	LASER All Mfg. from 1/2/86	
F	87-95	LEBARON All	
F	86	LEBARON All Mfg. from 1/2/86	
F	87-93	NEW YORKER All	
F	86	NEW YORKER All Mfg. from 1/2/86	
F	90-95	TOWN & COUNTRY All	
F	88	DODGE 600 All	
F	86-87	600 All Mfg. from 1/2/86	
F	86-89	ARIES All	
F	86-95	CARAVAN / GRAND CARAVAN All	
F	90	CARAVAN / GRAND CARAVAN All Mfg. from 1/2/86	
F	89-93	DAYTONA ES	
F	89-90	DAYTONA ES Turbo	
F	87-88	DAYTONA Pacifica	
F	86	DAYTONA All	
F	88-93	DYNASTY All Exc. Hydraulic Self Leveling System	
F	87-89	LANCER All	
F	86	LANCER All Mfg. from 1/2/86	
F	87-94	SHADOW All	
F	89-95	SPIRIT All	
F	89-95	PLYMOUTH ACCLAIM All	
F	87-88	CARAVELLE All	
F	86	CARAVELLE All Mfg. from 1/2/86	
F	86-89	RELIANT All	
F	87-94	SUNDANCE All	
142941 W			
R	93-97	VOLVO 850 All Exc. Hydraulic Self Leveling System	
R	98-04	C70 All	
R	98-00	S70 All	

Numerical listing

Shock	POP	Alternative No.	MTG Acc. Supplied
Pos.	Year	Application	
142941	W	-continued	
R	99-00	V70 R AWD Exc. Auto Rear Leveling	
R	98-00	V70 Base Exc. Auto Rear Leveling	
R	98-00	V70 GLT Exc. Auto Rear Leveling	
R	98-00	V70 T5 Exc. Auto Rear Leveling	
R	00	V70 2.4T Exc. Auto Rear Leveling	
R	00	V70 GLT SE Exc. Auto Rear Leveling	
R	98-99	V70 AWD Exc. Auto Rear Leveling	
R	98	V70 R Exc. Auto Rear Leveling	
142943	X		
F	01-02	SATURN L / LS / LW SERIES All	
142949	D		
R	00-03	NISSAN MAXIMA All	
142992	D		
R	08-11	FORD FOCUS All	
R	00-07	FOCUS Hatchback	
R	00-07	FOCUS Sedan	
143035	X		
F	99-05	CHEVROLET CAVALIER All	
F	99-05	PONTIAC SUNFIRE All	
F	02-07	SATURN VUE All	
143073	X		
R	05-09	BUICK ALLURE All Left	
R	97-05	CENTURY All Left	
R	05-09	LACROSSE All Left	
R	97-04	REGAL All Left	
R	00-11	CHEVROLET IMPALA All Left	
R	95-01	LUMINA All Left	
R	95-07	MONTE CARLO All Left	
R	98-02	OLDSMOBILE INTRIGUE All Left	
R	97-08	PONTIAC GRAND PRIX All Left	
143074	X		
R	05-09	BUICK ALLURE All Right	
R	97-05	CENTURY All Right	
R	05-09	LACROSSE All Right	
R	97-04	REGAL All Right	
R	00-11	CHEVROLET IMPALA All Right	
R	95-01	LUMINA All Right	
R	95-07	MONTE CARLO All Right	
R	98-02	OLDSMOBILE INTRIGUE All Right	
R	97-08	PONTIAC GRAND PRIX All Right	
143082	C		
F	00	BMW 323Ci Coupe	
F	00	323i Wagon	
F	01-06	325Ci All Sport Suspension; Exc. M-Sport Pack II	
F	01-06	325i All Exc. Sport Suspension M-Sport Pack II	
F	00	328Ci All	
F	99-00	328i All	
F	01-06	330Ci All Exc. Sport Suspension M-Sport Pack II	
F	97-00	528i All	
143084	W		
F	00-06	BMW X5 AWD	
143086	W		
F	96-06	MERCEDES-BENZ E320 All Exc. 4 Matic	
F	97	E420 All Exc. 4 Matic	
F	98-02	E430 All Exc. 4 Matic	
143087	B		
F	01-05	CHRYSLER SEBRING ST (MfrBodyCode), Coupe	
F	01-05	DODGE STRATUS ST (MfrBodyCode), Coupe	
F	01-04	HYUNDAI SANTA FE All	
F	05-09	TUCSON All	
F	97-04	MITSUBISHI DIAMANTE All	
F	00-05	ECLIPSE All	
F	99-03	GALANT All	
143088	C		
F	02-07	MITSUBISHI LANCER All	
F	03-06	OUTLANDER All	
143089	W		
F	03-07	SATURN ION All	
143091	D		
F	02-07	BUICK RENDEZVOUS All Exc. Hydraulic Self Leveling System	
143092	C		
F	03-07	CADILLAC CTS All	

Suspension Mounts

Shock	POP	Alternative No.	MTG Acc. Supplied
Pos.	Year	Application	
143093	C		
F	03-08	PONTIAC VIBE All	
F	03-08	TOYOTA MATRIX All	
143094	W		
R	03-08	PONTIAC VIBE All	
R	05-07	SCION TC All	
R	00-05	TOYOTA CELICA All	
R	03-08	COROLLA All	
R	03-08	MATRIX All	
R	01-09	PRIUS All	
143112	X		
R	98-02	MAZDA 626 All Right	
143140	C		
R	03-06	SUBARU BAJA All	
R	00-07	LEGACY All	
R	00-05	OUTBACK All	
143191	C		
F	94-97	VOLVO 850 Wagon Exc. Hydraulic Self Leveling System	
F	93-97	850 Sedan Exc. Hydraulic Self Leveling System	
F	06-07	C70 All	
F	98-04	C70 All	
F	01-07	S60 All	
F	98-00	S70 All	
F	99-06	S80 All Exc. Nivomat Rear Suspension	
F	06-07	V70 R, AWD	
F	04-05	V70 2.4	
F	04-05	V70 2.5T	
F	04-05	V70 R	
F	01-05	V70 T5	
F	04	V70 2.5T AWD	
F	01-03	V70 2.4T	
F	01-03	V70 Base	
F	02	V70 AWD	
F	99-00	V70 R AWD Exc. Auto Rear Leveling	
F	98-00	V70 Base Exc. Auto Rear Leveling	
F	98-00	V70 GLT Exc. Auto Rear Leveling	
F	00	V70 T5 Exc. Auto Rear Leveling	
F	00	V70 2.4T Exc. Auto Rear Leveling	
F	00	V70 GLT SE Exc. Auto Rear Leveling	
F	98-99	V70 AWD Exc. Auto Rear Leveling	
F	98	V70 R Exc. Auto Rear Leveling	
F	04-06	XC90 All	
F	03	XC90 AWD	
143193	W		
F	01-03	TOYOTA PRIUS All	
143194	W		
F	00-05	TOYOTA ECHO All Only fits O.E. P/N's 48609-52011 & 48609-52050	
143195	W		
F	00-05	TOYOTA ECHO All Only fits O.E. P/N 48609-52021	
143197	X		
R	90-94	LEXUS LS400 All Exc. Auto-Leveling System	
143198	C		
R	95-00	LEXUS LS400 All Exc. Auto-Leveling System	
143199	X		
F	90-94	LEXUS LS400 All Exc. Auto-Leveling System	
143200	W		
F	93-05	LEXUS GS300 All	
F	98-00	GS400 All	
F	01-05	GS430 All	
F	02-07	SC430 All	
143201	C		
F	00-05	TOYOTA CELICA All	
F	03-08	COROLLA All	
F	04-09	PRIUS All	
143202	A		
F	02-03	LEXUS ES300 All Exc. Electronic Adjustable Suspension	
F	04-06	ES330 All Exc. Adaptive Variable Suspension	
F	04-06	RX330 All	
F	06-07	RX400H All	
F	02-06	TOYOTA CAMRY All	
F	01-07	HIGHLANDER All	
F	04-08	SIENNA All	

Numerical listing

Shock	POP	Alternative No.	MTG Acc. Supplied
Pos.	Year	Application	
143202	A	-continued	
F	04-07	SOLARA All	
143204	C		
F	03-04	CHEVROLET TRACKER All	
F	01-02	TRACKER 2.5L 6Cyl V (2500)	
F	99-02	TRACKER 2.0L 4Cyl L (122)	
F	99-05	SUZUKI GRAND VITARA 2.5L 6Cyl V (2500)	
F	04	VITARA 2.5L 6Cyl V (2500)	
F	99-03	VITARA 2.0L 4Cyl L (2000)	
F	02-06	XL-7 All	
143205	W		
R	03-06	SUBARU FORESTER All	
R	04-06	IMPREZA All	
143206	X		
F	01-02	SAAB 9-3 Turbo	
F	99-02	9-3 SE	
F	99-01	9-3 Base	
143209	W		
R	00-06	NISSAN SENTRA All	
143210	X		
F	97-01	INFINITI Q45 All Exc. Active Suspension	
143214	C		
R	02-07	NISSAN ALTIMA All	
R	04-08	MAXIMA All	
143218	D		
F	98-02	MAZDA 626 All	
143219	X		
F	03	MAZDA PROTÉGÉ / PROTÉGÉS DX	
F	03	PROTÉGÉ / PROTÉGÉS ES	
F	03	PROTÉGÉ / PROTÉGÉS LX	
F	03	PROTÉGÉ / PROTÉGÉS SE	
F	99-02	PROTÉGÉ / PROTÉGÉS All	
143221	D		
R	99-03	MAZDA PROTÉGÉ / PROTÉGÉS All Left	
R	03	PROTÉGÉ / PROTÉGÉS DX Left	
R	03	PROTÉGÉ / PROTÉGÉS ES Left	
R	03	PROTÉGÉ / PROTÉGÉS LX Left	
R	03	PROTÉGÉ / PROTÉGÉS SE Left	
143223	C		
R	99-03	MAZDA PROTÉGÉ / PROTÉGÉS All Right	
R	03	PROTÉGÉ / PROTÉGÉS DX Right	
R	03	PROTÉGÉ / PROTÉGÉS ES Right	
R	03	PROTÉGÉ / PROTÉGÉS LX Right	
R	03	PROTÉGÉ / PROTÉGÉS SE Right	
143224	W		
F	03-04	MAZDA 6 All	
143226	W		
F	03-06	KIA SORENTO All	
143228	X		
F	95-02	KIA SPORTAGE All	
143233	X		
F	05-06	ACURA RSX Type-S Left	
F	02-05	HONDA CIVIC Coupe Left	
F	02-05	CIVIC Sedan Left	
143239	C		
F	06-11	CHEVROLET AVEO All	
F	04-11	AVEO All	
F	09-10	PONTIAC G3 All	
F	05-08	WAVE All	
143241	D		
F	04-07	BUICK RAINIER All	
F	03-06	CHEVROLET SSR All	
F	02-09	TRAILBLAZER All	
F	02-09	GMC ENVOY All	
F	03-08	ISUZU ASCENDER All	
F	02-04	OLDSMOBILE BRAVADA All	
F	05-09	SAAB 9-7X All	
143242	D		
F	02-05	FORD THUNDERBIRD All	
R	02-05	THUNDERBIRD All	
F	00-06	JAGUAR S TYPE All Exc. Computer Active Technology Suspension	
R	00-06	S TYPE All Exc. Computer Active Technology Suspension	
F	00-06	LINCOLN LS All	

Numerical listing

Shock	POP	Alternative No.	MTG Acc. Supplied
Pos.	Year	Application	
143242	D	-continued	
R	00-06	LS All	
143244	W		
F	03-06	FORD EXPEDITION All Exc. Adjustable Suspension	
F	03-05	LINCOLN NAVIGATOR All	
143246	W		
F	04-07	FORD FREESTAR All	
F	04-07	MERCURY MONTEREY Mini Passenger Van	
143248	D		
F	04-08	FORD PICKUP 1/2 TON, F-150 All	
F	06-08	LINCOLN MARK LT All	
143253	D		
F	01-12	FORD ESCAPE All	
F	08-11	MAZDA TRIBUTE All	
F	01-06	TRIBUTE All	
F	05-11	MERCURY MARINER FWD	
143255	W		
F	02-11	JEEP LIBERTY All Left	
143256	D		
R	00-02	CHRYSLER NEON All	
R	00-05	DODGE NEON All	
R	00-01	PLYMOUTH NEON All	
143259	W		
R	00-06	BMW X5 All	
143265	X		
F	05-06	ACURA RSX Type-S Right	
F	02-05	HONDA CIVIC Coupe Right	
F	02-05	CIVIC Sedan Right	
143266	W		
F	02-11	JEEP LIBERTY All Right	
143267	C		
F	00-06	MAZDA MPV All	
143278	X		
F	87-91	TOYOTA CAMRY All	
F	91-97	PREVIA All	
143280	X		
F	93-97	TOYOTA COROLLA Base Exc. LE Model	
F	93-97	COROLLA DX Exc. LE Model	
F	93	COROLLA All Trac Exc. LE Model	
143281	B		
F	98-02	CHEVROLET PRIZM All	
F	89-97	GEO PRIZM All	
F	90-91	LEXUS ES250 All	
F	97-02	TOYOTA COROLLA LE	
F	88-95	COROLLA LE	
F	88-92	COROLLA DLX	
F	88-92	COROLLA DLX All Trac	
F	88-92	COROLLA SR5	
F	88-91	COROLLA GTS	
143305	A		
F	12-17	HONDA ODYSSEY All From Chassis/VIN CB088499	
F	05-10	ODYSSEY All	
143315	B		
F	01-06	ACURA MDX All	
F	99-04	HONDA ODYSSEY All	
F	03-08	PILOT All	
143316	C		
F	07-13	CADILLAC ESCALADE All Exc. Electronic Ride Control	
F	07-13	ESCALADE ESV All Exc. Electronic Ride Control	
F	07-13	ESCALADE EXT All Exc. Electronic Ride Control	
F	07-13	CHEVROLET AVALANCHE 1500 All Exc. Electronic Ride Control	
F	07-13	PICKUP 1/2 TON, SILVERADO 1500 All Exc. Electronic Adjustable Suspension	
F	07-13	SUBURBAN 1/2 TON, 1500 All Exc. Z55 or ZW7 Ride Suspension	
F	07-14	TAHOE All Exc. Z55 or ZW7 Ride Suspension	
F	07-13	GMC SIERRA 1500 All Exc. Electronic Adjustable Suspension	
F	07-14	YUKON All Exc. Electronic Adjustable Suspension	

Suspension Mounts

Shock	POP	Alternative No.	MTG Acc. Supplied
Pos.	Year	Application	
143316	C	-continued	
F	07-14	YUKON XL 1/2 TON All Exc. Z55 Auto Ride Suspension	
143317	X		
R	03-06	FORD EXPEDITION All	
143318	W		
F	02-05	FORD EXPLORER All	
F	02-05	MERCURY MOUNTAINEER All	
143319	W		
R	02-05	FORD EXPLORER All	
R	02-05	MERCURY MOUNTAINEER All	
143321	C		
R	01-06	CHRYSLER SEBRING JR (MfrBodyCode), Sedan	
R	01-06	DODGE STRATUS Sedan	
143322	C		
F	02-06	NISSAN SENTRA All	
143323	C		
F	05-10	CHEVROLET COBALT LS	
F	05-10	COBALT LT	
F	10	COBALT Base	
F	10	COBALT LT Team Canada	
F	06-07	COBALT LTZ	
F	05	COBALT Base	
F	11	HHR All	
F	08-10	HHR LS Panel	
F	08-10	HHR LT Panel	
F	06-10	HHR LS	
F	06-10	HHR LT	
F	06-08	HHR Comfort LT	
F	06-08	HHR Elegance LT	
F	07	HHR Edicion Especial	
F	07-09	PONTIAC G5 All	
F	05-06	PURSUIT All	
143324	W		
F	06-08	DODGE PICKUP 1/2 TON, RAM 1500 (SEE RAM 1500) 4WD Exc. Mega Cab	
143325	C		
F	96-02	TOYOTA 4RUNNER 4WD	
F	01-07	SEQUOIA All	
F	95-04	TACOMA 4WD	
F	00-06	TUNDRA All	
143328	X		
R	99-00	CHRYSLER CIRRUS All	
R	99-00	DODGE STRATUS All	
R	99-00	PLYMOUTH BREEZE All	
143330	A		
F	06-10	FORD EXPLORER All	
F	06-10	MERCURY MOUNTAINEER All	
143335	D		
R	05-10	CHRYSLER 300 All	
R	08-10	DODGE CHALLENGER All	
R	06-10	CHARGER All	
R	05-08	MAGNUM All	
143336	C		
F	11-14	CHRYSLER 200 All	
F	07-10	SEBRING All	
F	08-14	DODGE AVENGER All	
143337	A		
R	11-14	CHRYSLER 200 All	
R	07-10	SEBRING All	
R	08-14	DODGE AVENGER All	
R	07-12	CALIBER All	
R	07-12	JEEP COMPASS All	
R	07-12	PATRIOT All	
143338	C		
R	04-16	TOYOTA SIENNA All	
143339	C		
F	17	TOYOTA SEQUOIA All Exc. Air Suspension	
F	08-16	SEQUOIA All	
F	17	TUNDRA All Exc. Air Suspension	
F	07-16	TUNDRA All	
143340	A		
R	08-11	TOYOTA SEQUOIA All	
R	07-16	TUNDRA All w/Off Road Package	
143341	C		
F	05-07	FORD FREESTYLE All	
F	05-10	MUSTANG / MUSTANG II All	

Numerical listing

Shock	POP	Alternative No.	MTG Acc. Supplied
Pos.	Year	Application	
143341	C	-continued	
F	05-07	MERCURY MONTEGO All	
143342	B		
F	06-11	HYUNDAI AZERA All	
F	06-10	SONATA All	
F	07-09	KIA AMANTI All	
143343	A		
F	06-11	TOYOTA RAV4 4WD	
143344	D		
F	06-11	AUDI A3 All	
F	08-09	TT All	
F	08-10	TT QUATTRO All	
F	09-12	VOLKSWAGEN CC All	
F	07-11	EOS All	
F	10-11	GOLF All	
F	06-14	GTI All	
F	06-17	JETTA All	
F	09-10	PASSAT All	
F	06-09	PASSAT All	
F	08	R32 All	
F	06-09	RABBIT All	
F	09-11	TIGUAN All	
143345	A		
R	06-11	AUDI A3 All	
R	08-09	TT All	
R	08-10	TT QUATTRO All	
R	09-12	VOLKSWAGEN CC All	
R	07-11	EOS All	
R	10-11	GOLF All	
R	06-14	GTI All	
R	06-17	JETTA All	
R	09-10	PASSAT All	
R	06-09	PASSAT All	
R	08	R32 All	
R	06-09	RABBIT All	
R	09-10	TIGUAN All	
143346	W		
F	02-07	NISSAN X-TRAIL All	
143349	A		
F	06-08	CHEVROLET OPTRA All	
F	06-08	SUZUKI FORENZA All	
F	06-08	RENO All	
143350	A		
R	06-08	CHEVROLET OPTRA All	
R	06-08	SUZUKI FORENZA All	
R	06-08	RENO All	
143353	B		
F	02-06	ACURA RSX Base	
F	02-06	RSX Type-S	
F	02-05	HONDA CIVIC Hatchback Exc. Hybrid & Si Models	
F	01	CIVIC All	
F	02-06	CR-V All	
F	03-06	ELEMENT All	
143354	C		
F	04-12	CHEVROLET MALIBU All Left	
F	05-10	PONTIAC G6 All Left	
F	07-09	SATURN AURA All Left	
143355	C		
F	04-12	CHEVROLET MALIBU All Right	
F	05-10	PONTIAC G6 All Right	
F	07-09	SATURN AURA All Right	
143356	W		
F	03-11	FORD CROWN VICTORIA All	
F	03-11	LINCOLN TOWN CAR All Exc. Limo	
F	03-11	MERCURY GRAND MARQUIS All	
143357	X		
F	07-11	FORD CROWN VICTORIA All	
F	03-06	CROWN VICTORIA Base	
F	03-06	CROWN VICTORIA LX	
F	04-05	CROWN VICTORIA LX Sport	
F	05	CROWN VICTORIA S	
F	05	CROWN VICTORIA Special Edition	
F	03	CROWN VICTORIA LWB	
F	03	CROWN VICTORIA S	
F	03-11	LINCOLN TOWN CAR Executive	
F	03-11	MERCURY GRAND MARQUIS All	
143358	W		
F	04-10	INFINITI QX56 All	
F	05-11	NISSAN ARMADA All	
F	04-11	TITAN All	

Numerical listing

Shock	POP	Alternative No.	MTG Acc. Supplied
Pos.	Year	Application	
143359	A		
F	04-10	INFINITI QX56 All	
F	05-11	NISSAN ARMADA All	
F	04-11	TITAN All	
143360	W		
F	06-10	FORD EXPLORER All	
F	06-10	MERCURY MOUNTAINEER All	
143361	W		
R	06-10	FORD EXPLORER All	
R	06-10	MERCURY MOUNTAINEER All	
143362	A		
R	06-10	FORD EXPLORER All	
R	06-10	MERCURY MOUNTAINEER All	
143363	B		
F	05-06	CHEVROLET EQUINOX All	
F	06	PONTIAC TORRENT All	
143364	D		
F	06-10	JEEP COMMANDER All	
F	05-10	GRAND CHEROKEE All	
143365	C		
F	10-12	MAZDA 3 Grand Touring	
F	10-12	3 GX	
F	10-12	3 I Touring	
F	08-12	3 GS	
F	08-12	3 GT	
F	04-12	3 i	
F	12	3 GS-SKY	
F	12	3 S	
F	08-09	3 S	
F	08	3 GX	
F	05	3 SP23	
F	06-10	5 All	
143366	A		
F	08-12	BUICK ENCLAVE All	
F	09-12	CHEVROLET TRAVERSE All	
F	07-12	GMC ACADIA All	
F	07-10	SATURN OUTLOOK All	
143367	C		
F	96-05	TOYOTA RAV4 All	
143368	C		
F	02-07	SATURN VUE All Replaces Mount in GM Service Kit 15269823	
143369	B		
F	05-10	CHRYSLER 300 RWD	
F	08-10	DODGE CHALLENGER All	
F	06-10	CHARGER RWD	
F	05-08	MAGNUM RWD	
143375	A		
R	06-11	CHEVROLET AVEO All	
R	04-11	AVEO All	
R	07-10	PONTIAC G3 All	
R	05-08	WAVE All	
R	04-09	SUZUKI SWIFT All	
143377	A		
F	07-10	NISSAN SENTRA All Left	
143378	A		
F	07-10	NISSAN SENTRA All Right	
143379	N		
F	05-12	NISSAN FRONTIER All	
F	05-11	PATHFINDER All	
F	05-12	XTERRA All	
F	09-11	SUZUKI EQUATOR All	
143380	A		
R	02-05	VOLKSWAGEN PASSAT FWD	
143381	A		
F	06-10	KIA MAGENTIS All Left	
F	06-10	OPTIMA All Left	
143382	A		
F	06-10	KIA MAGENTIS All Right	
F	06-10	OPTIMA All Right	
143383	A		
F	03-16	TOYOTA 4RUNNER All	
F	07-12	FJ CRUISER All	
F	05-12	TACOMA All	
143385	N		
F	05-09	DODGE DAKOTA All	
F	06-09	MITSUBISHI RAIDER All	

Suspension Mounts

Shock	POP	Alternative No.	MTG Acc. Supplied
Pos.	Year	Application	
143386	N		
R	06-10	HYUNDAI AZERA All	
R	06-10	SONATA All	
R	07-11	KIA RONDO All	
143387	N		
R	04-06	LEXUS RX330 All Left Exc. Air Suspension	
R	09	RX350 All Left	
R	07-08	RX350 All Left Exc. Air Suspension	
R	06-08	RX400H All Left	
R	04-07	TOYOTA HIGHLANDER All Left	
143388	N		
R	04-06	LEXUS RX330 All Right Exc. Air Suspension	
R	09	RX350 All Right	
R	07-08	RX350 All Right Exc. Air Suspension	
R	06-08	RX400H All Right	
R	04-07	TOYOTA HIGHLANDER All Right	
143389	N		
F	09-10	DODGE PICKUP 1/2 TON, RAM 1500 (SEE RAM 1500) 4WD	
F	11-12	RAM 1500 (SEE DODGE RAM 1500) 4WD	
143390	A		
R	05-07	FORD FIVE HUNDRED FWD Left	
R	05-07	MERCURY MONTEGO All Left	
143391	A		
R	05-07	FORD FIVE HUNDRED FWD Right	
R	05-07	MERCURY MONTEGO All Right	
143392	A		
F	06-12	FORD FUSION All	
F	07-12	LINCOLN MKZ All	
F	06	ZEPHYR All	
F	05-08	MAZDA 6 All	
F	06-11	MERCURY MILAN All	
143393	N		
R	15-16	FORD EXPEDITION 4WD Exc. Air Suspension	
R	15-16	EXPEDITION RWD Exc. Air Suspension	
R	10-14	EXPEDITION All Exc. Air Suspension	
R	07-09	EXPEDITION RWD	
R	11-16	LINCOLN NAVIGATOR 4WD Exc. Air Suspension	
R	11-16	NAVIGATOR RWD Exc. Air Suspension	
R	10	NAVIGATOR All Exc. Air Suspension	
R	07-09	NAVIGATOR All	
143394	N		
R	02-10	MITSUBISHI LANCER All	
R	03-11	OUTLANDER All	
143395	N		
F	07-17	NISSAN ALTIMA All	
143396	A		
R	03-07	NISSAN MURANO All	
R	04-09	QUEST All	
143397	N		
F	03-08	HYUNDAI TIBURON All	
143398	N		
F	10	MITSUBISHI ENDEAVOR All	
F	04-08	ENDEAVOR All	
F	04-10	GALANT All	
143399	N		
F	11-14	FORD FIESTA All	
F	11-14	MAZDA 2 All	
143400	FF		
R	11-12	FORD FIESTA All	
R	11	MAZDA 2 All	
143401	N		
F	02-07	SUZUKI AERIO All	
143402	N		
F	07-11	LEXUS ES350 All	
F	06-11	TOYOTA AVALON All	
F	07-11	CAMRY All	
F	08-13	HIGHLANDER All	
F	09-11	VENZA All	

Numerical listing

Shock	POP	Alternative No.	MTG Acc. Supplied
Pos.	Year	Application	
143404	N		
F	02-06	MINI COOPER All	
143405	FF		
F	02-11	MINI COOPER All	
143406	N		
F	05-10	SCION TC All	
143408	N		
R	98-05	LEXUS GS300 All	
R	98-00	GS400 All	
R	01-05	GS430 All	
R	01-05	IS300 All	
143409	FF		
F	06-11	HYUNDAI ACCENT All Left	
F	06-11	KIA RIO All Left	
F	06-11	RIO All Left	
143410	N		
F	06-11	HYUNDAI ACCENT All Right	
F	06-11	KIA RIO All Right	
F	06-11	RIO All Right	
143411	N		
R	06-11	HYUNDAI ACCENT All	
R	06-11	KIA RIO All	
R	06-11	RIO All	
143412	FF		
F	06-08	MAZDA MX-5 MIATA All	
R	06-08	MX-5 MIATA All	
143413	N		
R	06-11	TOYOTA CAMRY All Left	
143414	N		
R	06-11	TOYOTA CAMRY All Right	
143415	FF		
F	07-10	FORD EDGE All	
F	08	TAURUS All	
F	08	TAURUS X All	
F	07-10	LINCOLN MKX All	
F	08-09	MERCURY SABLE All	
143416	FF		
F	07-09	HYUNDAI ENTOURAGE All	
F	07-11	SANTA FE All	
F	07-11	VERACRUZ All	
F	06-11	KIA SEDONA All	
143417	FF		
F	08-14	SCION XD All	
F	06-14	TOYOTA YARIS All	
143418	N		
R	02-07	SUZUKI AERIO All	
143419	A		
F	04-06	KIA AMANTI All	
R	04-06	AMANTI All	
143421	FF		
F	00-04	VOLVO S40 All	
F	00-04	V40 All	
143422	N		
R	00-04	VOLVO S40 All	
R	00-04	V40 All	
143423	A		
R	03-06	CHRYSLER SEBRING JR (MfrBodyCode), Convertible	
R	03-06	SEBRING JR (MfrBodyCode), Sedan	
F	01-06	SEBRING JR (MfrBodyCode), Convertible	
F	01-06	SEBRING JR (MfrBodyCode), Sedan	
F	01-06	DODGE STRATUS Sedan	
R	01-06	STRATUS Sedan	
R	99-00	STRATUS All	
143424	N		
F	10-16	FORD EXPEDITION All	
F	07-09	EXPEDITION RWD	
F	10-12	PICKUP 1/2 TON, F-150 All	
F	07-16	LINCOLN NAVIGATOR All	
143425	A		
R	08	CHEVROLET MALIBU Base	
R	08	MALIBU Hybrid	
R	08	MALIBU LS	
R	08	MALIBU LT	
R	08	MALIBU LTZ	
R	04-07	MALIBU Maxx LS	

Numerical listing

Shock	POP	Alternative No.	MTG Acc. Supplied
Pos.	Year	Application	
143425	A	-continued	
R	04-07	MALIBU	Maxx LT
R	04	MALIBU	Maxx
R	05-10	PONTIAC	G6 All
R	07-09	SATURN	AURA XE
R	07-09	AURA	XR
R	07-08	AURA	Green Line
143455	N		
F	03-07	INFINITI	G35 All
F	06-07	M35	All
F	03-08	NISSAN	350Z All
143456	FF		
F	04-05	KIA RIO	Sedan Left
143457	FF		
F	04-05	KIA RIO	Sedan Right
143458	N		
F	02-05	KIA SEDONA	All
143459	FF		
F	04-06	PONTIAC	GTO All
143460	N		
F	10-12	CHEVROLET	CAMARO 3.6L 6Cyl V (217)
143461	N		
R	10-12	CHEVROLET	CAMARO 3.6L 6Cyl V (217) Left
143462	N		
R	10-12	CHEVROLET	CAMARO 3.6L 6Cyl V (217) Right
143463	N		
F	08-16	CHRYSLER	TOWN & COUNTRY All
F	08-16	DODGE	CARAVAN / GRAND CARAVAN All
F	09-11	VOLKSWAGEN	ROUTAN All
143464	FF		
F	01-03	MITSUBISHI	MONTERO All
143465	FF		
R	02-03	SUBARU	IMPREZA All Left
143466	FF		
R	02-03	SUBARU	IMPREZA All Right
143468	FF		
F	11-13	CHRYSLER	300 All
F	11-13	DODGE	CHARGER AWD
143469	N		
F	07-11	CHEVROLET	EQUINOX All
F	10-11	GMC	TERRAIN All
F	07-09	PONTIAC	TORRENT All
F	08-10	SATURN	VUE All
F	07-09	SUZUKI	XL-7 All
143473	FF		
F	10-15	CHEVROLET	CRUZE All
F	16	CRUZE	LIMITED All
143474	FF		
R	10-15	CHEVROLET	CRUZE All
R	16	CRUZE	LIMITED All
143475	N		
F	11-14	FORD	EXPLORER All
143476	N		
R	11-14	FORD	EXPLORER All
R	10-14	TAURUS	All
143477	N		
F	07-11	HYUNDAI	ELANTRA All
143486	FF		
F	13-14	CHEVROLET	TRAVERSE All
143491	FF		
F	07-12	MINI	COOPER All
143492	N		
F	98-13	SUBARU	FORESTER All
F	93-13	IMPREZA	All
F	90-13	LEGACY	All
F	00-13	OUTBACK	All
143495	N		
F	07-12	DODGE	CALIBER All
F	07-10	JEEP	COMPASS All
F	07-10	PATRIOT	All

Suspension Mounts, Strut Cushion

Shock	POP	Alternative No.	MTG Acc. Supplied
Pos.	Year	Application	
143496	N		
R	07-11	DODGE	CALIBER All
R	07-10	JEEP	COMPASS All
R	07-09	PATRIOT	All
143497	FF		
F	06-11	HONDA	CIVIC All
143498	N		
R	06-11	HONDA	CIVIC All
143509	FF		
R	11-13	TOYOTA	HIGHLANDER All Left
143510	FF		
R	11-13	TOYOTA	HIGHLANDER All Right
143516	FF		
F	09-12	NISSAN	CUBE All Left
F	07-11	TIIDA	All Left
F	07-11	VERSA	S Left
F	07-11	VERSA	SL Left
143517	FF		
F	09-12	NISSAN	CUBE All Right
F	07-11	VERSA	S Right
F	07-11	VERSA	SL Right
143522	FF		
F	11-13	NISSAN	FRONTIER S Mfg. to 12/12
F	11-13	FRONTIER	SL Mfg. to 12/12
F	09-13	FRONTIER	PRO-4X Mfg. to 12/12
F	05-13	FRONTIER	LE Mfg. to 12/12
F	05-10	FRONTIER	SE Mfg. to 12/12
143528	N		
F	12-15	HONDA	CIVIC All
143530	N		
R	12-13	HONDA	CIVIC All
143531	N		
R	04-11	MAZDA	3 All
R	06-10	5	All
143532	FF		
F	11-14	HYUNDAI	SONATA All
143533	FF		
R	11-12	HYUNDAI	SONATA All
143552	N		
F	06-08	VOLKSWAGEN	BORA All
F	06-08	JETTA	All
143553	FF		
F	10-12	TOYOTA	PRIUS All
143554	N		
R	10-12	TOYOTA	PRIUS All
143564	FF		
F	10-13	FORD	TRANSIT CONNECT All
Strut Cushion			
143057	B		
F	94	ASUNA	GT
F	92	GT	
F	93	GT, SE	All
F	94	SE	
F	92	SE	
F	88-92	AUDI	80 All
F	88-92	80	QUATTRO All
F	93-95	90	All
F	88-91	90	All
F	93-95	90	QUATTRO All
F	88-91	90	QUATTRO All
F	89-90	100	QUATTRO All
F	89-90	200	QUATTRO Wagon
F	80-87	4000	All
F	84-87	4000	QUATTRO All
F	83-87	COUPE	All
F	90-91	COUPE	QUATTRO All
F	90-94	V8	QUATTRO All
F	95-99	BMW	318TI All
F	97-05	BUICK	PARK AVENUE All
F	97-99	RIVIERA	All
F	95-05	CHEVROLET	CAVALIER All
R	04-05	CLASSIC	All
R	97-03	MALIBU	All
R	98-01	METRO	Non-ABS
R	89-91	SPRINT	All
F	99-04	CHRYSLER	300M All
F	93-04	CONCORDE	All
R	87-89	CONQUEST	All Exc. Electronic Adjustable Suspension

Numerical listing

Shock	POP	Alternative No.	MTG Acc. Supplied
Pos.	Year	Application	
143057	B	-continued	
F	83	E CLASS	All
F	83	EXECUTIVE	SEDAN All
F	93-04	INTREPID	CAN
F	81-83	LEBARON	All
F	99-01	LHS	All
F	94-97	LHS	All
R	00-02	NEON	All
F	94-96	NEW YORKER	All
F	83	NEW YORKER	All
R	01-10	PT CRUISER	All
F	96-00	SEBRING	Coupe
R	96-00	SEBRING	Coupe
F	95	SEBRING	All
R	95	SEBRING	All
F	82-83	DODGE	400 All
F	83	600	All
F	81-83	ARIES	All
F	83-87	CHARGER	All
F	90-95	COLT	Sedan
F	90-94	COLT	Hatchback
F	93-04	INTREPID	All
R	00-05	NEON	All
F	95-99	NEON	All
F	78-89	OMNI	All
F	82-84	RAMPAGE	All
F	91-93	EAGLE	2000 GTX CAN
F	89-96	SUMMIT	All
F	90-94	TALON	All
F	93-97	VISION	All
F	94-97	FORD	ASPIRE Non-ABS
F	81-96	ESCORT	All
F	82-88	EXP	All
F	00-05	FOCUS	Hatchback
F	00-05	FOCUS	Sedan
R	93-97	PROBE	All
F	89-92	PROBE	All
R	94-07	TAURUS	Sedan
F	84-85	TEMPO	All
R	89-97	GEO	METRO Non-ABS
F	85-87	HONDA	CIVIC Wagon, 4WD
F	92-95	HYUNDAI	ELANTRA Non-ABS
F	90-94	EXCEL	All
R	89-94	SONATA	All
F	91-96	INFINITI	G20 All
F	92-02	LEXUS	ES300 All
R	02	ES300	All Exc. Electronic Adjustable Suspension
R	92-01	ES300	All
F	90-94	MAZDA	323 All
R	93-97	626	All
R	88-92	626	All Exc. Electronic Adjustable Suspension or 4 Wheel Steer
F	86-87	626	Automatic Exc. Electronic Adjustable Suspension
R	86-87	626	Automatic Exc. Electronic Adjustable Suspension
F	83-85	626	All
R	83-85	626	All
R	84-85	GLC	All
R	81-83	GLC	Hatchback
R	81-83	GLC	Sedan
R	88-97	MX6	All
F	90-03	PROTÉGÉ / PROTÉGÉ5	All
F	91-93	MERCURY	CAPRI All
F	82-83	LN7	All
F	81-87	LYNX	All
R	94-05	SABLE	Sedan
F	84-85	TOPAZ	All
F	91-96	TRACER	FWD
F	93-98	VILLAGER	All
F	90-94	MITSUBISHI	ECLIPSE All
F	92-95	EXPO	All
R	94-98	GALANT	All
F	89-98	GALANT	All
F	89-96	MIRAGE	All
F	90-94	PRECIS	All
F	87-89	STARION	All
F	95-98	NISSAN	200SX All
F	90-96	300ZX	2+2
F	84-86	300ZX	All
F	00-01	ALTIMA	All
R	89-94	MAXIMA	All
R	87-88	MULTI	CAN
F	91-93	NX	All
F	83-90	PULSAR / PULSAR NX	All
F	93-98	QUEST	All
F	91-99	SENTRA	All
F	87-90	SENTRA	FWD
F	82-86	SENTRA	All
R	87-89	STANZA	Sedan
R	99-04	OLDSMOBILE	ALERO All
R	97-99	CUTLASS / CUTLASS SUPREME	All
F	92-93	PLYMOUTH	COLT All

Numerical listing

Shock	POP	Alternative No.	MTG Acc. Supplied
Pos.	Year	Application	

143057 B -continued

F 89-91 COLT Hatchback, FWD
 F 87-89 EXPO All
 F 78-89 HORIZON All
 F 90-94 LASER All
 F 95-99 NEON All
 F 81-83 RELIANT All
 F 83 SCAMP All
 F 85 TURISMO All
 F 83 TURISMO All
 R 94-99 PONTIAC FIREFLY CAN
 R 89-91 FIREFLY CAN
 R 99-05 GRAND AM All
 F 88-93 LEMANS All
 F 95-05 SUNFIRE All
 F 86-98 SAAB 900 All
 F 91-02 SATURN SC / SL / SW SERIES All
 F 98-02 SUBARU FORESTER All
 R 98-02 FORESTER All
 F 95-99 LEGACY All
 R 95-99 LEGACY All
 F 95-02 SUZUKI ESTEEM All
 R 95-02 ESTEEM All
 R 89-01 SWIFT All
 F 95-03 TOYOTA AVALON All
 R 95-03 AVALON All
 F 87-01 CAMRY All
 R 87-01 CAMRY All
 R 92-93 CELICA All
 F 75-85 CELICA All
 R 93-02 COROLLA All
 F 88 COROLLA FX
 F 88 COROLLA FX16
 F 80-87 COROLLA All
 F 75-79 COROLLA Wagon
 F 74 COROLLA All Mfg. from 8/74
 F 99-03 SOLARA All
 R 86-91 SUPRA All
 F 86 SUPRA All
 R 83-88 TERCEL Wagon
 F 87-93 VOLKSWAGEN FOX All
 F 82-88 QUANTUM All
 F 71-79 SUPER BEETLE All
 F 75-93 VOLVO 240 / 242 / 244 / 245 / 262 / 264 / 265 All

143058 D

F 93 ASUNA SUNFIRE (CANADIAN VEHICLE) All
 R 85-88 CHEVROLET NOVA All
 R 98-02 PRIZM All
 F 85-88 SPECTRUM All
 R 99-04 CHRYSLER 300M All
 R 98-04 CONCORDE All
 F 87-89 CONQUEST All Exc. Electronic Adjustable Suspension
 R 98-04 INTREPID CAN
 R 99-01 LHS All
 R 94-97 LHS All
 R 84-86 DODGE CONQUEST All
 R 98-04 INTREPID All
 R 95-00 FORD CONTOUR All
 R 91-96 ESCORT All
 R 93-97 GEO PRIZM All
 F 89 SPECTRUM All
 F 90-93 STORM Non-ABS
 F 90-92 ISUZU IMPULSE All
 F 91-93 STYLUS All
 F 86-89 MAZDA 323 FWD
 R 86-89 323 FWD
 R 92-03 PROTÉGÉ / PROTÉGÉS All
 R 90-91 PROTÉGÉ / PROTÉGÉS FWD
 R 99-02 MERCURY COUGAR All
 R 91-96 TRACER FWD
 R 87-89 TRACER FWD
 R 87-89 MITSUBISHI STARION All
 F 84-86 STARION LE
 R 84-86 STARION LE
 F 84-85 STARION LS
 R 84-85 STARION LS
 F 83 STARION All
 R 83 STARION All
 F 86 NISSAN STANZA Sedan
 F 82-85 STANZA All
 F 85-88 PONTIAC SUNBURST CAN
 F 87-88 PORSCHÉ 924 All
 F 77-82 924 All
 F 83-88 944 All
 F 86-87 SAAB 9000 All
 R 90-94 SUBARU LEGACY All
 F 83-86 TOYOTA CAMRY All
 R 84-92 COROLLA FWD
 F 85-93 VOLKSWAGEN CABRIOLET All
 F 85-98 GOLF All
 F 80-98 JETTA All

Strut Cushion

Shock	POP	Alternative No.	MTG Acc. Supplied
Pos.	Year	Application	

143058 D -continued

F 90-01 PASSAT All
 F 75-84 RABBIT All
 F 80-83 RABBIT PICKUP All
 F 75-89 SCIROCCO All
 F 84-92 VOLVO 740 / 745 / 760 / 780 All
 F 91-95 940 All Exc. Hydraulic Self Leveling System
 F 92-95 960 All

143059 C

R 73-79 AUDI FOX All
 F 92-98 BUICK SKYLARK All
 F 92-96 CHEVROLET BERETTA All
 F 87-94 CAVALIER All
 F 92-96 CORSICA All
 R 98-01 METRO Non-ABS
 R 95-07 MONTE CARLO All
 F 85-88 NOVA All
 F 98-02 PRIZM All
 F 89-91 SPRINT All
 F 86-93 CHRYSLER DAYTONA CAN
 F 88-93 DYNASTY CAN
 F 90-93 IMPERIAL All
 F 86-95 LEBARON All
 F 04-08 PACIFICA All
 F 90-00 TOWN & COUNTRY All
 F 00-07 VOYAGER / GRAND VOYAGER All
 F 84-00 DODGE CARAVAN / GRAND CARAVAN All
 F 78-83 CHALLENGER All
 F 85-91 COLT Vista, Wagon, FWD
 F 84 COLT Wagon
 F 71-80 COLT Wagon
 F 86-93 DAYTONA All
 F 88-93 DYNASTY All
 F 87-88 MINI RAM All
 R 95-99 NEON All
 F 90 OMNI All
 F 87-94 SHADOW All
 F 89-95 SPIRIT All
 F 89-91 EAGLE VISTA Wagon, CAN
 R 81-90 FORD ESCORT All
 R 82-88 EXP All
 F 78-83 FAIRMONT All
 F 88-93 FESTIVA All
 F 81-82 GRANADA All
 F 83-86 LTD / COUNTRY SEDAN / COUNTRY SQUIRE / CROWN VICTORIA All
 F 79-93 MUSTANG / MUSTANG II All
 F 94-07 TAURUS All
 R 86-93 TAURUS Sedan
 R 86-93 TAURUS Wagon
 F 84-94 TEMPO All
 F 87-88 THUNDERBIRD Non-ABS
 F 80-86 THUNDERBIRD All
 F 95-03 WINDSTAR All
 F 89-97 GEO METRO Non-ABS
 F 89-97 PRIZM All
 R 82-85 HONDA ACCORD All
 F 76-81 ACCORD All
 R 83-87 PRELUDE All
 F 79-87 PRELUDE All
 R 98-05 HYUNDAI ACCENT All
 F 97 ACCENT All Mfg. to 6/97
 F 95-96 ACCENT All
 R 95-96 ACCENT All
 F 86-89 EXCEL All
 F 82-87 LINCOLN CONTINENTAL All
 F 84-92 MARK VII All
 F 81-85 MAZDA GLC Hatchback
 F 81-85 GLC Sedan
 F 86-91 RX7 All
 R 91-93 MERCURY CAPRI All
 F 79-86 CAPRI All
 F 80-88 COUGAR All
 R 82-83 LN7 All
 R 81-87 LYNX All
 F 83-86 MARQUIS All
 F 86-05 SABLE All
 R 84-94 TOPAZ All
 F 87-91 TOPAZ All
 F 78-83 ZEPHYR All
 F 83-88 MITSUBISHI CORDIA All
 F 95-05 ECLIPSE All
 R 95-05 ECLIPSE All
 F 97-02 MIRAGE All
 F 87-89 PRECIS All
 F 83-88 TREDIA All
 F 80-88 NISSAN 200SX All
 F 79-82 210 All
 F 89-94 240SX All
 R 70-73 240Z All
 R 74-75 260Z All

Numerical listing

Shock	POP	Alternative No.	MTG Acc. Supplied
Pos.	Year	Application	

143059 C -continued

R 75-78 280Z All
 F 79-83 280ZX All
 F 79-82 310 All
 F 78-81 510 All
 F 81 810 All
 R 00-01 ALTIMA All
 F 90-94 AXXESS All
 R 90-94 AXXESS All
 F 74-78 B210 All
 F 76-78 F10 All
 F 89-94 MAXIMA All
 R 86-88 MAXIMA Sedan
 R 85 MAXIMA All
 F 82-84 MAXIMA All
 R 86-90 PULSAR / PULSAR NX All
 F 90-92 STANZA All
 F 92-98 OLDSMOBILE ACHIEVA All
 F 89-95 PLYMOUTH ACCLAIM All
 F 76-80 ARROW All
 F 79-82 CHAMP All
 F 84-91 COLT Vista, Wagon
 F 80-83 COLT Hatchback
 F 76-79 COLT Sedan
 F 76-79 COLT Wagon
 R 87-89 EXPO All
 F 90 HORIZON Hatchback
 R 95-99 NEON All
 F 78-83 SAPPORO All
 F 96-00 VOYAGER / GRAND VOYAGER Non-ABS
 F 84-00 VOYAGER / GRAND VOYAGER All
 R 84-88 PONTIAC FIERO All
 F 94-99 FIREFLY CAN
 F 89-91 FIREFLY CAN
 F 92-98 GRAND AM All Exc. Electronic Adjustable Suspension
 R 91-02 SATURN SC / SL / SW SERIES All
 F 89-01 SUZUKI SWIFT All
 F 72-73 TOYOTA CARINA All
 F 92-93 CELICA GT
 F 92-93 CELICA GTS
 F 92-93 CELICA ST
 F 90-91 CELICA AWD
 R 90-91 CELICA AWD
 F 86-89 CELICA All
 F 89-02 COROLLA All
 F 88 COROLLA DLX
 F 88 COROLLA GTS
 F 88 COROLLA LE
 F 88 COROLLA SR5
 F 79-82 CORONA All
 F 78-92 CRESSIDA All
 F 92-95 MR2 All
 F 85-89 MR2 All
 F 92-99 PASEO All
 F 81-84 STARLET All
 F 80-99 TERCEL All

143060 D

F 89-90 AUDI 100 All
 F 89-90 200 All
 F 78-88 5000 All
 F 05-09 BUICK ALLURE All
 F 82-05 CENTURY All
 R 85-90 ELECTRA All
 F 05-09 LACROSSE All
 F 91-99 LESABRE All
 R 86-99 LESABRE All
 F 90 LESABRE All Late Design Front Strut without Spring Guard
 F 91-96 PARK AVENUE All
 R 91-96 PARK AVENUE All
 F 88-04 REGAL All
 F 95-96 RIVIERA All
 F 84-89 SKYHAWK All
 F 80-91 SKYLARK All
 F 85-87 SOMERSET / SOMERSET REGAL All
 F 93 CADILLAC 60 SPECIAL All
 R 93 60 SPECIAL All
 F 91-92 BROUGHAM All
 F 82-88 CIMARRON All
 F 92-93 COMMERCIAL CHASSIS FWD
 R 92-93 COMMERCIAL CHASSIS FWD
 F 85-91 COMMERCIAL CHASSIS All
 F 91 COMMERCIAL CHASSIS All
 F 91-93 DEVILLE All
 R 85-93 DEVILLE All
 F 91-93 FLEETWOOD All
 R 85-93 FLEETWOOD All
 F 87-91 CHEVROLET BERETTA All
 F 82-86 CAVALIER All
 F 82-90 CELEBRITY All
 F 80-85 CITATION / CITATION II All

Numerical listing

Shock	POP	Alternative No.	MTG Acc. Supplied
Pos.	Year	Application	
143060	D	-continued	
F	04-05	CLASSIC All	
F	87-91	CORSICA All	
F	00-11	IMPALA All	
F	90-01	LUMINA All	
F	90-96	LUMINA APV All	
F	97-03	MALIBU All	
F	95-07	MONTE CARLO All	
F	02-05	VENTURE All	
F	97-01	VENTURE FWD	
F	84-85	CHRYSLER DAYTONA CAN	
F	84	E CLASS All	
F	85	EXECUTIVE LIMOUSINE All	
F	84	EXECUTIVE SEDAN All	
F	84-86	LASER All	
F	84-85	LEBARON All	
F	00-02	NEON All	
F	84-93	NEW YORKER All	
F	01-10	PT CRUISER All	
F	84-88	DODGE 600 All	
F	84-89	ARIES All	
F	85-89	COLT Hatchback	
F	85-88	COLT Sedan	
F	84-85	DAYTONA All	
F	85-89	LANCER All	
F	00-05	NEON All	
F	89-92	EAGLE VISTA Sedan, CAN	
F	90-91	VISTA Hatchback, CAN	
F	89	VISTA Hatchback	
R	97-03	FORD ESCORT All	
F	94-04	MUSTANG / MUSTANG II All	
R	98-05	HYUNDAI ACCENT All	
R	97	ACCENT All Mfg. from 6/97	
F	88-92	MAZDA 626 All Exc. Electronic Adjustable Suspension or 4 Wheel Steer	
F	88-97	MX6 All Exc. Electronic Adjustable Suspension or 4 Wheel Steer	
R	97-99	MERCURY TRACER FWD	
F	85-88	MINI COOPER All	
F	85-88	MIRAGE All	
F	89-90	SIGMA Non-ABS	
F	87-89	NISSAN 300ZX All	
R	93-99	ALTIMA All	
F	86-88	MAXIMA Sedan	
F	85	MAXIMA All	
F	86-88	MULTI CAN	
R	90-92	STANZA All	
F	87-89	STANZA Sedan	
F	86	STANZA Wagon, FWD	
R	94-99	OLDSMOBILE 88 SERIES All	
F	90-99	88 SERIES All	
R	90-91	88 SERIES All	
F	91-96	98 All	
R	91-96	98 All	
F	99-04	ALERO All	
F	95-96	AURORA All	
F	85-87	CALAIS All	
F	82-96	CIERA / CUTLASS CIERA All	
F	88-99	CUTLASS / CUTLASS SUPREME All	
F	88-91	CUTLASS CALAIS All	
F	87-94	CUTLASS CLASSIC / CUTLASS CRUISER All	
F	82-88	FIRENZA All	
F	98-02	INTRIGUE All	
F	96-99	LSS All	
R	96-99	LSS All	
F	80-84	OMEGA All	
F	97-98	REGENCY All	
R	97-98	REGENCY All	
F	90-04	SILHOUETTE All	
F	83-88	PLYMOUTH CARAVELLE All	
F	89-90	COLT DL, Wagon	
F	90	COLT Base, Wagon	
F	87-88	COLT Hatchback	
F	87-88	COLT Sedan	
F	85-86	COLT DL	
F	85-86	COLT E	
F	85-86	COLT Premier	
F	84-89	RELIANT All	
F	87-94	SUNDANCE All	
F	91	PONTIAC 6000 FWD	
F	82-90	6000 All	
F	90-99	BONNEVILLE All	
R	87-99	BONNEVILLE All	
F	99-05	GRAND AM All	
F	85-91	GRAND AM All	
F	88-03	GRAND PRIX All	
F	82-85	J2000 / SUNBIRD All	
F	99-05	MONTANA All	
F	80-84	PHOENIX All	
F	86-94	SUNBIRD All	
F	87-91	TEMPEST All	
F	90-98	TRANS SPORT All	

Strut Cushion

Shock	POP	Alternative No.	MTG Acc. Supplied
Pos.	Year	Application	
143061	W		
R	93	ASUNA SUNFIRE (CANADIAN VEHICLE) All Exc. Lotus Suspension	
R	88-92	AUDI 80 All	
R	93-95	90 All	
R	88-91	90 All	
F	91-94	100 All Mfg. Late 91	
R	89-90	100 All	
R	89-90	200 All	
R	80-87	4000 All	
R	84-87	4000 QUATTRO All	
F	95-97	A6 QUATTRO All	
R	83-87	COUPE All	
F	91-98	BMW 318i All	
F	84-85	318i All	
F	91-98	318IS All	
F	98-99	323i All	
F	87-88	325 All	
F	84-87	325E All	
F	87-95	325i All	
F	87-92	325IS All	
F	88-91	325IX All	
F	96-98	328i All	
F	89-95	525i All	
F	82-88	528E All	
F	94-95	530i All	
F	83-84	533i All	
F	91-93	535i All	
F	90	535i All Mfg. from 8/90	
F	85-89	535i All	
F	88	535IS All	
F	85-89	635CSI All	
F	86-92	735i All	
F	88-92	735iL All	
R	05-09	BUICK ALLURE All	
R	97-05	CENTURY All	
R	85-90	ELECTRA All	
F	05-09	LACROSSE All	
F	90	LESABRE All Early Design Front Strut with Spring Guard	
F	86-89	LESABRE All	
R	97-04	REGAL All	
F	86-89	RIVIERA All	
F	87-88	CADILLAC ALLANTE All	
F	87-90	BROUGHAM All	
F	85-90	COMMERCIAL CHASSIS All	
F	85-90	DEVILLE All	
F	86-89	ELDORADO All	
F	85-90	FLEETWOOD All	
F	86-89	SEVILLE All	
R	00-11	CHEVROLET IMPALA All	
R	95-01	LUMINA All	
F	95-00	FORD CONTOUR All	
R	97-03	ESCORT All	
R	89-92	GEO PRIZM All	
R	90-93	STORM Non-ABS	
F	99-04	HONDA ODYSSEY All	
R	90-92	ISUZU IMPULSE All	
R	91-93	STYLUS All	
F	90-91	LEXUS ES250 All	
R	90-91	ES250 All	
F	00-06	MAZDA MPV All	
F	99-02	MERCURY COUGAR All	
F	97-99	TRACER FWD	
F	86-90	OLDSMOBILE 88 SERIES All Early Design Front Strut with Spring Guard	
F	85-90	98 All	
R	98-02	INTRIGUE All	
F	91	PEUGEOT 504 / 505 / 604 All	
F	86-90	504 / 505 / 604 Sedan	
F	87-89	PONTIAC BONNEVILLE All	
F	88-98	SAAB 9000 All	
F	80-87	SUBARU BRAT All	
F	85-89	DL All	
F	85-89	GL Hatchback	
F	90-94	LEGACY All	
F	90-94	LOYALE All	
F	91-97	TOYOTA PREVIA All	
F	90-92	VOLKSWAGEN CORRADO All	
143062	W		
R	88-96	BUICK REGAL All	
R	90-94	CHEVROLET LUMINA All	
R	88-97	OLDSMOBILE CUTLASS / CUTLASS SUPREME All	
R	88-96	PONTIAC GRAND PRIX All	
143063	W		
R	91-95	ACURA LEGEND All	
R	89-90	LEGEND All Auto Leveling System	
R	86-88	LEGEND All	
R	85-89	BMW 635CSI All	
R	95-00	CHRYSLER CIRRUS All	
R	96-00	SEBRING Convertible	
R	95-00	DODGE STRATUS All	

Numerical listing

Shock	POP	Alternative No.	MTG Acc. Supplied
Pos.	Year	Application	
143063	W	-continued	
R	88-93	FORD FESTIVA All	
R	90-02	HONDA ACCORD All	
R	95-98	ODYSSEY All	
R	96-99	ISUZU OASIS All	
R	86-91	MAZDA RX7 All	
R	93	MITSUBISHI GALANT All	
R	90-92	GALANT AWD	
R	89	GALANT All	
R	96-00	PLYMOUTH BREEZE All	
R	90-92	VOLKSWAGEN CORRADO All	
R	87-93	FOX All	
R	85-98	GOLF All	
R	85-98	JETTA All	
R	98-01	PASSAT All	
R	82-88	QUANTUM All	
R	75-89	SCIROCCO All	
143064	D		
R	97-99	ACURA CL All	
F	97-00	EL CAN	
R	97-00	EL CAN	
F	90-01	INTEGRA All	
R	90-01	INTEGRA All	
F	89-90	LEGEND All Auto Leveling System	
F	86-88	LEGEND All	
F	92-94	VIGOR All	
F	92-94	VIGOR All	
F	95-00	CHRYSLER CIRRUS All	
F	96-00	SEBRING Convertible	
R	89	DODGE 2000 GTX CAN	
R	92-95	COLT All	
R	89-91	COLT Hatchback	
F	95-00	STRATUS All	
R	91-93	EAGLE 2000 GTX CAN	
R	92	SUMMIT Sedan	
R	89-91	SUMMIT All	
R	90-94	TALON All	
F	90-02	HONDA ACCORD All	
R	86-89	ACCORD All	
R	92-00	CIVIC All	
R	89-91	CIVIC Hatchback	
R	89-91	CIVIC Sedan	
R	93-97	CIVIC DEL SOL All	
F	97-01	CR-V All	
R	97-01	CR-V All	
F	89-91	CRX All	
R	88	CRX All	
F	95-98	ODYSSEY All	
R	92-01	PRELUDE All	
F	88-01	PRELUDE All	
F	96-99	ISUZU OASIS All	
F	95-99	KIA SPORTAGE All	
R	91-97	MAZDA MIATA Non-ABS	
R	90	MIATA All	
R	90-94	MITSUBISHI ECLIPSE All	
R	85-88	GALANT All	
R	89-02	MIRAGE All	
R	89-90	SIGMA Non-ABS	
R	89-94	NISSAN 240SX All	
R	90-96	300ZX 2+2	
F	96-00	PLYMOUTH BREEZE All	
R	90-94	LASER All	
R	90-94	SUBARU LOYALE All	
R	89-91	XT All	
R	85-88	XT FWD, Coil (RearSpringType)	
R	92-99	TOYOTA PASEO All	
R	91-99	TERCEL All	
R	87-90	TERCEL Hatchback	
R	87-90	TERCEL Sedan	

AIR ADJUSTABLE HOSE KITS

Hose kit **141099** is packaged with all Air Adjustable Shocks listed in this catalog. For those vehicles equipped with G.M. Self-Leveling Systems, it may be necessary to purchase adapter kit **141248**. Hose kit **140656** with separate fill valves can be installed on vehicles to allow Air Adjustable Shocks to be filled individually.

REPLACEMENT AIR FITTINGS KITS

Each kit packaged in individual plastic bags.

KIT PART NUMBER	CONTENTS OF KIT	
140701 Replacement Air Fill Valve.	1 Tee Valve 1 Cap 1 Metal Washer	1 Rubber Washer 2 Nuts 1 Air Pressure Warning Circle
140721 Necessary hardware to accomplish one complete installation; excluding hose assemblies.	1 Brass Fill Valve 1 Cap 1 Metal Washer	1 Rubber Washer 1 Nut 1 Air Pressure Warning Circle
141122 Replacement Hose and fittings.	2 Tube Nuts 2 Tube Clamps 6 'O' rings	1 Tube 3 Tubing Clips

G.M. SELF-LEVELING SYSTEM / HOSE KIT CROSS REFERENCE

General Motors vehicles equipped with factory installed G.M. Self-Leveling Systems require an adapter hose kit to operate with our Air Adjustable Shocks. See chart below for the correct application for your vehicle.

Use of conventional shock absorbers on these applications would require deactivation of the air compressor.

APPLICATION	AIR ADJUSTABLE NO.	HOSE KIT(S) REQUIRED
1979-85 Buick Riviera	49345	141099 or 141248*
1979-85 Cadillac Eldorado	49345	141099 or 141248*
1980-85 Cadillac Seville	49345	141099 or 141248*
1979-85 Oldsmobile Toronado	49345	141099 or 141248*
G.M. vehicles with electrically operated self-leveling system or vacuum operated self-leveling system (except above listings)	Listed with Vehicle	141099 and 141248**

* 141099 and 141248 are packaged with the Air Adjustable shocks. Shown for reference if replacement is required.

** 141099 is packaged with the Air Adjustable shocks. 141248 must be purchased separately and used with hose kit packaged with shocks.

No. 141099 Kit Contains:

- 4 - Tube Nuts
- 4 - Tube Clamps
- 10 - Packing 'O' Rings
- 1 - Tube
- 1 - Tee Block Air Valve Fitting
- 1 - Valve Core
- 6 - Tubing Clips
- 1 - Valve Cap
- 1 - Washer
- 2 - Hex Nuts
- 1 - Seal
- 1 - Warning Tag
- 1 - Instruction Sheet

No. 141248*** Kit Contains:

- 3 - Tube Nuts
- 3 - Tube Clamps
- 8 - Packing 'O' Rings
- 2 - Tubing Clips
- 1 - Valve stem adapter & seal sub-assy
- 1 - Valve stem adapter
- 1 - Self-tapping screw
- 1 - Coupling (brass)
- 1 - Compression Spring
- 1 - Valve core
- 1 - Tee clip
- 1 - Valve cap
- 1 - Instruction sheet

*** Used in conjunction with Hose Kit #141099.

SELF LEVELING SYSTEM ELECTRONIC COMPRESSOR DEACTIVATION PROCEDURE FOR GM MODELS

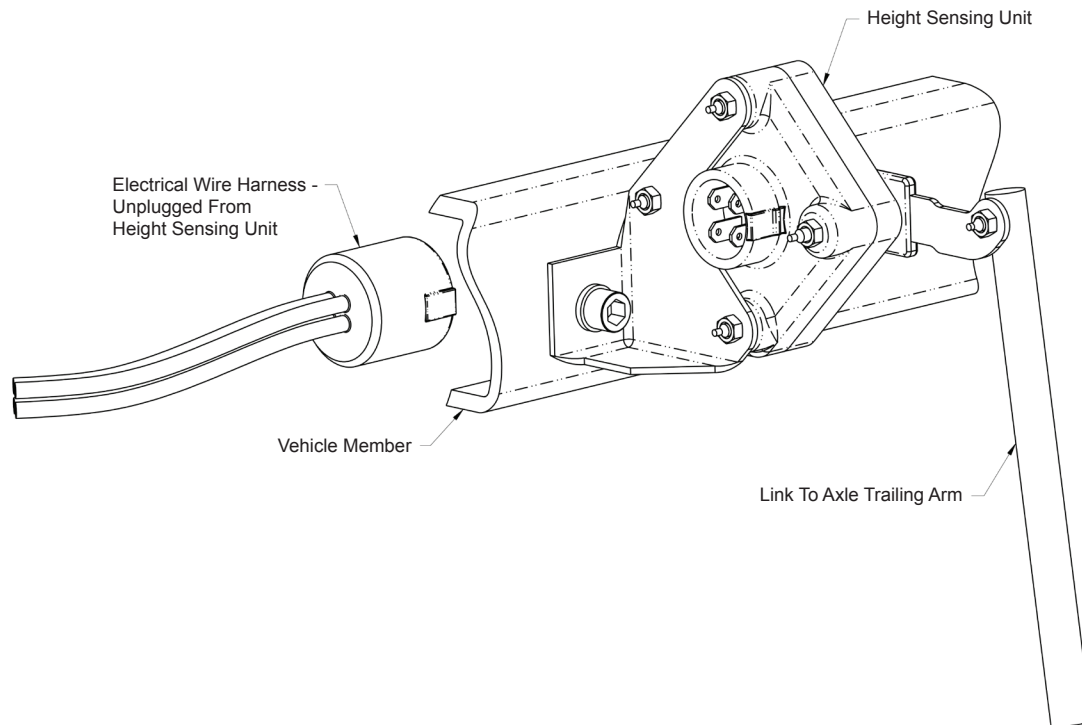

When installing conventional struts/shock absorbers on GM models equipped with self leveling rear suspension that uses an electronic compressor the following procedure should be used:

1. Locate height sensing unit on under body of vehicle approximately above the independent suspension/rear axle. Locate a small link connected to the independent suspension control arm/rear axle trailing arm. The upper end of this link will be connected to the electronic height sensing unit.
2. Unplug electrical wire harness from the height sensing unit. System is now deactivated.
3. Cover exposed electrical connector with tape or other suitable material and secure to underside of vehicle.
4. It is NOT necessary to disconnect link to suspension control/axle trailing arm.

















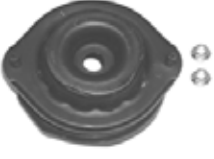

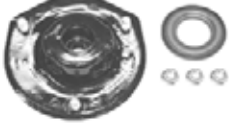









STRUT MOUNTS

 <p>141974</p>	 <p>142132</p>	 <p>142134</p>	 <p>142135</p>	 <p>142143</p>
 <p>142173</p>	 <p>142183</p>	 <p>142190</p>	 <p>142195</p>	 <p>142196</p>
 <p>142197</p>	 <p>142219</p>	 <p>142222</p>	 <p>142223</p>	 <p>142226</p>
 <p>142227</p>	 <p>142229</p>	 <p>142230</p>	 <p>142231</p>	 <p>142237</p>
 <p>142241</p>	 <p>142242</p>	 <p>142244</p>	 <p>142245</p>	 <p>142247</p>
 <p>142249</p>	 <p>142293</p>	 <p>142294</p>	 <p>142295</p>	 <p>142297</p>

STRUT MOUNTS

 <p>142298</p>	 <p>142300</p>	 <p>142302</p>	 <p>142307</p>	 <p>142316</p>
 <p>142317</p>	 <p>142326</p>	 <p>142329</p>	 <p>142330</p>	 <p>142393</p>
 <p>142402</p>	 <p>142405</p>	 <p>142412</p>	 <p>142413</p>	 <p>142419</p>
 <p>142426</p>	 <p>142427</p>	 <p>142430</p>	 <p>142437</p>	 <p>142439</p>
 <p>142524</p>	 <p>142525</p>	 <p>142526</p>	 <p>142527</p>	 <p>142532</p>
 <p>142535</p>	 <p>142536</p>	 <p>142546</p>	 <p>142556</p>	 <p>142562</p>

STRUT MOUNTS

 142567	 142568	 142573	 142623	 142625
 142626	 142640	 142641	 142642	 142647
 142649	 142650	 142651	 142652	 142654
 142735	 142744	 142746	 142749	 142751
 142752	 142753	 142757	 142762	 142825
 142826	 142827	 142828	 142832	 142836

STRUT MOUNTS



STRUT MOUNTS



STRUT MOUNTS

 <p>142837</p>	 <p>142838</p>	 <p>142840</p>	 <p>142841</p>	 <p>142842</p>
 <p>142843</p>	 <p>142851</p>	 <p>142856</p>	 <p>142860</p>	 <p>142861</p>
 <p>142880</p>	 <p>142930</p>	 <p>142931</p>	 <p>142932</p>	 <p>142933</p>
 <p>142935</p>	 <p>142936</p>	 <p>142937</p>	 <p>142938</p>	 <p>142940</p>
 <p>142941</p>	 <p>142942</p>	 <p>142943</p>	 <p>142949</p>	 <p>142992</p>
 <p>143035</p>	 <p>143073</p>	 <p>143074</p>	 <p>143082</p>	 <p>143084</p>

STRUT MOUNTS

 <p>143086</p>	 <p>143087</p>	 <p>143088</p>	 <p>143089</p>	 <p>143091</p>
 <p>143092</p>	 <p>143093</p>	 <p>143094</p>	 <p>143112</p>	 <p>143140</p>
 <p>143191</p>	 <p>143193</p>	 <p>143194</p>	 <p>143195</p>	 <p>143197</p>
 <p>143198</p>	 <p>143199</p>	 <p>143200</p>	 <p>143201</p>	 <p>143202</p>
 <p>143204</p>	 <p>143205</p>	 <p>143206</p>	 <p>143209</p>	 <p>143210</p>
 <p>143214</p>	 <p>143218</p>	 <p>143219</p>	 <p>143221</p>	 <p>143223</p>

STRUT MOUNTS

 <p>143365</p>	 <p>143366</p>	 <p>143367</p>	 <p>143368</p>	 <p>143369</p>
 <p>143375</p>	 <p>143377</p>	 <p>143378</p>	 <p>143379</p>	 <p>143380</p>
 <p>143381</p>	 <p>143382</p>	 <p>143383</p>	 <p>143385</p>	 <p>143386</p>
 <p>143387</p>	 <p>143388</p>	 <p>143389</p>	 <p>143390</p>	 <p>143391</p>
 <p>143392</p>	 <p>143395</p>	 <p>143396</p>	 <p>143397</p>	 <p>143400</p>

STRUT MOUNTS

 <p>143404</p>	 <p>143406</p>	 <p>143408</p>	 <p>143409</p>	 <p>143410</p>
 <p>143412</p>	 <p>143415</p>	 <p>143418</p>	 <p>143419</p>	 <p>143421</p>
 <p>143422</p>	 <p>143423</p>	 <p>143424</p>	 <p>143425</p>	 <p>143458</p>
 <p>143473</p>	 <p>143474</p>	 <p>143491</p>	 <p>143528</p>	

STEERING STABILIZER BOOTS

COLOR	BOOTS	PART NUMBER
RED		142001
BLACK		142005
DARK BLUE		142008

ELECTRONIC ADJUSTABLE SUSPENSION CONVERSION

Some vehicles equipped with Electronically Adjustable Suspension can have a non-adjustable strut/shock replacement. The following is a list of those vehicles and the procedures for replacement.

BUICK PARK AVENUE 1993-96 with CCR (Computer Command Ride)

- Remove the strut actuators
- Remove the CCR. It is located under the driver's seat.
 - Reference GM Document VSS20000025
- Remove struts and install G56718 front and one of the following rears: G56707, G56726, G56903, G56906

BUICK SKYLARK 1992-94 with CCR (Computer Command Ride)

- Remove the shock and strut actuators
- Remove the CCR. It is located behind the sound insulator panel, right side.
 - Reference GM Document VSS20000025
- Remove the shocks and struts and install G56719, G56720 front and 69749 rear.

CADILLAC DEVILLE 1991-93 with CCR (Computer Command Ride)

- Remove the strut actuators
 - Reference GM Document VSS20000025 and GM Service Manual for system adjustment.
- Remove struts and install G56718 front and one of the following rears: G56707, G56726, G56903, G56906

CADILLAC ELDORADO 1991-92 with CCR (Computer Command Ride) or SSS (Speed Sensitive Suspension)

- Remove the strut actuators
 - Reference GM Document VSS20000025 and GM Service Manual for system adjustment.
- Remove struts and install G56717 front and G56704 rear.

CADILLAC SEVILLE 1991-92 with CCR (Computer Command Ride) or SSS (Speed Sensitive Suspension)

- Remove the strut actuators
 - Reference GM Document VSS20000025 and GM Service Manual for system adjustment.
- Remove struts and install G56717 front and G56704 rear.

CHEVROLET CORVETTE 1990-96 with ERC (Electronic Ride Control)

- Remove the shock actuators.
- Unplug the ERC module. It is located in the rear cargo area.
- Remove the shocks and install 69811 or 75811 front and 69795 or 75795 rear.

FORD PROBE 1989-92 with PRC (Programmed Ride Control)

- Remove the strut actuators.
- Unplug the PRC module. It is located under the front passenger seat.
- Remove the struts and install G55600 front and G55601 rear.

FORD THUNDERBIRD TURBO COUPE 1987-88 with PRC (Programmed Ride Control)

- Remove the strut and shock actuators.
- Unplug the PRC module. It is located in the rear cargo area.
- Remove the struts and shocks and install G56504 front and 69709 rear.

MAZDA MX6 GT 1988-92 with AAS (Auto Adjust Suspension)

- Remove the strut actuators.
- Unplug the AAS module. It is located in the rear cargo area.
- Remove the struts and install G55600 front and G55601 rear.

MAZDA RX7 TURBO 1989-90 and MAZDA RX7 GXL 1986-88 with AAS (Auto Adjust Suspension)

- Remove the strut and shock actuators.
- Unplug the AAS module. It is located in the rear cargo area.
- Remove the struts and install G55542 front and G51031 rear.

ELECTRONIC ADJUSTABLE SUSPENSION CONVERSION

MAZDA 626 1988-92 with AAS (Auto Adjust Suspension)

- Remove the strut actuators.
- Unplug the AAS module. It is located in the rear cargo area.
- Remove the struts and install G55600 front and G55601 rear.

MAZDA 929 1988-89 with AAS (Auto Adjust Suspension)

- Remove the strut and shock actuators.
- Unplug the AAS module. It is located in the rear cargo area.
- Remove the struts and install G55713 front and G51192 rear.

MAZDA 929 1990-91 with AAS (Auto Adjust Suspension)

- Remove the strut and shock actuators.
- Unplug the AAS module. It is located in the rear cargo area.
- Remove the struts and install G55716 front and G51192 rear.

MERCURY COUGAR XR7 1987-88 with PRC (Programmed Ride Control)

- Remove the strut and shock actuators.
- Unplug the PRC module. It is located in the rear cargo area.
- Remove the struts and shocks and install G56504 front and 69709 rear.

MITSUBISHI MONTERO 1992-96 with VSA (Variable Shock Absorbers)

- Remove the shock actuators.
- Unplug the module. It is located behind the left rear trim panel.
- Remove the shocks and install G63782 or 77782 front and G63781 or 77781 rear.

NISSAN MAXIMA 1989-94 with NSS (Nissan Sonar Suspension) II

- Remove the strut actuators.
- Unplug the NSS module. It is located in the console.
- Remove the struts and install G55607, G55608 front and G44990 rear.

NISSAN PATHFINDER 1987-95 with ASA (Adjustable Shock Absorber)

- Remove the shock actuators.
- Unplug the control switch. It is located in the console.
- Remove the shocks and install G63904 or 77904 front and G63492 or 77492 rear.

OLDSMOBILE ACHIEVA 1992-94 with CCR (Computer Command Ride)

- Remove the shocks and strut actuators
- Remove the CCR. It is located behind the sound insulator panel, right side.
- Reference GM Document VSS2000025
- Remove the shocks and struts and install G56719, G56720 front and 69749 rear.

OLDSMOBILE NINETY EIGHT 1991-96 with CCR (Computer Command Ride)

- Remove the strut actuators.
- Remove the CCR. It is located under the driver's seat.
- Remove struts and install G56718 front and one of the following rears: G56707, G56726, G56903, G56906

PONTIAC BONNEVILLE 1994-99 with CCR (Computer Command Ride)

- Remove the strut actuators.
- Remove the CCR. It is located under the driver's seat.
- Remove struts and install G56718 front and one of the following rears: G56707, G56726, G56903, G56906

TOYOTA SUPRA from MARCH 1986-95 with TEMS (Toyota Electronic Modulated Systems)

- Remove the shock actuators.
- Unplug the TEMS module. It is located under the dash.
- Remove the shocks and install G51197 front and G51193 rear.

LEFT/RIGHT COMBINATIONS

ProGuard				Ultra Spring Seats (Cont'd)				Ultra Struts (Cont'd)			
61699	RL	61700	RR	G51761	FL	G51760	FR	G52063	FL	G52064	FR
Suspension Mounts				G51810	FL	G51811	FR	G52067	FL	G52068	FR
142146	FL	142145	FR	G51813	FL	G51814	FR	G52069	FL	G52070	FR
142228	RL	142229	RR	G51827	FL	G51828	FR	G52071	RL	G52072	RR
142403	RL	142404	RR	G51853	FL	G51854	FR	G52073	RL	G52074	RR
142408	FL	142409	FR	G51875	RL	G51876	RR	G52075	FL	G52076	FR
142426	RL	142427	RR	G51877	FL	G51878	FR	G52077	FL	G52078	FR
142535	RL	142536	RR	G51889	RL	G51890	RR	G52079	FL	G52080	FR
142642	RL	142641	RR	G51896	FL	G51897	FR	G52081	FL	G52082	FR
142650	FL	142649	FR	G51912	RL	G51913	RR	G52083	FL	G52084	FR
142826	FL	142825	FR	G51917	FL	G51918	FR	G52085	RL	G52086	RR
143036	FL	143037	FR	G51920	FL	G51921	FR	G52087	FL	G52088	FR
143071	RL	143072	RR	G51925	FL	G51926	FR	G52089	RL	G52090	RR
143073	RL	143074	RR	G51947	FL	G51948	FR	G52094	FL	G52095	FR
143113	RL	143112	RR	G51953	FL	G51954	FR	G52096	FL	G52097	FR
143220	RL	143222	RR	G51984	FL	G51985	FR	G52103	RL	G52104	RR
143221	RL	143223	RR	Ultra Struts				G52105	FL	G52106	FR
143231	FL	143264	FR	G52000	FL	G52001	FR	G52107	FL	G52108	FR
143233	FL	143265	FR	G52002	RL	G52003	RR	G52110	FL	G52111	FR
143255	FL	143266	FR	G52004	FL	G52007	FR	G52112	FL	G52113	FR
143354	FL	143355	FR	G52005	FL	G52006	FR	G52117	FL	G52118	FR
143377	FL	143378	FR	G52008	FL	G52009	FR	G52121	FL	G52122	FR
143381	FL	143382	FR	G52013	FL	G52014	FR	G52123	FL	G52124	FR
143387	RL	143388	RR	G52015	FL	G52016	FR	G52127	FL	G52128	FR
143390	RL	143391	RR	G52017	RL	G52018	RR	G52129	FL	G52130	FR
143409	FL	143410	FR	G52019	FL	G52020	FR	G52136	FL	G52137	FR
143413	RL	143414	RR	G52021	RL	G52022	RR	G52138	FL	G52139	FR
143413	RL	143414	RR	G52023	FL	G52024	FR	G52140	FL	G52141	FR
143456	FL	143457	FR	G52026	FL	G52027	FR	G52142	FL	G52143	FR
143461	RL	143462	RR	G52028	FL	G52029	FR	G52144	FL	G52145	FR
143461	RL	143462	RR	G52030	FL	G52031	FR	G52148	FL	G52149	FR
143465	RL	143466	RR	G52032	FL	G52033	FR	G52150	FL	G52151	FR
143509	RL	143510	RR	G52032	FL	G52033	FR	G52152	FL	G52153	FR
143509	RL	143510	RR	G52034	FL	G52035	FR	G52154	FL	G52155	FR
143516	FL	143517	FR	G52036	FL	G52037	FR	G52156	FL	G52157	FR
Ultra Spring Seats				G52038	FL	G52039	FR	G52158	FL	G52159	FR
G511019	FL	G511020	FR	G52055	FL	G52056	FR	G52160	FL	G52161	FR
G511031	FL	G511032	FR	G52057	FL	G52058	FR	G52162	RL	G52163	RR
G511054	FL	G511055	FR	G52061	FL	G52062	FR	G52164	FL	G52165	FR
G51188	FL	G51189	FR								

LEFT/RIGHT COMBINATIONS

Ultra Struts (Cont'd)

G52166	FL	G52167	FR
G52168	FL	G52169	FR
G52170	FL	G52171	FR
G52173	FL	G52174	FR
G52175	FL	G52176	FR
G52178	RL	G52179	RR
G52180	FL	G52181	FR
G52182	RL	G52183	RR
G52184	FL	G52185	FR
G52187	FL	G52188	FR
G52193	FL	G52194	FR
G52199	FL	G52200	FR
G52201	FL	G52202	FR
G52203	RL	G52204	RR
G52209	FL	G52210	FR
G52227	FL	G52228	FR
G52235	FL	G52236	FR
G52237	FL	G52238	FR
G52245	FL	G52246	FR
G52247	FL	G52248	FR
G52249	FL	G52250	FR
G52253	FL	G52254	FR
G52255	FL	G52256	FR
G52257	FL	G52258	FR
G52260	FL	G52261	FR
G52262	FL	G52263	FR
G52264	FL	G52265	FR
G52268	FL	G52269	FR
G52270	FL	G52271	FR
G52272	FL	G52273	FR
G52274	FL	G52275	FR
G52278	FL	G52279	FR
G52280	FL	G52281	FR
G52282	FL	G52283	FR
G52293	FL	G52294	FR
G52297	FL	G52298	FR
G52299	FL	G52300	FR
G52327	FL	G52328	FR
G52329	FL	G52330	FR

Ultra Struts (Cont'd)

G52331	FL	G52332	FR
G52333	RL	G52334	RR
G52335	RL	G52336	RR
G52346	FL	G52347	FR
G52348	FL	G52349	FR
G52351	FL	G52352	FR
G52353	FL	G52354	FR
G52355	FL	G52356	FR
G52360	FL	G52361	FR
G52362	FL	G52363	FR
G52374	FL	G52375	FR
G52382	FL	G52383	FR
G52384	FL	G52385	FR
G52386	FL	G52387	FR
G52389	FL	G52390	FR
G52393	RL	G52394	RR
G52395	FL	G52396	FR
G52398	FL	G52399	FR
G52400	FL	G52401	FR
G52420	FL	G52421	FR
G52422	FL	G52423	FR
G52425	FL	G52426	FR
G52428	FL	G52429	FR
G52432	FL	G52433	FR
G52435	FL	G52436	FR
G52437	FL	G52438	FR
G52439	FL	G52440	FR
G52447	FL	G52448	FR
G52449	FL	G52450	FR
G52453	FL	G52454	FR
G52459	FL	G52460	FR
G52483	FL	G52484	FR
G52485	RL	G52486	RR
G52491	FL	G52492	FR
G52494	FL	G52495	FR
G52502	FL	G52503	FR
G52507	FL	G52508	FR
G52519	FL	G52520	FR
G52524	FL	G52525	FR

Ultra Struts (Cont'd)

G52586	FL	G52587	FR
G52588	FL	G52589	FR
G52591	FL	G52592	FR
G52594	FL	G52595	FR
G52600	FL	G52601	FR
G52638	RL	G52639	RR
G55607	FL	G55608	FR
G55610	FL	G55611	FR
G55652	FL	G55653	FR
G55657	FL	G55658	FR
G55661	RL	G55662	RR
G55663	FL	G55664	FR
G55667	FL	G55666	FR
G55669	RL	G55668	RR
G55671	FL	G55670	FR
G55675	RL	G55676	RR
G55738	FL	G55737	FR
G55785	FL	G55784	FR
G55832	FL	G55833	FR
G55858	FL	G55857	FR
G55860	RL	G55859	RR
G55866	FL	G55865	FR
G55868	RL	G55867	RR
G55882	FL	G55881	FR
G55884	RL	G55883	RR
G55894	RL	G55893	RR
G55903	FL	G55904	FR
G55913	FL	G55912	FR
G55920	FL	G55921	FR
G55924	FL	G55923	FR
G55926	FL	G55925	FR
G55928	RL	G55927	RR
G55930	RL	G55929	RR
G55932	RL	G55931	RR
G55934	RL	G55933	RR
G55958	FL	G56758	FR
G55958	FL	G55951	FR
G55970	FL	G55971	FR
G55977	RL	G55976	RR

LEFT/RIGHT COMBINATIONS

Ultra Struts (Cont'd)

Ultra Struts (Cont'd)

Ultra Struts (Cont'd)

G55978	FL	G55960	FR	G56629	RL	G56628	RR	G56768	RL	G56767	RR
G55993	FL	G55994	FR	G56631	FL	G56632	FR	G56771	FL	G56770	FR
G56506	FL	G56514	FR	G56634	FL	G56633	FR	G56773	FL	G56774	FR
G56512	RL	G56513	RR	G56636	FL	G56635	FR	G56775	FL	G56776	FR
G56516	FL	G56517	FR	G56637	RL	G56571	RR	G56782	FL	G56781	FR
G56524	RL	G56523	RR	G56640	RL	G56641	RR	G56785	FL	G56784	FR
G56526	FL	G56525	FR	G56641	RL	G56640	RR	G56787	FL	G56786	FR
G56528	RL	G56527	RR	G56642	FL	G56643	FR	G56794	FL	G56793	FR
G56530	FL	G56529	FR	G56644	RL	G56645	RR	G56796	FL	G56795	FR
G56532	FL	G56531	FR	G56661	FL	G56660	FR	G56798	FL	G56797	FR
G56534	RL	G56533	RR	G56667	RL	G56668	RR	G56800	FL	G56799	FR
G56536	FL	G56535	FR	G56669	FL	G56670	FR	G56804	FL	G56803	FR
G56538	RL	G56537	RR	G56671	FL	G56672	FR	G56806	FL	G56805	FR
G56539	FL	G56540	FR	G56673	FL	G56674	FR	G56813	FL	G56814	FR
G56542	RL	G56541	RR	G56675	RL	G56676	RR	G56816	FL	G56815	FR
G56544	FL	G56543	FR	G56677	FL	G56678	FR	G56819	FL	G56820	FR
G56546	RL	G56545	RR	G56679	FL	G56680	FR	G56822	RL	G56821	RR
G56548	FL	G56547	FR	G56681	RL	G56682	RR	G56836	FL	G56837	FR
G56552	FL	G56551	FR	G56683	FL	G56684	FR	G56840	FL	G56841	FR
G56554	RL	G56553	RR	G56685	FL	G56686	FR	G56842	FL	G56843	FR
G56556	FL	G56555	FR	G56687	FL	G56688	FR	G56882	FL	G56883	FR
G56559	FL	G56558	FR	G56689	FL	G56690	FR	G56884	RL	G56885	RR
G56562	FL	G56561	FR	G56706	FL	G56705	FR	G56886	FL	G56887	FR
G56562	FL	G56561	FR	G56720	FL	G56719	FR	G56888	FL	G56889	FR
G56570	FL	G56569	FR	G56721	FL	G56722	FR	G56888	FL	G56889	FR
G56573	FL	G56576	FR	G56723	FL	G56724	FR	G56890	FL	G56891	FR
G56575	RL	G56574	RR	G56728	RL	G56729	RR	G56890	FL	G56891	FR
G56580	RL	G56579	RR	G56730	FL	G56731	FR	G56892	FL	G56893	FR
G56582	FL	G56581	FR	G56732	RL	G56733	RR	Ultra ReadyMounts			
G56586	FL	G56585	FR	G56734	RL	G56735	RR	G56917	FL	G56916	FR
G56589	FL	G56588	FR	G56739	FL	G56736	FR	G56919	FL	G56918	FR
G56601	FL	G56568	FR	G56750	FL	G56751	FR	G56921	FL	G56920	FR
G56602	FL	G56603	FR	G56752	FL	G56753	FR	G56924	RL	G56925	RR
G56604	FL	G56605	FR	G56754	FL	G56755	FR	G56930	FL	G56931	FR
G56615	FL	G56616	FR	G56756	FL	G56757	FR	G56932	RL	G56933	RR
G56618	FL	G56619	FR	G56759	FL	G56758	FR	G56934	FL	G56937	FR
G56621	FL	G56622	FR	G56761	FL	G56760	FR	G56949	RL	G56950	RR
G56625	FL	G56624	FR	G56764	RL	G56763	RR	G56952	RL	G56953	RR
G56627	FL	G56626	FR	G56766	FL	G56765	FR	G56954	RL	G56955	RR

LEFT/RIGHT COMBINATIONS

Ultra ReadyMounts (Cont'd)

G56956	FL	G56957	FR
G56958	FL	G56959	FR
G56962	FL	G56963	FR
G56968	RL	G56969	RR
G56970	FL	G56971	FR
G56973	RL	G56974	RR
G56976	FL	G56977	FR
G56989	FL	G56990	FR
G56991	FL	G56992	FR
G56993	FL	G56994	FR
G56996	FL	G56997	FR
G57001	FL	G57002	FR
G57003	RL	G57004	RR
G57007	FL	G57008	FR
G57011	FL	G57012	FR
G57028	FL	G57029	FR
G57030	FL	G57031	FR
G57032	RL	G57033	RR
G57034	FL	G57035	FR
G57037	FL	G57038	FR
G57041	FL	G57042	FR
G57043	RL	G57044	RR
G57045	FL	G57046	FR
G57047	FL	G57048	FR
G57049	FL	G57050	FR
G57054	FL	G57055	FR
G57057	RL	G57058	RR
G57061	RL	G57062	RR
G57063	FL	G57064	FR
G57065	FL	G57066	FR
G57067	RL	G57068	RR
G57069	FL	G57070	FR
G57071	FL	G57072	FR
G57073	FL	G57074	FR
G57076	FL	G57077	FR
G57078	RL	G57079	RR
G57081	FL	G57082	FR
G57084	FL	G57085	FR
G57086	RL	G57087	RR
G57088	FL	G57089	FR

Ultra ReadyMounts (Cont'd)

G57090	RL	G57091	RR
G57093	FL	G57094	FR
G57097	FL	G57098	FR
G57099	FL	G57100	FR
G57101	FL	G57102	FR
G57105	FL	G57106	FR
G57107	FL	G57108	FR
G57110	FL	G57111	FR
G57112	FL	G57113	FR
G57114	FL	G57115	FR
G57116	FL	G57117	FR
G57119	FL	G57120	FR
G57121	FL	G57122	FR
G57123	FL	G57124	FR
G57126	FL	G57127	FR
G57128	RL	G57129	RR
G57130	FL	G57131	FR
G57133	FL	G57134	FR
G57135	FL	G57136	FR
G57137	FL	G57138	FR
G57139	FL	G57140	FR
G57144	FL	G57145	FR
G57157	FL	G57158	FR
G57159	RL	G57160	RR
G57161	FL	G57162	FR
G57163	FL	G57164	FR
G57165	FL	G57166	FR
G57167	RL	G57168	RR
G57176	FL	G57177	FR
G57202	FL	G57203	FR
G57204	FL	G57205	FR

Ultra Truck Shocks

G64004	RL	G64005	RR
--------	----	--------	----

Guardian Struts

M51761	FL	M51760	FR
M52028	FL	M52029	FR
M52573	RL	M52574	RR
M55607	FL	M55608	FR
M55657	FL	M55658	FR

Guardian Struts (Cont'd)

M55661	RL	M55662	RR
M55663	FL	M55664	FR
M55667	FL	M55666	FR
M55675	RL	M55676	RR
M55894	RL	M55893	RR
M55913	FL	M55912	FR
M55920	FL	M55921	FR
M55970	FL	M55971	FR
M55977	RL	M55976	RR
M55978	FL	M55960	FR
M55993	FL	M55994	FR
M56506	FL	M56514	FR
M56516	FL	M56517	FR
M56539	FL	M56540	FR
M56559	FL	M56558	FR
M56618	FL	M56619	FR
M56621	FL	M56622	FR
M56661	FL	M56660	FR
M56671	FL	M56672	FR
M56673	FL	M56674	FR
M56675	RL	M56676	RR
M56677	FL	M56678	FR
M56720	FL	M56719	FR
M56739	FL	M56736	FR
M56806	FL	M56805	FR

Guardian ReadyMounts

M56924	RL	M56925	RR
M56930	FL	M56931	FR
M56932	RL	M56933	RR
M56934	FL	M56937	FR
M56949	RL	M56950	RR
M56956	FL	M56957	FR
M56962	FL	M56963	FR
M56970	FL	M56971	FR
M56973	RL	M56974	RR
M56976	FL	M56977	FR
M56991	FL	M56992	FR
M56996	FL	M56997	FR
M57007	FL	M57008	FR
M57011	FL	M57012	FR

LEFT/RIGHT COMBINATIONS

**Guardian ReadyMounts
(Cont'd)**

M57030	FL	M57031	FR
M57034	FL	M57035	FR
M57041	FL	M57042	FR
M57043	RL	M57044	RR
M57047	FL	M57048	FR
M57049	FL	M57050	FR
M57054	FL	M57055	FR
M57057	RL	M57058	RR
M57063	FL	M57064	FR
M57067	RL	M57068	RR
M57069	FL	M57070	FR
M57071	FL	M57072	FR
M57088	FL	M57089	FR
M57090	RL	M57091	RR
M57114	FL	M57115	FR

EXPLANATION OF SPECIFICATIONS

Part Number:	The catalog number for the individual shock absorber.
Extended Length*:	The length of the shock absorber when it is fully extended. See "How to Measure" instructions.
Collapsed Length*:	The length of the shock absorber when it is fully collapsed. See "How to Measure" instructions.
Stroke:	This is the approximate length of the stroke of the individual shock absorber being described.
Mounting Codes:	Indicates the type of mounting ends for the upper and lower end of each shock absorber. They are listed as follows: <ul style="list-style-type: none"> Stud type mounts ("S" & "DS") Eye ring and bushing mounts ("EB") Eye ring and bushing with sleeve mounts ("ES") Eye ring and bushing with bar pin mounts ("BP") Special mounting codes ("SP")

CONVERSION CHART

Fraction (Inches)	Decimal (Inches)	Metric (MM)	Fraction (Inches)	Decimal (Inches)	Metric (MM)
1/64	0.016	0.397	33/64	0.516	13.097
1/32	0.031	0.794	17/32	0.531	13.494
3/64	0.047	1.191	35/64	0.547	13.891
1/16	0.063	1.588	9/16	0.563	14.288
5/64	0.078	1.984	37/64	0.578	14.684
3/32	0.094	2.381	19/32	0.594	15.081
7/64	0.109	2.778	39/64	0.609	15.478
1/8	0.125	3.175	5/8	0.625	15.875
9/64	0.141	3.572	41/64	0.641	16.272
5/32	0.156	3.969	21/32	0.656	16.669
11/64	0.172	4.366	43/64	0.672	17.066
3/16	0.188	4.763	11/16	0.688	17.463
13/64	0.203	5.159	45/64	0.703	17.859
7/32	0.219	5.556	23/32	0.719	18.256
15/64	0.234	5.953	47/64	0.734	18.653
1/4	0.250	6.350	3/4	0.750	19.050
17/64	0.266	6.747	49/64	0.766	19.447
9/32	0.281	7.144	25/32	0.781	19.844
19/64	0.297	7.541	51/64	0.797	20.241
5/16	0.313	7.938	13/16	0.813	20.638
21/64	0.328	8.334	53/64	0.828	21.034
11/32	0.344	8.731	27/32	0.844	21.431
23/64	0.359	9.128	55/64	0.859	21.828
3/8	0.375	9.525	7/8	0.875	22.225
25/64	0.391	9.922	57/64	0.891	22.622
13/32	0.406	10.319	29/32	0.906	23.019
27/64	0.422	10.716	59/64	0.922	23.416
7/16	0.438	11.113	15/16	0.938	23.813
29/64	0.453	11.509	61/64	0.953	24.209
15/32	0.469	11.906	31/32	0.969	24.606
31/64	0.484	12.303	63/64	0.984	25.003
1/2	0.500	12.700	1	1.000	25.400

METRIC CONVERSION CHART

MILLIMETERS	INCHES	MILLIMETERS	INCHES	MILLIMETERS	INCHES
1	0.03937	10	0.39370	19	0.74803
2	0.07874	11	0.43307	20	0.78740
3	0.11811	12	0.47244	21	0.82677
4	0.15748	13	0.51181	22	0.86614
5	0.19685	14	0.55118	23	0.90551
6	0.23622	15	0.59055	24	0.94488
7	0.27559	16	0.62992	25	0.98425
8	0.31496	17	0.66929		
9	0.35433	18	0.70866		

HOW TO MEASURE EXTENDED & COLLAPSED LENGTHS OF SHOCK ABSORBERS

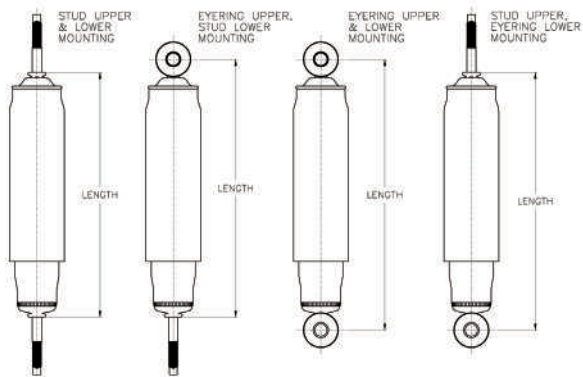

Instructions

1. Using the proper measuring points as shown above find the nearest replacement shock absorber from the listing increments of extended length.
2. Identify the proper mounting form the mounting codes and match these requirements by carefully measuring the mounting dimensions (top and bottom) of the shock absorber to be replaced.
3. Carefully take note of the following requirements:
 - a. **Mounting Accessories** - Contents and descriptions of parts are shown in this manual.
 - b. **Dust tubes** - This requirement should be noted in comparison with the shock absorber to be replaced. Shock absorber environment in its application makes this requirement necessary for piston rod protection and extended shock absorber life.
 - c. **Recoil Cutoff and Compression Bumper** - Carefully note these specifications- deviation of length requirements should not exceed $\pm 1/2$ ". These shock absorber designs are footnoted for easy identification.
 - d. **Limited Environment Application** - Most conventional shock absorbers are offered in "straight" construction to fit limited environment applications. These shock absorber designs are footnoted.

SHOCK ABSORBER DIAMETERS

Shown below are measuring points for diameters by type of shock absorber. Refer to the chart below which lists diameters for the various bore sizes available for each type.

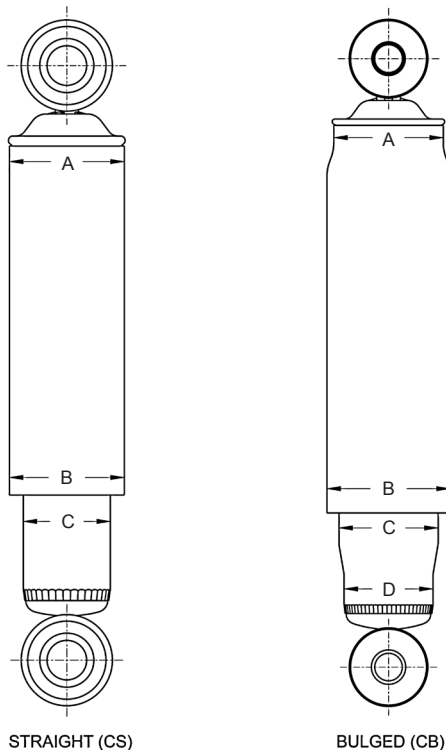

BORE SIZE	SHOCK ABSORBERS	TYPE (Shown Above)	Diameters			
			A	B	C	D
1 3/16"	Classic, Guardian, Ultra Pass. Car	CS	2.06	2.00	1.63	NA
1 3/16"	Classic, Guardian, Ultra Pass. Car	CB	2.06	2.19	1.81	1.63
1 3/8"	Ultra Truck	CS	NA	2.37	2.00	NA
1 3/8"	Ultra Truck	CB	2.37	2.50	2.19	2.00

MOUNTING CODE “ES” EYE RING AND BUSHING WITH STEEL SLEEVE

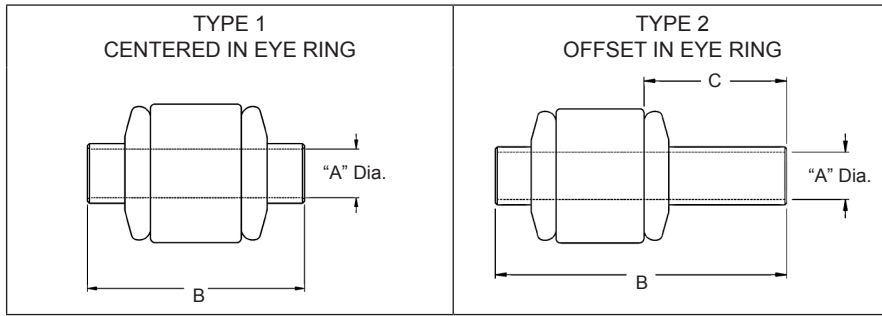

MOUNTING CODE	TYPE	DIMENSION			MOUNTING CODE	TYPE	DIMENSION			MOUNTING CODE	TYPE	DIMENSION		
		A	B	C			A	B	C			A	B	C
ES1	1	10MM	1.25	--	ES59	1	15MM	1.56	--	ES136	1	5/8	1.75	--
ES2	1	10MM	1.42	--	ES60	1	14MM	1.26	--	ES137	1	1/2	1.73	--
ES3	1	10MM	1.56	--	ES61	1	12MM	1.76	--	ES138	1	5/8	1.70	--
ES4	2	1/2	2.20	0.77	ES62	1	12MM	0.98	--	ES139	1	12MM	1.35	--
ES5	1	10MM	2.07	--	ES63	1	15MM	2.28	--	ES141	1	12MM	1.61	--
ES6	1	10MM	2.35	--	ES64	1	16MM	1.25	--	ES142	1	16MM	1.43	--
ES7	1	9/16	1.25	--	ES65	1	12MM	1.38	--	ES143	1	9/16	1.60	--
ES8	1	7/16	1.25	--	ES66	1	16MM	1.38	--	ES145	1	7/16	2.25	--
ES9	1	7/16	1.31	--	ES67	1	16MM	1.56	--	ES146	1	12MM	1.37	--
ES10	1	7/16	1.38	--	ES68	1	9/16	1.35	--	ES147	1	12MM	1.97	--
ES11	1	7/16	1.50	--	ES69	1	12MM	1.58	--	ES149	1	1/2	2.36	--
ES12	1	7/16	1.62	--	ES70	2	7/16	1.88	0.70	ES150	1	3/4	2.24	--
ES13	1	9/16	1.89	--	ES71	1	15MM	2.15	--	ES152	1	20MM	1.69	--
ES14	1	7/16	1.88	--	ES72	1	16MM	1.65	--	ES153	1	14MM	1.55	--
ES15	1	9/16	2.79	--	ES73	1	16MM	1.74	--	ES157	2	1/2	2.05	0.95
ES16	1	7/16	3.15	--	ES74	1	16MM	1.93	--	ES158	1	3/4	3.80	--
ES17	1	12MM	1.25	--	ES75	1	16MM	2.04	--	ES159	2	3/4	3.21	1.03
ES18	1	12MM	1.65	--	ES76	1	17/32	1.49	--	ES160	1	1.00	2.01	--
ES19	1	12MM	1.88	--	ES77	1	20MM	2.35	--	ES161	1	16MM	3.95	--
ES20	1	12MM	1.95	--	ES78	1	10MM	1.92	--	ES162	1	16MM	2.60	--
ES21	1	12MM	2.28	--	ES79	1	21/32	1.58	--	ES163	1	7/16	2.50	--
ES22	1	1/2	1.25	--	ES80	2	25/32	1.69	0.07	ES164	1	1/2	2.26	--
ES23	1	1/2	1.31	--	ES81	1	31/64	1.26	--	ES165	1	1/2	1.75	--
ES24	1	1/2	1.38	--	ES82	1	31/64	1.53	--	ES166	1	5/8	2.97	--
ES25	1	1/2	1.50	--	ES83	1	12MM	1.48	--	ES167	1	14MM	2.31	--
ES26	1	1/2	1.56	--	ES84	1	10MM	1.62	--	ES168	1	14MM	2.62	--
ES27	1	1/2	1.62	--	ES85	1	12MM	2.36	--	ES169	1	14MM	1.91	--
ES28	1	9/16	3.15	--	ES86	1	14MM	2.44	--	ES171	1	1/2	1.88	--
ES29	1	10MM	2.95	--	ES87	1	31/64	1.65	--	ES172	1	1/2	2.72	--
ES30	1	12MM	2.57	--	ES88	1	12MM	1.81	--	ES173	1	7/8	2.28	--
ES31	2	1/2	2.25	1.00	ES89	1	39/64	2.16	--	ES174	1	5/8	3.25	--
ES32	1	1/2	3.34	--	ES90	1	5/8	2.00	--	ES175	1	16MM	1.96	--
ES33	1	12MM	3.15	--	ES91	1	1/2	2.10	--	ES176	1	16MM	3.72	--
ES34	1	9/16	1.66	--	ES92	2	39/64	2.20	0.88	ES177	1	16MM	3.55	--
ES35	1	5/8	1.38	--	ES93	2	39/64	2.57	0.79	ES178	1	3/4	1.96	--
ES36	1	3/4	1.75	--	ES94	1	1/2	2.15	--	ES179	1	20MM	1.75	--
ES37	1	12MM	1.01	--	ES95	1	41/64	2	--	ES181	1	7/16	1.98	--
ES38	1	7/16	2.18	--	ES96	1	45/64	1.57	--	ES182	1	20MM	1.96	--
ES39	1	10MM	1.31	--	ES99	1	14MM	1.42	--	ES183	1	20MM	3.80	--
ES40	1	7/16	3.38	--	ES102	1	10MM	1.77	--	ES184	1	20MM	2.44	--
ES41	1	12MM	3.48	--	ES104	1	20MM	1.58	--	ES185	1	12MM	2.44	--
ES42	1	12MM	3.77	--	ES106	1	10MM	1.48	--	ES187	1	1.00	1.75	--
ES43	1	13MM	1.31	--	ES107	1	12MM	2.15	--	ES188	1	16MM	1.81	--
ES44	1	10MM	2.28	--	ES109	1	10MM	0.95	--	ES190	1	22MM	1.75	--
ES45	1	13MM	1.68	--	ES110	1	16MM	1.61	--	ES191	1	1.00	2.44	--
ES46	1	13MM	1.73	--	ES111	1	9MM	1.78	--	ES192	1	24MM	2.44	--
ES47	1	13MM	2.50	--	ES112	1	12MM	1.08	--	ES193	1	24MM	2.28	--
ES48	1	14MM	1.42	--	ES113	1	16MM	1.49	--	ES194	1	7/8	2.28	--
ES49	1	14MM	1.66	--	ES114	1	12MM	2.04	--	ES195	1	12.30	2.165	--
ES50	1	14MM	1.81	--	ES115	1	10MM	2.02	--	ES196	1	10.00	0.945	--
ES51	1	14MM	1.89	--	ES118	1	12MM	1.31	--	ES197	1	18.00	1.575	--
ES52	1	14MM	1.96	--	ES120	1	3/4	2.76	--	ES198	2	10.00	3.15	30mm
ES53	1	10MM	1.38	--	ES121	1	3/4	2.06	--	ES199	1	10.19	1.97	--
ES54	1	12MM	2.91	--	ES123	1	16MM	1.57	--	ES200	1	12.05	2.195	--
ES55	1	14MM	2	--	ES126	1	1/2	2.44	--	ES201	1	14.4	1.94	--
ES56	1	14MM	1.58	--	ES128	1	1/2	1.66	--	ES202	1	28.15	2.6	--
ES57	1	10MM	1.03	--	ES130	1	1/2	1.56	--	ES203	1	28.15	3.94	--
ES58	1	14MM	2.13	--	ES133	1	12MM	1.93	--	ES204	1	14.48	1.68	--

MOUNTING CODE “DS” & “S” STUD MOUNTS

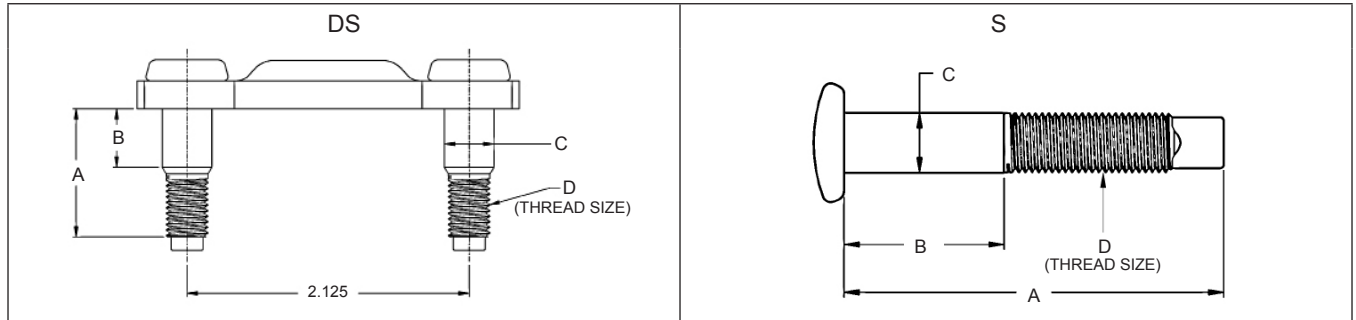

MOUNTING CODE	A	B	C	D
DS1	1.27	0.66	3/8	5/16-24
S1	2.37	1.00	3/8	3/8-24
S2	2.06	1.00	3/8	3/8-24
S3	2.67	1.37	10MM	3/8-16
S4	1.85	1.00	3/8	3/8-24
S5	1.29	1.14	13MM	3/8-24
S6	2.47	1.47	7/16	3/8-24
S7	1.97	1.00	3/8	3/8-24
S8	1.75	1.00	10MM	3/8-24
S9	1.84	1.05	7/16	3/8-24
S10	2.37	1.33	7/16	3/8-24
S11	3.00	1.12	3/8	3/8-24
S12	2.37	1.15	7/16	3/8-24
S13	2.06	1.35	3/8	3/8-24
S14	2.25	1.33	7/16	3/8-24
S15	3.29	1.98	3/8	3/8-24
S16	2.95	1.45	16MM	16MM
S17	2.15	1.03	7/16	3/8-24
S18	2.67	1.81	10MM	M10x1.25
S19	1.34	0.41	7/16	M10x1
S20	1.34	0.41	10MM	M10x1
S21	3.28	1.75	5/8	5/8-18
S22	0.75	0.35	10MM	M10x1
S23	1.84	1.05	3/8	3/8-24
S24	1.22	0.31	11MM	M10x1
S25	1.81	1.50	3/8	M10x1
S26	2.02	0.82	12MM	M10x1
S27	2.36	1.14	10MM	M10x1
S28	2.44	1.37	12MM	M10x1
S29	2.99	1.87	3/8	3/8-24
S30	2.59	1.41	10MM	M10x1
S31	0.79	0.40	17MM	10MM
S32	2.31	1.38	14MM	12MM
S33	3.44	2.17	10MM	M10x1
S34	1.06	0.59	5/16	M8x1.25
S35	2.60	1.12	7/16	3/8-24

MOUNTING CODE	A	B	C	D
S36	2.49	1.33	7/16	3/8-24
S37	3.18	1.41	12MM	M10x1
S38	2.75	1.70	14MM	12MM
S39	2.20	1.31	10MM	10MM
S40	2.52	1.33	7/16	3/8-24
S41	3.48	2.32	5/8	1/2-20
S42	3.50	2.00	5/8	5/8-18
S43	2.75	1.25	5/8	5/8-18
S44	1.57	0.39	10MM	M10x1.25
S45	2.36	1.00	10MM	M10x1.25
S46	1.57	1.18	10MM	M10x1.25
S47	2.20	1.31	10MM	M10x1.25
S48	2.55	1.51	10MM	M10x1.25
S49	2.67	1.29	10MM	M10x1.25
S50	2.95	1.57	10MM	M10x1.25
S51	3.00	1.65	10MM	M10x1.25
S52	1.18	0.74	10MM	M10x1.5
S53	2.16	1.89	10MM	M10x1.5
S54	2.42	1.28	15MM	M10x1.5
S55	2.51	1.39	10MM	M10x1.5
S56	2.67	1.53	11MM	M10x1.5
S57	2.95	1.40	27/64	M10x1.5
S58	2.98	1.68	10MM	M10x1.5
S59	2.98	1.68	12MM	M10x1.5
S60	3.46	1.96	9/16	M10x1.5
S61	3.11	1.45	14MM	M12x1.25
S62	3.24	1.70	9/16	M12x1.25
S63	3.54	2.24	17MM	M12x1.25
S64	2.36	1.18	12MM	M12x1.5
S65	2.89	1.65	12MM	M12x1.5
S66	1.39	0.15	12MM	M12x1.75
S67	2.40	1.53	9/16	M14x1.5
S68	2.95	1.45	5/8	M16x1.5
S69	1.32	1.37	39/64	M16x2
S70	1.88	0.90	7/16	M8x1.25
S71	1.42	0.71	10MM	M10x1.5

MOUNTING CODE “DS” & “S” STUD MOUNTS CONT'D

MOUNTING CODE	A	B	C	D
S72	1.88	0.58	0.433	M8x1.25
S73	3.13	1.52	12MM	M10x1
S74	2.66	1.24	10MM	M10x1
S75	1.57	0.47	10MM	M10x1.25
S76	3.41	1.67	0.425	M10x1
S77	2.21		9.89	M10x1
S78	2.76	1.57	12MM	M12x1.5
S79	2.93	2.02	10MM	M10x1.25
S80	1.18	0.39	12MM	M12x1.25
S81	2.80	1.53	12MM	M12x1.25
S82	3.70	1.54	10MM	M10x1.5
S83	3.17	2.14	10MM	M10x1.25
S84	1.18	0.20	12MM	M12x1.5
S85	3.35	1.85	11MM	M10x1
S86	2.90	1.65	10MM	M10x1.25

MOUNTING CODE	A	B	C	D
S87	3.21	2.09	10MM	M10x1.25
S88	2.55	1.30	12MM	M12x1.25
S89	3.35	2.18	10MM	M10x1.25
S90	3.08	2.00	10MM	M10x1.25
S91	1.20	0.79	10MM	M10x1.25
S92	1.42	0.63	10.5MM	M12x1.25
S93	3.15	1.93	10MM	M10x1.5
S94	2.83	1.77	10MM	M10x1
S95	2.52	1.34	12	M12x1.25
S96	2.56	0.98	10	M10x1.25
S97	1.50	0.51	12	M12x1.75
S98	2.72	1.34	12	M12x1.5
S99	3.07	1.61	12	M10x1.0
S100	1.89	1.38	12	M12x1.25
S101	1.77	1.22	10	M10x1.5

MOUNTING CODE “BP” EYE RING AND BUSHING WITH BAR PIN

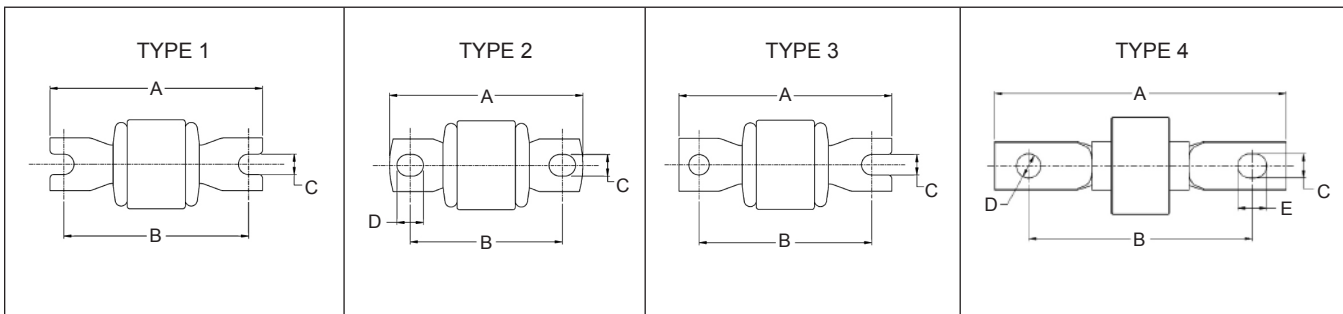

MOUNTING CODE	TYPE	A	B	C	D	E
BP1	1	2.72	2.20	0.33	--	--
BP2	1	3.59	3.12	0.32	--	--
BP3	1	2.82	2.38	0.33	--	--
BP4	1	3.19	2.38	0.33	--	--
BP5	1	3.19	2.75	0.33	--	--
BP6	1	4.25	3.62	0.33	--	--
BP7	2	3.13	2.50	0.35	0.42	--
BP8	2	3.50	2.87	0.35	0.42	--
BP9	1	3.38	2.60	0.35	0.57	--
BP10	2	3.5	2.74	0.50	0.50	--
BP11	1	2.96	2.52	0.33	--	--
BP12	1	3.75	3.14	0.33	--	--
BP13	1	3.45	3.00	0.33	--	--
BP14	2	3.43	2.87	0.45	--	--
BP15	4	4.56	3.62	0.39	0.47	0.39

MOUNTING CODE	TYPE	A	B	C	D	E
BP17	1	3.11	2.61	0.33	--	--
BP18	1	3.75	3.14	0.39	--	--
BP19	1	3.19	2.62	0.33	--	--
BP20	1	3.59	3.12	0.33	--	--
BP26	3	3.06	2.37	0.26	--	--
BP27	2	4.00	2.95	0.52	0.50	--
BP29	2	4.00	2.95	0.37	0.49	--
BP30	1	3.00	2.25	0.34	--	--
BP31	3	3.50	2.87	0.35	--	--
BP32	2	3.45	2.83	0.42	--	--
BP33	2	4.44	3.62	0.39	0.47	--
BP34	1	3.81	2.99	0.41	--	--
BP35	2	3.53	2.73	0.38	0.38	--
BP36	2	4.72	3.38	0.52	0.52	--

MOUNTING CODE “SP” SPECIAL MOUNTS

Part numbers with “SP” mounting codes are unique to the application.
Please reference the specific OE or Gabriel part for dimensions.

MOUNTING CODE "EB" EYE RING AND BUSHING

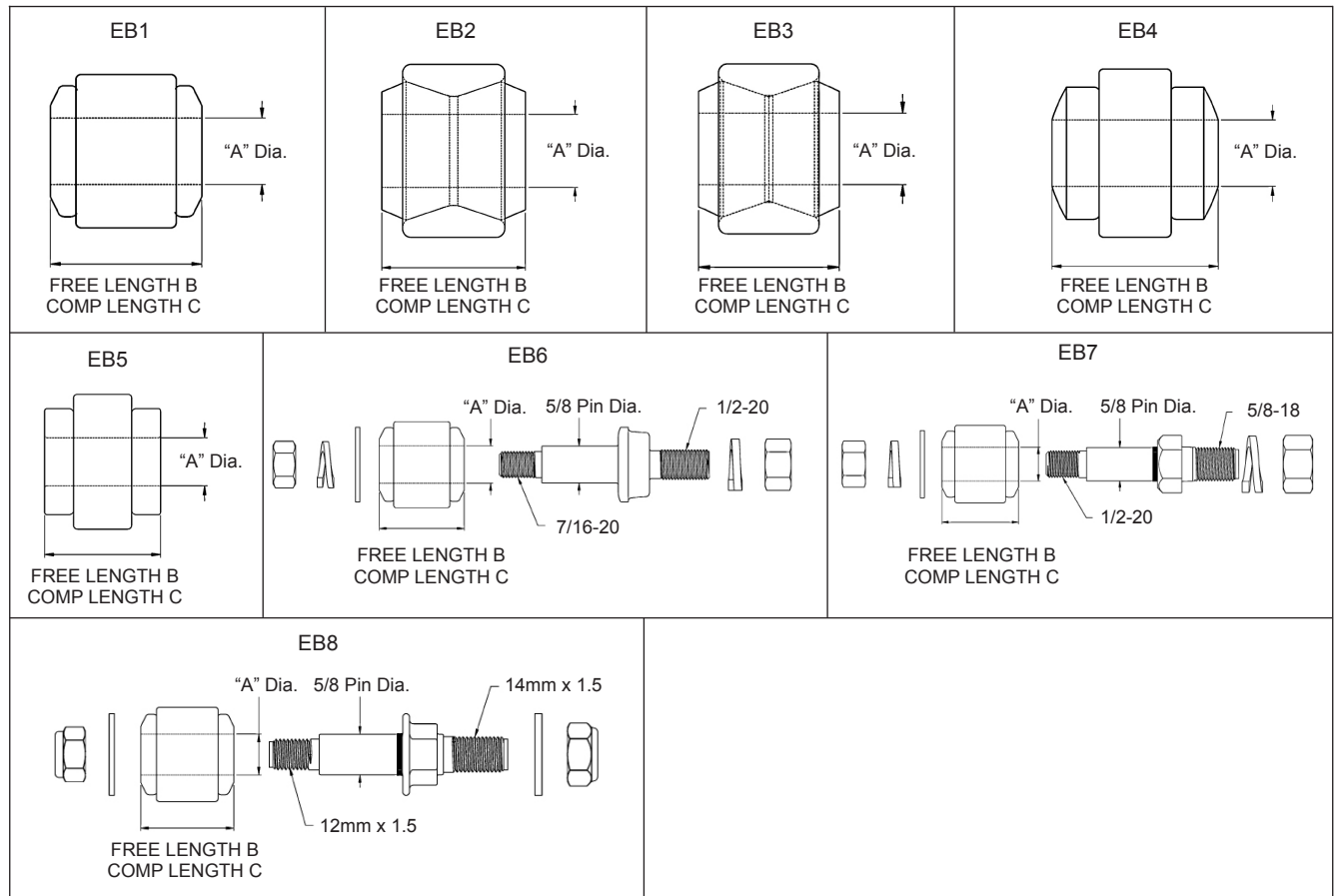

MOUNTING CODE	A DIAMETER	B FREE LENGTH	C COMP. LENGTH	VEHICLE MOUNTING PIN DIAMETER
EB1	5/8	1.44	1.31	5/8
EB2	3/4	1.75	1.50	3/4
EB3	1.00	1.91	1.75	1.00
EB4	11/16	1.72	1.55	11/16
EB5	5/8	1.51	1.25	5/8
EB6	5/8	1.44	1.31	Mounting pin furnished with shock absorber for 1/2 dia. vehicle mounting hole.
EB7	5/8	1.44	1.31	Mounting pin furnished with shock absorber for 5/8 dia. vehicle mounting hole.
EB8	5/8	1.44	1.31	Mounting pin furnished with shock absorber for 14MM dia. vehicle mounting hole.
EB9	1	1.75	--	1
EB10	1.00	1.00	--	1.00
EB11	3/8	0.83	--	3/8
EB12	10MM	1.18	--	10MM
EB13	12MM	1.03	--	12MM
EB14	15MM	1.41	--	15MM
EB15	15MM	1.76	--	15MM
EB16	16MM	1.5	--	16MM
EB17	17MM	1.18	--	17MM
EB18	19MM	1.65	--	19MM
EB19	20MM	1.75	--	20MM
EB20	45/64	1.05	--	45/64
EB21	45/64	1.39	--	45/64

SPECIFICATIONS BY PART NUMBER

CLASSIC SHOCK ABSORBERS

CATALOG PART NO.	EXTENDED LENGTH	COLLAPSED LENGTH	STROKE	UPPER MTG CODE	LOWER MTG CODE	CATALOG PART NO.	EXTENDED LENGTH	COLLAPSED LENGTH	STROKE	UPPER MTG CODE	LOWER MTG CODE
82001	15.98	10.37	5.61	ES64	ES64	82010	16.63	12.47	4.16	ES34	ES34
82003	18.55	11.44	7.11	ES24	ES24	82030	20.23	12.37	7.86	ES43	ES43
82004	14.17	8.81	5.36	S17	S1	82035	14.64	9.53	5.11	ES24	EB1
82005	17.2	12.44	4.76	S1	ES64	82040	21.7	12.84	8.86	S1	ES10
82007	18.23	11.37	6.86	EB1	EB1	82070	15.75	9.99	5.76	S1	DS1
82026	13.42	8.56	4.86	S1	S1	82110	14.1	8.99	5.11	S1	BP8
82051	22.14	13.28	8.86	BP8	EB1	82139	12.98	9.97	3.01	EB1	EB1
82060	23.23	13.87	9.36	EB1	EB1	82147	23.23	13.87	9.36	EB1	ES25
82066	22.7	13.34	9.36	S1	EB1	82602	23.23	13.87	9.36	BP8	EB1
82087	14.61	9.25	5.36	S1	BP20	82607	14.73	9.62	5.11	EB1	EB1
82090	16.11	10	6.11	S1	ES8	82609	25.64	15.03	10.61	EB1	ES35
82099	14.11	9	5.11	S1	BP19	82617	18.86	11.5	7.36	S1	EB4
82104	14.2	9.44	4.76	BP19	DS1	82618	25.73	15.12	10.61	BP14	EB1
82118	15.31	10.06	5.25	S5	BP19	82002	16.2	10.09	6.11	S17	ES14
82126	14.25	9.24	5.01	S36	DS1	82012	16.04	10.53	5.51	BP6	ES25
82131	22.39	13.53	8.86	ES27	EB4	82013	20.82	13.06	7.76	S29	BP20
82138	15.1	9.49	5.61	S1	BP3	82020	18.11	11	7.11	S8	ES62
82156	20.23	12.37	7.86	EB1	EB1	82025	12.95	9.19	3.76	S36	BP17
82039	17.7	10.84	6.86	S1	EB1	82031	16.23	10.37	5.86	ES18	ES18
82072	11.61	7.75	3.86	S1	ES8	82032	22.73	13.87	8.86	ES64	ES64
82075	16.1	10.34	5.76	S1	BP10	82033	18.79	12.03	6.76	ES25	EB19
82079	15.54	9.93	5.61	ES9	BP20	82038	24.67	14.06	10.61	S1	S1
82093	21.23	12.87	8.36	BP31	ES10	82046	26.04	15.43	10.61	EB4	EB4
82125	20.67	12.06	8.61	S8	S1	82049	13.17	8.31	4.86	S1	S1
82130	17.7	10.84	6.86	EB1	S36	82054	24.54	14.68	9.86	EB4	EB4
82601	13.61	8.75	4.86	S1	ES16	82062	24.23	14.37	9.86	ES24	ES24
82006	20.48	12.62	7.86	ES24	ES24	82065	19.04	11.93	7.11	EB4	EB4
82011	12.11	8	4.11	S1	ES11	82067	20.86	12.5	8.36	S1	EB4
82034	22.17	12.81	9.36	S1	S1	82074	18.7	11.34	7.36	S1	ES24
82047	20.23	12.37	7.86	EB1	EB1	82089	22.23	13.37	8.86	ES12	EB1
82069	14.59	9.31	5.28	S1	S1	82123	18.6	11.59	7.01	S9	EB1
82076	18.7	11.34	7.36	ES66	S1	82124	22.1	13.34	8.76	S17	EB1
82086	25.54	14.93	10.61	ES35	ES35	82129	12.51	8.5	4.01	S1	BP3
82103	22.7	13.34	9.36	ES145	S1	82603	17.7	10.84	6.86	S1	EB1
82109	13.64	8.74	4.90	S1	ES32	82610	23.23	13.87	9.36	EB1	EB1
82128	11.2	8.19	3.01	S36	ES40	82614	12.01	8.25	3.76	S12	ES5
82151	23.23	13.87	9.36	ES145	ES70	82615	15.69	10.43	5.26	EB4	BP11
82155	20.7	12.34	8.36	S1	EB1	82608	20.85	13.94	6.91	S12	ES39

FRONT LOAD CARRIERS

CATALOG PART NO.	EXTENDED LENGTH	COLLAPSED LENGTH	STROKE	UPPER MTG CODE	LOWER MTG CODE	CATALOG PART NO.	EXTENDED LENGTH	COLLAPSED LENGTH	STROKE	UPPER MTG CODE	LOWER MTG CODE
34051	13.28	8.67	4.61	S1	BP30	34052	13.62	9	4.62	S1	BP13
34073	14.29	9.37	4.92	S1	BP7	34058	17.13	11.01		S12	ES3
34057	13.57	8.87	4.87	S12	ES41	34076	14.59	9.87		S36	EB1
34036	14.16	9.53	4.63	EB1	ES24	43107	17.95	11.37	6.58	ES31	ES24

SPECIFICATIONS BY PART NUMBER

GUARDIAN SHOCK

CATALOG PART NO.	EXTENDED LENGTH	COLLAPSED LENGTH	STROKE	UPPER MTG CODE	LOWER MTG CODE	CATALOG PART NO.	EXTENDED LENGTH	COLLAPSED LENGTH	STROKE	UPPER MTG CODE	LOWER MTG CODE
49105	18.21	11.23	6.98	S1	S1	81878	17.73	11.12	6.61	ES18	ES18
49106	22.43	13.95	8.48	ES26	EB4	81890	25.28	14.92	10.36	BP14	ES185
49107	19.27	12.29	6.98	ES24	ES24	81893	18.27	13.51	4.76	S36	BP7
49110	22.08	13.85	8.23	EB4	EB4	81916	13.72	9.46	4.26	S36	BP10
49114	20.24	12.51	7.73	S1	EB1	81920	14.71	10.1	4.61	S12	BP11
49122	21.62	13.14	8.48	S1	ES10	81922	15.35	10.24	5.11	S12	U Bracket
49127	19.87	12.63	7.24	EB1	ES25	81933	13.97	9.11	4.86	S29	BP13
49128	22.77	14.04	8.73	BP14	EB1	81934	26.14	16.45	9.69	S20	ES84
49131	22.15	13.67	8.48	BP31	EB1	81096	13.7	8.84	4.86	S1	BP13
49135	21.62	13.14	8.48	BP14	S1	81726	16.48	10.87	5.61	ES126	ES128
49149	24.93	15.64	9.29	ES27	EB4	81789	23.73	14.12	9.61	BP14	ES34
49151	20.35	12.83	7.52	EB1	EB1	81794	19.85	14.19	5.66	S1	ES185
49152	20.27	13.04	7.23	BP31	EB1	81872	14.95	9.59	5.36	S1	ES64
49155	23.27	14.29	8.98	EB1	ES34	81882	15.63	10.37	5.26	ES69	ES69
49157	21.37	13.29	8.08	BP14	EB1	81892	24.2	14.09	10.11	S12	ES171
49162	20.02	12.79	7.23	ES24	ES24	81912	15.48	9.87	5.61	S62	BP7
49173	19.24	12.01	7.23	S1	ES25	81921	26.76	15.67	11.09	ES34	ES34
49178	23.12	13.89	9.23	S1	ES25	81928	13.78	9.52	4.26	S38	ES34
49193	21.27	13.29	7.98	BP14	ES10	81930	22.81	13.95	8.86	ES34	ES34
49196	23.74	14.26	9.48	S1	ES185	81935	24.19	15.93	8.26	S70	ES41
49197	21.27	13.29	7.98	EB1	ES185	81076	14.2	9.44	4.76	BP4	DS1
49199	20.68	12.7	7.98	S1	ES91	81082	23.23	13.87	9.36	EB1	ES185
81039	14.73	9.62	5.11	EB1	ES24	81164	23.23	13.87	9.36	EB1	ES34
81147	20.23	12.37	7.86	EB1	EB1	81242	19.2	11.59	7.61	S1	ES25
81270	17.67	10.56	7.11	S1	S1	81318	22.73	13.87	8.86	EB1	EB1
81446	14.61	9.25	5.36	S1	BP7	81394	17.47	11.21	6.26	S36	ES25
81482	24.23	14.37	9.86	BP14	ES34	81459	21.73	13.37	8.36	ES84	ES84
81490	14.85	9.84	5.01	S12	ES41	81469	22.54	13.68	8.86	EB4	EB4
81492	20.64	12.78	7.86	BP31	EB1	81481	19.7	11.84	7.86	S1	EB1
81494	13.61	8.75	4.86	S1	BP30	81484	20.23	12.37	7.86	EB1	ES25
81495	20.2	12.34	7.86	S1	EB1	81510	25.73	15.12	10.61	EB1	ES185
81507	14.26	9.15	5.11	S1	ES64	81514	22.14	13.28	8.86	BP31	EB1
81516	16.73	10.62	6.11	ES26	ES26	81541	14.7	9.34	5.36	S1	BP14
81548	20.6	12.59	8.01	S1	BP7	81581	22.54	13.68	8.86	ES141	ES141
81549	20.73	12.62	8.11	BP20	EB1	81870	13.86	9	4.86	S1	ES113
81559	13.2	8.59	4.61	S1	BP7	81871	22.04	13.43	8.61	EB2	EB2
81667	26.95	16.19	10.76	BP14	ES34	81891	21.09	13.33	7.76	EB5	ES24
81668	14.32	9.56	4.76	S29	BP11	81923	24.47	14.61	9.86	ES26	ES26
81713	14.42	9.31	5.11	S29	BP7	81926	21.25	13.24	8.01	ES88	ES65
81730	23.23	13.87	9.36	EB1	ES185	81285	23.2	13.84	9.36	S1	ES25
81744	14.52	9.76	4.76	S36	EB1	81340	20.7	12.34	8.36	S1	EB1
81750	13.61	8.75	4.86	S1	BP30	81478	12.6	8.59	4.01	S1	ES64
81836	14.75	9.39	5.36	S1	ES83	81496	20.49	12.63	7.86	ES27	ES27
81869	20.6	12.59	8.01	S1	BP7	81517	21.12	16.31	4.81	S29	ES84
81873	24.74	14.88	9.86	ES34	ES34	81560	23.14	13.78	9.36	BP13	ES27

SPECIFICATIONS BY PART NUMBER

GUARDIAN SHOCK (CONT'D)

CATALOG PART NO.	EXTENDED LENGTH	COLLAPSED LENGTH	STROKE	UPPER MTG CODE	LOWER MTG CODE	CATALOG PART NO.	EXTENDED LENGTH	COLLAPSED LENGTH	STROKE	UPPER MTG CODE	LOWER MTG CODE
81583	18.39	11.53	6.86	EB5	ES25	81562	19.85	15.54	4.31	S36	ES74
81676	17.73	11.12	6.61	EB1	EB1	81582	13.45	8.84	4.61	S1	BP4
81691	24.2	14.09	10.11	S1	ES25	81670	11.7	7.84	3.86	S1	BP7
81694	14.72	9.71	5.01	S36	ES25	81671	23.35	15.44	7.91	S1	ES85
81795	19.2	13.94	5.26	S1	ES143	81674	20.45	12.34	8.11	S1	ES185
81828	22.72	14.21	8.51	S36	ES185	81675	15.7	9.84	5.86	S1	EB1
81904	18.46	11.7	6.76	S1	ES185	81693	20.45	12.34	8.11	S12	BP7
81913	28.39	16.28	12.11	S12	ES171	81710	21.73	13.12	8.61	EB1	ES185
81914	15.48	9.87	5.61	S62	ES26	81714	14.2	9.09	5.11	S1	BP7
81917	23.03	13.92	9.11	EB1	ES185	81727	18.44	11.58	6.86	ES141	ES25
81918	26.97	15.86	11.11	EB1	ES185	81739	16.23	10.87	5.36	ES85	ES64
81919	22.3	13.54	8.76	S38	ES34	81742	22.6	13.59	9.01	S36	ES53
81924	20.78	12.67	8.11	ES185	ES185	81790	18.92	11.56	7.36	S29	ES24
81091	25.14	15.28	9.86	ES27	EB4	81791	15.2	9.59	5.61	S12	ES110
81095	21.7	12.84	8.86	BP14	S1	81792	13.6	9.69	3.91	S36	BP14
81097	18.2	11.09	7.11	EB1	S1	81793	22.78	13.67	9.11	ES84	ES84
81108	14.23	9.37	4.86	ES24	ES24	81821	23.23	13.87	9.36	ES41	ES41
81113	18.23	11.37	6.86	ES31	ES24	81823	25.73	15.12	10.61	BP14	ES185
81153	11.61	7.75	3.86	S1	ES38	81825	21.1	12.99	8.11	EB4	EB4
81174	23.23	13.87	9.36	ES34	ES34	81826	15.6	10.09	5.51	S12	BP7
81322	15.51	10	5.51	S1	ES67	81833	20.21	12.45	7.76	S36	ES185
81338	17.95	11.09	6.86	ES27	S12	81834	15.7	9.84	5.86	S1	BP13
81342	28.89	16.78	12.11	ES27	EB4	81837	26.28	15.42	10.86	BP13	ES27
81406	10.67	7.06	3.61	S1	S12	81880	14.73	9.62	5.11	ES10	EB1
81416	18.6	11.59	7.01	S9	EB1	81881	19.1	11.84	7.26	S36	ES143
81438	20.23	12.37	7.86	BP14	ES10	81902	14.75	9.39	5.36	S1	ES76
81440	24.6	14.59	10.01	S17	EB1	81905	26.97	15.86	11.11	EB1	ES185
81445	13.46	9.95	3.51	ES86	ES34	81906	21.11	13.1	8.01	S12	EB19
81450	17.88	12.72	5.16	BP27	ES137	81908	14.75	9.34	5.41	S1	BP19
81460	20.7	12.34	8.36	S1	ES91	81909	19.63	12.27	7.36	EB19	ES48
81461	23.7	13.84	9.86	S1	ES185	81910	22.48	13.62	8.86	ES19	ES110
81464	15.63	10.37	5.26	ES85	ES64	81911	19.04	11.68	7.36	S1	ES153
81491	13	8.74	4.26	S12	DS1	81925	14.7	9.59	5.11	S12	ES7
81498	22.1	13.34	8.76	S17	EB1	81927	21.01	15.87	5.14	S36	
81501	21.6	14.44	7.16	S1	ES64	81929	19.49	12.13	7.36	BP20	ES24
81508	21.6	13.34	8.26	S12	ES64	81931	26.53	16.02	10.51	ES34	ES34
81529	17.73	11.12	6.61	ES18	ES18	81932	15.87	10.51	5.36	S38	ES34
81530	21.92	13.06	8.86	S29	ES53	81936	20.3	12.19	8.11	S12	BP11
81538	24.23	14.37	9.86	EB1	EB1	81937	21.44	13.18	8.26	S47	EB1
81539	23.23	13.87	9.36	EB1	ES106	81542	20.1	12.34	7.76	S8	EB1
81540	25.73	15.12	10.61	EB1	ES106	81555	16.13	10.62	5.51	ES44	ES1
81553	15.2	9.59	5.61	S1	ES64	81557	16.29	10.93	5.36	ES64	ES112
81554	18.48	11.62	6.86	ES64	EB1	81741	18.31	13.64	4.67	ES69	ES4
81558	19.01	12.35	6.66	S1	ES109	81907	24.14	14.53	9.61	EB19	ES69

SPECIFICATIONS BY PART NUMBER

GUARDIAN STRUT

CATALOG PART NO.	EXTENDED LENGTH	COLLAPSED LENGTH	STROKE	UPPER MTG CODE	LOWER MTG CODE	CATALOG PART NO.	EXTENDED LENGTH	COLLAPSED LENGTH	STROKE	UPPER MTG CODE	LOWER MTG CODE
58183	21.18	13.3	7.88	EB4	EB4	M51230	16.2	10.98	5.22		
58347	17.87	11.49	6.38	ES31	ES24	M51252	18.82	12.02	6.8		
58349	23.18	14.3	8.88	EB1	ES34	M51254	21.3	14.30	7		
58350	18.6	11.65	6.95	S1	ES25	M51267	14.25	10.70	3.55		
58353	24.52	14.9	9.62	ES27	EB4	M51268	24.48	16.97	7.51		
58355	14.87	10.11	4.76	EB11	ES24	M51279	16.37	11.07	5.3		
58357	14.68	10.06	4.62	ES24	ES24	M51700	14.68	10.35	4.33		
58359	13.92	9.14	4.78	S1	BP13	M51703	20.6	16.65	3.95		
58360	15.42	9.89	5.53	S1	BP13	M51704	21.69	16.62	5.07		
58366	23.18	14.3	8.88	ES34	ES34	M51713	22	15.69	6.31		
58377	19.87	12.49	7.38	EB1	ES25	M51714	16.79	11.99	4.8		
58386	16.04	10.66	5.38	S36	ES25	M51718	16.61	11.41	5.2		
58387	23.15	14.03	9.12	S1	ES25	M51722	18.93	16.73	2.2		
58389	29.02	17.15	11.87	ES27	ES27	M51723	18.93	16.73	2.2		
58394	15.68	10.56	5.12	ES24	EB1	M51724	19.28	13.69	5.59		
58403	24.48	14.95	9.53	ES26	ES26	M51728	13.87	9.62	4.25		
58406	22.87	13.99	8.88	EB1	ES185	M51736	16.5	11.50	5		
58409	21.37	13.24	8.13	EB1	ES185	M51737	17.12	12.50	4.62		
58410	18.62	11.75	6.87	S12	EB1	M51738	24.57	17.09	7.48		
58411	18.68	12.06	6.62	ES31	ES26	M51760	25.17	19.37	5.8	SS6	
58412	26.68	16.18	10.5	ES34	ES34	M51761	25.17	19.37	5.8	SS6	
58413	20.68	13.06	7.62	ES27	ES27	M52028	20.47	12.68	7.79		
58414	15.04	10.16	4.88	S36	ES83	M52029	20.47	13.07	7.40		
58416	18.42	11.8	6.62	S12	ES25	M52573					
58421	13.42	8.89	4.53	S1	BP30	M52574					
58422	23.87	14.49	9.38	BP14	ES34	M55514	16.98	10.40	6.58		
58423	16.45	10.67	5.78	ES26	ES26	M55518	22.14	13.82	8.32		
58437	22.99	14.09	8.9	ES31	ES24	M55525	18.97	12.97	6.01		
58438	29.68	17.55	12.13	EB1	ES34	M55526	17.41	10.83	6.58		
58455	22.87	13.99	8.88	ES83	ES83	M55551	24.1	14.50	9.6		
58456	26.68	16.06	10.62	ES25	ES25	M55557	20	12.00	8		
58461	25.37	15.24	10.13	ES185	ES185	M55579	20.56	16.32	4.23		
58488	26.68	16.05	10.63	BP14	ES34	M55590	19.41	13.04	6.37		
58489	14.64	9.61	5.03	S29	BP11	M55591	16.94	10.76	6.18		
58500	15.04	10.16	4.88	S36	ES185	M55607	15.22	9.41	5.81		
58609	16.49	11.05	5.44	ES126	ES45	M55608	15.22	9.41	5.81		
58617	27.37	16.24	11.13	ES83	ES83	M55616	20.19	13.73	6.46		
58622	15.04	10.16	4.88	S36	EB1	M55657	17.23	10.93	6.3		
58623	22.54	13.91	8.63	S36	ES185	M55658	17.23	10.93	6.3		
58624	20.04	12.66	7.38	S36	ES185	M55661	19.57	11.76	7.81		
M51022	24.76	16.75	8.01			M55662	19.57	11.76	7.81		
M51077	18.02	12.75	5.27			M55663	17.34	11.26	6.09		
M51087	17.86	11.91	5.95			M55664	17.34	11.26	6.09		
M51204	18.63	14.83	3.8			M55665	24.78	16.33	8.45		

SPECIFICATIONS BY PART NUMBER

GUARDIAN STRUT (CONT'D)

CATALOG PART NO.	EXTENDED LENGTH	COLLAPSED LENGTH	STROKE	UPPER MTG CODE	LOWER MTG CODE	CATALOG PART NO.	EXTENDED LENGTH	COLLAPSED LENGTH	STROKE	UPPER MTG CODE	LOWER MTG CODE
M55666	16.65	10.61	6.04			M55949	23.13	16.09	7.05		
M55667	16.65	10.61	6.04			M55960	19.51	13.60	5.91		
M55675	20.84	12.64	8.20			M55970	17.63	11.90	5.73		
M55676	20.84	12.64	8.2			M55971	17.63	11.90	5.73		
M55679	15.72	10.10	5.62			M55974	18.01	11.14	6.88		
M55680	17	12.25	4.75			M55975	20.97	12.80	8.18		
M55681	20.69	14.36	6.34			M55976	20.23	12.12	8.11		
M55685	20.01	13.49	6.52			M55977	20.23	12.12	8.11		
M55693	24.59	15.59	9			M55978	19.51	13.60	5.91		
M55697	19.7	13.19	6.51			M55990	17.93	11.32	6.61		
M55698	19.92	13.14	6.78			M55991	20.87	14.53	6.34		
M55733	21.61	13.82	7.79			M55993	21.73	15.16	6.57		
M55745	20.47	13.27	7.2			M55994	21.73	15.16	6.57		
M55774	15.24	10.55	4.7			M55999	16.79	10.81	5.98		
M55786	24.75	16.50	8.25			M56501	20.18	12.01	8.18		
M55788	20.28	14.69	5.59			M56502	17.22	10.54	6.68		
M55800	19.63	12.38	7.25			M56504	20.37	13.14	7.24		
M55801	19.48	12.55	6.88			M56506	17.22	10.54	6.68		
M55802	15.31	10.37	4.94			M56509	16.82	10.66	6.17		
M55803	18.92	13.23	5.69			M56514	17.22	10.54	6.68		
M55804	18.55	12.05	6.49			M56515	16.15	8.44	7.71		
M55817	20.25	12.56	7.7			M56516	20.22	14.02	6.2		
M55820	16	11.25	4.75			M56517	20.22	13.94	6.28		
M55825	22.88	17.33	5.55			M56518	15.23	8.83	6.41		
M55831	23.26	15.67	7.59			M56520	18.95	12.56	6.39		
M55847	18.5	12.00	6.5			M56539	19.62	13.37	6.25		
M55848	20.16	11.87	8.30			M56540	19.62	13.37	6.25		
M55856	23.37	14.26	9.11			M56558	20.98	14.44	6.54		
M55870	16.78	11.56	5.22			M56559	20.98	14.44	6.54		
M55871	25.31	16.56	8.75			M56606	19.65	13.23	6.42		
M55877	15.24	10.55	4.7			M56612	20.39	14.21	6.18		
M55879	16.51	10.28	6.23			M56618	18.75	12.87	5.88		
M55892	20.19	14.09	6.9			M56619	18.75	12.87	5.88		
M55893	24.41	16.46	7.95			M56620	18.6	12.14	6.47		
M55894	24.41	16.46	7.95			M56621	19.12	13.00	6.12		
M55896	20.2	14.1	6.10			M56622	19.12	13.00	6.12		
M55901	20.41	13.65	6.76			M56660	19.62	13.87	5.75		
M55909	15.32	10.38	4.95			M56661	19.62	13.87	5.75		
M55910	19.23	13.09	6.14			M56671	20.5	13.62	6.87	B10	
M55912	19.32	12.31	7.02			M56672	20.5	13.61	6.87	B10	
M55913	19.32	12.31	7.02			M56673	18.89	11.48	7.41		
M55920	16.87	11.13	5.74			M56674	18.89	11.48	7.41		
M55921	16.87	11.13	5.74			M56675	20.95	12.25	8.7		
M55948	16.5	10.71	5.79			M56676	20.95	12.25	8.7		

SPECIFICATIONS BY PART NUMBER

GUARDIAN STRUT (CONT'D)

CATALOG PART NO.	EXTENDED LENGTH	COLLAPSED LENGTH	STROKE	UPPER MTG CODE	LOWER MTG CODE	CATALOG PART NO.	EXTENDED LENGTH	COLLAPSED LENGTH	STROKE	UPPER MTG CODE	LOWER MTG CODE
M56677	19.87	13.37	6.5			M56720	17.63	11.28	6.36		
M56678	19.87	13.37	6.5			M56736	23.31	16.65	6.66		
M56700	17.19	10.57	6.62			M56739	23.31	16.65	6.66		
M56707	21.6	13.77	7.84			M56805	18.75	12.75	6.00	B10	
M56708	18.77	10.85	7.92			M56806	18.75	12.75	6.00	B10	
M56718	18.63	11.07	7.57			M56810	20	13.50	6.5		
M56719	20.04	13.26	6.78			M56903	21.92	15.19	6.74		

HIJACKERS

CATALOG PART NO.	EXTENDED LENGTH	COLLAPSED LENGTH	STROKE	UPPER MTG CODE	LOWER MTG CODE	CATALOG PART NO.	EXTENDED LENGTH	COLLAPSED LENGTH	STROKE	UPPER MTG CODE	LOWER MTG CODE
49105	18.21	11.23	6.98	S1	S1	49107	19.27	12.29	6.98	ES24	ES24
49152	20.27	13.04	7.23	BP31	EB1	49114	20.24	12.51	7.73	S1	EB1
49205	21.12	13.13	7.99	S1	EB1	49127	19.87	12.63	7.24	EB1	ES25
49218	26.34	16.36	9.98	BP14	ES34	49151	20.35	12.83	7.52	EB1	EB1
49228	24.47	14.74	9.73	S15	BP14	49157	21.37	13.29	8.08	BP14	EB1
49230	20.27	12.79	7.48	ES185	ES185	49162	20.02	12.79	7.23	ES24	ES24
49235	24.77	15.04	9.73	ES34	ES34	49173	19.24	12.01	7.23	S1	ES25
49236	17.77	11.54	6.23	ES18	ES18	49193	21.27	13.29	7.98	BP14	ES10
49334	20.7	13.05	7.65	BP31	EB1	49196	23.74	14.26	9.48	S1	ES185
49135	21.62	13.14	8.48	BP14	S1	49197	21.27	13.29	7.98	EB1	ES185
49213	24.27	14.79	9.48	BP14	ES34	49207	22.81	14.06	8.75	EB1	ES106
49215	23.02	14.16	8.86	ES18	ES18	49216	20.74	12.76	7.98	S12	BP7
49231	24.27	14.79	9.48	BP14	ES34	49217	25.27	15.29	9.98	EB1	ES185
49237	24.18	14.45	9.73	S12	ES171	49221	18.36	11.88	6.48	ES141	ES25
49106	22.43	13.95	8.48	ES26	EB4	49222	18.77	12.04	6.73	EB1	ES25
49110	22.08	13.85	8.23	EB4	EB4	49225	25.77	15.54	10.23	BP14	ES185
49155	23.27	14.29	8.98	EB1	ES34	49229	23.99	15.11	8.88	ES152	ES153
49178	23.12	13.89	9.23	S1	ES25	49233	15.67	10.79	4.88	ES69	ES69
49203	20.24	12.51	7.73	S1	EB1	49241	25.77	15.54	10.23	EB1	ES185
49223	23.27	14.29	8.98	EB1	ES41	49309	18.52	11.5	7.02	EB1	S1
49226	20.77	13.04	7.73	BP20	EB1	49345	22.6	15.16	7.44	ES18	ES21
49304	14.35	9.75	4.60	ES10	EB1	49346	18.08	11.48	6.60	ES27	S12
49307	16.35	10.75	5.60	ES17	ES17	49370	21.6	15.04	6.56	S29	ES84
49311	22.44	14	8.44	EB1	EB1	49371	22.55	13.7	8.85	S29	ES53
49122	21.62	13.14	8.48	S1	ES10	49387	21.14	13.03	8.11	S12	EB2
49128	22.77	14.04	8.73	BP14	EB1	49388	21.79	13.39	8.40	S12	EB2
49149	24.93	15.64	9.29	ES27	EB4	49613	19.12	11.97	7.15	S1	ES185
49212	21.02	13.29	7.73	ES27	ES27	49614	19.04	11.94	7.10	S29	ES24
49232	25.09	15.16	9.93	BP14	ES185	49131	22.15	13.67	8.48	BP31	EB1
49234	19.77	13.98	5.79	S1	ES185	49199	20.68	12.7	7.98	S1	ES91
49254	17.86	12.45	5.41	S69	ES15	49214	23.27	14.29	8.98	EB1	ES41
49369	21.86	13.51	8.35	ES84	ES84	49310	20.35	12.75	7.60	EB1	EB1
49255	24.54	14.66	9.87								

SPECIFICATIONS BY PART NUMBER

LTV

CATALOG PART NO.	EXTENDED LENGTH	COLLAPSED LENGTH	STROKE	UPPER MTG CODE	LOWER MTG CODE	CATALOG PART NO.	EXTENDED LENGTH	COLLAPSED LENGTH	STROKE	UPPER MTG CODE	LOWER MTG CODE
58412	26.68	16.18	10.50	ES34	ES34	58461	25.37	15.24	10.13	ES185	ES185
58422	23.87	14.49	9.38	BP14	ES34	58617	27.37	16.24	11.13	ES83	ES83
58423	16.45	10.67	5.78	ES26	ES26	58661	14.22	9.59	4.63	S38	ES34
58488	26.68	16.05	10.63	BP14	ES34	58675	26.13	15.87	10.26	ES34	ES34
58489	14.64	9.61	5.03	S29	BP11	58778	24.34	14.46	9.88	S12	ES171
58622	15.04	10.16	4.88	S36	EB1	58808	28.38	16.75	11.63	ES41	ES41
58638	23.87	14.49	9.38	BP14	ES34	58929	14.54	9.76	4.78	S36	EB1
58662	24.68	15.36	9.32	ES34	ES34	58355	14.87	10.11	4.76	EB11	ES24
58803	15.24	10.37	4.87	S12	U Bracket	58366	23.18	14.3	8.88	ES34	ES34
58809	23.65	14.53	9.12	EB1	ES185	58421	13.42	8.89	4.53	S1	BP30
58810	31.42	18.42	13.00	EB1	ES185	58624	20.04	12.66	7.38	S36	ES185
58817	15.59	10.96	4.63	S12	ES60	58673	22.72	13.84	8.88	S38	ES34
58901	16.49	10.87	5.62	ES126	ES34	58717	22.87	13.99	8.88	ES25	ES25
58930	22.81	14.06	8.75	ES34	ES34	58942	24.37	15			
58350	18.6	11.65	6.95	S1	ES25	58183	21.18	13.3	7.88	EB4	EB4
58359	13.92	9.14	4.78	S1	BP13	58349	23.18	14.3	8.88	EB1	ES34
58403	24.48	14.95	9.53	ES26	ES26	58360	15.42	9.89	5.53	S1	BP13
58409	21.37	13.24	8.13	EB1	ES185	58386	16.04	10.66	5.38	S36	ES25
58413	20.68	13.06	7.62	ES27	ES27	58389	29.02	17.15	11.87	ES27	ES27
58414	15.04	10.16	4.88	S36	ES41	58406	22.87	13.99	8.88	EB1	ES185
58609	16.49	11.05	5.44	ES126	ES45	58438	29.68	17.55	12.13	EB1	ES34
58623	22.54	13.91	8.63	S36	ES185	58455	22.87	13.99	8.88	ES41	ES41
58674	23.22	14.09	9.13	S38	ES34	58625	22.36	13.83	8.53	EB1	EB20
58714	15.26	9.98	5.28	S62	BP7	58811	25.36	15.23	10.13	EB1	ES185
58715	28.34	16.46	11.88	S12	ES171	58906	19.98	12.7	7.28	ES27	ES27
58716	15.74	10.37	5.37	S62	ES26	58908	18.2	11.67	6.53	ES31	ES24
58783	14.59	10.21	4.38	S12	BP11	58353	24.52	14.9	9.62	ES27	EB4
58807	15.24	10.11	5.13	S36	EB1	58377	19.87	12.49	7.38	EB1	ES25
58812	22.45	14.07	8.38	ES86	EB20	58387	23.15	14.03	9.12	S1	ES25
58347	17.87	11.49	6.38	ES31	ES24	58410	18.62	11.75	6.87	S12	EB1
58357	14.68	10.06	4.62	ES24	ES24	58416	18.42	11.8	6.62	S12	ES25
58394	15.68	10.56	5.12	ES24	EB1	58456	26.68	16.06	10.62	ES25	ES25
58411	18.68	12.06	6.62	ES31	ES26	58500	15.04	10.16	4.88	S36	ES185
58437	22.99	14.09	8.90	ES31	ES24	58671	22.2	13.67	8.53	ES26	ES26

SPECIFICATIONS BY PART NUMBER

MAX CONTROL

CATALOG PART NO.	EXTENDED LENGTH	COLLAPSED LENGTH	STROKE	UPPER MTG CODE	LOWER MTG CODE	CATALOG PART NO.	EXTENDED LENGTH	COLLAPSED LENGTH	STROKE	UPPER MTG CODE	LOWER MTG CODE
77412	26.77	16.26	10.51	ES34	ES34	77492	22.33	13.6	8.73	EB1	EB1
77488	26.77	16.26	10.51	BP14	ES34	77524	26.87	15.87	11.00	EB1	ES83
77609	16.43	10.95	5.48	ES126	ES128	77525	22.9	14	8.90	EB1	ES83
77614	15.04	10.05	4.99	S36	EB1	77623	22.38	13.84	8.54	S38	ES83
77638	24.31	14.78	9.53	BP14	ES34	77673	22.38	13.84	8.54	S38	ES34
77662	24.31	14.78	9.53	ES34	ES34	77674	23.27	14.27	9.00	S38	ES34
77783	14.64	10.12	4.52	S12	BP11	77847	20.34	12.59	7.75	S1	BP7
77803	15.31	10.32	4.99	S29	U Bracket	77971	23.64	14.70	8.94		
77807	15.33	10.34	4.99	S36	EB1	77973	22.57	14.41	8.16		
77809	22.92	13.9	9.02	EB1	ES83	77978					
77810	31.53	18.5	13.03	EB1	ES83	77980					
77817	15.73	10.94	4.79	S12	ES60	77981	21.76	13.64	8.12	S57	ES26
77948	23.5	14.75	8.75	S38	ES34	77983	24.78	15.22	8.85	BP8	ES204
77949	16.16	10.67	5.49	S38	BP27	75755	20.34	12.59	7.75	S1	ES83
77950	27.5	17.5	10.00	ES34	ES34	75795	15.24	9.66	5.58	S12	ES110
77951	20.5	13	7.50	S38	ES34	75811	13.55	9.67	3.88	S36	BP14
77953	22.65	13.9	8.75	ES34	ES34	75898	19.85	14.18	5.67	S12	ES83
77955	22.57	13.91	8.66	S36	ES7	77183	20.86	13.01	7.85	EB1	EB1
77489	14.36	9.55	4.81	S29	BP11	77349	23.32	14.29	9.03	EB1	ES34
77714	15.34	9.84	5.50	S38	BP7	77355	14.85	9.86	4.99	EB1	ES24
77716	15.32	9.84	5.48	S38	ES26	77357	14.85	9.86	4.99	ES24	ES24
77778	24.38	14.36	10.02	S12	ES169	77359	13.55	8.84	4.71	S1	BP13
77815	21.97	13.2	8.77	S47	ES64	77377	19.87	12.23	7.64	EB1	ES25
77905	14.64	9.33	5.31	S1	ES83	77389	28.73	16.92	11.81	EB1	ES27
77952	29.68	17.43	12.25	EB1	ES185	77405	19.87	12.23	7.64	EB1	EB1
77954	13.83	9.08	4.75	S29	BP13	77406	22.92	13.9	9.02	EB1	ES83
77375	14.14	9.04	5.10	S12	BP7	77409	21.54	13.11	8.43	EB1	ES83
77403	24.31	14.78	9.53	ES26	ES26	77410	18.47	11.71	6.76	S12	EB1
77414	15.33	10.34	4.99	S36	ES83	77413	20.86	13.01	7.85	ES27	ES27
77422	23.92	14.39	9.53	BP14	ES34	77418	14.14	9.04	5.10	S1	BP11
77423	16.8	10.83	5.97	ES128	ES128	77424	20.34	12.59	7.75	S1	BP7
77494	21.78	13.52	8.26	EB2	EB2	77425	19.87	12.23	7.64	EB1	BP20
77661	13.72	9.5	4.22	S12	ES34	77455	22.92	13.9	9.02	ES83	ES83
77675	26.25	15.74	10.51	ES34	ES34	77456	26.73	15.94	10.79	EB1	ES83
77678	18.01	13.51	4.50	S36	BP7	77479	14.14	9.04	5.10	S1	ES113
77715	28.32	16.33	11.99	S12	ES171	77607	25.39	15.18	10.21	BP14	ES83
77717	22.92	13.9	9.02	ES25	ES25	77608	14.45	9.64	4.81	S36	EB1
77726	20.85	13.05	7.80	S12	EB19	77660	24.9	14.88	10.02	EB1	EB1
77808	28.73	16.92	11.81	EB1	ES83	77679	24.9	14.88	10.02	BP14	ES83
77829	22.33	13.6	8.73	ES88	ES65	77683	21.11	13.27	7.84	EB5	ES24
77947	15.63	10.88	4.75	S38	ES34	77772	14.51	9.72	4.79	S36	BP10
75676	19.66	11.83	7.83	S1	EB1	77781	18.57	11.8	6.77	S1	ES113
77421	13.55	8.84	4.71	S1	BP30	77782	14.14	9.04	5.10	S1	ES118
77454	22.77	14	8.77	ES141	ES141	77837	28.73	16.92	11.81	ES83	BP14
77461	25.39	15.18	10.21	EB1	ES83	77902	12.56	8.5	4.06	S1	ES64

SPECIFICATIONS BY PART NUMBER

MAX CONTROL (CONT'D)

CATALOG PART NO.	EXTENDED LENGTH	COLLAPSED LENGTH	STROKE	UPPER MTG CODE	LOWER MTG CODE
77903	14.64	9.33	5.31	S1	BP14
77904	14.83	9.54	5.29	S1	ES64
77907	19.87	12.23	7.64	EB1	EB1
77909	14.14	9.04	5.10	S1	ES17
77915	13.61	8.85	4.76	S1	BP7
77937	14.93	9.35	5.58	S1	BP19

CATALOG PART NO.	EXTENDED LENGTH	COLLAPSED LENGTH	STROKE	UPPER MTG CODE	LOWER MTG CODE
77958	14.51	9.35	5.16	S1	ES25
77967	20.75	13.13	7.62	S62	ES34
77968	24.71	15.09	9.62	EB1	ES185
77969	25.43	15.81	9.62	EB1	ES185
77979	19.52	12.16			

PRO GUARD

CATALOG PART NO.	EXTENDED LENGTH	COLLAPSED LENGTH	STROKE	UPPER MTG CODE	LOWER MTG CODE
61500	20.23	12.37	7.86	EB1	EB1
61504	13.7	8.92	4.78	S1	BP30
61506	21.86	13.58	8.28	EB1	EB1
61512	13.2	8.59	4.61	S1	BP7
61520	15.34	10.31	5.03	S36	ES41
61528	23.98	14.45	9.53	BP14	ES34
61531	16.73	10.7	6.03	ES26	ES26
61535	20.45	12.67	7.78	S1	BP7
61536	19.98	12.45	7.53	BP20	EB1
61542	16.73	10.95	5.78	ES126	ES128
61543	26.76	16.23	10.53	BP14	ES34
61544	14.54	9.75	4.79	S29	BP11
61555	14.14	9.11	5.03	S12	BP7
61591	14.47	9.71	4.76	S36	EB1
61599	13.8	9.52	4.28	S38	ES34
61600	24.51	14.98	9.53	ES34	ES34
61601	14.71	9.49	5.22	S1	ES83
61605	17.98	11.45	6.53	ES18	ES18
61611	15.48	9.95	5.53	S62	BP7
61613	15.48	9.95	5.53	S62	ES26
61614	22.98	13.95	9.03	ES41	ES41
61623	18.04	13.51	4.53	S36	BP7
61624	24.98	14.95	10.03	BP14	ES185
61626	13.73	9.45	4.28	S36	BP10
61627	22.98	13.95	9.03	ES185	ES185
61641	14.7	10.17	4.53	S12	BP11
61642	26.76	15.98	10.78	ES34	ES34
61643	15.36	10.33	5.03	S12	U Bracket
61658	24.48	14.7	9.78	ES26	ES26
61664	20.45	12.67	7.78	S1	BP7
61675	22.81	14.12	8.69	ES34	ES34
61676	21.25	13.31	7.94	ES88	ES65
61565	24.26	14.73	9.53	BP14	ES34
61592	21.45	13.17	8.28	S47	EB1

CATALOG PART NO.	EXTENDED LENGTH	COLLAPSED LENGTH	STROKE	UPPER MTG CODE	LOWER MTG CODE
61593	14.95	9.67	5.28	S1	ES64
61625	15.48	10.45	5.03	ES69	ES69
61629	26.98	15.95	11.03	ES185	ES185
61638	24.45	14.42	10.03	S12	ES171
61659	20.76	12.98	7.78	ES185	ES185
61662	12.23	8.45	3.78	S47	ES64
61663	15.7	10.92	4.78	S12	ES60
61717	22.75	14.56	8.19	ES47	ES26
61508	14.11	9	5.11	S1	ES64
61510	22.29	13.76	8.53	EB2	EB2
61525	15.01	9.95	5.06	EB1	ES24
61539	22.79	14.01	8.78	ES141	ES141
61552	13.95	9.17	4.78	S1	ES113
61559	22.98	13.95	9.03	EB1	ES185
61561	15.09	10.06	5.03	S36	EB1
61575	21.14	13.36	7.78	EB5	ES24
61606	14.7	9.34	5.36	S1	BP19
61612	28.39	16.36	12.03	S12	ES171
61615	20.3	12.27	8.03	S12	BP11
61616	19.39	12.23	7.16	BP20	ES24
61634	22.3	13.77	8.53	S38	ES34
61655	23.01	14.07	8.94	ES185	ES185
61777	15.62	10.68	4.94	ES164	ES68
61509	14.7	9.34	5.36	S1	BP14
61521	16.45	10.67	5.78	S12	ES25
61522	20.49	12.63	7.86	ES27	ES27
61523	13.7	8.92	4.78	S1	BP13
61524	23.26	14.23	9.03	EB1	ES34
61530	25.48	15.2	10.28	EB1	ES185
61538	17.98	11.45	6.53	ES18	ES18
61547	23.01	14.07	8.94	ES185	ES185
61560	18.45	11.67	6.78	S1	ES185
61609	22.48	13.7	8.78	ES110	ES19
61610	19.04	11.76	7.28	S1	ES153

SPECIFICATIONS BY PART NUMBER

PRO GUARD (CONT'D)

CATALOG PART NO.	EXTENDED LENGTH	COLLAPSED LENGTH	STROKE	UPPER MTG CODE	LOWER MTG CODE	CATALOG PART NO.	EXTENDED LENGTH	COLLAPSED LENGTH	STROKE	UPPER MTG CODE	LOWER MTG CODE
61646	22.57	14.29	8.28	S36	ES185	61597	24.14	14.61	9.53	ES104	ES69
61656	31.51	18.48	13.03	ES185	ES185	61598	23.79	15.01	8.78	ES152	ES153
61685	14.12	9.68	4.44	S11	BP9	61607	15.89	10.11	5.78	S12	ES64
61690	24.78	15.84	8.94	EB20	EB20	61608	19.64	12.36	7.28	ES99	ES48
61732	15.45	10.25	5.19	S36	ES35	61632	20.79	13.01	7.78	EB4	EB4
61734	23.97	15.27	8.69			61633	28.64	16.86	11.78	ES27	EB4
61501	12.6	8.59	4.01	S1	ES64	61635	23.27	14.24	9.03	S38	ES34
61502	20.67	12.06	8.61	S8	S1	61637	17.98	11.45	6.53	EB1	EB1
61503	21.12	16.31	4.81	S29	ES84	61647	23.23	13.95	9.28	S1	ES25
61505	18.95	11.67	7.28	EB1	S1	61649	23.26	14.23	9.03	ES34	ES34
61507	21.11	12.83	8.28	S1	EB2	61650	15.7	9.92	5.78	S1	BP13
61511	23.16	14.13	9.03	BP13	ES27	61651	24.4	14.64	9.76	S47	EB1
61516	18.23	11.37	6.86	ES31	ES24	61654	28.76	16.98	11.78	ES185	ES185
61517	14.98	9.95	5.03	ES24	ES24	61657	25.48	15.2	10.28	ES185	ES185
61518	18.73	11.7	7.03	S1	ES25	61679	14.71	9.49	5.22	S1	ES25
61519	19.98	12.45	7.53	EB1	ES25	61680	20.83	13.39	7.44	S38	ES34
61526	24.64	14.86	9.78	ES27	EB4	61681	29.71	17.77	11.94	EB1	ES41
61529	14.1	9.34	4.76	S1	BP4	61682	31.36	18.67	12.69	EB1	ES41
61532	23.98	14.45	9.53	EB1	EB1	61683	15.07	10.44	4.63	S11	U Bracket
61533	22.98	13.95	9.03	EB1	ES106	61684	12.82	8.88	3.94	S11	BP9
61534	26.98	15.95	11.03	EB1	ES106	61686	22.36	13.92	8.44	BP14	ES34
61540	13.7	8.92	4.78	S1	BP4	61687	23.87	14.68	9.19	BP14	ES34
61541	18.14	11.61	6.53	EB5	ES25	61688	25.19	15.31	9.88	BP14	ES34
61546	18.45	11.67	6.78	S1	ES64	61691	26.51	16.12	10.39	ES34	ES34
61549	15.89	10.11	5.78	S1	EB1	61692	26.05	15.87	10.18	ES34	ES34
61550	17.73	11.12	6.61	EB1	EB1	61696	22.45	14.5	7.95	BP18	ES26
61551	22.45	13.42	9.03	S1	ES25	61697	22.62	14.43	8.19	BP18	ES26
61553	15.09	10.06	5.03	S36	ES25	61699	19.41	12.65	6.76	EB2	EB2
61554	21.48	13.2	8.28	ES185	ES185	61700	20.37	13.11	7.26	EB2	EB2
61556	14.2	9.09	5.11	S1	BP7	61703	20.15	13.96	6.19	ES83	ES83
61557	18.42	11.88	6.54	ES141	ES25	61704	16.84	11.28	5.56	ES69	ES69
61558	22.45	13.42	9.03	S1	EB1	61709	27.58	17.14	10.44	ES34	ES34
61568	19.64	12.36	7.28	EB1	ES142	61710	27.58	17.14	10.44	ES34	ES34
61569	16.33	10.8	5.53	S12	BP7	61711	21.8	13.61	8.19	S36	ES26
61573	26.98	15.95	11.03	EB1	ES185	61712	23.3	14.26	9.04	S38	ES34
61582	24.98	14.95	10.03	EB1	EB1	61713	26.94	16	10.94	EB1	ES83
61584	25.48	15.2	10.28	BP13	ES26	61714	23.36	14.22	9.14	S62	ES77
61586	22.95	13.67	9.28	S1	EB1	61715	24.12	15.18	8.94	ES88	ES69
61588	21.11	13.08	8.03	S12	EB2	61716	26.5	16.33	10.17	ES34	ES34
61589	21.29	13.51	7.78	ES152	ES153	61718	21.33	13.64	7.69	ES128	ES45
61590	25.48	15.2	10.28	BP14	ES185	61720	15.92	11.23	4.69	ES17	ES19
61594	19.45	12.17	7.28	EB1	S17	61513	19.95	12.42	7.53	S8	EB1
61595	20.07	12.54	7.53	S36	ES185	61545	14.45	9.67	4.78	S1	ES64
61596	14.45	9.42	5.03	S1	ES69						

SPECIFICATIONS BY PART NUMBER

REAR LOAD CARRIER

CATALOG PART NO.	EXTENDED LENGTH	COLLAPSED LENGTH	STROKE	UPPER MTG CODE	LOWER MTG CODE	CATALOG PART NO.	EXTENDED LENGTH	COLLAPSED LENGTH	STROKE	UPPER MTG CODE	LOWER MTG CODE
43048	20.45	12.62	7.83	EB1	EB1	43067	24.61	14.78	9.83	ES27	EB4
43060	20.2	12.55	7.65	BP31	EB1	43096	22.61	13.78	8.83	ES27	EB4
43140	20.92	12.84	8.08	S1	EB1	43142	21.45	13.12	8.33	ES185	ES185
43162	22.99	14.38	8.61	BP14	ES34	43171	24.74	15.38	9.36	BP14	ES185
43163	25.05	15.69	9.36	BP14	ES34	43062	18.95	11.87		ES24	ES24
43167	22.99	13.88	9.11	ES185	ES185	43084	21.42	12.84		BP14	S1
43181	24.24	14.88	9.36	ES34	ES34	43085	20.61	12.78		EB4	ES27
43161	22.3	13.69	8.61	ES18	ES18	43093	20.2	12.62		ES24	ES24
43180	23.55	14.19	9.36	BP8	ES34	43138	18.18	11.1	7.08	ES27	S12
43049	21.86	13.28	8.58	BP31	EB1	43143	20.42	12.34	8.08	S1	ES91
43099	19.17	11.77	7.40	S1	ES25	43165	22.99	13.88	9.11	ES106	ES106
43111	22.9	13.82	9.08	ES34	ES34	43172	25.55	16.19	9.36	BP14	ES185
43058	19.95	12.37	7.58	EB1	ES25	43173	15.39	10.38	5.01	ES69	ES69

STEERING DAMPER

CATALOG PART NO.	EXTENDED LENGTH	COLLAPSED LENGTH	STROKE	UPPER MTG CODE	LOWER MTG CODE	CATALOG PART NO.	EXTENDED LENGTH	COLLAPSED LENGTH	STROKE	UPPER MTG CODE	LOWER MTG CODE
14040	19.73	12.12	7.61	EB1	ES24	14018	21.37	12.8	8.57	ES35	EB1
14071	20.7	12.79	7.91	ES53	ES65	14019	26.87	15.55	11.32	ES35	EB1
14017	24.04	14.43	9.61	EB1	EB1	14020	19.75	12.05	7.70	EB1	ES39
14039	15.73	12.12	3.51	ES41	ES41	43171	24.74	15.38	9.36	BP14	ES185
14004	17.48	11.28	6.20			43062	18.95	11.87		ES24	ES24
14005	14.49	9.41	5.08			43084	21.42	12.84		BP14	S1
14072	28.22	16.49	11.73			43085	20.61	12.78		EB4	ES27
14073	25.63	16.61	9.02			43093	20.2	12.62		ES24	ES24
14074	20.62	13.30	7.32	Eyelet	Eyelet	43138	18.18	11.1	7.08	ES27	S12
14075						43143	20.42	12.34	8.08	S1	ES91
14077	13.97	9.37				43165	22.99	13.88	9.11	ES106	ES106
14010	16.77	10.45	6.32	ES35	ES35	43172	25.55	16.19	9.36	BP14	ES185
14016	21.4	12.33	9.07	S1	S1	43173	15.39	10.38	5.01	ES69	ES69

STEERING STABILIZER

CATALOG PART NO.	EXTENDED LENGTH	COLLAPSED LENGTH	STROKE	UPPER MTG CODE	LOWER MTG CODE	CATALOG PART NO.	EXTENDED LENGTH	COLLAPSED LENGTH	STROKE	UPPER MTG CODE	LOWER MTG CODE
6801SE	19.33	12.16	7.17	EB1	EB1	6807SE	19.73	12.12	7.61	EB1	EB1
6804SE	24.08	14.67	9.41	EB1	EB1	6850SE	23.3	13.77	9.53	EB1	S1
6847SE	23	13.83	9.17	EB1	ES65	6856SE	27.3	15.77	11.53	S1	EB1
6853SE	19.33	12.05	7.28	EB1	ES24	6805SE	21.2	12.59	8.61	S1	EB1
6854SE	23.03	14.27	8.76	EB1	EB1	6826SE	21.17	12.31	8.86	S1	S1
6802SE	20.02	12.11	7.91	S1	S1	6828SE	21.23	12.87	8.36	EB1	EB1
6803SE	22.52	13.36	9.16	S1	S1	6848SE	18.04	11.18	6.86	ES62	ES109
6846SE	22.6	13.68	8.92	ES65	ES65	6849SE	20.17	11.81	8.36	S1	S1
6855SE	23.83	14.3	9.53	EB1	EB1	6851SE	21.27	12.49	8.78	S1	S1

SPECIFICATIONS BY PART NUMBER

STEERING STABILIZER (CONT'D)

CATALOG PART NO.	EXTENDED LENGTH	COLLAPSED LENGTH	STROKE	UPPER MTG CODE	LOWER MTG CODE
6852SE	20.27	11.99	8.28	S1	S1
6857SE	21.27	12.49	8.78	S1	S1
6858SE	21.27	12.49	8.78	S1	S1
6859SE	20.27	11.99	8.28	S1	S1

CATALOG PART NO.	EXTENDED LENGTH	COLLAPSED LENGTH	STROKE	UPPER MTG CODE	LOWER MTG CODE
6860SE	20.27	11.99	8.28	S1	S1
6861SE	20.27	11.99	8.28	S1	S1
6863SE	20.27	11.99	8.28	S1	S1
6862SE	20.27	11.99	8.28	S1	S1

ULTRA CARTRIDGE

CATALOG PART NO.	EXTENDED LENGTH	COLLAPSED LENGTH	STROKE	UPPER MTG CODE	LOWER MTG CODE
G44459	20.32	13.41	6.91		
G44713	26.08	18.74	7.34		
G44743	19.70	13.10	6.6		
G44763	19.95	13.82	6.13		
G44766	23.9	16.12	7.78		
G44767	21.04	14.21	6.84		
G44775	24.55	17.48	7.08		
G44869	21.36	15.65	5.71		
G44898	23.87	16.14	7.73		
G44903	19.81	13.59	6.22		
G44934	21.90	15.20	6.71		
G44938	23.49	16.28	7.21		
G44941	25.17	18.67	6.5		
G44944	19.18	13.29	5.90		
G44969	25.61	18.00	7.61		
G44982	19.72	13.66	6.07		
G44995	18.77	13.21	5.56		
G44450	22.17	14.55	7.62		
G44748	20.07	14.14	5.93		
G44752	24.22	17.81	6.41		
G44774	21.36	14.13	7.23		
G44800	21.05	15.24	5.82		
G44850	22.3	15.42	6.88		
G44856	24.24	16.79	7.45		
G44862	22.98	16.78	6.2		
G44990	24.79	16.89	7.90		
G44493	22.8	17.92	4.88		
G44495	20.74	14.65	6.09		
G44724	22.68	14.95	7.73		
G44776	24.66	16.77	7.90		
G44867	25.16	18.73	6.43		

CATALOG PART NO.	EXTENDED LENGTH	COLLAPSED LENGTH	STROKE	UPPER MTG CODE	LOWER MTG CODE
G44926	23.6	15.77	7.83		
G44936	21.06	14.69	6.37		
G44939	19.72	13.66	6.07		
G44999	20.93	14.23	6.7		
G44461	20.58	14.67	5.91		
G44477	24.98	16.77	8.21		
G44497	22.8	17.97	4.83		
G44745	24.66	17.48	7.18		
G44803	21.01	14.38	6.63		
G44940	20.37	14.14	6.24		
G44943	20.64	13.91	6.73		
G44991	25.24	18.24	7		
G44998	20.17	13.86	6.31		
G244002	20.66	14.21	6.44		
G44451	20.35	13.92	6.43		
G44735	21.95	14.35	7.6		
G44747	19.46	13.57	5.89		
G44783	20.81	13.66	7.15		
G44802	21.78	15.17	6.61		
G44868	23.14	17.33	5.82		
G44902	21.78	14.37	7.41		
G44920	25.22	18.02	7.2		
G44968	20.91	14.41	6.5		
G44986	21.45	14.95	6.5		
G44994	19.84	14.20	5.64		
G44997	21.76	14.76	7		
G44773	22.42	15.52	6.9		
G44918	20.57	14.59	5.98		
G44937	22.68	16.53	6.16		
G44947	23.9	16.55	7.35		

SPECIFICATIONS BY PART NUMBER

ULTRA SHOCK

CATALOG PART NO.	EXTENDED LENGTH	COLLAPSED LENGTH	STROKE	UPPER MTG CODE	LOWER MTG CODE	CATALOG PART NO.	EXTENDED LENGTH	COLLAPSED LENGTH	STROKE	UPPER MTG CODE	LOWER MTG CODE
69464	24.2	15.93	8.27	384557-1	ES41	70039	16.69	10.51	6.18		
69473	18.29	11.43	6.86	ES85	ES30	70040	18.03	11.38	6.65		
69575	20.16	12.4	7.76	S36	ES162	70045	20.51	14.37	6.14		
69589	17.54	11.53	6.01	ES19	ES59	70004					
69606	20.2	12.34	7.86	S1	EB1	69587	15.9	10.64	5.26	ES19	ES56
69675	14.61	9.25	5.36	S1	BP7	69590	17.82	11.21	6.61	S58	ES59
69676	19.7	11.84	7.86	S1	EB1	70049	21.57	15.08	6.5		
69863	24.43	14.91	9.52	S27	ES18	70052	26.41	16.18	10.23		
69898	19.85	14.19	5.66	S1	ES185	70053	23.81	14.52	9.28	S95	
69900	24.91	14.8	10.11	S1	ES67	70055	23.89	14.84	9.05	S96	
69909	16.63	10.88	5.75	ES69	ES69	70056	27.67	18.54	9.13		
70000	19.57	12.09	7.48	S64	ES113	70059	22.20	13.77	8.43		
70003	26.55	18.62	7.93	S34	ES147	70060	20.78	17.28	3.5		
70027	17.82	12.95	4.88			70061	22.24	14.09	8.14		
69450	26.25	16	10.25	S48	EB5	70064	20.31	15.23	5.07	S99	
69591	17.73	11.72	6.01	ES185	ES185	70065	19.8	12.75	7.04	S37	
69592	20.07	12.56	7.51	S1	ES107	70068	22.51	14.88	7.63		
69600	13.61	8.75	4.86	S1	BP30	70077	15.11	12	3.11	S100 (Stud)	(Eyelet)
69907	23.35	15.16	8.19	S50	ES113	70086	25.27	18.66	6.61	S56	ES19
69945	26.35	16.45	9.90	S19	ES84	70089	20.43	16.45	3.97	S51	
70010	22.56	14.09	8.47	BP15	ES69	70095	15.27	10.02	5.23	ES19	
69574	20.26	12.5	7.76	S36	ES7	70096	23.14	15.27	7.87	S97	
69585	22.5	13.99	8.51	BP18	ES18	70098	15.03	10.47	4.56		
69604	20.64	12.78	7.86	BP31	EB1	70105	21.81	15.94	5.86		
69622	14.73	9.62	5.11	ES10	EB1	69407	18.92	11.56	7.36	S29	ES24
69624	21.7	12.84	8.86	BP14	S1	69416	20.15	13.45	6.70	ES3	ES56
69625	14.11	9	5.11	S1	BP19	69417	18.25	11.99	6.26	ES71	ES121
69724	22.14	13.28	8.86	BP31	EB1	69420	22.81	14.68	8.13	S1	EB3
69755	20.45	12.34	8.11	S1	ES185	69462	24.11	15.01	9.10	S50	ES80
69766	17.48	10.95	6.53	S36	EB21	69586	23.5	15.62	7.88	S20	ES89
69962	21.11	15.1	6.01	S36	U Bracket	69593	20.07	12.56	7.51	S1	ES107
70013	22.95	14.88	8.07	S44	ES113	69616	16.63	10.87	5.76	ES18	ES19
70038	23.11	15.67	7.44	S22		69632	21.78	13.42	8.36	ES84	ES84
70041	21.38	14.8	6.57			69661	20.1	15.04	5.06	S36	ES137
69465	17.94	12.78	5.16	ES162	ES65	69670	14.1	9.34	4.76	S1	EB1
69594	19.42	12.41	7.01	EB1	ES34	69671	18.1	11.34	6.76	S1	ES133
69595	20.34	12.83	7.51	EB1	ES34	69674	21.2	12.84	8.36	S1	ES64
69633	20.7	12.34	8.36	S1	ES91	69677	18.45	11.34	7.11	S1	ES8
69901	16.69	10.51	6.18	S52	ES143	69689	15.63	10.37	5.26	ES85	ES85
69952	21.45	18.38	3.07	S33	ES3	69703	17.95	11.09	6.86	ES27	S12
70028	25.39	16.42	8.98			69704	10.67	7.06	3.61	S1	S12
70031	21.89	14.41	7.48			69706	13.46	9.95	3.51	ES86	ES34
70033	22.44	15.51	6.93			69709	23.7	13.84	9.86	S1	ES185
70036	23.86	14.49	9.36			69713	23.85	14.59	9.26	S17	EB1
70037	21.34	13.7	7.64								

SPECIFICATIONS BY PART NUMBER

ULTRA STRUTS (CONT'D)

CATALOG PART NO.	EXTENDED LENGTH	COLLAPSED LENGTH	STROKE	UPPER MTG CODE	LOWER MTG CODE	CATALOG PART NO.	EXTENDED LENGTH	COLLAPSED LENGTH	STROKE	UPPER MTG CODE	LOWER MTG CODE
69714	14.1	9.94	4.16	S1	BP17	69861	15.51	10.23	5.28	S39	ES28
69715	13.98	9.37	4.61	ES18	ES110	69877	20.94	14.76	6.18	S26	ES3
69723	21.12	16.31	4.81	S29	ES84	69878	20.94	14.76	6.18	S30	ES3
69725	21.6	13.09	8.51	S1	ES69	69884	16.73	10.62	6.11	EB1	EB1
69727	13.13	9.12	4.01	BP14	ES53	69891	21.61	13.1	8.51	S12	ES10
69733	17.88	12.72	5.16	BP27	ES137	69903	21.69	12.99	8.70	S27	ES18
69749	21.92	13.06	8.86	S29	ES53	69946	24.04	14.33	9.71	S25	ES6
69756	20.45	12.34	8.11	S12	BP7	69966	17.62	11.27	6.35	S33	ES3
69757	24.6	17.54	7.06	S1	ES85	69995	22.57	13.91	8.66		
69760	16.26	12.6	3.66	ES18	ES79	69996	19.1	15.04	4.06	S36	ES169
69782	15.1	10.34	4.76	ES67	ES61	69998	17.91	14.09	3.82	S67	ES92
69787	17.79	11.53	6.26	ES27	ES19	70001	22.52	13.94	8.58	BP34	ES72
69794	14.6	10.69	3.91	S36	BP14	70020	21.89	13.14	8.75	S60	ES53
69795	15.2	9.59	5.61	S12	ES110	70023	21.81	15.94	5.87		
69805	18.19	11.93	6.26	ES71	ES71	70024	23.39	19.48	3.9	S84	
69808	22.74	13.63	9.11	ES84	ES84	70032	26.18	15.31	10.87		
69811	13.6	9.69	3.91	S36	BP14	70034	22.95	17.39	5.55		
69813	24.26	14.15	10.11	S1	EB1	70078	19.68	12.12	7.55	S61	
69820	19.1	11.84	7.26	S36	ES143	69773	22.44	17.38	5.06	S33	ES69
69845	19.2	13.94	5.26	S36	ES143	69880	21.1	12.84	8.26	S1	EB1
69858	21.23	12.87	8.36	ES18	ES18	69885	17.63	11.37	6.26	ES43	ES43

ULTRA SPRING SEATS

CATALOG PART NO.	EXTENDED LENGTH	COLLAPSED LENGTH	STROKE	UPPER MTG CODE	LOWER MTG CODE	CATALOG PART NO.	EXTENDED LENGTH	COLLAPSED LENGTH	STROKE	UPPER MTG CODE	LOWER MTG CODE
G51077	18.02	12.75	5.27			G51739	21.36	16.79	4.57		
G51087	17.86	11.91	5.95			G51747	23.51	14.91	8.61		
G511054	19.48	15.15	4.33			G51760	25.17	19.37	5.8	SS6	
G511055	19.48	15.15	4.33			G51761	25.17	19.37	5.8	SS6	
G51254	21.3	14.30	7			G51802	20.83	14.09	6.74		
G51267	14.25	10.70	3.55			G51805	27.13	16.61	10.52		
G51268	24.48	16.97	7.51			G51806	15.74	11.34	4.41		
G51279	16.37	11.07	5.3			G51807	21.93	17.48	4.45		
G51477	18.14	13.36	4.78			G51815	18.07	13.46	4.61		
G51703	20.6	16.65	3.95			G51842	19.05	12.75	6.30		
G51713	22	15.69	6.31			G51859	18.5	14.29	4.21		
G51715	14.92	10.43	4.49			G51870	21.22	15.43	7.79		
G51718	16.61	11.41	5.2			G51891	17.8	13.54	4.26		
G51721	24.88	17.95	6.94			G51022	24.76	16.75	8.01		
G51725	21.12	14.62	6.5			G51063	21.31	13.05	8.26		
G51727	17.62	12.87	4.75			G51204	18.63	14.83	3.8		
G51728	13.87	9.62	4.25			G51230	16.2	10.98	5.22		
G51736	16.5	11.50	5			G51255	15.76	11.54	4.22		
G51737	17.12	12.50	4.62			G51286	15.65	10.84	4.81		
G51738	24.57	17.09	7.48			G51700	14.68	10.35	4.33		

SPECIFICATIONS BY PART NUMBER

ULTRA SPRING SEATS (CONT'D)

CATALOG PART NO.	EXTENDED LENGTH	COLLAPSED LENGTH	STROKE	UPPER MTG CODE	LOWER MTG CODE	CATALOG PART NO.	EXTENDED LENGTH	COLLAPSED LENGTH	STROKE	UPPER MTG CODE	LOWER MTG CODE
G51704	21.69	16.62	5.07			G51724	19.28	13.69	5.59		
G51714	16.79	11.99	4.8			G51774	16.73	11.88	4.85		
G51719	19.84	15.70	4.14			G51794	17.28	11.06	6.22		
G51722	18.93	16.73	2.2			G51795	18.78	12.01	6.77		
G51746	22.12	17.37	4.75	SS2		G51796	14.25	10.71	3.54		
G51756	20.37	17.75	2.62			G51804	26.18	15.83	10.35		
G51758	21.5	15.34	5.85	SS6		G51812	19.96	13.94	6.02		
G51759	23.25	15.12	8.12	SS2		G51813	23.98	19.21	4.77		
G51765	15.56	10.99	4.01			G51814	23.98	19.21	4.77		
G51766	15.56	10.99	4.01			G51827	16.61	10.67	5.94		
G51783	24.41	14.45	9.96			G51828	16.61	10.67	5.94		
G51798	15.35	11.1	4.25			G51834	19.52	14.68	4.84	S1	E2
G51803	14.41	10.12	4.29			G51838	19.02	12.72	6.3		
G51826	28.54	20.47	8.07			G51855	23.26	17.55	5.7		
G51858	15.35	11.18	4.17			G51856	21.18	15.11	6.07		
G51863	20.30	12.48	7.83			G51865	20.86	16.45	4.41		
G51874	20.43	16.41	4.01			G51878	17.67	12.91	4.76		
G51887	15.55	12.08	3.47			G51880	18.42	12	6.42		
G51039	23.41	15.28	8.14			G51888	15.55	12.08	3.47		
G51256	22.66	15.45	7.22			G511001					
G51712	21.1	14.80	6.3			G511031					
G51729	21.5	14.26	7.24			G511032					
G51757	17.37	13.12	4.25			G511040					
G51767	18.19	12.36	5.83			G511041					
G51772	26	17.37	8.63	S4		G511042					
G51799	23.03	14.65	8.38			G511061					
G51810	19.17	13.27	5.90			G511063					
G51811	19.17	13.27	5.90			G511066					
G51848	21.41	13.66	7.75			G511070					
G51850	16.1	11.06	5.04			G511072					
G51852	13.89	10.66	3.23			G511074					
G51853	16.85	12	4.84			G511004	17.12	12.24	4.88		
G51854	16.85	12	4.84			G511019					
G51861	19.21	15.15	4.05			G511020					
G51864	21.57	17.16	4.41			G511021					
G51879	15.67	10.94	4.73			G511030	24.88	15.04	9.84		ES153
G51896	18.54	14.09	4.45			G511037	23.23	15.08	8.15		ES3
G51897	18.54	14.09	4.45			G511043	16.85	12.20	4.64	S100	ES61
G51195	18.12	13.42	4.70			G511057					
G51196	14.93	9.95	4.98			G51716	14.68	10.35	4.33		
G51252	18.82	12.02	6.8			G51830	14.92	10.55	4.37		
G51253	21.3	14.30	7			G51898	16.57	12.09	4.49		
G51264	16.01	11.28	4.73			G51899	17.04	11.73	5.31		
G51723	18.93	16.73	2.2			G51900	22.83	14.92	7.91		

SPECIFICATIONS BY PART NUMBER

ULTRA SPRING SEATS (CONT'D)

CATALOG PART NO.	EXTENDED LENGTH	COLLAPSED LENGTH	STROKE	UPPER MTG CODE	LOWER MTG CODE	CATALOG PART NO.	EXTENDED LENGTH	COLLAPSED LENGTH	STROKE	UPPER MTG CODE	LOWER MTG CODE
G51901	22.4	19.32	3.07			G51976	23.22	14.72	8.5		
G51906	20.07	14.49	5.59			G51982	22.24	13.97	8.26	S101	ES60
G51907	21.34	13.74	7.6			G51983					
G51908	17.44	11.3	6.14			G51984	21.57	14.21	7.36		
G51909	18.30	12.68	5.63			G51985	21.57	14.21	7.36		
G51910	18.03	12.36	5.67			G51990	23.34	14.68	8.66		
G51911	18.86	15	3.86			G51993	24.84	15.11	9.72		
G51912	23.43	15.79	7.64			G51995					
G51913	23.43	15.79	7.64			G51101	22.83	18.07	4.76		
G51914	15.16	10.94	4.21			G51743	22	18.12	3.88	SS4	
G51915	27.56	19.32	8.23			G51006	21.01	13.00	8.01		
G51916	16.33	11.22	5.11			G51007	21.87	13.86	8.01		
G51917	17.68	12.91	4.76			G51027	20.17	12.41	7.76		
G51918	17.68	12.91	4.76			G51030	23.24	14.72	8.53		
G51919	23.31	15.79	7.52			G51031	22	14.50	7.5		
G51920	20.9	16.88	4.01			G51033	23.85	15.59	8.26		
G51921	20.9	16.88	4.01			G51034	19.31	12.41	6.91		
G51922	20.91	16.64	4.25			G51046	22.48	15.22	7.26		
G51923	20.23	14.69	5.55			G51047	20.17	12.41	7.76		
G51924	22.56	15.28	7.28			G51060	21.81	14.44	7.37		
G51925	20.9	17.71	3.18			G51078	20.79	13.69	7.1		
G51926	20.9	17.71	3.18			G51097	22.83	18.07	4.76		
G51927	19.8	15.51	4.29			G51099	22.05	18.19	3.86		
G51928	21.33	15.55	5.78			G51100	23.62	15.9	7.72		
G51930	22.28	15.27	7			G51161					
G51933	19.8	12.48	7.32			G51170	19.31	12.41	6.9		
G51934	16.37	11.57	4.8			G51173	17.27	11.00	6.27		
G51935	17	12.16	4.84			G51180	18	12.00	6		
G51936	15.39	10.78	4.6			G51183	16.1	10.33	5.77		
G51937	21.77	17.79	3.97			G51184	16.85	10.70	6.15		
G51947	24.96	19.29	5.67			G51186	19.48	12.72	6.76		
G51948	24.96	19.29	5.67			G51188	24.21	14.38	9.83		
G51949	18.27	14.49	3.78			G51189	17.81	12.18	5.63		
G51953	21.77	19.32	2.44			G51190	21.38	15.35	6.03		
G51954	21.77	19.32	2.44			G51191	21.18	15.07	6.11		
G51955	17.32	14.33	2.99			G51192	24.21	14.38	9.84		
G51960						G51193	20.81	14.09	6.72		
G51961	18.93	13.11	5.82			G51197	20.37	15.76	4.61		
G51966	21.49	14.68	6.81			G51216	23.23	15.35	7.88		
G51968	24.8	16.22	8.58			G51227	12.00	7.13	4.87		
G51969	19.33	12.51	6.81	S102	ES152	G51229	21.23	14.97	6.26		
G51971	25.47	17.60	7.87	S52	ES153	G51232	21.73	14.97	6.76		
G51972	17.00	12.00	5			G51249	24.48	16.97	7.51		
G51975	15.78	11.37	4.4			G51330	21.46	13.43	8.03		

SPECIFICATIONS BY PART NUMBER

ULTRA SPRING SEATS (CONT'D)

CATALOG PART NO.	EXTENDED LENGTH	COLLAPSED LENGTH	STROKE	UPPER MTG CODE	LOWER MTG CODE	CATALOG PART NO.	EXTENDED LENGTH	COLLAPSED LENGTH	STROKE	UPPER MTG CODE	LOWER MTG CODE
G51346						G51847	24.8	17.04	7.76		
G51424	20.23	12.97	7.26			G51849	17.95	12.36	5.59		
G51709	20.44	15.32	5.12			G51857	18.62	12.24	6.38		
G51710	23.08	16.02	7.06			G51860	19.96	16.29	3.67		
G51711	17.25	14.75	2.5			G51871	15.7	11.77	3.93		
G51720	21.05	16.14	4.91			G51875	18.11	12.32	5.79		
G51740	24.5	19	5.50	SS4		G51876	18.11	12.32	5.79		
G51742	22.12	17.37	4.75	S2		G51877	17.67	12.91	4.76		
G51744	19.75	15.5	4.25			G51881	16.57	11.65	4.92		
G51764	19.69	14.36	5.33			G51882	18.62	12.24	6.38		
G51768	16.87	12.12	4.75			G51883	19.52	12.48	7.04		
G51769	21.61	17.67	3.94			G51884	16.53	13.5	3.03		
G51770	20.37	17.75	2.62			G51885	24.44	15.39	9.05		
G51771	18.12	13.12	5			G51886	16.22	10.74	5.48		
G51773	18	13.5	4.50			G51889	19.29	12.91	6.38		
G51825	22.48	16.1	6.38			G51890	19.29	12.91	6.38		
G51829	24.88	15.75	9.13			G51892	23	15.86	7.14		
G51831	17.59	13.88	3.71	S1	E2	G51904	16.22	11.5	4.72		
G51832	22.13	17.48	4.65			G51905	23.74	17.79	5.95		
G51833	25.51	16.29	9.21			G51970	17.32	12.36	4.96		
G51835	22.08	16.45	5.63	S1	E2	G51013	22.47	14.46	8.01		
G51836	19.53	16.69	2.83			G51064					
G51837	19.21	13.39	5.83			G51165	21.26	13.44	7.82		
G51839	18.58	13.34	5.24			G51181	21.31	13.36	7.95		
G51840	18.77	12.55	6.22	S1	E2	G51182	16.13	10.33	5.8		
G51841	20.98	14.29	6.69			G51290	19.78	13.07	6.71		

ULTRA STRUTS

CATALOG PART NO.	EXTENDED LENGTH	COLLAPSED LENGTH	STROKE	UPPER MTG CODE	LOWER MTG CODE	CATALOG PART NO.	EXTENDED LENGTH	COLLAPSED LENGTH	STROKE	UPPER MTG CODE	LOWER MTG CODE
G52005	19.02	11.81	7.21			G52125	22	14.13	7.87		
G52006	19.02	11.81	7.21			G52393	20.07	13.14	6.92		
G52008	22.2	15.04	7.16			G52394	20.07	13.14	6.92		
G52009	22.2	15.04	7.16			G55551	24.1	14.50	9.6		
G52028	20.47	12.68	7.79			G55557	20	12.00	8		
G52029	20.47	13.07	7.40			G55591	16.94	10.76	6.18		
G52081	22.83	16.3	6.53			G55661	19.57	11.76	7.81		
G52082	22.83	16.3	6.53			G55662	19.57	11.76	7.81		
G52094	17.28	13.03	4.25			G55675	20.84	12.64	8.20		
G52095	17.28	13.03	4.25			G55676	20.84	12.64	8.2		
G52103	24.13	15.82	8.31			G55680	17	12.25	4.75		
G52104	24.13	15.82	8.31			G55681	22.44	12.17	10.27		
G52121	17.51	13.3	4.21			G55685	20.01	13.49	6.52		
G52122	17.51	13.3	4.21			G55693	24.59	15.59	9		

SPECIFICATIONS BY PART NUMBER

ULTRA STRUTS (CONT'D)

CATALOG PART NO.	EXTENDED LENGTH	COLLAPSED LENGTH	STROKE	UPPER MTG CODE	LOWER MTG CODE	CATALOG PART NO.	EXTENDED LENGTH	COLLAPSED LENGTH	STROKE	UPPER MTG CODE	LOWER MTG CODE
G55697	19.7	13.19	6.51			G56661	19.62	13.87	5.75		
G55698	19.92	13.14	6.78			G56671	20.5	13.62	6.87	B10	
G55786	24.75	16.50	8.25			G56672	20.5	13.61	6.87	B10	
G55802	15.31	10.37	4.94			G56684	21.12	14.37	6.75	B10	
G55803	18.92	13.23	5.69			G56707	21.6	13.77	7.84		
G55825	22.88	17.33	5.55			G56708	18.77	10.85	7.92		
G55848	20.16	11.87	8.30			G56718	18.63	11.07	7.57		
G55870	16.78	11.56	5.22			G56758	21.75	14.50	7.25	B17	
G55871	25.31	16.56	8.75			G56759	27.75	14.50	13.25		
G55877	15.24	10.55	4.7			G56772	20.8	13.38	7.42	B18	
G55892	20.19	14.09	6.9			G56773	20.94	12.87	8.07	B13	
G55893	24.41	16.46	7.95			G56774	20.94	12.87	8.07	B13	
G55894	24.41	16.46	7.95			G56802	20.75	14.12	6.63	B11	
G55896	20.2	14.1	6.10			G56805	18.75	12.75	6.00	B10	
G55901	20.41	13.65	6.76			G56806	18.75	12.75	6.00	B10	
G55909	15.32	10.38	4.95			G56807	21	14.25	6.75		
G55910	19.23	13.09	6.14			G56809	19.75	13.12	6.62		
G55912	19.32	12.31	7.02			G56810	20	13.50	6.5		
G55913	19.32	12.31	7.02			G56812	16.62	10.32	6.37		
G55914	17.65	11.48	6.17			G56817	16.59	10.9	5.69		
G55948	16.5	10.71	5.79			G56836	18.84	13.12	5.72		
G55949	23.13	16.09	7.05			G56837	18.84	13.12	5.72		
G55960	19.51	13.60	5.91			G56886	20.09	13.79	6.30		
G55974	18.01	11.14	6.88			G56888	21.38	14.49	6.89		
G55978	19.51	13.60	5.91			G56889	21.38	14.49	6.89		
G55999	16.79	10.81	5.98			G56894	20.98	14.29	6.69		
G56501	20.18	12.01	8.18			G52013	20.52	13.5	7.02		
G56502	17.22	10.54	6.68			G52014	20.52	13.5	7.02		
G56506	17.22	10.54	6.68			G52025	19.61	13.15	6.46		
G56509	16.82	10.66	6.17			G52026	22.8	14.84	7.96		
G56514	17.22	10.54	6.68			G52027	22.8	14.84	7.96		
G56516	20.22	14.02	6.2			G52032	21.54	14.13	7.41		
G56517	20.22	13.94	6.28			G52033	21.54	14.13	7.41		
G56518	15.23	8.83	6.41			G52038	20.04	13.11	6.93		
G56522	16.41	9.98	6.43			G52039	20.04	13.11	6.93		
G56537	23.39	15.00	8.39			G52131	22.71	15.74	6.97		
G56538	23.39	15.00	8.39			G55525	18.97	12.97	6.01		
G56540	19.62	13.37	6.25			G55589	20.44	12.69	7.76		
G56568	25	17.75	7.25			G55590	19.41	13.04	6.37		
G56601	25	17.75	7.25			G55663	17.34	11.26	6.09		
G56606	19.65	13.23	6.42			G55664	17.34	11.26	6.09		
G56620	18.6	12.14	6.47			G55666	16.65	10.61	6.04		
G56621	19.12	13.00	6.12			G55772	20.35	13.85	6.5		
G56622	19.12	13.00	6.12			G55774	15.24	10.55	4.7		
G56660	19.62	13.87	5.75			G55800	19.63	12.38	7.25		

SPECIFICATIONS BY PART NUMBER

ULTRA STRUTS (CONT'D)

CATALOG PART NO.	EXTENDED LENGTH	COLLAPSED LENGTH	STROKE	UPPER MTG CODE	LOWER MTG CODE	CATALOG PART NO.	EXTENDED LENGTH	COLLAPSED LENGTH	STROKE	UPPER MTG CODE	LOWER MTG CODE
G55801	17.25	10.25	7			G55657	19.56	13.27	6.3		
G55804	18.55	12.05	6.49			G55658	17.23	10.93	6.3		
G55831	23.26	15.67	7.59			G55667	16.65	10.61	6.04		
G55834	16.77	10.05	6.72			G55668	20.34	12.83	7.51		
G55856	23.37	14.26	9.11			G55669	20.34	12.83	7.51		
G55891	15.53	9.78	5.75			G55679	15.72	10.10	5.62		
G55920	16.87	11.13	5.74			G55745	20.47	13.27	7.2		
G55921	16.87	11.13	5.74			G55752	22.75	14.63	8.12		
G55970	17.63	11.90	5.73			G55817	20.25	12.56	7.7		
G55971	17.63	11.90	5.73			G55821	23.3	15.95	7.35		
G55991	20.87	14.53	6.34			G55828	19	13.00	6		
G56515	16.15	8.44	7.71			G55847	18.5	12.00	6.5		
G56539	19.62	13.37	6.25			G55879	16.51	10.28	6.23		
G56558	20.98	14.44	6.54			G56504	20.34	13.14	7.24		
G56561	23	16.37	6.62			G56508	17.52	10.66	6.87		
G56562	23	16.37	6.62			G56523	22.5	14.00	8.5		
G56581	20.74	13.59	7.15			G56551	16.6	10.42	6.18		
G56664	17.86	12.45	5.41			G56559	20.98	14.44	6.54		
G56683	21.12	14.37	6.75	B10		G56572	20.55	13.66	6.89		
G56700	17.19	10.57	6.62			G56582	20.74	13.59	7.15		
G56721	18.91	11.48	7.43			G56598	19.74	15.23	4.51		
G56722	18.91	11.48	7.43			G56615	22.62	16.00	6.62		
G56799	21.1	14.53	6.57	B17		G56616	22.62	16.00	6.62		
G56800	21.1	14.53	6.57	B17		G56618	18.75	12.87	5.88		
G56882	20.44	13.69	6.75			G56619	18.75	12.87	5.88		
G56883	20.44	13.69	6.75			G56624	25.37	18.00	7.37		
G56887	20.09	13.79	6.30			G56631	20.74	13.59	7.15		
G56903	21.92	15.19	6.74			G56632	20.74	13.59	7.15		
G52004	21.02	14.69	6.33			G56633	20.08	12.52	7.56		
G52007	21.02	14.69	6.33			G56635	16.6	10.42	6.18		
G52030	24.88	17.95	6.93			G56636	16.6	10.42	6.18		
G52031	24.88	17.95	6.93			G56642	17.3	11.14	6.16		
G52034	21.38	14.41	6.97			G56643	17.3	11.14	6.16		
G52035	21.38	14.41	6.97			G56644	19.07	12.00	7.07		
G52116	19.29	13.07	6.22			G56645	19.07	12.00	7.07		
G52117	21.69	14.76	6.93			G56673	18.89	11.48	7.41		
G52118	21.69	14.76	6.93			G56674	18.89	11.48	7.41		
G52127	23.3	15.6	7.7			G56675	20.95	12.25	8.7		
G52128	23.3	15.6	7.7			G56676	20.95	12.25	8.7		
G52138	16.96	11.02	5.94			G56677	19.87	13.37	6.5		
G52139	16.96	11.02	5.94			G56678	19.87	13.37	6.5		
G52245	20.51	13.39	7.13			G56685	21.12	14.37	6.75	B11	
G55526	17.41	10.83	6.58			G56686	21.12	14.37	6.75	B11	
G55579	20.56	16.32	4.23			G56691	22.5	14.75	7.75		
G55653	18.73	12.25	6.49			G56701	18.49	11.34	7.15		

SPECIFICATIONS BY PART NUMBER

ULTRA STRUTS (CONT'D)

CATALOG PART NO.	EXTENDED LENGTH	COLLAPSED LENGTH	STROKE	UPPER MTG CODE	LOWER MTG CODE	CATALOG PART NO.	EXTENDED LENGTH	COLLAPSED LENGTH	STROKE	UPPER MTG CODE	LOWER MTG CODE
G56705	17.63	11.28	6.36			G52194	19.09	14.29	4.8		
G56706	17.63	11.28	6.36			G55514	16.98	10.40	6.58		
G56728	20.95	12.25	8.7			G55518	22.14	13.82	8.32		
G56729	20.95	12.25	8.7			G55527	23.23	16.54	6.69		
G56730	23.72	16.95	6.77			G55586	16.32	9.67	6.65		
G56731	23.72	16.95	6.77			G55607	15.22	9.41	5.81		
G56736	23.31	16.65	6.66			G55608	15.22	9.41	5.81		
G56739	23.31	16.65	6.66			G55615	16.26	11.06	5.2		
G56778	21.37	14.37	7			G55616	20.19	13.73	6.46		
G56781	19.37	14.00	5.37			G55652	18.73	12.25	6.49		
G56784	20.25	14.25	6			G55670	15.39	9.73	5.66		
G56785	20.25	14.25	6			G55672	19.05	12.57	6.48		
G56786	13.37	8.50	4.87			G55715	19.42	13.5	5.92		
G56787	13.37	8.50	4.87			G55742	14.3	8.35	5.95		
G56795	20.62	14.75	5.87	B11		G55743	14.35	8.36	5.99		
G56796	20.67	14.21	6.46			G55771	18.99	13.42	5.58		
G56819	21.35	15.18	6.16	B12		G55773	15.84	10.03	5.81		
G56820	21.35	15.18	6.16	B12		G55787	16	10.25	5.75		
G56821	23.27	15.90	7.36			G55788	20.28	14.69	5.59		
G56822	23.27	15.90	7.36			G55805	24.5	18.00	6.5		
G56839	19.33	13.42	5.91			G55820	16	11.25	4.75		
G56884	22.34	14.9	7.44			G55832	16.61	10.61	6		
G56885	22.34	14.9	7.44			G55833	16.61	10.61	6		
G56899	21.1	14.8	6.30			G55849	15.71	9.86	5.85		
G52065	22.72	15.39	7.32			G55878	18.61	11.02	7.59		
G52096	20.7	13.42	7.28			G55881	16.65	10.35	6.3		
G52097	20.7	13.42	7.28			G55882	16.65	10.35	6.3		
G52098	20.6	13.85	6.75			G55911	16.22	9.72	6.5		
G52110	18.14	11.96	6.19			G55975	20.97	12.80	8.18		
G52111	18.14	11.96	6.19			G55976	20.23	12.12	8.11		
G52112	21.41	14	7.41			G55977	20.23	12.12	8.11		
G52113	21.41	14	7.41			G55993	21.73	15.16	6.57		
G52148	22.12	14.76	7.36			G55994	21.73	15.16	6.57		
G52150	24.68	16.69	7.99			G56524	22.25	14.00	8.25		
G52151	24.68	16.69	7.99			G56527	19.06	11.60	7.46		
G52154	19.29	12.52	6.77			G56528	19.06	11.60	7.46		
G52155	19.29	12.52	6.77			G56545	25.12	17.5	7.62		
G52156	19.84	12.59	7.25			G56546	25.12	17.5	7.62		
G52157	19.84	12.59	7.25			G56547	19.76	12.89	6.87		
G52158	23	15.94	7.06			G56548	19.76	12.89	6.87		
G52159	23	15.94	7.06			G56552	16.6	10.42	6.18		
G52160	19.68	13.15	6.53			G56586	19.25	12.87	6.37		
G52161	19.68	13.15	6.53			G56587	16	11.75	4.25		
G52193	19.09	14.29	4.8			G56591	17.5	12.12	5.37	SS2	

SPECIFICATIONS BY PART NUMBER

ULTRA STRUTS (CONT'D)

CATALOG PART NO.	EXTENDED LENGTH	COLLAPSED LENGTH	STROKE	UPPER MTG CODE	LOWER MTG CODE	CATALOG PART NO.	EXTENDED LENGTH	COLLAPSED LENGTH	STROKE	UPPER MTG CODE	LOWER MTG CODE
G56599	22.28	17.20	5.08			G52601					
G56608	17.13	12.2	4.93			G52638					
G56625	25.37	18.00	7.37			G52639					
G56634	20.08	12.52	7.56			G52123	22.01	14.84	7.17		
G56655	20.03	13.38	6.65			G52124	22.01	14.84	7.17		
G56680	21.26	15.9	5.36	B2		G52175	20.86	13.85	7		
G56681	23.3	15.26	8.04			G52176	20.86	13.85	7		
G56682	23.3	15.26	8.04			G52235	19.21	14.92	4.29		
G56687	22.56	15.98	6.58			G52236	19.21	14.92	4.29		
G56688	22.56	15.98	6.58			G52237	19.64	14.92	4.72		
G56717	17.9	10.86	7.05			G52238	19.64	14.92	4.72		
G56782	19.37	14.00	5.37			G52253	25.35	16.57	8.77		
G56790	18.5	12.87	5.62	B7		G52254	25.35	16.57	8.77		
G56791	20.25	16.12	4.13			G52255	20.03	13.22	6.81		
G56797	23.82	16.54	7.28			G52256	20.03	13.22	6.81		
G56798	23.54	16.34	7.2			G52257	23.5	15.59	7.91		
G56801	17.25	11.75	5.5	B2		G52258	23.5	15.59	7.91		
G56841	20.51	13.63	6.88			G52260	25.31	17.28	8.02		
G56890	20.47	13.31	7.16			G52261	25.31	17.28	8.02		
G56891	20.47	13.31	7.16			G52262	21.61	13.7	7.91		
G52420						G52263	21.61	13.7	7.91		
G52421						G52264	19.48	12.72	6.77		
G52422						G52265	19.48	12.72	6.77		
G52423						G52268	21.5	14.72	6.77		
G52428						G52269	21.5	14.72	6.77		
G52429						G52270	22.05	16.34	5.71		
G52459						G52271	22.05	16.34	5.71		
G52460						G52272	20.23	14.68	5.55		
G52491						G52273	20.23	14.68	5.55		
G52492						G52274	19.72	13.19	6.54		
G52502						G52275	19.72	13.19	6.54		
G52503						G52276	18.30	11.3	7.01		
G52507						G52278	19.45	13.5	5.94		
G52508						G52279	19.45	13.5	5.94		
G52519						G52280	19.48	12.87	6.61		
G52520						G52281	19.48	12.87	6.61		
G52585						G52282	20.83	13.86	6.97		
G52586						G52283	20.83	13.86	6.97		
G52587						G52293	24.4	15.59	8.81		
G52588						G52294	24.4	15.59	8.81		
G52589						G52295	20.43	15.78	4.63		
G52594						G52297	16.45	11.14	5.31		
G52595						G52298	16.45	11.14	5.31		
G52600						G52299	20.62	15.11	5.51		

SPECIFICATIONS BY PART NUMBER

ULTRA STRUTS (CONT'D)

CATALOG PART NO.	EXTENDED LENGTH	COLLAPSED LENGTH	STROKE	UPPER MTG CODE	LOWER MTG CODE	CATALOG PART NO.	EXTENDED LENGTH	COLLAPSED LENGTH	STROKE	UPPER MTG CODE	LOWER MTG CODE
G52300	20.62	15.11	5.51			G52432	19.17	15.08	4.09		
G52301	20.23	14.68	5.55			G52433	19.17	15.08	4.09		
G52314	20.98	16.34	4.65			G52435	19.48	13.5	5.98		
G52329	20.74	13.5	7.24			G52436	19.48	13.5	5.98		
G52330	20.74	13.5	7.24			G52437					
G52331	19.48	12.71	6.77			G52438					
G52332	19.48	12.71	6.77			G52439					
G52333	22.44	13.78	8.66			G52440					
G52334	22.44	13.78	8.66			G52447	22.44	16.02	6.41		
G52335	21.46	14.06	7.4			G52448	22.44	16.02	6.41		
G52336	21.46	14.06	7.4			G52449					
G52346	18.86	13.31	5.55			G52450					
G52347	18.86	13.31	5.55			G52453	21.22	14.60	6.61		
G52348	26.37	21.53	4.84			G52454	21.22	14.60	6.61		
G52349	26.37	21.53	4.84			G52485					
G52351	24.13	16.69	7.44			G52486					
G52352	24.13	16.69	7.44			G52494	20.87	15.16	5.71		
G52353	20.07	13.93	6.14			G52495	20.87	15.16	5.71		
G52354	20.07	13.93	6.14			G52524	21.29	16.41	4.88		
G52355	20.43	15.86	4.56			G52525	21.29	16.41	4.88		
G52356	20.43	15.86	4.56			G52591	20.11	13.66	6.45		
G52360	24.6	17.04	7.55			G52592	20.11	13.66	6.45		
G52361	24.6	17.04	7.55			G56640	22.12	14.37	7.75		
G52362	21.57	14.21	7.36			G56641	22.12	14.37	7.75		
G52363	21.57	14.21	7.36			G56742					
G52374	21.25	15	6.25			G52000	21.97	15.35	6.62		
G52375	21.25	15	6.25			G52001	21.97	15.35	6.62		
G52382	17.28	13.3	3.97			G52002	21.97	15.39	6.58		
G52383	17.28	13.3	3.97			G52003	21.97	15.39	6.58		
G52384						G52015	18.86	13.35	5.51		
G52385	19.21	11.85	7.36			G52016	18.86	13.35	5.51		
G52386						G52017	21.77	13.9	7.87		
G52387						G52018	21.77	13.9	7.87		
G52389						G52019	19.17	12.64	6.53		
G52390						G52020	19.17	12.64	6.53		
G52395	15.78	11.37	4.40			G52021	21.42	13.66	7.76		
G52396	19.48	12.87	6.61			G52022	21.42	13.66	7.76		
G52398	18.62	11.29	7.32			G52023	19.84	13.54	6.30		
G52399	18.62	11.29	7.32			G52024	19.84	13.54	6.30		
G52400	19.56	12.67	6.88			G52036	19.37	15.04	4.33		
G52401	19.56	12.67	6.88			G52037	19.37	15.04	4.33		
G52406						G52055	18.82	12.76	6.06		
G52425	19.68	14.44	5.23			G52056	18.82	12.76	6.06		
G52426	19.68	14.44				G52057	18.11	13.31	4.8		

SPECIFICATIONS BY PART NUMBER

ULTRA STRUTS (CONT'D)

CATALOG PART NO.	EXTENDED LENGTH	COLLAPSED LENGTH	STROKE	UPPER MTG CODE	LOWER MTG CODE	CATALOG PART NO.	EXTENDED LENGTH	COLLAPSED LENGTH	STROKE	UPPER MTG CODE	LOWER MTG CODE
G52058	18.11	13.31	4.8			G52163	22.2	14.13	8.07		
G52061	21.49	16.32	5.17			G52164	16.25	10.78	5.47		
G52062	21.49	16.32	5.17			G52165	16.25	10.78	5.47		
G52063	18.43	12.52	5.91			G52166	21.22	13.81	7.41		
G52064	21.88	14.13	7.75			G52167	21.22	13.81	7.41		
G52066	20.7	13.62	7.08			G52168	21.61	14.17	7.44		
G52067	20.24	15.39	4.85			G52169	21.61	14.17	7.44		
G52068	20.24	15.39	4.85			G52170	20.9	16.02	4.88		
G52069	20.39	15.12	5.28			G52171	20.9	16.02	4.88		
G52070	20.39	15.12	5.28			G52172	20.66	16.32	4.33		
G52073	23.81	15.70	8.11			G52173	21.61	15.23	6.38		
G52074	23.81	15.70	8.11			G52174	21.61	15.23	6.38		
G52075	19.32	12.56	6.77			G52178	25	16.57	8.43		
G52076	19.32	12.56	6.77			G52179	25	16.57	8.43		
G52077	19.07	13.16	5.91			G52180	21.85	15.11	6.74		
G52078	19.07	13.16	5.91			G52181	21.85	15.11	6.74		
G52079	18.54	12.44	6.10			G52182	25.35	16.18	9.17		
G52080	18.54	12.44	6.10			G52183	25.35	16.18	9.17		
G52083	20.66	14.56	6.61			G52184	22.75	14.96	7.79		
G52084	20.66	14.56	6.61			G52185	22.75	14.96	7.79		
G52085	23.81	16.33	7.48			G52187	23.26	14.8	8.46		
G52086	23.81	16.33	7.48			G52188	23.26	14.8	8.46		
G52087	20.68	14.63	6.06			G52199	19.44	14.76	4.68		
G52088	24.56	14.63	9.94			G52200	19.44	14.76	4.68		
G52089	23.81	16.33	7.48			G52201	22.51	15.94	6.57		
G52090	23.81	16.33	7.48			G52202	22.51	15.94	6.57		
G52105	23.3	16.57	6.73			G52203	26.33	17.95	8.38		
G52106	23.3	16.57	6.73			G52204	26.33	17.95	8.38		
G52107	23.22	16.18	7.04			G52205	20.47	17.67	2.8		
G52108	23.22	16.18	7.04			G52206	19.21	13.18	6.03		
G52129	17.82	11.49	6.34			G52209	19.21	13.18	6.03		
G52130	17.82	11.49	6.34			G52210	25.7	17	8.69		
G52136	17.63	11.57	6.06			G52227	19.84	13.93	5.91		
G52137	17.63	11.57	6.06			G52228	19.84	13.93	5.91		
G52140	24.13	16.97	7.16			G52244	23.15	15.82	7.33		
G52141	24.13	16.97	7.16			G52246	20.51	13.39	7.13		
G52142	18.38	14.05	4.33			G52247	20.78	13.66	7.12		
G52143	18.38	14.05	4.33			G52248	20.78	13.66	7.12		
G52144	20.35	15.39	4.96			G52249	23.03	16.85	6.18		
G52145	20.35	15.39	4.96			G52250	23.03	16.85	6.18		
G52149	22.12	14.76	7.36			G55505	16.98	10.40	6.58		
G52152	21.77	13.93	7.84			G55507	20.37	14.08	6.29		
G52153	21.77	13.93	7.84			G55509	19.36	13.35	6.01		
G52162	22.2	14.13	8.07			G55510	20.67	13.55	7.12		

SPECIFICATIONS BY PART NUMBER

ULTRA STRUTS (CONT'D)

CATALOG PART NO.	EXTENDED LENGTH	COLLAPSED LENGTH	STROKE	UPPER MTG CODE	LOWER MTG CODE	CATALOG PART NO.	EXTENDED LENGTH	COLLAPSED LENGTH	STROKE	UPPER MTG CODE	LOWER MTG CODE
G55511	17.89	11.85	6.05			G55727	17.87	10.23	7.63		
G55512	16.52	9.76	6.76			G55728	19.12	13.38	5.74		
G55515	17.45	11.24	6.22			G55729	22.78	14.16	8.62		
G55516	20.39	13.41	6.99			G55731	18.21	10.38	7.83		
G55521	17.37	11.06	6.31			G55732	18.8	12.97	5.83		
G55529	20.03	12.50	7.53			G55733	21.61	13.82	7.79		
G55531	16.66	10.10	6.56			G55746	20.31	11.56	8.75		
G55534	16.66	10.23	6.43			G55749	15.3	9.48	5.82		
G55539	18.02	11.95	6.07			G55757	25.15	14.81	8.25		
G55542	14.7	8.27	6.44			G55763	15.56	9.88	5.68		
G55544	16.66	10.26	6.4			G55766	18.97	12.70	6.27		
G55546	17.25	11.17	6.08			G55769	24.35	15.03	9.32		
G55561	16.38	9.84	6.54			G55770	15.65	8.92	6.73		
G55580	20	12.50	7.5			G55776	27.1	16.30	10.8		
G55587	15.93	10.07	5.86			G55780	17.43	11.09	6.34		
G55588	20.8	13.05	7.75			G55781	16	10.50	5.5		
G55592	15.96	9.54	6.42			G55782	18.89	13.02	5.87		
G55600	16.09	9.60	6.49			G55784	21.25	14.00	7.25		
G55601	20	12.50	7.5			G55785	21.25	14.00	7.25		
G55602	16.68	9.69	6.99			G55795	18.25	11.25	7		
G55603	22.49	14.15	8.34			G55797	17.9	11.00	6.9		
G55605	15.93	10.03	5.9			G55818	14.41	10.71	3.7		
G55606	19.95	12.47	7.48			G55819	18	13.40	4.6		
G55609	16.34	10.65	5.69			G55850	15.71	9.86	5.85		
G55610	16.17	10.90	5.27			G55857	18.14	11.57	6.57		
G55611	16.17	10.80	5.37			G55858	18.14	11.57	6.57		
G55665	24.78	16.33	8.45			G55859	21.52	12.02	9.5		
G55671	15.39	9.73	5.66			G55860	21.52	12.02	9.5		
G55673	16.82	11.05	5.77			G55865	21.46	12.96	6.08		
G55692	19.09	12.55	6.54			G55866	21.7	15.63	6.08		
G55704	19.26	13.97	5.29			G55867	22.96	14.95	8.01		
G55705	19.01	12.00	7.01			G55868	22.96	14.95	8.01		
G55706	18.53	12.72	5.81			G55883	20.47	11.81	8.66		
G55707	20.11	14.24	5.87			G55884	20.47	11.81	8.66		
G55708	20.54	14.00	6.54			G55890	19.33	11.52	7.81		
G55710	16.67	9.7	6.97			G55903	13.88	7.84	6.04		
G55712	20.52	14.00	6.52			G55904	16.61	10.47	6.14		
G55713	17.79	11.43	6.36			G55925	20.63	14.21	6.42		
G55714	20.5	14.00	6.5			G55926	20.63	14.21	6.42		
G55719	18.2	11.36	6.84			G55927	21.38	12.82	8.56		
G55723	13.84	8.52	5.32			G55929	22.99	15.12	7.87		
G55724	17.46	12.41	5.05			G55930	22.99	15.12	7.87		
G55725	16.58	10.7	5.88			G55933	21.75	14.00	8.47		
G55726	18.06	13.19	4.87			G55934	22.48	14.00	8.48		

SPECIFICATIONS BY PART NUMBER

ULTRA STRUTS (CONT'D)

CATALOG PART NO.	EXTENDED LENGTH	COLLAPSED LENGTH	STROKE	UPPER MTG CODE	LOWER MTG CODE	CATALOG PART NO.	EXTENDED LENGTH	COLLAPSED LENGTH	STROKE	UPPER MTG CODE	LOWER MTG CODE
G55945	16.20	10.36	5.84			G56592	20.75	15.75	5	SS2	
G55951	16.26	11.53	4.74			G56593	25.25	17.37	7.87		
G55952	25.06	16.11	8.95			G56594	20.03	15.23	4.8		
G55958	16.26	11.53	4.74			G56595	20.03	15.23	4.81		
G55989	18.49	11.34	7.15			G56596	18.25	13.50	4.75	SS2	
G55990	17.93	11.32	6.61			G56597	14.5	9.87	4.62		
G55992	16.99	10.40	6.59			G56600	23.81	16.33	7.48	S1	E2
G56503	20.01	14.25	5.76			G56602	24.06	16.93	7.13		
G56512	20.5	13.75	6.75			G56603	24.06	16.93	7.13		
G56513	20.5	13.75	6.75			G56604	20.71	15.98	4.73		
G56520	18.95	12.56	6.39			G56605	20.71	15.98	4.73		
G56525	16.91	10.48	6.43			G56607	16.14	11.81	4.33		
G56526	16.91	10.48	6.43			G56611	19.25	12.97	6.28		
G56529	16.9	10.55	6.35			G56612	20.39	14.21	6.18		
G56530	16.9	10.55	6.35			G56626	19.12	13	6.12		
G56531	18.37	12.62	5.75			G56627	19.12	13	6.12		
G56532	18.37	12.62	5.75			G56628	21.5	13.62	7.87	B2	
G56533	21.87	14.12	7.75			G56629	21.5	13.62	7.87	B2	
G56534	21.87	14.12	7.75			G56637	22.12	14.12	8		
G56535	20.2	12.83	7.37			G56667	20.81	13.23	7.58		
G56536	23.39	15.00	8.39			G56668	20.81	13.23	7.58		
G56541	20.59	12.48	8.11			G56669	17.65	10.57	7.09		
G56542	20.59	12.48	8.11			G56670	17.65	10.57	7.09		
G56543	21.55	15.18	6.38			G56679	21.26	15.9	5.36	B2	
G56544	21.55	15.18	6.38			G56689	19.12	13.12	6		
G56553	22.58	14.4	8.18			G56690	19.12	13.12	6		
G56554	22.58	14.4	8.18			G56703	17.90	10.85	7.05		
G56555	20.77	14.25	6.53			G56704	17.73	11.07	6.66		
G56556	20.77	14.25	6.53			G56713	18.01	10.76	7.25		
G56557	13.12	10.37	2.75			G56714	18.53	10.62	7.91		
G56565	16.77	11.81	4.96			G56715	17.84	9.98	7.87		
G56566	22.68	15.31	7.37			G56716	17.43	10.89	6.54		
G56569	19.12	12.25	6.87			G56719	20.04	13.26	6.78		
G56570	19.12	12.25	6.87			G56720	17.63	11.28	6.36		
G56571	22.12	14.12	8			G56723	17.63	11.28	6.36		
G56573	19.87	13.50	6.37			G56724	17.63	11.28	6.36		
G56574	23.5	16.00	7.5			G56732	22.91	15.41	7.50		
G56575	23.5	16.00	7.5			G56733	22.91	15.41	7.50		
G56576	19.87	13.50	6.37			G56734	24.31	17.32	6.99		
G56577						G56735	24.31	17.32	6.99		
G56579	25.5	17.12	8.37			G56750	18.74	12.76	5.98		
G56585	19.25	12.87	6.37			G56751	18.74	12.76	5.98		
G56588	25.37	18.00	7.37			G56760	21.5	17.00	4.5		
G56589	25.37	18.00	7.37			G56761	21.5	17.00	4.5		

SPECIFICATIONS BY PART NUMBER

ULTRA STRUTS (CONT'D)

CATALOG PART NO.	EXTENDED LENGTH	COLLAPSED LENGTH	STROKE	UPPER MTG CODE	LOWER MTG CODE
G56762	20.5	14.00	6.5	B9	
G56763	23.25	15.75	7.5		
G56764	23.25	15.75	7.5		
G56765	19.87	14.25	5.62		
G56766	19.87	14.25	5.62		
G56767	21.75	14.37	7.37	B9	
G56768	21.75	14.37	7.37	B9	
G56769	21.75	14.50	7.25		
G56770	22.25	17.12	5.12		
G56771	22.25	17.12	5.12		
G56775	16.98	9.9	7.08		
G56776	16.98	9.9	7.08		
G56792	19.5	16.12	3.38		
G56793	19.13	13	6.13		
G56794	19.13	13	6.13		
G56803	21.43	14.98	6.45	B16	
G56804					
G56813	21.73	15.75	5.98		
G56814	21.73	15.75	5.98		
G56838	21.06	17.99	3.07		
G56840	20.51	13.63	6.88		

CATALOG PART NO.	EXTENDED LENGTH	COLLAPSED LENGTH	STROKE	UPPER MTG CODE	LOWER MTG CODE
G56842	19.47	13.41	6.06		
G56843	19.47	13.41	6.06		
G56892	17.87	12.24	5.63		
G56893	17.87	12.24	5.63		
G55533	20.94	13.65	7.29		
G55584	17.87	11.05	6.83		
G55593	17.7	12.05	5.65		
G55594	17.7	12.05	5.65		
G55716	19.38	12.38	7		
G55722	18.53	10.71	7.82		
G55730	15.65	8.92	6.73		
G55737	20.68	13.15	7.53		
G55738	20.68	13.15	7.53		
G55796	24.75	16.50	8.25		
G55923	20.75	13.74	7.01		
G55924	20.75	13.74	7.01		
G55928	21.38	12.82	8.56		
G55931	22.47	14.00	8.47		
G55932	18.16	11.62	6.54		
G56580	25.5	17.12	8.37		

ULTRA TRUCK SHOCK

CATALOG PART NO.	EXTENDED LENGTH	COLLAPSED LENGTH	STROKE	UPPER MTG CODE	LOWER MTG CODE
G63355	14.98	9.95	5.03	EB1	ES24
G63375	14.14	9.11	5.03	S12	BP7
G63403	24.58	14.8	9.78	ES26	ES26
G63414	15.09	10.06	5.03	S36	ES41
G63421	13.7	8.92	4.78	S1	BP30
G63422	24.01	14.48	9.53	BP14	ES34
G63423	16.76	10.73	6.03	ES26	ES26
G63424	20.45	12.67	7.78	S1	BP7
G63488	26.61	16.33	10.28	BP14	ES34
G63489	14.42	9.64	4.78	S29	BP11
G63492	22.58	13.8	8.78	EB1	EB1
G63494	22.39	13.86	8.53	EB19	EB19
G63609	16.5	10.97	5.53	ES126	ES128
G63622	15.32	10.29	5.03	S36	EB1
G63623	22.57	14.29	8.28	S36	ES185
G63661	13.8	9.52	4.28	S38	ES34
G63662	24.58	15.05	9.53	ES34	ES34
G63675	26.86	16.08	10.78	ES34	ES34
G63678	18.09	13.56	4.53	S36	BP7
G63679	25.01	14.98	10.03	BP14	ES185
G63690	18.01	11.48	6.53	ES18	ES18

CATALOG PART NO.	EXTENDED LENGTH	COLLAPSED LENGTH	STROKE	UPPER MTG CODE	LOWER MTG CODE
G63714	15.39	9.86	5.53	S62	BP7
G63715	28.55	16.52	12.03	S12	ES171
G63716	16.39	9.86	6.53	S62	ES26
G63726	21.05	12.77	8.28	S12	EB19
G63772	13.73	9.45	4.28	S36	BP10
G63776	20.76	12.98	7.78	ES185	ES185
G63778	24.55	14.52	10.03	S12	ES171
G63783	14.59	10.21	4.38	S12	BP11
G63803	15.36	10.33	5.03	S12	U Bracket
G63809	22.98	13.95	9.03	EB1	ES185
G63810	31.6	18.57	13.03	EB1	ES185
G63813	12.23	8.45	3.78	S47	ES64
G63815	21.95	13.17	8.78	S47	ES64
G63817	15.8	11.02	4.78	S12	ES60
G63818	16.51	10.98	5.53	ES126	ES128
G63829	22.52	13.74	8.78	ES88	ES65
G63842	23.33	14.8	8.53	ES18	ES126
G63844	22.52	13.74	8.78	ES87	ES19
G63847	20.45	12.67	7.78	S1	BP7
G63848	15.87	10.59	5.28	S38	ES34
G63866	22.81	14.12	8.69	ES34	ES34

SPECIFICATIONS BY PART NUMBER

ULTRA TRUCK SHOCK (CONT'D)

CATALOG PART NO.	EXTENDED LENGTH	COLLAPSED LENGTH	STROKE	UPPER MTG CODE	LOWER MTG CODE	CATALOG PART NO.	EXTENDED LENGTH	COLLAPSED LENGTH	STROKE	UPPER MTG CODE	LOWER MTG CODE
G63867	27.31	16.37	10.94	ES82	ES82	G63547	13.61	9.08	4.53	S1	ES113
G63870	24.89	15.2	9.69	ES82	ES82	G63548	21.11	13.08	8.03	S12	EB19
G63872	21.65	13.29	8.36	ES128	ES128	G63610	21.95	13.17	8.78	S47	EB1
G63879	23	14.31	8.69	BP10	ES34	G63611	14.95	9.67	5.28	S1	ES64
G63884	14.72	9.78	4.94	S47	EB13	G63614	15.09	10.06	5.03	S36	EB1
G63886	20.8	13.36	7.44	S38	ES34	G63616	23.78	14.25	9.53	S38	EB19
G63892	23.97	15.28	8.69	ES19	ES87	G63624	20.17	12.64	7.53	S36	ES185
G63894	12.82	8.88	3.94	S11	BP9	G63638	24.33	14.8	9.53	BP14	ES34
G63895	14.12	9.68	4.44	S11	BP9	G63676	15.48	10.45	5.03	ES69	ES69
G63897	23.87	14.68	9.19	BP14	ES34	G63683	21.14	13.36	7.78	EB5	ES24
G63905	14.7	9.34	5.36	S1	ES76	G63721	20.21	12.43	7.78	S12	BP11
G63909	14.11	9	5.11	S1	ES64	G63782	13.7	9.09	4.61	S1	ES118
G63958	13.8	9.13	4.67	S29	BP13	G63860	24.33	14.39	9.94	S1	EB1
G63959	24.78	15.84	8.94	ES34	ES34	G63883	22.82	14.38	8.44	ES34	ES13
G64003	16.84	11.28	5.56	ES69	ES69	G63885	22.24	13.56	8.68	S59	ES36
G64016	15.91	11.22	4.69	ES19	ES17	G63890	23.97	15.28	8.69	ES87	ES87
G63349	23.33	14.3	9.03	EB1	ES34	G63891	23.97	15.28	8.69	ES87	ES87
G63406	22.98	13.95	9.03	EB1	ES185	G63903	14.7	9.34	5.36	S1	BP14
G63425	20.01	12.48	7.53	BP20	EB1	G63904	14.95	9.95	5.00	S1	ES64
G63454	22.79	14.01	8.78	ES141	ES141	G63929	14.72	9.71	5.01	S36	EB1
G63673	22.3	13.77	8.53	S38	ES34	G63961	26.51	16.12	10.39	ES34	ES34
G63674	23.39	14.36	9.03	S38	ES34	G63962	26.05	15.87	10.18	ES34	ES34
G63689	19.08	12.05	7.03	EB1	EB1	G64006	22.75	13.81	8.94	S1	ES81
G63717	22.98	13.95	9.03	ES41	ES41	G64026	16.26	11.57	4.69	ES73	ES73
G63722	19.49	12.21	7.28	BP20	ES24	G64027	13.62	8.74	4.88	S47	ES118
G63773	22.98	13.95	9.03	EB1	ES185	G64028	20.75	13.19	7.56	EB16	ES113
G63828	23.16	15.13	8.03	S21	EB20	G64033	14.72	10.36	4.36	ES51	ES51
G63832	17.16	11.38	5.78	S21	ES153	G64040	15.9	11.1	4.8	ES42	ES50
G63845	24.58	14.8	9.78	ES87	ES19	G64042	14.92	10.55	4.37	ES18	ES18
G63862	25.07	14.94	10.13	S1	ES67	G64079	29.37	17.32	12.05	ES83	ES83
G63888	31.36	18.67	12.69	EB1	ES41	G63347	18.08	11.55	6.53	ES31	ES35
G63896	22.36	13.92	8.44	BP14	ES34	G63357	14.98	9.95	5.03	ES24	ES24
G63907	20.23	12.37	7.86	EB1	EB1	G63366	23.26	14.23	9.03	ES34	ES34
G63915	13.2	8.59	4.61	S1	BP7	G63405	20.01	12.48	7.53	EB1	EB1
G63937	14.7	9.34	5.36	S1	BP19	G63413	20.76	12.98	7.78	ES27	ES27
G64008	21.79	13.6	8.19	S57	ES26	G63438	29.33	17.3	12.03	EB1	ES34
G64012	24.11	15.17	8.94	ES88	ES69	G63461	25.51	15.23	10.28	EB1	ES41
G64015	21.32	13.63	7.69	ES45	ES128	G63479	13.95	9.17	4.78	S1	ES113
G63173	21.86	13.58	8.28	EB1	EB1	G63525	22.98	13.95	9.03	EB1	ES185
G63299	18.08	11.55	6.53	EB1	EB1	G63620	19.55	12.27	7.28	EB1	S17
G63359	13.7	8.92	4.78	S1	BP13	G63712	22.48	13.7	8.78	ES110	ES19
G63409	21.48	13.2	8.28	EB1	ES185	G63720	21.39	12.86	8.53	S36	ES22
G63410	18.55	11.77	6.78	S12	EB1	G63775	27.08	16.05	11.03	EB1	ES185
G63455	22.98	13.95	9.03	ES41	ES41	G63808	28.86	17.08	11.78	EB1	ES185

SPECIFICATIONS BY PART NUMBER

ULTRA TRUCK SHOCK (CONT'D)

CATALOG PART NO.	EXTENDED LENGTH	COLLAPSED LENGTH	STROKE	UPPER MTG CODE	LOWER MTG CODE	CATALOG PART NO.	EXTENDED LENGTH	COLLAPSED LENGTH	STROKE	UPPER MTG CODE	LOWER MTG CODE
G63864	15	10.56	4.44	ES67	ES61	G63398	20.42	12.14	8.28	S1	S1
G63873	15.75	10.56	5.19	ES82	ES82	G63404	17.05	11.02	6.03	S1	ES64
G63875	17.67	11.73	5.94	ES13	ES13	G63411	18.58	11.8	6.78	ES31	ES26
G63878	24.16	14.97	9.19	ES34	ES13	G63416	18.55	11.77	6.78	S12	ES185
G63882	21	13.31	7.69	BP10	ES34	G63418	13.95	9.17	4.78	S1	BP11
G63965	24.14	15.2	8.94	BP14	ES34	G63419	24.08	14.55	9.53	EB1	EB1
G63967	22.62	14.43	8.19	BP18	ES26	G63420	27.08	16.05	11.03	EB1	ES106
G64001	14.67	11.47	3.20	S11	U Bracket	G63426	18.01	11.48	6.53	ES18	ES18
G64002	20.15	13.96	6.19	ES83	ES83	G63427	22.98	13.95	9.03	EB1	ES106
G64007	22.75	13.81	8.94	S1	ES81	G63432	21.11	12.83	8.28	S1	EB19
G64010	26.94	16	10.94	EB1	ES83	G63434	22.68	13.9	8.78	EB19	S32
G64031	21.19	13.5	7.69	ES34	EB1	G63437	23.33	14.05	9.28	ES31	ES24
G64032	18.7	12.09	6.61	ES49	ES49	G63439	29.76	17.23	12.53	EB1	ES185
G64047	25.03	15	10.03	ES		G63440	26.33	15.55	10.78	EB1	EB1
G64050	19.55	12.91	6.65	ES30	ES137	G63441	26.33	15.55	10.78	EB1	ES25
G64143						G63443	23.33	13.95	9.38	EB1	EB1
G64144						G63444	23.3	14.02	9.28	S1	ES64
G64157						G63445	23.09	14.06	9.03	S36	ES185
G64063	19.17	13.26	5.9			G63446	23.3	14.02	9.28	S12	EB1
G64071	18.66	12.12	6.53			G63447	30.18	17.65	12.53	S12	ES25
G64074	23.74	17.08	6.65	S98		G63456	26.85	16.07	10.78	EB1	ES185
G64080	21.57	17.72	3.85	ES69	ES33	G63457	13.7	8.92	4.78	S1	BP4
G64087	22.63	13.78	8.85	S29		G63460	23.16	14.13	9.03	BP13	ES27
G64101	23.81	15.7	8.11	ES35		G63484	20.05	12.52	7.53	S8	EB1
G64105	19.68	12.04	7.63	S47		G63490	19.08	12.05	7.03	EB1	ES25
G64107						G63491	19.05	11.77	7.28	EB1	S1
G64111	26.54	15.71	10.83	S57	ES123	G63495	14.95	9.67	5.28	S1	ES64
G64121	25.35	16.17	9.18	ES34	ES34	G63499	25.58	15.3	10.28	BP13	ES26
G64140	22.40	14.02	8.39	ES45	ES45	G63500	15.09	10.06	5.03	S36	ES25
G64146	18.34	11.77	5.78	ES69		G63502	18.51	11.98	6.53	ES25	ES141
G63183	20.79	13.01	7.78	EB4	EB4	G63506	21.4	12.64	8.76	S32	S32
G63187	22.92	13.39	9.53	S1	S1	G63510	21.29	13.26	8.03	EB19	EB19
G63306	19.85	12.57	7.28	ES24	ES24	G63511	22.45	13.42	9.03	S1	ES25
G63350	18.82	11.79	7.03	S1	ES25	G63524	27.08	16.05	11.03	EB1	ES185
G63353	24.74	14.96	9.78	ES27	EB4	G63603	16.12	10.59	5.53	S36	ES185
G63360	15.7	9.92	5.78	S1	BP13	G63604	19.74	12.46	7.28	EB1	ES142
G63371	21.98	13.45	8.53	ES24	ES24	G63605	24.24	14.71	9.53	EB19	ES27
G63377	20.08	12.55	7.53	EB1	ES25	G63606	21.29	13.51	7.78	ES152	ES153
G63386	16.11	10.58	5.53	S36	ES25	G63607	25.58	15.3	10.28	BP14	ES185
G63387	23.32	14.04	9.28	S1	ES25	G63608	14.56	9.78	4.78	S36	EB1
G63389	28.74	16.96	11.78	ES27	EB4	G63612	14.45	9.67	4.78	S1	ES64
G63394	16.01	10.48	5.53	EB1	ES24	G63615	23.66	13.88	9.78	S38	S38
G63396	16.55	10.77	5.78	S12	ES25	G63617	27.58	16.3	11.28	ES83	EB1

SPECIFICATIONS BY PART NUMBER

ULTRA TRUCK SHOCK (CONT'D)

CATALOG PART NO.	EXTENDED LENGTH	COLLAPSED LENGTH	STROKE	UPPER MTG CODE	LOWER MTG CODE	CATALOG PART NO.	EXTENDED LENGTH	COLLAPSED LENGTH	STROKE	UPPER MTG CODE	LOWER MTG CODE
G63621	16.46	10.93	5.53	S12	BP7	G63918	21.25	13.56	7.69	ES34	ES141
G63625	22.56	13.78	8.78	EB1	ES24	G63919	21.25	13.56	7.69	ES58	ES153
G63626	21.14	13.36	7.78	EB5	ES24	G63928	22.73	13.87	8.86	EB1	EB1
G63635	14.45	9.42	5.03	S1	ES69	G63949	17.73	11.12	6.61	EB1	EB1
G63639	24.16	14.63	9.53	EB19	ES69	G63950	14.2	9.09	5.11	S1	BP7
G63640	23.89	15.11	8.78	ES152	ES153	G63963	24.75	15.06	9.69	EB1	ES185
G63660	25.08	15.05	10.03	EB1	EB1	G63964	25.48	15.53	9.95	EB1	ES185
G63671	22.48	13.7	8.78	ES26	ES26	G63966	22.45	14.5	7.95	BP18	ES26
G63692	27.58	16.3	11.28	EB1	EB1	G63969	20.75	13.31	7.44	S62	ES34
G63694	22.18	13.4	8.78	S38	EB20	G63970	27.58	17.14	10.44	ES34	ES34
G63707	15.89	10.11	5.78	S12	ES64	G63971	27.58	17.14	10.44	ES34	ES34
G63708	19.74	12.46	7.28	ES48	EB19	G64000	27.36	17.68	9.68	ES34	ES34
G63710	18.96	11.93	7.03	S1	ES153	G64004	19.07	12.13	6.94	S1	ES81
G63781	18.45	11.93	6.52	S1	ES113	G64005	19.75	12.31	7.44	S1	ES81
G63798	15.98	10.2	5.78	S1	EB1	G64009	23.29	14.25	9.04	S38	ES34
G63799	18.55	11.77	6.78	S1	ES185	G64011	23.36	14.21	9.15	S62	ES87
G63811	25.51	15.23	10.28	EB1	ES41	G64013	26.52	16.33	10.19	ES34	ES34
G63812	22.56	13.78	8.78	ES86	ES36	G64014	22.75	14.56	8.19	ES47	ES45
G63837	28.23	17.95	10.28	BP8	ES41	G64029	21.73	13.54	8.19	S38	ES36
G63869	20.26	12.82	7.44	ES41	ES41	G64030	22.56	13.86	8.70	S38	ES36
G63877	16.93	11.24	5.69	ES69	ES69	G64036	22.67	13.66	9.01	S45	ES51
G63880	22.5	14.06	8.44	BP18	ES18	G64037	26.37	15.47	10.9	S55	ES147
G63881	14.71	9.49	5.22	S1	ES25	G64038	24.48	15.07	9.41	S63	ES69
G63887	29.71	17.77	11.94	EB1	ES41	G64043	14.09	9.68	4.41	S61	
G63889	20.44	12.75	7.69	S1	ES81	G64044	25.98	16.22	9.76	ES49	ES49
G63893	15.07	10.44	4.63	S11	U Bracket	G64046	18.62	14.72	3.9	S65	ES93
G63898	25.19	15.31	9.88	BP14	ES34	G64048	17.16	11.57	5.59	ES75	ES113
G63900	14.1	9.34	4.76	S1	BP4	G64049	14.96	11.65	3.31	S51	ES55
G63902	12.6	8.59	4.01	S1	ES64	G64052	20.86	13.11	7.75	ES83	ES83
G63906	20.49	12.63	7.86	ES27	ES27	G64056	20.51	13.11	7.4	S18	ES83
G63908	18.23	11.37	6.86	ES31	ES24	G63868	15.61	10.67	4.94	ES164	ES68
G63914	21.12	16.31	4.81	S29	ES84						

DISPOSAL OF OLD OR DEFECTIVE GAS-PRESSURIZED SHOCKS & STRUTS

STORAGE OF USED SHOCK ABSORBERS AND STRUTS

Used struts and shocks should be stored so that any oil leakage will be properly collected. Those containers used to store this product should be labeled "USED OIL".

Used struts and shocks can either be punctured to recycle the shock oil or disposed of in a manner consistent with local or state programs.

RECYCLING OF SHOCK AND STRUT OIL

1. FOR YOUR SAFETY, ALWAYS WEAR SAFETY GLASSES AND PROTECTIVE GLOVES WHEN PUNCTURING STRUTS AND SHOCKS.
2. Securely mount the strut or shock in a vice in the horizontal position. Make sure that the piston rod is fully extended prior to drilling the unit (Fig. #1).
3. Using a 1/16" or 1/8" drill bit, drill a hole in a downward direction approximately 1.0" from the bottom of the strut or shock (Fig #2). It is important to cover the area where the hole is being drilled with a towel or some type of shield to prevent spraying gas and oil upon initial penetration of the drill bit.
4. After the gas pressure is released continue drilling into the inner cylinder of the strut or shock unit, approximately 1/2" deep. Drill a second 1/2" hole near the top of the unit.
5. Remove the strut or shock from the vice and hold it over a container to collect the used oil. Hand stroke the unit to completely purge the oil from the cylinder of the unit (Fig #3).
6. Collect all used oil, **being careful not to mix this oil with any other waste or refuse**. Store in DOT approved containers labeled "USED OIL".
7. Dispose of the remaining strut or shock body and internal parts in accordance with local or state regulations (e.g., scrap metal recycler).
8. Store, dispose, and/or transport used oil in accordance with EPA regulations and your state's used oil program.

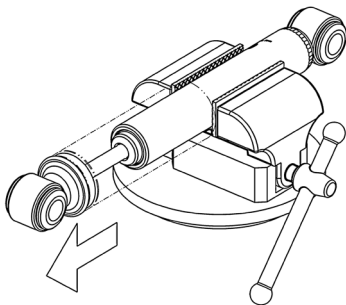

FIG. #1

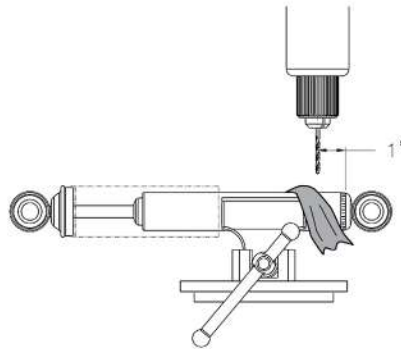

FIG. #2

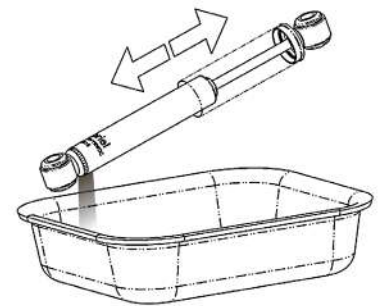

FIG. #3