

FURRION DV1100

Instruction Manual

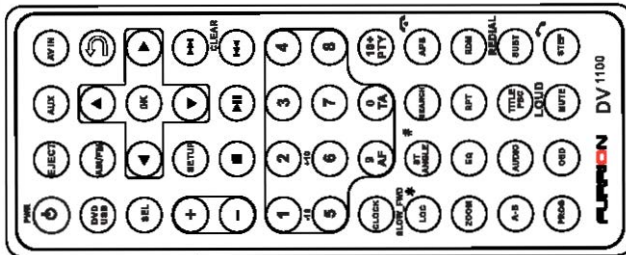
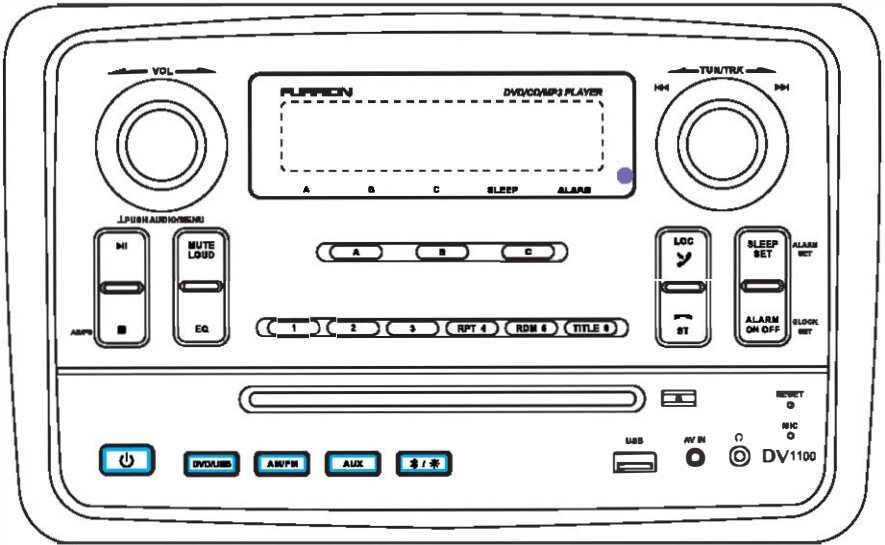

4 IN 1 WALLMOUNT ENTERTAINMENT SYSTEM

WITH DVD/CD/USB/BLUETOOTH/AM/FM

PRECAUTION



WARNING: TO REDUCE THE RISK OF FIRE OR ELECTRIC SHOCK, DO NOT EXPOSE THIS APPLIANCE TO RAIN OR MOISTURE.

CAUTION: TO REDUCE THE RISK OF ELECTRIC SHOCK, DO NOT REMOVE COVER (OR BACK). NO USER SERVICEABLE PARTS INSIDE. REFER SERVICING TO QUALIFIED SERVICE PERSONNEL.



The lightning flash with arrowhead symbol, within an equilateral triangle, is intended to alert the user to the presence of uninsulated dangerous voltage within the products enclosure that may be of sufficient magnitude to constitute a risk of electric shock to persons.



The exclamation point within an equilateral triangle is intended to alert user to the presence of important operating and maintenance (servicing) instructions in the literature accompanying the appliance.

CLASS 1 LASER PRODUCT

Laser product symbol: located on the rear panel of the unit, indicate this player is a class laser product, only use weak laser and no hazardous radiation outside of the unit.

1. Read through this instruction manual before installation and use.
2. Do not touch the power plug with wet hand.
3. Switch off the main power when the unit is not in use. (Disconnect the power plug from the power outlet when you do not intend to use the unit for a prolonged period of time.) Before moving the unit, remove the disc from the unit/ tray first.
4. Do not open the cover or touch any of the components exposed out of the unit, only for qualified technicians.
5. Do not expose the unit under direct sunlight or nearby objects that radiate heat to avoid damage the unit.
6. Do not place the unit in moist and humid conditions, which effect the pick-up of the unit lead to out of work.
7. Place the unit on a flat surface and ventilative condition. Please ensure the ventilation holes are not covered to avoid overheating and malfunction.
8. Clear the panel and case with soft dry cloth only, do not apply any kind of thinner, alcohol or sprays.
9. The apparatus shall not be exposed to dripping or splashing and that no objects filled with liquids, such as vases, shall be placed on the apparatus .

Contents

1. Before Operation.....	3
1.1 Feature.....	3
1.2 Precautions.....	3
1.3 Maintenance and Cleaning of Discs.....	4
1.4 Battery Information of the Remote Control.....	4
1.5 The Remote Control Description.....	5
1.6 Locations and Names of the Controls.....	6
1.7 Wiring Diagram.....	10
1.8 Mounting Installation.....	13
2. Common Operation.....	14
3. Radio Operation.....	16
4. Basic Disc, USB Operation.....	18
4.1 Begin Playback.....	18
4.2 Pause Playback.....	19
4.3 Stop Playback.....	19
4.4 Select Chapter/Track with the the >> / << Buttons.....	19
4.5 Select Chapter/Track with the Number Buttons.....	19
4.6 Select Chapter/Track with the Root/PBC Menu.....	19
4.7 Terminate the Playback.....	20
5. Advanced Disc, USB Operation.....	20
5.1 Playback with Speed.....	20
5.2 Playback with Slow Speed.....	20
5.3 Playback with Still Frame.....	21
5.4 Playback Repeatedly.....	21
5.4.1 One/All Repeat.....	21
5.4.2 A-B Repeat.....	21
5.5 Playback from a specified Chapter/Track or a Specified Time.....	22
5.6 Playback in Random.....	22
5.7 Playback in Different Angle.....	22
5.8 Playback in Zoom Mode.....	22
5.9 Change the Caption Language.....	23
5.10 Change the Audio Language.....	23
5.11 Look over the Playback Status.....	23
5.12 Program Playback.....	24
5.13 Playback the Picture CD in JPEG Format.....	24
5.14 Mp4 OPERATION.....	25
5.15 ESP and ID3 Function.....	25
5.16 USB Operation.....	25
5.17 The DVD System Menu Setup Operation.....	25
5.18 The Parental Control.....	29
5.19 The Region Code.....	30
6. Bluetooth Handfree System.....	31
7. The Trouble Shooting.....	33
8. Specification.....	34

1. Before Operation

Thank you for purchasing a Furrion Product, we hope you will enjoy using our product. For maximum enjoyment please look through the following manual to learn about all the features of your Furrion Stereo.

1.1 Features:

Digital AM / FM Tuner

DVD/CD-R/RW/MP3/MP4/WMA Compatible

Bluetooth function

Auxiliary inputs on front and rear

USB input with charging function*

3 Zone multi room audio output

Backlit controls with Sleep Tight light function

Clock/Alarm Clock

2 x RCA Audio/Video outputs for connecting 2 additional Tv's

1.2 Precautions

Ensure to connect this product to a 12V DC negative ground battery system which is standard in North America and European Vehicles.

Ensure when installing the Stereo all wire ends which are not being used are terminated with a insulated end to avoid wires shorting or earthing which can lead to the risk of fire or electrical shock.

Avoid inserting foreign objects into the disk loading slot of the Stereo as this will cause malfunction.

Do not expose this product in moist or wet environments, if condensation is present in the screen, wait for 1 hour or more for the moisture to evaporate

If the interior of the vehicle is extremely hot, do not use the player until the vehicle internal temperature has cooled down.

Do not use cleaning products on the front face of the product, only use a slightly damp cloth for cleaning.

Do Not attempt to disassemble or adjust this product, contact a service center for assistance

1.3 Maintenance and Cleaning of Discs

Disc Maintenance

1. To keep the disc clean, handle the disc by its edge, do not touch the disc surface of the play side.
2. Do not stick paper or tape on the disc. If there is glue (or analog) on the disc surface, must wipe it up before using.
3. Do not expose the disc to direct sunlight, or nearby heat sources such as caliduct, or leave it in a car parked in direct sunlight where there can be a considerable rise in temperature.
4. Put the disc inside disc case to keep temperature after finishing playback.

Disc Cleaning

1. Before playing, wipe the disc with a clean lint. wipe the disc outwards from the disc center.
2. Do not use petrol, thinners, commercially available cleaners or anti-static sprays for plastic LP's to wipe discs.

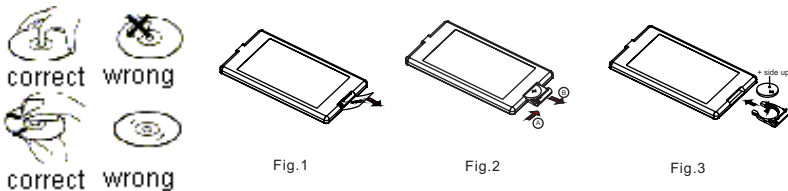

1.4 Battery Information of the Remote Control

Replace Battery in the Remote Control:

1. Before using the remote control for the first time, pull the insulating sheet out of the remote control as the direction indicated by the arrow. (see fig. 1)
2. Press the movable block hold as the direction indicated by the A arrow (See fig.2), then pull the battery holder out of the remote control as the direction indicated by the B arrow(see fig.2).
3. Replace the old battery by a new battery with (+) polarity side upward. (See fig.3).
4. Insert the battery holder to the original position in remote control. (See fig.3).

Note about the Battery of the Remote Control:

1. Improper use of battery may cause overheating or explosion. so that Result in injury or fire .
2. Battery leakage may cause damage to the remote control(Battery Life: 6 months with normal use in normal room temperature).
3. Do not short the battery.
4. Do not throw the battery into the fire.
5. To avoid the risk of accident, keep the battery out of reach of children.

1.5 The Remote Control Description

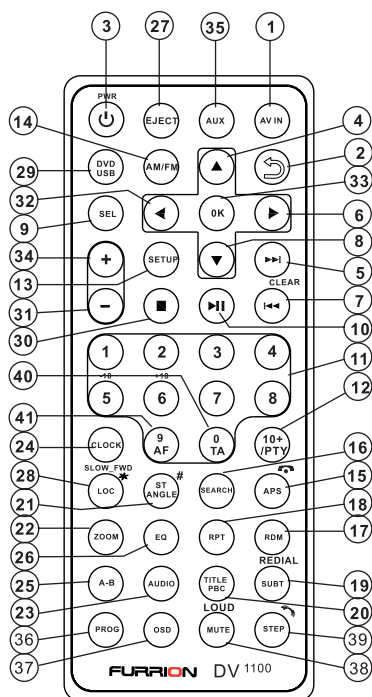

- | | |
|-------------------------------------|-------------------------|
| 1. AV IN BUTTON | 29. DVD/USB MODE BUTTON |
| 2. BACK BUTTON | 30. STOP BUTTON |
| 3. POWER BUTTON | 31. VOLUME- BUTTON |
| 4. ^ BUTTON | 32. < BUTTON |
| 5. >> BUTTON | 33. OK BUTTON |
| 6. > BUTTON | 34. VOLUME+ BUTTON |
| 7. <</CLEAR BUTTON | 35. AUX MODE BUTTON |
| 8. v BUTTON | 36. PROG BUTTON |
| 9. SEL BUTTON | 37. OSD BUTTON |
| 10. PLAY/PAUSE BUTTON | 38. MUTE/LOUD BUTTON |
| 11. NUMBER(0~10,+10
-10) BUTTONS | 39. STEP/TEL BUTTON |
| 12. 10+/PTY BUTTON | 40. TABUTTON |
| 13. SETUP BUTTON | 41. AF BUTTON |
| 14. AM/FM BUTTON | |
| 15. APS/HAND UP BUTTON | |
| 16. SEARCH BUTTON | |
| 17. RDM BUTTON | |
| 18. RPT BUTTON | |
| 19. SUBTITLE/REDIAL BUTTON | |
| 20. TITLE/PBC BUTTON | |
| 21. ST/ANGEL/# BUTTON | |
| 22. ZOOM BUTTON | |
| 23. AUDIO BUTTON | |
| 24. CLOCK BUTTON | |
| 25. A-B BUTTON | |
| 26. EQ BUTTON | |
| 27. EJECT BUTTON | |
| 28. LOC/SLOW-FWD/* BUTTON | |

1.6 Locations and Names of the Controls

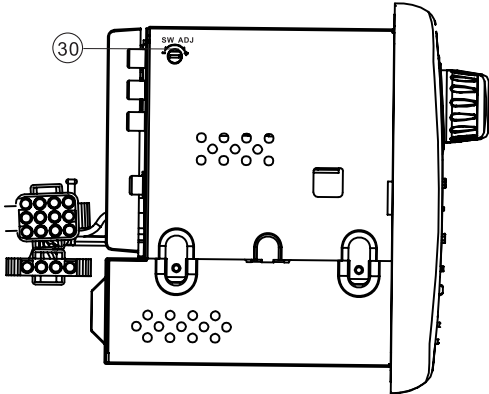
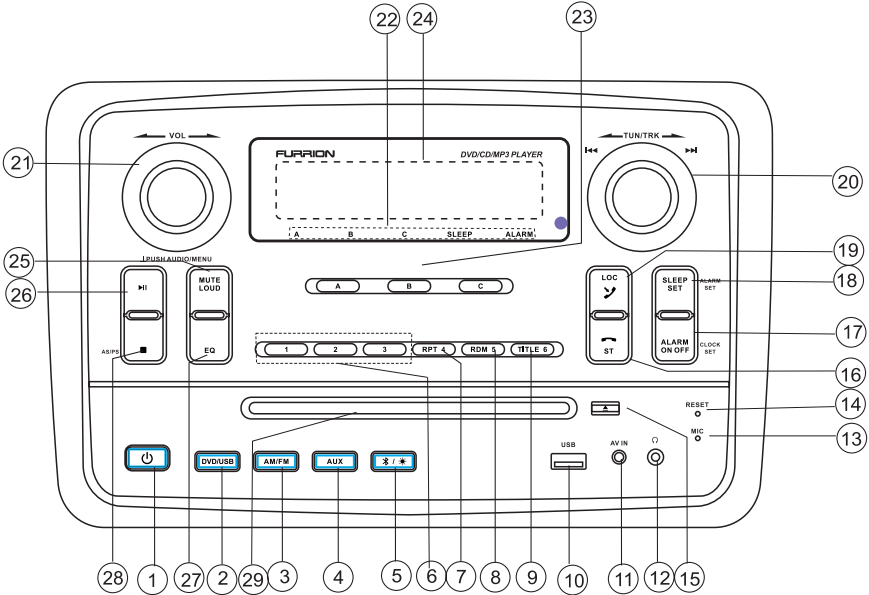

1. POWER BUTTON
2. DVD/USB MODE BUTTON
3. AM/FM MODE BUTTON
4. AUX MODE BUTTON
5. BT \star /DIMMER \star BUTTON
6. 1/2/3 BUTTON
7. 4/RPT BUTTON
8. 5/RDM BUTTON
9. 6/TITLE BUTTON
10. USB SOCKET
11. AV IN SOCKET
12. HEADPHONE SOCKET
13. MICROPHONE
14. RESET BUTTON
15. EJECT BUTTON
16. HANG UP/ST BUTTON
17. ALARM ON OF/CLOCK SET F BUTTON
18. SLEEP SET/ALARM SET BUTTON
19. TEL /LOC BUTTON
20. TUN/TRK \gg /|/ \ll KNOB
21. VOL KNOB/SEL BUTTON
22. INDICATOR LIGHT
23. ZONE A/B/C BUTTON
24. LCD DISPLAY
25. MUTE/LOUD BUTTON
26. \gg |/| \ll PLAY/PAUSE BUTTON
27. EQ BUTTON
28. STOP/AS/PS BUTTON
29. DISC SLOT
30. SUBWOOPER VOLUME ADJUSTER

QUICK REFERENCE GUIDE

General Operation

Power On/Off STANDBY	Press POWER to turn the unit on or enter standby mode. Long press POWER to turn the unit off.
Mute	Press MUTE to silence the audio. "MUTE" will flash in the display. Press MUTE again to cancel.
Selecting a Source	Press DVD/USB, AM/FM, AUX, ✖ to select between Disc (after inserting a disc), USB (After inserting a USB storage), Tuner, AUX and Bluetooth.
Volume Adjust	Rotating VOL KNOB to adjust volume.
Audio Adjustment	Press VOL KNOB to select between VOL, BAS (without EQ preset), TRE (without EQ preset), BAL, FAD and BEEP. Rotate it to select audio feature.
Preset EQ Curves	Press EQ to select between MOVIE, MUSIC, CLASSIC, CONCERT.
ALARM SET	In AM/FM mode, press and hold ALARM SET to enter time setup, rotate VOL KNOB to adjust hour. Press it briefly to minute setting and rotate it to adjust. Once time is set, the unit will automatically set after a few seconds,
ALARM ON/ OFF	Press ALARM ON/OFF to turn on or cancel the alarm setting. When alarm is set on, the ALARM light illuminate
CLOCK SET	Press and hold CLOCK SET to enter CLOCK Setup, rotate VOL KNOB to adjust hour. Press it briefly to minute setting and rotate it to adjust. Once time is set, the unit will automatically set after a few seconds.
SLEEP SET	Press SLEEP SET to adjust the elapsed time before sleep mode begins.
LOUD ON/OFF	Press and hold LOUD to turn on or off LOUD mode.
DIMMER	Press and hold  for over 2 seconds to dim the face illumination.
SPEAKER SELECTION	Press A, B or C to select speaker output, the corresponding light illuminate once it is selected.
RESET	Press PRSET with a cuspidal object to make the unit be reset to factory default and re-instate the correct functions.



Radio Operation

Area frequency selection	Press and hold FM/AM for 10 seconds to set AM/FM Radio region (Europe/USA1/ USA2).
Manual Tuning	Rotate TUN << or TUN>> momentarily to move radio frequency up or down one step at a time.
Seek Tuning	Rotate and hold TUN << or TUN>> to search the next strongest station automatically.
Band	Press FM/AM to select between FM1,FM2,FM3,AM1 and AM2.
Storing and recalling Station Presets	Press and hold any one of the six preset button(1-6) to stored the current frequency. Press the corresponding preset button to recall the frequency stored.
Automatically Store Stations	Press and hold AS/PS to automatically store the six strongest stations in the current band. (Up to 18 FM stations and 12 AM stations can be store).
Scan Tuning	Press AS/PS to scan presets 1-6 on the current band
LOC	Press LOC to turn on/ off LOC
Sereo/Mono	In FM mode, press ST to select the Sereo or Mono sound mode.
Using PTY to select Program	Press and hold VOL KNOB to enable selection of the PTY program program group. Once a group is displayed, rotate the VOL Knob or press the 6 number buttons to select your desired PTY program.
AF/TA	Press and hold VOL KNOB to access TA/AF seting mode, then rotate it to turn on/off TA/AF function
RDS On/Off	Press and hold B for 5 seconds can turn on/off

Disc USB Opreation

Insert Disc	With the label facing up, insert a disc into the Disc slot. The disc will automatically begin playback.
Eject CD	Press EJECT to eject the disc
Track Select	Rotate TRK >> or TRK << to skip to next or previous track/chapter.
Fast Forward and Backward	Rotate and hold TRK >> or TRK << to fast forwards or backwards.
Pause Playback	Press > to temporarily stop the playback. Press > again to resume playback.
Stop Playback	Press ■ once to pause the playback, press > to resume; press ■ twice to stop playback, then press > to start playback from the beginning of the first chapter/track.
Repeat	Press RPT to repeat current playing track/chapter. Press RPT to resume.
Random	Press RDM to play each track in random order. Press RDM again to resume.
Title	In DVD/VCD mode, press TITLE to display the title list.

BLUETOOTH OPERATION

Dial or accept call	Press  to accept, dial or redial a call.
Reject or End call	Press  to reject or end a call.

1.7 Wiring Diagram

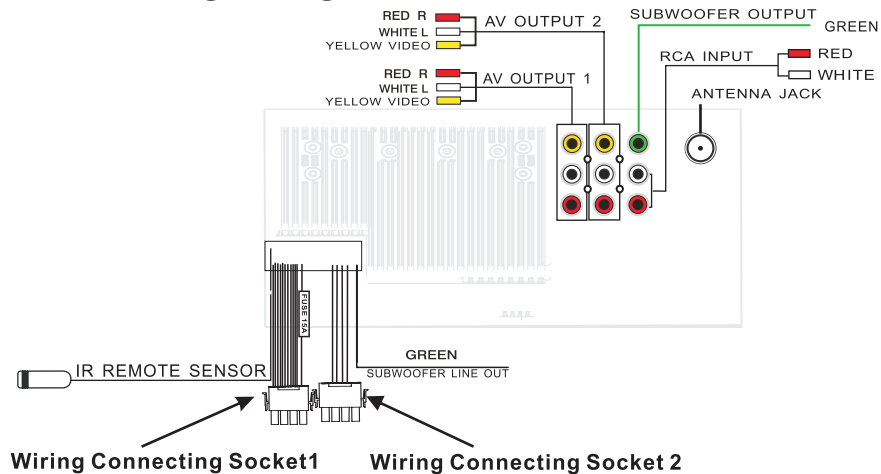

The Description of the Wiring Diagram for Socket 1 and Socket 2

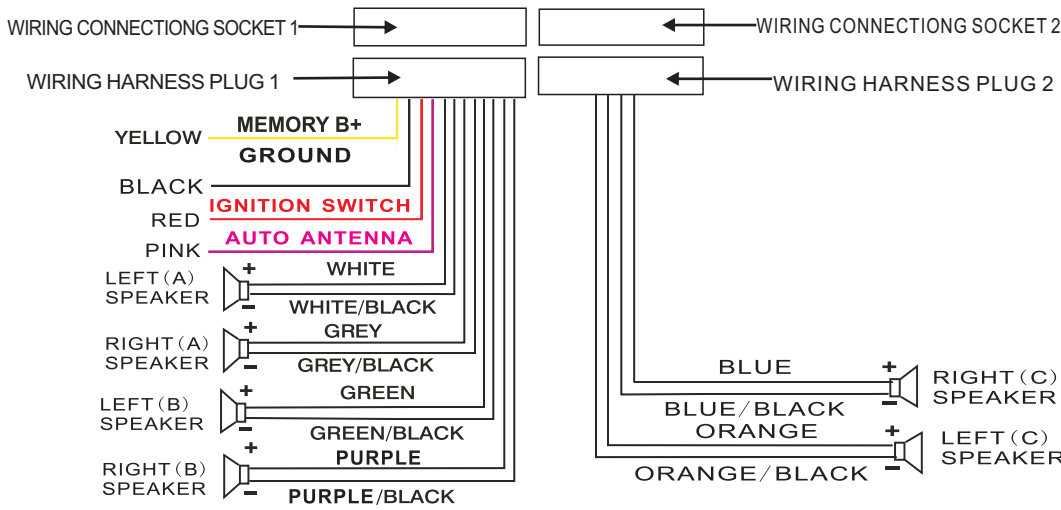

WIRING CONNECTIONG SOCKET 1 VIEW

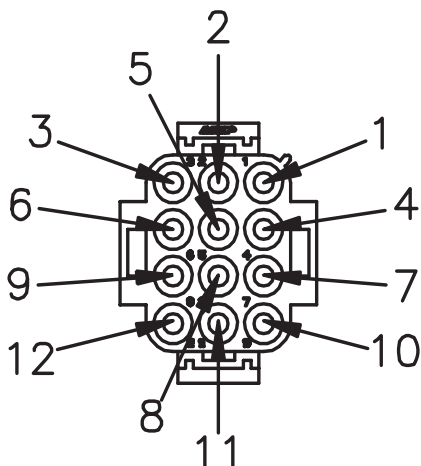

PIN NO	COLOR	FUNCTION
1	BLACK	POWER GROUND (-12VDC)
2	YELLOW	+12VDC BATTERY POWER
3	RED	+12VDC ACCESSORY POWER
4	PURPLE	RIGHT (B) SPEAKER (+)
5	GRAY/BLACK	RIGHT (A) SPEAKER (-)
6	WHITE	LEFT (A) SPEAKER (+)
7	PURPLE/BLACK	RIGHT (B) SPEAKER (-)
8	GREEN	LEFT (B) SPEAKER (+)
9	WHITE/BLACK	LEFT (A) SPEAKER (-)
10	PINK	+12VDC TRIGGER
11	GREEN/BLACK	LEFT (B) SPEAKER (-)
12	GRAY	RIGHT (A) SPEAKER (+)

WIRING CONNECTIONG SOCKET 2 VIEW

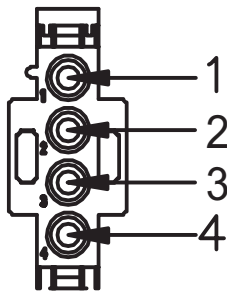

PIN NO	COLOR	FUNCTION
1	BLUE	RIGHT(C)SPEAKER (+)
2	BLUE/BLACK	RIGHT(C)SPEAKER (-)
3	ORANGE	LEFT(C)SPEAKER (+)
4	ORANGE/BLACK	LEFT(C)SPEAKER (-)

WIRES FROM RV, BOAT OR TRUCK

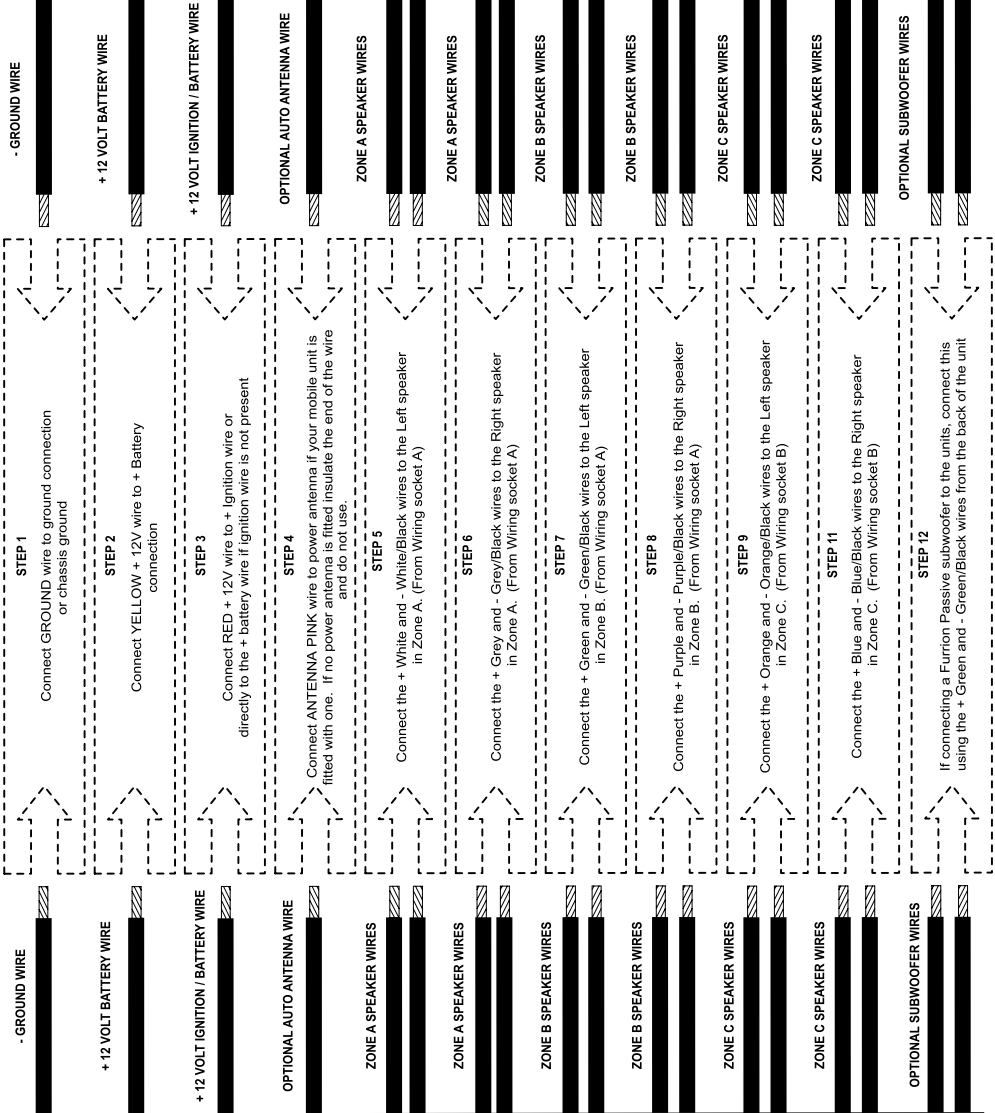

POWER AND SPEAKER WIRE FROM STEREO CONNECTOR

1.8 Mounting Installation

Location

- * Choose a mounting location away from humid areas, water sources, appliances or any equipment that can radiate heat.
- * Select an area on a wall or cabinet which is free from cable, fuel or brake lines and ensure the area behind the wall mount stereo has a vent hole or if it is an enclosed box and has adequate room around the rear of the unit for cooling.
- * Ensure when the stereo is mounted in the cut out that the wires at the rear of the unit are not pressed against the heat sink

Mounting Opening

- * Refer to following mounting hole diagram, measure and cut a mounting area.

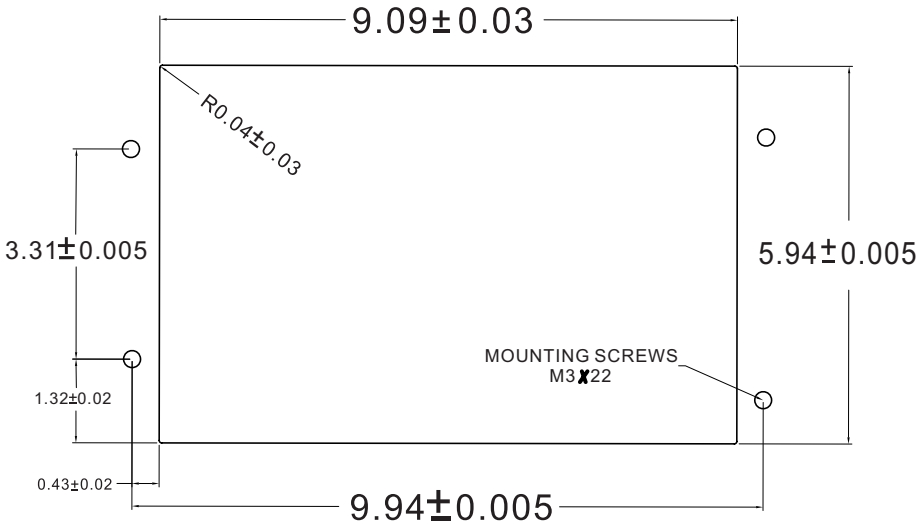

- * Where possible leave around 1 to 2 inches of space inside the cabinet around the sides and rear of the stereo housing to help with airflow and ventilation.

Installing the unit.

- * Before finally installing the unit, connect the wiring temporarily and make sure the unit and the system work properly.
- * Fix the unit with screw according to following diagram.

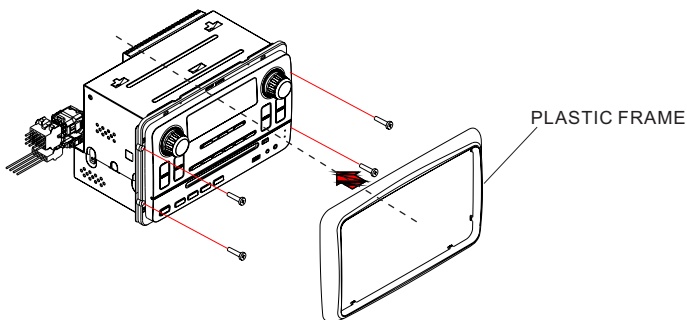

2. Common Operation

1. Turning On and Off the unit

By pressing the power button will turn on or enter standby mode

Sleep Tight function

By holding the power button for 5 seconds while the unit is in standby mode will enable Sleep Tight mode, this is where all illumination on the front panel will turn off on the unit.

2. Selecting a Source:

DVD / USB - once a DVD or USB is inserted into the unit, the unit will automatically switch to display this source menu. Press this function button to select DVD if a disk is already installed and the unit is playing from another source.

AM/FM - by pressing this button will scroll through the FM1, FM2, FM3, AM1, AM2.

To switch this unit's AM/FM receiver between USA and Europe frequencies press and hold the AM/FM button for 10 seconds until the region is displayed on the screen.

AUX-this button allows you to scroll through the AUX inputs fitted to the stereo

AUX input - connection on the rear of the unit, (normally used to connect TV sound input)

AV IN - connection on front of unit to connect an external audio source

BLUETOOTH / DIMMER - by pressing this button will enable bluetooth connection, if the button is held in for over 2 seconds it will then dim the face illumination by 1 of the 3 stages each time pressed.

3. Volume Adjust

Rotate the volume knob clockwise to increase volume, rotate anticlockwise to reduce volume.

4. Mute

Press MUTE button to mute whatever source is playing and display mute on the screen.

Press the mute button again to release unit from mute.

5. Clock and Alarm Set

1) To display the clock on the LCD display, press Clock button on the remote control

2) To Adjust or set the clock, press and hold the Clock Set button on the front of the unit or hold the Clock button on the remote control until the clock set feature is displayed on the LCD display of the stereo then use the volume knob on the unit or + and - buttons on the remote control to adjust the time, push in the volume knob on the stereo or press the SEL button on the remote control to change from setting hours to minutes. Once time is set the stereo will automatically set after a few seconds of not pressing any functions.

3) To set the Alarm Clock the Stereo must be in AM/FM mode when the Alarm Set button is held in. The alarm clock is set in the same way as above for the clock set. Once the alarm clock is set, you will see the ALARM light illuminated under the LCD display.

Press the alarm on /off button to turn on or cancel the alarm setting.

6. To select a preset EQ mode
Press the EQ button to select the preset music equalizer curves: MOVIE, MUSIC, CLASSIC, CONCERT .The sound effect will be changed.
7. To turn on/off LOUD mode
Press and hold LOUD button on the front panel to turn on/off LOUD mode.
- 8.To adjust the sound equalizer curves
To adjust the sound equalizer curves, briefly and repeatedly press the SEL button to select the sound equalizer curves of VOL, BAS(without preset EQ), TRE (without preset EQ), BAL, FAD,BEEP(ON/OFF), then rotate the VOL knob on the front panel or press the + or - button to adjust level.
- 9.To preset the unit to sleep mode
Press the SLEEP SET button to select the time you want to make the unit go sleep mode in. There are four modes for select.
00: The sleep mode off
15: The INDICATOR light SLEEP will be lighted, The unit will go to sleep mode in 15 minutes
30: The INDICATOR light SLEEP will be lighted, The unit will go to sleep mode in 30 minutes
60: The INDICATOR light SLEEP will be lighted, The unit will go to sleep mode in 60 minutes
NOTE: Only the ALARM ON mode is selected, the above preset function can effect.
- 10.To preset the unit from sleep mode to turning on
Press and hold the SLEEP SET to pop up the preset clock interface. adjust the time you want the unit to turn on in.

NOTE: Only the ALARM ON mode is selected, the above preset function can effect.
- 11.ALARM ON OFF BUTTON
Press the ALARM ON OFF BUTTON to select the ALARM ON or ALARM OFF mode.
ALARM ON: The INDICATOR light ALARM will be on.
ALARM OFF:The INDICATOR light ALARM will be off.
- 12.ZONE A/B/C BUTTON
Pressing zone A, B or C buttons will turn on or off the audio source in each of the different areas which your speakers are connected. A blue indication light with A, B and C is displayed under the LCD display and when lit is to indicate when sound is being fed to the Zone.
- 13.Press the ↶ button or TITLE button up to the previous menu.
- 14.To reset the unit
when the display is incorrect, or the function buttons are not effective or sound is distorted, then use a sharp point to press the RESET button, that will make the unit be reset to factory default and re-instate the correct functions.

3. Radio Operation

1. FREQUENCY SELECT

In RADIO mode. Press and hold the AM/FM button to select your desired frequency EUROPE, USA1 or USA2.

2. AM/FM BUTTON

In RADIO mode, press the AM/FM button to select your desired radio band of FM1, FM2, FM3, AM1, AM2, and the selected band will be displayed on the small monitor of the front panel.

3. TUNE/SEEK UP/DOWN

In RADIO mode:

- 1) Rotate the TUN/TRK KNOB to the right or left limit position stopping for about 1 second or Press and hold the >>| / |<< button on the remote control to automatically search up/down for a available station from the current frequency.
- 2) Rotate the TUN/TRK KNOB or the press the >>| / |<< button on the remote control to manually search up or down with step by step for your desired station from the current frequency.

4. AS/PS BUTTON

In RADIO mode:

- 1) When pressing and holding the AS/PS button on the front panel or APS button on the remote control, the radio searches from the lowest frequency and checks the signal strength level until 1 cycle search is finished. And then the 6 strongest stations are preset to the corresponding preset number memory bank. The AS operation is implemented in each bank of the selected band. When the AS operation is finished, it will resume broadcasting on the M1. (It can store 3x6 stations for FM and 2x6 stations for AM in all)
- 2) When briefly pressing the AS/PS button on the front panel or APS button on the remote control, the radio searches for each preset station from the M1. When the field strength level is more than the threshold level of the stop level, the radio holds at that preset number for a few seconds with releasing mute, and then searches again. After finishing a circle of searching, it will stop searching on the M1.

NOTE: In FM band, FM1, FM2, FM3 is checked one at a time.

In AM band, AM1, AM2 is checked one at a time.

5. PRESET STATION [1-6] BUTTONS

In RADIO mode:

- 1) To memorize the current frequency on the current band, press and hold any one of the six preset buttons (1-6) .
- 2) To recall the preset memory on the current band, press one of the preset buttons [1-6] .

6. STEREO/MONO BUTTON

Press the ST button to select the STEREO or MONO sound mode for FM band.

7. LOC BUTTON

- 1) In RADIO mode, when the signal of the distance radio station are very weak and the receiving effect is bad during tuning, check whether there is the word LOC on LCD. If there is the word LOC on LCD, press this button to turn off the LOC function, then tune again for the distance radio station;
- 2) In RADIO mode, when the signals from the local radio stations are too strong, this could lead to interference. press this button to turn on the LOC function, and the LOC icon will be lit up on the LCD. Re-tune for the local station required.

8. PTY (PROGRAM TYPE) BUTTON

Long press the SEL button on the front panel or press the PTY button on remote shortly to select one of the following mode.

When PTY group is on, press the VOL+ or VOL- button on the remote controller or rotate the VOL knob on the front panel to select one of PTY programs: <-->NEWS<-->AFFAIRS<-->INFO<-->SPORT<-->EDUCATE<-->DRAMA<-->CULTURE <-->SCIENCE<--> VARIED<-->WEATHER<-->FINANCE<-->CHILDREN<-->SOCIAL<-->RELIGION<-->PHONE IN<-->TRAVEL<-->LEISURE<-->DOCUMENT< -->PTY NONE<-->POP M< -->ROCK M<-->EASY M<-->LIGHT M<--> CLASSICS<-->OTHER M<-->JAZZ<-->COUNTRY<-->NATION M<-->OLDIES<-->FOLK M<-->

When PTY group is on, pressing the 6 number buttons also can select one of PTY programs as above.

After selecting one of the PTY programs, it will display SEEK PTY and automatically search for the station of the PTY program. If the station of the PTY program does not exist, it will display PTY NONE and then return back to the normal station.

Note: Press and hold the SPEAKER SELECTION BUTTON B on the front panel for 5 seconds can turn on/off RDS mode.

9. AF [ALTERNATIVE FREQUENCIES] BUTTON

Long press the SEL button on the front panel or press the AF button on the remot control briefly, the AF switchingmode is selected and the state of the AF switching mode is displayed by AF segment.

Segment off: AF switching mode off.

Segment on: AF switching mode on, and has RDS information.

Segment flashing: AF switching mode on, but RDS information is not received yet.

When the AF switching mode is selected, the radio checks the signal strength of the AF all the time. The interval of checking time of each AFs depends on the signal strength of the current station, from a few minute for the strong station to a few seconds for the weak station. Every time that a new AF is stronger than the current station, it switches over to that frequency for very short time, and the NEW FREQUENCY is displayed for 1-2 second. Because the mute time of the AF switching or the checking time is very short, it is almost inaudible in case of normal program. (When AF flash on LCD, it will search for the stronger RDS station. If AF and TP flash on LCD, it can only search for the traffic announcement station).

In FM mode, when AF is on, SEEK, (SCAN), AUTO-MEMORY function can only receive and save the RDS program.

10. TA [TRAFFIC ANNOUNCEMENT] BUTTON

Long press SEL button on the front panel then rotate it or press the TA button on remote shortly to turn on TA search mode.

When traffic announcement is transmitted:

- 1). If the unit is in Disc Play mode, it will switch to radio mode temporarily.
- 2). Temporarily switch over to an EON linked station when EON detects a traffic announcement on that other program, and TA, TP will be displayed on LCD

* TA interruption function:

The current traffic announcement is cancelled by pressing TA button shortly.

* When TA is on, SEEK, (SCAN), AUTO MEMORY function can be received or saved only when traffic program identification code has been received.

4 Basic Disc, USB Operation

4.1 Begin playback

1. Press the **POWER** button briefly to turn on the DVD player.

After turning on the DVD player, please turn on the monitor, and ensure that the video output of the monitor is the video input from the DVD player connected with the monitor.

? Common Question

Q: There is not anything is displayed on TV screen when the DVD player is turned on. How to solve the problem?

A: Ensure that the TV was set to right video input(not TV channel); for example, if you make VIDEO1 INPUT of TV and DVD player connected with each other, then you need set TV to VIDEO1.

2. Insert a disc into the **DISC SLOT**(Label surface up).

! NOTE

1. For some discs that are seriously scratched or poor manufacturing or recording quality, it may not play.

2. If the player can not read disc under normal condition, please try to eject and reload the disc again.

3. Remark:

1) In addition to normal CD and DVD, this unit supports to play CD-R, CD-R/W, DVD-R and DVD-R/W as well; however, depending on the conditions of the recording equipment, recording program or the disc itself, some CD-R, CD-R/W, DVD-R or DVD-R/W may not play.

2) When dealing with CD-R, CD-R/W, DVD-R or DVD-R/W recording, too high recording speed may result in poor signal quality and therefore, it is recommendable to select as lower as possible recording speed.

4.2 Pause Playback

When playing DVD/VCD/CD/MP4/MP3/WMA discs, press the PAUSE/PLAY button on the front panel or remote control to pause the playback, press the PAUSE/PLAY button again to resume normal playback.

4.3 Stop Playback

When playing DVD/VCD/MP3/WMA/CD discs, press the STOP button once to pause the playback, then press the PLAY button to resume the normal playback; press the STOP button twice to stop the playback, then press the PLAY button to start playback from the beginning of the first chapter/track.

4.4 Select Chapter/Track with the TUN/TRK KNOB or the >>|/|<< Button

Rotate the TUN/TRK KNOB on the front panel or the >>|/|<< button on the remote control during playback to select the next or last chapter/track to playback.

Note: Rotate the TUN/TRK KNOB or press the >>|/|<< button multiple times to advance multiple chapters/tracks forward or backward.

4.5 Select Chapter/Track with the Number Buttons

When playing DVD/VCD(PBC OFF)/MP3/WMA/CD discs, press one of the 1~9 and the 0/TA number buttons to directly select and play the 1st to 10th track / chapter (the 0/TA button is used as the 10 button).

If you want to play the track/chapter with serial number bigger than 10, use the 10+, 1~9 and 0/TA button. For example 1, to play the 13th track/ chapter, firstly press the 10+ button once, then press the 3 button. For example 2, to play the 34th track/chapter, firstly press the 10+ button for 3 times, then press the 4 button.(the 0/TA button is used as the 0 button)

Note: pressing and holding the +10 or -10 buttons will allow you to play the next 10 or last 10 chapter/track(only for MP3/WMA).

4.6 Select Chapter/Track with the Root/PBC Menu (If the disc includes the root/PBC menu)

When playing DVD discs:

1. Press the TITLE button on the remote control to display the title list.
2. Press the direction buttons to select your desired title, and then press the OK or PLAY button to open the root menu of the selected title.
3. Press the direction buttons to select your desired chapter, finally press the OK or PLAY button to play the selected chapter.

During playback, pressing the TITLE button on front panel or long pressing the TITLE button on the remote can directly display the root menu of the title that is playing.

In VCD mode

1. When starting to turn on the PBC function, it will play from the beginning of the disc till it display the PBC menu on TV screen if the disc include the PBC menu.
2. Press the number buttons to select your desired track to play.

In MP3/WMA mode

1. The root menu is displayed on the monitor screen all the time (and the TITLE or MENU button is not available).
2. Press the direction buttons to select your desired FOLDER, then press the OK or PLAY button to open the FOLDER, and then press the direction buttons to select your desired file, finally press the OK button to play the selected file.

In CD mode, the TITLE, PBC, MENU buttons are disabled.

4.7 Terminate the Playback

1. Press the EJECT button to eject disc.
2. Press and hold the POWER button on the front panel or briefly press the POWER button on the remote controller to turn off the DVD player.

5. Advanced Disc, USB Operation

5.1 Playback with Speed

During normal playback, Rotate the TUN/TRK to the right or left limit position stopping for about 1 second or press and hold the >>|/|<< button on the remote controller continuously to fast forwards or backwards at the following speeds: x2, x4, x8, x16, x20, normal.

During speed playback, press the PLAY button to resume normal playback.

5.2 Playback with Slow Speed

During playback, press the SLOW_FWD button to execute the Slow Forward function.

With each consecutive pressing of the SLOW_FWD button, the playback speed decreases. The speed levels in Slow Forward as follows: x1/2, x1/3, x1/4, x1/5, x1/6, 1/7, normal.

During slow forward, press the PLAY button to resume normal playback.

The function is only for video.

5.3. Playback with still frame

If the unit is currently running DVD.VCD disc, press the STEP button consecutively to display the still frame forward with step by step.

Press the PLAY button to resume normal playback.

5.4 Playback Repeatedly

5.4.1 ONE/ALL Repeat

1. In the mode of DVD disc playback:
Press the RPT button to select REP CHAPTER, REP TITLE, REP ALL or REP OFF.
2. In the mode of VCD(PBC OFF)/CD disc playback:
press the RPT button to select REP ONE, REP ALL or OFF.

When it is in the state of PBC ON, during VCD disc playing, the RPT button are not available.

3. In the mode of MP3/WMA disc playback:
Press the RPT button to select REP ONE, REP DIR, REP ALL or OFF.

5.4.2 A-B Repeat

Press the **A-B** button if you want to repeat a specific segment on a disc that you define:

1. Press the **A-B** button at a point (A) where you want it to be the start point of the repeat segment. Press the **A-B** button again at a point (B) where you want it to be the terminal point of the repeat segment. Then it will play the segment repeatedly.
2. To cancel the A-B repeat mode and resume normal playback, press the **A-B** button for the third time.

Note:

During VCD/MP3/WMA/CD playback, points A and B must be within the same track.

During DVD playback, points A and B can be selected from different chapters.

5.5 Playback from a specified chapter/track or a specified time

1. When playing DVD discs, press the SEARCH button to display a interface and highlight the title item, then use the number buttons to input the serial number of the title; use the direction buttons to highlight the chapter item, then use the number buttons to input the serial number of the chapter; finally press the OK or PLAY button to play the selected chapter.
2. When playing VCD/MP3/WMA/CD discs, press the SEARCH button to display a interface and highlight the track item, then use the number buttons to input the serial number of the track; finally press the OK or PLAY button to play the selected track .

5.6 Playback in Random

When playing DVD/VCD(PBC OFF)/MP3/WMA/CD discs, press the RDM button to switch between RANDOM (ON)/RANDOM OFF. When in RANDOM (ON) mode, it will play in random.

5.7 Playback in Different Angle

1. When playing VCD/MP3/WMA/CD discs, the ANGLE button on the IR remote control is not available.
2. When playing DVD discs, press the ANGLE button repeatedly on the IR remote control to view in different angle. (This function is only for the DVD discs with ANGLE function)

5.8 Playback in Zoom Mode

In DVD/VCD mode, during playback, press the ZOOM button continuously to enlarge a certain area of the images on the screen with these multiples:

ZOOMx2,ZOOMx3,ZOOMx4,ZOOMx1/2,ZOOMx1/3,ZOOMx1/4,ZOOM OFF.
Press one of the \wedge / v / $>$ / $<$ buttons to select the area you want to enlarge.

5.9 Change the Caption Language

When playing DVD discs, press the SUBTITLE button repeatedly to select the language of the caption or turn off the caption.(depend on the disc used.)

When playing VCD/MP3/WMA/CD discs, the button is not available.

5.10 Change the Audio Language

1. When playing DVD discs, press the AUDIO button repeatedly on the IR remote control to select the desired language type(depend on the disc used)
2. When playing VCD discs, press the AUDIO button repeatedly to select the sound mode of the MONO L, MONO R, and Stereo, no language function.
3. When playing CD/WMA/MP3 discs, the AUDIO button is invalid.

5.11 Look over the Playback Status

1. When playing DVD discs, press the OSD button repeatedly on the remote control to turn on/off the playback status. When it is on, it will display the information such as: the serial number of the playing title, the serial number of the playing chapter, the elapsed time of the playing chapter, the remaining time of the playing chapter, the elapsed time of the playing title, the remaining time of the playing title, etc.
2. When playing VCD/CD discs, press the OSD button repeatedly on the remote control to turn on/off the playback status. When it is on, it will display the information such as: the serial number of the playing track, the elapsed time of the playing track, the remaining time of the playing track, the elapsed time of the disc, the remaining time of the disc.

5.12 Program Playback

It allows you to enter the order in which you want some chapters/tracks in DVD/VCD/MP3/WMA/CD disc to play.

- 1 During playback, press the PROG button to enter a program interface as follows:

for DVD discs

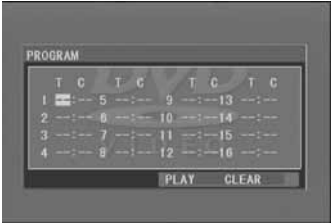

for VCD/MP3/WMA/CD discs



- 2 Use the direction buttons to move cursor onto the desired place for inputting the sequence number.
 - 3 Use the number button to input desired sequence number of title/chapter/track with desired sequence.
 - 4 Use the direction button to move cursor onto Play item, then press the OK button to play the programmed titles/chapters/tracks in programmed order; only pressing the PLAY button also can play the programmed titles/chapters/tracks in programmed order.
- * To exit program playback, firstly press the STOP button, then press the PLAY button to enter sequence playback; or press the PROG button twice again.
 - * To remove the all programmed sequence numbers, move the cursor onto Clear item, then press the OK button.
 - * To change the programmed sequence, move the cursor onto the item you want to change, input the desired sequence number.
 - * During VCD playback, if it is in PBC ON mode, at the same time of entering the state of program playback, it turns off PBC mode.

5.13 Playback the Picture CD in JPEG Format

1. The root menu is displayed on the monitor when beginning to switch on DISC mode. At the time, it plays MP3/WMA file.(the TITLE or MENU button is not available).
In the root menu, the left file sort icon is for MP3/WMA file; the middle file sort icon is for JPEG file; the right file sort icon is for VIDEO file. If one of these 3 file sort does not exist, you can not move cursor onto the file sort icon.
2. When displaying the root menu, press the direction buttons to select your desired FOLDER, file or file sort icon, then press the OK or PLAY button to open the FOLDER, or play the selected file, or play only this sort of file.
When displaying the root menu, you can also use the number buttons to select the serial number of the file and play the file.
When you select a JPEG file sort icon, press the ^ or > button to select the first JPEG file, then press the v button to select the desired JPEG file, finally press the OK or PLAY/PAUSE button to display the JPEG picture in full screen from the selected JPEG picture.

3. During JPEG playback, press one of the >/</^/v buttons to change the angle of viewing picture that is displaying as follows:
 >: 90 deg cw; <: 90deg ccw; ^: UP<-->DOWN; v: LEFT<-->RIGHT
 During JPEG playback, press the PROG button to change the mode of refresh picture. During JPEG playback, press the STOP button to stop playing and return to the root menu.
- * During JPEG playback, the following buttons are not available: SLOW-FWD, SUBTITLE, TITLE, ANGLE, STEP, AUDIO, RDM and A-B.
- * In JPEG mode, the other operations are same as ones in MP3/WMA mode.

5.14 MP4 Operation

1. The root menu is displayed on TV when beginning to switch on DISC mode, then it will automatically play the first file.
 During playback, press the STOP button to stop playing and return to the root menu.
2. When displaying the root menu, press the direction buttons to select your desired FOLDER or file, then press the OK or PLAY button to open the FOLDER, or play the selected file.
 When displaying the root menu, you can also use the number buttons to select the serial number of the file and play the file.
- * The ANGLE, PROG, RDM, and TITLE/PBC button are not valid.
- * The other functions are same as ones in DVD disc; but the RPT function is same as one in MP3/WMA.

5.15 ESP and ID3 Function

There is ESP function for all formats of discs.

In MP3/WMA mode, during playback, the information of the file name, folder name, song s title, artist and album will be scrolling on the LCD display. As long as the current playing MP3 music contains relevant ID3 tag information in version 1.0/2.0 format, the 3 items underlined above will be scrolling on the LCD display; otherwise, they will not.

5.16 USB Operation

Power on the DVD player, then insert the USB storage, then the monitor will display the root menu of the USB storage

This device support picture(JPG format), audio(MP3 or WMA format) and Video(MP4 format), all the operations are same as ones of the corresponding format.

Note: The USB input with charging function (not all products can be charged from the unit)

5.17 The DVD System Menu Setup Operation

1. Press the SETUP button on the remote controller to access the DVD System Menu on the monitor.
2. There are 6 setup pages in all for the System Menu. Press the > or < button to select an desired setup page.
3. Press the ^ or v button to select an setup item in the selected setup page.
4. Press the > button to enter the setup item. Then press the v or ^ button to select a desired mode of the setup item, finally press the OK button to confirm it.
- * Press the < button to return to the upper level.
- * Press the SETUP button again or use the direction buttons to highlight the item of the EXIT SETUP and then press the OK button to exit the System Menu.

For the DVD System Menu, there are 6 setup pages in all. They display as follows:

5.17.1 SYSTEM SETUP



TV TYPE

The setup item is for matching TV screen size.

4:3 PS: Choose the item when connecting a TV set with 4:3 screen. When playing the pictures with 16:9 size, the left and right parts of the video will be cut out, and display in full screen.

4:3 LB: Choose the item when connecting a TV set with 4:3 screen. When playing the pictures with 16:9 size, the top and bottom parts of the TV screen will be turned into a black square respectively.

16:9: Choose the item when connecting a TV set with 16:9 wide screen.

PASSWORD

This setup item is for locking or unlocking the rating level of the Parental Control. The defaulted state is locked. The defaulted password is 0000.

You can set a new password that you like: Select the PASSWORD item and then press the > button to enter it, then input the original password 0000, and then press the OK button to unlock it. Press the > button to enter it again, then input a new password that you like and then press the OK button to make it effective. Before the other persons see the Manual, you should get the password in mind and cut out the part of PASSWORD in the Manual.

RATING

The item is for setting a new rating level of the Parental Control.

1. Select the PASSWORD item and then press the > button to enter it, then input the password mentioned above, and then press the OK button to unlock the setting of the rating level of the Parental Control.
2. Select the RATING item and then press the > button to enter it, then use the direction buttons to select your desired rating level, then press the OK button to confirm.
3. Select the PASSWORD item again and then press the > button to enter it, then input the password, and then press the OK button to lock the new setting of the rating level of the Parental Control.

DEFAULT

This item is for making all setup items change back to original status.

5.17.2 LANGUAGE SETUP



OSD LANGUAGE

This item is for selecting the language of the SYSTEM MENU and all operating prompt interface displayed during playback.

AUDIO LANG

This item is for selecting a audio language.

SUBTITLE LANG

This item is for selecting a subtitle language.

MENU LANG

This item is for selecting a disc menu language.

5.17.3 AUDIO SETUP



KEY

It is for selecting your desired basic music tone(from low to high).

5.17.4 VIDEO SETUP



BRIGHTNESS

It is for adjusting the brightness of the video output.

CONTRAST

It is for adjusting the contrast of the video output

HUE

It is for adjusting the hue of the video output.

SATURATION

It is for adjusting the saturation of the video output.

SHARPNESS

It is for adjusting the sharpness of the video output.

5.17.5 SPEAKER SETUP**DOWNMIX**

It is for selecting your desired sound effect when there is no center speaker and subwoofer. There are 3 modes: LT/RT, STEREO, VSS.

LT/RT: When playing a disc with PRO LOGIC Dolby stereo effect, choose the item, so it will output audio signal with vivid theatre effect.

STEREO: If you choose the item, when outputting audio signal with 5.1 channels, it will output the left and right channels of signal ; when outputting audio signal with 2 channels, it will output the common 2 channels of stereo signal.

VSS: If you choose the item, when playing a disc recorded with 5.1 channels, the main channel speakers can output audio signal with VSS effect.

5.17.6 OUTPUT SETUP**DYNAMIC RANGE**

After selecting the compression mode of LINE OUT, set the item, so you can adjust the linear compression ratio. If you set it to be FULL, the Peak-to-Peak value of the audio signal is the minimum; if you set it to be OFF, the Peak-to-Peak value is the maximum.

DUAL MONO

It is for selecting a desired audio output mode for the left and right ways of signal.

It is mainly for Karaoke of Ac3. There are 4 modes in all as follows:

STEREO, MONO L, MONO R, MIX MONO.

5.18 The Parental Control

Q:After inserting DVD disc into disc compartment, a dialogue window will appear asking for a password of 4 digits. Why ?

A:This is because that the disc movie you are playing was rated with the Parental Control, and the current rating level of DVD player is lower than one of current disc. You must input right password and enter it to entry Parental Control setup menu and then set a equal or higher rating level than one of current disc. So that you can playback the disc.

! NOTE

- * If you have not changed the password, the factory preset password for the DVD player will be empty. So that you should input a desired password and input it again to verify it to enter the Parental Control setup menu.
- * For the rating level setup of Parental Control of the DVD player, please refer to the relative content of LOCK setup menu for details.

Accessories: Parental Control

The Parental Control function of a DVD player can control the playback of movie rated level in a disc. Can set the DVD player(include software player in PC) to be a certain rating level with SETUP MENU on TV screen.If the rating level set in the disc is higher than one set in the DVD player, the DVD player can not playback the disc. Sometimes the Parental Control sequences in some discs are different from each other. The rating level setup can be protected by the password. Therein, if you select Unlock item, the Parental Control function will be invalid, the content of disc will be played totally.

The disc movie can be designed as that the DVD player will playback the different version of content of a same movie according to the different rating level set by Parental Control. Depend on the DVD feature of seamless switching described above, the scenes that are not fitting for children will be cleared or replaced by the other fitting scene automatically.

All rating levels of Parental Control are as follows:

- | | |
|---|----------|
| | Unlock |
| 1 | Kid Safe |
| 2 | G |
| 3 | PG |
| 4 | PG 13 |
| 5 | PG R |
| 6 | R |
| 7 | NC 17 |
| 8 | Adult |

5.19 The Region Code

Q: No DVD playback. Screen displays REGION ERROR after inserting disc into disc compartment. Why ?

A: Because the DVD player and disc have different region codes. If they do not match, the DVD player cannot play the disc.

Appendix: The region code of DVD:

The Motion Picture Association of America (MPAA) divided the world into 6 regions, and named every region a code, namely region code. The region codes and the countries or areas represented by the region codes are as follows:

Region 1: America, Canada, East-Pacific Inlands;

Region 2: Japan, West Europe, North Europe, Egypt, South Africa, Middle East;

Region 3: South-east Asian countries include Taiwan, Hong Kong, South Korea, Thailand, Indonesia, etc.;

Region 4: Australia, New Zealand, Central South America, South Pacific Inlands;

Region 5: Russia, Mongolia, Indian Peninsula, Middle Asia, East Europe, North Korea, North Africa, North-west Asia etc.;

Region 6: China mainland.

6. BLUE TOOTH HANDFREE SYSTEM

1. Pairing and connection

- 1) Turn on the Bluetooth mode of the mobile phone;
- 2) Select the item of Finding the Bluetooth Device and enter it. After finishing the finding, it will show the name of the Bluetooth Device if finding a Bluetooth Device. Select it and enter it, then it will show a interface that ask you to input a password, input the password 0000 and then enter it. Then it will tell you pair OK.
- 3) For some mobile phones, they can automatically connect with the BT device of the car audio system after pairing is ok; for some mobile phones, they need to select the paired BT device and press the CONNECTION button . When connection is ok, the LCD of the car audio system will show LINK OK.

2. Use the mobile phone to do connection or disconnection

In the connection status, find the paired and connected Bluetooth Device, then press the disconnection button to do disconnection.

In the disconnection status, find the paired and disconnected Bluetooth Device, then press the connection button to do connection.

3. In the connection status: Mobile phone transfers to the car audio whenever a dialling takes place; Mobile phone transfers to the car audio whenever receiving a call.

4. Dialling when in connection status

4.1 Dial with the mobile phone directly.

4.2 Dial with remote control with the following procedures:

(1) Input telephone number with number buttons 0-9

- * Short press CLEAR button to cancel the wrongly input number if necessary

(2) Short press TEL to execute the dialling.

4.3 To redial the last phone number dialed

- (1) Short press TEL button ,it will show last phone number on LCD, then it will execute the dialling
- (2) Short press REDIAL button, It will dial the last phone number.

5. Accept/Reject/End Call

5.1 Incoming call Ringing, short press TEL button to accept the call

5.2 To reject incoming call, short press HANG UP button to reject the call

5.3 During a phone call, short press HANG UP button to end the call

Note: When a incoming call is present the caller's phone number will be displayed on the screen.

6. Dialling or receiving call when the unit is in standby (while your phone is paired)
When the Stereo is in sleep mode (Acc on and standby), to execute a dialling (with mobile phone) or receiving a call, the car audio will temporarily wake up.

7. To play a AUDIO file from a external bluetooth device (mobile phone) on the Wall mount Stereo

After the device has been paired successfully and the Wall mount Stereo screen displays LINK OK.

If your mobile device supports A2DP you will then be able to stream music from your Blue Tooth device so it can be played by the stereo speaker.

You must select on your mobile blue tooth device to play the audio through bluetooth.

If your mobile device supports AVRCP then you will be able to control the basic phone audio output functions by the Wall mount Stereo controls. Eg. Play Pause.

7. The Trouble Shooting

Please read the user's manual carefully before using the DVD player. If you have any problems with this product please refer to the below Trouble shooting guide to help you resolve the issue.

NO PICTURE, SOUND AND INDICATION

- * Ensure that the power switch is on.
- * Ensure that the wall inlet is ok.
- * Ensure that the power cord is not damaged or the fuse is not blown.
- * Ensure that the power plug is connected to the inlet tightly.

NO SOUND BUT PICTURE OK

- * Ensure that the player's audio output has a good connection with TV's audio input.
- * Check whether the audio connector is damaged.
- * Check whether you have turned down the volume.
- * Ensure that you have set the right AUDIO setup of the player.
- * Ensure that the audio is not under mute.

NO PICTURE BUT SOUND OK

- * Ensure that the player's video output has a good connection with TV's video input.
- * Ensure that you have turned your TV to the AV input channel connecting to your player.
- * Check whether the video connector is damaged.
- * Ensure that you have set the right VIDEO settings of the player.

BLACK AND WHITE PICTURE OR SCREEN ROLLING

- * Ensure that you have set the right TV SYSTEM (e.g. PAL, NTSC) setting.

FLAWS OF PICTURE OR SOUND

- * Check whether the setting of AUDIO is right.
- * Check whether the disc is scratched or stained.
- * Check whether the AV connector and the output terminal is stained.
- * Check whether there is condensation inside the Lens. If so, leave the player off for an hour or so, then try again.
- * Check whether the installation angle is less than 30°.

DISPLAY NO DISC OR BAD DISC

- * Ensure that you have put the disc on the tray.
- * Check whether the disc is put in the reverse side.
- * Check whether the disc is distorted.
- * Check whether the disc is stained or scratched badly.
- * Ensure that the disc format is compatible to the player.
- * Ensure that the temperature inside the car is not too high. If so, cool off until the ambient temperature returns to normal.
- * Replace another disc to insert it into the disc compartment.

REMOTE CONTROL IS INSENSITIVE OR DOES NOT WORK

- * Check the batteries of remote control and make sure that they are not flat.
- * Direct the remote control to the IR sensor of the player.
- * Check whether there are some obstacles between the remote control and IR sensor.

SOME FUNCTION BUTTONS DO NOT WORK

- * Turn off the power, then turn on again.
- * Reset the unit to zero, then turn on again.
- * Remove the front panel from the unit, then install it again and then turn on again.

THE RADIO DOES NOT WORK

- * Check whether the antenna cable is connected firmly. Or manually tune for a station.

STEREO FUNCTIONS LOCK UP or BLUE TOOTH FUNCTION IS NOT RESPONDING TO DEVICE

- * Use a metal pin to press the software reset button in the recess hole on the front of the stereo.

8. Specification

General Specification

Power Supply Requirement.....	DC 12V
Maximum Power Output.....	6 x 25W RMS 6x40W Max(at DC 14.4 V)
Maximum Sub woofer Power Output.....	1 x 50W
Dimensions(w x h x d).....	281 x 173 x 175mm

DVD Deck Specification

Format.....	DVD/VCD/JPEG/MP4/MP3/WMA/CD
Video System.....	NTSC/PAL/PAL-M/PAL-N/AUTO(optional)
Audio System.....	24 bit/96KHz
Loading System.....	Auto Loading
Mounting Angle.....	0 to +/-30

Video Specification

Video Type.....	16:9 and 4:3
Video Output level.....	Composite:1.0± 0.2Vp-p Load impedance: 75 ohms
Horizontal Resolution.....	600

Audio Specification

Audio Output(Analog audio).....	2.0 ⁺⁰ -1.0Vrms
Frequency Response.....	20Hz ~ 20KHz(at 1KHz 0 dB)
S/N Ratio(Audio).....	≥90dB(at 1KHz 0 dB)
Separation.....	50dB
Speaker Output.....	4 Ω Min Load (connect 4 - 8 Ω speakers)

Radio Specification

FM Section

Frequency range.....	87.5MHz - 107.9MHz(US) 87.5MHz - 108.0MHz(EU)
Usable sensitivity.....	3uV
I.F Frequency.....	10.7MHz

AM Section

Frequency.....	530KHz - 1710KHz(US) 522KHz - 1620KHz(EU)
----------------	--