

FLUKE®

62 MAX/62 MAX +

Infrared Thermometer

Users Manual

Introduction

The Fluke 62 MAX and 62 MAX + Infrared Thermometers (the Product) can determine the surface temperature by measuring the amount of infrared energy radiated by the target's surface. Note that the Japanese models indicate Celsius only.

Warning

Read all safety information before you use the Product.

Safety Information

A **Warning** identifies conditions and procedures that are dangerous to the user. A **Caution** identifies conditions and procedures that can cause damage to the Product or the equipment under test.

Table 1 tells you about symbols used on the Product and in this manual.

Warning

To prevent eye damage and personal injury:

- **Read all safety Information before you use the Product.**
- **Do not use the Product if it operates incorrectly.**
- **Use the Product only as specified, or the protection supplied by the Product can be compromised.**
- **Before you use the Product, inspect the case. Do not use the Product if it appears damaged. Look for cracks or missing plastic.**

- **See emissivity information for actual temperatures. Reflective objects result in lower than actual temperature measurements. These objects pose a burn hazard.**
- **Do not look directly into the laser with optical tools (for example, binoculars, telescopes, microscopes). Optical tools can focus the laser and be dangerous to the eye.**
- **Do not look into the laser. Do not point laser directly at persons or animals or indirectly off reflective surfaces.**
- **Replace the batteries when the low battery indicator shows to prevent incorrect measurements.**
- **Do not use the Product around explosive gas, vapor, or in damp or wet environments.**
- **Use the Product only as specified or hazardous laser radiation exposure can occur.**

Table 1. Symbols







Symbol	Meaning	Symbol	Meaning
	Risk of danger. Important information. See Manual.		This product complies with the WEEE Directive (2002/96/EC) marking requirements. The affixed label indicates that you must not discard this electrical/electronic product in domestic household waste. Product Category: With reference to the equipment types in the WEEE Directive Annex I, this product is classed as category 9 "Monitoring and Control Instrumentation" product. Do not dispose of this product as unsorted municipal waste.

Table 1. Symbols (cont.)

Symbol	Meaning	Symbol	Meaning
	Warning. Laser.		Conforms to European Union directives.
	Battery		Conforms to relevant Australian standards.
 沪制01120009号	Conforms to China Metrology Certification		

Maintenance

Caution

To avoid damage to the Product, do not leave the thermometer on or near objects of high temperature.

How to Change the Battery

To install or change the AA IEC LR06 battery, open the battery compartment and replace the battery as shown in Figure 16.

How to Clean the Product

Use soap and water on a damp sponge or soft cloth to clean the Product case. Carefully wipe the surface with a moist cotton swab. The swab may be moistened with water. See Figure 17.

Specifications

	62 MAX	62 MAX +
Temperature Range	-30 °C to 500 °C (-22 °F to 932 °F)	-30 °C to 650 °C (-22 °F to 1202 °F)
Accuracy (Calibration geometry with ambient temperature 23 °C ±2 °C)	<p>≥0 °C: ±1.5 °C or ±1.5 % of reading, whichever is greater (≥32 °F: ±3 °F or ±1.5 % of reading, whichever is greater)</p> <p>≥ -10 °C to <0 °C: ±2 °C (≥14 °F to <32 °F: ±4 °F)</p> <p>< -10 °C: ±3 °C (<14 °F: ±6 °F)</p>	<p>≥0 °C: ±1 °C or ±1 % of reading, whichever is greater (≥32 °F: ±2 °F or ±1 % of reading, whichever is greater)</p> <p>≥ -10 °C to <0 °C: ±2 °C (≥14 °F to <32 °F: ±4 °F)</p> <p>< -10 °C: ±3 °C (<14 °F: ±6 °F)</p>
Response Time (95 %)	<500 ms (95 % of reading)	<300 ms (95 % of reading)
Spectral Response	8 to 14 microns	
Emissivity	0.10 to 1.00	
Temperature Coefficient	±0.1 °C/°C or ±0.1 %/°C of reading (whichever is greater)	

62 MAX/62 MAX + Users Manual

Optical Resolution	10:1 (calculated at 90 % energy)	12:1 (calculated at 90 % energy)
Display Resolution	0.1 °C (0.2 °F)	
Repeatability (% of reading)	±0.8 % of reading or ±1.0 °C (2 °F), whichever is greater	±0.5 % of reading or ±0.5 °C (1 °F), whichever is greater
Power	1 AA IEC LR06 Battery	
Battery Life	10 hours with laser and backlight on	8 hours with laser and backlight on
Weight	255 g (8.99 oz)	
Size	(175 x 85 x 75) mm (6.88 x 3.34 x 2.95) inches	
Operating Temperature	0 °C to 50 °C (32 °F to 122 °F)	
Storage Temperature	-20 °C to 60 °C (-4 °F to 140 °F), (without battery)	
Operating Humidity	10 % to 90 % RH non-condensing @ 30 °C (86 °F)	
Operating Altitude	2000 meters above mean sea level	
Storage Altitude	12,000 meters above mean sea level	

Infrared Thermometer
Standards and Agency Approval

Ingress Protection Rating	IP 54 per IEC 60529
Drop Test	3 meters
Vibration and Shock	IEC 60068-2-6 2.5 g, 10 to 200 Hz, IEC 60068-2-27, 50 g, 11 ms
EMC	EN 61326-1:2006 EN 61326-2:2006

Standards and Agency Approval

Compliance EN/IEC 61010-1
Laser Safety EN 60825-1 Class 2
Implement Standard Q/SXAV37

The Product

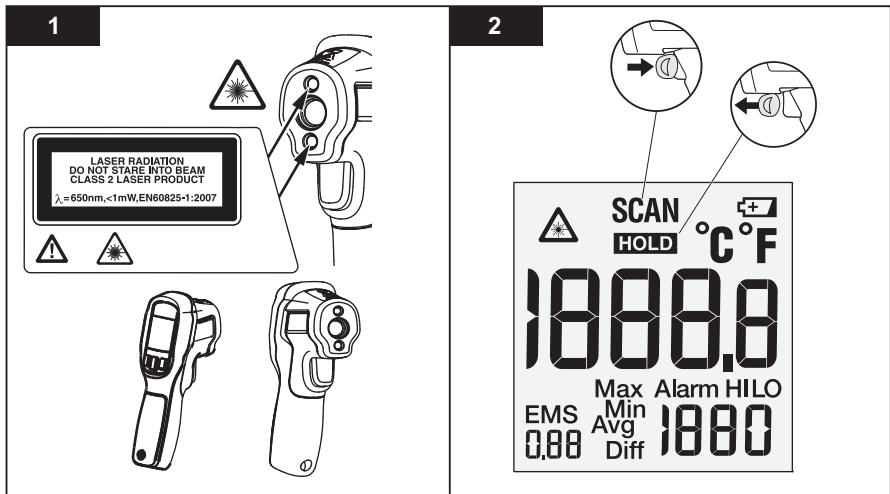

3

4

°F/°C

5

EMS

5

6

Max/Min/Avg/Diff

△ SCAN °F	△ SCAN °F	△ SCAN °F	△ SCAN °F
68.0	68.0	68.0	68.0
EMS 0.95 Max 90	EMS 0.95 Min 68	EMS 0.95 Avg 76	EMS 0.95 Diff 22
SEL	SEL	SEL	SEL

7

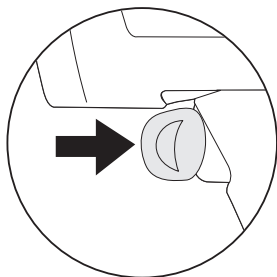
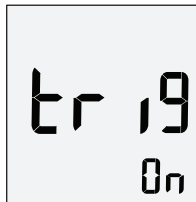

+

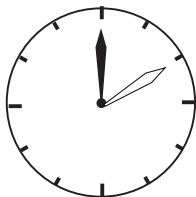

=

10 min



OFF

gtt16.eps

Infrared Thermometer

The Product

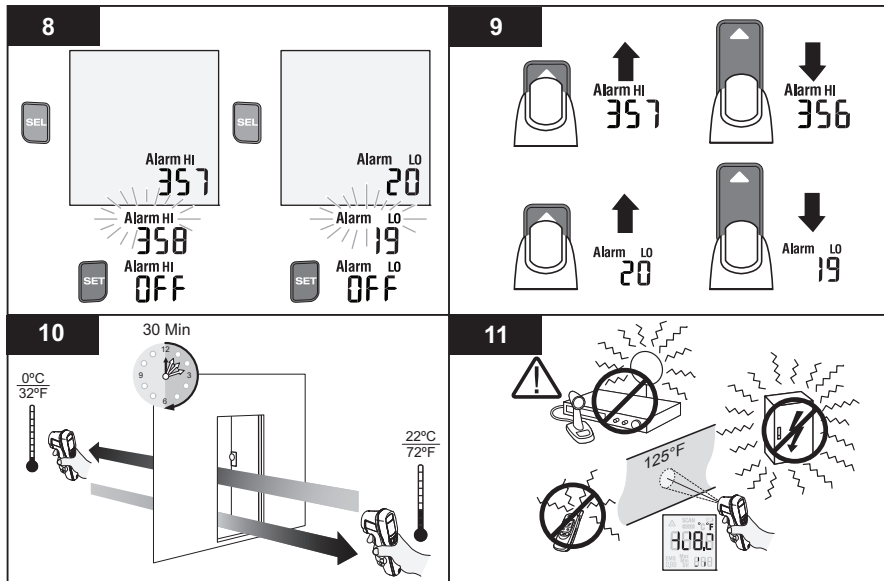

gtt15.eps

62 MAX/62 MAX +

Users Manual

12

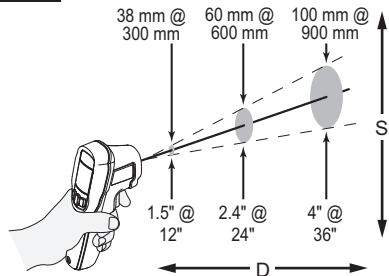

62 MAX
D:S = 10:1

13

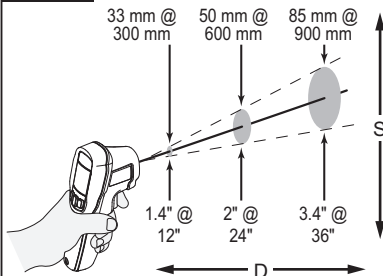

62 MAX +
D:S = 12:1

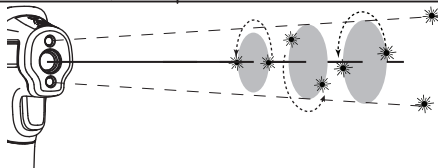

gtt08-11.eps

Infrared Thermometer

The Product

14

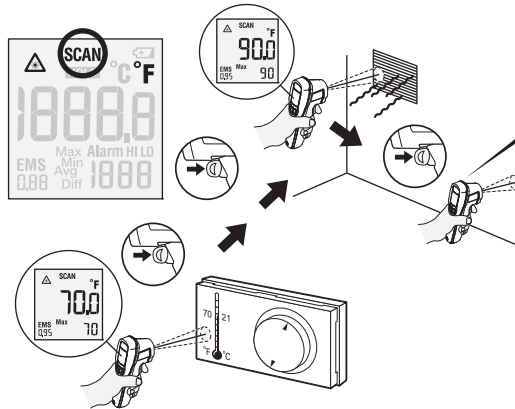

SCAN	°F	68.0	EMS Max 90
SEL	SCAN	°F	68.0
	EMS Min 68		
SEL	SCAN	°F	68.0
	EMS Avg 76		
SEL	SCAN	°F	68.0
	EMS Diff 22		

SCAN

The diagram shows three hands holding the infrared thermometer and scanning across a surface. A 'SCAN' label with an arrow points to the right. A callout shows the display with 80.0°F and EMS Min 70.

gtt03.eps

15

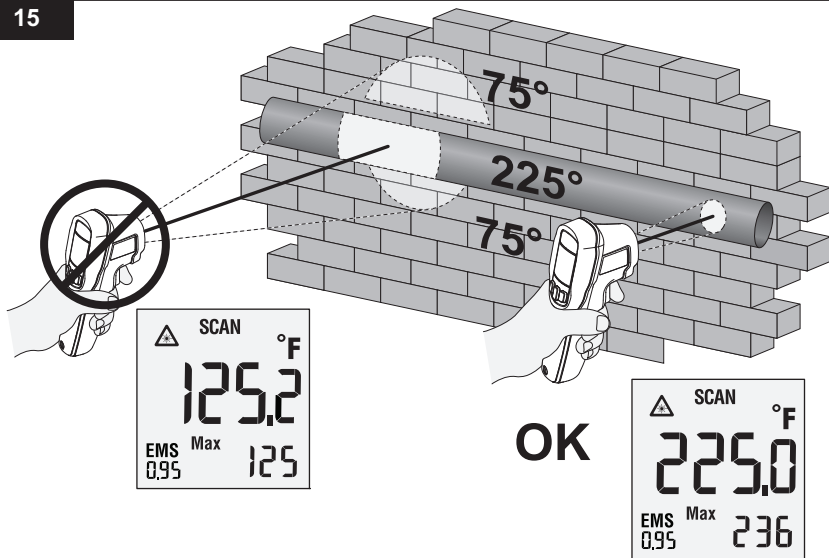

gtt04.eps

Infrared Thermometer
The Product

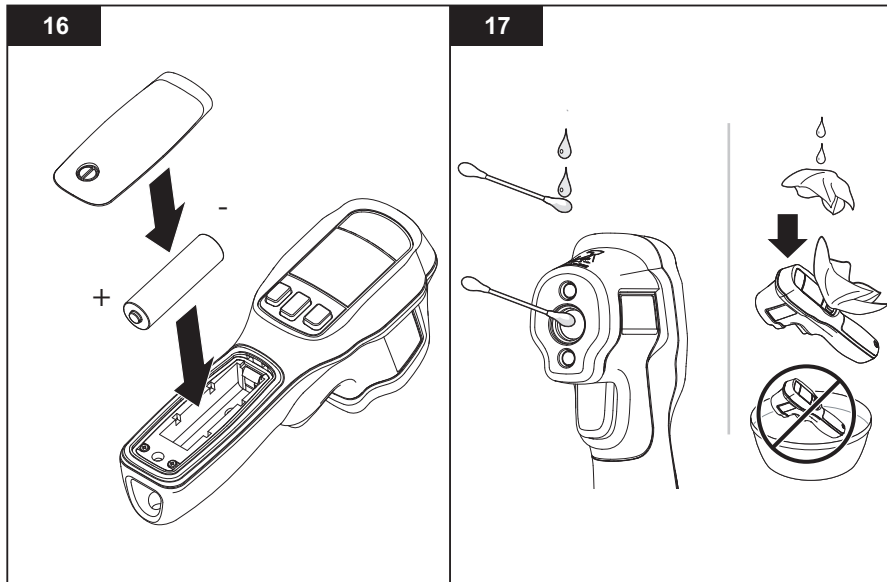

Shop for other automotive tools on our website.