

FLO ~ PRO

PERFORMANCE EXHAUST



2018

FULL-LINE CATALOG

DIESEL EXHAUST - MUFFLERS - TIPS & STACKS - ELBOWS - CLAMPS - X/Y PIPES

WHAT WE OFFER



COMPANY PROFILE

Founded in 1981, FLO~PRO Performance Exhaust has always been on the leading edge of exhaust manufacturing. Everything from mufflers for your car, SUV or truck, to 4"-5" direct fit Diesel Exhaust kits for your big diesel engine. No matter what you drive, FLO~PRO has a product that is made from only the highest quality materials to meet your exact needs. Our mission is to provide quality customer service along with the highest quality exhaust components made with the customer in mind to allow for easy and painless installation.

DIESEL EXHAUST

Our diesel exhaust kits are made from 16ga CNC mandrel bent steel. Offering both Aluminized and T409 stainless steel exhaust systems, we have one of the most diverse products on the market. We have direct fit exhaust kits for your Cummins, Duramax or Powerstroke! With all pre-bent and pre-welded hangers, you never have to guess where a pipe goes. Everything just fits right into place.



TIPS & STACKS

We also offer the largest selection of polished T304 stainless steel exhaust tips & 6"-8" stacks to put the finishing touch to the best sounding exhaust in the industry! So whether you've got a diesel relic, a shiny rig right off the lot or ANYTHING in between, your performance exhaust solution is with FLO~PRO.

UNIVERSAL MUFFLERS

We are all about options at FLO~PRO. Not all mufflers, vehicles and customers are created equal. Our selection of direct and universal fit mufflers offer a wide variety of sound and performance gains. We are confident that we have a solution for even the most particular customer needs.

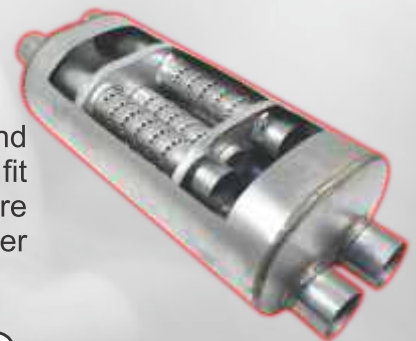

PIPES & TUBING

We also offer a wide selection of universal bends and X/Y pipes to complement any custom exhaust setup. Our universal mandrel bends are available in aluminum, aluminized and polished T304 stainless steel. Size ranges from 1 1/2" to 5" OD. If it is exhaust related, we have got you covered!

TABLE OF CONTENTS

DIRECT FIT EXHAUST SYSTEMS	6-39
GMC/CHEVROLET DURAMAX _____	6-17
FORD POWERSTROKE _____	18-27
DODGE CUMMINS _____	28-37
LIGHT DUTY TRUCKS (ECODIESEL, TITAN XD, CANYON, ECOBOOST, POWER WAGON) _____	38-39
EGR RACE KITS	40-45
DURAMAX _____	40
POWERSTROKE _____	40-42
CUMMINS _____	43-45
DIESEL ACCESSORIES	46-47
MUFFLER REPLACEMENT PIPES _____	46
TAIL PIPES, CLAMPS, Y-PIPES _____	47
EXHAUST TIPS & STACKS	48-64
DIESEL TIPS _____	48-51
DIESEL STACKS _____	52
VARIOUS OUTLET _____	54-62
BLACK CHROME _____	63
BLACK POWDER COATED _____	64
RESONATORS	66-71
TWISTER _____	66-67
GLASS PACKS _____	68-70
BAFFLE PACKS _____	71
UNIVERSAL MUFFLERS	72-92
POLISHED STAINLESS _____	72
FLO~PRO ORIGINAL _____	73-77
HEAVY DUTY _____	78-81
HD BIG OVAL _____	82-83
FLO~MAX _____	84-88
SUPER V _____	89-92
UNIVERSAL ACCESSORIES	93-97
UNIVERSAL MANDREL BENDS _____	93-95
Y-PIPES, X-PIPES, HEADER COLLECTORS _____	96
DEALER P.O.S. MATERIALS _____	97
PART NUMBER INDEX _____	98-102

THE FLO~PRO DIFFERENCE

MACHINED TURBO FLANGE



We make our exhaust systems stronger where they need to be the strongest with machined turbo flanges. Most of our systems come with a machined flange that matches perfectly to your stock or aftermarket turbo.

The alternative construction of a turbo flange is to over expand the pipe and flare it out. We used to do that, but that process created a weak spot in the 16ga steel and often had to replace downpipes for damages caused by stress and vibrations off the turbo. If you order a FLO~PRO kit, your turbo clamp will thank you!

WON'T CLAMP YOUR STYLE

Exhaust pipes were made round, they should stay that way! FLO~PRO includes lapjoint style clamps in every kit we sell. Lapjoint clamps keep the pipe round and have two (2) independent bolts that need to be torqued to 50lbft for an everlasting hold. Since the exhaust is not being damaged by saddle clamps or u-bolt clamps, modifications down the road are made simple. If your pipe has been damaged by a saddle clamp, you could end up having to replace your entire exhaust system.

Another bonus is that if you order a stainless exhaust system, we include stainless clamps. Sure, aluminized clamps are cheaper and do the same thing, but you ordered a stainless exhaust! Everything is stainless from the flange, clamps, hanger and even the weld.



CONTOUR BENT HANGERS

Why would you buy a system that only has 1" of weld holding the hangers on? Your truck works as hard as you do and hangers take a beating. We machine all our exhaust hangers to contour to the shape of the pipe. This allows us to apply a longer bead of weld to the hanger to greatly reduce hanger failure. Where there was once less than one inch (1") of weld before, now we have 4-6" of weld on our hangers. Using alternative hanger clamps causes unnecessary stress and added time to installing your kit. The clamps don't typically have a whole lot of surface area to weld, so we try and avoid using them as much as possible.



DIRECT FIT EXHAUST SYSTEMS

DURAMAX - POWERSTROKE - CUMMINS - LIGHT DUTY

PAGES 6-39

EGR RACE KITS

DURAMAX - POWERSTROKE - CUMMINS



PAGES 40-45



UNIVERSAL DIESEL ACCESSORIES

TAILPIPES - ADAPTERS - MUFFLER DELETE

PAGES 46-47

IMPORTANT

Any product that requires the removal of ANY emissions control device is strictly prohibited and is intended for closed course racing only for non-registered vehicles.

1994-2000 6.5L GMC/CHEV

TURBO BACK SINGLE SYSTEM



4" Turbo Back Single

ALUMINIZED STAINLESS

1994-2000 6.5L, 1500/2500/3500, Race Exhaust, 3" Downpipe
 EC-CC/SB-LB-Dually. **19410** sold separately.....
 No Muffler Kit, Pickup ONLY!

822
822NM

SS822
SS822NM

2 1/2" CROSSOVER PIPE



19410

Get all the power out of your 6.5L diesel & bolt-on the 4" turbo-back (**822** kit) with crossover pipe (**19410**).

3" TURBO DIRECT PIPES (2001-2010)



2001-2004
10101

*Will not fit LLY, LBZ, LMM or ANY California EGR emission trucks!



2004.5-2010
10100

WARNING

Any product that requires the removal of ANY emissions control device is strictly prohibited and is intended for closed course racing only for non-registered vehicles. Our systems were designed to fit factory vehicles without ANY after market 5th wheel or in-bed gooseneck hitches, chassis mods etc.

2001-2007 DURAMAX

EGR KITS ON PG. 40

DOWNPIPE BACK SINGLE SYSTEM



4" Downpipe Back Single

ALUMINIZED STAINLESS

2001-2007 6.6L, 2500/3500, LB7-LLY-LBZ, Race Exhaust

Off Road, EC-CC/SB-LB-Dually, Pickup ONLY! 801 SS801

No Muffler Kit, Pickup ONLY! 801NM SS801NM

5" Downpipe Back Single

ALUMINIZED STAINLESS

2001-2007 6.6L, 2500/3500, LB7-LLY-LBZ, Race Exhaust, 4" Cat Pipe

Off Road, EC-CC/SB-LB-Dually, Pickup ONLY! 601 SS601

No Muffler Kit, Pickup ONLY! 601NM SS601NM

DOWNPIPE BACK DUAL SYSTEM



4" Downpipe Back Duals

ALUMINIZED STAINLESS

2001-2007 6.6L, 2500HD, Excludes Dually, Race Exhaust

Off Road, EC-CC/SB-LB, See Note, Pickup ONLY! 701 SS701

2001-2007 6.6L, 3500, LB7-LLY-LBZ, Dually, Pickup ONLY! 726 SS726

***Note:** Dual tail pipes may not fit or require modifications with suspension mods, air bags and/or hitches.

WARNING

Any product that requires the removal of ANY emissions control device is strictly prohibited and is intended for closed course racing only for non-registered vehicles. Our systems were designed to fit factory vehicles without ANY after market 5th wheel or in-bed gooseneck hitches, chassis mods etc.

2001-2007 DURAMAX

CAT BACK SINGLE SYSTEM



4" Cat Back Single

ALUMINIZED STAINLESS

2001-2005 6.6L, 2500/3500, LB7-LLY, Factory 4 Bolt Flange
EC-CC/SB-LB-Dually, Pickup ONLY! **823** **SS823**

2001-2007 6.6L, 2500/3500, LB7-LLY-LBZ, No Flange
EC-CC/SB-LB-Dually, Pickup ONLY! **820** **SS820**

CAT BACK DUAL SYSTEM



4" Cat Back Duals

ALUMINIZED STAINLESS

2001-2005 6.6L, 2500/3500, LB7-LLY, Factory 4 Bolt Flange
EC-CC/SB-LB-Dually, Pickup ONLY! **723** **SS723**

2001-2007 6.6L, 2500HD, LB7-LLY-LBZ, Excludes Dually
EC-CC/SB-LB, See Note, Pickup ONLY! **720** **SS720**

2001-2007 6.6L, 3500, LB7-LLY-LBZ, Dually, See Note, Pickup ONLY! **727** **SS727**

***Note:** Dual tail pipes may not fit or require modifications with suspension mods, air bags and/or hitches.

WARNING

Any product that requires the removal of ANY emissions control device is strictly prohibited and is intended for closed course racing only for non-registered vehicles. Our systems were designed to fit factory vehicles without ANY after market 5th wheel or in-bed gooseneck hitches, chassis mods etc.

2007.5-2010 DURAMAX

EGR KITS ON PG. 40

CAT & DPF RACE PIPES



4" Cat & DPF Race Pipes

	LENGTH	ALUMINIZED	STAINLESS
2007-2010 6.6L, 2500/3500, LMM, Pickup ONLY! With 4-Bolt Flange, No Bungs	48 3/4"	10810	40810
2007-2010 6.6L, 2500/3500, LMM, DPF Race Pipe Regular Cab Long Box, No Bungs.....	30 3/8"	18253	48253
Extended Cab Short Box, No Bungs.....	41 1/8"	18223	48223
Extended Cab Long Box, No Bungs.....	55 1/4"	18243	48243
Crew Cab Short Box, No Bungs.....	50 3/8"	18213	48213
Crew Cab Long Box, No Bungs.....	63"	18233	48233

CAT BACK SINGLE SYSTEM - CAB & CHASSIS



4" Cat Back Single

	ALUMINIZED	STAINLESS
2007.5-2010 6.6L, 2500/3500, LMM, Cab & Chassis, Race Exhaust Regular Cab, Cab & Chassis ONLY!	851	-

***Note:** Does not work on ambulance or similar chassis models.

WARNING

Any product that requires the removal of ANY emissions control device is strictly prohibited and is intended for closed course racing only for non-registered vehicles. Our systems were designed to fit factory vehicles without ANY after market 5th wheel or in-bed gooseneck hitches, chassis mods etc.

2007.5-2010 DURAMAX

DPF BACK SINGLE SYSTEM



5" DPF Back Single

ALUMINIZED STAINLESS

2007.5-2010 6.6L, 2500/3500, LMM, w/ Tip
 EC-CC/SB-LB-Dually, Pickup ONLY!

628 -

DPF BACK DUAL SYSTEM



4" DPF Back Duals

ALUMINIZED STAINLESS

2007.5-2010 6.6L, 2500/3500, LMM, w/ Tips
 EC-CC/SB-LB , Pickup ONLY!

728 -

***Note:** Dual tail pipes may not fit or require modifications with suspension mods, air bags and/or hitches.
 Redirecting of brake lines is required for installation of this kit.

3" TURBO DIRECT PIPE



2004.5-2010
10100

WARNING

Any product that requires the removal of ANY emissions control device is strictly prohibited and is intended for closed course racing only for non-registered vehicles. Our systems were designed to fit factory vehicles without ANY after market 5th wheel or in-bed gooseneck hitches, chassis mods etc.

2007.5-2010 DURAMAX

EGR KITS ON PG. 40

DOWNPIPE BACK SINGLE SYSTEM



4" Downpipe Back Single

ALUMINIZED STAINLESS

2007.5-2010 6.6L, 2500/3500, LMM, Race Exhaust

EC-CC/SB-LB-Dually, Pickup ONLY!

834 SS834
834NM SS834NM

No Muffler Kit, Pickup ONLY!

5" Downpipe Back Single

ALUMINIZED STAINLESS

2007.5-2010 6.6L, 2500/3500, LMM, Race Exhaust, 4" Cat Pipe

EC-CC/SB-LB-Dually, Pickup ONLY!

634 SS634
634NM SS634NM

No Muffler Kit, Pickup ONLY!

DOWNPIPE BACK DUAL SYSTEM



4" Downpipe Back Duals

ALUMINIZED STAINLESS

2007.5-2010 6.6L, 2500/3500, LMM, Race Exhaust

EC-CC/SB-LB, Pickup ONLY!

734 -

***Note:** Dual tail pipes may not fit or require modifications with suspension mods, air bags and/or hitches.

WARNING

Any product that requires the removal of ANY emissions control device is strictly prohibited and is intended for closed course racing only for non-registered vehicles. Our systems were designed to fit factory vehicles without ANY after market 5th wheel or in-bed gooseneck hitches, chassis mods etc.

2011-2015 DURAMAX

CAT & DPF RACE PIPES



4" Cat & DPF Race Pipes

ALUMINIZED STAINLESS

2011-2015* 6.6L, 2500/3500, LML Cat & DPF Race Kit w/ Adapter
EC-CC/SB-LB w/o 4-Bolt Flange - Clamp Incl. **862** **SS862**

2011-2015* 6.6L, 2500/3500, LML Cat Race Pipe
EC-CC/SB-LB w/ 4-Bolt Flange..... **11111** **41111**

2011-2015* 6.6L, 2500/3500, LML DPF Race Pipe
EC-CC/SB-LB w/ Adapter & 4-Bolt Flange **11112** **41112**

***Note:** These kits will only fit models equipped with v-band clamp and will not work for trucks equipped with the 3-bolt flange off the turbo direct pipe! You can alternatively order the turbo direct pipe #10102 to use with this exhaust. Please see our 2015.5+ exhaust on page 14. These kits may also fit Cab & Chassis with some modification.

CAT BACK SINGLE SYSTEM



4" Cat Back Single

ALUMINIZED STAINLESS

2011-2015 6.6L, 2500/3500, LML, Race Exhaust
EC-CC/SB-LB-Dually, Pickup ONLY! **860** **SS860**
No Muffler Kit, Pickup ONLY! **861** **SS861**

5" Cat Back Single

ALUMINIZED STAINLESS

2011-2015 6.6L, 2500/3500, LML, Race Exhaust
EC-CC/SB-LB-Dually, Pickup ONLY! **660** **SS660**
No Muffler Kit, Pickup ONLY! **661** **SS661**

4" Cat Back Duals

ALUMINIZED STAINLESS

2011-2015 6.6L, 2500/3500, LML, Race Exhaust
EC-CC/SB-LB No-Muffler, Pickup ONLY! **761** **SS761**

***Note:** Dual tail pipes may not fit or require modifications with suspension mods, air bags and/or hitches.
To make a full downpipe back kit, add a **11111** pipe to any of these cat back kits.

WARNING

Any product that requires the removal of ANY emissions control device is strictly prohibited and is intended for closed course racing only for non-registered vehicles. Our systems were designed to fit factory vehicles without ANY after market 5th wheel or in-bed gooseneck hitches, chassis mods etc.

2011-2015 DURAMAX

EGR KITS ON PG. 40

DOWNPIPE BACK SINGLE SYSTEM



4" Downpipe Back Single

ALUMINIZED STAINLESS

2011-2015* 6.6L, 2500/3500, LML, Race Exhaust
 EC-CC/SB-LB-Dually, Pickup ONLY!
 No Muffler Kit, Pickup ONLY!

864 SS864
 864NM SS864NM

5" Downpipe Back Single

ALUMINIZED STAINLESS

2011-2015* 6.6L, 2500/3500, LML, Race Exhaust
 EC-CC/SB-LB-Dually, w/ 4" Cat Pipe, Pickup ONLY!
 No Muffler Kit, w/ 4" Cat Pipe, Pickup ONLY!

664 SS664
 664NM SS664NM

***Note:** These kits will only fit models equipped with v-band clamp and will not work for trucks equipped with the 3-bolt flange off the turbo direct pipe!

5" Downpipe Back Duals

ALUMINIZED STAINLESS

2011-2015* 6.6L, 2500/3500, LML, Race Exhaust
 EC-CC/SB-LB No-Muffler, w/ 4" Cat Pipe, Pickup ONLY!

764 -

***Note:** You will have to remove your spare tire for successful installation of this exhaust kit. Dual tail pipes may not fit or require modifications with suspension mods, air bags and/or hitches.

3" TURBO DIRECT PIPE



2011-2015*
10102

***Note:** The turbo direct pipe on some of the 2015 models has a 3-bolt flange instead of a V-band clamp. This pipe will work on 2011-2014 LML Duramax trucks and 2015 LML Duramax without 3-bolt flange or with after market exhaust.

WARNING

Any product that requires the removal of ANY emissions control device is strictly prohibited and is intended for closed course racing only for non-registered vehicles. Our systems were designed to fit factory vehicles without ANY after market 5th wheel or in-bed gooseneck hitches, chassis mods etc.

2015.5-2016 DURAMAX

CAT & DPF RACE PIPE KIT



4" CAT & DPF Race Pipes

ALUMINIZED STAINLESS

2015.5-2016 6.6L, 2500/3500, LML, Race Exhaust
 EC-CC/SB-LB-Dually, w/ OEM 3-Bolt Flange, Pickup ONLY! **872** **SS872**

3" TURBO DIRECT PIPE



2015.5-2016
10103
 w/ 3-Bolt Flange
 Bolts included!

OUR 3-BOLT FLANGE

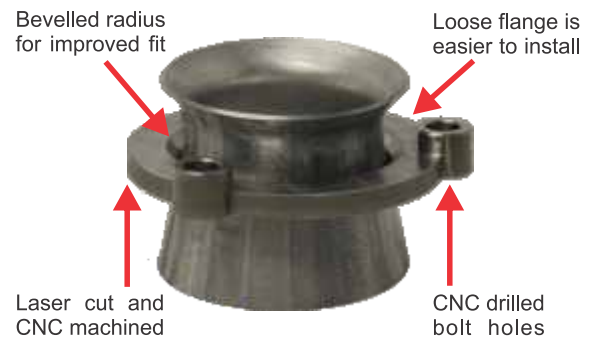

DOWNPIPE BACK SINGLE SYSTEM



4" Downpipe Back Single

ALUMINIZED STAINLESS

2015.5-2016 6.6L, 2500/3500, LML, Race Exhaust (w/ OEM Flange)
 EC-CC/SB-LB-Dually, Pickup ONLY! **871** **SS871**
 No Muffler Kit, Pickup ONLY! **871NM** **SS871NM**

5" Downpipe Back Single

ALUMINIZED STAINLESS

2015.5-2016 6.6L, 2500/3500, LML, Race Exhaust (w/ OEM Flange)
 EC-CC/SB-LB-Dually, w/ 4" Cat Pipe, Pickup ONLY! **671** **SS671**
 No Muffler Kit, w/ 4" Cat Pipe, Pickup ONLY! **671NM** **SS671NM**

WARNING

Any product that requires the removal of ANY emissions control device is strictly prohibited and is intended for closed course racing only for non-registered vehicles. Our systems were designed to fit factory vehicles without ANY after market 5th wheel or in-bed gooseneck hitches, chassis mods etc.

2015.5-2016 DURAMAX

DOWNPIPE BACK DUAL SYSTEM



5" Downpipe Back Duals

ALUMINIZED STAINLESS

2015.5-2016* 6.6L, 2500/3500, LML, Race Exhaust (w/ OEM Flange)
 EC-CC/SB-LB No-Muffler, w/ 4" Cat Pipe, Pickup ONLY! 771 SS771

***Note:** You will have to remove your spare tire for successful installation of this exhaust kit.
 Dual tail pipes may not fit or require modifications with suspension mods, air bags and/or hitches.

2016-2017 CANYON 2.8L

TURBO BACK SINGLE SYSTEM

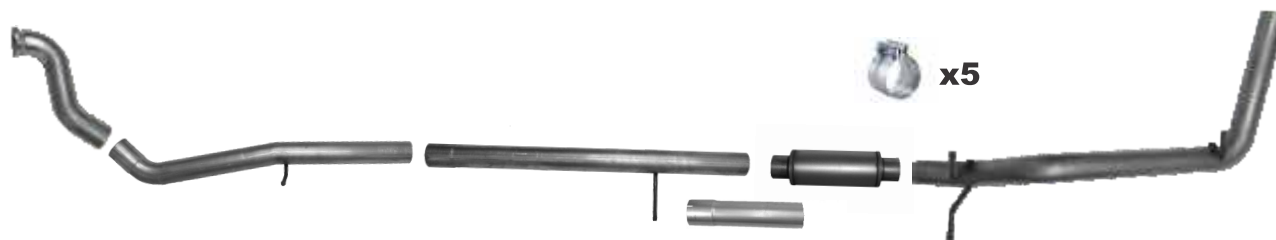

3" Turbo Back Single

ALUMINIZED STAINLESS

2016 2.8L, Chev. Colorado / GMC Canyon, Race Exhaust
 All Wheelbases, With Muffler, 4WD ONLY! 875 SS875

***Note:** Will not fit GMC Savanna or Chevrolet Express vans!

WARNING

Any product that requires the removal of ANY emissions control device is strictly prohibited and is intended for closed course racing only for non-registered vehicles. Our systems were designed to fit factory vehicles without ANY after market 5th wheel or in-bed gooseneck hitches, chassis mods etc.

2017+ DURAMAX

IMPORTANT NOTE

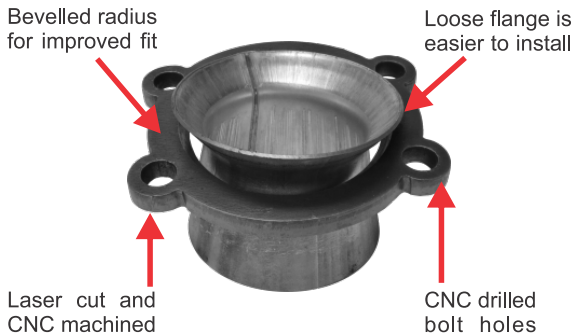

In 2017, GMC made a production change to the connection between the catalytic converter and the turbo direct pipe on the L5P. Please ensure you have the newest **4-bolt style flange** before ordering any of the kits listed on these pages. If you have a 3-bolt flange instead, please refer to our **2015.5-2016 LML** exhaust systems. (pages 14-15)

CAT & DPF RACE PIPE KIT



4" CAT & DPF Race Pipes

ALUMINIZED STAINLESS

2017+ 6.6L, 2500/3500, L5P, Race Exhaust

EC-CC/SB-LB-Dually, w/ OEM 4-Bolt Flange, Pickup ONLY! **882** **SS882**

DOWNPIPE BACK SINGLE SYSTEM



4" Downpipe Back Single

ALUMINIZED STAINLESS

2017+ 6.6L, 2500/3500, L5P, Race Exhaust (w/ OEM Flange)

EC-CC/SB-LB-Dually, Pickup ONLY! **880** **SS880**

No Muffler Kit, Pickup ONLY! **880NM** **SS880NM**

5" Downpipe Back Single

ALUMINIZED STAINLESS

2017+ 6.6L, 2500/3500, L5P, Race Exhaust (w/ OEM Flange)

EC-CC/SB-LB-Dually, w/ 4" Cat Pipe, Pickup ONLY! **680** **SS680**

No Muffler Kit, w/ 4" Cat Pipe, Pickup ONLY! **680NM** **SS680NM**

WARNING

Any product that requires the removal of ANY emissions control device is strictly prohibited and is intended for closed course racing only for non-registered vehicles. Our systems were designed to fit factory vehicles without ANY after market 5th wheel or in-bed gooseneck hitches, chassis mods etc.

2017+ DURAMAX

DOWNPIPE BACK DUAL SYSTEM

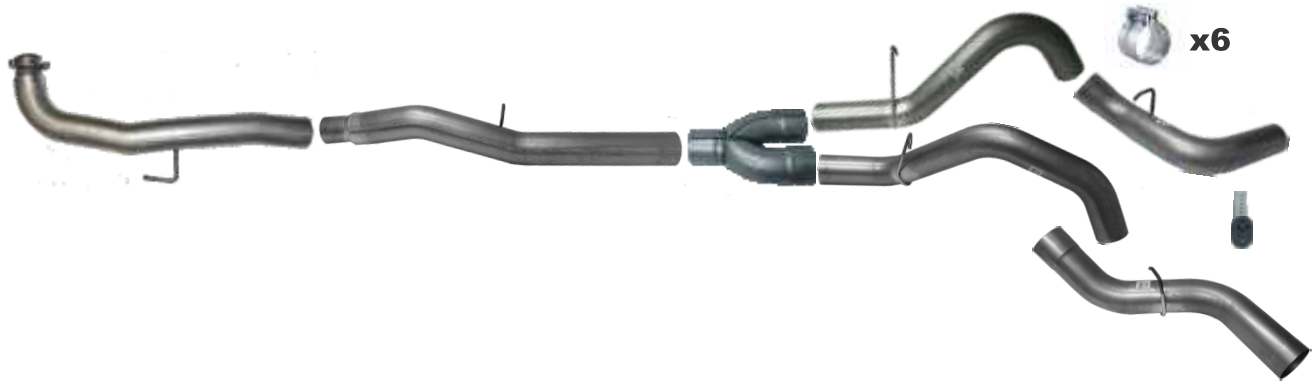

5" Downpipe Back Duals

ALUMINIZED STAINLESS

2017+ 6.6L, 2500/3500, L5P, Race Exhaust (w/ OEM Flange) EC-CC/SB-LB No-Muffler, w/ 4" Cat Pipe, Pickup ONLY!	780	-
--	-----	---

***Note:** You will have to remove your spare tire for successful installation of this exhaust kit.
Dual tail pipes may not fit or require modifications with suspension mods, air bags and/or hitches.

CAB & CHASSIS - DOWNPIPE BACK SINGLE SYSTEM



4" Downpipe Back Single

ALUMINIZED STAINLESS

2017+ 6.6L, 3500, L5P, Race Exhaust (w/ OEM Flange) EC-CC/SB-LB-Dually, Cab & Chassis!	887	SS887
No Muffler Kit, Cab & Chassis!	887NM	SS887NM

5" Downpipe Back Single

ALUMINIZED STAINLESS

2017+ 6.6L, 3500, L5P, Race Exhaust (w/ OEM Flange) EC-CC/SB-LB-Dually, w/ 4" Cat Pipe, Cab & Chassis!	687	SS687
No Muffler Kit, w/ 4" Cat Pipe, Cab & Chassis!	687NM	SS687NM

WARNING

Any product that requires the removal of ANY emissions control device is strictly prohibited and is intended for closed course racing only for non-registered vehicles. Our systems were designed to fit factory vehicles without ANY after market 5th wheel or in-bed gooseneck hitches, chassis mods etc.

1994-1997.5 POWERSTROKE

TURBO BACK SINGLE SYSTEM

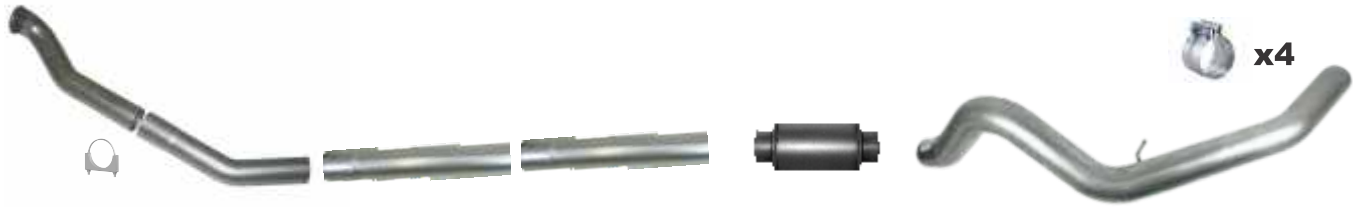

4" Turbo Back Single

ALUMINIZED STAINLESS

1994-1997.5 7.3L, F250/350, Race Exhaust

EC/SB-LB-Dually, 3" 2pc Downpipe, Pickup ONLY!

821

SS821

No Muffler Kit, Pickup ONLY!

821NM

SS821NM

***Note:** Only fits trucks without dual fuel tanks!

3" 2PC TURBO DOWNPIPE



858 - Aluminized

SS858 - Stainless

STOCK BALL & SOCKET
BOLTED CONNECTION

4" CAT RACE PIPE



39403 - Aluminized

69403 - Stainless

STOCK BALL & SOCKET
BOLTED CONNECTION

WARNING

Any product that requires the removal of ANY emissions control device is strictly prohibited and is intended for closed course racing only for non-registered vehicles. Our systems were designed to fit factory vehicles without ANY after market 5th wheel or in-bed gooseneck hitches, chassis mods etc.

1999-2003 POWERSTROKE

TURBO BACK SINGLE SYSTEM



4" Turbo Back Single

ALUMINIZED STAINLESS

1999-2003 7.3L, F250/350, Auto/Manual, Race Exhaust EC-CC/SB-LB-Dually, Pickup ONLY!	831	SS831
No Muffler Kit, Pickup ONLY!	831NM	SS831NM

1999-2003 7.3L, F350/450/550, Race Exhaust With Muffler, Cab & Chassis ONLY!	866*	-
---	------	---

*Note: For use with trucks equipped with a Rear Center Mounted Fuel Tank ONLY!

5" Turbo Back Single

ALUMINIZED STAINLESS

1999-2003 7.3L, F250/350, Race Exhaust, 4" Turbo Pipe, Auto/Manual EC-CC/SB-LB-Dually, Pickup ONLY!	631	SS631
No Muffler Kit, Pickup ONLY!	631NM	SS631NM

TURBO BACK DUAL SYSTEM



4" Turbo Back Duals

ALUMINIZED STAINLESS

1999-2003 7.3L, F250/350, Auto/Manual, Race Exhaust EC-CC/SB-LB, Excludes Dually, See Note, Pickup ONLY!	731	SS731
---	-----	-------

*Note: Dual tail pipes may not fit or require modifications with suspension mods, air bags and/or hitches.

WARNING

Any product that requires the removal of ANY emissions control device is strictly prohibited and is intended for closed course racing only for non-registered vehicles. Our systems were designed to fit factory vehicles without ANY after market 5th wheel or in-bed gooseneck hitches, chassis mods etc.

2003-2007 POWERSTROKE

TURBO BACK SINGLE SYSTEM

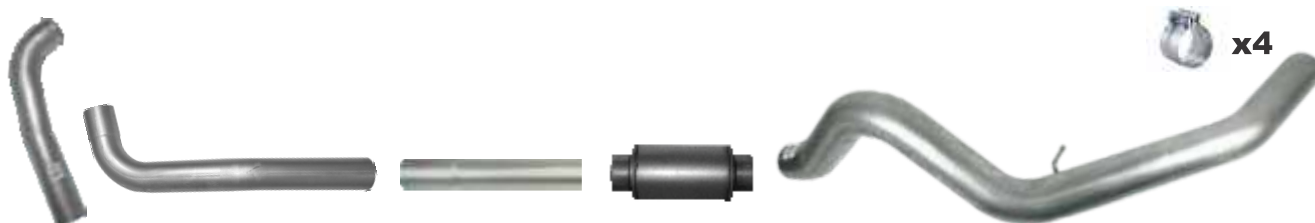

4" Turbo Back Single

	ALUMINIZED	STAINLESS
2003-2005 6.0L, Excursion, Auto Only, Race Exhaust	817	SS817
2003-2007 6.0L, F250/F350/Harley, Race Exhaust, 3 1/2" Downpipe Automatic/Manual, EC-CC/SB-LB-Dually, Pickup ONLY!	524	-
2003-2007 6.0L, F250/F350/Harley, Race Exhaust, 4" Downpipe Manual Only! EC-CC/SB-LB-Dually, Pickup ONLY!	424	SS424
2003-2007 6.0L, F250/F350/Harley, Race Exhaust, 4" Downpipe Automatic Only! EC-CC/SB-LB-Dually, Pickup ONLY!	824	SS824
Automatic Only! No Muffler Kit, Pickup ONLY!	824NM	SS824NM

5" Turbo Back Single

	ALUMINIZED	STAINLESS
2003-2007 6.0L F250/F350/Harley, Race Exhaust, 4" Downpipe Automatic Only! EC-CC/SB-LB-Dually	614	SS614
No Muffler Kit.....	614NM	SS614NM

TURBO BACK DUAL SYSTEM



4" Turbo Back Duals

	ALUMINIZED	STAINLESS
2003-2004 6.0L, F250/F350, Race Exhaust, Auto Only! EC-CC/SB-LB, Excludes Dually, See Note, Pickup ONLY!	714	SS714
2005-2007 6.0L, F250/F350, Race Exhaust, Auto Only! EC-CC/SB-LB, Excludes Dually, See Note, Pickup ONLY!	716	SS716

***Note:** Dual tail pipes may not fit or require modifications with suspension mods, air bags and/or hitches.

WARNING

Any product that requires the removal of ANY emissions control device is strictly prohibited and is intended for closed course racing only for non-registered vehicles. Our systems were designed to fit factory vehicles without ANY after market 5th wheel or in-bed gooseneck hitches, chassis mods etc.

2003-2007 POWERSTROKE

EGR KITS ON PG. 40

CAT BACK SINGLE SYSTEM

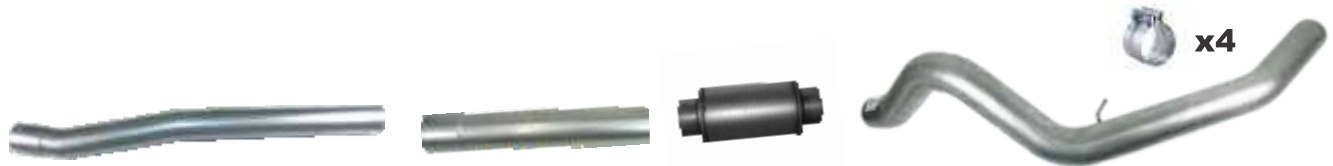

4" Cat Back Single

ALUMINIZED STAINLESS

2003-2007 6.0L F250/F350/Harley, Pickup ONLY!
Automatic/Manual, EC-CC/SB-LB-Dually

825 SS825

CAT BACK DUAL SYSTEM



4" Cat Back Duals

ALUMINIZED STAINLESS

2003-2004 6.0L F250/F350/Harley, Excludes Dually
Automatic/Manual, EC-CC/SB-LB, See Note, Pickup ONLY!

706 -

2005-2007 6.0L F250/F350, Excludes Dually
Automatic/Manual, EC-CC/SB-LB, See Note, Pickup ONLY!

715 -

***Note:** Dual tail pipes may not fit or require modifications with suspension mods, air bags and/or hitches.

TURBO UP Y-PIPE



30400
T304 SS

MADE WITH
INTERLOCKING INNER BRAID
FOR MAXIMUM DURABILITY!



EGR KITS ON
PG. 40

WARNING

Any product that requires the removal of ANY emissions control device is strictly prohibited and is intended for closed course racing only for non-registered vehicles. Our systems were designed to fit factory vehicles without ANY after market 5th wheel or in-bed gooseneck hitches, chassis mods etc.

2007.5-2010 POWERSTROKE

DPF RACE PIPES



38113NB

DPF Race Pipes

ALUMINIZED STAINLESS

2007.5-2010 6.4L, F250/F350/F450/F550, Pickup & C&C

3 1/2" DPF Race Pipe 8-Bolt Flange (Factory Size).....	38113NB	68113NB
4" DPF Race Pipe 8-Bolt Flange, No Bungs.....	38123NB	-
5" DPF Race Pipe 8-Bolt Flange, No Bungs.....	38133NB	-

CAT & DPF RACE PIPES



846



837NB

Race Pipe Kits & Downpipes

ALUMINIZED STAINLESS

2007.5-2010 6.4L, F250/F350/F450/F550, Pickup & C&C

4" 2pc Turbo Downpipe, Auto ONLY!	846	SS846
4" CAT & DPF Race Pipes No Bungs.....	837NB	SS837NB

POLISHED STAINLESS UP-PIPES W/ GASKETS



30801

PASS. UP-PIPE
EGR Present
w/ EGT Sensor Bung



30801R

PASS. UP-PIPE
EGR Removed
w/ EGT Sensor Bung



30802R

DRIVER UP-PIPE
EGR Present/Removed
w/ EBP Sensor Bung & plug

WARNING

Any product that requires the removal of ANY emissions control device is strictly prohibited and is intended for closed course racing only for non-registered vehicles. Our systems were designed to fit factory vehicles without ANY after market 5th wheel or in-bed gooseneck hitches, chassis mods etc.

2007.5-2010 POWERSTROKE

EGR KITS ON PG. 41

DPF BACK SINGLE SYSTEM



4" DPF Back Single

ALUMINIZED STAINLESS

2007.5-2010 6.4L, F250/F350, w/ Tip
Auto/Manual, EC-CC/SB-LB-Dually, Pickup ONLY! **830** -

5" DPF Back Single

ALUMINIZED STAINLESS

2007.5-2010 6.4L, F250/F350, w/ Tip
Auto/Manual, EC-CC/SB-LB-Dually, Pickup ONLY! **630** -

DPF BACK DUAL SYSTEM



4" DPF Back Duals

ALUMINIZED STAINLESS

2007.5-2010 6.4L, F250/F350, w/ Tips
Auto/Manual, EC-CC/SB-LB-Dually, Pickup ONLY! **730** -

***Note:** Dual tail pipes may not fit or require modifications with suspension mods, air bags and/or hitches.

POLISHED STAINLESS UP-PIPE KITS (MORE KITS ON PG. 41)



30800
(EGR Present)



30800R
(EGR Removed)

WARNING

Any product that requires the removal of ANY emissions control device is strictly prohibited and is intended for closed course racing only for non-registered vehicles. Our systems were designed to fit factory vehicles without ANY after market 5th wheel or in-bed gooseneck hitches, chassis mods etc.

2007.5-2010 POWERSTROKE

DOWNPIPE BACK SINGLE SYSTEM

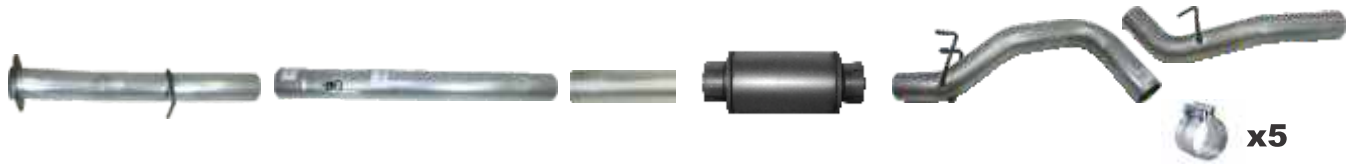

4" Downpipe Back Single

ALUMINIZED STAINLESS

2008-2010 6.4L, F250/F350, Auto/Manual, Race Exhaust

EC-CC/SB-LB-Dually No Bungs, Pickup ONLY!

832NB

SS832NB

No Bungs, No Muffler, Pickup ONLY!

833NB

SS833NB

2008-2010 6.4L, F450/F550, Cab & Chassis ONLY!

Race Exhaust, No Bungs, With Muffler.....

867

-

***Note:** For use with trucks equipped with a Rear Centre Mounted Fuel Tank ONLY!

5" Downpipe Back Single

ALUMINIZED STAINLESS

2008-2010 6.4L, F250/F350, Auto/Manual, Race Exhaust

EC-CC/SB-LB-Dually No Bungs, Pickup ONLY!

632NB

SS632NB

No Bungs, No Muffler, Pickup ONLY!

633NB

SS633NB

DOWNPIPE BACK DUAL SYSTEM



4" Downpipe Back Duals

ALUMINIZED STAINLESS

2008-2010 6.4L, F250/F350, Race Exhaust

No Bungs, Pickup ONLY!

733NB

SS733NB

***Note:** Dual tail pipes may not fit or require modifications with suspension mods, air bags and/or hitches.

WARNING

Any product that requires the removal of ANY emissions control device is strictly prohibited and is intended for closed course racing only for non-registered vehicles. Our systems were designed to fit factory vehicles without ANY after market 5th wheel or in-bed gooseneck hitches, chassis mods etc.

2007.5-2010 POWERSTROKE

EGR KITS ON PG. 41

TURBO BACK SINGLE SYSTEM



4" Turbo Back Single

ALUMINIZED STAINLESS

2008-2010 6.4L, F250/F350, Auto Only, Race Exhaust
 EC-CC/SB-LB-Dually, No Bungs, Pickup ONLY!
 No Muffler, No Bungs, Pickup ONLY!

843NB **SS843NB**
838NB **SS838NB**

5" Turbo Back Single

ALUMINIZED STAINLESS

2008-2010 6.4L, F250/F350, Auto Only, Race Exhaust
 EC-CC/SB-LB-Dually, No Bungs, Pickup ONLY!
 No Muffler, No Bungs, Pickup ONLY!

643NB **SS643NB**
638NB **SS638NB**

TURBO BACK DUAL SYSTEM



4" Turbo Back Duals

ALUMINIZED STAINLESS

2008-2010 6.4L, F250/F350, Auto Only, Race Exhaust
 EC-CC/SB-LB, No Muffler, No Bungs, Pickup ONLY!

738NB **SS738NB**

***Note:** Dual tail pipes may not fit or require modifications with suspension mods, air bags and/or hitches.

WARNING

Any product that requires the removal of ANY emissions control device is strictly prohibited and is intended for closed course racing only for non-registered vehicles. Our systems were designed to fit factory vehicles without ANY after market 5th wheel or in-bed gooseneck hitches, chassis mods etc.

2011-2017 POWERSTROKE

CAT & DPF RACE KIT



Cat & DPF Race Pipes

ALUMINIZED STAINLESS

2011-2017 6.7L, F250/F350, Cat & DPF Race Pipes
4" Race Exhaust No Bungs, Pickup ONLY!

857NB SS857NB

DPF BACK SINGLE SYSTEM



5" DPF Back Single

ALUMINIZED STAINLESS

2011-2017 6.7L, F250/F350, w/ Tip
Automatic Only, EC-CC/SB-LB-Dually, Pickup ONLY!

640 -

*Note: 2015-2017 models may require drilling and tapping for reinstallation of the sensor in the over the axle pipe.

CAB & CHASSIS - DOWNPIPE BACK

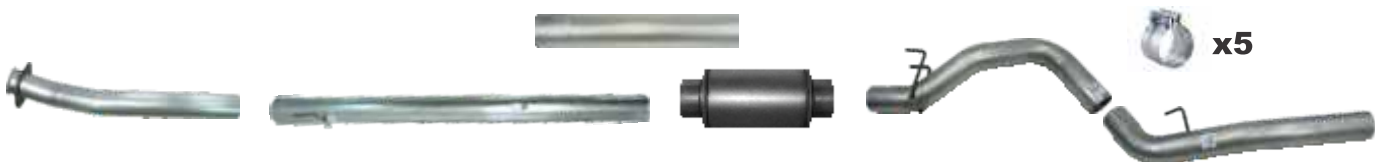

4" Downpipe Back Single

ALUMINIZED STAINLESS

2011-2017 6.7L, F350/F450/F550, Race Exhaust
EC-CC/SB-LB-Dually, No Bungs, Cab & Chassis!

877 SS877
877NM SS877NM

*Note: Will fit models equipped with center mounted rear fuel tank.

WARNING

Any product that requires the removal of ANY emissions control device is strictly prohibited and is intended for closed course racing only for non-registered vehicles. Our systems were designed to fit factory vehicles without ANY after market 5th wheel or in-bed gooseneck hitches, chassis mods etc.

2011-2017 POWERSTROKE

EGR KITS ON PG. 42

DOWNPIPE BACK SINGLE SYSTEM



4" Downpipe Back Single

ALUMINIZED STAINLESS

2011-2017 6.7L, F250/F350, Auto ONLY, Race Exhaust
 EC-CC/SB-LB-Dually, No Bungs, Pickup ONLY!
 EC-CC/SB-LB-Dually, No Bungs, No Muffler, Pickup ONLY!

852NB **SS852NB**
853NB **SS853NB**

5" Downpipe Back Single

ALUMINIZED STAINLESS

2011-2017 6.7L F250/F350, Race Exhaust, 4" Downpipe
 EC-CC/SB-LB-Dually, Pickup ONLY!
 EC-CC/SB-LB-Dually, No Muffler, Pickup ONLY!

652NB **SS652NB**
653NB **SS653NB**

DOWNPIPE BACK DUAL SYSTEM



4" Downpipe Back Duals

ALUMINIZED STAINLESS

2011-2017 6.7L F250/F350, Auto ONLY, Race Exhaust
 EC-CC/SB-LB-Dually, No Muffler, Pickup ONLY!

753NB **SS753NB**

5" Downpipe Back Duals

ALUMINIZED STAINLESS

2011-2017 6.7L F250/F350, Race Exhaust, 4" Cat Pipe
 EC-CC/SB-LB-Dually, No Muffler, Pickup ONLY!

767 **-**

***Note:** You will have to remove your spare tire for successful installation of the 5" dual kit.
 Dual tail pipes may not fit or require modifications with suspension mods, air bags and/or hitches.

WARNING

Any product that requires the removal of ANY emissions control device is strictly prohibited and is intended for closed course racing only for non-registered vehicles. Our systems were designed to fit factory vehicles without ANY after market 5th wheel or in-bed gooseneck hitches, chassis mods etc.

1989-2002 DODGE PICKUP

4" TURBO DOWN PIPES

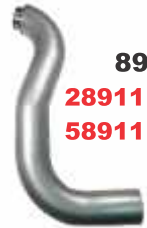

89-93 5.9L
28911 - Aluminized
58911 - Stainless



94-02 5.9L
D1 - Aluminized
59411 - Stainless

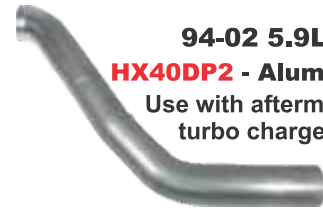

94-02 5.9L
HX40DP2 - Aluminized
 Use with aftermarket turbo chargers

TURBO BACK SINGLE SYSTEM



4" Turbo Back Single

ALUMINIZED STAINLESS

1989-1993 5.9L, W250/W350, Race Exhaust, 4WD ONLY!

RC-EC/LB, Pickup ONLY! **847** **SS847**
 No Muffler Kit, Pickup ONLY! **847NM** **SS847NM**

1994-2002 5.9L, 2500/3500, Race Exhaust

RC-EC/SB-LB-Dually, Pickup ONLY! **802** **SS802**
 No Muffler Kit, Pickup ONLY! **802NM** **SS802NM**

5" Turbo Back Single

ALUMINIZED STAINLESS

1994-2002 5.9L, 2500/3500, Race Exhaust, 4" Downpipe

RC-EC/SB-LB-Dually, Pickup ONLY! **602** **SS602**
 No Muffler Kit, Pickup ONLY! **602NM** **SS602NM**

TURBO BACK DUAL SYSTEM



4" Turbo Back Duals

ALUMINIZED STAINLESS

1994-2002 5.9L, 2500/3500, Race Exhaust

RC-EC/SB-LB, 4x4 ONLY!, **See Note**, Pickup ONLY! **702** **SS702**

***Note:** Dual tail pipes may not fit or require modifications with suspension mods, air bags and/or hitches.

WARNING

Any product that requires the removal of ANY emissions control device is strictly prohibited and is intended for closed course racing only for non-registered vehicles. Our systems were designed to fit factory vehicles without ANY after market 5th wheel or in-bed gooseneck hitches, chassis mods etc.

2003-2004 CUMMINS

4" TURBO DOWN PIPES



03-04 5.9L
2031 - Aluminized
5031 - Stainless

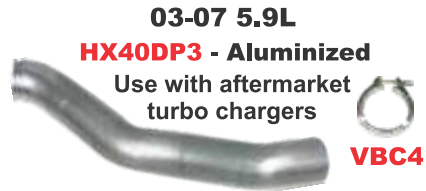

03-07 5.9L
HX40DP3 - Aluminized
 Use with aftermarket turbo chargers



VBC4

TURBO BACK SINGLE SYSTEM

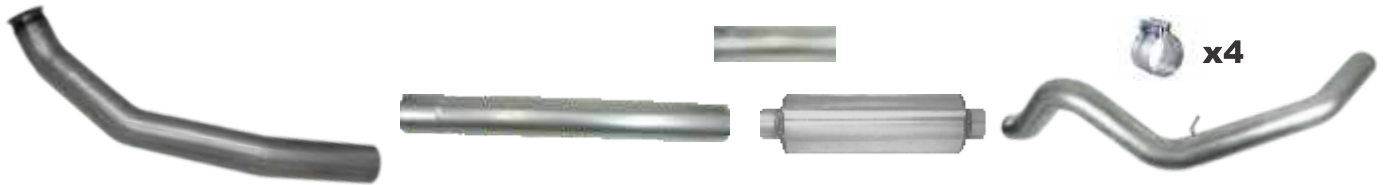

4" Turbo Back Single

ALUMINIZED STAINLESS

2003-2004 5.9L, 2500/3500, Race Exhaust

EC-QC/SB-LB-Dually, Pickup ONLY!

805 SS805
805NM SS805NM

No Muffler Kit, Pickup ONLY!

5" Turbo Back Single

ALUMINIZED STAINLESS

2003-2004 5.9L, 2500/3500, Race Exhaust, 4" Downpipe

EC-QC/SB-LB-Dually, Pickup ONLY!

605 SS605
605NM SS605NM

No Muffler Kit, Pickup ONLY!

TURBO BACK DUAL SYSTEM



4" Turbo Back Duals

ALUMINIZED STAINLESS

2003-2004 5.9L, 2500/3500, Race Exhaust

EC-QC/SB-LB-Dually, **See Note**, Pickup ONLY!

705 SS705

***Note:** Dual tail pipes may not fit or require modifications with suspension mods, air bags and/or hitches.

WARNING

Any product that requires the removal of ANY emissions control device is strictly prohibited and is intended for closed course racing only for non-registered vehicles. Our systems were designed to fit factory vehicles without ANY after market 5th wheel or in-bed gooseneck hitches, chassis mods etc.

2004.5-2007 CUMMINS

4" TURBO DOWNPIPES

04.5-11 5.9L HO & 6.7L

20811 - Aluminized
50811 - Stainless



03-07 5.9L

HX40DP3 - Aluminized
Use with aftermarket
turbo chargers

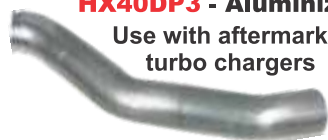

VBC4

CAT BACK SINGLE SYSTEM

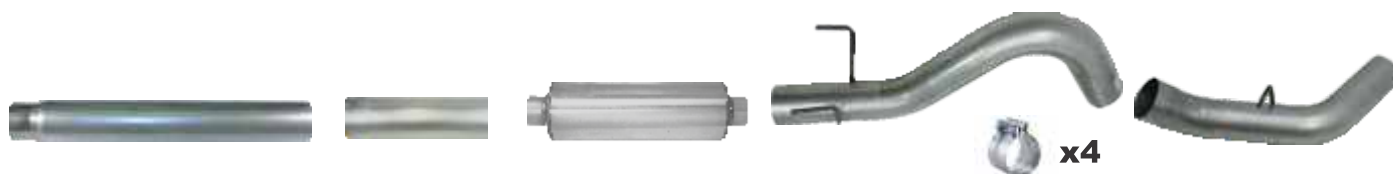

4" Cat Back Single

ALUMINIZED STAINLESS

2004-2007 5.9L, 2500/3500, HO600

EC-QC/SB-LB-Dually, MC/SB, Pickup ONLY!

818

-

5" Cat Back Single

ALUMINIZED STAINLESS

2004-2007 5.9L, 2500/3500, HO600

EC-QC/SB-LB-Dually, MC/SB, Pickup ONLY!

618

SS618

CAT BACK DUAL SYSTEM



4" Cat Back Duals

ALUMINIZED STAINLESS

2004-2007 5.9L, 2500/3500, HO600

EC-QC/SB-LB-Dually, MC/SB, Pickup ONLY!

718

-

***Note:** Dual tail pipes may not fit or require modifications with suspension mods, air bags and/or hitches.

WARNING

Any product that requires the removal of ANY emissions control device is strictly prohibited and is intended for closed course racing only for non-registered vehicles. Our systems were designed to fit factory vehicles without ANY after market 5th wheel or in-bed gooseneck hitches, chassis mods etc.

2004.5-2007 CUMMINS

TURBO BACK SINGLE SYSTEM

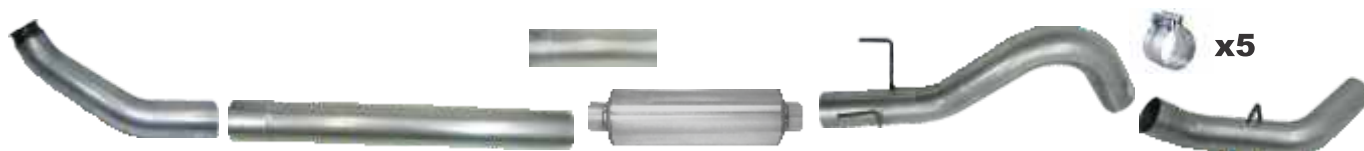

4" Turbo Back Single

ALUMINIZED STAINLESS

2004.5-2007 5.9L, 2500/3500, HO 600, Race Exhaust

QC-MC/SB-LB-Dually, Pickup ONLY!

819

SS819

No Muffler Kit, Pickup ONLY!

819NM

SS819NM

5" Turbo Back Single

ALUMINIZED STAINLESS

2004.5-2007 5.9L, 2500/3500, HO 600, Race Exhaust

EC-QC/SB-LB-Dually, MC/SB, Pickup ONLY!

619

SS619

No Muffler, Pickup ONLY!

619NM

SS619NM

TURBO BACK DUAL SYSTEM



4" Turbo Back Duals

ALUMINIZED STAINLESS

2004.5-2007 5.9L, 2500/3500, HO 600, Race Exhaust

EC-QC/SB-LB-Dually, MC/SB, **See Note**, Pickup ONLY!

719

SS719

***Note:** Dual tail pipes may not fit or require modifications with suspension mods, air bags and/or hitches.

WARNING

Any product that requires the removal of ANY emissions control device is strictly prohibited and is intended for closed course racing only for non-registered vehicles. Our systems were designed to fit factory vehicles without ANY after market 5th wheel or in-bed gooseneck hitches, chassis mods etc.

2007.5-2009 CUMMINS

CAT & DPF RACE PIPE KITS (835FNB SHOWN)



Cat & DPF Race Pipes

ALUMINIZED STAINLESS

2007-2012 6.7L, 2500/3500, Pickup ONLY!

Cat Race Pipe, No Bungs	27111	57111
DPF Race Pipe, No Bungs.....	27113NB	57113NB

4" Cat & DPF Race Pipes, No Bungs.....	835NB	SS835NB
4" Cat & DPF Race Pipes, w/OEM Flanges, No Bungs.....	835FNB	SS835FNB

2007-2010 6.7L, 3500/4500/5500, 4" Cat & DPF Race Pipe

No Bungs, Cab & Chassis ONLY!	27123	57123
-------------------------------------	-------	-------

DPF BACK SINGLE SYSTEM



5" DPF Back Single

ALUMINIZED STAINLESS

2007.5-2009 6.7L, 2500/3500, w/ Tip

RC-QC-MC/SB-LB-Dually, Pickup ONLY!	629	-
---	-----	---

4" DPF Back Duals

ALUMINIZED STAINLESS

2007.5-2009 6.7L, 2500/3500, w/ Tips

RC-QC-MC/SB-LB-Dually, MC/SB, Pickup ONLY!	729	-
--	-----	---

***Note:** Dual tail pipes may not fit or require modifications with Suspension mods and/or Air Bags.

WARNING

Any product that requires the removal of ANY emissions control device is strictly prohibited and is intended for closed course racing only for non-registered vehicles. Our systems were designed to fit factory vehicles without ANY after market 5th wheel or in-bed gooseneck hitches, chassis mods etc.

2007.5-2009 CUMMINS

EGR KITS ON PG. 43

TURBO BACK SINGLE SYSTEM



4" Turbo Back Single

ALUMINIZED STAINLESS

2007-2009 6.7L, 2500/3500, Race Exhaust

No Bungs, With Muffler, Pickup ONLY!	1836	SS1836
No Bungs, No Muffler, Pickup ONLY!	1839	SS1839

5" Turbo Back Single

ALUMINIZED STAINLESS

2007-2009 6.7L, 2500/3500, Race Exhaust

No Bungs, With Muffler, Pickup ONLY!	1636	SS1636
No Bungs, No Muffler, Pickup ONLY!	1639	SS1639

2007-2010, 6.7L, 3500/4500/5500, Race Exhaust

No Bungs With Muffler, Cab & Chassis ONLY!	645	SS645
No Bungs No Muffler, Cab & Chassis ONLY!	644	SS644

TURBO BACK DUAL SYSTEM



4" Turbo Back Duals

ALUMINIZED STAINLESS

2007-2009 6.7L, 2500/3500, 5" Race Pipes

No Muffler, No Bungs, See Note , Pickup ONLY!	739NB	SS739NB
--	-------	---------

***Note:** Dual tail pipes may not fit or require modifications with suspension mods, air bags and/or hitches.
Will fit 2010-2012 pickup with removal of spare tire and heat shield.

WARNING

Any product that requires the removal of ANY emissions control device is strictly prohibited and is intended for closed course racing only for non-registered vehicles. Our systems were designed to fit factory vehicles without ANY after market 5th wheel or in-bed gooseneck hitches, chassis mods etc.

2010-2012 CUMMINS

CAT & DPF RACE PIPE KITS (835FNB SHOWN)



Cat & DPF Race Pipes

ALUMINIZED STAINLESS

2007-2012 6.7L, 2500/3500

Cat Race Pipe, No Bungs, Pickup ONLY!	27111	57111
DPF Race Pipe, No Bungs, Pickup ONLY!	27113NB	57113NB

4" Cat & DPF Race Pipes, No Bungs.....	835NB	SS835NB
4" Cat & DPF Race Pipes, w/OEM Flanges, No Bungs.....	835FNB	SS835FNB

2011-2012 6.7L, 3500/4500/5500, 4" Cat & DPF Race Pipe

With Muffler, Cab & Chassis ONLY!	21123	-
No Muffler, Cab & Chassis ONLY!	21122	-

2011-2012 6.7L, 3500/4500/5500, 4" SCR Race Pipe

For Cab to Axle Length greater than 70", Cab & Chassis ONLY!	21125	-
For Cab to Axle Length less than 70", Cab & Chassis ONLY!	21124	-

*Note: Requires both the Cat & DPF race pipe with the SCR race pipe to remove all filters!

DPF BACK SINGLE SYSTEM



5" DPF Back Single

ALUMINIZED STAINLESS

2010-2012 6.7L, 2500/3500, w/ Tip

RC-QC-MC/SB-LB-Dually, Pickup ONLY!	641	-
---	-----	---

WARNING

Any product that requires the removal of ANY emissions control device is strictly prohibited and is intended for closed course racing only for non-registered vehicles. Our systems were designed to fit factory vehicles without ANY after market 5th wheel or in-bed gooseneck hitches, chassis mods etc.

2010-2012 CUMMINS

EGR KITS ON PG. 44

TURBO BACK SINGLE SYSTEM

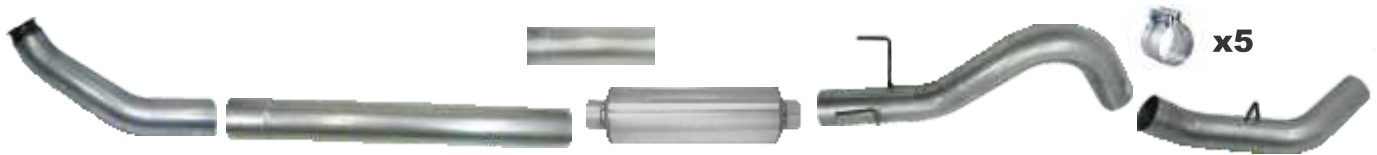

4" Turbo Back Single

ALUMINIZED STAINLESS

2010-2012 6.7L, 2500/3500, Race Exhaust

No Bungs, With Muffler, Pickup ONLY! 1848 SS1848

No Bungs, No Muffler, Pickup ONLY! 1849 SS1849

5" Turbo Back Single

ALUMINIZED STAINLESS

2010-2012 6.7L, 2500/3500, Pickup, Race Exhaust

No Bungs, With Muffler, Pickup ONLY! 1648 SS1648

No Bungs, No Muffler, Pickup ONLY! 1649 SS1649

2007-2010 6.7L, 3500/4500/5500, Race Exhaust

No Bungs, With Muffler, Cab & Chassis ONLY! 645 SS645

No Bungs, No Muffler, Cab & Chassis ONLY! 644 SS644

2011-2017, 6.7L, 3500/4500/5500, Race Exhaust

No Bungs, With Muffler, Cab & Chassis ONLY! 655 SS655

No Bungs, No Muffler, Cab & Chassis ONLY! 654 SS654

TURBO BACK DUAL SYSTEM



5" Turbo Back Duals

ALUMINIZED STAINLESS

2010-2012, 6.7L, 2500/3500, Pickup, Race Exhaust

No Bungs, No Muffler **See Note**, Pickup ONLY! 766 -

***Note:** Dual tail pipes may not fit or require modifications with suspension mods, air bags and/or hitches.

WARNING

Any product that requires the removal of ANY emissions control device is strictly prohibited and is intended for closed course racing only for non-registered vehicles. Our systems were designed to fit factory vehicles without ANY after market 5th wheel or in-bed gooseneck hitches, chassis mods etc.

2013-2018 CUMMINS

CAT/DPF/SCR RACE PIPE KITS



4" CAT & DPF Race Pipe Kits

ALUMINIZED STAINLESS

2013-2018 6.7L, 2500/3500, Pickup ONLY!

QC-MC/SB-LB-Dually, No Bungs **868NB** **SS868NB**

*Note: This kit will not fit the Regular Cab!

CAB & CHASSIS - CAT/DPF & SCR RACE PIPES



4" CAT/DPF/SCR Race Pipes

ALUMINIZED STAINLESS

2013-2017 6.7L, 3500/4500/5500, 4" Cat & DPF Race Pipe

With Muffler, Cab & Chassis ONLY! **21127** -

No Muffler, Cab & Chassis ONLY! **21126** -

2013-2017 6.7L, 3500/4500/5500, 4" SCR Race Pipe

For Cab to Axle Length greater than 70", Cab & Chassis ONLY! **21129** -

For Cab to Axle Length less than 70", Cab & Chassis ONLY! **21128** -

*Note: Requires both the Cat & DPF race pipe with the SCR race pipe to remove all filters!

DOWNPIPE BACK SINGLE SYSTEM



4" Downpipe Back Single

ALUMINIZED STAINLESS

2013-2018 6.7L, 2500/3500, Race Exhaust

With Muffler, No Bungs, Pickup ONLY! **1874** **SS1874**

No Muffler, No Bungs, Pickup ONLY! **1873** **SS1873**

*Note: This kit will fit BOTH leaf and coil spring suspension equipped trucks.

WARNING

Any product that requires the removal of ANY emissions control device is strictly prohibited and is intended for closed course racing only for non-registered vehicles. Our systems were designed to fit factory vehicles without ANY after market 5th wheel or in-bed gooseneck hitches, chassis mods etc.

2013-2018 CUMMINS

EGR KITS ON PG. 45

TURBO BACK SINGLE SYSTEM



5" Turbo Back Single

ALUMINIZED STAINLESS

2013-2018 6.7L, 2500/3500, Race Exhaust

With Muffler, No Bungs, Pickup ONLY!

1674

SS1674

No Muffler, No Bungs, Pickup ONLY!

1673

SS1673

***Note:** This kit will fit BOTH leaf and coil spring suspension equipped trucks.

TURBO BACK SINGLE SYSTEM - CAB & CHASSIS

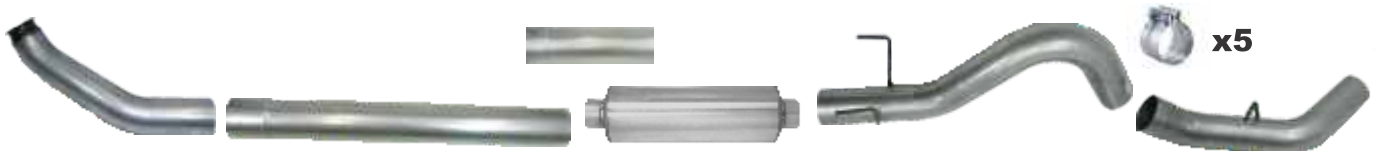

5" Turbo Back Single

ALUMINIZED STAINLESS

2011-2017 6.7L, 3500/4500/5500, Race Exhaust

No Bungs, With Muffler, Cab & Chassis ONLY!

655

SS655

No Bungs, No Muffler, Cab & Chassis ONLY!

654

SS654

TURBO BACK DUAL SYSTEM



5" Turbo Back Duals

ALUMINIZED STAINLESS

2013-2018, 6.7L, 2500/3500, Pickup, Race Exhaust

No Bungs, No Muffler **See Note**, Pickup ONLY!

768

-

***Note:** This kit will fit BOTH leaf and coil spring suspension equipped trucks. Removal of spare tire is required.

***Note:** Will not fit air-ride or centre mounted shock equipped models!

WARNING

Any product that requires the removal of ANY emissions control device is strictly prohibited and is intended for closed course racing only for non-registered vehicles. Our systems were designed to fit factory vehicles without ANY after market 5th wheel or in-bed gooseneck hitches, chassis mods etc.

LIGHT DUTY DIESEL SYSTEMS

ECODIESEL 3.0L RAM & JEEP

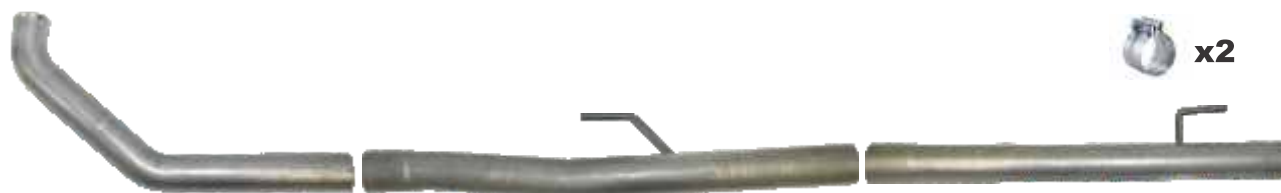

Ram 1500 ECODIESEL

ALUMINIZED STAINLESS

2014-2016 3.0L ECODIESEL, Ram 1500, Pickup, Race Exhaust

No Bungs, Uses Stock Muffler!

863NB

SS863NB

*Note: Will not fit REGULAR CAB!!!

Jeep Grand Cherokee

ALUMINIZED STAINLESS

2014-2017 3.0L ECODIESEL, Jeep Grand Cherokee, Race Exhaust

No Bungs, Use Stock Muffler

876

SS876

NISSAN 5.0L TITAN XD

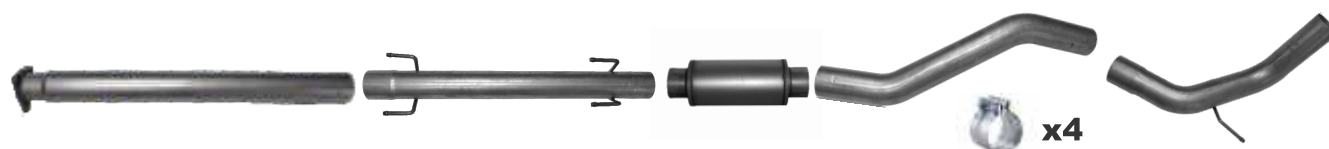

4" Downpipe Back Single

ALUMINIZED STAINLESS

2016-2017 5.0L Cummins, Nissan Titan XD, Pickup, Race Exhaust

4" 2 pc Race Pipe Kit Only!

879

SS879

No Bungs, With Muffler

878

SS878

No Bungs, No Muffler

878NM

SS878NM

5" Downpipe Back Single

ALUMINIZED STAINLESS

2016-2017 5.0L Cummins, Nissan Titan XD, Pickup, Race Exhaust

No Bungs, With Muffler

678

SS678

No Bungs, No Muffler

678NM

SS678NM

WARNING

Any product that requires the removal of ANY emissions control device is strictly prohibited and is intended for closed course racing only for non-registered vehicles. Our systems were designed to fit factory vehicles without ANY after market 5th wheel or in-bed gooseneck hitches, chassis mods etc.

LIGHT DUTY DIESEL SYSTEMS

GMC/CHEV 2.8L CANYON/COLORADO

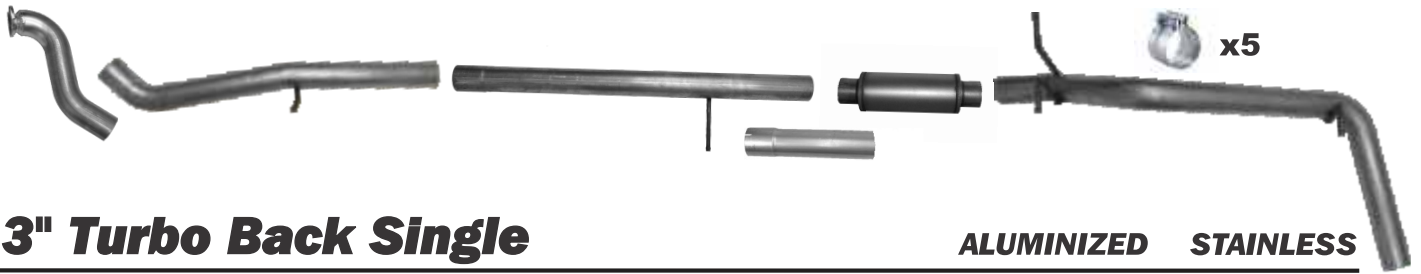

3" Turbo Back Single

ALUMINIZED STAINLESS

2016 2.8L, Chev. Colorado / GMC Canyon, Race Exhaust

All Wheelbases, With Muffler, 4WD ONLY! 875 SS875

*Note: Will not fit GMC Savanna or Chevrolet Express vans!

LIGHT DUTY GAS SYSTEMS

FORD F-150 ECOBOOST

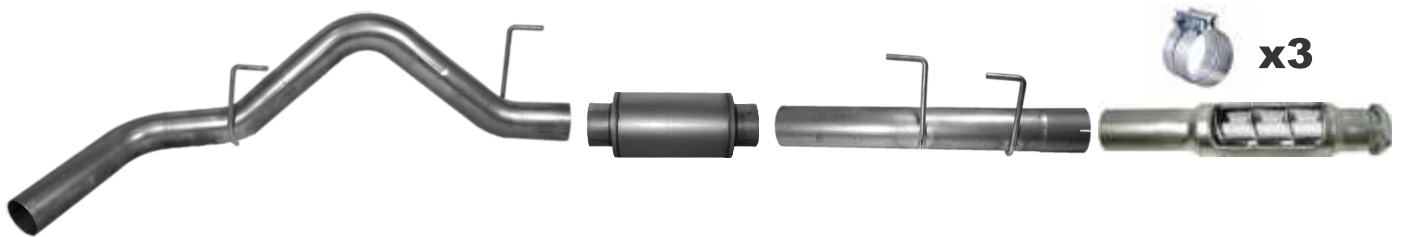

4" Cat Back Single

ALUMINIZED STAINLESS

2011-2014 3.5L, F150 ECOBOOST

Non-Resonated, With Muffler 865 SS865

With ~~Twister~~ Resonator & Muffler 865RS SS865RS

DODGE HEMI POWER WAGON



4" Cat Back Single

ALUMINIZED STAINLESS

2014-2017 6.4L V8, 2500/3500

With ~~Twister~~ Resonator 883 SS883

*Note: Will fit both coil and leaf spring equipped vehicles. WILL NOT FIT VEHICLES WITH AIR RIDE

WARNING

Any product that requires the removal of ANY emissions control device is strictly prohibited and is intended for closed course racing only for non-registered vehicles. Our systems were designed to fit factory vehicles without ANY after market 5th wheel or in-bed gooseneck hitches, chassis mods etc.

2004-2016 GMC EGR KITS

EGR BLOCK OFF PLATES



EGRBLBZ
2006-2007 LBZ



EGRLMM
2007.5-2010 LMM



EGRLML
2011-2016 LML



409902
FUEL RAIL PLUG
2004.5-2010

2003-2007 FORD EGR KITS

EGR COOLER & VALVE RACE KITS



EGR60
COOLER & VALVE
w/ UP-PIPE



EGR61
COOLER & VALVE
w/o UP-PIPE



EGR62
COOLER ONLY



EGR60EX
UP-PIPE

WARNING

Any product that requires the removal of ANY emissions control device is strictly prohibited and is intended for closed course racing only for non-registered vehicles. Our systems were designed to fit factory vehicles without ANY after market 5th wheel or in-bed gooseneck hitches, chassis mods etc.

2008-2010 FORD EGR KITS

EGR RACE KITS & INTERCOOLER PIPES



IE300

INTAKE ELBOW



EGR64CD

COOLER ONLY



EC64

COOLER & VALVE
w/ Intake Elbow



IC300

INTERCOOLER PIPE



EGR64

EGR BLOCK-OFF

EGR RACE & UP-PIPE KITS

PIPES LISTED INDIVIDUALLY ON PAGE 23



30800EGR

EGR & COOLER
w/ UP-PIPES



30800

UP-PIPE KIT
EGR Present



30800R

UP-PIPE KIT
EGR Removed

WARNING

Any product that requires the removal of ANY emissions control device is strictly prohibited and is intended for closed course racing only for non-registered vehicles. Our systems were designed to fit factory vehicles without ANY after market 5th wheel or in-bed gooseneck hitches, chassis mods etc.

2011-2014 FORD EGR KITS

EGR RACE KITS



302201
EGR & COOLER
w/ OEM Pyro Plate
Incl. 1/8 NPT adapter

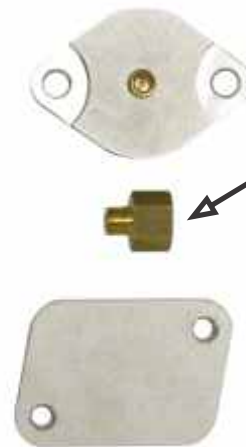

302202
EGR ONLY
w/ OEM Pyro Plate
Incl. 1/8 NPT adapter

2015-2016 FORD EGR KITS

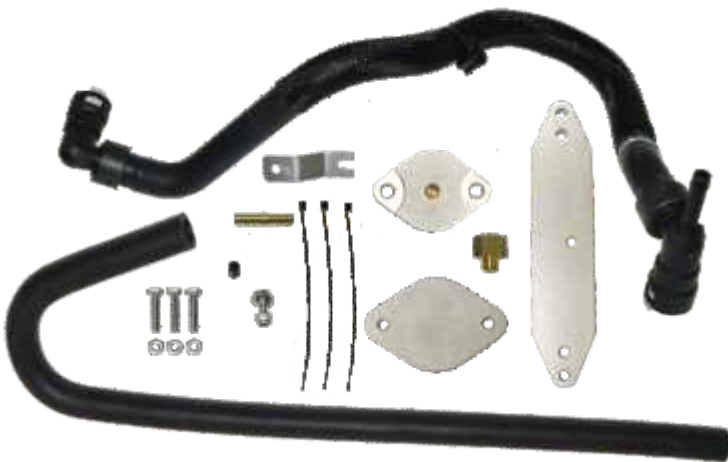

315000
EGR & COOLER
w/ OEM Pyro Plate
Incl. 1/8 NPT adapter

WARNING

Any product that requires the removal of ANY emissions control device is strictly prohibited and is intended for closed course racing only for non-registered vehicles. Our systems were designed to fit factory vehicles without ANY after market 5th wheel or in-bed gooseneck hitches, chassis mods etc.

2007.5-2009 DODGE EGR KITS

EGR RACE KITS & INTAKE PARTS



301001

EGR & COOLER
FITS 2007.5-2009
P/U & C&C



213021

EGR BLOCK-OFF
FITS 2007.5-2017
PICKUP ONLY!



213000

EGR & COOLER
FITS 2007.5-2017
PICKUP ONLY!

**FITS
UP TO
2017!**



301002

EGR ONLY
FITS 2007.5-2017
P/U & C&C



301003

COOLER ONLY
FITS 2007.5-2009
P/U & C&C



409901

FUEL RAIL SHIM
FITS 2007.5-2012
P/U & C&C



409902

FUEL RAIL PLUG
FITS 2007.5-2014
P/U & C&C



501001

INTAKE MANIFOLD
FITS 2007.5-2012



501002

BOOST TUBE
FITS 2007.5-2009

***Note:** 501002 & 501003 must be used with 501001

WARNING

Any product that requires the removal of ANY emissions control device is strictly prohibited and is intended for closed course racing only for non-registered vehicles. Our systems were designed to fit factory vehicles without ANY after market 5th wheel or in-bed gooseneck hitches, chassis mods etc.

2010-2012 DODGE EGR KITS

EGR RACE KITS & INTAKE PARTS



301008

EGR & COOLER
w/ Recir. Hose
Pickup ONLY!

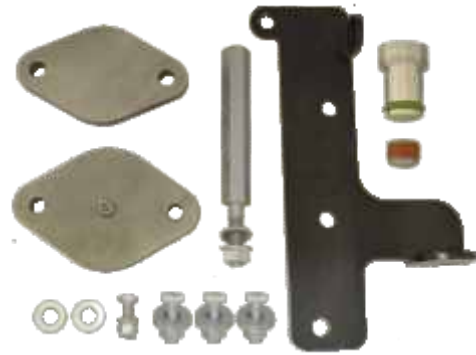

301005

COOLER ONLY
FITS 2007.5-2012 P/U
FITS 2009-2012 C&C



409901

FUEL RAIL SHIM
FITS 2007.5-2012
P/U & C&C



501001

INTAKE MANIFOLD
FITS 2007.5-2012



501003

BOOST TUBE
FITS 2010-2012



409902

FUEL RAIL PLUG
FITS 2007.5-2014
P/U & C&C

***Note:** 501002 & 501003 must be used with 501001

WARNING

Any product that requires the removal of ANY emissions control device is strictly prohibited and is intended for closed course racing only for non-registered vehicles. Our systems were designed to fit factory vehicles without ANY after market 5th wheel or in-bed gooseneck hitches, chassis mods etc.

MUFFLER REPLACEMENT PIPES

STRAIGHT MUFFLER REPLACEMENT PIPE

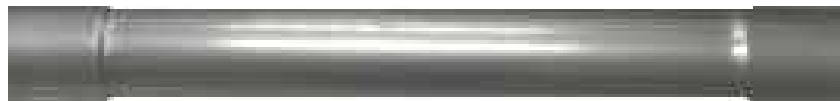

Straight Muffler Pipes

	ALUMINIZED	STAINLESS
4" ID-ID 20" LENGTH	40220	90220
4" ID-ID 30" LENGTH	40230	90230
5" ID-ID 20" LENGTH	50220	95220
5" ID-ID 30" LENGTH	50230	95230

***Note:** Measure the overall length of the muffler in your exhaust kit or alternatively cross reference to the mufflers on pg. 81 to determine which pipe you need.

MODEL SPECIFIC MUFFLER REPLACEMENT PIPES

04.5-07 DODGE HO600



4" ID-ID

20515 - Aluminized
50515 - Stainless

99-06 FORD POWERSTROKE 01-06 GMC/CHEV DURAMAX



3 1/2" OD-OD

48830 - Aluminized
98830 - Stainless

07.5-09 DODGE 6.7L



4" ID-ID

20814 - Aluminized

07.5-10 GMC/CHEV DURAMAX



4" ID-ID

10814 - Aluminized

WARNING

Any product that requires the removal of ANY emissions control device is strictly prohibited and is intended for closed course racing only for non-registered vehicles. Our systems were designed to fit factory vehicles without ANY after market 5th wheel or in-bed gooseneck hitches, chassis mods etc.

TAILPIPES & ACCESSORIES

94-97.5 FORD 3 1/2" TAILPIPE | UNIVERSAL 5" 2 PC TAILPIPE



4" & 5" EXHAUST CLAMPS (MORE SIZES ON PAGE 95)

 **TORCA LAP JOINT CLAMPS INCLUDED IN EVERY KIT WE MAKE!**



ALUMINIZED



STAINLESS

	ALUMINIZED	STAINLESS
4" CLAMP	LJ400	LJ400SS
5" CLAMP	LJ500	LJ500SS

Note: Our lap joint clamps are also available in smaller sizes listed on PG. 95

UNIVERSAL CONVERTER ADAPTER KITS (5000 SHOWN)



	ALUMINIZED	STAINLESS
3 1/2" ID - 4" OD TIP ADAPTER	354AD	-
4" ID - 5" ID 6" LENGTH ADAPTER.....	898	9898
3 1/2" ID - 4" ID ADAPTER KIT	4000	9400
4" ID - 5" ID ADAPTER KIT.....	5000	9500

3" SEGMENT SET EXPANDERS



- 3 1/2" EXPANDER - **EXP350**
- 3 1/2" O-RING - **OR350**
- 4" EXPANDER - **EXP400**
- 4" O-RING - **OR400**
- 5" EXPANDER - **EXP500**
- 5" O-RING - **OR500**

UNIVERSAL Y-PIPE



- Y4001** 4" Aluminized
- SY400** 4" Stainless
- Y500** 5" Aluminized

MORE ON PAGE 96

DIESEL TIPS



Stamped Rolled Angle

Part #	IN	OUT	LEN.
4515F	4"	5"	15"
5615F	5"	6"	15"



Bolt-On
Stamped Rolled Angle

Part #	IN	OUT	LEN.
4515FB	4"	5"	15"
5615FB	5"	6"	15"

**ALSO
AVAILABLE
IN BLACK
PG. 64**

ST110 Length 22"



Turn Out

IN 4" OUT 5"



Turn Down

Part #	IN	OUT	LEN.
7715TD	3 1/2"	3 1/2"	15"
405015TD	4"	5"	20"
505015TD	5"	5"	22"

VENTED TIPS - FOR DPF PRESENT VEHICLES

**INCL. IN ALL OUR
DPF BACK KITS!**



Vented Rolled Angle

Part #	IN	OUT	LEN.
405014RAC	4"	5"	14"
506014RAC	5"	6"	14"

**F=FRONT
B=BACK**



Bolt-On

Ford 6.4L - Angle Cut

Part #	IN	OUT	LEN.
ST125B	4"	5"	6"
ST125F	4"	5"	8"

ST11070B Length 22"



Bolt-On

2007+ 6.6L Duramax

IN 4" OUT 5"

DIESEL TIPS

ROLLED ANGLE CUT - 20 DEGREE



Roller Angle Cut

Part #	IN	OUT	LEN.
354012RAC	3 1/2"	4"	12"
354015RAC	3 1/2"	4"	15"
355012RAC	3 1/2"	5"	12"
355015RAC	3 1/2"	5"	15"
405012RAC	4"	5"	12"
405015RAC	4"	5"	15"
405018RAC	4"	5"	18"
406012RAC	4"	6"	12"
406015RAC	4"	6"	15"
406018RAC	4"	6"	18"
407015RAC	4"	7"	15"
407018RAC	4"	7"	18"
506012RAC	5"	6"	12"
506015RAC	5"	6"	15"
506018RAC	5"	6"	18"
507015RAC	5"	7"	15"



Bolt-On

Roller Angle Cut

Part #	IN	OUT	LEN.
6815RAB	3"	4"	15"
7815RAB	3 1/2"	4"	15"
355012RACB	3 1/2"	5"	12"
8912RAB	4"	5"	12"
8915RAB	4"	5"	15"
8918RAB	4"	5"	18"
8012RAB	4"	6"	12"
8015RAB	4"	6"	15"
8018RAB	4"	6"	18"
407015RACB	4"	7"	15"
407018RACB	4"	7"	18"
408015RACB	4"	8"	15"
408018RACB	4"	8"	18"
9012RAB	5"	6"	12"
9015RAB	5"	6"	15"
506018RACB	5"	6"	18"
507015RACB	5"	7"	15"
508015RACB	5"	8"	15"
6015RAB	6"	6"	15"

PENCIL TIP - STRAIGHT CUT

8912PT

Length 12"



Bolt-On

Pencil Tip

IN 4"

OUT 5"



**SMALLER
SIZES ON
PG. 54**

Pencil Tip

Part #	IN	OUT	LEN.
405012PT	4"	5"	12"
405015PT	4"	5"	15"

DIESEL TIPS

MITER ANGLE CUT



Bolt-On

45 Degree Miter Angle Cut

Part #	IN	OUT	LEN.
8912ACB	4"	5"	12"
8915ACB	4"	5"	15"
8012ACB	4"	6"	12"
8015ACB	4"	6"	15"
8018ACB	4"	6"	18"
407015ACB	4"	7"	15"
407018ACB	4"	7"	18"
408015ACB	4"	8"	15"
408018ACB	4"	8"	18"
9015ACB	5"	6"	15"
9012ACB	5"	6"	12"
507015ACB	5"	7"	15"
508015ACB	5"	8"	15"

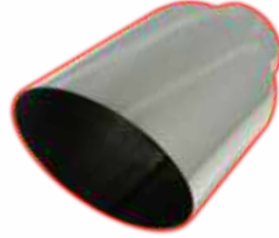

45 Degree Miter Angle Cut

Part #	IN	OUT	LEN.
407015AC	4"	7"	15"
5615AC	5"	6"	15"
507015AC	5"	7"	15"
508015AC	5"	8"	15"



15 Degree Miter Angle Cut

Part #	IN	OUT	LEN.
8912AC	4"	5"	12"
8915AC	4"	5"	15"
8012AC	4"	6"	12"
8015AC	4"	6"	15"
9012AC	5"	6"	12"
9015AC	5"	6"	15"

DIESEL TIPS

DOUBLE WALL TIPS



Bolt-On

Non-Resonated Slant

Part #	IN	OUT	LEN.
ST538NS	4"	5"	12"
ST540NS	4"	6"	12"
ST541NS	4"	7"	12"
ST590NS	5"	6"	12"
ST591NS	5"	7"	12"

ST40013D12 Length 12"



Non-Resonated Slant

IN 4" OUT 5"

ST538N Length 13"



Bolt-On

Non-Resonated Straight

IN 4" OUT 5"

ST538S Length 12"



Resonated Slant

IN 4" OUT 5"



**BLACK POWDER
COATED ON PG. 64**

**BLACK CHROME
ON PG. 63**

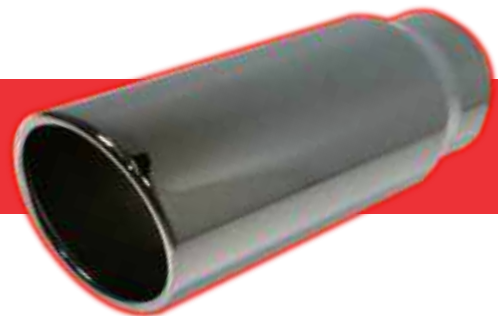

DIESEL STACKS

POLISHED STAINLESS



45 Degree Miter Cut

Part #	IN	OUT	LEN.
AC5632	5"	6"	32"
AC5644	5"	6"	44"
AC5732	5"	7"	32"
AC5744	5"	7"	44"
AC5832	5"	8"	32"
AC5844	5"	8"	44"

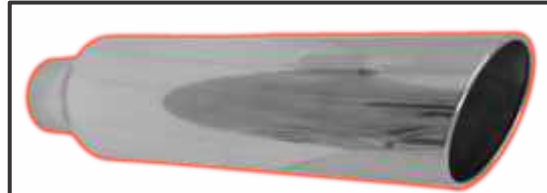

20 Degree Rolled Angle Cut

Part #	IN	OUT	LEN.
RA5632	5"	6"	32"
RA5644	5"	6"	44"
RA5732	5"	7"	32"
RA5744	5"	7"	44"
RA5832	5"	8"	32"
RA5844	5"	8"	44"

BLACK POWDER COATED

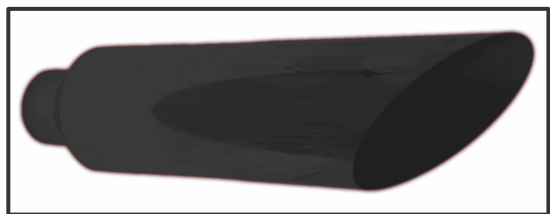

45 Degree Miter Cut

Part #	IN	OUT	LEN.
AC5632K	5"	6"	32"
AC5644K	5"	6"	44"
AC5732K	5"	7"	32"
AC5744K	5"	7"	44"
AC5832K	5"	8"	32"
AC5844K	5"	8"	44"

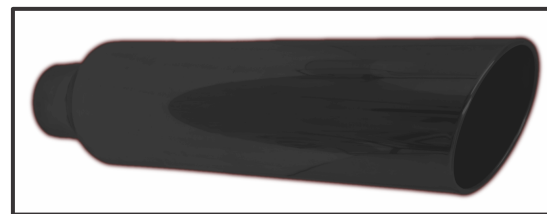

20 Degree Rolled Angle Cut

Part #	IN	OUT	LEN.
RA5632K	5"	6"	32"
RA5644K	5"	6"	44"
RA5732K	5"	7"	32"
RA5744K	5"	7"	44"
RA5832K	5"	8"	32"
RA5844K	5"	8"	44"



VARIOUS OUTLET TIPS

OVAL - ROUND - DOUBLE WALL - DUAL OUTLET

PAGES 54-60

CLASSIC STYLE

MITER CUT - ROLLED ANGLE - TURN DOWN



PAGES 61-62



BLACK CHROME & POWDER COATED

PAGES 63-64

**ALL OUR TIPS ARE POLISHED
T304 STAINLESS STEEL
UNLESS OTHERWISE STATED**

VARIOUS OUTLET TIPS



Double Wall Oval Slant

Part #	IN	OUT	LEN.
ST251612	2 1/2"	3"x4 1/2"	12"
ST251615	2 1/2"	3"x4 1/2"	15"
ST301612	3"	3"x4 1/2"	12"
ST301615	3"	3"x4 1/2"	15"



Bolt-On

Double Wall Oval Slant

Part #	IN	OUT	LEN.
ST251709	2 1/2"	3"x4 1/2"	9"
ST251712	2 1/2"	3"x4 1/2"	12"
ST301712	3"	3"x4 1/2"	12"



Double Wall Straight

Part #	IN	OUT	LEN.
ST009	2 1/4"	3"	8"
ST012C	2 1/4"	4"	8"



Rolled Edge Pencil Tip

Part #	IN	OUT	LEN.
ST007A	1 3/4"	2"	10"
ST007B	2"	2 1/4"	10"
ST007	2 1/4"	2 1/2"	10"
243512PT	2 1/4"	3 1/2"	12"
243518PT	2 1/4"	3 1/2"	18"
243522PT	2 1/4"	3 1/2"	22"
253518PT	2 1/2"	3 1/2"	18"

PT42

Length 8"



Onan Generator Pencil Tip

IN 1 5/8"

OUT 2"

ST024

Length 8"



Double Wall Round Slant

IN 2 1/4"

OUT 4"

ST014

Length 7"



Round Slant

IN 2 1/4"

OUT 4 1/2"

ST006

Length 8"



D.W. Round Resonated Slant

IN 2 1/4"

OUT 3 1/2"

ST025A

Length 6"



Round Slant Turn Up

IN 2 1/4"

OUT 3"

DOUBLE WALL TIPS

ST075

Length 9"

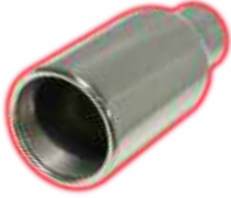

DW Rolled Round

IN 2 1/4"

OUT 4"

ST076

Length 7"



DW Rolled Slant

IN 2 1/4"

OUT 4"

ST038S

Length 12"



DW Resonated Round Slant

IN 3"

OUT 4"

ST131

Length 7"



DW Round Slant

IN 2 1/4"

OUT 3 1/2"

ST137

Length 7"



DW Slant

IN 2 1/4"

OUT 3 1/2"

ST133

Length 4"



DW Straight

IN 2 1/4"

OUT 3 1/2"

243512RADW Length 12"



DW Rolled Angle

IN 2 1/4"

OUT 3 1/2"

DW Straight

DW Slant

Part #	IN	OUT	LEN.
ST135A	2 1/4"	3"	7"
ST135B	2 1/4"	3 1/2"	7"
ST135C	2 1/2"	3 1/2"	7"

Part #	IN	OUT	LEN.
ST136A	2 1/4"	3"	8"
ST136B	2 1/4"	3 1/2"	8"
ST136C	2 1/4"	4"	8"



DW Round Slant

Part #	IN	OUT	LEN.
ST092	1 1/2"	2 1/2"	5"
ST093	1 3/4"	2 1/2"	5"



DW Angle

Part #	IN	OUT	LEN.
ST139	2 1/2"	4"	5"
ST140	3"	4"	5"



DW Slant

Part #	IN	OUT	LEN.
ST25013B16	2 1/2"	3 1/2"	16"
ST25013C16	2 1/2"	4"	16"

DOUBLE WALL TIPS

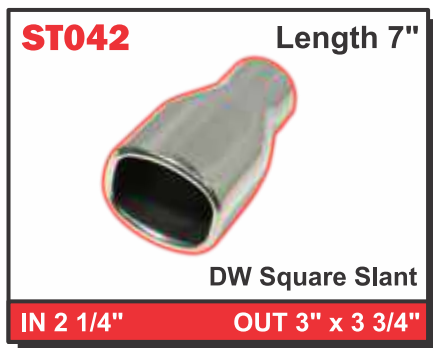

SLANTS & STRAIGHTS

ST015S Length 6"

 Double Layer Slant
IN 2" OUT 3"

ST015 Length 6"

 Double Layer Straight
IN 2" OUT 3"

ST141 Length 5"

 Double Layer Slant
IN 2 1/2" OUT 4"

ST052 Length 8"

 Double Layer Rolled Slant
IN 2 1/4" OUT 4"

ST132 Length 7"

 Round Rolled Slant
IN 2 1/4" OUT 3 1/2"

ST081 Length 9"

 Rolled Oval Slant
IN 2 1/4" OUT 2 1/2" X 6"

ST043S Length 9"

 Rolled Oval Slant
IN 2 1/4" OUT 3" x 5 1/2"

ST101 Length 9"

 Offset Inlet Oval Slant
IN 2 1/4" OUT 2 3/4" x 6"

ST114 Length 8"

 Oval Slant
IN 2 1/4" OUT 1 3/4" x 4"

Oval Rolled Angle Cut

Part #	IN	OUT	LEN.
ST083	2 1/4"	3"x4"	18"
ST082	2 1/4"	4"x5"	18"
ST055	2 1/4"	4"x5"	15"

ST062 Length 7"

 Rolled Oval Resonated Slant
IN 2 1/4" OUT 3 3/4" x 4 1/2"

ST062N Length 7"

 Rolled Oval Non-Resonated Slant
IN 2 1/4" OUT 3 3/4" x 4 1/2"

CAMARO STYLE



BLACK CHROME - MORE BLACK CHROME ON PG. 63



BLACK POWDER COATED - MORE BLACK POWDER COATED ON PG. 64



VARIOUS OUTLET TIPS

VEHICLE SPECIFIC TIPS

ST091 Length 17"



Mopar Rectangular Slant

IN 2 1/4" OUT 1 3/4" x 3 3/4"

ST090 Length 14"



Mopar Oval Slant

IN 3" OUT 1 3/4" x 4 1/4"

ST10970B Out Len. 12"



Bolt-On

Rolled 70 Degree Side Exit

IN 3 1/2" OUT 4"

LEFT & RIGHT DUALS TIPS

ST045L **ST045R**
Len. 12"



Moon Shape Slant w/ In. Pipe

IN 2 1/4" OUT 3 3/4" x 6"

ST045D **ST045P**
Len. 12"



Moon Shape Slant w/o In. Pipe

IN 2 1/4" OUT 3 3/4" x 6"

ST2004L **ST2004R**
Len. 10"



Dual "D" Shape Slant

IN 2 1/2" OUT 3 1/4"

ST124L **ST124R**
Len. 8"



Dual Rolled Slant

IN 2 1/4" OUT 4" x 6"

ST120L **ST120R**
Len. 12"



Rolled Dual "D" Shape Slant

IN 2 1/4" OUT 2 3/4" x 3 1/4"

DUAL OUTLET TIPS

ST048

Length 10"



DW Round Turn-Up

IN 2 1/4"

OUT 3"

ST079

Length 9"



Oval Slant

IN 2 1/4"

OUT 3" x 3 1/2"

ST080

Length 13"



DW Slant

IN 3"

OUT 3"

ST084

Length 9"



Oval Slant

IN 2 1/4"

OUT 3" x 2 1/4"

ST025S

Length 12"



Round Turn-Up Slant

IN 2 1/4"

OUT 3"

ST026S

Length 12"



Rolled Round Slant

IN 2 1/4"

OUT 3 1/2"

ST121

Length 14"

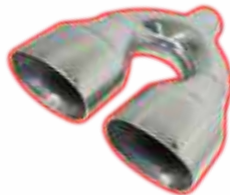

DW Oval

IN 2 1/4"

OUT 3 1/2" x 5 1/2"

ST123

Length 13"

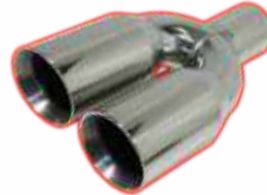

DW Round Slant

IN 2 1/2"

OUT 3 1/2"

ST130

Length 16"



DW Round

IN 3"

OUT 4"

ST123C

Length 13"



Chrome
over
Stainless

DW Round Slant

IN 2 1/2"

OUT 3 1/2"

ST123C1

Length 13"



Chrome
over
Stainless

DW Round Slant

IN 3"

OUT 3 1/2"

CLASSIC MITRE CUT

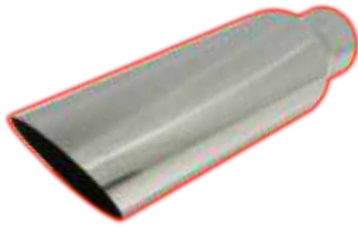

45 Degree Mitre Cut

Part #	IN	OUT	LEN.
4612AC	2 ¼"	3"	12"
4616AC	2 ¼"	3"	16"
4712AC	2 ¼"	3 ½"	12"
4718AC	2 ¼"	3 ½"	18"
4722AC	2 ¼"	3 ½"	22"
5618AC	2 ½"	3"	18"
5712AC	2 ½"	3 ½"	12"
5718AC	2 ½"	3 ½"	18"
5722AC	2 ½"	3 ½"	22"
5818AC	2 ½"	4"	18"
5822AC	2 ½"	4"	22"



45 Degree Mitre Cut

Part #	IN	OUT	LEN.
202409AC	2"	2 ¼"	9"
242509AC	2 ¼"	2 ½"	9"
243012AC	2 ¼"	3"	12"
243016AC	2 ¼"	3"	16"
243018AC	2 ¼"	3"	18"
243024AC	2 ¼"	3"	24"
243512AC	2 ¼"	3 ½"	12"
243516AC	2 ¼"	3 ½"	16"
243518AC	2 ¼"	3 ½"	18"
243522AC	2 ¼"	3 ½"	22"
253518AC	2 ½"	3 ½"	18"
253522AC	2 ½"	3 ½"	22"
244012AC	2 ¼"	4"	12"
244018AC	2 ¼"	4"	18"
254012AC	2 ½"	4"	12"
254018AC	2 ½"	4"	18"
254022AC	2 ½"	4"	22"
304012AC	3"	4"	12"
304018AC	3"	4"	18"
304022AC	3"	4"	22"



15 Degree Mitre Cut

Part #	IN	OUT	LEN.
243518AC15	2 ¼"	3 ½"	18"
243522AC15	2 ¼"	3 ½"	22"
254012AC15	2 ½"	4"	12"
254018AC15	2 ½"	4"	18"
254022AC15	2 ½"	4"	22"
303512AC15	3"	3 ½"	12"
304012AC15	3"	4"	12"

**DIESEL
SIZES ON
PG. 48-51**

CLASSIC ROLLED & ETC.



20 Degree Rolled Angle Cut

Part #	IN	OUT	LEN.
4612RAC	2 1/4"	3"	12"
4616RAC	2 1/4"	3"	16"
4712RAC	2 1/4"	3 1/2"	12"
4718RAC	2 1/4"	3 1/2"	18"
4722RAC	2 1/4"	3 1/2"	22"
5618RAC	2 1/2"	3"	18"
5712RAC	2 1/2"	3 1/2"	12"
5718RAC	2 1/2"	3 1/2"	18"
5812RAC	2 1/2"	4"	12"
5818RAC	2 1/2"	4"	18"
6815RAB*	3"	4"	15"

* Bolt On



Double Wall Slant

Part #	IN	OUT	LEN.
ST013A	2 1/4"	3"	8"
ST013A12	2 1/4"	3"	12"
ST013A16	2 1/4"	3"	16"
ST013B	2 1/4"	3 1/2"	8"
ST013B12	2 1/4"	3 1/2"	12"
ST013B16	2 1/4"	3 1/2"	16"
ST013C	2 1/4"	4"	8"
ST013C12	2 1/4"	4"	12"
ST30013C12	3"	4"	12"



20 Degree Rolled Angle Cut

Part #	IN	OUT	LEN.
243012RAC	2 1/4"	3"	12"
243016RAC	2 1/4"	3"	16"
243512RAC	2 1/4"	3 1/2"	12"
243516RAC	2 1/4"	3 1/2"	16"
243518RAC	2 1/4"	3 1/2"	18"
243522RAC	2 1/4"	3 1/2"	22"
244012RAC	2 1/4"	4"	12"
244018RAC	2 1/4"	4"	18"
253512RAC	2 1/2"	3 1/2"	12"
253518RAC	2 1/2"	3 1/2"	18"
254009RAC	2 1/2"	4"	9"
254012RAC	2 1/2"	4"	12"
254018RAC	2 1/2"	4"	18"
254022RAC	2 1/2"	4"	22"
303512RAC	3"	3 1/2"	12"
304012RAC	3"	4"	12"
304015RAC	3"	4"	15"



Turn Down

Part #	IN	OUT	LEN.
3409TD	2"	2 1/4"	9"
4509TD	2 1/4"	2 1/2"	9"
5612TD	2 1/2"	2 3/4"	12"
6615TD	3"	3"	15"
6715TD	3"	3 1/2"	15"
7715TD	3 1/2"	3 1/2"	15"

BLACK CHROME TIPS

ST043S2

Length 9"



Oval Rolled Slant

IN 2 1/4"

OUT 3" x 5 1/2"

ST0812

Length 9"



Oval Rolled Slant

IN 2 1/4"

OUT 2 1/2" x 6"

ST0792

Length 9"



Dual Oval Slant

IN 2 1/4"

OUT 3" x 3 1/2"



15 Degree Rolled Angle Cut

Part #	IN	OUT	LEN.
243016RAC2	2 1/4"	3"	16"
243518RAC2	2 1/4"	3 1/2"	18"
243522RAC2	2 1/4"	3 1/2"	22"
244018RAC2	2 1/4"	4"	18"
254009RAC2	2 1/2"	4"	9"
405012RAC2	4"	5"	12"
405015RAC2	4"	5"	15"
8915RAB2*	4"	5"	15"
506015RAC2	5"	6"	15"



45 Degree Mitre Cut

Part #	IN	OUT	LEN.
243016AC2	2 1/4"	3"	16"
243522AC2	2 1/4"	3 1/2"	22"
243518AC2	2 1/4"	3 1/2"	18"
244018AC2	2 1/4"	4"	18"

* Bolt On

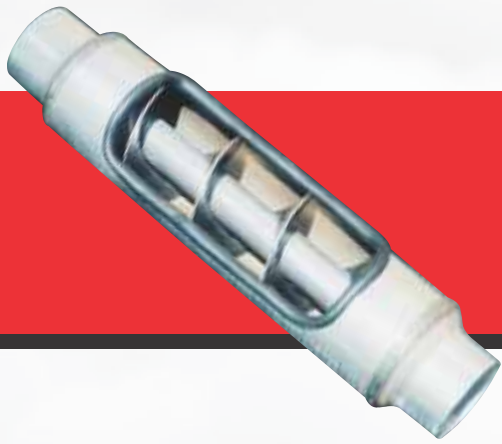

RESONATORS

GLASSPACKS - BAFFLE PACKS - TWISTERS

PAGES 66-71

UNIVERSAL MUFFLERS

FLO~PRO - MAX - SUPER V



PAGES 72-92



TRUCK MUFFLERS

DIESEL - 2500HD - HEAVY DUTY

PAGES 78-83

ACCESSORIES

X/Y PIPES - HEADER COLLECTORS - MANDREL BENDS - CLAMPS



PAGES 93-97

TWISTER RESONATORS

TWISTER RACE RESONATOR

The TWISTER's corkscrew baffle design provides the best performance, noise reduction, fit and affordability

**STEEL WELDED
CONSTRUCTION**

**OUR SPIRAL DESIGN IS
LESS RESTRICTIVE THAN
ALTERNATIVE RESONATORS**

**DUAL FLOW PATH
CANCELS NOISE**

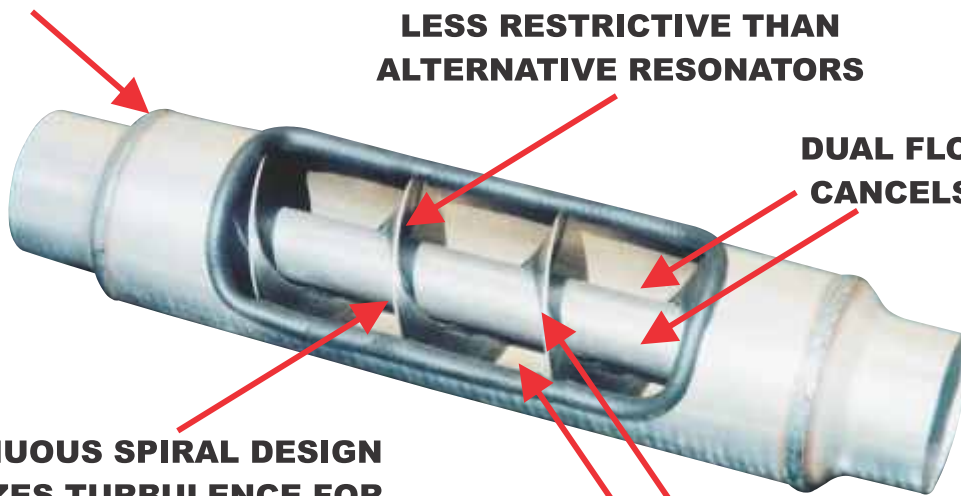

**CONTINUOUS SPIRAL DESIGN
MINIMIZES TURBULENCE FOR
GREATER FLOW, INCREASING
HORSEPOWER OVER OTHERS**

**DUAL FLOW PATH CREATES A VACUUM
THAT ACCELERATES THE EXHAUST**

- Race Muffler that fits in tight places
- Reduces noise to meet most track requirements
- Insignificant loss of horsepower from open headers
- Great fit for street-legal high performance cars & trucks
- Eliminates cab drone in diesel truck applications

TWISTER RESONATORS

F4 SERIES - 4" CASE DIAMETER

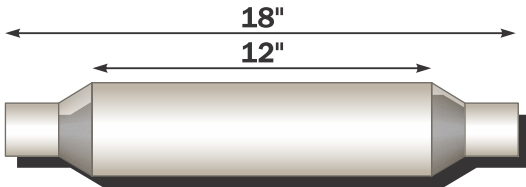
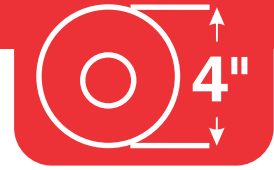

Inlet	Outlet	Part #
2-1/4"	2-1/4"	41244
2-1/2"	2-1/2"	41255
3"	3"	41277
3-1/2"	3-1/2"	41288

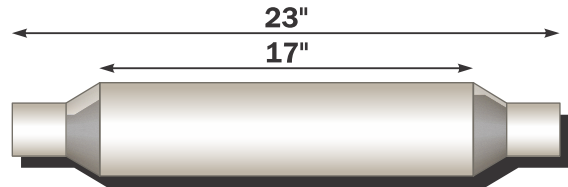

Inlet	Outlet	Part #
2-1/4"	2-1/4"	41744
2-1/2"	2-1/2"	41755
3"	3"	41777

F5 SERIES - 5" CASE DIAMETER

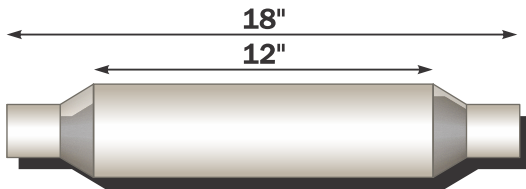
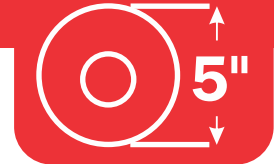

Inlet	Outlet	AL	SS
3"	3"	51277	-
3-1/2"	3-1/2"	51288	-
4"	4"	51299	71299
5"	5"	51600	71600

AL = ALUMINIZED
SS = 409 STAINLESS

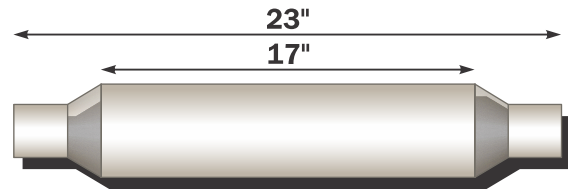

Inlet	Outlet	AL	SS
3"	3"	51777	-
3-1/2"	3-1/2"	51788	-
4"	4"	51799	71799



AL = ALUMINIZED
SS = 409 STAINLESS

GLASS PACK RESONATORS

CASE DIAMETER	CASE LENGTH	CORE DIAMETER	OVERALL LENGTH	INLET SIZE	OFFSET	PART NUMBER
3"	10"	1-3/4"	15"	1-3/4"	STRAIGHT	3010STR
3"	10"	2"	15"	2"	STRAIGHT	3010STR2
3"	12"	1-3/4"	12"	BLANK		3012
3"	12"	1-3/4"	17"	1-3/4"	STRAIGHT	3012ST
3"	15"	1-3/4"	15"	BLANK		3015
3"	15"	1-3/4"	20"	1-3/4"	STRAIGHT	3015ST
3"	17"	1-3/4"	17"	BLANK		3018
3"	17"	1-3/4"	22"	1-3/4"	STRAIGHT	3018ST
3-1/2"	9"	2"	9"	BLANK		3509
3-1/2"	9"	2"	14"	2"	STRAIGHT	3509ST
3-1/2"	12"	2"	12"	BLANK		3512
3-1/2"	12"	2"	17"	2"	STRAIGHT	3512ST
3-1/2"	12"	2"	18"	2"	SINGLE	3512S0
3-1/2"	15"	2"	15"	BLANK		3515
3-1/2"	15"	2"	21"	2"	STRAIGHT	3515ST
3-1/2"	17"	2"	17"	BLANK		3518
3-1/2"	17"	2"	22"	2"	STRAIGHT	3518ST
3-1/2"	17"	2"	22"	2-1/4"	STRAIGHT	3518STX
3-1/2"	17"	2"	22"	2-1/2"	STRAIGHT	3518STXX
3-1/2"	17"	2"	23"	2"	SINGLE	3518S0
3-1/2"	17"	2"	23"	2"	DOUBLE	3518D0
3-1/2"	20"	2"	25"	2"	STRAIGHT	3520ST
3-1/2"	20"	2"	20"	BLANK		3520
3-1/2"	24"	2"	24"	BLANK		3524
3-1/2"	24"	2"	29"	2"	STRAIGHT	3524ST
3-1/2"	30"	2"	30"	BLANK		3530
3-1/2"	30"	2"	35"	2"	STRAIGHT	3530ST
3-1/2"	36"	2"	36"	BLANK		3536
3-1/2"	36"	2"	41"	2"	STRAIGHT	3536ST
4"	9"	2-1/4"	9"	BLANK		4009
4"	12"	2-1/4"	12"	BLANK		4012
4"	12"	2-1/4"	17"	2-1/4"	STRAIGHT	4012ST
4"	15"	2-1/4"	20"	2-1/4"	STRAIGHT	4015ST
4"	15"	2-1/4"	15"	BLANK		4015

GLASS PACK RESONATORS

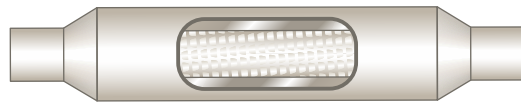

CASE DIAMETER	CASE LENGTH	CORE DIAMETER	OVERALL LENGTH	INLET SIZE	OFFSET	PART NUMBER
4"	17"	2-1/2"	24"	2-1/2"	STRAIGHT	4518ST
4"	17"	2-1/2"	17"	BLANK		4518
4"	17"	2-1/4"	17"	BLANK		4018
4"	17"	2-1/4"	22"	2-1/4"	STRAIGHT	4018ST
4"	17"	2-1/4"	23"	2-1/4"	SINGLE	4018S0
4"	17"	2-1/4"	23"	2-1/4"	DOUBLE	4018DO
4"	17"	3"	24"	3"	STRAIGHT	4318ST
4"	17"	3"	17"	BLANK		4318
4"	24"	2-1/4"	24"	BLANK		4024
4"	24"	2-1/4"	29"	2-1/4"	STRAIGHT	4024ST
4"	30"	2-1/4"	35"	2-1/4"	STRAIGHT	4030ST
4"	30"	2-1/4"	30"	BLANK		4030
5"	17"	3"	24"	2-1/2"	STRAIGHT	5018ST
5"	17"	3"	24"	3"	STRAIGHT	5318ST
5"	30"	3"	37"	3"	STRAIGHT	5330ST

POWER PACKS - DUAL OUTLET GLASS PACKS

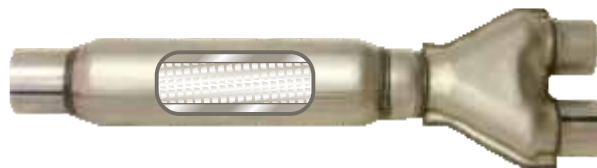

CASE DIAMETER	CASE LENGTH	CORE DIAMETER	OVERALL LENGTH	INLET SIZE	OUTLET SIZE	PART NUMBER
4"	15"	3"	29"	2-1/4"	2-1/4" DUAL	PP214
4"	15"	3"	29"	2-1/2"	2-1/2" DUAL	PP2512
4"	15"	3"	29"	2-1/2"	2-1/4" DUAL	PP2514
4"	15"	3"	29"	3"	2-1/2" DUAL	PP3012
4"	15"	3"	29"	3"	2-1/4" DUAL	PP3014

POLISHED T304 GLASS PACKS



**HEAVY GAUGE STAINLESS
STEEL CONSTRUCTION**



**HIGH TEMP SOUND
ABSORBING MATERIAL
RESISTS MELTDOWN,
MATTING & BLOWOUT**

**THICK STAINLESS STEEL
MESH ADDS ADDITIONAL
SOUND ABSORPTION AND
PREVENTS BLOWOUT**

**STRAIGHT
THROUGH
DESIGN**

CASE DIAMETER	CASE LENGTH	CORE DIAMETER	OVERALL LENGTH	END SIZES	END POSITION	PART NUMBER
3-1/2"	12"	2-1/4"	16"	2-1/4"	STRAIGHT	3512RS
3-1/2"	15"	2-1/4"	19"	2-1/4"	STRAIGHT	3515RS
4"	12"	2-1/2"	16"	2-1/2"	STRAIGHT	4512RS
4"	15"	2-1/2"	19"	2-1/2"	STRAIGHT	4515RS
4"	12"	3"	16"	3"	STRAIGHT	4312RS
4"	15"	3"	19"	3"	STRAIGHT	4315RS

BAFFLE PACK RESONATORS

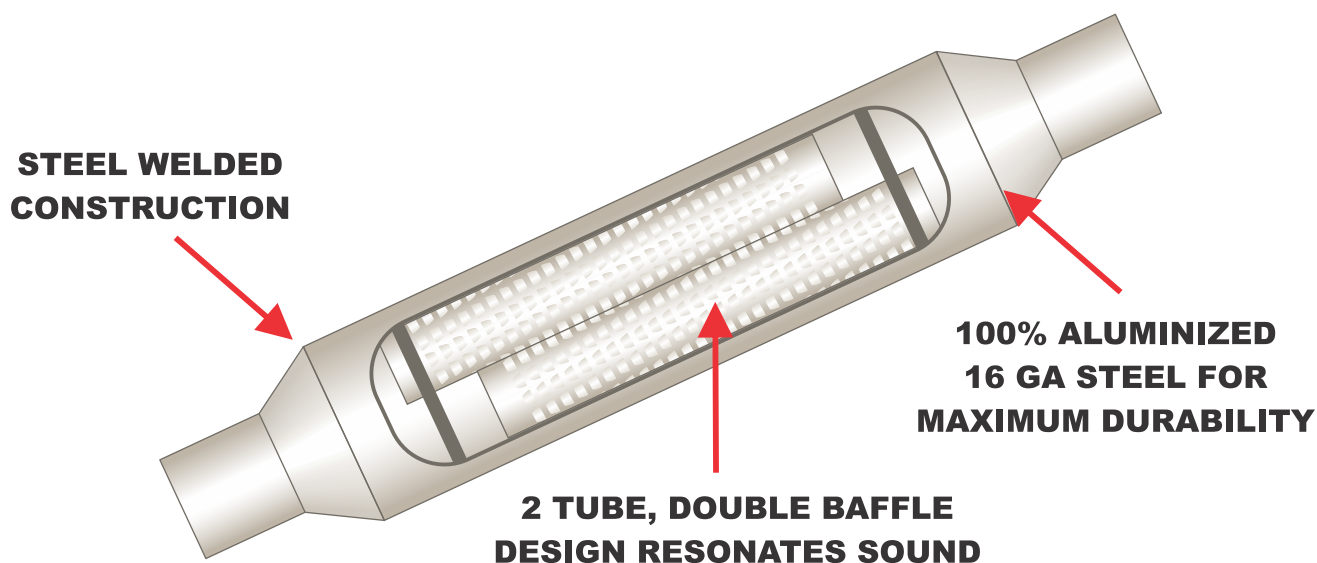

CASE DIAMETER	CASE LENGTH	OVERALL LENGTH	INLET SIZE	OUTLET SIZE	OFFSET	PART NUMBER
3"	10"	16"	1"	1"	STRAIGHT	3303
3"	10"	16"	1-1/2"	1-1/2"	STRAIGHT	3300
3"	10"	16"	1-3/4"	1-3/4"	STRAIGHT	3302
3"	12"	17"	1-1/2"	1-1/2"	STRAIGHT	3301
4"	12"	18"	2"	2"	STRAIGHT	4406
4"	12"	18"	2"	2"	SINGLE	4405
4"	15"	21"	2"	2"	STRAIGHT	4423
4"	17"	23"	2"	2"	STRAIGHT	4415
4"	17"	23"	2-1/4"	2-1/4"	STRAIGHT	4415X
4"	17"	23"	2-1/2"	2-1/2"	STRAIGHT	4415XX
4"	17"	23"	2"	2"	SINGLE	4414
4"	17"	23"	2-1/4"	2-1/4"	SINGLE	4414X
4"	17"	23"	2-1/2"	2-1/2"	SINGLE	4414XX
4"	17"	23"	2"	2"	DOUBLE	4418
4"	17"	23"	2-1/4"	2-1/4"	DOUBLE	4418X
4"	17"	23"	2-1/2"	2-1/2"	DOUBLE	4418XX
4"	20"	26"	2"	2"	STRAIGHT	4420
4"	24"	30"	2"	2"	STRAIGHT	4421
4"	24"	30"	2-1/4"	2-1/4"	STRAIGHT	4422
5"	20"	28"	2-1/2"	2-1/4"	STRAIGHT	5520
5"	22"	29"	3"	3"	STRAIGHT	5522

POLISHED 304 MUFFLERS



6" Round Slant

Part #	IN	OUT	LEN.
SM106S	2 1/4"	4"	14"
SM106S5	2 1/2"	4"	14"



6" Round Slant

Part #	IN	OUT	LEN.
SM125	2 1/4"	4"	14"
SM1255	2 1/2"	4"	14"



6" Round Slant Silencer

Part #	IN	OUT	LEN.
SM142S5	2 1/2"	4"	16"

SM115 Body 14"



6" DW Round Slant

IN 2 1/4" OUT 4"

SM111 Body 14"



6" Round Slant

IN 2 1/4" OUT 4 1/2"

SM123 Body 14"



5" Round Slant Silencer

IN 2 1/4" OUT 3 3/8"

SM117 Body 14"



5" x 8" Oval DW Slant

IN 2 1/4" OUT 4"

SM129 Body 14"



5" x 8" Oval Slant

IN 2 1/4" OUT 4 1/2"

SS6 5" Round



Stainless Strap

SS58 5" x 8" Oval



Stainless Strap

FLO~PRO ORIGINAL

***The Only Packing in this
Baby... is The Punch!***

FLO~PRO has proven it beats the competition with louvered pipe that accelerates the exhaust flow through our muffler. The louvers also give a deep performance sound without the use of fiberglass that eventually blows out!

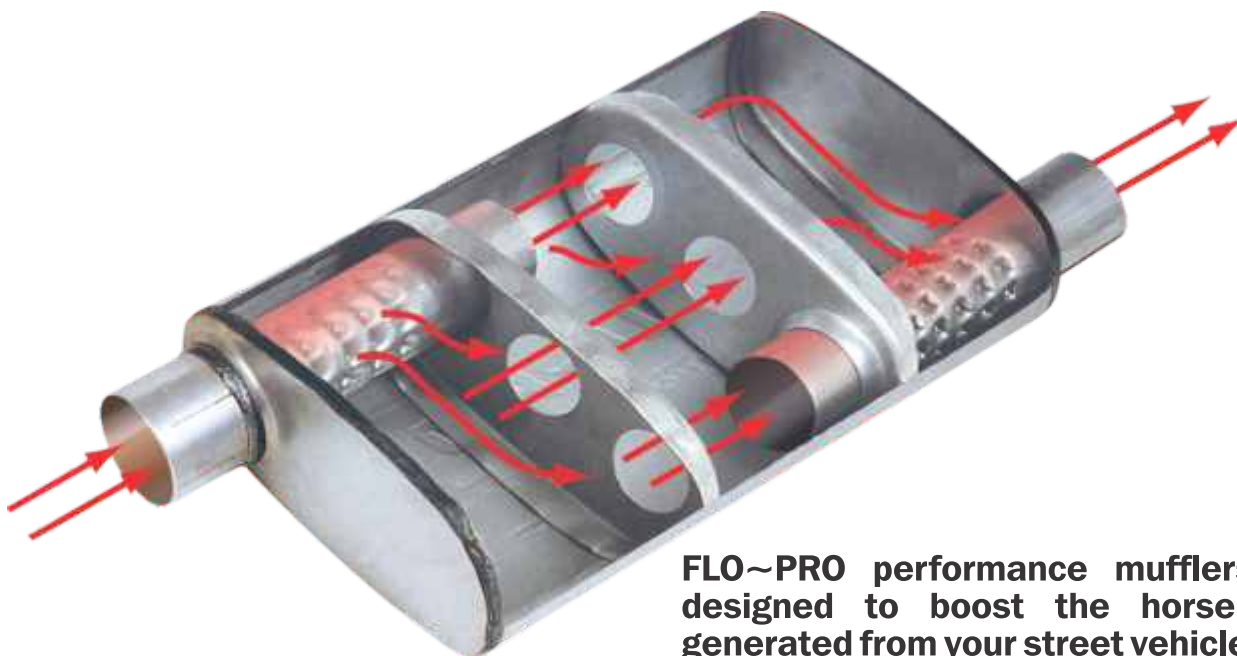

The Answer is Obvious...

FLO~PRO increases horsepower, adds fuel economy and is constructed to give you years of worry-free performance.

FLO~PRO performance mufflers are designed to boost the horsepower generated from your street vehicle.

The 100% Aluminized steel welded construction will outlast conventional locked-seam, double wrap mufflers.

FLO~PRO
PERFORMANCE MUFFLERS

FLO~PRO ORIGINAL

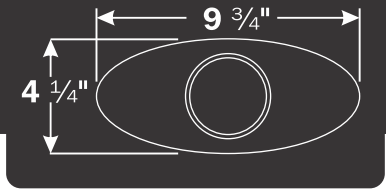

OFFSET / CENTER

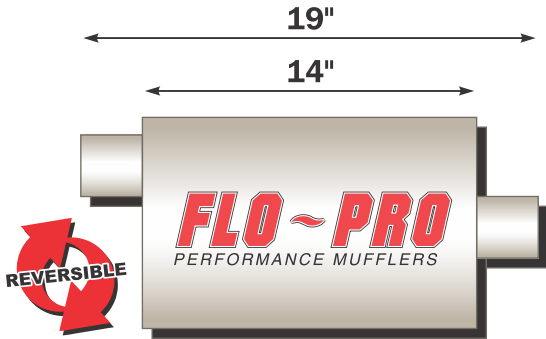

Inlet	Outlet	Part #
2"	2"	FP200
2-1/4"	2-1/4"	FP214
2-1/2"	2-1/2"	FP212
3"	3"	FP300

OFFSET / OFFSET

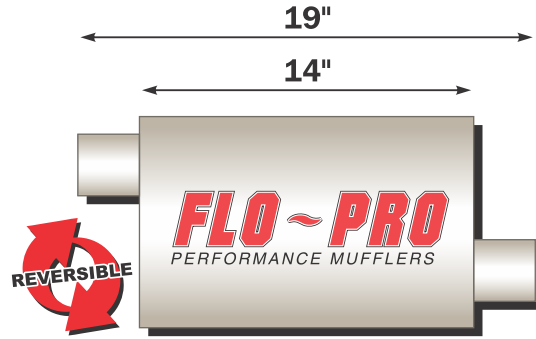

Inlet	Outlet	Part #
2"	2"	FP201
2-1/4"	2-1/4"	FP215
2-1/2"	2-1/2"	FP211
3"	3"	FP301

OFFSET / CENTER

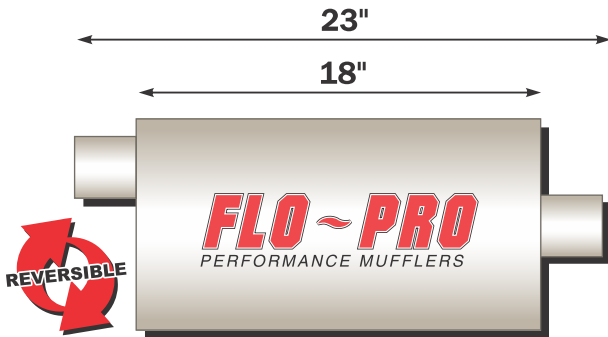

Inlet	Outlet	Part #
2-1/4"	2-1/4"	FP765
2-1/2"	2-1/2"	FP760
3"	3"	FP757

OFFSET / OFFSET

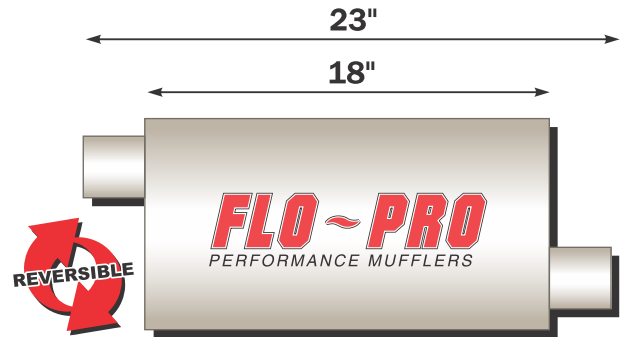

Inlet	Outlet	Part #
2-1/4"	2-1/4"	FP774
2-1/2"	2-1/2"	FP775

FLO~PRO ORIGINAL

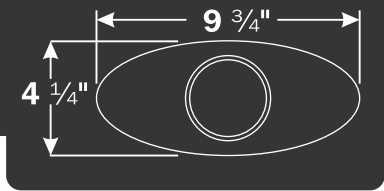

CENTER / DUALS

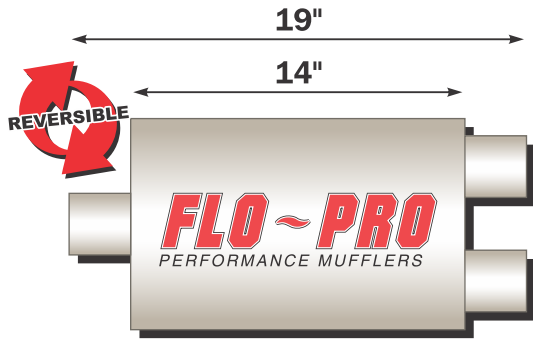

Inlet	Outlet	Part #
2-1/4"	2-1/4"	FP223

CAMARO DUAL OUTLET

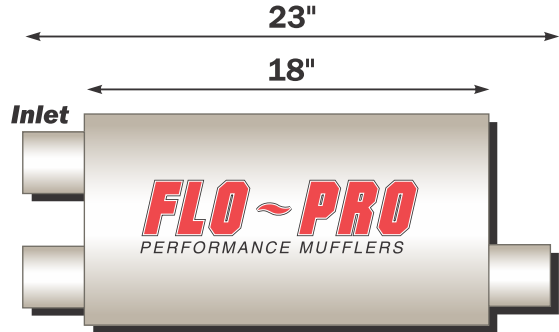

Inlet	Outlet	Part #
2-1/4"	2-1/4"	FP759
2-1/2"	2-1/4"	FP767
3"	2-1/2"	FP768

BUICK GRAND NATIONAL

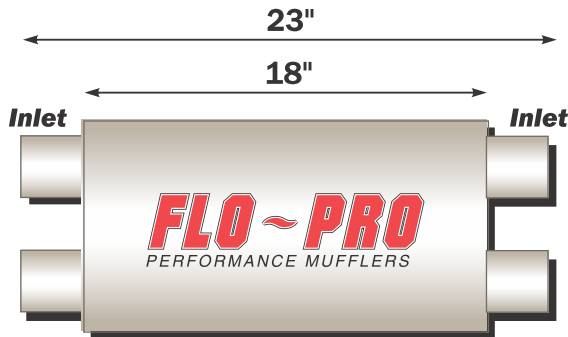

Inlet	Outlet	Part #
2-1/4"	2-1/4"	FP761

CHEV / GM PICKUP

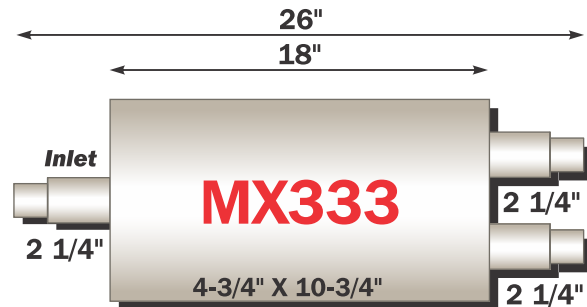

OFFSET / OFFSET

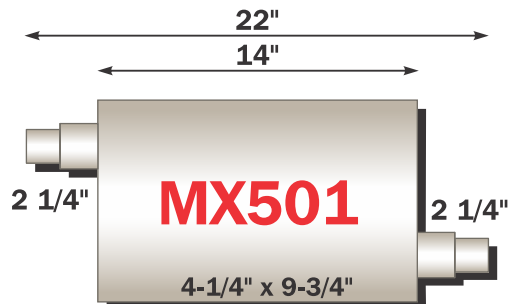

CAMARO

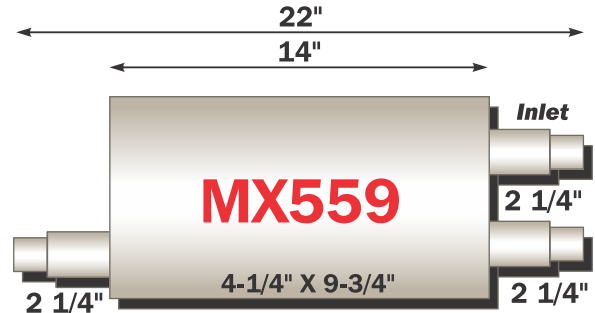

FLO~PRO ORIGINAL

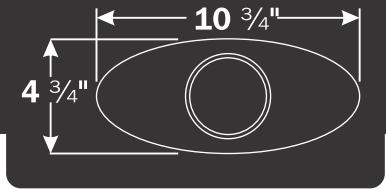

DIESEL MUFFLER

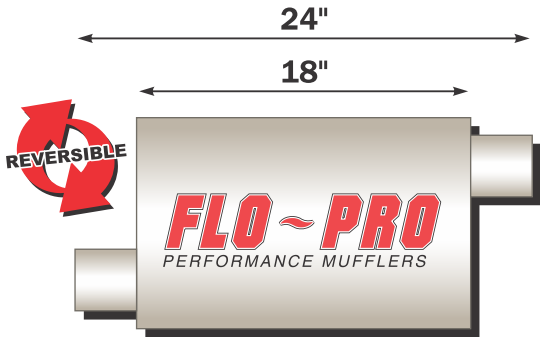

Inlet	Outlet	Part #
3-1/2"	3-1/2"	FP729

**UNIVERSAL REPLACEMENT
99-05 FORD 7.3L
01-05 GM DURAMAX**

OFFSET / CENTER

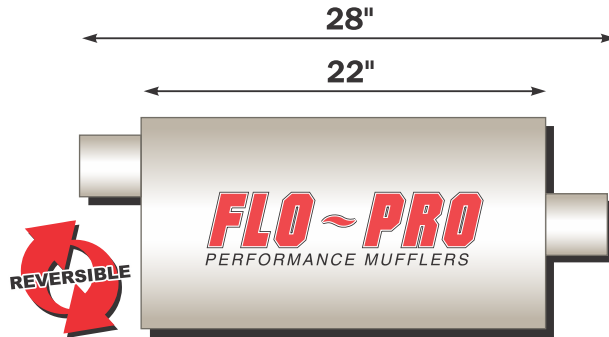

Inlet	Outlet	Part #
2-1/4"	2-1/4"	FP754
2-1/2"	2-1/2"	FP551
3"	3"	FP710*

* **FP710** HAS BEEN SPECIFICALLY DESIGNED FOR FORD V10 MODELS.

CENTER / OFFSET

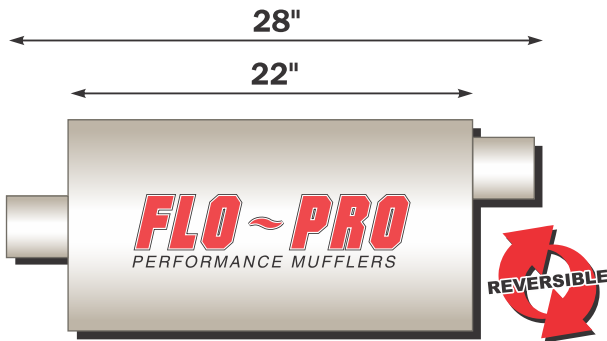

Inlet	Outlet	Part #
3"	3"	FP747
3"	3"	FP746*

* **FP746** HAS BEEN REDESIGNED FROM THE **FP747**, FOR REDUCED NOISE LEVELS CLOSER TO STOCK SOUND.

OFFSET / OFFSET

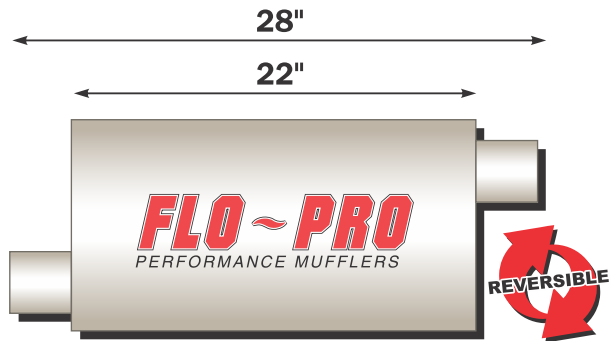

Inlet	Outlet	Part #
2-3/4"	2-3/4"	FP730
3"	3"	FP732

FLO~PRO ORIGINAL

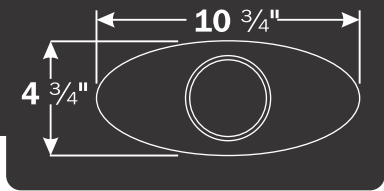

CENTER / DUAL

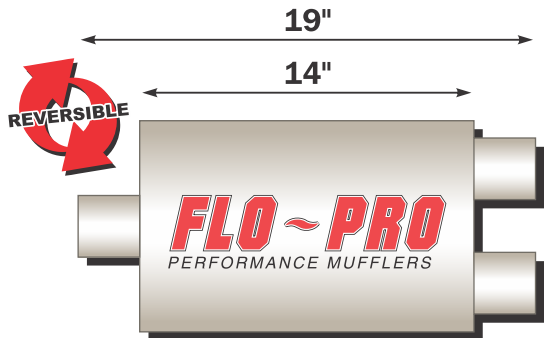

Inlet	Outlet	Part #
2-1/2"	2"	FP738
2-1/2"	2-1/4"	FP737
2-1/2"	2-1/2"	FP727
3"	2-1/4"	FP740
3"	2-1/2"	FP739

CENTER / DUAL

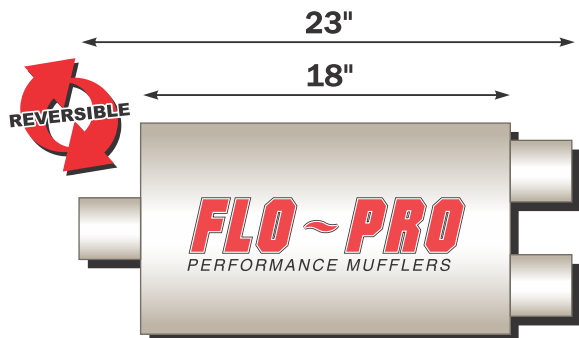

Inlet	Outlet	Part #
2-1/2"	2-1/2"	FP736
3"	2-1/4"	FP741

CENTER / DUAL

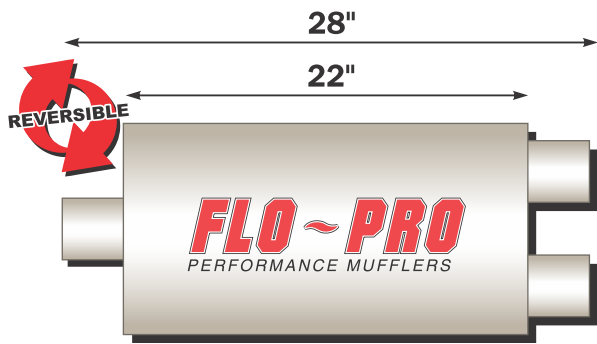

Inlet	Outlet	Part #
3"	2-1/4"	FP744
3"	2-1/4"	FP745*
3"	2-1/2"	FP731
3"	3"	FP733

DUAL / DUAL

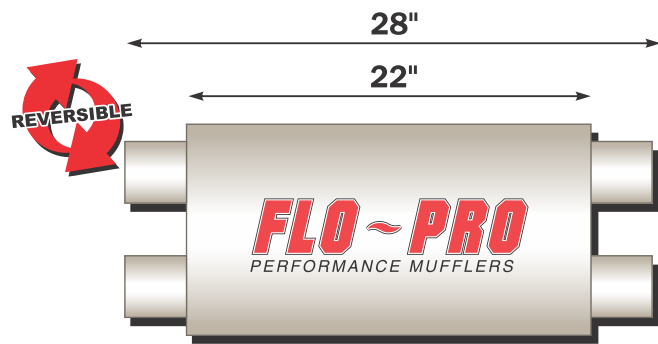

Inlet	Outlet	Part #
2"	2"	FP735
2-1/4"	2-1/4"	FP726

* **FP745** HAS BEEN REDESIGNED FROM THE **FP744** FOR REDUCED NOISE LEVELS CLOSER TO STOCK SOUND.

HEAVY DUTY MUFFLERS

- Cars, Light Truck & Medium Duty Trucks
- All Welded Construction
- 100% Aluminized

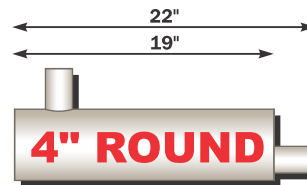
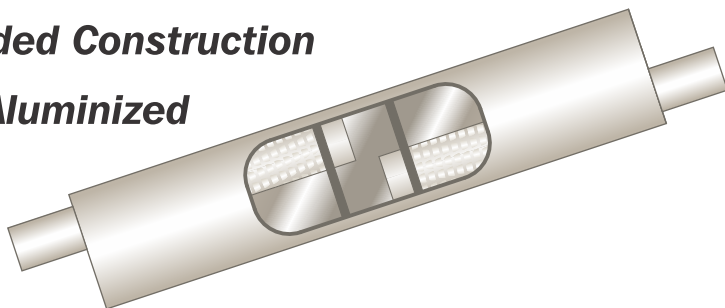

Inlet	Outlet	Part #
1-1/2"	1-1/2"	1953

ONAN GENERATOR

6" ROUND - CASE DIAMETER

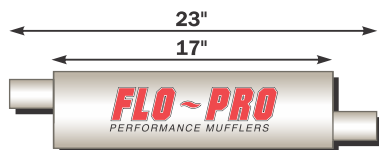

Inlet	Outlet	Part #
1-3/4"	1-3/4"	1009
2"	2"	1010

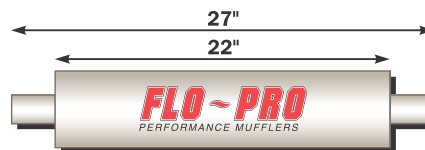

Inlet	Outlet	Part #
2-1/2"	2-1/2"	1016

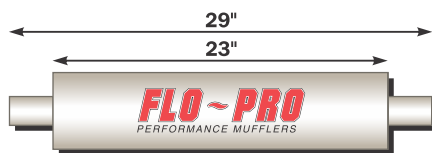

Inlet	Outlet	AL	SS
3"	3"	6173	7173

AL = ALUMINIZED
SS = 409 STAINLESS

NEW

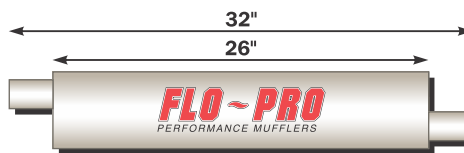

Inlet	Outlet	Part #
2"	2"	1011
2-1/4"	2-1/4"	1012
2-1/2"	2-1/4"	1013
2-1/2"	2-1/2"	4010

HEAVY DUTY MUFFLERS

7" ROUND - CASE DIAMETER

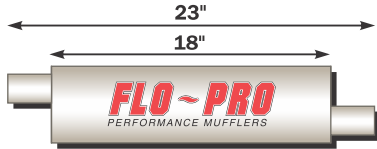

Inlet	Outlet	Part #
2-1/4"	2-1/4"	2000

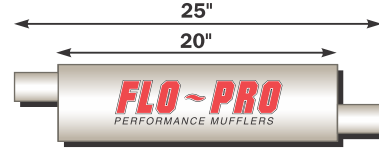

Inlet	Outlet	Part #
3"	3"	3020

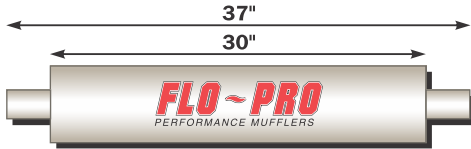

Inlet	Outlet	Part #
3"	3"	4126

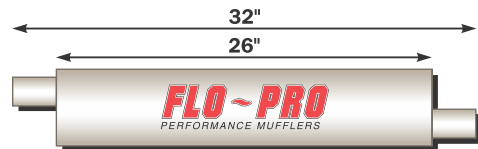

Inlet	Outlet	Part #
2-1/4"	2-1/4"	4014
2-1/2"	2-1/4"	4011
2-1/2"	2-1/2"	4013
3"	3"	4115

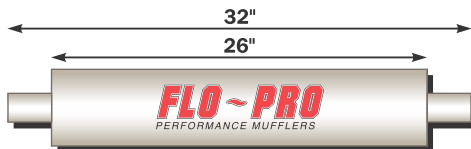

Inlet	Outlet	Part #
3"	3"	4025

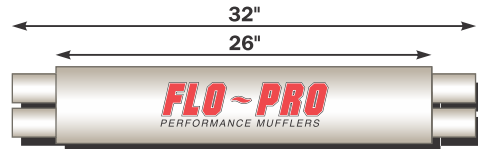

Inlet	Outlet	Part #
2-1/4"	2-1/4"	4020
2-1/2"	2-1/2"	4017

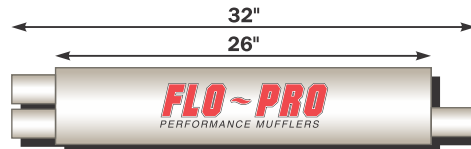

Inlet	Outlet	Part #
2-1/2"	2-1/2"	4122

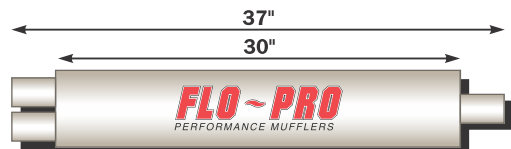

Inlet	Outlet	Part #
2-1/2"	3"	4027

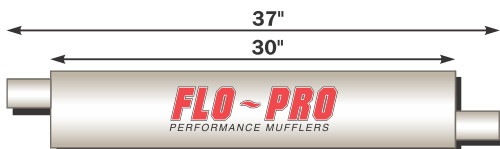

Inlet	Outlet	Part #
3"	3"	4114

94-95 CHEV/GMC PICKUP

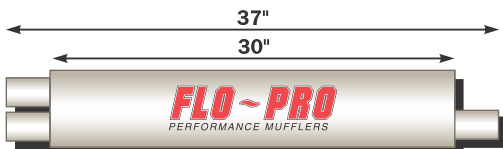

Inlet	Outlet	Part #
2-1/2"	2-1/2"	4123

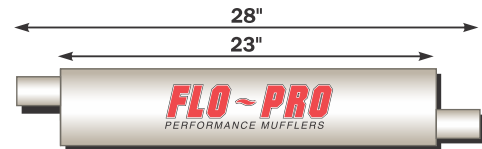

Inlet	Outlet	Part #
2-3/4"	2-3/4"	3019

HEAVY DUTY MUFFLERS

8" ROUND - CASE DIAMETER

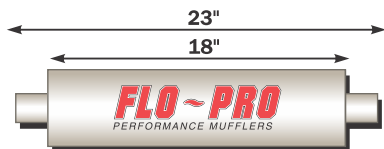

Inlet	Outlet	Part #
3-1/2"	4"	8890

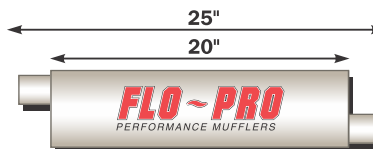

Inlet	Outlet	Part #
3"	3"	1976

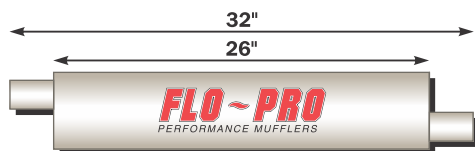

Inlet	Outlet	Part #
2-1/2"	2-1/2"	1978
4"	3"	8972*
4"	4"	8992

*8972 FITS 1994-02 DODGE CUMMINS

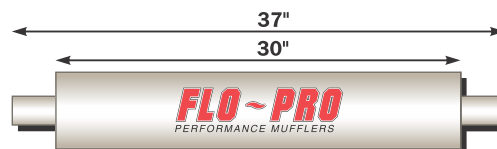

Inlet	Outlet	Part #
3"	3"	1974
3-1/2"	3-1/2"	8880
4"	4"	8990

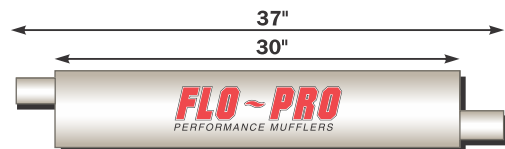

Inlet	Outlet	Part #
3"	3"	1972

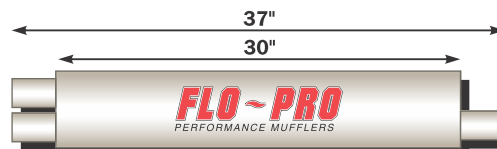

Inlet	Outlet	Part #
2-1/2"	3"	1975

HEAVY DUTY DIESEL

8" ROUND - ALUMINIZED

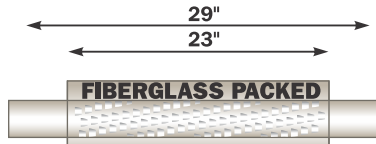

FIBERGLASS PACKED
PERFORATED CORE

Inlet	Outlet	Part #
4"	4"	6195
5"	5"	6196

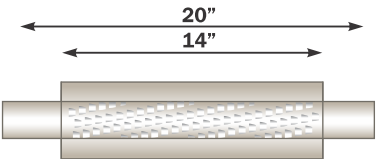

PERFORATED CORE

Inlet	Outlet	Part #
4"	4"	6185
5"	5"	6186

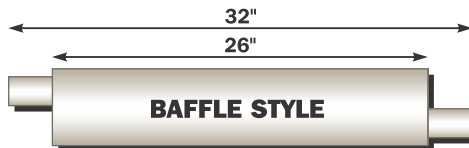

BAFFLE STYLE

Inlet	Outlet	Part #
4"	3"	8972*
4"	4"	8992

*8972 FITS 1994-02 DODGE CUMMINS

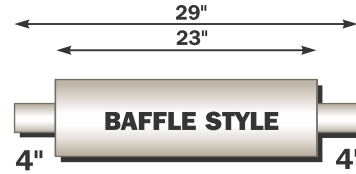

BAFFLE STYLE

Inlet	Outlet	Part #
4"	4"	6192

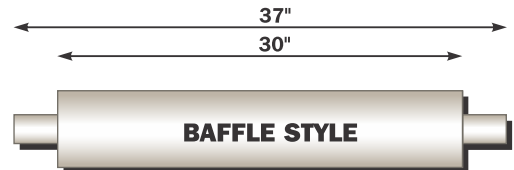

BAFFLE STYLE

Inlet	Outlet	Part #
3-1/2"	3-1/2"	8880
4"	4"	8990

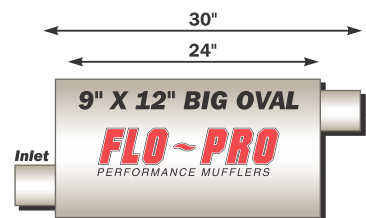

9" X 12" BIG OVAL

FLO~PRO
PERFORMANCE MUFFLERS

Reversible

Inlet	Outlet	Part #
4"	4"	2507

8" ROUND - T409 STAINLESS

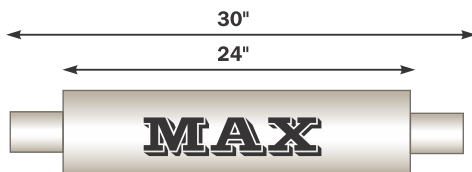

MAX
PERFORATED CORE

Inlet	Outlet	Part #
4"	4"	M12772
5"	5"	M12774

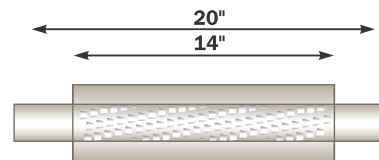

PERFORATED CORE

Inlet	Outlet	Part #
4"	4"	7185
5"	5"	7186

HD BIG OVAL

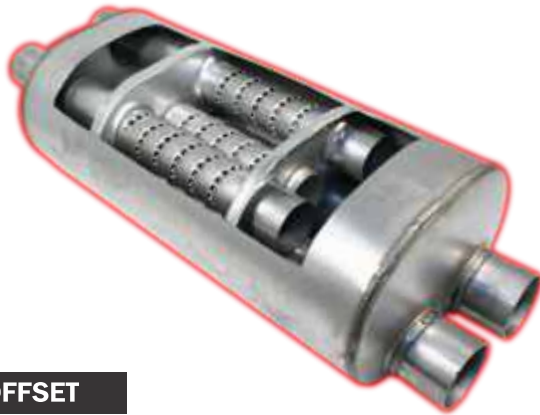
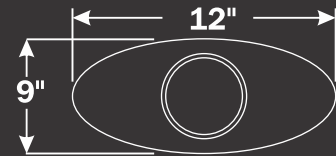

CENTER / OFFSET



Inlet	Outlet	Part #
3"	3"	1500

DIRECT FIT GM "Classic 1500"
4.8L & 5.3L Engines

DUAL / DUAL



Inlet	Outlet	Part #
3"	3"	2503

DIRECT FIT GM "Classic 1500 HD"
6.0L Engines

DUAL / DUAL

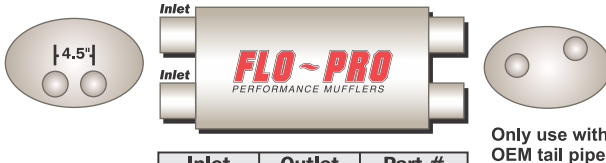

Inlet	Outlet	Part #
3"	3"	2500

DIRECT FIT GM "Classic 2500HD"
6.0L Engines

OFFSET / OFFSET



Inlet	Outlet	Part #
3-1/2"	3-1/2"	2510
4"	4"	2507

2510 DIRECT FIT GM "07NBS 2500 HD"
6.0L & 6.2L Engines

CENTER / OFFSET



Inlet	Outlet	Part #
3"	3"	2501

Use with universal tailpipe

1500 GM Pick Up
4.8L & 5.3L

CENTER / DUAL

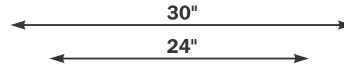

Inlet	Outlet	Part #
3"	2-1/2"	2502

Can be used with most
aftermarket 2 1/2" dual tail pipes

Custom Duals
Outlets will not
fit OEM tail pipe.

FLO~PRO MAX MUFFLER



DENSELY SPACED SMALLER HOLES ELIMINATES BLOWOUT & MAINTAINS A DEEP TONED PERFORMANCE SOUND

HEAVY GAUGE STAINLESS STEEL CONSTRUCTION WITH WELDED JOINTS & SEAMS FOR MAXIMUM DURABILITY

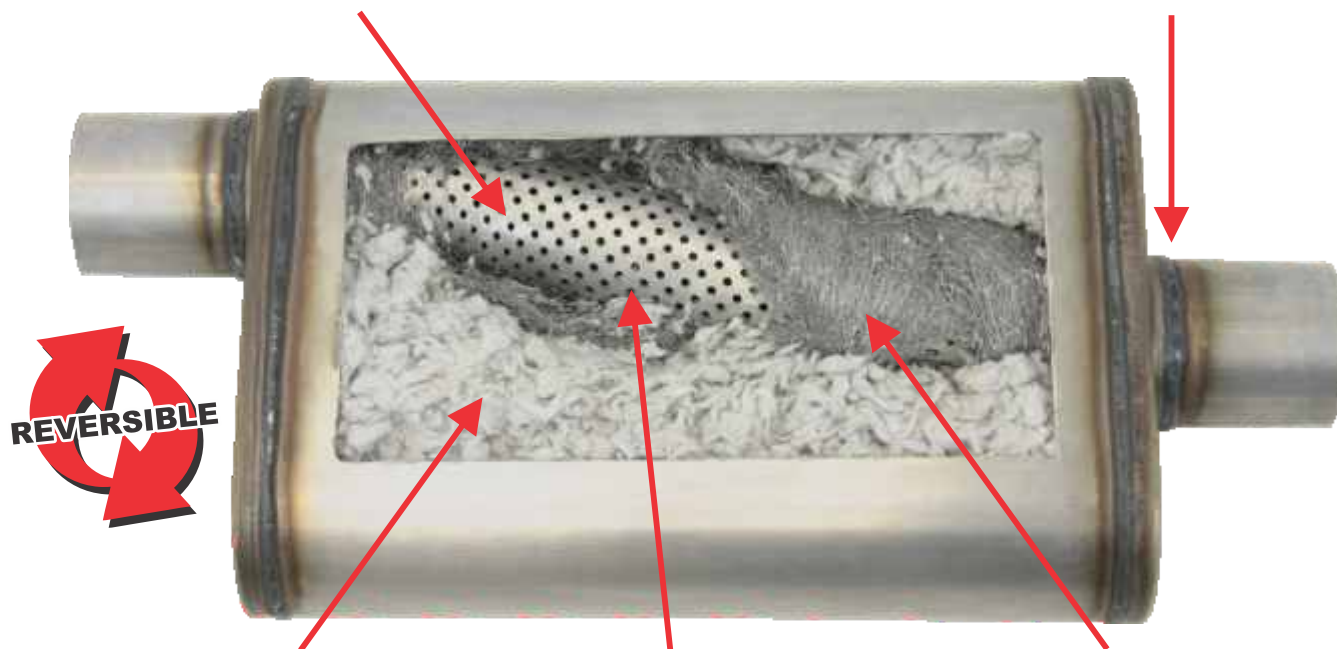

DENSELY PACKED WITH HIGH TEMP MATERIAL THAT RESISTS MELTDOWN, MATTING & BLOWOUT

STAINLESS STEEL MESH ADDS ADDITIONAL SOUND ABSORPTION & PREVENTS AGAINST BLOWOUT

STRAIGHT THROUGH MANDREL BENT CORE FOR LOW RESTRICTION

MAX MUFFLERS

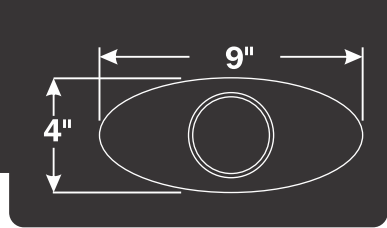

OFFSET / CENTER

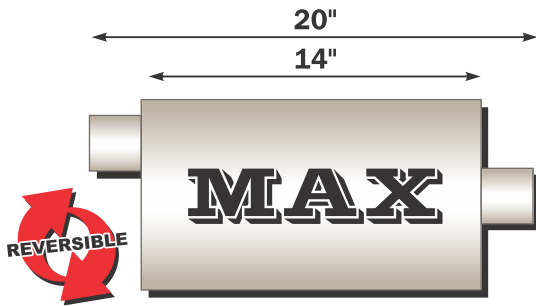

Inlet	Outlet	Part #
2"	2"	M11224
2-1/4"	2-1/4"	M11225
2-1/2"	2-1/2"	M11226
3"	3"	M11229

OFFSET / OFFSET

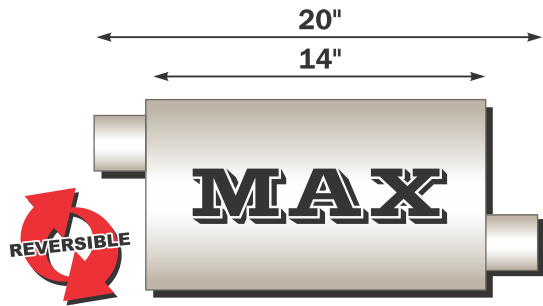

Inlet	Outlet	Part #
2"	2"	M11234
2-1/4"	2-1/4"	M11235
2-1/2"	2-1/2"	M11236
3"	3"	M11239

OFFSET / CENTER

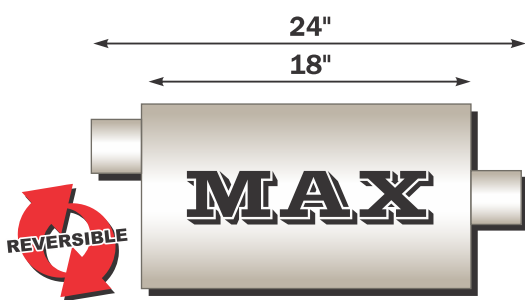

Inlet	Outlet	Part #
2-1/4"	2-1/4"	M11255
2-1/2"	2-1/2"	M11256
3"	3"	M11259

OFFSET / OFFSET

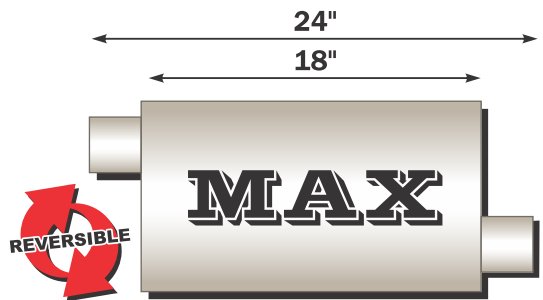

Inlet	Outlet	Part #
2-1/4"	2-1/4"	M11265
2-1/2"	2-1/2"	M11266

MAX MUFFLERS

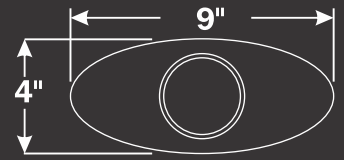

CENTER / DUAL

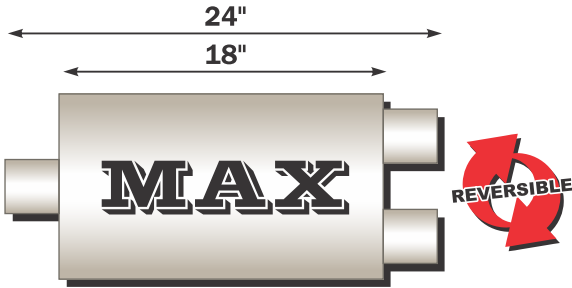

Inlet	Outlet	Part #
2-1/2"	2-1/4"	M11258
2-1/2"	2-1/2"	M11268
3"	2-1/4"	M11278
3"	2-1/2"	M11288



MAX MUFFLERS

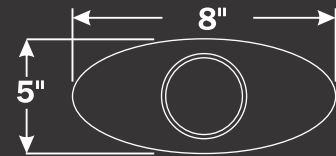

OFFSET / CENTER

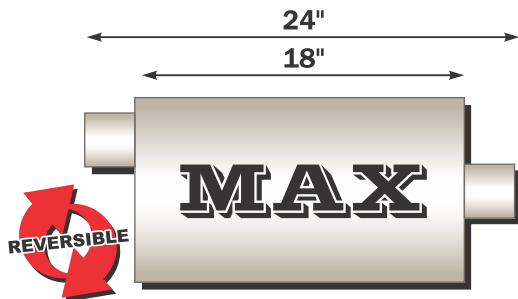

Inlet	Outlet	Part #
2-1/4"	2-1/4"	M12255
2-1/2"	2-1/2"	M12256
3"	3"	M12259

OFFSET / CENTER

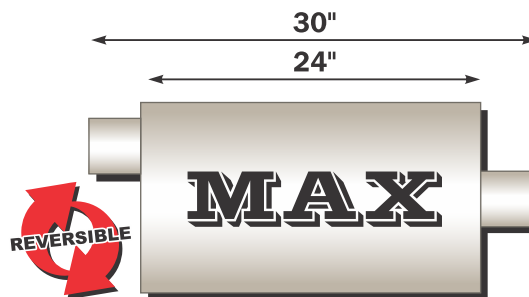

Inlet	Outlet	Part #
3"	3"	M12289

CENTER / DUAL

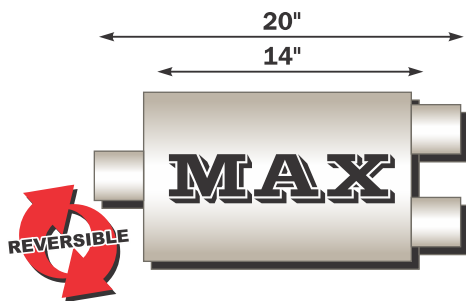

Inlet	Outlet	Part #
2-1/4"	2-1/4"	M12149
2-1/2"	2-1/2"	M12158
3"	2-1/2"	M12198

CENTER / DUAL

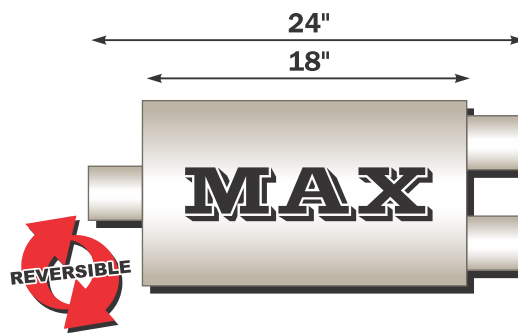

Inlet	Outlet	Part #
2-1/2"	2-1/4"	M12258
2-1/2"	2-1/2"	M12268
3"	2-1/4"	M12278
3"	2-1/2"	M12288
3"	3"	M12298

DUAL / DUAL

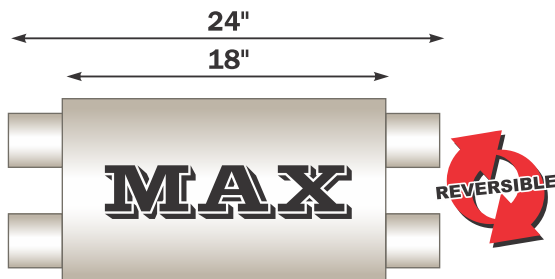

Inlet	Outlet	Part #
2-1/2"	2-1/2"	M12468
3"	3"	M12469

MAX MUFFLERS

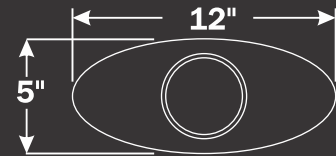

OFFSET / CENTER

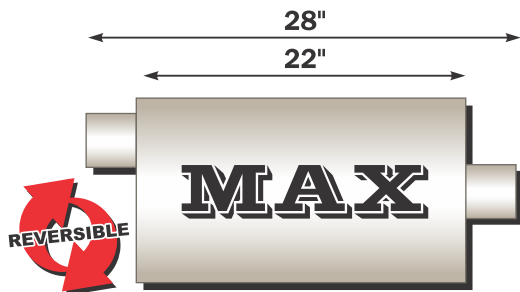

Inlet	Outlet	Part #
3"	3"	M12589

CENTER / DUAL

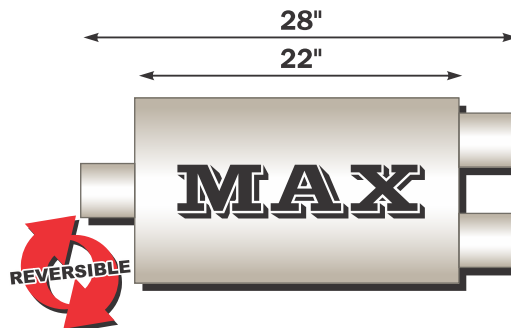

Inlet	Outlet	Part #
3"	2-1/4"	M12585
3"	2-1/2"	M12588
3"	3"	M12590

DUAL / DUAL

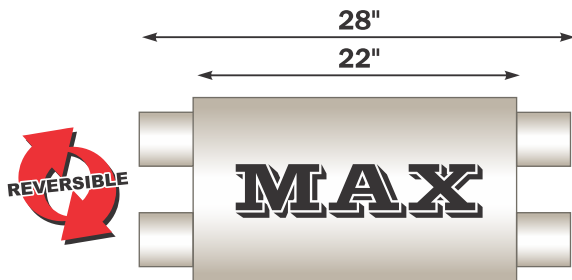

Inlet	Outlet	Part #
2-1/4"	2-1/4"	M12567
2-1/2"	2-1/2"	M12568

8" ROUND CENTER / DUAL

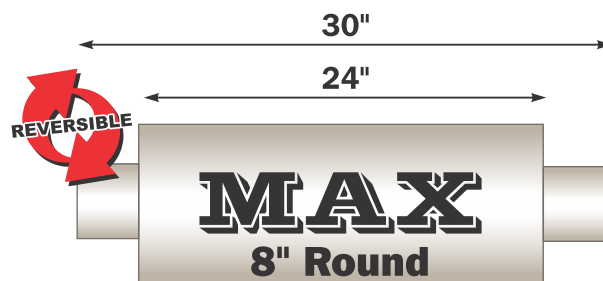

Inlet	Outlet	Part #
4"	4"	M12772
5"	5"	M12774



SUPER V MUFFLER

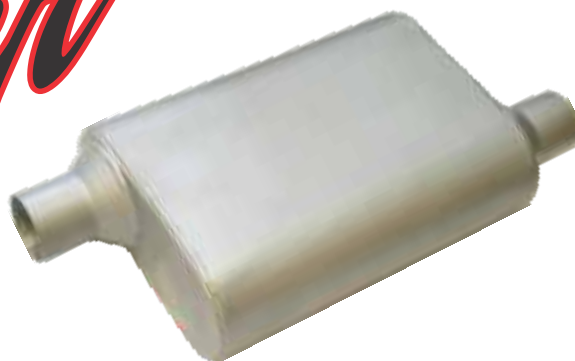

PERFORMANCE MUFFLERS



**GREAT SOUND
ADDED PERFORMANCE
QUALITY CONSTRUCTION**

***Performance Sound
...at a price you can afford!***

SUPER V MUFFLER

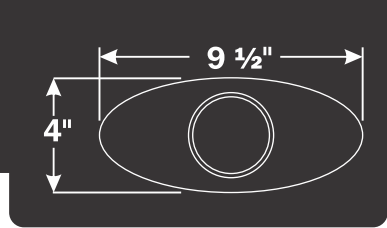

SINGLE CHAMBER



CENTER / CENTER

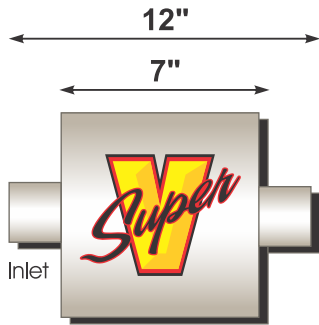

Inlet	Outlet	Part #
2-1/2"	2-1/2"	V425109
3"	3"	V430109

CENTER / DUAL

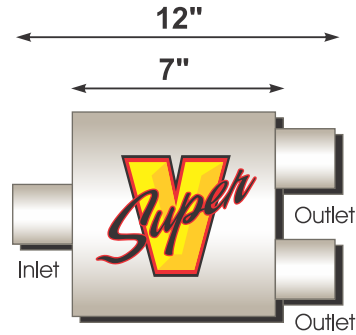

Inlet	Outlet	Part #
2-1/2"	2-1/4"	V425122
3"	2-1/4"	V430122

OFFSET / CENTER

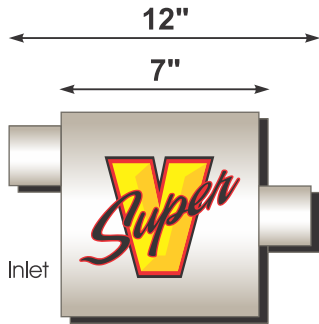

Inlet	Outlet	Part #
2-1/4"	2-1/4"	V72441
2-1/2"	2-1/2"	V72541
3"	3"	V73041

OFFSET / OFFSET

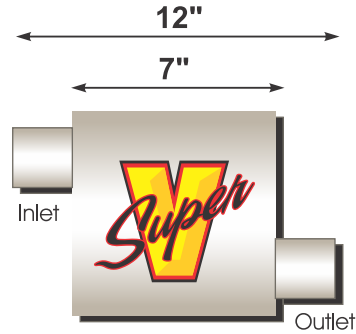

Inlet	Outlet	Part #
2-1/2"	2-1/4"	V72443
2-1/2"	2-1/2"	V72543

SUPER V MUFFLER

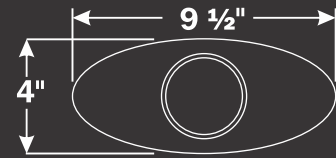

DOUBLE CHAMBER

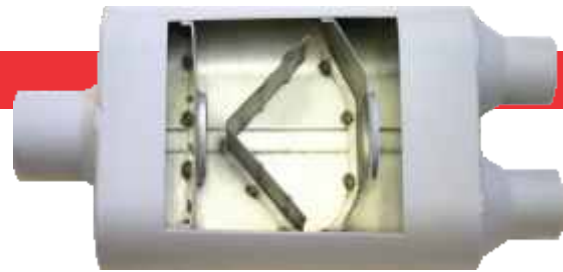

CENTER / CENTER

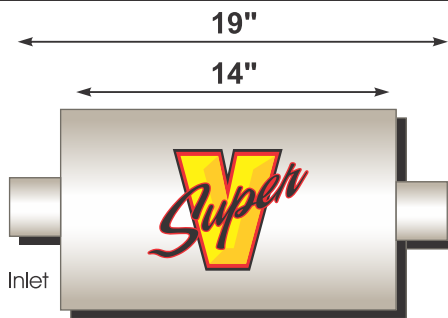

Inlet	Outlet	Part #
2-1/4"	2-1/4"	V42440
3"	3"	V43040

CENTER / OFFSET

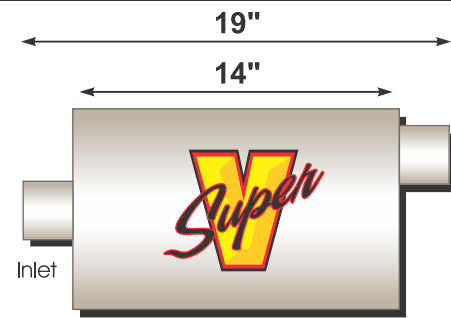

Inlet	Outlet	Part #
2-1/4"	2-1/4"	V42442
3"	3"	V43042

OFFSET / CENTER

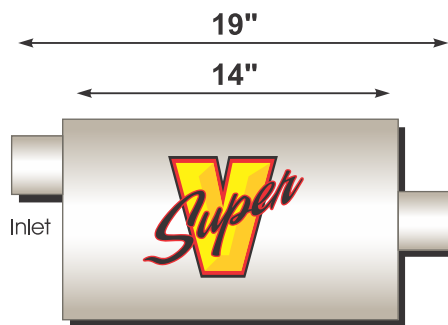

Inlet	Outlet	Part #
2"	2"	V42041
2-1/4"	2-1/4"	V42441
2-1/2"	2-1/2"	V42541
3"	3"	V43041

OFFSET / OFFSET

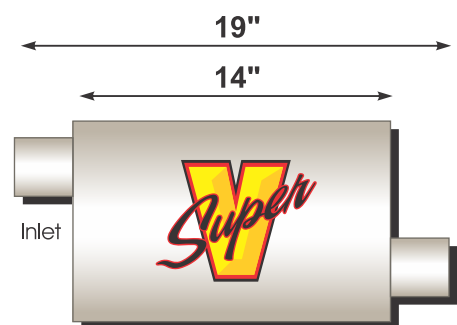

Inlet	Outlet	Part #
2"	2"	V42043
2-1/4"	2-1/4"	V42443
2-1/2"	2-1/2"	V42543
3"	3"	V43043

SUPER V MUFFLER

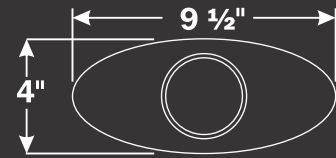

DUAL / DUAL



Inlet	Outlet	Part #
2-1/4"	2-1/4"	V524554
2-1/2"	2-1/2"	V525554

CENTER / DUAL

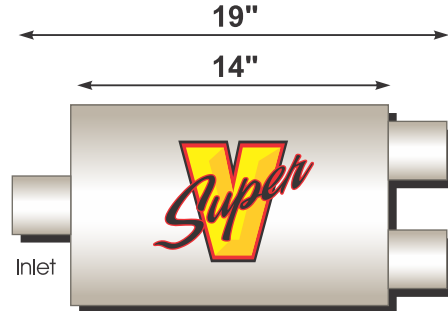

Inlet	Outlet	Part #
2-1/4"	2-1/4"	V424422
2-1/2"	2-1/4"	V425422
2-1/2"	2-1/2"	V425400
3"	2-1/4"	V430422
3"	2-1/2"	V430402

CAMARO DUAL OUTLET

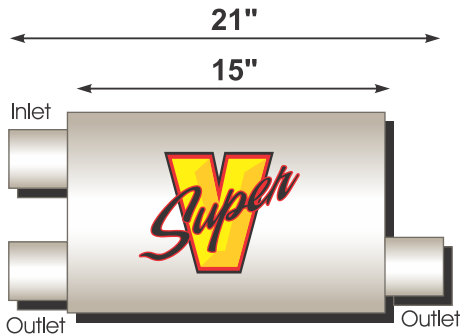

Inlet	Outlet	Part #
2-1/2"	2-1/2"	V42583

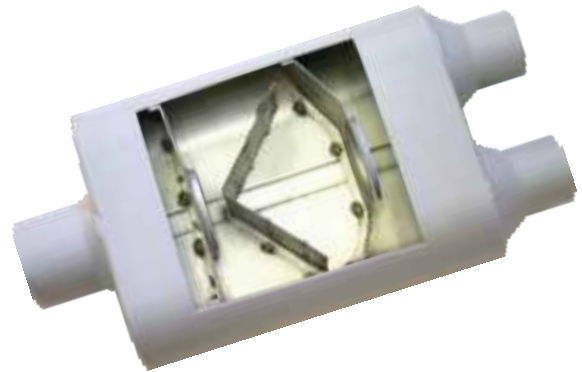

DOUBLE V-BAFFLE

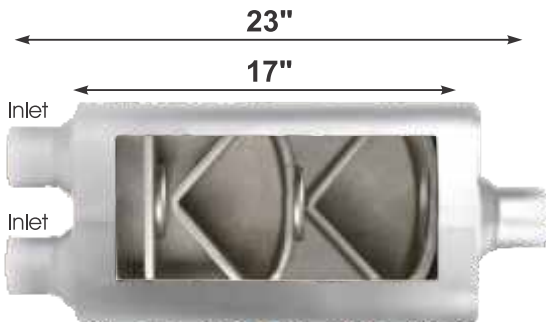

Inlet	Outlet	Part #
2-1/4"	3"	V524553



UNIVERSAL MANDREL BENDS

ALUMINIZED STEEL



Part Number	Size	Ends	Bend	Radius	A Length	B Length
113180	1-1/2"	OD OD	180°	3"	8"	8"
213180	1-3/4"	OD OD	180°	3"	8"	8"
313180	2"	OD OD	180°	3"	8"	8"
413180	2-1/4"	OD OD	180°	3"	12"	12"
514180	2-1/2"	OD OD	180°	4"	12"	12"
614180	3"	OD OD	180°	6"	12"	12"
715180	3-1/2"	OD OD	180°	5"	12"	12"
11390	1-1/2"	OD OD	90°	3"	6"	8"
21390	1-3/4"	OD OD	90°	3"	6"	8"
31390	2"	OD OD	90°	3"	6"	8"
41390	2-1/4"	OD OD	90°	3"	8"	16"
51490	2-1/2"	OD OD	90°	4"	8"	16"
61490	3"	OD OD	90°	6"	8"	16"
71590	3-1/2"	OD OD	90°	5"	8"	16"
81690	4"	OD OD	90°	6-1/4"	12"	18"
82690	4"	ID OD	90°	6-1/4"	12"	18"
91890	5"	OD OD	90°	7-1/2"	12"	18"
92890	5"	ID OD	90°	7-1/2"	12"	18"
11345	1-1/2"	OD OD	45°	3"	6"	8"
21345	1-3/4"	OD OD	45°	3"	6"	8"
31345	2"	OD OD	45°	3"	6"	8"
41345	2-1/4"	OD OD	45°	3"	8"	16"
51445	2-1/2"	OD OD	45°	4"	8"	16"
61445	3"	OD OD	45°	6"	8"	16"
71545	3-1/2"	OD OD	45°	5"	8"	16"
81645	4"	OD OD	45°	6-1/4"	12"	18"
82645	4"	ID OD	45°	6-1/4"	12"	18"
91845	5"	OD OD	45°	7-1/2"	12"	18"
92845	5"	ID OD	45°	7-1/2"	12"	18"

UNIVERSAL MANDREL BENDS

POLISHED T304 STAINLESS STEEL



Part Number	Size	Ends	Bend	Radius	A Length	B Length
153180	1-1/2"	OD OD	180°	3"	8"	8"
253180	1-3/4"	OD OD	180°	3"	8"	8"
353180	2"	OD OD	180°	3"	8"	8"
453180	2-1/4"	OD OD	180°	3"	12"	12"
554180	2-1/2"	OD OD	180°	4"	12"	12"
654180	3"	OD OD	180°	6"	12"	12"
755180	3-1/2"	OD OD	180°	5"	12"	12"
856180	4"	OD OD	180°	6-1/4"	16"	16"
15390	1-1/2"	OD OD	90°	3"	6"	8"
25390	1-3/4"	OD OD	90°	3"	6"	8"
35390	2"	OD OD	90°	3"	6"	8"
45390	2-1/4"	OD OD	90°	3"	8"	16"
55490	2-1/2"	OD OD	90°	4"	8"	16"
65490	3"	OD OD	90°	6"	8"	16"
75590	3-1/2"	OD OD	90°	5"	8"	16"
85690	4"	OD OD	90°	6-1/4"	12"	20"
95890	5"	OD OD	90°	7-1/2"	12"	20"
15345	1-1/2"	OD OD	45°	3"	6"	8"
25345	1-3/4"	OD OD	45°	3"	6"	8"
35345	2"	OD OD	45°	3"	6"	8"
45345	2-1/4"	OD OD	45°	3"	8"	16"
55445	2-1/2"	OD OD	45°	4"	8"	16"
65445	3"	OD OD	45°	6"	8"	16"
75445	3-1/2"	OD OD	45°	5"	8"	16"
85645	4"	OD OD	45°	6-1/4"	12"	20"
95845	5"	OD OD	45°	7-1/2"	12"	20"

UNIVERSAL MANDREL BENDS

LIGHTWEIGHT ALUMINUM



Part Number	Size	Ends	Bend	Radius	A Length	B Length
373180	2"	OD OD	180°	3"	8"	8"
473180	2-1/4"	OD OD	180°	3"	12"	12"
574180	2-1/2"	OD OD	180°	4"	12"	12"
674180	3"	OD OD	180°	6"	12"	12"
37390	2"	OD OD	90°	3"	6"	8"
47490	2-1/4"	OD OD	90°	3"	8"	16"
57490	2-1/2"	OD OD	90°	4"	8"	16"
67490	3"	OD OD	90°	6"	8"	16"
37345	2"	OD OD	45°	3"	6"	8"
47445	2-1/4"	OD OD	45°	3"	8"	16"
57445	2-1/2"	OD OD	45°	4"	8"	16"
67445	3"	OD OD	45°	6"	8"	16"

THESE **ALUMINUM** BENDS WORK WELL FOR CUSTOM COLD AIR INTAKE MODS!

LAP JOINT STYLE CLAMPS



Size	Material	Part Number
2"	Aluminized	LJ200
2-1/4"	Aluminized	LJ225
2-1/2"	Aluminized	LJ250
3"	Aluminized	LJ300
4"	Aluminized	LJ400
4"	409 Stainless	LJ400SS
5"	Aluminized	LJ500
5"	409 Stainless	LJ500SS

GREAT FOR DIY INSTALLS

EXHAUST ACCESSORIES

Y-PIPES



SINGLE SIZE	DUAL SIZE	OVERALL LENGTH	ALUMINIZED PART NUMBER	STAINLESS PART NUMBER
2" ID	2" ID	10"	Y2001	SY200
2-1/4" ID	2-1/4" ID	10"	Y2141	SY214
2-1/2" ID	2-1/2" ID	10"	Y2121	SY212
2-1/2" ID	2-1/4" ID	10"	Y252141	SY25214
3" ID	2-1/4" ID	10"	Y32141	SY3214
3" ID	2-1/2" ID	10"	Y32121	SY3212
3" ID	3" ID	10"	Y3001	SY300
4" ID	4" ID	14"	Y4001	SY400
5" ID	5" ID	14"	Y500	-

X-PIPES - A.K.A. CROSSOVER PIPES



SINGLE SIZE	DUAL SIZE	OVERALL LENGTH	ALUMINIZED PART NUMBER	STAINLESS PART NUMBER
2-1/4" ID	2-1/4" ID	12"	X2141	SX214
2-1/2" ID	2-1/2" ID	12"	X2121	SX212
3" ID	3" ID	12"	X3001	SX300

HEADER COLLECTOR KITS

HC1W

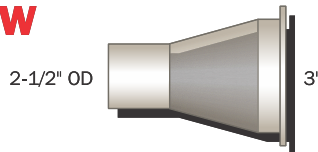

WITH 3/8" WELDED FLANGE

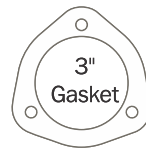

1/8" thick metal core

Kit Contains:

- 2 - 3" Collectors**
- 2 - 3" Gaskets**
- 2 - 3" Flanges**

HC2W



WITH 5/16" WELDED FLANGE

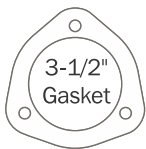

1/8" thick metal core

Kit Contains:

- 2 - 3-1/2" Collectors**
- 2 - 3-1/2" Gaskets**
- 2 - 3-1/2" Flanges**

DEALER P.O.S. MATERIALS

FLO~PRO PERFORMANCE EXHAUST

3' BY 8' SHOP BANNER - BANNERFLO



**CATALOG
REORDER
CAT**



**BROCHURE
STAND (FULL)
BRO**



**COUNTERTOP
DISPLAY
TBDISPLAY**

PART NUMBER INDEX

424	20	819	31	1976	80	4414	71
524	20	820	8	1978	80	4415	71
601	7	821	18	2000	79	4418	71
602	28	822	6	2031	29	4420	71
605	29	823	8	2500	82	4421	71
614	20	824	20	2501	82	4422	71
618	30	825	21	2502	82	4423	71
619	31	830	23	2503	82	4518	69
628	10	831	19	2504	83	5000	47
629	32	834	11	2505	83	5031	29
630	23	846	22	2506	83	5520	71
631	19	847	28	2507	81,82	5522	71
634	11	851	9	2508	83	6173	78
640	26	858	18	2509	83	6185	81
641	34	860	12	2510	82	6186	81
644	33,35	861	12	2511	83	6192	81
645	33,35	862	12	3012	68	6195	81
654	35,37	864	13	3015	68	6196	81
655	35,37	865	39	3018	68	7173	78
660	12	866	19	3019	79	7185	81
661	12	867	24	3020	79	7186	81
664	13	871	14	3300	71	8872	81
671	14	872	14	3301	71	8880	80,81
678	38	875	15,39	3302	71	8890	80
680	16	876	38	3303	71	8972	80
687	17	877	26	3509	68	8990	80,81
701	7	878	38	3512	68	8992	80,81
702	28	879	38	3515	68	9400	47
705	29	880	16	3518	68	9500	47
706	21	882	16	3520	68	9898	47
714	20	883	39	3524	68	10100	6,10
715	21	887	17	3530	68	10101	6
716	20	898	47	3536	68	10102	13
718	30	1009	78	4000	47	10103	14
719	31	1010	78	4009	68	10810	9
720	8	1011	78	4010	78	10814	46
723	8	1012	78	4011	79	11111	12
726	7	1013	78	4012	68	11112	12
727	8	1016	78	4013	79	11345	93
728	10	1500	82	4014	79	11390	93
729	32	1636	33	4015	68	12354	47
730	23	1639	33	4017	79	12355	47
731	19	1648	35	4018	69	15345	94
734	11	1649	35	4020	79	15390	94
761	12	1673	37	4024	69	18213	9
764	13	1674	37	4025	79	18223	9
766	35	1836	33	4027	79	18233	9
767	27	1839	33	4030	69	18243	9
768	37	1848	35	4114	79	18253	9
771	15	1849	35	4115	79	19410	6
780	17	1873	36	4122	79	20515	46
801	7	1874	36	4123	79	20811	30
802	28	1953	78	4126	79	20814	46
805	29	1972	80	4318	69	21021	45
817	20	1974	80	4405	71	21122	34
818	30	1975	80	4406	71	21123	34

PART NUMBER INDEX

21124	34	51490	93	301008	44	244018RAC	62
21125	34	51600	67	302201	42	244018RAC2	63
21126	36	51777	67	302202	42	253512RAC	62
21127	36	51788	67	313180	93	253518AC	61
21128	36	51799	67	315000	42	253518PT	54
21129	36	55445	94	353180	94	253518RAC	62
21345	93	55490	94	373180	95	253522AC	61
21390	93	57111	32,34	409901	43,44	254009RAC	62
25345	94	57123	32	409902	40,43,44	254009RAC2	63
25390	94	57445	95	413180	93	254012AC	61
27111	32,34	57490	95	453180	94	254012AC15	61
27123	32	58911	28	473180	95	254012RAC	62
28911	28	59411	28	501001	43,44	254018AC	61
30400	21	61445	93	501002	43	254018AC15	61
30800	23,41	61490	93	501003	44	254018RAC	62
30801	22	65445	94	514180	93	254022AC	61
31345	93	65490	94	554180	94	254022AC15	61
31390	93	67445	95	574180	95	254022RAC	62
35345	94	67490	95	614180	93	27113NB	32,34
35390	94	69403	18	654180	94	3010STR	68
37345	95	71299	67	674180	95	3010STR2	68
37390	95	71545	93	715180	93	3012ST	68
39403	18	71590	93	755180	94	3015ST	68
39407	47	71600	67	856180	94	3018ST	68
40220	46	71799	67	202409AC	61	303512AC15	61
40230	46	75445	94	242509AC	61	303512RAC	62
40810	9	75590	94	243012AC	61	303512RACK	64
41111	12	81645	93	243012RAC	62	304012AC	61
41112	12	81690	93	243016AC	61	304012AC15	61
41244	67	82645	93	243016AC2	63	304012RAC	62
41255	67	82690	93	243016RAC	62	304012RACK	64
41277	67	85645	94	243016RAC2	63	304015RAC	62
41288	67	85690	94	243018AC	61	304018AC	61
41345	93	90220	46	243024AC	61	304022AC	61
41390	93	90230	46	243512AC	61	30800EGR	41
41744	67	91845	93	243512PT	54	30800R	23,41
41755	67	91890	93	243512RAC	62	30801R	22
41777	67	92845	93	243512RADW	55	30802R	22
45345	94	92890	93	243516AC	61	3409TD	62
45390	94	95220	46	243516RAC	62	3509ST	68
47445	95	95230	46	243518AC	61	3512RS	70
47490	95	95845	94	243518AC15	61	3512S0	68
48213	9	95890	94	243518AC2	63	3512ST	68
48223	9	98830	46	243518PT	54	3515RS	70
48233	9	113180	93	243518RAC	62	3515ST	68
48243	9	153180	94	243518RAC2	63	3518DO	68
48253	9	213000	43,45	243522AC	61	3518SO	68
48830	46	213020	45	243522AC15	61	3518ST	68
50220	46	213021	43	243522AC2	63	3518STX	68
50230	46	213180	93	243522PT	54	3518STXX	68
50515	46	213522	45	243522RAC	62	3520ST	68
50811	30	253180	94	243522RAC2	63	3524ST	68
51277	67	301001	43	244012AC	61	3530ST	68
51288	67	301002	43	244012RAC	62	3536ST	68
51299	67	301003	43	244018AC	61	354012RAC	49
51445	93	301005	44	244018AC2	63	354015RAC	49

PART NUMBER INDEX

354AD	47	4515F	48	5718ACK	64	824NM	20
355012RAC	49	4515FB	48	5718RAC	62	831NM	19
355012RACB	49	4515FBK	64	5718RACK	64	832NB	24
355015RAC	49	4515FK	64	5722AC	61	833NB	24
355015RACBK	64	4515RS	70	5809ACK	64	834NM	11
38113NB	22	4518ST	69	5809RACK	64	835FNB	32,34
38123NB	22	4612AC	61	5812RAC	62	835NB	32,34
4012ST	68	4612ACK	64	5812RACK	64	837NB	22
4015ST	68	4612RAC	62	5818AC	61	838NB	25
4018DO	69	4612RACK	64	5818ACK	64	843NB	25
4018SO	69	4616AC	61	5818RAC	62	847NM	28
4018ST	69	4616RAC	62	5818RACK	64	852NB	27
4024ST	69	4616RACK	64	5822AC	61	853NB	27
4030ST	69	4707RACK	64	6015RAB	49	857NB	26
405012ACBK	64	4712AC	61	601NM	7	863NB	38
405012PT	49	4712ACX	64	602NM	28	864NM	13
405012RAC	49	4712RAC	62	605NM	29	865RS	39
405012RAC2	63	4712RACX	64	614NM	20	868NB	36
405012RACBX	64	4718AC	61	619NM	31	871NM	14
405014RAC	48	4718ACK	64	631NM	19	877NM	26
405015PT	49	4718RAC	62	632NB	24	878NM	38
405015RAC	49	4718RACK	64	633NB	24	880NM	16
405015RAC2	63	4722AC	61	634NM	11	887NM	17
405015RACBX	64	4722RAC	62	638NB	25	8912AC	50
405015TD	48	5018ST	69	643NB	25	8912ACB	50
405015TDBK	64	505015TD	48	652NB	27	8912PT	49
405018RAC	49	506012RAC	49	653NB	27	8912RAB	49
406012RAC	49	506014RAC	48	6615TD	62	8915AC	50
406012RACBX	64	506015RAC	49	664NM	13	8915ACB	50
406015RAC	49	506015RAC2	63	6715TD	62	8915RAB	49
406015RACBX	64	506015RACBX	64	671NM	14	8915RAB2	63
406018RAC	49	506018RAC	49	678NM	38	8918RAB	49
407015AC	50	506018RACB	49	680NM	16	9012AC	50
407015ACB	50	507015AC	50	68113NB	22	9012ACB	50
407015RAC	49	507015ACB	50	6815RAB	49,62	9012RAB	49
407015RACB	49	507015RAC	49	687NM	17	9015AC	50
407015RACBX	64	507015RACB	49	733NB	24	9015ACB	50
407018ACB	50	507015RACBX	64	738NB	25	9015RAB	49
407018RAC	49	508015AC	50	739NB	33	AC5632	52
407018RACB	49	508015ACB	50	753NB	27	AC5632K	52
408015ACB	50	508015RACB	49	7715TD	48,62	AC5644	52
408015RACB	49	508015RACBX	64	7815RAB	49	AC5644K	52
408015RACBX	64	5318ST	69	8012AC	50	AC5732	52
408018ACB	50	5330ST	69	8012ACB	50	AC5732K	52
408018RACB	49	5612TD	62	8012RAB	49	AC5744	52
4312RS	70	5615AC	50	8015AC	50	AC5744K	52
4315RS	70	5615F	48	8015ACB	50	AC5832	52
4318ST	69	5615FB	48	8015RAB	49	AC5832K	52
4414X	71	5615FBK	64	8018ACB	50	AC5844	52
4414XX	71	5615FK	64	8018RAB	49	AC5844K	52
4415X	71	5618AC	61	801NM	7	D1	28
4415XX	71	5618RAC	62	802NM	28	DS200	69
4418X	71	57113NB	32,34	805NM	29	EC64	41
4418XX	71	5712AC	61	819NM	31	EGR60	40
4509TD	62	5712RAC	62	821NM	18	EGR60EX	40
4512RS	70	5718AC	61	822NM	6	EGR61	40

PART NUMBER INDEX

EGR62	40	LJ300	95	PT42	54	SS643NB	25
EGR64CD	41	LJ400	47,95	RA5632	52	SS644	33,35
EGRLBZ	40	LJ400SS	47,95	RA5632K	52	SS645	33,35
EGRLML	40	LJ500	47,95	RA5644	52	SS652NB	27
EGRLMM	40	LJ500SS	47,95	RA5644K	52	SS653NB	27
EXP350	47	M11224	85	RA5732	52	SS654	35,37
EXP400	47	M11225	85	RA5732K	52	SS655	35,37
EXP500	47	M11226	85	RA5744	52	SS660	12
FP200	74	M11229	85	RA5744K	52	SS661	12
FP201	74	M11234	85	RA5832	52	SS664	13
FP211	74	M11235	85	RA5832K	52	SS664NM	13
FP212	74	M11236	85	RA5844	52	SS671	14
FP214	74	M11239	85	RA5844K	52	SS671NM	14
FP215	74	M11255	85	SM106S	72	SS678	38
FP223	75	M11256	85	SM106S5	72	SS678NM	38
FP300	74	M11258	86	SM111	72	SS680	16
FP301	74	M11259	85	SM115	72	SS680NM	16
FP551	76	M11265	85	SM117	72	SS687	17
FP710	76	M11266	85	SM123	72	SS687NM	17
FP726	77	M11268	86	SM125	72	SS701	7
FP727	77	M11278	86	SM1255	72	SS702	28
FP729	76	M11288	86	SM129	72	SS705	29
FP730	76	M12149	87	SM142S5	72	SS714	20
FP731	77	M12158	87	SS1636	33	SS716	20
FP732	76	M12198	87	SS1639	33	SS719	31
FP733	77	M12255	87	SS1648	35	SS720	8
FP735	77	M12256	87	SS1649	35	SS723	8
FP736	77	M12258	87	SS1673	37	SS726	7
FP737	77	M12259	87	SS1674	37	SS727	8
FP738	77	M12268	87	SS1836	33	SS731	19
FP739	77	M12278	87	SS1839	33	SS733NB	24
FP740	77	M12288	87	SS1848	35	SS738NB	25
FP741	77	M12289	87	SS1849	35	SS739NB	33
FP744	77	M12298	87	SS1873	36	SS753NB	27
FP745	77	M12468	87	SS1874	36	SS761	12
FP746	76	M12469	87	SS424	20	SS771	15
FP747	76	M12567	88	SS58	72	SS801	7
FP754	76	M12568	88	SS6	72	SS801NM	7
FP757	74	M12585	88	SS601	7	SS802	28
FP759	75	M12588	88	SS601NM	7	SS802NM	28
FP760	74	M12589	88	SS602	28	SS805	29
FP761	75	M12590	88	SS602NM	28	SS805NM	29
FP765	74	M12772	81,88	SS605	29	SS817	20
FP767	75	M12774	81,88	SS605NM	29	SS819	31
FP768	75	MX333	75	SS614	20	SS819NM	31
FP774	74	MX501	75	SS614NM	20	SS820	8
FP775	74	MX559	75	SS618	30	SS821	18
HC1W	96	OR350	47	SS619	31	SS821NM	18
HC2W	96	OR400	47	SS619NM	31	SS822	6
HX40DP2	28	OR500	47	SS631	19	SS822NM	6
HX40DP3	29,30	PP2000	69	SS631NM	19	SS823	8
IC300	41	PP214	69	SS632NB	24	SS824	20
IE300	41	PP2512	69	SS633NB	24	SS824NM	20
LJ200	95	PP2514	69	SS634	11	SS825	21
LJ225	95	PP3012	69	SS634NM	11	SS831	19
LJ250	95	PP3014	69	SS638NB	25	SS831NM	19

PART NUMBER INDEX

SS832NB	24	ST015S	57	ST116	56	SY3214	96
SS833NB	24	ST024	54	ST118	56	SY400	96
SS834	11	ST025A	54	ST119	56	SY44	47
SS834NM	11	ST025S	60	ST120L	59	V42041	91
SS835FNB	32,34	ST026S	60	ST120R	59	V42043	91
SS835NB	32,34	ST027D	58	ST121	60	V42440	91
SS837NB	22	ST027D2	58	ST123	60	V42441	91
SS838NB	25	ST027DK	58	ST123C	60	V42442	91
SS843NB	25	ST027E	58	ST123C1	60	V424422	92
SS846	22	ST027E2	58	ST124L	59	V42443	91
SS847	28	ST027EK	58	ST124R	59	V425109	90
SS847NM	28	ST027G	58	ST125B	48	V425122	90
SS852NB	27	ST027H	58	ST125F	48	V425400	92
SS853NB	27	ST027R	58	ST130	60	V42541	91
SS857NB	26	ST038S	55	ST131	55	V425422	92
SS858	18	ST039A	56	ST132	57	V42543	91
SS860	12	ST039B	56	ST133	55	V42583	92
SS861	12	ST040	56	ST135A	55	V430109	90
SS862	12	ST041	56	ST135B	55	V430122	90
SS863NB	38	ST042	56	ST135C	55	V43040	91
SS864	13	ST043S2	63	ST136A	55	V430402	92
SS864NM	13	ST045L	59	ST136B	55	V43041	91
SS865	39	ST045R	59	ST136C	55	V43042	91
SS865RS	39	ST048	60	ST137	55	V430422	92
SS868NB	36	ST049	56	ST139	55	V43043	91
SS871	14	ST052	57	ST140	55	V524553	92
SS871NM	14	ST053	56	ST141	57	V524554	92
SS872	14	ST05312	56	ST2004L	59	V525554	92
SS875	15,39	ST054	56	ST2004R	59	V72441	90
SS876	38	ST054D	59	ST25013B16	55	V72443	90
SS877	26	ST054P	59	ST25013C16	55	V72541	90
SS877NM	26	ST055	57	ST251612	54	V72543	90
SS878	38	ST062	57	ST251615	54	V73041	90
SS878NM	38	ST062N	57	ST251709	54	VBC4	29,30
SS879	38	ST070	56	ST251712	54	X2121	96
SS880	16	ST073S	57	ST30013C12	62	X2141	96
SS880NM	16	ST075	55	ST301612	54	X3001	96
SS882	16	ST076	55	ST301615	54	Y2001	96
SS883	39	ST079	60	ST301712	54	Y2121	96
SS887	17	ST0792	63	ST40013D12	51	Y2141	96
SS887NM	17	ST080	60	ST538N	51	Y252141	96
ST006	54	ST081	57	ST538NS	51	Y3001	96
ST007	54	ST0812	63	ST538S	51	Y32121	96
ST007A	54	ST081K	64	ST540NS	51	Y32141	96
ST007B	54	ST082	57	ST541NS	51	Y4001	47,96
ST009	54	ST083	57	ST590NS	51	Y500	47,96
ST012C	54	ST084	60	ST591NS	51		
ST013A	62	ST090	59	SX212	96		
ST013A12	62	ST091	59	SX214	96		
ST013A16	62	ST092	55	SX300	96		
ST013B	62	ST093	55	SY200	96		
ST013B12	62	ST101	57	SY212	96		
ST013B16	62	ST10970B	59	SY214	96		
ST013C	62	ST110	48	SY25214	96		
ST013C12	62	ST11070B	48	SY300	96		
ST014	54	ST114	57	SY3212	96		