



65-70 Mustang Rack and Pinion Conversion Kit



Mustang Rack & Pinion System

Note: For safety, disconnect battery cables and ensure that the vehicle is properly supported by jack stands.

Before painting or powder coating of the cradle, we recommend that you pre-fit the entire system to ensure proper fitment for your application.

Installation Recommendations	pg 3
Removal of Factory Steering	pg 4
Inventory	pg 5-6
Installation of:	
Rack and Cradle	pg 7-8
Universal Joint and Steering	
Shaft Installation.....	pg 9
Flaming River Tilt Column	pg 10-11
Original Steering Wheel Installation	pg 10
Aftermarket Steering Wheel Installation	pg 11
Electrical System Notes	pg 12
Power Steering Pump Installation	pg 13
Power Steering Bleeding Procedure	pg 14
Additional Installation Products	pg 15

WARRANTY DISCLAIMER: Flaming River's® Limited Warranty

Flaming River® warrants its products to be free from defects in material and workmanship for a period of one (1) year after the date of purchase, except that: All steering columns are warranted for a period of three (3) years from the date of purchase. The Big Switch (part number FR1005) is warranted for a period of three (3) years from the date of purchase, provided that it is not mounted with a steel bracket and provided further that it is adequately protected from environmental conditions. All electrical products other than the Big Switch are warranted for a period of ninety (90) days from the date of purchase. Flaming River's® warranty liability is limited to the replacement of defective products. Flaming River® is not liable for any labor costs associated with any warranty claim, or for any incidental or consequential damages. Improper installation, abuse, racing, and/or modification of the products voids this warranty. No warranty of merchantability or fitness for a particular purpose is made by Flaming River® with respect to any of its products. Warnings and Recommendations It is the customer's responsibility to determine the suitability of a given Flaming River® product for the customer's uses. Likewise, it is the customer's responsibility to install a Flaming River® product. Contact the vehicle manufacturer whenever installing a switch to confirm the appropriateness of using such a switch and the recommended placement of the switch on the vehicle. Use qualified chassis specialists for the installation of all steering related components. Be aware that the installation of certain Flaming River® products may adversely impact a manufacturer's warranty with respect to certain vehicles and other manufactured goods. Flaming River will repair or replace any product found to be defective in material or workmanship. Improper installation, abuse, racing and/or modification VOID WARRANTY. Flaming River® is not responsible for any labor costs associated with any warranty.

Note: For safety, disconnect battery cables and ensure that vehicle is properly supported by jack stands.

We recommend that you always install new outer tie rod ends when installing this kit.

Note: 65-66 Mustangs with V8 and power assist need to replace outer tie rods using manual V8 outer tie rod end.



We recommend a professional alignment to set the proper alignment settings.

Note: **** The use of Flaming River Headers may be necessary with use of the Power Rack and Pinion System. ****

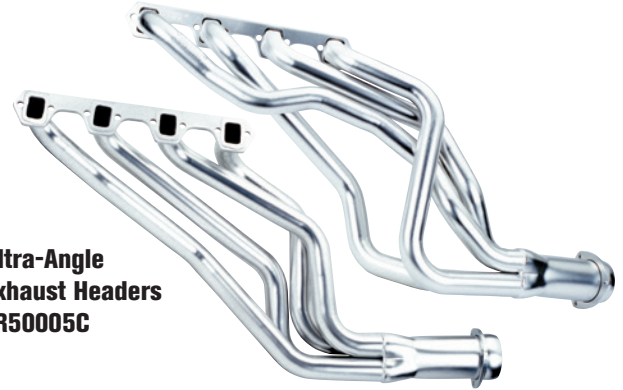

Ultra-Angle
Exhaust Headers
FR50005C



Note: Flaming River Recommends that you use synthetic or high grade power steering fluid.



FR1610 Stainless Braided Hose Kit
recommended but sold separately

Color Verification To Be Completed Before Disassembly

Before disconnecting the turn signal connector, verify the factory wiring colors and turn signal operation. The use of a wiring diagram is recommended. This will be used when connecting the new Flaming River Steering Column.

- Brake Light Switch _____
- Right Rear Turn Signal _____
- Left Rear Turn Signal _____
- Turn Signal Power _____
- Hazard Power _____
- Right Front Turn Signal _____
- Left Front Turn Signal _____
- Horn _____

Original System Removal

- 1) For safety, disconnect your battery.
- 2) Before disassembly, measure from zerk to zerk on the outer tie rod ends.

Write this dimension down for future reference. _____

Original Column Removal

64 ½ - 67 Long Shaft Steering Box Column Removal (See Diagram Below)

- 1) Remove horn button by pushing down on horn hub and turning counter clockwise.
- 2) Remove steering wheel retaining nut and remove steering wheel (A) by using a steering wheel puller.
- 3) Disconnect the electrical plug towards the base of the column (B).
- 4) Remove the column support bracket under the dash. There are two nuts one on each side of the column. (B-1)
- 5) Remove the upper bushing located at the center of the turn signal switch.
- 6) Remove the column tube by sliding it up off the steering box shaft.

67-70 Short Shaft Steering Box Column Removal

- 1) Remove horn button by pushing down and turning counter clockwise.
- 2) Remove steering wheel retaining nut and remove steering wheel (A) by using a steering wheel puller.
- 3) Disconnect the electrical plug towards the base of the column (B).
- 4) Remove the column support bracket under the dash. There are two nuts one on each side of the column. (B-1)
- 5) Remove the four screws holding the floor mount to the firewall.
- 6) Remove the rag joint (B-2) pinch bolt in order to separate the steering box from the column.

Steering Box and Linkage Removal

- 1) Remove the pitman arm from the steering box (C) using a pitman arm puller.
- 2) If you have power steering, remove pump, lines, and valve and assist cylinder. (See diagram below) A shorter belt may need to be installed.
- 3) Remove the two bolts that retain the idler arm to the frame.
- 4) Remove the cotter pins, castle nuts, separate the tie rod ends from the spindles and remove the steering linkage (D) from the car.
- 5) Remove the three retaining bolts that secure the gearbox (C) and remove the gearbox.

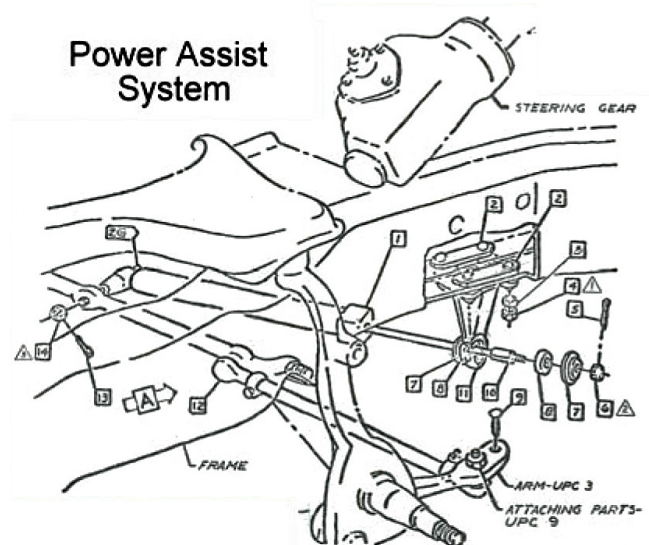
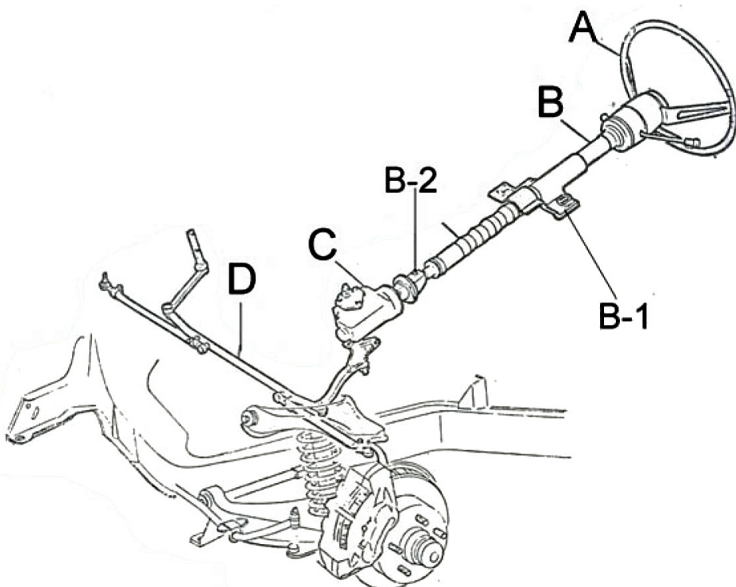

Item No.	Part No.	Description	Qty	Power/Manual
1.	BOLT-3/8-16X3.5	3/8-16 Grade 8 Bolt 3.5" long	2	
2.	NUT-3/8-16	Nylock Lock Nut 3/8-16	2	
3.	WASH-3/8	3/8" Flat Washer	4	
4.	BOLT-7/16-14X3.5	7/16-14 Grade 8 Bolt 3.5" Long	3	
5.	NUT-7/16-14	Nylock Lock Nut 7/16-14	3	
6.	WASH-7/16	7/16 Flat Washers	6	
7.	FR1850	18" DD Shaft	1	
8.	FR20099-2	67-70 Floor Mount	1	
9.	FR65MUMT	65-66 Floor Mount	1	
10.	FRBSH-1	Mustang Column Mount Bushing	1	
11.	Screw-10	#10 x 3/8" Hex Head Metal Screw	2	
12.	NUT-11/16-18	11/16-18 Jam Nut	2	
13.	FRM16X6AN	M16-1.5 X 6 AN Fitting	1	Power Kit Only
14.	FRM14X6AN	M14 -1.5 X 6 AN Fitting	1	Power Kit Only
15.	FR20118	Female Wiring Adapter	1	
16.	FRHRN2	Horn Relay	1	
17.	FR300MUCOL	29" Column For Original Wheel	1	
	(Ford Spline) Only in Kits for Original OEM Steering Wheel			
18.	FR300COL	29" Column for Aftermarket Wheel 1		
	(GM Spline) Only In Kits for AfterMarket Steering Wheels			
19.	FR1614	Power Steering Reservoir	1	Power Kit Only
20.	FR1789P	3/4 DD x FR Power Billet U-Joint	1	Power Kit Only
21.	FR1934	3/4 DD x 1" DD Chromemoly U-Joint	1	Power Kit Only
22.	FR1926	3/4" DD X 3/4" DD Chromemoly U-Joint	1	Power Kit Only
23.	FRMBPW1	P/S Steering Pump Bracket	1	Power Kit Only
24.	100480	Power Rack & Pinion Cradle Assembly	1	Power Kit Only
25.	FRPMP5B-V	Pump w/ V-Belt Pulley	1	Power Kit Only
26.		Support Bearing Bracket Bent	1	Power Kit Only
27.	FR1810	3/4 Zinc Support Bearing	1	Power Kit Only

1965-70 Mustang Cradle and Shaft Assembly - Power

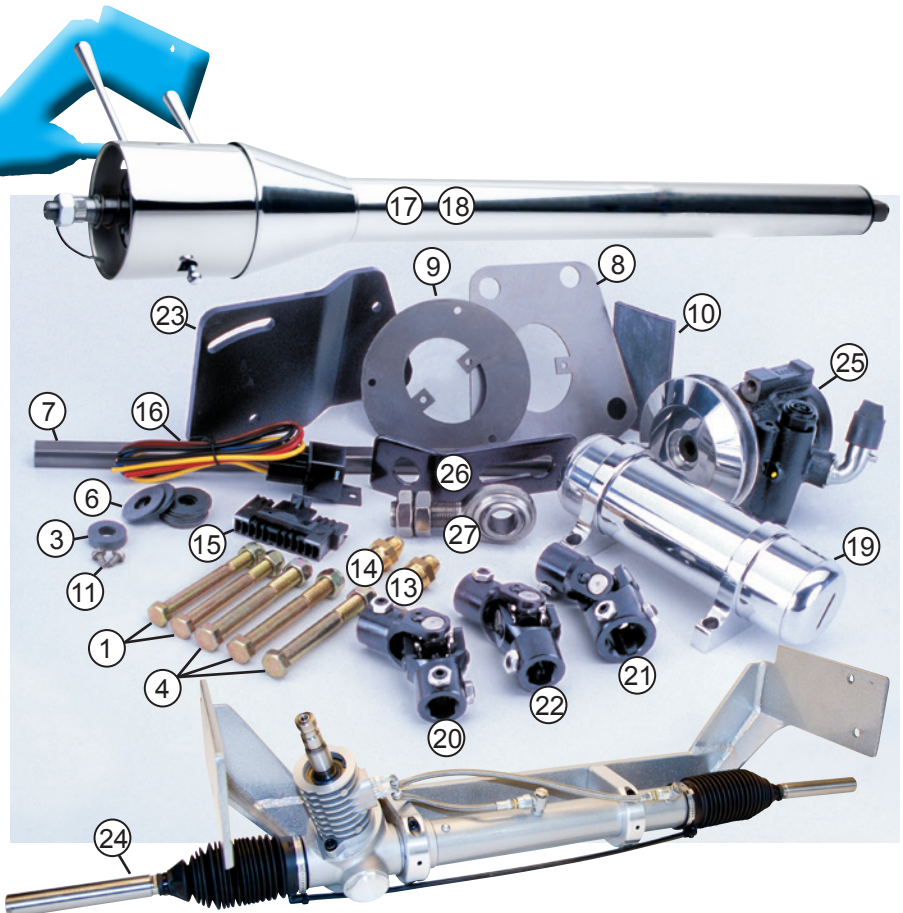

Item No.	Part No.	Description	Qty	Power/Manual
1.	BOLT-3/8-16X3.5	3/8-16 Grade 8 Bolt 3.5" long	2	
2.	NUT-3/8-16	Nylock Lock Nut 3/8-16	2	
3.	WASH-3/8	3/8" Flat Washer	4	
4.	BOLT-7/16-14X3.5	7/16-14 Grade 8 Bolt 3.5" Long	3	
5.	NUT-7/16-14	Nylock Lock Nut 7/16-14	3	
6.	WASH-7/16	7/16 Flat Washers	6	
7.	BOLT-3/8-16X1	3/8-16 Grade 8 Bolt 1" long	2	Manual Kit Only
8.	BOLT-3/8-16X1.5	3/8-16 Grade 8 Bolt 1.5" Long	2	Manual Kit Only
9.	NUT-3/8-16	Nylock Lock Nut 3/8-16	4	Manual Kit Only
10.	FR1507C	Manual Rack Mounting Clamp	1	Manual Kit Only
7.	FR1850	18" DD Shaft	1	
8.	FR20099-2	67-70 Floor Mount	1	
9.	FR65MUMT	65-66 Floor Mount	1	
10.	FRBSH-1	Mustang Column Mount Bushing	1	
11.	Screw-10	#10 x 3/8" Hex Head Metal Screw	2	
12.	NUT-11/16-18	11/16-18 Jam Nut	2	
17.	BK10200	Support Bearing Bracket Bent	1	Manual Kit Only
18.	FR1810-2	3/4 Zinc Support Bearing	1	Manual Kit Only
15.	FR20118	Female Wiring Adapter	1	
16.	FRHRN2	Horn Relay	1	
17.	FR300MUCOL	29" Column For Original Wheel	1	
	(Ford Spline) Only in Kits for Original OEM Steering Wheel			
18.	FR300COL	29" Column for Aftermarket Wheel 1		
	(GM Spline) Only In Kits for AfterMarket Steering Wheels			
23.	FR1507-3Q-3	Manual Rack and Pinion	1	Manual Kit Only
24.	FR1709DD	9/16-26 x 3/4DD U-Joint	1	Manual Kit Only
25.	FR1716DD	3/4 DD x 3/4DD U-Joint	1	Manual Kit Only
26.	FR1717DD	1 DD x 3/4 DD U-Joint	1	Manual Kit Only
27.	FRM5-MU65H	Manual Cradle	1	Manual Kit Only

1965-70 Mustang Cradle and Shaft Assembly Manual

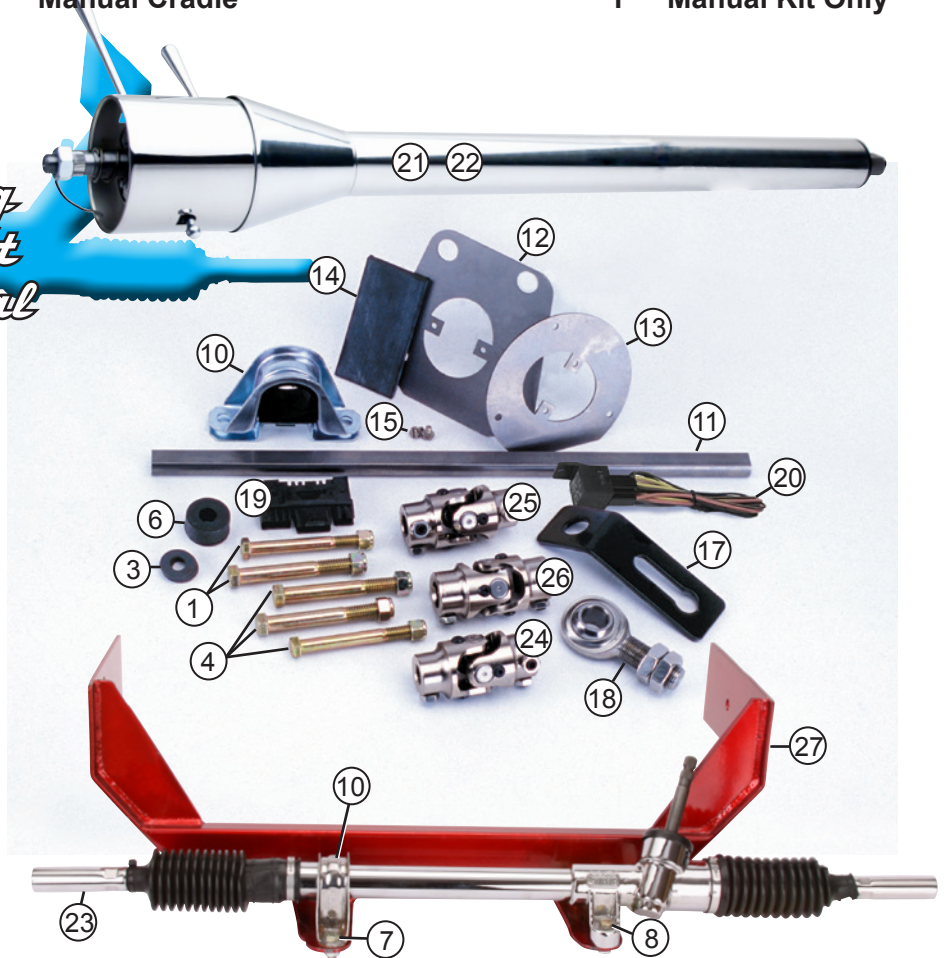

Flaming River Manual Rack and Pinion Installation

1) Install the rack and pinion cross member by sliding it into place in between the frame rails, installing the new hardware using three 7/16" bolts where the gear box was mounted and two 3/8" bolts where the idler arm was located. Tighten all nuts and bolts to 50-65 ft lbs.



Driver Side Mounting



Passenger Side Mounting



Rack-Mounting Clamp

2) Place the passenger rack-mounting clamp onto the right side of the rack tube and place the rack onto the cradle.

3) Install the rack mounting bolts from the bottom of the cradle through the rack mounts and tighten all four nuts and bolts securely.

4) Install tie rod ends onto the rack and pinion assembly.

5) **To install the outer tie rod ends you must load the front suspension. (Securely placing jack stands under the lower control arms and lowering the car onto the jack stands accomplishes this.)**

Install the outer tie rod ends into the spindle and tighten the castle nuts to 30-40 ft lbs. Make sure to install cotter pins into the castle nut and tie rod end and bend the tabs over for security.

Flaming River Power Rack and Pinion Installation

1) Install the Power Rack and Pinion Cradle Assembly by sliding it into place in between the frame rails, installing the new hardware using three 7/16" bolts where the gear box was mounted and two 3/8" bolts where the idler arm was located. Tighten all nuts and bolts to 50-65 ft lbs.



Driver Side Mounting



Passenger Side Mounting

2) Install the jam nuts and outer tie rod ends onto the rack and pinion assembly.

3) **To install the outer tie rod ends in the spindle arms, you must load the front suspension. (Securely placing jack stands under the lower control arms and lowering the car onto the jack stands accomplishes this.)** Install the outer tie rod ends into the spindle and tighten the castle nuts to 30-40 ft lbs. Make sure to install cotter pins into the castle nut and tie rod end and bend the tabs over for security.

Rotating the Pinion Shaft for Steering Linkage Alignment

*Pillow Block Clamp
Mounting Bolts*

Set Screw

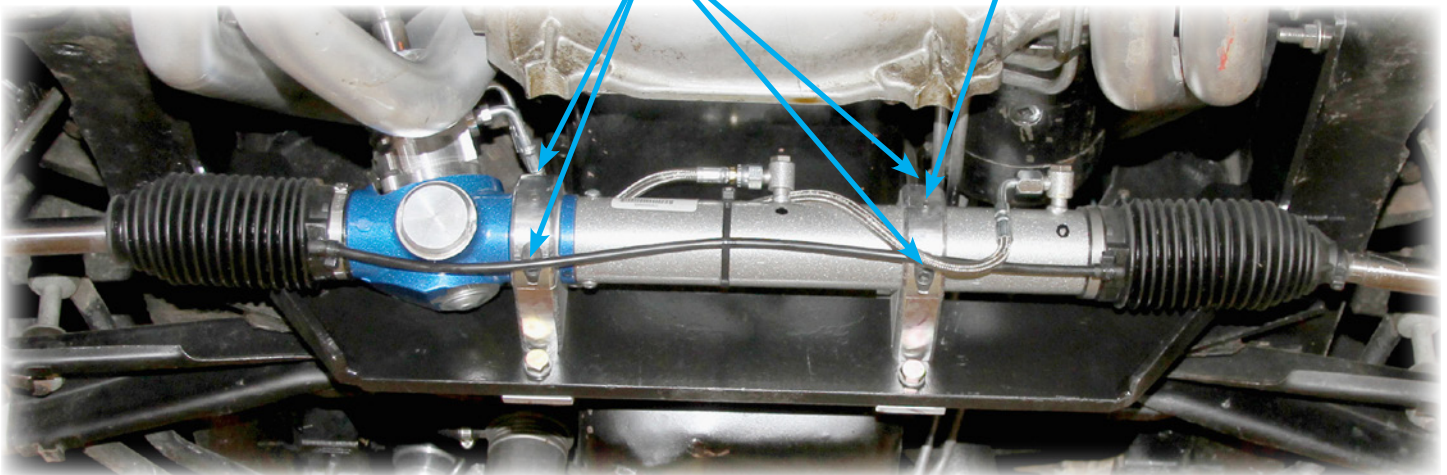

1) The Flaming River Power Rack and Pinion Cradle Assembly comes preassembled from the factory, however you may need to adjust the pinion angle for proper u-joint alignment. – First, loosen the set screw on the passenger side pillow block. Next, loosen the (4) four pillow block clamp mounting bolts, then adjust your pinion angle. Once your pinion angle is set, tighten the (4) four pillow block mounting clamp bolts and then the set screw. (See picture above)

Rack & Pinion Universal Joint System

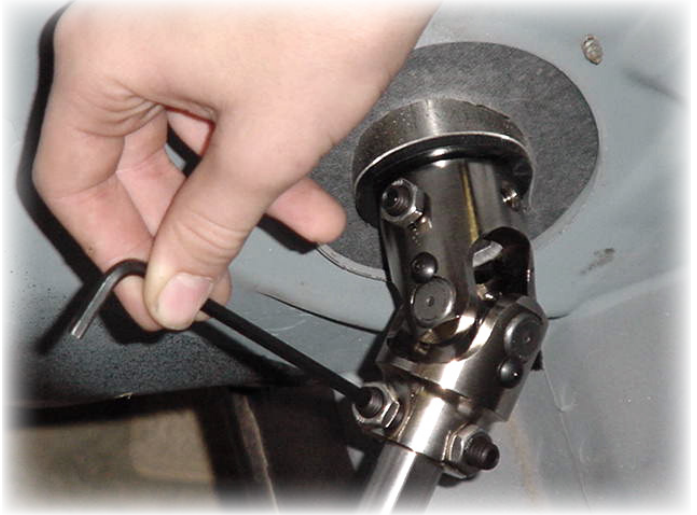
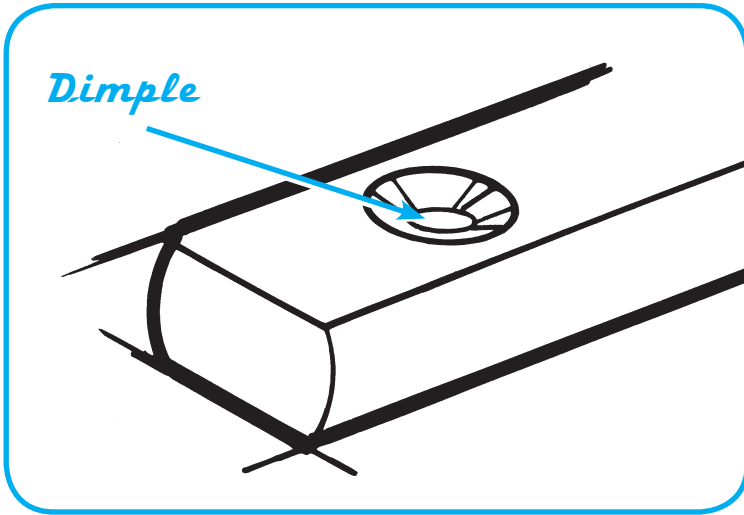

- 1) Install support-bearing mount onto the rear cradle bolt. (Diagram below). Note: The angle of this mount is set for most applications. Some adjustment may be necessary for the correct angle and u-joint alignment.
- 2) We recommend the use of 3/4" dowel rod to mock up the steering shaft to obtain the correct length of the shafts.
- 3) Install your shaft kit and snug each set screw so that it will leave a mark in the shafts.
- 4) Remove shaft and dimple each set screw mark using a 1/4" drill bit. (As shown above.)
- 5) Re-install the shafts using red high strength thread locker on the set screw threads. Tighten each set screw to 25 ft. lbs. Tighten all lock nuts securely. We recommend that you inspect set screws periodically for tightness

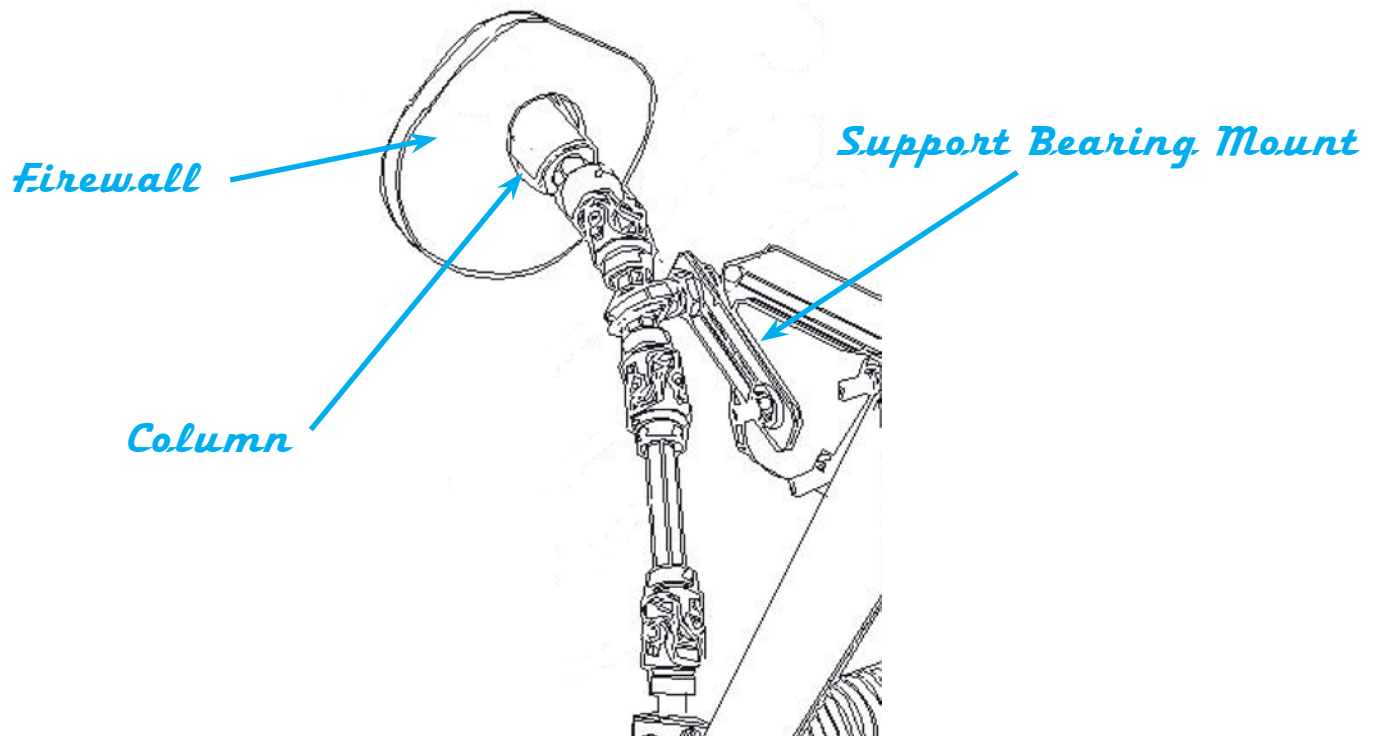

Flaming River Tilt Column Installation

1) Using your original dash support (note: you must first place a shim that is included between the support and the column to ensure a tight fit. This is included in your installation kit). Hold the column under the dash and tighten the two support nuts.

(Or, you can install our new 65-70 Mustang dash mount FR20114FD, sold separately – See page 15)

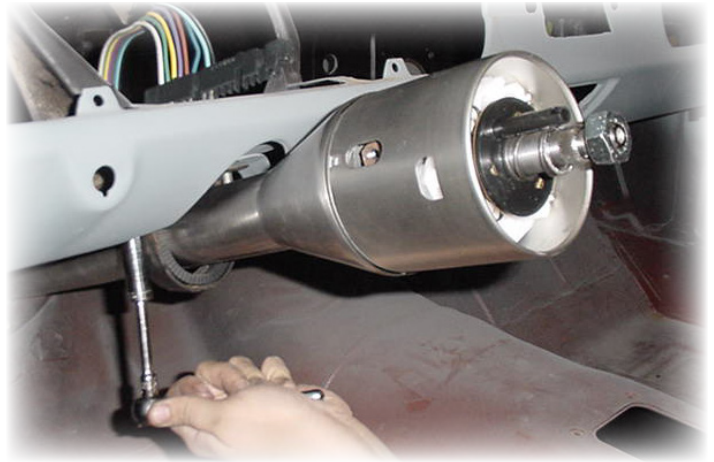

2) Make sure that the column is straight before securing column.

3) Mark the location of the tabs on the column using a center punch or scribe, then remove the column from the car and drill a small pilot hole for each screw.



4) Fasten the new floor mount to the column by using the screws provided with the hardware kit then reinstall the steering column into the car.

Waterfall Style Steering Wheel



FR20150

Waterfall
Steering Wheel
Adapter

FR20150HGAD - FR Column
FR20150FD - FR Ford Column

Woody's III Style Steering Wheel



FR20123

5/6 Bolt
Steering Wheel
Adapter

FR20119TA - FR Column
FR20119FD - FR Ford Column

Aftermarket Wheel Installation

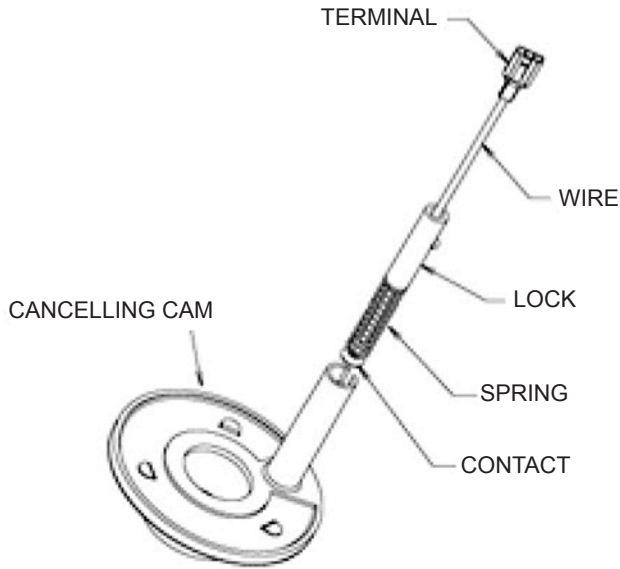

1) Install horn contact kit into canceling cam tube and turn to lock.

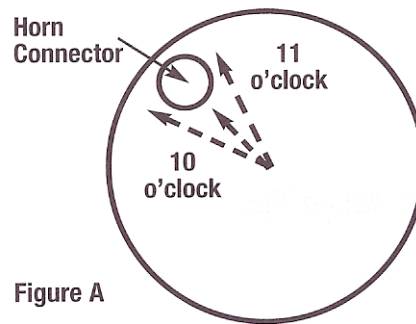

Figure A



2) Align steering wheel adapter so that the canceling cam hole is at approx the 11 O'clock position and that one of the steering wheel mounting holes is at the 12 O'clock position.

3) To install the wheel adapter run the horn contact wire through the hole for the canceling cam and place the adapter on to the splined column shaft.

4) Tighten the adapter-retaining nut until the adapter is approximately 1/16" away from the column shroud.

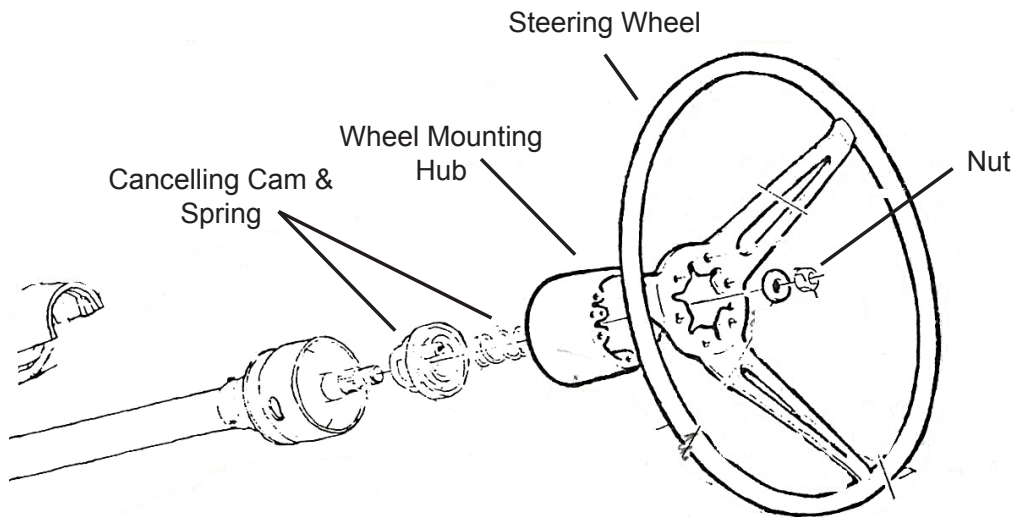

Note: The following Flaming River part numbers for wheel adapters for aftermarket wheels.
 FR20119FD 5-6 Bolt Wheel Adapter
 FR20113FD 9 Bolt Wheel Adapter
 FR3302FD 3 Bolt Wheel Adapter

For instructions on how to install original Mustang steering wheel with either a stock finish or wood finish, see additional installation supplement enclosed.

Connecting the Electric System

<u>Wiring Circuit</u>	<u>Vehicle Wiring</u>	<u>Pin Location</u>	<u>Column Wiring</u>
Brake Light Switch	Green or Green/Red	P	White
Right Rear Turn Signal	Orange/Blue	N	Dark Green
Left Rear Turn Signal	Green/Orange	M	Yellow
Turn Signal Power	Blue	L	Purple
Hazard Power	White/Red	K	Brown
	(See note below 64 1/2-66) (66-70 Black/Red)		
Right Front Turn Signal	White/Blue	J	Dark Blue
Left Front Turn Signal	Green/White	H	Light Blue
Horn	Yellow/Green	G	Black

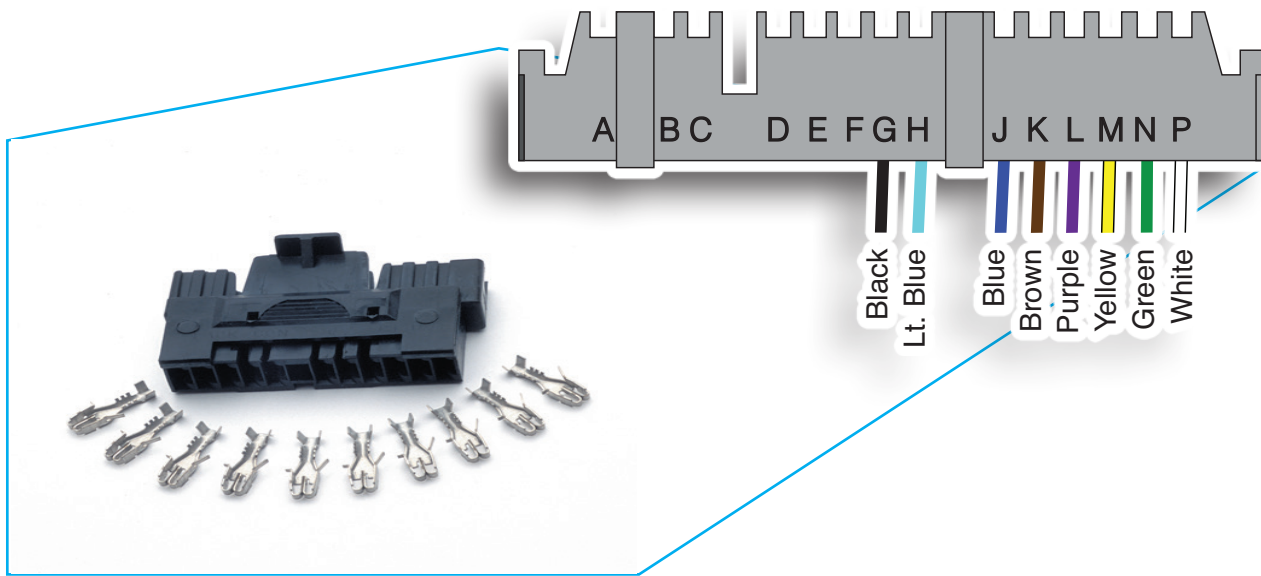

The yellow wire from the vehicle connects to TERMINAL 30 (Yellow wire) on the horn relay; the blue wire with the yellow stripe connects to TERMINAL 87 (Red Wire) on the horn relay. The black wire from the column connects to TERMINAL 85 (Brown wire) on the horn relay. Run a jumper wire from TERMINAL 86 (Blue wire) to TERMINAL 30 on the horn relay.

NOTE: FOR 1964-½ MUSTANGS, HORN RELAY IS NOT REQUIRED FOR THIS APPLICATION; VEHICLE HAS RELAY FROM THE FACTORY. BLACK WIRE FROM COLUMN WILL BE CONNECTED TO BLUE WITH YELLOW STRIPE TO COMPLETE THE GROUND CIRCUIT.

HAZARD NOTE: FROM 1964 ½ TO 1966; VEHICLES DID NOT HAVE HAZARDS, SO NO HAZARD POWER WIRE IS PRESENT, BUT CAN BE ADDED BY PURCHASING PART # FR20118-1

Color Verification to be completed before disassembly

- Brake Light Switch: _____
- RR Turn Signal: _____
- LR Turn Signal: _____
- Turn Signal Power: _____
- Hazard Power: _____
- RF Turn Signal: _____
- LF Turn Signal: _____
- Horn: _____

Power Steering Pump Installation

Note: The pump included in this kit must be used with the rack. Use of any other pump will void warranty.

1) Install the pump mounting bracket onto the water pump as shown in Photo A. Next install the pump to the bracket by installing two bolts through the back of the bracket into the pump as shown in Photo B. Only snug the bolts, it will have to be adjusted once the belt is adjusted.

Note: Pump mounting bracket for 289 ci motor. Bracket may need to be modified for use with 302 and 351W motors.

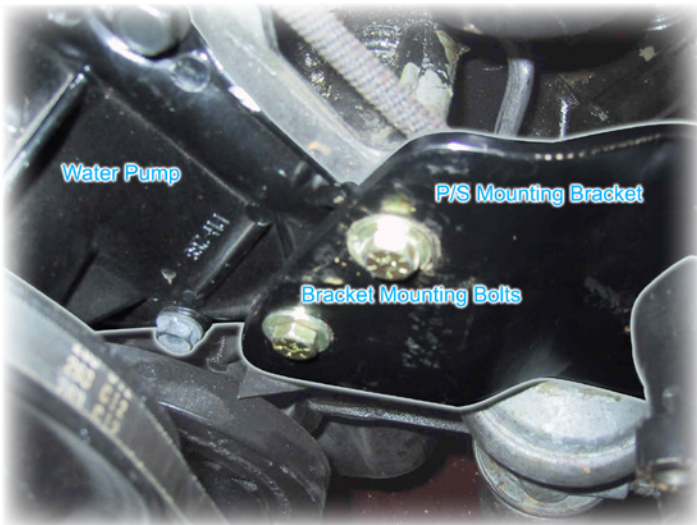

Photo A

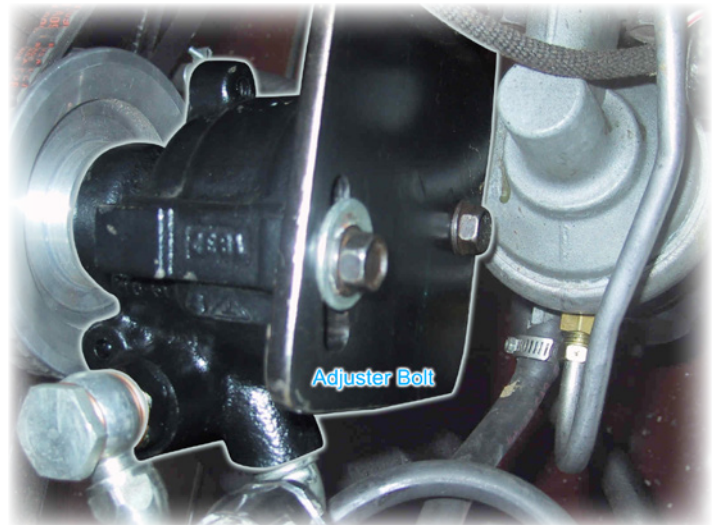
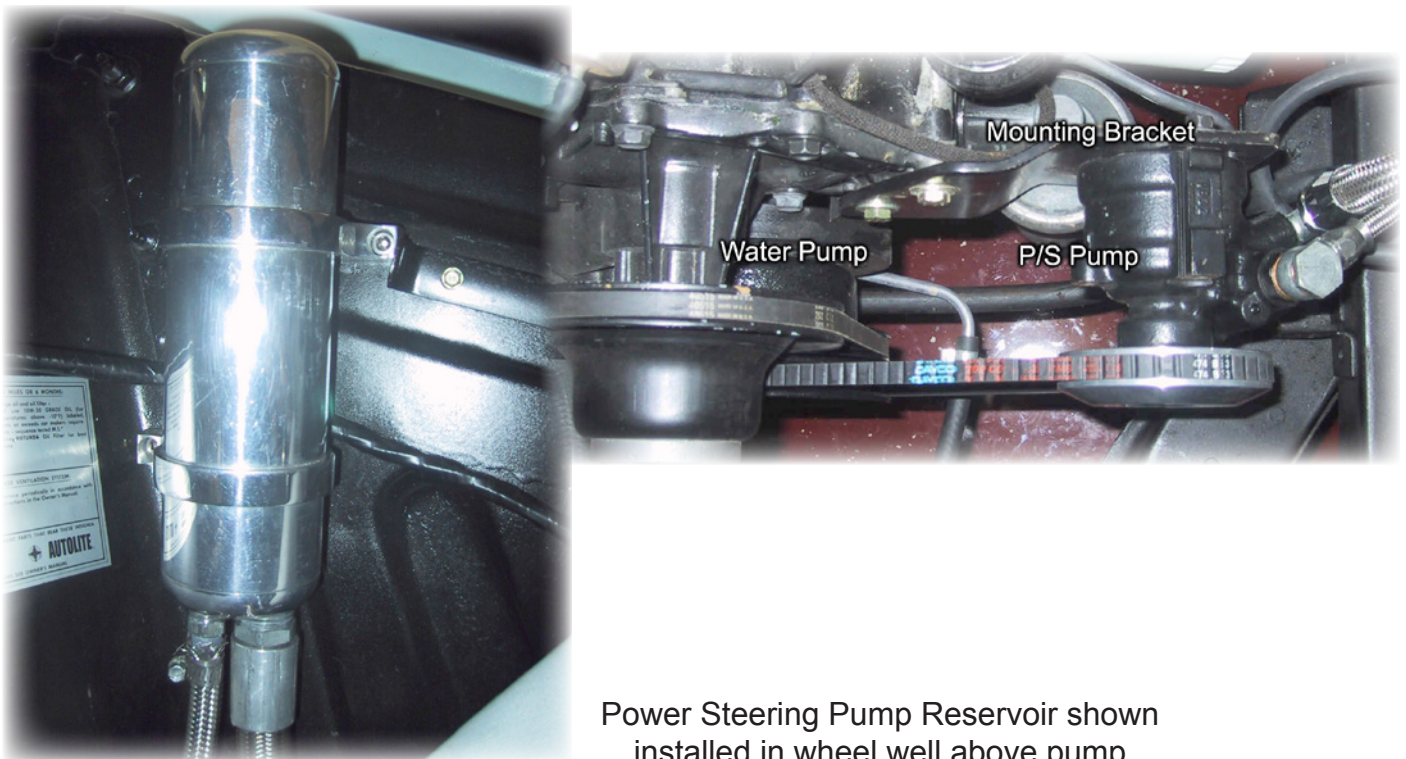

Photo B



Power Steering Pump Reservoir shown installed in wheel well above pump



Instruction Bulletin #1021

Correct Bleeding Procedure for Flaming River Power Rack & Pinion Systems.

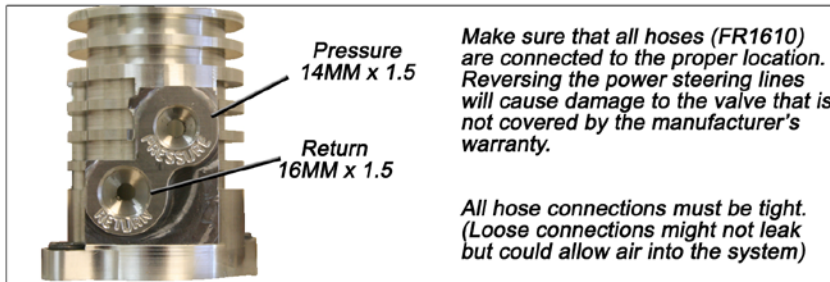

Important

***** Power Steering Fluid*****
Use clean, new power steering fluid only.

- 1) Turn Ignition Off
 - 2) Raise front wheels off the ground.
 - 3) Turn the steering wheel full left.
 - 4) Fill fluid level to "Full Cold" level or if using remote reservoir 1" over inner tube.
 - 5) With assistant checking fluid level and condition, turn steering wheel lock to lock at least 20 times.
 - 6) While turning wheels check fluid level constantly.
 - 7) Start engine. With engine idling, maintain fluid level. Reinstall cap.
 - 8) Return wheels to center. Lower front wheels to the ground.
 - 9) Keep engine running for two (2) minutes.
 - 10) Turn steering wheel in both directions.
 - 11) If all proper conditions apply, bleeding is complete.
 - 12) If any problem remains see "Special Conditions".
- Verify:
Smooth power assist
Noiseless operation
Proper fluid level
No system leaks
Proper fluid condition
No bubbles, no foam, no discoloration.

Note: On systems with long return lines or fluid coolers, turn steering wheel lock to lock at least 40 times.

Trapped air may cause fluid to overflow. Thoroughly clean spilled fluid to allow for leak check.

Note: No bubbles are allowed.

For any sign of bubbles, recheck connections then repeat step 5.

Special Conditions:



- Foam or bubbles in fluid

Fluid must be completely free of bubbles. In step 5, be alert to periodic bubbles that could indicate a loose connection or leaky O-Ring seal in either the return hose or pressure hose.

- Discolored fluid (milky, opaque, or light tan color)

Switch ignition off. Wait two (2) minutes. Recheck hose connections. Repeat steps 7-10. If condition still exists, replace and check a possible cause:

- Return hose clamps
- Return hose o-ring
- Pressure hose o-ring
- Gear cylinder line o-rings

Fill system and repeat bleed procedure for each possible cause. Repeat steps 7-10 to verify whether noise has been eliminated.



- Pump whine or groan

With engine running, recheck hoses for possible contact with frame body or engine. If no contact is found, follow either method below to cool down fluid and re-pressurize system.

Method 1:
Normal Cool Down

Switch engine off.
Wait for system to cool.
Install reservoir cap.

Method 2:
Partial Fluid Replacement

Switch engine off. Use a Suction device to remove fluid from the reservoir. Refill with cool, clean fluid. Install Reservoir cap.

After either method of cooling, start engine and allow engine to reach normal operating temperature. If noise persists, remove and replace power steering pump. Repeat bleed procedure following pump replacement.

WARRANTY DISCLAIMER:

Flaming River® warrants its products to be free from defects in material and workmanship for a period of one (1) year after the date of purchase. It is the customer's responsibility to determine the suitability of a given Flaming River® product for the customer's uses. Use qualified chassis specialists for the installation of all steering related components. Be aware that the installation of certain Flaming River® products may adversely impact a manufacturer's warranty with respect to certain vehicles and other manufactured goods. Flaming River will repair or replace any product found to be defective in material or workmanship. Improper installation, abuse, racing and/or modification VOID WARRANTY. Flaming River® is not responsible for any labor costs associated with any warranty.

Additional Installation Products



FR20114FD – 1965-70
Mustang Dash Mount Clamp – (Satin)
FR20114FDPL – 1965-70
Mustang Dash Mount Clamp – (Polished)

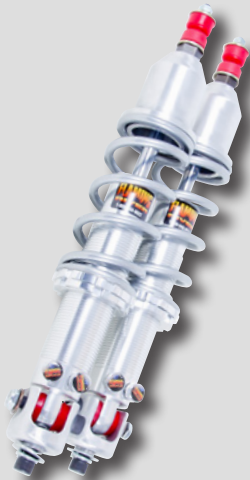

SHOCKS &
HIGH OUTPUT ALTERNATORS
(See website for application details)

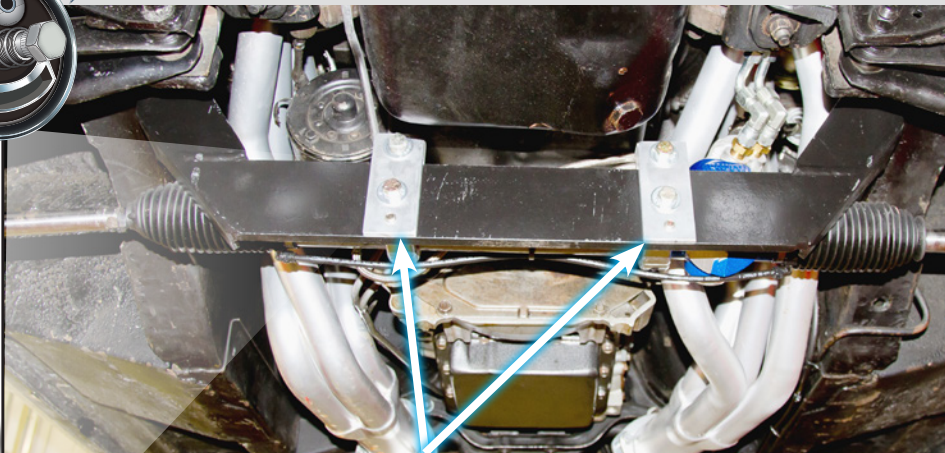
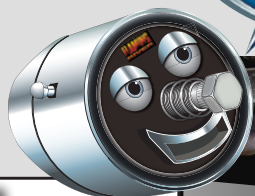
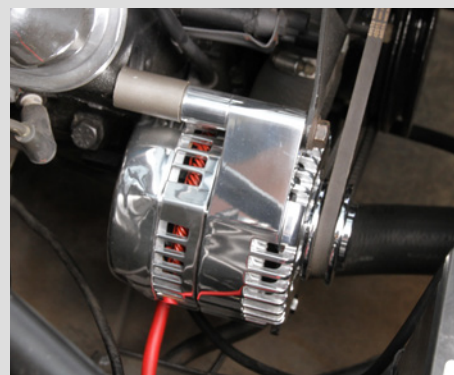

FR20060MU Cradle Rack & Pinion
Riser Kit

In order to ensure the best customer experience possible, we've created a Customer Satisfaction Survey to gather important feedback about different facets of our business. We would appreciate it if you could please take a couple of minutes to fill out this survey about your experience.

The results of the survey will be used to improve and gather feedback about customer service, technical and sales support, order processing and fulfillment, manufacturing, and new product development.

