



INSTRUCTIONS

EZ-EFI® 2.0 Self Tuning Fuel Injection System Kit Part Numbers 30400-KIT, 30401-KIT, 30402-KIT, 30403-KIT

Thank you for choosing FAST™ products; we are proud to be your manufacturer of choice. Please read this instruction sheet carefully before beginning installation, and also take a moment to review the included limited warranty information.

Please begin by checking that you have received all of the parts that come with your kit.

30400-KIT – EZ-EFI® 2.0 Base Kit



QTY	PART#	DESCRIPTION
1	304151MCAS	EZ-EFI 2.0® Assembled Throttle Body
1	30326	EZ-EFI 2.0® ECU Module
1	30633	EZ-EFI 2.0® Touchscreen Hand-held Unit
1	30308	Harness, EZ-EFI 2.0® Main
1	30310	Harness, EZ-EFI 2.0® Hand-held Cable

1	170637	Tach Adapter Assembly, FAST™
1	30087	Sensor, Coolant Temp
1	30278	Brass Bushing, 1/2" MPT X 3/8" FPT
1	170408	O2 Sensor, Bosch LSU4 Wideband
1	30168	Weld in O2 Fitting
1	30169	O2 Sensor Plug
1	82042	Gasket, Square Bore Carb
12	NS6548	Tie Strap, Black
4	30291	Screw, #12x1" LG., Self Tap, SS
1	304150TBJ	Throttle Ball Join, Linkage, for 304150
1	304150TBJNUT	Nut, 1/4"-28, Nylon Lock (for 304150TBJ)
1	30428	Sensor, Fuel Pressure, EZ EFI 2.0
1	30425FSB	Fuel Pressure Sensor Adapter
1	30425SPA	Billet Spacer, for FAST 30425 Fuel Sensor
2	30425MS	Screw, #10x2" LG., Self Tap, SS (FOR EZEFI)
1	30493	Suction Cup Mount, for EZ 2.0 Hand-held
10	170665	Loom, Braided Wire Split
2	170666	Ring Term, 12-10 AWG, 3/8 Stud, Shrink
1	170667	Hex Key, 4mm Long Arm Reach
1	170669	Butt Splice, 14-16 AWG, Shrink
1	170655	Badge, FAST EZ-EFI Chrome
4	54023C	Fitting, Fuel -8SAE O-Ring to -6AN
1	54023D	Plug W/O-Ring, -8SAE

30401-KIT – EZ-EFI® 2.0 Master In-Tank Kit (also includes everything in base kit)



QTY	PART#	DESCRIPTION
1	307034	450 LPH In-Tank Fuel Pump
1	307035	In-Tank Pump Pre-Filter
1	307036	In-Tank Pump Pigtail
1	30272	Fuel Filter, -6AN Black
1	30313	Harness, EZ-EFI® FP Relay Solid State
1	54027G	Fuel Pressure Gauge, FAST 0-100 PSI
7	30275	Fitting, -6AN Straight Push Lock End
4	30276	Fitting, -6AN 90Deg Push Lock End
25	30295	Hose, Fuel Injection, 3/8"OD x 1' SAE30R9
12	30295-HC	Hose Clamp, For 30295 FI Hose
1	307030	Fuel Pressure Regulator, 30-70 psi Adj.
2	30251	Fitting, -6AN to Straight Oring -6AN
1	30273	Plug Port with Socket Hex Oring, -6AN
3	30258BS	SS Screw, 10-16x5/8" For 30258RB
2	30339	Fitting, Bulkhead -6AN to -6AN
2	30340	Fitting, Bulkhead Nut -6AN
4	30341	Nylon Washer, For -6AN
1	30342-18	Fuel Hose, 3/8IDx18.5"LG Submersible, 30R10
1	30346	Fitting, Sealed 2 Wire
1	30347	Nylon Lock Nut, For 2 Wire Fitting
1	30348	Sealing Ring, For 2 Wire Fitting
2	30349	Female Weatherpack Terminal, 14-16
1	170223	2 Pin Weatherpack Connector - Shroud
1	170268	2 Pin Weather Pack Connector - Tower
2	170082	Male Terminal for Weatherpack Connector
4	170085	Green Seal for Weatherpack Connector
1	170029	Wire, 6' 14-Gauge Red
1	30353	Wire, 6' 14Gauge Blank
2	G31240	Hose Clamp, 40-60 MM 1 5/8-2 3/8
1	170668	Ring Terminal
6	30280	6' of 3/16" Vacuum Hose

Before Getting Started

O2 Bung:

Your new EFI system is going to require the installation of an O2 sensor in order to continuously monitor the air-fuel ratio of your engine. In order to do this, you will need to weld an O2 sensor bung into your exhaust system (see the O2 sensor section for complete instructions.) If you do not have access to a welder and your car is running before performing this conversion, consider driving your car to a qualified exhaust shop to have this bung welded in before beginning installation. This will prevent you from having to remove a section of your exhaust to carry to the shop later on.

NOTE: If you drive the car with the bung welded in before performing the conversion, be sure to install the included O2 plug to cap off the bung instead of the oxygen sensor. Installing the oxygen sensor without it being connected to power will prevent it from being heated and will cause carbon to build up which can damage the sensor element.

Other parts you might need:

FAST™ engineers have worked hard to ensure that your new EZ-EFI® kit includes everything you will need to perform the conversion with basic tools found in most shops. However, certain applications may require extra parts not included that you may want to purchase before beginning. Check out the list below and consider if any of these apply to your application.

Fuel injection-rated fuel system – As with all modern fuel injection systems, the EZ-EFI® requires a much higher pressure fuel system than carbureted applications do. For this reason, you will need to install a new fuel injection-rated fuel system in your vehicle. If you purchased a 30401-KIT or 30402-KIT 55 Master Kit, or one of the FAST™ fuel kits, then you have everything you need to make the switch.

“T” fittings for the vacuum system – The EZ-EFI® throttle body provides two 3/8" and one 1/8" manifold vacuum ports and one 1/8" ported vacuum port. (Ported vacuum ports do not provide a vacuum signal at idle.) If the carburetor being removed from your vehicle utilized more than this number of ports, you may require a barbed T fitting of the appropriate size to multiply the number of ports available on the EZ throttle body. If you will be running a return-style fuel system (explained in the “Fuel System Types” section below), be aware that the fuel pressure regulator will require an 1/8" vacuum port.

Carburetor flange adapter/intake manifold – The EZ-EFI® throttle body is designed to bolt onto manifolds with a four barrel, square bore carburetor flange (such as is utilized by a 4150-style carburetor). If your manifold is set up for any other style carburetor, realize that you will either need a carburetor adapter or a new manifold.



Holley-style cable mount/spring return kit - Check to see if the throttle/transmission cable mount system and also the throttle return spring system that you are currently using will work with your new throttle body. The EZ-EFI® throttle body is designed to work with Holley-style cable mount systems but may work with others as well. Keep in mind that even though the throttle shafts on your new throttle body feature return springs, a stronger extension-style throttle return springs is also required. If you need a new system, consider the FAST™ 304147 kit. It is designed specifically for this application. If your vehicle has a 700R4 transmission, you will also need a cable corrector kit such as TCI® PN 376715. This kit is included with the FAST™ 304147 kit.

Ignition system – In order for your EZ-EFI® to control ignition timing (optional) on a traditional, single coil, distributor-equipped engine, it must have a crank reference signal at TDC from either a crank trigger or a “locked out” distributor with an integrated pickup. The EZ-EFI® system and wiring harness are set up to be plug-and-play with our FAST™ Crank Trigger kits or Dual Sync Distributors. A capacitive discharge (CD)-style ignition box is also required for the EZ-EFI® to control timing. The CD ignition box will receive the ECU’s ignition output signal and fire the coil.

No special requirements are necessary if the EZ-EFI® will not be controlling timing. However, even in this case, a CD ignition (or other form of aftermarket ignition product that provides a clean digital tach output signal) is still recommended for best results.

For a coil per cylinder engine, a FAST™ EZ-LS™ or FAST™ XIM™ ignition system is required. It will supply the EZ-EFI® with an RPM signal and also drive the coils. The EZ-EFI® will have timing control in this scenario.

Spark plugs and wires – Non-resistor spark plugs and solid core spark plug wires are both very noisy and interfere with electronics – including the EZ-EFI® system. If either of those is currently installed on the engine, replace them now. Resistor-style spark plugs often have an “R” in their PN. If you are unsure about what style of spark plugs or wires you have, it is best to look up their PNs to find their specs.

2” hole saw – The EZ-EFI® main wiring harness comes with a 2” firewall pass-through grommet preinstalled in case you decide to route your harness through the firewall in order to mount your ECU inside the cab (optional). If you choose this option and do not already have a 2” diameter hole in your firewall, the easiest way to make one is with a hole saw.

Throttle Body Installation

1. Start the installation of your new EZ-EFI[®] system by installing the throttle body. (**NOTE:** If you will be installing a new distributor, such as the FAST[™] Dual Sync Distributor, you may have more room to work if you complete the first part of that installation before bolting down the throttle body.)
2. Begin by removing your carburetor. As you remove the carburetor, note if each of the 1/8" vacuum lines are run to ported or manifold vacuum. Determining if a vacuum port is "ported" or "manifold" vacuum varies on each carburetor; refer to the manufacturer's specs for your particular carburetor.
NOTE: If you will have the carburetor removed for a length of time, be sure to plug your manifold with clean rags so that no foreign debris is allowed to enter the engine.
3. Install your new EZ-EFI[®] throttle body using the provided gasket and fasten using the screws or studs that were used for your carburetor.



4. If your carburetor had a Holley-style linkage you can reuse the same cable stops and return springs. Otherwise, you will need a cable mount and return spring kit such as FAST[™] PN 304147. Be sure to utilize a cable corrector plate (included with the 304147 kit) if running a 700R4 transmission. A common size throttle ball stud and nylock nut are included for connecting the throttle cable to the linkage.
5. Reconnect all vacuum hoses being sure to connect any ported vacuum systems to the correct 1/8" port as shown below. Leave any unused ports capped with the provided rubber caps.

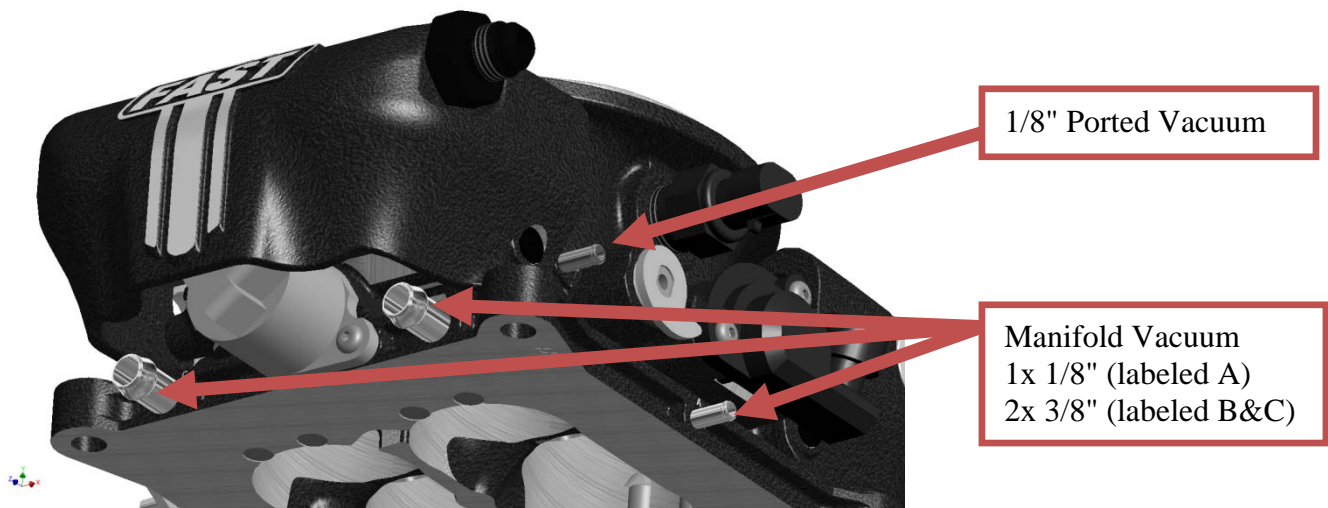

- When your entire installation is finished, be sure to install an air cleaner onto your throttle body (using the stud from the carburetor that you removed.) Standard carburetor-style air cleaners fit the EZ-EFI[®] throttle body or check out FAST[™] PN 30420 for the matching air cleaner to your EZ-EFI[®] throttle body.

Fuel System Types

If you have not already done so, you must now choose the type of fuel system you will run. For the most reliable and best performing system, FAST[™] engineers recommend an in-tank mounted pump running a “return-style” flow.

Return vs. Returnless:

“Return-style” systems constantly pump fuel in a circuit starting at the tank, running up to the engine and then any excess fuel is returned to the tank. Fuel pressure is controlled with a mechanical pressure regulator in this style system. Return-style systems are the most consistent in terms of fuel pressure and fuel flow, which adds to the stability of the EFI system. Return-style systems also help to keep the fuel cooler by circulating it out of the hot engine bay and by constantly cooling the fuel pump. This helps prevent a condition known as vapor lock where the fuel boils and disrupts the running engine.

“Returnless-style” systems pump fuel from the tank to the engine, but do not return fuel to the tank. The EZ-EFI[®] ECU controls fuel pressure in this scenario by varying the speed of the pump. These systems may be more convenient if there is a shortage of available inlets/vents to the fuel tank and one is not easily added. It also prevents the need to run a second fuel line down the length of the car.

NOTE: Returnless-style fuel systems require the use of the in-tank pump included with PN 30401-KIT. They also require a solid state fuel pump relay as used in the EZ-EFI[®] fuel pump relay harness that is included with PN 30401-KIT. (That relay / harness is compatible with both return and returnless-style fuel systems and is included with PN 30402-KIT as well.)

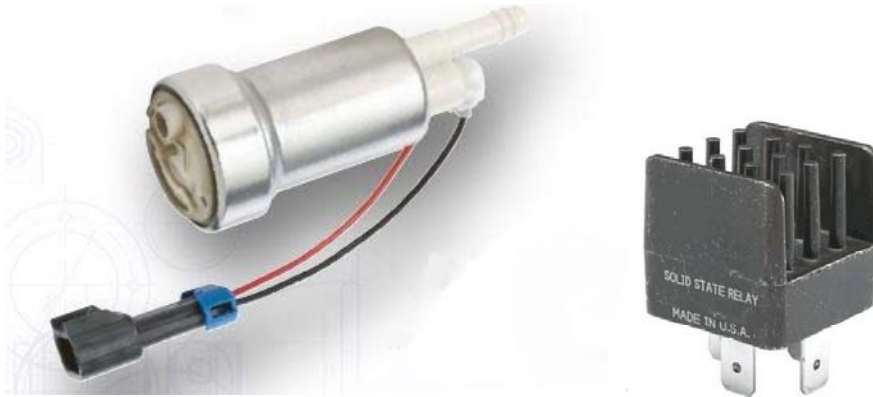

In-tank vs In-line:

In-tank pumps are preferred over in-line pumps for multiple reasons. Most importantly, in-tank pumps do not experience the priming issues that can sometimes occur with in-line pumps. In-tank pumps can be found on practically all late model cars due to their simplicity and effectiveness, and as stated above, are required for returnless-style fuel systems.

In-line pumps can be easier to install in certain scenarios but are sensitive to mounting location. In-line pumps must be mounted close to the tank and lower than the lowest point of the fuel tank in order to properly prime.

Fuel System Installation

CAUTION: Installation of this product requires detailed knowledge of automotive systems and repair procedures. Installation of fuel system parts and any fuel tank modifications must be carried out by a qualified automotive technician. Installation of fuel system parts requires handling of gasoline. Ensure that work is performed in a well-ventilated area with an approved fire extinguisher nearby. Extinguish all open flames, prohibit smoking and eliminate all sources of ignition in the area of the vehicle before proceeding with the installation. When working with fuel systems, eye goggles and other safety apparel should be worn as needed to protect against debris and sprayed gasoline. The finished work must be checked carefully to ensure there are no fuel leaks.

All fuel lines and connectors used in the installation of your fuel injection system should be rated for the higher pressure associated with fuel injection systems. It is not recommended that you use the factory hard lines as part of your installation unless the ends allow for the proper connection to high pressure systems.

Be mindful as you route your fuel hoses that you keep them away from sources of heat and moving components on your vehicle.

In-tank Fuel Pump System Installation:

1. Begin by dropping your fuel tank and removing your fuel sending unit module. Be sure to clean the area around the sending unit before removal and be sure that no debris enters the tank while you are working on it.
2. With the sending unit out, remove the old fuel pump and replace with your new pump. Two 40-60mm hose clamps are included with the FAST™ in-tank fuel kits to order to mount the pump. A sock-type pre-filter is also provided and should be connected to the bottom of the pump. Connect the pump to a tank outlet being sure to use the submersible-rated hose. If an outlet is not available, a bulkhead fitting has been included with the fuel kit to provide for one. If using the bulkhead fitting, be sure to use the provided nylon washers on either side of the hole.

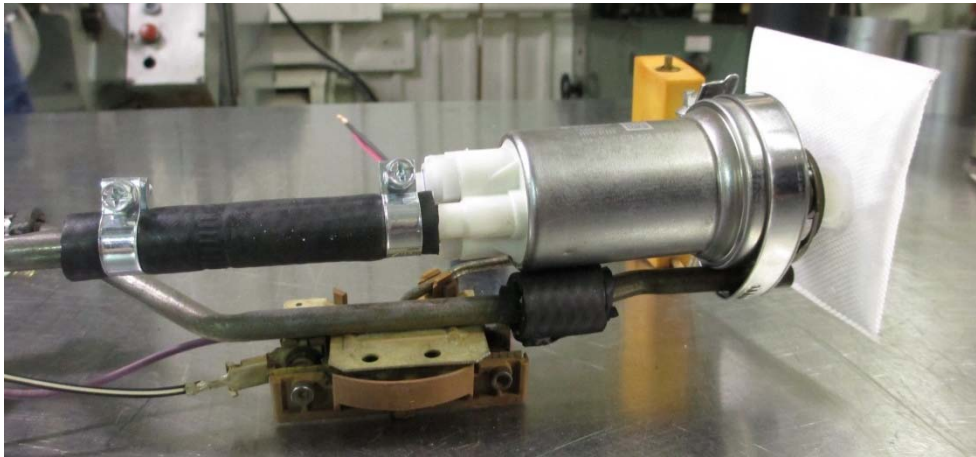

3. Wire the pump using the included pigtail and feed the wires out of the tank using the supplied two-wire sealed bulkhead fitting.
4. With the fuel pump module complete and reinstalled in the tank, now run the rest of the system as shown in the layout on the following page.
5. If running a returnless-style fuel system, plug off one of the ports on the throttle body (either port can be used as the inlet and the other will be plugged.) You will not need to install the fuel pressure regulator or the return line to the fuel tank.

In-Tank Fuel Pump System Layout

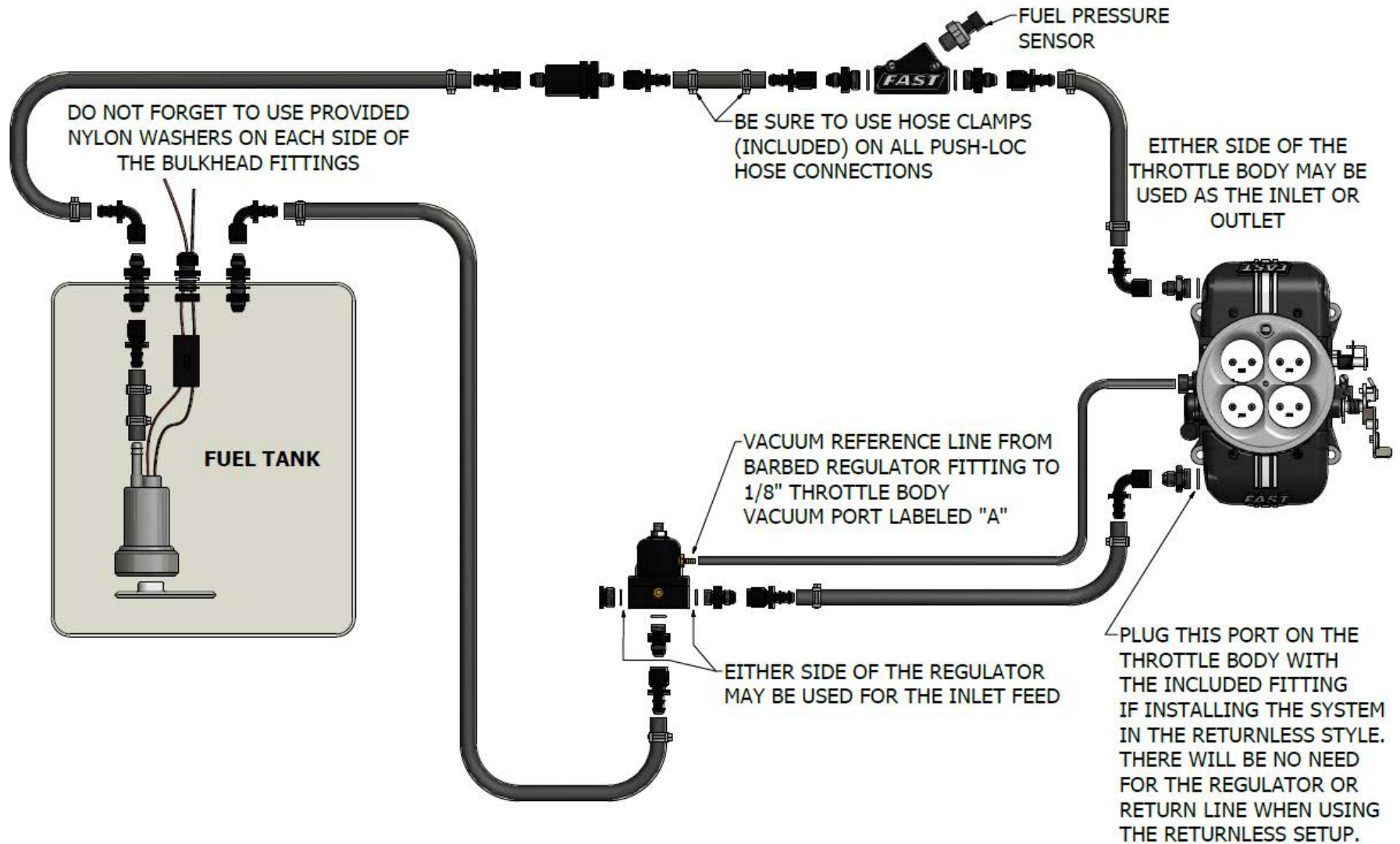

To assemble hoses, use the following procedure.

6. Cut hose to the desired length using a fine tooth saw or cut-off wheel. Be sure to clean the cut edges of any loose material.
7. Lube the barbed end of the fitting with a light oil such as WD-40.
8. Slide a loose hose clamp over the hose so that it is ready to use when the hose has been installed.



9. Place the fitting in a vise. Take care to not scratch the finish on the fitting. Placing a shop rag over the vise jaws can be helpful. For straight fittings it is easiest to attach them to a male and clamp the male fitting in the vise. This helps prevent the fitting from spinning during installation.
10. Now, push the hose onto the fitting until the hose is flush with the plastic finisher.

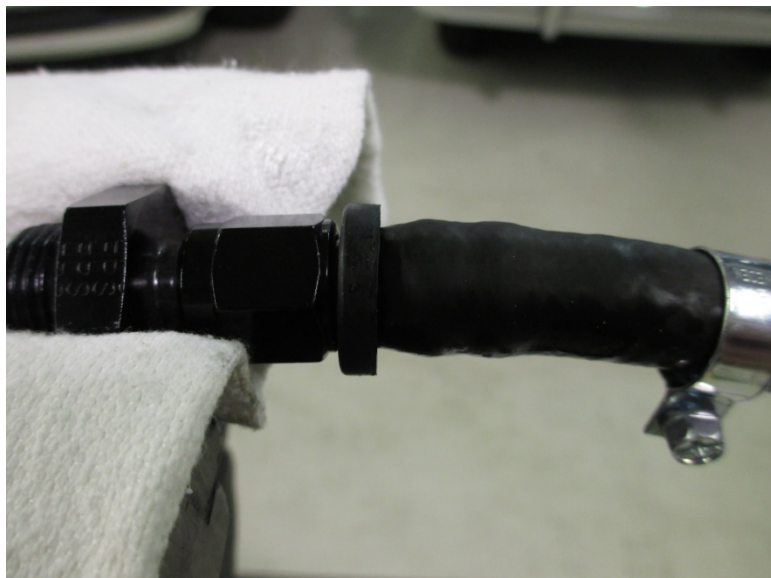

11. Slide the hose clamp over the barbed section and tighten.



Fuel Pressure Regulator Installation (only used for return style systems):

12. Install the two supplied -6AN fittings. One will be installed in the bottom of the regulator (outlet/return port), and the other will be installed in one of the inlet ports on the side of the regulator (choose either side based on easiest hose routing in your application.) The unused inlet port on the other side should be blocked off with the included plug.
NOTE: Since these fittings have o-rings, thread tape/sealant is not required or recommended.
13. Now install the included 1/8" barb fitting in the port on the side of the top half of the regulator and the included pressure gage in the port on the front of the regulator.
NOTE: both of these parts have 1/8" NPT threads and DO require thread sealant or tape.



14. With the regulator now preassembled, mount using the supplied mounting bracket and screws.
15. Finally be sure to connect the barbed fitting to the manifold vacuum port on the throttle body using the supplied 1/8" vacuum hose.

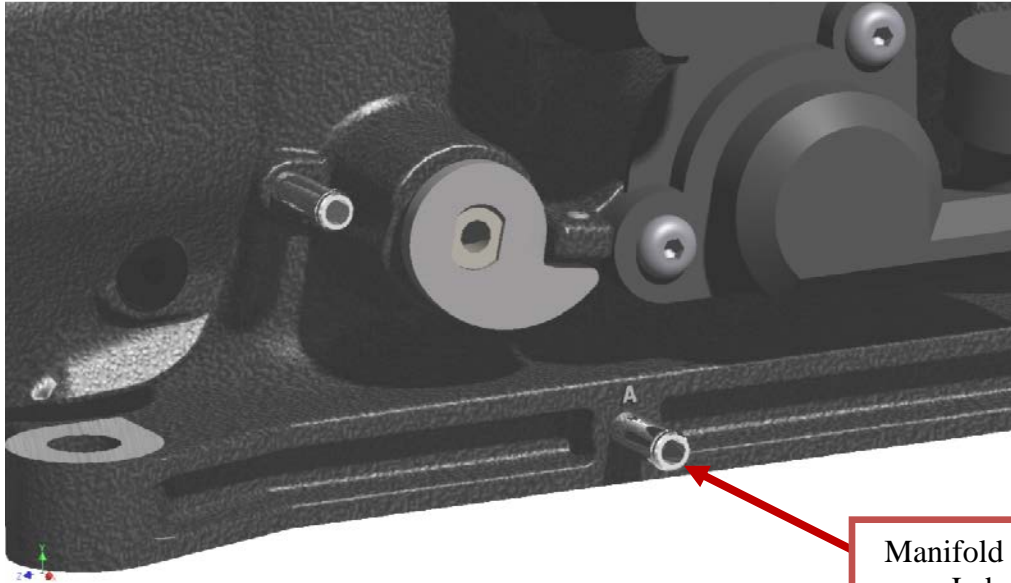

Manifold Vacuum Port
Labeled "A"
Connect Regulator Here

When connecting the fuel return line to the tank (return-style fuel systems only), be sure not to use a vent fitting that is necessary for proper operation of the fuel tank. If there is no appropriate fitting available, use a bulkhead fitting included with your kit. The fuel tank must remain appropriately vented for proper operation.

In-Tank Fuel Pump Wiring:

Wiring needs to be passed into the tank to power the pump. A sealed bulkhead fitting and other wiring components are supplied for this purpose. Some of the final assembly is left for the user to complete to custom fit the installation to their vehicle.

IN-TANK FUEL PUMP KIT - WIRING COMPONENTS

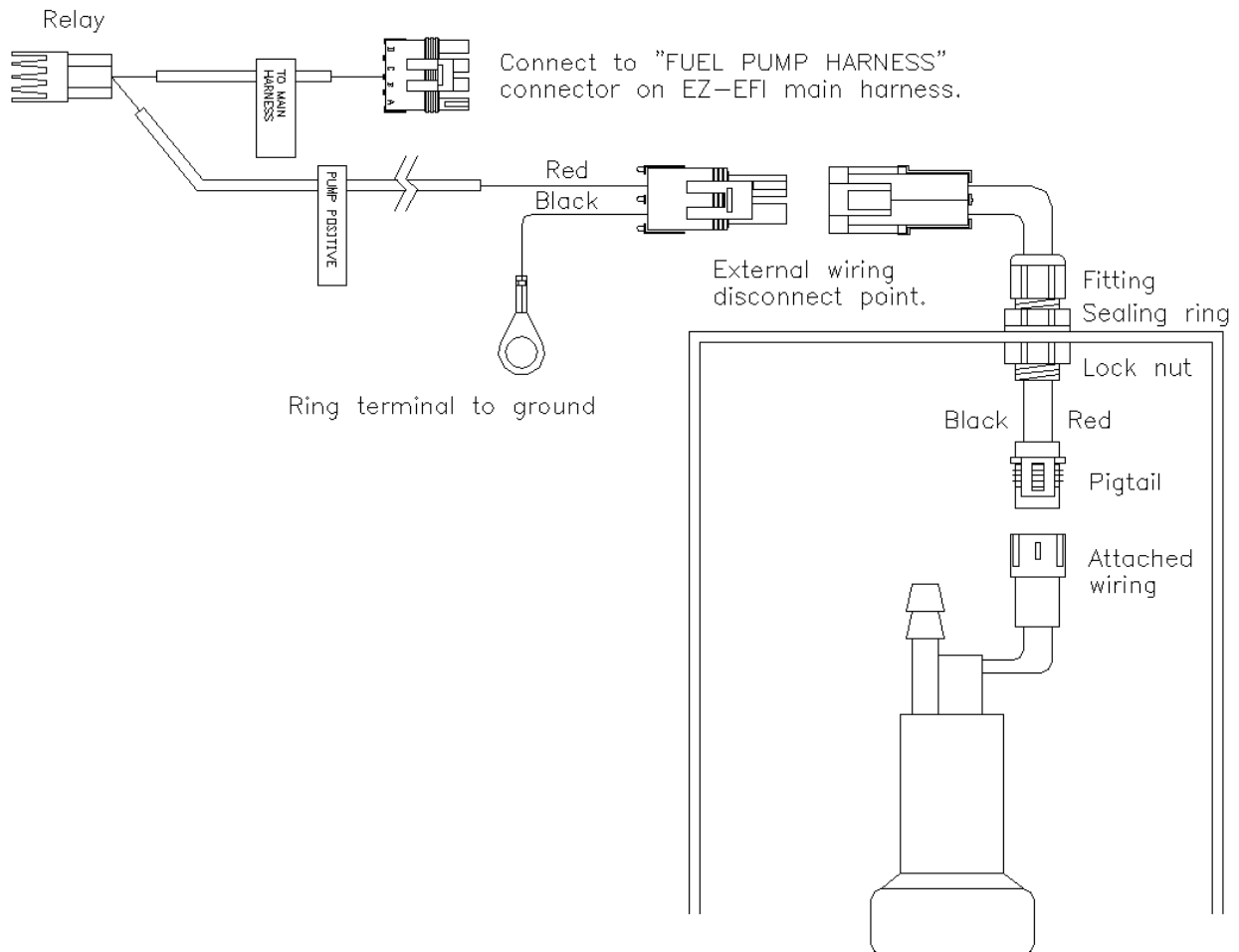

Electrical Bulkhead Fitting Notes:

- The electrical fitting uses the single nylon washer with the larger inside diameter (compared to washers used with the fuel line fittings).
- Drill an 11/16" hole. Feed the fitting through the plastic washer and through the hole in the tank. Secure the fitting with the plastic lock nut. Tighten it to approximately 33 in.-lbs.
- The fitting has holes for passing two wires into the tank. Once the wires are passed through the fitting, the dome nut on top is tightened to compress the seal and make a liquid tight seal around the wires. Tighten it to approximately 22 in.-lbs.

Wiring Assembly:

1. The kit includes a pigtail that mates to the pump. Connect the pigtail to the pump and feed its two loose wires through the two-hole seal in the electrical bulkhead fitting.
2. Route and secure the in-tank portion of the wiring so that it does not interfere with the operation of the fuel level sensing arm/float.
3. Tighten the dome nut on top of the electrical fitting to compress the seal and lock the wires in place.
4. A mating pair of Weather-Pack connectors is included so that the wiring to the tank can be easily disconnected. Install one of the Weather-Pack connectors – using a pair of wire seals and terminals - onto the wires coming out of the fuel tank. To follow the normal convention, use the “shroud” connector housing shown in the drawing along with the male terminals. It does not matter which wire goes into which cavity as long as the mating connector is assembled the same way – red in either position A or position B in both connectors.



5. Install the remaining connector, terminals and seals onto the red “PUMP POSITIVE” feed wire from the fuel pump relay harness and to one end of the supplied length of loose black wire. Make sure red connects to red and black to black when the two connectors are mated.
6. The remaining loose end of the black wire needs to be connected to ground. A blue ring terminal is included for this purpose. Cut the black wire to a convenient length and install the ring terminal. After the ring terminal has been crimped on, use a heat gun or other heat source on the insulation to shrink it and seal it to the wire. A good ground connection is important for proper operation. Be sure that the ring terminal touches clean, bare metal.

In-Line Fuel Pump System Installation:

- In-Line fuel pump system installation is similar to the in-tank installation except that the fuel sender module removal is not required. However, if there is a fuel pump already installed in your tank from your previous fuel system, it is recommended that you remove it. Also, many stock systems have a sock type pre-filter installed in-tank. If your application does, please check that the sock filter is clean. Clogged filters can strain your new in-line pump.
- **IMPORTANT: be sure to mount your in-line fuel pump below the lowest point of your fuel tank; otherwise, the pump will not be able to properly prime if the fuel level is low. Also, mount the pump as close to the fuel tank as possible for best performance.**
- Follow the diagram below for proper installation. Keep in mind that the fuel pump included with the FAST™ kit features an integrated pre-filter. If you run a different pump without a pre-filter, be sure to install a pre-filter in-line before the pump.

In-Line Pump Fuel System Layout

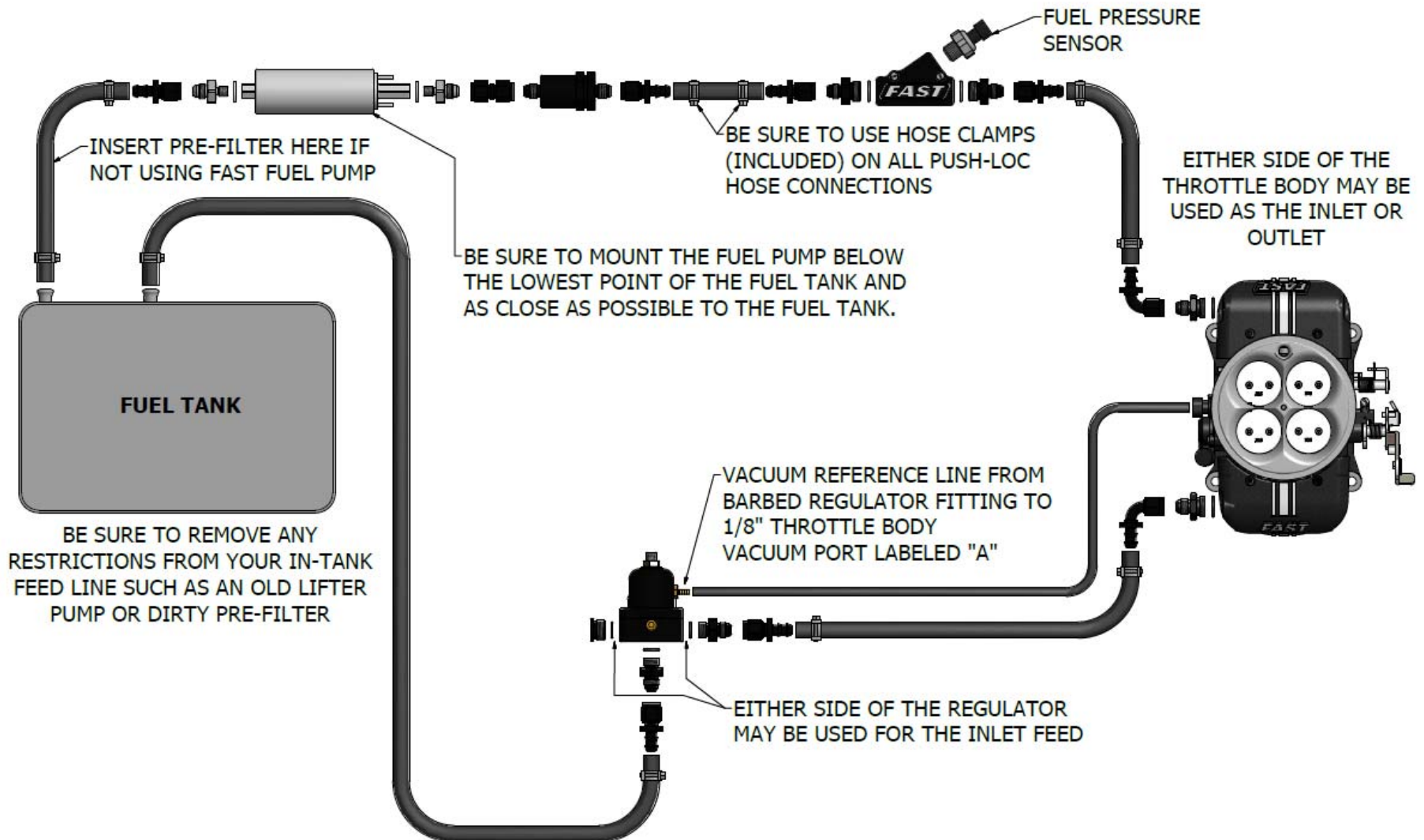

In-Line Fuel Pump Wiring:

Wiring components for connecting power and ground to the fuel pump are supplied. Some of the final assembly is left for the user to complete to custom fit the installation to their vehicle.

IN-LINE FUEL PUMP KIT - WIRING COMPONENTS

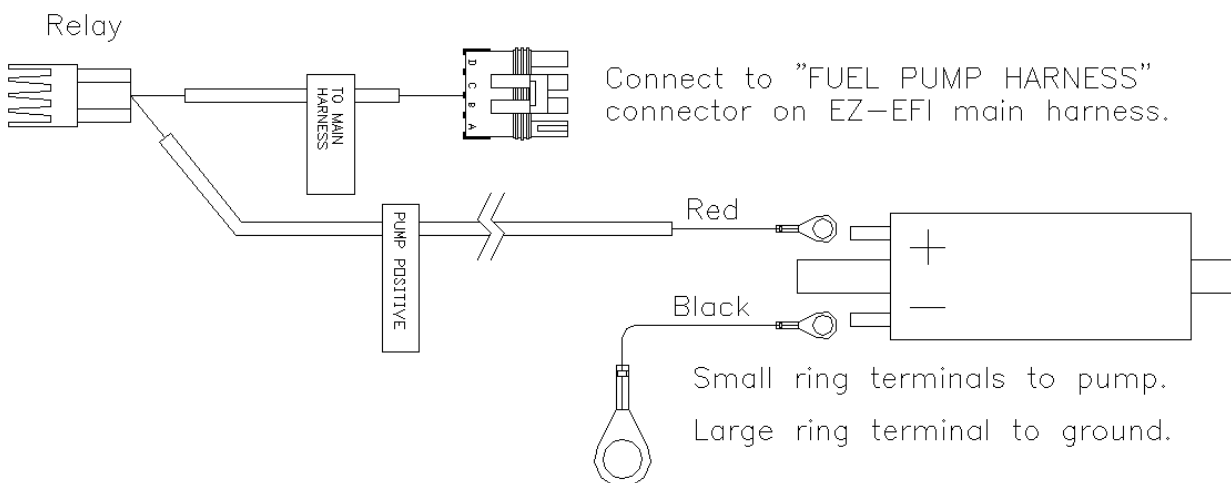

Wiring Assembly:

1. The kit includes two small, blue ring terminals. Crimp one onto the red "PUMP POSITIVE" feed wire from the fuel pump relay harness and the other to one end of the supplied length of loose black wire.
2. Install these small ring terminals onto the threaded wiring studs on the fuel pump. Polarity is marked on the fuel pump. Secure the red wire to the positive (+) post and the black wire to the negative (-) post using the supplied lock washers and nuts.
3. The remaining loose end of the black wire needs to be connected to ground. A larger blue ring terminal is included for this purpose. Cut the black wire to a convenient length and install the ring terminal. One of the fuel pump mounting bolts is often a convenient ground location. After the ring terminal has been crimped on, use a heat gun or other heat source on the insulation to shrink it and seal it to the wire. A good ground connection is important for proper operation. Be sure that the ring terminal touches clean, bare metal.

O2 Bung Installation

The Wideband Oxygen Sensor needs to be mounted in the exhaust system. A threaded fitting and block off plug are provided. The fitting needs to be welded into place. To install the fitting, drill a 7/8" diameter hole and weld the fitting centered in the hole. If you do not have access to a welder, any competent exhaust shop can install the fitting for you. Use the supplied block off plug (not the oxygen sensor) to cap off your new oxygen sensor fitting until you are ready to complete the rest of the EZ-EFI® installation. Oxygen sensors use a built-in heater. If the sensor is installed, but not connected, it will not be heated and deposits may build up in the sensor and cause damage.

NOTE: Installing the threaded oxygen sensor fitting should be the first step in the installation process. It should be done before you begin removing your existing fuel/induction system. That way, you can still drive to an exhaust shop if needed.



Wideband Oxygen Sensor Installation Notes:

- Install the sensor just upstream of the catalytic converter (if present). The sensor can be installed after the converter, but the readings will register slightly leaner than if measured before the converter.
- Ideally, the sensor should be mounted at least 10° above horizontal (wire side up, sensor tip down). This prevents moisture from collecting in the sensor.

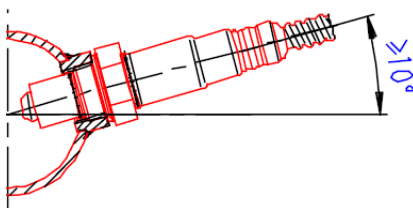

- The sensor should not be installed closer than 20 inches from the cylinder head to ensure excessive heat does not damage the sensor.
- The sensor should be installed in or after the collector. This gives the ECU an average reading across an entire bank instead of from just one cylinder.
- The sensor should not be mounted near the open end of the exhaust system. At low engine speeds, free air may reverberate into the exhaust and cause false readings.
- The system will not function properly if there are any exhaust leaks. Any fresh air that gets to the sensor will cause false lean readings. The ECU will respond by adding fuel that the engine doesn't need.

NOTE: The use of leaded fuel will significantly reduce the lifespan of the oxygen sensor.

Coolant Temperature Sensor Installation



The Coolant Temperature Sensor monitors engine coolant temperature. It is typically installed in an existing mounting hole on the top of the intake manifold. The sensor has 3/8" NPT threads. The supplied adapter may be required to install the sensor in some manifolds with 1/2" NPT threads. The engine block or cylinder head may have a provision for mounting a coolant temperature sensor. Just be aware that heat radiated from headers may be absorbed by the metal sensor body and skew the temperature readings to the ECU. Also, depending on your application, you may have to drain some coolant before removing the plug in your manifold to prevent overflow. Use thread sealant or tape when installing the sensor and the adapter.

ECU (Electronic Control Unit) Installation



ECU Installation Notes:

- The ECU is water resistant when the USB port plug is in place. It can be mounted in the engine compartment or in the vehicle's interior.
- The USB port is used to connect the ECU to a computer in the event that an ECU update becomes available. The USB port is not used in normal operation.
- Avoid mounting locations that expose the ECU to extreme heat or that confine it to a closed area with no air circulation.
- The ECU should not be mounted close to electrically "noisy" components. In particular, keep good spacing (try for 2 feet minimum) from ignition components (ignition boxes, coils, distributors, etc.).
- There are LEDs on the front face of the ECU which can be used to monitor its operation and to signal if the on-board diagnostics has detected a problem. To take advantage of this feature, the ECU will need to be mounted so that the front face of the ECU is visible. The hand-held will also indicate if any faults have been detected so the ECU does not have to be visible to the driver.
- Self-tapping screws are included for mounting the ECU.

Wiring Harness Installation

Wiring Harness Installation Notes:



- The main battery wires, labeled "BATTERY POS" and "BATTERY NEG" **MUST BE CONNECTED DIRECTLY** to the battery. Connecting them anywhere else invites

problems with electrical noise. These kinds of problems are difficult to diagnose. The wires may be extended if needed using automotive grade 10 gauge (or larger) wire.

- Yellow ring terminals are included for making the battery connections. After the ring terminals have been crimped on, use a heat gun or other heat source on the insulation to shrink it and seal it to the wire.
- Be sure the “12V SWITCHED” wire is connected to a source that is hot with the key in the On/Run and Crank positions. Losing the 12V switched source during cranking can lead to a no start condition and other problems. The green “SW IGN” LED on the ECU indicates power on the “12V SWITCHED” wire and should stay lit during cranking.
- Do **NOT** connect the “12V SWITCHED” wire to the positive side of an ignition coil.
- A butt splice is included for tapping into an existing 12V switched wire if necessary. After the splice has been crimped on, use a heat gun or other heat source on the insulation to shrink it and seal it to the wire.
- The main connector on the wiring harness has an integrated retaining bolt that secures the connector to the ECU. A 4 mm hex key is included with the kit for tightening this bolt.
- The wiring harness should be kept away from ignition components (ignition boxes, coils, distributors, etc.) as much as possible. There will be places where plug wires run past the wiring harness. That is often unavoidable and not a problem. Just try to keep them – or other parts of the ignition system’s wiring – from running parallel to the wiring harness. And do not bundle the wiring harness together with other “noisy” wiring in the vehicle.
- As with any wiring, it is good practice to avoid routing the wiring harness around sharp edges or near high temperature components such as headers.
- A length of loose, braided wire covering is included. It can be used as needed to protect the loose wires in the wiring harness once they have been routed and cut to length. After cutting the wire covering, use a cigarette lighter or other heat source to seal the cut and prevent fraying.
- The fuse on the red “BATTERY POS” wire is 25A. All other fuses in the harness are 1A.

The connections on the wiring harness are all clearly labeled. They are connected as follows:

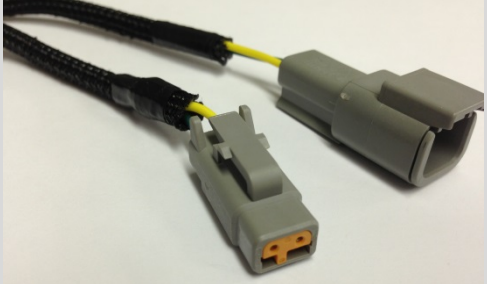
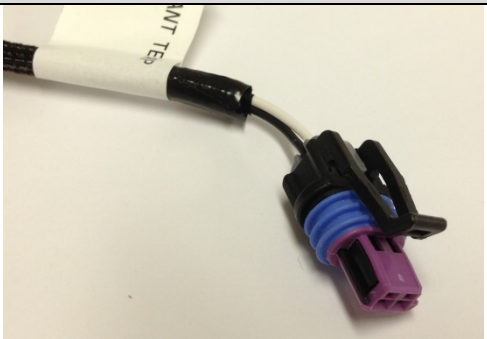
LABEL	PHOTO / LOOSE WIRE COLOR	CONNECTS TO...
12V Switched	Pink	Switched ignition source (hot in On/Run and Crank). This turns the ECU on and off. Do NOT connect to the positive side of an ignition coil.
A/C Input	Gray	Air conditioner switch. Feeding power to this wire tells the ECU that the air conditioner has been switched on. Idle speed will be bumped up and the fan outputs will be activated.
Battery NEG	Black	DIRECTLY to negative post of battery.
Battery POS	Red	DIRECTLY to positive post of battery.

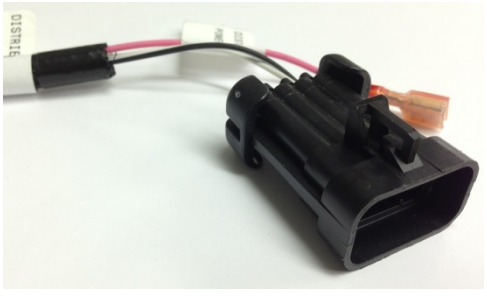
CAN Link		CAN enabled devices: FAST™ EZ-LS™, FAST™ XIM™, TCI® EZ-TCU™, etc.
Configurable Input	Gray/Black	Reserved for future use.
Configurable Output	Blue/Yellow	Reserved for future use.
Coolant Temp		Coolant Temperature Sensor (CTS) typically installed in intake manifold. (This lead comes from the throttle body harness.)
Crank Trigger		<p>FAST™ Crank Trigger or other 2-wire inductive pickup. This is one option for a crank reference input to allow EZ-EFI® to control ignition timing. See Ignition System Options for more details.</p> <p>If this connector is being used, the “DISTRIBUTOR” connector and “RPM INPUT” wire will not be used.</p>
Distributor		<p>FAST™ Dual Sync Distributor connector or other discrete pickup. This is one option for a crank reference input to allow EZ-EFI® to control ignition timing. This connector is also used to interface to a FAST™ EZ-LS™ / FAST™ XIM™ ignition system for coil-per-cylinder applications. See Ignition System Options for more details.</p> <p>If this connector is being used, the “CRANK TRIGGER” connector and “RPM INPUT” wire will not be used.</p>
Distributor Power	Pink	FAST™ Dual Sync Distributor power wire. This feeds 12V switched power to a FAST™ Dual Sync Distributor or this can power a FAST™ EZ-LS™ / FAST™ XIM™ ignition

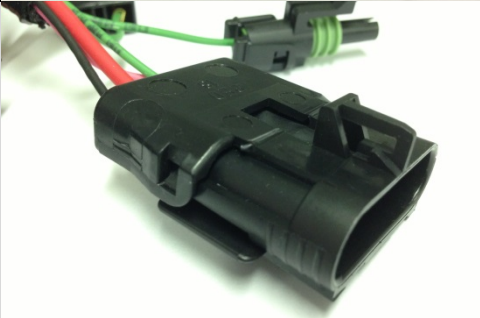
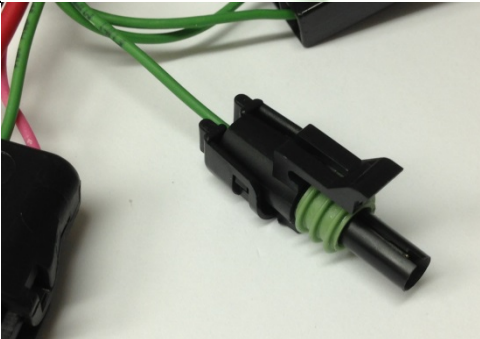
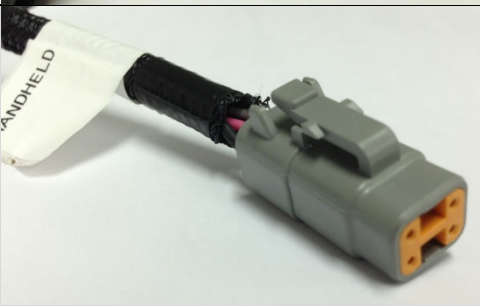
		system.
Fan 1 Relay	Blue	Negative control side of a relay for powering an electric fan. Do NOT wire directly to fan.
Fan 2 Relay	Blue/White	Negative control side of a relay for powering a second electric fan. Do NOT wire directly to fan.
Fuel Pressure		Fuel pressure sensor.
Fuel Pump Harness / Relay (multi-pin)		EZ-EFI® fuel pump relay harness included with EZ-EFI® fuel system kits.
Fuel Pump Harness / Relay (single-pin)		Negative control side of a relay for powering a fuel pump. Do NOT wire directly to fuel pump. Not used with pre-wired EZ-EFI® fuel pump relay harness included with EZ-EFI® fuel system kits.
Hand-Held		Hand-held cable that links the main wiring harness to the hand-held user interface.
Nitrous Input	Gray/Red	Nitrous activation wire. Feeding power to this wire tells the ECU that a nitrous oxide system has been activated.

Oxygen Sensor		Wideband oxygen sensor (O2) mounted in exhaust.
Points Output	Brown	<p>“Points” input on an ignition box to make it fire. Only used when EZ-EFI® is controlling ignition timing. See Ignition System Options for more details.</p> <p>If this wire is being used, the “RPM INPUT” wire will not be used, and vice versa.</p>
RPM Input	<p>White</p> 	<p>A tach output from an ignition box or other source. Or the EZ-EFI® RPM Module. This is the RPM input for the ECU when it is not controlling ignition timing. See Ignition System Options for more details.</p> <p>Do NOT connect this wire directly to an ignition coil. See RPM Module notes.</p> <p>If this wire is being used, the “POINTS OUTPUT” wire, “CRANK TRIGGER” connector and “DISTRIBUTOR” connector will not be used.</p>
Throttle Body		Pigtail on throttle body.

Relay wiring:

The switched outputs from the ECU are not meant to directly drive high-current devices such as fuel pumps or electric fans. The following diagram shows how to wire a standard relay (not included) between the ECU and a high-current (greater than 1 Amp) device.

FUEL PUMP / FAN RELAY WIRING

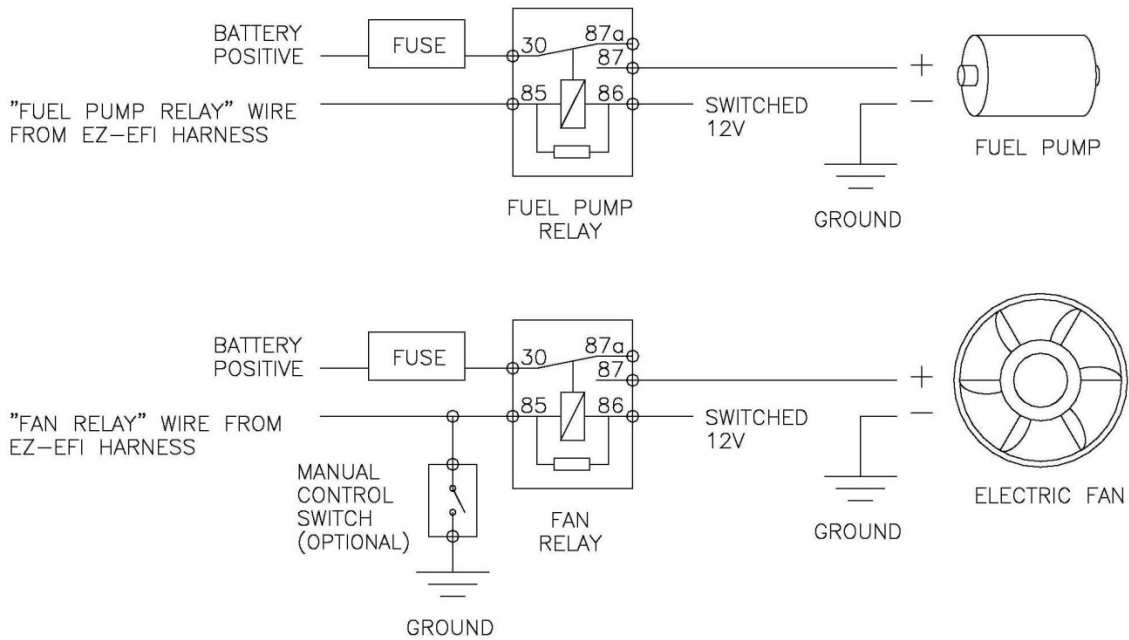

NOTE: The fuel pump relay used in the EZ-EFI® 2.0 fuel pump relay harness is a special solid state relay. It is compatible with return style fuel systems and required for returnless style fuel systems. Its wiring is different than standard relays.

SOLID STATE RELAY WIRING

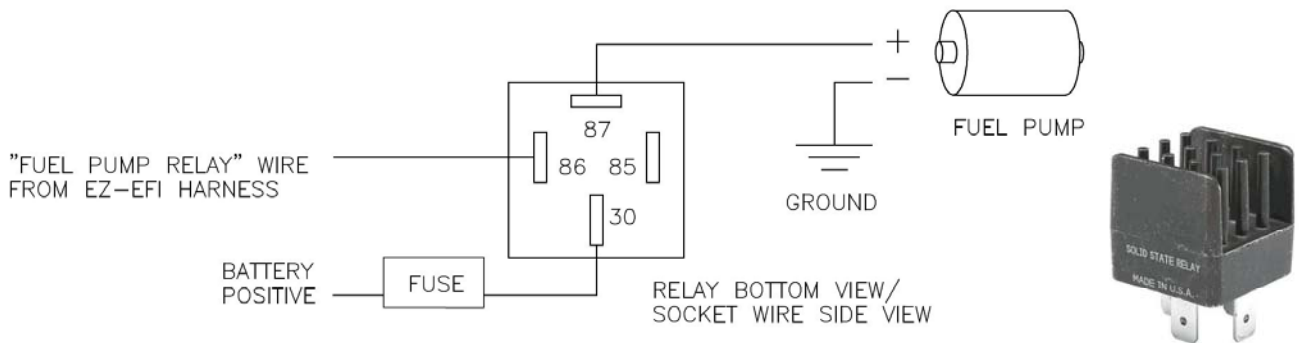

Ignition System Options

The ignition system components that are needed and the wiring harness connections that will be used depend on the type of engine and whether or not the EZ-EFI® ignition timing control capability will be used. In all cases, the EZ-EFI® requires some form of input signal to tell it RPM. If the EZ-EFI® will be controlling timing, that input signal will have some specific requirements and the EZ-EFI® will also interface with an external ignition that will drive the coil(s).

Single Coil, Distributor Equipped Engine – WITHOUT Timing Control

In this scenario, ignition is handled just like it would be with a carburetor. It could be an old mechanical points distributor or any number of more modern solutions for ignition on carbureted engines. In any case, something else is driving the coil and determining when it should fire. The EZ-EFI® just needs to know each time the coil fires. That will tell it engine RPM. If a CD ignition box is being used, EZ-EFI® will get its RPM signal from the ignition box’s “tach” output. If a traditional, dwell-controlled inductive coil ignition system is being used (no CD ignition box), the EZ-EFI® will get its RPM signal by going through the RPM Module to the negative side of the coil. See the RPM Module section for much more detail and important warnings.

In the Setup Wizard, select “NONE” on the Ignition Type screen.

		If using...		
		CD Ignition	Traditional Inductive Coil Ignition	
Harness Connections	Inputs	"DISTRIBUTOR"	n/c	n/c
		"CRANK TRIGGER"	n/c	n/c
		"RPM INPUT"	CD Ignition Tach Output	RPM Module
	Output	"POINTS OUTPUT"	n/c	n/c

n/c = no connection

Single Coil, Distributor-Equipped Engine – WITH Timing Control

In this scenario, EZ-EFI® needs to know engine position – not just engine speed – so that it can command a spark at specific points in the engine cycle. EZ-EFI® will be looking for a crank signal to occur at or very close to TDC. This signal needs to occur in the same spot all the time. It cannot move around with engine speed or load as it would in a distributor with mechanical and/or vacuum advance. If the crank signal moves around, so will the actual ignition timing. This is beyond the control of the ECU. The ECU only has full and final control of ignition timing when it is fed a steady, consistent crank signal. There are several ways to provide this.

- A. **FAST™ Crank Trigger** – The FAST™ Crank Trigger consists of a trigger wheel that attaches to the crank and a sensor that watches as the teeth pass by. Roll the motor over to TDC on #1 compression stroke. Install the trigger wheel and sensor bracket so that the sensor is lined up with one of the teeth on the trigger wheel.

The “CRANK TRIGGER” connector in the harness mates directly to the sensor.

In the Setup Wizard, select “FAST Crank Trigger / 2 Wire” on the Ignition Type screen.

Rotor Phasing

When using a crank trigger, the distributor's orientation in the engine is not critical to the ECU. However, it is still important to phase the rotor to the cap. This will ensure that the rotor is in the correct position throughout the timing sweep in order to fire to the correct cylinder terminal. If the rotor is not properly phased, during operation the rotor tip can sweep too far away from the correct terminal, causing a weak spark or misfire and a lot of electrical noise.

1. Roll the engine over to 30° BTDC. 30° is a good average timing that will work well with most EZ-EFI® installations. If you know that your engine will be running significantly higher or lower timing, please adjust accordingly.
2. Set the distributor to the #1 position and drop it into the engine. Do not clamp it down yet.
3. Set the cap on the distributor and mark the middle of the #1 terminal on the distributor body. Remove the cap.
4. Rotate the distributor body until the center of the mark you made is lined up with the center of the rotor tip. Then clamp down the distributor and install the cap.
5. Your rotor is now phased.

- B. **FAST™ Dual-Sync Distributor** – The FAST™ Dual-Sync Distributor is designed as a “locked out” unit. It has no weights or springs or vacuum canisters. Once it is set in place, it provides a crank signal that does not move with engine speed or load - exactly what the EZ-EFI® needs. Also, the rotor is pre-phased from the factory at 30° BTDC.

Roll the engine over to TDC on #1 compression stroke. Follow the instructions included with the distributor for a TDC install. The built in LEDs will indicate when the distributor is lined up correctly. Because the FAST™ Dual-Sync Distributor is pre-phased, no extra steps are required to achieve proper rotor phasing.

An alternate installation method can be used that does not require the distributor to be powered.

1. Verify that the module in the distributor is installed in the 0° position. (Refer to the instructions included with the distributor for details.)
2. Roll the engine over to 30° BTDC.
3. Set the distributor to the #1 position and drop it into the engine. Do not clamp it down yet.
4. Set the cap on the distributor and mark the middle of the #1 terminal on the distributor body. Remove the cap.
5. Rotate the distributor body until the center of the mark you made is lined up with the center of the rotor tip. Then clamp down the distributor and install the cap.
6. Your crank signal is now set and your rotor is phased. Because the FAST™ Dual-Sync Distributor is pre-phased at 30° BTDC, lining up the rotor tip and terminal with the engine at 30° BTDC also puts the pickup in the correct location.

The “DISTRIBUTOR” connector in the harness mates directly to the distributor.

There is also a “DISTRIBUTOR POWER” wire in the harness to feed the power wire on the distributor. The mating male terminal is supplied loose in the kit. It can be installed on the distributor's power wire to complete this connection.

In the Setup Wizard, select “FAST Distributor” on the Ignition Type screen.

- C. **MSD Crank Trigger** – Roll the engine over to TDC on #1 compression stroke. Install the trigger wheel and sensor bracket so that the sensor is lined up with one of the magnets in the trigger wheel.

A wiring adapter will be needed to connect this to the “CRANK TRIGGER” connector in the harness. Matching up the wire colors correctly is important for stable, consistent timing. If they are backwards the engine will still run, but ignition timing will likely be less stable and actual timing may drift with RPM away from the commanded value.

“CRANK TRIGGER” CONNECTOR PIN #	FAST™ WIRE COLOR	MSD CRANK TRIGGER WIRE COLOR
1	Black	Violet
2	Red	Green

In the Setup Wizard, select “FAST Crank Trigger / 2 Wire” on the Ignition Type screen.

Rotor Phasing

When using a crank trigger, the distributor’s orientation in the engine is not critical to the ECU. However, it is still important to phase the rotor to the cap. This will ensure that the rotor is in the correct position throughout the timing sweep in order to fire to the correct cylinder terminal. If the rotor is not properly phased, during operation the rotor tip can sweep too far away from the correct terminal, causing a weak spark or misfire and a lot of electrical noise.

1. Roll the motor over to 30° BTDC. 30° is a good average timing that will work well with most EZ-EFI® installations. If you know that your engine will be running significantly higher or lower timing, please adjust accordingly.
 2. Set the distributor to the #1 position and drop it into the engine. Do not clamp it down yet.
 3. Set the cap on the distributor and mark the middle of the #1 terminal on the distributor body. Remove the cap.
 4. Rotate the distributor body until the center of the mark you made is lined up with the center of the rotor tip. Then clamp down the distributor and install the cap.
 5. Your rotor is now phased.
- D. **MSD 2-Wire Distributor** – In stock form, these are not configured for use with aftermarket fuel injection systems. The following procedure must be followed.
1. Start by locking out the centrifugal advance on your distributor. The distributor must be physically “locked out” so that the relationship between the pickup and the paddle wheel does not change with engine speed or load. Refer to the manufacturer’s instructions for the proper procedure to lock out the centrifugal advance for your distributor. (This is a very important step; please do not skip.)
 2. Once your distributor is locked out, roll the engine over to TDC on #1 compression stroke, and set your distributor to the #1 position.
 3. Insert your distributor into the engine but do not clamp it down yet.
 4. Rotate the distributor body so that the pickup is aligned with the closest paddle on the paddle wheel. It is important for this the paddle to be as centered as possible, but there will

be an opportunity to check the alignment and compensate for any misalignment with the hand-held later in this installation procedure.

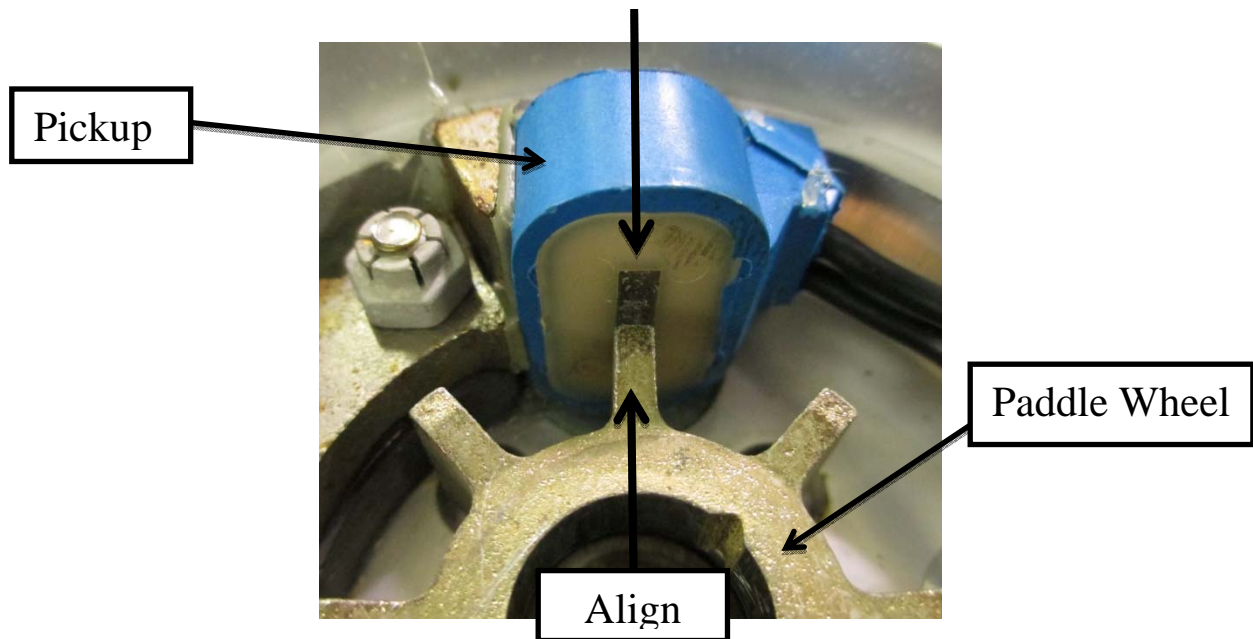

5. Clamp down the distributor.
6. Next, it is important to phase the rotor to the cap. This will ensure that the rotor is in the correct position throughout the timing sweep in order to fire to the correct cylinder terminal. If the rotor is not properly phased then during operation the rotor tip can sweep too far away from the correct terminal causing a weak spark or mis-fire and a lot of electrical noise. In order to correctly phase your distributor, you will need a phasable rotor (such as MSD PN 84211) if you do not already have one.



Phasable Rotor

7. Install the phasable rotor bottom and loosely install the rotor top.

8. Next, rotate the motor backwards from TDC to 30° BTDC. 30° is a good average timing that will work well with most EZ-EFI® installations. If you know that your engine will be running significantly higher or lower timing, please adjust accordingly.
9. Set the cap on the distributor and mark the middle of the #1 terminal on the distributor body.

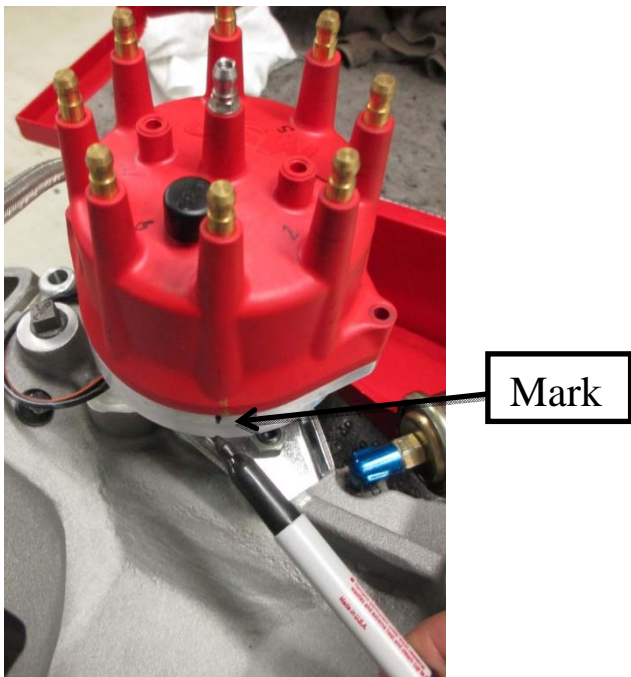

10. Remove the cap and adjust the phasable part of the rotor until the center of the rotor tip is lined up with the center of the mark you made. Then tighten the rotor adjuster screw and install the cap.
11. Your crank signal is now set and your rotor is phased.

A wiring adapter will be needed to connect this to the “CRANK TRIGGER” connector in the harness. Matching up the wire colors correctly is important for stable, consistent timing. If they are backwards, the engine will still run but ignition timing will likely be less stable and actual timing may drift with RPM away from the commanded value.

“CRANK TRIGGER” CONNECTOR PIN #	FAST™ WIRE COLOR	MSD DISTRIBUTOR WIRE COLOR
1	Black	Black/Orange
2	Red	Black/Violet

In the Setup Wizard, select “FAST Crank Trigger / 2 Wire” on the Ignition Type screen.

		If using...				
		FAST™ Crank Trigger	FAST™ Dual Sync Distributor	MSD Crank Trigger	MSD 2-Wire Distributor	
Harness Connections	Inputs	"DISTRIBUTOR"	n/c	FAST™ Dual Sync Distributor	n/c	
		"CRANK TRIGGER"	FAST™ Crank Trigger	n/c	MSD Crank Trigger*	MSD 2-Wire Distributor*
		"RPM INPUT"	n/c	n/c	n/c	n/c
Output	"POINTS OUTPUT"	CD Ignition Points Input	CD Ignition Points Input	CD Ignition Points Input	CD Ignition Points Input	

n/c = no connection * requires adapter harness

Ignition Output

In all of these cases, the brown “POINTS OUTPUT” wire in the harness will connect to a CD ignition box’s “points” input. This is how the ECU tells the ignition when to fire the coil.

Coil-Per-Cylinder Engine – WITH Timing Control

Modern coil-per-cylinder engines have complex crank and cam trigger wheels. FAST™ EZ-LS™ and FAST™ XIM™ ignition systems read in and decode the factory crank and cam signals to give the EZ-EFI® engine speed and position. The FAST™ EZ-LS™ and FAST™ XIM™ ignition systems also drive the coils.

These ignition systems are connected to the EZ-EFI® through the “DISTRIBUTOR” and “CAN LINK” connections in the harness.

There is also a “DISTRIBUTOR POWER” wire in the harness that can be used to feed 12V switched power to the FAST™ EZ-LS™ or FAST™ XIM™ ignition harness. The mating male terminal is supplied loose in the kit. It can be installed on the “+12V SW” wire on the ignition harness to complete this connection.

In the Setup Wizard, select “EZ-LS / XIM” on the Ignition Type screen.

		If using...	
		FAST™ EZ-LS™ / XIM™	
Harness Connections	Inputs	"DISTRIBUTOR"	FAST™ EZ-LS™ / XIM™
		"CRANK TRIGGER"	n/c
		"RPM INPUT"	n/c
Output	"POINTS OUTPUT"	n/c	
In/Out	"CAN LINK"	FAST™ EZ-LS™ / XIM™	

n/c = no connection

RPM Module



EZ-EFI[®] is an advanced fuel injection system. Engine speed is one of the fundamental elements of its fueling calculations. When not controlling ignition timing, it relies on the vehicle's existing ignition system for a steady, reliable RPM signal. An inconsistent or noisy RPM signal can appear to the ECU as erratic engine speed. Spikes, dropouts and general instability of the RPM signal fed into the ECU can have an adverse effect on the running of the engine. It can also interfere with proper learning or prevent learning altogether.

There are two basic options for supplying the EZ-EFI[®] ECU with an RPM input when relying on the vehicle's existing ignition system.

- 1. Aftermarket capacitive discharge (CD) ignition** – An aftermarket capacitive discharge (CD) ignition box is recommended. This form of ignition is beneficial to just about any application. Having a known good, strong spark prevents a host of potential running issues. This type of ignition is also well suited for use with EZ-EFI[®] because it typically has a “Tach” output which is a clean digital signal. This is the preferred RPM source for the EZ-EFI[®] system when it is not controlling timing.

Other aftermarket ignition products besides ignition boxes may also supply a clean digital tach signal. For example, an aftermarket HEI module with a dedicated tach output (not to be confused with the “TACH” terminal in the cap of a standard HEI distributor) can be a good RPM source for the EZ-EFI[®] system.

If using one of these ignitions, the “RPM INPUT” wire in the EZ-EFI[®] wiring harness is connected directly to the “Tach” output from the ignition box. The RPM Module included with the kit is not used in this case. And no part of the EZ-EFI[®] system is connected to the coil.

NOTE: Some aftermarket ignitions have a feature for displaying their programmed rev limit. This is accomplished by briefly outputting an RPM signal on their tach output wire soon after key-on. The intent is to have the vehicle's tachometer display the rev limit setting. This feature is not well suited for some fuel injection systems – including EZ-EFI[®] – as it appears the engine is actually running at that speed. This can lead to the ECU rapidly pulsing the injectors (injecting a large quantity of fuel) and flooding the engine. Contact your ignition vendor to verify whether or not your ignition product has this feature and for details on

disabling it. Keep in mind that it is normal for the EZ-EFI[®] system's "pre-squirt" feature (discussed in the EZ-EFI[®] SYSTEM FEATURES section) to pulse the injectors for a second or two right at key-on. This feature can be distinguished from a potential ignition issue in several ways:

- The "pre-squirt" feature will inject a measured amount of fuel – it will not come anywhere near flooding the engine.
- The "pre-squirt" feature will not continue to occur on subsequent key cycles unless the engine has been started.
- The "pre-squirt" feature will not cause the blue CRANK/DIAG LED on the face of the ECU to come on solid when the engine isn't running as a false RPM signal would. It also won't cause a tachometer to display a non-zero RPM value.

2. **Inductive coil** – Another source for an RPM signal is the negative side of the ignition coil in a traditional dwell-controlled inductive ignition system. This is one in which the coil is fed power on one side and is charged by grounding the other side – either by "points" or some form of electronic module. A standard, unmodified HEI is one example of this type of ignition system.

To use this RPM signal option, the **RPM Module is required**. The RPM Module connects to the negative side of the coil and outputs a "Tach" signal to the ECU. The RPM Module is connected as follows:

WIRE COLOR	CONNECTION
Black	Engine block
Black	Engine block
White	Negative side of coil
Yellow	"RPM INPUT" wire in wiring harness

The RPM Module is provided to allow this convenient installation option. But keep in mind that it has limitations. The negative side of an ignition coil is one of the noisiest points on the engine. There are large voltage spikes and ringing when the coil fires. Different coils will have different noise characteristics. And this noise can change as the engine runs. Anything that affects how hard the coil has to work to fire the spark plug – changing cylinder pressure, worn plugs or plug wires, etc. – will affect this signal.

In most applications, the RPM Module will be able to deal with these challenges and feed a clean RPM signal to the ECU. But the old saying – garbage in, garbage out – applies here. If the inductive ignition system is just too noisy or inconsistent, it may need to be abandoned in favor of an aftermarket ignition box.

RPM Module Installation Notes:

- HEI distributors (and possibly others) have a terminal labeled "TACH". However, that is not a clean digital tach signal like an aftermarket ignition box would supply. Instead, it is simply another terminal connected to the negative side of the coil. Do **NOT** connect the "RPM

INPUT” wire in the EZ-EFI[®] wiring harness directly to that terminal. The ECU will be damaged. In a case like that, the RPM Module is required since what you are really doing is connecting to the negative side of a dwell-controlled coil.

- Do **NOT** bypass the RPM Module and connect the “RPM INPUT” wire in the EZ-EFI[®] wiring harness directly to the negative side of the coil. It may actually start up and run that way. But the ECU will be damaged and system performance will degrade.
- Do **NOT** connect anything from the EZ-EFI[®] system to the coil – RPM Module or “RPM INPUT” wire – when using an aftermarket ignition box.
- Mechanical issues such as a worn distributor gear can make the time between coil firings inconsistent – possibly causing the ECU to see an erratic RPM signal. This applies to either type of ignition if they are taking their input from a distributor mounted pick-up. This is another example of how a deficiency in the ignition system can affect the performance of the EZ-EFI[®] system. Eliminating excessive play in the distributor or installing a crank trigger will help this situation.

Setup/Initial Cranking

1. Disconnect the fuel pump relay harness from the main wiring harness. Or if you are using your own fuel pump relay, disconnect it from the green control wire from the main wiring harness. This is to prevent the fuel pump from priming at key-on before you’ve had a chance to select your fuel system type (return or returnless) in the Setup Wizard.
2. Connect the hand-held to the main wiring harness using the hand-held cable.
3. Turn the ignition switch on and wait for the hand-held to power up and display the home screen.
4. Reconnect the fuel pump relay harness.
5. Select Setup Wizard in the hand-held. It will walk you through initial setup and cranking.

Hand-Held

Hand-Held Notes

- The hand-held communicates with the ECU via the short pigtail exiting from the bottom. A separate, long hand-held cable connects the hand-held to the main harness. The hand-held cable provides power to the hand-held from the same 12V switched source used for the ECU. So the hand-held will power on and off with the ignition switch.
- The mini-USB port on the top of the hand-held is used to connect the hand-held to a computer in the event that a hand-held update becomes available.
- Please do not attempt to operate the hand-held while driving. For safety, have a passenger monitor live data or adjust settings as needed if the vehicle is moving.
- The hand-held is compatible with mounting brackets that fit a Garmin Nuvi 2455LT GPS unit. A suction cup mount for the hand-held is included in the kit.
- The hand-held has a touch screen calibration procedure that can be accessed by pressing and continuing to hold anywhere on the screen as the handheld is powered on. After about 4 seconds, the calibration screen will appear and walk you through the short calibration process. The purpose of this calibration is to sync up the touch-sensitive screen with the graphics on the

display. The result is that where you see a “button” on the screen is also where you need to touch to select it. This calibration is performed at the factory. It is unlikely that it will ever need to be repeated.

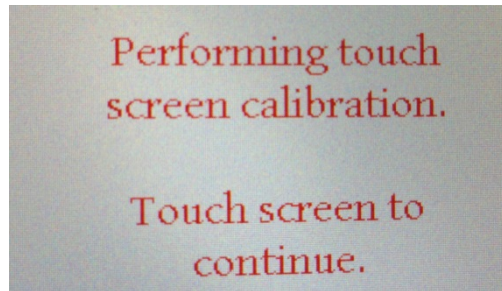

Home Screen

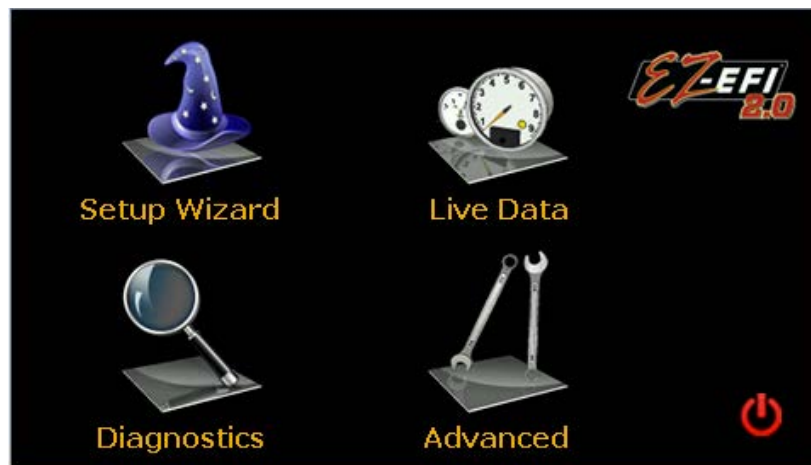

Setup Wizard

The Setup Wizard is a guided configuration process used for initial setup. This can also be used to reset an ECU back to stock.

Live Data

Pressing the Live Data icon navigates to a series of dashes that display live ECU data.

Diagnostics

The Diagnostics area offers access to error codes and other system information and tools.

Advanced

The Advanced menu allows access to individual settings - some that were part of the Setup Wizard as well as other optional settings and adjustments.



Screen Disable

This button turns the screen blank. Touching anywhere on the screen will bring back the normal display.

Setup Wizard

Setup Wizard Notes

- Running the Setup Wizard will overwrite the previous configuration and any user adjustments that have been made. It will also erase any learning that has taken place. The ECU will be restored to its factory “stock” settings.
- Depending on the application, not all Setup Wizard screens will be accessed; only the needed settings are visited.
- To navigate through the Setup Wizard, use the red and green arrow buttons found in the corners of the screen. Pressing the “Next” button will save the settings of that screen to the ECU and proceed to the next screen. Pressing the “Back” button will discard any changes made to the current screen and return to the previous screen. If the “Next” button is not available, then this screen requires more input before continuing.
- Screens that are only accessible from the Advanced menu use a “Cancel” button to discard changes and a “Confirm” button to save changes.

Setup Wizard Navigation Buttons			
<p>“BACK” Discard changes. Retreat to previous screen.</p>			<p>“NEXT” Save changes. Proceed to next screen.</p>
Advanced Navigation Buttons			
<p>“CANCEL” Discard changes. Return to Advanced screen.</p>			<p>“CONFIRM” Save changes. Return to Advanced screen.</p>

Engine Parameters

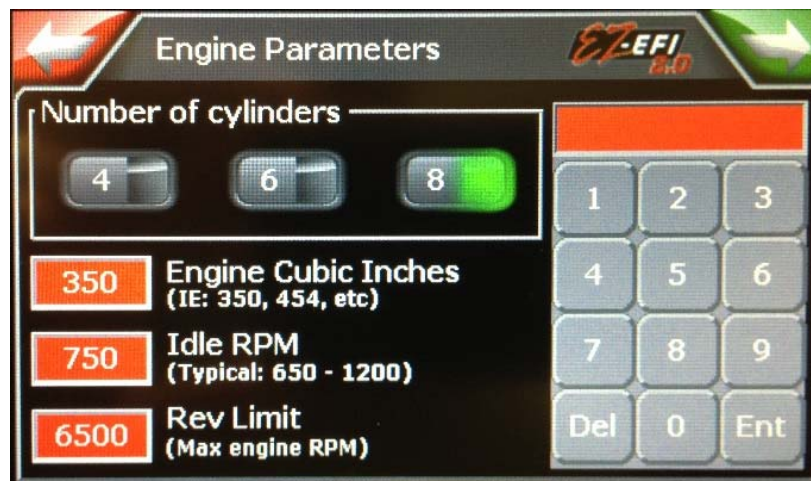

To adjust a setting, touch the Engine Cubic Inches, Idle RPM or Rev Limit textbox. Then enter desired numbers on the keypad and press Ent. The value will be sent to the selected textbox.

- **Number of cylinders** – Choose from 4, 6, or 8. The button's LED will indicate selection.
- **Engine Cubic Inches** – To convert from liters to cubic inches use the following formula:
Cubic Inches = Liters × 61.0237.
- **Idle RPM** – The target idle speed maintained by the IAC motor, and by idle timing trim if the EZ-EFI® is controlling ignition timing and the idle timing trim feature is enabled.

Some engines like to idle higher than others. This setting allows you to easily try different idle speeds to see what works best for yours. Keep in mind that this is setting the idle speed for a fully warmed-up engine. If the engine is cold, the ECU will try to maintain a slightly higher idle than called for here. If you return to this setting from the Advanced menu and make large changes, you may want to use the IAC Calibration option (also accessed through the Advanced menu). This will help you adjust the resting position of the throttle blades so that the idle motor is operating in the preferred range.

Keep in mind that once the idle motor is in its fully closed position (the Live Dashes show IAC at 5), it cannot bring the idle speed down any further no matter what setting is entered here. If this happens, you will need to adjust the idle screw on the throttle body to close the blades more. (Again, you'll want to use the IAC Calibration option afterwards.) The other extreme is if the Live Dashes show IAC at 180. At that point, the idle motor is fully open and is unable to let any more air into the engine to raise the idle speed.

If for some reason an IAC is not being used in a custom application, the **Idle RPM** setting is still important. Besides serving as a target for the IAC (and idle timing trim if applicable) to maintain, this setting also helps the ECU determine when the engine is idling. For an application without an IAC, set **Idle RPM** to match the engine's actual idle speed.

- **Rev Limit** - To protect the engine from an over speed condition, the maximum allowable speed can be restricted with this setting. When RPM reaches this value, the injectors will be disabled. Once RPM has dropped, injection will resume.

NOTE: Keep in mind that the Rev Limiter will prevent the engine from spinning itself too fast under its own power. But it does not protect against something else spinning the engine too fast – such as a downshift into a gear that is too low.

Fuel System

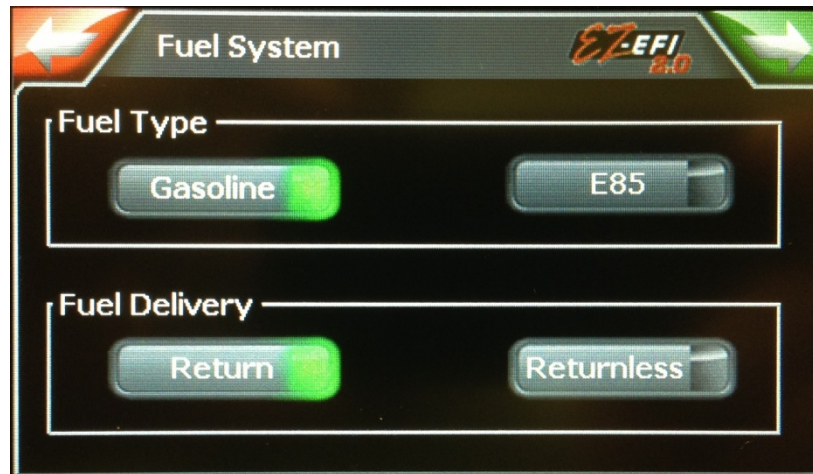

- **Fuel Type** – Select gasoline or E85.
- **Fuel Delivery** – Select “Return” if the fuel system uses a mechanical fuel pressure regulator and has a return line back to the fuel tank. Select “Returnless” for electronic control of fuel pressure. Refer back to the Fuel Systems Type section for more detail.

Ignition Type



- **None** – Select if EZ-EFI® will not be controlling ignition timing.
- **EZ-LS/XIM** – Select if using a FAST™ EZ-LS™ or FAST™ XIM™ Ignition System.
- **FAST Distributor** – Select if using a FAST™ Dual-Sync Distributor or other discrete, square wave-type RPM signal.
- **FAST Crank Trigger / 2 Wire** – Select if using a FAST™ Crank Trigger or other 2-wire inductive, sine-wave type RPM signal.

EZ-LS/XIM Setup



- **EZ-LS** – Select if using a FAST™ EZ-LS™ ignition system.
- **GM** – Select if using a FAST™ XIM™ ignition system on a GM LS engine.
- **Ford** – Select if using a FAST™ XIM™ ignition system on a Ford Mod or Coyote engine.
- **Chrysler** – Select if using a FAST™ XIM™ ignition system on a Chrysler Hemi engine.

Ignition Timing



Setting up a timing curve is simple using the hand-held. Adjusting the three values explained below will allow the ECU to construct a full, RPM-based timing curve. This takes the place of changing weights and springs to adjust mechanical advance in a traditional distributor.

- **Idle** – While the engine is at idle RPM, this will be the base timing. Keep in mind that both idle trim and vacuum advance (discussed later) can apply an offset to this base timing value.
- **All-In** – The maximum amount of timing used on the base timing curve. Timing will ramp up from **Idle** timing to **All-In** timing as RPM increases towards the **All-In RPM**.
- **All-In RPM** – When the engine reaches this RPM, timing will have ramped all the way up to the **All-In** value. This setting is adjusted with the slider along the bottom of the screen.

The final ignition timing the engine sees (Total Timing) is composed of three components:

Base Timing	Value from RPM-based timing curve
+ Idle Adv	Timing added or subtracted to influence idle speed (Optional. See Advanced menu.)
+ Vacuum Adv	Timing added based on manifold vacuum (Optional. See Advanced menu.)
= Total Timing	

Timing related data is only valid when EZ-EFI® is controlling timing.

Select System

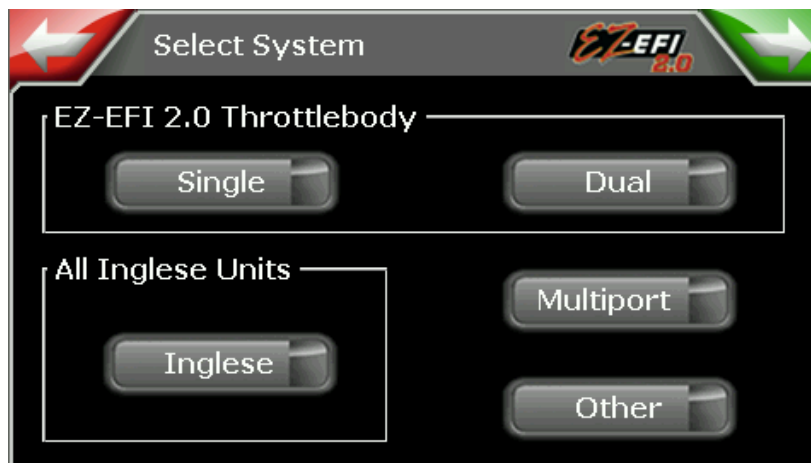

- **Single** – Select this option if using one EZ-EFI® 2.0 eight-injector throttle body.
- **Dual** – Select this option if using two EZ-EFI® 2.0 throttle bodies.
- **Inglese** – Select this option if using any Inglese™ kit. Selecting the exact Inglese™ kit is done from another screen.
- **Multiport** – Select this option for port-injected applications where fuel is supplied by injectors near each intake port instead of from an EZ-EFI® 2.0 throttle body.
- **Other** – Select this option for any special case. It allows configuration of number of injectors, custom injector size and configurable fuel pressure.

This screen is only accessible through the Setup Wizard – it is not available in the Advanced menu. If this selection needs to be changed after the initial install, the Setup Wizard must be re-run to configure the ECU properly for the new throttle body / intake setup.

Inglese™ Setup



There are two main styles of Inglese™ systems: Down Draft (Eight-Stack) and Side Draft. If using a Down Draft system, select the kit based on rated horsepower of the kit or the injector part number. If a Side Draft system is used, choose between Single or Dual.

Injector Specs



To adjust a setting, touch the Injector lb/hr or Fuel Pressure PSI textbox. Then enter desired numbers on the keypad and press Ent. The value will be sent to the selected textbox.

- **Number of Injectors** – Choose from 4, 6 or 8. The button's LED will indicate selection.
- **Injector lb./hr. @ 43 psi** – This is the injector's rated flow measured at 43 psi. Refer to the injector's datasheet to obtain this information. If the injector is rated at a different psi, a conversion must be performed as shown below.

$$\text{New flow} = \text{Old flow} \times \sqrt{\frac{\text{New Pressure}}{\text{Old Pressure}}}$$

As an example, assume the injector's flow rating is 65 lb/hr @ 58 psi. The flow rating @ 43 psi is calculated as follows.

$$\text{New flow} = 65 \times \sqrt{\frac{43}{58}}$$

$$\text{New flow} = 56 \text{ lb/hr}$$

- **Fuel Pressure PSI** – Enter the fuel pressure you will be using. If a returnless fuel system is being used, the ECU will control the fuel pump to maintain the pressure entered here. If a return-style fuel system is being used, this should be set to match the pressure the mechanical fuel pressure regulator will be set to.

43 psi is the recommended pressure for EZ-EFI[®] throttle bodies and for Inglese[™] Side Draft systems. 60 psi is the recommended pressure for Inglese[™] Down Draft, 8-stack systems.

For EZ-EFI[®] throttle bodies and all Inglese[™] kits, the settings on this screen will be pre-set to the appropriate values by the Setup Wizard. This screen will be skipped in the Setup Wizard for those applications. It should not need to be revisited later through the Advanced menu.

If these settings are being changed after the initial setup because a different throttle body / intake setup is being used, the Setup Wizard must be re-run to configure the ECU properly for the new parts. These and other settings will be affected.

TPS Calibration

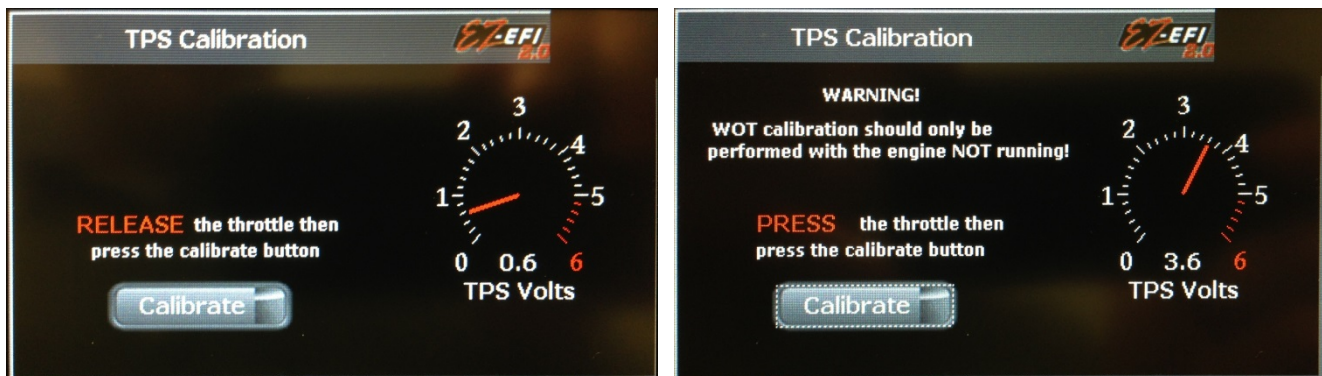

The throttle position sensor (TPS) sends a voltage to the ECU that varies with throttle movement. The ECU needs to know what voltage corresponds to closed and full throttle. This process gives it that information. Note that the “Next/Confirm” button will not become available until the full calibration process is complete.

1. While the red text displays “RELEASE”, leave the throttle in its fully closed resting position. Press the “Calibrate” button. The button’s LED will be active while the throttle’s closed voltage is being captured. When completed, the LED will turn off.
2. The red text will then display “PRESS”. Press the throttle all the way to its wide-open throttle (WOT) position. Hold it there and press the “Calibrate” button again. The LED will come back on as the throttle’s WOT voltage is being captured. When completed, the LED will turn

off for the final time and the throttle can be released. The “Next/Confirm” button will become available.

NOTE: The full throttle procedure is meant to be performed with the engine NOT running!

Fuel System Test

The fuel system test procedure differs slightly depending on the fuel system selected. Shown below are the two types of tests that may run. These tests are meant to be performed with the engine not running.

The Fuel System Test screen can also be accessed from outside the Setup Wizard by selecting Fuel System from the Advanced menu. After confirming the fuel system settings, you will be taken to the appropriate Fuel System Test screen.

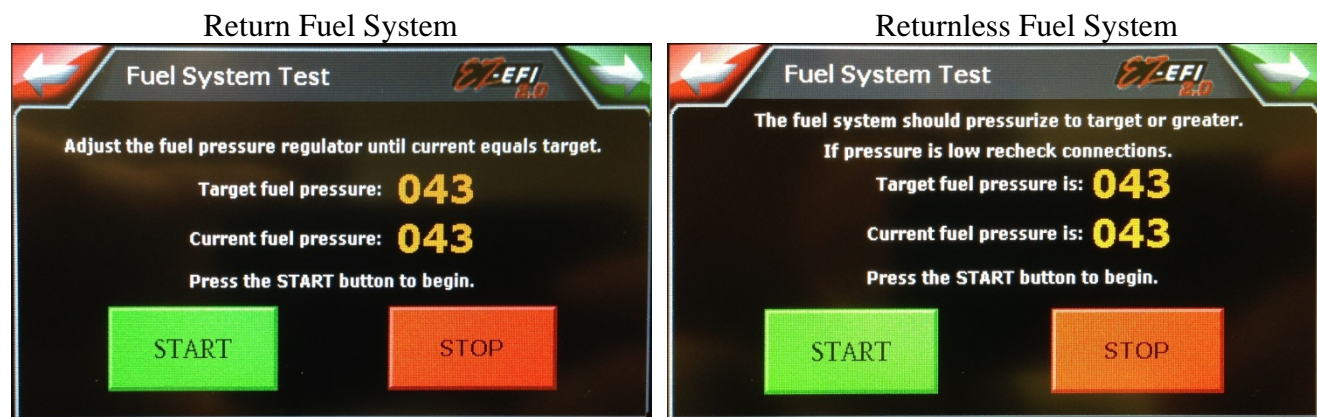

Return Fuel System

The first test is for return style fuel systems that use a mechanical fuel pressure regulator and a return line back to the fuel tank. The target fuel pressure will be shown along with current fuel pressure. Pressing the “START” button will engage the fuel pump. Pressing the “STOP” button will turn the pump off. For safety, the fuel pump will automatically turn off after approximately 10 seconds. Use this time to adjust the regulator and ensure that current fuel pressure is equal to target fuel pressure. Turn the adjustment screw on the top of the regulator clockwise to raise the pressure or counter clockwise to lower it. Be sure to tighten down the jam nut when finished adjusting the fuel pressure.

The test can be re-run as necessary by pressing the “START” button again.

NOTE: If the pump does not come on during this test (or comes on but only for an instant) and if the blue CRANK/DIAG LED on the ECU is flashing rapidly, it is likely that a safety built into the ECU has shut the pump down in response to higher than expected (greater than 75 psi) fuel pressure. The fuel pump is disabled in the event that a return-style fuel system (which runs the pump wide open) was selected in the hand-held when there is no mechanical fuel pressure regulator and return line actually installed in the vehicle. This prevents the pump from straining against a closed system and building excess pressure.

If this happens and the vehicle really is using a return-style fuel system:

1. Turn the ignition switch off and wait for all of the LEDs on the ECU to turn off.
2. Back the adjustment screw on the regulator all the way out to lower the fuel pressure.
3. Turn the ignition switch back on and go back through the Setup Wizard.
4. If the condition persists, see the On-Board Diagnostics section for more detail on the Fuel Pressure Control error code.

If the vehicle is really using a returnless-style fuel system:

1. Turn the ignition switch off and wait for all of the LEDs on the ECU to turn off.
2. Disconnect the fuel pump relay harness from the main wiring harness.
3. Turn the ignition switch back on and wait for the hand-held to power up and display the home screen.
4. Reconnect the fuel pump relay harness.
5. Go back through the Setup Wizard and be sure to select “Returnless” on the Fuel System screen.

Returnless Fuel System



The second test is for returnless-style fuel systems that have no mechanical fuel pressure regulator or return line back to the fuel tank and are controlled electronically. Pressing the “START” button will engage the fuel pump. Pressing the “STOP” button will turn the pump off. For safety the fuel pump will automatically turn off after approximately 10 seconds. Use this time to verify that the fuel system can build and maintain fuel pressure equal to or greater than the target fuel pressure.

Without a mechanical fuel pressure regulator and a return line back to the fuel tank, a returnless fuel system typically does not have an easy way to relieve excess pressure other than through the injectors when the engine is running. That is why this test is only looking for fuel pressure to be equal to or greater than the target fuel pressure instead of being exactly equal to it. If fuel pressure goes above the target fuel pressure, the fuel pump may stop running before the “STOP” button is pressed. Or it might not come on at all when the “START” button is pressed. This is normal.

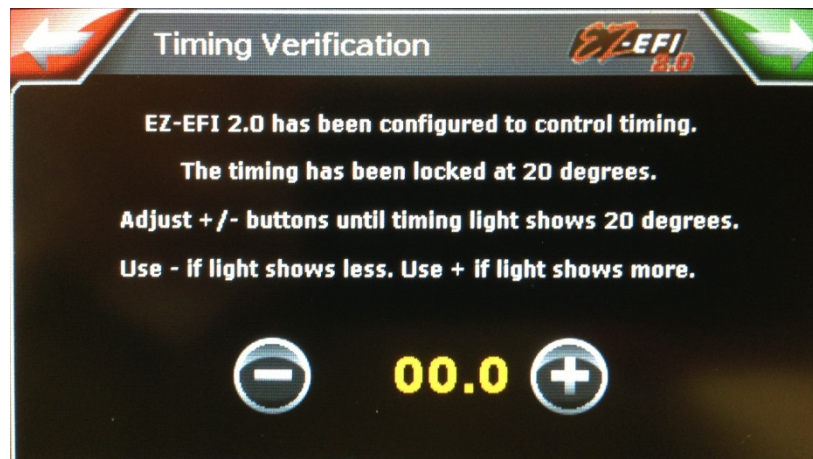
Timing Verification



After starting the engine, use a timing light to verify that the timing is correct. The ECU will lock the timing to 20° of advance during this test. That is what the timing light should show. If it doesn't, use the Plus or Minus buttons to fine tune the ignition setup until the timing light does show 20° of advance. Once it does, you can use the “Next” button to proceed to the next screen.

IF TIMING LIGHT IS SHOWING...	USE...	IN ORDER TO...
Less than 20° BTDC	Minus button 	Advance Timing
More than 20° BTDC	Plus button 	Retard Timing

If timing needs to be verified again after the initial pass through the Setup Wizard – for example, if a distributor is removed and re-installed – select Ignition Type from the Advanced menu. That will prompt you to confirm your ignition type and then lead back to this Timing Verification screen so that timing can be dialed in again with a timing light.

Additional background information

The ECU expects to see crank signals occur when the engine is at a specific location. When the ECU sees a crank signal, it assumes the engine is at the prescribed location and goes about the business of calculating how long it needs to wait from there before firing a spark. If the crank signals are not occurring where the ECU expects them to, that time calculation will be off and the actual timing will be offset from the commanded timing.

For example, on a single coil engine getting its crank signals from a crank trigger or a distributor, the ECU expects those crank signals to occur at TDC (0° BTDC). That is the “00.0” that appears on the Timing Verification screen. If the crank signals are indeed occurring at TDC, the ECU's calculations will be correct and a timing light will show actual timing that matches commanded timing. Commanded timing is locked at 20° BTDC during this test. If the crank signals are instead occurring at 3° BTDC (due to physical misalignment - the crank trigger or distributor not being installed right at TDC), the ECU's calculations will be based on incorrect information – namely that the engine is really at 3° BTDC when the ECU thinks it is at 0° BTDC. In this case, a timing light will show actual timing to be 23° BTDC instead of the 20° BTDC the ECU is shooting for.

Adjusting this setting is telling the ECU that the crank signals aren't occurring exactly where it is expecting them to. As this setting is adjusted, the ECU recalculates when to fire a spark and actual timing moves. You will know this setting is correct when a timing light shows the actual timing matching the commanded 20° BTDC. In the example above, that would happen when the Plus button had been used to raise this setting from “00.0” to “03.0”.

Of course, any misalignment of the crank trigger or distributor could be corrected by physically moving them in a process of trial and error (and in extreme cases, that may still be required). For most installations though, this on-screen approach allows timing to be dialed in quickly and easily with a few button presses.

Additional information for FAST™ EZ-LS™ / FAST™ XIM™

As mentioned above, with a traditional single coil engine using a crank trigger or distributor, the ECU expects crank signals at TDC (0° BTDC). When used with a FAST™ EZ-LS™ or FAST™ XIM™ ignition system, the ECU expects the crank signals at different locations depending on the make of the engine. For example, the ECU will expect crank signals from an EZ-LS™ ignition to occur at 50° BTDC so that will be the base setting on the Timing Verification screen. (“50.0” instead of the “00.0” in the previous example.) From there, it can be adjusted up or down as described above. If timing was a little off like in the previous example (timing light showing 23° BTDC instead of the 20° BTDC the ECU is shooting for), this setting would end up being raised from “50.0” to “53.0”.

CRANK SIGNAL SOURCE	ECU EXPECTS CRANK SIGNAL AT...
Crank Trigger	0° BTDC
Distributor	0° BTDC
EZ-LS™	50° BTDC
XIM™ – GM	50° BTDC
XIM™ – Ford	60° BTDC
XIM™ - Chrysler	52° BTDC

IAC Calibration

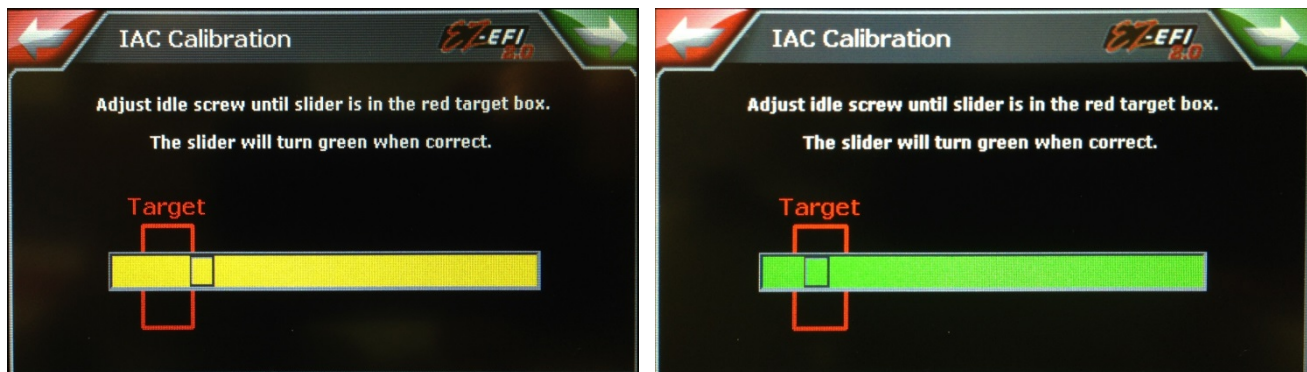

Adjust the idle screw on the throttle body until the indicator in the slider is in the red target box. This is adjusting the resting position of the throttle blades so that the idle motor (an electronically controlled stepper motor that allows air to bypass the throttle blades) is operating in the preferred position. This ensures that the idle motor has enough range of motion to help bring the idle speed up or down as needed.

TURNING IDLE SCREW...	THROTTLE BLADES	IAC	INDICATOR IN SLIDER
Clockwise	Open	Closes	Moves to the left
Counter-clockwise	Closes	Opens	Moves to the right

NOTE FOR 500C.I.D. or LARGER ENGINES: The idle motor's entire range of movement is from 5 to 180 "counts." Higher counts mean the idle motor is open more and allowing more air to bypass the throttle blades. Adjusting the throttle blade so that the bar is roughly centered on the "target" will put the idle motor at approximately 20 counts. This setting will work well for most engines. For larger engines, the throttle blades may need to be adjusted differently. If the engine struggles or stalls when the gas pedal is released, the throttle blades may need to be opened up slightly. That means shooting for the indicator to be shaded to the left side of the "target" on this screen. This will cause the idle motor to operate at a more closed position (lower counts) at idle. Since it will have more room to open if engine speed dips, it will be able to bypass more air to keep the engine running.

After setting the blades and pressing the "Next" button, the TPS Calibration screen will be revisited. The throttle position sensor is connected to the throttle shaft. So adjusting the resting position of the throttle blades may have changed the voltage the ECU is receiving from the TPS at idle (the wide open throttle reading will not have changed). To account for this, the throttle's closed voltage needs to be recaptured.

That's it! The ECU is configured for your engine and is ready to get to work learning more about it.

Advanced

EZ-EFI® is simple for the user to configure, and only requires running the Setup Wizard to begin operating. However, for the user that wants the extra control, many additional features can be found in the Advanced menu.

Some settings found here will have already been configured in the Setup Wizard. (And have already been discussed.) They can be accessed here individually. Other settings are only accessible through the Advanced menu.

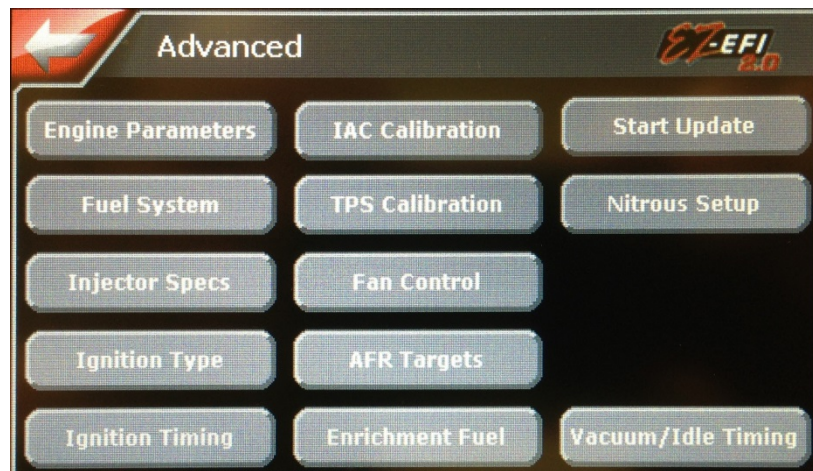

Fan Control

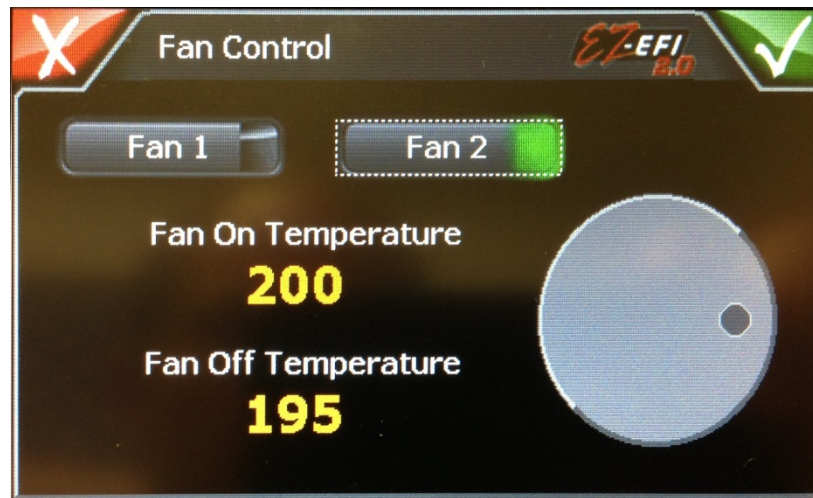

EZ-EFI® has two electric fan outputs with independently adjustable Fan On Temperatures. Select the desired fan and adjust the activation point with the dial on the right hand side of the screen. Rotate the dial clockwise to raise the activation point and counter clockwise to lower the activation point.

Fan Off Temperature is automatically adjusted up or down along with the Fan On Temperature.

When coolant temperature goes above a Fan On Temperature setting, that fan output becomes active and its output wire goes to ground to trigger a fan relay. (Fan 1 uses the blue “FAN 1 RELAY” wire. Fan 2 uses the blue/white “FAN 2 RELAY” wire.) When coolant temperature drops below that fan’s Fan Off Temperature setting, the output is disabled.

AFR Targets

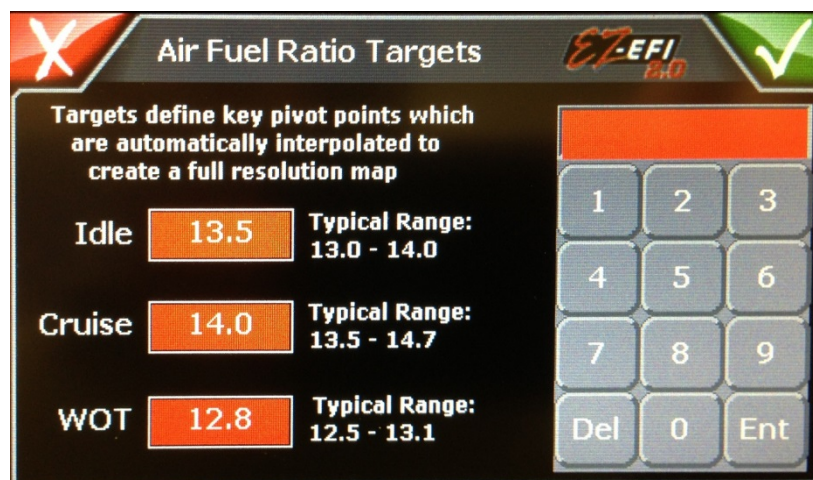

To adjust a setting, touch the Idle, Cruise or WOT textbox. Then enter the desired air/fuel ratio on the keypad using three digits and press Ent. For example, enter “135” for a 13.5 air/fuel ratio. The value

will be sent to the selected textbox. (For E85 applications, you may only need to enter two digits. For example, enter “92” for a 9.2 air/fuel ratio.)

The ECU is constantly working to keep the air/fuel ratio at the current target air/fuel ratio. It is preloaded with typical targets. This is where those targets can be adjusted if desired. Keep in mind that a higher number means a “leaner” air/fuel ratio – less fuel. And a lower number means a “richer” air/fuel ratio – more fuel.

Different operating conditions require different air/fuel ratios. The EZ-EFI[®] system distills these different requirements down to three simple settings. Any of them can be adjusted while the engine is running so different settings can be evaluated.

- **Idle AF** – This is the target when the engine is idling. This can have a pronounced effect on idle quality. It is worth experimenting with to see what your engine likes. If you notice the engine struggle or if RPM dips considerably with load changes at idle (going into gear or turning steering wheel to full lock, for example), it may prefer a richer Idle Air/Fuel target.
- **Cruise AF** – Once the engine is above idle, it will switch to using this target. The engine will spend the vast majority of its time in this area. This setting has the largest effect on your fuel mileage. A leaner target (higher number) will use less fuel.

Because these settings are so simple to adjust, you may consider changing them for special situations. If you are going on a long, relaxed highway run, you can temporarily set this a little bit leaner to maximize fuel economy. Then set it back for normal around-town driving.

- **WOT AF** – Once the engine starts to see more load (LOAD value around 50% or higher), the ECU will start transitioning from using the Cruise Air/Fuel target to using this Wide Open Throttle Air/Fuel target. By the time the engine is under full load, the ECU will be using this target. For intermediate loads, the ECU interpolates between the Cruise and WOT targets. That is, it changes its target from the Cruise setting to the WOT setting in proportion to how much the load has changed from a cruising load to full load.

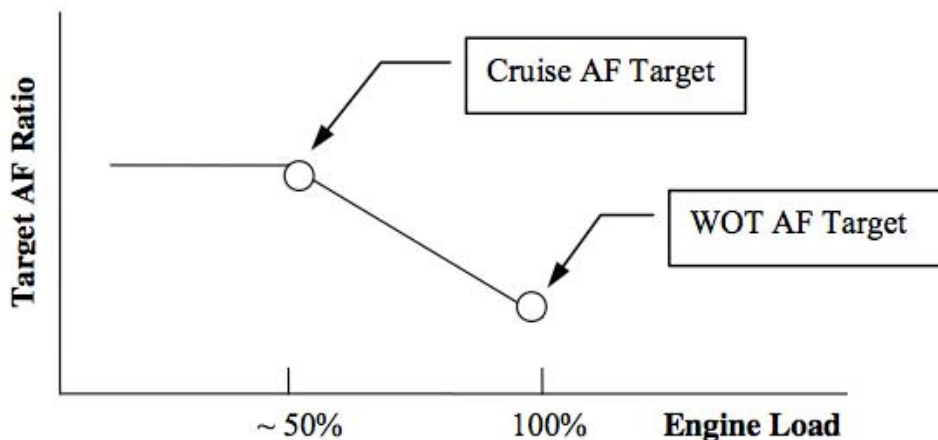

Just as the Cruise Air/Fuel target can be adjusted for fuel economy, the WOT Air/Fuel target can be adjusted for maximum power. It is quite possible that the engine can make more power at an air/fuel ratio that is leaner (higher number) than the preloaded WOT Air/Fuel target. Or it might prefer a richer (lower number) air/fuel ratio. This is less likely, but it all depends on the engine.

Remember that an air/fuel ratio that is too lean (higher number) can cause severe engine damage – especially at WOT! When changing any of the targets to a leaner value, do so in small increments and pay close attention for any signs of detonation, etc.

Additional information for E85

Due to the unique properties of E85, different air/fuel ratios are used with that fuel. E85 air/fuel ratios will be numerically lower. Multiplying a gasoline air/fuel ratio by 0.68 gives a good approximation of the equivalent E85 air/fuel ratio.

$$E85 \text{ Air/Fuel Ratio} = \text{Gasoline Air/Fuel Ratio} \times 0.68$$

For example, if an engine likes to idle at 13.5:1 air/fuel ratio on gasoline, it should like somewhere around a 9.2:1 air/fuel ratio when running on E85.

Enrichment Fuel

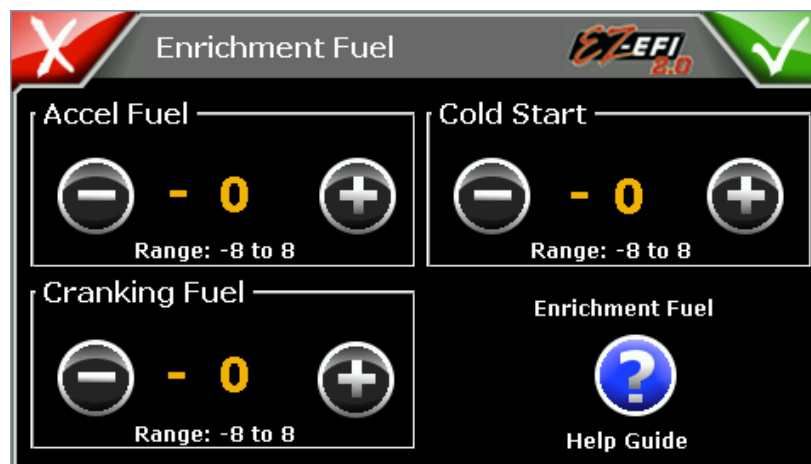

Accel Fuel

When the throttle is opened quickly, the engine needs an extra dose of fuel for smooth operation. In electronic fuel injection, this is commonly referred to as Acceleration Enrichment or Accel Fuel. It is very similar to the accelerator pump on a carburetor. The ECU is preloaded with typical settings for Accel Fuel. This feature allows you to adjust those settings for more or less Accel Fuel by selecting a positive or negative adjustment factor. Selecting zero leaves the ECU to use the preloaded values.

Accel Fuel is a fine-tuning detail to adjust how the engine responds to throttle changes. In general, it should only be adjusted after the ECU has had some time to learn and the engine is running well in steady-state operation - throttle not changing. An exception to this is when the EZ-EFI® system is installed on a port-injected application where fuel is supplied by injectors near each intake port instead of from an EZ-EFI® throttle body. These applications often require less Accel Fuel than a throttle body injection setup. It may help to start out with Accel Fuel set to a negative value for port-injection applications.

Tuning Accel Fuel is a subjective process. You may be able to feel that it's not quite right, but it can sometimes be difficult to tell which way the adjustment needs to go. You may notice it when free-revving the engine in neutral, pulling away from a stop or any time the throttle is opened quickly. The Accel Fuel adjustment applies to all of these situations. The best setting will be the one that works well for all of them. It is not necessarily the setting that makes one specific situation absolutely perfect, as that may require too much compromise in the others.

If there is too much Accel Fuel, when the throttle is opened quickly the engine will sometimes feel as if it is struggling and/or generally not running cleanly. If there is too little Accel Fuel, you may notice a delay from when you open the throttle to when the engine responds.

The Live Data screens may be useful in tuning Accel Fuel. Having somebody watch the live Air/Fuel Ratio (AFR) data (either the numeric display or the bar graph) while you drive and make quick throttle changes may reveal whether the engine is getting too much or too little Accel Fuel. When the throttle is opened quickly, there is a lot going on. AFR will often swing back and forth. You want to watch for an overall trend.

As with most settings, it is good practice to make small, incremental changes and see what happens. If you make large changes to Accel Fuel, it is possible that you can go from too little to too much fuel without realizing you've passed right over the setting that makes the engine the happiest.

The Accel Fuel setting can also be used as a troubleshooting tool for a specific type of installation problem. If the EZ-EFI® system does not have a good ground connection to the battery, it is possible for the various sensor readings to appear jumpy to the ECU. (This jumpiness in the sensor readings may or may not show up on the hand-held's Live Display screens.) This can fool the ECU into repeatedly invoking the Accel Fuel feature, causing extra fuel to be injected. This could lead to an overly rich and unstable idle and prevent the ECU from learning. Once the engine is fully warmed up, if temporarily turning the Accel Fuel setting all the way down makes the engine idle noticeably better (or conversely, if turning it all the way up makes it idle worse), that could indicate a bad ground or some other source of noise. After the test, remember to set the Accel Fuel setting back to its previous value.

SETTING	EFFECT
Positive	More Accel Fuel
Negative	Less Accel Fuel

Cranking Fuel

The ECU is programmed to inject extra fuel during cranking. Most engines should be able to crank and start with the pre-programmed amount of cranking fuel. However, if the engine seems to want

more or less cranking fuel, that adjustment can be made here.

SETTING	EFFECT
Positive	More cranking fuel
Negative	Less cranking fuel

Cold Start

After the engine has started, the ECU’s closed-loop fuel control will begin altering fueling to maintain the target air/fuel ratio. When the engine is cold, the target air/fuel ratio is adjusted to a richer (lower number) value. As the engine warms up, this adjustment is tapered out to zero by the time coolant temperature reaches approximately 125° F.

This setting can be used to make this coolant temperature-based adjustment to target air/fuel ratio more or less aggressive.

SETTING	EFFECT
Positive	Target air/fuel ratio richened more
Negative	Target air/fuel ratio richened less

Start Update

If an update to the hand-held becomes available, this button will be used in the update process. If this button is pressed while the hand-held is in normal use, the hand-held will reset and go back to the home screen.

Nitrous Setup

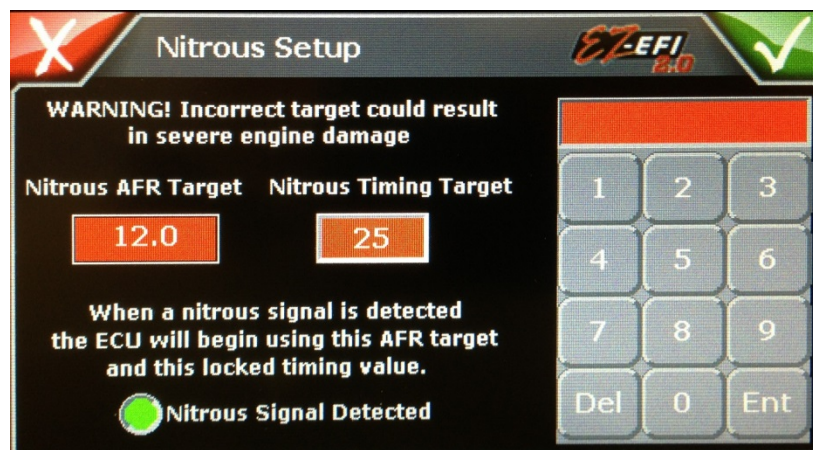

To adjust a setting, touch the Nitrous AFR Target or Nitrous Timing textbox. Then enter the desired numbers on the keypad and press Ent. The value will be sent to the selected textbox. When entering an air/fuel ratio, use three digits. For example, enter “120” for a 12.0 air/fuel ratio. (For E85 applications, you may only need to enter two digits. For example, enter “82” for an 8.2 air/fuel ratio.)

Improper use of nitrous oxide systems can result in costly engine damage. Typical naturally aspirated engine air/fuel ratio targets and timing targets are unsafe for nitrous oxide use. Be sure you understand the proper configuration of nitrous oxide systems before deciding on these settings.

When the ECU has detected the activation of a nitrous oxide system (by having power applied to the gray/red “NITROUS INPUT” wire), it will begin using the special settings found on the Nitrous Setup screen. The closed-loop fuel control will work to maintain the **Nitrous AFR Target**. And if the EZ-EFI[®] is being used to control ignition timing, timing will be locked at the **Nitrous Timing Target** value. (**NOTE:** This is NOT an amount that timing will be retarded. It is the final timing value the engine will see.) Learning will also be disabled while the nitrous oxide system is active.

A “Nitrous Signal Detected” LED is provided on this screen. It can be used to verify that the wiring is properly installed and the ECU has successfully detected the activation signal from the nitrous oxide system.

EZ-EFI[®] is intended to be used with the same type of “wet” nitrous oxide systems commonly used on carbureted engines. “Wet” is the type where the majority of the additional fuel required to support the nitrous oxide is supplied by the nitrous oxide kit itself, as opposed to a “dry” kit where the extra fuel is supplied by the fuel injection system. While the EZ-EFI[®] system may be capable of supplying all of the additional fuel needed to support the nitrous oxide, it is not set up to deliver all of that extra fuel instantly.

An EZ-EFI[®] system used in conjunction with a “wet” kit has a distinct advantage over a carburetor in that EFI uses its closed-loop fuel control to fine tune the final air/fuel ratio. This can help make up for a less than perfectly dialed in nitrous oxide system and offers easier tunability and more consistency. Also, because it is able to alter ignition timing, the EZ-EFI[®] does not need an external timing retard device.

NOTE: If the EZ-EFI[®] is NOT being used to control ignition timing, it CANNOT provide the reduced timing typically used with a nitrous oxide system no matter what is entered on this screen. An external timing retard device will be needed.

Vacuum/Idle Timing

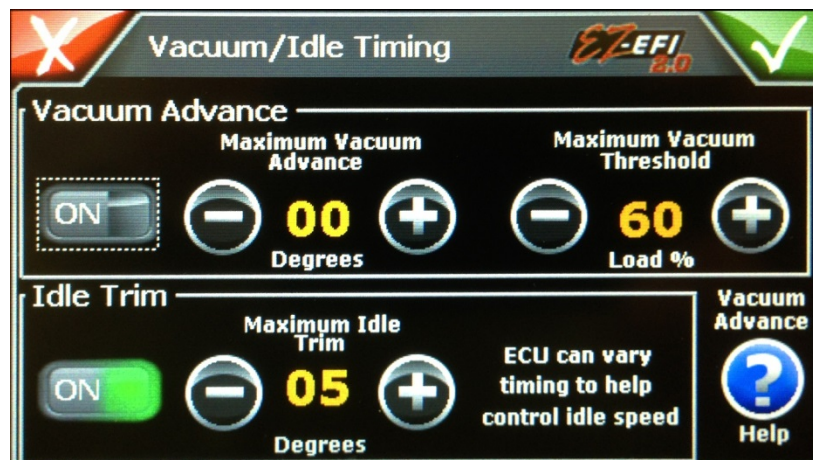

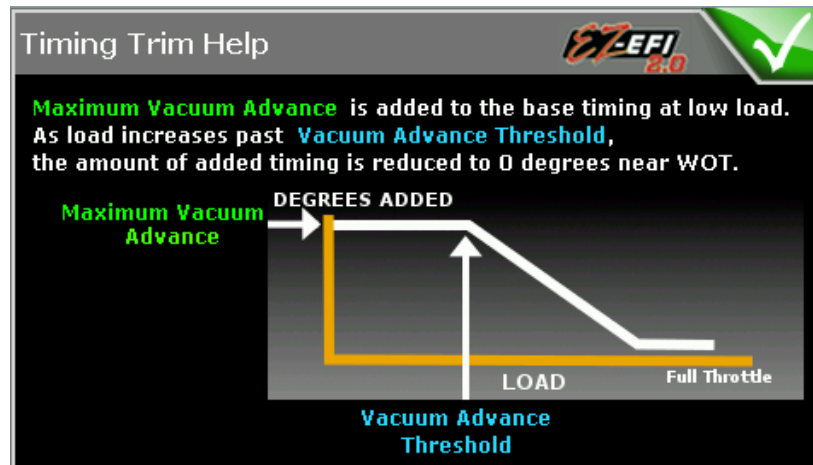

Vacuum Advance

An RPM-based timing curve is set on the Timing Setup screen. It is similar to mechanical advance on a traditional distributor. The Vacuum Advance feature is similar to a vacuum canister on a traditional distributor. It can add ignition advance based on manifold vacuum as read by the MAP sensor. This feature is disabled when the throttle is closed to mimic a traditional ported vacuum arrangement. The amount of advance that is added is greatest just off idle at low load / high manifold vacuum. Once past an adjustable load / vacuum threshold, the extra advance tapers down to zero as the engine approaches 100% load / zero vacuum (full throttle conditions). At that point, timing will be solely based on the RPM-based timing curve – no offsets from Vacuum Advance or Idle Trim.

- **Vacuum Advance ON** – Use this button to enable the Vacuum Advance feature. The button's LED is illuminated green when this feature is enabled.
- **Maximum Vacuum Advance** – The maximum ignition advance added just off idle.
- **Maximum Vacuum Threshold** – The breakpoint above which the added ignition advance will begin tapering out. Load can be monitored live on the Master Dash to help fine tune this setting.

Vacuum Advance Help – This button brings up a help screen. Press the “Confirm” button on the help screen to close it.

Idle Trim

Advancing or retarding ignition timing can make an engine want to speed up or slow down. The EZ-EFI® can use this principal as another way (in addition to the idle motor) to maintain the desired idle speed. Besides giving the ECU additional influence on engine speed, the Idle Trim feature can also react very quickly. For both of these reasons, it is often a nice complement to the idle motor.

- **Idle Trim ON** - Use this button to enable the Idle Trim feature. The button's LED is illuminated green when this feature is enabled.
- **Maximum Idle Trim** – Sets the maximum number of degrees of timing the ECU can add or

subtract to influence idle speed. Some engines may like more, some may like less. 5 degrees is usually a good starting point.

The final ignition timing the engine sees (Total Timing) is composed of three components:

Base Timing	Value from RPM-based timing curve
+ Idle Adv	Timing added or subtracted to influence idle speed (Optional. See Advanced menu.)
+ Vacuum Adv	Timing added based on manifold vacuum (Optional. See Advanced menu.)
= Total Timing	









Timing-related data is only valid when EZ-EFI® is controlling timing.

Live Data

The Live Data section of the hand-held consists of a series of dashes that display live ECU data.

To switch between dashes or to return to the home screen, use the tabs at the bottom of the screen. The text will highlight green to indicate the current screen.

Across the top of every dash are 4 LEDs that indicate the following:

LABEL	DESCRIPTION	OFF	ON
Learning	This indicates that all of the enable conditions for learning are met and that learning is currently enabled. This can be used as feedback to give the driver a feel for when the ECU will or will not learn.	 Learning Gray	 Learning Green
O2 On	The oxygen sensor has been initialized and is providing feedback to the ECU. This must be ON before closed loop fuel control is possible.	 O2 On Gray	 O2 On Green
Nitrous	A nitrous signal has been detected and the user defined nitrous AFR and timing values are in effect.	 Nitrous Gray	 Nitrous Green
Error	The ECU's on-board diagnostics has detected a problem. Refer to the Codes screen in the Diagnostics section of the hand-held to determine what code has been set.	 Error Gray	 Error Red

Dash 1



Dash 2



Dash 3



Master Dash



The Master Dash is designed for easy viewing of all sensors and user accessible values. For example, this dash may be used as an overview to quickly verify that all sensors are reading expected values. Also note that the ignition timing-related values are given along the bottom of the Master Dash – the three component parts as well as the end result.

$$\text{Base Timing} + \text{Idle Adv} + \text{Vacuum Adv} = \text{Total Timing}$$

DATA LABEL	DESCRIPTION
AFR	Air/Fuel Ratio. The reading from the wideband oxygen sensor.
Air Temp	This is the temperature of the air entering the throttle body. It can be displayed in either Fahrenheit or Celsius.
Base Timing	Ignition timing value taken from the main RPM-based timing curve. This makes up one part of the final timing value the engine sees. Base Timing + Idle Adv + Vacuum Adv = Total Timing Timing related data is only valid when EZ-EFI® is controlling timing.
Battery	Battery voltage.
Coolant Temp	This is the temperature of the engine. It can be displayed in either Fahrenheit or Celsius.
FP DC %	Duty cycle of the fuel pump control output. With a returnless-style fuel system, this goes up and down to raise and lower fuel pressure. With a return-style fuel system, this remains at 100% when the fuel pump is running.
Fuel Pressure	Fuel pressure in psi. It is normal for this to rise and fall with varying engine load. Fuel pressure will be lower at idle and in normal driving when there is the more vacuum in the intake manifold. Fuel pressure will rise as the engine approaches wide open throttle. This is true of both return and returnless style fuel systems.
IAC	Idle Air Control. This is the position of the idle motor. At idle, it will move around to maintain the target idle speed. Displayed in “counts”. Higher counts mean the idle motor is open more and allowing more air to bypass the throttle blades. Its range is from 5 to 180. Generally, this will be around 20 idling out of gear with a fully warmed-up engine.

Idle Adv	Degrees of ignition timing added or subtracted by the ECU (if enabled) to influence idle speed. This makes up one part of the final timing value the engine sees. Base Timing + Idle Adv + Vacuum Adv = Total Timing Timing-related data is only valid when EZ-EFI® is controlling timing.
Inj DC %	Injector duty cycle. This is a comparison of how long the injectors are open compared to how much total time is available for them to be open. At higher RPM, there is less time between injector openings. If this reaches 100%, it means the injectors physically cannot flow any more fuel. They are already being held wide open.
Lb/Hr	Current total fuel flow rate into the engine. Given in pounds per hour. This can be used to get a rough approximation of current engine power. Horsepower = Fuel Flow (lbs/hr) x 2
Load	Calculated Load. A comparison of the current manifold pressure vs. the ambient atmospheric pressure. Unlike the reading from the MAP sensor – which is affected by altitude – Load should always be consistent. That is, wide open throttle should always be around 100% regardless of altitude and ambient atmospheric pressure.
MAP	Manifold Absolute Pressure. This is a measure of the load on the engine. It is displayed in kPa (kilopascals). Its range is from 0 kPa (a perfect vacuum) to 105 kPa. With the engine off, this will read around 100 kPa. It will drop down when the engine is started.
O2 Cor %	Current closed-loop correction based on the reading from the wideband oxygen (O2) sensor. This is the percent of fuel being added (displays as a positive number) or removed (displays as a negative number) to achieve the target air/fuel ratio. As the ECU learns more and more, this will tend to get smaller and smaller in steady state driving.
RPM	Engine speed
Target AFR	Target Air/Fuel Ratio. The ratio the ECU is working to maintain. This is determined by engine load and the settings on the AFR Targets screen found on the Advanced menu.
Total Timing	The final timing value the engine sees. A timing light should agree with this value. It is made up of several different values. Base Timing + Idle Adv + Vacuum Adv = Total Timing Timing-related data is only valid when EZ-EFI® is controlling timing.
TPS %	Throttle Position Sensor. This tells you how far the throttle blades are open. The Setup Wizard takes care of calibrating this sensor. It can easily be verified using this display. If you ever notice the TPS reading is not 0 at idle, it should be re-calibrated. This can be done by selecting TPS Calibration from the Advanced menu.
TPS Volts	The current signal voltage being returned from the throttle position sensor to the ECU. It should sweep smoothly from a lower value to a higher value as the throttle is opened. The ECU uses this value to determine TPS %.
Vacuum Adv	Degrees of ignition timing added based on manifold vacuum (if enabled). This makes up one part of the final timing value the engine sees. Base Timing + Idle Adv + Vacuum Adv = Total Timing Timing-related data is only valid when EZ-EFI® is controlling timing.

Diagnostics



Codes

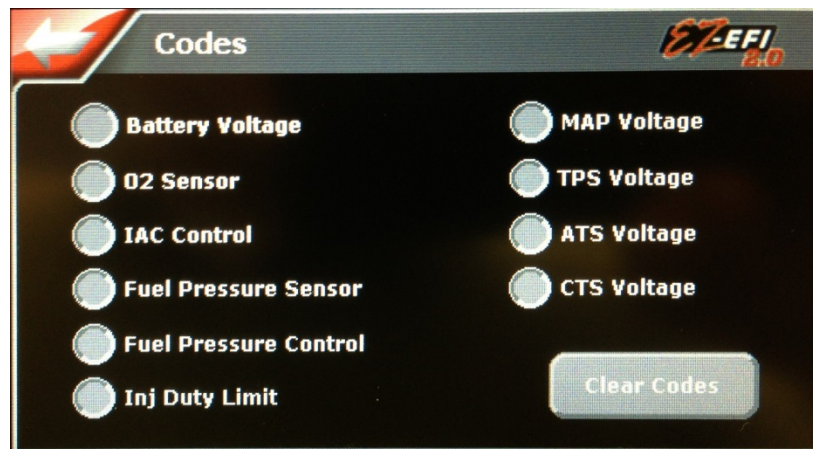

When an error code is set, the blue CRANK/DIAG LED on the ECU will flash rapidly and the “Error” LED displayed on the hand-held’s Live Dashes will turn on. If that happens, use this screen to find out which code has been set. Codes can also be cleared here.

See the On-Board Diagnostics section for more detail on error codes.

Master Dash

Brings up the Master Dash for a quick overview of all available sensor readings. See the Live Data section for more detail.

Tech Support

Provides a list of resources for getting answers to your questions.

System Info

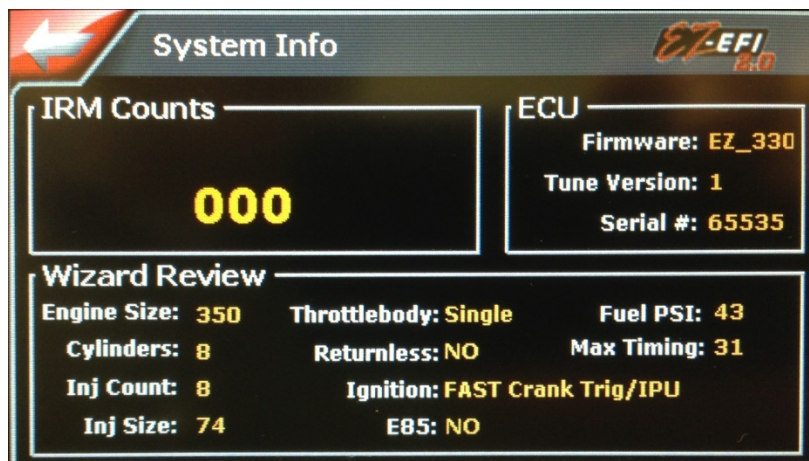

IRM Counts

The Ignition Reliability Monitor number gives a relative indication of the stability of the RPM signal being fed into the ECU. It is a running total of RPM signal errors the ECU has detected. A higher number indicates a noisier RPM signal. This value is stored until it is viewed on this screen. It is reset back to zero upon leaving this screen. It will then begin to count up again if the RPM signal remains noisy.

ECU

This section shows information about the ECU.

Wizard Review

This section shows a summary of the settings entered in the Setup Wizard.

Hand-Held Help

Provides basic how-to's related to using the hand-held.

EZ-EFI[®] SYSTEM FEATURES

Adaptive Learning

In their most basic form, electronic fuel injection (EFI) systems compare various inputs (primarily engine speed and load) to pre-programmed “base fuel tables” stored in the ECU. These fixed base fuel tables tell the ECU how much fuel to inject for a given engine speed and load.

All competent EFI systems use an oxygen sensor to monitor the resulting air/fuel ratio in real time. The better systems use a “wideband” oxygen sensor as used in the EZ-EFI[®] system. The reading from the

wideband oxygen sensor provides very accurate feedback to the ECU so it knows if more or less fuel is needed to achieve the desired air/fuel ratio. Adjusting the fueling based on feedback from an oxygen sensor is commonly referred to as “closed-loop” fuel control.

Closed-loop fuel control is a very powerful feature. It constantly makes fueling adjustments to compensate for different engine conditions. It is at its best when operating with well-tuned base fuel tables. Developing good base fuel tables requires significant time and experience. Closed-loop fuel control can help compensate for less than perfect base fuel tables. However, there are limits to what it can do. It is not a substitute for proper tuning. The more work closed loop has to do, the less efficiently it can keep the actual air/fuel ratio close to the target ratio.

The Adaptive Learning feature of the EZ-EFI[®] system goes beyond normal closed-loop fuel control. Besides using the oxygen sensor feedback to adjust instantaneous fueling, it also uses it to adjust the underlying base fuel table so that over time, it tunes itself. Closed-loop fuel control is happily left with only fine adjustments to make.

The theory of the Adaptive Learning feature is pretty straight forward. Actually implementing it is rather complicated. But all of that work is built into the ECU already. All that is left to do is drive.

Operational Notes:

- The EZ-EFI[®] system has a “pre-squirt” feature that helps starting by injecting a measured amount of fuel into the manifold at key-on. A clicking sound can be heard from the throttle body as the injectors pulse. Once this feature has been activated (key-on, fuel injectors cycled), it will be disabled until the engine has run. This prevents flooding the engine if the ignition is cycled on and off multiple times for whatever reason. Also bear in mind that less “pre-squirt” is used at higher engine temperatures. If the engine is hot enough at key-on, there may be little to no “pre-squirt” clicking heard. For both of these reasons, not hearing the injectors clicking at every key-on is not a sign of a problem.
- A “flood clear” mode is available if the engine does somehow become flooded and does not want to start. If the throttle is held open past 80% while cranking, no fuel will be injected. Continue to hold the throttle open while cranking. Once the extra fuel is purged and the engine starts to fire, release the throttle and allow the engine to settle on its own.
- In normal conditions, it is good practice (but not strictly required) to key-on and listen for the “pre-squirt” feature (injectors clicking in the throttle body) to finish before cranking the engine. This takes about 2 seconds to complete.
- The wideband oxygen sensor has an internal heater to keep it at the correct operating temperature. The warm-up process begins at key-on. If the engine has cooled completely in particularly cold weather, giving the sensor some time to heat up (allowing 10-15 seconds between key-on and cranking) may contribute to smoother starting. The “O2 On” LED displayed on the hand-held’s Live Dashes will indicate when the oxygen sensor has warmed up and begun functioning properly. Until then, there will be no closed loop fuel control.
- Moving the throttle pedal during the first several seconds after key-on (as the fuel pump is being primed) will also cause additional fuel to be injected. This has the effect of adding additional “pre-squirt” fuel. This is typically not required. Care should be taken to avoid accidentally moving the pedal during this time.

- Learning does not begin until the engine is warmed up. Coolant temperature must be above 140° F for learning to begin.
- There are various qualifying conditions that must be satisfied for learning to take place. This prevents the ECU from learning from inappropriate feedback. Many of the learning qualifiers have to do with making sure the engine is in a steady state condition – no rapid changes. The “Learning” LED displayed on the hand-held’s Live Dashes will indicate when learning is enabled. This can be used as feedback to give the driver a feel for when the ECU will or will not learn.
- Learning will take place automatically as the vehicle is driven. No special procedures need to be followed. Just drive normally. However, it is possible to help speed up the learning process on a fresh installation. A good method is to open the throttle a small amount and hold the pedal steady. Let the vehicle accelerate up through the gears. Hold the pedal steady as long as reasonably possible. Slow down and repeat the process several times using larger throttle openings each time. It is NOT required that you go through this process with every throttle position. Don’t do anything to risk your safety or that of other motorists!
- While the ECU is still going through the initial learning process, you may discover driving conditions where the engine is not perfectly happy. This is a natural part of the learning process. Unless the engine is really unhappy, don’t try to avoid those conditions. Instead, gently return there and allow the ECU to learn what the engine wants. It should soon feel much better.
- Changes made to the tune in the ECU – through learning or hand-held adjustments – are held in short-term memory within the ECU until the next key-off. At that time, the changes are saved into long-term memory. The “BATTERY POS” and “BATTERY NEG” wires must be connected directly to the battery. If all power (“12V SWITCHED” and “BATTERY POS”) is cut to the ECU at one time, any new learning will be lost. Once a proper power down sequence has occurred (when the ECU’s POWER LED has gone out approximately 5-10 seconds from key-off), the battery leads can be disconnected, or the ECU can be disconnected from the wiring harness if necessary. Once saved into long-term memory, the tune can remain in an un-powered ECU for years.
- The EZ-EFI[®] system is intended for naturally aspirated engines only – no turbos or superchargers.
- Along with air/fuel ratio and other fueling-related factors, ignition timing also plays a large role in how an engine runs. If the EZ-EFI[®] is not being used to control ignition timing, be sure that the ignition system has an appropriate timing curve. Don’t forget to consider factors like mechanical and vacuum advance. For example, if the engine has a surging idle, it might want a richer (lower number) Idle Air/Fuel target. Or it might want less timing. Or, the cause could be oscillating timing caused by overly light springs in the distributor. Another example would be if idle speed often dips and threatens to stall. The engine may prefer a different Idle Air/Fuel target. It could also be that more base timing or more vacuum advance would give the engine a more robust idle. These examples happen to be about idle, but of course, timing affects all modes of engine operation – tip-in, acceleration, cruise, etc. The point is that air/fuel ratio and timing both need to be optimized for the engine to run at its best.
- If you ever notice the TPS reading is not 0 at idle, make sure that nothing is interfering with the throttle linkage and preventing it from returning to its fully closed position. If the throttle linkage is in its fully closed position (resting on the idle screw) and TPS is still reading above

0, the TPS should be re-calibrated. This can be done by selecting TPS Calibration from the Advanced menu.

- It is normal for fuel pressure to rise and fall with varying engine load. Fuel pressure will be lower at idle and in normal driving when there is more vacuum in the intake manifold. Fuel pressure will rise as the engine approaches wide open throttle. This is true of both return and returnless style fuel systems.
- With a return style fuel system, the fuel pump will run for several seconds after key-on to prime the fuel system. With a returnless fuel system, the ECU will only run the pump as much as it needs to in order to reach and maintain the target fuel pressure. The pump may run for different lengths of time at any given key-on. It may not run at all in some cases. All of this is normal with a returnless fuel system.
- There is some adjustability built into the linkage between the throttle shafts. It should be set up as close to a one-to-one arrangement as reasonably possible – as opposed to a progressive setup. Having all four blades open at the same time gives the best fuel distribution.

EZ-Test Indicator Lights

The EZ-EFI[®] ECU features a series of LEDs that can be used to monitor its operation and to signal if the on-board diagnostics has detected a problem.

LABEL	COLOR	DESCRIPTION	DURING NORMAL RUNNING
CRANK/DIAG	Blue	Indicates that the ECU is receiving a crank signal and is reading RPM. If the on-board diagnostics has detected a problem, this LED will flash rapidly. If that happens, refer to the Codes screen in the Diagnostics section of the hand-held to determine what code has been set.	Solid
POWER	Green	Indicates that the ECU is powered on. This LED should remain on whenever the vehicle is keyed-on. After the vehicle is keyed-off, this LED will remain lit for several seconds and then fade out. This is normal and indicates that the ECU is going through its proper shut down procedure. If this LED goes out immediately at key-off, there is a problem. The most likely cause is that power to the "BATTERY POS" wire is being lost at the same time as the 12V switched source. If the ECU does not shut down properly, new learning, new user adjustments and other internal information will not be retained by the ECU.	Solid
SW IGN	Green	Indicates that the ECU is receiving a 12V switched input. This LED should remain on whenever the vehicle is keyed-on - including during cranking. Losing the 12V switched input during cranking can lead to a host of starting and running issues. If this is happening, a different 12V switched source must be found. This LED should go out immediately at key-off.	Solid
INJ A	Orange	Indicates when each injector output is active. These will start to appear more solid as RPM increases.	Flashing
INJ B			
INJ C			
INJ D			
POINTS	Red	Indicates that the ECU's ignition output is active. This LED will still be on even if the EZ-EFI [®] is not set up to control timing.	Solid

On-Board Diagnostics

The EZ-EFI[®] system includes a robust self-diagnostics feature. The ECU constantly monitors various inputs and outputs for any deviations from normal operation. If any are detected, the blue CRANK/DIAG LED on the ECU flashes rapidly as a warning that there is a problem. (That LED comes on solid when the ECU detects an RPM input. It will be lit solid while the engine is running normally). Also, the “Error” LED displayed on the hand-held’s Live Dashes acts like a Check Engine Light. It will signal if an error code has been set. The hand-held can be used to read any error codes that have been set.

Once an error code is set, it is saved in the ECU until the ECU is reset by keying-off and allowing the ECU to complete its shutdown procedure. The shutdown procedure is complete when both green LEDs on the ECU turn off. This takes approximately 5-10 seconds. Error codes can also be cleared with the hand-held at any time.

The following error codes are possible:

ERROR CODE	TRIGGERING EVENTS
ATS Voltage	Air Temperature Sensor signal voltage too high or too low
Battery Voltage	Battery voltage below 7V or above 19V for 10 seconds
CTS Voltage	Coolant Temperature Sensor signal voltage too high or too low
Fuel Pressure Control	<p><u>In return fuel system mode:</u> Higher than expected (greater than 75 psi) fuel pressure detected. The fuel pump is disabled in the event that a return-style fuel system (which runs the pump wide open) was selected in the hand-held when there is no mechanical fuel pressure regulator and return line actually installed in the vehicle. This prevents the pump from straining against a closed system and building excess pressure.</p> <p>The code can be cleared but the pump will remain disabled until the ECU has been power cycled, or until the Fuel Delivery type has been changed to “Returnless” on the Fuel System screen.</p> <p><u>In returnless fuel system mode:</u> Lower than expected fuel pressure detected. The fuel pump control output has maxed out at 100% while fuel pressure has remained below the fuel pressure target. This usually indicates a physical problem with the fuel system – leak, clogged filter, etc. The fuel pump is not disabled.</p>
Fuel Pressure Sensor	Fuel pressure sensor signal voltage too high or too low
IAC Control	Idle Air Control motor malfunctioning
Inj Duty Limit	Injector duty cycle over 100% (an indication that injectors cannot supply enough fuel. The ECU has determined that the injectors need to be open longer than the time available.)
MAP Voltage	Manifold Absolute Pressure sensor signal voltage too high or too low

O2 Sensor	Wideband oxygen sensor unable to initialize, disconnected or malfunctioning
TPS Voltage	Throttle Position Sensor signal voltage too high or too low

Troubleshooting O2, IAC, Fuel Pressure Sensor, MAP, TPS, ATS and CTS Faults

1. Verify that the offending sensor is installed and connected to the wiring harness.
2. With the ECU keyed-on, use the hand-held to look for a valid reading from the offending sensor. For IAC, watch for a changing reading with the engine idling.
3. Verify that the wiring harness itself is not damaged. Visually inspect the wiring harness from the sensor back to the ECU looking for cut, pinched, abraded or melted sections. Using a multi-meter, check continuity from the sensor connector back to the ECU. Also make sure no pins in a particular sensor connector are shorted to each other.
4. For the wideband oxygen sensor, also check to see if the sensor tip gets hot (check carefully!) with the ECU keyed-on.
5. If no other problems can be found, try replacing the sensor.

Troubleshooting Battery Voltage Fault

1. Verify that the battery and charging system are in good condition.
2. Verify solid, corrosion-free connections at the battery and switched ignition source.
3. Verify that the wiring harness itself is not damaged. Visually inspect the wiring harness looking for cut, pinched, abraded or melted sections.

Troubleshooting Fuel Pressure Control Fault (in Return Fuel System Mode)

1. Verify that a mechanical fuel pressure regulator and return line are installed.
2. Verify that the regulator is not set above 75 psi.
3. Verify that the return line is not restricted. If using an existing factory fuel tank fitting to feed fuel back into the tank, make sure it does not have a check valve preventing flow into the tank.
4. Check for a Fuel Pressure Sensor fault. If there is an issue with the sensor or its wiring that is causing the fuel pressure reading to be artificially maxed out at 99 psi, that will disable the pump. (**NOTE:** A Fuel Pressure Sensor fault resulting in a false 0 psi reading or caused by the fuel pressure sensor being disconnected from the harness will not disable the pump.)

Troubleshooting Fuel Pressure Control Fault (in Returnless Fuel System Mode)

1. Verify that the fuel pump relay harness is connected to the main harness and to the pump.
2. Verify that the fuel pump is solidly wired to ground.
3. Verify that the fuel pressure sensor is installed and connected to the main harness.
4. To test items 1-3 plus the pump and the relay, BRIEFLY connect the green "FUEL PUMP RELAY" wire in the 1-way Weather-Pack connector to ground. This should cause the pump to run – which can sometimes be heard. A change in the fuel pressure reading in the hand-held's Live Dashes is further evidence that the pump ran.
5. Verify that the fuel pump fuse in the main harness is installed and in good condition.

6. Verify all fuel line connections are tight and leak-free – including connections in the tank.
7. Verify that there is plenty of fuel in the tank.
8. Verify that the fuel filters (including the sock-type filter in the tank) are not clogged.
9. Verify that the fuel tank is vented.
10. Verify that the vehicle is plumbed for a returnless-style fuel system – no mechanical fuel pressure regulator and return line installed. If those are installed, change the Fuel Delivery type to “Return” on the Fuel System Screen. The Fuel System screen can be accessed within the Setup Wizard or from the Advanced menu.

Troubleshooting Inj DC Limit Fault

1. Verify that the fuel system and fuel injectors are rated to support the engine’s power level.
2. Verify there is plenty of fuel in the tank.
3. Verify fuel pressure during a wide open throttle run. Have an assistant monitor fuel pressure while you drive. Fuel pressure at wide open throttle should equal, or very nearly equal, the static pressure. For a return style fuel system, that is the pressure the mechanical fuel pressure regulator was set to with pump on and engine off. Or it is the target fuel pressure selected for a returnless fuel system. If it is significantly lower, the fuel system is not keeping up with the engine’s fuel demand.
4. Check for any debris in the fuel pump/fuel filters.
5. Verify that the fuel tank is vented.

NOTE: If the fuel system or injectors are not supplying enough fuel for the engine, it is most likely to only be a problem at high RPM and high load. Unless there is a major, fundamental failure in the fuel system, an Inj DC Limit fault should not mean it is unsafe to run the engine. Just be careful to avoid high RPM/high load until the issue has been resolved.

When an error code is set, learning will be disabled until it is cleared. The two exceptions to this are the IAC and Inj DC Limit faults. An IAC fault does not disable learning because a failed IAC does not affect the fueling calculations. An Inj DC Limit fault does not permanently disable learning. Instead it only temporarily disables learning while injector duty cycle is above 100%. Once injector duty cycle drops back below 100%, learning can resume.

Engine Protection/Limp Mode

Besides being a powerful troubleshooting tool, the on-board diagnostics also protect the engine. Contingency plans are built into the ECU so that if a sensor fails, protective action can be taken. If, for example, there is a problem with the coolant temperature sensor, the ECU’s electric fan control outputs will be switched on to guard against over heating.

If the ECU detects a problem with a sensor, it will switch to using pre-programmed default values in the affected part of the fueling calculations. This puts the ECU into “limp” mode. If there is a problem with any of the sensors, the engine will still have a chance to run so the vehicle will not be stranded. (The exception is the RPM signal. Without an engine speed input, the engine will not run.) Depending

on circumstances and which sensor has failed, the change in the engine's behavior may be very obvious or it may be hardly noticeable. If you notice any change in how the engine is running, it's a good idea to check the blue CRANK/DIAG LED on the ECU (it will flash rapidly) or the "Error" LED displayed on the hand-held's Live Dashes. These both signal that an error code has been set. You can also go directly to the Codes section of the hand-held. Even if the engine is running well, an error code will prevent further learning. Also, the problem that caused the error code to be set may have a larger effect later under different conditions.

Keep in mind that error codes are cleared when the ECU is reset (key-off for approximately 5-10 seconds). So if you suspect a problem, it is best to check for error codes before powering down the ECU. A persistent problem (sensor disconnected, for example) will set an error code when the ECU is keyed-on. But an intermittent problem may only be detected while the engine is running.

Load-Indexed Speed Density

The EZ-EFI[®] system operates with a fueling strategy known as Load-Indexed Speed Density. Just like a traditional Speed Density system, it uses manifold pressure, air temperature and engine speed, along with other considerations to calculate the proper amount of fuel to inject. At wide open throttle, manifold pressure is equal to the ambient atmospheric pressure. If you drive at high altitude, the ECU will see a lower manifold pressure at wide open throttle (since atmospheric pressure is lower) than it would at sea level. A traditional Speed Density strategy uses manifold pressure to locate values in various lookup tables. So the engine will operate differently at high altitude than it would at sea level. The EZ-EFI[®] system's Load-Indexed Speed Density avoids this inconsistency by using a calculated "Load" for table lookups instead of raw manifold pressure. This "Load" is a comparison of the current manifold pressure vs. the ambient atmospheric pressure. This means that at any altitude, full throttle (or any other throttle position) operates on the same parts of the lookup tables. At full throttle at high altitude, the ECU will still see manifold pressure that is lower than it would at sea level. But because that lower manifold pressure is equal to the ambient atmospheric pressure, it is still considered 100% load.

This all happens behind the scenes and requires no special attention from the driver.

Complementary Parts-

PART#	DESCRIPTION
30401-FK	In-Tank Fuel Kit
30402-FK	In-Line Fuel Kit
30420	EZ-EFI 2.0 Matching Air Cleaner (14 x 12 x 3)
3012001	EZ-EFI 2.0 Matching SBC Valve Cover
3011011	EZ-EFI 2.0 Matching BBC Valve Cover
3035001	EZ-EFI 2.0 Matching SBF Valve Cover
304147	EZ-EFI Cable Mount Kit
TCI 370816	700R4 TV Cable Corrector and Cable Mount Kit
TCI 376715	700R4 TV Cable Corrector Bracket
301270	SBC Crank Trigger for 7.00" Balancer
301280	SBC Crank Trigger for 8.00" Balancer
301180	BBC Crank Trigger for 8.00" Balancer
303565	SBF Crank Trigger for 6.562" Balancer
305005	SBC/BBC Dual-Sync Distributor
305017	BBC Tall Deck Dual-Sync Distributor
305007	SBF Dual-Sync Distributor
305009	Ford Windsor Dual-Sync Distributor
305010	FE Ford Dual-Sync Distributor
305015	Ford 351C-460 Dual-Sync Distributor
305011	Small Block Chrysler Dual-Sync Distributor
305012	B Engine Chrysler (383-400)Dual-Sync Distributor
305013	RB Engine Chrysler (426-440) Dual-Sync Distributor
305016	Pontiac Dual-Sync Distributor
305018	Oldsmobile Dual-Sync Distributor

REVISIONS

LTR	DESCRIPTION	DATE
A	INITIAL RELEASE	05/13/13

ECU

1	INJ A	BLACK
2	INJ B	BROWN
3	INJ C	YELLOW
4	INJ D	GREEN
5	IAC A-HI	RED
6	DISCRETE RPM INPUT	WHITE
7	A/C INPUT	GRAY
8	CONFIG INPUT	GRAY/BLACK
9	FUEL PUMP	LIGHT GREEN
10	FAN 1	BLUE
11	IAC A-LO	BLUE
12	IAC B-HI	YELLOW
13	IAC B-LO	BLACK
14	PC TXD	GREEN
15	PC RXD	GRAY
16	POINTS OUT	BROWN
17	CONFIG OUTPUT	BLUE/YELLOW
18	FAN 2	BLUE/WHITE
19	DIGITAL GND	BLACK
20	INDUCTIVE RPM INPUT	RED
21	O2 Vs / R+	BLACK
22	O2 Rcal / P-	GREEN
23	O2 Ip / P+	RED
24	O2 Vs/Ip / S+	YELLOW
25	O2 H- / H-	WHITE
26	MAP	WHITE/VIOLET
27	CTS	WHITE
28	FUEL PRESSURE	WHITE/BLACK
29	TPS	WHITE/RED
30	ATS	WHITE/PINK
31	BATTERY	RED
32	12V SWITCHED	PINK
33	NITROUS INPUT	GRAY/RED
34	CAN_L	GREEN
35	CAN_H	YELLOW
36	5V REFERENCE	RED/WHITE
37	ANALOG GND	BLACK/PINK
38	DIGITAL GND	BLACK/WHITE
39	POWER GND	BLACK
40	POWER GND	BLACK

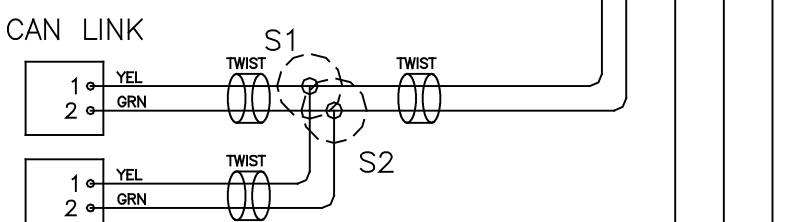

SX
DENOTES SPLICE

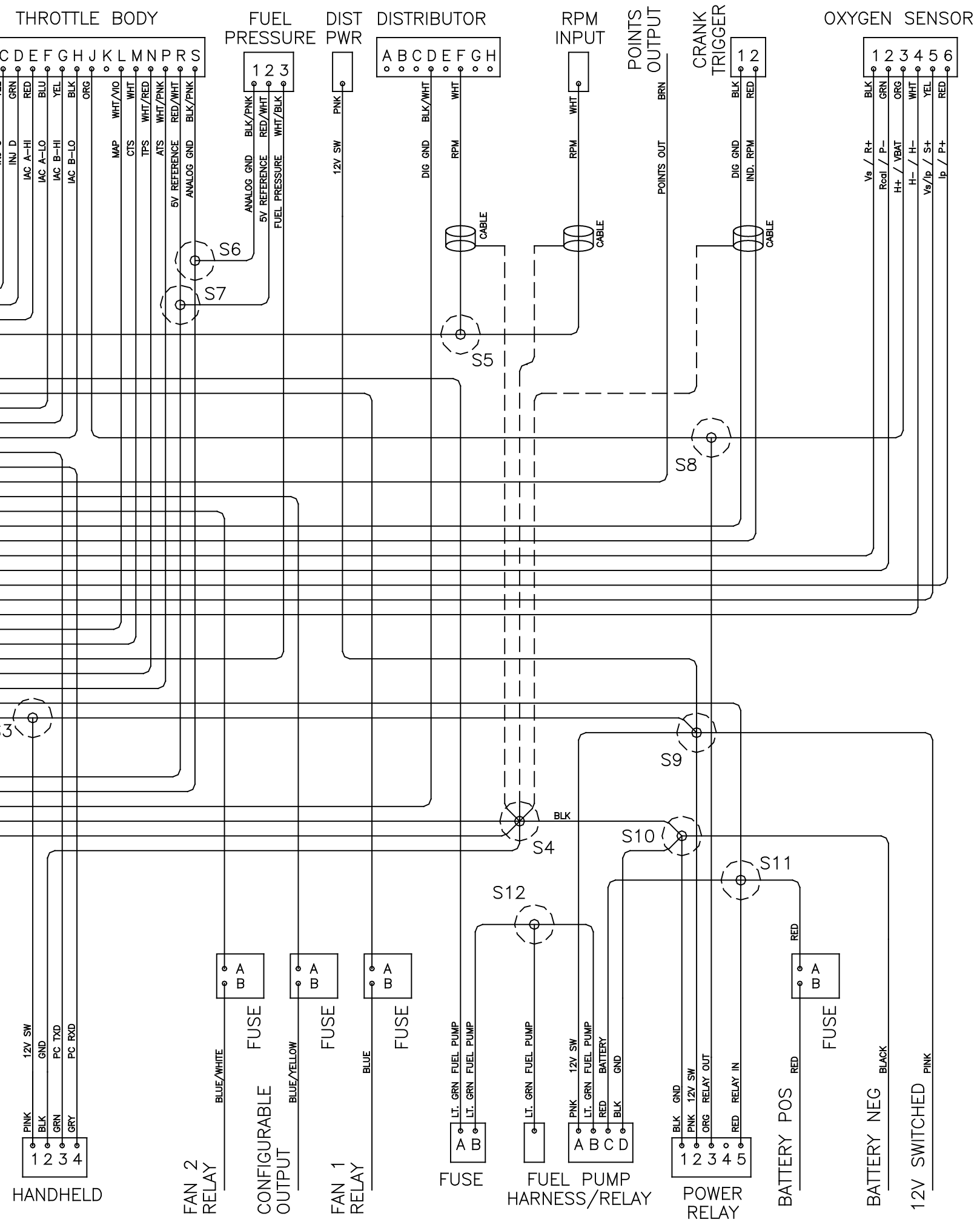

PN 30308
EZ-EFI 2.0 MAIN HARNESS

RELAY

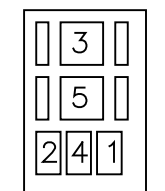

WIRE SIDE VIEW

www.fuelatpark.com
FAST
FUEL AIR SPARK TECHNOLOGY

EZ-EFI 2.0 MAIN WIRING SCHEMATIC

REV: A DRAWING NO: 30308 SCHEMATIC

INSTRUCTION PN: FAST4-201 SHEET NO: 1 OF 1

REVISIONS		
LTR	DESCRIPTION	DATE
A	INITIAL RELEASE	06/12/13

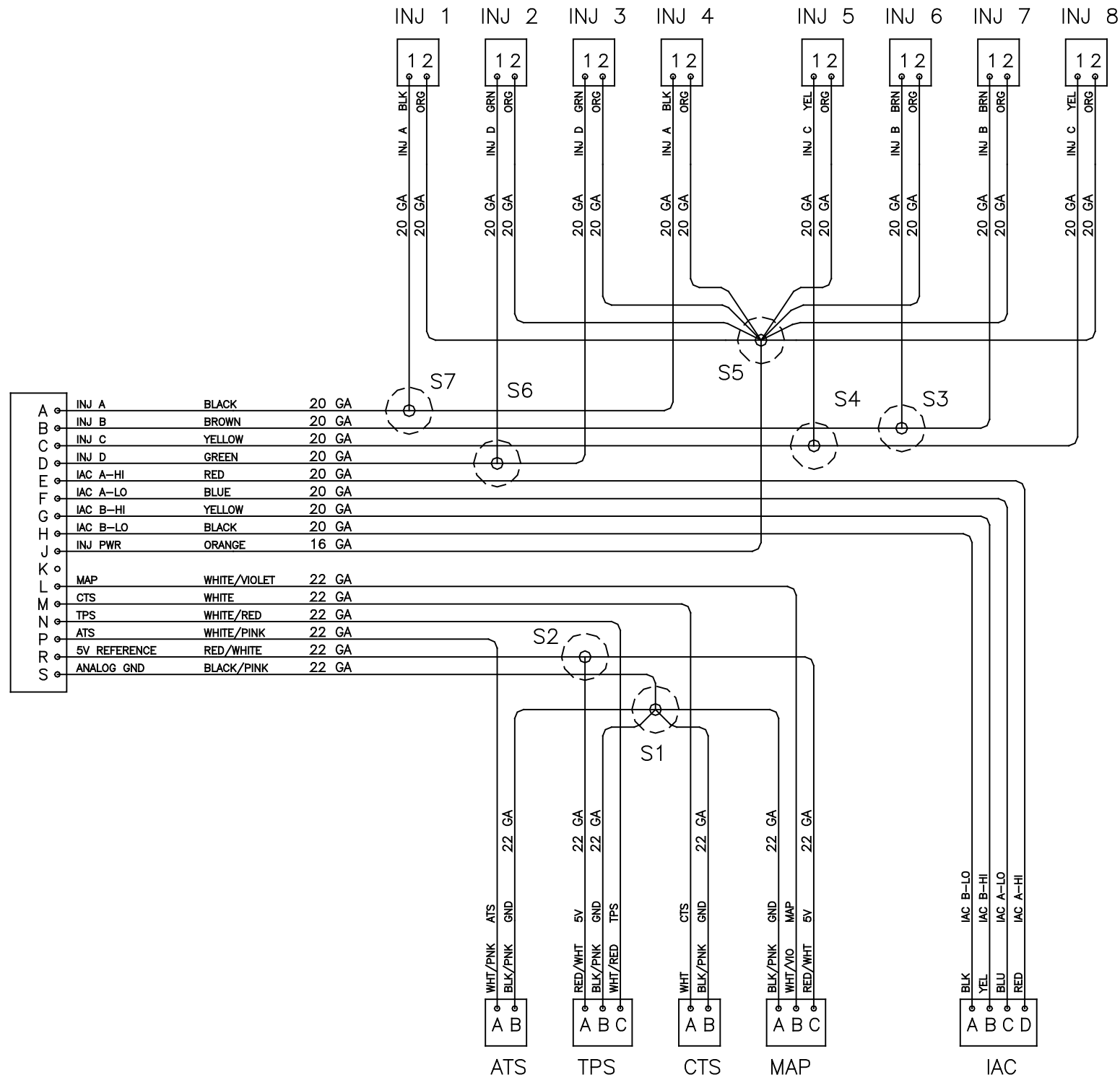

PN 30309
EZ-EFI 2.0 THROTTLE BODY HARNESS



DENOTES SPLICE

www.fuelatspark.com		EZ-EFI 2.0 THROTTLE BODY HARNESS WIRING SCHEMATIC	
FAST FUEL AIR SPARK TECHNOLOGY		DRAWN BY : RLW	DATE : 06/12/13
REV : A	DRAWING NO : 30309 SCHEMATIC		
INSTRUCTION PN: FAST4-202		SHEET NO : 1 OF 1	