

2016



**ENGINEERED
FOR ADVENTURE**





Is it the intensity of accelerating down a fresh stretch of asphalt? The surge of adrenaline after catching air on an open trail? Maybe it's the unexplainable sense of freedom you feel hitting the highway for that next two-wheel adventure? At Dowco® Powersports, we're driven by your hardcore enthusiasm for the ride. Our innovative riding accessories are engineered for adventure, utilizing the best materials and craftsmanship known to the motorcycling industry. We have 90 years of American design and engineering prowess — the wisdom of several generations of riders who understand the thrill of a backwoods trail or an open road. We gear you up. We pack you out. And we'll be there mile after exhilarating mile.

WHAT MOVES YOU?





Rally Pack



KEEPING YOU ON THE MOVE

Our innovative riding accessories are engineered for adventure, utilizing the best materials and craftsmanship known to the motorcycle industry. We have 90 years of American design and engineering prowess – the wisdom of several generations of riders who understand the thrill of a backwoods trail and the freedom of the open road. We gear you up. We pack you out. And we'll be there mile after exhilarating mile.

You need to spend your time & energy enjoying your sport, not concerned about the products that you use. That is why our warranties are so simple. Should any defect in material or workmanship be found within the specified time periods, we will repair or replace your product. Dowco provides a limited warranty to the original purchaser to be free from defects in material and workmanship. See the adjoining page for details.

Fastrax



Rally-Pack





LIMITED LIFETIME WARRANTY

- ▷ Guardian WeatherAll Plus Motorcycle Cover
- ▷ Guardian Scooter Cover
- ▷ Guardian EZ-Zip Motorcycle Covers
- ▷ Fastrax Backroads Series
- ▷ All Willie & Max bags



TWO-YEAR LIMITED WARRANTY

- ▷ All Iron Rider luggage
- ▷ Fastrax Xtreme Series - Tank Bag
- ▷ Fastrax Value Series - Tank Bag
- ▷ Guardian UltraLite Motorcycle Cover
- ▷ Guardian ATV Covers
- ▷ Guardian UTV Covers
- ▷ Guardian Snowmobile Covers
- ▷ Rally Pack Luggage System



THREE-YEAR LIMITED WARRANTY

- ▷ Guardian UltraLite Plus Motorcycle Cover
- ▷ Guardian Hi-Viz



FIVE-YEAR LIMITED WARRANTY

- ▷ Guardian WeatherAll Motorcycle Cover





It's a sad fact of life. Sometimes you have to get out of the saddle. When you do, protect your ride from the elements in any climate with a Guardian® cover by Dowco. Designed in Wisconsin, USA using premium fabrics, Guardian motorcycle covers shelter your baby from the storm, for the night, or the entire off-season. A motorcycle is no small investment. Take care of the machine that fosters your passion for riding with a cover that's guaranteed to last.

WEATHERALL® PLUS

IMPROVED FOR
2016

INDUSTRY-LEADING LIFETIME WARRANTY



GUARDIAN COVER ALARM

ITEM #	COLOR	SIZE
26038-00	Black	Universal

GUARDIAN WEATHERALL PLUS MOTORCYCLE COVER

ITEM #	COLOR	SIZE
50002-02	Black	Medium
50003-02	Black	Large
50004-02	Black	XL
50005-02	Black	XXL
50006-02	Black	XXXL
50124-00	Black	Sport
51223-00	Black	Small / Medium cruisers
51614-00	Black	Adventure touring
05142	Black	Scooter

- ▷ Dowco's top-of-the-line and most popular cover
- ▷ Made with ClimaShield® Plus
 - ▷ Waterproof & breathable
 - ▷ 300D polyester fabric with a durable water-repellant top coat
 - ▷ Polyurethane & mildew-resistant undercoating
 - ▷ Provides maximum protection against rain, mildew, and fading caused by the sun's UV rays
- ▷ All seams are taped to ensure maximum waterproofness
- ▷ Soft cotton is used to protect the windshield
- ▷ Heat shield used in places that may encounter warm pipes
- ▷ Reflective Moisture-Guard® vent system prevents moisture build-up under the cover
- ▷ Elastic shock cord is sewn into the bottom of the cover to provide a snug fit
- ▷ Polyester webbing belly strap is sewn in to prevent the cover from coming off in high winds
- ▷ Sewn-in hole for wheel lock to be passed through for added security
- ▷ Sewn-in alarm pockets allow for the use of the Dowco Guardian Cover Alarm (sold separately; see page 9)
- ▷ Includes convenient compression storage bag for easy transporting
- ▷ Limited lifetime warranty



Sport



Cruiser



Adventure Touring



NEW FOR
2016
Scooter

WEATHERALL PLUS

TOP
SELLER

OUTSIDE, EVERYDAY IN ALL CLIMATES



Spyder



Trike

GUARDIAN

COVERS

GUARDIAN WEATHERALL PLUS SPYDER COVER

ITEM #	COLOR	SIZE
04583	Black	All Spyderys

GUARDIAN WEATHERALL PLUS TRIKE COVER

ITEM #	COLOR	SIZE
50084-00	Black	Fits trikes up to 105" x 61.5"
51060-00	Black	Fits trikes up to 119" x 61.5"

- ▷ Dowco's top-of-the-line and most popular cover
- ▷ Made with ClimaShield Plus
 - ▷ Waterproof & breathable
 - ▷ 300D polyester fabric with a durable water-repellant top coat
 - ▷ Polyurethane & mildew-resistant undercoating
 - ▷ Provides maximum protection against rain, mildew, and fading caused by the sun's UV rays
- ▷ All seams are taped to ensure maximum waterproofness
- ▷ Soft cotton is used to protect the windshield
- ▷ Heat shield used in places that may encounter warm pipes
- ▷ Reflective Moisture-Guard vent system prevents moisture build-up under the cover
- ▷ Elastic shock cord is sewn into the bottom of the cover to provide a snug fit
- ▷ Polyester webbing belly strap is sewn in to prevent the cover from coming off in high winds
- ▷ Sewn-in hole for wheel lock to be passed through for added security
- ▷ Sewn-in alarm pockets allow for the use of the Dowco Guardian Cover Alarm (sold separately; see page 9)
- ▷ Includes convenient drawstring pack for easy transporting
- ▷ Limited lifetime warranty



GUARDIAN COVER ALARM

ITEM #	COLOR	SIZE
26038-00	Black	Universal

- ▷ Add extra security to any Guardian WeatherAll Plus cover or ATV cover by dropping into any one of the sewn-in pockets and tethering to bike (excludes Guardian Weather All Plus EZ-Zip covers)
- ▷ Emits 130dB warning when cover is tampered with
- ▷ Battery-powered (9-volt)
- ▷ No special wiring required
- ▷ Installs in minutes without tools
- ▷ Two-year limited warranty



GUARDIAN WEATHERALL PLUS EZ-ZIP® MOTORCYCLE COVER

ITEM #	COLOR	SIZE
50020-00	Black	Cruisers, small touring
50021-00	Black	Touring
50022-00	Black	Large touring

IMPROVED FOR
2016

- ▷ Waterproof, breathable, and easier to install versus traditional covers
- ▷ Rear zipper makes installation on larger bikes fast, easy, and convenient
- ▷ Zipper location & design protects surfaces from scratches
- ▷ Access to saddlebags or other storage areas without removing cover
- ▷ Made with ClimaShield Plus
 - ▷ Waterproof & breathable
 - ▷ 300D polyester fabric with a durable water repellant top coat
 - ▷ Polyurethane & mildew-resistant undercoating
 - ▷ Provides maximum protection against rain, mildew, and fading caused by the sun's UV rays
- ▷ All seams are taped to ensure maximum waterproofness
- ▷ Soft cotton is used to protect the windshield
- ▷ Integrated rear antenna pass-through included
- ▷ Heat shield used in places that may encounter warm pipes
- ▷ Moisture-Guard vent system prevents moisture build-up under the cover
- ▷ Elastic shock cord is sewn into the bottom of the cover to provide a snug fit
- ▷ Polyester webbing belly strap sewn in to prevent the cover from coming off in wind
- ▷ Sewn-in grommets allow use of a cable lock
- ▷ Includes compression storage bag
- ▷ Limited lifetime warranty

WEATHERALL®

OUTSIDE USAGE IN NORTHERN CLIMATES



GUARDIAN

COVERS

GUARDIAN WEATHERALL MOTORCYCLE COVER

ITEM #	COLOR	SIZE
50002-03	Grey	Medium
50003-03	Grey	Large
50004-03	Grey	XL
50005-03	Grey	XXL
50006-03	Grey	XXXL
50007-00	Grey	Sport

- ▶ Made with ClimaShield®:
 - ▶ Heavy duty, waterproof, & breathable
 - ▶ 300D coated polyester fabric with a durable water-repellant top coat
 - ▶ Polyurethane & mildew-resistant undercoating
 - ▶ Provides excellent protection against rain, mildew, and fading caused by the sun's UV rays
- ▶ All seams are taped to ensure maximum waterproofness
- ▶ Soft cotton is used to protect the windshield
- ▶ Heat shield used in places that may encounter warm pipes
- ▶ Moisture-Guard vent system prevents moisture build-up under the cover
- ▶ Elastic shock cord is sewn into the bottom of the cover to provide a snug fit
- ▶ Polyester webbing belly strap is sewn in to prevent the cover from coming off in high winds
- ▶ Includes convenient compression storage bag for easy transporting
- ▶ Five-year limited warranty

SCOOTER

FOR EVERYDAY INDOOR & OUTDOOR USAGE



S & M



L & XL

GUARDIAN SCOOTER COVER

ITEM #	COLOR	SIZE
50009-00	Grey	S - 50CC & under
50010-00	Grey	M - 80CC to 250CC w/ mirrors
50011-00	Grey	L - 80CC to 250CC w/ full windshield
51224-00	Grey	XL - Up to 650CC

- ▷ Designed specifically to fit a scooter's unique design
- ▷ Made with ClimaShield:
 - ▷ Heavy duty, waterproof, & breathable
 - ▷ 300D coated polyester fabric with a durable water-repellant top coat
 - ▷ Polyurethane & mildew-resistant undercoating
 - ▷ Provides excellent protection against rain, mildew, and fading caused by the sun's UV rays
- ▷ Heat shield used in places that may encounter hot pipes
- ▷ Includes convenient compression storage bag for easy transporting
- ▷ Elastic shock cord is sewn into the bottom of the cover to provide a snug fit
- ▷ Plastic grommets allow the use of a cable to lock the cover to the bike
- ▷ Limited lifetime warranty

ULTRALITE® PLUS

TOP
SELLER

OUTDOOR USAGE WHEN TRAVELING, SHORT OR LONG-TERM PARKED IN A GARAGE



M, L, XL



Adventure Touring

GUARDIAN

COVERS

GUARDIAN ULTRALITE PLUS MOTORCYCLE COVER

ITEM #	COLOR	SIZE
26035-00	Grey	Medium
26036-00	Grey	Large
26037-00	Grey	XL
26045-00	Grey	Adventure touring

- ▷ Designed for travel when space is a concern
- ▷ Compression storage bag included for quick & easy storage
- ▷ When cover is in use, this exterior storage compartment can be used for gloves, sunglasses, or other items.
- ▷ Cover is made with a 75D rip-stop polyester with polyurethane and mildew-resistant undercoating for enhanced water & mildew resistance. It's not waterproof, but very close
- ▷ Soft cotton protects the windshield
- ▷ Elastic shock cord is sewn into the bottom of the cover to provide a snug fit
- ▷ Polyester webbing belly strap is sewn in to prevent the cover from coming off in high winds
- ▷ Plastic grommets allow the use of a cable to lock the cover to the bike
- ▷ Three-year limited warranty

ULTRALITE®

OCCASIONAL OUTDOOR USAGE, SHORT OR LONG-TERM INDOOR STORAGE



Blue



Grey

GUARDIAN ULTRALITE MOTORCYCLE COVER - BLUE

ITEM #	COLOR	SIZE
26010-01	Blue	Medium
26034-01	Blue	Large
26011-01	Blue	XL

GUARDIAN ULTRALITE MOTORCYCLE COVER - GREY

ITEM #	COLOR	SIZE
26010-00	Grey	Medium
26034-00	Grey	Large
26011-00	Grey	XL

- ▷ Designed for travel when space is a concern
- ▷ Includes compression storage bag
- ▷ Cover is made with a 70D with polyurethane and mildew-resistant undercoating for enhanced water & mildew resistance. It's not waterproof, but very close
- ▷ Sewn-in vent allows moisture to escape
- ▷ Soft cotton protects the windshield
- ▷ Elastic shock cord is sewn into the bottom of the cover to provide a snug fit
- ▷ Plastic grommets allow the use of a cable to lock the cover to the bike
- ▷ Two-year limited warranty

HALF COVERS

COMPACT LIGHTWEIGHT, IDEAL FOR TRAVEL



Gold Wing



Ultra Classic

GUARDIAN

COVERS

NEW FOR
2016

GUARDIAN PREMIUM HALF COVER

ITEM #	COLOR	SIZE
05140	Black	Large touring

- ▶ Constructed using high tech microfiber material
- ▶ Folds compactly for travel
- ▶ Sewn-in storage bag
- ▶ Reflective piping for added nighttime visibility
- ▶ Comes equipped with foot peg straps for easy attachment and antenna pass-through access in the rear of the cover
- ▶ Intended to fit Honda Gold Wings, Harley Davidson Ultras, Road Glide and Electra Glide, Indian Roadmaster, Kawasaki Vulcan 1700, Victory Cross County, and more
- ▶ Two-year limited warranty



Cruisers & Touring



Spyder



Sport

GUARDIAN TRAVELER® HALF COVER

ITEM #	COLOR	SIZE
26014-00	Grey	Cruisers & touring
26015-00	Grey	Sport
04818D	Grey	Spyders

- ▶ Designed to be a lightweight cover
- ▶ Keeps moisture and the sun's heat off seats, dash, and other essential parts of your bike
- ▶ Cover is made with a 70D polyester with polyurethane & mildew-resistant undercoating for enhanced water resistance. It's not waterproof, but very close
- ▶ Elastic shock cord is sewn into the bottom of the cover to provide a snug fit
- ▶ Includes two foot-peg straps to securely hold cover to bike in high winds
- ▶ Two-year limited warranty

HI-VIZ

DAILY OUTDOOR USAGE FOR TRAVELING OR URBAN PARKING, SHORT OR LONG-TERM PARKING IN GARAGE

GUARDIAN

COVERS



GUARDIAN HI-VIZ MOTORCYCLE COVER

ITEM #	SIZE
04822	M - Sport bikes & small cruisers (w/o windshield)
04823	L - Cruisers, touring, & sport touring
04824	XL - Large touring

- ▷ Hi-Viz for added security & nighttime visibility
- ▷ Designed for travel when space is a concern
- ▷ Includes compression bag
- ▷ Cover is made with a 150D polyester with polyurethane and mildew-resistant undercoating for enhanced water & mildew resistance. It's not waterproof, but very close.
- ▷ Sewn-in vent allows moisture to escape
- ▷ Soft cotton protects the windshield
- ▷ Elastic shock cord is sewn into the bottom of the cover to provide a snug fit
- ▷ Polyester webbing belly strap is sewn in to prevent the cover from coming off in high winds
- ▷ Plastic grommets allow the use of a cable to lock the cover to the bike
- ▷ Three-year limited warranty



INDOOR DUST

INDOOR GARAGE STORAGE USAGE ONLY



Vintage / Sport model



GUARDIAN INDOOR DUST COVER

ITEM #	COLOR	SIZE
51055-00	Black	Large cruisers / small touring
51056-00	Black	Large touring models
51057-00	Black	Vintage
51017-00	Black	Sports
51227-00	Black	Custom bikes up to 109"
51228-00	Black	Custom bikes up to 96"
51235-00	Black	Custom bikes up to 124"

- ▷ Made in Wisconsin, USA
- ▷ The ultimate indoor cover
- ▷ Lifetime limited warranty
- ▷ Made with a 10oz cotton duck with water-resistant & mildew-resistant coatings. This is the perfect material for indoor storage due to its ability to allow moisture to escape while keeping dust and dirt off the bike. The underside of the cover has napped soft cotton that provides maximum protection for all surfaces of your bike.
- ▷ Elastic shock cord sewn into the bottom of the cover to provide a snug fit
- ▷ Reinforced grommets allow the use of a cable to lock the cover to the bike

MOTORCYCLE COVER FIT LIST

MAKE	MODEL	WEATHERALL PLUS	EZ-ZIP	WEATHERALL	ULTRALITE PLUS	ULTRALITE & HI-VIZ	COTTON STORAGE	TRAVELER
Aprilia	All Sport Bikes / Naked Sport	SP		SP	M	M	51057-00	SP
Aprilia	ETV 1000 CapoNord	AT		L	L	L	N/A	XL
Aprilia	Falco R SL 1000 / Futura RST 1000	L		L	M	M	51228-00	XL
Aprilia	RSV 1000R / RSV4	SP		SP	M	M	51057-00	SP
Aprilia	SL750 Shiver / SL750 Sliver / SMV	SP		SP	M	M	51228-00	SP
Aprilia	850 Mana / Touno 1000R	SP		SP	M	M	51057-00	SP
Bimota	Bimota (All Models)	SP		SP	M	M	51057-00	SP
BMW	1300GT / K1200GT	XL		XL	L	L	51055-00	XL
BMW	K1600GT / K1600GTL	XXL	XXL	XXL	XL	XL	51056-00	XL
BMW	F650 / F650GS / F650CS	AT		L	L	L	N/A	SP
BMW	F700GS / F800GS	AT / L		L	AT / L	L	N/A	XL
BMW	F800GT	L		L	L	L	51055-00	XL
BMW	F800S / F800R / F800ST	SP / M		SP / M	M	M	51057-00	SP
BMW	G650GS	AT	L	L	AT	M	N/A	SP
BMW	HP2 Enduro	AT			AT	L	N/A	
BMW	K100LT	L		L	L	L	51055-00	XL
BMW	K100RS	SP / M		SP / M	M	M	51228-00	SP
BMW	K100RT	L		L	L	L	51055-00	XL
BMW	K1100RS / K1200RS / K1200S	SP / M		SP / M	M	M	51228-00	SP
BMW	R1200GS / R1150GS	AT		L	AT	L	N/A	XL
BMW	R1200 GS Adventure	XL		XL	L	L	51055-00	XL
BMW	K1200LT / K1200CL	XXL	XXL	XXL	XL	XL	51056-00	XL
BMW	K1200S / K1300S	L		L	L	L	51055-00	XL
BMW	K1200R	SP		SP	M	M	51228-00	SP
BMW	K1200ST	L		L	L	L	51055-00	XL
BMW	K75	SP / M		SP / M	M	M	51057-00	SP
BMW	K75RT	L		L	L	L	51055-00	XL
BMW	R100	SP / M		SP / M	M	M	51228-00	SP
BMW	R100GS	AT		L	AT	L	N/A	SP
BMW	R100R / R100RS / R80RT / R100RT	L		L	L	L	51055-00	XL
BMW	R1100RS	L		L	L	L	51228-00	SP
BMW	R1150R / R1200R	L		L	L	L	51055-00	
BMW	R1200C / R1200CE	L		L	L	L	51055-00	XL
BMW	R1100RT / R1150RT / 1200RT	L		L	L	L	51055-00	XL
BMW	R1100S / R1200S	SP		SP	M	M	51228-00	SP
BMW	R65	SP / M		SP / M	M	M	51057-00	SP
BMW	R650CS / R65LS	L		L	L	L	51228-00	XL
BMW	R75S / R80 / R80ST	M		M	M	M	51228-00	SP
BMW	S1000RR	SP		SP	M	M	51057-00	SP
BMW	HP4	SP		SP	M	M	51057-00	SP
BMW	R NINE T	SP		SP	M	M	51057-00	SP
BMW	R1200ST	SP		SP	M	M	51228-00	SP
Buell	All Sport Models	SP / M		SP / M	M	M	51057-00	SP
Buell	Ulysses	AT		L	AT	L	N/A	SP
Cagiva	Cagiva (All Models)	SP / M		SP / M	L	L	51057-00	SP
Can-Am	Spyder (All Models)	Spyder						Spyder
Ducati	748 Sport / 748S Sport	SP		SP	M	M	51057-00	SP
Ducati	749 / 749S / 749R / 848	SP		SP	M	M	51057-00	SP
Ducati	750 Sport / 1000 Sport	SP		SP	M	M	51057-00	SP
Ducati	966R / 996 / 996S / 998 / 999 / 999R / 999S	SP		SP	M	M	51057-00	SP
Ducati	GT 1000	L		L	L	L	51228-00	XL
Ducati	Hypermotard 1100	SP		SP	M	M	51228-00	SP
Ducati	Monsters (All)	SP		SP	M	M	51057-00	SP
Ducati	Multistrada	AT		L	AT	L	N/A	XL
Ducati	Multistrada Granturismo	L		L	L	L	51055-00	
Ducati	ST2 / ST3 / ST4	L		L	L	L	51055-00	XL

MAKE	MODEL	WEATHERALL PLUS	EZ-ZIP	WEATHERALL	ULTRALITE PLUS	ULTRALITE & HI-VIZ	COTTON STORAGE	TRAVELER
Ducati	Panigale	SP		SP	M	M	51057-00	SP
Ducati	Diavel Strada	L		L	M	M	51228-00	SP
Ducati	Diavel	SP		SP	M	M	51228-00	SP
Ducati	Scrambler	M		M	M	M	51057-00	SP
Excelsior-Henderson	Super X	L		L	L	L	51055-00	XL
Harley-Davidson	Dyna T Sport/All Dynas with Windshield	CR/L	XL	L	L	L	51055-00	XL
Harley-Davidson	Dyna Switchback	CR/L	XL	L	L	L	51055-00	XL
Harley-Davidson	Dyna Street Bob	CR/L	XXL	L	L	L	51228-00	XL
Harley-Davidson	Fat Bob	CR/L	XL	L	L	L	51228-00	XL
Harley-Davidson	FLHT Electra Glide Standard	XL	XL	XL	L	L	51055-00	XL
Harley-Davidson	FLHT-C Electra Glide / Classic	XL	XL	XL	L	L	51055-00	XL
Harley-Davidson	2014 FLHTCU Ultra / FLHTL Ultra Limited	XXL	XL	XXL	XL	XL	51056-00	XL
Harley-Davidson	FLHT-C Ultra Classic Electra Glide	XL	XL	XL	L	L	51055-00	XL
Harley-Davidson	FLHTK Ultra Limited	XL		XL	L	L	51055-00	XL
Harley-Davidson	FLHX Street Glide / FLTRX Road Glide	XL		XL	L	L	51055-00	XL
Harley-Davidson	Road Kings (All)	XL		XL	L	L	51055-00	XL
Harley-Davidson	FLSTC Heritage Softail Classic	XL	XXL	XL	L	L	51055-00	XL
Harley-Davidson	FLSTF Fat Boy	CR / L		L	L	L	51228-00	SP
Harley-Davidson	FLSTS Heritage Springer	CR / L		L	L	L	51055-00	SP
Harley-Davidson	FLSTSB Softail Crossbones	CR / L		L	L	L	51055-00	SP
Harley-Davidson	FLTRU Ultra Classic Tour Glide	XXL		XXL	XL	XL	51056-00	XL
Harley-Davidson	FXD Dyna Super Glide/ Dyna Low rider	CR / M		M	M	M	51228-00	SP
Harley-Davidson	FXCWC Softail Rocker	CR / L		L	L	L	51228-00	XL
Harley-Davidson	FXDS Dyna Convertible	CR / L		L	L	L	51055-00	XL
Harley-Davidson	FXDWG Dyna Wide Glide	CR / L		L	L	L	51055-00	XL
Harley-Davidson	FXR Low Rider/FXR Super Glide	CR / M		M	M	M	51228-00	SP
Harley-Davidson	FXRT Sport Glide	CR/L		L	XL	XL	51055-00	XL
Harley-Davidson	FXST Softails (All)	CR / L		L	L	L	51228-00	SP
Harley-Davidson	FXSTD Softail Deuce	CR / L		L	L	L	51228-00	n/a
Harley-Davidson	FXSTS Springer Softail	CR / L		L	L	L	51228-00	SP
Harley-Davidson	FXSTSI Softail	CR / L		L	L	L	51228-00	SP
Harley-Davidson	FXSB Breakout	CR/L		L	L	L	51228-00	SP
Harley-Davidson	FLS Softail Slim	CR/L		L	L	L	51228-00	SP
Harley-Davidson	FLSTN Softail Deluxe	CR / L		L	L	L	51228-00	SP
Harley-Davidson	Sportsters (All)	M		M	M	M	51057-00	SP
Harley-Davidson	Sportster 1200 T	CL/L		L	L	L	51055-00	SP
Harley-Davidson	Sportsters with Windshield	CL/L		L	L	L	51055-00	SP
Harley-Davidson	V-Rod	CR / L		L	L	L	51228-00	SP
Harley-Davidson	Tri-Glide	Trike					N/A	XL
Honda	250/450 Rebel	M		M	M	M	51228-00	SP
Honda	599	SP		SP	M	M	51057-00	SP
Honda	Nighthawk (All)	M		M	M	M	51228-00	SP
Honda	919	SP		SP	M	M	51228-00	SP
Honda	CB 1000R	SP/M		M	M	M	51228-00	SP
Honda	CBR (All)	SP		SP	M	M	51228-00	SP
Honda	CM 230 / CM 250/ CM 450	M	XL	M	M	M	51057-00	SP
Honda	CX 550	M	XL	M	M	M	51228-00	SP
Honda	CRF 230M	SP	XXL	SP	M	M	51057-00	SP
Honda	DN-01	SP	XXXL	SP	M	M	51057-00	SP
Honda	Fury	XL	XXXL	XL	L	L	51055-00	XL
Honda	GL1200 Gold Wing GL	XL	XXXL	XL	L	L	51055-00	XL
Honda	GL1500 Gold Wing	XXL		XXL	XL	XL	51056-00	XL
Honda	FB6	XXXL		XXXL	XL	XL	51056-00	XL
Honda	2014 Valkyrie	XXXL		XXXL	XL	XL	51056-00	XL
Honda	Gold Wing 1800	XXXL		XXXL	XL	XL	51056-00	XL
Honda	NT700V	L	XL	L	L	L	51055-00	XL

GUARDIAN

FASTRAX

RALLY PACK

IRON RIDER

WILLIE & MAX

MAKE	MODEL	WEATHERALL PLUS	EZ-ZIP	WEATHERALL	ULTRALITE PLUS	ULTRALITE & HI-VIZ	COTTON STORAGE	TRAVELER
Honda	Pacific Coast	L		L	M	M	N/A	SP
Honda	RC51	SP		SP	M	M	N/A	SP
Honda	Sabre / V45/ V65	CR / L		L	M	M	51228-00	SP
Honda	VT 1300 Stateline/Interstate/Saber	XL		XL	L	L	51228-00	XL
Honda	Shadows all 750 and 1100	CR / L	XL	L	L	L	51055-00	XL
Honda	Shadow DLX 600	CR / M	XXL	M	L	L	51228-00	SP
Honda	Silver Wing (Motorcycle)	CL/L		L	M	M	N/A	SP
Honda	ST1100 / ST1300	L		L	M	M	51228-00	SP
Honda	Valkyrie / Valkyrie Rune / Valkyrie Touring	XL		XL	M	M	51228-00	SP
Honda	Valkyrie Interstate	XXL		XXL	L	L	51057-00	XL
Honda	VF1100C Magna	M		M	M	M	51228-00	SP
Honda	VF500 Ascot	M		M	XL	XL	51056-00	XL
Honda	VFR Interceptors All	SP		SP	XL	XL	51056-00	XL
Honda	VF 700/750 Magna	CR / L		L	XL	XL	51056-00	XL
Honda	VTX 1300 / VTX 1800 All	XL	XL	XL	AT	L	N/A	
Honda	NC700X	L		L	M	M	51057-00	SP
Honda	CTX700N	M		M	M	M	51057-00	SP
Honda	CB1100	CL/M		M	L	L	51055-00	XL
Honda	CB600F	SP		SP	L	L	51055-00	XL
Honda	CTX1300	XL	XL	XL	M	M	51057-00	SP
Honda	Super Hawk 1000	SP		SP	AT	M	N/A	SP
Indian	Chieftan	XXXL	XXXL	XXXL	M	M	51228-00	SP
Indian	Chief Vintage	XXXL	XXXL	XXXL	M	M	51057-00	SP
Indian	Chief Classic	XXXL	XXXL	XXXL	AT / L	L	N/A	XL
KTM	950 Adventure S	AT		L	L	L	51228-00	XL
KTM	Duke / Super Duke	SP		SP	L	L	51228-00	XL
KTM	1190 RC8	SP		SP	L	L	51055-00	XL
Kawasaki	Nomad ALL	XL	XL	XL	XL	XL	51057-00	XL
Kawasaki	Concourse / Concourse 14	L		L	L	L	51228-00	XL
Kawasaki	Eliminator 125	M		M	L	L	51055-00	XL
Kawasaki	KLR650	AT		M	M	M	51228-00	SP
Kawasaki	KZ440 LTD / KZ450 LTD / KZ550 LTD / KZ750 LTD	M		M	L	L	51055-00	XL
Kawasaki	Ninja (all)	SP		SP	L	L	51055-00	XL
Kawasaki	Versys / 650LT / 1000LT	AT / L		L	M	M	51057-00	SP
Kawasaki	VN 750 Vulcan / VN 800 Vulcan	CR / L		L	M	M	51057-00	XL
Kawasaki	Vulcan 1600 Mean Streak	CR / L		L	M	M	51057-00	SP
Kawasaki	Vulcan 1500/1600/1700 Classic	XL	XL	XL	M	M	51057-00	SP
Kawasaki	Vulcan 1700 Voyager	XXL	XXL	XXL	L	L	51055-00	XL
Kawasaki	Vulcan 2000	CR / L		L	M	M	51228-00	SP
Kawasaki	Vulcan 2000 Classic LT	XL	XL	XL	L	L	51228-00	SP
Kawasaki	Vulcan 500 / 550 LTD	M		M	L	L	51055-00	XL
Kawasaki	Vulcan 800 / 1500 Drifter	XL	XL	XL	XL	XL	51057-00	XL
Kawasaki	Vulcan 900 Classic / Vulcan 900 Classic LT	L		L	M	M	51228-00	SP
Kawasaki	Z 750	SP		SP	M	M	51228-00	SP
Kawasaki	W 650	M		M	M	M	51228-00	SP
Kawasaki	ZRX 1100 / 1200	SP		SP	M	M	51228-00	SP
Kawasaki	Z1000	SP		SP	M	M	51228-00	SP
Kawasaki	ZG1200 Voyager	XL	XL	XL	M	M	51228-00	SP
Kawasaki	ZL600 / 1000 Eliminator	M		M	AT	M	N/A	SP
Kawasaki	Vulcan S	L		L	M	M	51228-00	SP
Kawasaki	Vulcan Vaquero	XL	XL	XL	L	L	51055-00	XL
Kawasaki	ZN 1300 Voyager	XXL	XXL	XXL	L	L	51228-00	XL
Kawasaki	ZN 750 / 1100 LTD	M		M	M	M	51228-00	SP
Kawasaki	ZR 550 Zephyr / ZR 750 Zephyr	M		M	L	L	51228-00	XL
Kawasaki	ZR-7S	SP		SP	M	M	51228-00	SP
Kawasaki	ZRX 1100/1200	SP		SP	L	L	51228-00	XL
Kawasaki	ZX 6 / ZX 10 / ZX 11 / ZX 14	SP		SP	M	M	51228-00	SP
Kawasaki	ZZR600/1200	SP		SP	L	L	51055-00	XL
Kawasaki	KLX 250S/250SF/Super Sherpa	AT		M	M	M	51228-00	SP
Moto-Guzzi	Breva (All)	SP		SP	AT / L	L	N/A	XL
Moto-Guzzi	California (All)	XL	XL	XL	M	M	51228-00	SP

MAKE	MODEL	WEATHERALL PLUS	EZ-ZIP	WEATHERALL	ULTRALITE PLUS	ULTRALITE & HI-VIZ	COTTON STORAGE	TRAVELER
Moto-Guzzi	Centauro V10/V11	L		L	M	M	50157-00	SP
Moto-Guzzi	Griso All	SP		SP	L	L	51055-00	XL
Moto-Guzzi	Jackal	L		L	M	M	51057-00	SP
Moto-Guzzi	LeMans / Nero Corsa V11	SP		SP	L	L	51228-00	XL
Moto-Guzzi	Nevada Classic 750	L		L	L	L	51055-00	XL
Moto-Guzzi	Norge 1200	SP		SP	L	L	51228-00	XL
Moto-Guzzi	Norge GT	L		L	M	M	N/A	SP
Moto-Guzzi	Sport Bikes / Naked Sport Bikes	SP		SP	L	L	51228-00	XL
Moto-Guzzi	Stelvio 1200	AT / L		L	L	L	51055-00	XL
Moto-Guzzi	V7/V11 All	SP		SP	L	L	51055-00	XL
MV Augusta	All models	SP		SP	XL	XL	51057-00	XL
Suzuki	Bandit 600S / 1200 / 1200S / 1250S	SP		SP	M	M	51228-00	SP
Suzuki	B-King	AT		L	AT	L	N/A	XL
Suzuki	Boulevard C50 / C50 Touring / Volusia	XL	XL	XL	L	L	51055-00	XL
Suzuki	Boulevard C90 / C90 Touring	XXL	XXL	XXL	XL	XL	51056-00	XL
Suzuki	Boulevard M50 / M90	CR / L		L	L	L	51055-00	XL
Suzuki	Boulevard M95	CR/L		L	L	L	51228-00	SP
Suzuki	Boulevard S40 / Boulevard S50 / Savage	CR/M		M	M	M	51228-00	SP
Suzuki	Boulevard S83	CR/L		L	L	L	51228-00	XL
Suzuki	C109 R/C109RT	XXL	XXL	XXL	XL	XL	51056-00	XL
Suzuki	M109R	XL	XL	XL	L	L	51055-00	XL
Suzuki	DRZ 400	AT/M		M	M	M	51057-00	SP
Suzuki	Gladius	SP		SP	M	M	51228-00	SP
Suzuki	GS-450 All	M		M	M	M	51057-00	SP
Suzuki	GS-500E / GS-500F	S		S	M	M	51057-00	SP
Suzuki	GS-550GL / GS-550	M		M	M	M	51228-00	SP
Suzuki	GS-850 / GS-850	XL	XL	XL	L	L	51055-00	XL
Suzuki	GS-1100 GKE	L		L	L	L	51055-00	XL
Suzuki	GS-1100	M		M	M	M	51228-00	SP
Suzuki	GSR-600 / GSR-750 / GSR-1100	SP		SP	M	M	51228-00	SP
Suzuki	GSX-650 / GSX-750 / GSX-S750 / GSX-S1000	SP		SP	M	M	51228-00	SP
Suzuki	GSXR 600/750/1000/1100	SP		SP	M	M	51228-00	SP
Suzuki	GV-1400GD	XL	XL	XL	L	L	51055-00	XL
Suzuki	GZ-250 / TU250 / GZ250	M		M	M	M	51057-00	SP
Suzuki	Hayabusa	SP		SP	M	M	51228-00	SP
Suzuki	Intruder 750/800/1400	CR / M		M	M	M	51228-00	SP
Suzuki	Intruder 1500	XL		XL	L	L	51055-00	XL
Suzuki	Katana 600 / Katana 750	SP		SP	L	L	51228-00	SP
Suzuki	Marauder 800 / Marauder 1600	L		L	L	L	51228-00	XL
Suzuki	RF 900R	SP		SP	M	M	51057-00	SP
Suzuki	SV-650/1000	SP		SP	M	M	51057-00	SP
Suzuki	TL 1000R / TL 1000S	SP		SP	M	M	51057-00	SP
Suzuki	Volusia 800	XL	XL	XL	L	L	51055-00	XL
Suzuki	V-Strom 650 / 1000 / 650XT	M		M	M	M	51057-00	SP
Triumph	America	M		M	M	M	51228-00	SP
Triumph	America Classic/ America LT	XL	XL	XL	L	L	51055-00	XL
Triumph	Bonneville All	M		M	M	M	51228-00	SP
Triumph	Daytona 600 / 650 / 675 / 900 / 955	SP		SP	M	M	51228-00	SP
Triumph	Legend	M		M	M	M	51228-00	SP
Triumph	Rocket III	XL	XL	XL	L	L	51055-00	XL
Triumph	Rocket III Touring	XXXL	XXXL	XXXL	XL	XL	51056-00	XL
Triumph	Scrambler	SP		SP	M	M	51228-00	SP
Triumph	Speed Four	SP		SP	M	M	51228-00	SP
Triumph	Speed Triple	SP		SP	M	M	51228-00	SP
Triumph	Speedmaster	SP		M	M	M	51228-00	SP
Triumph	Sprint RS	SP		SP	M	M	51228-00	SP
Triumph	Sprint ST	SP		SP	M	M	51228-00	SP
Triumph	Sprint GT	L		L	L	L	51228-00	SP
Triumph	Thruxton 900	M		SP / M	M	M	51228-00	SP
Triumph	Thunderbird	M		M	M	M	51228-00	SP
Triumph	Thunderbird Sport	AT		M	AT	M	51228-00	SP

GUARDIAN

FASTRAX

RALLY PACK

IRON RIDER

WILLIE & MAX

MAKE	MODEL	WEATHERALL PLUS	EZ-ZIP	WEATHERALL	ULTRALITE PLUS	ULTRALITE & HI-VIZ	COTTON STORAGE	TRAVELER
Triumph	Thunderbrid LT	XXL	XXL	XXL	XL	XL	51056-00	XL
Triumph	Thunderbrid Special Edition	L		L	L	L	51055-00	XL
Triumph	Tiger	AT		L	L	L	N/A	XL
Triumph	Trophy 900 / 1200	L		L	L	L	51055-00	SP
Triumph	TT 600	SP		SP	M	M	51055-00	SP
Victory	High Ball	XL		XL	L	L	51055-00	XL
Victory	Classic Cruiser	CR / L		L	L	L	51228-00	XL
Victory	Cross Country / Roads	XXXL	XXXL	XXXL	XL	XL	51056-00	XL
Victory	Cross Country Tour	XXXL	XXXL	XXXL	XL	XL	51056-00	XL
Victory	Board Walk	L		L	L	L	51055-00	SP
Victory	Hard Ball	XL		XL	L	L	51055-00	XL
Victory	Jackpot	L		L	L	L	51056-00	XL
Victory	Judge	L		L	L	L	51228-00	SP
Victory	Gunner	M		M	M	M	51228-00	SP
Victory	Hammer	M		M	M	M	51228-00	SP
Victory	Kingpin	XL	XL	XL	L	L	51055-00	XL
Victory	Kingpin Tour	XXL	XXL	XXL	XL	XL	51056-00	XL
Victory	Touring Cruiser	XL	XL	XL	L	L	51055-00	XL
Victory	V925C / V92C	M		M	M	M	51228-00	SP
Victory	Vegas / Vegas Jackpot / 8 Ball	CR/L		L	L	L	51228-00	SP
Victory	Victory V92C Deluxe	L		L	L	L	51055-00	SP
Victory	Vision	XXXL	XXXL	XXXL	XL	XL	51055-00	XL
Yamaha	Fazer 700	M		M	M	M	51228-00	SP
Yamaha	FJ1100 / FJ1200	L		L	L	L	51228-00	SP
Yamaha	FJ600	SP		SP	M	M	51228-00	SP
Yamaha	FJR1300	L		L	L	L	51228-00	SP
Yamaha	FZ1 / FZ6 / FZ6R / FZ08 / FZ09	SP		SP	M	M	51228-00	SP
Yamaha	FZ600 / FZ700 / FZ750 / FZR1000	SP		SP	M	M	51228-00	SP
Yamaha	Bolt	M		M	M	M	51228-00	SP
Yamaha	Maxim	M		M	M	M	51057-00	SP
Yamaha	Radian 600	XL	XL	XL	L	L	51055-00	XL
Yamaha	Raider	XXL	XXL	XXL	XL	XL	51056-00	XL
Yamaha	Roadliner	XXL	XXL	XXL	XL	XL	51056-00	XL
Yamaha	Road Star /Midnight Star	XL	XL	XL	L	L	51055-00	XL
Yamaha	Road Star Silverado	XL	XL	XL	L	L	51055-00	XL
Yamaha	Road Warrior	XL	XL	XL	L	L	51055-00	XL
Yamaha	Royal Star	XL	XL	XL	L	L	51055-00	XL
Yamaha	Royal Star Midnight Silverado	XL	XL	XL	L	L	51055-00	XL
Yamaha	Royal Star Touring Deluxe	XL	XL	XL	L	L	51055-00	XL
Yamaha	Royal Star Venture	XXXL	XXXL	XXXL	XL	XL	51056-00	SP
Yamaha	RZ350	SP		SP	M	M	51057-00	SP
Yamaha	RZ500	SP		SP	M	M	51057-00	SP
Yamaha	Seca	SP		SP	M	M	51057-00	SP
Yamaha	Stratoliner /Stradoliner Deluxe	XXL	XXL	XXL	XL	XL	51056-00	XL
Yamaha	Striker	L		L	L	L	51028-00	SP
Yamaha	SRX250	M		M	M	M	51228-00	SP
Yamaha	SRX600	SP		SP	M	M	51228-00	SP
Yamaha	V Star 1100 Clasic	XL	XL	XL	L	L	51055-00	XL
Yamaha	V Star 1100 Custom	L		L	L	L	51228-00	SP
Yamaha	V Star 1300	CR/L		L	L	L	51228-00	SP
Yamaha	V Star 1300 Tour	XL	XL	XL	L	L	51055-00	SP
Yamaha	V Star 250/650	M		M	M	M	51228-00	SP
Yamaha	V Star 950 / 950 Tour	L		L	L	L	51228-00	SP
Yamaha	Virago 250	M		M	M	M	51228-00	SP
Yamaha	VMAX	M/CR		M/L	M	M	51228-00	SP
Yamaha	XJ700 /750 Maxim	SP		SP	M	M	51228-00	SP
Yamaha	Virago 535/700 / 750/ 1000/1100	M/CR		M	M	M	51228-00	SP
Yamaha	YZF -R1 / YZF R6 /YZF600R YZF R3	SP		SP	M	M	51057-00	SP
Yamaha	Super Tenere	AT		L	L	L	N/A	SP
Yamaha	WR 250	M/AT		M	M	M	N/A	SP
Zero	S / SR / DS	SP		SP	M	M	51228-00	SP
Zero	FX	M		M	M	M	51057-00	SP

SCOOTER FIT LIST & COVERS FEATURES

MAKE	MODEL	GUARDIAN SCOOTER
Aprilia	Atlantic 125 / 250 / 500	XL
Aprilia	Scarabeo 125	M
Aprilia	Scarabeo 150 w/ or w/o windshield	XL
Aprilia	Scarabeo 50	M
Aprilia	Scarabeo 50 w/ luggage rack	L
Aprilia	Scarabeo 500	XL
Aprilia	SR 50	M
Honda	Big Ruckus	L
Honda	Elite 50 S	S
Honda	Elite 50 SR	S
Honda	Elite 80	M
Honda	Helix	XL
Honda	Metropolitan / Metropolitan II	M
Honda	Reflex	XL
Honda	Ruckus	M
Honda	Silver Wing (Scooter)	XL
Italjet	Dragster 125 LC	L
Italjet	Dragster 180 LC	L
Italjet	Dragster 50 LC	L
Italjet	Formula 125 LC	L
Italjet	Formula 50 LC	L
Italjet	Jet-Set 50 / 125 / 150	M
Italjet	Jupiter 125 / 150 / 250	L
Italjet	Millenium 125 / 150	L
Italjet	Torpedo 125-4T	M
Italjet	Torpedo 150-4T	M
Italjet	Torpedo 50-2T	M
Italjet	Torpedo 50-4T	M
Kymco	Agility 50	M
Kymco	Agility 125	L
Kymco	Bet & Win 150 / 120	L
Kymco	Cobra Cross	M
Kymco	Cobra Racer	M
Kymco	Filly	M
Kymco	Grand Vista 250	XL
Kymco	People S 125 / 150 / 200 / 250	L
Kymco	People 50	M
Kymco	Super 9	M
Kymco	Vitality	L
Kymco	Xciting 250	XL
Kymco	Xciting 500	XL
Kymco	ZX-50	M
Malaguti	Ciak	M
Malaguti	F10 Jet Line	M
Malaguti	F12 Phantom	M
Malaguti	F18 Warrior	M
Malaguti	Fire Fox	M
Malaguti	Phantom 100 F12	M
Malaguti	Yesterday Euro w/o windshield	M
Malaguti	Yesterday West 1 w/o windshield	M
MuZ	Moskito w/o windshield	M
MuZ	Moskito w/ windshield	L

MAKE	MODEL	GUARDIAN SCOOTER
Piaggio	MP3 250-500	XL
Piaggio	BV Tourer	L
Suzuki	Burgman 400	XL
Suzuki	Burgman 650	XL
Vespa	ET 2	M
Vespa	ET 4	M
Vespa	Grandturismo 200	L
Vespa	PX150	L
Yamaha	C3	M
Yamaha	Majesty 400	XL
Yamaha	Riva 125	L
Yamaha	Riva Jog	S
Yamaha	Riva Razz	S
Yamaha	T-Max	XL
Yamaha	Vino	M
Yamaha	XC 125	S
Yamaha	Zuma	M
Yamaha	Zuma 125	L

MOTORCYCLE COVERS FEATURES	WeatherAll Plus	EZ-Zip	WeatherAll	UltraLite Plus	UltraLite	Traveler	Scooter	Custom Bike	Hi-Viz
Lifetime warranty	/	/					/	/	
Five-year warranty			/						
Three-year warranty				/					/
Two-year warranty					/	/			
ClimaShield Plus	/	/							
ClimaShield			/				/		
Waterproof taped seams	/	/	/						
EZ installation		/							
Alarm system pockets	/								
Moisture-Guard vent	/	/	/						/
Moisture vent				/	/	/			
Under-bike straps	/	/	/	/					/
Lockable grommets	/	/	/	/	/		/	/	
Soft windshield liner	/	/	/	/					
Aluminized heat shield	/	/	/				/		
Shock cord in hem	/	/	/	/	/	/	/	/	/
Storage bag	/	/	/	/	/	/	/	/	/

GUARDIAN

FASTRAX

RALLY PACK

IRON RIDER

WILLIE & MAX

ATV COVERS



GUARDIAN TRAILERABLE RATCHET-FASTENING ATV COVER TRAILERABLE & FOR EVERYDAY INDOOR & OUTDOOR USE

ITEM #	COLOR	SIZE
04629	Black	Fits units up to 81.5" x 45.75" x 35.75"
04630	Black	Fits units up to 86.75" x 50" x 38"
04631	Black	Fits units up to 93.25" x 50" x 40.75"

- ▶ Full-size, industry-leading ATV cover
- ▶ Features integrated ratchet fastening system
- ▶ Easy to install
- ▶ Lockable to deter theft or tampering
- ▶ Closeable access slots for trailer tie-downs
- ▶ Made with ClimaShield
 - ▶ Heavy duty, waterproof, & breathable
 - ▶ 300D coated polyester fabric with a durable water-repellant top coat
 - ▶ Polyurethane & mildew-resistant undercoating
 - ▶ Provides excellent protection against rain, mildew, and fading caused by the sun's UV rays
- ▶ Two-year limited warranty



Black



Camo

GUARDIAN ATV COVER - BLACK

ITEM #	COLOR	SIZE
26018-01	Black	XL
26041-01	Black	XXL
26042-01	Black	XXXL
26043-01	Black	Sport

- ▶ Full-size, industry-leading ATV cover
- ▶ Features integrated ratchet fastening system
- ▶ Easy to install
- ▶ Lockable to deter theft or tampering
- ▶ Closeable access slots for trailer tie-downs
- ▶ Made with ClimaShield
 - ▶ Heavy duty, waterproof, & breathable
 - ▶ 300D coated polyester fabric with a durable water repellant top coat
 - ▶ Polyurethane & mildew-resistant undercoating
 - ▶ Provides excellent protection against rain, mildew, and fading caused by the sun's UV rays
- ▶ Sewn-in alarm pockets allow for the use of the Dowco Guardian Cover Alarm (sold separately; see page 9)
- ▶ Two-year limited warranty

GUARDIAN ATV COVER - CAMO

ITEM #	COLOR	SIZE
26018-00	Camo	XL
26041-00	Camo	XXL
26042-00	Camo	XXXL

UTV COVERS

EVERYDAY, ANYWHERE UTV COVER



GUARDIAN UTV COVER

ITEM #	COLOR	SIZE
26044-00	Black	2-passenger UTVs
26052-00	Black	4-passenger UTVs

- ▶ Full-size UTV cover featuring the EZ-Zip® system, allowing easy installation & removal of the cover
- ▶ Constructed from lightweight 200D polyester
- ▶ Includes double-stitched, interlocked seams that offer superior strength & water resistance
- ▶ Sewn-in alarm pockets allow for the use of the Dowco Guardian Cover Alarm (sold separately)
- ▶ Two-year limited warranty

GUARDIAN

FASTRAX

RALLY PACK

IRON RIDER

WILLIE & MAX

SNOWMOBILE COVERS



GUARDIAN TRI-LAYER SNOWMOBILE COVER

EVERYDAY OUTDOOR USE

ITEM #	COLOR	SIZE
03487	Black	Fits tracks 121" - 129"
03488	Black	Fits tracks 136" - 146"
51097	Black	Fits tracks up to 163"

- ▶ Full-size, industry-leading snowmobile cover
- ▶ Constructed out of heavy duty lined 600D solution-dyed polyester providing maximum protection from the elements of the weather, dust, & dirt
- ▶ Features integrated ratchet fastening system
- ▶ Easy to install
- ▶ Lockable to deter theft or tampering
- ▶ Closeable access slots for trailer tie-downs
- ▶ Two-year limited warranty



GUARDIAN SNOWMOBILE STORAGE COVER

SHORT OR LONG-TERM INDOOR USE

ITEM #	COLOR	SIZE
53006-00	Black	Medium
53007-00	Black	Large
53010-00	Black	XL



- ▶ Full-size snowmobile cover
- ▶ Made with a 10oz cotton duck with water-resistant & mildew-resistant coatings. This is the perfect material for indoor storage due to its ability to allow moisture to escape while keeping dust and dirt off the snowmobile. The underside of the cover has napped soft cotton that provides maximum protection for all surfaces of your snowmobile.
- ▶ Features a sewn-in elastic shock cord along the hem
- ▶ Extra adjustable top straps & buckles
- ▶ Made in the USA
- ▶ Two-year limited warranty

GUARDIAN ACCESSORIES



GUARDIAN HELMET BAG

ITEM #	COLOR	SIZE
59001-00	Black	Universal

- ▶ Soft helmet bag that will fit any motorcycle helmet
- ▶ Made of polyester with internal sherpa lining protecting helmet from scratch & damage
- ▶ Attached carry handle
- ▶ Two-year limited warranty



GUARDIAN DELUXE RAIN SUIT

ITEM #	COLOR	SIZE
26046-00	Black	Small
26047-00	Black	Medium
26048-00	Black	Large
26049-00	Black	XL
26050-00	Black	XXL

- ▶ Constructed of 100% polyester PVC
- ▶ Features a concealed sewn-in hood
- ▶ Reflective piping for increased visibility at night
- ▶ Two large front pockets with an additional pocket on inside liner and drawstring waist
- ▶ Pants feature large zip opening and elastic boot cuff to help keep feet & legs dry
- ▶ One-year limited warranty





Fastrax[®]

You live to fly along on the rugged wilderness trail. A grin passes your face as knobby tires throw off clogs of mud in your wake. The trip, the torque, and the freewheeling adventurer in every sport-touring rider demands luggage that is tough and uncompromising. Durable, water-resistant, and tricked-out with thoughtful details, Fastrax[®] gear is up to any challenge you and your bike can throw at it.

GUARDIAN

FASTRAX

RALLY PACK

IRON RIDER

WILLIE & MAX

SPORT & ADVENTURE

Fastrax



FASTRAX BACKROADS TANK BAG

ITEM #	COLOR	SIZE
50143-00	Black	14" x 8.25" x 10.5" Expands to: 14" x 11.25" x 10.5"

- ▶ Built from durable 1680D UV-coated, weather-resistant polyester
- ▶ Lockable, water-resistant zipper
- ▶ Hi-Viz lined inside for added style and ease of seeing your gear
- ▶ Equipped for both strap or magnetic mounting
- ▶ Attached sewn-in rain hood
- ▶ Integrated molded carrying handle
- ▶ Includes pull-out style backpack sling
- ▶ Zippered expansion
- ▶ Four internal mesh pockets
- ▶ Audio port on top of bag with clear electronics storage area
- ▶ External clear map pocket included with bag, fastens to top of the bag accommodating maps up to 9" x 7"
- ▶ Hydration bladder storage pocket integrated into lid of bag
- ▶ Adjustable exposed storage access in lid
- ▶ 19L capacity, 27L expanded capacity
- ▶ Limited lifetime warranty





FASTRAX BACKROADS TAIL BAG

ITEM #	COLOR	SIZE
50144-00	Black	16" x 8.75" x 11" Expands to: 16" x 11" x 11"

- ▷ Built from durable 1680D UV-coated, weather-resistant polyester
- ▷ Lockable, water-resistant zipper
- ▷ Hi-Viz lined inside for added style and ease of seeing your gear
- ▷ Comes equipped to be strap-mounted
- ▷ Attached sewn-in rain hood
- ▷ Integrated molded carrying handle
- ▷ Includes pull-out style backpack sling
- ▷ Zippered expansion
- ▷ Four internal mesh pockets
- ▷ Large internal lid pocket
- ▷ Adjustable exposed storage access in lid
- ▷ Includes "dry bag" additional storage, clips to D-rings on top of the bag
- ▷ 25L capacity, 28L expanded capacity
- ▷ Limited lifetime warranty

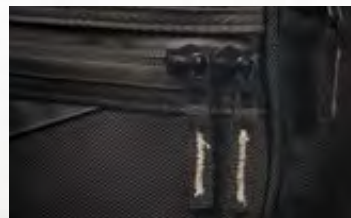

GUARDIAN

FASTRAX

RALLY PACK

IRON RIDER

WILLIE & MAX

FASTRAX SADDLEBAGS

Fastrax



FASTRAX BACKROADS SADDLEBAGS

ITEM #	COLOR	SIZE
50145-00	Black	18" x 10.875" x 8.25" per side Expands to: 18" x 12" x 8.25" per side

- ▶ Built from durable 1680D UV-coated, weather-resistant polyester
- ▶ Sold as a pair
- ▶ Trucker tarp-lined front provides additional durability
- ▶ Large saddlebag storage for daily or travel use
- ▶ Lockable, water-resistant zipper
- ▶ Hi-Viz lined inside for added style and ease of seeing your gear
- ▶ Comes equipped to be strap-mounted
- ▶ Attached sewn-in rain hood
- ▶ Expandable V-gussets increase your storage
- ▶ Large internal lid pocket
- ▶ Adjustable exposed storage access in lid
- ▶ 25L capacity, 28L expanded capacity per side
- ▶ Limited lifetime warranty



FASTRAX TANK BAG



FASTRAX BACKROADS SMALL TANK BAG

ITEM #	COLOR	SIZE
04891	Black	13" x 5.25" x 7"

- ▷ Built from durable 1680D UV-coated, weather-resistant polyester
- ▷ Trucker tarp-lined front provides additional durability
- ▷ Water-resistant zippers
- ▷ Non-slip Dowco dot pattern material on bottom
- ▷ Air vented cell phone / GPS pocket
- ▷ Equipped for both strap or magnetic mounting
- ▷ Secondary exterior pocket for smaller items
- ▷ Rain cover with window for cell phone / GPS
- ▷ Black reflective piping for safety at night
- ▷ 7.9L capacity
- ▷ Two-year limited warranty



FASTRAX XTREME



FASTRAX XTREME MOTO BACKPACK

ITEM #	COLOR	SIZE
04743	Black	Universal

- ▷ Water-resistant zippers
- ▷ Reinforced sidewalls help bag maintain its shape
- ▷ Black reflective stripe around base
- ▷ Reflective screen print logo and Hi-Viz elements
- ▷ Two-year limited warranty



FASTRAX XTREME TAIL BAG

ITEM #	COLOR	SIZE
04738	Black	12" x 6" x 9.5"

- Water-resistant zippers
- Bungee web on lid
- Reinforced sidewalls help bag maintain its shape
- Black reflective stripe around base
- Reflective screen print logo and Hi-Viz elements
- Non-slip material on bottom of bag helps bag stay in place
- Quick-release mounting straps included
- Two-year limited warranty



FASTRAX XTREME TANK BAG

ITEM #	COLOR	SIZE
04739	Black	13" x 7.5" x 8.5"

- Water-resistant zippers
- Bungee web on lid
- Reinforced sidewalls help bag maintain its shape
- Black reflective stripe around base
- Reflective screen print logo and Hi-Viz elements
- Non-slip material on bottom of bag helps bag stay in place
- Quick-release mounting straps included
- Two-year limited warranty

Rally Pack

LOWE





Rally Pack

The joy of riding is your true destination, and you don't sweat the small stuff. Functionality is priority one when it comes to your luggage. Rally Pack® fits the bill. These roll bags hold your stuff, hold their shape, and hold their own against the good looks of your bike. It's go-to, do-all luggage at an affordable price. Don't over-think it.

GUARDIAN

FASTRAX

RALLY PACK

IRON RIDER

WILLIE & MAX

TOUR PACK BAG

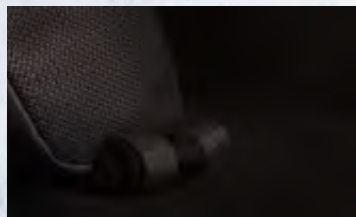

NEW FOR
2016

RALLY PACK TOUR PACK BAG

ITEM #	COLOR	EXTERIOR SIZE
04910	Black	20" x 9" x 14"

- ▷ Water resistant zippers
- ▷ Foamcore construction throughout the bag for added shape retention and durability
- ▷ 40L carrying capacity
- ▷ Reflective strip for added nighttime visibility
- ▷ External pockets for transporting smaller items
- ▷ Two-year limited warranty

LUGGAGE SYSTEM



RALLY PACK LUGGAGE SYSTEM

ITEM #	COLOR	EXTERIOR SIZE
50030-00	Black	Large Roll Bag 13.5" x 16" x 10" Small Roll Bag 13.5" x 10" x 9.5"

- ▷ Durable, weather-resistant, heavy-duty polyester
- ▷ Sold as a pair
- ▷ Foam-core construction maintains shape of bag for ease of packing & protection
- ▷ Water-resistant zippers
- ▷ Convenient front loading pockets
- ▷ Bags may be used separately, or together for added capacity
- ▷ Universal straps fit most sissy bar & luggage rack combinations
- ▷ Reflective strip for added nighttime visibility & safety
- ▷ Includes rain hood
- ▷ Mounts easily with quick-release web straps
- ▷ 35L large roll bag capacity
- ▷ 21L small roll bag capacity
- ▷ Two-year limited warranty

GUARDIAN

FASTRAX

RALLY PACK

IRON RIDER

WILLIE & MAX

VALUE SERIES

IMPROVED FOR
2016



RALLY PACK VALUE TANK BAG

ITEM #	COLOR	SIZE
50106-00	Black	12.3" x 6" x 9.75"

- ▶ Easy-to-use tank bag constructed of water-resistant 1680D polyester
- ▶ Multi-magnet design and strap mounting system with non-skid base and straps that ensure firm tank position
- ▶ Features sewn-in rain hood
- ▶ Full-length map pocket
- ▶ 10L capacity
- ▶ Two-year limited warranty

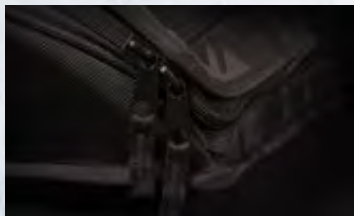



RALLY PACK VALUE TAIL BAG

ITEM #	COLOR	SIZE
50104-00	Black	15" x 9" x 11"

- ▶ Easy-to-use tail bag is constructed of water-resistant 1680D polyester
- ▶ Installs easily with web strapping
- ▶ Quick-release buckles
- ▶ Web strap handle and sewn-in rain hood
- ▶ 22L capacity
- ▶ Two-year limited warranty



RALLY PACK VALUE SADDLEBAGS

ITEM #	COLOR	SIZE
50105-00	Black	16" x 10" x 7.3"

- ▶ Easy-to-install saddlebags constructed of water-resistant 1680D polyester
- ▶ Includes cotton heat shield panels that protect side or underseat / tail area from exhaust
- ▶ Quick-release buckles
- ▶ Web strap handle and sewn-in rain hood
- ▶ 32 L capacity total
- ▶ Two-year limited warranty





You demand authenticity in every aspect of the riding experience. Logging mile after mile over curvy ribbons of asphalt, you've forged a deep appreciation for having the very best along for the ride. It's true for the friends who share your journey as well as the gear that makes getting there an honest pleasure. That's where Iron Rider® comes in. This is luggage you're happy to sling over your back fender and carry a thousand miles to your next surprise destination. It looks right on your bike, carries all your stuff safely and securely, and stands up to the rigors of any road trip. Iron Rider bags are smartly designed, skillfully crafted and just right for you and your adventure-seeking compadres. You've earned the right to demand quality. Iron Rider delivers.

TAIL BAGS



NEW FOR
2016

IRON RIDER FRENZY TAIL BAG

ITEM #	COLOR	EXTERIOR SIZE
04979	Black	10" x 10" x 10"

- ▷ Bag can be mounted directly on the rear fender, rear seat, or luggage rack
- ▷ Water-resistant zipper throughout
- ▷ 1680D polyester construction
- ▷ Black reflective piping for added nighttime visibility & safety
- ▷ Includes protective film to protect fender (cut to size for ride)
- ▷ Non-slip material on bottom of bag
- ▷ Includes rain cover
- ▷ 16L carrying capacity
- ▷ Two-year limited warranty

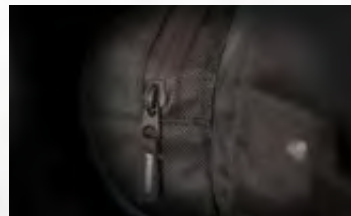

IDER

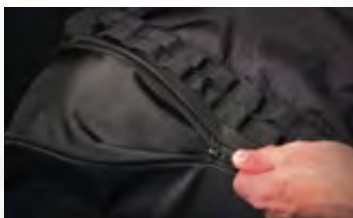
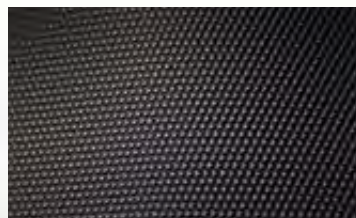

IRON RIDER RUMBLE TAIL BAG

ITEM #	COLOR	EXTERIOR SIZE
04890	Black	Anchor bag: 15" x 6" x 26" Top roll bag: 15" x 3" x 10" Top roll bag expands to: 15" x 5" x 10"

- ▷ Bag can be mounted directly on the rear fender, rear seat, or luggage rack
- ▷ Two bags in one: large base bag, with top small bag for added storage or use as a solo bag
- ▷ Water-resistant zipper throughout
- ▷ 1680D polyester construction
- ▷ MOLLE webbing for modular pouch attachment
- ▷ Black reflective piping for added nighttime visibility & safety
- ▷ Four 1-inch quick-release buckles and rear mounting straps for mounting
- ▷ Two large external pockets with elastic straps for storing tools
- ▷ 5" bottom, drop-down expansion on both sides
- ▷ No conversion straps required to mount additional bags on top
- ▷ Non-slip material on bottom of bag
- ▷ Includes rain covers for each bag
- ▷ Includes protective film to protect fender (cut to size for ride)
- ▷ 38L anchor bag capacity
- ▷ 7L optional top roll bag capacity, 12L expanded
- ▷ Two-year limited warranty

GUARDIAN

FASTRAX

RALLY PACK

IRON RIDER

WILLIE & MAX

TOURING BAG



IRON RIDER QUEST TOUR-PAK® RACK BAG

ITEM #	COLOR	EXTERIOR SIZE
04879	Black	12" x 11" x 20" Expands to: 12" x 14" x 20"

- ▶ Fits nicely on the Harley-Davidson Tour-Pak luggage rack
- ▶ Water-resistant zippers throughout
- ▶ 1680D polyester construction
- ▶ Black reflective piping for added nighttime visibility & safety
- ▶ Integrated universal mounting system with four quick-release buckles
- ▶ Multiple internal mesh storage pockets
- ▶ Soft lined top storage pocket, ideal for sunglasses or other delicate items
- ▶ Front pocket organizer
- ▶ Two large external side pockets
- ▶ Proven four-corner mounting system
- ▶ Rain cover with optional expansion
- ▶ Dual side carrying handles and stowable top carrying handle
- ▶ External D-rings for added functionality
- ▶ 43L capacity, 55L expanded capacity
- ▶ Two-year limited warranty

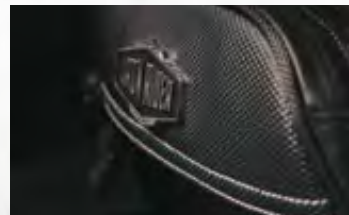

SISSY BAR BAG

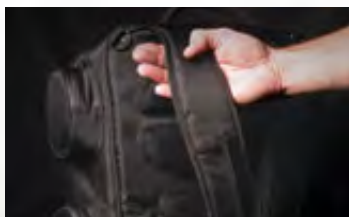

IRON RIDER WEEKENDER SISSY BAR BAG

ITEM #	COLOR	EXTERIOR SIZE
04880	Black	7" x 19" x 13.5"

- ▶ Water-resistant zipper throughout
- ▶ 1680D polyester construction
- ▶ Thermoformed EVA armored lid with internal padded laptop sleeve provides stability & security
- ▶ Black reflective piping for safety at night
- ▶ Soft-lined waterproof sunglass storage pocket
- ▶ Large front pocket with multiple storage pockets
- ▶ Hidden straps easily convert to backpack
- ▶ Reinforced carrying handle
- ▶ Four external side pockets
- ▶ External D-rings for added functionality & mounting options
- ▶ Sissy bar mounting system with straps
- ▶ Two snap shackle hooks for quick access
- ▶ Includes rain cover
- ▶ 29L capacity
- ▶ Two-year limited warranty

GUARDIAN

FASTRAX

RALLY PACK

IRON RIDER

WILLIE & MAX

SISSY BAR BAG



IRON RIDER BRUTE LARGE SISSY BAR BAG

ITEM #	COLOR	EXTERIOR SIZE
04881	Black	15.5" x 21" x 11"

- ▶ 1680D polyester construction
- ▶ Large capacity main compartment
- ▶ Black reflective piping for added nighttime visibility & safety
- ▶ Four 1-inch quick-release buckles and rear mounting straps for mounting
- ▶ Two large external side pockets
- ▶ Two small soft lined pockets for abrasion-resistant storage
- ▶ Zipper removes top compartment dividing wall to accommodate large objects
- ▶ Non-slip material on bottom
- ▶ Mesh internal pockets with laptop sleeve
- ▶ External D-rings for added functionality & storage options
- ▶ Rain cover with optional expansion
- ▶ 60L capacity
- ▶ Two-year limited warranty



MESSENGER BAG

NEW FOR
2016



IRON RIDER MESSENGER BAG

ITEM #	COLOR	EXTERIOR SIZE
05150	Black	16.5" x 12.5" x 6.75"

- ▶ The perfect bag to take you to and from the office, and beyond
- ▶ Features universal mounting straps working well with a luggage rack or sissy bar
- ▶ Waterproof zippers and reflective piping
- ▶ Padded reinforcement throughout, carry handle, and shoulder strap
- ▶ Soft-lined external pockets for delicate items
- ▶ Multiple internal & external storage pockets to isolate smaller items
- ▶ Two-year limited warranty

GUARDIAN

FASTRAX

RALLY PACK

IRON RIDER

WILLIE & MAX

TANK BAG



IRON RIDER TANK BAG - MAGNET MOUNT

ITEM #	COLOR	EXTERIOR SIZE
50130-00	Black	11.25" x 4.75" x 7.5"

- ▷ 1680D polyester construction
- ▷ Durable magnetic mount
- ▷ Water-resistant zipper
- ▷ Soft grip bottom
- ▷ Pass-through for electronic devices
- ▷ Black reflective piping for added nighttime visibility & safety
- ▷ Accommodates maps up to 7" x 6.5"
- ▷ Two-year limited warranty



MAP POCKET

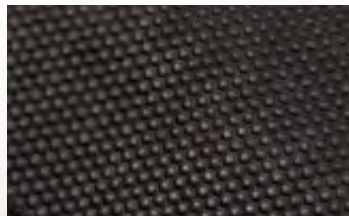

IRON RIDER MAGNETIC MAP POCKET

ITEM #	COLOR	EXTERIOR SIZE
50116-00	Black	11.25" x 18.75" x 17.3"

- ▷ 1680D polyester construction
- ▷ Durable magnetic mount
- ▷ Soft grip bottom
- ▷ Accommodates maps up to 8.25" x 8.5"
- ▷ Two-year limited warranty

GUARDIAN

FASTRAX

RALLY PACK

IRON RIDER

WILLIE & MAX

IMPROVED FOR
2016

MODULAR LUGGAGE SYSTEM

Luggage without baggage, the Iron Rider Modular Luggage System (MLS) gives you the ability you pack as much or as little as you need. We know every trip is unique, and Iron Rider was created with this in mind, allowing you to take only the gear you need, with as much or as little as your destination dictates.





Lockable zippers with pulls



Large openings for easy packing



Plastic molded handles



Universal mounting straps fits most sissy bars



Weatherproof zippers



Non-slip rubberized base for added stability

The MLS adapts to the needs of you, the rider. Unlike other luggage products, each individual bag can be used separately or combined with other pieces for additional storage. Made from durable 1680 polyester, each bag offers generous storage areas, convenient exterior pockets, interior compartments, zipper pulls with extenders, molded clip-on handles, rain covers, and a non-slip rubberized base for stability.

- ▷ Pack for a weekend trip or pack for a week-long trip
- ▷ Convenient "his" and "hers" luggage set-up
- ▷ Keep wet rain gear or damp bike cover away from dry clothing
- ▷ Separate "riding gear" from regular clothes for added convenience

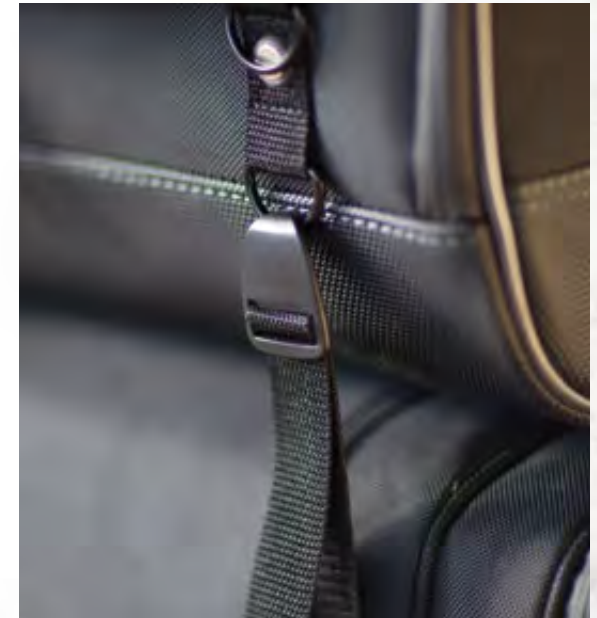

Unique D-rings allow bag-to-bag attachment



Bottom rack attachment straps and metal rivets

MLS SYSTEM BAGS



IRON RIDER MAIN BAG (MB)

ITEM #	COLOR	EXTERIOR SIZE
50125-00	Black	21" x 11.5" x 11.5"

- ▷ The largest bag in the modular luggage system
- ▷ Features front access pockets and expandable sides
- ▷ Rigid construction allows stacking of other MLS bags and helps bag maintain its shape
- ▷ Removable molded handle, shoulder strap, and rain hood
- ▷ 35L capacity
- ▷ Two-year limited warranty



IRON RIDER LARGE ROLL BAG (LRB)

ITEM #	COLOR	SIZE
50156-00	Black	18" x 10" x 13"

- ▷ Features both side & front access pockets
- ▷ Rigid construction allows stacking of other MLS bags and helps bag maintain its shape
- ▷ Removable molded handle, shoulder strap, and rain hood
- ▷ 31L capacity
- ▷ Two-year limited warranty



IRON RIDER OVERNIGHT BAG (OB)

ITEM #	COLOR	EXTERIOR SIZE
50126-00	Black	14" x 10.5" x 9"

- ▷ The ideal bag for any short trip
- ▷ Features front access pockets
- ▷ Rigid construction allows for stacking of other MLS bags and helps bag maintain its shape
- ▷ Removable molded handle, shoulder strap, and rain hood
- ▷ 20L capacity
- ▷ Two-year limited warranty



IRON RIDER ROLL BAG (RB)

ITEM #	COLOR	SIZE
50127-00	Black	14" x 10.5" x 6.5"

- ▷ Valuable on any trip for storage of rain gear, jacket, gloves, or travel cover
- ▷ Rigid construction allows stacking of other MLS bags and helps bag maintain its shape
- ▷ Combine with other MLS bags for additional storage
- ▷ Includes rain hood
- ▷ 15L capacity
- ▷ Two-year limited warranty



IRON RIDER RAIN HOOD

ITEM #	COLOR	SIZE
50149-00	Black	Universal

- ▷ Universally designed to protect practically all sissy bar luggage from the elements using a unique compression system to fit snug, despite the size of the luggage
- ▷ Built-in slots & flaps keep your luggage dry & secure
- ▷ Constructed from durable polyester
- ▷ Waterproof with heat-taped seams
- ▷ Two-year limited warranty

MLS CONFIGURATION OPTIONS



Iron Rider chrome logo on each bag



Rain covers included to protect bags from the elements

Each piece of the Iron Rider luggage is designed to securely attach with other pieces on virtually any bike equipped with a luggage rack and sissy bar. This allows the rider to add, remove, or combine separate luggage pieces as storage needs change. Select from four different luggage products to create the right amount of luggage for any riding situation.

Below are 18 configuration options taking into consideration safety and balanced load capacity. Most riders will stack two bags, and sometimes 3 if they feel safe. It all depends on the type of ride you're going on, your comfort level with riding with luggage, and your center of gravity!



OB, LRB, MB



OB, LRB, LRB

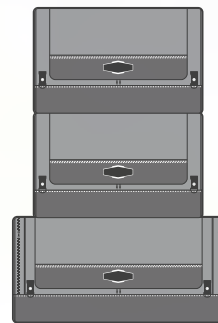

OB, OB, LRB

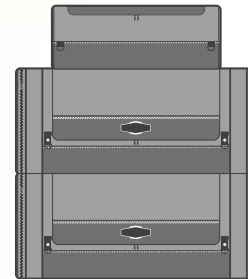

RB, LRB, LRB



RB, LRB, LRB

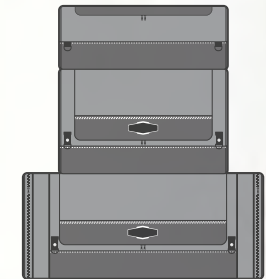

RB, OB, LRB



RB, LRB, LRB



RB, OB, LRB

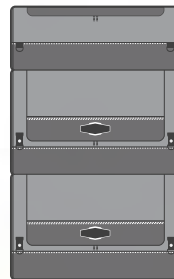

OB, OB



MB, MB

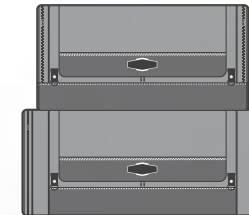

LRB, MB

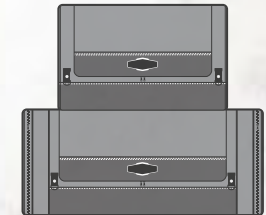

OB, MB

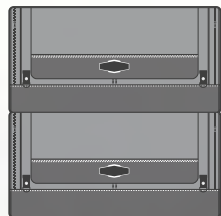

LRB, LRB

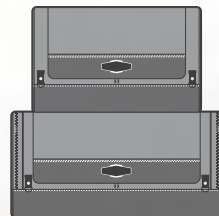

OB, LRB

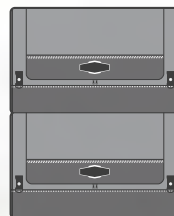

OB, OB

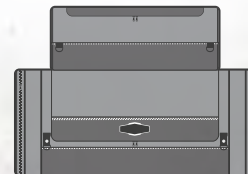

RB, MB

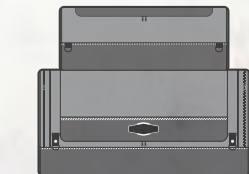

RB, LRB

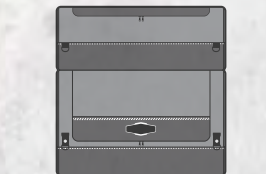

RB, OB





We know how you obsess over your motorcycle. You want your pride and joy to be seen with authentic gear. You want gear that gets noticed while it gets the job done. Gear that whispers the tales of American motorcycling legends who have traveled these roads before. Willie and Max were two such legends. They'd understand your need for adventure ... and quality luggage. Made by master craftsmen with pride, premium leather, and time-honored techniques, Willie & Max® bags have evolved through thousands of rider miles to feature both classic and modern designs. Available in an array of sizes, styles, materials, badging, and trim, the Willie & Max brand has grown from obscurity to icon, allowing every enthusiast to experience a custom look that is as custom as their own ride.

SADDLEBAGS

NEW FOR
2016



- ▷ 100% high quality leather
- ▷ Mounting slots in back of the bag
- ▷ Must be used in conjunction with a hard mount or detachable bracket system (not included)
- ▷ In order to ensure multiple models & style fitments, bolt-on bags are not pre-drilled
- ▷ Made in the USA
- ▷ Limited lifetime warranty





MONTANA PLAIN LEATHER SADDLEBAGS

ITEM #	COLOR	EXTERIOR SIZE
8004-03	Black	11" x 13" x 7"



MONTANA STUDED LEATHER SADDLEBAGS

ITEM #	COLOR	EXTERIOR SIZE
8004A-03	Black	11" x 13" x 7"



VENTURA LEATHER SADDLEBAGS

ITEM #	COLOR	EXTERIOR SIZE
8011-03	Black	11" x 13" x 8"



MIGHTY LEGEND PLAIN LEATHER SADDLEBAGS

ITEM #	COLOR	EXTERIOR SIZE
8021-03	Black	12" x 16" x 8"



MIGHTY LEGEND STUDED LEATHER SADDLEBAGS

ITEM #	COLOR	EXTERIOR SIZE
8021A-03	Black	12" x 16" x 8"

NEW FOR
2016

WINDSHIELD & FORK BAGS

- ▷ 100% American leather
- ▷ Intended to mount to the windshield of a bike
- ▷ Made in the USA
- ▷ Limited lifetime warranty



High mount clips on back of bags



Low mount clips on back of bags





WINDSHIELD BAG SMALL

ITEM #	COLOR	EXTERIOR SIZE	BIKE TYPE
8066-H	Black	5" x 9" x 3.5"	HD high mount
8066-L	Black	5" x 9" x 3.5"	Metric low mount



WINDSHIELD BAG LARGE

ITEM #	COLOR	EXTERIOR SIZE	BIKE TYPE
8062-H	Black	5" x 10.5" x 3.5"	HD high mount
8062-L	Black	5" x 10.5" x 3.5"	Metric low mount



FORK BAG OVAL

ITEM #	COLOR	EXTERIOR SIZE	BIKE TYPE
8064	Black	5.5" x 10" x 4"	Universal



WINDSHIELD BAG STUDDED

ITEM #	COLOR	EXTERIOR SIZE	BIKE TYPE
8066A-H	Black	5" x 9" x 3.5"	HD high mount
8066A-L	Black	5" x 9" x 3.5"	Metric low mount



WINDSHIELD BAG STUDDED

ITEM #	COLOR	EXTERIOR SIZE	BIKE TYPE
8062A-H	Black	5" x 10.5" x 3.5"	HD high mount
8062A-L	Black	5" x 10.5" x 3.5"	Metric low mount



STUDDED FORK BAG OVAL

ITEM #	COLOR	EXTERIOR SIZE	BIKE TYPE
8064A	Black	5.5" x 10" x 4"	Universal

LIMITED EDITION SWINGARM BAG





BROWN LEATHER TRIANGLE SWINGARM BAG

ITEM #	COLOR	EXTERIOR SIZE
59909-00	Brown	10.5" x 11.5" x 4.5" Fits Harley-Davidson Softails, Yamaha Road Star, Kawasaki Vulcan 900, Suzuki C50

BROWN LEATHER SPORTSTER SWINGARM BAG

ITEM #	COLOR	EXTERIOR SIZE
59907-00	Brown	10.5" x 11.5" x 4.5" Fits Harley-Davidson Sportsters or custom hard tail bikes

- ▷ Available for order now - limited quantities; when they're gone, they're gone!
- ▷ 100% American leather
- ▷ Mounting slots in back of the bag
- ▷ Brown hornet corrected grain cattle hide 8-9oz.
- ▷ Limited edition debossed logo and "Made in the USA" branding
- ▷ Upgraded leather mounting straps included for easy installation
- ▷ Durable bag construction using brown leather with chrome buckle and added magnetic securing attachment
- ▷ Made in the USA
- ▷ Limited lifetime warranty



SWINGARM BAGS



- ▷ 100% leather
- ▷ Mounting slots in back of the bag
- ▷ Upgraded leather mounting straps included for easy installation
- ▷ Durable bag construction using high-quality leather with added magnetic securing attachment
- ▷ Made in the USA
- ▷ Limited lifetime warranty





BLACK LEATHER SWINGARM BAG – DUAL SHOCK W/ BLACK MATTE BUCKLE – SPORTSTER

ITEM #	COLOR	EXTERIOR SIZE
59906-00	Black	10.5" x 11.5" x 4.5" Fits Harley-Davidson Sportsters or custom hard tail bikes



BLACK LEATHER SWINGARM BAG – DUAL SHOCK W/ CHROME BUCKLE

ITEM #	COLOR	EXTERIOR SIZE
59904-00	Black	10.5" x 11.5" x 4.5" Fits Harley-Davidson Sportsters or custom hard tail bikes



BLACK LEATHER SWINGARM BAG W/ BLACK MATTE BUCKLE – TRIANGLE SWINGARM

ITEM #	COLOR	EXTERIOR SIZE
59893-00	Black	10.5" x 11.5" x 4.5" Fits Harley-Davidson Softails, Yamaha Road Stars, Kawasaki Vulcan 900, Suzuki C50



BLACK LEATHER SWINGARM BAG W/ CHROME BUCKLE – TRIANGLE SWINGARM

ITEM #	COLOR	EXTERIOR SIZE
59823-00	Black	10.5" x 11.5" x 4.5" Fits Harley-Davidson Softails, Yamaha Road Stars, Kawasaki Vulcan 900, Suzuki C50

SWINGARM BAGS



- ▷ Slotted mounting slots in back of the bag
- ▷ Synthetic leather material has feel of real leather, yet durable & weather-resistant
- ▷ Upgraded leather mounting straps included for easy installation
- ▷ Durable bag construction with chrome buckles and added magnetic securing attachments
- ▷ Made in the USA
- ▷ Limited lifetime warranty





BLACK SWINGARM BAG - DUAL SHOCK

ITEM #	COLOR	EXTERIOR SIZE
59778-00	Black	10.5" x 11.5" x 4.5" Fits Harley-Davidson Sportsters or custom hard tail bikes



BLACK SWINGARM BAG - TRIANGLE SWINGARM

ITEM #	COLOR	EXTERIOR SIZE
59776-00	Black	10.5" x 11.5" x 4.5" Fits Harley-Davidson Softails, Yamaha Road Stars, Kawasaki Vulcan 900, Suzuki C50



BROWN SWINGARM BAG - DUAL SHOCK

ITEM #	COLOR	EXTERIOR SIZE
59779-00	Brown	10.5" x 11.5" x 4.5" Fits Harley-Davidson Sportsters or custom hard tail bikes



BROWN SWINGARM BAG - TRIANGLE SWINGARM

ITEM #	COLOR	EXTERIOR SIZE
59777-00	Brown	10.5" x 11.5" x 4.5" Fits Harley-Davidson Softails, Yamaha Road Stars, Kawasaki Vulcan 900, Suzuki C50

TOOL BAGS



- ▷ Universal install
- ▷ Multiple mounting options including forks, swing arms, handle bars, & others
- ▷ Full function metal buckles
- ▷ Made of synthetic leather
- ▷ Made in the USA
- ▷ Limited lifetime warranty





AMERICAN CLASSIC TOOL BAG

ITEM #	COLOR	EXTERIOR SIZE
58280-01	Black	12" x 5" x 2.5"



BLACK MAGIC TOOL BAG

ITEM #	COLOR	EXTERIOR SIZE
58282-20	Black	12" x 5" x 2.5"



BRAIDED SERIES TOOL BAG

ITEM #	COLOR	EXTERIOR SIZE
58232-20	Black	12" x 5" x 3.5"



DELUXE TOOL BAG

ITEM #	COLOR	EXTERIOR SIZE
58100-01	Black	12" x 5" x 2.5"

TOOL BAGS



GREY THUNDER STUDED TOOL BAG

ITEM #	COLOR	EXTERIOR SIZE
58245-01	Black	12" x 5" x 2.5"



GREY THUNDER TOOL BAG

ITEM #	COLOR	EXTERIOR SIZE
58246-20	Black	12" x 5" x 2.5"



RANGER STUDED TOOL BAG

ITEM #	COLOR	EXTERIOR SIZE
58252-01	Black	12" x 5" x 2.5"



RAPTOR SERIES TOOL BAG

ITEM #	COLOR	EXTERIOR SIZE
58210-00	Black	12" x 5" x 2.5"



REVOLUTION TOOL BAG

ITEM #	COLOR	EXTERIOR SIZE
59512-00	Black	12" x 5.5" x 4"



STANDARD SERIES COMPACT TOOL BAG

ITEM #	COLOR	EXTERIOR SIZE
58111-00	Black	8" x 5" x 4"



STANDARD SERIES TOOL BAG

ITEM #	COLOR	EXTERIOR SIZE
58100-00	Black	12" x 5" x 2.5"



WARRIOR TOOL BAG

ITEM #	COLOR	EXTERIOR SIZE
58272-01	Black	12" x 5" x 2.5"

WINDSHIELD BAGS





DUAL PURPOSE WINDSHIELD BAG / HANDLEBAR POUCH

ITEM #	COLOR	EXTERIOR SIZE
58611-00	Black	7.5" x 4" x 2.5"

- ▷ Opens & closes quickly with hook & loop closure system
- ▷ Made of synthetic leather
- ▷ Includes zip ties and peel & stick hook & loop strips
- ▷ Made in the USA
- ▷ Limited lifetime warranty



REVOLUTION WINDSHIELD BAG

ITEM #	COLOR	EXTERIOR SIZE
59513-00	Black	10.5" x 6" x 2.5"

- ▷ Universal windshield bag mounts to chrome strap on your windshield
- ▷ High-quality chrome quarter-turn fastener keeps contents protected
- ▷ Made of synthetic leather
- ▷ Made in the USA
- ▷ Limited lifetime warranty



TAKE ALONG WINDSHIELD BAG

ITEM #	COLOR	EXTERIOR SIZE
58011-00	Black	10.5" x 5.5" x 3"

- ▷ Easy-mount bracket mounts to the windshield crossbar using existing nuts & bolts
- ▷ Turnbuckles on the bracket allow easy removal
- ▷ Bracket & bags will conform to the curve of the windshield
- ▷ Carry strap included
- ▷ Made of synthetic leather
- ▷ Made in the USA
- ▷ Limited lifetime warranty



TWO-POUCH WINDSHIELD BAG

ITEM #	COLOR	EXTERIOR SIZE
04725	Black	21.25" x 2.25" x 6.5" Harley-Davidson 1996-2013 FLH & FLHD windshield 4" & taller; Willie & Max fairing

- ▷ Mounts between windshield & fairing
- ▷ Hook & loop fasteners
- ▷ Pass-through for electronics
- ▷ Made of synthetic leather
- ▷ One-year limited warranty

REVOLUTION SADDLEBAGS



SADDLEBAG MOUNTING OPTIONS

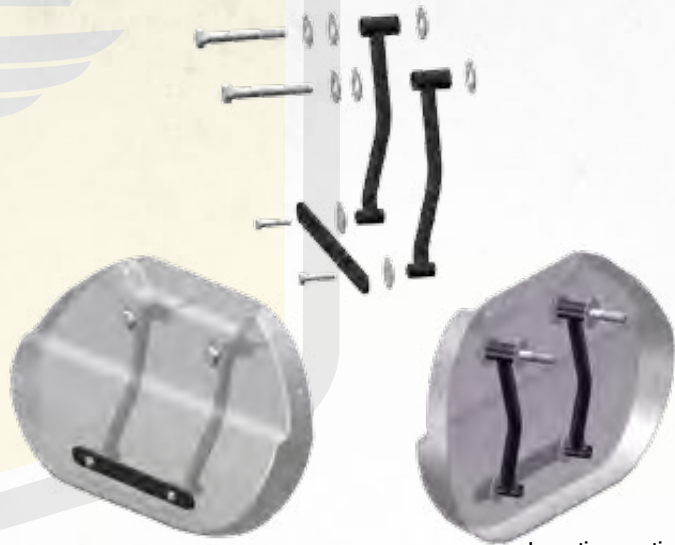

Innovative mounting system included with all hard mount bags.

HARD MOUNT STYLE

- ▷ Injection-molded backs contour to fit Willie & Max's exclusive new universal hard mount system. Each hard mount bag includes rock-solid adjustable mounting brackets & hardware to fit most cruisers on the market
- ▷ Powder-coated wire frame and reinforced gussets retain saddlebag shape & look for the long haul
- ▷ High-quality chrome buckles feature quick-release system for fast access to saddlebags
- ▷ Front & rear enclosure snaps aid in lid security at high speeds



THROW OVER STYLE

- ▷ Reinforced backs provide superior bag stability when compared to "other" throw overs
- ▷ Reinforced yokes for secure universal mounting above or below the seat
- ▷ Zip-off yokes and carry handles make removal & transport a breeze
- ▷ Powder-coated wire frame & reinforced gussets retain saddlebag shape & look for the long haul
- ▷ High-quality chrome buckles feature hidden quick release system for fast access to saddlebags
- ▷ Front & rear closure snaps aid in lid security at high speeds



SADDLEBAG SUPPORT / HARD MOUNT KIT

ITEM #	COLOR
58633-00	Black

- ▷ Designed to work with all Willie & Max saddlebags or any throw-over style saddlebag with a reinforced backing or tub for rigidity & load distribution.
- ▷ Specific applications may require additional hardware
- ▷ Made of steel
- ▷ Limited lifetime warranty

REVOLUTION SADDLEBAGS



REVOLUTION SERIES RETRO THROW OVER SADDLEBAGS

ITEM #	COLOR	EXTERIOR SIZE
59487-00	Black	S - 18.5" x 10.5" x 6"
59486-00	Black	L - 20.5" x 11.5" x 6"



- Features reinforced backs
- Powder-coated wire frames and reinforced gussets retain saddlebag shape
- Chrome buckles with quick-release fastener & zip-off yokes
- Made of synthetic leather
- Capacity: Small - 15L per side, Large - 18.5L per side
- Made in the USA
- Limited lifetime warranty

REVOLUTION SERIES RETRO HARDMOUNT SADDLEBAGS

ITEM #	COLOR	EXTERIOR SIZE
59481-00	Black	S - 18.5" x 10.5" x 6"
59480-00	Black	L - 20.5" x 11.5" x 6"



- Features injection-molded backs contoured to fit hard mount system (included)
- Mounting brackets & hardware to fit most cruisers on the market
- Includes all the features of the throw over series, less the zip-off yokes
- Made in the USA
- Limited lifetime warranty



REVOLUTION SERIES SWOOPED THROW OVER SADDLEBAGS

ITEM #	COLOR	EXTERIOR SIZE
03443	Black	S - 18.5" x 10.5" x 6"
03442	Black	L - 20.5" x 11.5" x 6"



- Features reinforced backs
- Powder-coated wire frames and reinforced gussets retain saddlebag shape
- Chrome buckles with quick-release fastener & zip-off yokes
- Made of synthetic leather
- Capacity: Small - 15L per side, Large - 18.5L per side
- Made in the USA
- Limited lifetime warranty

REVOLUTION SERIES SWOOPED HARD MOUNT SADDLEBAGS

ITEM #	COLOR	EXTERIOR SIZE
03437	Black	S - 18.5" x 10.5" x 6"
03436	Black	L - 20.5" x 11.5" x 6"



- Features injection-molded backs contoured to fit hard mount system (included)
- Mounting brackets & hardware to fit most cruisers on the market
- Includes all the features of the throw over series, less the zip-off yokes
- Made in the USA
- Limited lifetime warranty



REVOLUTION SERIES STANDARD THROW OVER SADDLEBAGS

ITEM #	COLOR	EXTERIOR SIZE
59483-00	Black	S - 18.5" x 10.5" x 6"
59482-00	Black	L - 20.5" x 11.5" x 6"



- ▷ Features reinforced backs
- ▷ Powder-coated wire frames and reinforced gussets retain saddlebag shape
- ▷ Chrome buckles with quick-release fastener & zip-off yokes
- ▷ Made of synthetic leather
- ▷ Capacity: Small - 15L per side, Large - 18.5L per side
- ▷ Made in the USA
- ▷ Limited lifetime warranty

REVOLUTION SERIES STANDARD HARD MOUNT SADDLEBAGS

ITEM #	COLOR	EXTERIOR SIZE
59477-00	Black	S - 18.5" x 10.5" x 6"
59476-00	Black	L - 20.5" x 11.5" x 6"



- ▷ Features injection-molded backs contoured to fit hard mount system (included)
- ▷ Mounting brackets & hardware to fit most cruisers on the market
- ▷ Includes all the features of the throw over series, less the zip-off yokes
- ▷ Made in the USA
- ▷ Limited lifetime warranty



REVOLUTION SERIES BELTED THROW OVER SADDLEBAGS

ITEM #	COLOR	EXTERIOR SIZE
59485-00	Black	S - 18.5" x 10.5" x 6"
59484-00	Black	L - 20.5" x 11.5" x 6"



- ▷ Features reinforced backs
- ▷ Powder-coated wire frames and reinforced gussets retain saddlebag shape
- ▷ Chrome buckles with quick-release fastener & zip-off yokes
- ▷ Made of synthetic leather
- ▷ Capacity: Small - 15L per side, Large - 18.5L per side
- ▷ Made in the USA
- ▷ Limited lifetime warranty

REVOLUTION SERIES BELTED HARD MOUNT SADDLEBAGS

ITEM #	COLOR	EXTERIOR SIZE
59479-00	Black	S - 18.5" x 10.5" x 6"
59478-00	Black	L - 20.5" x 11.5" x 6"



- ▷ Features injection-molded backs contoured to fit hard mount system (included)
- ▷ Mounting brackets & hardware to fit most cruisers on the market
- ▷ Includes all the features of the throw over series, less the zip-off yokes
- ▷ Made in the USA
- ▷ Limited lifetime warranty

SLANT SADDLEBAGS



BLACK JACK LARGE SLANT SADDLEBAGS

ITEM #	COLOR	EXTERIOR SIZE
59589-00 Large	Black	16" x 11" x 6.5"
59588-00 Compact	Black	12" x 9.5" x 5.5"

- ▷ Features a sleek, clean look
- ▷ Zip-off yokes and quick-release buckles
- ▷ Sewn-in handles for easy transfer from the bike
- ▷ Plastic reinforcing for shape retention
- ▷ Made of synthetic leather
- ▷ Made in the USA
- ▷ Limited lifetime warranty



BRAIDED SERIES LARGE SLANT SADDLEBAGS

ITEM #	COLOR	EXTERIOR SIZE
58709-20	Black	16" x 11" x 6.5"

- ▷ Features three-strand braided design
- ▷ Zip-off yokes and quick-release buckles
- ▷ Sewn-in handles for easy transfer from the bike
- ▷ Plastic reinforcing for shape retention
- ▷ Made of synthetic leather
- ▷ Made in the USA
- ▷ Limited lifetime warranty



BLACK MAGIC SERIES SLANT SADDLEBAGS

ITEM #	COLOR	EXTERIOR SIZE
58736-20 Large	Black	16" x 11" x 6.5"
59708-20 Compact	Black	12" x 9.5" x 5.5"

- ▷ Three-strand braided design with large gold & silver eagle
- ▷ Zip-off yokes and quick-release buckles
- ▷ Sewn-in handles for easy transfer from the bike
- ▷ Plastic reinforcing for shape retention
- ▷ Made of synthetic leather
- ▷ Made in the USA
- ▷ Limited lifetime warranty



BRAIDED SERIES STANDARD SLANT SADDLEBAGS

ITEM #	COLOR	EXTERIOR SIZE
58701-20 Standard	Black	14" x 12" x 5.5"
58707-20 Compact	Black	12" x 9.5" x 5.5"

- ▷ Features three-strand braid design
- ▷ Zip-off yokes and quick-release buckles
- ▷ Sewn-in handles for easy transfer from the bike
- ▷ Plastic reinforcing for shape retention
- ▷ Made of synthetic leather
- ▷ Made in the USA
- ▷ Limited lifetime warranty



DELUXE SERIES LARGE SLANT SADDLEBAGS

ITEM #	COLOR	EXTERIOR SIZE
58718-00	Black	16" x 11" x 6.5"

- ▷ Features 1.5" silver concho with decorative lace
- ▷ Zip-off yokes and quick-release buckles
- ▷ Sewn-in handles for easy transfer from the bike
- ▷ Plastic reinforcing for shape retention
- ▷ Made of synthetic leather
- ▷ Made in the USA
- ▷ Limited lifetime warranty



DELUXE SERIES SLANT SADDLEBAGS

ITEM #	COLOR	EXTERIOR SIZE
58700-00 Standard	Black	14" x 12" x 5.5"
58707-00 Compact	Black	12" x 9.5" x 5.5"

- ▷ Features 1.5" silver concho with decorative lace
- ▷ Zip-off yokes and quick-release buckles
- ▷ Sewn-in handles for easy transfer from the bike
- ▷ Plastic reinforcing for shape retention
- ▷ Made of synthetic leather
- ▷ Made in the USA
- ▷ Limited lifetime warranty



GREY THUNDER SERIES SLANT SADDLEBAGS

ITEM #	COLOR	EXTERIOR SIZE
58705-20 Standard	Black	12" x 9.5" x 5.5"
58746-20 Large	Black	16" x 11" x 6.5"

- ▷ Features three-strand braided accent and grey color accents
- ▷ Zip-off yokes and quick-release buckles
- ▷ Sewn-in handles for easy transfer from the bike
- ▷ Plastic reinforcing for shape retention
- ▷ Made of synthetic leather
- ▷ Made in the USA
- ▷ Limited lifetime warranty



GREY THUNDER STUDED SERIES SLANT SADDLEBAGS

ITEM #	COLOR	EXTERIOR SIZE
58706-01 Compact	Black	12" x 9.5" x 5.5"
58745-01 Large	Black	16" x 11" x 6.5"

- ▷ Three-strand braid, grey color accents with studs & silver eagle
- ▷ Zip-off yokes and quick-release buckles
- ▷ Sewn-in handles for easy transfer from the bike
- ▷ Plastic reinforcing for shape retention
- ▷ Made of synthetic leather
- ▷ Made in the USA
- ▷ Limited lifetime warranty

SLANT SADDLEBAGS



RANGER SERIES LARGE SLANT SADDLEBAGS - BRAIDED

ITEM #	COLOR	EXTERIOR SIZE	USA
58750-20	Black	16" x 11" x 6.5"	

- ▶ Three-strand braid design and small front pocket for added storage
- ▶ Zip-off yokes and quick-release buckles
- ▶ Sewn-in handles for easy transfer from the bike
- ▶ Plastic reinforcing for shape retention
- ▶ Made of synthetic leather
- ▶ Made in the USA
- ▶ Limited lifetime warranty



RANGER SERIES LARGE SLANT SADDLEBAGS - PLAIN

ITEM #	COLOR	EXTERIOR SIZE	USA
58750-00	Black	16" x 11" x 6.5"	

- ▶ Small front pocket for added storage
- ▶ Zip-off yokes and quick-release buckles
- ▶ Sewn-in handles for easy transfer from the bike
- ▶ Plastic reinforcing for shape retention
- ▶ Made of synthetic leather
- ▶ Made in the USA
- ▶ Limited lifetime warranty



RANGER SERIES LARGE SLANT SADDLEBAGS - STUDED

ITEM #	COLOR	EXTERIOR SIZE	USA
58750-01	Black	16" x 11" x 6.5"	

- ▶ Nickel chrome studding and small front pocket for added storage
- ▶ Zip-off yokes and quick-release buckles
- ▶ Sewn-in handles for easy transfer from the bike
- ▶ Plastic reinforcing for shape retention
- ▶ Made of synthetic leather
- ▶ Made in the USA
- ▶ Limited lifetime warranty



RANGER SERIES STANDARD SLANT SADDLEBAGS

ITEM #	COLOR	EXTERIOR SIZE	USA
58702-01	Black	14" x 12" x 5.5"	

- ▶ Features studded design
- ▶ Zip-off yokes and quick-release buckles
- ▶ Sewn-in handles for easy transfer from the bike
- ▶ Plastic reinforcing for shape retention
- ▶ Made of synthetic leather
- ▶ Made in the USA
- ▶ Limited lifetime warranty



RAPTOR SERIES SLANT SADDLEBAGS

ITEM #	COLOR	EXTERIOR SIZE	USA
58801-00 Compact	Black	12" x 9.5" x 5.5"	
58802-00 Standard	Black	14" x 12" x 5.5"	
58803-00 Large	Black	16" x 11" x 6.5"	

- ▶ Features clean, sleek look
- ▶ Zip-off yokes and hook & loop enclosure
- ▶ Sewn-in handles for easy transfer from the bike
- ▶ Plastic reinforcing for shape retention
- ▶ Made of synthetic leather
- ▶ Made in the USA
- ▶ Limited lifetime warranty

STRAIGHT SADDLEBAGS



AMERICAN CLASSIC SERIES STRAIGHT SADDLEBAGS

ITEM #	COLOR	EXTERIOR SIZE	
58380-00	Black	14.5" x 11.5" x 5.5"	

- ▶ Features studs, conchos, and fringe
- ▶ Zip-off yokes and quick-release buckles
- ▶ Sewn-in handles for easy transfer from the bike
- ▶ Plastic reinforcing for shape retention
- ▶ Made of synthetic leather
- ▶ Made in the USA
- ▶ Limited lifetime warranty



BRAIDED SERIES STRAIGHT SADDLEBAGS

ITEM #	COLOR	EXTERIOR SIZE	
58330-20	Black	14.5" x 12" x 5.5"	

- ▶ Features three-strand braid along perimeter of the base and lid of the bags
- ▶ Zip-off yokes and quick-release buckles
- ▶ Sewn-in handles for easy transfer from the bike
- ▶ Plastic reinforcing for shape retention
- ▶ Made of synthetic leather
- ▶ Made in the USA
- ▶ Limited lifetime warranty



STANDARD SERIES STRAIGHT SADDLEBAGS

ITEM #	COLOR	EXTERIOR SIZE	
58301-00	Black	11" x 12" x 3.5"	

- ▶ Zip-off yokes and quick-release buckles
- ▶ Sewn-in handles for easy transfer from the bike
- ▶ Plastic reinforcing for shape retention
- ▶ Made of synthetic leather
- ▶ Made in the USA
- ▶ Limited lifetime warranty



STANDARD SERIES TOURING SADDLEBAGS

ITEM #	COLOR	EXTERIOR SIZE	
58311-00	Black	14" x 13" x 5.5"	

- ▶ Zip-off yokes and quick-release buckles
- ▶ Sewn-in handles for easy transfer from the bike
- ▶ Plastic reinforcing for shape retention
- ▶ Made of synthetic leather
- ▶ Made in the USA
- ▶ Limited lifetime warranty



WARRIOR SERIES STRAIGHT SADDLEBAGS

ITEM #	COLOR	EXTERIOR SIZE	
58320-00	Black	14" x 10" x 4.5"	

- ▶ Features conchos, fringe, studded & braided design
- ▶ Zip-off yokes and quick-release buckles
- ▶ Sewn-in handles for easy transfer from the bike
- ▶ Plastic reinforcing for shape retention
- ▶ Made of synthetic leather
- ▶ Made in the USA
- ▶ Limited lifetime warranty



SADDLEBAG SUPPORT / HARD MOUNT KIT

ITEM #	COLOR
58633-00	Black

- ▶ Designed to work with all Willie & Max saddlebags or any throw-over style saddlebag with a reinforced backing or tub for rigidity & load distribution.
- ▶ Specific applications may require additional hardware
- ▶ Made of steel
- ▶ Limited lifetime warranty

SADDLEBAG MEASUREMENT

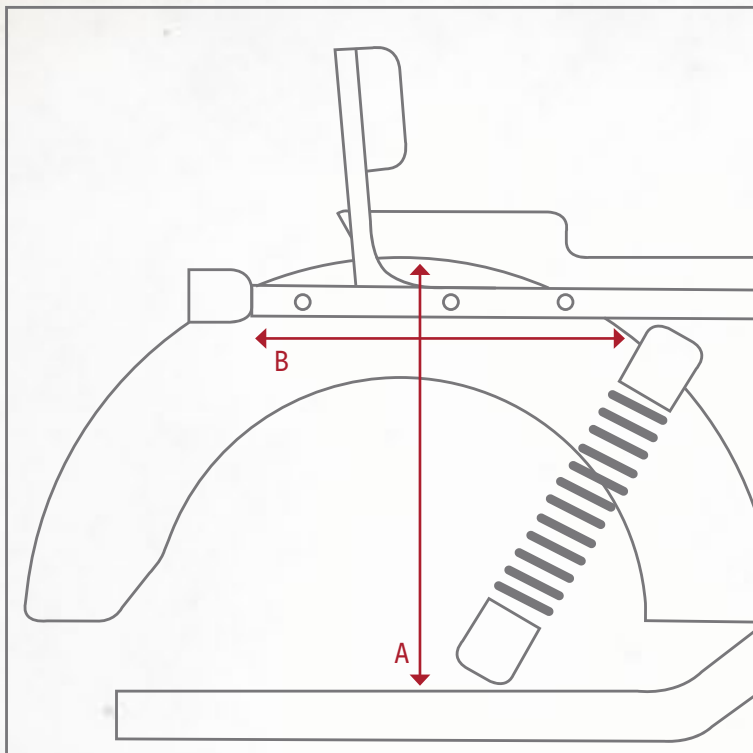

**** All bikes are different, please use this as a reference only**

Proper measurements required for fitting saddlebags are as follows:

1. Bags are measured from the back of the bag
2. **Measure side to side (B):** From the back of the seat (rider's position) or shock to the back of the turn signal. Measurement should be greater than the top of the bag length (L).
3. **Measurement from the top to bottom (A):** From the bottom of the seat pad or to the top of the fender to the top of the exhaust pipe. Subtract 2 inches from measurement. This is your maximum saddlebag height (H) for clearance.
4. **Maximum Clearance (MC):** The second measurement in (parentheses) is the maximum clearance on the bag. Longest point to longest point.

All throw-over saddlebags must be used in conjunction with a saddlebag support bracket to keep bags from interfering with any operating components. Two inches of space must be allowed between bottom of bag and top of exhaust pipes for safety. Re-check clearance when saddlebag is loaded (and with rider if you will have passenger) to reassure clearance requirements have been met. **** Do not overload bags - recommended maximum weight is 10 lbs. per side.**



Height x Length x Maximum Clearance x Depth



SISSY BAR BAGS



- ▷ Attached carry handle
- ▷ Quick-release buckles
- ▷ Made of synthetic leather
- ▷ Made in the USA
- ▷ Limited lifetime warranty





AMERICAN CLASSIC SERIES SISSY BAR BAG

ITEM #	COLOR	EXTERIOR SIZE
58480-00	Black	8" x 10" x 4.5"



BLACK JACK SISSY BAR BAG

ITEM #	COLOR	EXTERIOR SIZE
59591-00	Black	8" x 10" x 4.5"



BLACK MAGIC SERIES SISSY BAR BAG

ITEM #	COLOR	EXTERIOR SIZE
58411-00	Black	8" x 10" x 4.5"



BRAIDED SERIES SISSY BAR BAG

ITEM #	COLOR	EXTERIOR SIZE
58481-20	Black	8" x 10" x 4.5"

SISSY BAR BAGS



DELUXE SERIES SISSY BAR BAG

ITEM #	COLOR	EXTERIOR SIZE
58451-00	Black	8" x 10" x 4.5"



GREY THUNDER SERIES SISSY BAR BAG

ITEM #	COLOR	EXTERIOR SIZE
58446-20	Black	8" x 10" x 4.5"



GREY THUNDER STUDED SERIES SISSY BAR BAG

ITEM #	COLOR	EXTERIOR SIZE
58445-01	Black	8" x 10" x 4.5"



RANGER SERIES SISSY BAR BAG

ITEM #	COLOR	EXTERIOR SIZE
58452-01	Black	8" x 10" x 4.5"





RAPTOR SERIES SISSY BAR BAG

ITEM #	COLOR	EXTERIOR SIZE
58472-00	Black	8" x 10" x 4.5"



STANDARD SERIES COMPACT SISSY BAR BAG

ITEM #	COLOR	EXTERIOR SIZE
58421-00	Black	6" x 8" x 3"



WARRIOR SERIES SISSY BAR BAG

ITEM #	COLOR	EXTERIOR SIZE
58431-00	Black	8" x 10" x 4.5"



TRUNK BAGS



BLACK JACK TOUR TRUNK BAG

ITEM #	COLOR	EXTERIOR SIZE
59592-00	Black	13" x 9.5" x 10"



- ▷ Features a sleek, clean design
- ▷ Quick-release buckles
- ▷ Attached carry handle and plastic reinforcing for shape retention
- ▷ Made of synthetic leather
- ▷ Made in the USA
- ▷ Limited lifetime warranty



BLACK MAGIC SERIES TOUR TRUNK BAG

ITEM #	COLOR	EXTERIOR SIZE
58509-20	Black	13" x 9.5" x 10"



- ▷ Three-strand braid design and large gold & silver eagle medallion
- ▷ Quick-release buckles
- ▷ Attached carry handle and plastic reinforcing for shape retention
- ▷ Made of synthetic leather
- ▷ Made in the USA
- ▷ Limited lifetime warranty



BRAIDED SERIES TOUR TRUNK BAG

ITEM #	COLOR	EXTERIOR SIZE
58507-20	Black	13" x 9.5" x 10"



- ▷ Features three-strand braid
- ▷ Quick-release buckles
- ▷ Attached carry handle and plastic reinforcing for shape retention
- ▷ Made of synthetic leather
- ▷ Made in the USA
- ▷ Limited lifetime warranty



DELUXE SERIES TOUR TRUNK BAG

ITEM #	COLOR	EXTERIOR SIZE
58506-00	Black	13" x 9.5" x 10"



- ▷ Features clean, sleek design with silver concho
- ▷ Quick-release buckles
- ▷ Attached carry handle and plastic reinforcing for shape retention
- ▷ Made of synthetic leather
- ▷ Made in the USA
- ▷ Limited lifetime warranty



GREY THUNDER SERIES TOUR TRUNK BAG

ITEM #	COLOR	EXTERIOR SIZE
58510-20	Black	13" x 9.5" x 10"



- ▷ Three-strand braid design with grey accents
- ▷ Quick-release buckles
- ▷ Attached carry handle and plastic reinforcing for shape retention
- ▷ Made of synthetic leather
- ▷ Made in the USA
- ▷ Limited lifetime warranty



GREY THUNDER STUDED SERIES TOUR TRUNK BAG

ITEM #	COLOR	EXTERIOR SIZE
58511-01	Black	13" x 9.5" x 10"



- ▷ Three-strand braid with grey accents/studding
- ▷ Quick-release buckles
- ▷ Attached carry handle and plastic reinforcing for shape retention
- ▷ Made of synthetic leather
- ▷ Made in the USA
- ▷ Limited lifetime warranty



RANGER SERIES STUDED TOUR TRUNK BAG

ITEM #	COLOR	EXTERIOR SIZE	USA
58502-01	Black	13" x 9.5" x 10"	

- Features studded design
- Quick-release buckles
- Attached carry handle and plastic reinforcing for shape retention
- Made of synthetic leather
- Made in the USA
- Limited lifetime warranty



RAPTOR SERIES TOUR TRUNK BAG

ITEM #	COLOR	EXTERIOR SIZE	USA
58517-00	Black	13" x 9.5" x 10"	

- Features clean, sleek design
- Quick-release buckles
- Attached carry handle and plastic reinforcing for shape retention
- Made of synthetic leather
- Made in the USA
- Limited lifetime warranty



REVOLUTION SERIES TRUNK BAG

ITEM #	COLOR	EXTERIOR SIZE	USA
59488-00	Black	13.5" x 15.5" x 9.5"	

- Quick-release buckle
- Attached carry handle and plastic reinforcing for shape retention
- Powder-coated wire frame and reinforced gussets
- Universal mounting system with standard hook & loop system will fit most sissy bars with luggage rack combo
- Made of synthetic leather
- Made in the USA
- Limited lifetime warranty



STANDARD SERIES TOUR TRUNK BAG

ITEM #	COLOR	EXTERIOR SIZE	USA
58505-00	Black	13" x 9.5" x 10"	

- Features clean, sleek design
- Quick-release buckles
- Attached carry handle and plastic reinforcing for shape retention
- Made of synthetic leather
- Made in the USA
- Limited lifetime warranty



WARRIOR SERIES TOUR TRUNK BAG

ITEM #	COLOR	EXTERIOR SIZE	USA
58512-01	Black	13" x 9.5" x 10"	

- Three-strand braid design, studs, and conchos with fringe
- Quick-release buckles
- Attached carry handle and plastic reinforcing for shape retention
- Made of synthetic leather
- Made in the USA
- Limited lifetime warranty

ACCESSORIES



THE HOOKER

ITEM #	COLOR	EXTERIOR SIZE
58622-00	Black	Adjustable from 12" to 20" x 7.5"

- ▷ Fits under the passenger seat or pad
- ▷ Extended D-rings allow quick & easy attachment of bungee hooks
- ▷ Made of synthetic leather
- ▷ Made in the USA
- ▷ Limited lifetime warranty

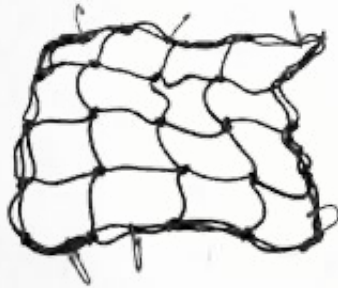

MOTORCYCLE BUNGEE / CARGO NET

ITEM #	COLOR	SIZE
04628	Black	12" x 12" flat

- ▷ Six vinyl-coated hooks
- ▷ Secures loads up to 25 pounds
- ▷ Perfect for storing your helmet or jacket to the back of your bike
- ▷ One-year limited warranty



LARGE UNIVERSAL TRUNK LINER

ITEM #	COLOR	EXTERIOR SIZE
03409	Black	8" x 11.5" x 7.5" or 11.5 liters

- ▷ Liner with mesh handle
- ▷ Makes it easy to carry gear on & off your bike
- ▷ Made of polyester
- ▷ One-year limited warranty



BELT GUARD BAG

ITEM #	COLOR	SIZE
59799-00	Black	11" x 5" x 2.5"



- ▷ Rigid plastic back
- ▷ Coated steel mounting bracket & stud included - easy to install to a belt drive
- ▷ Quick-release chrome clasps
- ▷ Perfect for storing a pair of gloves and sunglasses, or a small lunch
- ▷ One-year limited warranty



REVOLUTION SERIES HANDLEBAR BAG

ITEM #	COLOR	EXTERIOR SIZE
59511-00	Black	13" x 9" x 6"

- Universal handlebar bag with universal mounting
- High quality chrome quarter-turn fastener
- Limited lifetime warranty



SMALL UNIVERSAL SADDLEBAG LINER

ITEM #	COLOR	EXTERIOR SIZE
03407	Black	4" x 9.5" x 8" or 5 liters

- Set of two liners
- Liner with mesh handle
- Makes it easy to carry gear on & off your bike
- Made of polyester
- One-year limited warranty



SPORT HOOKER

ITEM #	COLOR	EXTERIOR SIZE
03363	Black	Adjustable from 12" to 20" x 7.5"

- Fits under the passenger seat or pad
- Extended D-rings allow quick & easy attachment of bungee hooks
- Made of polyester
- One-year limited warranty



UNIVERSAL SADDLEBAG COOLER BAG INSERT

ITEM #	COLOR	EXTERIOR SIZE
04742	Black	15" x 4.75" x 9.25"

- Soft-sided cooler with shoulder strap
- Perfect for keeping beverages cold or meals hot for hours
- Heavy-duty polyester outer shell is durable & long-lasting
- Fits anywhere and is easy to stow when not in use
- One-year limited warranty





Learn more about motorcycle accessories we have.