

The Premier Manufacturer of Automotive Restoration Interiors since 1969



2016 MASTER CATALOG



## ABOUT DISTINCTIVE INDUSTRIES

It started in 1969 in a little Santa Monica car upholstery shop, with a dream, a prayer, and whole lot of pride. It has become an industry legend. Manufacturing perfect factory replacement automotive interior products since 1969, Distinctive Industries pioneered the aftermarket replacement interior industry. Since then, Distinctive Industries has quietly become the world's leading provider of OEM quality interiors for 1960's, 1970's, 1980's, 1990's, and early 2000's muscle car, special interest, and collectible vehicles. These factory reproduction interiors capture the essence of original manufacturing techniques, utilizing exact factory color matching, grain, and textured materials. Our products are continuously recognized for quality in craftsmanship. Our interiors are cut on state-of-the-art digital cutting machines, sewn to original specifications, and inspected by the most knowledgeable manufacturing staff in the industry. Often copied, but never equaled, Distinctive Industries is your one stop solution for all of your auto interior restoration needs.

## ABOUT THIS CATALOG

Distinctive Industries has combined all of our catalogs into one Master Catalog. This catalog covers all products for all car lines including Bronco, Camaro, Chevelle, Comet/Cyclone, Cougar, Cutlass/442, Datsun Roadster/Z, Econoline/Ford Pickup, Fairlane, Falcon, Firebird, Galaxie, GTO/Lemans, Impala, Mustang, Nova, Ranchero, Riviera,

Sylark/GS, and Torino. The catalog is sorted by Ford, GM, and Imports with the carlines in alphabetical order.

*Look no further, this 2016 Distinctive Industries Master Catalog is the source for all Distinctive Industries products, and product details.*



LIFE IS **BETTER** IN COLOR

**SHWEIKI  
MEDIA**  
MAKING LIVES BETTER THROUGH PRINT



# NEW PRODUCTS SECTION

Don't forget about Distinctive Industries' partner companies for all your other interior and restyling needs.

**CLASSIC**  
SOFT TRIM

**ROADWIRE**

*Signature*  
Automotive Products

# NEW PRODUCTS



The Distinctive Industries Touring II seat is manufactured using the proven Procar® by Scat seat frame and foam and is covered in high quality, Distinctive Industries restoration upholstery. The steel seat frame is **TIG welded** and **electrostatically coated** for strength and durability. The completed seat offers a **20 position reclining seat back** and includes a **18 position sliding seat track** built into the frame all which adds up to a comfortable and customizable seating position for the occupant.

The Touring II seats are an innovative product in that the seat frame is specifically designed and manufactured for use as a **supportive, bolstered seat** unlike many other currently offered seat's that are simply bolstered using nothing more than a bolstered foam which will eventually break down and separate. The support, detail and value that the Touring II seat offers is simply unmatched by any other seat!

The Distinctive Industries Touring II seats have been painstakingly patterned to very closely **mimic the original upholstery's design** and details for a seat compliments your existing original interior while the **20 position reclining seat back** is a real solution to a problem that has existed with the original seats for decades.

The **Distinctive Industries Touring II Mustang** seat is a drop in option for both restoration oriented and Resto-mod themed vehicles and have the added value of matching the rest of the Distinctive Industries interior product line.

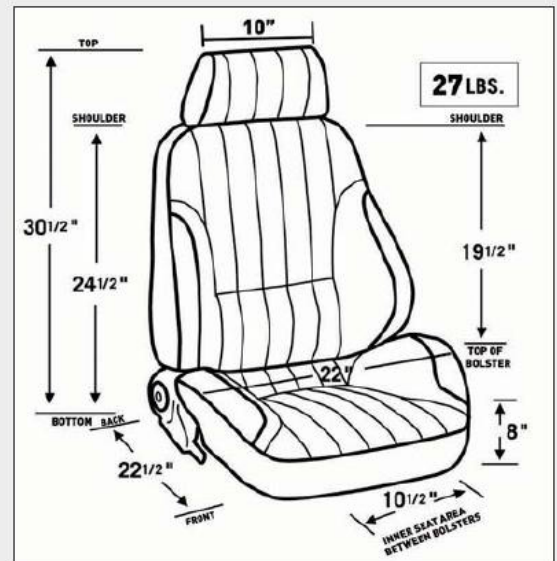

## introducing *Touring II* Seats

brought to you by  distinctive industries  
Premium Restoration Interior Products

& **PROCAR**  
by Scat



## Attention to Detail

Don't worry, seats are color matched to all Distinctive Industries' products and mimic the original interior design.



## Comfort & Support

Procar® by Scat seat frames are designed to support high bolstered injection molded seat foam, making this the perfect bolstered seat platform. Headrest brackets are already installed in the seat and headrests are included, but not installed.

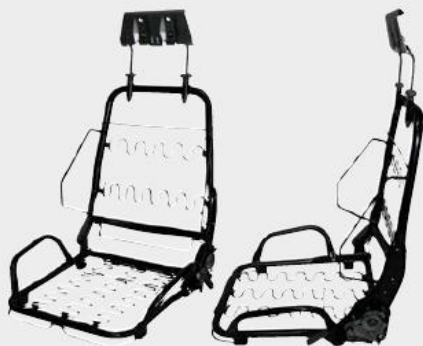

## Strength & Durability

Procar® by Scat has perfected the manufacturing process. Seat frames and tracks are TIG welded and electrostatically coated for long life and durability.



## Lean Back

Feel free to lean back and get comfortable with 20 reclining seat positions and 18 seat tracking positions. Enjoy the perfect driving position!



# FOR 1965-73 MUSTANGS

# NEW PRODUCTS



The Distinctive Industries Touring II seat is manufactured using the proven Procar® by Scat seat frame and foam and is covered in high quality, Distinctive Industries restoration upholstery. The steel seat frame is **TIG welded** and **electrostatically coated** for strength and durability. The completed seat offers a **20 position reclining seat back** and includes a **18 position sliding seat track** built into the frame all which adds up to a comfortable and customizable seating position for the occupant.

The Touring II seats are an innovative product in that the seat frame is specifically designed and manufactured for use as a **supportive, bolstered seat** unlike many other currently offered seat's that are simply bolstered using nothing more than a bolstered foam which will eventually break down and separate. The support, detail and value that the Touring II seat offers is simply unmatched by any other seat!

The Distinctive Industries Touring II seats have been painstakingly patterned to very closely **mimic the original upholstery's design** and details for a seat compliments your existing original interior while the **20 position reclining seat back** is a real solution to a problem that has existed with the original seats for decades.

The **Distinctive Industries Touring II Camaro** seat is a drop in option for both restoration oriented and Resto-mod themed vehicles and have the added value of matching the rest of the Distinctive Industries interior product line.

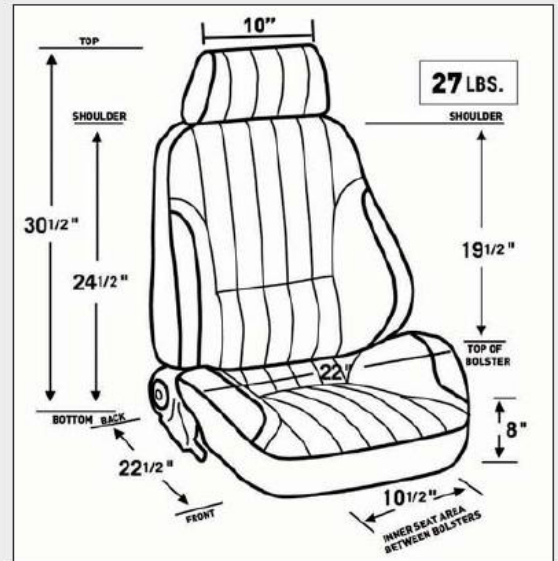

## introducing *Touring II* Seats

brought to you by  distinctive industries  
Premium Restoration Interior Products

& **PROCAR**  
by *Scat* Seats



## Attention to Detail

Don't worry, seats are color matched to all Distinctive Industries' products and mimic the original interior design.



## Comfort & Support

Procar® by Scat seat frames are designed to support high bolstered injection molded seat foam, making this the perfect bolstered seat platform. Headrest brackets are already installed in the seat and headrests are included, but not installed.



## Strength & Durability

Procar® by Scat has perfected the manufacturing process. Seat frames and tracks are TIG welded and electrostatically coated for long life and durability.



## Lean Back

Feel free to lean back and get comfortable with 20 reclining seat positions and 18 seat tracking positions. Enjoy the perfect driving position!



# FOR 1967-71 CAMAROS

# NEW PRODUCTS



The Distinctive Industries Touring II seat is manufactured using the proven Procar® by Scat seat frame and foam and is covered in high quality, Distinctive Industries restoration upholstery. The steel seat frame is **TIG welded** and **electrostatically coated** for strength and durability. The completed seat offers a **20 position reclining seat back** and includes a **18 position sliding seat track** built into the frame all which adds up to a comfortable and customizable seating position for the occupant.

The Touring II seats are an innovative product in that the seat frame is specifically designed and manufactured for use as a **supportive, bolstered seat** unlike many other currently offered seat's that are simply bolstered using nothing more than a bolstered foam which will eventually break down and separate. The support, detail and value that the Touring II seat offers is simply unmatched by any other seat!

The Distinctive Industries Touring II seats have been painstakingly patterned to very closely **mimic the original upholstery's design** and details for a seat compliments your existing original interior while the **20 position reclining seat back** is a real solution to a problem that has existed with the original seats for decades.

The **Distinctive Industries Touring II Chevelle** seat is a drop in option for both restoration oriented and Resto-mod themed vehicles and have the added value of matching the rest of the Distinctive Industries interior product line.

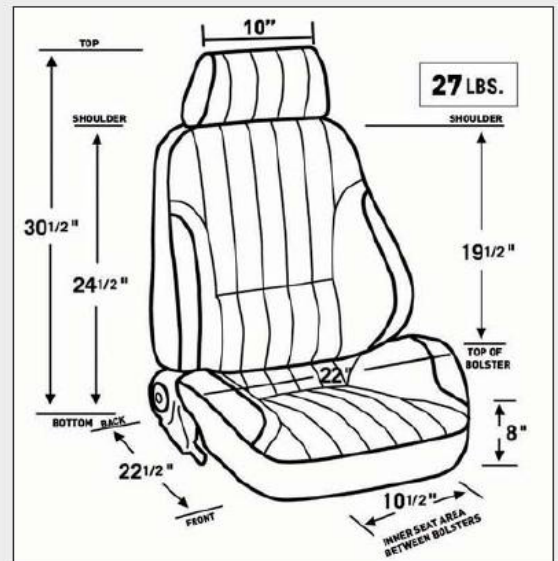

## introducing *Touring II* Seats

brought to you by  distinctive industries  
Premium Restoration Interior Products

& **PROCAR**  
by *Scat* Seats





## Attention to Detail

Don't worry, seats are color matched to all Distinctive Industries' products and mimic the original interior design.



## Comfort & Support

Procar® by Scat seat frames are designed to support high bolstered injection molded seat foam, making this the perfect bolstered seat platform. Headrest brackets are already installed in the seat and headrests are included, but not installed.

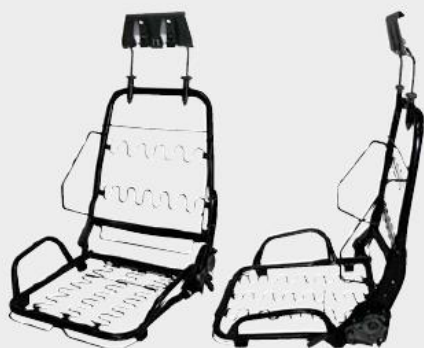

## Strength & Durability

Procar® by Scat has perfected the manufacturing process. Seat frames and tracks are TIG welded and electrostatically coated for long life and durability.



## Lean Back

Feel free to lean back and get comfortable with 20 reclining seat positions and 18 seat tracking positions. Enjoy the perfect driving position!



# FOR 1964-72 CHEVELLES

**Introduction To The Catalog**

Thank you for choosing Distinctive Industries as your provider of Restoration Interior Products. The catalog you are reading was designed with the input of our existing customers and moving forward, will continue to be a representation of their needs, and the needs of restoration experts worldwide.

**Design**

We have designed our catalog for the Restoration Professional, from the Local Upholstery and Restoration Shop, to the National Distributor of Restoration Products. The thought was to create a catalog that eases the pain of product entry for those building catalogs, and to ease ordering for those that order directly from the catalog. We accomplished this by listing product by year, model, and trim level. You will find this catalog to be easy to use.

**Descriptions**

Descriptions are a blend of Marketing and Technical descriptions. After polling our customers we found that aside from the design, missing was a good description of the products in today's catalogs. We remedied that by providing a blended description as a basis for our customers to expand upon, or use as is.

**Colors**

Color swatches are placed near the product with labeled color codes to avoid confusion. Color Code boxes are located near the applicable products. We offer many special order color combinations as well as an option for leather in most cases.

**Images**

Images are available for License through Distinctive Industries.  
• Licensed images must be accompanied and located adjacent to the matching Distinctive Industries product.



**Table of Contents**

1966-77 interior parts and accessories

1978-86 interior parts and accessories

© Copyright 2016, Distinctive Industries, all rights reserved. No part of this publication may be duplicated or reproduced without written permission from Distinctive Industries.



## 1966-86 INTERIOR PARTS & ACCESSORIES

### 1966-86 SEAT UPHOLSTERY

Our 1966-86 Bronco Seat Upholstery is a correct reproduction of the original. We offer the original Sierra grain with Rosette grain inserts in 32 oz. vinyl, with the correct patterns sewn as original.

#### Features

- Original Sierra grain vinyl with Rosette grain inserts
- Correct 6 stitch per inch stitching
- Correct colors matched to the original vinyl
- Limited lifetime warranty

#### 1966-77

1966 BUCKET SEATS - FRONT	101493* <sup>1</sup>
1966 PONY BUCKET SEATS - FRONT	067637* <sup>2</sup>
1966 WAGON BENCH SEAT - FRONT	101495
1967-73 BENCH SEAT - FRONT	101487* <sup>1</sup>
1966 WITH FRONT BUCKETS - REAR BENCH SEAT	101501* <sup>1</sup>
1967 BUCKET SEATS - FRONT	101494
1968-77 BUCKET SEATS - FRONT	101481* <sup>1</sup>
1968-77 BUCKET SEATS - FRONT	101485* <sup>1</sup>
1966 PONY BENCH SEAT - REAR	101497* <sup>2</sup>
1967 REAR JUMP SEAT	101502
1968-77 BENCH SEAT - REAR	101476* <sup>1</sup>
1968-77 BENCH SEAT - REAR	101477

#### 1978-86

1978-86 LOW-BACK BUCKET SEATS - FRONT	101488* <sup>1</sup>
1984-86 HI-BACK BUCKET SEATS - FRONT	101491* <sup>1</sup>

\*<sup>1</sup>NOTE: This seat features Sierra inserts, a popular option for Broncos.  
 \*<sup>2</sup>NOTE: The 1966 Bronco Pony interior was a Dealer installed option.

### 1966-67 TOURING BUCKET SEAT UPHOLSTERY & FOAM

Our 1966-77 Touring Bucket Seats feature raised bolsters and side panels. The Touring Seat is body contoured to create modern ergonomics for the classic car. We offer the original Sierra grain with Rosette grain inserts in 32 oz. vinyl, with the correct horizontal patterns sewn as original

1966-67 TOURING BUCKET SEATS - FRONT	101486
1966-67 TOURING BUCKET SEAT FOAM - FRONT	063598



#### 1966-77 COLORS

BLACK	L-958
PARCHMENT	L-3096
SILVER MINK	L-1770
WHITE	L-4062

#### 1978-86 COLORS

BLUE	L-2250
RED	L-3116
SADDLE	L-3099
TAN	L-2288



**Don't Forget About SEAT HEATERS!!!**  
 Now Available Easy to install  
**PerfectFit® Carbon Fiber Seat Heaters**  
 with a small concealable switch  
**PART #061001**

**1966-86 INTERIOR PARTS & ACCESSORIES**

**1966-77 DOOR/QUARTER PANELS**

Our 1966-77 Door/Quarter Panels are a correct reproduction of the original. We offer original Sierra grain in 32 oz. vinyl, and correct dielectrically heat sealed vertical patterns as original. Carbon Fiber is available at an additional charge.

Features

- Original Sierra grain vinyl
- Correct dielectric "Heat Seal" stitched pattern
- Correct colors matched to the original vinyl
- .100-inch thickness poly-coated "Autoboard" backing
- Door Panel backs are perimeter stapled for maximum adhesion
- Limited lifetime warranty

1966-77 FRONT DOOR PANELS	<b>106062</b>
1966-76 REAR QUARTER PANELS	<b>106070</b>
1977 REAR QUARTER PANELS	<b>106088</b>



**1966-77 SUNVISORS**

Our 1966-77 Sunvisors are in the original Crater grain vinyl for 1966 Broncos and Sierra grain vinyl for 1967-77 Broncos, with the vinyl binding stitched, just like the originals. All Sunvisors are sold in pairs.

1966 SUNVISORS	<b>105619</b>
1967-77 SUNVISORS	<b>105627</b>



**1966-77 COLORS**

BLACK	L-958	SILVER MINK	L-1770
BLACK CARBON FIBER	251	SILVER CARBON FIBER	252
PARCHMENT	L-3096	WHITE	L-4062

**1966-77 SUNVISOR COLORS**

1966 WHITE	H-741	1967-77 BLACK	L-958
1966 BLACK	H-754	1967-77 PARCHMENT	L-3096
1966 TAN	H-837		

## 1966-86 INTERIOR PARTS & ACCESSORIES

### 1966-86 INTERIOR ACCESSORIES

Distinctive Industries Seat Heaters provide therapeutic heat and body warmth in any classic car, using the same technology as late model or current vehicles. Each kit comes with switch, harnesses, and two carbon fiber element pads to complete one seat install. Switch can be dash, console, or hidden in a place of choice. Seat Heaters are sold individually, not in pairs.

1964-89 CARBON FIBER SEAT HEATERS **061001**

Distinctive Industries High-Density Seat Foam is designed to work as a system with our upholstery. Our High-Density Seat Foam is firm, form fitting, and features a Typar® web backing for strength, which prevents spring intrusion and ensures a quality fit and long lasting life. Seat Foam is sold individually, not in pairs.

1966-67 STANDARD BUCKET SEAT FOAM **064007STD6566**

1968-77 STANDARD BUCKET SEAT FOAM **064010STD69**

Our 1968-69 Rear Armrest Upholstery is reproduced in the correct Sierra grain in 32 oz. vinyl and stitched as original.

1968-69 ARMREST COVERS - REAR **101521**



1966-77 COLORS	
BLACK	L-958
PARCHMENT	L-3096
SILVER MINK	L-1770
WHITE	L-4062

1978-86 COLORS	
BLUE	L-2250
RED	L-3116
SADDLE	L-3099
TAN	L-2288



1969 Bronco

# Hands On

EXPERIENCE

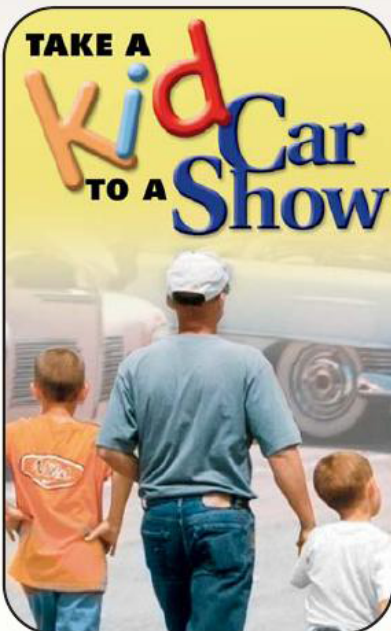

Can you whoop a kid on video games? Probably not. But you can show them a whole new “reality” by taking them to a car show. Encouraging a child to get outside, see glistening paint jobs, and hear the purr of finely tuned engines will awaken all of their senses. You might even be surprised at how much your own enthusiasm is rekindled!

Life is full of choices for kids. You can help them make the right ones by sharing your appreciation for cool old cars. The practical knowledge you share with a child today...just may be the experience that sets them on a lifetime of success.

## Introduction To The Catalog

Thank you for choosing Distinctive Industries as your provider of Restoration Interior Products. The catalog you are reading was designed with the input of our existing customers and moving forward, will continue to be a representation of their needs, and the needs of restoration experts worldwide.

### Design

We have designed our catalog for the Restoration Professional, from the Local Upholstery and Restoration Shop, to the National Distributor of Restoration Products. The thought was to create a catalog that eases the pain of product entry for those building catalogs, and to ease ordering for those that order directly from the catalog. We accomplished this by listing product by year, model, and trim level. You will find this catalog to be easy to use.

### Descriptions

Descriptions are a blend of Marketing and Technical descriptions. After polling our customers we found that aside from the design, missing was a good description of the products in today's catalogs. We remedied that by providing a blended description as a basis for our customers to expand upon, or use as is.

### Colors

Color swatches are placed near the product with labeled color codes to avoid confusion. Color Code boxes are located near the applicable products. We offer many special order color combinations as well as an option for leather in most cases.

### Images

Images are available for License through Distinctive Industries.

- Licensed images must be accompanied and located adjacent to the matching Distinctive Industries product.



## Table of Contents

1960-63 interior parts and accessories

1964 interior parts and accessories

1965 interior parts and accessories

1966 interior parts and accessories

1967 interior parts and accessories

© Copyright 2016, Distinctive Industries, all rights reserved. No part of this publication may be duplicated or reproduced without written permission from Distinctive Industries.



## 1960-63 INTERIOR PARTS & ACCESSORIES

### 1960-62 SEAT UPHOLSTERY

Our 1960-62 Comet Seat Upholstery is a correct reproduction of the original. We offer the original Crush grain in 32 oz. vinyl, with the correct vertical patterns, S-22 logo (where applicable), and sewn as original.

#### Features

- Original Crush grain vinyl
- Correct 6 stitch per inch stitching
- Correct colors matched to the original vinyl
- Limited lifetime warranty

CUSTOM SEDAN BENCH SEAT - FRONT **\*SEEKING PATTERN\***

CUSTOM 2 DOOR SEDAN BENCH SEAT -

REAR **\*SEEKING PATTERN\***

1961-62 S-22 SEDAN BUCKET SEATS - FRONT **100024**

1961-62 S-22 SEDAN BENCH SEAT - REAR **106112**



### 1963 SEAT UPHOLSTERY

Our 1963 Comet Seat Upholstery is a correct reproduction of the original. We offer the original Crush grain in 32 oz. vinyl, with the correct vertical patterns, silver Tinsel welt, and sewn as original.

#### Features

- Original Crush grain vinyl
- Correct 6 stitch per inch stitching
- Correct colors matched to the original vinyl
- Limited lifetime warranty

S-22 HARDTOP/SEDAN BUCKET SEATS -

FRONT **\*SEEKING PATTERN\***

S-22 HARDTOP BENCH SEAT - REAR **\*SEEKING PATTERN\***

S-22 SEDAN BENCH SEAT - REAR **\*SEEKING PATTERN\***

S-22 CONVERTIBLE BUCKET SEATS - FRONT **\*SEEKING PATTERN\***

S-22 CONVERTIBLE BENCH SEAT - REAR **\*SEEKING PATTERN\***

CUSTOM HARDTOP/SEDAN 2 DOOR

BENCH SEAT - FRONT **106120**

CUSTOM SEDAN BENCH SEAT - REAR **\*SEEKING PATTERN\***

CUSTOM HARDTOP BENCH SEAT - REAR **106122**

CUSTOM CONVERTIBLE BENCH SEAT - FRONT **106123**

CUSTOM CONVERTIBLE BENCH SEAT - REAR **106124**



#### 1960-63 COLORS

BLACK	L-110
LIGHT BLUE	L-1761
PALOMINO	L-2288
RED	L-1377
TURQUOISE	L-1934

L-110

L-1761

L-2288

L-1377

L-1934

### 1960-63 INTERIOR ACCESSORIES

Distinctive Industries Seat Heaters provide therapeutic heat and body warmth in any classic car, using the same technology as late model or current vehicles. Each kit comes with switch, harnesses, and two carbon fiber element pads to complete one seat install. Switch can be dash, console, or hidden in a place of choice. Seat Heaters are sold individually, not in pairs.

1960-67 CARBON FIBER SEAT HEATERS **061001**

**Don't Forget About SEAT HEATERS!!!**

Now Available Easy to install  
PerfectFit® Carbon Fiber Seat Heaters  
with a small concealable switch  
**PART #061001**



## 1964 INTERIOR PARTS & ACCESSORIES

### 1964 SEAT UPHOLSTERY

Our 1964 Comet/Cyclone Seat Upholstery is a correct reproduction of the original. We offer the original Crush grain in 32 oz. vinyl, with the correct dielectrically heat sealed vertical patterns, and sewn as original. Emblems and seat buttons not included.

#### Features

- Original Crush grain vinyl
- Correct dielectric "Heat Seal" Pattern
- Correct 6 stitch per inch stitching
- Correct colors matched to the original vinyl
- Limited lifetime warranty

404 BUCKET SEATS - FRONT *SEEKING PATTERN*	
404 SEDAN BENCH SEAT - FRONT *SEEKING PATTERN*	
CALIENTE HARDTOP BUCKET SEATS - FRONT	106306
CALIENTE HARDTOP BENCH SEAT - FRONT	106310
CYCLONE HARDTOP BUCKET SEATS - FRONT	106302
404 BENCH SEAT - REAR *SEEKING PATTERN*	
CALIENTE HARDTOP BENCH SEAT - REAR	106312
CYCLONE HARDTOP BENCH SEAT - REAR	106304

### 1964 DOOR/QUARTER PANELS

Our 1965 Door/Quarter Panels are a correct reproduction of the original. We offer original Crush grain in 32 oz. vinyl, and correct dielectrically heat sealed horizontal patterns as original.

#### Features

- Original Sierra grain vinyl
- Correct dielectric "Heat Seal" stitched pattern
- Correct colors matched to the original vinyl
- .100-inch thickness poly-coated "Autoboard" backing
- Door Panel backs are perimeter stapled for maximum adhesion
- Limited lifetime warranty

COMET/CYCLONE 2 DOOR FRONT DOOR PANELS	106198
COMET/CYCLONE 2 DOOR HARDTOP REAR QUARTER PANELS	106200

### 1964 INTERIOR ACCESSORIES

Distinctive Industries Seat Heaters provide therapeutic heat and body warmth in any classic car, using the same technology as late model or current vehicles. Each kit comes with switch, harnesses, and two carbon fiber element pads to complete one seat install. Switch can be dash, console, or hidden in a place of choice. Seat Heaters are sold individually, not in pairs.

1960-67 CARBON FIBER SEAT HEATERS	061001
-----------------------------------	--------



#### 1964 COLORS

BLACK	L-110	RED	L-1377
BLUE	L-1761	TURQUOISE	L-1934
IVY GOLD	L-2503	WHITE	L-1752
PALOMINO	L-2288		

**NOTE: A popular non-original color option is Ivy Gold. Ivy Gold is Sierra grain as it was not available in 1964.**

## 1965 INTERIOR PARTS & ACCESSORIES

### 1965 SEAT UPHOLSTERY

Our 1965 Comet/Cyclone Seat Upholstery is a correct reproduction of the original. We offer the original Sierra grain in 32 oz. vinyl, with the correct dielectrically heat sealed horizontal patterns, and sewn as original. Seat back medallions are not included.

#### Features

- Original Sierra grain vinyl
- Correct dielectric "Heat Seal" Pattern
- Correct 6 stitch per inch stitching
- Correct colors matched to the original vinyl
- Limited lifetime warranty

CALIENTE HARDTOP BUCKET SEATS -

FRONT **\*SEEKING PATTERN\***

CALIENTE HARDTOP BENCH SEAT - FRONT **\*SEEKING PATTERN\***

CALIENTE CONVERTIBLE BUCKET SEATS -

FRONT **\*SEEKING PATTERN\***

CALIENTE CONVERTIBLE BENCH SEAT -

FRONT **\*SEEKING PATTERN\***

CYCLONE HARDTOP BUCKET SEATS - FRONT

**106148**

CYCLONE HARDTOP BENCH SEAT - REAR

**106149**

CYCLONE CONVERTIBLE BENCH SEAT -

REAR **\*SEEKING PATTERN\***



### 1965 DOOR/QUARTER PANELS

Our 1965 Door/Quarter Panels are a correct reproduction of the original. We offer original Sierra grain in 32 oz. vinyl, and correct dielectrically heat sealed horizontal patterns as original. Door panel emblems are not included.

#### Features

- Original Sierra grain vinyl
- Correct dielectric "Heat Seal" stitched pattern
- Correct colors matched to the original vinyl
- .100-inch thickness poly-coated "Autoboard" backing
- Door Panel backs are perimeter stapled for maximum adhesion
- Limited lifetime warranty

COMET/CYCLONE 2 DOOR FRONT DOOR PANELS **106203**

COMET/CYCLONE 2 DOOR HARDTOP

REAR QUARTER PANELS **106211**

### 1965 INTERIOR ACCESSORIES

Distinctive Industries Seat Heaters provide therapeutic heat and body warmth in any classic car, using the same technology as late model or current vehicles. Each kit comes with switch, harnesses, and two carbon fiber element pads to complete one seat install. Switch can be dash, console, or hidden in a place of choice. Seat Heaters are sold individually, not in pairs.

1960-67 CARBON FIBER SEAT HEATERS **061001**

#### 1965 COLORS

BLACK	L-958	PALOMINO	L-2288
BLUE	L-2287	RED	L-957
IVY GOLD	L-2503	TURQUOISE	L-2929

**Don't Forget About SEAT HEATERS!!!**  
 Now Available Easy to install  
 PerfectFit® Carbon Fiber Seat Heaters  
 with a small concealable switch  
**PART #061001**



## 1966-67 INTERIOR PARTS & ACCESSORIES

### 1966 SEAT UPHOLSTERY

Our 1966 Comet/Cyclone Seat Upholstery is a correct reproduction of the original. We offer the original Sierra grain in 32 oz. vinyl, with the correct vertical patterns sewn as original. Seat back medallions are not included.

#### Features

- Original Sierra grain vinyl
- Correct 6 stitch per inch stitching
- Correct colors matched to the original vinyl
- Limited lifetime warranty

CALIENTE HARDTOP/CONVERTIBLE BUCKET SEATS -

FRONT **\*SEEKING PATTERN\***

CYCLONE BUCKET SEATS - FRONT **106260**

CALIENTE HARDTOP BENCH SEAT - REAR **\*SEEKING PATTERN\***

CALIENTE CONVERTIBLE BENCH SEAT -

REAR **\*SEEKING PATTERN\***

CYCLONE HARDTOP BENCH SEAT - REAR **\*SEEKING PATTERN\***

CYCLONE CONVERTIBLE BENCH SEAT - REAR **106262**

### 1967 SEAT UPHOLSTERY

Our 1967 Comet/Cyclone Seat Upholstery is a correct reproduction of the original. We offer the original Sierra grain in 32 oz. vinyl, with the correct patterns sewn as original.

#### Features

- Original Sierra grain vinyl
- Correct 6 stitch per inch stitching
- Correct colors matched to the original vinyl
- Limited lifetime warranty

CALIENTE HARDTOP/CONVERTIBLE BUCKET SEATS -

FRONT **\*SEEKING PATTERN\***

CALIENTE HARDTOP/CONVERTIBLE BENCH SEAT -

FRONT **\*SEEKING PATTERN\***

CYCLONE BUCKET SEATS - FRONT **\*SEEKING PATTERN\***

CALIENTE HARDTOP BENCH SEAT - REAR **\*SEEKING PATTERN\***

CALIENTE CONVERTIBLE BENCH SEAT -

REAR **\*SEEKING PATTERN\***

CYCLONE HARDTOP BENCH SEAT - REAR **\*SEEKING PATTERN\***

CYCLONE CONVERTIBLE BENCH SEAT -

REAR **\*SEEKING PATTERN\***

#### 1966-67 COLORS

AQUA	L-2929	IVY GOLD	L-2503
BLACK	L-958	PARCHMENT	L-2613
BLUE	L-2287	RED	L-2920

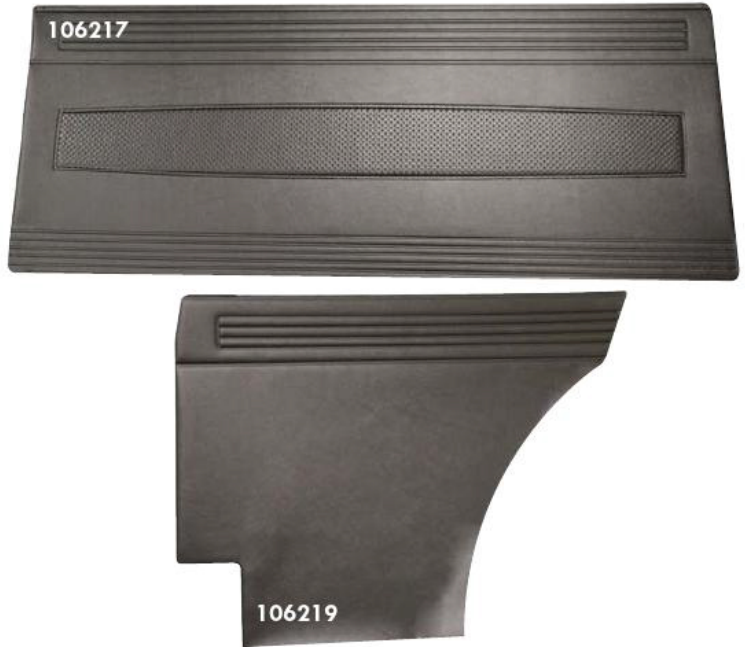
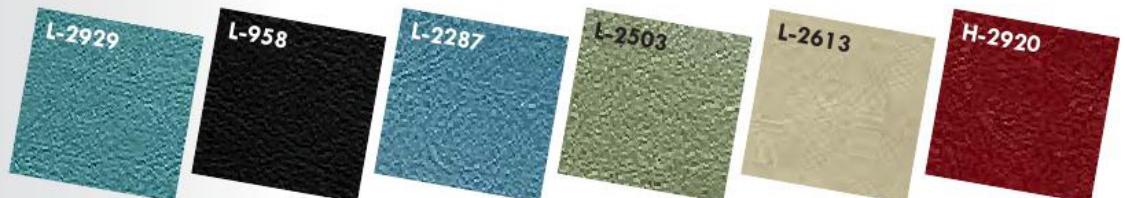

COMET/CYCLONE

### 1967 DOOR/QUARTER PANELS

Our 1965 Door/Quarter Panels are a correct reproduction of the original. We offer original Sierra grain with Stacatto inserts in 32 oz. vinyl, and correct dielectrically heat sealed horizontal patterns as original. Door panel emblems are not included.

#### Features

- Original Sierra grain vinyl with Stacatto inserts
- Correct dielectric "Heat Seal" stitched pattern
- Correct colors matched to the original vinyl
- .100-inch thickness poly-coated "Autoboard" backing
- Door Panel backs are perimeter stapled for maximum adhesion
- Limited lifetime warranty

CYCLONE FRONT DOOR PANELS **106217**

CYCLONE 2 DOOR HARDTOP REAR QUARTER PANELS **106219**

### 1966-67 INTERIOR ACCESSORIES

Distinctive Industries Seat Heaters provide therapeutic heat and body warmth in any classic car, using the same technology as late model or current vehicles. Each kit comes with switch, harnesses, and two carbon fiber element pads to complete one seat install. Switch can be dash, console, or hidden in a place of choice. Seat Heaters are sold individually, not in pairs.

1960-67 CARBON FIBER SEAT HEATERS **061001**

## Introduction To The Catalog

Thank you for choosing Distinctive Industries as your provider of Restoration Interior Products. The catalog you are reading was designed with the input of our existing customers and moving forward, will continue to be a representation of their needs, and the needs of restoration experts worldwide.

### Design

We have designed our catalog for the Restoration Professional, from the Local Upholstery and Restoration Shop, to the National Distributor of Restoration Products. The thought was to create a catalog that eases the pain of product entry for those building catalogs, and to ease ordering for those that order directly from the catalog. We accomplished this by listing product by year, model, and trim level. You will find this catalog to be easy to use.

### Descriptions

Descriptions are a blend of Marketing and Technical descriptions. After polling our customers we found that aside from the design, missing was a good description of the products in today's catalogs. We remedied that by providing a blended description as a basis for our customers to expand upon, or use as is.

### Colors

Color swatches are placed near the product with labeled color codes to avoid confusion. Color Code boxes are located near the applicable products. We offer many special order color combinations as well as an option for leather in most cases.

### Images

Images are available for License through Distinctive Industries.

- Licensed images must be accompanied and located adjacent to the matching Distinctive Industries product.



## Table of Contents

1967 interior parts and accessories

1968 interior parts and accessories

1969 interior parts and accessories

1970 interior parts and accessories

1971-73 interior parts and accessories

© Copyright 2016, Distinctive Industries, all rights reserved. No part of this publication may be duplicated or reproduced without written permission from Distinctive Industries.



## 1967 INTERIOR PARTS & ACCESSORIES

### 1967 STANDARD/DÉCOR SEAT UPHOLSTERY

Our 1967 Cougar Standard/Décor Seat Upholstery is a correct reproduction of the original featuring the embossed stripe on the seat back. We offer the original Sierra grain in 32 oz. vinyl, with the correct vertical patterns sewn as original.

#### Features

- Original Sierra grain vinyl
- Correct 6 stitch per inch stitching
- Correct colors matched to the original vinyl
- Limited lifetime warranty

STANDARD/DÉCOR BUCKET SEATS - FRONT	<b>106914</b>
STANDARD/DÉCOR BENCH SEAT - FRONT	<b>106906</b>
STANDARD/DÉCOR WITH BUCKETS - REAR BENCH SEAT	<b>106922</b>

### 1967 XR7 SEAT UPHOLSTERY

Our 1967 Cougar XR7 Seat Upholstery is a correct reproduction of the original in vinyl. We offer the original Sierra grain with Laredo grain bolsters in 32 oz. vinyl, with the correct vertical patterns sewn as original.

#### Features

- Original Sierra grain vinyl with Laredo grain bolsters
- Correct 6 stitch per inch stitching
- Correct colors matched to the original vinyl
- Limited lifetime warranty

XR7 BUCKET SEATS - FRONT	<b>106864</b>
XR7 BENCH SEAT - REAR	<b>106872</b>



#### 1967 STANDARD/DÉCOR COLORS

AQUA	L-2929
BLACK	L-958
BLUE	L-2287
IVY GOLD	L-2503
PARCHMENT	L-3096
RED	L-2920
SADDLE	L-3099

#### 1967 XR7 COLORS

AQUA	L-2929
BLACK	L-958
BLUE	L-2505
MEDIUM IVY GOLD	L-3628
PARCHMENT	L-3096
RED	L-3116
SADDLE	L-3099

### 1967 XR7 VINYL/LEATHER SEAT UPHOLSTERY

We offer original-styled vinyl/leather upholstery for the 1967 Cougar XR7. *Please call for color and availability.*

1967 Cougar with Standard/Décor Interior



**1967 INTERIOR PARTS & ACCESSORIES**

**1967 HEADLINERS**

Our 1967 Headliners are in the original Crater grain vinyl, constructed just like the original.

1967-68 HARDTOP HEADLINER **107312**

**1967 INTERIOR ACCESSORIES**

Distinctive Industries Seat Heaters provide therapeutic heat and body warmth in any classic car, using the same technology as late model or current vehicles. Each kit comes with switch, harnesses, and two carbon fiber element pads to complete one seat install. Switch can be dash, console, or hidden in a place of choice. Seat Heaters are sold individually, not in pairs.

1967-73 CARBON FIBER SEAT HEATERS **061001**



**1967 HEADLINER COLORS**

AQUA	H-813	LIGHT GREEN	H-755
BLACK	H-754	MEDIUM BLUE	H-814
BRIGHT RED	H-812	RED	H-863
DARK AQUA	H-956	SADDLE	H-926
DARK GREEN	H-1030	TAN	H-837
IVY GOLD	H-1029	WHITE	H-741
LIGHT BLUE	H-836		

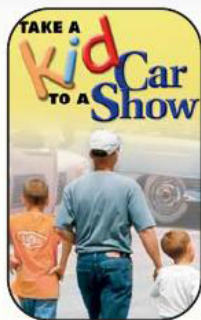

Can you whoop a kid on video games? Probably not. But you can show them a whole new "reality" by taking them to a car show. Encouraging a child to get outside, see glistening paint jobs, and hear the purr of finely tuned engines will awaken all of their senses. You might even be surprised at how much your own enthusiasm is rekindled!

Life is full of choices for kids. You can help them make the right ones by sharing your appreciation for cool old cars. The practical knowledge you share with a child today...just may be the experience that sets them on a lifetime of success.



## 1968 INTERIOR PARTS & ACCESSORIES

### 1968 STANDARD SEAT UPHOLSTERY

Our 1968 Cougar Standard Seat Upholstery is a correct reproduction of the original. We offer the original Sierra grain in 32 oz. vinyl, with the correct horizontal patterns sewn as original.

#### Features

- Original Sierra grain vinyl
- Correct 6 stitch per inch stitching
- Correct colors matched to the original vinyl
- Limited lifetime warranty

STANDARD BUCKET SEATS - FRONT

106955

STANDARD BENCH SEAT - REAR

106963



### 1968 DÉCOR SEAT UPHOLSTERY

Our 1968 Cougar Décor Seat Upholstery is a correct reproduction of the original. We offer the original Sierra grain with Laredo grain inserts in 32 oz. vinyl, with the correct vertical patterns sewn as original.

#### Features

- Original Sierra grain vinyl with Laredo grain inserts
- Correct 6 stitch per inch stitching
- Correct colors matched to the original vinyl
- Limited lifetime warranty

DÉCOR BUCKET SEATS - FRONT

107003

DÉCOR BENCH SEAT - REAR

107011



#### 1968 STANDARD COLORS

BLACK	L-958
BLUE	L-2287
IVY GOLD	L-2503
MAROON	L-3116
NUGGET GOLD	L-3448
PARCHMENT	L-3096
SADDLE	L-3099
TURQUOISE	L-2929

#### 1968 DÉCOR COLORS

BLACK	L-958
BLUE	L-3627
NUGGET GOLD	L-3448
PARCHMENT	L-3096
RED	L-3116
SADDLE	L-3099



## 1968 INTERIOR PARTS & ACCESSORIES

### 1968 XR7 SEAT UPHOLSTERY

Our 1968 Cougar XR7 Seat Upholstery is a correct reproduction of the original in vinyl. We offer the original Sierra grain vinyl with Levant grain bolsters in 32 oz. vinyl, with the correct vertical patterns sewn as original.

#### Features

- Original Sierra grain vinyl with Levant grain bolsters
- Correct 6 stitch per inch stitching
- Correct colors matched to the original vinyl
- Limited lifetime warranty

XR7 BUCKET SEATS - FRONT

107052

XR7 BENCH SEAT - REAR

107060



1968 XR7 COLORS	
BLACK	L-958
DARK BLUE	L-2505
DARK IVY GOLD	L-3628
DARK RED	L-3116
NUGGET GOLD	L-3448
PARCHMENT	L-3096
SADDLE	L-3099
TURQUOISE	L-2929

### 1968 XR7 VINYL/LEATHER SEAT UPHOLSTERY

We offer original-styled vinyl/leather upholstery for the 1968 Cougar XR7. *Please call for color and availability.*



1968 Cougar XR7



## 1968 INTERIOR PARTS & ACCESSORIES

### 1968 HEADLINERS

Our 1968 Headliners are in the original Crater grain vinyl, constructed just like the original.

1967-68 HARDTOP HEADLINER

107312

### 1968 INTERIOR ACCESSORIES

Distinctive Industries Seat Heaters provide therapeutic heat and body warmth in any classic car, using the same technology as late model or current vehicles. Each kit comes with switch, harnesses, and two carbon fiber element pads to complete one seat install. Switch can be dash, console, or hidden in a place of choice. Seat Heaters are sold individually, not in pairs.

1967-73 CARBON FIBER SEAT HEATERS

061001

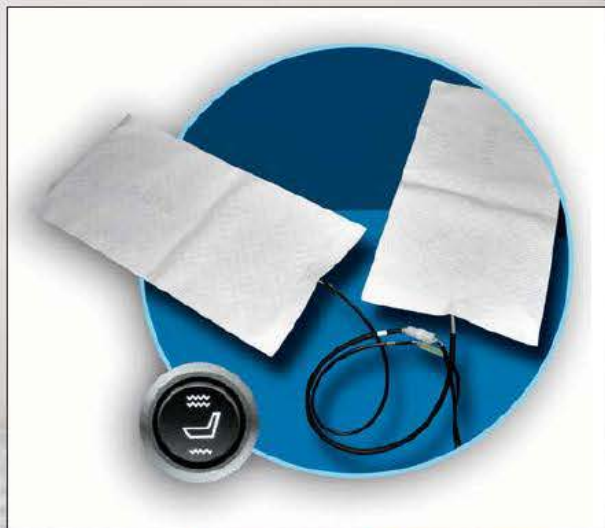

### 1968 HEADLINER COLORS

AQUA	H-813
BLACK	H-754
BRIGHT RED	H-812
DARK AQUA	H-956
DARK GREEN	H-1030
IVY GOLD	H-1029
LIGHT BLUE	H-836
LIGHT GREEN	H-755
MEDIUM BLUE	H-814
RED	H-863
SADDLE	H-926
TAN	H-837
WHITE	H-741



## 1969 INTERIOR PARTS & ACCESSORIES

### 1969 STANDARD SEAT UPHOLSTERY

Our 1969 Cougar Standard Seat Upholstery is a correct reproduction of the original. We offer the original Corinthian grain in 32 oz. vinyl, with the correct horizontal patterns sewn as original. Headrests are included.

#### Features

- Original Corinthian grain vinyl
- Correct 6 stitch per inch stitching
- Correct colors matched to the original vinyl
- Limited lifetime warranty

STANDARD BUCKET SEATS - FRONT **107086**  
STANDARD HARDTOP BENCH SEAT - REAR **107094**

### 1969 DÉCOR SEAT UPHOLSTERY

Our 1969 Cougar Décor Seat Upholstery is a correct reproduction of the original. We offer the original Corinthian grain with Levant grain inserts in 32 oz. vinyl, with the correct dielectrically heat sealed vertical patterns and sewn as original. Headrests are included.

#### Features

- Original Corinthian grain vinyl with Levant grain inserts
- Correct dielectric "Heat Seal" Pattern
- Correct 6 stitch per inch stitching
- Correct colors matched to the original vinyl
- Limited lifetime warranty

DÉCOR BUCKET SEATS - FRONT **107128**  
DÉCOR HARDTOP BENCH SEAT - REAR **107136**  
DÉCOR CONVERTIBLE BENCH SEAT - REAR **107151**

### 1969 XR7 SEAT UPHOLSTERY

Our 1969 Cougar XR7 Seat Upholstery is a correct reproduction of the original in vinyl. We offer the original Corinthian grain with Levant grain horizontal stripe in 32 oz. vinyl, with the correct vertical patterns sewn as original. Headrests are included.

#### Features

- Original Corinthian grain vinyl with Levant grain horizontal stripe
- Correct 6 stitch per inch stitching
- Correct colors matched to the original vinyl
- Limited lifetime warranty

XR7 BUCKET SEATS - FRONT **107169**  
XR7 HARDTOP BENCH SEAT - REAR **107171**  
XR7 CONVERTIBLE BENCH SEAT - REAR **107177**



### 1969 XR7 VINYL/LEATHER SEAT UPHOLSTERY

We offer original-styled vinyl/leather upholstery for the 1969 Cougar XR7. *Please call for color and availability.*



#### 1969 XR7 COLORS

BLACK	L-3722
DARK BLUE	L-2505
DARK IVY GOLD	L-3628
DARK RED	L-3724
LIGHT AQUA	L-2929
NUGGET GOLD	L-3625
SADDLE	L-3099
WHITE	L-4062

#### 1969 DÉCOR COLORS

BLACK	L-3722
DARK RED	L-3724
IVY GOLD	L-2503
LIGHT AQUA	L-2929
LIGHT BLUE	L-3627
NUGGET GOLD	L-3625
SADDLE	L-3099
WHITE	L-4062

#### 1969 STANDARD COLORS

BLACK	L-3722	LIGHT BLUE	L-3627
DARK RED	L-3724	NUGGET GOLD	L-3625
GOLD	L-2503	WHITE	L-4062

## 1969 INTERIOR PARTS & ACCESSORIES

### 1969 ELIMINATOR SEAT UPHOLSTERY

Our 1969 Cougar Eliminator Seat Upholstery is a correct reproduction of the original. We offer the original Corinthian grain with Comfortweave inserts, and Levant grain bar stripe in 32 oz. vinyl, with the correct vertical patterns sewn as original. Headrests are not included.

#### Features

- Original Corinthian grain vinyl with Comfortweave inserts
- Correct 6 stitch per inch stitching
- Correct colors matched to the original vinyl
- Limited lifetime warranty

ELIMINATOR BUCKET SEATS WITH COMFORTWEAVE - FRONT	<b>107178</b>
ELIMINATOR HARDTOP BENCH SEAT WITH COMFORTWEAVE - REAR	<b>107179</b>

### 1969 HEADLINERS

Our 1969 Headliners are in the original Crater grain vinyl, constructed just like the original.	
1969-70 HARDTOP HEADLINER	<b>107314</b>

### 1969 INTERIOR ACCESSORIES

Distinctive Industries Seat Heaters provide therapeutic heat and body warmth in any classic car, using the same technology as late model or current vehicles. Each kit comes with switch, harnesses, and two carbon fiber element pads to complete one seat install. Switch can be dash, console, or hidden in a place of choice. Seat Heaters are sold individually, not in pairs.

1967-73 CARBON FIBER SEAT HEATERS	<b>061001</b>
-----------------------------------	---------------

Our Cougar Door Pull Straps features 32 oz. vinyl in the original Corinthian grain vinyl and steel inserts, just like the originals.	
1969 DOOR PULL STRAPS	<b>107181</b>



#### 1969 XR7 COLORS

BLACK	L-3722	GINGER	L-4061
DARK BLUE	L-2505	NUGGET GOLD	L-3625
DARK IVY GOLD	L-3628	SADDLE	L-3099
DARK RED	L-3724	WHITE	L-4062



#### 1969 ELIMINATOR COLORS

BLACK	L-3722
BLUE	L-3627
WHITE	L-4062

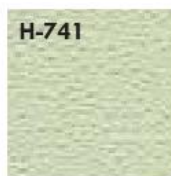

#### 1969 HEADLINER COLORS

AQUA	H-813	LIGHT GREEN	H-755
BLACK	H-754	MEDIUM BLUE	H-814
BRIGHT RED	H-812	RED	H-863
DARK AQUA	H-956	SADDLE	H-926
DARK GREEN	H-1030	TAN	H-837
IVY GOLD	H-1029	WHITE	H-741
LIGHT BLUE	H-836		



**1970 INTERIOR PARTS & ACCESSORIES**

**1970 STANDARD SEAT UPHOLSTERY**

Our 1970 Cougar Standard Seat Upholstery is a correct reproduction of the original. We offer the original Corinthian grain with Ruffino grain inserts in 32 oz. vinyl, with the correct horizontal patterns sewn as original.

Features

- Original Corinthian grain vinyl with Ruffino grain inserts
- Correct 6 stitch per inch stitching
- Correct colors matched to the original vinyl
- Limited lifetime warranty

STANDARD BUCKET SEATS - FRONT	<b>107243</b>
STANDARD HARDTOP BENCH SEAT - REAR	<b>107250</b>
STANDARD CONVERTIBLE BENCH SEAT - REAR	<b>107255</b>

**1970 DÉCOR SEAT UPHOLSTERY**

Our 1970 Cougar Décor Seat Upholstery is a correct reproduction of the original. We offer the original Corinthian grain with Comfortweave grain inserts, and Levant grain stripe in 32 oz. vinyl, with the correct vertical patterns sewn as original.

Features

- Original Corinthian grain vinyl with Comfortweave grain inserts
- Correct 6 stitch per inch stitching
- Correct colors matched to the original vinyl
- Limited lifetime warranty

DÉCOR BUCKET SEATS WITH COMFORTWEAVE - FRONT	<b>107185</b>
DÉCOR HARDTOP BENCH SEAT WITH COMFORTWEAVE - REAR	<b>107193</b>
DÉCOR CONVERTIBLE BENCH SEAT WITH COMFORTWEAVE - REAR	<b>107195</b>



**1970 STANDARD COLORS**

BLACK	L-3722
BLUE	L-3788
MEDIUM GREEN	L-4060
RED	L-3724
WHITE	L-4062

**1970 DÉCOR COLORS**

BLACK	L-3722
DARK RED	L-3724
MEDIUM BLUE	L-3788
MEDIUM BROWN	L-4061
MEDIUM GREEN	L-4234
WHITE	L-4062



## 1970 INTERIOR PARTS & ACCESSORIES

### 1970 XR7 SEAT UPHOLSTERY

Our 1970 Cougar XR7 Seat Upholstery is a correct reproduction of the original in vinyl. We offer the original Corinthian grain in 32 oz. vinyl, with the correct vertical patterns sewn as original.

#### Features

- Original Corinthian grain vinyl
- Correct 6 stitch per inch stitching
- Correct colors matched to the original vinyl
- Limited lifetime warranty

XR7 BUCKET SEATS - FRONT	<b>107219</b>
XR7 BUCKET SEATS WITH HOUNDSTOOTH - FRONT	<b>107276</b>
XR7 HARDTOP BENCH SEAT - REAR	<b>107227</b>
XR7 CONVERTIBLE BENCH SEAT - REAR	<b>107229</b>
XR7 HARDTOP BENCH SEAT WITH HOUNDSTOOTH - REAR	<b>107280</b>

### 1970 HEADLINERS

Our 1970 Headliners are in the original Crater grain vinyl, constructed just like the original.

1969-70 HARDTOP HEADLINER	<b>107314</b>
---------------------------	---------------

### 1970 INTERIOR ACCESSORIES

Distinctive Industries Seat Heaters provide therapeutic heat and body warmth in any classic car, using the same technology as late model or current vehicles. Each kit comes with switch, harnesses, and two carbon fiber element pads to complete one seat install. Switch can be dash, console, or hidden in a place of choice. Seat Heaters are sold individually, not in pairs.

1967-73 CARBON FIBER SEAT HEATERS	<b>061001</b>
-----------------------------------	---------------

### 1970 XR7 VINYL/LEATHER SEAT UPHOLSTERY

We offer original-styled vinyl/leather upholstery for the 1970 Cougar XR7. *Please call for color and availability.*



#### 1970 XR7 COLORS

BLACK	L-3722
BLUE	L-3788
GINGER	L-4061
GREEN	L-3628
RED	L-3724
WHITE	L-4062



#### 1970 HEADLINER COLORS

AQUA	H-813	LIGHT GREEN	H-755
BLACK	H-754	MEDIUM BLUE	H-814
BRIGHT RED	H-812	RED	H-863
DARK AQUA	H-956	SADDLE	H-926
DARK GREEN	H-1030	TAN	H-837
IVY GOLD	H-1029	WHITE	H-741
LIGHT BLUE	H-836		

**Don't Forget About SEAT HEATERS!!!**  
 Now Available Easy to install  
 PerfectFit® Carbon Fiber Seat Heaters  
 with a small concealable switch  
**PART #061001**

## 1971-73 INTERIOR PARTS & ACCESSORIES

### 1971-73 DÉCOR/DELUXE & XR7 SEAT UPHOLSTERY

Our 1971-73 Cougar Décor/Deluxe and XR7 Seat Upholstery is a correct reproduction of the original in vinyl. We offer the original Corinthian grain with Comfortweave grain inserts in 32 oz. vinyl, with the correct dielectrically heat sealed vertical patterns and sewn as original. The original Cougar accent belt (T-shape insert) is included.

#### Features

- Original Corinthian grain vinyl with Comfortweave inserts
- Correct dielectric "Heat Seal" Pattern
- Correct 6 stitch per inch stitching
- Correct colors matched to the original vinyl
- Limited lifetime warranty

DELUXE BUCKET SEATS WITH COMFORTWEAVE - FRONT	107300
XR7 BUCKET SEATS - FRONT	107294
DELUXE HARDTOP BENCH SEAT WITH COMFORTWEAVE - REAR	107302
DELUXE CONVERTIBLE BENCH SEAT WITH COMFORTWEAVE - REAR	107304
XR7 HARDTOP BENCH SEAT - REAR	107297
XR7 CONVERTIBLE BENCH SEAT - REAR	107295

### 1971-73 INTERIOR ACCESSORIES

Distinctive Industries Seat Heaters provide therapeutic heat and body warmth in any classic car, using the same technology as late model or current vehicles. Each kit comes with switch, harnesses, and two carbon fiber element pads to complete one seat install. Switch can be dash, console, or hidden in a place of choice. Seat Heaters are sold individually, not in pairs.

1967-73 CARBON FIBER SEAT HEATERS **061001**

Our Convertible Windlace is the correct Corinthian grain in 32 oz. vinyl, just like the originals, and are sold in pairs.

1971-73 CONVERTIBLE WINDLACE **107308**

### 1971-73 XR7 VINYL/LEATHER SEAT UPHOLSTERY

We offer original-styled vinyl/leather upholstery for the 1971-73 Cougar XR7. *Please call for color and availability.*

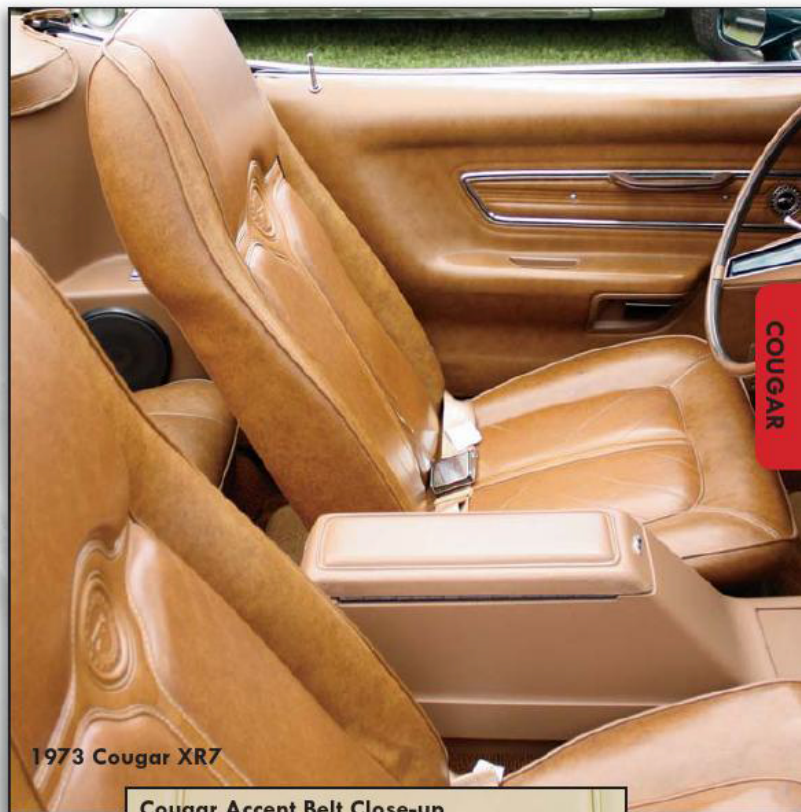

1973 Cougar XR7

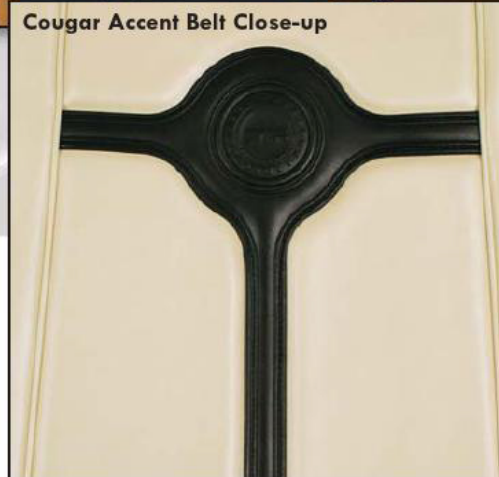

Cougar Accent Belt Close-up



#### 1971-73 COLORS

BLACK	L-3722
BLUE	L-3788
GINGER	L-4061
WHITE	L-4062

## Introduction To The Catalog

Thank you for choosing Distinctive Industries as your provider of Restoration Interior Products. The catalog you are reading was designed with the input of our existing customers and moving forward, will continue to be a representation of their needs, and the needs of restoration experts worldwide.

### Design

We have designed our catalog for the Restoration Professional, from the Local Upholstery and Restoration Shop, to the National Distributor of Restoration Products. The thought was to create a catalog that eases the pain of product entry for those building catalogs, and to ease ordering for those that order directly from the catalog. We accomplished this by listing product by year, model, and trim level. You will find this catalog to be easy to use.

### Descriptions

Descriptions are a blend of Marketing and Technical descriptions. After polling our customers we found that aside from the design, missing was a good description of the products in today's catalogs. We remedied that by providing a blended description as a basis for our customers to expand upon, or use as is.

### Colors

Color swatches are placed near the product with labeled color codes to avoid confusion. Color Code boxes are located near the applicable products. We offer many special order color combinations as well as an option for leather in most cases.

### Images

Images are available for License through Distinctive Industries.

- Licensed images must be accompanied and located adjacent to the matching Distinctive Industries product.



## Table of Contents

1962-67 Econoline interior parts and accessories

1999-04 Lightning interior parts and accessories

1957-75 Ford Pickup interior parts and accessories

© Copyright 2016, Distinctive Industries, all rights reserved. No part of this publication may be duplicated or reproduced without written permission from Distinctive Industries.



# ECONOLINE/LIGHTNING/PICKUP

## 1962-67 INTERIOR PARTS & ACCESSORIES

### 1962-67 ECONOLINE SEAT UPHOLSTERY

Our 1962-67 Econoline Seat Upholstery is a correct reproduction of the original. We offer the original Crush grain for 1962-65 models and Sierra grain vinyl for 1966-67 models in 32 oz. vinyl, with the correct dielectrically heat sealed vertical patterns, and sewn as original.

#### Features

- Original Crush/Sierra grain vinyl
- Correct dielectric "Heat Seal" Pattern
- Correct 6 stitch per inch stitching
- Correct colors matched to the original vinyl
- Limited lifetime warranty

1962-65 FALCON DELUXE CLUB WAGON BUCKET SEATS - FRONT	102578
1962-65 FALCON DELUXE CLUB WAGON 2ND ROW BENCH SEAT	102578
1964-65 BUCKET SEATS - FRONT	102566
1964 STATION BUS BUCKET SEATS - FRONT	102568
1965 2ND ROW BENCH SEAT	102574
1966-67 FALCON DELUXE CLUB WAGON BUCKET SEATS - FRONT	102582



### 1962-67 INTERIOR ACCESSORIES



Distinctive Industries Seat Heaters provide therapeutic heat and body warmth in any classic car, using the same technology as late model or current vehicles. Each kit comes with switch, harnesses, and two carbon fiber element pads to complete one seat install. Switch can be dash, console, or hidden in a place of choice. Seat Heaters are sold individually, not in pairs.

1962-67 CARBON FIBER SEAT HEATERS **061001**

Our 1961-67 Spare Tire Wheel Covers are in the original grain vinyl with durable Jute padding lining the back and attaching strap, just like the originals.

1961-67 DELUXE SPARE TIRE COVER - 14" **102581**

#### 1962-67 ECONOLINE COLORS

BEIGE	L-2176
BLACK	L-958
BLUE	L-2250
GREEN	L-1988
PALOMINO	L-2288
RED	L-957

#### 1962-67 ECONOLINE TOW-TONE COLORS

BLUE	L-1761/L-1763
------	---------------



ECONOLINE/PICKUP



1999-04 INTERIOR PARTS & ACCESSORIES

Don't Forget About SEAT HEATERS!!!  
 Now Available Easy to install  
 PerfectFit® Carbon Fiber Seat Heaters  
 with a small concealable switch  
 PART #061001



1999-04 LIGHTNING SEAT UPHOLSTERY

Our 1999-04 Lightning Seat Upholstery is a correct reproduction of the original. We offer the original Ultra Suede trim with Leather inserts, correct SVT logo, and sewn as original.

\*NOTE: Officially licensed Ford SVT Product.

Features

- Original grain vinyl
- Correct 6 stitch per inch stitching
- Correct colors matched to the original vinyl
- Limited lifetime warranty

1999-04 LIGHTNING 40/60 BENCH SEAT - FRONT 070350

1999-04 LIGHTNING COLORS

BLACK/BLACK	799/I=L-910
GREY/BLACK	784/I=L-910



The difference between **MEN & Boys** is the size of their toys!

Even if there is a generation or two between you and a child, collector cars can be a terrific common ground. Your enthusiasm and knowledge could be the spark of a child's lifelong passion. Bring kids to your playground...a car show...and have fun.

Life is full of choices for kids. You can help them make the right ones by sharing your appreciation for cool old cars. (And a kid might even call you "cool" too!)



Take a Kid to a Car Show is a program of ARMO, the Automotive Restoration Market Organization, a SEMA Council.



## 1957-75 INTERIOR PARTS & ACCESSORIES

### 1957-75 PICKUP VINYL SEAT UPHOLSTERY

Our 1957-75 Seat Upholstery is a correct reproduction of the original. We offer the original Sierra grain vinyl for 1964-72 models with the Ford Thunder Bolt and Cog logo, and Corinthian grain vinyl for 1971 and 1975 models in 32 oz. vinyl with the correct grain inserts, correct dielectrically heat sealed patterns and sewn as original. Our 1961-63 Custom Seat Upholstery is all vinyl and does not have cloth inserts.

#### Features

- Original Sierra and Corinthian grain vinyl
- Correct dielectric "Heat Seal" Pattern
- Correct 6 stitch per inch stitching
- Correct colors matched to the original vinyl
- Limited lifetime warranty

#### 1957-66 F-SERIES BENCH SEAT - FRONT **\*SEEKING PATTERN\***

1964 F150/F250 BENCH SEAT - FRONT **102483\*1**

1965-66 F100/F250 BENCH SEAT - FRONT **102491\*1/2**

1967-72 F100/F250 CUSTOM CAB  
BENCH SEAT - FRONT **102493**

1971 F100/F250 RANGER XLT BENCH SEAT - FRONT **102496**

1975 F150/F250/F350 BENCH SEAT -  
FRONT (OPTIONAL KNIT/VINYL) **102509**

1975 F150/F250/F350 BENCH SEAT -  
FRONT (VINYL REPLACEMENT) **102515**

**\*1NOTE: Available in OEM Material or a vinyl replacement.**

**\*2NOTE: Officially licensed Ford Product.**



### 1962-72 PICKUP SUNVISORS

Our 1962-72 Sunvisors are in the original grain vinyl, with the vinyl binding stitched, just like the originals. All Sunvisors are sold in pairs.

1962-66 TRUCK SUNVISORS - CRATER GRAIN VINYL **105619**

1967-77 TRUCK SUNVISORS - SIERRA GRAIN VINYL **105627**

### 1957-75 PICKUP COLORS

1964 BLACK	L-958	1975 GINGER	L-4070
1964 LIGHT GRAY	L-1750	1975 GREEN	L-3530
1964-66 BEIGE	L-2176	1975 RED	L-3440
1964-66 GREEN	L-1988	1975 WHITE	L-4072
1964-66 RED	L-957	BLUE	L-2287
1964-66 WHITE	L-2290	PARCHMENT	L-3096
1965-66 BLUE	L-2250	SILVER MINK	L-1770
1975 BLACK	L-3437	TURQUOISE	L-2929
1975 BLUE	L-3435		

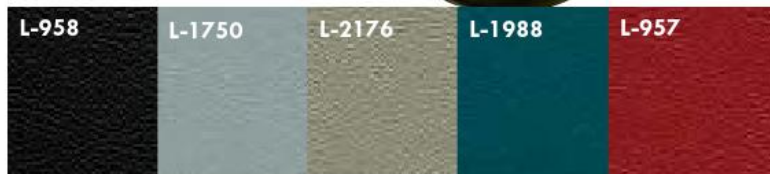

## 1957-75 INTERIOR PARTS & ACCESSORIES

### 1957-75 INTERIOR ACCESSORIES

Distinctive Industries Seat Heaters provide therapeutic heat and body warmth in any classic car, using the same technology as late model or current vehicles. Each kit comes with switch, harnesses, and two carbon fiber element pads to complete one seat install. Switch can be dash, console, or hidden in a place of choice. Seat Heaters are sold individually, not in pairs.

1957-04 CARBON FIBER SEAT HEATERS **061001**

Although not originally offered our Map Pockets are a nice addition and are available in interior matching colors in 32 oz. Sierra grain vinyl. Our Map Pockets attach to the door panels and feature a zipper.

1961-66 STANDARD & 1964-66 CUSTOM CAB  
DOOR PANEL MAP POCKETS **105643**



ECONOLINE/PICKUP

#### 1957-75 PICKUP COLORS

1964 BLACK	L-958
1964 LIGHT GRAY	L-1750
1964-66 BEIGE	L-2176
1964-66 GREEN	L-1988
1964-66 RED	L-957
1964-66 WHITE	L-2290
1965-66 BLUE	L-2250
1975 BLACK	L-3437
1975 BLUE	L-3435
1975 GINGER	L-4070
1975 GREEN	L-3530
1975 RED	L-3440
1975 WHITE	L-4072
BLUE	L-2287
PARCHMENT	L-3096
SILVER MINK	L-1770
TURQUOISE	L-2929



## Introduction To The Catalog

Thank you for choosing Distinctive Industries as your provider of Restoration Interior Products. The catalog you are reading was designed with the input of our existing customers and moving forward, will continue to be a representation of their needs, and the needs of restoration experts worldwide.

### Design

We have designed our catalog for the Restoration Professional, from the Local Upholstery and Restoration Shop, to the National Distributor of Restoration Products. The thought was to create a catalog that eases the pain of product entry for those building catalogs, and to ease ordering for those that order directly from the catalog. We accomplished this by listing product by year, model, and trim level. You will find this catalog to be easy to use.

### Descriptions

Descriptions are a blend of Marketing and Technical descriptions. After polling our customers we found that aside from the design, missing was a good description of the products in today's catalogs. We remedied that by providing a blended description as a basis for our customers to expand upon, or use as is.

### Colors

Color swatches are placed near the product with labeled color codes to avoid confusion. Color Code boxes are located near the applicable products. We offer many special order color combinations as well as an option for leather in most cases.

### Images

Images are available for License through Distinctive Industries.

- Licensed images must be accompanied and located adjacent to the matching Distinctive Industries product.



## Table of Contents

1963 interior parts and accessories

1964 interior parts and accessories

1965 interior parts and accessories

1966 interior parts and accessories

1967 interior parts and accessories

1968-69 interior parts and accessories

© Copyright 2016, Distinctive Industries, all rights reserved. No part of this publication may be duplicated or reproduced without written permission from Distinctive Industries.



## 1963 INTERIOR PARTS & ACCESSORIES

### 1963 SEAT UPHOLSTERY

Our 1963 Fairlane Seat Upholstery is a correct reproduction of the original. We offer the original Crush grain in 32 oz. vinyl, with the correct patterns, silver Tinsel welt, and sewn as original. Seat back medallions not included.

\* 500 Hardtop/Sedans have bench seats and Sports Coupe have bucket seats.

#### Features

- Original Crush grain vinyl
- Correct 6 stitch per inch stitching
- Correct colors matched to the original vinyl
- Limited lifetime warranty

SPORTS COUPE BUCKET SEATS - FRONT	100446
500 2 DOOR SEDAN SPLIT BENCH - FRONT	100396
SPORTS COUPE BENCH SEAT - REAR	100461
500 2 DOOR SEDAN BENCH SEAT - REAR	100404
500 2 DOOR HARDTOP BENCH SEAT - REAR	100487

### 1963 DOOR/QUARTER PANELS

Our 1963 Door/Quarter Panels are a correct reproduction of the original. We offer original Crush grain in 32 oz. vinyl, and correct dielectrically heat sealed patterns as original.

#### Features

- Original Crush grain vinyl
- Correct dielectric "Heat Seal" stitched pattern
- Correct colors matched to the original vinyl
- .100-inch thickness poly-coated "Autoboard" backing
- Door Panel backs are perimeter stapled for maximum adhesion
- Limited lifetime warranty

SPORTS COUPE FRONT DOOR PANELS *SEEKING PATTERN*
500 2 DOOR HARDTOP FRONT DOOR PANELS *SEEKING PATTERN*
500 SEDAN FRONT DOOR PANELS *SEEKING PATTERN*
SPORTS COUPE REAR QUARTER PANELS *SEEKING PATTERN*
500 2 DOOR HARDTOP REAR QUARTER PANELS *SEEKING PATTERN*
500 SEDAN REAR QUARTER PANELS *SEEKING PATTERN*

### 1963 INTERIOR ACCESSORIES

Distinctive Industries Seat Heaters provide therapeutic heat and body warmth in any classic car, using the same technology as late model or current vehicles. Each kit comes with switch, harnesses, and two carbon fiber element pads to complete one seat install. Switch can be dash, console, or hidden in a place of choice. Seat Heaters are sold individually, not in pairs.

1963-69 CARBON FIBER SEAT HEATERS 061001



#### 1963 COLORS

BLACK	L-110	PALOMINO	L-2288
BLUE	L-1761	RED	L-1377
IVY GOLD	L-2503		

**NOTE:** A popular non-original color option is Ivy Gold. Ivy Gold is Sierra grain as it was not available in 1963.

## 1964 INTERIOR PARTS & ACCESSORIES

### 1964 SEAT UPHOLSTERY

Our 1964 Fairlane Seat Upholstery is a correct reproduction of the original. We offer the original Crush grain in 32 oz. vinyl, with the correct patterns, silver Tinsel welt, and sewn as original. Emblems not included.

\* 500 Hardtop/Sedans have bench seats and Sports Coupe have bucket seats.

#### Features

- Original Crush grain vinyl
- Correct 6 stitch per inch stitching
- Correct colors matched to the original vinyl
- Limited lifetime warranty

SPORTS COUPE BUCKETS SEATS - FRONT	<b>100495</b>
500 2 DOOR BENCH SEAT - FRONT	<b>100503</b>
4 DOOR/STATION WAGON BENCH SEAT - FRONT	<b>100496</b>
500 2 DOOR HARDTOP - REAR BENCH SEAT	<b>100511</b>
500 SEDAN - REAR BENCH SEAT *SEEKING PATTERN*	
SPORTS COUPE - REAR BENCH SEAT	<b>100743</b>
500 4 DOOR SEDAN BENCH SEAT - REAR	<b>100497</b>
500 4 DOOR STATION WAGON BENCH SEAT- REAR	<b>100498</b>

#### Two-Tone Upholstery

SPORTS COUPE BUCKET SEATS - FRONT	<b>100719</b>
500 4 DOOR/WAGON BENCH SEAT - FRONT	<b>100509</b>
500 2 DOOR HARDTOP/SEDAN BENCH SEAT - FRONT	<b>100727</b>
SPORTS COUPE - REAR BENCH SEAT	<b>100735</b>
500 2 DOOR HARDTOP BENCH SEAT - REAR	<b>100728</b>
500 2 DOOR SEDAN - REAR BENCH SEAT *SEEKING PATTERN*	
500 4 DOOR SEDAN - REAR BENCH SEAT	<b>100729</b>
500 WAGON - REAR BENCH SEAT	<b>100731</b>

### 1964 INTERIOR ACCESSORIES

Distinctive Industries Seat Heaters provide therapeutic heat and body warmth in any classic car, using the same technology as late model or current vehicles. Each kit comes with switch, harnesses, and two carbon fiber element pads to complete one seat install. Switch can be dash, console, or hidden in a place of choice. Seat Heaters are sold individually, not in pairs.

1963-69 CARBON FIBER SEAT HEATERS **061001**

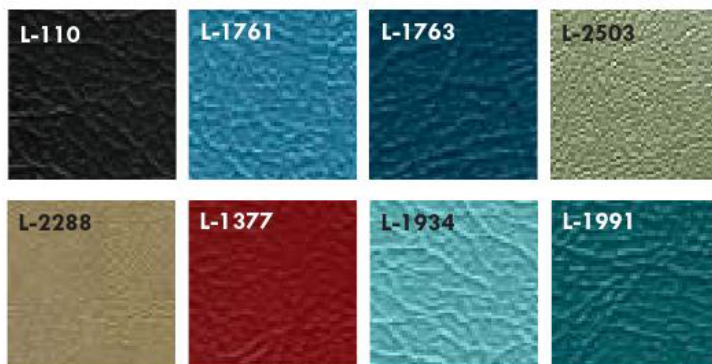

1964 COLORS			
BLACK	L-110	PALOMINO	L-2288
BLUE	L-1761	RED	L-1377
IVY GOLD	L-2503		

**NOTE:** A popular non-original color option is Ivy Gold. Ivy Gold is Sierra grain as it was not available in 1964.

1964 TWO-TONE COLORS	
BLUE	L-1761 (L-1763)
TURQUOISE	L-1934 (L-1991)

## 1964 INTERIOR PARTS & ACCESSORIES

### 1964 DOOR/QUARTER PANELS

Our 1964 Door/Quarter Panels are a correct reproduction of the original. We offer original Crush grain in 32 oz. vinyl, and correct dielectrically heat sealed patterns as original. 500 panels come with the 3 chrome accent buttons installed. Sports Coupe panels come with the correct sheet chrome and embossing on the Mylar®, door panel reflector, and come with the 3 chrome accent buttons installed.

#### Features

- Original Crush grain vinyl
- Correct dielectric "Heat Seal" stitched pattern
- Correct colors matched to the original vinyl
- .100-inch thickness poly-coated "Autoboard" backing
- Door Panel backs are perimeter stapled for maximum adhesion
- Limited lifetime warranty

500 2 DOOR SPORTS COUPE FRONT DOOR PANELS - WITH MYLAR	<b>103465</b>
500 2 DOOR FRONT DOOR PANELS	<b>103468</b>
500 2 DOOR SPORTS COUPE REAR QUARTER PANELS - WITH MYLAR	<b>103473</b>
500 2 DOOR HARDTOP REAR QUARTER PANELS	<b>103474</b>
500 2 DOOR SEDAN REAR QUARTER PANELS	<b>103470</b>

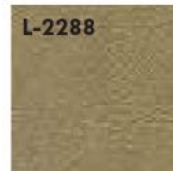
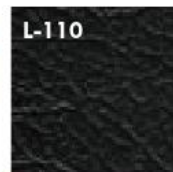
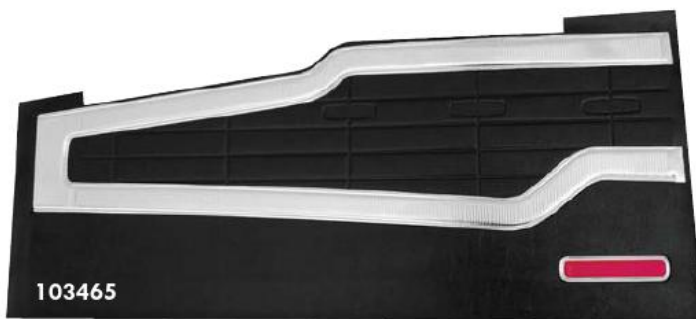

**Don't Forget About SEAT HEATERS!!!**  
 Now Available Easy to install  
 PerfectFit® Carbon Fiber Seat Heaters  
 with a small concealable switch  
**PART #061001**



#### 1964 COLORS

BLACK	L-110
BLUE	L-1761
IVY GOLD	L-2503
PALOMINO	L-2288
RED	L-1377

**NOTE:** A popular non-original color option is Ivy Gold. Ivy Gold is Sierra grain as it was not available in 1964.

**1965 INTERIOR PARTS & ACCESSORIES**

**1965 SEAT UPHOLSTERY**

Our 1965 Fairlane Seat Upholstery is a correct reproduction of the original. We offer the original Sierra grain in 32 oz. vinyl, with the correct patterns, silver Tinsel welt, and sewn as original. Emblems not included.

*\* 500 Hardtop/Sedans have bench seats and Sports Coupe have bucket seats.*

Features

- Original Sierra grain vinyl
- Correct 6 stitch per inch stitching
- Correct colors matched to the original vinyl
- Limited lifetime warranty

SPORTS COUPE BUCKET SEATS - FRONT	<b>100792</b>
500 2 DOOR BENCH SEAT - FRONT	<b>100818</b>
500 2 DOOR HARDTOP - REAR BENCH SEAT	<b>100826</b>
SPORTS COUPE - REAR BENCH SEAT	<b>100800</b>
500 SEDAN BENCH SEAT - REAR <b>*SEEKING PATTERN*</b>	

**Two-Tone Upholstery**

SPORTS COUPE BUCKET SEATS - FRONT	<b>100750</b>
500 2 DOOR BENCH SEAT - FRONT	<b>100768</b>
500 2 DOOR HARDTOP - REAR BENCH SEAT	<b>100776</b>
SPORTS COUPE - REAR BENCH SEAT	<b>100784</b>
500 2 DOOR SEDAN - REAR BENCH SEAT <b>*SEEKING PATTERN*</b>	

**Don't Forget About SEAT HEATERS!!!**  
 Now Available Easy to install  
**PerfectFit® Carbon Fiber Seat Heaters**  
 with a small concealable switch  
**PART #061001**



**1965 COLORS**

BLACK	L-958
BLUE	L-2287
IVY GOLD	L-2503
PALOMINO	L-2288
RED	L-957
WHITE	L-2290

**1965 TWO-TONE COLORS**

BLUE	L-2287 (L-2505)
TURQUOISE	L-2929 (L-3097)

FAIRLANE

**1965 INTERIOR ACCESSORIES**

Distinctive Industries Seat Heaters provide therapeutic heat and body warmth in any classic car, using the same technology as late model or current vehicles. Each kit comes with switch, harnesses, and two carbon fiber element pads to complete one seat install. Switch can be dash, console, or hidden in a place of choice. Seat Heaters are sold individually, not in pairs.

1963-69 CARBON FIBER SEAT HEATERS **061001**

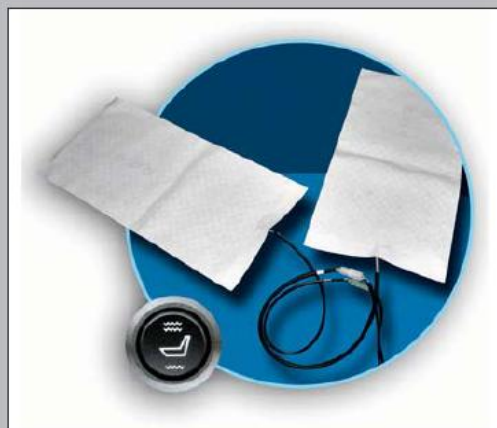



## 1965 INTERIOR PARTS & ACCESSORIES

### 1965 DOOR/QUARTER PANELS

Our 1965 Door/Quarter Panels are a correct reproduction of the original. We offer original Sierra grain in 32 oz. vinyl, and correct dielectrically heat sealed patterns as original. Door panel medallions, and buttons are included.

**Features**

- Original Sierra grain vinyl
- Correct dielectric "Heat Seal" stitched pattern
- Correct colors matched to the original vinyl
- .100-inch thickness poly-coated "Autoboard" backing
- Door Panel backs are perimeter stapled for maximum adhesion
- Limited lifetime warranty

- 500 2 DOOR HARDTOP FRONT DOOR PANELS **103499**
- 500 2 DOOR SPORTS COUPE FRONT DOOR PANELS **103515**
- 500 2 DOOR HARDTOP REAR QUARTER PANELS **103507**
- 500 2 DOOR SPORTS COUPE REAR QUARTER PANELS **103523**



**1965 COLORS**

- |          |        |
|----------|--------|
| BLACK    | L-958  |
| BLUE     | L-2287 |
| IVY GOLD | L-2503 |
| PALOMINO | L-2288 |
| RED      | L-957  |

FAIRLANE



## 1966 INTERIOR PARTS & ACCESSORIES

### 1966 500 UPHOLSTERY

Our 1966 Fairlane 500 Seat Upholstery is a correct reproduction of the original, with the inserts Vischette grain and the correct dielectrically heat sealed lines in the upper part of the back rest. We offer the original Sierra grain in 32 oz. vinyl, with the correct vertical patterns sewn as original.

#### Features

- Original Sierra grain vinyl
- Correct 6 stitch per inch stitching
- Correct colors matched to the original vinyl
- Limited lifetime warranty

500 2 DOOR BENCH SEAT - FRONT	<b>100602</b>
500 CONVERTIBLE BENCH SEAT - REAR	<b>100604</b>
500 2 DOOR HARDTOP BENCH SEAT - REAR	<b>100606</b>



#### 1966 500 COLORS

AQUA	L-2929
BLACK	L-958
BLUE	L-2095
EMBERGLO	L-2921
IVY GOLD	L-2503
PARCHMENT	L-2613
RED	L-2920
SADDLE	L-3099

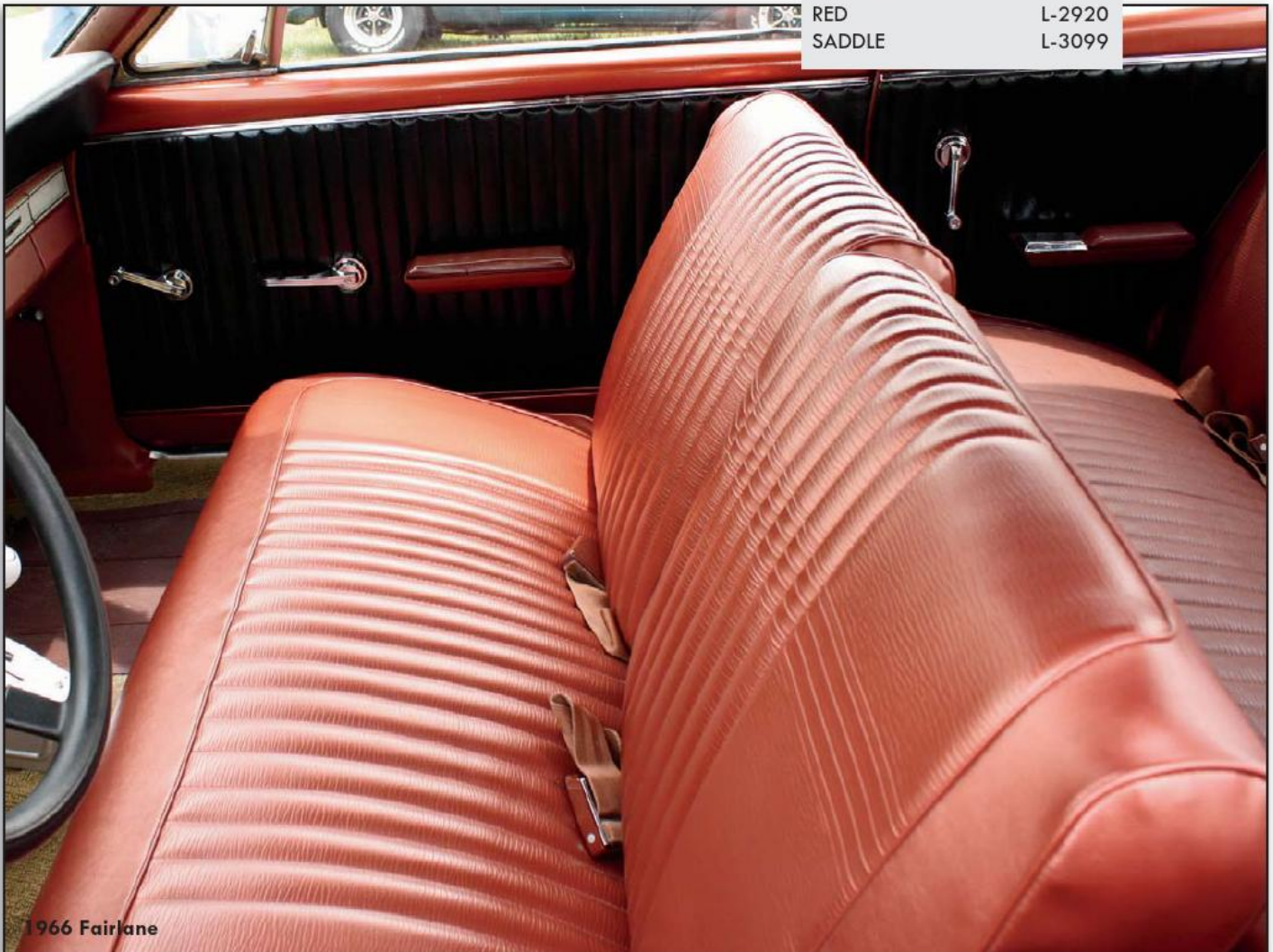

1966 Fairlane

## 1966 INTERIOR PARTS & ACCESSORIES

### 1966 500XL/GT UPHOLSTERY

Our 1966 Fairlane 500XL, GT, and GTA Seat Upholstery is a correct reproduction of the original. We offer the original Sierra grain with Rosette grain inserts in 32 oz. vinyl, with the correct horizontal patterns sewn as original. Seat back medallions included.

#### Features

- Original Sierra grain vinyl with Rosette grain inserts
- Correct 6 stitch per inch stitching
- Correct colors matched to the original vinyl
- Limited lifetime warranty

500XL, GT & GTA 2 DOOR BUCKET SEATS - FRONT	100594
500XL, GT & GTA 2 DOOR HARDTOP	
BENCH SEAT - REAR	100610
500XL, GT & GTA CONVERTIBLE BENCH SEAT - REAR	100628

### 1966 500XL/GT DOOR/QUARTER PANELS

Our 1966 Fairlane 500XL, GT, and GTA Door/Quarter Panels are a correct reproduction of the original with the chrome rectangular trim. We offer original Sierra grain with Rosette grain inserts in 32 oz. vinyl, and correct dielectrically heat sealed patterns as original.

#### Features

- Original Sierra grain vinyl with Rosette grain inserts
- Correct dielectric "Heat Seal" stitched pattern
- Correct colors matched to the original vinyl
- .100-inch thickness poly-coated "Autoboard" backing
- Door Panel backs are perimeter stapled for maximum adhesion
- Limited lifetime warranty

1966-67 500XL, GT & GTA FRONT DOOR PANELS	103531
1966-67 500XL, GT & GTA 2 DOOR HARDTOP	
REAR QUARTER PANELS	103549
1966-67 500XL, GT & GTA CONVERTIBLE REAR	
QUARTER PANELS	103556



1966 Fairlane GT



103531



103549



### 1966 500XL COLORS

AQUA	L-2929 (I=L-2951)
BLACK	L-958 (I=L-2949)
BLUE	L-2095 (I=L-2946)
EMBERGLO	L-2921 (I=L-2948)
IVY GOLD	L-2503 (I=L-2947)
PARCHMENT	L-2613 (I=L-2945)
RED	L-2920 (I=L-2954)
SADDLE	L-3099 (I=L-3099)

**NOTE:** I=Insert.

**1966 INTERIOR PARTS & ACCESSORIES**

**1966 HEADLINERS/SUNVISORS**

Our 1966 Headliners are in the original Crater grain vinyl, constructed just like the original.

1966-67 2 DOOR SEDAN HEADLINER **105098**

1966-67 2 DOOR HARDTOP HEADLINER **105106**

Our 1966 Sunvisors are in the original Crater grain vinyl, with the vinyl binding stitched, just like the originals. All Sunvisors are sold in pairs.

1966 2 DOOR HARDTOP SUNVISORS **105502**

1966-67 CONVERTIBLE SUNVISORS **105528**



**1966 INTERIOR ACCESSORIES**

Distinctive Industries Seat Heaters provide therapeutic heat and body warmth in any classic car, using the same technology as late model or current vehicles. Each kit comes with switch, harnesses, and two carbon fiber element pads to complete one seat install. Switch can be dash, console, or hidden in a place of choice. Seat Heaters are sold individually, not in pairs.

1963-69 CARBON FIBER SEAT HEATERS **061001**



Distinctive Industries High-Density Seat Foam is designed to work as a system with our upholstery. Our High-Density Seat Foam is firm, form fitting, and features a Typar® web backing for strength, which prevents spring intrusion and ensures a quality fit and long lasting life. Seat Foam is sold individually, not in pairs.

BUCKET SEAT FOAM **064402BKT6667**

Our Convertible Top Boot features the correct Sierra grain in 32 oz. vinyl and fastens just like the original. Snaps are included.

1966-67 CONVERTIBLE TOP BOOTS **105726**

Our Convertible Well Liner is Sierra grain in 32 oz. vinyl, just like the originals.

1966-67 CONVERTIBLE WELL LINER **105734**

Our Quarter Trim features 32 oz. vinyl in the correct Sierra grain and is stitched, just like the originals.

1966-67 CONVERTIBLE QUARTER TRIM WITH ARMREST **105262**



**1966 COLORS**

**Hardtop Colors**

AQUA	H-813	LIGHT GREEN	H-755
BLACK	H-754	RED	H-863
IVY GOLD	H-1029	WHITE	H-741
LIGHT BLUE	H-836		

**Convertible Colors**

AQUA	L-2929	IVY GOLD	L-2503
BLACK	L-958	PARCHMENT	L-2613
BLUE	L-2095	RED	L-2920

FAIRLANE



## 1967 INTERIOR PARTS & ACCESSORIES

### 1967 500 UPHOLSTERY

Our 1967 Fairlane 500 Seat Upholstery is a correct reproduction of the original. We offer the original Sierra grain vinyl trim in 32 oz. vinyl with the correct grain on the inserts, and correct vertical patterns sewn as original. Seat back medallions are not included.

#### Features

- Original Sierra grain vinyl
- Correct 6 stitch per inch stitching
- Correct colors matched to the original vinyl
- Limited lifetime warranty

500 2 DOOR BENCH SEAT - FRONT	<b>100669</b>
500 2 DOOR HARDTOP BENCH SEAT - REAR	<b>100701</b>
500 CONVERTIBLE BENCH SEAT - REAR	<b>100693</b>

### 1967 500 DOOR/QUARTER PANELS

Our 1967 Fairlane 500 Door/Quarter Panels are a correct reproduction of the original with the chrome rectangular trim. We offer original Sierra grain in 32 oz. vinyl with a Woodgrain insert, and correct dielectrically heat sealed horizontal patterns as original. Emblems not included.

#### Features

- Original Sierra grain vinyl
- Correct dielectric "Heat Seal" stitched pattern
- Correct colors matched to the original vinyl
- .100-inch thickness poly-coated "Autoboard" backing
- Door Panel backs are perimeter stapled for maximum adhesion
- Limited lifetime warranty

500 2 DOOR FRONT DOOR PANELS	<b>100746</b>
500 2 DOOR HARDTOP REAR QUARTER PANELS	<b>100748</b>
500 CONVERTIBLE REAR QUARTER PANELS	<b>100747</b>

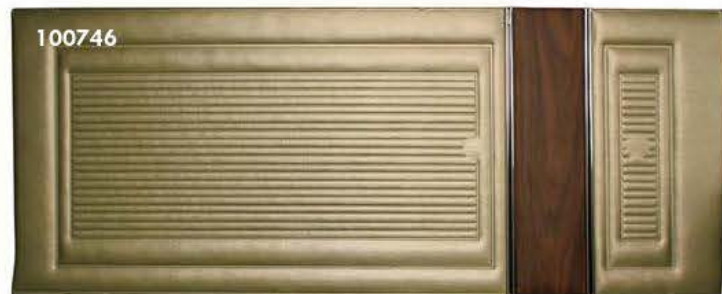

#### 1967 500 COLORS

AQUA	L-2929
BLACK	L-958
BLUE	L-2287
EMBERGLO	L-2921
IVY GOLD	L-2503
PARCHMENT	L-3096
RED	L-2920
SADDLE	L-3099

## 1967 INTERIOR PARTS & ACCESSORIES

### 1967 500XL UPHOLSTERY

Our 1967 Fairlane 500XL, GT, and GTA Seat Upholstery is a correct reproduction of the original. We offer the original Sierra grain with Rosette grain inserts in 32 oz. vinyl, with the correct horizontal patterns sewn as original. Seat back medallions are not included.

#### Features

- Original Sierra grain vinyl with Rosette grain inserts
- Correct 6 stitch per inch stitching
- Correct colors matched to the original vinyl
- Limited lifetime warranty

500XL, GT & GTA 2 DOOR BUCKET SEATS - FRONT	<b>100651</b>
500XL, GT & GTA 2 DOOR HARDTOP	
BENCH SEAT - REAR	<b>100677</b>
500XL, GT & GTA CONVERTIBLE BENCH SEAT - REAR	<b>100685</b>

### 1967 500XL DOOR/QUARTER PANELS

Our 1967 Fairlane 500XL, GT, and GTA Door/Quarter Panels are a correct reproduction of the original with the chrome rectangular trim. We offer original Sierra grain with Rosette grain inserts in 32 oz. vinyl, and correct dielectrically heat sealed patterns as original.

#### Features

- Original Sierra grain vinyl
- Correct dielectric "Heat Seal" stitched pattern
- Correct colors matched to the original vinyl
- .100-inch thickness poly-coated "Autoboard" backing
- Door Panel backs are perimeter stapled for maximum adhesion
- Limited lifetime warranty

1966-67 500XL, GT & GTA FRONT DOOR PANELS	<b>103531</b>
1966-67 500XL, GT & GTA 2 DOOR HARDTOP	
REAR QUARTER PANELS	<b>103549</b>
1966-67 500XL, GT & GTA CONVERTIBLE REAR QUARTER PANELS	<b>103556</b>

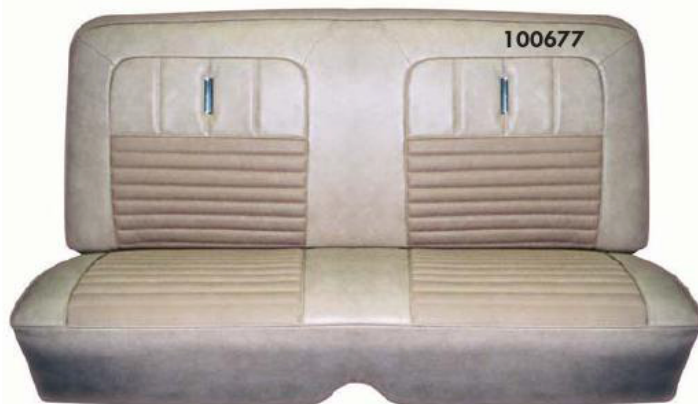

#### 1967 500XL COLORS

AQUA	L-2929 (I=L-2951)
BLACK	L-958 (I=L-2949)
BLUE	L-2287 (I=L-2946)
EMBERGLO	L-2921 (I=L-2948)
IVY GOLD	L-2503 (I=L-2947)
PARCHMENT	L-3096 (I=L-2288)
RED	L-2920 (I=L-2954)
SADDLE	L-3099 (I=L-3099)

NOTE: I=Insert.



## 1967 INTERIOR PARTS & ACCESSORIES

### 1967 HEADLINERS/SUNVISORS

Our 1967 Headliners are in the original Crater grain vinyl, constructed just like the original.

1966-67 2 DOOR SEDAN HEADLINER **105098**  
 1966-67 2 DOOR HARDTOP HEADLINER **105106**

Our 1967 Sunvisors are in the original Crater grain vinyl, with the vinyl binding stitched, just like the originals. All Sunvisors are sold in pairs.

1967 2 DOOR HARDTOP SUNVISORS **105510**  
 1966-67 CONVERTIBLE SUNVISORS **105528**



### 1967 INTERIOR ACCESSORIES

Distinctive Industries Seat Heaters provide therapeutic heat and body warmth in any classic car, using the same technology as late model or current vehicles. Each kit comes with switch, harnesses, and two carbon fiber element pads to complete one seat install. Switch can be dash, console, or hidden in a place of choice. Seat Heaters are sold individually, not in pairs.

1963-69 CARBON FIBER SEAT HEATERS **061001**



Distinctive Industries High-Density Seat Foam is designed to work as a system with our upholstery. Our High-Density Seat Foam is firm, form fitting, and features a Typar® web backing for strength, which prevents spring intrusion and ensures a quality fit and long lasting life. Seat Foam is sold individually, not in pairs.  
**BUCKET SEAT FOAM 064402BKT6667**

Our Convertible Top Boot features the correct Sierra grain in 32 oz. vinyl and fastens just like the original. Snaps are included.  
**1966-67 CONVERTIBLE TOP BOOTS 105726**

Our Convertible Well Liner is Sierra grain 32 oz. vinyl, just like the originals.  
**1966-67 CONVERTIBLE WELL LINER 105734**

Our Quarter Trim features 32 oz. vinyl in the correct Sierra grain and is stitched, just like the originals.  
**1966-67 CONVERTIBLE QUARTER TRIM WITH ARMREST 105262**



### 1967 COLORS

#### Hardtop Colors

AQUA	H-813	LIGHT GREEN	H-755
BLACK	H-754	MEDIUM BLUE	H-814
DARK AQUA	H-956	RED	H-863
IVY GOLD	H-1029	WHITE	H-741
LIGHT BLUE	H-836		

#### Convertible Colors

AQUA	L-2929	IVY GOLD	L-2503
BLACK	L-958	PARCHMENT	L-2613
BLUE	L-2287	RED	L-2920

FAIRLANE

**1968-69 INTERIOR PARTS & ACCESSORIES**

**1968-69 DOOR/QUARTER PANELS**

Our 1968-69 Fairlane & Cobra Door/Quarter Panels are a correct reproduction of the original with the chrome rectangular trim. We offer original Sierra grain in 32 oz. vinyl, and correct dielectrically heat sealed patterns as original.

Features

- Original Sierra grain vinyl
- Correct dielectric "Heat Seal" stitched pattern
- Correct colors matched to the original vinyl
- .100-inch thickness poly-coated "Autoboard" backing
- Door Panel backs are perimeter stapled for maximum adhesion
- Limited lifetime warranty

2 DOOR FRONT DOOR PANELS	<b>103881</b>
2 DOOR SPORTS ROOF REAR QUARTER PANELS	<b>103883</b>
2 DOOR FORMAL ROOF REAR QUARTER PANELS	<b>103885</b>

**1968-69 INTERIOR ACCESSORIES**

Distinctive Industries Seat Heaters provide therapeutic heat and body warmth in any classic car, using the same technology as late model or current vehicles. Each kit comes with switch, harnesses, and two carbon fiber element pads to complete one seat install. Switch can be dash, console, or hidden in a place of choice. Seat Heaters are sold individually, not in pairs.

1963-69 CARBON FIBER SEAT HEATERS **061001**



FAIRLANE



**1968-69 COLORS**

BLACK	L-958
BLUE	L-2287
IVY GOLD	L-2503
PARCHMENT	L-3096
RED	L-2920
TURQUOISE	L-2929
WHITE	L-2290

**Take a Kid to a Car Show**  
is dedicated to:

- Sharing the classic car hobby with kids
- Encouraging involvement by a new generation of automotive restoration enthusiasts
- Giving kids a constructive choice in how to spend their time

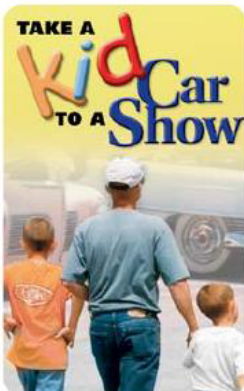

Take a Kid to a Car Show is a program of ARMO, the Automotive Restoration Market Organization, a SEMA Council.





## Introduction To The Catalog

Thank you for choosing Distinctive Industries as your provider of Restoration Interior Products. The catalog you are reading was designed with the input of our existing customers and moving forward, will continue to be a representation of their needs, and the needs of restoration experts worldwide.

### Design

We have designed our catalog for the Restoration Professional, from the Local Upholstery and Restoration Shop, to the National Distributor of Restoration Products. The thought was to create a catalog that eases the pain of product entry for those building catalogs, and to ease ordering for those that order directly from the catalog. We accomplished this by listing product by year, model, and trim level. You will find this catalog to be easy to use.

### Descriptions

Descriptions are a blend of Marketing and Technical descriptions. After polling our customers we found that aside from the design, missing was a good description of the products in today's catalogs. We remedied that by providing a blended description as a basis for our customers to expand upon, or use as is.

### Colors

Color swatches are placed near the product with labeled color codes to avoid confusion. Color Code boxes are located near the applicable products. We offer many special order color combinations as well as an option for leather in most cases.

### Images

Images are available for License through Distinctive Industries.

- Licensed images must be accompanied and located adjacent to the matching Distinctive Industries product.



## Table of Contents

1960-62 interior parts and accessories

1963 interior parts and accessories

1964 interior parts and accessories

1965 interior parts and accessories

1966-67 interior parts and accessories

© Copyright 2016, Distinctive Industries, all rights reserved. No part of this publication may be duplicated or reproduced without written permission from Distinctive Industries.



## 1960-62 INTERIOR PARTS & ACCESSORIES

### 1960 SEAT UPHOLSTERY

Our 1960 Falcon Seat Upholstery is a correct reproduction of the original. We offer the original Crush grain in 32 oz. vinyl, with the correct patterns sewn as original.

#### Features

- Original Crush grain vinyl
- Correct 6 stitch per inch stitching
- Correct colors matched to the original vinyl
- Limited lifetime warranty

FUTURA BENCH SEAT - FRONT **\*SEEKING PATTERN\***

FUTURA 2 DOOR HARDTOP BENCH SEAT -

REAR **\*SEEKING PATTERN\***



### 1961-62 SEAT UPHOLSTERY

Our 1961-62 Falcon Seat Upholstery is a correct reproduction of the original. We offer the original Crush grain in 32 oz. vinyl, with the correct dielectrically heat sealed vertical patterns, heat sealed Falcon logos (where applicable), and sewn as original. Seat buttons not included.

#### Features

- Original Crush grain vinyl
- Correct dielectric "Heat Seal" Pattern
- Correct 6 stitch per inch stitching
- Correct colors matched to the original vinyl
- Limited lifetime warranty

FUTURA WITH FRONT BUCKETS - FRONT/REAR SET	<b>100018</b>
DELUXE 2 DOOR WITH FRONT BENCH - FRONT/REAR SET	<b>100019</b>
DELUXE 2 DOOR WAGON - FRONT/REAR SET	<b>100020</b>
FUTURA BUCKET SEATS - FRONT	<b>100024</b>
DELUXE FUTURA 2 DOOR BENCH SEAT - FRONT	<b>104430</b>
DELUXE FUTURA 2 DOOR TWO-TONE BENCH SEAT - FRONT	<b>104422</b>
FUTURA 2 DOOR BENCH SEAT - REAR	<b>100040</b>
DELUXE 2 DOOR BENCH SEAT - REAR	<b>104448</b>
DELUXE 2 DOOR TWO-TONE BENCH SEAT - REAR	<b>104414</b>
DELUXE STATION WAGON BENCH SEAT - REAR	<b>100026</b>
DELUXE STATION WAGON TWO-TONE BENCH SEAT - REAR	<b>100028</b>



### 1961-62 DOOR/QUARTER PANELS

Our 1961-62 Door/Quarter Panels are a correct reproduction of the original. We offer original Crush grain in 32 oz. vinyl, correct Mylar®, and correct dielectrically heat sealed vertical patterns as original.

#### Features

- Original Crush grain vinyl
- Correct dielectric "Heat Seal" stitched pattern
- Correct colors matched to the original vinyl
- .100-inch thickness poly-coated "Autoboard" backing
- Door Panel backs are perimeter stapled for maximum adhesion
- Limited lifetime warranty

FUTURA FRONT DOOR PANELS	<b>103036</b>
FUTURA REAR QUARTER PANELS	<b>103044</b>

#### 1961-62 COLORS

BLACK	L-110
BLUE	L-1761
RED	L-1377

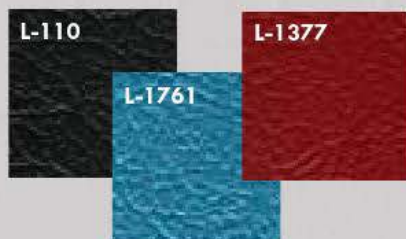

## 1960-62 INTERIOR PARTS & ACCESSORIES

### 1961-62 HEADLINERS/SUNVISORS

Our 1961-62 Headliners are in the original Crater grain vinyl, constructed just like the original.

1960-65 2 DOOR HEADLINER **105023**

1960-65 SEDAN DELIVERY HEADLINER **105033**



Our 1961-62 Sunvisors are in the original Crater grain vinyl, with the vinyl binding stitched, just like the originals. All Sunvisors are sold in pairs.

1961-65 2 DOOR SEDAN SUNVISORS **105585**



### 1961-62 HEADLINER/ SUNVISOR COLORS

BLACK	H-754
BLUE	H-836
PALOMINO	H-837
BRIGHT RED	H-812
RED	H-863
TURQUOISE	H-956
WHITE	H-741

### 1961-62 INTERIOR ACCESSORIES



Distinctive Industries Seat Heaters provide therapeutic heat and body warmth in any classic car, using the same technology as late model or current vehicles. Each kit comes with switch, harnesses, and two carbon fiber element pads to complete one seat install. Switch can be dash, console, or hidden in a place of choice. Seat Heaters are sold individually, not in pairs.

1961-67 CARBON FIBER SEAT HEATERS **061001**



1961 Falcon

## 1963 SEAT UPHOLSTERY

Our 1963 Falcon Seat Upholstery is a correct reproduction of the original. We offer the original Crush grain in 32 oz. vinyl, with the correct patterns, heat sealed Falcon logos (where applicable), silver Tinsel welt, and sewn as original. Seat back medallions not included. Hardtop/Convertible models with Front Bucket Seats, and Two-Tone Upholstery are considered Deluxe.

### Features

- Original Crush grain vinyl
- Correct 6 stitch per inch stitching

- Correct colors matched to the original vinyl
- Limited lifetime warranty

FUTURA 2 DOOR HARDTOP SPORT/SPRINT WITH FRONT BUCKETS - FRONT/REAR SET	100083
FUTURA 2 DOOR HARDTOP WITH FRONT BENCH - FRONT/REAR SET	100084
FUTURA 2 DOOR SEDAN WITH FRONT BENCH - FRONT/REAR SET	100085
FUTURA CONVERTIBLE SPORT/SPRINT WITH FRONT BUCKETS - FRONT/REAR SET	100086
FUTURA CONVERTIBLE WITH FRONT BENCH - FRONT/REAR SET	100087
FUTURA 4 DOOR SEDAN WITH FRONT BENCH - FRONT/REAR SET	100088
FUTURA 4 DOOR STATION WAGON WITH FRONT BENCH - FRONT/REAR SET	100090
FUTURA 2 DOOR HARDTOP SPORT/SPRINT BUCKET SEATS - FRONT	100183
FUTURA 2 DOOR HARDTOP/SEDAN BENCH SEAT - FRONT	100065
FUTURA CONVERTIBLE SPORT/SPRINT BUCKET SEATS - FRONT	100057
FUTURA CONVERTIBLE BENCH SEAT - FRONT	100060
FUTURA 4 DOOR SEDAN BENCH SEAT - FRONT	100117
FUTURA 2 DOOR SEDAN WITH FRONT BUCKETS - REAR BENCH SEAT	100073
FUTURA 2 DOOR SEDAN WITH FRONT BENCH - REAR BENCH SEAT	100075
FUTURA 2 DOOR HARDTOP SPORT/SPRINT WITH FRONT BUCKETS - REAR BENCH SEAT	100184
FUTURA 2 DOOR HARDTOP WITH FRONT BENCH - REAR BENCH SEAT	100099
FUTURA CONVERTIBLE SPORT/SPRINT WITH FRONT BUCKETS - REAR BENCH SEAT	100081
FUTURA CONVERTIBLE WITH FRONT BENCH - REAR BENCH SEAT	100107
FUTURA 4 DOOR SEDAN WITH FRONT BENCH - REAR BENCH SEAT	100119
FUTURA 2 DOOR STATION WAGON WITH FRONT BENCH - REAR BENCH SEAT	100109
FUTURA 4 DOOR STATION WAGON WITH FRONT BENCH - REAR BENCH SEAT	100111

### Two-Tone Upholstery

FUTURA 2 DOOR HARDTOP SPORT/SPRINT WITH FRONT BUCKETS - FRONT/REAR SET	100100
FUTURA 2 DOOR HARDTOP WITH FRONT BENCH - FRONT/REAR SET	100101
FUTURA 2 DOOR SEDAN WITH FRONT BENCH - FRONT/REAR SET	100102
FUTURA CONVERTIBLE SPORT/SPRINT WITH FRONT BUCKETS - FRONT/REAR SET	100103
FUTURA CONVERTIBLE WITH FRONT BENCH - FRONT/REAR SET	100104
FUTURA 4 DOOR SEDAN WITH FRONT BENCH - FRONT/REAR SET	100105
FUTURA 2 DOOR HARDTOP SPORT/SPRINT BUCKET SEATS -FRONT	104505
FUTURA BENCH SEAT - FRONT	101311
FUTURA CONVERTIBLE SPORT/SPRINT BUCKET SEATS - FRONT	101303
FUTURA CONVERTIBLE BENCH SEAT - FRONT	101320
FUTURA 4 DOOR SEDAN BENCH SEAT - FRONT	101338
FUTURA 2 DOOR HARDTOP SPORT/SPRINT WITH FRONT BUCKETS - REAR BENCH SEAT	101329
FUTURA 2 DOOR HARDTOP WITH FRONT BENCH - REAR BENCH SEAT	101345
FUTURA 2 DOOR SEDAN WITH FRONT BUCKETS - REAR BENCH SEAT	100115
FUTURA 2 DOOR SEDAN WITH FRONT BENCH - REAR BENCH SEAT	101349
FUTURA 4 DOOR SEDAN WITH FRONT BENCH - REAR BENCH SEAT	100339
FUTURA CONVERTIBLE SPORT/SPRINT WITH FRONT BUCKETS - REAR BENCH SEAT	101337
FUTURA CONVERTIBLE WITH FRONT BENCH - REAR BENCH SEAT	101352
FUTURA 2 DOOR STATION WAGON WITH FRONT BENCH - REAR BENCH SEAT	101341

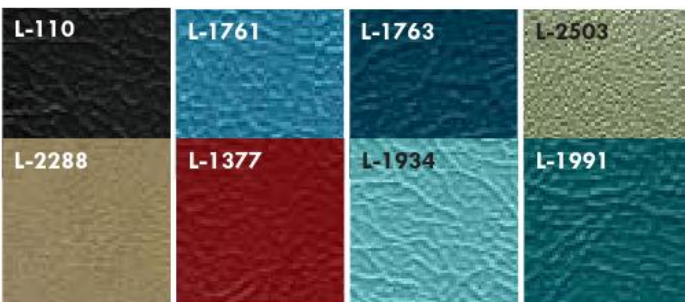

### 1963 COLORS

BLACK	L-110	PALOMINO	L-2288
IVY GOLD	L-2503	RED	L-1377

### 1963 TWO-TONE COLORS

BLUE	L-1761 (S=L-1763)	TURQUOISE	L-1934 (S=L-1991)
------	-------------------	-----------	-------------------

**NOTE: A popular non-original color option is Ivy Gold. Ivy Gold is Sierra grain as it was not available in 1963.**

## 1963 INTERIOR PARTS & ACCESSORIES

### 1963 DOOR/QUARTER PANELS

Our 1963 Door/Quarter Panels are a correct reproduction of the original. We offer original Crush grain in 32 oz. vinyl, correct Mylar®, and dielectrically heat sealed horizontal patterns as original.

#### Features

- Original Crush grain vinyl
- Correct dielectric "Heat Seal" stitched pattern
- Correct colors matched to the original vinyl
- .100-inch thickness poly-coated "Autoboard" backing
- Door Panel backs are perimeter stapled for maximum adhesion
- Limited lifetime warranty

FUTURA FRONT DOOR PANELS	<b>103093</b>
FUTURA 4 DOOR FRONT DOOR PANELS	<b>103077</b>
FUTURA 2 DOOR HARDTOP REAR QUARTER PANELS	<b>103101</b>
FUTURA 2 DOOR SEDAN REAR QUARTER PANELS	<b>103127</b>
FUTURA CONVERTIBLE REAR QUARTER PANELS	<b>103119*</b>
FUTURA 4 DOOR REAR DOOR PANELS	<b>103085</b>

#### 1963 COLORS

BLACK	L-110	PALOMINO	L-2288
BLUE	L-1761	RED	L-1377
IVY GOLD	L-2503	TURQUOISE	L-1934

**NOTE:** A popular non-original color option is Ivy Gold. Ivy Gold is Sierra grain as it was not available in 1963.



### 1963 HEADLINERS/SUNVISORS

Our 1963 Headliners are in the original Crater grain vinyl, constructed just like the original.

1960-65 2 DOOR SEDAN HEADLINER	<b>105023</b>
1963-65 2 DOOR HARDTOP HEADLINER	<b>105031</b>
1960-65 SEDAN DELIVERY HEADLINER	<b>105033</b>

Our 1963 Sunvisors are in the original Crater grain vinyl, with the vinyl binding stitched, just like the originals. All Sunvisors are sold in pairs.

1961-65 2 DOOR SEDAN SUNVISORS	<b>105585</b>
--------------------------------	---------------



#### 1963 HEADLINER/SUNVISOR COLORS

BLACK	H-754
BLUE	H-836
PALOMINO	H-837
BRIGHT RED	H-812
RED	H-863
TURQUOISE	H-956
WHITE	H-741

## 1963 INTERIOR PARTS & ACCESSORIES

### 1963 INTERIOR ACCESSORIES

Distinctive Industries Seat Heaters provide therapeutic heat and body warmth in any classic car, using the same technology as late model or current vehicles. Each kit comes with switch, harnesses, and two carbon fiber element pads to complete one seat install. Switch can be dash, console, or hidden in a place of choice. Seat Heaters are sold individually, not in pairs.

1961-67 CARBON FIBER SEAT HEATERS **061001**

Distinctive Industries High-Density Seat Foam is designed to work as a system with our upholstery. Our High-Density Seat Foam is firm, form fitting, and features a Typar® web backing for strength, which prevents spring intrusion and ensures a quality fit and long lasting life. Seat Foam is sold individually, not in pairs.

2 DOOR HARDTOP/SEDAN BUCKET SEAT FOAM **064301BUCKET63**  
 CONVERTIBLE BUCKET SEAT FOAM **064311BUCKET63**

Our Convertible Top Boot features the correct Crush grain in 32 oz. vinyl and fastens just like the original. Snaps are included.

CONVERTIBLE TOP BOOT **105692**

Our Convertible Well Liner is Crush grain in 32 oz. vinyl, just like the originals.

CONVERTIBLE WELL LINER **105716**

Our Quarter Trim features 32 oz. vinyl in the correct Crush grain and is stitched, just like the originals.

1963-65 CONVERTIBLE QUARTER TRIM W/ARMREST **105254**



#### 1963 COLORS

BLACK	L-110
BLUE	L-1761
IVY GOLD	L-2503
PALOMINO	L-2288
RED	L-1377
TURQUOISE	L-1934



1963 Falcon Sprint

## 1964 INTERIOR PARTS & ACCESSORIES

### 1964 SEAT UPHOLSTERY

Our 1964 Falcon Seat Upholstery is a correct reproduction of the original. We offer the original Crush grain in 32 oz. vinyl, with the correct vertical patterns, heat sealed Falcon logos (where applicable), silver Tinsel welt, and sewn as original. Seat back medallions are not included.

#### Features

- Original Crush grain vinyl
- Correct 6 stitch per inch stitching

- Correct colors matched to the original vinyl
- Limited lifetime warranty

FUTURA 2 DOOR HARDTOP SPORT/SPRINT WITH FRONT BUCKETS - FRONT/REAR SET	<b>100188</b>
FUTURA 2 DOOR HARDTOP WITH FRONT BENCH - FRONT/REAR SET	<b>100189</b>
FUTURA 2 DOOR SEDAN WITH FRONT BENCH - FRONT/REAR SET	<b>100190</b>
FUTURA CONVERTIBLE SPORT/SPRINT WITH FRONT BUCKETS - FRONT/REAR SET	<b>100191</b>
FUTURA CONVERTIBLE WITH FRONT BENCH - FRONT/REAR SET	<b>100192</b>
FUTURA STATION WAGON WITH FRONT BENCH - FRONT/REAR SET	<b>100193</b>
FUTURA 4 DOOR SEDAN WITH FRONT BENCH - FRONT/REAR SET	<b>100195</b>
FUTURA 2 DOOR HARDTOP SPORT/SPRINT BUCKET SEATS - FRONT	<b>100123</b>
FUTURA 2 DOOR SPLIT BENCH SEAT - FRONT	<b>100149</b>
FUTURA CONVERTIBLE SPORT/SPRINT BUCKET SEATS - FRONT	<b>100131</b>
FUTURA CONVERTIBLE SPLIT BENCH SEAT - FRONT	<b>104703</b>
FUTURA 4 DOOR/STATION WAGON BENCH SEAT - FRONT	<b>100181</b>
FUTURA 2 DOOR HARDTOP BENCH SEAT - REAR	<b>100156</b>
FUTURA 2 DOOR SEDAN BENCH SEAT - REAR	<b>100172</b>
FUTURA 4 DOOR SEDAN BENCH SEAT - REAR	<b>100174</b>
FUTURA CONVERTIBLE BENCH SEAT - REAR	<b>100164</b>
FUTURA STATION WAGON WITH FRONT BENCH - REAR BENCH SEAT	<b>101182</b>

<b>Two-Tone Upholstery</b>	
FUTURA 2 DOOR HARDTOP SPORT/SPRINT WITH FRONT BUCKETS - FRONT/REAR SET	<b>100208</b>
FUTURA 2 DOOR HARDTOP WITH FRONT BENCH - FRONT/REAR SET	<b>100209</b>
FUTURA 2 DOOR SEDAN WITH FRONT BENCH - FRONT/REAR SET	<b>100210</b>
FUTURA CONVERTIBLE SPORT/SPRINT WITH FRONT BUCKETS - FRONT/REAR SET	<b>100211</b>
FUTURA CONVERTIBLE WITH FRONT BENCH - FRONT/REAR SET	<b>100212</b>
FUTURA STATION WAGON WITH FRONT BENCH - FRONT/REAR SET	<b>100200</b>
FUTURA 2 DOOR HARDTOP SPORT/SPRINT BUCKET SEATS - FRONT	<b>101360</b>
FUTURA 2 DOOR SPLIT BENCH SEAT - FRONT	<b>101386</b>
FUTURA CONVERTIBLE SPORT/SPRINT BUCKET SEATS - FRONT	<b>101378</b>
FUTURA CONVERTIBLE SPLIT BENCH SEAT - FRONT	<b>101390</b>
FUTURA 2 DOOR HARDTOP BENCH SEAT - REAR	<b>101394</b>
FUTURA 2 DOOR SEDAN BENCH SEAT - REAR	<b>101410</b>
FUTURA CONVERTIBLE BENCH SEAT - REAR	<b>101402</b>
FUTURA STATION WAGON BENCH SEAT - REAR	<b>101414</b>

#### 1964 COLORS

BLACK	L-110
BLUE	L-1761
IVY GOLD	L-2503
PALOMINO	L-2288
RED	L-1377
TURQUOISE	L-1934

**NOTE:** A popular non-original color option is Ivy Gold. Ivy Gold is Sierra grain as it was not available in 1964.

#### 1964 TWO-TONE COLORS

BLUE	L-1761 (I=L-1763)
TURQUOISE	L-1934 (I=L-1991)

**NOTE:** I=Insert.



## 1964 INTERIOR PARTS & ACCESSORIES

### 1964 DOOR/QUARTER PANELS

Our 1964 Door/Quarter Panels are a correct reproduction of the original. We offer original Crush grain in 32 oz. vinyl, correct Mylar® and dielectrically heat sealed horizontal patterns as original.

#### Features

- Original Crush grain vinyl
- Correct dielectric "Heat Seal" stitched pattern
- Correct colors matched to the original vinyl
- .100-inch thickness poly-coated "Autoboard" backing
- Door Panel backs are perimeter stapled for maximum adhesion
- Limited lifetime warranty

FUTURA FRONT DOOR PANELS	<b>103150</b>
FUTURA 4 DOOR SEDAN FRONT DOOR PANELS	<b>103143</b>
FUTURA 2 DOOR HARDTOP REAR QUARTER PANELS	<b>103168</b>
FUTURA 2 DOOR SEDAN REAR QUARTER PANELS	<b>103172</b>
FUTURA CONVERTIBLE REAR QUARTER PANELS	<b>103176</b>
FUTURA 4 DOOR SEDAN REAR DOOR PANELS	<b>103184</b>



#### 1964 COLORS

BLACK	L-110
BLUE	L-1761
IVY GOLD	L-2503
PALOMINO	L-2288
RED	L-1377
TURQUOISE	L-1934

**NOTE:** A popular non-original color option is Ivy Gold. Ivy Gold is Sierra grain as it was not available in 1964.

### 1964 HEADLINERS/SUNVISORS

Our 1964 Headliners are in the original Crater grain vinyl, constructed just like the original.

1960-65 2 DOOR SEDAN HEADLINER	<b>105023</b>
1963-65 2 DOOR HARDTOP HEADLINER	<b>105031</b>
1960-65 SEDAN DELIVERY HEADLINER	<b>105033</b>

Our 1964 Sunvisors are in the original Crater grain vinyl, with the vinyl binding stitched, just like the originals. All Sunvisors are sold in pairs.

1961-65 2 DOOR SEDAN SUNVISORS	<b>105585</b>
--------------------------------	---------------

#### 1964 HEADLINER/SUNVISOR COLORS

BLACK	H-754	RED	H-863
BLUE	H-836	TURQUOISE	H-956
PALOMINO	H-837	WHITE	H-741
BRIGHT RED	H-812		





**1964 INTERIOR PARTS & ACCESSORIES**

**1964 INTERIOR ACCESSORIES**

Distinctive Industries Seat Heaters provide therapeutic heat and body warmth in any classic car, using the same technology as late model or current vehicles. Each kit comes with switch, harnesses, and two carbon fiber element pads to complete one seat install. Switch can be dash, console, or hidden in a place of choice. Seat Heaters are sold individually, not in pairs.

1961-67 CARBON FIBER SEAT HEATERS **061001**

Distinctive Industries High-Density Seat Foam is designed to work as a system with our upholstery. Our High-Density Seat Foam is firm, form fitting, and features a Typar® web backing for strength, which prevents spring intrusion and ensures a quality fit and long lasting life. Seat Foam is sold individually, not in pairs.

2 DOOR HARDTOP/SEDAN BUCKET  
 SEAT FOAM **064302BUCKET64**  
 CONVERTIBLE BUCKET SEAT FOAM **064345BUCKET64**

Our Convertible Top Boot features the correct Crush grain in 32 oz. vinyl and fastens just like the original. Snaps are included.

1964-65 CONVERTIBLE TOP BOOT **105700**

Our Convertible Well Liner is Crush grain in 32 oz. vinyl, just like the originals.

1964-65 CONVERTIBLE WELL LINER **105718**

Our Quarter Trim features 32 oz. vinyl in the correct Crush grain and is stitched, just like the originals.

1963-65 CONVERTIBLE QUARTER TRIM W/ARMREST **105254**



**1964 COLORS**

BLACK	L-110
BLUE	L-1761
IVY GOLD	L-2503
PALOMINO	L-2288
RED	L-1377
TURQUOISE	L-1934

*NOTE: A popular non-original color option is Ivy Gold. Ivy Gold is Sierra grain as it was not available in 1964.*



1964 Falcon Futura

## 1965 INTERIOR PARTS & ACCESSORIES

### 1965 SEAT UPHOLSTERY

Our 1965 Falcon Seat Upholstery is a correct reproduction of the original. We offer the original Sierra grain in 32 oz. vinyl, with the correct vertical patterns sewn as original. Seat back medallions are not included.

#### Features

- Original Sierra grain vinyl
- Correct 6 stitch per inch stitching
- Correct colors matched to the original vinyl
- Limited lifetime warranty



FUTURA 2 DOOR HARDTOP WITH FRONT BUCKETS - FRONT/REAR SET	<b>100233</b>
FUTURA 2 DOOR HARDTOP WITH FRONT BUCKETS - FRONT/REAR SET WITH LOGO	<b>100234</b>
FUTURA 2 DOOR HARDTOP WITH FRONT BENCH - FRONT/REAR SET	<b>100235</b>
FUTURA 2 DOOR SEDAN WITH FRONT BENCH - FRONT/REAR SET	<b>100236</b>
FUTURA CONVERTIBLE WITH FRONT BUCKETS - FRONT/REAR SET	<b>100237</b>
FUTURA CONVERTIBLE WITH FRONT BENCH - FRONT/REAR SET	<b>100238</b>
FUTURA 4 DOOR SEDAN WITH FRONT BENCH - FRONT/REAR SET	<b>100240</b>
FUTURA 4 DOOR STATION WAGON - FRONT/REAR SET	<b>100241</b>
FUTURA 2 DOOR HARDTOP BUCKET SEATS - FRONT	<b>100198</b>
FUTURA BUCKET SEATS WITH LOGO - FRONT	<b>101439</b>
FUTURA BENCH SEAT WITH LOGO - FRONT	<b>101438</b>
FUTURA CONVERTIBLE BUCKET SEATS - FRONT	<b>100197</b>
FUTURA SPLIT BENCH SEAT - FRONT	<b>100206</b>
FUTURA 4 DOOR/STATION WAGON BENCH SEAT - FRONT	<b>100228</b>
FUTURA 2 DOOR HARDTOP BENCH SEAT - REAR	<b>100214</b>
FUTURA 2 DOOR SEDAN BENCH SEAT - REAR	<b>100225</b>
FUTURA 4 DOOR SEDAN BENCH SEAT - REAR	<b>101459</b>
FUTURA CONVERTIBLE BENCH SEAT - REAR	<b>100222</b>
FUTURA STATION WAGON BENCH SEAT - REAR	<b>100230</b>

#### Two-Tone Upholstery

FUTURA 2 DOOR HARDTOP WITH FRONT BUCKETS - FRONT/REAR SET	<b>100242</b>
FUTURA 2 DOOR HARDTOP WITH FRONT BUCKETS - FRONT/REAR SET WITH LOGO	<b>100239</b>
FUTURA 2 DOOR HARDTOP WITH FRONT BENCH - FRONT/REAR SET	<b>100243</b>
FUTURA 2 DOOR SEDAN WITH FRONT BENCH - FRONT/REAR SET	<b>100244</b>
FUTURA CONVERTIBLE WITH FRONT BUCKETS - FRONT/REAR SET	<b>100245</b>
FUTURA CONVERTIBLE WITH FRONT BENCH - FRONT/REAR SET	<b>100246</b>
FUTURA 4 DOOR SEDAN WITH FRONT BENCH - FRONT/REAR SET	<b>100247</b>
FUTURA 4 DOOR STATION WAGON - FRONT/REAR SET	<b>100248</b>
FUTURA BUCKET SEATS WITH LOGO - FRONT	<b>101430</b>
FUTURA BENCH SEAT WITH LOGO - FRONT	<b>101431</b>
FUTURA 2 DOOR HARDTOP BUCKET SEATS - FRONT	<b>101428</b>
FUTURA CONVERTIBLE BUCKET SEATS - FRONT	<b>101432</b>
FUTURA SPLIT BENCH SEAT - FRONT	<b>101436</b>
FUTURA 4 DOOR/STATION WAGON BENCH SEAT - FRONT	<b>101455</b>
FUTURA 2 DOOR HARDTOP BENCH SEAT - REAR	<b>101444</b>
FUTURA 2 DOOR SEDAN BENCH SEAT - REAR	<b>101469</b>
FUTURA 4 DOOR SEDAN BENCH SEAT - REAR	<b>101453</b>
FUTURA CONVERTIBLE BENCH SEAT - REAR	<b>101451</b>
FUTURA STATION WAGON BENCH SEAT - REAR	<b>101457</b>

FALCON



#### 1965 COLORS

BLACK	L-958
BLUE	L-2287
IVY GOLD	L-2503
PALOMINO	L-2288
RED	L-957
TURQUOISE	L-2929

#### 1965 TWO-TONE COLORS

BLUE	L-2287 (I=L-2505)
TURQUOISE	L-2929 (I=L-3097)

**NOTE: I=Insert.**

## 1965 INTERIOR PARTS & ACCESSORIES

### 1965 DOOR/QUARTER PANELS

Our 1965 Door/Quarter Panels are a correct reproduction of the original. We offer original Sierra grain in 32 oz. vinyl, correct Mylar®, and dielectrically heat sealed patterns as original. Door/Quarter Panels feature 2 horizontal lines on the panels with vertical lines on the inserts.

#### Features

- Original Sierra grain vinyl
- Correct dielectric "Heat Seal" stitched pattern
- Correct colors matched to the original vinyl
- .100-inch thickness poly-coated "Autoboard" backing
- Door Panel backs are perimeter stapled for maximum adhesion
- Limited lifetime warranty

FUTURA 2 DOOR FRONT DOOR PANELS	<b>103218</b>
FUTURA 2 DOOR FRONT DOOR PANELS - TWO-TONE	<b>104067</b>
FUTURA 4 DOOR SEDAN FRONT DOOR PANELS	<b>103242</b>
FUTURA 4 DOOR SEDAN FRONT DOOR PANELS - TWO-TONE	<b>103261</b>
FUTURA 2 DOOR HARDTOP REAR QUARTER PANELS	<b>103226</b>
FUTURA 2 DOOR HARDTOP REAR QUARTER PANELS - TWO-TONE	<b>104075</b>
FUTURA CONVERTIBLE REAR QUARTER PANELS	<b>103234</b>
FUTURA CONVERTIBLE REAR QUARTER PANELS - TWO-TONE	<b>104083</b>
FUTURA 4 DOOR SEDAN REAR DOOR PANELS	<b>103259</b>
FUTURA 4 DOOR SEDAN REAR DOOR PANELS - TWO-TONE	<b>103263</b>
FUTURA 2 DOOR SEDAN REAR QUARTER PANELS	<b>103230</b>
FUTURA 2 DOOR SEDAN REAR QUARTER PANELS - TWO-TONE	<b>104079</b>



#### 1965 COLORS

BLACK	L-958
BLUE	L-2287
IVY GOLD	L-2503
PALOMINO	L-2288
RED	L-957
TURQUOISE	L-2929

#### 1965 TWO-TONE DOOR/QUARTER COLORS

BLUE	L-2287 (I=L-2505)
TURQUOISE	L-2929 (I=L-3097)

**NOTE: I=Insert.**

## 1965 INTERIOR PARTS & ACCESSORIES

### 1965 HEADLINERS/SUNVISORS

Our 1965 Headliners are in the original Crater grain vinyl, constructed just like the original.

1960-65 2 DOOR SEDAN HEADLINER	<b>105023</b>
1964-65 2 DOOR HARDTOP HEADLINER	<b>105031</b>
1960-65 SEDAN DELIVERY HEADLINER	<b>105033</b>



Our 1965 Sunvisors are in the original Crater grain vinyl, with the vinyl binding stitched, just like the originals. All Sunvisors are sold in pairs.

1961-65 2 DOOR SEDAN SUNVISORS	<b>105585</b>
--------------------------------	---------------

### 1965 INTERIOR ACCESSORIES

Distinctive Industries Seat Heaters provide therapeutic heat and body warmth in any classic car, using the same technology as late model or current vehicles. Each kit comes with switch, harnesses, and two carbon fiber element pads to complete one seat install. Switch can be dash, console, or hidden in a place of choice. Seat Heaters are sold individually, not in pairs.

1961-67 CARBON FIBER SEAT HEATERS	<b>061001</b>
-----------------------------------	---------------

Distinctive Industries High-Density Seat Foam is designed to work as a system with our upholstery. Our High-Density Seat Foam is firm, form fitting, and features a Typar® web backing for strength, which prevents spring intrusion and ensures a quality fit and long lasting life.

HARDTOP/SEDAN BUCKET SEAT FOAM - SOLD INDIVIDUALLY	<b>064358</b>
CONVERTIBLE BUCKET SEAT FOAM - SOLD INDIVIDUALLY	<b>064360</b>

Our Convertible Top Boot features the correct Sierra grain in 32 oz. vinyl and fastens just like the original. Snaps are included.

1964-65 CONVERTIBLE TOP BOOT	<b>105700</b>
------------------------------	---------------

Our Convertible Well Liner is Sierra grain in 32 oz. vinyl, just like the originals.

1964-65 CONVERTIBLE WELL LINER	<b>105718</b>
--------------------------------	---------------

Our Quarter Trim features 32 oz. vinyl in the correct Sierra grain and is stitched, just like the originals.

1963-65 CONVERTIBLE QUARTER TRIM W/ARMREST	<b>105254</b>
--	---------------



#### 1965 HEADLINER/ SUNVISOR COLORS

BLACK	H-754
BLUE	H-836
PALOMINO	H-837
BRIGHT RED	H-812
RED	H-863
TURQUOISE	H-956
WHITE	H-741



#### 1965 COLORS

BLACK	L-958
BLUE	L-2287
IVY GOLD	L-2503
PALOMINO	L-2288
RED	L-957
TURQUOISE	L-2929

## 1966-67 INTERIOR PARTS & ACCESSORIES

### 1966-67 SEAT UPHOLSTERY

Our 1966-67 Falcon Seat Upholstery is a correct reproduction of the original. We offer the original Sierra grain in 32 oz. vinyl, with the correct vertical patterns, correct embossing on the seat back and upper lean back, and sewn as original. Emblems, and seat buttons not included.

#### Features

- Original Sierra grain vinyl
- Correct 6 stitch per inch stitching
- Correct colors matched to the original vinyl
- Limited lifetime warranty

FUTURA 2 DOOR WITH FRONT BUCKETS - FRONT/REAR SET	<b>100250</b>
FUTURA 2 DOOR WITH FRONT BENCH - FRONT/REAR SET	<b>100251</b>
FUTURA 2 DOOR BUCKET SEATS - FRONT	<b>100255</b>
FUTURA 2 DOOR BENCH SEAT - FRONT	<b>100263</b>
FUTURA 2 DOOR SEDAN BENCH SEAT - REAR	<b>100271</b>

#### Two-Tone Upholstery

FUTURA 2 DOOR WITH FRONT BUCKETS - FRONT/REAR SET	<b>100252</b>
FUTURA 2 DOOR WITH FRONT BENCH - FRONT/REAR SET	<b>100253</b>
FUTURA 2 DOOR BUCKET SEATS - FRONT	<b>101471</b>
FUTURA 2 DOOR BENCH SEAT - FRONT	<b>101473</b>
FUTURA 2 DOOR SEDAN BENCH SEAT - REAR	<b>101475</b>

### 1966-67 DOOR/QUARTER PANELS

Our 1966-67 Door/Quarter Panels are a correct reproduction of the original. We offer original Sierra grain in 32 oz. vinyl, correct Mylar® and correct dielectrically heat sealed vertical patterns as original.

#### Features

- Original Sierra grain vinyl
- Correct dielectric "Heat Seal" stitched pattern
- Correct colors matched to the original vinyl
- .100-inch thickness poly-coated "Autoboard" backing
- Door Panel backs are perimeter stapled for maximum adhesion
- Limited lifetime warranty

FUTURA 2 DOOR SPORTS COUPE FRONT DOOR PANELS	<b>103275</b>
FUTURA 2 DOOR SPORTS COUPE FRONT DOOR PANELS - TWO-TONE	<b>103291</b>
FUTURA 2 DOOR SPORTS COUPE REAR QUARTER PANELS	<b>103283</b>
FUTURA 2 DOOR SPORTS COUPE REAR QUARTER PANELS - TWO-TONE	<b>103309</b>

### 1966-67 INTERIOR ACCESSORIES

Distinctive Industries Seat Heaters provide therapeutic heat and body warmth in any classic car, using the same technology as late model or current vehicles. Each kit comes with switch, harnesses, and two carbon fiber element pads to complete one seat install. Switch can be dash, console, or hidden in a place of choice. Seat Heaters are sold individually, not in pairs.

1961-67 CARBON FIBER SEAT HEATERS **061001**

Distinctive Industries High-Density Seat Foam is designed to work as a system with our upholstery. Our High-Density Seat Foam is firm, form fitting, and features a Typar® web backing for strength, which prevents spring intrusion and ensures a quality fit and long lasting life. Seat Foam is sold individually, not in pairs.

BUCKET SEAT FOAM **064402BKT6667**



#### 1966-67 COLORS

BLACK	L-958
AQUA	L-2929 (INSERT L-3097)
BLUE	L-2287 (INSERT L-2505)
IVY GOLD	L-2503 (INSERT L-2286)
PARCHMENT	L-2613 (INSERT L-2586)
RED	L-2920 (INSERT L-3116)



## Introduction To The Catalog

Thank you for choosing Distinctive Industries as your provider of Restoration Interior Products. The catalog you are reading was designed with the input of our existing customers and moving forward, will continue to be a representation of their needs, and the needs of restoration experts worldwide.

### Design

We have designed our catalog for the Restoration Professional, from the Local Upholstery and Restoration Shop, to the National Distributor of Restoration Products. The thought was to create a catalog that eases the pain of product entry for those building catalogs, and to ease ordering for those that order directly from the catalog. We accomplished this by listing product by year, model, and trim level. You will find this catalog to be easy to use.

### Descriptions

Descriptions are a blend of Marketing and Technical descriptions. After polling our customers we found that aside from the design, missing was a good description of the products in today's catalogs. We remedied that by providing a blended description as a basis for our customers to expand upon, or use as is.

### Colors

Color swatches are placed near the product with labeled color codes to avoid confusion. Color Code boxes are located near the applicable products. We offer many special order color combinations as well as an option for leather in most cases.

### Images

Images are available for License through Distinctive Industries.

- Licensed images must be accompanied and located adjacent to the matching Distinctive Industries product.



## Table of Contents

1960-61 interior parts and accessories
1962 500/500XL interior parts and accessories
1963 500/500XL interior parts and accessories
1964 500/500XL interior parts and accessories
1965 500/500XL interior parts and accessories
1966 500/500XL interior parts and accessories
1967 500/500XL interior parts and accessories
1968 500/500XL interior parts and accessories

© Copyright 2016, Distinctive Industries, all rights reserved. No part of this publication may be duplicated or reproduced without written permission from Distinctive Industries.





## 1960-62 INTERIOR PARTS & ACCESSORIES

### 1960-61 HEADLINERS

Our 1960-61 Headliners are in the original grain vinyl, constructed just like the original.

1960-61 HEADLINER **105140**

### 1962 500 SEAT UPHOLSTERY

Our 1962 Galaxie 500 Seat Upholstery is a correct reproduction of the original with 3" wide vertical stripes, and black/chrome vertical bands. We offer the original Crush grain in 32 oz. vinyl, with the correct vertical patterns sewn as original.

#### Features

- Original Crush grain vinyl
- Correct 6 stitch per inch stitching
- Correct colors matched to the original vinyl
- Limited lifetime warranty

500 2 DOOR SPLIT BENCH SEAT - FRONT **101733**  
 500 2 DOOR HARDTOP BENCH SEAT - REAR **101741**  
 500 2 DOOR SEDAN BENCH SEAT - REAR **101750**  
 500 CONVERTIBLE BENCH SEAT - REAR **101758**

### 1962 500 DOOR/QUARTER PANELS

Our 1962 Galaxie 500 Door/Quarter Panels are a correct reproduction of the original. We offer original Crush grain in 32 oz. vinyl, and correct dielectrically heat sealed patterns as original.

#### Features

- Original Crush grain vinyl
- Correct dielectric "Heat Seal" stitched pattern
- Correct colors matched to the original vinyl
- .100-inch thickness poly-coated "Autoboard" backing
- Door Panel backs are perimeter stapled for maximum adhesion
- Limited lifetime warranty

500 2 DOOR FRONT DOOR PANELS **\*SEEKING PATTERN\***  
 500 2 DOOR HARDTOP REAR QUARTER  
 PANELS **\*SEEKING PATTERN\***  
 500 CONVERTIBLE REAR QUARTER  
 PANELS **\*SEEKING PATTERN\***



#### 1962 500 COLORS

BLACK	L-110	RED	L-1377
BLUE	L-1761	LIGHT TURQUOISE	L-1934
CHESTNUT	L-2921	TURQUOISE	L-1991
DARK BLUE	L-1763	WHITE	L-1752

**NOTE: Chestnut is not available in Crush grain vinyl therefore we substitute Sierra grain Emberglo. Both colors match but the grains are different.**

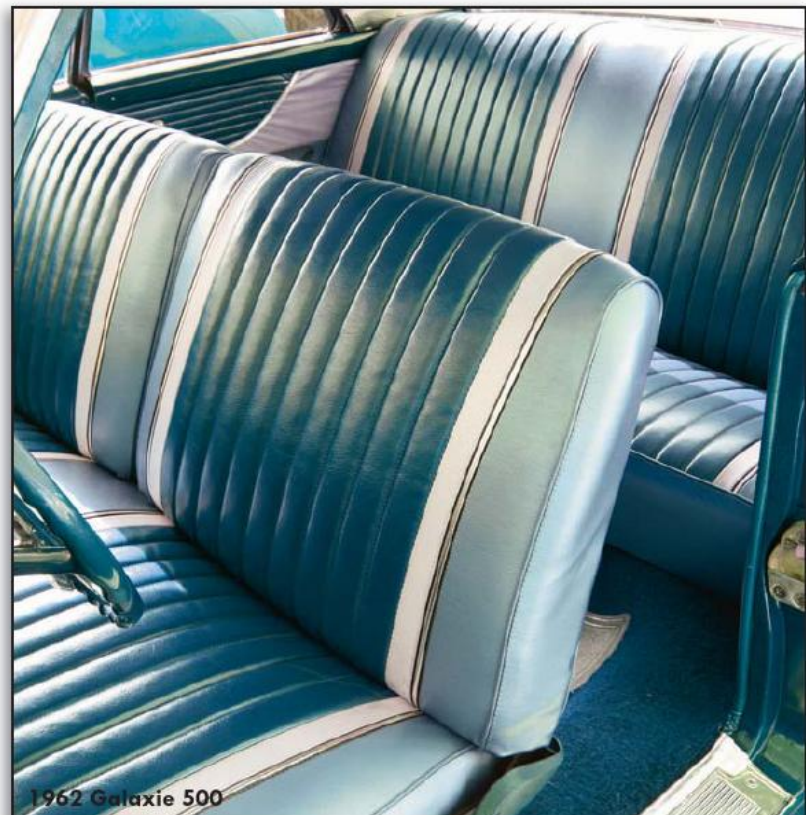

1962 Galaxie 500

## 1962 INTERIOR PARTS & ACCESSORIES

### 1962 500XL SEAT UPHOLSTERY

Our 1962 Galaxie 500XL Seat Upholstery is a correct reproduction of the original, and features both vertical stripes. One 9" long black/chrome stripe, and 1 stripe the same color as the insert. We offer the original Crush grain in 32 oz. vinyl, with the correct vertical patterns sewn as original.

#### Features

- Original Crush grain vinyl
- Correct 6 stitch per inch stitching
- Correct colors matched to the original vinyl
- Limited lifetime warranty

500XL BUCKET SEATS - FRONT	101840
500XL 2 DOOR HARDTOP BENCH SEAT - REAR	101841
500XL CONVERTIBLE BENCH SEAT - REAR	101842

### 1962 500XL DOOR/QUARTER PANELS

Our 1962 Galaxie 500XL Door/Quarter Panels are a correct reproduction of the original. We offer original Crush grain in 32 oz. vinyl, and correct dielectrically heat sealed patterns as original.

#### Features

- Original Crush grain vinyl
- Correct dielectric "Heat Seal" stitched pattern
- Correct colors matched to the original vinyl
- .100-inch thickness poly-coated "Autoboard" backing
- Door Panel backs are perimeter stapled for maximum adhesion
- Limited lifetime warranty

500XL FRONT DOOR PANELS	*SEEKING PATTERN*
500XL 2 DOOR HARDTOP REAR QUARTER PANELS	*SEEKING PATTERN*
500XL CONVERTIBLE REAR QUARTER PANELS	*SEEKING PATTERN*



#### 1962 500XL COLORS

BLACK	L-110	LIGHT BLUE	L-1761
BLUE	L-1761	LIGHT TURQUOISE	L-1934
CHESTNUT	L-2921	TURQUOISE	L-1991
DARK BLUE	L-1763	WHITE	L-1752
RED	L-1377		

**NOTE:** Chestnut is not available in Crush grain vinyl therefore we substitute Sierra grain Emberglo. Both colors match but the grains are different.

**Don't Forget About SEAT HEATERS!!!**  
 Now Available Easy to install  
 PerfectFit® Carbon Fiber Seat Heaters  
 with a small concealable switch  
**PART #061001**







## 1962 INTERIOR PARTS & ACCESSORIES

### 1962 INTERIOR ACCESSORIES

Distinctive Industries High-Density Seat Foam is designed to work as a system with our upholstery. Our High-Density Seat Foam is firm, form fitting, and features a Typar® web backing for strength, which prevents spring intrusion and ensures a quality fit and long lasting life. Seat Foam is sold individually, not in pairs.

1962-63 500XL SEAT FOAM -

BUCKET SEAT

**064906BUCKET6263**

Distinctive Industries Seat Heaters provide therapeutic heat and body warmth in any classic car, using the same technology as late model or current vehicles. Each kit comes with switch, harnesses, and two carbon fiber element pads to complete one seat install. Switch can be dash, console, or hidden in a place of choice. Seat Heaters are sold individually, not in pairs.

1962-68 CARBON FIBER SEAT HEATERS

**061001**

Our Convertible Top Boot features the correct Crush grain in 32 oz. vinyl and fastens just like the original. Snaps are included. CONVERTIBLE TOP BOOT \*SEEKING PATTERN\*

Our Convertible Well Liner is in 32 oz. Crush grain vinyl, just like the originals.

CONVERTIBLE WELL LINER \*SEEKING PATTERN\*

Our Quarter Trim features 32 oz. vinyl in the correct Crush grain and is stitched, just like the originals.

500XL REAR QUARTER TRIM \*SEEKING PATTERN\*

CONVERTIBLE REAR QUARTER TRIM \*SEEKING PATTERN\*



**064906BUCKET6263**



1962 Galaxie 500



### 1962 500 & 500XL COLORS

BLACK	L-110	LIGHT BLUE	L-1761
BLUE	L-1761	LIGHT TURQUOISE	L-1934
CHESTNUT	L-2921	TURQUOISE	L-1991
DARK BLUE	L-1763	WHITE	L-1752
RED	L-1377		

**NOTE:** Chestnut is not available in Crush grain vinyl therefore we substitute Sierra grain Emberglo. Both colors match but the grains are different.

**1963 INTERIOR PARTS & ACCESSORIES**

**1963 500 SEAT UPHOLSTERY**

Our 1963 Galaxie 500 Seat Upholstery is a correct reproduction of the original and features Vischette inserts with 7 vertical pleats, and has silver Tinsel welt. We offer the original Crush grain in 32 oz. vinyl, with the correct vertical patterns sewn as original.

Features

- Original Crush grain vinyl with Vischette inserts
- Correct 6 stitch per inch stitching
- Correct colors matched to the original vinyl
- Limited lifetime warranty

500 2 DOOR SPLIT BENCH SEAT - FRONT	<b>101907</b>
500 2 DOOR HARDTOP BENCH SEAT - REAR	<b>101908</b>
500 2 DOOR SEDAN BENCH SEAT - REAR	<b>101919</b>
500 CONVERTIBLE BENCH SEAT - REAR	<b>101916</b>



**1963 500 COLORS**

BLACK	L-110
BLUE	L-1761
CHESTNUT	L-2921
DARK BLUE	L-1763
RED	L-1377
LIGHT BLUE	L-1761
LIGHT TURQUOISE	L-1934
TURQUOISE	L-1991
WHITE	L-1752

**NOTE: Chestnut is not available in Crush grain vinyl therefore we substitute Sierra grain Emberglo. Both colors match but the grains are different.**



Those hands stay small for such a short time. Now's the time to lead a child down a path that could expand into a lifetime of enjoyment. Going to a car show is a history lesson, a social event and storytime all wrapped up into one!

Life is full of choices for kids. You can help them make the right ones by showing them your appreciation for cool old cars. Your passion for collector cars today may even nurture a shared interest for years to come...when those hands are as big as your own.



Take a Kid to a Car Show is a program of ARMO, the Automotive Restoration Market Organization, a SEMA Council.



## 1963 INTERIOR PARTS & ACCESSORIES

### 1963 500 DOOR/QUARTER PANELS

Our 1963 Galaxie 500 Door/Quarter Panels are a correct reproduction of the original. We offer original Crush grain in 32 oz. vinyl, correct Mylar® trim, and correct dielectrically heat sealed horizontal patterns as original.

#### Features

- Original Crush grain vinyl
- Correct dielectric "Heat Seal" stitched pattern
- Correct colors matched to the original vinyl
- .100-inch thickness poly-coated "Autoboard" backing
- Door Panel backs are perimeter stapled for maximum adhesion
- Limited lifetime warranty

500 2 DOOR FRONT DOOR PANELS	101909
500 4 DOOR HARDTOP/SEDAN FRONT DOOR PANELS	101903
500 THREE-TONE 2 DOOR FRONT DOOR PANELS	101913
500 THREE-TONE 4 DOOR HARDTOP/SEDAN FRONT DOOR PANELS	101902
500 2 DOOR HARDTOP REAR QUARTER PANELS	101910
500 THREE-TONE 2 DOOR HARDTOP REAR QUARTER PANELS	101914
500 2 DOOR SEDAN/POST REAR QUARTER PANELS	101912
500 2 DOOR FASTBACK REAR QUARTER PANELS	101920
500 CONVERTIBLE REAR QUARTER PANELS	101911
500 4 DOOR HARDTOP/SEDAN REAR DOOR PANELS	101904
500 THREE-TONE 4 DOOR HARDTOP/SEDAN REAR DOOR PANELS	101901



#### 1963 500 COLORS

BLACK	L-110
BLUE	L-1761
CHESTNUT	L-2921
DARK BLUE	L-1763
RED	L-1377
LIGHT BLUE	L-1761
LIGHT TURQUOISE	L-1934
TURQUOISE	L-1991
WHITE	L-1752

**NOTE:** Chestnut is not available in Crush grain vinyl therefore we substitute Sierra grain Emberglo. Both colors match but the grains are different.

## 1963 INTERIOR PARTS & ACCESSORIES

### 1963 500XL SEAT UPHOLSTERY

Our 1963 Galaxie 500XL Seat Upholstery is a correct reproduction of the original, and features both vertical stripes. One 9" long black/Mylar® stripe, and 1 stripe the same color as the insert. We offer the original Crush grain in 32 oz. vinyl, with the correct vertical patterns sewn as original.

#### Features

- Original Crush grain vinyl
- Correct 6 stitch per inch stitching
- Correct colors matched to the original vinyl
- Limited lifetime warranty

500XL BUCKET SEATS - FRONT	<b>101840</b>
500XL 2 DOOR HARDTOP BENCH SEAT - REAR	<b>101841</b>
500XL CONVERTIBLE BENCH SEAT - REAR	<b>101842</b>
500XL 2 DOOR FASTBACK BENCH SEAT - REAR	<b>101865</b>

### 1963 INTERIOR ACCESSORIES

Distinctive Industries High-Density Seat Foam is designed to work as a system with our upholstery. Our High-Density Seat Foam is firm, form fitting, and features a Typar® web backing for strength, which prevents spring intrusion and ensures a quality fit and long lasting life. Seat Foam is sold individually, not in pairs. 1962-63 500XL SEAT FOAM - BUCKET SEAT **064906BUCKET6263**

Distinctive Industries Seat Heaters provide therapeutic heat and body warmth in any classic car, using the same technology as late model or current vehicles. Each kit comes with switch, harnesses, and two carbon fiber element pads to complete one seat install. Switch can be dash, console, or hidden in a place of choice. Seat Heaters are sold individually, not in pairs. 1962-68 CARBON FIBER SEAT HEATERS **061001**

Our Convertible Top Boot features the correct Crush grain in 32 oz. vinyl and fastens just like the original. Snaps are included. CONVERTIBLE TOP BOOT **\*SEEKING PATTERN\***

Our Convertible Well Liner is in 32 oz. Crush grain vinyl, just like the originals. CONVERTIBLE WELL LINER **\*SEEKING PATTERN\***

Our Quarter Trim features 32 oz. vinyl in the correct Crush grain and is stitched, just like the originals. 500XL REAR QUARTER TRIM **\*SEEKING PATTERN\***  
 CONVERTIBLE REAR QUARTER TRIM **\*SEEKING PATTERN\***

### 1963 500XL DOOR/QUARTER PANELS

Our 1963 Galaxie 500XL Door/Quarter Panels are a correct reproduction of the original. We offer original Crush grain in 32 oz. vinyl, and correct dielectrically heat sealed patterns as original.

#### Features

- Original Crush grain vinyl
- Correct dielectric "Heat Seal" stitched pattern
- Correct colors matched to the original vinyl
- .100-inch thickness poly-coated "Autoboard" backing
- Door Panel backs are perimeter stapled for maximum adhesion
- Limited lifetime warranty

500XL 2 DOOR FRONT DOOR PANELS <b>*SEEKING PATTERN*</b>
500XL 2 DOOR HARDTOP REAR QUARTER PANELS <b>*SEEKING PATTERN*</b>
500XL 2 DOOR FASTBACK REAR QUARTER PANELS <b>*SEEKING PATTERN*</b>
500XL CONVERTIBLE REAR QUARTER PANELS <b>*SEEKING PATTERN*</b>



064906BUCKET6263

#### 1963 500 & 500XL COLORS

BLACK	L-110
BLUE	L-1761
CHESTNUT	L-2921
DARK BLUE	L-1763
RED	L-1377
LIGHT BLUE	L-1761
LIGHT TURQUOISE	L-1934
TURQUOISE	L-1991
WHITE	L-1752

**NOTE:** Chestnut is not available in Crush grain vinyl therefore we substitute Sierra grain Emberglo. Both colors match but the grains are different.



GALAXIE



## 1964 INTERIOR PARTS & ACCESSORIES



### 1964 500 COLORS

BLACK	L-110
DARK BLUE	L-1763
LIGHT BLUE	L-1761
LIGHT TURQUOISE	L-1934
PALOMINO	L-2288
RED	L-1377
TURQUOISE	L-1991
WHITE	L-1752

### 1964 500 SEAT UPHOLSTERY

Our 1964 Galaxie 500 Seat Upholstery is a correct reproduction of the original with 5 vertical embossing stripes, and 2 vertical chrome (Mylar®) stripes. We offer the original Crush grain in 32 oz. vinyl, with the correct vertical patterns, silver Tinsel welt, and sewn as original. Seat back medallions, or buttons are included where applicable.

#### Features

- Original Crush grain vinyl
- Correct 6 stitch per inch stitching
- Correct colors matched to the original vinyl
- Limited lifetime warranty

500 2 DOOR SPLIT BENCH SEAT - FRONT	<b>101900</b>
500 4 DOOR SEDAN BENCH SEAT - FRONT	<b>101905</b>
500 2 DOOR SEDAN - REAR BENCH SEAT	<b>101922</b>
500 2 DOOR HARDTOP WITH FRONT BENCH - REAR BENCH SEAT	<b>101915</b>
500 CONVERTIBLE WITH FRONT BENCH - REAR BENCH SEAT	<b>101916</b>
500 4 DOOR WITH FRONT BENCH - REAR BENCH SEAT	<b>101923</b>

### 1964 500 DOOR/QUARTER PANELS

Our 1964 Galaxie 500 Door/Quarter Panels are a correct reproduction of the original. We offer original Crush grain in 32 oz. vinyl, and correct dielectrically heat sealed patterns as original. Door panel medallions, or buttons are included where applicable.

**\* NOTE: Our 1964 Galaxie 500 Door/Quarter Panels have a slightly thinner Mylar® profile than the originals.**

#### Features

- Original Crush grain vinyl
- Correct dielectric "Heat Seal" stitched pattern
- Correct colors matched to the original vinyl
- .100-inch thickness poly-coated "Autoboard" backing
- Door Panel backs are perimeter stapled for maximum adhesion
- Limited lifetime warranty

500 2 DOOR FRONT DOOR PANELS	<b>102204</b>
500 2 DOOR HARDTOP/FASTBACK REAR QUARTER PANELS	<b>102228</b>
500 CONVERTIBLE REAR QUARTER PANELS	<b>102236</b>

**1964 INTERIOR PARTS & ACCESSORIES**

**1964 500XL SEAT UPHOLSTERY**

Our 1964 Galaxie 500XL Seat Upholstery is a correct reproduction of the original with 12 horizontal pleated lines on the seat back, and 10 horizontal lines on the seat bottom with 1 vertical line running through both. We offer the original Crush grain in 32 oz. vinyl, with the correct horizontal patterns, silver Tinsel welt, and sewn as original. Seat back medallions are not included.

Features

- Original Crush grain vinyl
- Correct 6 stitch per inch stitching
- Correct colors matched to the original vinyl
- Limited lifetime warranty

500XL 2 DOOR BUCKET SEATS - FRONT	<b>101998</b>
500XL HARDTOP WITH FRONT BUCKETS - REAR BENCH SEAT	<b>102004</b>
500XL CONVERTIBLE WITH FRONT BUCKETS - REAR BENCH SEAT	<b>102008</b>



**101998**

**1964 500XL DOOR/QUARTER PANELS**

Our 1964 Galaxie 500XL Door/Quarter Panels are a correct reproduction of the original. We offer original Crush grain in 32 oz. vinyl, and correct dielectrically heat sealed patterns as original.

Features

- Original Crush grain vinyl
- Correct dielectric "Heat Seal" stitched pattern
- Correct colors matched to the original vinyl
- .100-inch thickness poly-coated "Autoboard" backing
- Door Panel backs are perimeter stapled for maximum adhesion
- Limited lifetime warranty

500XL 2 DOOR FRONT DOOR PANELS <b>*SEEKING PATTERN*</b>
500XL 2 DOOR HARDTOP REAR QUARTER PANELS <b>*SEEKING PATTERN*</b>
500XL FASTBACK REAR QUARTER PANELS <b>*SEEKING PATTERN*</b>
500XL CONVERTIBLE REAR QUARTER PANELS <b>*SEEKING PATTERN*</b>



**1964 500XL COLORS**

BLACK	L-110
DARK BLUE	L-1763
LIGHT BLUE	L-1761
LIGHT TURQUOISE	L-1934
PALOMINO	L-2288
RED	L-1377
TURQUOISE	L-1991
WHITE	L-1752



## 1964 INTERIOR PARTS & ACCESSORIES

### 1964 INTERIOR ACCESSORIES

Distinctive Industries High-Density Seat Foam is designed to work as a system with our upholstery. Our High-Density Seat Foam is firm, form fitting, and features a Typar® web backing for strength, which prevents spring intrusion and ensures a quality fit and long lasting life. Seat Foam is sold individually, not in pairs.

500XL SEAT FOAM - BUCKET SEAT **064907BUCKET64**

Distinctive Industries Seat Heaters provide therapeutic heat and body warmth in any classic car, using the same technology as late model or current vehicles. Each kit comes with switch, harnesses, and two carbon fiber element pads to complete one seat install. Switch can be dash, console, or hidden in a place of choice. Seat Heaters are sold individually, not in pairs.

1962-68 CARBON FIBER SEAT HEATERS **061001**

Our Convertible Top Boot features the correct Crush grain in 32 oz. vinyl and fastens just like the original. Snaps are included.

CONVERTIBLE TOP BOOT **102038**

Our Convertible Well Liner is in 32 oz. Crush grain vinyl, just like the originals.

CONVERTIBLE WELL LINER **\*SEEKING PATTERN\***

Our Quarter Trim features 32 oz. vinyl in the correct Crush grain and is stitched, just like the originals.

CONVERTIBLE QUARTER TRIM **102020**

500 REAR QUARTER TRIM **\*SEEKING PATTERN\***



### 1964 500 & 500XL COLORS

BLACK	L-110
DARK BLUE	L-1763
LIGHT BLUE	L-1761
LIGHT TURQUOISE	L-1934
PALOMINO	L-2288
RED	L-1377
TURQUOISE	L-1991
WHITE	L-1752



1964 Galaxie

## 1965 INTERIOR PARTS & ACCESSORIES

### 1965 500 SEAT UPHOLSTERY

Our 1965 Galaxie 500 Seat Upholstery is a correct reproduction of the original with 9 vertical pleated lines, and 6 buttons on the top of the seat back. We offer the original Sierra grain in 32 oz. vinyl, with the correct vertical patterns sewn as original. Seat back medallions, or buttons are included where applicable.

#### Features

- Original Sierra grain vinyl
- Correct 6 stitch per inch stitching
- Correct colors matched to the original vinyl
- Limited lifetime warranty

500 2 DOOR SPLIT BENCH SEAT - FRONT	<b>102061</b>
500 2 DOOR HARDTOP/SEDAN BENCH SEAT - REAR	<b>102081</b>
500 CONVERTIBLE BENCH SEAT - REAR	<b>102079</b>

### 1965 500 DOOR/QUARTER PANELS

Our 1965 Galaxie 500 Door/Quarter Panels are a correct reproduction of the original. We offer original Sierra grain in 32 oz. vinyl, and correct dielectrically heat sealed patterns as original. Door panel medallions, or buttons are included where applicable.

#### Features

- Original Sierra grain vinyl
- Correct dielectric "Heat Seal" stitched pattern
- Correct colors matched to the original vinyl
- .100-inch thickness poly-coated "Autoboard" backing
- Door Panel backs are perimeter stapled for maximum adhesion
- Limited lifetime warranty

500 2 DOOR FRONT DOOR PANELS	<b>102087</b>
500 2 DOOR HARDTOP REAR QUARTER PANELS	<b>102097</b>
500 CONVERTIBLE REAR QUARTER PANELS	<b>102095</b>



#### 1965 500 COLORS

BLACK	L-958
BLUE	L-2287 (I=L-2095)
IVY GOLD	L-2503 (I=L-2286)
PALOMINO	L-2288
RED	L-957
TURQUOISE	L-2929 (I=L-3097)
WHITE	L-2290

NOTE: I=Insert.





## 1965 INTERIOR PARTS & ACCESSORIES

### 1965 500XL SEAT UPHOLSTERY

Our 1965 Galaxie 500XL Seat Upholstery is a correct reproduction of the original featuring 3 heat sealed vertical lines, and 3 pleated lines in the center. We offer the original Sierra grain in 32 oz. vinyl, with the correct vertical patterns sewn as original. Seat back medallions not included.

#### Features

- Original Sierra grain vinyl
- Correct 6 stitch per inch stitching
- Correct colors matched to the original vinyl
- Limited lifetime warranty

500XL 2 DOOR BUCKET SEATS - FRONT	102137
500XL 2 DOOR HARDTOP BENCH SEAT - REAR	102140
500XL CONVERTIBLE BENCH SEAT - REAR	102145



### 1965 500XL DOOR/QUARTER PANELS

Our 1965 Galaxie 500XL Door/Quarter Panels are a correct reproduction of the original. We offer original Sierra grain in 32 oz. vinyl, and correct dielectrically heat sealed patterns as original.

#### Features

- Original Crush grain vinyl
- Correct dielectric "Heat Seal" stitched pattern
- Correct colors matched to the original vinyl
- .100-inch thickness poly-coated "Autoboard" backing
- Door Panel backs are perimeter stapled for maximum adhesion
- Limited lifetime warranty

500XL 2 DOOR FRONT DOOR PANELS *SEEKING PATTERN*
500XL 2 DOOR HARDTOP REAR QUARTER PANELS *SEEKING PATTERN*
500XL CONVERTIBLE REAR QUARTER PANELS *SEEKING PATTERN*



#### 1965 500XL COLORS

BLACK	L-958
BLUE	L-2287 (I=L-2095)
IVY GOLD	L-2503 (I=L-2286)
PALOMINO	L-2288
RED	L-957
TURQUOISE	L-2929 (I=L-3097)
WHITE	L-2290

**NOTE: I=Insert.**



**1965 INTERIOR PARTS & ACCESSORIES**

**1965 INTERIOR ACCESSORIES**

Distinctive Industries High-Density Seat Foam is designed to work as a system with our upholstery. Our High-Density Seat Foam is firm, form fitting, and features a Typar® web backing for strength, which prevents spring intrusion and ensures a quality fit and long lasting life. Seat Foam is sold individually, not in pairs.

SEAT FOAM - BUCKET SEAT **064923GLX65**

Distinctive Industries Seat Heaters provide therapeutic heat and body warmth in any classic car, using the same technology as late model or current vehicles. Each kit comes with switch, harnesses, and two carbon fiber element pads to complete one seat install. Switch can be dash, console, or hidden in a place of choice. Seat Heaters are sold individually, not in pairs.

1962-68 CARBON FIBER SEAT HEATERS **061001**

Our Convertible Top Boot features the correct Sierra grain in 32 oz. vinyl and fastens just like the original. Snaps are included.

1965-66 CONVERTIBLE TOP BOOT **102111**

Our Convertible Well Liner is in 32 oz. Sierra grain vinyl, just like the originals.

1965-66 CONVERTIBLE WELL LINER **\*SEEKING PATTERN\***

Our Quarter Trim features 32 oz. vinyl in the correct Sierra grain and is stitched, just like the originals.

CONVERTIBLE REAR QUARTER TRIM **102103**



**1965 500 COLORS**

BLACK	L-958
BLUE	L-2287
IVY GOLD	L-2503
PALOMINO	L-2288
RED	L-957
TURQUOISE	L-2929
WHITE	L-2290



GALAXIE



## 1966 INTERIOR PARTS & ACCESSORIES

### 1966 500 SEAT UPHOLSTERY

Our 1966 Galaxie 500 Seat Upholstery is a correct reproduction of the original featuring the Leaf embossed center stripe. We offer the original Sierra grain in 32 oz. vinyl, with the correct vertical patterns sewn as original.

#### Features

- Original Sierra grain vinyl
- Correct 6 stitch per inch stitching
- Correct colors matched to the original vinyl
- Limited lifetime warranty

500 2 DOOR SPLIT BENCH SEAT - FRONT	<b>102247</b>
500 2 DOOR HARDTOP/SEDAN BENCH SEAT - REAR	<b>102249</b>
500 CONVERTIBLE BENCH SEAT - REAR	<b>102273</b>

### 1966 500 DOOR/QUARTER PANELS

Our 1966 Galaxie 500 Door/Quarter Panels are a correct reproduction of the original. We offer original Sierra grain with Rosette inserts in 32 oz. vinyl, and correct dielectrically heat sealed patterns as original.

#### Features

- Original Sierra grain vinyl with Rosette grain inserts
- Correct dielectric "Heat Seal" stitched pattern
- Correct colors matched to the original vinyl
- .100-inch thickness poly-coated "Autoboard" backing
- Door Panel backs are perimeter stapled for maximum adhesion
- Limited lifetime warranty

500 2 DOOR FRONT DOOR PANEL	<b>101925</b>
500 2 DOOR HARDTOP REAR QUARTER PANELS	<b>101926</b>
500 CONVERTIBLE REAR QUARTER PANELS	<b>101927</b>



#### 1966 500 COLORS

BLACK	L-958
BLUE	L-2287 (PANEL L-2095)
EMBERGLO	L-2921
IVY GOLD	L-2503 (PANEL L-2286)
PARCHEMENT	L-2613 (PANEL L-2288)
RED	L-2920 (PANEL L-3116)
TURQUOISE	L-2929 (PANEL L-3097)

**Don't Forget About SEAT HEATERS!!!**  
 Now Available Easy to install  
 PerfectFit® Carbon Fiber Seat Heaters  
 with a small concealable switch  
**PART #061001**

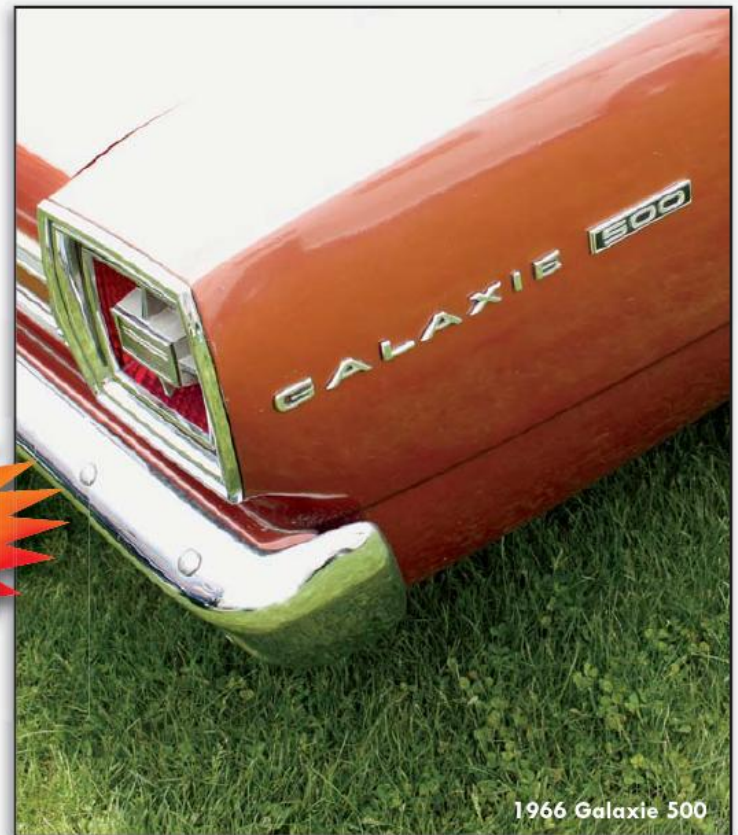

1966 Galaxie 500

## 1966 INTERIOR PARTS & ACCESSORIES

### 1966 500XL SEAT UPHOLSTERY

Our 1966 Galaxie 500XL Seat Upholstery is a correct reproduction of the original with 3 vertical pleats. We offer the original Sierra grain with Rosette inserts in 32 oz. vinyl, with the correct horizontal patterns sewn as original. Seat back medallions are not included.

#### Features

- Original Sierra grain vinyl with Rosette grain inserts
- Correct 6 stitch per inch stitching
- Correct colors matched to the original vinyl
- Limited lifetime warranty

500XL 2 DOOR BUCKET SEATS - FRONT	<b>102251</b>
500XL 2 DOOR HARDTOP BENCH SEAT - REAR	<b>102269</b>
500XL CONVERTIBLE BENCH SEAT - REAR	<b>102270</b>

### 1966 500XL DOOR/QUARTER PANELS

Our 1966 Galaxie 500XL Door/Quarter Panels are a correct reproduction of the original. We offer original Sierra grain with Rosette inserts in 32 oz. vinyl, and correct dielectrically heat sealed vertical patterns as original.

#### Features

- Original Sierra grain vinyl with Rosette grain inserts
- Correct dielectric "Heat Seal" stitched pattern
- Correct colors matched to the original vinyl
- .100-inch thickness poly-coated "Autoboard" backing
- Door Panel backs are perimeter stapled for maximum adhesion
- Limited lifetime warranty

500XL FRONT DOOR PANEL	<b>101917</b>
500XL 2 DOOR HARDTOP REAR QUARTER PANELS	<b>101918</b>
500XL CONVERTIBLE REAR QUARTER PANELS	<b>102272</b>



### 1966 500XL COLORS

BLACK	L-958 (STRIPE=L-2949)
BLUE	L-2287 (STRIPE=L-2946)
EMBERGLO	L-2921 (STRIPE=L-2948)
IVY GOLD	L-2503 (STRIPE=L-2947)
PARCHMENT	L-2613 (STRIPE=L-2945)
RED	L-2920 (STRIPE=L-2954)
TURQUOISE	L-2929 (STRIPE=L-2951)





## 1966 INTERIOR PARTS & ACCESSORIES

### 1966 HEADLINERS

Our 1966 Headliners are in the original Crater grain vinyl, constructed just like the original.  
**HEADLINER 105154**

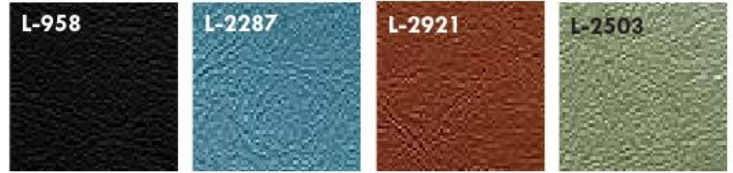

### 1966 INTERIOR ACCESSORIES

Distinctive Industries Seat Heaters provide therapeutic heat and body warmth in any classic car, using the same technology as late model or current vehicles. Each kit comes with switch, harnesses, and two carbon fiber element pads to complete one seat install. Switch can be dash, console, or hidden in a place of choice. Seat Heaters are sold individually, not in pairs.

1962-68 CARBON FIBER SEAT HEATERS **061001**

Our Convertible Top Boot features the correct Sierra grain in 32 oz. vinyl and fastens just like the original. Snaps are included.  
**1965-66 CONVERTIBLE TOP BOOT 102111**

Our Convertible Well Liner is in 32 oz. Sierra grain vinyl, just like the originals.

**1965-66 CONVERTIBLE WELL LINER \*SEEKING PATTERN\***

Our Quarter Trim features 32 oz. vinyl in the correct Sierra grain and is stitched, just like the originals.  
**CONVERTIBLE REAR QUARTER TRIM 102271**



### 1966 500 & 500XL COLORS

BLACK	L-958
BLUE	L-2287
EMBERGLO	L-2921
IVY GOLD	L-2503
PARCHMENT	L-2613
RED	L-2920
TURQUOISE	L-2929



**1967 INTERIOR PARTS & ACCESSORIES**

**1967 500 SEAT UPHOLSTERY**

Our 1967 Galaxie 500 Seat Upholstery is a correct reproduction of the original featuring Leaf embossed inserts, and 6 vertical pleats. We offer the original Sierra grain in 32 oz. vinyl, with the correct vertical patterns sewn as original.

Features

- Original Sierra grain vinyl
- Correct 6 stitch per inch stitching
- Correct colors matched to the original vinyl
- Limited lifetime warranty

- |  |               |
|--|---------------|
| 500 2 DOOR SPLIT BENCH SEAT - FRONT                                | <b>102275</b> |
| 500 4 DOOR HARDTOP/SEDAN & COUNTRY SQUIRE WAGON BENCH SEAT - FRONT | <b>102348</b> |
| 500 CONVERTIBLE BENCH SEAT - REAR                                  | <b>102276</b> |
| 500 & 500XL 2 DOOR HARDTOP BENCH SEAT - REAR                       | <b>102347</b> |
| 500 COUNTRY SQUIRE WAGON BENCH SEAT - REAR                         | <b>102349</b> |



**1967 500 DOOR/QUARTER PANELS**

Our 1967 Galaxie 500 Door/Quarter Panels are a correct reproduction of the original. We offer original Sierra grain in 32 oz. vinyl, Woodgrain insert, and correct dielectrically heat sealed vertical patterns as original.

Features

- Original Sierra grain vinyl
- Correct dielectric "Heat Seal" stitched pattern
- Correct colors matched to the original vinyl
- .100-inch thickness poly-coated "Autoboard" backing
- Door Panel backs are perimeter stapled for maximum adhesion
- Limited lifetime warranty

- |  |               |
|--|---------------|
| 500 2 DOOR FRONT DOOR PANELS                   | <b>102278</b> |
| 500 CONVERTIBLE REAR QUARTER PANELS            | <b>102280</b> |
| 500 & 500XL 2 DOOR HARDTOP REAR QUARTER PANELS | <b>102283</b> |



1967 500 COLORS	
AQUA	L-2929 (PANEL L-3097)
BLACK	L-958
BLUE	L-2287 (PANEL L-2095)
PARCHMENT	L-3096
RED	L-2920 (PANEL L-3116)
SADDLE	L-3099



## 1967 INTERIOR PARTS & ACCESSORIES

### 1967 500XL SEAT UPHOLSTERY

Our 1967 Galaxie 500XL Seat Upholstery is a correct reproduction of the original featuring Leaf embossed inserts on the seat back. We offer the original Sierra grain in 32 oz. vinyl, with the correct vertical patterns sewn as original.

#### Features

- Original Sierra grain vinyl
- Correct 6 stitch per inch stitching
- Correct colors matched to the original vinyl
- Limited lifetime warranty

500XL 2 DOOR BUCKET SEATS - FRONT	<b>102274</b>
500XL LUXURY BUCKET SEATS - FRONT	<b>102281</b>
500 & 500XL 2 DOOR HARDTOP BENCH SEAT - REAR	<b>102347</b>
500XL LUXURY BENCH SEAT - REAR <b>*SEEKING PATTERN*</b>	

### 1967 500XL DOOR/QUARTER PANELS

Our 1967 Galaxie 500XL Door/Quarter Panels are a correct reproduction of the original. We offer original Sierra grain in 32 oz. vinyl, and correct dielectrically heat sealed vertical patterns as original. Original door trim aluminum plate not included.

#### Features

- Original Sierra grain vinyl
- Correct dielectric "Heat Seal" stitched pattern
- Correct colors matched to the original vinyl
- .100-inch thickness poly-coated "Autoboard" backing
- Door Panel backs are perimeter stapled for maximum adhesion
- Limited lifetime warranty

500XL 2 DOOR FRONT DOOR PANELS	<b>102284</b>
500XL CONVERTIBLE REAR QUARTER PANELS <b>*SEEKING PATTERN*</b>	
500 & 500XL 2 DOOR HARDTOP REAR QUARTER PANELS	<b>102283</b>

### 1967 INTERIOR ACCESSORIES

Distinctive Industries Seat Heaters provide therapeutic heat and body warmth in any classic car, using the same technology as late model or current vehicles. Each kit comes with switch, harnesses, and two carbon fiber element pads to complete one seat install. Switch can be dash, console, or hidden in a place of choice. Seat Heaters are sold individually, not in pairs.

1962-68 CARBON FIBER SEAT HEATERS **061001**

Our Convertible Top Boot features the correct Sierra grain in 32 oz. vinyl and fastens just like the original. Snaps are included.  
**CONVERTIBLE TOP BOOT \*SEEKING PATTERN\***

Our Convertible Well Liner is in 32 oz. Sierra grain vinyl, just like the originals.  
**CONVERTIBLE WELL LINER \*SEEKING PATTERN\***

Our Quarter Trim features 32 oz. vinyl in the correct Sierra grain and is stitched, just like the originals.  
**CONVERTIBLE REAR QUARTER TRIM **105401****

### 1967 HEADLINERS

Our 1967 Headliners are in the original Crater grain vinyl, constructed just like the original.  
**1967-68 HEADLINER **105150****



#### 1967 500XL COLORS

AQUA	L-2929 (PANEL L-3097)
BLACK	L-958
BLUE	L-2287 (PANEL L-2095)
PARCHMENT	L-3096
RED	L-2920 (PANEL L-3116)
SADDLE	L-3099

## 1968 INTERIOR PARTS & ACCESSORIES

### 1968 500/500XL SEAT UPHOLSTERY

Our 1968 Galaxie 500/500XL Seat Upholstery is a correct reproduction of the original. The 500 Seat Upholstery has 10 vertical pleats, and the 500XL has 8 vertical pleats. We offer the original Sierra grain with Kiwi inserts in 32 oz. vinyl, with the correct vertical patterns sewn as original.

#### Features

- Original Sierra grain vinyl with Kiwi grain inserts
- Correct 6 stitch per inch stitching
- Correct colors matched to the original vinyl
- Limited lifetime warranty

500XL BUCKET SEATS - FRONT	<b>102285</b>
500 & 500XL 2 DOOR BENCH SEAT - FRONT	<b>102293</b>
500 & 500XL SPORTSROOF BENCH SEAT - REAR	<b>102297</b>
500 & 500XL CONVERTIBLE BENCH SEAT - REAR	<b>102301</b>
500 & 500XL FORMAL ROOF BENCH SEAT - REAR	<b>*SEEKING PATTERN*</b>

### 1968 500XL DOOR/QUARTER PANELS

Our 1968 Galaxie 500XL Door/Quarter Panels are a correct reproduction of the original. We offer original Sierra grain with Kiwi inserts in 32 oz. vinyl, and correct dielectrically heat sealed patterns as original.

#### Features

- Original Sierra grain vinyl with Kiwi grain inserts
- Correct dielectric "Heat Seal" stitched pattern
- Correct colors matched to the original vinyl
- .100-inch thickness poly-coated "Autoboard" backing
- Door Panel backs are perimeter stapled for maximum adhesion
- Limited lifetime warranty

500 & 500XL FRONT DOOR PANELS	<b>102319</b>
500 & 500XL 2 DOOR HARDTOP REAR QUARTER PANELS	<b>102320</b>
500 & 500XL SPORTSROOF REAR QUARTER PANELS	<b>102322</b>
500 & 500XL CONVERTIBLE REAR QUARTER PANELS	<b>102327</b>

### 1968 500 & 500XL COLORS

AQUA	L-2929 (TRIM=L-3474 TWO-TONE)
BLACK	L-958 (TRIM=L-3437)
BLUE	L-2287 (TRIM=L-3441)
IVY GOLD	L-2503 (TRIM=L-3530 TWO-TONE)
MAROON	L-3116 (TRIM=L-3440)
NUGGET GOLD	L-3448 (TRIM=L-3442)
PARCHMENT	L-3096 (TRIM=L-3443)



GALAXIE





## 1968 INTERIOR PARTS & ACCESSORIES

### 1968 HEADLINERS

Our 1968 Headliners are in the original Crater grain vinyl, constructed just like the original.

1967-68 HEADLINER **105150**



### 1968 INTERIOR ACCESSORIES

Distinctive Industries Seat Heaters provide therapeutic heat and body warmth in any classic car, using the same technology as late model or current vehicles. Each kit comes with switch, harnesses, and two carbon fiber element pads to complete one seat install. Switch can be dash, console, or hidden in a place of choice. Seat Heaters are sold individually, not in pairs.

1962-68 CARBON FIBER SEAT HEATERS **061001**

Our Convertible Top Boot features the correct Sierra grain in 32 oz. vinyl and fastens just like the original. Snaps are included. CONVERTIBLE TOP BOOT **\*SEEKING PATTERN\***

Our Convertible Well Liner is in 32 oz. Sierra grain vinyl, just like the originals.

CONVERTIBLE WELL LINER **102343**



### 1968 500 & 500XL COLORS

AQUA	L-2929
BLACK	L-958
BLUE	L-2287
IVY GOLD	L-2503
MAROON	L-3116
NUGGET GOLD	L-3448
PARCHMENT	L-3096



Our Quarter Trim features 32 oz. vinyl in the correct Sierra grain and is stitched, just like the originals.

CONVERTIBLE REAR QUARTER TRIM **105403**



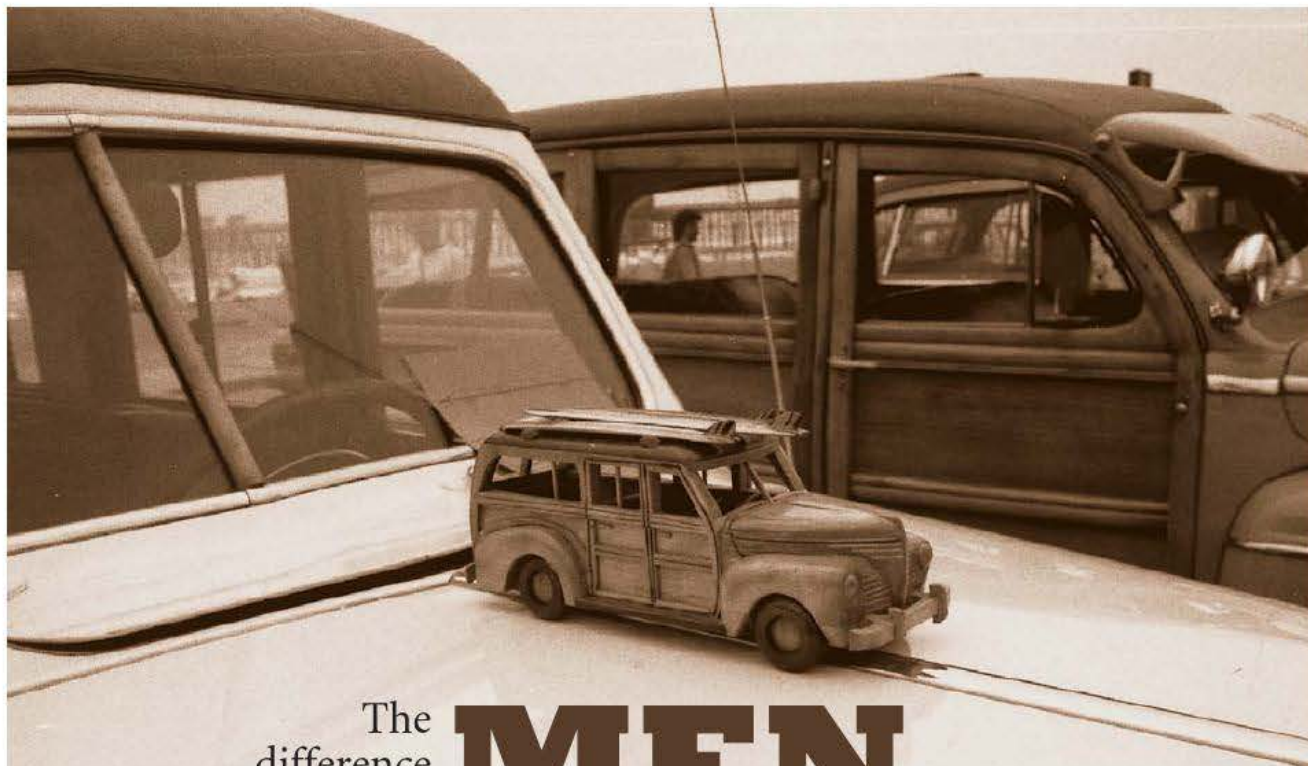

The  
difference  
between

**MEN**

**& Boys**

*is the size of  
their toys!*

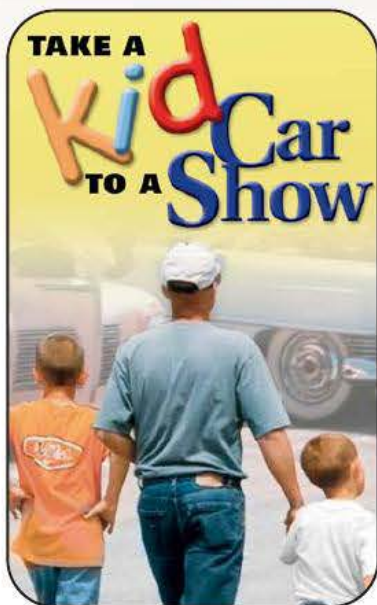

**E**ven if there is a generation or two between you and a child, collector cars can be a terrific common ground. Your enthusiasm and knowledge could be the spark of a child's lifelong passion. Bring kids to *your* playground...a car show...and have fun.

Life is full of choices for kids. You can help them make the right ones by sharing your appreciation for cool old cars. (And a kid might even call you "cool" too!)



Take a Kid to a Car Show is a program of ARMO, the Automotive Restoration Market Organization, a SEMA Council.



Thank you for choosing Distinctive Industries as your provider of Restoration Interior Products. The catalog you are reading was designed with the input of our existing customers and moving forward, will continue to be a representation of their needs, and the needs of restoration experts worldwide.

**Design**

We have designed our catalog for the Restoration Professional, from your Local Upholstery and Restoration Shop, to the National Distributor of Restoration Products. The thought was to create a catalog that eases the pain of product entry for those building catalogs, and to ease ordering for those that order directly from the catalog. We accomplished this by listing product by year, model, and trim level. You will find this catalog to be easy to use.

**Descriptions**

Descriptions are a blend of Marketing and Technical descriptions. After polling our customers we found that aside from the design, missing was a good description of the products in today's catalogs. We remedied that by providing a blended description as a basis for our customers to expand upon, or use as is.

**Colors**

Color swatches are placed near the product with labeled color codes to avoid confusion. Color Code boxes are located near the applicable products. We offer many special order color combinations as well as an option for leather in most cases.

**Images**

Images are available for License through Distinctive Industries.  
 • Licensed images must be accompanied and located adjacent to the matching Distinctive Industries product.

**Table of Contents**

1965-66 Pony (Deluxe) interior parts and accessories

1965 Standard interior parts and accessories

1966 Standard interior parts and accessories

1967 Standard, Deluxe and *Shelby* interior parts and accessories

1967 Standard interior parts and accessories

1968 Standard, Deluxe and *Shelby* interior parts and accessories

1968 Standard interior parts and accessories

1969 Standard interior parts and accessories

1969 Deluxe, Grande and MACH 1 interior parts and accessories

1970 Standard interior parts and accessories

1970 Deluxe, Grande and MACH 1 interior parts and accessories

1971-73 Standard interior parts and accessories

1971-73 Deluxe, Grande and MACH 1 interior parts and accessories

© Copyright 2016, Distinctive Industries, all rights reserved. No part of this publication may be duplicated or reproduced without written permission from Distinctive Industries.



## 1965-66 PONY (DELUXE) INTERIOR PARTS & ACCESSORIES

### 1965-66 PONY (DELUXE) BUCKET SEAT UPHOLSTERY

Our 1965-66 Pony Upholstery features the original "Running Pony" embossed panel along with the correct Sierra grain skirts and inserts in 32 oz. vinyl. Our welting is solid for black and vinyl wrapped for all other colors to ensure an exact color match. The vertical and horizontal pleats are stitched, just like the originals, the chrome emblem is included.

\* **Official Ford Licensed Product**

\* *We offer other colors as a special order (see samples).*

#### Features

- Original Sierra grain vinyl with "Running Pony" panel
- Correct 6 stitch per inch stitching
- Correct colors matched to the original vinyl
- Limited lifetime warranty

COUPE BUCKET SEATS - FRONT/REAR SET	<b>067603</b>
FASTBACK (2+2) BUCKET SEATS - FRONT/REAR SET	<b>067629</b>
CONVERTIBLE BUCKET SEATS - FRONT/REAR SET	<b>067611</b>
BUCKETS SEATS - FRONT	<b>067637</b>
COUPE BENCH SEAT - REAR	<b>067605</b>
FASTBACK (2+2) BENCH SEAT - REAR	<b>067632</b>
CONVERTIBLE BENCH SEAT - REAR	<b>067613</b>

### 1965-66 PONY (DELUXE) FRONT BENCH SEAT UPHOLSTERY

We offer the Pony Upholstery for the Front Bench Seat though it was not original on the Mustang. Our 1965-66 Pony Upholstery features the original "Running Pony" embossed panel along with the correct Sierra grain skirts and inserts in 32 oz. vinyl. Our welting is solid for black and vinyl wrapped for all other colors to ensure an exact color match. The vertical and horizontal pleats are stitched, just like the originals, the chrome emblem is included.

\* **Official Ford Licensed Product**

\* *We offer other colors as a special order (see samples).*

#### Features

- Original Sierra grain vinyl with "Running Pony" panel
- Correct 6 stitch per inch stitching
- Correct colors matched to the original vinyl
- Limited lifetime warranty

COUPE BENCH SEATS - FRONT/REAR SET	<b>067652</b>
FASTBACK (2+2) BENCH SEATS - FRONT/REAR SET	<b>067678</b>
CONVERTIBLE BENCH SEATS - FRONT/REAR SET	<b>067660</b>
BENCH SEAT - FRONT	<b>067686</b>

### 1965-66 CUSTOM LEATHER SEAT UPHOLSTERY

We offer custom leather upholstery for the 1965-66 Mustang. Custom options include contrasting colors and stitching, as well as solid color upholstery. *Please call for color and option availability.*



Now Two-Tone Door Panels are available in **CARBON FIBER!**

### 1965-66 UPHOLSTERY COLORS

#### Solid Colors

1965 RED	L-957
1966 RED	L-2920
BLACK	L-958
PALOMINO	L-2288
PARCHMENT	L-2613
WHITE	L-2290

#### Original Two-Tone Colors

PONY BLUE/WHITE	L-2287/L-2290
EMBERGLO/PARCHMENT	L-2921/L-2613
IVY GOLD/WHITE	L-2503/L-2290
TURQUOISE/WHITE	L-2929/L-2290

#### Non-Original Two-Tone Colors

1965 RED/WHITE	L-957/L-2290
1966 RED/WHITE	L-2920/L-2290
BLACK/WHITE	L-958/L-2290

## 1965-66 PONY (DELUXE) INTERIOR PARTS & ACCESSORIES

### 1965-66 PONY TOURING BUCKET SEAT UPHOLSTERY & ACCESSORIES

Our 1965-66 Touring Bucket Seats feature raised bolsters and side panels. The Touring Seat is body contoured to create modern ergonomics for the classic car.

#### Features

- Original Sierra grain vinyl with "Running Pony" panel
- Raised bolsters and side panels
- Correct 6 stitch per inch stitching
- Correct colors matched to the original vinyl
- Limited lifetime warranty

COUPE BUCKET SEATS - FRONT/REAR SET	<b>067819</b>
FASTBACK (2+2) BUCKET SEATS - FRONT/REAR SET	<b>067835</b>
CONVERTIBLE BUCKET SEATS - FRONT/REAR SET	<b>067827</b>
BUCKET SEATS - FRONT	<b>067843</b>
1965-67 TOURING SEAT FOAM - SOLD INDIVIDUALLY	<b>063958</b>
1965-66 PONY (DELUXE) TOURING BUCKET SEAT HEADREST	<b>067810</b>

*\*Note: Includes all attaching hardware, and installation instructions.*



### 1965-66 PONY (DELUXE) HEADLINERS/SUNVISORS

Our 1965-66 Sunvisors are offered in Standard and Premium versions. The Premium Sunvisors feature a thicker and more dense padding that is correct in appearance and feel. The Sunvisors are in the original Crater grain vinyl for Coupes/Fastbacks and Sierra for Convertibles dielectrically seamed with the vinyl binding stitched, just like the originals. All Sunvisors are sold in pairs.

COUPE/FASTBACK (2+2) SUNVISORS - STANDARD	<b>069757</b>
COUPE/FASTBACK (2+2) SUNVISORS - PREMIUM	<b>069682</b>
CONVERTIBLE SUNVISORS - STANDARD	<b>069708</b>
CONVERTIBLE SUNVISORS - PREMIUM	<b>069690</b>

Our Universal Headliner fits 1965-70 models with extra material for a trim to fit application in the original Crater grain vinyl.  
1965-70 COUPE HEADLINER - UNIVERSAL **069393**



#### 1965-66 HEADLINER/SUNVISOR COLORS

1965 BRIGHT RED	H-812
AQUA	H-813
BLACK	H-754
DARK AQUA	H-956
DARK GREEN	H-1030
IVY GOLD	H-1029
LIGHT BLUE	H-836
LIGHT GREEN	H-755
MEDIUM BLUE	H-814
RED	H-863
SADDLE	H-926
TAN	H-837
WHITE	H-741

## 1965-66 PONY (DELUXE) INTERIOR PARTS & ACCESSORIES

### 1965-66 PONY (DELUXE) INTERIOR ACCESSORIES

Our 1965-66 Pony Convertible Top Boot features the correct Sierra grain in 32 oz. vinyl is padded and fastens just like the original.

1965-66 CONVERTIBLE TOP BOOT **069500**

Although not originally offered for the Mustang our Convertible Boot Bag features Corinthian grain in 32 oz. vinyl and is available in interior matching colors.

1965-66 CONVERTIBLE BOOT BAG **069575**



Our Convertible Well Liner is in 32 oz Sierra grain vinyl and is available in interior matching colors.

1965-66 CONVERTIBLE WELL LINER **069963**

Distinctive Industries 1965-66 Pony bucket seat Headrest Covers are in the correct Sierra grain in 32 oz. vinyl. All mounting hardware, and installation instructions are included.

1965-66 PONY BUCKET SEAT HEADREST **067813**

Our Mustang Coupe Quarter Trim features 32 oz. vinyl in the correct Sierra grain and is stitched, just like the originals.

1965-66 COUPE QUARTER TRIM - 1 PIECE **067638**

1965-66 COUPE QUARTER TRIM **067645**

Our Mustang Convertible Quarter Trim features 32 oz. vinyl in the correct Sierra grain and is stitched, just like the originals.

CONVERTIBLE QUARTER TRIM **069799**

Although not originally offered our Map Pockets are a nice addition and are available in interior matching colors. Our Map Pockets attach to the rear of the front bucket seats.

MAP POCKETS **069302**

Distinctive Industries High-Density Seat Foam is designed to work as a system with our upholstery. Our High-Density Seat Foam is firm, form fitting, and features a Typar® web backing for strength, which prevents spring intrusion and ensures a quality fit and long lasting life.

BUCKET SEAT FOAM - SOLD INDIVIDUALLY **064006PNY6566**

Distinctive Industries Seat Heaters provide therapeutic heat and body warmth in any classic car, using the same technology as late model or current vehicles. Each kit comes with switch, harnesses, and two carbon fiber element pads to complete one seat install. Switch can be dash, console, or hidden in a place of choice. Seat Heaters are sold individually, not in pairs.

1965-73 CARBON FIBER SEAT HEATERS **061001**



### 1965-66 UPHOLSTERY COLORS

1965 RED	L-957
1966 RED	L-2920
BLACK	L-958
PONY BLUE	L-2287
EMBERGLO	L-2921
IVY GOLD	L-2503
PALOMINO	L-2288
PARCHMENT	L-2613
TURQUOISE	L-2929
WHITE	L-2290

## 1965 STANDARD INTERIOR PARTS & ACCESSORIES

### 1965 STANDARD SEAT UPHOLSTERY

Our 1965 Mustang Standard Upholstery features the original Sierra grain in 32 oz. vinyl for the skirts and inserts. Our welting is solid for black and vinyl wrapped for all other colors to ensure an exact color match. The horizontal pleats are stitched, just like the originals, with the correct spacing.

\* **We offer other colors as a special order (see samples).**

#### Features

- Original Sierra grain vinyl
- Correct 6 stitch per inch stitching
- Correct colors matched to the original vinyl
- Limited lifetime warranty

COUPE BUCKET SEATS - FRONT/REAR SET	<b>067702</b>
COUPE BENCH SEATS - FRONT/REAR SET	<b>067710</b>
FASTBACK (2+2) BUCKET SEATS - FRONT/REAR SET	<b>067744</b>
CONVERTIBLE BUCKET SEATS - FRONT/REAR SET	<b>067728</b>
CONVERTIBLE BENCH SEATS - FRONT/REAR SET	<b>067736</b>
BUCKET SEATS - FRONT	<b>067769</b>
BENCH SEAT - FRONT	<b>067777</b>
COUPE BENCH SEAT - REAR	<b>067703</b>
FASTBACK (2+2) BENCH SEAT - REAR	<b>067745</b>
CONVERTIBLE BENCH SEAT - REAR	<b>067729</b>

### 1965 STANDARD TOURING BUCKET SEAT UPHOLSTERY & FOAM

Our 1965-66 Touring Bucket Seats feature raised bolsters and side panels. The Touring Seat is body contoured to create modern ergonomics for the classic car.

#### Features

- Original Sierra grain vinyl
- Raised bolsters and side panels
- Correct 6 stitch per inch stitching
- Correct colors matched to the original vinyl
- Limited lifetime warranty

COUPE BUCKET SEATS - FRONT/REAR SET	<b>067868</b>
FASTBACK (2+2) BUCKET SEATS - FRONT/REAR SET	<b>067884</b>
CONVERTIBLE BUCKET SEATS - FRONT/REAR SET	<b>067876</b>
BUCKET SEATS - FRONT	<b>067892</b>
1965-67 TOURING SEAT FOAM - SOLD INDIVIDUALLY	<b>063958</b>

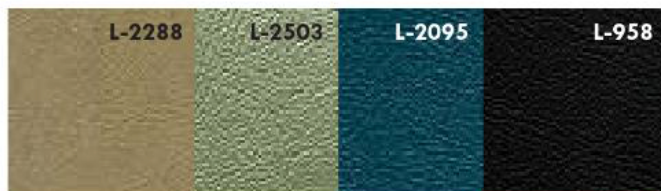

1965 COLORS	
BLACK	L-958
BLUE	L-2095
IVY GOLD	L-2503
PALOMINO	L-2288
RED	L-957
WHITE	L-2290



### 1965 CUSTOM LEATHER SEAT UPHOLSTERY

We offer custom leather upholstery for the 1965 Mustang. Custom options include contrasting colors and stitching, as well as solid color upholstery. **Please call for color and option availability.**

## 1965 STANDARD INTERIOR PARTS & ACCESSORIES

### 1965 STANDARD DOOR PANELS

Our 1965 Mustang Standard Door Panels feature the original Sierra grain in 32 oz. vinyl. The dielectric patterns and pleats are correct along with the chrome (Mylar®) C-trim. Correct hole placement is pre-cut into the panel backed by die cut fiber board, just like the originals.

\* We offer other colors as a special order (see samples).

#### Features

- Original Sierra grain vinyl
- Correct dielectric "Heat Seal" stitched pattern
- Correct colors matched to the original vinyl
- .100-inch thickness poly-coated "Autoboard" backing
- Door Panel backs are perimeter stapled for maximum adhesion
- Limited lifetime warranty

FRONT DOOR PANELS

067785



### 1965 TWO-TONE DOOR PANELS

Although not originally offered for the Mustang, Two-Tone Door Panels are a popular upgrade. The Distinctive Industries' Two-Tone Door Panels are offered in any combination of colors for a given year. Our panels feature the same construction and design as our restoration door panels.



#### Features

- Original Sierra grain vinyl
- Correct dielectric "Heat Seal" stitched pattern
- Correct colors matched to the original vinyl
- .100-inch thickness poly-coated "Autoboard" backing
- Door Panel backs are perimeter stapled for maximum adhesion
- Limited lifetime warranty

1965 TWO-TONE DOOR PANELS

067793



#### 1965 COLORS

BLACK	L-958
BLUE	L-2095
IVY GOLD	L-2503
PALOMINO	L-2288
RED	L-957
WHITE	L-2290

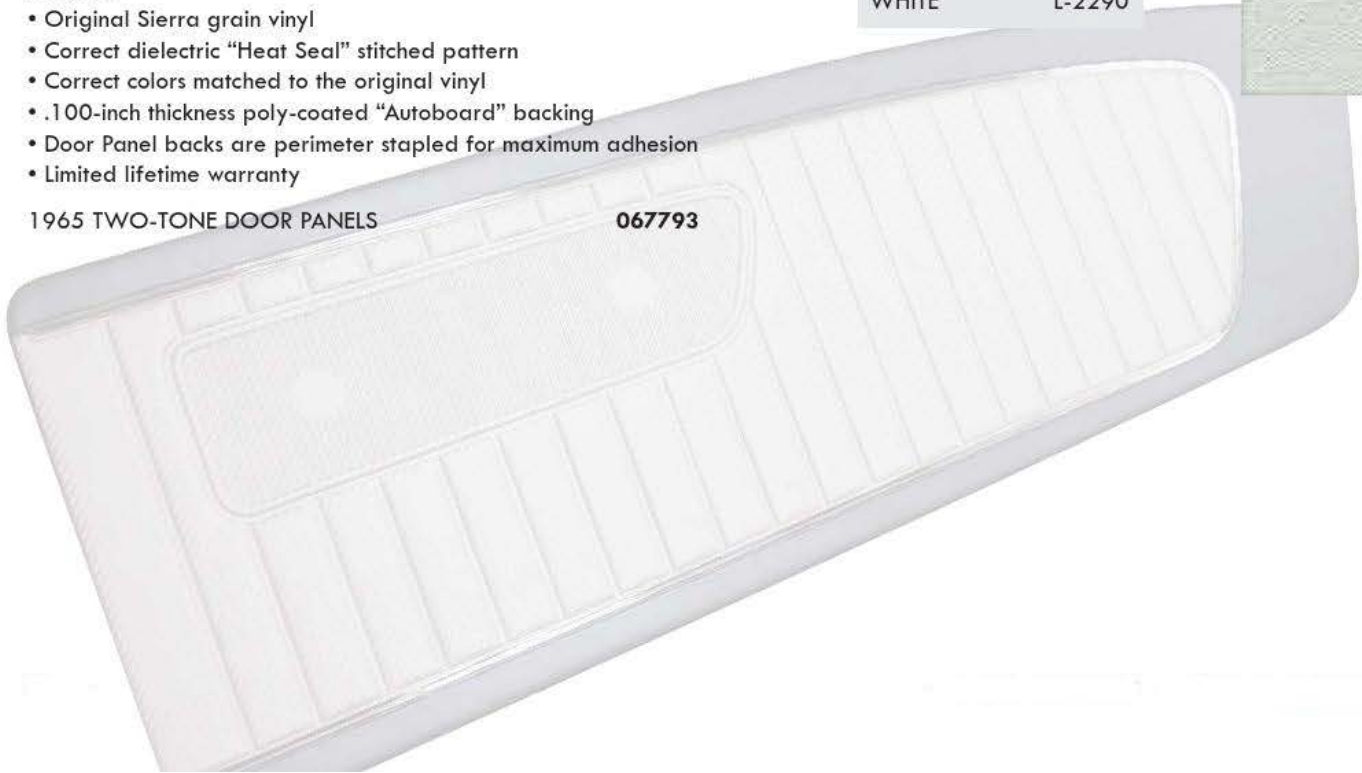



## 1965 STANDARD INTERIOR PARTS & ACCESSORIES



### 1965 STANDARD HEADLINERS/SUNVISORS

Our 1965-66 Sunvisors are offered in Standard and Premium versions. The Premium Sunvisors feature a thicker and more dense padding that is correct in appearance and feel. The Sunvisors are in the original Crater grain vinyl for Coupes/Fastbacks and Sierra for Convertibles dielectrically seamed with the vinyl binding stitched, just like the originals. All Sunvisors are sold in pairs.

COUPE/FASTBACK (2+2) SUNVISORS - STANDARD	<b>069757</b>
COUPE/FASTBACK (2+2) SUNVISORS - PREMIUM	<b>069682</b>
CONVERTIBLE SUNVISORS - STANDARD	<b>069708</b>
CONVERTIBLE SUNVISORS - PREMIUM	<b>069690</b>

Our 1965-66 Headliners are in the original Crater grain vinyl constructed just like the originals.

1965-68 COUPE HEADLINER	<b>069401</b>
1965-66 FASTBACK (2+2) HEADLINER	<b>069419</b>

Our Universal Headliner fits 1965-70 models with extra material for a trim to fit application in the original Crater grain vinyl.

1965-70 COUPE HEADLINER - UNIVERSAL	<b>069393</b>
-------------------------------------	---------------

### 1965 HEADLINER/SUNVISOR COLORS

1965 BRIGHT RED	H-812	LIGHT GREEN	H-755
AQUA	H-813	MEDIUM BLUE	H-814
BLACK	H-754	RED	H-863
DARK AQUA	H-956	SADDLE	H-926
DARK GREEN	H-1030	TAN	H-837
IVY GOLD	H-1029	WHITE	H-741
LIGHT BLUE	H-836		



### 1965 CARPET COLORS

BLACK	501	MAROON	625
BLACK	601	OLIVE GREEN	609
BRIGHT BLUE	541	RED	615
BRIGHT RED	565	SADDLE	621
DARK BLUE	602	TURQUOISE	508
LIGHT BLUE	622		

### 1965 STANDARD CARPET KITS

Our high quality Carpet Kits are available in either 80/20 loop or Nylon loop carpet.

- 500 series part numbers are 80/20
- 600 series part numbers are Nylon

1965-66 COUPE TRUNK CARPET KIT - NYLON	<b>071175</b>
1965-66 COUPE TRUNK CARPET KIT - 80/20	<b>071176</b>
1965-66 CONVERTIBLE TRUNK CARPET KIT - NYLON	<b>071217</b>
1965-66 CONVERTIBLE TRUNK CARPET KIT - 80/20	<b>071218</b>
1965-66 FASTBACK (2+2) TRUNK CARPET KIT - NYLON	<b>071241</b>
1965-66 FASTBACK (2+2) TRUNK CARPET KIT - 80/20	<b>071242</b>
1965-68 COUPE/FASTBACK KICK PANEL CARPET - 80/20	<b>071091</b>
1965-68 COUPE/FASTBACK KICK PANEL CARPET - NYLON	<b>071092</b>
1965-68 CONVERTIBLE KICK PANEL CARPET - 80/20	<b>071083</b>
1965-68 CONVERTIBLE KICK PANEL CARPET - NYLON	<b>071084</b>
1965-68 FASTBACK (2+2) FOLD DOWN CARPET 3PC KIT - 80/20	<b>071099</b>
1965-68 FASTBACK (2+2) FOLD DOWN CARPET 3PC KIT - NYLON	<b>071100</b>

## 1965 STANDARD INTERIOR PARTS & ACCESSORIES

### 1965 STANDARD/DELUXE PACKAGE TRAYS

Our Package Trays are die-cut fiber board with correct speaker placement where applicable, covered with 32 oz vinyl in Sierra grain. Color match to interior upholstery.

- 1965-68 COUPE PACKAGE TRAY NO SPEAKER HOLE **064212**  
 1965-67 COUPE PACKAGE TRAY WITH  
 SPEAKER HOLES **064220**

### 1965 STANDARD INTERIOR ACCESSORIES

Our 1965-66 Convertible Top Boot features the correct Sierra grain in 32 oz. vinyl is padded and fastens just like the original.

- 1965-66 CONVERTIBLE TOP BOOT **069500**  
 Although not originally offered for the Mustang our Convertible Boot Bag features Corinthian grain in 32 oz. vinyl and is available in interior matching colors.  
 1965-66 CONVERTIBLE BOOT BAG **069575**

- Our Quarter Trim features 32 oz. vinyl in the correct Sierra grain and is stitched, just like the originals.  
 1965-66 COUPE QUARTER TRIM **067645**  
 1965-66 COUPE QUARTER TRIM - 1 PIECE **067638**  
 1965-66 CONVERTIBLE QUARTER TRIM **069799**

- Our Convertible Well Liner is in 32 oz Sierra grain vinyl and is available in interior matching colors.  
 1965-66 CONVERTIBLE WELL LINER **069963**

- Although not originally offered our Map Pockets are a nice addition and are available in interior matching colors. Our Map Pockets attach to the rear of the front bucket seats.  
 1965-66 MAP POCKET **069302**

- Although not originally offered Bucket Seat Headrests are a popular upgrade. Distinctive Industries 1965 "Halo" Bucket Seat Headrest Covers are in the correct Sierra grain in 32 oz. vinyl. Headrests come with all mounting hardware and installation instructions.  
 1965-67 STANDARD BUCKET SEAT HEADREST **067805**  
 1965-67 TOURING BUCKET SEAT HEADREST **067800**

- Distinctive Industries High-Density Seat Foam is designed to work as a system with our upholstery. Our High-Density Seat Foam is firm, form fitting, and features a Tyvar® web backing for strength, which prevents spring intrusion and ensures a quality fit and long lasting life.  
 1965-66 BUCKET SEAT FOAM -  
 SOLD INDIVIDUALLY **064007STD6566**

- Distinctive Industries Seat Heaters provide therapeutic heat and body warmth in any classic car, using the same technology as late model or current vehicles. Each kit comes with switch, harnesses, and two carbon fiber element pads to complete one seat install. Switch can be dash, console, or hidden in a place of choice. Seat Heaters are sold individually, not in pairs.  
 1965-73 CARBON FIBER SEAT HEATERS **061001**



### 1965 COLORS

BLACK	L-958
BLUE	L-2095
IVY GOLD	L-2503
PALOMINO	L-2288
RED	L-957
WHITE	L-2290

## 1966 STANDARD INTERIOR PARTS & ACCESSORIES

### 1966 STANDARD SEAT UPHOLSTERY

Our 1966 Mustang Standard Upholstery features the original Sierra grain with Rosette inserts in 32 oz. vinyl for the skirts and inserts. Our welting is solid for black and vinyl wrapped for all other colors to ensure an exact color match. The horizontal pleats are stitched, just like the originals, with the correct spacing.

\* **We offer other colors as a special order (see samples).**

#### Features

- Original Sierra grain vinyl with Rosette inserts
- Correct 6 stitch per inch stitching
- Correct colors matched to the original vinyl
- Limited lifetime warranty

COUPE BUCKET SEATS - FRONT/REAR SET	<b>067900</b>
COUPE BENCH SEATS - FRONT/REAR SET	<b>067918</b>
FASTBACK (2+2) BUCKET SEATS - FRONT/REAR SET	<b>067942</b>
CONVERTIBLE BUCKET SEATS - FRONT/REAR SET	<b>067926</b>
CONVERTIBLE BENCH SEATS - FRONT/REAR SET	<b>067934</b>
BUCKETS SEATS - FRONT	<b>067967</b>
BENCH SEAT - FRONT	<b>067975</b>
COUPE BENCH SEAT - REAR	<b>067910</b>
FASTBACK (2+2) BENCH SEAT - REAR	<b>067950</b>
CONVERTIBLE BENCH SEAT - REAR	<b>067930</b>



### 1966 STANDARD TOURING BUCKET SEAT UPHOLSTERY & FOAM

Our 1965-66 Touring Bucket Seats feature raised bolsters and side panels. The Touring Seat is body contoured to create modern ergonomics for the classic car.

#### Features

- Original Sierra grain vinyl with Rosette inserts
- Raised bolsters and side panels
- Correct 6 stitch per inch stitching
- Correct colors matched to the original vinyl
- Limited lifetime warranty

COUPE BUCKET SEATS - FRONT/REAR SET	<b>068015</b>
FASTBACK (2+2) BUCKET SEATS - FRONT/REAR SET	<b>068031</b>
CONVERTIBLE BUCKET SEATS - FRONT/REAR SET	<b>068023</b>
BUCKET SEATS - FRONT	<b>068049</b>
1965-67 TOURING SEAT FOAM - SOLD INDIVIDUALLY	<b>063958</b>

### 1966 CUSTOM LEATHER SEAT UPHOLSTERY

We offer custom leather upholstery for the 1966 Mustang. Custom options include contrasting colors and stitching, as well as solid color upholstery. **Please call for color and option availability.**

### 1966 COLORS

BLACK	L-958 (I=L-2949)
BLUE	L-2287 (I=L-2946) (DP=L-2505)
PARCHMENT	L-2613 (I=L-2945)
RED	L-2920 (I=L-2954)
TURQUOISE	L-2929 (I=L-2951) DP=L-3097

**NOTE: I=Insert and DP=Door Panel.**





## 1966 STANDARD INTERIOR PARTS & ACCESSORIES

### 1966 STANDARD DOOR PANELS

Our 1966 Mustang Standard Door Panels feature the original Sierra grain in 32 oz. vinyl. The dielectric patterns and pleats are correct along with the chrome (Mylar®) C-trim. Correct hole placement is pre-cut into the panel backed by die cut fiber board, just like the originals.

\* *We offer other colors as a special order (see samples).*

#### Features

- Original Sierra grain vinyl
- Correct dielectric "Heat Seal" stitched pattern
- Correct colors matched to the original vinyl
- .100-inch thickness poly-coated "Autoboard" backing
- Door Panel backs are perimeter stapled for maximum adhesion
- Limited lifetime warranty

FRONT DOOR PANELS 067983



### 1966 TWO-TONE DOOR PANELS

Although not originally offered for the Mustang, Two-Tone Door Panels are a popular upgrade. The Distinctive Industries' Two-Tone Door Panels are offered in any combination of colors for a given year. Our panels feature the same construction and design as our restoration door panels.

#### Features

- Original Sierra grain vinyl
- Correct dielectric "Heat Seal" stitched pattern
- Correct colors matched to the original vinyl
- .100-inch thickness poly-coated "Autoboard" backing
- Door Panel backs are perimeter stapled for maximum adhesion
- Limited lifetime warranty

1966 TWO-TONE DOOR PANELS 067991



### 1966 STANDARD/DELUXE PACKAGE TRAYS

Our Package Trays are die-cut fiber board with correct speaker placement where applicable, covered with 32 oz vinyl in Sierra grain. Color match to interior upholstery.

1965-68 COUPE PACKAGE TRAY NO SPEAKER HOLE 064212

1965-67 COUPE PACKAGE TRAY WITH SPEAKER HOLES 064220

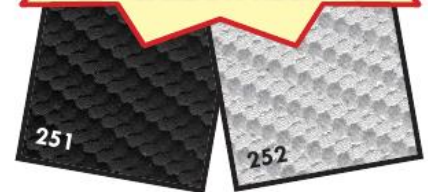

#### 1966 COLORS

BLACK	L-958
BLUE	L-2287
PARCHMENT	L-2613
RED	L-2920
TURQUOISE	L-2929

## 1966 STANDARD INTERIOR PARTS & ACCESSORIES



### 1966 STANDARD HEADLINERS/SUNVISORS

Our 1965-66 Sunvisors are offered in Standard and Premium versions. The Premium Sunvisors feature a thicker and more dense padding that is correct in appearance and feel. The Sunvisors are in the original Crater grain vinyl for Coupes/Fastbacks and Sierra for Convertibles dielectrically seamed with the vinyl binding stitched, just like the originals. All Sunvisors are sold in pairs.

COUPE/FASTBACK (2+2) SUNVISORS - STANDARD	<b>069757</b>
COUPE/FASTBACK (2+2) SUNVISORS - PREMIUM	<b>069682</b>
CONVERTIBLE SUNVISORS - STANDARD	<b>069708</b>
CONVERTIBLE SUNVISORS - PREMIUM	<b>069690</b>

Our 1965-66 Headliners are in the original Crater grain vinyl constructed just like the original.

1965-68 COUPE HEADLINER	<b>069401</b>
1965-66 FASTBACK (2+2) HEADLINER	<b>069419</b>

Our Universal Headliner fits 1965-70 models with extra material for a trim to fit application in the original Crater grain vinyl.

1965-70 COUPE HEADLINER - UNIVERSAL	<b>069393</b>
-------------------------------------	---------------

### 1966 HEADLINER/SUNVISOR COLORS

1965 BRIGHT RED	H-812	LIGHT GREEN	H-755
AQUA	H-813	MEDIUM BLUE	H-814
BLACK	H-754	RED	H-863
DARK AQUA	H-956	SADDLE	H-926
DARK GREEN	H-1030	TAN	H-837
IVY GOLD	H-1029	WHITE	H-741
LIGHT BLUE	H-836		



### 1966 CARPET COLORS

BLACK	501	MAROON	625
BLACK	601	OLIVE GREEN	609
BRIGHT BLUE	541	RED	615
BRIGHT RED	565	SADDLE	621
DARK BLUE	602	TURQUOISE	508
LIGHT BLUE	622		

### 1966 STANDARD CARPET KITS

Our high quality Carpet Kits feature either 80/20 loop or Nylon loop carpet.

- 500 series part numbers are 80/20
- 600 series part numbers are Nylon

1965-66 COUPE TRUNK CARPET KIT - NYLON	<b>071175</b>
1965-66 COUPE TRUNK CARPET KIT - 80/20	<b>071176</b>
1965-66 CONVERTIBLE TRUNK CARPET KIT - NYLON	<b>071217</b>
1965-66 CONVERTIBLE TRUNK CARPET KIT - 80/20	<b>071218</b>
1965-66 FASTBACK (2+2) TRUNK CARPET KIT - NYLON	<b>071241</b>
1965-66 FASTBACK (2+2) TRUNK CARPET KIT - 80/20	<b>071242</b>
1965-68 COUPE/FASTBACK KICK PANEL CARPET - 80/20	<b>071091</b>
1965-68 COUPE/FASTBACK KICK PANEL CARPET - NYLON	<b>071092</b>
1965-68 CONVERTIBLE KICK PANEL CARPET - 80/20	<b>071083</b>
1965-68 CONVERTIBLE KICK PANEL CARPET - NYLON	<b>071084</b>
1965-68 FASTBACK (2+2) FOLD DOWN CARPET 3PC KIT - 80/20	<b>071099</b>
1965-68 FASTBACK (2+2) FOLD DOWN CARPET 3PC KIT - NYLON	<b>071100</b>

## 1966 STANDARD INTERIOR PARTS & ACCESSORIES



069963



069500

069302



L-958

L-2949

L-2287

L-2946

L-2505

L-2613

L-2945

L-2920

L-2954

L-2929

L-2951

L-3097

### 1966 COLORS

BLACK	L-958 (I=L-2949)
BLUE	L-2287 (I=L-2946) (DP=L-2505)
PARCHMENT	L-2613 (I=L-2945)
RED	L-2920 (I=L-2954)
TURQUOISE	L-2929 (I=L-2951) DP=L-3097)

**NOTE: I=Insert and DP=Door Panel.**

### 1966 STANDARD INTERIOR ACCESSORIES

Our 1965-66 Convertible Top Boot features the correct Sierra grain in 32 oz. vinyl is padded and fastens just like the original.  
 1965-66 CONVERTIBLE TOP BOOT **069500**

Although not originally offered for the Mustang our Convertible Boot Bag features Corinthian grain in 32 oz. vinyl and is available in interior matching colors.  
 1965-66 CONVERTIBLE BOOT BAG **069575**

Our Mustang Coupe Quarter Trim features 32 oz. vinyl in the correct Sierra grain and is stitched, just like the originals.  
 1965-66 COUPE QUARTER TRIM **067645**  
 1965-66 COUPE QUARTER TRIM - 1 PIECE **067638**

Our Convertible Quarter Trim features 32 oz. vinyl in the correct Sierra grain and is stitched, just like the originals.  
 1965-66 CONVERTIBLE QUARTER TRIM **069799**

Our Convertible Well Liner is in 32 oz Sierra grain vinyl and is available in interior matching colors.  
 1965-66 CONVERTIBLE WELL LINER **069963**

Although not originally offered our Map Pockets are a nice addition and are available in interior matching colors. Our Map Pockets attach to the rear of the front bucket seats.  
 1965-66 MAP POCKET **069302**

Although not originally offered Bucket Seat Headrests are a popular upgrade. Distinctive Industries 1966 "Halo" Bucket Seat Headrest Covers are in the correct Sierra grain in 32 oz. vinyl. Headrests come with all mounting hardware and installation instructions.

1965-67 STANDARD BUCKET SEAT HEADREST **067805**  
 1965-67 TOURING BUCKET SEAT HEADREST **067800**

Distinctive Industries High-Density Seat Foam is designed to work as a system with our upholstery. Our High-Density Seat Foam is firm, form fitting, and features a Tytar® web backing for strength, which prevents spring intrusion and ensures a quality fit and long lasting life.  
 1965-66 BUCKET SEAT FOAM -  
 SOLD INDIVIDUALLY  
**064007STD6566**



Distinctive Industries Seat Heaters provide therapeutic heat and body warmth in any classic car, using the same technology as late model or current vehicles. Each kit comes with switch, harnesses, and two carbon fiber element pads to complete one seat install. Switch can be dash, console, or hidden in a place of choice. Seat Heaters are sold individually, not in pairs.  
 1965-73 CARBON FIBER SEAT HEATERS **061001**

## 1967 STANDARD & DELUXE/SHELBY INTERIOR PARTS & ACCESSORIES



### 1967 STANDARD SEAT UPHOLSTERY

Our 1967 Mustang Standard Upholstery features the original Sierra grain in 32 oz. vinyl for the skirts and inserts. Our welting is solid for black and vinyl wrapped for all other colors to ensure an exact color match. The horizontal pleats are stitched, just like the originals, with the correct spacing. Seat back buttons are not included with Deluxe/*Shelby* seat upholstery.

\* **We offer other colors as a special order (see samples).**

\* **1967 Standard/Deluxe is distinguished by 1 single button in the upper center of the front bucket seat back (not included).**

#### Features

- Original Sierra grain vinyl
- Correct 6 stitch per inch stitching
- Correct colors matched to the original vinyl
- Limited lifetime warranty

COUPE BUCKET SEATS - FRONT/REAR SET	<b>068106</b>
COUPE BENCH SEATS - FRONT/REAR SET	<b>068114</b>
FASTBACK (2+2) BUCKET SEATS - FRONT/REAR SET	<b>068148</b>
CONVERTIBLE BUCKET SEATS - FRONT/REAR SET	<b>068122</b>
CONVERTIBLE BENCH SEATS - FRONT/REAR SET	<b>068130</b>
BUCKET SEATS - FRONT	<b>068163</b>
BENCH SEAT - FRONT	<b>068171</b>
COUPE BENCH SEAT - REAR	<b>068107</b>
FASTBACK (2+2) BENCH SEAT - REAR	<b>068149</b>
CONVERTIBLE BENCH SEAT - REAR	<b>068123</b>

### 1967 CUSTOM LEATHER SEAT UPHOLSTERY

We offer custom leather upholstery for the 1967 Mustang. Custom options include contrasting colors and stitching, as well as solid color upholstery. **Please call for color and option availability.**



### 1967 COLORS

BLACK	L-958
BLUE	L-2287 (I=L-2505) (DP=L-2505)
IVY GOLD	L-2503 (I=L-2286) (DP=L-2286)
PARCHMENT	L-3096
RED	L-2920
SADDLE	L-3099
TURQUOISE	L-2929 (I=L-3444) (DP=L-3097)

**NOTE: I=Insert and DP=Door Panel.**

## 1967 STANDARD & DELUXE/SHELBY INTERIOR PARTS & ACCESSORIES

### 1967 STANDARD TOURING BUCKET SEAT UPHOLSTERY & FOAM

Our 1967 Touring Bucket Seats feature raised bolsters and side panels. The Touring Seat is body contoured to create modern ergonomics for the classic car.

#### Features

- Original Sierra grain vinyl
- Raised bolsters and side panels
- Correct 6 stitch per inch stitching
- Correct colors matched to the original vinyl
- Limited lifetime warranty

COUPE BUCKET SEATS - FRONT/REAR SET	<b>068213</b>
FASTBACK (2+2) BUCKET SEATS - FRONT/REAR SET	<b>068239</b>
CONVERTIBLE BUCKET SEATS - FRONT/REAR SET	<b>068221</b>
BUCKET SEATS - FRONT	<b>068247</b>
1965-67 TOURING SEAT FOAM - SOLD INDIVIDUALLY	<b>063958</b>

### 1967 DELUXE/SHELBY BUCKETS SEAT UPHOLSTERY WITH COMFORTWEAVE INSERTS

Our 1967 Mustang Deluxe and *Shelby* Upholstery features the original Sierra grain in 32 oz. vinyl, for the skirts and Comfortweave inserts. Our welting is solid for black and vinyl wrapped for all other colors to ensure an exact color match. The horizontal pleats are stitched, just like the originals, with the correct spacing. Seat back buttons are not included with Deluxe/*Shelby* seat upholstery.

\* *We offer other colors as a special order (see samples).*

\* *1967 Deluxe and Shelby has a single button in the center of the front bucket seats that is not included.*

#### Features

- Original Sierra grain vinyl with Comfortweave inserts
- Correct 6 stitch per inch stitching
- Correct colors matched to the original vinyl
- Limited lifetime warranty

COUPE BUCKET SEATS - FRONT/REAR SET	<b>068102</b>
COUPE BENCH SEAT - FRONT/REAR SET	<b>068115</b>
FASTBACK (2+2) BUCKET SEATS - FRONT/REAR SET	<b>068132</b>
CONVERTIBLE BUCKET SEATS - FRONT/REAR SET	<b>068116</b>
CONVERTIBLE BENCH SEAT - FRONT/REAR SET	<b>068131</b>
BUCKET SEATS - FRONT	<b>068168</b>
BENCH SEAT - FRONT	<b>068173</b>
COUPE BENCH SEAT - REAR	<b>068109</b>
FASTBACK (2+2) BENCH SEAT - REAR	<b>068155</b>
CONVERTIBLE BENCH SEAT - REAR	<b>068125</b>

### 1967 CUSTOM LEATHER SEAT UPHOLSTERY

We offer custom leather upholstery for the 1967 Mustang. Custom options include contrasting colors and stitching, as well as solid color upholstery. *Please call for color and option availability.*



#### 1967 COLORS

BLACK	L-958
BLUE	L-2287 (I=L-2505) (DP=L-2505)
IVY GOLD	L-2503 (I=L-2286) (DP=L-2286)
PARCHMENT	L-3096
RED	L-2920
SADDLE	L-3099
TURQUOISE	L-2929 (I=L-3444) (DP=L-3097)

**NOTE: I=Insert and DP=Door Panel.**



## 1967 STANDARD INTERIOR PARTS & ACCESSORIES



### 1967 STANDARD DOOR PANELS

Our 1967 Mustang Standard Door Panels feature the original Sierra grain in 32 oz. vinyl. The dielectric patterns and pleats are correct along with the chrome (Mylar®) trim. Correct hole placement is pre-cut into the panel backed by die cut fiber board, just like the originals.

*\* We offer other colors as a special order (see samples).*

#### Features

- Original Sierra grain vinyl
- Correct dielectric "Heat Seal" stitched pattern
- Correct colors matched to the original vinyl
- .100-inch thickness poly-coated "Autoboard" backing
- Door Panel backs are perimeter stapled for maximum adhesion
- Limited lifetime warranty

FRONT DOOR PANELS

**068189**

### 1967 TWO-TONE DOOR PANELS

Although not originally offered for the Mustang, Two-Tone Door Panels are a popular upgrade. The Distinctive Industries' Two-Tone Door Panels are offered in any combination of colors for a given year. Our panels feature the same construction and design as our restoration door panels.

#### Features

- Original Sierra grain vinyl
- Correct dielectric "Heat Seal" stitched pattern
- Correct colors matched to the original vinyl
- .100-inch thickness poly-coated "Autoboard" backing
- Door Panel backs are perimeter stapled for maximum adhesion
- Limited lifetime warranty

1967 TWO-TONE DOOR PANELS

**068197**



### 1967 COLORS

BLACK	L-958
BLUE	L-2287 (I=L-2505) (DP=L-2505)
IVY GOLD	L-2503 (I=L-2286) (DP=L-2286)
PARCHMENT	L-3096
RED	L-2920
SADDLE	L-3099
TURQUOISE	L-2929 (I=L-3444) (DP=L-3097)

**NOTE: I=Insert and DP=Door Panel.**



## 1967 STANDARD INTERIOR PARTS & ACCESSORIES

### 1967 STANDARD INTERIOR ACCESSORIES

Our 1967-68 Convertible Top Boot features the correct Sierra grain in 32 oz. vinyl is padded and fastens just like the original.  
**CONVERTIBLE TOP BOOT 069518**

Our Convertible Well Liner is in 32 oz Sierra grain vinyl and is available in interior matching colors.  
**1966-68 CONVERTIBLE WELL LINER 069971**

Our Convertible Boot Bag features Corinthian grain in 32 oz. vinyl and is available in interior matching colors.  
**CONVERTIBLE BOOT BAG 069575**

Our Quarter Trim features 32 oz. vinyl in the correct Sierra grain and is stitched, just like the originals.  
**1967-68 CONVERTIBLE QUARTER TRIM 069799**  
**1967-68 COUPE QUARTER TRIM 069781**

Although not originally offered our Map Pockets are a nice addition and are available in interior matching colors. Our Map Pockets attach to the rear of the front bucket seats.  
**MAP POCKETS 069302**

Although not originally offered Bucket Seat Headrests are a popular upgrade. Distinctive Industries 1967 "Halo" Bucket Seat Headrest Covers are in the correct Sierra grain in 32 oz. vinyl. Headrests come with all mounting hardware and installation instructions.  
**1965-67 STANDARD BUCKET SEAT HEADREST 067805**  
**1965-67 TOURING BUCKET SEAT HEADREST 067800**

Distinctive Industries High-Density Seat Foam is designed to work as a system with our upholstery. Our High-Density Seat Foam is firm, form fitting, and features a Typar® web backing for strength, which prevents spring intrusion and ensures a quality fit and long lasting life.  
**BUCKET SEAT FOAM - SOLD INDIVIDUALLY 064008STD67**

Distinctive Industries Seat Heaters provide therapeutic heat and body warmth in any classic car, using the same technology as late model or current vehicles. Each kit comes with switch, harnesses, and two carbon fiber element pads to complete one seat install. Switch can be dash, console, or hidden in a place of choice. Seat Heaters are sold individually, not in pairs.  
**1965-73 CARBON FIBER SEAT HEATERS 061001**

### 1967 STANDARD/DELUXE PACKAGE TRAYS

Our Package Trays are die-cut fiber board with correct speaker placement where applicable, covered with 32oz vinyl in Sierra grain. Color match to interior upholstery.

**1965-68 COUPE PACKAGE TRAY NO SPEAKER HOLE 064212**  
**1965-67 COUPE PACKAGE TRAY WITH SPEAKER HOLES 064220**

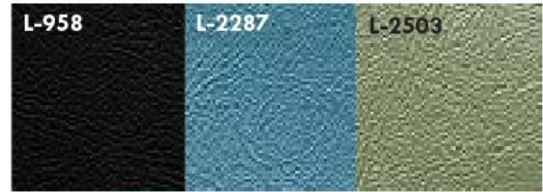

### 1967 COLORS

BLACK	L-958	RED	L-2920
BLUE	L-2287	SADDLE	L-3099
IVY GOLD	L-2503	TURQUOISE	L-2929
PARCHMENT	L-3096		



## 1967 STANDARD INTERIOR PARTS & ACCESSORIES



### 1967 STANDARD HEADLINERS/SUNVISORS

Our 1967-68 Sunvisors are in the original Crater grain vinyl dielectrically seamed with the vinyl binding stitched, just like the originals. All Sunvisors are sold in pairs.

1965-68 COUPE/FASTBACK (2+2) SUNVISORS - PREMIUM	<b>069682</b>
1967-68 COUPE/FASTBACK (2+2) SUNVISORS	<b>069765</b>
1967-68 CONVERTIBLE SUNVISORS	<b>069716</b>

Our 1965-68 Headliners are in the original Crater grain vinyl constructed just like the original.

1965-68 COUPE HEADLINER	<b>069401</b>
-------------------------	---------------

Our Universal Headliner fits 1965-70 models with extra material for a trim to fit application in the original Crater grain vinyl.

1965-70 COUPE HEADLINER - UNIVERSAL	<b>069393</b>
-------------------------------------	---------------



### 1967 HEADLINER/SUNVISOR COLORS

1965 BRIGHT RED	H-812	LIGHT GREEN	H-755
AQUA	H-813	MEDIUM BLUE	H-814
BLACK	H-754	RED	H-863
DARK AQUA	H-956	SADDLE	H-926
DARK GREEN	H-1030	TAN	H-837
IVY GOLD	H-1029	WHITE	H-741
LIGHT BLUE	H-836		

### 1967 STANDARD CARPET KITS

Our high quality Carpet Kits feature either 80/20 loop or Nylon loop carpet.

- 500 series part numbers are 80/20
- 600 series part numbers are Nylon

1967-68 COUPE TRUNK CARPET KIT - NYLON	<b>071260</b>
1967-68 COUPE TRUNK CARPET KIT - 80/20	<b>071261</b>
1967-68 CONVERTIBLE TRUNK CARPET KIT - NYLON	<b>071262</b>
1967-68 CONVERTIBLE TRUNK CARPET KIT - 80/20	<b>071263</b>
1967-68 FASTBACK (2+2) TRUNK CARPET KIT - NYLON	<b>071264</b>
1967-68 FASTBACK (2+2) TRUNK CARPET KIT - 80/20	<b>071265</b>
1965-68 COUPE/FASTBACK KICK PANEL CARPET - 80/20	<b>071091</b>
1965-68 COUPE/FASTBACK KICK PANEL CARPET - NYLON	<b>071092</b>
1965-68 CONVERTIBLE KICK PANEL CARPET - 80/20	<b>071083</b>
1965-68 CONVERTIBLE KICK PANEL CARPET - NYLON	<b>071084</b>
1965-68 FASTBACK (2+2) FOLD DOWN CARPET 3PC KIT - 80/20	<b>071099</b>
1965-68 FASTBACK (2+2) FOLD DOWN CARPET 3PC KIT - NYLON	<b>071100</b>

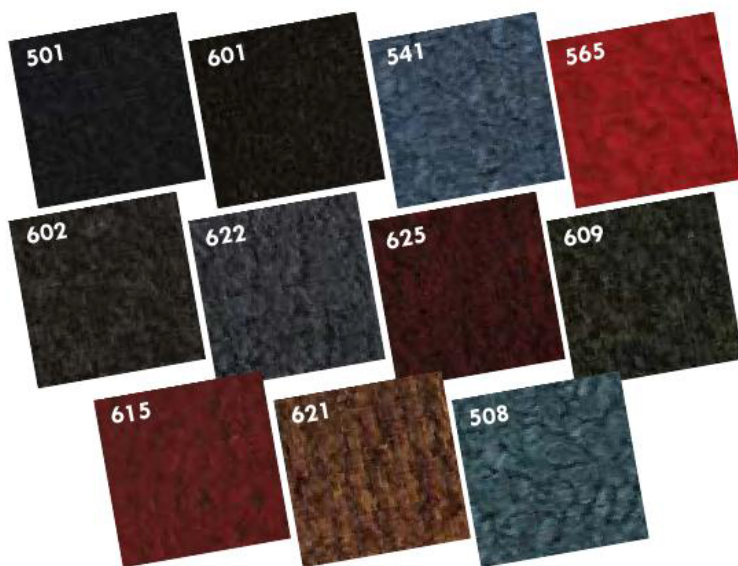

### 1967 CARPET COLORS

BLACK	501	MAROON	625
BLACK	601	OLIVE GREEN	609
BRIGHT BLUE	541	RED	615
BRIGHT RED	565	SADDLE	621
DARK BLUE	602	TURQUOISE	508
LIGHT BLUE	622		

## 1968 STANDARD & DELUXE/SHELBY INTERIOR PARTS & ACCESSORIES

### 1968 STANDARD SEAT UPHOLSTERY

Our 1968 Mustang Standard Upholstery features the original Sierra grain skirts and Kiwi grain inserts in 32 oz. vinyl. Our welting is solid for black and vinyl wrapped for all other colors to ensure an exact color match. The vertical pleats are stitched, just like the originals, with the correct spacing.

- \* We offer other colors as a special order (see samples).
- \* 1968 Standard/Deluxe is distinguished by 2 buttons in the upper center of the front bucket seat back (not included).

#### Features

- Original Sierra grain vinyl with Kiwi grain vinyl inserts
- Correct 6 stitch per inch stitching
- Correct colors matched to the original vinyl
- Limited lifetime warranty

COUPE BUCKET SEATS - FRONT/REAR SET	068304
COUPE BENCH SEATS - FRONT/REAR SET	068312
FASTBACK (2+2) BUCKET SEATS - FRONT/REAR SET	068346
FASTBACK (2+2) BENCH SEATS - FRONT/REAR SET	068353
CONVERTIBLE BUCKET SEATS - FRONT/REAR SET	068320
BUCKET SEATS - FRONT	068361
BENCH SEAT - FRONT	068379
COUPE BENCH SEAT - REAR	068310
FASTBACK (2+2) BENCH SEAT - REAR	068350
CONVERTIBLE BENCH SEAT - REAR	068330

### 1968 DELUXE/SHELBY BUCKETS SEAT UPHOLSTERY WITH COMFORTWEAVE INSERTS

Our 1968 Mustang Deluxe and *Shelby* Upholstery features the original Sierra grain in 32 oz. vinyl for the skirts and Comfortweave inserts. Our welting is solid for black and vinyl wrapped for all other colors to ensure an exact color match. The vertical pleats are stitched, just like the originals, with the correct spacing.

- \* 1968 Deluxe and Shelby have two buttons in the center of the front bucket seats that is not included.
- \* We offer other colors as a special order (see samples).

#### Features

- Original Sierra grain vinyl with Comfortweave inserts
- Correct 6 stitch per inch stitching
- Correct colors matched to the original vinyl
- Limited lifetime warranty

COUPE BUCKET SEATS - FRONT/REAR SET	068306
COUPE BENCH SEAT - FRONT/REAR SET	068315
FASTBACK (2+2) BUCKET SEATS - FRONT/REAR SET	068348
FASTBACK (2+2) BENCH SEAT - FRONT/REAR SET	068355
CONVERTIBLE BUCKET SEATS - FRONT/REAR SET	068324
BUCKET SEATS - FRONT	068363
BENCH SEAT - FRONT	068380
COUPE BENCH SEAT - REAR	068311
FASTBACK (2+2) BENCH SEAT - REAR	068352
CONVERTIBLE BENCH SEAT - REAR	068335



### 1968 COLORS

BLACK	L-958
BLUE	L-2287 (I=L-3435)
IVY GOLD	L-2503 (I=L-3530)
MAROON	L-3116
NUGGET	L-3448
PARCHMENT	L-3096
SADDLE	L-3099
TURQUOISE	L-2929

NOTE: I=Insert.

### 1968 STANDARD TOURING BUCKET SEAT UPHOLSTERY & ACCESSORIES

Our 1968 Standard Touring Bucket Seats feature raised bolsters and side panels. The Touring Seat is body contoured to create modern ergonomics for the classic car.

#### Features

- Original Sierra grain vinyl with Kiwi grain inserts
- Raised bolsters and side panels
- Correct 6 stitch per inch stitching
- Correct colors matched to the original vinyl
- Limited lifetime warranty

BUCKET SEATS - FRONT	068359
1968-69 LO-BACK TOURING BUCKET SEAT FOAM	064022LBT0UR6869

\*Note: 1968 Mustang Touring Bucket Seat Foam comes with 3 pieces of foam.

### 1968 CUSTOM LEATHER SEAT UPHOLSTERY

We offer custom leather upholstery for the 1968 Mustang. Custom options include contrasting colors and stitching, as well as solid color upholstery. *Please call for color and option availability.*

## 1968 STANDARD & DELUXE/SHELBY INTERIOR PARTS & ACCESSORIES

### 1968 STANDARD, DELUXE & SHELBY DOOR PANELS

Our 1968 Mustang Standard Door Panel features the original Sierra grain in 32 oz. vinyl. The dielectric patterns and pleats are correct along with the chrome (Mylar®) trim. The correct hole placement is pre-cut into the panel and backed by die cut fiber board, just like the originals.

\* We offer other colors as a special order (see samples).

#### Features

- Original Sierra grain vinyl
- Correct dielectric "Heat Seal" stitched pattern
- Correct colors matched to the original vinyl
- .100-inch thickness poly-coated "Autoboard" backing
- Door Panel backs are perimeter stapled for maximum adhesion

STANDARD FRONT DOOR PANELS **068387**

Our 1968 Mustang Deluxe/*Shelby* Door Panels feature the original Sierra grain with Kiwi grain inserts in 32 oz. vinyl. The dielectric patterns and pleats are correct along with the chrome (Mylar®) trim and wood grain strip. Correct hole placement is pre-cut into the panel backed by die cut fiber board, just like originals.

\* We offer other colors as a special order (see samples)

#### Features

- Original Sierra grain vinyl
- Correct dielectric "Heat Seal" stitched pattern
- Correct colors matched to the original vinyl
- .100-inch thickness poly-coated "Autoboard" backing
- Door Panel backs are perimeter stapled for maximum adhesion

DELUXE FRONT DOOR PANELS **068395**

### 1968 TWO-TONE DOOR PANELS

Although not originally offered for the Mustang, Two-Tone Door Panels are a popular upgrade. The Distinctive Industries' Two-Tone Door Panels are offered in any combination of colors for a given year. Our panels feature the same construction and design as our restoration door panels.

#### Features

- Original Sierra grain vinyl
- Correct dielectric "Heat Seal" stitched pattern
- Correct colors matched to the original vinyl
- .100-inch thickness poly-coated "Autoboard" backing
- Door Panel backs are perimeter stapled for maximum adhesion

1968 TWO-TONE DOOR PANELS - STANDARD **068403**

### 1968 STANDARD/DELUXE PACKAGE TRAYS

Our Package Trays are die-cut fiber board with correct speaker placement where applicable, covered with 32oz vinyl in Sierra grain. Color match to interior upholstery.

1965-68 COUPE PACKAGE TRAY NO SPEAKER HOLE **064212**

1968 PACKAGE TRAY WITH SPEAKER HOLES **064238**



1968 Mustang Deluxe/*Shelby* Door Panels now feature the correct indent.

### 1968 COLORS

BLACK	L-958
BLUE	L-2287 (I=L-3435) (DP=L-2505)
IVY GOLD	L-2503 (I=L-3530) (DP=L-2286)
MAROON	L-3116
NUGGET	L-3448
PARCHMENT	L-3096
SADDLE	L-3099
TURQUOISE	L-3097
WHITE	L-2290

**NOTE: I=Insert and DP=Door Panel.**



## 1968 STANDARD & DELUXE/SHELBY INTERIOR PARTS & ACCESSORIES

### 1968 STANDARD INTERIOR ACCESSORIES

Our 1968 Convertible Top Boot features the correct Sierra grain in 32 oz. Vinyl is padded and fastens just like the original.  
**CONVERTIBLE TOP BOOT 069526**

Although not originally offered for the Mustang our Convertible Boot Bag features Corinthian grain in 32 oz. vinyl and is available in interior matching colors.  
**CONVERTIBLE BOOT BAG 069575**

Our Convertible Well Liner is in 32 oz. Sierra grain vinyl and is available in interior matching colors.  
**1967-68 CONVERTIBLE WELL LINER 069971**

Our Quarter Trim features 32 oz. vinyl in the correct Sierra grain and is stitched, just like the originals.  
**1967-68 CONVERTIBLE QUARTER TRIM 069799**  
**1967-68 COUPE QUARTER TRIM 069781**



Distinctive Industries High-Density Seat Foam is designed to work as a system with our upholstery. Our High-Density Seat Foam is firm, form fitting, and features a Typar® web backing for strength, which prevents spring intrusion and ensures a quality fit and long lasting life. 1968 Mustang Bucket Seat Foam comes with 3 pieces of foam.  
**BUCKET SEAT FOAM - SOLD INDIVIDUALLY 064009STD68**

Distinctive Industries Seat Heaters provide therapeutic heat and body warmth in any classic car, using the same technology as late model or current vehicles. Each kit comes with switch, harnesses, and two carbon fiber element pads to complete one seat install. Switch can be dash, console, or hidden in a place of choice. Seat Heaters are sold individually, not in pairs.  
**1965-73 CARBON FIBER SEAT HEATERS 061001**

Our 1968 Headrest Covers are in the correct Sierra grain in 32 oz. vinyl.  
**1968 BUCKET SEAT HEADREST 068365**

### 1968 SHELBY CONVERTIBLE TOP BOOT

Our 1968 *Shelby* Convertible Top Boot features the correct Sierra grain in 32 oz. vinyl is padded and fastens just like the original.  
**SHELBY CONVERTIBLE TOP BOOT 069530**



### 1968 COLORS

BLACK	L-958
BLUE	L-2287 (I=L-3435) (DP=L-2505)
IVY GOLD	L-2503 (I=L-3530) (DP=L-2286)
MAROON	L-3116
NUGGET	L-3448
PARCHMENT	L-3096
SADDLE	L-3099
TURQUOISE	L-3097
WHITE	L-2290

**NOTE: I=Insert and DP=Door Panel.**

## 1968 STANDARD INTERIOR PARTS & ACCESSORIES

### 1968 STANDARD HEADLINERS/SUNVISORS

Our 1967-68 Sunvisors are in the original Crater grain vinyl for Coupes/Fastbacks and Sierra for Convertibles dielectrically seamed with the vinyl binding stitched, just like the originals. All Sunvisors are sold in pairs.

1965-68 COUPE/FASTBACK (2+2) SUNVISORS - PREMIUM	<b>069682</b>
1967-68 COUPE/FASTBACK (2+2) SUNVISORS	<b>069765</b>
1967-68 CONVERTIBLE SUNVISORS	<b>069716</b>

Our 1965-68 Headliners are in the original Crater grain vinyl constructed just like the original.

1965-68 COUPE HEADLINER	<b>069401</b>
-------------------------	---------------

Our Universal Headliner fits 1965-70 models with extra material for a trim to fit application in the original Crater grain vinyl.

1965-70 COUPE HEADLINER - UNIVERSAL	<b>069393</b>
-------------------------------------	---------------



### 1968 HEADLINER/ SUNVISOR COLORS

AQUA	H-813	LIGHT GREEN	H-755
BLACK	H-754	MED BLUE	H-814
DARK AQUA	H-956	RED	H-863
DARK GREEN	H-1030	SADDLE	H-926
IVY GOLD	H-1029	TAN	H-837
LIGHT BLUE	H-836	WHITE	H-741

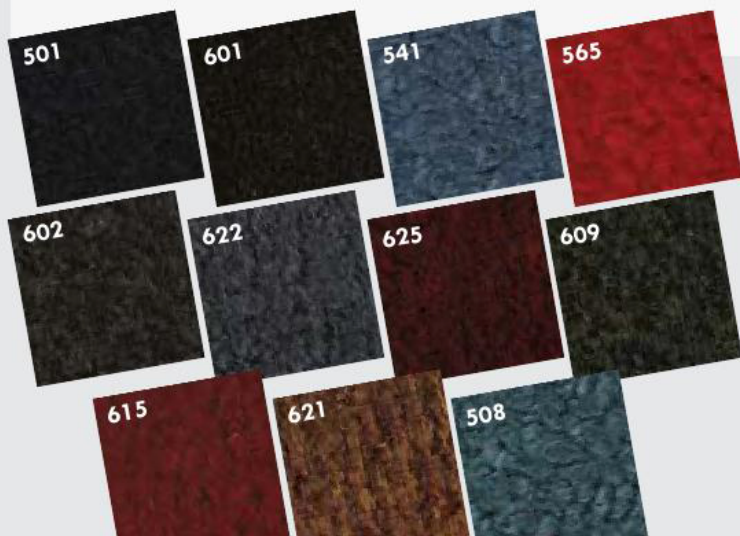

### 1968 CARPET COLORS

BLACK	501	MAROON	625
BLACK	601	OLIVE GREEN	609
BRIGHT BLUE	541	RED	615
BRIGHT RED	565	SADDLE	621
DARK BLUE	602	TURQUOISE	508
LIGHT BLUE	622		

### 1968 STANDARD CARPET KITS

Our high quality Carpet Kits feature either 80/20 loop or Nylon loop carpet.

- 500 series part numbers are 80/20
- 600 series part numbers are Nylon

1967-68 COUPE TRUNK CARPET KIT - NYLON	<b>071260</b>
1967-68 COUPE TRUNK CARPET KIT - 80/20	<b>071261</b>
1967-68 CONVERTIBLE TRUNK CARPET KIT - NYLON	<b>071262</b>
1967-68 CONVERTIBLE TRUNK CARPET KIT - 80/20	<b>071263</b>
1967-68 FASTBACK (2+2) TRUNK CARPET KIT - NYLON	<b>071264</b>
1967-68 FASTBACK (2+2) TRUNK CARPET KIT - 80/20	<b>071265</b>
1965-68 COUPE/FASTBACK KICK PANEL CARPET - 80/20	<b>071091</b>
1965-68 COUPE/FASTBACK KICK PANEL CARPET - NYLON	<b>071092</b>
1965-68 CONVERTIBLE KICK PANEL CARPET - 80/20	<b>071083</b>
1965-68 CONVERTIBLE KICK PANEL CARPET - NYLON	<b>071084</b>
1965-68 FASTBACK (2+2) FOLD DOWN CARPET 3PC KIT - 80/20	<b>071099</b>
1965-68 FASTBACK (2+2) FOLD DOWN CARPET 3PC KIT - NYLON	<b>071100</b>

## 1969 STANDARD INTERIOR PARTS & ACCESSORIES

### 1969 STANDARD SEAT UPHOLSTERY

Our 1969 Mustang Standard Upholstery features the original Corinthian grain skirts and Kiwi grain inserts in 32 oz. vinyl. Our welting is solid for black and vinyl wrapped for all other colors to ensure an exact color match. The vertical pleats are sewn, just like the originals, with the correct spacing and design. Matching headrests are included.

\* *We offer other colors as a special order (see samples).*

#### Features

- Original Corinthian grain vinyl with Kiwi grain vinyl inserts
- Correct 6 stitch per inch stitching
- Correct colors matched to the original vinyl
- Limited lifetime warranty

COUPE BUCKET SEATS - FRONT/REAR SET	<b>068502</b>
COUPE BENCH SEAT - FRONT/REAR SET	<b>068551</b>
SPORTSROOF BUCKET SEATS - FRONT/REAR SET	<b>068528</b>
CONVERTIBLE BUCKET SEATS - FRONT/REAR SET	<b>068510</b>
BUCKET SEATS - FRONT	<b>068536</b>
BENCH SEAT - FRONT	<b>068554</b>
COUPE BENCH SEAT - REAR	<b>068505</b>
SPORTSROOF BENCH SEAT - REAR	<b>068530</b>
CONVERTIBLE BENCH SEAT - REAR	<b>068520</b>

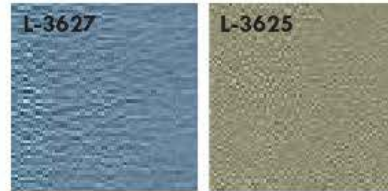

### 1969 COLORS

BLACK	L-3722
DARK RED	L-3724
DARK IVY GOLD	L-3628
LIGHT BLUE	L-3627
LIGHT NUGGET GOLD	L-3625



### 1969 STANDARD DOOR PANELS

Our 1969 Mustang Standard Door Panels feature the original Corinthian grain in 32 oz. vinyl. The dielectric patterns and pleats are correct. The correct hole placement is pre-cut into the panel and is backed by die cut fiber board, just like the originals.

\* *We offer other colors as a special order (see samples).*

#### Features

- Original Corinthian grain vinyl
- Correct dielectric "Heat Seal" stitched pattern
- Correct colors matched to the original vinyl
- .100-inch thickness poly-coated "Autoboard" backing
- Door Panel backs are perimeter stapled for maximum adhesion

FRONT DOOR PANELS	<b>068544</b>
-------------------	---------------

### 1969 SHELBY CONVERTIBLE TOP BOOT

Our 1969 *Shelby* Convertible Top Boot features the correct Corinthian grain in 32 oz. vinyl is padded and fastens just like the original.

SHELBY CONVERTIBLE TOP BOOT	<b>069567</b>
-----------------------------	---------------

### 1969 STANDARD INTERIOR ACCESSORIES

Our 1969-73 Convertible Top Boot features the correct Corinthian grain in 32 oz. vinyl and fastens just like the original.

\* *Padding is included.*

1969-70 CONVERTIBLE TOP BOOT	<b>069534</b>
------------------------------	---------------

Although not originally offered for the Mustang our Convertible Boot Bag features Corinthian grain in 32 oz. vinyl and is available in interior matching colors.

CONVERTIBLE BOOT BAG	<b>069575</b>
----------------------	---------------

Our Convertible Well Liners come in 32 oz. Corinthian grain vinyl and are available in interior matching colors.

1969-70 CONVERTIBLE WELL LINER	<b>069989</b>
--------------------------------	---------------

Our Quarter Trim features 32 oz. vinyl in the correct Corinthian grain and is stitched, just like the originals.

1969-70 COUPE QUARTER TRIM	<b>068643</b>
1969-70 CONVERTIBLE QUARTER TRIM	<b>069773</b>

Distinctive Industries High-Density Seat Foam is designed to work as a system with our upholstery. Our High-Density Seat Foam is firm, form fitting, and features a Tyvar® web backing for strength, which prevents spring intrusion and ensures a quality fit and long lasting life.

LO-BACK BUCKET SEAT  
FOAM - SOLD INDIVIDUALLY  
**064010STD69**





## 1969 STANDARD INTERIOR PARTS & ACCESSORIES

### 1969 HEADLINER, SUNVISOR & SAIL PANEL COLORS

BLACK	H-754
DARK GREEN	H-1030
DARK RED	H-863
IVY GOLD	H-1029
LIGHT BLUE	H-836
MEDIUM BLUE	H-814
TAN	H-837
WHITE	H-741

### 1969 STANDARD HEADLINERS/SUNVISORS/ SAIL PANELS

Our 1969-70 Sunvisors are in the original Crater grain vinyl dielectrically sealed with the vinyl binding stitched, just like the originals. All Sunvisors are sold in pairs.

1969-70 COUPE/SPORTSROOF SUNVISORS **069724**

The Distinctive Industries Convertible Sunvisors for the 1969-73 Mustang feature the original Corinthian grain in 32 oz. vinyl dielectrically sealed with the vinyl binding stitched, just like the originals. All Sunvisors are sold in pairs.

1969-73 CONVERTIBLE SUNVISORS **069732**



Our 1969-70 Headliners are in the original Crater grain vinyl constructed as were the original.

1969-70 COUPE HEADLINER **069427**

1969-70 SPORTSROOF HEADLINER **069435**

Our Universal Headliner fits 1965-70 models with extra material for a trim to fit application in the original Crater grain vinyl.

1965-70 COUPE HEADLINER - UNIVERSAL **069393**

Our 1969-70 Sail Panels are in the original Crater grain vinyl construction. Featuring the correct clip retainer, interior lamp ring and foam spacer block.

1969-70 SPORTSROOF SAIL PANELS **069468**

### 1969 STANDARD TRUNK CARPET KIT

Our high quality Carpet Kits feature either 80/20 loop or Nylon loop carpet.

- 500 series part numbers are 80/20
- 600 series part numbers are Nylon

COUPE TRUNK CARPET KIT - NYLON **071267**

COUPE TRUNK CARPET KIT - 80/20 **071268**

CONVERTIBLE TRUNK CARPET KIT - NYLON **071270**

CONVERTIBLE TRUNK CARPET KIT - 80/20 **071271**

SPORTSROOF (2+2) TRUNK CARPET KIT - NYLON **071272**

SPORTSROOF (2+2) TRUNK CARPET KIT - 80/20 **071273**

### 1969 CARPET COLORS

BLACK	501
BLACK	601
BRIGHT BLUE	541
BRIGHT RED	565
DARK BLUE	602
LIGHT BLUE	622
MAROON	625
OLIVE GREEN	609
RED	615
SADDLE	621
TURQUOISE	508

## 1969 DELUXE/GRANDE AND MACH 1 BUCKET & BENCH SEAT UPHOLSTERY

### 1969 DELUXE/GRANDE SEAT UPHOLSTERY

Our 1969 Mustang Deluxe/Grande Upholstery features the original Corinthian grain skirts with Ruffino grain upper and Comfortweave lower seat-back inserts along with the Comfortweave seat-bottom inserts in 32 oz. vinyl. Our welting is solid for black and vinyl wrapped for all other colors to ensure an exact color match. Matching headrests covers are included. The dielectric patterns and pleats are just like the originals with the correct spacing and design.

- \* *Grande originally came with a cloth insert in the seat-bottom that is not available at this time.*
- \* *Grande is a Coupe only model.*
- \* *Deluxe Convertible comes with Ruffino grain inserts in the seat-bottom.*
- \* *We offer other colors as a special order (see samples).*

#### Features

- Corinthian grain vinyl with Ruffino and Comfortweave inserts
- Correct 6 stitch per inch stitching
- Correct colors matched to the original vinyl
- Limited lifetime warranty

DELUXE/GRANDE COUPE BUCKET SEATS - FRONT/REAR SET	<b>068569</b>
DELUXE SPORTSROOF BUCKET SEATS - FRONT/REAR SET	<b>068585</b>
DELUXE CONVERTIBLE BUCKET SEATS - FRONT/REAR SET	<b>068577</b>
DELUXE/GRANDE BUCKET SEATS - FRONT	<b>068593</b>
DELUXE BENCH SEAT - FRONT	<b>068597</b>
DELUXE/GRANDE COUPE BENCH SEAT - REAR	<b>068573</b>
DELUXE SPORTSROOF BENCH SEAT - REAR	<b>068589</b>
DELUXE CONVERTIBLE BENCH SEAT - REAR	<b>068579</b>

### 1969 DELUXE/GRANDE INTERIOR ACCESSORIES

Distinctive Industries High-Density Seat Foam is designed to work as a system with our upholstery. Our High-Density Seat Foam is firm, form fitting, and features a Typar® web backing for strength, which prevents spring intrusion and ensures a quality fit and long lasting life.

1969 DELUXE LO-BACK BUCKET SEAT FOAM **064015DLBLB69**

### 1969 CUSTOM LEATHER SEAT UPHOLSTERY

We offer custom leather upholstery for the 1969 Mustang. Custom options include contrasting colors and stitching, as well as solid color upholstery. *Please call for color and option availability.*



#### 1969 COLORS

##### DELUXE/GRANDE

BLACK	L-3722
DARK RED	L-3724
DARK IVY GOLD	L-3628
LIGHT BLUE	L-3627
LIGHT NUGGET GOLD	L-3625
WHITE	L-4062



**Don't Forget About SEAT HEATERS!!!**  
 Now Available Easy to install  
 PerfectFit® Carbon Fiber Seat Heaters  
 with a small concealable switch  
**PART #061001**

## 1969 DELUXE/GRANDE AND MACH 1 BUCKET & BENCH SEAT UPHOLSTERY

### 1969 MACH 1 SEAT UPHOLSTERY

Our 1969 MACH 1 Upholstery features the original Corinthian grain skirts with Comfortweave inserts along with a color coded stripe in the front bucket upper seat-back in 32 oz. vinyl. The dielectric patterns and pleats are just like the originals with the correct spacing and design. Our welting is solid for black and vinyl wrapped for all other colors to ensure an exact color match.  
 \* **We offer other colors as a special order (see samples).**

#### Features

- Original Corinthian grain vinyl with Comfortweave inserts
- Correct 6 stitch per inch stitching
- Correct colors matched to the original vinyl
- Limited lifetime warranty

BUCKET SEATS - FRONT/REAR SET	<b>068619</b>
BUCKETS SEATS - FRONT	<b>068601</b>
BENCH SEATS - REAR	<b>068621</b>



### 1969 MACH 1 STYLE CONVERTIBLE REAR BENCH SEAT

Our 1969 MACH 1 style rear seat for the Mustang convertible features the same pattern and design as the MACH 1 rear seat. Although the MACH 1 was SportRoof only this is a popular option for the convertible.

CONVERTIBLE MACH 1 STYLE REAR BENCH SEAT	<b>068625</b>
--	---------------

### 1969 MACH 1 TOURING BUCKET SEAT UPHOLSTERY & ACCESSORIES

Our 1969 MACH 1 Touring Bucket Seats feature raised bolsters and side panels. The Touring Seat is body contoured to create modern ergonomics for the classic car.

#### Features

- Original Corinthian grain vinyl with Comfortweave inserts
- Raised bolsters and side panels
- Correct 6 stitch per inch stitching
- Correct colors matched to the original vinyl
- Limited lifetime warranty

BUCKET SEATS - FRONT	<b>068668</b>
1969-70 MACH 1/SHELBY TOURING BUCKET SEAT FOAM	<b>064026TOUR6970</b>
1968-69 LO-BACK TOURING BUCKET SEAT FOAM	<b>064022LBTour6869</b>

\*NOTE: 1969 Mustang Bucket Seat Foam comes with 3 pieces of foam.

### 1969 MACH 1 INTERIOR ACCESSORIES

Distinctive Industries High-Density Seat Foam is designed to work as a system with our upholstery. Our High-Density Seat Foam is firm, form fitting, and features a Typar® web backing for strength, which prevents spring intrusion and ensures a quality fit and long lasting life.

1969-70 MACH 1 HI-BACK BUCKET SEAT FOAM - SOLD INDIVIDUALLY	<b>064055HBK6970</b>
---	----------------------



### 1969 COLORS

**MACH 1**  
 BLACK - RED STRIPE  
 BLACK - BLACK STRIPE  
 WHITE - RED STRIPE  
 WHITE - WHITE STRIPE



## 1970 STANDARD INTERIOR PARTS & ACCESSORIES

### 1970 STANDARD SEAT UPHOLSTERY

Our 1970 Mustang Standard Upholstery features the original Corinthian grain skirts and Ruffino grain inserts in 32 oz. vinyl. Our welting is solid for black and vinyl wrapped for all other colors to ensure an exact color match. The dielectric patterns and pleats are just like the originals with the correct spacing and design.

\* **We offer other colors as a special order (see samples).**

#### Features

- Original Corinthian grain vinyl with Ruffino grain vinyl inserts
- Correct 6 stitch per inch stitching
- Correct colors matched to the original vinyl
- Limited lifetime warranty

COUPE BUCKET SEATS - FRONT/REAR SET	<b>068700</b>
SPORTSROOF BUCKET SEATS - FRONT/REAR SET	<b>068726</b>
CONVERTIBLE BUCKET SEATS - FRONT/REAR SET	<b>068718</b>
BUCKET SEATS - FRONT	<b>068734</b>
COUPE BENCH SEAT - REAR	<b>068710</b>
SPORTSROOF BENCH SEAT - REAR	<b>068730</b>
CONVERTIBLE BENCH SEAT - REAR	<b>068720</b>

### 1970 STANDARD DOOR PANELS

Our 1970 Mustang Standard Door Panels features the original Corinthian grain in 32 oz. vinyl. The dielectric patterns and pleats are correct. The correct hole placement is pre-cut into the panel and backed by die cut fiber board, just like the originals.

\* **We offer other colors as a special order (see samples).**

#### Features

- Original Corinthian grain vinyl
- Correct dielectric "Heat Seal" stitched pattern
- Correct colors matched to the original vinyl
- .100-inch thickness poly-coated "Autoboard" backing
- Door Panel backs are perimeter stapled for maximum adhesion

FRONT DOOR PANELS	<b>068742</b>
-------------------	---------------

### 1970 CUSTOM LEATHER SEAT UPHOLSTERY

We offer custom leather upholstery for the 1970 Mustang. Custom options include contrasting colors and stitching, as well as solid color upholstery. **Please call for color and option availability.**

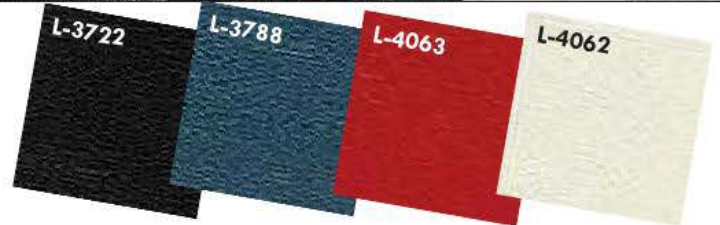

### 1970 COLORS

BLACK	L-3722
BLUE	L-3788
VERMILLION	L-4063
WHITE	L-4062

## 1970 STANDARD INTERIOR PARTS & ACCESSORIES



### 1970 STANDARD INTERIOR ACCESSORIES

Our 1969-70 Convertible Top Boot features the correct Corinthian grain in 32 oz. vinyl and fastens just like the original.

**\* Padding is included.**

1969-70 CONVERTIBLE TOP BOOT **069534**

Although not originally offered for the Mustang our Convertible Boot Bag features Corinthian grain in 32 oz. vinyl and is available in interior matching colors.

CONVERTIBLE BOOT BAG **069575**

Our Convertible Well Liners come in 32 oz. Corinthian grain vinyl and are available in interior matching colors.

1969-70 CONVERTIBLE WELL LINER **069989**

Our Quarter Trim features 32 oz. vinyl in the correct Corinthian grain and is stitched, just like the originals.

1969-70 COUPE QUARTER TRIM **068643**

1969-70 CONVERTIBLE QUARTER TRIM **069773**

Distinctive Industries High-Density Seat Foam is designed to work as a system with our upholstery. Our High-Density Seat Foam is firm, form fitting, and features a Typar® web backing for strength, which prevents spring intrusion and ensures a quality fit and long lasting life.

HI-BACK BUCKET SEAT FOAM -  
SOLD INDIVIDUALLY **064011STD70**

Distinctive Industries Seat Heaters provide therapeutic heat and body warmth in any classic car, using the same technology as late model or current vehicles. Each kit comes with switch, harnesses, and two carbon fiber element pads to complete one seat install. Switch can be dash, console, or hidden in a place of choice. Seat Heaters are sold individually, not in pairs.

1965-73 CARBON FIBER SEAT HEATERS **061001**



### 1970 COLORS

BLACK	L-3722
BLUE	L-3788
VERMILLION	L-4063
WHITE	L-4062

## 1970 STANDARD INTERIOR PARTS & ACCESSORIES



### 1970 HEADLINER/SUNVISOR/ SAIL PANEL COLORS

BLACK	H-754
DARK GREEN	H-1030
DARK RED	H-863
IVY GOLD	H-1029
LIGHT BLUE	H-836
MEDIUM BLUE	H-814
TAN	H-837
WHITE	H-741



### 1970 CARPET COLORS

BLACK	501
BLACK	601
BRIGHT BLUE	541
BRIGHT RED	565
DARK BLUE	602
LIGHT BLUE	622
MAROON	625
OLIVE GREEN	609
RED	615
SADDLE	621
TURQUOISE	508



### 1970 STANDARD HEADLINERS/SUNVISORS/ SAIL PANELS

Our 1969-70 Sunvisors are in the original Crater grain vinyl dielectrically seamed with the vinyl binding stitched, just like the originals. All Sunvisors are sold in pairs.

1969-70 COUPE/SPORTSROOF SUNVISORS **069724**

The Distinctive Industries Convertible Sunvisors for the 1969-73 Mustang feature the original Corinthian grain in 32 oz. vinyl dielectrically seamed with the vinyl binding stitched, just like the originals. All Sunvisors are sold in pairs.

1969-73 CONVERTIBLE SUNVISORS **069732**

Our 1969-70 Headliners are in the original Crater grain vinyl constructed as were the original.

1969-70 COUPE HEADLINER **069427**

1969-70 SPORTSROOF HEADLINER **069435**

Our Universal Headliner fits 1965-70 models with extra material for a trim to fit application in the original Crater grain vinyl.

1965-70 COUPE HEADLINER - UNIVERSAL **069393**

Our 1969-70 Sail Panels are in the original Crater grain vinyl construction. Featuring the correct clip retainer, interior lamp ring and foam spacer block.

1969-70 SPORTSROOF SAIL PANELS **069468**

### 1970 STANDARD TRUNK CARPET KIT

Our high quality Carpet Kits feature either 80/20 loop or Nylon loop carpet.

- 500 series part numbers are 80/20

- 600 series part numbers are Nylon

COUPE TRUNK CARPET KIT - NYLON **071274**

COUPE TRUNK CARPET KIT - 80/20 **071275**

SPORTSROOF TRUNK CARPET KIT - NYLON **071332**

SPORTSROOF TRUNK CARPET KIT - 80/20 **071333**

## 1970 DELUXE/GRANDE AND MACH 1 INTERIOR PARTS & ACCESSORIES

### 1970 DELUXE/GRANDE SEAT UPHOLSTERY

Our 1970 Mustang Deluxe/Grande Upholstery features the original Corinthian grain skirts with Ruffino grain upper and Comfortweave lower seat-back inserts along with the Comfortweave seat-bottom inserts in 32 oz. vinyl. Our welting is solid for black and vinyl wrapped for all other colors to ensure an exact color match. The dielectric patterns and pleats are just like the originals with the correct spacing and design. Seat back buttons/emblems are not included.

\* **Grande originally came with a cloth insert in the seat-bottom that is not available at this time.**

\* **Grande is a Coupe only model.**

\* **Deluxe Convertible comes with Ruffino grain inserts in the seat-bottom.**

\* **We offer other colors as a special order (see samples).**

#### Features

- Corinthian grain vinyl with Ruffino and Comfortweave inserts
- Correct 6 stitch per inch stitching
- Correct colors matched to the original vinyl
- Limited lifetime warranty

DELUXE/GRANDE COUPE BUCKET SEATS - FRONT/REAR SET	<b>068759</b>
DELUXE SPORTSROOF BUCKET SEATS - FRONT/REAR SET	<b>068775</b>
DELUXE CONVERTIBLE BUCKET SEATS - FRONT/REAR SET	<b>068767</b>
DELUXE/GRANDE BUCKET SEATS - FRONT	<b>068783</b>
DELUXE/GRANDE COUPE BENCH SEAT - REAR	<b>068793</b>
DELUXE/GRANDE SPORTSROOF BENCH SEAT - REAR	<b>068776</b>

### 1970 MACH 1 SEAT UPHOLSTERY

Our 1970 MACH 1 Upholstery features the original Corinthian grain skirts with Comfortweave inserts along with a color coded stripe in the front bucket upper seat-back in 32 oz. vinyl. The dielectric patterns and pleats are just like the originals with the correct spacing and design. Our welting is solid for black and vinyl wrapped for all other colors to ensure an exact color match.

\* **We offer other colors as a special order (see samples).**

#### Features

- Corinthian grain vinyl with Comfortweave grain vinyl inserts
- Correct 6 stitch per inch stitching
- Correct colors matched to the original vinyl
- Limited lifetime warranty

BUCKET SEATS - FRONT/REAR SET	<b>068817</b>
BUCKET SEATS - FRONT	<b>068809</b>
BENCH SEAT - REAR	<b>068811</b>

### 1970 DELUXE/GRANDE AND MACH 1/SHELBY INTERIOR ACCESSORIES

Distinctive Industries High-Density Seat Foam is designed to work as a system with our upholstery. Our High-Density Seat Foam is firm, form fitting, and features a Typar® web backing for strength, which prevents spring intrusion and ensures a quality fit and long lasting life.

1969-70 MACH 1 HI-BACK BUCKET SEAT FOAM -  
SOLD INDIVIDUALLY **064055HBK6970**

1969-70 MACH 1/SHELBY TOURING  
BUCKET SEAT FOAM **064026TOUR6970**

### 1970 MACH 1 STYLE CONVERTIBLE REAR BENCH SEAT

Our 1970 MACH 1 style rear seat for the Mustang convertible features the same pattern and design as the MACH 1 rear seat. Although the MACH 1 was SportRoof only this is a popular option for the convertible.

CONVERTIBLE MACH 1 STYLE REAR BENCH SEAT **068625**

#### 1970 COLORS

##### DELUXE / GRANDE

BLACK	L-3722
BLUE	L-3788
GINGER	L-4061
IVY	L-4060
VERMILLION	L-4063
WHITE	L-4062

##### MACH 1

BLACK - GRAY STRIPE
BLACK - BLACK STRIPE
BLACK - RED STRIPE
WHITE - WHITE STRIPE
WHITE - GRAY STRIPE



## 1971-73 STANDARD INTERIOR PARTS & ACCESSORIES

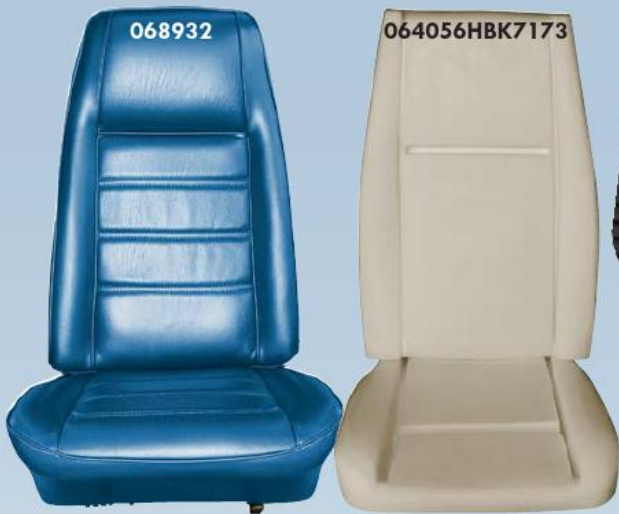

### 1971-73 STANDARD SEAT UPHOLSTERY

Our 1971-73 Mustang Standard Upholstery features the original Corinthian grain skirts with Ruffino grain inserts in 32 oz. vinyl. Our welting is solid for black and vinyl wrapped for all other colors to ensure an exact color match. The dielectric patterns and pleats are just like the originals with the correct spacing and design. \* **We offer other colors as a special order (see samples).**

#### Features

- Corinthian grain vinyl with Ruffino grain inserts
- Correct 6 stitch per inch stitching
- Correct colors matched to the original vinyl
- Limited lifetime warranty

COUPE BUCKET SEATS - FRONT/REAR SET	<b>068908</b>
SPORTSROOF BUCKET SEATS - FRONT/REAR SET	<b>068924</b>
CONVERTIBLE BUCKET SEATS - FRONT/REAR SET	<b>068916</b>
BUCKET SEATS - FRONT	<b>068932</b>
COUPE BENCH SEAT - REAR WITHOUT SEAT BELT ASSEMBLY	<b>068910</b>
SPORTSROOF BENCH SEAT - REAR	<b>068930</b>
CONVERTIBLE BENCH SEAT - REAR	<b>068920</b>
1972-73 REAR BENCH SEAT - WITH SIDE ARMRESTS	<b>068935</b>

### 1971-73 STANDARD DOOR PANELS

Our 1971-73 Mustang Standard Door Panels feature the original Corinthian grain in 32 oz. vinyl. The dielectric patterns and pleats are correct. The correct hole placement is pre-cut into the panel and backed by die cut fiber board, just like the originals. \* **We offer other colors as a special order (see samples).**

#### Features

- Original Corinthian grain vinyl
- Correct dielectric "Heat Seal" stitched pattern
- Correct colors matched to the original vinyl
- .100-inch thickness poly-coated "Autoboard" backing
- Door Panel backs are perimeter stapled for maximum adhesion

FRONT DOOR PANELS	<b>068940</b>
-------------------	---------------



### 1971-73 COLORS

BLACK	L-3722
BLUE	L-3788
GINGER	L-4061
GREEN	L-4234
VERMILLION	L-4063
WHITE	L-4062

**NOTE: Ginger not available for pattern #068916.**

### 1971-73 CUSTOM LEATHER SEAT UPHOLSTERY

We offer custom leather upholstery for the 1971-73 Mustang. Custom options include contrasting colors and stitching, as well as solid color upholstery. **Please call for color and option availability.**

### 1971-73 STANDARD INTERIOR ACCESSORIES

Our 1971-73 Convertible Top Boot features the correct Corinthian grain in 32 oz. vinyl and fastens just like the original.

\* **Padding is included.**

CONVERTIBLE TOP BOOT	<b>069542</b>
----------------------	---------------

Although not originally offered for the Mustang our Convertible Boot Bag features Corinthian grain in 32 oz. vinyl and is available in interior matching colors.

CONVERTIBLE BOOT BAG	<b>069575</b>
----------------------	---------------

Our Convertible Well Liners come in 32 oz. Corinthian grain vinyl and are available in interior matching colors.

CONVERTIBLE WELL LINER	<b>069997</b>
------------------------	---------------

Distinctive Industries High-Density Seat Foam is designed to work as a system with our upholstery. Our High-Density Seat Foam is firm, form fitting, and features a Typar® web backing for strength, which prevents spring intrusion and ensures a quality fit and long lasting life.

HI-BACK BUCKET SEAT FOAM - SOLD INDIVIDUALLY	<b>064056HBK7173</b>
--	----------------------

Distinctive Industries Seat Heaters provide therapeutic heat and body warmth in any classic car, using the same technology as late model or current vehicles. Each kit comes with switch, harnesses, and two carbon fiber element pads to complete one seat install. Switch can be dash, console, or hidden in a place of choice. Seat Heaters are sold individually, not in pairs.

1965-73 CARBON FIBER SEAT HEATERS	<b>061001</b>
-----------------------------------	---------------



## 1971-73 STANDARD INTERIOR PARTS & ACCESSORIES



### 1971-73 HEADLINER/ SUNVISOR/ SAIL PANEL COLORS

BLACK	H-770
DARK GREEN	H-1325
GINGER	H-1217
MAROON	H-1210
RED	H-1328
WEDGEWOOD BLUE	H-1565
WHITE	H-1513



069476



### 1971-73 STANDARD HEADLINERS/SUNVISORS/ SAIL PANELS

Our 1971-73 Sunvisors are in the original Tier grain vinyl dielectrically sealed with the vinyl binding stitched, just like the originals. All Sunvisors are sold in pairs.

COUPE/SPORTSROOF SUNVISORS **069740**

The Distinctive Industries Convertible Sunvisors for the 1969-73 Mustang feature the original Corinthian grain in 32 oz. vinyl dielectrically sealed with the vinyl binding stitched, just like the originals. All Sunvisors are sold in pairs.

1969-73 CONVERTIBLE SUNVISORS **069732**

Our 1971-73 Headliners are in the original Tier grain vinyl constructed just like the original.

COUPE HEADLINER **069443**

SPORTSROOF HEADLINER **069450**

Our 1971-73 Sail Panels are in the original Tier grain vinyl construction. Featuring the correct clip retainer.

SPORTSROOF SAIL PANELS **069476**

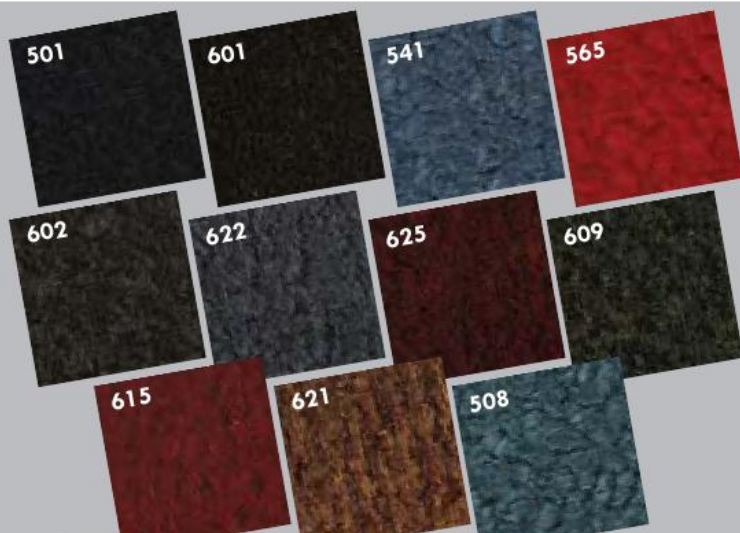

### 1971-73 CARPET COLORS

BLACK	501	MAROON	625
BLACK	601	OLIVE GREEN	609
BRIGHT BLUE	541	RED	615
BRIGHT RED	565	SADDLE	621
DARK BLUE	602	TURQUOISE	508
LIGHT BLUE	622		



071424

### 1971-73 STANDARD TRUNK CARPET KIT

Our high quality Carpet Kits feature either 80/20 loop or Nylon loop carpet.

• 500 series part numbers are 80/20

• 600 series part numbers are Nylon

COUPE TRUNK CARPET KIT - NYLON **071365**

COUPE TRUNK CARPET KIT - 80/20 **071366**

SPORTSROOF TRUNK CARPET KIT - NYLON **071424**

SPORTSROOF TRUNK CARPET KIT - 80/20 **071423**

## 1971-73 DELUXE/GRANDE AND MACH 1 INTERIOR PARTS & ACCESSORIES

### DELUXE/GRANDE SEAT UPHOLSTERY

Our 1971-73 Mustang Deluxe/Grande Upholstery features the original Corinthian grain skirts with Comfortweave inserts in 32 oz. vinyl. Our welting is solid for black and vinyl wrapped for all other colors to ensure an exact color match. The dielectric patterns and pleats are just like the originals with the correct spacing and design.

\* *Grande originally came with a cloth insert in the seat-Bottom that is not available at this time.*

\* *Grande is a Coupe only model.*

\* *We offer other colors as a special order (see samples).*



068981

#### Features

- Corinthian grain vinyl with Comfortweave grain inserts
- Correct 6 stitch per inch stitching
- Correct colors matched to the original vinyl
- Limited lifetime warranty

DELUXE/GRANDE COUPE BUCKET SEATS - FRONT/REAR SET	068957
DELUXE SPORTSROOF BUCKET SEATS - FRONT/REAR SET	068973
DELUXE CONVERTIBLE BUCKET SEATS - FRONT/REAR SET	068965
DELUXE/GRANDE BUCKET SEATS - FRONT	068981
DELUXE SPORTSROOF BENCH SEAT - REAR	068985
DELUXE CONVERTIBLE BENCH SEAT - REAR	069050

### MACH 1 SEAT UPHOLSTERY

Our 1971-73 MACH 1 Upholstery features the original Corinthian grain skirts with Comfortweave inserts along with the Levant grain color coded stripes in 32 oz. vinyl. The dielectric patterns and pleats are just like the originals with the correct spacing and design. Our welting is solid for black and vinyl wrapped for all other colors to ensure an exact color match.

\* *The MACH 1 upholstery was available on all SportsRoof models as an option.*

\* *We offer other colors as a special order (see samples).*

#### Features

- Corinthian grain vinyl with Comfortweave grain inserts
- Correct 6 stitch per inch stitching
- Correct colors matched to the original vinyl
- Limited lifetime warranty

BUCKET SEATS - FRONT/REAR SET	069054
BUCKET SEATS - FRONT	069062

### 1971-73 COLORS

#### DELUXE/GRANDE

BLACK	L-3722
BLUE	L-3788
GINGER	L-4061
GREEN	L-4234
VERMILLION	L-4063
WHITE	L-4062

#### MACH 1

BLACK - SILVER
BLACK - BLACK
DARK BLUE - BLUE
DARK RED - RED
GINGER - GINGER
GREEN - GREEN
VERMILLION - BLACK
WHITE - SILVER



### 1971-73 MACH 1 STYLE CONVERTIBLE REAR BENCH SEAT

Our 1971-73 MACH 1 style rear seat for the Mustang convertible features the same pattern and design as the MACH 1 rear seat. Although the MACH 1 was SportsRoof only this is a popular option for the convertible.

CONVERTIBLE MACH 1 STYLE REAR BENCH SEAT	069070
--	--------

### 1971-1973 DELUXE/MACH 1 INTERIOR ACCESSORIES

Distinctive Industries High-Density Seat Foam is designed to work as a system with our upholstery. Our High-Density Seat Foam is firm, form fitting, and features a Typar® web backing for strength, which prevents spring intrusion and ensures a quality fit and long lasting life.

HI-BACK BUCKET SEAT FOAM - SOLD INDIVIDUALLY	064056HBK7173
--	---------------

### 1971-73 MACH 1 TOURING BUCKET SEAT UPHOLSTERY & ACCESSORIES

Our 1971-73 MACH 1 Touring Bucket Seats feature raised bolsters and side panels. The Touring Seat is body contoured to create modern ergonomics for the classic car.

#### Features

- Original Corinthian grain vinyl with Comfortweave inserts
- Raised bolsters and side panels
- Correct 6 stitch per inch stitching
- Correct colors matched to the original vinyl
- Limited lifetime warranty

BUCKET SEATS - FRONT	069096
1971-73 DELUXE/MACH 1 TOURING BUCKET SEAT FOAM	064028TOUR7173

**NOW OFFERS!**

## SEAT HEATERS

for Fox Body Mustangs!

Seat Heaters Provide therapeutic heat and body warmth in any classic or special interest vehicle, using the same technology as late model or current vehicles.



### Carbon Fiber High/Low

#### This Product Offers:

- Large heating area - two 11X22 pads
- High and low heat settings
- Trimable - for trim lines and length...therefore one size fits all
- Even heat distribution over entire surface
- Eight-foot long switch harness
- Installs Under Existing Upholstery

Each kit comes complete with switch, harnesses and two carbon fiber element pads to complete one seat install. Switch can be dash, console, or hidden in a place of choice.



Thank you for choosing Distinctive Industries as your provider of Restoration Interior Products. The catalog you are reading was designed with the input of our existing customers and moving forward, will continue to be a representation of their needs, and the needs of restoration experts worldwide.

**Design**

We have designed our catalog for the Restoration Professional, from the Local Upholstery and Restoration Shop, to the National Distributor of Restoration Products. The thought was to create a catalog that eases the pain of product entry for those building catalogs, and to ease ordering for those that order directly from the catalog. We accomplished this by listing product by year, model, and trim level. You will find this catalog to be easy to use.

**Descriptions**

Descriptions are a blend of Marketing and Technical descriptions. After polling our customers we found that aside from the design, missing was a good description of the products in today's catalogs. We remedied that by providing a blended description as a basis for our customers to expand upon, or use as is.

**Colors**

Color swatches are placed near the product with labeled color codes to avoid confusion. Color Code boxes are located near the applicable products. We offer many special order color combinations as well as an option for leather in most cases.

**Images**

Images are available for License through Distinctive Industries.

- Licensed images must be accompanied and located adjacent to the matching Distinctive Industries product.

**Table of Contents**

- 1961-62 interior parts and accessories
- 1963 interior parts and accessories
- 1964 interior parts and accessories
- 1965 interior parts and accessories
- 1966 interior parts and accessories
- 1967 interior parts and accessories
- 1968 interior parts and accessories
- 1969 interior parts and accessories
- 1970-71 interior parts and accessories
- 1972-76 interior parts and accessories
- 1977-79 interior parts and accessories

© Copyright 2016, Distinctive Industries, all rights reserved. No part of this publication may be duplicated or reproduced without written permission from Distinctive Industries.

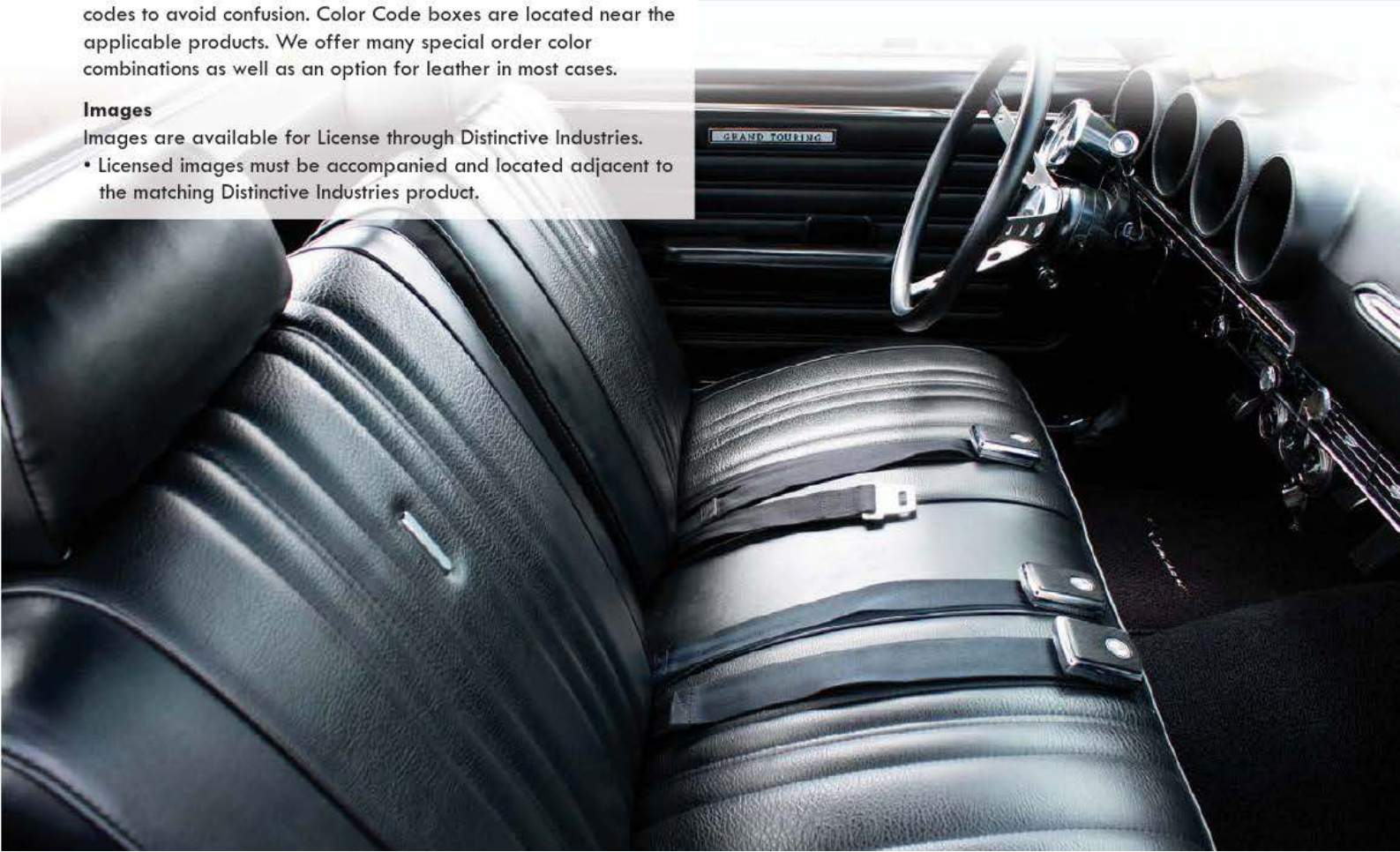



## 1961-62 INTERIOR PARTS & ACCESSORIES

### 1961-1962 DELUXE SEAT UPHOLSTERY

Our 1961-62 Ranchero Deluxe Seat Upholstery is a correct reproduction of the original. We offer the original Crush grain in 32 oz. vinyl, with the correct vertical patterns sewn as original. Seat buttons not included.

#### Features

- Original Crush grain vinyl
- Correct 6 stitch per inch stitching
- Correct colors matched to the original vinyl
- Limited lifetime warranty

BUCKET SEATS

100024

BENCH SEAT

104430

### 1961-62 DELUXE DOOR PANELS

Our 1961-62 Deluxe Door Panels are a correct reproduction of the original. We offer original Crush grain in 32 oz. vinyl, correct Mylar®, and correct dielectrically heat sealed vertical patterns as original.

#### Features

- Original Crush grain vinyl
- Correct dielectric "Heat Seal" stitched pattern
- Correct colors matched to the original vinyl
- .100-inch thickness poly-coated "Autoboard" backing
- Door Panel backs are perimeter stapled for maximum adhesion
- Limited lifetime warranty

FRONT DOOR PANELS

103036

### 1961-62 HEADLINERS

Our 1961-62 Headliners are in the original Crater grain vinyl, constructed just like the original.

1960-65 HEADLINER

105015

### 1961-62 INTERIOR ACCESSORIES

Distinctive Industries Seat Heaters provide therapeutic heat and body warmth in any classic car, using the same technology as late model or current vehicles. Each kit comes with switch, harnesses, and two carbon fiber element pads to complete one seat install. Switch can be dash, console, or hidden in a place of choice. Seat Heaters are sold individually, not in pairs.

1961-79 CARBON FIBER SEAT HEATERS

061001

#### 1961-62 COLORS

BLACK	L-110
BLUE	L-1761
RED	L-1377

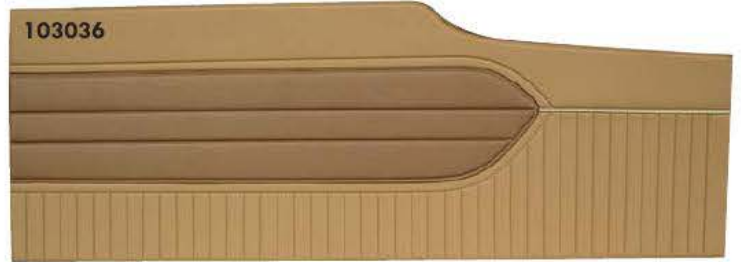
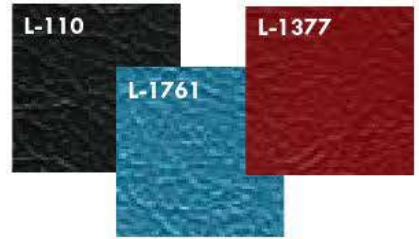

#### 1957-62 HEADLINER COLORS

AQUA	H-813	MEDIUM BLUE	H-814
BLACK	H-754	PALOMINO	H-837
DARK AQUA	H-956	RED	H-863
IVY GOLD	H-1029	TURQUOISE	H-956
LIGHT BLUE	H-836	WHITE	H-741

## 1963 INTERIOR PARTS & ACCESSORIES

### 1963 DELUXE SEAT UPHOLSTERY

Our 1963 Deluxe Ranchero Seat Upholstery is a correct reproduction of the original. We offer the original Crush grain in 32 oz. vinyl, with the correct patterns sewn as original. Seat back medallions are not included.

#### Features

- Original Crush grain vinyl
- Correct 6 stitch per inch stitching
- Correct colors matched to the original vinyl
- Limited lifetime warranty

BUCKET SEATS **100183**  
BENCH SEAT **100065**

#### Two-Tone Upholstery

BUCKET SEATS **104505**  
BENCH SEAT **101311**

### 1963 DELUXE DOOR PANELS

Our 1963 Deluxe Door Panels are a correct reproduction of the original. We offer original Crush grain in 32 oz. vinyl, correct embossed sheet Mylar®, and correct dielectrically heat sealed patterns as original.

#### Features

- Original Crush grain vinyl
- Correct dielectric "Heat Seal" stitched pattern
- Correct colors matched to the original vinyl
- .100-inch thickness poly-coated "Autoboard" backing
- Door Panel backs are perimeter stapled for maximum adhesion
- Limited lifetime warranty

FRONT DOOR PANELS **103093**

### 1963 HEADLINERS

Our 1963 Headliners are in the original Crater grain vinyl, constructed just like the original.

1960-65 HEADLINER **105015**

### 1963 INTERIOR ACCESSORIES

Distinctive Industries Seat Heaters provide therapeutic heat and body warmth in any classic car, using the same technology as late model or current vehicles. Each kit comes with switch, harnesses, and two carbon fiber element pads to complete one seat install. Switch can be dash, console, or hidden in a place of choice. Seat Heaters are sold individually, not in pairs.

1961-79 CARBON FIBER SEAT HEATERS **061001**

#### 1963 COLORS

BLACK	L-110
BLUE	L-1761
IVY GOLD	L-2503
PALOMINO	L-2288
RED	L-1377
TURQUOISE	L-1934

#### 1963 TWO-TONE COLORS

BLUE	L-1761 (I=L-1763)
TURQUOISE	L-1934 (I=L-1991)

**NOTE: I=Insert.**

**NOTE: A popular non-original color option is Ivy Gold. Ivy Gold is Sierra grain as it was not available in 1963.**

**NOTE: Palomino is Sierra grain vinyl just like the originals.**



#### 1963 HEADLINER COLORS

AQUA	H-813	MEDIUM BLUE	H-814
BLACK	H-754	PALOMINO	H-837
DARK AQUA	H-956	RED	H-863
IVY GOLD	H-1029	TURQUOISE	H-956
LIGHT BLUE	H-836	WHITE	H-741

## 1964 INTERIOR PARTS & ACCESSORIES

### 1964 DELUXE SEAT UPHOLSTERY

Our 1964 Deluxe Ranchero Seat Upholstery is a correct reproduction of the original. We offer the original Crush grain in 32 oz. vinyl, with the correct vertical patterns sewn as original. Seat back medallions are not included.

#### Features

- Original Crush grain vinyl
- Correct 6 stitch per inch stitching
- Correct colors matched to the original vinyl
- Limited lifetime warranty

BUCKET SEATS	100123
BENCH SEAT	100149

#### Two-Tone Upholstery

BUCKET SEATS	101360
BENCH SEAT	101386

### 1964 DELUXE DOOR PANELS

Our 1964 Deluxe Door Panels are a correct reproduction of the original. We offer original Crush grain in 32 oz. vinyl, correct embossed sheet Mylar®, and correct dielectrically heat sealed horizontal patterns as original.

#### Features

- Original Crush grain vinyl
- Correct dielectric "Heat Seal" stitched pattern
- Correct colors matched to the original vinyl
- .100-inch thickness poly-coated "Autoboard" backing
- Door Panel backs are perimeter stapled for maximum adhesion
- Limited lifetime warranty

FRONT DOOR PANELS	103150
-------------------	--------

### 1964 HEADLINERS

Our 1964 Headliners are in the original Crater grain vinyl, constructed just like the original.

1960-65 HEADLINER	105015
-------------------	--------

### 1964 INTERIOR ACCESSORIES

Distinctive Industries Seat Heaters provide therapeutic heat and body warmth in any classic car, using the same technology as late model or current vehicles. Each kit comes with switch, harnesses, and two carbon fiber element pads to complete one seat install. Switch can be dash, console, or hidden in a place of choice. Seat Heaters are sold individually, not in pairs.

1961-79 CARBON FIBER SEAT HEATERS	061001
-----------------------------------	--------



#### 1964 COLORS

BLACK	L-110
BLUE	L-1761 (I=L-1763) TWO-TONE ONLY
IVY GOLD	L-2503
PALOMINO	L-2288
RED	L-1377
TURQUOISE	L-1934 (I=L-1991) TWO-TONE ONLY

**NOTE: I=Insert.**

**NOTE: A popular non-original color option is Ivy Gold. Ivy Gold is Sierra grain as it was not available in 1964.**

**NOTE: Palomino is Sierra grain vinyl just like the originals.**



#### 1964 HEADLINER COLORS

AQUA	H-813	MEDIUM BLUE	H-814
BLACK	H-754	PALOMINO	H-837
DARK AQUA	H-956	RED	H-863
IVY GOLD	H-1029	TURQUOISE	H-956
LIGHT BLUE	H-836	WHITE	H-741

## 1965 INTERIOR PARTS & ACCESSORIES

### 1965 DELUXE SEAT UPHOLSTERY

Our 1965 Deluxe Ranchero Seat Upholstery is a correct reproduction of the original. We offer the original Sierra grain in 32 oz. vinyl, with the correct vertical patterns sewn as original. Seat back medallions are not included.

#### Features

- Original Sierra grain vinyl
- Correct 6 stitch per inch stitching
- Correct colors matched to the original vinyl
- Limited lifetime warranty

BUCKET SEATS	100198
BUCKET SEATS - WITH FALCON LOGO	101439
BENCH SEAT	100206
BENCH SEAT - WITH FALCON LOGO	101439

#### Two-Tone Upholstery

BUCKET SEATS	101428
BENCH SEAT	101436

### 1965 DELUXE DOOR PANELS

Our 1965 Deluxe Door Panels are a correct reproduction of the original. We offer original Sierra grain in 32 oz. vinyl, correct Mylar®, and dielectrically heat sealed patterns as original. Door Panels feature 2 horizontal lines on the panels with vertical lines on the inserts.

#### Features

- Original Sierra grain vinyl
- Correct dielectric "Heat Seal" stitched pattern
- Correct colors matched to the original vinyl
- .100-inch thickness poly-coated "Autoboard" backing
- Door Panel backs are perimeter stapled for maximum adhesion
- Limited lifetime warranty

FRONT DOOR PANELS	103218
-------------------	--------

#### Two-Tone Door Panels

DELUXE FRONT DOOR PANELS	104067
--------------------------	--------

\* *Deluxe Two-Tone Door Panels have standard Mylar® and the insert in the middle of the of the Mylar® is darker than the trim.*

### 1965 HEADLINERS

Our 1965 Headliners are in the original Crater grain vinyl, constructed just like the original.

1960-65 HEADLINER	105015
-------------------	--------

### 1965 INTERIOR ACCESSORIES

Distinctive Industries Seat Heaters provide therapeutic heat and body warmth in any classic car, using the same technology as late model or current vehicles. Each kit comes with switch, harnesses, and two carbon fiber element pads to complete one seat install. Switch can be dash, console, or hidden in a place of choice. Seat Heaters are sold individually, not in pairs.

1961-79 CARBON FIBER SEAT HEATERS	061001
-----------------------------------	--------

1965 COLORS			
BLACK	L-958	PALOMINO	L-2288
BLUE	L-2287	RED	L-957
IVY GOLD	L-2503	TURQUOISE	L-2929

1965 TWO-TONE COLORS	
BLUE	L-2287 (I=L-2505)
TURQUOISE	L-2929 (I=L-3097)

**NOTE: I=Insert.**



H-813	H-754	H-956	H-1029
H-836	H-814	H-837	H-863
	H-956	H-741	

#### 1965 HEADLINER COLORS

AQUA	H-813	MEDIUM BLUE	H-814
BLACK	H-754	PALOMINO	H-837
DARK AQUA	H-956	RED	H-863
IVY GOLD	H-1029	TURQUOISE	H-956
LIGHT BLUE	H-836	WHITE	H-741



## 1966 INTERIOR PARTS & ACCESSORIES

### 1966 SEAT UPHOLSTERY

Our 1966 Ranchero Seat Upholstery is a correct reproduction of the original. We offer the original Sierra grain in 32 oz. vinyl, with the correct vertical patterns sewn as original.

#### Features

- Original Sierra grain vinyl with Rosette grain inserts
- Correct 6 stitch per inch stitching
- Correct colors matched to the original vinyl
- Limited lifetime warranty

1966 STANDARD BUCKET SEATS **100255**  
 1966 STANDARD BENCH SEAT **100263**

### 1966 DOOR PANELS

Our 1966 Door Panels are a correct reproduction of the original. Featuring original chrome Mylar® trim, original Sierra grain in 32 oz. vinyl, and correct dielectrically heat sealed vertical patterns as original.

#### Features

- Original Sierra grain vinyl
- Correct dielectric "Heat Seal" stitched pattern
- Correct colors matched to the original vinyl
- .100-inch thickness poly-coated "Autoboard" backing
- Door Panel backs are perimeter stapled for maximum adhesion
- Limited lifetime warranty

1966 CUSTOM FRONT DOOR PANELS **103275**

#### Two-Tone Door Panels

1966 CUSTOM FRONT DOOR PANELS **103291**

### 1966 HEADLINERS/SUNVISORS

Our 1966 Headliners are in the original Crater grain vinyl, constructed just like the original.

1966-67 HEADLINER **105114**

Our 1966 Sunvisors are in the original Crater grain vinyl, with the vinyl binding stitched, just like the originals. All Sunvisors are sold in pairs.

1966 SUNVISORS **105502**

### 1966 INTERIOR ACCESSORIES

Distinctive Industries Seat Heaters provide therapeutic heat and body warmth in any classic car, using the same technology as late model or current vehicles. Each kit comes with switch, harnesses, and two carbon fiber element pads to complete one seat install. Switch can be dash, console, or hidden in a place of choice. Seat Heaters are sold individually, not in pairs.

1961-79 CARBON FIBER SEAT HEATERS **061001**



#### 1966 COLORS

AQUA	L-2929 (I=L-3097)
BLACK	L-958 (I=L-958)
BLUE	L-2095 (I=L-2505)
PARCHMENT	L-2613 (I=L-2586)
RED	L-2920 (I=L-3116)

\*NOTE: I=Insert.



#### 1966 HEADLINER/SUNVISOR COLORS

AQUA	H-813	LIGHT GREEN	H-755
BLACK	H-754	MEDIUM BLUE	H-814
DARK AQUA	H-956	RED	H-863
IVY GOLD	H-1029	WHITE	H-741
LIGHT BLUE	H-836		

## 1967 INTERIOR PARTS & ACCESSORIES



### 1967 COLORS

AQUA	L-2929 (I=L-2951)
BLACK	L-958 (I=L-2949)
BLUE	L-2287 (I=L-2946)
EMBERGLO	L-2921 (I=L-2948)
IVY GOLD	L-2503 (I=L-2947)
PARCHMENT	L-3096 (I=L-2288)
RED	L-2920 (I=L-2954)
SADDLE	L-3099 (I=L-3099)

NOTE: I=Insert.

### 1967 SEAT UPHOLSTERY

Our 1967 Ranchero Seat Upholstery is a correct reproduction of the original. We offer the original Sierra grain with Rosette grain inserts (Standard bench seat comes with Sierra inserts) in 32 oz. vinyl, with the correct horizontal patterns sewn as original. Seat back medallions are not included.

#### Features

- Original Sierra grain vinyl with Rosette grain inserts
- Correct 6 stitch per inch stitching
- Correct colors matched to the original vinyl
- Limited lifetime warranty

1967 500XL/GT BUCKET SEATS	<b>100651</b>
1967 STANDARD BENCH SEAT	<b>100669</b>

### 1967 DOOR PANELS

Our 1967 Door Panels are a correct reproduction of the original with the chrome rectangular trim. We offer original Sierra grain in 32 oz. vinyl, and correct dielectrically heat sealed patterns as original. 500 Door Panels feature a horizontal pattern with a Woodgrain inserts, and 500XL/GT Door Panels feature a vertical pattern with Rosette grain vinyl inserts.

#### Features

- Original Sierra grain vinyl
- Correct dielectric "Heat Seal" stitched pattern
- Correct colors matched to the original vinyl
- .100-inch thickness poly-coated "Autoboard" backing
- Door Panel backs are perimeter stapled for maximum adhesion
- Limited lifetime warranty

1967 500 FRONT DOOR PANELS	<b>100746</b>
1967 500XL/GT FRONT DOOR PANELS	<b>103531</b>

**Don't Forget About SEAT HEATERS!!!**

Now Available Easy to install  
**PerfectFit® Carbon Fiber Seat Heaters**  
 with a small concealable switch  
**PART #061001**



## 1967 INTERIOR PARTS & ACCESSORIES

### 1967 HEADLINERS/SUNVISORS

Our 1967 Headliners are in the original Crater grain vinyl, constructed just like the original.

1966-67 HEADLINER

105114



Our 1967 Sunvisors are in the original Crater grain vinyl, with the vinyl binding stitched, just like the originals. All Sunvisors are sold in pairs.

1967-69 SUNVISORS

105510

### 1967 INTERIOR ACCESSORIES



Distinctive Industries Seat Heaters provide therapeutic heat and body warmth in any classic car, using the same technology as late model or current vehicles. Each kit comes with switch, harnesses, and two carbon fiber element pads to complete one seat install. Switch can be dash, console, or hidden in a place of choice. Seat Heaters are sold individually, not in pairs.

1961-79 CARBON FIBER SEAT HEATERS

061001



### 1967 HEADLINER/SUNVISOR COLORS

AQUA	H-813	LIGHT GREEN	H-755
BLACK	H-754	MEDIUM BLUE	H-814
DARK AQUA	H-956	RED	H-863
IVY GOLD	H-1029	WHITE	H-741
LIGHT BLUE	H-836		



The difference between **MEN & Boys** is the size of their toys!

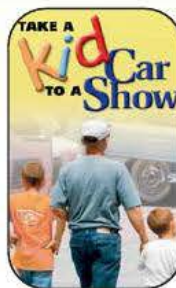

Even if there is a generation or two between you and a child, collector cars can be a terrific common ground. Your enthusiasm and knowledge could be the spark of a child's lifelong passion. Bring kids to your playground...a car show...and have fun.

Life is full of choices for kids. You can help them make the right ones by sharing your appreciation for cool old cars. (And a kid might even call you "cool" too!)



Take a Kid to a Car Show is a program of ARMO, the Automotive Restoration Market Organization, a SEMA Council.

## 1968 INTERIOR PARTS & ACCESSORIES

### 1968 SEAT UPHOLSTERY

Our 1968 Ranchero Seat Upholstery is a correct reproduction of the original. We offer the original Sierra grain with Kiwi grain inserts in 32 oz. vinyl, with the correct vertical patterns sewn as original. Seat back medallions are not included.

#### Features

- Original Sierra grain vinyl with Kiwi grain inserts
- Correct 6 stitch per inch stitching
- Correct colors matched to the original vinyl
- Limited lifetime warranty

#### GT BUCKET SEATS

100859\*

\*Uses Comfortweave vinyl on inserts for bucket seats.

#### STANDARD BENCH SEAT

100867



### 1968 STANDARD DOOR PANELS

Our 1968 Standard Door Panels are a correct reproduction of the original. We offer original Sierra grain in 32 oz. vinyl, and correct dielectrically heat sealed horizontal patterns as original. Emblems not included.

#### Features

- Original Sierra grain vinyl
- Correct dielectric "Heat Seal" stitched pattern
- Correct colors matched to the original vinyl
- .100-inch thickness poly-coated "Autoboard" backing
- Door Panel backs are perimeter stapled for maximum adhesion
- Limited lifetime warranty

#### 1968-69 STANDARD FRONT DOOR PANELS

103881

#### 1968-69 GT FRONT DOOR PANELS

103895



### 1968 INTERIOR ACCESSORIES



Distinctive Industries Seat Heaters provide therapeutic heat and body warmth in any classic car, using the same technology as late model or current vehicles. Each kit comes with switch, harnesses, and two carbon fiber element pads to complete one seat install. Switch can be dash, console, or hidden in a place of choice. Seat Heaters are sold individually, not in pairs.

#### 1961-79 CARBON FIBER SEAT HEATERS

061001



#### 1968 COLORS

BLACK	L-3722 (I=L-3437)
NUGGET GOLD	L-3625 (I=L-3442)
RED	L-3724 (I=L-3440)
WHITE	L-4062 (I=L-4072)

**NOTE:** I=Insert.

**NOTE:** The inserts for White are Ruffino grain due to availability in Kiwi grain vinyl.



## 1968 INTERIOR PARTS & ACCESSORIES



### 1968 HEADLINERS/SUNVISORS/ REAR PILLAR PANELS

Our 1968 Headliners are in the original Crater grain vinyl, constructed just like the original.

1968-69 HEADLINER **105189**

Our 1968 Sunvisors are in the original Crater grain vinyl, with the vinyl binding stitched, just like the originals. All Sunvisors are sold in pairs.

1967-69 SUNVISORS **105510**

Distinctive Industries Rear Pillar Panels are correct reproductions of the original and are covered in Crater grain vinyl.

1968-69 REAR PILLAR PANELS **105924**



### 1968 HEADLINER/SUNVISOR/ REAR PILLAR PANELS COLORS

AQUA	H-813	LIGHT GREEN	H-755
BLACK	H-754	MEDIUM BLUE	H-814
DARK AQUA	H-956	RED	H-863
IVY GOLD	H-1029	WHITE	H-741
LIGHT BLUE	H-836		



1968 Ranchero

## 1969 INTERIOR PARTS & ACCESSORIES

### 1969 SEAT UPHOLSTERY

Our 1969 Ranchero Seat Upholstery is a correct reproduction of the original. We offer the original Corinthian grain with Kiwi grain inserts in 32 oz. vinyl, with the correct vertical patterns sewn as original. Seat back medallions are not included.

#### Features

- Original Corinthian grain vinyl with Kiwi grain inserts
- Correct 6 stitch per inch stitching
- Correct colors matched to the original vinyl
- Limited lifetime warranty

GT BUCKET SEATS	100917
GT BUCKET SEATS WITH COMFORTWEAVE	100917CW
BENCH SEAT	100925
BENCH SEAT WITH COMFORTWEAVE	100925CW

### 1969 STANDARD DOOR PANELS

Our 1969 Standard Door Panels are a correct reproduction of the original. We offer original Corinthian grain in 32 oz. vinyl, and correct dielectrically heat sealed horizontal patterns as original. Emblems not included.

#### Features

- Original Corinthian grain vinyl
- Correct dielectric "Heat Seal" stitched pattern
- Correct colors matched to the original vinyl
- .100-inch thickness poly-coated "Autoboard" backing
- Door Panel backs are perimeter stapled for maximum adhesion
- Limited lifetime warranty

1968-69 STANDARD FRONT DOOR PANELS	103881
1968-69 GT FRONT DOOR PANELS	103895

### 1969 HEADLINERS/SUNVISORS/ REAR PILLAR PANELS

Our 1969 Headliners are in the original Crater grain vinyl, constructed just like the original.

1968-69 HEADLINER	105189
-------------------	--------

Our 1969 Sunvisors are in the original Crater grain vinyl, with the vinyl binding stitched, just like the originals. All Sunvisors are sold in pairs.

1967-69 SUNVISORS	105510
-------------------	--------

Distinctive Industries Rear Pillar Panels are correct reproductions of the original and are covered in Crater grain vinyl.

1968-69 REAR PILLAR PANELS	105924
----------------------------	--------

### 1969 INTERIOR ACCESSORIES

Distinctive Industries Seat Heaters provide therapeutic heat and body warmth in any classic car, using the same technology as late model or current vehicles. Each kit comes with switch, harnesses, and two carbon fiber element pads to complete one seat install. Switch can be dash, console, or hidden in a place of choice. Seat Heaters are sold individually, not in pairs.

1961-79 CARBON FIBER SEAT HEATERS	061001
-----------------------------------	--------



#### 1969 COLORS

BLACK	L-3722 (I=L-3437)
BLUE	L-3627 (I=L-3441)
DARK IVY GOLD	L-3628 (I=L-3531)
NUGGET GOLD	L-3625 (I=L-3442)
RED	L-3724 (I=L-3440)
WHITE	L-4062 (I=L-4072)

**NOTE: I=Insert.**

**NOTE: The inserts for White are Ruffino grain due to availability in Kiwi grain vinyl.**



#### 1969 HEADLINER/SUNVISOR/ REAR PILLAR PANELS COLORS

AQUA	H-813	LIGHT GREEN	H-755
BLACK	H-754	MEDIUM BLUE	H-814
DARK AQUA	H-956	RED	H-863
IVY GOLD	H-1029	WHITE	H-741
LIGHT BLUE	H-836		

## 1970-71 INTERIOR PARTS & ACCESSORIES

### 1970-71 SEAT UPHOLSTERY

Our 1970-71 Ranchero Seat Upholstery is a correct reproduction of the original. We offer the original Corinthian grain with Ruffino grain inserts in 32 oz. vinyl, with the correct patterns sewn as original.

#### Features

- Original Corinthian grain vinyl with Ruffino grain inserts
- Correct 6 stitch per inch stitching
- Correct colors matched to the original vinyl
- Limited lifetime warranty

1970 500/GT/SQUIRE BUCKET SEATS **100966\***

1971 500/GT/SQUIRE BUCKET SEATS **101022\***

*\*Uses Comfortweave vinyl on inserts for bucket seats.*

1970-71 500/GT (STANDARD) BENCH SEAT **101162**



### 1970-71 STANDARD DOOR PANELS

Our 1970-71 Standard (500/GT) Door Panels are a correct reproduction of the original. We offer original Corinthian grain in 32 oz. vinyl, rectangular chrome (Mylar®) strip, and correct dielectrically heat sealed vertical patterns as original.

#### Features

- Original Corinthian grain vinyl
- Correct dielectric "Heat Seal" stitched pattern
- Correct colors matched to the original vinyl
- .100-inch thickness poly-coated "Autoboard" backing
- Door Panel backs are perimeter stapled for maximum adhesion
- Limited lifetime warranty

FRONT DOOR PANELS **103945**



### 1970-71 INTERIOR ACCESSORIES

Our Package Tray is a high quality vinyl covered package tray. Utilizing modern material and covered in the correct Corinthian grain in 32 oz. vinyl for durability and long life.

REAR COMPARTMENT PACKAGE TRAY **105908**

Distinctive Industries Seat Heaters provide therapeutic heat and body warmth in any classic car, using the same technology as late model or current vehicles. Each kit comes with switch, harnesses, and two carbon fiber element pads to complete one seat install. Switch can be dash, console, or hidden in a place of choice. Seat Heaters are sold individually, not in pairs.

1961-79 CARBON FIBER SEAT HEATERS **061001**



#### 1970-71 COLORS

BLACK	L-3722 (I=L-3400)
BLUE	L-3788 (I=L-4069)
GINGER	L-4061 (I=L-4070)
IVY	L-3628 (I=L-4071)
RED	L-3724 (I=L-3440)
VERMILLION	L-4063 (I=L-4073)
WHITE	L-4062 (I=L-4072)

**NOTE: I=Insert.**

## 1970-71 INTERIOR PARTS & ACCESSORIES

### 1970-71 HEADLINERS/SUNVISORS/ REAR PILLAR PANELS

Our 1970-71 Headliners are in the original Tier grain vinyl, constructed just like the original.

HEADLINER

105197



Our 1970-71 Sunvisors are in the original Tier grain vinyl, with the vinyl binding stitched, just like the originals. All Sunvisors are sold in pairs.

SUNVISORS

105544



#### 1970-71 HEADLINER/SUNVISOR/ REAR PILLAR PANEL COLORS

BLACK	H-770
BLUE	H-1208
DARK GREEN	H-1325
GINGER	H-1217
MAROON	H-1210
RED	H-1328
WEDGEWOOD BLUE	H-1565
WHITE	H-1513

Distinctive Industries Rear Pillar Panels are correct reproductions of the original and are covered in Tier grain vinyl.

1970-71 REAR PILLAR PANELS

105932

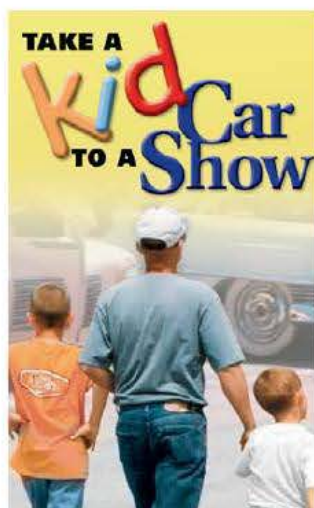

#### Take a Kid to a Car Show is dedicated to:

- Sharing the classic car hobby with kids
- Encouraging involvement by a new generation of automotive restoration enthusiasts
- Giving kids a constructive choice in how to spend their time

Take a Kid to a Car Show is a program of ARMO, the Automotive Restoration Market Organization, a SEMA Council.





## 1972-76 INTERIOR PARTS & ACCESSORIES



### 1972-1976 SEAT UPHOLSTERY

Our 1972-76 Ranchero Seat Upholstery is a correct reproduction of the original. We offer the original Corinthian grain with Ruffino grain inserts in 32 oz. vinyl, with the correct patterns sewn as original.

#### Features

- Original Corinthian grain vinyl with Ruffino grain inserts
- Correct 6 stitch per inch stitching
- Correct colors matched to the original vinyl
- Limited lifetime warranty

1972-73 500/GT/SQUIRE BUCKET SEATS	101089*
1972-73 500 STANDARD SPLIT BENCH SEAT	101097
1972 GT/SQUIRE SPLIT BENCH SEAT	101204
1973 GT/SQUIRE BUCKET SEATS	101220*
1974-76 BUCKET SEATS <b>*SEEKING PATTERN*</b>	
1974-76 STANDARD SPLIT BENCH SEAT	101154
1974-76 GT SPLIT BENCH SEAT	101246

\*Uses Comfortweave vinyl on inserts for bucket seats.

### 1972-76 STANDARD DOOR PANELS

Our 1972-76 Standard Door Panels are a correct reproduction of the original. We offer original Corinthian grain in 32 oz. vinyl, correct Mylar®, and dielectrically heat sealed vertical patterns as original. Emblems not included.

#### Features

- Original Corinthian grain vinyl
- Correct dielectric "Heat Seal" stitched pattern
- Correct colors matched to the original vinyl
- .100-inch thickness poly-coated "Autoboard" backing
- Door Panel backs are perimeter stapled for maximum adhesion
- Limited lifetime warranty

1972-76 FRONT DOOR PANELS	104000
---------------------------	--------



### 1972-76 COLORS

BLACK	L-3722 (I=L-3400)
BLUE	L-3788 (I=L-4069)
GINGER	L-4061 (I=L-4070)
GREEN	L-4234 (I=L-4238)
MAROON	L-3724 (I=L-3440)
WHITE	L-4062 (I=L-4072)

**NOTE: I=Insert.**

**NOTE: The inserts for Red are Kiwi grain due to availability in Ruffino grain vinyl.**

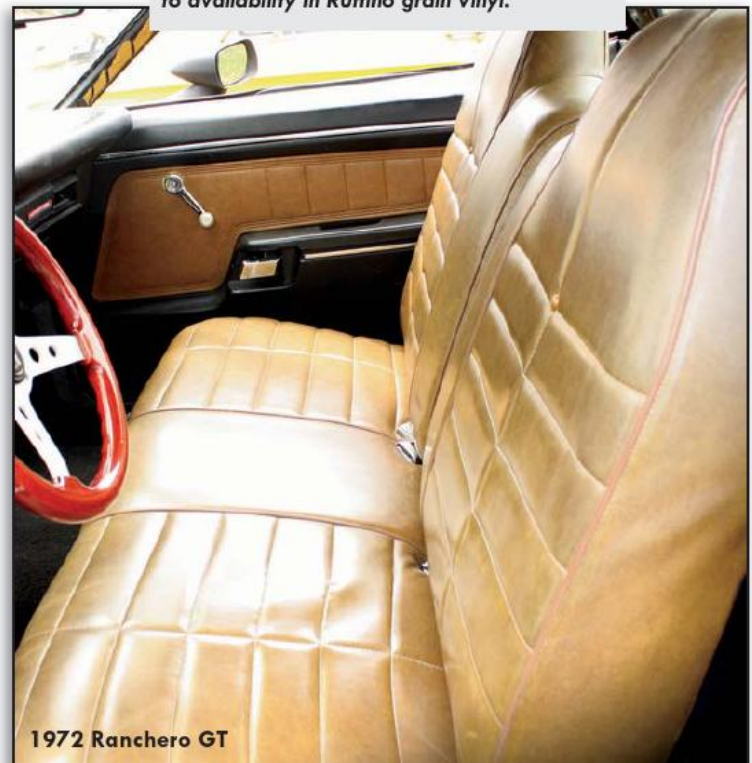

1972 Ranchero GT

## 1972-76 INTERIOR PARTS & ACCESSORIES

### 1972-76 HEADLINERS/SUNVISORS

Our 1972-76 Headliners are in the original Tier grain vinyl, constructed just like the original.

1972-79 HEADLINER **105205**



Our 1972-76 Sunvisors are in the original Tier grain vinyl, with the vinyl binding stitched, just like the originals. All Sunvisors are sold in pairs.

1972-79 SUNVISORS **105569**

### 1972-76 INTERIOR ACCESSORIES

Our Package Tray is a high quality vinyl covered package tray. Utilizing modern material and covered in the correct Corinthian grain in 32 oz. vinyl for durability and long life.

1972-79 REAR COMPARTMENT PACKAGE TRAY **105916**

Distinctive Industries Seat Heaters provide therapeutic heat and body warmth in any classic car, using the same technology as late model or current vehicles. Each kit comes with switch, harnesses, and two carbon fiber element pads to complete one seat install. Switch can be dash, console, or hidden in a place of choice. Seat Heaters are sold individually, not in pairs.

1961-79 CARBON FIBER SEAT HEATERS **061001**



### 1972-76 HEADLINER/SUNVISOR COLORS

BLACK	H-770
BLUE	H-1208
DARK GREEN	H-1325
GINGER	H-1217
MAROON	H-1210
RED	H-1328
WEDGEWOOD BLUE	H-1565
WHITE	H-1513



## 1977-79 INTERIOR PARTS & ACCESSORIES

### 1977-79 SEAT UPHOLSTERY

Our 1977-79 Ranchero Seat Upholstery is a correct reproduction of the original. We offer the original Corinthian grain with Ruffino grain inserts in 32 oz. vinyl, with the correct vertical patterns sewn as original. Upholstery for 1 armrest included.

#### Features

- Original Corinthian grain vinyl with Ruffino grain inserts
- Correct 6 stitch per inch stitching
- Correct colors matched to the original vinyl
- Limited lifetime warranty

#### Two-Tone Upholstery

- |   |               |
|---|---------------|
| 1977-79 STANDARD SPLIT BENCH SEAT   | <b>101188</b> |
| 1977-78 STANDARD/GT FLIGHT BENCH SEAT -<br>SOLID BOTTOM/SPLIT BACK WITH 1 ARMREST | <b>101189</b> |
| 1977-79 SOLID BOTTOM/SPLIT BACK<br>WITH 1 ARMREST *SEEKING PATTERN*               |               |

#### 1977-79 COLORS

BLACK	L-3722 (I=L-3400)	MAROON	L-3724 (I=L-3440)
BLUE	L-3788 (I=L-3788)	SADDLE	L-4061 (I=L-4070)

**NOTE:** I=Insert.

**NOTE:** The inserts for Blue are Corinthian grain due to availability in Ruffino grain vinyl.

**NOTE:** The inserts for Maroon are Kiwi grain due to availability in Ruffino grain vinyl.

### 1977-79 DOOR PANELS

Our 1977-79 Door Panels are a correct reproduction of the original. We offer original Corinthian grain in 32 oz. vinyl, and correct dielectrically heat sealed patterns as original.

#### Features

- Original Corinthian grain vinyl
- Correct dielectric "Heat Seal" stitched pattern
- Correct colors matched to the original vinyl
- .100-inch thickness poly-coated "Autoboard" backing
- Door Panel backs are perimeter stapled for maximum adhesion
- Limited lifetime warranty

FRONT DOOR PANELS \*SEEKING PATTERN\*



1978 Ranchero GT

## 1977-79 INTERIOR PARTS & ACCESSORIES

### 1977-79 HEADLINERS/SUNVISORS

Our 1977-79 Headliners are in the original Tier grain vinyl, constructed just like the original.

1972-79 HEADLINER **105205**



Our 1977-79 Sunvisors are in the original Tier grain vinyl, with the vinyl binding stitched, just like the originals. All Sunvisors are sold in pairs.

1972-79 SUNVISORS **105569**

### 1977-79 INTERIOR ACCESSORIES

Our Package Tray is a high quality vinyl covered package tray. Utilizing modern material and covered in the correct Corinthian grain in 32 oz. vinyl for durability and long life.

1972-79 REAR COMPARTMENT PACKAGE TRAY **105916**



Distinctive Industries Seat Heaters provide therapeutic heat and body warmth in any classic car, using the same technology as late model or current vehicles. Each kit comes with switch, harnesses, and two carbon fiber element pads to complete one seat install. Switch can be dash, console, or hidden in a place of choice. Seat Heaters are sold individually, not in pairs.

1961-79 CARBON FIBER SEAT HEATERS **061001**



#### 1977-79 HEADLINER/SUNVISOR COLORS

BLACK	H-770
BLUE	H-1208
DARK GREEN	H-1325
GINGER	H-1217
MAROON	H-1210
RED	H-1328
WEDGEWOOD BLUE	H-1565
WHITE	H-1513



#### 1977-79 COLORS

BLACK	L-3722
BLUE	L-3788
MAROON	L-3724
SADDLE	L-4061

## Introduction To The Catalog

Thank you for choosing Distinctive Industries as your provider of Restoration Interior Products. The catalog you are reading was designed with the input of our existing customers and moving forward, will continue to be a representation of their needs, and the needs of restoration experts worldwide.

### Design

We have designed our catalog for the Restoration Professional, from the Local Upholstery and Restoration Shop, to the National Distributor of Restoration Products. The thought was to create a catalog that eases the pain of product entry for those building catalogs, and to ease ordering for those that order directly from the catalog. We accomplished this by listing product by year, model, and trim level. You will find this catalog to be easy to use.

### Descriptions

Descriptions are a blend of Marketing and Technical descriptions. After polling our customers we found that aside from the design, missing was a good description of the products in today's catalogs. We remedied that by providing a blended description as a basis for our customers to expand upon, or use as is.

### Colors

Color swatches are placed near the product with labeled color codes to avoid confusion. Color Code boxes are located near the applicable products. We offer many special order color combinations as well as an option for leather in most cases.

### Images

Images are available for License through Distinctive Industries.

- Licensed images must be accompanied and located adjacent to the matching Distinctive Industries product.



## Table of Contents

1968 interior parts and accessories

1969 interior parts and accessories

1970 interior parts and accessories

1971 interior parts and accessories

1972-73 interior parts and accessories

1974-76 interior parts and accessories

© Copyright 2016, Distinctive Industries, all rights reserved. No part of this publication may be duplicated or reproduced without written permission from Distinctive Industries.



## 1968 INTERIOR PARTS & ACCESSORIES

### 1968 SEAT UPHOLSTERY

Our 1968 Torino Seat Upholstery is a correct reproduction of the original. We offer the original Sierra grain with Kiwi grain inserts in 32 oz. vinyl, with the correct vertical patterns sewn as original. Seat back medallions/emblems are not included.

#### Features

- Original Sierra grain vinyl with Kiwi grain inserts
- Correct 6 stitch per inch stitching
- Correct colors matched to the original vinyl
- Limited lifetime warranty

BUCKET SEATS- FRONT/REAR SET	100835
BENCH SEAT - FRONT/REAR SET	100836
CONVERTIBLE WITH FRONT BUCKET SEATS - FRONT/REAR SET	100837
CONVERTIBLE WITH FRONT BENCH SEAT - FRONT/REAR SET	100838
BUCKET SEATS - FRONT	100859
BENCH SEAT - FRONT	100867
SPORTSROOF WITH FRONT BUCKET SEATS - REAR BENCH SEAT	100864
SPORTSROOF WITH FRONT BENCH SEAT - REAR BENCH SEAT	100875
CONVERTIBLE WITH FRONT BUCKET SEATS - REAR BENCH SEAT	100861
CONVERTIBLE WITH FRONT BENCH SEAT - REAR BENCH SEAT	100883



#### 1968 COLORS

BLACK	L-958 (I=L-3437)
BLUE	L-2287 (I=L-3435)
IVY GOLD	L-2503 (I=L-3530)
NUGGET GOLD	L-3448 (I=L-3442)
PARCHMENT	L-3096 (I=L-3443)
RED	L-3116 (I=L-3440)
TURQUOISE	L-2929 (I=L-3444)
WHITE	L-2290 (I=L-4072)

NOTE: I=Insert.

## 1968 INTERIOR PARTS & ACCESSORIES

### 1968 DOOR/QUARTER PANELS

Our 1968 Door/Quarter Panels are a correct reproduction of the original. We offer original Sierra grain in 32 oz. vinyl, and correct dielectrically heat sealed horizontal patterns as original. Door Panel emblems are not included.

#### Features

- Original Sierra grain vinyl
- Correct dielectric "Heat Seal" stitched pattern
- Correct colors matched to the original vinyl
- .100-inch thickness poly-coated "Autoboard" backing
- Door Panel backs are perimeter stapled for maximum adhesion
- Limited lifetime warranty

1968-69 FRONT DOOR PANELS	<b>103895</b>
1968-69 COBRA FRONT DOOR PANELS	<b>103881</b>
1968-69 SPORTSROOF REAR QUARTER PANELS	<b>103903</b>
1968-69 COBRA SPORTSROOF REAR QUARTER PANELS	<b>103883</b>
1968-69 FORMAL ROOF REAR QUARTER PANELS	<b>103911</b>
1968-69 COBRA FORMAL ROOF REAR QUARTER PANELS	<b>103885</b>
1968-69 CONVERTIBLE REAR QUARTER PANELS	<b>103929</b>

*\* This Door Panel does not include upper metal reinforcements or attaching weatherstrip.*

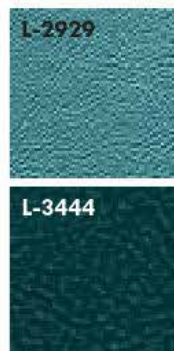

#### 1968 COLORS

BLACK	L-958 (I=L-3437)
BLUE	L-2287 (I=L-3435)
IVY GOLD	L-2503 (I=L-3530)
NUGGET GOLD	L-3448 (I=L-3442)
PARCHMENT	L-3096 (I=L-3443)
RED	L-3116 (I=L-3440)
TURQUOISE	L-2929 (I=L-3444)

NOTE: I=Insert.

1968 Formal Roof Torino



## 1968 INTERIOR PARTS & ACCESSORIES

### 1968 HEADLINERS/ SUNVISORS/SAIL PANELS

Our 1968 Headliners are in the original Crater grain vinyl, constructed just like the original.

1968-69 SPORTSROOF HEADLINER **105130**  
 1968-69 FORMAL ROOF HEADLINER **105122**

Our 1968 Sunvisors are in the original Crater grain vinyl, with the vinyl binding stitched, just like the originals. All Sunvisors are sold in pairs.

1968-69 HARDTOP SUNVISORS **105510**  
 1968-69 CONVERTIBLE SUNVISORS **105536**



Our 1968 Sail Panels are in the original Crater grain vinyl construction.

1968-69 SPORTSROOF SAIL PANELS **104190**



### 1968 INTERIOR ACCESSORIES

Distinctive Industries Seat Heaters provide therapeutic heat and body warmth in any classic car, using the same technology as late model or current vehicles. Each kit comes with switch, harnesses, and two carbon fiber element pads to complete one seat install. Switch can be dash, console, or hidden in a place of choice. Seat Heaters are sold individually, not in pairs.

1968-76 CARBON FIBER SEAT HEATERS **061001**

Our Convertible Top Boot features the correct Sierra grain in 32 oz. vinyl and fastens just like the original. Snaps are included.

1968-69 CONVERTIBLE TOP BOOT **105742**

Although not originally offered for the Torino our Convertible Boot Bag features Sierra grain in 32 oz. vinyl and is available in interior matching colors.

1968-71 CONVERTIBLE TOP BOOT BAG **105809**

Our Convertible Well Liner is in 32 oz. Sierra grain vinyl, just like the originals.

1968-69 CONVERTIBLE WELL LINER **105759**

Our Convertible Quarter Trim features 32 oz. vinyl in the correct Sierra grain and is stitched, just like the originals.

1968-69 CONVERTIBLE QUARTER TRIM W/ARMREST **105270**

#### 1968 HEADLINERS/ SUNVISORS COLORS

BLACK	H-770
BLUE	H-1208
DARK GREEN	H-1325
GINGER	H-1217
MAROON	H-1210
RED	H-1328
WEDGEWOOD BLUE	H-1565
WHITE	H-1513



#### 1968 COLORS

BLACK	L-958
BLUE	L-2287
IVY GOLD	L-2503
NUGGET GOLD	L-3448
PARCHMENT	L-3096
RED	L-3116
TURQUOISE	L-2929



## 1969 INTERIOR PARTS & ACCESSORIES

### 1969 SEAT UPHOLSTERY

Our 1969 Torino Seat Upholstery is a correct reproduction of the original. We offer the original Corinthian grain with Kiwi grain inserts in 32 oz. vinyl, with the correct vertical patterns sewn as original. Seat back medallions are not included.

#### Features

- Original Corinthian grain vinyl with Kiwi grain inserts
- Correct 6 stitch per inch stitching
- Correct colors matched to the original vinyl
- Limited lifetime warranty

BUCKET SEATS - FRONT/REAR SET	100943
BUCKET SEATS WITH COMFORTWEAVE	
- FRONT/REAR SET	100944
BENCH SEAT - FRONT/REAR SET	100945
BENCH SEAT WITH COMFORTWEAVE	
- FRONT/REAR SET	100946
CONVERTIBLE WITH FRONT BUCKET SEATS	
- FRONT/REAR SET	100947
CONVERTIBLE WITH FRONT BENCH SEAT	
- FRONT/REAR SET	100949
BUCKET SEATS - FRONT	100917
BUCKET SEATS WITH COMFORTWEAVE - FRONT	100917CW
BENCH SEAT - FRONT	100925
BENCH SEAT WITH COMFORTWEAVE - FRONT	100925CW
SPORTSROOF BENCH SEAT - REAR	100933
SPORTSROOF BENCH SEAT WITH	
COMFORTWEAVE - REAR	100933CW
CONVERTIBLE BENCH SEAT - REAR	100941
CONVERTIBLE BENCH SEAT WITH	
COMFORTWEAVE - REAR	100941CW

### 1969 DOOR/QUARTER PANELS

Our 1969 Door/Quarter Panels are a correct reproduction of the original. We offer original Corinthian grain in 32 oz. vinyl, and correct dielectrically heat sealed horizontal patterns as original. Emblems not included.

#### Features

- Original Corinthian grain vinyl
- Correct dielectric "Heat Seal" stitched pattern
- Correct colors matched to the original vinyl
- .100-inch thickness poly-coated "Autoboard" backing
- Door Panel backs are perimeter stapled for maximum adhesion
- Limited lifetime warranty

1968-69 FRONT DOOR PANELS	103895
1968-69 COBRA FRONT DOOR PANELS	103881
1968-69 SPORTSROOF REAR QUARTER PANELS	103903
1968-69 COBRA SPORTSROOF REAR	
QUARTER PANELS	103883
1968-69 FORMAL ROOF REAR QUARTER PANELS	103911
1968-69 COBRA FORMAL ROOF REAR	
QUARTER PANELS	103885
1968-69 CONVERTIBLE REAR QUARTER PANELS	103929

\* This Door Panel does not include upper metal reinforcements or attaching weatherstrip.



#### 1969 COLORS

BLACK	L-3722 (I=L-3437)
BLUE	L-3627 (I=L-3441)
DARK IVY GOLD	L-3628 (I=L-3531)
NUGGET GOLD	L-3625 (I=L-3442)
RED	L-3724 (I=L-3440)
TURQUOISE	L-2929 (I=L-2929)
WHITE	L-4062 (I=L-4072)

**NOTE:** I=Insert.

**NOTE:** Turquoise is only available in Sierra grain vinyl.

**NOTE:** The inserts for White are Ruffino grain due to availability in Kiwi grain vinyl.



## 1969 INTERIOR PARTS & ACCESSORIES

### 1969 HEADLINERS/ SUNVISORS/SAIL PANELS

Our 1969 Headliners are in the original Crater grain vinyl, constructed just like the original.

1968-69 SPORTSROOF HEADLINER **105130**  
 1968-69 FORMAL ROOF HEADLINER **105122**

Our 1969 Sunvisors are in the original Crater grain vinyl, with the vinyl binding stitched, just like the originals. All Sunvisors are sold in pairs.

1968-69 HARDTOP SUNVISORS **105510**  
 1968-69 CONVERTIBLE SUNVISORS **105536**

Our 1969 Sail Panels are in the original Crater grain vinyl construction.

1968-69 SPORTSROOF SAIL PANELS **104190**

### 1969 INTERIOR ACCESSORIES



Distinctive Industries Seat Heaters provide therapeutic heat and body warmth in any classic car, using the same technology as late model or current vehicles. Each kit comes with switch, harnesses, and two carbon fiber element pads to complete one seat install. Switch can be dash, console, or hidden in a place of choice. Seat Heaters are sold individually, not in pairs.

1968-76 CARBON FIBER SEAT HEATERS **061001**

Our Convertible Top Boot features the correct Corinthian grain in 32 oz. vinyl and fastens just like the original. Snaps are included.

1968-69 CONVERTIBLE TOP BOOT **105742**

Although not originally offered for the Torino our Convertible Boot Bag features Corinthian grain in 32 oz. vinyl and is available in interior matching colors.

1968-69 CONVERTIBLE TOP BOOT BAG **105809**

Our Convertible Well Liner is in 32 oz. Corinthian grain vinyl, just like the originals.

1968-69 CONVERTIBLE WELL LINER **105759**

Our Convertible Quarter Trim features 32 oz. vinyl in the correct Corinthian grain and is stitched, just like the originals.

1968-69 CONVERTIBLE QUARTER TRIM W/ARMREST **105270**



### 1969 HEADLINERS/ SUNVISORS/ SAIL PANEL COLORS

AQUA	H-813
BLACK	H-754
DARK AQUA	H-956
IVY GOLD	H-1029
LIGHT BLUE	H-836
MEDIUM BLUE	H-814
RED	H-863
WHITE	H-741



### 1969 COLORS

BLACK	L-3722
BLUE	L-3627
DARK IVY GOLD	L-3628
NUGGET GOLD	L-3625
RED	L-3724
TURQUOISE	L-2929
WHITE	L-4062

## 1970 INTERIOR PARTS & ACCESSORIES

### 1970 SEAT UPHOLSTERY

Our 1970 Torino Seat Upholstery is a correct reproduction of the original. We offer the original Corinthian grain with Ruffino grain inserts in 32 oz. vinyl, with the correct horizontal patterns sewn as original.

#### Features

- Original Corinthian grain vinyl with Ruffino grain inserts
- Correct 6 stitch per inch stitching
- Correct colors matched to the original vinyl
- Limited lifetime warranty

BUCKET SEATS - FRONT/REAR SET	100961
BENCH SEAT - FRONT/REAR SET	100962
CONVERTIBLE WITH FRONT BUCKET SEATS - FRONT/REAR SET	100963
CONVERTIBLE WITH FRONT BENCH SEAT - FRONT/REAR SET	100964
BUCKET SEATS - FRONT	100966
SPLIT BENCH SEAT - FRONT	100974
SPORTSROOF WITH FRONT BUCKET SEATS - REAR BENCH SEAT	100982
SPORTSROOF WITH FRONT BENCH SEAT - REAR BENCH SEAT	101006
CONVERTIBLE WITH FRONT BUCKET SEATS - REAR BENCH SEAT	100990
CONVERTIBLE WITH FRONT BENCH SEAT - REAR BENCH SEAT	101014

**\*NOTE:** Bucket Seat interiors use Comfortweave grain vinyl for the seat inserts



**Don't Forget About SEAT HEATERS!!!**  
 Now Available Easy to install  
 PerfectFit® Carbon Fiber Seat Heaters  
 with a small concealable switch  
**PART #061001**



1970 Torino

#### 1970 COLORS

BLACK	L-3722 (I=L-3400)
BLUE	L-3788 (I=L-4069)
DARK RED	L-3724 (I=L-3440)
GINGER	L-4061 (I=L-4070)
IVY	L-3628 (I=L-4071)
VERMILLION	L-4063 (I=L-4073)
GREEN	L-4234 (I=L-4238)
WHITE	L-4062 (I=L-4072)

**NOTE:** I=Insert.

**NOTE:** The inserts for Dark Red are Kiwi grain due to availability in Ruffino grain vinyl.

## 1970 INTERIOR PARTS & ACCESSORIES

### 1970 DOOR/QUARTER PANELS

Our 1970 Door/Quarter Panels are a correct reproduction of the original. We offer original Corinthian grain in 32 oz. vinyl, rectangular chrome (Mylar®) strip, and correct dielectrically heat sealed vertical patterns as original.

#### Features

- Original Corinthian grain vinyl
- Correct dielectric "Heat Seal" stitched pattern
- Correct colors matched to the original vinyl
- .100-inch thickness poly-coated "Autoboard" backing
- Door Panel backs are perimeter stapled for maximum adhesion
- Limited lifetime warranty

1970-71 FRONT DOOR PANELS	103945
1970-71 SPORTSROOF REAR QUARTER PANELS	103952
1970-71 FORMAL ROOF REAR QUARTER PANELS	103960
1970-71 CONVERTIBLE REAR QUARTER PANELS	103978 <sup>1</sup>
1970-71 GT CONVERTIBLE REAR QUARTER PANELS - WITHOUT SPEAR	103770 <sup>1</sup>
1970 GT FRONT DOOR PANELS - WITHOUT SPEAR	103747 <sup>2</sup>
1970 GT FRONT DOOR PANELS - WITH SPEAR	103796
1970 GT HARDTOP REAR QUARTER PANELS - WITHOUT SPEAR	103754 <sup>2</sup>
1970 GT HARDTOP REAR QUARTER PANELS - WITH SPEAR	103804

**\*NOTE:** Bucket Seat interiors use Comfortweave grain vinyl for the seat inserts

**<sup>1</sup>NOTE:** This Door Panel does not include upper metal reinforcements or attaching weatherstrip.

**<sup>2</sup>NOTE:** This Door Panels requires reuse of the original aluminum spears.



#### 1970 COLORS

BLACK	L-3722 (I=L-3400)
BLUE	L-3788 (I=L-4069)
DARK RED	L-3724 (I=L-3440)
GINGER	L-4061 (I=L-4070)
IVY	L-3628 (I=L-4071)
VERMILLION	L-4063 (I=L-4073)
GREEN	L-4234 (I=L-4238)
WHITE	L-4062 (I=L-4072)

**NOTE:** I=Insert.

**NOTE:** The inserts for Dark Red are Kiwi grain due to availability in Ruffino grain vinyl.

## 1970 INTERIOR PARTS & ACCESSORIES

### 1970 INTERIOR ACCESSORIES

Distinctive Industries Seat Heaters provide therapeutic heat and body warmth in any classic car, using the same technology as late model or current vehicles. Each kit comes with switch, harnesses, and two carbon fiber element pads to complete one seat install. Switch can be dash, console, or hidden in a place of choice. Seat Heaters are sold individually, not in pairs.

1968-76 CARBON FIBER SEAT HEATERS **061001**

Our Convertible Top Boot features the correct Corinthian grain in 32 oz. vinyl and fastens just like the original. Snaps are included.

1970-71 CONVERTIBLE TOP BOOT **105767**

Although not originally offered for the Torino our Convertible Boot Bag features Corinthian grain in 32 oz. vinyl and is available in interior matching colors.

1970-71 CONVERTIBLE TOP BOOT BAG **105809**

Our Convertible Well Liner is in 32 oz. Corinthian grain vinyl, just like the originals.

1970-71 CONVERTIBLE WELL LINER **105775**

Our Convertible Quarter Trim features 32 oz. vinyl in the correct Corinthian grain and is stitched, just like the originals.

1970-71 CONVERTIBLE QUARTER TRIM W/ARMREST **105288**

### 1970 HEADLINERS/ SUNVISORS

Our 1970 Headliners are in the original Tier grain vinyl, constructed just like the original.

1970-71 SPORTSROOF HEADLINER **105155**

1970-71 FORMAL ROOF HEADLINER **105148**



Our 1970 Sunvisors are in the original Tier grain vinyl, with the vinyl binding stitched, just like the originals. All Sunvisors are sold in pairs.

1970-71 HARDTOP SUNVISORS **105544**

1970-71 CONVERTIBLE SUNVISORS **105551**



#### 1970 COLORS

BLACK	L-3722
BLUE	L-3788
DARK RED	L-3724
GINGER	L-4061
IVY	L-3628
VERMILLION	L-4063
GREEN	L-4234
WHITE	L-4062

#### 1970 HEADLINERS/ SUNVISORS COLORS

BLACK	H-770
BLUE	H-1208
DARK GREEN	H-1325
GINGER	H-1217
MAROON	H-1210
RED	H-1328
WEDGEWOOD BLUE	H-1565
WHITE	H-1513

1970 Torino GT

## 1971 INTERIOR PARTS & ACCESSORIES

### 1971 SEAT UPHOLSTERY

Our 1971 Torino Seat Upholstery is a correct reproduction of the original. We offer the original Corinthian grain with Ruffino grain inserts in 32 oz. vinyl, with the correct horizontal patterns sewn as original.

#### Features

- Original Corinthian grain vinyl with Ruffino grain inserts
- Correct 6 stitch per inch stitching
- Correct colors matched to the original vinyl
- Limited lifetime warranty

SPORTSROOF WITH FRONT BUCKET SEATS - FRONT/REAR SET	101016
SPORTSROOF WITH FRONT BENCH SEAT - FRONT/REAR SET	101017
CONVERTIBLE WITH FRONT BUCKET SEATS - FRONT/REAR SET	101018
CONVERTIBLE WITH FRONT BENCH SEAT - FRONT/REAR SET	101019
BUCKET SEATS - FRONT	101022*
BENCH SEAT - FRONT	101030
SPORTSROOF WITH FRONT BUCKET SEATS - REAR BENCH SEAT	101048*
SPORTSROOF WITH FRONT BENCH SEAT - REAR BENCH SEAT	101063
CONVERTIBLE WITH FRONT BENCH SEAT - REAR BENCH SEAT	101071*
CONVERTIBLE WITH FRONT BUCKET SEATS - REAR BENCH SEAT	101055

**\*NOTE:** Bucket Seat interiors use Comfortweave grain vinyl for the seat inserts.

### 1971 DOOR/QUARTER PANELS

Our 1971 Door/Quarter Panels are a correct reproduction of the original. We offer original Corinthian grain in 32 oz. vinyl, rectangular chrome (Mylar®) strip, and correct dielectrically heat sealed vertical patterns as original. 1971 GT features chrome spear with black padded insert.

#### Features

- Original Corinthian grain vinyl
- Correct dielectric "Heat Seal" stitched pattern
- Correct colors matched to the original vinyl
- .100-inch thickness poly-coated "Autoboard" backing
- Door Panel backs are perimeter stapled for maximum adhesion
- Limited lifetime warranty

1970-71 FRONT DOOR PANELS	103945
1971 GT FRONT DOOR PANEL - WITH SPEAR	103846
1970-71 SPORTSROOF REAR QUARTER PANELS	103952
1970-71 FORMAL ROOF REAR QUARTER PANELS	103960
1970-71 CONVERTIBLE REAR QUARTER PANELS	103978
<b>* This Door Panel does not include upper metal reinforcements or attaching weatherstrip.</b>	
1970-71 GT CONVERTIBLE REAR QUARTER PANELS - WITHOUT SPEAR	103770
<b>* This Door Panel does not include upper metal reinforcements or attaching weatherstrip.</b>	
1971 GT HARDTOP REAR QUARTER PANELS - WITH SPEAR	103853



#### 1971 COLORS

BLACK	L-3722 (I=L-3400)
BLUE	L-3788 (I=L-4069)
GINGER	L-4061 (I=L-4070)
VERMILLION	L-4063 (I=L-4073)
GREEN	L-4234 (I=L-4238)
WHITE	L-4062 (I=L-4072)

**NOTE:** I=Insert.

## 1971 INTERIOR PARTS & ACCESSORIES

### 1971 HEADLINERS/ SUNVISORS

Our 1971 Headliners are in the original Tier grain vinyl, constructed just like the original.

- 1970-71 SPORTSROOF HEADLINER **105155**
- 1970-71 FORMAL ROOF HEADLINER **105148**

Our 1971 Sunvisors are in the original Tier grain vinyl, with the vinyl binding stitched, just like the originals. All Sunvisors are sold in pairs.

- 1970-71 HARDTOP SUNVISORS **105544**
- 1970-71 CONVERTIBLE SUNVISORS **105551**



### 1971 INTERIOR ACCESSORIES

Distinctive Industries Seat Heaters provide therapeutic heat and body warmth in any classic car, using the same technology as late model or current vehicles. Each kit comes with switch, harnesses, and two carbon fiber element pads to complete one seat install. Switch can be dash, console, or hidden in a place of choice. Seat Heaters are sold individually, not in pairs.

- 1968-76 CARBON FIBER SEAT HEATERS **061001**

Our Convertible Top Boot features the correct Corinthian grain in 32 oz. vinyl and fastens just like the original. Snaps are included.

- 1970-71 CONVERTIBLE TOP BOOT **105767**



Although not originally offered for the Torino our Convertible Boot Bag features Corinthian grain in 32 oz. vinyl and is available in interior matching colors.

- 1970-71 CONVERTIBLE TOP BOOT BAG **105809**

Our Convertible Well Liner is in 32 oz. Corinthian grain vinyl, just like the originals.

- 1970-71 CONVERTIBLE WELL LINER **105775**

Our Convertible Quarter Trim features 32 oz. vinyl in the correct Corinthian grain and is stitched, just like the originals.

- 1970-71 CONVERTIBLE QUARTER TRIM W/ARMREST **105288**



#### 1971 HEADLINERS/ SUNVISORS COLORS

BLACK	H-770
BLUE	H-1208
DARK GREEN	H-1325
GINGER	H-1217
MAROON	H-1210
RED	H-1328
WEDGEWOOD BLUE	H-1565
WHITE	H-1513



#### 1971 COLORS

BLACK	L-3722
BLUE	L-3788
GINGER	L-4061
VERMILLION	L-4063
GREEN	L-4234
WHITE	L-4062

## 1972-73 INTERIOR PARTS & ACCESSORIES

### 1972-73 SEAT UPHOLSTERY

Our 1972-73 Torino Seat Upholstery is a correct reproduction of the original. We offer the original Corinthian grain with Ruffino grain inserts in 32 oz. vinyl, with the correct patterns sewn as original.

#### Features

- Original Corinthian grain vinyl with Ruffino grain inserts
- Correct 6 stitch per inch stitching
- Correct colors matched to the original vinyl
- Limited lifetime warranty

1972 BUCKET SEATS WITH COMFORTWEAVE - FRONT/REAR SET	101073
1972 GT HARDTOP WITH FRONT BENCH SEAT - FRONT/REAR SET	101075
1972 4 DOOR WITH FRONT BENCH SEAT - FRONT/REAR SET	101076
1973 HARDTOP WITH FRONT BUCKET SEATS - FRONT/REAR SET	101127
1973 GRAN TORINO SPORT WITH FRONT BENCH SEAT - FRONT/REAR SET	101128
1972-73 BUCKET SEATS WITH COMFORTWEAVE - FRONT	101089*
1972-73 SPLIT BENCH SEAT - FRONT	101097
1972 GT SPLIT BENCH SEAT - FRONT	101204
1972 4 DOOR BENCH SEAT - FRONT	101099
1973 BUCKET SEATS - FRONT	101139*
1973 GRAN TORINO SPORT BENCH SEAT - FRONT	101220
1974-76 GRAN TORINO BENCH SEAT - FRONT	101154
1972-73 HARDTOP WITH FRONT BUCKET SEATS AND COMFORTWEAVE - REAR BENCH SEAT	101105*
1972 GT HARDTOP WITH FRONT BENCH SEAT - REAR BENCH SEAT	101212
1972 4 DOOR BENCH SEAT - REAR	101101
1972 GRAN TORINO SPORT WITH FRONT BENCH SEAT- REAR BENCH SEAT	101238
1973 2 DOOR HARDTOP WITH FRONT BUCKET SEATS - REAR BENCH SEAT	101140*

\*NOTE: Bucket Seat interiors use Comfortweave grain vinyl for the seat inserts



#### 1972-73 COLORS

BLACK	L-3722 (I=L-3400)
BLUE	L-3788 (I=L-4069)
GINGER	L-4061 (I=L-4070)
GREEN	L-4234 (I=L-4238)
MAROON	L-3724 (I=L-3440)
WHITE	L-4062 (I=L-4072)

NOTE: I=Insert.

NOTE: The inserts for Maroon are Kiwi grain due to availability in Ruffino grain vinyl.





1972-73 INTERIOR PARTS & ACCESSORIES

1972-1973 DOOR/QUARTER PANELS

Our 1972-73 Door/Quarter Panels are a correct reproduction of the original. We offer original Corinthian grain in 32 oz. vinyl, and correct dielectrically heat sealed patterns as original. Emblem not included.

Features

- Original Corinthian grain vinyl
- Correct dielectric "Heat Seal" stitched pattern
- Correct colors matched to the original vinyl
- .100-inch thickness poly-coated "Autoboard" backing
- Door Panel backs are perimeter stapled for maximum adhesion
- Limited lifetime warranty

FRONT DOOR PANELS	104000
SPORTSROOF REAR QUARTER PANELS	104018
FORMAL ROOF REAR QUARTER PANELS	104026



1972-73 COLORS

BLACK	L-3722 (I=L-3400)
BLUE	L-3788 (I=L-4069)
GINGER	L-4061 (I=L-4070)
GREEN	L-4234 (I=L-4238)
MAROON	L-3724 (I=L-3440)
WHITE	L-4062 (I=L-4072)

NOTE: I=Insert.

NOTE: The inserts for Maroon are Kiwi grain due to availability in Ruffino grain vinyl.

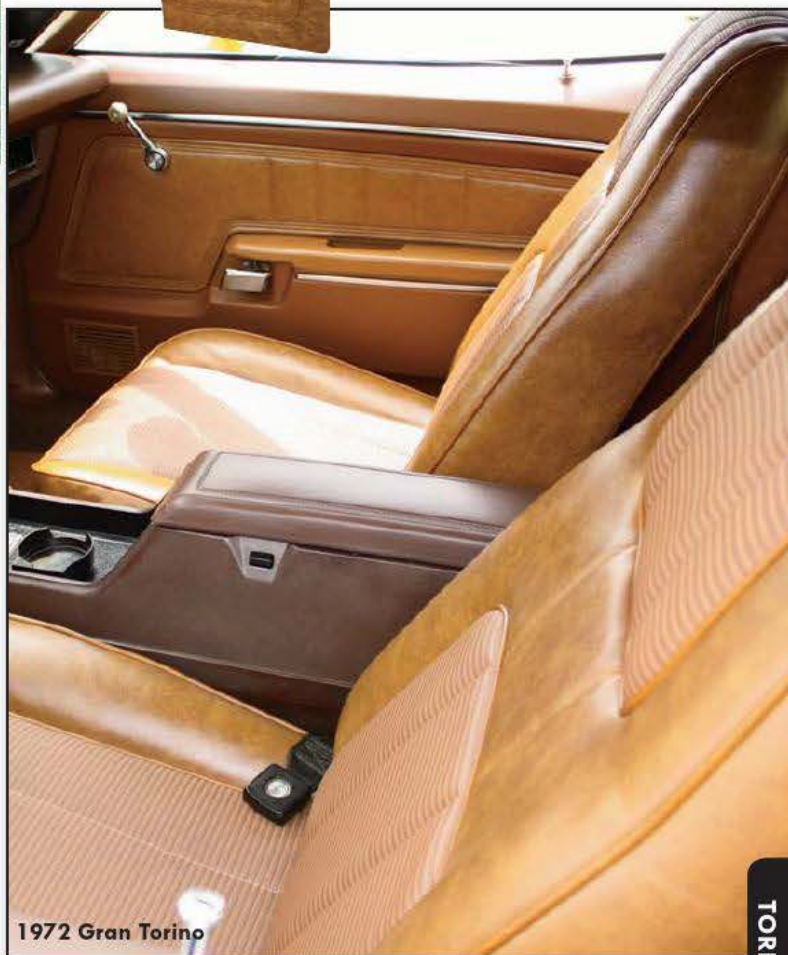

1972 Gran Torino

## 1972-73 INTERIOR PARTS & ACCESSORIES

### 1972-73 HEADLINERS/ SUNVISORS/SAIL PANELS

Our 1972-73 Headliners are in the original Tier grain vinyl, constructed just like the original.

1972-73 SPORTSROOF HEADLINER **105171**

1972-76 FORMAL ROOF HEADLINER **105163**



Our 1972-73 Sunvisors are in the original Tier grain vinyl, with the vinyl binding stitched, just like the originals. All Sunvisors are sold in pairs.

1972-79 HARDTOP SUNVISORS **105569**



Our 1972-73 Sail Panels are in the original Tier grain vinyl construction.

1972-76 FORMAL ROOF SAIL PANELS **104240**

### 1972-73 INTERIOR ACCESSORIES



Distinctive Industries Seat Heaters provide therapeutic heat and body warmth in any classic car, using the same technology as late model or current vehicles. Each kit comes with switch, harnesses, and two carbon fiber element pads to complete one seat install. Switch can be dash, console, or hidden in a place of choice. Seat Heaters are sold individually, not in pairs.

1968-76 CARBON FIBER SEAT HEATERS **061001**



### 1972-73 HEADLINER/SUNVISOR/ SAIL PANEL COLORS

BLACK	H-770
BLUE	H-1208
DARK GREEN	H-1325
GINGER	H-1217
MAROON	H-1210
RED	H-1328
WEDGEWOOD BLUE	H-1565
WHITE	H-1513



### 1972-73 COLORS

BLACK	L-3722
BLUE	L-3788
GINGER	L-4061
GREEN	L-4234
MAROON	L-3724
WHITE	L-4062

**NOTE:** The inserts for Dark Red are Kiwi grain due to availability in Ruffino grain vinyl.

**1974-76 INTERIOR PARTS & ACCESSORIES**



**1974-1976 SEAT UPHOLSTERY**

Our 1974-76 Torino Seat Upholstery is a correct reproduction of the original. We offer the original Corinthian grain in 32 oz. vinyl, with the correct vertical patterns sewn as original.

Features

- Original Corinthian grain vinyl
- Correct 6 stitch per inch stitching
- Correct colors matched to the original vinyl
- Limited lifetime warranty

GRAN TORINO BROUGHAM WITH FRONT BENCH - FRONT/REAR SET	<b>101244</b>
STANDARD BENCH SEAT - FRONT	<b>101154*</b>
GRAN TORINO BUCKET SEATS - FRONT <b>*SEEKING PATTERN*</b>	
1974 GRAN TORINO SPORT FLIGHT BENCH SEAT - FRONT	<b>101147</b>
GRAN TORINO BROUGHAM/GT BENCH SEAT - FRONT	<b>101246*</b>
1974-75 GRAN TORINO SPORT FLIGHT BENCH SEAT - REAR	<b>101149</b>
GRAN TORINO BROUGHAM 2 DOOR HARDTOP BENCH SEAT - REAR	<b>101253</b>

**\*NOTE: These front bench seats have Ruffino grain inserts.**

**1974-1976 DOOR/QUARTER PANELS**

Our 1974-76 Door/Quarter Panels are a correct reproduction of the original. We offer original Corinthian grain in 32 oz. vinyl, and correct dielectrically heat sealed patterns as original. Emblem not included.

Features

- Original Corinthian grain vinyl
- Correct dielectric "Heat Seal" stitched pattern
- Correct colors matched to the original vinyl
- .100-inch thickness poly-coated "Autoboard" backing
- Door Panel backs are perimeter stapled for maximum adhesion
- Limited lifetime warranty

FRONT DOOR PANELS	<b>104000</b>
SPORTSROOF REAR QUARTER PANELS	<b>104018</b>
FORMAL ROOF REAR QUARTER PANELS	<b>104026</b>



**1974-76 HEADLINERS/SUNVISORS**

Our 1974-76 Headliners are in the original Tier grain vinyl, constructed just like the original.

1972-76 FORMAL ROOF HEADLINER **105163**

Our 1974-76 Sunvisors are in the original Tier grain vinyl, with the vinyl binding stitched, just like the originals. All Sunvisors are sold in pairs.

1972-79 HARDTOP SUNVISORS **105569**

Our 1974-76 Sail Panels are in the original Tier grain vinyl construction.

1972-76 FORMAL ROOF SAIL PANELS **104240**

**1974-76 INTERIOR ACCESSORIES**

Distinctive Industries Seat Heaters provide therapeutic heat and body warmth in any classic car, using the same technology as late model or current vehicles. Each kit comes with switch, harnesses, and two carbon fiber element pads to complete one seat install. Switch can be dash, console, or hidden in a place of choice. Seat Heaters are sold individually, not in pairs.

1968-76 CARBON FIBER SEAT HEATERS **061001**



**1974-76 COLORS**

BLACK	L-3722	GREEN	L-4234
BLUE	L-3788	MAROON	L-3724
GINGER	L-4061	WHITE	L-4062



**1974-76 HEADLINER/SUNVISOR/SAIL PANEL COLORS**

BLACK	H-770	MAROON	H-1210
BLUE	H-1208	RED	H-1328
DARK GREEN	H-1325	WEDGEWOOD BLUE	H-1565
GINGER	H-1217	WHITE	H-1513



## Introduction To The Catalog

Thank you for choosing Distinctive Industries as your provider of Restoration Interior Products. The catalog you are reading was designed with the input of our existing customers and moving forward, will continue to be a representation of their needs, and the needs of restoration experts worldwide.

### Design

We have designed our catalog for the Restoration Professional, from the Local Upholstery and Restoration Shop, to the National Distributor of Restoration Products. The thought was to create a catalog that eases the pain of product entry for those building catalogs, and to ease ordering for those that order directly from the catalog. We accomplished this by listing product by year, model, and trim level. You will find this catalog to be easy to use.

### Descriptions

Descriptions are a blend of Marketing and Technical descriptions. After polling our customers we found that aside from the design, missing was a good description of the products in today's catalogs. We remedied that by providing a blended description as a basis for our customers to expand upon, or use as is.

### Colors

Color swatches are placed near the product with labeled color codes to avoid confusion. Color Code boxes are located near the applicable products. We offer many special order color combinations as well as an option for leather in most cases.

### Images

Images are available for License through Distinctive Industries.

- Licensed images must be accompanied and located adjacent to the matching Distinctive Industries product.

## Table of Contents

1967 Standard and Deluxe interior parts and accessories

1968 Standard and Deluxe interior parts and accessories

1969 Standard and Deluxe interior parts and accessories

1970 Standard and Custom interior parts and accessories

1971 Standard and Custom interior parts and accessories

1972 Standard interior parts and accessories

1973 Standard and Type LT interior parts and accessories

1974-76 Standard and Type LT interior parts and accessories

1977 Standard and Type LT interior parts and accessories

1978 Standard, Type LT, and Z28 interior parts and accessories

1979 Standard, Berlinetta, Type LT, and Z28 interior parts and accessories

1980-81 Standard and Custom interior parts and accessories



## 1967 STANDARD INTERIOR PARTS & ACCESSORIES

### 1967 STANDARD SEAT UPHOLSTERY

Our 1967 Camaro Standard Seat Upholstery is a correct reproduction of the original. We offer the original Madrid grain in 32 oz. vinyl, with the correct dielectrically heat sealed vertical patterns and sewn as original.

#### Features

- Original Madrid grain vinyl
- Correct dielectric "Heat Seal" Pattern
- Correct 6 stitch per inch stitching
- Correct colors matched to the original vinyl
- Limited lifetime warranty

#### Description

Description	Part #
COUPE BUCKET SEATS - FRONT/REAR SET	<b>072017</b>
COUPE BENCH SEAT - FRONT/REAR SET	<b>072025</b>
CONVERTIBLE BUCKET SEATS - FRONT/REAR SET	<b>072058</b>
FRONT BUCKET SEATS WITH FOLDING REAR BENCH - FRONT/REAR SET	<b>072066</b>
FRONT BENCH SEAT WITH FOLDING REAR BENCH - FRONT/REAR SET	<b>072074</b>
BUCKET SEATS - FRONT	<b>072009</b>
BENCH SEAT - FRONT	<b>072033</b>
COUPE BENCH SEAT - REAR	<b>072035</b>
CONVERTIBLE BENCH SEAT - REAR	<b>072041</b>
FOLD DOWN BENCH SEAT - REAR	<b>072092</b>

### 1967 STANDARD PRE-ASSEMBLED DOOR/QUARTER PANELS

Our 1967 Standard Pre-Assembled Door/Quarter Panels are a correct reproduction of the original. We offer original Madrid grain in 32 oz. vinyl, correct dielectrically heat sealed patterns and door panel trim molding as original.

#### Features

- Original Madrid grain vinyl
- Correct dielectric "Heat Seal" stitched pattern
- Correct colors matched to the original vinyl
- Trim moldings attached where applicable
- .100-inch thickness poly-coated "Autoboard" backing
- Door Panel backs are perimeter stapled for maximum adhesion
- Limited lifetime warranty

#### Description

Description	Part #
FRONT DOOR PANELS	<b>073700P</b>
COUPE REAR QUARTER PANELS	<b>073734P</b>

### 1967 STANDARD UNASSEMBLED DOOR/QUARTER PANELS

Our 1967 Standard Door/Quarter Panels are a correct reproduction of the original. We offer original Madrid grain in 32 oz. vinyl, and correct dielectrically heat sealed patterns as original.

#### Features

- Original Madrid grain vinyl
- Correct dielectric "Heat Seal" stitched pattern
- Correct colors matched to the original vinyl
- .100-inch thickness poly-coated "Autoboard" backing
- Door Panel backs are perimeter stapled for maximum adhesion
- Limited lifetime warranty

#### Description

Description	Part #
FRONT DOOR PANELS	<b>073700</b>
COUPE REAR QUARTER PANELS	<b>073734</b>
CONVERTIBLE REAR QUARTER PANELS	<b>073767</b>



### 1967 STANDARD COLORS

BLACK	L-2295
GOLD	L-3025
LIGHT BLUE	L-2302
RED	L-3048
WHITE	L-2305



## 1967 DELUXE INTERIOR PARTS & ACCESSORIES

### 1967 DELUXE SEAT UPHOLSTERY

Our 1967 Camaro Deluxe Seat Upholstery is a correct reproduction of the original. We offer the original Madrid grain in 32 oz. vinyl, with the correct dielectrically heat sealed vertical and horizontal patterns with the contrasting accent stripe and sewn as original.

#### Features

- Original Madrid grain vinyl
- Correct contrasting accent stripe
- Correct dielectric "Heat Seal" Pattern
- Correct 6 stitch per inch stitching
- Correct colors matched to the original vinyl
- Limited lifetime warranty

#### Description

Description	Part #
COUPE BUCKET SEATS - FRONT/REAR SET	072116
COUPE BENCH SEAT - FRONT/REAR SET	072124
CONVERTIBLE BUCKET SEATS - FRONT/REAR SET	072157
FRONT BUCKET SEATS WITH FOLDING REAR BENCH - FRONT/REAR SET	072165
FRONT BENCH SEAT WITH FOLDING REAR BENCH - FRONT/REAR SET	072173
BUCKET SEATS - FRONT	072108
BENCH SEAT - FRONT	072132
COUPE BENCH SEAT - REAR	072181
COUPE BENCH SEAT - REAR FOR STANDARD MODELS	072175
<i>*NOTE: This Deluxe pattern seat upholstery is for Standard rear bench seats with correct Standard upholstery dimensions.</i>	
CONVERTIBLE BENCH SEAT - REAR	072183
FOLD DOWN BENCH SEAT - REAR	072199



#### 1967 DELUXE COLORS

BLACK	L-2295
BRIGHT BLUE	L-2309
GOLD	L-3025
PARCHMENT	L-3047
RED	L-3048
TURQUOISE	L-3046
YELLOW	L-3049

#### 1967 CUSTOM LEATHER SEAT UPHOLSTERY

We offer custom leather upholstery for the 1967 Camaro. Custom options include contrasting colors and stitching, as well as solid color upholstery. *Please call for color and option availability.*

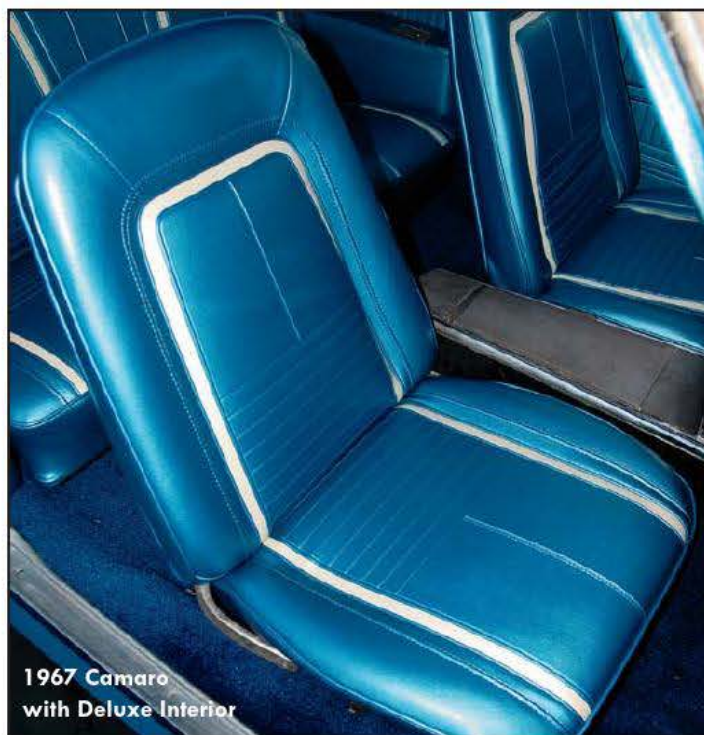

1967 Camaro  
with Deluxe Interior



## 1967 STANDARD AND DELUXE INTERIOR PARTS & ACCESSORIES

### 1967 TOURING BUCKET SEAT UPHOLSTERY & ACCESSORIES

Our 1967 Touring Bucket Seats feature raised bolsters and side panels. The Touring Seat is body contoured to create modern ergonomics for the classic car.

Features

- Original Madrid grain vinyl
- Raised bolsters and side panels
- Correct 6 stitch per inch stitching
- Correct colors matched to the original vinyl
- Limited lifetime warranty

STANDARD BUCKET SEATS - FRONT	<b>072236</b>
DELUXE BUCKET SEATS - FRONT	<b>072233</b>
1967-68 STANDARD TOURING BUCKET SEAT FOAM	<b>065013TRNGSTD6768</b>

## Take a Kid to a Car Show is dedicated to:

- Sharing the classic car hobby with kids
- Encouraging involvement by a new generation of automotive restoration enthusiasts
- Giving kids a constructive choice in how to spend their time

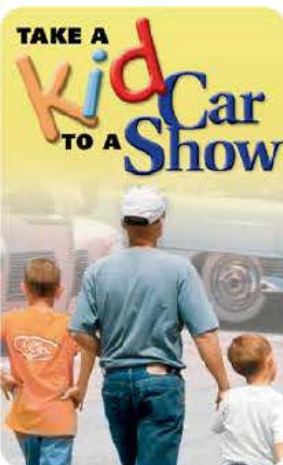

Take a Kid to a Car Show is a program of ARMO, the Automotive Restoration Market Organization, a SEMA Council.



### 1967 DELUXE UNASSEMBLED DOOR/QUARTER PANELS

Our 1967 Deluxe Door/Quarter Panels are a correct reproduction of the original. We offer original Madrid grain in 32 oz. vinyl.

Features

- Original Madrid grain vinyl
- Correct colors matched to the original vinyl
- .100-inch thickness poly-coated "Autoboard" backing
- Limited lifetime warranty

<i>Description</i>	<i>Part #</i>
FRONT DOOR PANELS - NOT AVAILABLE AT THIS TIME	
COUPE REAR QUARTER PANELS	<b>073809</b>
CONVERTIBLE REAR QUARTER PANELS	<b>073825</b>



### 1967 DELUXE COLORS

BLACK	L-2295	RED	L-3048
BRIGHT BLUE	L-2309	TURQUOISE	L-3046
GOLD	L-3025	YELLOW	L-3049
PARCHMENT	L-3047		

## 1967 STANDARD AND DELUXE INTERIOR PARTS & ACCESSORIES



### 1967 INTERIOR ACCESSORIES

Our 1967-69 Rear Armrest Upholstery is reproduced in the correct Madrid grain in 32 oz vinyl and stitched as original.

1967-69 DELUXE COUPE REAR ARMREST - WITH ASH TRAY **073403**

1967-69 CONVERTIBLE REAR ARMREST - WITH ASH TRAY **073411**

Our Convertible Top Boot features the correct Madrid grain in 32 oz. vinyl and fastens just like the original. Clips are included on the Pre-assembled Convertible Top Boot.

1967-69 CONVERTIBLE TOP BOOT **073502**

1967-69 PRE-ASSEMBLED CONVERTIBLE TOP BOOT **073504**

Our Package Tray is a high quality vinyl covered package tray. Utilizing modern material and covered in the correct Madrid grain in 32 oz for durability and long life.

1967-69 COUPE VINYL COVERED PACKAGE TRAY **072227**

Our Package Tray is a high quality colored board. Utilizing modern material for durability and long life.

1967-69 STANDARD PACKAGE TRAY BOARD **072229**

Distinctive Industries High-Density Seat Foam is designed to work as a system with our upholstery. Our High-Density Seat Foam is firm, form fitting, and features a Typar® web backing for strength, which prevents spring intrusion and ensures a quality fit and long lasting life. Seat Foam is sold individually, not in pairs.

1967-68 STANDARD BUCKET SEAT FOAM **065003BUCKET6768**  
DELUXE BUCKET SEAT FOAM **065010BUCKET67DLX**



Distinctive Industries Seat Heaters provide therapeutic heat and body warmth in any classic car, using the same technology as late model or current vehicles. Each kit comes with switch, harnesses, and two carbon fiber element pads to complete one seat install. Switch can be dash, console, or hidden in a place of choice. Seat Heaters are sold individually, not in pairs.

1967-81 CARBON FIBER SEAT HEATERS **061001**

### 1967 STANDARD/DELUXE COLORS

BLACK	L-2295	PARCHMENT	L-3047
BRIGHT BLUE	L-2309	RED	L-3048
GOLD	L-3025	TURQUOISE	L-3046
LIGHT BLUE	L-2302	YELLOW	L-3049







## 1968 STANDARD INTERIOR PARTS & ACCESSORIES

### 1968 STANDARD SEAT UPHOLSTERY

Our 1968 Camaro Standard Seat Upholstery is a correct reproduction of the original. We offer the original Madrid grain in 32 oz. vinyl, with the correct dielectrically heat sealed patterns as well as being sewn as original.

#### Features

- Original Madrid grain vinyl
- Correct dielectric "Heat Seal" Pattern
- Correct 6 stitch per inch stitching
- Correct colors matched to the original vinyl
- Limited lifetime warranty

#### Description

Description	Part #
COUPE BUCKET SEATS - FRONT/REAR SET	<b>072017</b>
COUPE BENCH SEAT - FRONT/REAR SET	<b>072025</b>
CONVERTIBLE BUCKET SEATS - FRONT/REAR SET	<b>072058</b>
FRONT BUCKET SEATS WITH FOLDING REAR BENCH - FRONT/REAR SET	<b>072207</b>
FRONT BENCH SEAT WITH FOLDING REAR BENCH - FRONT/REAR SET	<b>072215</b>
BUCKET SEATS - FRONT	<b>072009</b>
BENCH SEAT - FRONT	<b>072033</b>
COUPE BENCH SEAT - REAR	<b>072035</b>
CONVERTIBLE BENCH SEAT - REAR	<b>072041</b>
FOLD DOWN BENCH SEAT - REAR	<b>072223</b>



#### 1968 STANDARD COLORS

BLACK	L-2295
RED	L-3048
WHITE	L-2305

1968 Camaro Z28

## 1968 STANDARD INTERIOR PARTS & ACCESSORIES

### 1968 STANDARD PRE-ASSEMBLED DOOR/QUARTER PANELS

Our 1968 Standard Pre-Assembled Door/Quarter Panels are a correct reproduction of the original. We offer original Madrid grain in 32 oz. vinyl as well as correct horizontal dielectrically heat sealed patterns as original. Our interior door panels come assembled and feature metal upper rails, door lock ferrules, interior door to window seals, as well as interior door panel moldings.

#### Features

- Original Madrid grain vinyl
- Correct horizontal dielectric "Heat Seal" Pattern
- Correct colors matched to the original vinyl
- Metal upper rail
- Door lock ferrules
- Interior door to window seals
- Door panel trim moldings attached
- .100-inch thickness poly-coated "Autoboard" backing
- Door Panel backs are perimeter stapled for maximum adhesion
- Limited lifetime warranty

Description	Part #
FRONT DOOR PANELS	073718P
COUPE REAR QUARTER PANELS	073742P
CONVERTIBLE REAR QUARTER PANELS	073775P

\* Convertible Rear Quarter Panels have ABS plastic upper rails.

### 1968 STANDARD UNASSEMBLED DOOR/QUARTER PANELS

Our 1968 Standard Door/Quarter Panels are a correct reproduction of the original. We offer original Madrid grain in 32 oz. vinyl, and correct dielectrically heat sealed patterns as original.

#### Features

- Original Madrid grain vinyl
- Correct dielectric "Heat Seal" Pattern
- Correct colors matched to the original vinyl
- .100-inch thickness poly-coated "Autoboard" backing
- Door Panel backs are perimeter stapled for maximum adhesion
- Limited lifetime warranty

Description	Part #
FRONT DOOR PANELS	073718
COUPE REAR QUARTER PANELS	073742
CONVERTIBLE REAR QUARTER PANELS	073775



### 1968 STANDARD COLORS

BLACK	L-2295
GREEN GOLD	L-3307
MEDIUM BLUE	L-3297
RED	L-3048
WHITE	L-2305

## 1968 DELUXE INTERIOR PARTS & ACCESSORIES

### 1968 DELUXE/HOUNDSTOOTH SEAT UPHOLSTERY

#### Deluxe

Our 1968 Camaro Deluxe Seat Upholstery is a correct reproduction of the original. We offer the original Madrid grain in 32 oz. vinyl, with the correct horizontal dielectrically heat sealed pleats as well as being sewn as original. Emblems not included.

#### Features

- Original Madrid grain vinyl
- Correct dielectric "Heat Seal" Pattern
- Correct 6 stitch per inch stitching
- Correct colors matched to the original vinyl
- Limited lifetime warranty

#### Description

COUPE BUCKET SEATS - FRONT/REAR SET	<b>072322</b>
COUPE BENCH SEAT - FRONT/REAR SET	<b>072306</b>
CONVERTIBLE BUCKET SEATS - FRONT/REAR SET	<b>072363</b>
FRONT BUCKET SEATS WITH FOLDING REAR BENCH - FRONT/REAR SET	<b>072348</b>
FRONT BENCH SEAT WITH FOLDING REAR BENCH - FRONT/REAR SET	<b>072355</b>
BUCKET SEATS - FRONT	<b>072330</b>
BENCH SEAT - FRONT	<b>072314</b>
COUPE BENCH SEAT - REAR	<b>072371</b>
CONVERTIBLE BENCH SEAT - REAR	<b>072389</b>
FOLD DOWN BENCH SEAT - REAR	<b>072397</b>

#### Houndstooth

Our 1968 Camaro Houndstooth Seat Upholstery utilizes the 1969 Houndstooth pattern. We offer the sought after Houndstooth material, with the correct horizontal pleats stitched as original. Emblems not included.

#### Features

- Houndstooth material
- Correct horizontal pleats
- Correct 6 stitch per inch stitching
- Limited lifetime warranty

#### Description

COUPE BUCKET SEATS - FRONT/REAR SET	<b>072720</b>
CONVERTIBLE BUCKET SEATS - FRONT/REAR SET	<b>072721</b>
FRONT BUCKET SEATS WITH FOLDING REAR BENCH - FRONT/REAR SET	<b>072722</b>
COUPE/CONVERTIBLE BUCKET SEATS - FRONT	<b>072723</b>
COUPE BENCH SEAT - REAR	<b>072724</b>
CONVERTIBLE BENCH SEAT - REAR	<b>072725</b>
FOLD DOWN BENCH SEAT - REAR	<b>072726</b>

### 1968 CUSTOM LEATHER SEAT UPHOLSTERY

We offer custom leather upholstery for the 1968 Camaro. Custom options include contrasting colors and stitching, as well as solid color upholstery. *Please call for color and option availability.*



### 1968 HOUNDSTOOTH COLORS

BLACK	L-2295
PEARL	L-2305

### 1968 DELUXE COLORS

BLACK	L-2295	RED	L-3048
GREEN GOLD	L-3307	TURQUOISE	L-3046
MEDIUM BLUE	L-3297	WHITE	L-2305
PARCHMENT	L-3295		



### 1968 TOURING BUCKET SEAT UPHOLSTERY & ACCESSORIES

Our 1968 Touring Bucket Seats feature raised bolsters and side panels. The Touring Seat is body contoured to create modern ergonomics for the classic car.

#### Features

- Original Madrid grain vinyl for Deluxe interiors
- Houndstooth material for Houndstooth interiors
- Raised bolsters and side panels
- Correct 6 stitch per inch stitching
- Correct colors matched to the original vinyl
- Limited lifetime warranty

HOUNDSTOOTH BUCKET SEATS - FRONT	<b>072300</b>
DELUXE BUCKET SEATS - FRONT	<b>072301</b>

## 1968 DELUXE INTERIOR PARTS & ACCESSORIES

### 1968 DELUXE PRE-ASSEMBLED DOOR/QUARTER PANELS

Our 1968 Deluxe Pre-Assembled Door/Quarter Panels are a correct reproduction of the original. We offer original Madrid grain in 32 oz. vinyl. Our interior Door/Quarter Panels come assembled and feature metal upper rails, interior to window seals, as well as interior door panel moldings.

**Features**

- Original Madrid grain vinyl
- Correct colors matched to the original vinyl
- Metal upper rail
- Interior Quarter Panel to window seals
- Quarter Panel trim moldings attached
- .100-inch thickness poly-coated "Autoboard" backing
- Limited lifetime warranty

**Description**

FRONT DOOR PANELS - NOT AVAILABLE AT THIS TIME  
 COUPE REAR QUARTER PANELS  
 CONVERTIBLE REAR QUARTER PANELS

**Part #**

073817P  
 073833P

\* *Convertible Rear Quarter Panels have ABS plastic upper rails.*

### 1968 DELUXE UNASSEMBLED DOOR/QUARTER PANELS

Our 1968 Deluxe Door/Quarter Panels are a correct reproduction of the original. We offer original Madrid grain in 32 oz. vinyl.

**Features**

- Original Madrid grain vinyl
- Correct colors matched to the original vinyl
- .100-inch thickness poly-coated "Autoboard" backing
- Limited lifetime warranty

**Description**

FRONT DOOR PANELS - NOT AVAILABLE AT THIS TIME  
 COUPE REAR QUARTER PANELS  
 CONVERTIBLE REAR QUARTER PANELS

**Part #**

073817  
 073833



**1968 DELUXE COLORS**

BLACK	L-2295	RED	L-3048
GREEN GOLD	L-3307	TURQUOISE	L-3046
MEDIUM BLUE	L-3297	WHITE	L-2305
PARCHMENT	L-3295		



## 1968 STANDARD AND DELUXE INTERIOR PARTS & ACCESSORIES

### 1968 INTERIOR ACCESSORIES

Our 1967-69 Rear Armrest Upholstery is reproduced in the correct Madrid grain in 32 oz vinyl and stitched as original.

1967-69 DELUXE COUPE REAR ARMREST - WITH ASH TRAY **073403**

1967-69 CONVERTIBLE REAR ARMREST - WITH ASH TRAY **073411**

Our Convertible Top Boot features the correct Madrid grain in 32 oz. vinyl and fastens just like the original. Clips are included on the Pre-assembled Convertible Top Boot.

1967-69 CONVERTIBLE TOP BOOT **073502**

1967-69 PRE-ASSEMBLED CONVERTIBLE TOP BOOT **073504**

Our Package Tray is a high quality vinyl covered package tray. Utilizing modern material and covered in the correct Madrid grain in 32 oz for durability and long life.

1967-69 COUPE VINYL COVERED PACKAGE TRAY **072227**

Our Package Tray is a high quality colored board. Utilizing modern material for durability and long life.

1967-69 STANDARD PACKAGE TRAY BOARD **072229**

Distinctive Industries High-Density Seat Foam is designed to work as a system with our upholstery. Our High-Density Seat Foam is firm, form fitting, and features a Typar® web backing for strength, which prevents spring intrusion and ensures a quality fit and long lasting life. Seat Foam is sold individually, not in pairs.

1967-68 STANDARD BUCKET SEAT FOAM **065003BUCKET6768**

DELUXE BUCKET SEAT FOAM **065007CAM68**

Distinctive Industries Seat Heaters provide therapeutic heat and body warmth in any classic car, using the same technology as late model or current vehicles. Each kit comes with switch, harnesses, and two carbon fiber element pads to complete one seat install. Switch can be dash, console, or hidden in a place of choice. Seat Heaters are sold individually, not in pairs.

1967-81 CARBON FIBER SEAT HEATERS **061001**

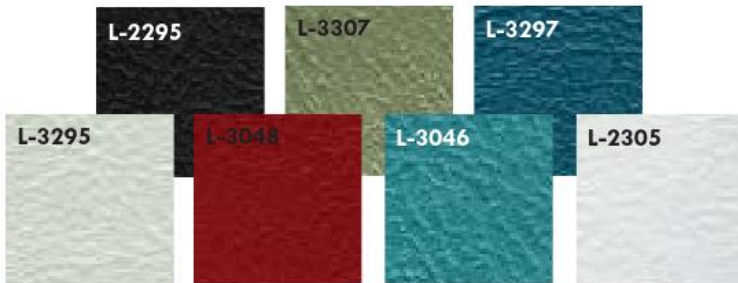

### 1968 DELUXE COLORS

BLACK	L-2295	RED	L-3048
GREEN GOLD	L-3307	TURQUOISE	L-3046
MEDIUM BLUE	L-3297	WHITE	L-2305
PARCHMENT	L-3295		

## 1969 STANDARD INTERIOR PARTS & ACCESSORIES

### 1969 STANDARD SEAT UPHOLSTERY

Our 1969 Camaro Standard Seat Upholstery is a correct reproduction of the original. We offer the original Madrid grain in 32 oz. vinyl, with the correct dielectrically heat sealed horizontal patterns as well as being sewn as original.

#### Features

- Original Madrid grain vinyl
- Correct dielectric "Heat Seal" Pattern
- Correct 6 stitch per inch stitching
- Correct colors matched to the original vinyl
- Limited lifetime warranty

#### Description

Description	Part #
COUPE BUCKET SEATS - FRONT/REAR SET	<b>072405</b>
CONVERTIBLE BUCKET SEATS - FRONT/REAR SET	<b>072439</b>
FRONT BUCKET SEATS WITH FOLDING REAR BENCH - FRONT/REAR SET	<b>072421</b>
BUCKET SEATS - FRONT	<b>072413</b>
COUPE BENCH SEAT - REAR	<b>072447</b>
CONVERTIBLE BENCH SEAT - REAR	<b>072454</b>
FOLD DOWN BENCH SEAT - REAR	<b>072462</b>

### 1969 STANDARD PRE-ASSEMBLED DOOR/QUARTER PANELS

Our 1969 Standard Pre-Assembled Door/Quarter Panels are a correct reproduction of the original. We offer original Madrid grain in 32 oz. vinyl as well as correct horizontal dielectrically heat sealed patterns as original. Our interior door panels come assembled and feature metal upper rails, door lock ferrules, interior door to window seals, as well as interior door panel moldings.

#### Features

- Original Madrid grain vinyl
- Correct horizontal dielectric "Heat Seal" Pattern
- Correct colors matched to the original vinyl
- Metal upper rail
- Interior door to window seals and door lock ferrules
- Door panel trim moldings attached
- .100-inch thickness poly-coated "Autoboard" backing
- Door Panel backs are perimeter stapled for maximum adhesion
- Limited lifetime warranty

#### Description

Description	Part #
FRONT DOOR PANELS	<b>073726P</b>
COUPE REAR QUARTER PANELS	<b>073759P</b>
CONVERTIBLE REAR QUARTER PANELS	<b>073783P</b>

\* Convertible Rear Quarter Panels have ABS plastic upper rails.

### 1969 STANDARD UNASSEMBLED DOOR/QUARTER PANELS

Our 1969 Standard Door/Quarter Panels are a correct reproduction of the original. We offer original Madrid grain in 32 oz. vinyl, and correct dielectrically heat sealed patterns as original.

#### Features

- Original Madrid grain vinyl
- Correct dielectric "Heat Seal" Pattern
- Correct colors matched to the original vinyl
- .100-inch thickness poly-coated "Autoboard" backing
- Door Panel backs are perimeter stapled for maximum adhesion
- Limited lifetime warranty

#### Description

Description	Part #
FRONT DOOR PANELS	<b>073726</b>
COUPE REAR QUARTER PANELS	<b>073759</b>
CONVERTIBLE REAR QUARTER PANELS	<b>073783</b>



#### 1969 STANDARD COLORS

BLACK	L-2295
DARK BLUE	L-3598
DARK GREEN	L-3606
IVORY	L-2305
MEDIUM GREEN	L-3603
RED	L-3597

## 1969 DELUXE INTERIOR PARTS & ACCESSORIES

### 1969 DELUXE/HOUNDSTOOTH SEAT UPHOLSTERY

#### Deluxe

Our 1969 Camaro Deluxe Seat Upholstery is a correct reproduction of the original. We offer the original Madrid grain with simulated Comfortweave inserts in 32 oz. vinyl, with the correct vertical pleats and buttons. Includes seat back medallions or buttons.

#### Features

- Original Madrid grain vinyl
- Comfortweave inserts
- Correct 6 stitch per inch stitching
- Correct colors matched to the original vinyl
- Limited lifetime warranty

#### Description

COUPE BUCKET SEATS - FRONT/REAR SET	<b>072504</b>
CONVERTIBLE BUCKET SEATS - FRONT/REAR SET	<b>072538</b>
FRONT BUCKET SEATS WITH FOLDING REAR BENCH - FRONT/REAR SET	<b>072520</b>
BUCKET SEATS - FRONT	<b>072512</b>
COUPE BENCH SEAT - REAR	<b>072546</b>
CONVERTIBLE BENCH SEAT - REAR	<b>072553</b>
FOLD DOWN BENCH SEAT - REAR	<b>072561</b>

#### Houndstooth

Our 1969 Camaro Deluxe Houndstooth Seat Upholstery is a correct reproduction of the original. We offer the original Madrid grain in 32 oz. vinyl, with the correct Houndstooth cloth inserts along with the correct vertical pleats and buttons. Includes seat back medallions or buttons.

#### Features

- Original Madrid grain vinyl
- Houndstooth inserts
- Correct 6 stitch per inch stitching
- Correct colors matched to the original vinyl
- Limited lifetime warranty

#### Description

COUPE BUCKET SEATS - FRONT/REAR SET	<b>072712</b>
CONVERTIBLE BUCKET SEATS - FRONT/REAR SET	<b>072713</b>
BUCKET SEATS WITH FOLDING REAR BENCH - FRONT/REAR SET	<b>072714</b>
COUPE/CONVERTIBLE BUCKET SEATS - FRONT	<b>072715</b>
COUPE BENCH SEAT - REAR	<b>072716</b>
CONVERTIBLE BENCH SEAT - REAR	<b>072717</b>
FOLD DOWN BENCH SEAT - REAR	<b>072718</b>

### 1969 CUSTOM LEATHER SEAT UPHOLSTERY

We offer custom leather upholstery for the 1969 Camaro. Custom options include contrasting colors and stitching, as well as solid color upholstery. **Please call for color and option availability.**



### 1969 DELUXE COLORS

BLACK	L-2295	MEDIUM GREEN	L-3603
DARK BLUE	L-3598	RED	L-3597
DARK GREEN	L-3606		

### 1969 TOURING BUCKET SEAT UPHOLSTERY & ACCESSORIES

Our 1969 Touring Bucket Seats feature raised bolsters and side panels. The Touring Seat is body contoured to create modern ergonomics for the classic car.

#### Features

- Original Madrid grain vinyl for Deluxe interiors
- Houndstooth material for Houndstooth interiors
- Raised bolsters and side panels
- Correct 6 stitch per inch stitching
- Correct colors matched to the original vinyl
- Limited lifetime warranty

HOUNDSTOOTH BUCKET SEATS - FRONT	<b>072468</b>
DELUXE BUCKET SEATS - FRONT	<b>072470</b>

#### L-2295



#### L-1969



### 1969 HOUNDSTOOTH COLORS

BLACK/ORANGE	L-2295
BLACK/IVORY	L-2295
ORANGE/BLACK	L-1969
IVORY/BLACK	L-2305

## 1969 STANDARD AND DELUXE INTERIOR PARTS & ACCESSORIES

### 1969 DELUXE PRE-ASSEMBLED DOOR/QUARTER PANELS

Our 1969 Deluxe Pre-Assembled Door/Quarter Panels are a correct reproduction of the original. We offer original Madrid grain in 32 oz. vinyl. Our interior Door/Quarter Panels come assembled and feature metal upper rails, interior to window seals, as well as interior door panel moldings.

#### Features

- Original Madrid grain vinyl
- Correct colors matched to the original vinyl
- Metal upper rail
- Interior Quarter Panel to window seals
- Quarter Panel trim moldings attached
- .100-inch thickness poly-coated "Autoboard" backing
- Limited lifetime warranty

#### Description

FRONT DOOR PANELS - NOT AVAILABLE AT THIS TIME

COUPE REAR QUARTER PANELS

CONVERTIBLE REAR QUARTER PANELS

\* **Convertible Rear Quarter Panels have ABS plastic upper rails.**

#### Part #

**073817P**

**073833P**



### 1969 DELUXE UNASSEMBLED DOOR/QUARTER PANELS

Our 1969 Deluxe Door/Quarter Panels are a correct reproduction of the original. We offer original Madrid grain in 32 oz. vinyl.

#### Features

- Original Madrid grain vinyl
- Correct colors matched to the original vinyl
- .100-inch thickness poly-coated "Autoboard" backing
- Limited lifetime warranty

#### Description

FRONT DOOR PANELS - NOT AVAILABLE AT THIS TIME

COUPE REAR QUARTER PANELS

CONVERTIBLE REAR QUARTER PANELS

#### Part #

**073817**

**073833**



### 1969 DELUXE COLORS



BLACK	L-2295
DARK BLUE	L-3598
DARK GREEN	L-3606
MEDIUM GREEN	L-3603
RED	L-3597





## 1969 STANDARD AND DELUXE INTERIOR PARTS & ACCESSORIES



### 1969 INTERIOR ACCESSORIES

Our 1967-69 Rear Armrest Upholstery is reproduced in the correct Madrid grain in 32 oz vinyl and stitched as original.

1967-69 DELUXE COUPE REAR ARMREST - WITH ASH TRAY **073403**

1967-69 CONVERTIBLE REAR ARMREST - WITH ASH TRAY **073411**

Our Convertible Top Boot features the correct Madrid grain in 32 oz. vinyl and fastens just like the original. Clips are included on the Pre-assembled Convertible Top Boot.

1967-69 CONVERTIBLE TOP BOOT **073502**

1967-69 PRE-ASSEMBLED CONVERTIBLE TOP BOOT **073504**

Our Package Tray is a high quality vinyl covered package tray. Utilizing modern material and covered in the correct Madrid grain in 32 oz for durability and long life.

1967-69 HARDTOP VINYL COVERED PACKAGE TRAY **072227**

Our Package Tray is a high quality colored board. Utilizing modern material for durability and long life.

1967-69 STANDARD PACKAGE TRAY BOARD **072229**

Distinctive Industries Headrest Cover features the correct Madrid grain in 32 oz vinyl, just like the original.

HEADREST COVER **073445**

Distinctive Industries High-Density Seat Foam is designed to work as a system with our upholstery. Our High-Density Seat Foam is firm, form fitting, and features a Typar® web backing for strength, which prevents spring intrusion and ensures a quality fit and long lasting life. Seat Foam is sold individually, not in pairs.

STANDARD BUCKET SEAT FOAM **065006CAM69**

DELUXE BUCKET SEAT FOAM **065007CAM68**

STANDARD TOURING BUCKET SEAT FOAM **065016TRNGSTD69**

DELUXE TOURING BUCKET SEAT FOAM **065023TRGDLX69**

Distinctive Industries Seat Heaters provide therapeutic heat and body warmth in any classic car, using the same technology as late model or current vehicles. Each kit comes with switch, harnesses, and two carbon fiber element pads to complete one seat install. Switch can be dash, console, or hidden in a place of choice. Seat Heaters are sold individually, not in pairs.

1967-81 CARBON FIBER SEAT HEATERS **061001**

**Don't Forget About SEAT HEATERS!!!**

Now Available Easy to install  
PerfectFit® Carbon Fiber Seat Heaters  
with a small concealable switch

**PART #061001**

#### 1969 STANDARD COLORS

BLACK	L-2295
DARK BLUE	L-3598
DARK GREEN	L-3606
IVORY	L-2305
MEDIUM GREEN	L-3603
RED	L-3597

#### 1969 DELUXE COLORS

BLACK	L-2295
DARK BLUE	L-3598
DARK GREEN	L-3606
MEDIUM GREEN	L-3603
RED	L-3597



## 1970 STANDARD AND CUSTOM INTERIOR PARTS & ACCESSORIES

### 1970 STANDARD SEAT UPHOLSTERY

Our 1970 Camaro Standard Seat Upholstery is a correct reproduction of the original. We offer the original Madrid grain with Laredo inserts in 32 oz. vinyl, with the correct dielectrically heat sealed horizontal patterns as well as being sewn as original.

#### Features

- Original Madrid grain vinyl
- Laredo grain inserts
- Correct dielectric "Heat Seal" Pattern
- Correct 6 stitch per inch stitching
- Correct colors matched to the original vinyl
- Limited lifetime warranty

#### Description

BUCKET SEATS - FRONT/REAR SET  
 BUCKET SEATS - FRONT  
 REAR SEAT

#### Part #

**072587**  
**072595**  
**072603**

### 1970 STANDARD UNASSEMBLED DOOR PANELS

Our 1970 Standard Door Panels are a correct reproduction of the original. We offer original Madrid grain in 32 oz. vinyl, and correct dielectrically heat sealed patterns as original.

#### Features

- Original Madrid grain vinyl
- Correct dielectric "Heat Seal" Pattern
- Correct colors matched to the original vinyl
- .100-inch thickness poly-coated "Autoboard" backing
- Door Panel backs are perimeter stapled for maximum adhesion
- Limited lifetime warranty

1970-71 FRONT DOOR PANELS

**072611**

### 1970 CUSTOM SEAT UPHOLSTERY

Our 1970 Camaro Custom Seat Upholstery is a correct reproduction of the original. We offer the original Madrid grain with simulated Comfortweave inserts in 32 oz. vinyl correctly sewn as original.

#### Features

- Original Madrid grain vinyl
- Comfortweave inserts
- Correct 6 stitch per inch stitching
- Correct colors matched to the original vinyl
- Limited lifetime warranty

#### Description

BUCKET SEATS - FRONT  
 REAR SEAT

#### Part #

**072637**  
**072645**

### 1970 STANDARD/CUSTOM COLORS

BLACK	L-2295
GREEN	L-3606
METALLIC BLUE	L-3319
SANDALWOOD	L-4138
SADDLE	L-3887



### 1970 CUSTOM LEATHER SEAT UPHOLSTERY

We offer custom leather upholstery for the 1970 Camaro. Custom options include contrasting colors and stitching, as well as solid color upholstery. *Please call for color and option availability.*

### 1970 INTERIOR ACCESSORIES

Distinctive Industries Seat Heaters provide therapeutic heat and body warmth in any classic car, using the same technology as late model or current vehicles. Each kit comes with switch, harnesses, and two carbon fiber element pads to complete one seat install. Switch can be dash, console, or hidden in a place of choice. Seat Heaters are sold individually, not in pairs.

1967-81 CARBON FIBER SEAT HEATERS

**061001**

### 1970 HEADLINERS

Our 1970 Headliners are in the original Premier Perforated grain vinyl, constructed just like the original. Headliners come with extra material to cover Sunvisors.

1970-73 HEADLINER

**072480**

### 1970 HEADLINER COLORS

BLACK	H-1179
DARK BLUE	H-1183
DARK GREEN	H-1276
DARK SADDLE	H-1185
SANDALWOOD	H-1180
WHITE	H-1181



## 1971 STANDARD INTERIOR PARTS & ACCESSORIES

### 1971 STANDARD SEAT UPHOLSTERY

Our 1971 Camaro Standard Seat Upholstery is a correct reproduction of the original. We offer the original Madrid grain with Elk grain inserts in 32 oz. vinyl correctly sewn as original.

#### Features

- Original Madrid grain vinyl
- Elk grain inserts
- Correct 6 stitch per inch stitching
- Correct colors matched to the original vinyl
- Limited lifetime warranty

#### Description

1971-72 BUCKET SEATS - FRONT/REAR SET  
 1971-72 BUCKET SEATS - FRONT  
 1971-72 REAR SEAT

#### Part #

**073932**  
**073908**  
**073916**



### 1971 STANDARD UNASSEMBLED DOOR PANELS

Our 1971 Standard Door Panels are a correct reproduction of the original. We offer original Madrid grain in 32 oz. vinyl, and correct dielectrically heat sealed patterns as original.

#### Features

- Original Madrid grain vinyl
- Correct dielectric "Heat Seal" Pattern
- Correct colors matched to the original vinyl
- .100-inch thickness poly-coated "Autoboard" backing
- Door Panel backs are perimeter stapled for maximum adhesion
- Limited lifetime warranty

1970-71 FRONT DOOR PANELS

**072611**

### 1971 CUSTOM UNASSEMBLED DOOR PANELS

Our 1971 Custom Door Panels are a correct reproduction of the original. We offer original Madrid grain in 32 oz. vinyl, and correct dielectrically heat sealed patterns as original.

#### Features

- Original Madrid grain vinyl
- Correct dielectric "Heat Seal" Pattern
- Correct colors matched to the original vinyl
- .100-inch thickness poly-coated "Autoboard" backing
- Door Panel backs are perimeter stapled for maximum adhesion
- Limited lifetime warranty

FRONT DOOR PANELS

**072702**

### 1971 CUSTOM LEATHER SEAT UPHOLSTERY

We offer custom leather upholstery for the 1971 Camaro. Custom options include contrasting colors and stitching, as well as solid color upholstery. *Please call for color and option availability.*

### 1971 INTERIOR ACCESSORIES

Distinctive Industries Seat Heaters provide therapeutic heat and body warmth in any classic car, using the same technology as late model or current vehicles. Each kit comes with switch, harnesses, and two carbon fiber element pads to complete one seat install. Switch can be dash, console, or hidden in a place of choice. Seat Heaters are sold individually, not in pairs.

1967-81 CARBON FIBER SEAT HEATERS

**061001**

### 1971 HEADLINERS

Our 1971 Headliners are in the original Premier Perforated grain vinyl, constructed just like the original. Headliners come with extra material to cover Sunvisors.

1970-73 HEADLINER

**072480**

#### 1971 HEADLINER COLORS

BLACK	H-1179
DARK BLUE	H-1183
DARK GREEN	H-1276
DARK SADDLE	H-1185
SANDALWOOD	H-1180
WHITE	H-1181

#### 1971 STANDARD/CUSTOM COLORS

BLACK	L-2295
DARK BLUE	L-4135
DARK JADE	L-4146
DARK SANDALWOOD	L-4139
SANDALWOOD	L-4138



## 1972 STANDARD INTERIOR PARTS & ACCESSORIES

### 1972 STANDARD SEAT UPHOLSTERY

Our 1972 Camaro Standard Seat Upholstery is a correct reproduction of the original. We offer the original Madrid grain with Elk grain inserts in 32 oz. vinyl correctly sewn as original. Includes seat back medallions or buttons.

#### Features

- Original Madrid grain vinyl
- Elk grain inserts
- Correct 6 stitch per inch stitching
- Correct colors matched to the original vinyl
- Limited lifetime warranty

#### Description

1971-72 BUCKET SEATS - FRONT/REAR SET

1971-72 BUCKET SEATS - FRONT

1971-72 REAR SEAT

#### Part #

**073932**

**073908**

**073916**



### 1972 STANDARD COLORS

BLACK	L-2295
BLUE	L-4135
COVERT	L-4425
GREEN	L-4424
TAN	L-4426
WHITE	L-4421

### 1972 HEADLINER COLORS

BLACK	H-1179
DARK BLUE	H-1183
DARK GREEN	H-1276
DARK SADDLE	H-1185
SANDALWOOD	H-1180
WHITE	H-1181

### 1972 STANDARD UNASSEMBLED DOOR PANELS



Our 1972 Standard Door Panels are a correct reproduction of the original. We offer original Madrid grain in 32 oz. vinyl, and correct dielectrically heat sealed patterns as original.

#### Features

- Original Madrid grain vinyl
- Correct dielectric "Heat Seal" Pattern
- Correct colors matched to the original vinyl
- .100-inch thickness poly-coated "Autoboard" backing
- Door Panel backs are perimeter stapled for maximum adhesion
- Limited lifetime warranty

FRONT DOOR PANELS

**072744**

### 1972 HEADLINERS

Our 1972 Headliners are in the original Premier Perforated grain vinyl, constructed just like the original. Headliners come with extra material to cover Sunvisors.

1970-73 HEADLINER

**072480**

### 1972 INTERIOR ACCESSORIES

Distinctive Industries Seat Heaters provide therapeutic heat and body warmth in any classic car, using the same technology as late model or current vehicles. Each kit comes with switch, harnesses, and two carbon fiber element pads to complete one seat install. Switch can be dash, console, or hidden in a place of choice. Seat Heaters are sold individually, not in pairs.

1967-81 CARBON FIBER SEAT HEATERS

**061001**

### 1972 CUSTOM LEATHER SEAT UPHOLSTERY

We offer custom leather upholstery for the 1972 Camaro. Custom options include contrasting colors and stitching, as well as solid color upholstery. *Please call for color and option availability.*

**Don't Forget About SEAT HEATERS!!!**

**Now Available Easy to install  
PerfectFit® Carbon Fiber Seat Heaters**  
with a small concealable switch  
**PART #061001**





## 1973 STANDARD AND CUSTOM INTERIOR PARTS & ACCESSORIES

### 1973 STANDARD SEAT UPHOLSTERY

Our 1973 Camaro Standard Seat Upholstery is a correct reproduction of the original. We offer the original Madrid grain with Turbo grain inserts in 32 oz. vinyl correctly sewn as original. Includes seat back medallions or buttons.

#### Features

- Original Madrid grain vinyl
- Turbo grain inserts
- Correct 6 stitch per inch stitching
- Correct colors matched to the original vinyl
- Limited lifetime warranty

#### Description

BUCKET SEATS - FRONT/REAR SET  
 BUCKET SEATS - FRONT  
 REAR SEAT

#### Part #

**072769**  
**072777**  
**072785**



### 1973 STANDARD/ CUSTOM COLORS

BEIGE	L-4535
BLACK	L-2295
GREEN	L-4513
SADDLE	L-4544
WHITE	L-2305

### 1973 STANDARD UNASSEMBLED DOOR PANELS

Our 1973 Standard Door Panels are a correct reproduction of the original. We offer original Madrid grain in 32 oz. vinyl, and correct dielectrically heat sealed patterns as original.

#### Features

- Original Madrid grain vinyl
- Correct dielectric "Heat Seal" Pattern
- Correct colors matched to the original vinyl
- .100-inch thickness poly-coated "Autoboard" backing
- Door Panel backs are perimeter stapled for maximum adhesion
- Limited lifetime warranty

1973-75 FRONT DOOR PANELS

**072793**

### 1973 TYPE LT SEAT UPHOLSTERY

Our 1973 Camaro Custom Seat Upholstery is a correct reproduction of the original. We offer the original Madrid grain with simulated Comfortweave inserts in 32 oz. vinyl, with the correct vertical pleats and buttons.

#### Features

- Original Madrid grain vinyl
- Comfortweave inserts
- Correct 6 stitch per inch stitching
- Correct colors matched to the original vinyl
- Limited lifetime warranty

#### Description

TYPE LT BUCKET SEATS - FRONT/REAR SET  
 TYPE LT BUCKET SEATS - FRONT  
 TYPE LT REAR SEAT

#### Part #

**072802**  
**072803**  
**072804**

### 1973 CUSTOM LEATHER SEAT UPHOLSTERY

We offer custom leather upholstery for the 1973 Camaro. Custom options include contrasting colors and stitching, as well as solid color upholstery. *Please call for color and option availability.*

### 1973 INTERIOR ACCESSORIES

Distinctive Industries Seat Heaters provide therapeutic heat and body warmth in any classic car, using the same technology as late model or current vehicles. Each kit comes with switch, harnesses, and two carbon fiber element pads to complete one seat install. Switch can be dash, console, or hidden in a place of choice. Seat Heaters are sold individually, not in pairs.

1967-81 CARBON FIBER SEAT HEATERS

**061001**

### 1973 HEADLINERS

Our 1973 Headliners are in the original Premier Perforated grain vinyl, constructed just like the original. Headliners come with extra material to cover Sunvisors.

1970-73 HEADLINER

**072480**

### 1973 HEADLINER COLORS

BLACK	H-1179
DARK BLUE	H-1183
DARK GREEN	H-1276
DARK SADDLE	H-1185
SANDALWOOD	H-1180
WHITE	H-1181

## 1974-76 STANDARD AND CUSTOM INTERIOR PARTS & ACCESSORIES

### 1974-76 STANDARD SEAT UPHOLSTERY

Our 1974-76 Camaro Standard Seat Upholstery is a correct reproduction of the original. We offer the original Madrid grain with Oxen grain inserts in 32 oz. vinyl correctly sewn as original. Includes seat back medallions or buttons.

#### Features

- Original Madrid grain vinyl
- Oxen grain inserts
- Correct 6 stitch per inch stitching
- Correct colors matched to the original vinyl
- Limited lifetime warranty

#### Description

1974-76 BUCKET SEATS - FRONT/REAR SET	<b>072827</b>
1974-76 BUCKET SEATS - FRONT	<b>072835</b>
1974-76 REAR SEAT	<b>072843</b>

#### Part #



### 1974-76 STANDARD/CUSTOM COLORS

BEIGE	L-4535	LIGHT BUCKSKIN	L-3887
BLACK	L-2295	SADDLE	L-4766
DARK FIRETHORN	L-4979	RED	L-4769
DARK SADDLE	L-4544	WHITE	L-2305
GREEN	L-4764		



### 1974-76 STANDARD UNASSEMBLED DOOR PANELS

Our 1974-76 Standard Door Panels are a correct reproduction of the original. We offer original Madrid grain in 32 oz. vinyl, and correct dielectrically heat sealed patterns as original.

#### Features

- Original Madrid grain vinyl
- Correct dielectric "Heat Seal" Pattern
- Correct colors matched to the original vinyl
- .100-inch thickness poly-coated "Autoboard" backing
- Door Panel backs are perimeter stapled for maximum adhesion
- Limited lifetime warranty

#### Description

1973-75 FRONT DOOR PANELS	<b>072793</b>
1976-77 FRONT DOOR PANELS	<b>073999</b>

#### Part #

### 1974-76 TYPE LT UNASSEMBLED DOOR PANELS

Our 1974-76 Type LT Door Panels are a correct reproduction of the original. We offer original Madrid grain in 32 oz. vinyl, and correct dielectrically heat sealed patterns as original.

#### Features

- Original Madrid grain vinyl
- Correct dielectric "Heat Seal" Pattern
- Correct colors matched to the original vinyl
- .100-inch thickness poly-coated "Autoboard" backing
- Door Panel backs are perimeter stapled for maximum adhesion
- Limited lifetime warranty

1974-77 TYPE LT FRONT DOOR PANELS	<b>073106</b>
-----------------------------------	---------------

### 1974-76 TYPE LT SEAT UPHOLSTERY

Our 1974-76 Camaro Type LT Seat Upholstery is a correct reproduction of the original. We offer the original Madrid grain with Oxen grain inserts in 32 oz. vinyl correctly sewn as original.

#### Features

- Original Madrid grain vinyl with Oxen grain inserts
- Correct 6 stitch per inch stitching
- Correct colors matched to the original vinyl
- Limited lifetime warranty

#### Description

1974-75 TYPE LT BUCKET SEATS - FRONT/REAR SET	<b>072869</b>
1974-75 TYPE LT BUCKET SEATS - FRONT	<b>072870</b>
1974-75 TYPE LT SEAT - REAR	<b>072871</b>
1976 TYPE LT BUCKET SEATS - FRONT/REAR SET	<b>072990</b>
1976 TYPE LT BUCKET SEATS - FRONT	<b>072991</b>
1976 TYPE LT SEAT - REAR	<b>073007</b>

#### Part #



## 1977 STANDARD AND CUSTOM INTERIOR PARTS & ACCESSORIES



### 1977 STANDARD/CUSTOM COLORS

BLACK	L-958
DARK FIRETHORN	L-4979
WHITE	L-3718



### 1977 STANDARD SEAT UPHOLSTERY

Our 1977 Camaro Standard Seat Upholstery is a correct reproduction of the original. We offer the original Sierra grain with Oxen grain inserts in 32 oz. vinyl correctly sewn as original.

#### Features

- Original Sierra grain vinyl
- Oxen grain inserts
- Correct 6 stitch per inch stitching
- Correct colors matched to the original vinyl
- Limited lifetime warranty

#### Description

1977-78 BUCKET SEATS - FRONT/REAR SET	<b>073023</b>
1977-78 BUCKET SEATS - FRONT	<b>073031</b>
1977-78 REAR SEAT	<b>073049</b>

### 1977 STANDARD UNASSEMBLED DOOR PANELS

Our 1977 Standard Door Panels are a correct reproduction of the original. We offer original Sierra grain in 32 oz. vinyl, and correct dielectrically heat sealed patterns as original.

#### Features

- Original Sierra grain vinyl
- Correct dielectric "Heat Seal" Pattern
- Correct colors matched to the original vinyl
- .100-inch thickness poly-coated "Autoboard" backing
- Door Panel backs are perimeter stapled for maximum adhesion
- Limited lifetime warranty

1976-77 FRONT DOOR PANELS	<b>073999</b>
---------------------------	---------------

### 1977 TYPE LT SEAT UPHOLSTERY

Our 1977 Camaro Type LT Seat Upholstery is a correct reproduction of the original. We offer the original Sierra grain with Plisse grain inserts in 32 oz. vinyl correctly sewn as original.

#### Features

- Original Sierra grain vinyl
- Plisse grain inserts
- Correct 6 stitch per inch stitching
- Correct colors matched to the original vinyl
- Limited lifetime warranty

#### Description

TYPE LT BUCKET SEATS - FRONT/REAR SET	<b>073079</b>
TYPE LT BUCKET SEATS - FRONT	<b>073080</b>
TYPE LT SEAT - REAR	<b>073098</b>

### 1977 TYPE LT UNASSEMBLED DOOR PANELS

Our 1977 Type LT Door Panels are a correct reproduction of the original. We offer original Sierra grain with Plisse inserts in 32 oz. vinyl, and correct dielectrically heat sealed patterns as original.

#### Features

- Original Sierra grain vinyl
- Plisse grain inserts
- Correct dielectric "Heat Seal" Pattern
- Correct colors matched to the original vinyl
- .100-inch thickness poly-coated "Autoboard" backing
- Door Panel backs are perimeter stapled for maximum adhesion
- Limited lifetime warranty

1974-77 TYPE LT FRONT DOOR PANELS	<b>073106</b>
-----------------------------------	---------------

## 1978 STANDARD AND CUSTOM INTERIOR PARTS & ACCESSORIES

### 1978 STANDARD SEAT UPHOLSTERY

Our 1978 Camaro Standard Seat Upholstery is a correct reproduction of the original. We offer the original Sierra grain with Oxen grain inserts in 32 oz. vinyl correctly sewn as original.

#### Features

- Original Sierra grain vinyl
- Oxen grain inserts
- Correct 6 stitch per inch stitching
- Correct colors matched to the original vinyl
- Limited lifetime warranty

#### Description

Description	Part #
1977-78 BUCKET SEATS - FRONT/REAR SET	<b>073023</b>
1977-78 BUCKET SEATS - FRONT	<b>073031</b>
1977-78 REAR SEAT	<b>073049</b>



### 1978 STANDARD/CUSTOM COLORS

BLACK	L-958
CAMEL	L-3099
CARMINE	L-5198
GREEN	L-5105
WHITE	L-3718

### 1978 STANDARD UNASSEMBLED DOOR PANELS

Our 1978 Standard Door Panels are a correct reproduction of the original. We offer original Sierra grain in 32 oz. vinyl, and correct dielectrically heat sealed patterns as original.

#### Features

- Original Sierra grain vinyl
- Correct dielectric "Heat Seal" Pattern
- Correct colors matched to the original vinyl
- .100-inch thickness poly-coated "Autoboard" backing
- Door Panel backs are perimeter stapled for maximum adhesion
- Limited lifetime warranty

1978-81 FRONT DOOR PANELS	<b>073126</b>
---------------------------	---------------



### 1978 TYPE LT/Z28 SEAT UPHOLSTERY

Our 1978 Camaro Custom Seat Upholstery is a correct reproduction of the original. We offer the original Sierra grain with Rattan inserts in 32 oz. vinyl, with the correct vertical pleats and buttons.

#### Features

- Original Sierra grain vinyl
- Rattan inserts
- Correct 6 stitch per inch stitching
- Correct colors matched to the original vinyl
- Limited lifetime warranty

#### Description

Description	Part #
TYPE LT - Z28 BUCKET SEATS - FRONT/REAR SET	<b>073131</b>
TYPE LT - Z28 BUCKET SEATS - FRONT	<b>073132</b>
TYPE LT - Z28 SEAT - REAR	<b>073133</b>

### 1978 TYPE LT/Z28 UNASSEMBLED DOOR PANELS

Our 1978 Custom Door Panels are a correct reproduction of the original. We offer original Rattan grain in 32 oz. vinyl with carpeted lower panels, and correct dielectrically heat sealed patterns as original.

#### Features

- Original Rattan grain vinyl
- Correct colors matched to the original vinyl
- .100-inch thickness poly-coated "Autoboard" backing
- Door Panel backs are perimeter stapled for maximum adhesion
- Limited lifetime warranty

1978-79 TYPE LT/Z28 FRONT DOOR PANELS	<b>073134</b>
---------------------------------------	---------------



## 1979 STANDARD AND CUSTOM INTERIOR PARTS & ACCESSORIES

### 1979 STANDARD SEAT UPHOLSTERY

Our 1979 Camaro Standard Seat Upholstery is a correct reproduction of the original. We offer the original Sierra grain with Oxen grain inserts in 32 oz. vinyl correctly sewn as original.

#### Features

- Original Sierra grain vinyl
- Oxen grain inserts
- Correct 6 stitch per inch stitching
- Correct colors matched to the original vinyl
- Limited lifetime warranty

Description	Part #
BUCKET SEATS - FRONT/REAR SET	<b>073155</b>
BUCKET SEATS - FRONT	<b>073156</b>
REAR SEAT	<b>073157</b>

### 1979 STANDARD UNASSEMBLED DOOR PANELS

Our 1979 Standard Door Panels are a correct reproduction of the original. We offer original Sierra grain in 32 oz. vinyl, and correct dielectrically heat sealed patterns as original.

#### Features

- Original Sierra grain vinyl
- Correct dielectric "Heat Seal" Pattern
- Correct colors matched to the original vinyl
- .100-inch thickness poly-coated "Autoboard" backing
- Door Panel backs are perimeter stapled for maximum adhesion
- Limited lifetime warranty

1978-81 FRONT DOOR PANELS	<b>073126</b>
---------------------------	---------------

### 1979 CUSTOM LEATHER SEAT UPHOLSTERY

We offer custom leather upholstery for the 1979 Camaro. Custom options include contrasting colors and stitching, as well as solid color upholstery. *Please call for color and option availability.*

### 1979 BERLINETTA SEAT UPHOLSTERY

Our 1979 Camaro Custom Seat Upholstery is a correct reproduction of the original. We offer the original Sierra grain with Rattan inserts in 32 oz. vinyl, with the correct vertical pleats and buttons.

#### Features

- Original Sierra grain vinyl
- Rattan inserts
- Correct 6 stitch per inch stitching
- Correct colors matched to the original vinyl
- Limited lifetime warranty

Description	Part #
BERLINETTA BUCKET SEATS - FRONT/SET	<b>073163</b>
BERLINETTA BUCKET SEATS - FRONT	<b>073164</b>
BERLINETTA SEAT - REAR	<b>073165</b>

### 1979 INTERIOR ACCESSORIES

Distinctive Industries Seat Heaters provide therapeutic heat and body warmth in any classic car, using the same technology as late model or current vehicles. Each kit comes with switch, harnesses, and two carbon fiber element pads to complete one seat install. Switch can be dash, console, or hidden in a place of choice. Seat Heaters are sold individually, not in pairs.

1967-81 CARBON FIBER SEAT HEATERS **061001**

### 1979 STANDARD/CUSTOM COLORS

BLACK	L-958
BLUE	L-4836
CAMEL	L-3099
CARMINE	L-5198
GREEN	L-5357
WHITE	L-3718



### 1979 TYPE LT/Z28 UNASSEMBLED DOOR PANELS

Our 1979 Custom Door Panels are a correct reproduction of the original. We offer original Rattan grain in 32 oz. vinyl with carpeted lower panels, and correct dielectrically heat sealed patterns as original.

#### Features

- Original Rattan grain vinyl
- Correct colors matched to the original vinyl
- .100-inch thickness poly-coated "Autoboard" backing
- Door Panel backs are perimeter stapled for maximum adhesion
- Limited lifetime warranty

1978-79 TYPE LT/Z28 FRONT DOOR PANELS	<b>073134</b>
---------------------------------------	---------------

## 1980-81 STANDARD AND CUSTOM INTERIOR PARTS & ACCESSORIES

### 1980-81 STANDARD SEAT UPHOLSTERY

Our 1980-81 Camaro Standard Seat Upholstery is a correct reproduction of the original. We offer the original Sierra grain with Oxen grain inserts in 32 oz. vinyl correctly sewn as original.

#### Features

- Original Sierra grain vinyl
- Oxen grain inserts
- Correct 6 stitch per inch stitching
- Correct colors matched to the original vinyl
- Limited lifetime warranty

#### Description

1980-81 BUCKET SEATS - FRONT/REAR SET	<b>Part #</b> <b>073168</b>
1980-81 BUCKET SEATS - FRONT	<b>073169</b>
1980-81 REAR SEAT	<b>073170</b>

### 1980-81 STANDARD UNASSEMBLED DOOR PANELS

Our 1980-81 Standard Door Panels are a correct reproduction of the original. We offer original Sierra grain in 32 oz. vinyl, and correct dielectrically heat sealed patterns as original.

#### Features

- Original Sierra grain vinyl
- Correct dielectric "Heat Seal" Pattern
- Correct colors matched to the original vinyl
- .100-inch thickness poly-coated "Autoboard" backing
- Door Panel backs are perimeter stapled for maximum adhesion
- Limited lifetime warranty

1978-81 FRONT DOOR PANELS	<b>073126</b>
---------------------------	---------------

### 1980-81 INTERIOR ACCESSORIES

Distinctive Industries Seat Heaters provide therapeutic heat and body warmth in any classic car, using the same technology as late model or current vehicles. Each kit comes with switch, harnesses, and two carbon fiber element pads to complete one seat install. Switch can be dash, console, or hidden in a place of choice. Seat Heaters are sold individually, not in pairs.

1967-81 CARBON FIBER SEAT HEATERS	<b>061001</b>
-----------------------------------	---------------

### 1980-81 CUSTOM LEATHER SEAT UPHOLSTERY

We offer custom leather upholstery for the 1980-81 Camaro. Custom options include contrasting colors and stitching, as well as solid color upholstery. *Please call for color and option availability.*

#### 1980-81 STANDARD/ CUSTOM COLORS

1980 CAMEL	L-3099
1981 CAMEL	L-2288
BLACK	L-958
BLUE/DARK BLUE	L-5490
CARMINE	L-5198
RED	L-3048
SILVER	L-925





## Introduction To The Catalog

Thank you for choosing Distinctive Industries as your provider of Restoration Interior Products. The catalog you are reading was designed with the input of our existing customers and moving forward, will continue to be a representation of their needs, and the needs of restoration experts worldwide.

### Design

We have designed our catalog for the Restoration Professional, from the Local Upholstery and Restoration Shop, to the National Distributor of Restoration Products. The thought was to create a catalog that eases the pain of product entry for those building catalogs, and to ease ordering for those that order directly from the catalog. We accomplished this by listing product by year, model, and trim level. You will find this catalog to be easy to use.

### Descriptions

Descriptions are a blend of Marketing and Technical descriptions. After polling our customers we found that aside from the design, missing was a good description of the products in today's catalogs. We remedied that by providing a blended description as a basis for our customers to expand upon, or use as is.

### Colors

Color swatches are placed near the product with labeled color codes to avoid confusion. Color Code boxes are located near the applicable products. We offer many special order color combinations as well as an option for leather in most cases.

### Images

Images are available for License through Distinctive Industries.  
• Licensed images must be accompanied and located adjacent to the matching Distinctive Industries product.

## Table of Contents

1964 interior parts and accessories

1965 interior parts and accessories

1966 interior parts and accessories

1967 interior parts and accessories

1968 interior parts and accessories

1969 interior parts and accessories

1970-72 interior parts and accessories

© Copyright 2016, Distinctive Industries, all rights reserved. No part of this publication may be duplicated or reproduced without written permission from Distinctive Industries.



## 1964 INTERIOR PARTS & ACCESSORIES



### 1964 SEAT UPHOLSTERY

Our 1964 Chevelle Seat Upholstery is a correct reproduction of the original. We offer the original Seville grain in 32 oz vinyl correctly sewn as original.

#### Features

- Original Seville grain vinyl
- Correct 6 stitch per inch stitching
- Correct colors matched to the original vinyl
- Limited lifetime warranty

#### Description

Description	Part #
COUPE BUCKET SEATS - FRONT/REAR SET	090028
COUPE BENCH SEAT - FRONT/REAR SET	090029
CONVERTIBLE BUCKET SEATS - FRONT/REAR SET	090030
CONVERTIBLE BENCH SEAT - FRONT/REAR SEAT	090031
BUCKET SEATS - FRONT	090001
BENCH SEAT - FRONT	090019
COUPE BENCH SEAT - REAR	090027
CONVERTIBLE BENCH SEAT - REAR	090035

\* Chevelle and El Camino share the same front seat upholstery from 1964-72.

### 1964 COLORS

BLACK	L-920	SADDLE	L-1621
FAWN	L-1975	TURQUOISE	L-1934
LIGHT BLUE	L-1409	WHITE	L-1213
RED	L-1425		

### 1964 INTERIOR ACCESSORIES

Our Convertible Top Boot features the correct Seville grain in 32 oz. vinyl is padded and fastens just like the original. Clips are not included.

CONVERTIBLE TOP BOOT

092122

Distinctive Industries Quarter Trim Panels are a correct reproduction of the original. We offer original Seville grain in 32 oz vinyl.

CONVERTIBLE QUARTER TRIM WITH ARMREST

092023



Our Armrest Covers are designed to fit correctly, and to insure the perfect color match to our interior products. Die cut from 32 oz Seville grain vinyl.

1964-67 ARMREST COVER

091234

Our Package Tray is a high quality colored board. Utilizing modern material for durability and long life. Does not include rear speaker holes.

1964-65 COLORED PACKAGE TRAY BOARD

091286

Distinctive Industries El Camino Storage Compartment Trim Panels are located in the rear corners of the cab near the storage area behind the seat. Includes two Trim Panels.

1964-67 EL CAMINO STORAGE COMPARTMENT

TRIM PANELS

090980

Distinctive Industries High-Density Seat Foam is designed to work as a system with our upholstery. Our High-Density Seat Foam is firm, form fitting, and features a Typar® web backing for strength, which prevents spring intrusion and ensures a quality fit and long lasting life.

1964-65 BUCKET SEAT FOAM

064111

Distinctive Industries Seat Heaters provide therapeutic heat and body warmth in any classic car, using the same technology as late model or current vehicles. Each kit comes with switch, harnesses, and two carbon fiber element pads to complete one seat install. Switch can be dash, console, or hidden in a place of choice. Seat Heaters are sold individually, not in pairs.

1964-72 CARBON FIBER SEAT HEATERS

061001



## 1964 INTERIOR PARTS & ACCESSORIES

### 1964 PRE-ASSEMBLED DOOR/QUARTER PANELS

Distinctive Industries 1964 Pre-Assembled Door/Quarter Panels are a correct reproduction of the original. We offer original Seville grain in 32 oz vinyl. The dielectric patterns are correct along with the chrome (Mylar®) trim, and embossed Chevy medallion. Correct hole placement is pre-cut into the panel backed by die cut fiber board, just like the originals.

#### Features

- Original Seville grain vinyl
- Correct dielectric "Heat Seal" pattern
- Correct colors matched to the original vinyl
- Door trim molding attached (where applicable)
- .100-inch thickness Poly-coated "Autoboard" backing
- Door Panel backs are perimeter stapled for maximum adhesion
- Limited lifetime warranty

#### Description

FRONT DOOR PANELS

#### Part #

**090040P**

\* *Chevelle and El Camino share the same front door panels from 1964-67.*

COUPE REAR QUARTER PANELS

**090044P**

### 1964 UNASSEMBLED DOOR/QUARTER PANELS

Our 1964 Door/Quarter Panels are a correct reproduction of the original. We offer original Seville grain in 32 oz vinyl, and correct dielectrically heat sealed patterns as original. Does not include lower Door/Quarter Panel molding (where applicable).

#### Features

- Original Seville grain vinyl
- Correct dielectric "Heat Seal" pattern
- Correct colors matched to the original vinyl
- .100-inch thickness Poly-coated "Autoboard" backing
- Door Panel backs are perimeter stapled for maximum adhesion
- Limited lifetime warranty

#### Description

FRONT DOOR PANELS

#### Part #

**090040**

\* *Chevelle and El Camino share the same front door panels from 1964-72.*

COUPE REAR QUARTER PANELS

**090044**

2 DOOR WAGON REAR QUARTER PANELS

**090045**

CONVERTIBLE REAR QUARTER PANELS

**090042**

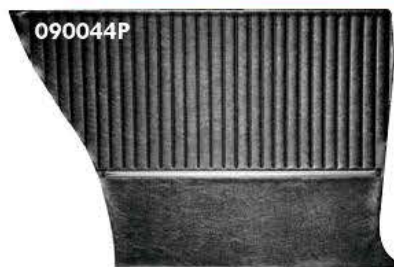

### 1964 COLORS

BLACK	L-920
FAWN	L-1975
LIGHT BLUE	L-1409
RED	L-1425
SADDLE	L-1621
TURQUOISE	L-1934
WHITE	L-1213

## 1965 INTERIOR PARTS & ACCESSORIES

### 1965 SEAT UPHOLSTERY

Our 1965 Chevelle Seat Upholstery is a correct reproduction of the original. We offer the original Madrid grain in 32 oz vinyl, with the correct dielectrically heat sealed patterns. The horizontal pleats are stitched, just like the originals, with the correct spacing.

#### Features

- Original Madrid grain vinyl
- Correct dielectric "Heat Seal" pattern
- Correct 6 stitch per inch stitching
- Correct colors matched to the original vinyl
- Limited lifetime warranty

#### Description

Description	Part #
COUPE BUCKET SEATS - FRONT/REAR SET	090051
COUPE BENCH SEAT - FRONT/REAR SET	090052
CONVERTIBLE BUCKET SEATS - FRONT/REAR SET	090053
CONVERTIBLE BENCH SEAT - FRONT/REAR SET	090054
2 DOOR WAGON BENCH SEAT - FRONT/REAR SET	090055
BUCKET SEATS - FRONT	090043
BENCH SEAT - FRONT	090050
COUPE BENCH SEAT - REAR	090068
CONVERTIBLE BENCH SEAT - REAR	090076
2 DOOR WAGON BENCH SEAT - REAR	090070

\* *Chevelle and El Camino share the same front seat upholstery from 1964-72.*

#### Optional Two-Tone Upholstery

COUPE BUCKET SEATS - FRONT/REAR SET	090056
COUPE BENCH SEAT - FRONT/REAR SET	090057
CONVERTIBLE BUCKET SEATS - FRONT/REAR SET	090058
CONVERTIBLE BENCH SEAT - FRONT/REAR SET	090059
2 DOOR WAGON BENCH SEAT - FRONT/REAR SET	090060
BUCKET SEATS - FRONT	090084
BENCH SEAT - FRONT	090092
COUPE BENCH SEAT - REAR	090100
CONVERTIBLE BENCH SEAT - REAR	090118
2 DOOR WAGON BENCH SEAT - REAR	090072

\* *Chevelle and El Camino share the same front seat upholstery from 1964-72.*

### 1965 CUSTOM LEATHER SEAT UPHOLSTERY

We offer custom leather upholstery for the 1965 Chevelle. Custom options include contrasting colors and stitching, as well as solid color upholstery. **Please call for color and option availability.**

#### 1965 COLORS

BLACK	L-2295
FAWN	L-2313
LIGHT BLUE	L-2302
RED	L-3048
SADDLE	L-3887
TURQUOISE	L-2297
WHITE	L-2305

#### 1965 TWO-TONE COLORS

BLACK	L-2305 (I=L-2295)
FAWN	L-2313 (I=L-2586)
LIGHT BLUE	L-2302 (I=L-2298)
RED	L-3048 (I=L-3724)
SADDLE	L-3887 (I=L-4139)
TURQUOISE	L-2297 (I=L-3045)
WHITE	L-2305 (I=L-2295)

### 1965 INTERIOR ACCESSORIES

Our Convertible Top Boot features the correct Madrid grain in 32 oz. vinyl is padded and fastens just like the original. Clips are not included. Does not include attaching clips.

CONVERTIBLE TOP BOOT **092049**

Distinctive Industries Quarter Trim Panels are a correct reproduction of the original. We offer original Madrid grain in 32 oz vinyl. 1965-67 CONVERTIBLE QUARTER TRIM WITH ARMREST **092031**

Our Armrest Covers are designed to fit correctly, and to insure the perfect color match to our interior products. Die cut from 32 oz Madrid grain vinyl.

1964-67 ARMREST COVER **091234**

Our Package Tray is a high quality colored board. Utilizing modern material for durability and long life.

1964-65 COLORED PACKAGE TRAY BOARD **091286**

Distinctive Industries El Camino Storage Compartment Trim Panels are located in the rear corners of the cab near the storage area behind the seat. Includes two Trim Panels.

1964-67 EL CAMINO STORAGE COMPARTMENT TRIM PANELS **090980**

Distinctive Industries High-Density Seat Foam is designed to work as a system with our upholstery. Our High-Density Seat Foam is firm, form fitting, and features a Typar® web backing for strength, which prevents spring intrusion and ensures a quality fit and long lasting life.

1964-65 BUCKET SEAT FOAM **064111**

Distinctive Industries Seat Heaters provide therapeutic heat and body warmth in any classic car, using the same technology as late model or current vehicles. Each kit comes with switch, harnesses, and two carbon fiber element pads to complete one seat install. Switch can be dash, console, or hidden in a place of choice. Seat Heaters are sold individually, not in pairs.

1964-72 CARBON FIBER SEAT HEATERS **061001**



## 1965 INTERIOR PARTS & ACCESSORIES

### 1965 PRE-ASSEMBLED DOOR/QUARTER PANELS

Distinctive Industries 1965 Pre-Assembled Door/Quarter Panels are a correct reproduction of the original. We offer original Madrid grain in 32 oz vinyl. The dielectric patterns are correct along with hole placement pre-cut into the panel backed by die cut fiber board, just like the originals. We offer Door/Quarter Panels in Solid or Two-tone with a dark vinyl lower portion. Does not include emblems.

#### Features

- Original Madrid grain vinyl
- Correct dielectric "Heat Seal" pattern
- Correct colors matched to the original vinyl
- Door trim molding attached (where applicable)
- .100-inch thickness Poly-coated "Autoboard" backing
- Door Panel backs are perimeter stapled for maximum adhesion
- Limited lifetime warranty

Description	Part #
FRONT DOOR PANELS	091033P
FRONT DOOR PANELS - TWO-TONE	091066P
* Chevelle and El Camino share the same front door panels from 1964-67.	

COUPE REAR QUARTER PANELS	091041P
COUPE REAR QUARTER PANELS - TWO-TONE	091074P
STATION WAGON 2 DOOR REAR QUARTER PANELS	091025P

### 1965 UNASSEMBLED DOOR/QUARTER PANELS

Our 1965 Door/Quarter Panels are a correct reproduction of the original. We offer original Madrid grain in 32 oz vinyl, and correct dielectrically heat sealed patterns as original. We offer Door/Quarter Panels in Solid or Two-tone with a dark vinyl lower portion. Does not include lower Door/Quarter Panel molding, and emblems (where applicable).

#### Features

- Original Madrid grain vinyl
- Correct dielectric "Heat Seal" pattern
- Correct colors matched to the original vinyl
- .100-inch thickness Poly-coated "Autoboard" backing
- Door Panel backs are perimeter stapled for maximum adhesion
- Limited lifetime warranty

Description	Part #
FRONT DOOR PANELS	091033
FRONT DOOR PANELS - TWO-TONE	091066
* Chevelle and El Camino share the same front door panels from 1964-72.	

COUPE REAR QUARTER PANELS	091041
COUPE REAR QUARTER PANELS - TWO-TONE	091074
CONVERTIBLE REAR QUARTER PANELS	091058
CONVERTIBLE REAR QUARTER PANELS - TWO-TONE	091082
STATION WAGON 2 DOOR REAR QUARTER PANELS	091025



#### 1965 COLORS

BLACK	L-2295
FAWN	L-2313
LIGHT BLUE	L-2302
RED	L-3048
SADDLE	L-3887
TURQUOISE	L-2297
WHITE	L-2305

#### 1965 TWO-TONE COLORS

BLACK	L-2305 (I=L-2295)
FAWN	L-2313 (I=L-2586)
LIGHT BLUE	L-2302 (I=L-2298)
RED	L-3048 (I=L-3724)
SADDLE	L-3887 (I=L-4139)
TURQUOISE	L-2297 (I=L-3045)
WHITE	L-2305 (I=L-2295)

## 1965 INTERIOR PARTS & ACCESSORIES

### 1965 SUNVISORS

Our 1965 Sunvisors are in the original Tier grain vinyl for Chevelle/El Camino SS and Basketweave grain vinyl for El Camino, with the vinyl binding stitched, just like the originals. All Sunvisors are sold in pairs.

1965-67 CONVERTIBLE SUNVISORS **091302**

\* 1965-67 Convertible Sunvisors are in the original Madrid grain.





## 1966 INTERIOR PARTS & ACCESSORIES

### 1966 SEAT UPHOLSTERY

Our 1966 Chevelle Seat Upholstery is a correct reproduction of the original. We offer the original Madrid grain in 32 oz vinyl, with the correct dielectrically heat sealed patterns.

#### Features

- Original Madrid grain vinyl
- Correct dielectric "Heat Seal" pattern
- Correct 6 stitch per inch stitching
- Correct colors matched to the original vinyl
- Limited lifetime warranty

#### Description

Description	Part #
COUPE BUCKET SEATS - FRONT/REAR SET	090120
COUPE BENCH SEAT - FRONT/REAR SET	090121
CONVERTIBLE BUCKET SEATS - FRONT/REAR SET	090122
CONVERTIBLE BENCH SEAT - FRONT/REAR SET	090123
BUCKET SEATS - FRONT	090126
BENCH SEAT - FRONT	090134
COUPE BENCH SEAT - REAR	090142
CONVERTIBLE BENCH SEAT - REAR	090159

\* Chevelle and El Camino share the same front seat upholstery from 1964-72.

#### Optional Two-Tone Upholstery

COUPE BUCKET SEATS - FRONT/REAR SET	090169
COUPE BENCH SEAT - FRONT/REAR SET	090170
CONVERTIBLE BUCKET SEATS - FRONT/REAR SET	090171
CONVERTIBLE BENCH SEAT - FRONT/REAR SET	090172
BUCKET SEATS - FRONT	090167
BENCH SEAT - FRONT	090175
COUPE BENCH SEAT - REAR	090183
CONVERTIBLE BENCH SEAT - REAR	090191

\* Chevelle and El Camino share the same front seat upholstery from 1964-72.

### 1966 CUSTOM LEATHER SEAT UPHOLSTERY

We offer custom leather upholstery for the 1966 Chevelle. Custom options include contrasting colors and stitching, as well as solid color upholstery. *Please call for color and option availability.*



### 1966 INTERIOR ACCESSORIES

Our Convertible Top Boot features the correct Madrid grain in 32 oz. vinyl is padded and fastens just like the original. Clips are not included.

1966-67 CONVERTIBLE TOP BOOT	092064
1966-67 PRE-ASSEMBLED CONVERTIBLE TOP BOOT	092065

Distinctive Industries Quarter Trim Panels are a correct reproduction of the original. We offer original Madrid grain in 32 oz vinyl.

1965-67 CONVERTIBLE QUARTER TRIM WITH ARMREST **092031**

Our Armrest Covers are designed to fit correctly, and to insure the perfect color match to our interior products. Die cut from 32 oz Madrid grain vinyl.

1964-67 ARMREST COVER **091234**

Our Sail Panel Boards are correct reproductions of the original. Sail Panels are uncovered and sold as pairs.

EARLY STYLE DESIGN - 4" X 15" **091840**

Our Package Tray is a high quality colored board. Utilizing modern material for durability and long life. Does not include rear Speaker holes.

1966-67 COLORED PACKAGE TRAY BOARD - 1ST DESIGN **091284**

1966-67 COLORED PACKAGE TRAY BOARD - 2ND DESIGN **091288**

Distinctive Industries El Camino Storage Compartment Trim Panels are located in the rear corners of the cab near the storage area behind the seat. Includes two Trim Panels.

1964-67 EL CAMINO STORAGE COMPARTMENT TRIM PANELS **090980**

Distinctive Industries High-Density Seat Foam is designed to work as a system with our upholstery. Our High-Density Seat Foam is firm, form fitting, and features a Typar® web backing for strength, which prevents spring intrusion and ensures a quality fit and long lasting life. Seat Foam is sold individually, not in pairs.

1966-70 A-BODY BUCKET SEAT FOAM **067116GM6670**

Distinctive Industries Seat Heaters provide therapeutic heat and body warmth in any classic car, using the same technology as late model or current vehicles. Each kit comes with switch, harnesses, and two carbon fiber element pads to complete one seat install. Switch can be dash, console, or hidden in a place of choice. Seat Heaters are sold individually, not in pairs.

1964-72 CARBON FIBER SEAT HEATERS **061001**

#### 1966 TWO-TONE COLORS

FAWN	L-2313 (I=L-2586)
LIGHT BLUE	L-2302 (I=L-2298)
TURQUOISE	L-2297 (I=L-3045)

#### 1966 COLORS

BLACK	L-2295
BRONZE	L-2795
BRIGHT BLUE	L-2309
FAWN	L-2313
LIGHT BLUE	L-2302
RED	L-3048
TURQUOISE	L-2297
WHITE	L-2305

## 1966 INTERIOR PARTS & ACCESSORIES

### 1966 PRE-ASSEMBLED DOOR/QUARTER PANELS

Distinctive Industries 1966 Pre-Assembled Door/Quarter Panels are a correct reproduction of the original. We offer original Madrid grain with Worm (also known as Crushed Ice) grain on bottom in 32 oz vinyl. The dielectric patterns are correct along with the chrome (Mylar®) trim, and hole placement pre-cut into the panel backed by die cut fiber board, just like the originals. We offer Door/Quarter Panels in Solid or Two-tone with a dark vinyl lower portion.

#### Features

- Original Madrid grain with Worm grain vinyl on bottom
- Correct dielectric "Heat Seal" pattern
- Correct colors matched to the original vinyl
- Door trim molding attached (where applicable)
- .100-inch thickness Poly-coated "Autoboard" backing
- Door Panel backs are perimeter stapled for maximum adhesion
- Limited lifetime warranty

#### Description

Description	Part #
FRONT DOOR PANELS	091090P
FRONT DOOR PANELS - TWO-TONE	091124P
* <i>Chevelle/El Camino share the same front door panels from 1964-67.</i>	
COUPE REAR QUARTER PANELS	091108P
COUPE REAR QUARTER PANELS - TWO-TONE	091132P

\* *On Solid Color Door/Quarter Panels the lower part of the door panel is Worm grain vinyl as original. Worm grain is the same as main color except on white the bottom is always black Worm grain vinyl.*

### 1966 UNASSEMBLED DOOR/QUARTER PANELS

Our 1966 Door/Quarter Panels are a correct reproduction of the original. We offer original Madrid grain with Worm (also known as Crushed Ice) grain on bottom in 32 oz vinyl, and dielectrically heat sealed patterns as original. We offer Door/Quarter Panels in Solid or Two-tone with a dark vinyl lower portion. Does not include Lower Door/Quarter Panel moldings and emblems (where applicable).

#### Features

- Original Madrid grain with Worm grain vinyl on bottom
- Correct dielectric "Heat Seal" pattern
- Correct colors matched to the original vinyl
- .100-inch thickness Poly-coated "Autoboard" backing
- Door Panel backs are perimeter stapled for maximum adhesion
- Limited lifetime warranty

#### Description

Description	Part #
FRONT DOOR PANELS	091090
FRONT DOOR PANELS - TWO-TONE	091124
* <i>Chevelle/El Camino share the same front door panels from 1964-72.</i>	
COUPE REAR QUARTER PANELS	091108
COUPE REAR QUARTER PANELS - TWO-TONE	091132
CONVERTIBLE REAR QUARTER PANELS	091116

\* *On Solid Color Door/Quarter Panels the lower part of the door panel is Worm grain vinyl as original. Worm grain is the same as main color except on white the bottom is always black Worm grain vinyl.*



#### 1966 COLORS

BLACK	L-2295
BRONZE	L-2795
BRIGHT BLUE	L-2309
FAWN	L-2313
LIGHT BLUE	L-2302
RED	L-3048
TURQUOISE	L-2297
WHITE	L-2305

#### 1966 TWO-TONE COLORS

FAWN	L-2313 (I=L-2586)
LIGHT BLUE	L-2302 (I=L-2298)
TURQUOISE	L-2297 (I=L-3045)

## 1966 INTERIOR PARTS & ACCESSORIES

### 1966 COLORS

BLACK	L-2295
BRONZE	L-2795
BRIGHT BLUE	L-2309
FAWN	L-2313
LIGHT BLUE	L-2302
RED	L-3048
TURQUOISE	L-2297
WHITE	L-2305

### 1966 SUNVISORS

Our 1966 Sunvisors are in the original Tier grain vinyl for Chevelle/El Camino SS and Basketweave grain vinyl for El Camino, with the vinyl binding stitched, just like the originals. All Sunvisors are sold in pairs.

CONVERTIBLE SUNVISORS 091302

\* 1965-67 Convertible Sunvisors are in the original Madrid grain.

CHEVELLE

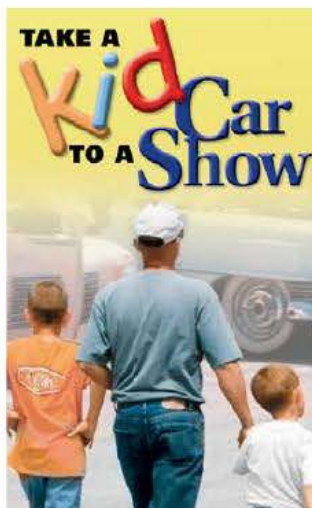

### Take a Kid to a Car Show is dedicated to:

- Sharing the classic car hobby with kids
- Encouraging involvement by a new generation of automotive restoration enthusiasts
- Giving kids a constructive choice in how to spend their time

Take a Kid to a Car Show is a program of ARMO, the Automotive Restoration Market Organization, a SEMA Council.



1966 Chevelle

## 1967 INTERIOR PARTS & ACCESSORIES

### 1967 INTERIOR ACCESSORIES



**1967 SEAT UPHOLSTERY**

Our 1967 Chevelle Seat Upholstery is a correct reproduction of the original. We offer the original Madrid grain in 32 oz vinyl correctly sewn as original.

#### Features

- Original Madrid grain vinyl
- Correct 6 stitch per inch stitching
- Correct colors matched to the original vinyl
- Limited lifetime warranty

#### Description

Description	Part #
COUPE BUCKET SEATS - FRONT/REAR SET	<b>090235</b>
COUPE BENCH SEAT - FRONT/REAR SET	<b>090236</b>
CONVERTIBLE BUCKET SEATS - FRONT/REAR SET	<b>090237</b>
CONVERTIBLE BENCH SEAT - FRONT/REAR SET	<b>090238</b>
BUCKET SEATS - FRONT	<b>090209</b>
BENCH SEAT - FRONT	<b>090217</b>
COUPE BENCH SEAT - REAR	<b>090225</b>
CONVERTIBLE BENCH SEAT - REAR	<b>090233</b>

\* Chevelle and El Camino share the same front seat upholstery from 1964-72.



#### 1967 COLORS

AQUA	L-3046	LIGHT BLUE	L-2302
BLACK	L-2295	RED	L-3048
BRIGHT BLUE	L-2309	WHITE	L-2305
GOLD	L-3025		

Our Convertible Top Boot features the correct Madrid grain in 32 oz. vinyl is padded and fastens just like the original. Clips are not included.

1966-67 CONVERTIBLE TOP BOOT	<b>092064</b>
1966-67 PRE-ASSEMBLED CONVERTIBLE TOP BOOT	<b>092065</b>

Distinctive Industries Quarter Trim Panels are a correct reproduction of the original. We offer original Madrid grain in 32 oz vinyl.

1965-67 CONVERTIBLE QUARTER TRIM WITH ARMREST	<b>092031</b>
---	---------------

Our Armrest Covers are designed to fit correctly, and to insure the perfect color match to our interior products. Die cut from 32 oz Madrid grain vinyl.

1964-67 ARMREST COVER	<b>091234</b>
-----------------------	---------------



Distinctive Industries Headrests features the original Madrid grain in 32 oz. vinyl, just like the originals.

1967 BENCH SEAT HEADREST COVER	<b>092068</b>
--------------------------------	---------------

Our Package Tray is a high quality colored board. Utilizing modern material for durability and long life.

1966-67 COLORED PACKAGE TRAY BOARD - 1ST DESIGN	<b>091284</b>
1966-67 COLORED PACKAGE TRAY BOARD - 2ND DESIGN	<b>091288</b>

Distinctive Industries El Camino Storage Compartment Trim Panels are located in the rear corners of the cab near the storage area behind the seat. Includes two Trim Panels.

1964-67 EL CAMINO STORAGE COMPARTMENT TRIM PANELS	<b>090980</b>
---	---------------

Distinctive Industries High-Density Seat Foam is designed to work as a system with our upholstery. Our High-Density Seat Foam is firm, form fitting, and features a Typar® web backing for strength, which prevents spring intrusion and ensures a quality fit and long lasting life. Seat Foam is sold individually, not in pairs.

1966-70 A-BODY BUCKET SEAT FOAM	<b>067116GM6670</b>
---------------------------------	---------------------

Distinctive Industries Seat Heaters provide therapeutic heat and body warmth in any classic car, using the same technology as late model or current vehicles. Each kit comes with switch, harnesses, and two carbon fiber element pads to complete one seat install. Switch can be dash, console, or hidden in a place of choice. Seat Heaters are sold individually, not in pairs.

1964-72 CARBON FIBER SEAT HEATERS	<b>061001</b>
-----------------------------------	---------------

### 1967 CUSTOM LEATHER SEAT UPHOLSTERY

We offer custom leather upholstery for the 1967 Chevelle. Custom options include contrasting colors and stitching, as well as solid color upholstery. *Please call for color and option availability.*

## 1967 INTERIOR PARTS & ACCESSORIES

### 1967 PRE-ASSEMBLED DOOR/QUARTER PANELS

Distinctive Industries 1967 Pre-Assembled Door Panels are a correct reproduction of the original. We offer original Madrid grain in 32 oz vinyl. The dielectric patterns are correct along with hole placement pre-cut into the panel backed by die cut fiber board, and the (4) Door Panel medallions installed, just like the originals.

#### Features

- Original Madrid grain vinyl
- Correct dielectric "Heat Seal" pattern
- Correct colors matched to the original vinyl
- Comes with the (4) door panels medallions installed
- Door trim molding attached (where applicable)
- .100-inch thickness Poly-coated "Autoboard" backing
- Door Panel backs are perimeter stapled for maximum adhesion
- Limited lifetime warranty

#### Description

FRONT DOOR PANELS

#### Part #

091157P

\* Chevelle and El Camino share the same front door panels from 1964-67.



### 1967 UNASSEMBLED DOOR/QUARTER PANELS

Our 1967 Door/Quarter Panels are a correct reproduction of the original. We offer original Madrid grain in 32 oz vinyl, and correct dielectrically heat sealed patterns as original. Does not include Door Panel medallions/emblems.

#### Features

- Original Madrid grain vinyl
- Correct dielectric "Heat Seal" pattern
- Correct colors matched to the original vinyl
- .100-inch thickness Poly-coated "Autoboard" backing
- Door Panel backs are perimeter stapled for maximum adhesion
- Limited lifetime warranty

#### Description

FRONT DOOR PANELS

#### Part #

091157

\* Chevelle and El Camino share the same front door panels from 1964-72.



COUPE REAR QUARTER PANELS

091165

CONVERTIBLE REAR QUARTER PANELS

091173

### 1967 SUNVISORS

Our 1967 Sunvisors are in the original Surrey (also known as Line-Dot and Impala Leatherette) grain vinyl, dielectrically seamed with the vinyl binding stitched, just like the originals. All Sunvisors are sold in pairs.

CONVERTIBLE SUNVISORS

091302

\* 1965-67 Convertible Sunvisors are in the original Madrid grain.

#### 1967 COLORS

AQUA	L-3046
BLACK	L-2295
BRIGHT BLUE	L-2309
GOLD	L-3025
LIGHT BLUE	L-2302
RED	L-3048
WHITE	L-2305

## 1968 INTERIOR PARTS & ACCESSORIES

### 1968 SEAT UPHOLSTERY

Distinctive Industries 1968 Chevelle Malibu, Super Sport, and El Camino Seat Upholstery is a correct reproduction of the original. We offer the original Madrid grain in 32 oz vinyl, with the correct dielectrically heat sealed patterns.

#### Features

- Original Madrid grain vinyl
- Correct dielectric "Heat Seal" pattern
- Correct 6 stitch per inch stitching
- Correct colors matched to the original vinyl
- Limited lifetime warranty

#### Description

Description	Part #
MALIBU & SS COUPE BUCKET SEATS - FRONT/REAR SET	090276
COUPE BENCH SEAT - FRONT/REAR SET	090277
CONVERTIBLE BUCKET SEATS - FRONT/REAR SET	090278
CONVERTIBLE BENCH SEAT - FRONT/REAR SET	090279
MALIBU, SS & EL CAMINO BUCKET SEATS - FRONT BENCH SEAT - FRONT	090241
COUPE BENCH SEAT - REAR	090266
CONVERTIBLE BENCH SEAT - REAR	090274

\* *Malibu, SS, and El Camino share the same front seat upholstery from 1964-72.*

### 1968 CUSTOM LEATHER SEAT UPHOLSTERY

We offer custom leather upholstery for the 1968 Chevelle. Custom options include contrasting colors and stitching, as well as solid color upholstery. *Please call for color and option availability.*



#### 1968 COLORS

BLACK	L-2295
DARK BLUE	L-3598
GOLD	L-3307
LIGHT BLUE	L-2302
MEDIUM BLUE	L-3297
PEARL	L-3295
RED	L-3048
SADDLE	L-3887
TURQUOISE	L-3046
WHITE	L-2305

### 1968 INTERIOR ACCESSORIES

Our Convertible Top Boot features the correct Madrid grain in 32 oz. vinyl is padded and fastens just like the original. Clips are not included.

1968-72 CONVERTIBLE TOP BOOT **092072**

Distinctive Industries Quarter Trim Panels are a correct reproduction of the original. We offer original Madrid grain in 32 oz vinyl.

1968-72 CONVERTIBLE QUARTER TRIM WITH ARMREST **092056**

1968-72 COUPE QUARTER TRIM WITH ARMREST **092015**

Our Armrest Covers are designed to fit correctly, and to insure the perfect color match to our interior products. Die cut from 32 oz Madrid grain vinyl.

1968-72 ARMREST COVER **091235**

Distinctive Industries Headrests features the original Madrid grain in 32 oz. vinyl, just like the originals.

1968-72 BUCKET SEAT HEADRESTS - FRONT **092114**

1968-72 BENCH SEAT HEADRESTS - FRONT **092080**

Our Door Jamb Windlace is the correct Madrid grain in 32 oz. vinyl, just like the originals, and are sold in pairs.

1968-69 DOOR JAMB WINDLACE - COUPE **092171**

1968-69 DOOR JAMB WINDLACE - CONVERTIBLE **092173**

Our Package Tray is a high quality colored board. Utilizing modern material for durability and long life. Does not include rear speaker holes.

1968-72 COLORED PACKAGE TRAY BOARD **091289**

Distinctive Industries High-Density Seat Foam is designed to work as a system with our upholstery. Our High-Density Seat Foam is firm, form fitting, and features a Typar® web backing for strength, which prevents spring intrusion and ensures a quality fit and long lasting life. Seat Foam is sold individually, not in pairs.

1966-70 A-BODY BUCKET SEAT FOAM **067116GM6670**

Distinctive Industries Seat Heaters provide therapeutic heat and body warmth in any classic car, using the same technology as late model or current vehicles. Each kit comes with switch, harnesses, and two carbon fiber element pads to complete one seat install. Switch can be dash, console, or hidden in a place of choice. Seat Heaters are sold individually, not in pairs.

1964-72 CARBON FIBER SEAT HEATERS **061001**



092072

092173

092171

## 1968 INTERIOR PARTS & ACCESSORIES

### 1968 PRE-ASSEMBLED DOOR/QUARTER PANELS

Distinctive Industries 1968 Pre-Assembled Door/Quarter Panels are a correct reproduction of the original. We offer original Madrid grain in 32 oz vinyl. The dielectric patterns are correct along with the chrome (Mylar®) trim, metal upper rail, inner window felt, and hole placement pre-cut into the panel backed by die cut fiber board, just like the originals. Does not include Door/Quarter Panel emblems (where applicable).

#### Features

- Original Madrid grain vinyl
- Correct dielectric "Heat Seal" pattern
- Correct colors matched to the original vinyl
- Door trim molding attached (where applicable)
- Metal upper rail
- Inner window felt attached
- .100-inch thickness Poly-coated "Autoboard" backing
- Door Panel backs are perimeter stapled for maximum adhesion
- Limited lifetime warranty

Description	Part #
FRONT DOOR PANELS	091181P
EL CAMINO FRONT DOOR PANELS	090951P
COUPE REAR QUARTER PANELS	091199P
CONVERTIBLE REAR QUARTER PANELS	091207P

\* *Convertible Rear Quarter Panels have ABS plastic upper rails.*

### 1968 UNASSEMBLED DOOR/QUARTER PANELS

Our 1968 Door/Quarter Panels are a correct reproduction of the original. We offer original Madrid grain in 32 oz vinyl, and correct dielectrically heat sealed patterns as original.

#### Features

- Original Madrid grain vinyl
- Correct dielectric "Heat Seal" pattern
- Correct colors matched to the original vinyl
- .100-inch thickness Poly-coated "Autoboard" backing
- Door Panel backs are perimeter stapled for maximum adhesion
- Limited lifetime warranty

Description	Part #
FRONT DOOR PANELS	091181

\* *Chevelle and El Camino share the same front door panels from 1964-72.*

COUPE REAR QUARTER PANELS	091199
CONVERTIBLE REAR QUARTER PANELS	091207

#### 1968 COLORS

BLACK	L-2295	PEARL	L-3295
DARK BLUE	L-3598	RED	L-3048
GOLD	L-3307	SADDLE	L-3887
LIGHT BLUE	L-2302	TURQUOISE	L-3046
MEDIUM BLUE	L-3297	WHITE	L-2305



CHEVELLE



## 1968 INTERIOR PARTS & ACCESSORIES



## 1968 SUNVISORS

Our 1968 Sunvisors are in the original Bedford Ribbed grain vinyl, with the vinyl binding stitched, just like the originals. All Sunvisors are sold in pairs.

CONVERTIBLE SUNVISORS

091330

\* 1968-69 Convertible Sunvisors are in the original Madrid grain.

### 1968 COLORS

BLACK	L-2295
DARK BLUE	L-3598
GOLD	L-3307
LIGHT BLUE	L-2302
MEDIUM BLUE	L-3297
PEARL	L-3295
RED	L-3048
SADDLE	L-3887
TURQUOISE	L-3046
WHITE	L-2305



# HandsOn

EXPERIENCE



Take a Kid to a Car Show is a program of ARMO, the Automotive Restoration Market Organization, a SEMA Council.

**C**an you whoop a kid on video games? Probably not. But you can show them a whole new “reality” by taking them to a car show. Encouraging a child to get outside, see glistening paint jobs, and hear the purr of finely tuned engines will awaken all of their senses. You might even be surprised at how much your own enthusiasm is rekindled!

Life is full of choices for kids. You can help them make the right ones by sharing your appreciation for cool old cars. The practical knowledge you share with a child today...just may be the experience that sets them on a lifetime of success.

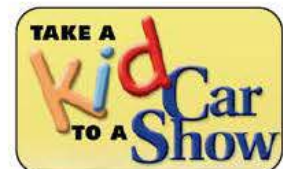



## 1969 INTERIOR PARTS & ACCESSORIES

### 1969 SEAT UPHOLSTERY

Our 1969 Chevelle Seat Upholstery is a correct reproduction of the original. We offer the original Madrid grain in 32 oz vinyl, with the correct dielectrically heat sealed patterns including the Basketweave center stripe insert, just like the originals.

#### Features

- Original Madrid grain vinyl and Basketweave insert
- Correct dielectric "Heat Seal" pattern
- Correct 6 stitch per inch stitching
- Correct colors matched to the original vinyl
- Limited lifetime warranty

Description	Part #
COUPE BUCKET SEATS - FRONT/REAR SET	090284
COUPE BENCH SEAT - FRONT/REAR SET	090285
CONVERTIBLE BUCKET SEATS - FRONT/REAR SET	090286
CONVERTIBLE BENCH SEAT - FRONT/REAR SET	090287
BUCKET SEATS - FRONT	090282
BENCH SEAT - FRONT	090290
COUPE BENCH SEAT - REAR	090308
CONVERTIBLE BENCH SEAT - REAR	090316

\* *Chevelle and El Camino share the same front seat upholstery from 1964-72.*

### 1969 CUSTOM LEATHER SEAT UPHOLSTERY

We offer custom leather upholstery for the 1969 Chevelle. Custom options include contrasting colors and stitching, as well as solid color upholstery. *Please call for color and option availability.*



### 1969 COLORS

BLACK	L-2295
DARK BLUE	L-3598
DARK GREEN	L-3606
LIGHT GREEN	L-3603
PARCHMENT	L-2300
RED	L-3597
SADDLE	L-3887
WHITE	L-2305



### 1969 INTERIOR ACCESSORIES

Our Convertible Top Boot features the correct Madrid grain in 32 oz. vinyl is padded and fastens just like the original. Clips are not included.

1968-72 CONVERTIBLE TOP BOOT **092072**

Distinctive Industries Quarter Trim Panels are a correct reproduction of the original. We offer original Madrid grain in 32 oz vinyl.

1968-72 CONVERTIBLE QUARTER TRIM WITH ARMREST **092056**

1968-72 COUPE QUARTER TRIM WITH ARMREST **092015**

Our Armrest Covers are designed to fit correctly, and to insure the perfect color match to our interior products. Die cut from 32 oz Madrid grain vinyl.

1968-72 ARMREST COVER **091235**

Distinctive Industries Headrests features the original Madrid grain in 32 oz. vinyl, just like the originals.

1968-72 BUCKET SEAT HEADRESTS - FRONT **092114**

1968-72 BENCH SEAT HEADRESTS - FRONT **092080**

Our Door Jamb Windlace is the correct Madrid grain in 32 oz. vinyl, just like the originals, and are sold in pairs.

1968-69 DOOR JAMB WINDLACE - COUPE **092171**

1968-69 DOOR JAMB WINDLACE - CONVERTIBLE **092173**

Our Package Tray is a high quality colored board. Utilizing modern material for durability and long life.

1968-72 COLORED PACKAGE TRAY BOARD **091289**

Distinctive Industries High-Density Seat Foam is designed to work as a system with our upholstery. Our High-Density Seat Foam is firm, form fitting, and features a Typar® web backing for strength, which prevents spring intrusion and ensures a quality fit and long lasting life. Seat Foam is sold individually, not in pairs.

1966-70 A-BODY BUCKET SEAT FOAM **067116GM6670**

Distinctive Industries Seat Heaters provide therapeutic heat and body warmth in any classic car, using the same technology as late model or current vehicles. Each kit comes with switch, harnesses, and two carbon fiber element pads to complete one seat install. Switch can be dash, console, or hidden in a place of choice. Seat Heaters are sold individually, not in pairs.

1964-72 CARBON FIBER SEAT HEATERS **061001**

## 1969 INTERIOR PARTS & ACCESSORIES

CHEVELLE



### 1969 PRE-ASSEMBLED DOOR/QUARTER PANELS

Distinctive Industries 1969 Pre-Assembled Door Panels are a correct reproduction of the original. We offer original Madrid grain in 32 oz vinyl. The dielectric patterns are correct along with the chrome (Mylar®) trim, metal upper rail, inner window felt, and hole placement pre-cut into the panel backed by die cut fiber board, just like the originals. Does not include Door Panel emblems.

#### Features

- Original Madrid grain vinyl
- Correct dielectric "Heat Seal" pattern
- Correct colors matched to the original vinyl
- Door trim molding attached (where applicable)
- Metal upper rail
- Inner window felt attached
- .100-inch thickness Poly-coated "Autoboard" backing
- Door Panel backs are perimeter stapled for maximum adhesion
- Limited lifetime warranty

#### Description

Description	Part #
FRONT DOOR PANELS	091215P
EL CAMINO FRONT DOOR PANELS	090969P
COUPE REAR QUARTER PANELS	091223P
CONVERTIBLE REAR QUARTER PANELS	091231P

\* Convertible Rear Quarter Panels have ABS plastic upper rails.

### 1969 UNASSEMBLED DOOR/QUARTER PANELS

Our 1969 Door/Quarter Panels are a correct reproduction of the original. We offer original Madrid grain in 32 oz vinyl, and correct dielectrically heat sealed patterns as original. Does not include Door Panel emblems.

#### Features

- Original Madrid grain vinyl
- Correct dielectric "Heat Seal" pattern
- Correct colors matched to the original vinyl
- .100-inch thickness Poly-coated "Autoboard" backing
- Door Panel backs are perimeter stapled for maximum adhesion
- Limited lifetime warranty

#### Description

Description	Part #
FRONT DOOR PANELS	091215

\* Chevelle and El Camino share the same front door panels from 1964-72.

COUPE REAR QUARTER PANELS	091223
CONVERTIBLE REAR QUARTER PANELS	091231

### 1969 SUNVISORS

Our 1969 Sunvisors are in the original Bedford Ribbed grain vinyl, with the vinyl binding stitched, just like the originals. All Sunvisors are sold in pairs.

CONVERTIBLE SUNVISORS	091330
-----------------------	--------

\* 1968-69 Convertible Sunvisors are in the original Madrid grain.



#### 1969 COLORS

BLACK	L-2295
DARK BLUE	L-3598
DARK GREEN	L-3606
LIGHT GREEN	L-3603
PARCHMENT	L-2300
RED	L-3597
SADDLE	L-3887
WHITE	L-2305

#### 1969 SUNVISOR COLORS

BLACK	H-600
GREEN GOLD	H-979
WHITE	H-978

## 1970-72 INTERIOR PARTS & ACCESSORIES

### 1970 SEAT UPHOLSTERY

Our 1970 Chevelle Seat Upholstery is a correct reproduction of the original. We offer the original Madrid grain with Diamond Waffle grain stripes in 32 oz vinyl, with the correct dielectrically heat sealed patterns.

#### Features

- Original Madrid grain vinyl
- Diamond Waffle grain stripes
- Correct dielectric "Heat Seal" pattern
- Correct 6 stitch per inch stitching
- Correct colors matched to the original vinyl
- Limited lifetime warranty

#### Description

Description	Part #
COUPE BUCKET SEATS - FRONT/REAR SET	<b>090359</b>
COUPE BENCH SEAT - FRONT/REAR SET	<b>090360</b>
CONVERTIBLE BUCKET SEATS - FRONT/REAR SET	<b>090361</b>
CONVERTIBLE BENCH SEAT - FRONT/REAR SET	<b>090362</b>
BUCKET SEATS - FRONT	<b>090324</b>
BENCH SEAT - FRONT	<b>090332</b>
COUPE BENCH SEAT - REAR	<b>090340</b>
CONVERTIBLE BENCH SEAT - REAR	<b>090357</b>

\* Chevelle and El Camino share the same front seat upholstery from 1964-72.



1970 Chevelle



#### 1970 COLORS

BLACK	L-2295
DARK GREEN	L-3896
GOLD	L-3888
IVORY	L-3895
MEDIUM BLUE	L-3883
RED	L-3889
SADDLE	L-3887



#### 1970 CUSTOM LEATHER SEAT UPHOLSTERY

We offer custom leather upholstery for the 1970 Chevelle. Custom options include contrasting colors and stitching, as well as solid color upholstery. *Please call for color and option availability.*

## 1970-72 INTERIOR PARTS & ACCESSORIES

### 1970-72 4 DOOR SEDAN AND STATION WAGON SEAT UPHOLSTERY

Our 1970-72 Chevelle Seat Upholstery is a correct reproduction of the original. We offer the original Madrid grain with 2 Laredo grain stripes for 1970 models and Madrid grain with Elk grain inserts for 1971-72 in 32 oz vinyl, with the correct dielectrically heat sealed patterns.

#### Features

- Original Madrid grain vinyl
- Correct dielectric "Heat Seal" pattern
- Correct 6 stitch per inch stitching
- Correct colors matched to the original vinyl
- Limited lifetime warranty

1971-72 BENCH SEAT - FRONT **090407**

### 1970-72 INTERIOR ACCESSORIES

Our Convertible Top Boot features the correct Madrid grain in 32 oz. vinyl is padded and fastens just like the original. Clips are not included.

1968-72 CONVERTIBLE TOP BOOT **092072**

Distinctive Industries Quarter Trim Panels are a correct reproduction of the original. We offer original Madrid grain in 32 oz vinyl.

1968-72 CONVERTIBLE QUARTER TRIM WITH ARMREST **092056**

1968-72 COUPE QUARTER TRIM WITH ARMREST **092015**

Our Armrest Covers are designed to fit correctly, and to insure the perfect color match to our interior products. Die cut from 32 oz Madrid grain vinyl.

1968-72 ARMREST COVER **091235**

Our Door Jamb Windlace is the correct Madrid grain in 32 oz. vinyl, just like the originals, and are sold in pairs.

1970-72 DOOR JAMB WINDLACE **092175**

Our Package Tray is a high quality colored board. Utilizing modern material for durability and long life.

1968-72 COLORED PACKAGE TRAY BOARD **091289**

Distinctive Industries High-Density Seat Foam is designed to work as a system with our upholstery. Our High-Density Seat Foam is firm, form fitting, and features a Typar® web backing for strength, which prevents spring intrusion and ensures a quality fit and long lasting life. Seat Foam is sold individually, not in pairs.

1966-70 A-BODY BUCKET SEAT FOAM **067116GM6670**

1971-72 A-BODY BUCKET SEAT FOAM **067124GM7172**

Distinctive Industries Seat Heaters provide therapeutic heat and body warmth in any classic car, using the same technology as late model or current vehicles. Each kit comes with switch, harnesses, and two carbon fiber element pads to complete one seat install. Switch can be dash, console, or hidden in a place of choice. Seat Heaters are sold individually, not in pairs.

1964-72 CARBON FIBER SEAT HEATERS **061001**

### 1970-72 COLORS

1970-72 BLACK	L-2295
1970 DARK GREEN	L-3896
1970 GOLD	L-3888
1970 IVORY	L-3895
1970 MEDIUM BLUE	L-3883
1970 RED	L-3889
1970 SADDLE	L-3887
1971-72 IVORY	L-2305
1971 BLUE	L-4135
1971 JADE	L-4146
1971 SADDLE	L-4139
1971 SANDALWOOD	L-4138
1972 COVERT	L-4425
1972 DARK GREEN	L-4424
1972 TAN	L-4426
1972 WHITE	L-4421

**092072**

**092072**

**092072**

**092114**

**1970-72 CUSTOM LEATHER SEAT UPHOLSTERY**

We offer custom leather upholstery for the 1970-72 Chevelle. Custom options include contrasting colors and stitching, as well as solid color upholstery. *Please call for color and option availability.*

**1968-72 BUCKET SEAT HEADRESTS - FRONT** **092114**

**1968-72 BENCH SEAT HEADRESTS - FRONT** **092080**

L-2295  
L-3896  
L-3888  
L-3895  
L-3883  
L-3889  
L-3887  
L-2305  
L-4135  
L-4146  
L-4139  
L-4138  
L-4425  
L-4424  
L-4426  
L-4421  
L-3889  
L-3887  
L-4135  
L-4146  
L-4139  
L-4425  
L-4424  
L-4426  
L-4421  
L-4138  
L-2305  
L-4426

## 1970-72 INTERIOR PARTS & ACCESSORIES

### 1970-72 PRE-ASSEMBLED DOOR/QUARTER PANELS

Distinctive Industries 1970-72 Pre-Assembled Door Panels are a correct reproduction of the original. We offer original Madrid grain in 32 oz vinyl. The dielectric patterns are correct along with the chrome (Mylar®) trim, metal upper rail, inner window felt, and hole placement pre-cut into the panel backed by die cut fiber board, just like the originals. Does not include emblems (where applicable).

#### Features

- Original Madrid grain vinyl
- Correct dielectric "Heat Seal" pattern
- Correct colors matched to the original vinyl
- Door trim molding attached (where applicable)
- Metal upper rail
- Inner window felt attached
- .100-inch thickness Poly-coated "Autoboard" backing
- Door Panel backs are perimeter stapled for maximum adhesion
- Limited lifetime warranty

#### Description

FRONT DOOR PANELS	Part #
EL CAMINO FRONT DOOR PANELS	<b>091249P</b>
COUPE REAR QUARTER PANELS	<b>090977P</b>
CONVERTIBLE REAR QUARTER PANELS	<b>091256P</b>

\* **Convertible Rear Quarter Panels have ABS plastic upper rails.**

### 1970-72 UNASSEMBLED DOOR/QUARTER PANELS

Our 1970-72 Door/Quarter Panels are a correct reproduction of the original. We offer original Madrid grain in 32 oz vinyl, and correct dielectrically heat sealed patterns as original. Does not include emblems (where applicable).

#### Features

- Original Madrid grain vinyl
- Correct dielectric "Heat Seal" pattern
- Correct colors matched to the original vinyl
- .100-inch thickness Poly-coated "Autoboard" backing
- Door Panel backs are perimeter stapled for maximum adhesion
- Limited lifetime warranty

#### Description

FRONT DOOR PANELS	Part #
	<b>091249</b>

\* **Chevelle and El Camino share the same front door panels from 1964-72.**

COUPE REAR QUARTER PANELS	<b>091256</b>
CONVERTIBLE REAR QUARTER PANELS	<b>091264</b>

### 1970-72 COLORS

1970-72 BLACK	L-2295	1971 BLUE	L-4135
1970 DARK GREEN	L-3896	1971 JADE	L-4146
1970 GOLD	L-3888	1971 SADDLE	L-4139
1970 IVORY	L-3895	1971 SANDALWOOD	L-4138
1970 MEDIUM BLUE	L-3883	1972 COVERT	L-4425
1970 RED	L-3889	1972 DARK GREEN	L-4424
1970 SADDLE	L-3887	1972 TAN	L-4426
1971-72 IVORY	L-2305	1972 WHITE	L-4421



## 1970-72 INTERIOR PARTS & ACCESSORIES

### 1970-72 SUNVISORS

Our 1970-72 Sunvisors are in the original Premier Perforated grain vinyl, with the vinyl binding stitched, just like the originals. All Sunvisors are sold in pairs.

1970 MALIBU/EL CAMINO/SS COUPE SUNVISOR **091331**

1971-72 MALIBU/EL CAMINO/SS COUPE SUNVISORS **091336**

CONVERTIBLE SUNVISORS **091332**

\* 1970-72 Convertible Sunvisors are in the original Madrid grain.

### 1970-72 SUNVISOR COLORS

BLACK	H-1179
BUCKSKIN	H-1186
DARK BLUE	H-1183
DARK GREEN	H-1276
DARK RED	H-1411
DARK SADDLE	H-1185
LIGHT BLUE	H-1182
MEDIUM BLUE	H-1482
SANDALWOOD	H-1180
WHITE	H-1181



## 1970-72 INTERIOR PARTS & ACCESSORIES



### 1971-72 SEAT UPHOLSTERY

Our 1971-72 Chevelle Seat Upholstery is a correct reproduction of the original. We offer the original Madrid grain with Elk grain inserts in 32 oz vinyl correctly sewn as original.

#### Features

- Original Madrid grain vinyl and Elk grain insert
- Correct 6 stitch per inch stitching
- Correct colors matched to the original vinyl
- Limited lifetime warranty

#### Description

COUPE BUCKET SEATS - FRONT/REAR SET	<b>090415</b>
COUPE BENCH SEAT - FRONT/REAR SET	<b>090416</b>
CONVERTIBLE BUCKET SEATS - FRONT/REAR SET	<b>090417</b>
CONVERTIBLE BENCH SEAT - FRONT/REAR SET	<b>090418</b>
BUCKET SEATS - FRONT	<b>090365</b>
BENCH SEAT - FRONT	<b>090373</b>
4 DOOR SEDAN/WAGON BENCH SEAT - FRONT	<b>090407</b>
COUPE BENCH SEAT - REAR	<b>090381</b>
CONVERTIBLE BENCH SEAT - REAR	<b>090399</b>

\* Chevelle and El Camino share the same front seat upholstery from 1964-72.

### 1971-72 COLORS

1971 BLUE	L-4135 (I=L-4165)
1971 JADE	L-4146 (I=L-4171)
1971 SADDLE	L-4139 (I=L-4168)
1971 SANDALWOOD	L-4138 (I=L-4167)
1972 COVERT	L-4425 (I=L-4438)
1972 DARK GREEN	L-4424 (I=L-4437)
1972 WHITE	L-4421 (I=L-4434)
BLACK	L-2295 (I=L-3931)

### 1971-72 CUSTOM LEATHER SEAT UPHOLSTERY

We offer custom leather upholstery for the 1971-72 Chevelle. Custom options include contrasting colors and stitching, as well as solid color upholstery. *Please call for color and option availability.*

**Don't Forget About SEAT HEATERS!!!**

Now Available Easy to install  
**PerfectFit® Carbon Fiber Seat Heaters**  
 with a small concealable switch  
**PART #061001**



## Introduction To The Catalog

Thank you for choosing Distinctive Industries as your provider of Restoration Interior Products. The catalog you are reading was designed with the input of our existing customers and moving forward, will continue to be a representation of their needs, and the needs of restoration experts worldwide.

### Design

We have designed our catalog for the Restoration Professional, from the Local Upholstery and Restoration Shop, to the National Distributor of Restoration Products. The thought was to create a catalog that eases the pain of product entry for those building catalogs, and to ease ordering for those that order directly from the catalog. We accomplished this by listing product by year, model, and trim level. You will find this catalog to be easy to use.

### Descriptions

Descriptions are a blend of Marketing and Technical descriptions. After polling our customers we found that aside from the design, missing was a good description of the products in today's catalogs. We remedied that by providing a blended description as a basis for our customers to expand upon, or use as is.

### Colors

Color swatches are placed near the product with labeled color codes to avoid confusion. Color Code boxes are located near the applicable products. We offer many special order color combinations as well as an option for leather in most cases.

### Images

Images are available for License through Distinctive Industries.

- Licensed images must be accompanied and located adjacent to the matching Distinctive Industries product.



## Table of Contents

1963 interior parts and accessories

1964 interior parts and accessories

1965 interior parts and accessories

1966 interior parts and accessories

1967 interior parts and accessories

1968 interior parts and accessories

1969 interior parts and accessories

1970 interior parts and accessories

1971-72 interior parts and accessories

© Copyright 2016, Distinctive Industries, all rights reserved. No part of this publication may be duplicated or reproduced without written permission from Distinctive Industries.







## 1963 INTERIOR PARTS & ACCESSORIES

### 1963 F-85 SEAT UPHOLSTERY

Our 1963 Cutlass F-85 Seat Upholstery is a correct reproduction of the original. We offer the original Seville grain in 32 oz. vinyl, with the correct horizontal patterns, carpeted seat back, and sewn as original. Seat buttons/emblems not included.

#### Features

- Original Seville grain vinyl
- Correct 6 stitch per inch stitching
- Correct colors matched to the original vinyl
- Limited lifetime warranty

BUCKET SEATS - FRONT	097994
BENCH SEAT - FRONT <b>*SEEKING PATTERN*</b>	
COUPE BENCH SEAT - REAR	097997
CONVERTIBLE BENCH SEAT - REAR <b>*SEEKING PATTERN*</b>	



### 1963 F-85 DOOR/QUARTER PANELS

Our 1963 Cutlass F-85 Door/Quarter Panels are a correct reproduction of the original with carpeted bottom portion, and 5 horizontal pleats accented with Mylar® trim. We offer original Seville grain in 32 oz. vinyl, and correct dielectrically heat sealed horizontal patterns as original.

#### Features

- Original Seville grain vinyl
- Correct dielectric "Heat Seal" stitched pattern
- Correct colors matched to the original vinyl
- .100-inch thickness poly-coated "Autoboard" backing
- Door Panel backs are perimeter stapled for maximum adhesion
- Limited lifetime warranty

FRONT DOOR PANELS	098000
COUPE REAR QUARTER PANELS	098001
CONVERTIBLE REAR QUARTER PANELS <b>*SEEKING PATTERN*</b>	



#### 1963 COLORS

BEIGE	L-1975
BLACK	L-920
BLUE	L-1409
RED	L-1425
SADDLE	L-1621
WHITE	L-1213

### 1963 INTERIOR ACCESSORIES

Our 1963 Rear Armrest Upholstery is reproduced in the correct Seville grain in 32 oz. vinyl and stitched as original.

COUPE ARMREST COVERS - REAR	097999
-----------------------------	--------

Distinctive Industries Seat Heaters provide therapeutic heat and body warmth in any classic car, using the same technology as late model or current vehicles. Each kit comes with switch, harnesses, and two carbon fiber element pads to complete one seat install. Switch can be dash, console, or hidden in a place of choice. Seat Heaters are sold individually, not in pairs.

1963-72 CARBON FIBER SEAT HEATERS	061001
-----------------------------------	--------

**Don't Forget About SEAT HEATERS!!!**

Now Available Easy to install  
PerfectFit® Carbon Fiber Seat Heaters  
with a small concealable switch  
**PART #061001**



CUTLASS/442

## 1964 INTERIOR PARTS & ACCESSORIES

### 1964 CUTLASS/442/HOLIDAY MODELS SEAT UPHOLSTERY

Our 1964 Cutlass Seat Upholstery is a correct reproduction of the original. We offer the original Seville grain in 32 oz. vinyl, with the correct vertical patterns, carpeted seat back, and sewn as original.

#### Features

- Original Seville grain vinyl
- Correct 6 stitch per inch stitching
- Correct colors matched to the original vinyl
- Limited lifetime warranty

BUCKET SEATS - FRONT	098004
BENCH SEAT - FRONT *SEEKING PATTERN*	
COUPE BENCH SEAT - REAR	098012
CONVERTIBLE BENCH SEAT - REAR	098020

### 1964 CUTLASS/442/HOLIDAY MODELS DOOR/QUARTER PANELS

Our 1964 Cutlass Door/Quarter Panels are a correct reproduction of the original with carpeted bottom portion, and 6 vertical pleats accented with Mylar® trim. We offer original Seville grain in 32 oz. vinyl, and correct dielectrically heat sealed vertical patterns as original.

#### Features

- Original Seville grain vinyl
- Correct dielectric "Heat Seal" stitched pattern
- Correct colors matched to the original vinyl
- .100-inch thickness poly-coated "Autoboard" backing
- Door Panel backs are perimeter stapled for maximum adhesion
- Limited lifetime warranty

FRONT DOOR PANELS	098022
COUPE REAR QUARTER PANELS	098025
CONVERTIBLE REAR QUARTER PANELS	098031

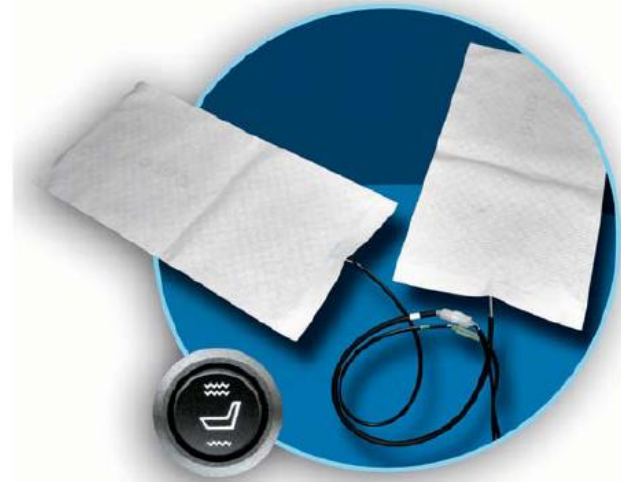

### 1964 INTERIOR ACCESSORIES

Our Convertible Top Boot features the correct Seville grain in 32 oz. vinyl and fastens just like the original. Clips are not included.

CONVERTIBLE TOP BOOT **098027**

Our 1964 Rear Armrest Upholstery is reproduced in the correct Seville grain in 32 oz. vinyl and stitched as original.

CONVERTIBLE REAR ARMREST COVERS **092023**

Distinctive Industries High-Density Seat Foam is designed to work as a system with our upholstery. Our High-Density Seat Foam is firm, form fitting, and features a Tytar® web backing for strength, which prevents spring intrusion and ensures a quality fit and long lasting life.

1964-65 BUCKET SEAT FOAM **064111**

Distinctive Industries Seat Heaters provide therapeutic heat and body warmth in any classic car, using the same technology as late model or current vehicles. Each kit comes with switch, harnesses, and two carbon fiber element pads to complete one seat install. Switch can be dash, console, or hidden in a place of choice. Seat Heaters are sold individually, not in pairs.

1963-72 CARBON FIBER SEAT HEATERS **061001**



#### 1964 COLORS

BLACK	L-920
BLUE	L-1409
RED	L-1425
SADDLE	L-1621
WHITE	L-1213

## 1965 INTERIOR PARTS & ACCESSORIES

### 1965 CUTLASS SPORTS COUPE SEAT UPHOLSTERY

Our 1965 Cutlass Seat Upholstery is a correct reproduction of the original. We offer the original Madrid grain in 32 oz. vinyl, with the correct horizontal patterns and sewn as original. Seat buttons/medallions are included.

*\*All Sports Coupe models are Sedans.*

#### Features

- Original Madrid grain vinyl
- Correct 6 stitch per inch stitching
- Correct colors matched to the original vinyl
- Limited lifetime warranty

BUCKET SEATS - FRONT **098046**

BENCH SEAT - FRONT **\*SEEKING PATTERN\***

SEDAN BENCH SEAT - REAR **098053**

### 1965 CUTLASS SPORTS COUPE DOOR/QUARTER PANELS

Our 1965 Cutlass Door/Quarter Panels are a correct reproduction of the original with carpeted bottom portion, and 2 horizontal and vertical pleats. We offer original Madrid grain in 32 oz. vinyl, and correct dielectrically heat sealed horizontal patterns as original. Door panel buttons not included.

*\*All Sports Coupe models are Sedans.*

#### Features

- Original Madrid grain vinyl
- Correct dielectric "Heat Seal" stitched pattern
- Correct colors matched to the original vinyl
- .100-inch thickness poly-coated "Autoboard" backing
- Door Panel backs are perimeter stapled for maximum adhesion
- Limited lifetime warranty

FRONT DOOR PANELS **098111**

SEDAN REAR QUARTER PANELS **098129**

**Don't Forget About SEAT HEATERS!!!**

Now Available Easy to install  
PerfectFit® Carbon Fiber Seat Heaters  
with a small concealable switch  
**PART #061001**



#### 1965 COLORS

BLACK	L-2295
BLUE	L-2302
BRONZE	L-2795
FAWN	L-2586
RED	L-2324
WHITE	L-4421



## 1965 INTERIOR PARTS & ACCESSORIES

### 1965 CUTLASS/442/HOLIDAY MODELS SEAT UPHOLSTERY

Our 1965 Cutlass Seat Upholstery is a correct reproduction of the original. We offer the original Madrid grain in 32 oz. vinyl, with the correct vertical patterns, carpeted seat back, and sewn as original. Seat buttons/emblems not included.

#### Features

- Original Madrid grain vinyl
- Correct 6 stitch per inch stitching
- Correct colors matched to the original vinyl
- Limited lifetime warranty

BUCKET SEATS - FRONT	<b>098061</b>
BENCH SEAT - FRONT *SEEKING PATTERN*	
COUPE BENCH SEAT - REAR	<b>098079</b>
CONVERTIBLE BENCH SEAT - REAR	<b>098087</b>

### 1965 CUTLASS/442/HOLIDAY MODELS DOOR/QUARTER PANELS

Our 1965 Cutlass Door/Quarter Panels are a correct reproduction of the original with carpeted bottom portion, and 8 horizontal pleats. We offer original Madrid grain in 32 oz. vinyl, and correct dielectrically heat sealed horizontal patterns as original.

#### Features

- Original Madrid grain vinyl
- Correct dielectric "Heat Seal" stitched pattern
- Correct colors matched to the original vinyl
- .100-inch thickness poly-coated "Autoboard" backing
- Door Panel backs are perimeter stapled for maximum adhesion
- Limited lifetime warranty

FRONT DOOR PANELS	<b>098095</b>
COUPE REAR QUARTER PANELS	<b>098103</b>
CONVERTIBLE REAR QUARTER PANELS	<b>098109</b>

### 1965 INTERIOR ACCESSORIES

Our Convertible Top Boot features the correct Madrid grain in 32 oz. vinyl and fastens just like the original. Clips are not included.  
**CONVERTIBLE TOP BOOT 098132**

Our 1965 Rear Armrest Upholstery is reproduced in the correct Madrid grain in 32 oz. vinyl and stitched as original.  
**1965-67 CONVERTIBLE REAR ARMREST COVERS 092031**

Distinctive Industries High-Density Seat Foam is designed to work as a system with our upholstery. Our High-Density Seat Foam is firm, form fitting, and features a Typar® web backing for strength, which prevents spring intrusion and ensures a quality fit and long lasting life.  
**1964-65 BUCKET SEAT FOAM 064111**

Distinctive Industries Seat Heaters provide therapeutic heat and body warmth in any classic car, using the same technology as late model or current vehicles. Each kit comes with switch, harnesses, and two carbon fiber element pads to complete one seat install. Switch can be dash, console, or hidden in a place of choice. Seat Heaters are sold individually, not in pairs.  
**1963-72 CARBON FIBER SEAT HEATERS 061001**



#### 1965 COLORS

BLACK	L-2295
BLUE	L-2302
BRONZE	L-2795
PARCHMENT	L-2300
RED	L-2324



## 1966 INTERIOR PARTS & ACCESSORIES

### 1966 CUTLASS SPORTS COUPE SEAT UPHOLSTERY

Our 1966 Cutlass Seat Upholstery is a correct reproduction of the original. We offer the original Madrid grain in 32 oz. vinyl, with the correct patterns and sewn as original.

*\*All Sports Coupe models are Sedans.*

#### Features

- Original Madrid grain vinyl
- Correct 6 stitch per inch stitching
- Correct colors matched to the original vinyl
- Limited lifetime warranty

BENCH SEAT - FRONT **\*SEEKING PATTERN\***

BENCH SEAT - REAR **\*SEEKING PATTERN\***

### 1966 CUTLASS/442/HOLIDAY MODELS SEAT UPHOLSTERY

Our 1966 Cutlass Seat Upholstery is a correct reproduction of the original. We offer the original Madrid grain in 32 oz. vinyl, with the correct horizontal patterns, vertical trim stripe, carpeted seat back on bench seats, and sewn as original. Seat buttons/emblems not included.

#### Features

- Original Madrid grain vinyl
- Correct 6 stitch per inch stitching
- Correct colors matched to the original vinyl
- Limited lifetime warranty

BUCKET SEATS - FRONT

BENCH SEAT - FRONT

COUPE BENCH SEAT - REAR

CONVERTIBLE BENCH SEAT - REAR

**098152**

**098160**

**098178**

**098186**

### 1966 CUTLASS SPORTS COUPE DOOR/QUARTER PANELS

Our 1966 Cutlass Door/Quarter Panels are a correct reproduction of the original with carpeted bottom portion. We offer original Madrid grain in 32 oz. vinyl, and correct dielectrically heat sealed horizontal patterns as original.

*\*All Sports Coupe models are Sedans.*

#### Features

- Original Madrid grain vinyl
- Correct dielectric "Heat Seal" stitched pattern
- Correct colors matched to the original vinyl
- .100-inch thickness poly-coated "Autoboard" backing
- Door Panel backs are perimeter stapled for maximum adhesion
- Limited lifetime warranty

FRONT DOOR PANELS **\*SEEKING PATTERN\***

COUPE REAR QUARTER PANELS **\*SEEKING PATTERN\***

CONVERTIBLE REAR QUARTER PANELS **\*SEEKING PATTERN\***

### 1966 CUTLASS/442/HOLIDAY MODELS DOOR/QUARTER PANELS

Our 1966 Cutlass Door/Quarter Panels are a correct reproduction of the original with carpeted bottom portion, and horizontal pleats with 2 vertical pleats in the middle of the panel. We offer original Madrid grain in 32 oz. vinyl, and correct dielectrically heat sealed horizontal patterns as original.

#### Features

- Original Madrid grain vinyl
- Correct dielectric "Heat Seal" stitched pattern
- Correct colors matched to the original vinyl
- .100-inch thickness poly-coated "Autoboard" backing
- Door Panel backs are perimeter stapled for maximum adhesion
- Limited lifetime warranty

FRONT DOOR PANEL

**098194**

COUPE REAR QUARTER PANELS

**098202**

CONVERTIBLE REAR QUARTER PANELS

**098210**



#### 1966 COLORS

BLACK	L-2295
BRONZE	L-2795
LIGHT BLUE	L-2302
PEARL	L-3295
PARCHMENT	L-2300
METALLIC RED	L-2324

**Don't Forget About SEAT HEATERS!!!**  
 Now Available Easy to install  
**PerfectFit® Carbon Fiber Seat Heaters**  
 with a small concealable switch  
**PART #061001**

1966 INTERIOR PARTS & ACCESSORIES

1966 INTERIOR ACCESSORIES

Our Convertible Top Boot features the correct Madrid grain in 32 oz. vinyl and fastens just like the original. Clips are not included with the Unassembled Convertible Top Boot.

- 1966-67 UNASSEMBLED CONVERTIBLE TOP BOOT **098222**
- 1966-67 PRE-ASSEMBLED CONVERTIBLE TOP BOOT **092065**

Our 1966 Rear Armrest Upholstery is reproduced in the correct Madrid grain in 32 oz. vinyl and stitched as original.

- 1965-67 CONVERTIBLE REAR ARMREST COVERS **092031**

Distinctive Industries High-Density Seat Foam is designed to work as a system with our upholstery. Our High-Density Seat Foam is firm, form fitting, and features a Typar® web backing for strength, which prevents spring intrusion and ensures a quality fit and long lasting life. Seat Foam is sold individually, not in pairs.

- 1966-70 BUCKET SEAT FOAM **067116GM6670**

Distinctive Industries Seat Heaters provide therapeutic heat and body warmth in any classic car, using the same technology as late model or current vehicles. Each kit comes with switch, harnesses, and two carbon fiber element pads to complete one seat install. Switch can be dash, console, or hidden in a place of choice. Seat Heaters are sold individually, not in pairs.

- 1963-72 CARBON FIBER SEAT HEATERS **061001**

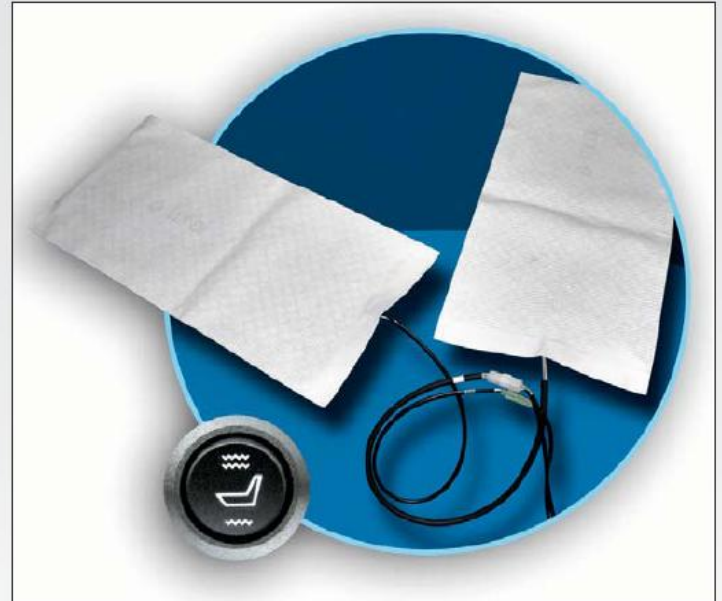

1966 COLORS

BLACK	L-2295
BRONZE	L-2795
LIGHT BLUE	L-2302
PEARL	L-3295
PARCHMENT	L-2300
METALLIC RED	L-2324





## 1967 INTERIOR PARTS & ACCESSORIES

### 1967 CUTLASS SPORTS COUPE SEAT UPHOLSTERY

Our 1967 Cutlass Seat Upholstery is a correct reproduction of the original. We offer the original Madrid grain in 32 oz. vinyl, with the correct patterns and sewn as original.

*\*All Sports Coupe models are Sedans.*

#### Features

- Original Madrid grain vinyl
- Correct 6 stitch per inch stitching
- Correct colors matched to the original vinyl
- Limited lifetime warranty

BUCKET SEATS - FRONT **\*SEEKING PATTERN\***

BENCH SEAT - FRONT **\*SEEKING PATTERN\***

SEDAN BENCH SEAT - REAR **\*SEEKING PATTERN\***

### 1967 CUTLASS SPORTS COUPE DOOR/QUARTER PANELS

Our 1967 Cutlass Door/Quarter Panels are a correct reproduction of the original with carpeted bottom portion. We offer original Madrid grain in 32 oz. vinyl, and correct dielectrically heat sealed horizontal patterns as original.

*\*All Sports Coupe models are Sedans.*

#### Features

- Original Madrid grain vinyl
- Correct dielectric "Heat Seal" stitched pattern
- Correct colors matched to the original vinyl
- .100-inch thickness poly-coated "Autoboard" backing
- Door Panel backs are perimeter stapled for maximum adhesion
- Limited lifetime warranty

FRONT DOOR PANELS **\*SEEKING PATTERN\***

COUPE REAR QUARTER PANELS **\*SEEKING PATTERN\***

CONVERTIBLE REAR QUARTER PANELS **\*SEEKING PATTERN\***

### 1967 CUTLASS/442/SUPREME HOLIDAY MODELS SEAT UPHOLSTERY

Our 1967 Cutlass Seat Upholstery is a correct reproduction of the original. We offer the original Madrid grain in 32 oz. vinyl, with the correct horizontal patterns and sewn as original. Seat buttons/emblems not included.

#### Features

- Original Madrid grain vinyl
- Correct 6 stitch per inch stitching
- Correct colors matched to the original vinyl
- Limited lifetime warranty

BUCKET SEATS - FRONT

**098236**

BENCH SEAT WITH ARMREST - FRONT **\*SEEKING PATTERN\***

COUPE BENCH SEAT - REAR

**098244**

CONVERTIBLE BENCH SEAT - REAR

**098251**

### 1967 CUTLASS/442/SUPREME HOLIDAY MODELS DOOR/QUARTER PANELS

Our 1967 Cutlass Door/Quarter Panels are a correct reproduction of the original with carpeted bottom portion, and horizontal pleats with 6 vertical pleats accented with Mylar® trim. We offer original Madrid grain in 32 oz. vinyl, and correct dielectrically heat sealed horizontal patterns as original.

#### Features

- Original Madrid grain vinyl
- Correct dielectric "Heat Seal" stitched pattern
- Correct colors matched to the original vinyl
- .100-inch thickness poly-coated "Autoboard" backing
- Door Panel backs are perimeter stapled for maximum adhesion
- Limited lifetime warranty

FRONT DOOR PANELS

**098269**

COUPE REAR QUARTER PANELS

**098277**

CONVERTIBLE REAR QUARTER PANELS

**098285**

#### 1967 COLORS

BLACK	L-2295
BLUE	L-2302
CHAMPAGNE	L-2313
RED	L-3048
YELLOW	L-3049

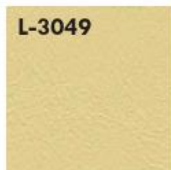

1967 INTERIOR PARTS & ACCESSORIES

1967 INTERIOR ACCESSORIES

Our Convertible Top Boot features the correct Madrid grain in 32 oz. vinyl and fastens just like the original. Clips are not included with the Unassembled Convertible Top Boot.

- 1966-67 UNASSEMBLED CONVERTIBLE TOP BOOT **098222**
- 1966-67 PRE-ASSEMBLED CONVERTIBLE TOP BOOT **092065**

Our 1967 Rear Armrest Upholstery is reproduced in the correct Madrid grain in 32 oz. vinyl and stitched as original.

- 1965-67 CONVERTIBLE REAR ARMREST COVERS **092031**

Distinctive Industries High-Density Seat Foam is designed to work as a system with our upholstery. Our High-Density Seat Foam is firm, form fitting, and features a Typar® web backing for strength, which prevents spring intrusion and ensures a quality fit and long lasting life. Seat Foam is sold individually, not in pairs.

- 1966-70 BUCKET SEAT FOAM **067116GM6670**

Distinctive Industries Seat Heaters provide therapeutic heat and body warmth in any classic car, using the same technology as late model or current vehicles. Each kit comes with switch, harnesses, and two carbon fiber element pads to complete one seat install. Switch can be dash, console, or hidden in a place of choice. Seat Heaters are sold individually, not in pairs.

- 1963-72 CARBON FIBER SEAT HEATERS **061001**



1967 COLORS	
BLACK	L-2295
BLUE	L-2302
CHAMPAGNE	L-2313
RED	L-3048
YELLOW	L-3049



**HandsOn**  
EXPERIENCE



Take a Kid to a Car Show is a program of ARMO, the Automotive Restoration Market Organization, a SEMA Council.

Can you whoop a kid on video games? Probably not. But you can show them a whole new "reality" by taking them to a car show. Encouraging a child to get outside, see glistening paint jobs, and hear the purr of finely tuned engines will awaken all of their senses. You might even be surprised at how much your own enthusiasm is rekindled!

Life is full of choices for kids. You can help them make the right ones by sharing your appreciation for cool old cars. The practical knowledge you share with a child today...just may be the experience that sets them on a lifetime of success.





## 1968 INTERIOR PARTS & ACCESSORIES

### 1968 CUTLASS/442/S/SPORTS COUPE/HOLIDAY MODELS SEAT UPHOLSTERY

Our 1968 Cutlass Seat Upholstery is a correct reproduction of the original. We offer the original Madrid grain in 32 oz. vinyl, with the correct vertical patterns, heat sealed Diamond Perforated insert, and sewn as original. Seat buttons/emblems not included.

**\*All Sports Coupe models are Sedans.**

#### Features

- Original Madrid grain vinyl
- Correct dielectric "Heat Seal" Diamond Perforated pattern
- Correct 6 stitch per inch stitching
- Correct colors matched to the original vinyl
- Limited lifetime warranty

BUCKET SEATS - FRONT	<b>098301</b>
BENCH SEAT - FRONT	<b>098319</b>
2 DOOR COUPE BENCH SEAT - REAR	<b>098327</b>
2 DOOR SEDAN BENCH SEAT - REAR	<b>098343</b>
CONVERTIBLE BENCH SEAT - REAR	<b>098335</b>

### 1968 CUTLASS SUPREME SEAT UPHOLSTERY

Our 1968 Cutlass Seat Upholstery is a correct reproduction of the original. We offer the original Madrid grain in 32 oz. vinyl, with the correct vertical patterns, and sewn as original.

#### Features

- Original Madrid grain vinyl
- Correct dielectric "Heat Seal" Diamond Perforated pattern
- Correct 6 stitch per inch stitching
- Correct colors matched to the original vinyl
- Limited lifetime warranty

BUCKET SEATS - FRONT	<b>*SEEKING PATTERN*</b>
BENCH SEAT - FRONT	<b>*SEEKING PATTERN*</b>
BENCH SEAT - REAR	<b>*SEEKING PATTERN*</b>



### 1968 CUTLASS/442/S/SPORTS COUPE/HOLIDAY MODELS DOOR/QUARTER PANELS

Our 1968 Cutlass Door/Quarter Panels are a correct reproduction of the original. We offer original Madrid grain with Diamond Perforated inserts in 32 oz. vinyl, and correct dielectrically heat sealed vertical patterns as original. Door Panels have 1 horizontal Mylar® strip across the top of the panel, and 2 horizontal Mylar® strips across the bottom of the panel with Diamond Perforated insert across the top of the panel and Madrid grain vinyl across the bottom of the panel.

**\*All Sports Coupe models are Sedans.**

#### Features

- Original Madrid grain vinyl with Diamond embossed inserts
- Correct dielectric "Heat Seal" Diamond Perforated pattern
- Correct colors matched to the original vinyl
- .100-inch thickness poly-coated "Autoboard" backing
- Door Panel backs are perimeter stapled for maximum adhesion
- Limited lifetime warranty

HOLIDAY COUPE/CONVERTIBLE FRONT DOOR PANELS	<b>098350</b>
442/SPORTS COUPE/SEDAN FRONT DOOR PANELS	<b>098368</b>
442/HOLIDAY COUPE REAR QUARTER PANELS	<b>098376</b>
442/CONVERTIBLE REAR QUARTER PANELS	<b>098384</b>
442/SPORTS COUPE/SEDAN REAR QUARTER PANELS	<b>098392</b>

CUTLASS/442



#### 1968 COLORS

BLACK	L-2295	PARCHMENT	L-3295
BLUE	L-3883	TEAL	L-2302
GARNET	L-3724	WHITE	L-2305
GOLD	L-3307		

## 1968 INTERIOR PARTS & ACCESSORIES

### 1968 CUTLASS SUPREME DOOR/QUARTER PANELS

Our 1968 Cutlass Door/Quarter Panels are a correct reproduction of the original with carpeted bottom portion. We offer original Madrid grain in 32 oz. vinyl, and correct dielectrically heat sealed horizontal patterns as original.

#### Features

- Original Madrid grain vinyl
- Correct dielectric "Heat Seal" stitched pattern
- Correct colors matched to the original vinyl
- .100-inch thickness poly-coated "Autoboard" backing
- Door Panel backs are perimeter stapled for maximum adhesion
- Limited lifetime warranty

FRONT DOOR PANELS **\*SEEKING PATTERN\***

COUPE REAR QUARTER PANELS **\*SEEKING PATTERN\***

CONVERTIBLE REAR QUARTER PANELS **\*SEEKING PATTERN\***

### 1968 INTERIOR ACCESSORIES

Distinctive Industries Headrest Covers features the correct Madrid grain in 32 oz vinyl, just like the original. These Headrest Covers are a sewn on cover that covers the original molded foam headrest.

- |                                     |               |
|-------------------------------------|---------------|
| 1968-72 BUCKET SEAT HEADREST COVERS | <b>099036</b> |
| 1968-72 BENCH SEAT HEADREST COVERS  | <b>099044</b> |

Our 1968 Rear Armrest Upholstery is reproduced in the correct Madrid grain in 32 oz. vinyl and stitched as original.

- |   |               |
|---|---------------|
| 1968-72 COUPE REAR ARMREST COVERS       | <b>092015</b> |
| 1968-72 CONVERTIBLE REAR ARMREST COVERS | <b>092056</b> |

Our Door Jamb Windlace is the correct Madrid grain in 32 oz. vinyl, just like the originals, and are sold in pairs.

- |  |               |
|--|---------------|
| 1968-69 COUPE DOOR JAMB WINDLACE       | <b>092171</b> |
| 1968-69 CONVERTIBLE DOOR JAMB WINDLACE | <b>092173</b> |

Our Convertible Top Boot features the correct Madrid grain in 32 oz. vinyl and fastens just like the original.

- |                              |               |
|------------------------------|---------------|
| 1968-72 CONVERTIBLE TOP BOOT | <b>099020</b> |
|------------------------------|---------------|

Distinctive Industries High-Density Seat Foam is designed to work as a system with our upholstery. Our High-Density Seat Foam is firm, form fitting, and features a Typar® web backing for strength, which prevents spring intrusion and ensures a quality fit and long lasting life. Seat Foam is sold individually, not in pairs.

- |                          |                     |
|--------------------------|---------------------|
| 1966-70 BUCKET SEAT FOAM | <b>067116GM6670</b> |
|--------------------------|---------------------|

Distinctive Industries Seat Heaters provide therapeutic heat and body warmth in any classic car, using the same technology as late model or current vehicles. Each kit comes with switch, harnesses, and two carbon fiber element pads to complete one seat install. Switch can be dash, console, or hidden in a place of choice. Seat Heaters are sold individually, not in pairs.

- |                                   |               |
|-----------------------------------|---------------|
| 1963-72 CARBON FIBER SEAT HEATERS | <b>061001</b> |
|-----------------------------------|---------------|



1968 Cutlass Convertible

CUTLASS/442



092171



092173



L-2295

L-3883

L-3724

L-3307

L-3295

L-2302

L-2305

#### 1968 COLORS

BLACK	L-2295
BLUE	L-3883
GARNET	L-3724
GOLD	L-3307
PARCHMENT	L-3295
TEAL	L-2302
WHITE	L-2305

## 1969 INTERIOR PARTS & ACCESSORIES

### 1969 CUTLASS/442/S/SPORTS COUPE/HOLIDAY MODELS SEAT UPHOLSTERY

Our 1969 Cutlass Seat Upholstery is a correct reproduction of the original. We offer the original Madrid grain in 32 oz. vinyl, with the correct vertical patterns, heat sealed Diamond Perforated insert on all models except for Supreme and sewn as original. Seat buttons/emblems are included.

*\*All Sports Coupe models are Sedans.*

#### Features

- Original Madrid grain vinyl
- Correct dielectric "Heat Seal" Diamond Perforated pattern
- Correct 6 stitch per inch stitching
- Correct colors matched to the original vinyl
- Limited lifetime warranty

BUCKET SEATS - FRONT	<b>098418</b>
BENCH SEAT - FRONT	<b>098426</b>
2 DOOR COUPE BENCH SEAT - REAR	<b>098434</b>
2 DOOR SEDAN BENCH SEAT - REAR	<b>098459</b>
CONVERTIBLE BENCH SEAT - REAR	<b>098442</b>

### 1969 CUTLASS SUPREME SEAT UPHOLSTERY

Our 1969 Cutlass Seat Upholstery is a correct reproduction of the original. We offer the original Madrid grain in 32 oz. vinyl, with the correct vertical patterns, carpeted seat bottom and sewn as original. Seat buttons/medallions are included.

#### Features

- Original Madrid grain vinyl
- Correct 6 stitch per inch stitching
- Correct colors matched to the original vinyl
- Limited lifetime warranty

2 DOOR COUPE BUCKET SEATS - FRONT <b>*SEEKING PATTERN*</b>	
2 DOOR BENCH SEAT WITH ARMREST - FRONT	<b>098475</b>
2 DOOR COUPE BENCH SEAT - REAR	<b>098483</b>

**Don't Forget About SEAT HEATERS!!!**

Now Available Easy to install  
**PerfectFit® Carbon Fiber Seat Heaters**  
 with a small concealable switch  
**PART #061001**



#### 1969 COLORS

BLACK	L-2295
BLUE	L-2302
GOLD	L-3599
GREEN	L-3603
PARCHMENT	L-2313
RED	L-3597
WHITE	L-2305

## 1969 INTERIOR PARTS & ACCESSORIES

### 1969 CUTLASS/442/S/SPORTS COUPE/HOLIDAY MODELS DOOR/QUARTER PANELS

Our 1969 Cutlass Door/Quarter Panels are a correct reproduction of the original. We offer original Madrid grain with Diamond embossed inserts in 32 oz. vinyl, and correct dielectrically heat sealed vertical patterns as original. Door Panels have 1 horizontal Mylar® strip across the top of the panel, and 2 horizontal Mylar® strips across the bottom of the panel with Diamond Perforated insert across the top of the panel and Madrid grain vinyl across the bottom of the panel.

*\*All Sports Coupe models are Sedans.*

#### Features

- Original Madrid grain vinyl with Diamond Perforated inserts
- Correct dielectric "Heat Seal" stitched pattern
- Correct colors matched to the original vinyl
- .100-inch thickness poly-coated "Autoboard" backing
- Door Panel backs are perimeter stapled for maximum adhesion
- Limited lifetime warranty

HOLIDAY COUPE/CONVERTIBLE FRONT DOOR PANELS **098350**  
 442/SPORTS COUPE/SEDAN FRONT DOOR PANELS **098368**  
 442/HOLIDAY COUPE REAR QUARTER PANELS **098376**  
 442/CONVERTIBLE REAR QUARTER PANELS **098384**  
 442/SPORTS COUPE/SEDAN REAR QUARTER PANELS **098392**

### 1969 CUTLASS SUPREME DOOR/QUARTER PANELS

Our 1969 Cutlass Door/Quarter Panels are a correct reproduction of the original. We offer original Madrid grain in 32 oz. vinyl, and correct dielectrically heat sealed patterns as original.

#### Features

- Original Madrid grain vinyl
- Correct dielectric "Heat Seal" stitched pattern
- Correct colors matched to the original vinyl
- .100-inch thickness poly-coated "Autoboard" backing
- Door Panel backs are perimeter stapled for maximum adhesion
- Limited lifetime warranty

FRONT DOOR PANELS **\*SEEKING PATTERN\***  
 COUPE REAR QUARTER PANELS **\*SEEKING PATTERN\***  
 CONVERTIBLE REAR QUARTER PANELS **\*SEEKING PATTERN\***

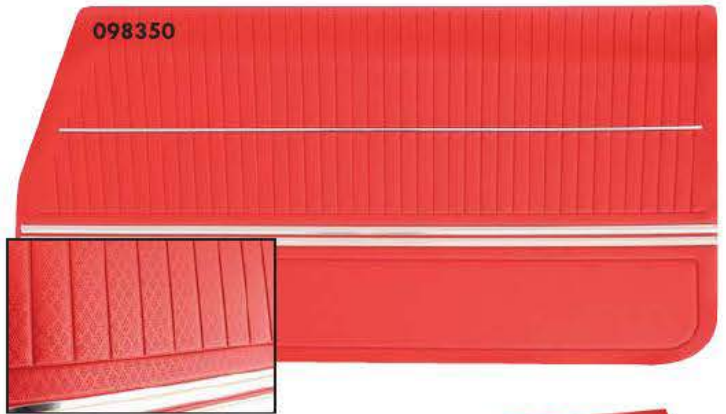

CUTLASS/442



#### 1969 COLORS

BLACK	L-2295
BLUE	L-2302
GOLD	L-3599
GREEN	L-3603
PARCHMENT	L-2313
RED	L-3597
WHITE	L-2305

## 1969 INTERIOR PARTS & ACCESSORIES

### 1969 INTERIOR ACCESSORIES

Distinctive Industries Headrest Covers features the correct Madrid grain in 32 oz vinyl, just like the original. These Headrest Covers are a sewn on cover that covers the original molded foam headrest.

- 1968-72 BUCKET SEAT HEADREST COVERS **099036**
- 1968-72 BENCH SEAT HEADREST COVERS **099044**

Our 1969 Rear Armrest Upholstery is reproduced in the correct Madrid grain in 32 oz. vinyl and stitched as original.

- 1968-72 COUPE REAR ARMREST COVERS **092015**
- 1968-72 CONVERTIBLE REAR ARMREST COVERS **092056**

Our Door Jamb Windlace is the correct Madrid grain in 32 oz. vinyl, just like the originals, and are sold in pairs.

- 1968-69 COUPE DOOR JAMB WINDLACE **092171**
- 1968-69 CONVERTIBLE DOOR JAMB WINDLACE **092173**

Our Convertible Top Boot features the correct Madrid grain in 32 oz. vinyl and fastens just like the original.

- 1968-72 CONVERTIBLE TOP BOOT **099020**

Distinctive Industries High-Density Seat Foam is designed to work as a system with our upholstery. Our High-Density Seat Foam is firm, form fitting, and features a Typar® web backing for strength, which prevents spring intrusion and ensures a quality fit and long lasting life. Seat Foam is sold individually, not in pairs.

- 1966-70 BUCKET SEAT FOAM **067116GM6670**

Distinctive Industries Seat Heaters provide therapeutic heat and body warmth in any classic car, using the same technology as late model or current vehicles. Each kit comes with switch, harnesses, and two carbon fiber element pads to complete one seat install. Switch can be dash, console, or hidden in a place of choice. Seat Heaters are sold individually, not in pairs.

- 1963-72 CARBON FIBER SEAT HEATERS **061001**

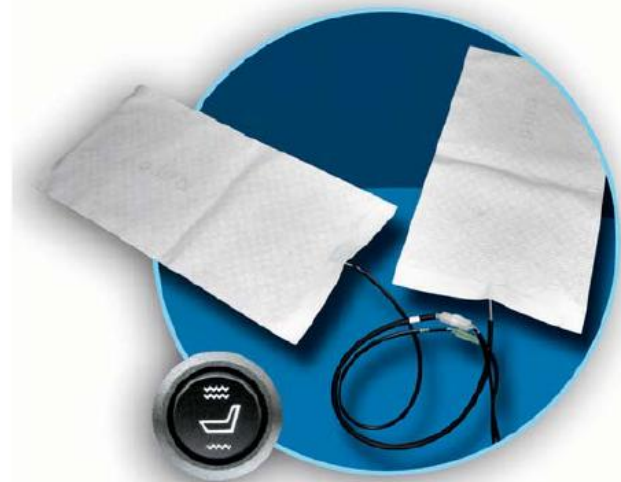

1969 COLORS	
BLACK	L-2295
BLUE	L-2302
GOLD	L-3599
GREEN	L-3603
PARCHMENT	L-2313
RED	L-3597
WHITE	L-2305

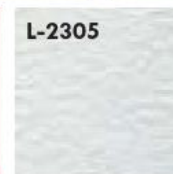

CUTLASS/442

## 1970 INTERIOR PARTS & ACCESSORIES

### 1970 CUTLASS/442/SUPREME/HOLIDAY MODELS SEAT UPHOLSTERY

Our 1970 Cutlass Seat Upholstery is a correct reproduction of the original. We offer the original Madrid grain with Ruffino grain inserts in 32 oz. vinyl, with the correct patterns, carpeted seat back on Supreme bench seat models, and sewn as original. Seat buttons are included.

#### Features

- Original Madrid grain vinyl with Ruffino grain inserts
- Correct 6 stitch per inch stitching
- Correct colors matched to the original vinyl
- Limited lifetime warranty

BUCKET SEATS - FRONT	098525
BENCH SEAT - FRONT	098533
COUPE BENCH SEAT - REAR	098541
CONVERTIBLE BENCH SEAT - REAR	098558

### 1970 CUTLASS/442/S/SPORTS COUPE/HOLIDAY MODELS SEAT UPHOLSTERY

Our 1970 Cutlass Seat Upholstery is a correct reproduction of the original. We offer the original Madrid grain with Pigskin grain inserts in 32 oz. vinyl, with the correct horizontal patterns and sewn as original. Seat buttons are included.

*\*All Sports Coupe models are Sedans.*

#### Features

- Original Madrid grain vinyl with Pigskin grain inserts
- Correct 6 stitch per inch stitching
- Correct colors matched to the original vinyl
- Limited lifetime warranty

BUCKET SEATS - FRONT	098608
BENCH SEAT - FRONT	098616
2 DOOR COUPE BENCH SEAT - REAR	098624
2 DOOR SEDAN BENCH SEAT - REAR	098632



#### 1970 COLORS

BLACK	L-2295(I=L-3931)
DARK METALLIC GREEN	L-3896(I=L-3935)
DARK SADDLE	L-3886(I=L-3939)
GOLD	L-3888(I=L-3934)
MEDIUM BLUE	L-3883(I=L-3932)
PEARL	L-3895(I=L-3938)

**NOTE: I=Insert.**





## 1970 INTERIOR PARTS & ACCESSORIES

### 1970 CUTLASS/442/SUPREME/HOLIDAY MODELS DOOR/QUARTER PANELS

Our 1970 Cutlass Door/Quarter Panels are a correct reproduction of the original. We offer original Madrid grain in 32 oz. vinyl, and correct dielectrically heat sealed patterns as original. Cutlass Supreme Holiday Coupe/Convertible/442 Door Panels feature carpeted bottom portion, and Burlwood insert accented with Mylar® trim in the middle of the panel.

#### Features

- Original Madrid grain vinyl with Burlwood inserts
- Correct dielectric "Heat Seal" stitched pattern
- Correct colors matched to the original vinyl
- .100-inch thickness poly-coated "Autoboard" backing
- Door Panel backs are perimeter stapled for maximum adhesion
- Limited lifetime warranty

SUPREME FRONT DOOR PANELS	098566
SUPREME COUPE REAR QUARTER PANELS	098574
SUPREME CONVERTIBLE REAR QUARTER PANELS	098582

### 1970 CUTLASS/442/S/SPORTS COUPE/HOLIDAY MODELS DOOR/QUARTER PANELS

Our 1970 Cutlass Door/Quarter Panels are a correct reproduction of the original. We offer original Madrid grain in 32 oz. vinyl, and correct dielectrically heat sealed patterns as original. Cutlass S/442 Sports Coupe/Holiday Coupe Door Panels feature carpeted bottom portion, Burlwood spear accented with Mylar® trim, and Pigskin insert along the top of the panel.

**\*All Sports Coupe models are Sedans.**

#### Features

- Original Madrid grain vinyl with Burlwood inserts
- Correct dielectric "Heat Seal" stitched pattern
- Correct colors matched to the original vinyl
- .100-inch thickness poly-coated "Autoboard" backing
- Door Panel backs are perimeter stapled for maximum adhesion
- Limited lifetime warranty

COUPE FRONT DOOR PANELS	098640
SEDAN FRONT DOOR PANELS	098665
COUPE REAR QUARTER PANELS	098657
SEDAN REAR QUARTER PANELS	098673



#### 1970 COLORS

BLACK	L-2295
BLUE	L-3883
GOLD	L-3888
GREEN	L-3606
IVORY	L-3895
SADDLE*	L-5013
WHITE	L-2305

**NOTE: \*Saddle was a color option for Supreme models only.**



## 1970 INTERIOR PARTS & ACCESSORIES

### 1970 INTERIOR ACCESSORIES

Distinctive Industries Headrest Covers features the correct Madrid grain in 32 oz vinyl, just like the original. These Headrest Covers are a sewn on cover that covers the original molded foam headrest.

- 1968-72 BUCKET SEAT HEADREST COVERS **099036**
- 1968-72 BENCH SEAT HEADREST COVERS **099044**

Our 1970 Rear Armrest Upholstery is reproduced in the correct Madrid grain in 32 oz. vinyl and stitched as original.

- 1968-72 COUPE REAR ARMREST COVERS **092015**
- 1968-72 CONVERTIBLE REAR ARMREST COVERS **092056**

Distinctive Industries Quarter Trim Panels are a correct reproduction of the original. We offer original Madrid grain in 32 oz vinyl.

- COUPE QUARTER TRIM **098677**

Our Door Jamb Windlace is the correct Madrid grain in 32 oz. vinyl, just like the originals, and are sold in pairs.

- 1970-72 COUPE/CONVERTIBLE DOOR JAMB WINDLACE **092175**

Our Convertible Top Boot features the correct Madrid grain in 32 oz. vinyl and fastens just like the original.

- 1968-72 CONVERTIBLE TOP BOOT **099020**

Distinctive Industries High-Density Seat Foam is designed to work as a system with our upholstery. Our High-Density Seat Foam is firm, form fitting, and features a Tyvar® web backing for strength, which prevents spring intrusion and ensures a quality fit and long lasting life. Seat Foam is sold individually, not in pairs.

- 1966-70 BUCKET SEAT FOAM **067116GM6670**

Distinctive Industries Seat Heaters provide therapeutic heat and body warmth in any classic car, using the same technology as late model or current vehicles. Each kit comes with switch, harnesses, and two carbon fiber element pads to complete one seat install. Switch can be dash, console, or hidden in a place of choice. Seat Heaters are sold individually, not in pairs.

- 1963-72 CARBON FIBER SEAT HEATERS **061001**



#### 1970 COLORS

BLACK	L-2295
BLUE	L-3883
GOLD	L-3888
GREEN	L-3606
IVORY	L-3895
SADDLE*	L-5013
WHITE	L-2305

**NOTE: \*Saddle was a color option for Supreme models only.**



1970 Cutlass Supreme





## 1971-72 INTERIOR PARTS & ACCESSORIES

### 1971-72 CUTLASS/442/SUPREME MODELS SEAT UPHOLSTERY

Our 1971-72 Cutlass Seat Upholstery is a correct reproduction of the original. We offer the original Madrid grain with Elk grain inserts in 32 oz. vinyl, with the correct vertical patterns and sewn as original. Bench seats include 2 headrest covers, and a center armrest cover.

#### Features

- Original Madrid grain vinyl with Elk grain inserts
- Correct 6 stitch per inch stitching
- Correct colors matched to the original vinyl
- Limited lifetime warranty

BUCKET SEATS - FRONT	098699
BENCH SEAT - FRONT	098707
2 DOOR COUPE BENCH SEAT - REAR	098715
CONVERTIBLE BENCH SEAT - REAR	098723

L-2295	L-3931	L-4135	L-4165
L-2305	L-2305	L-4146	L-4171
L-3895	L-3895	L-4424	L-4437
L-4139	L-4168	L-4421	L-4434

#### 1971-72 SUPREME COLORS

1971-72 BLACK	L-2295 (I=L-3931)
1971-72 BLUE	L-4135 (I=L-4165)
1971-72 WHITE	L-2305 (I=L-2305)
1971 JADE GREEN	L-4146 (I=L-4171)
1971 WHITE	L-3895 (I=L-3895)
1972 GREEN	L-4424 (I=L-4437)
1972 SADDLE	L-4139 (I=L-4168)
1972 WHITE	L-4421 (I=L-4434)

NOTE: I=Insert.

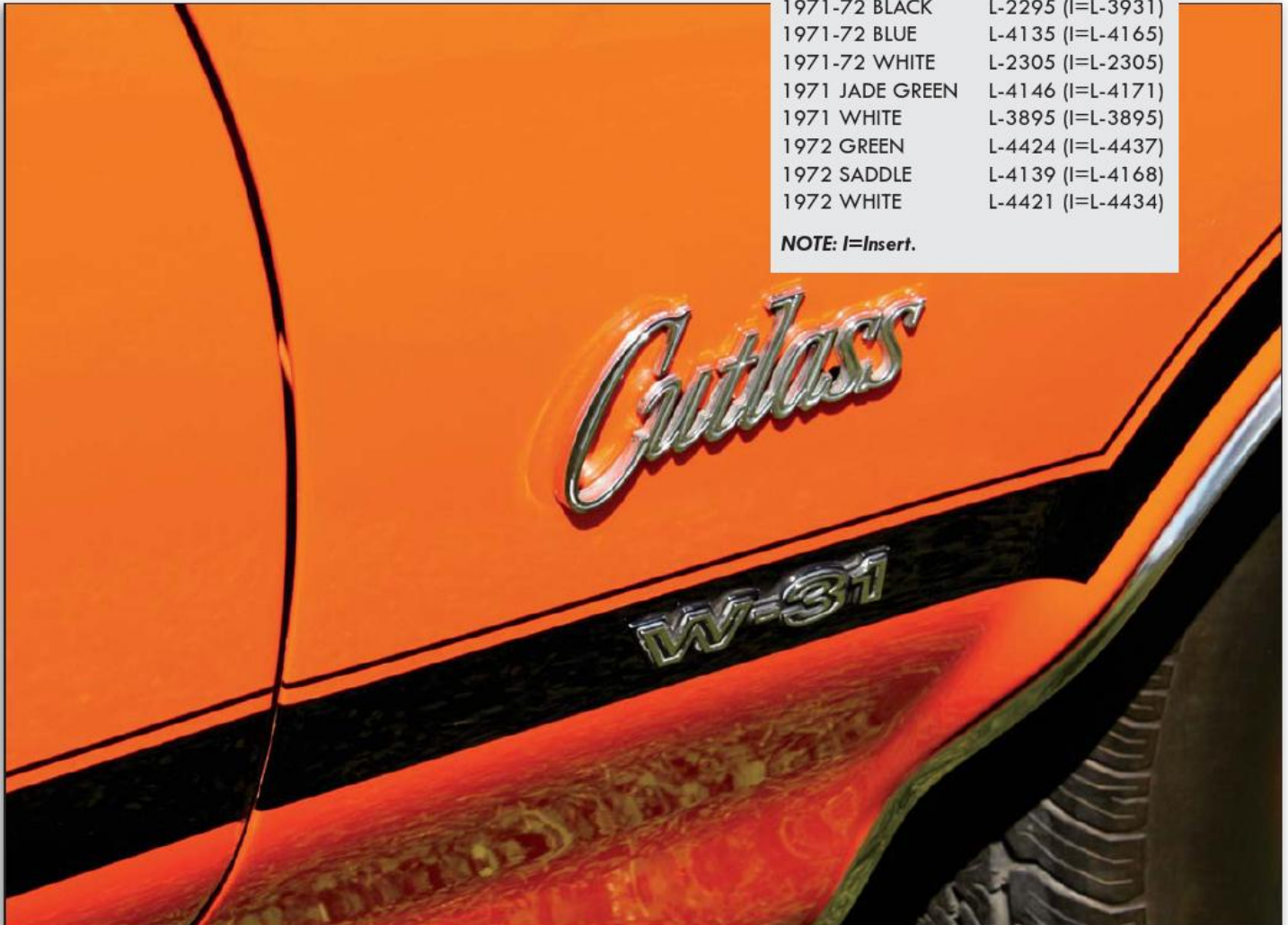

## 1971-72 INTERIOR PARTS & ACCESSORIES

### 1971-72 CUTLASS/442/S/SPORTS COUPE MODELS SEAT UPHOLSTERY

Our 1971-72 Cutlass Seat Upholstery is a correct reproduction of the original. We offer the original Madrid grain with Pigskin grain vinyl for 1971 models and Elk grain inserts for 1972 models in 32 oz. vinyl, with the correct horizontal patterns and sewn as original. Seat buttons/medallions are included.

*\*All Sports Coupe models are Sedans.*

#### Features

- Original Madrid grain vinyl with Pigskin or Elk grain inserts
- Correct 6 stitch per inch stitching
- Correct colors matched to the original vinyl
- Limited lifetime warranty

#### 1971

BUCKET SEATS - FRONT	098806
BENCH SEAT - FRONT	098814
COUPE BENCH SEAT - REAR	098822
SEDAN BENCH SEAT - REAR	098830

#### 1972

BUCKET SEATS - FRONT	098806
BENCH SEAT - FRONT	098814
COUPE BENCH SEAT - REAR	098822
SEDAN BENCH SEAT - REAR	098830



#### 1971-72 S COLORS

1971-72 WHITE	L-2305 (I=L-2305)
1971 BLACK	L-2295 (I=L-2295)
1971 BLUE	L-4135 (I=L-4135)
1971 GREEN	L-4146 (I=L-4146)
1971 WHITE	L-3895 (I=L-3895)
1972 BLACK	L-2295 (I=L-3931)
1972 BLUE	L-4135 (I=L-4165)
1972 GREEN	L-4424 (I=L-4437)
1972 SADDLE	L-4139 (I=L-4168)
1972 WHITE	L-4421 (I=L-4434)

NOTE: I=Insert.



1972 Cutlass 442

## 1971-72 INTERIOR PARTS & ACCESSORIES

### 1971-72 DOOR/QUARTER PANELS

Our 1971-72 Cutlass Door/Quarter Panels are a correct reproduction of the original. We offer original Madrid grain in 32 oz. vinyl, carpeted bottom portion, and correct dielectrically heat sealed patterns as original.

**\*All Sports Coupe models are Sedans.**

#### Features

- Original Madrid grain vinyl
- Correct dielectric "Heat Seal" stitched pattern
- Correct colors matched to the original vinyl
- .100-inch thickness poly-coated "Autoboard" backing
- Door Panel backs are perimeter stapled for maximum adhesion
- Limited lifetime warranty

#### 1971

Cutlass S/442/Sports Coupe Door Panels feature Rosewood spear accented with Mylar® trim, and Pigskin insert in the middle of the panel. Cutlass Supreme Coupe/Convertible/442 Door Panels feature Rosewood insert accented with Mylar® trim in the middle of the panel.

COUPE FRONT DOOR PANELS	<b>098897</b>
SEDAN FRONT DOOR PANELS	<b>098913</b>
SUPREME FRONT DOOR PANELS	<b>098855</b>
COUPE REAR QUARTER PANELS	<b>098905</b>
SEDAN REAR QUARTER PANELS	<b>098921</b>
SUPREME COUPE REAR QUARTER PANELS	<b>098863</b>
SUPREME CONVERTIBLE REAR QUARTER PANELS	<b>098871</b>

#### 1972

Cutlass S/442/Sports Coupe Door Panels feature Rosewood spear accented with Mylar® trim, and Elk grain vinyl insert in the middle of the panel. Cutlass Supreme Coupe/Convertible/442 Door Panels feature Rosewood insert accented with Mylar® trim in the middle of the panel.

COUPE FRONT DOOR PANELS	<b>098988</b>
SEDAN FRONT DOOR PANELS	<b>099002</b>
SUPREME FRONT DOOR PANELS	<b>098947</b>
COUPE REAR QUARTER PANELS	<b>098996</b>
SEDAN REAR QUARTER PANELS	<b>099010</b>
SUPREME COUPE REAR QUARTER PANELS <b>*SEEKING PATTERN*</b>	
SUPREME CONVERTIBLE REAR QUARTER PANELS	<b>098962</b>

#### 1971-72 SUPREME COLORS

1971-72 BLACK	L-2295 (I=L-3931)
1971-72 BLUE	L-4135 (I=L-4165)
1971-72 WHITE	L-2305 (I=L-2305)
1971 JADE GREEN	L-4146 (I=L-4171)
1971 WHITE	L-3895 (I=L-3895)
1972 GREEN	L-4424 (I=L-4437)
1972 SADDLE	L-4139 (I=L-4168)
1972 WHITE	L-4421 (I=L-4434)

**NOTE: I=Insert.**



#### 1971-72 S COLORS

1971-72 WHITE	L-2305 (I=L-2305)
1971 BLACK	L-2295 (I=L-2295)
1971 BLUE	L-4135 (I=L-4135)
1971 GREEN	L-4146 (I=L-4146)
1971 WHITE	L-3895 (I=L-3895)
1972 BLACK	L-2295 (I=L-3931)
1972 BLUE	L-4135 (I=L-4165)
1972 GREEN	L-4424 (I=L-4437)
1972 SADDLE	L-4139 (I=L-4168)
1972 WHITE	L-4421 (I=L-4434)

**NOTE: I=Insert.**



## 1971-72 INTERIOR PARTS & ACCESSORIES

### 1971-72 INTERIOR ACCESSORIES

Distinctive Industries Headrest Covers features the correct Madrid grain in 32 oz vinyl, just like the original. These Headrest Covers are a sewn on cover that covers the original molded foam headrest.

- 1968-72 BUCKET SEAT HEADREST COVERS **099044**
- 1968-72 BENCH SEAT HEADREST COVERS **099036**

Our 1971-72 Rear Armrest Upholstery is reproduced in the correct Madrid grain in 32 oz. vinyl and stitched as original.

- 1968-72 COUPE REAR ARMREST COVERS **092015**
- 1968-72 CONVERTIBLE REAR ARMREST COVERS **092056**

Our Door Jamb Windlace is the correct Madrid grain in 32 oz. vinyl, just like the originals, and are sold in pairs.

- 1970-72 COUPE/CONVERTIBLE DOOR JAMB WINDLACE **092175**

Our Convertible Top Boot features the correct Madrid grain in 32 oz. vinyl and fastens just like the original.

- 1968-72 CONVERTIBLE TOP BOOT **099020**

Distinctive Industries High-Density Seat Foam is designed to work as a system with our upholstery. Our High-Density Seat Foam is firm, form fitting, and features a Typar® web backing for strength, which prevents spring intrusion and ensures a quality fit and long lasting life. Seat Foam is sold individually, not in pairs.

- 1971-72 BUCKET SEAT FOAM **067124GM7172**

Distinctive Industries Seat Heaters provide therapeutic heat and body warmth in any classic car, using the same technology as late model or current vehicles. Each kit comes with switch, harnesses, and two carbon fiber element pads to complete one seat install. Switch can be dash, console, or hidden in a place of choice. Seat Heaters are sold individually, not in pairs.

- 1963-72 CARBON FIBER SEAT HEATERS **061001**



#### 1971-72 S COLORS

- |               |                   |
|---------------|-------------------|
| 1971-72 WHITE | L-2305 (I=L-2305) |
| 1971 BLACK    | L-2295 (I=L-2295) |
| 1971 BLUE     | L-4135 (I=L-4135) |
| 1971 GREEN    | L-4146 (I=L-4146) |
| 1971 WHITE    | L-3895 (I=L-3895) |
| 1972 BLACK    | L-2295 (I=L-3931) |
| 1972 BLUE     | L-4135 (I=L-4165) |
| 1972 GREEN    | L-4424 (I=L-4437) |
| 1972 SADDLE   | L-4139 (I=L-4168) |
| 1972 WHITE    | L-4421 (I=L-4434) |

NOTE: I=Insert.

#### 1971-72 SUPREME COLORS

- |                 |                   |
|-----------------|-------------------|
| 1971-72 BLACK   | L-2295 (I=L-3931) |
| 1971-72 BLUE    | L-4135 (I=L-4165) |
| 1971-72 WHITE   | L-2305 (I=L-2305) |
| 1971 JADE GREEN | L-4146 (I=L-4171) |
| 1971 WHITE      | L-3895 (I=L-3895) |
| 1972 GREEN      | L-4424 (I=L-4437) |
| 1972 SADDLE     | L-4139 (I=L-4168) |
| 1972 WHITE      | L-4421 (I=L-4434) |

NOTE: I=Insert.

**Introduction To The Catalog**

Thank you for choosing Distinctive Industries as your provider of Restoration Interior Products. The catalog you are reading was designed with the input of our existing customers and moving forward, will continue to be a representation of their needs, and the needs of restoration experts worldwide.

**Design**

We have designed our catalog for the Restoration Professional, from the Local Upholstery and Restoration Shop, to the National Distributor of Restoration Products. The thought was to create a catalog that eases the pain of product entry for those building catalogs, and to ease ordering for those that order directly from the catalog. We accomplished this by listing product by year, model, and trim level. You will find this catalog to be easy to use.

**Descriptions**

Descriptions are a blend of Marketing and Technical descriptions. After polling our customers we found that aside from the design, missing was a good description of the products in today's catalogs. We remedied that by providing a blended description as a basis for our customers to expand upon, or use as is.

**Colors**

Color swatches are placed near the product with labeled color codes to avoid confusion. Color Code boxes are located near the applicable products. We offer many special order color combinations as well as an option for leather in most cases.

**Images**

Images are available for License through Distinctive Industries.  
 • Licensed images must be accompanied and located adjacent to the matching Distinctive Industries product.



**Table of Contents**

1967-69 Standard & 1967 Custom seat upholstery

1968-69 Custom seat upholstery

1967-69 Standard door and quarter panels

1967-69 Custom quarter panels

1967-69 Standard/Custom interior parts and accessories

1971 interior parts and accessories

© Copyright 2016, Distinctive Industries, all rights reserved. No part of this publication may be duplicated or reproduced without written permission from Distinctive Industries.



## 1967-69 INTERIOR PARTS & ACCESSORIES



### 1967 STANDARD/CUSTOM & 1968-69 STANDARD SEAT UPHOLSTERY

Our 1967 Standard/Custom and 1968-69 Standard Firebird Seat Upholstery is a correct reproduction of the original featuring horizontal pleats with 1 vertical line in the middle of the seat. We offer the original Madrid grain in 32 oz. vinyl, with the correct horizontal patterns and sewn as original.

#### Features

- Original Madrid grain vinyl
- Correct 6 stitch per inch stitching
- Correct colors matched to the original vinyl
- Limited lifetime warranty

BUCKET SEATS - FRONT/REAR SET	<b>074203</b>
BENCH SEATS WITH FOLD DOWN REAR SEAT - FRONT/REAR SET	<b>074245</b>
BENCH SEAT - FRONT/REAR SET	<b>074260</b>
BUCKET SEATS - FRONT	<b>074229</b>
BENCH SEAT - FRONT	<b>074286</b>
BENCH SEAT - REAR	<b>074284</b>
FOLD-DOWN BENCH SEAT - REAR	<b>074285</b>

<b>L-2295</b>	<b>L-2309</b>	<b>L-3055</b>	<b>L-3025</b>	<b>L-2300</b>																
<b>L-3048</b>	<table border="1"> <thead> <tr> <th colspan="2">1967 STANDARD/CUSTOM COLORS</th> </tr> </thead> <tbody> <tr> <td>BLACK</td> <td>L-2295</td> </tr> <tr> <td>BRIGHT BLUE</td> <td>L-2309</td> </tr> <tr> <td>DARK BLUE</td> <td>L-3055</td> </tr> <tr> <td>GOLD</td> <td>L-3025</td> </tr> <tr> <td>PARCHMENT</td> <td>L-2300</td> </tr> <tr> <td>RED</td> <td>L-3048</td> </tr> <tr> <td>TURQUOISE</td> <td>L-3045</td> </tr> </tbody> </table>				1967 STANDARD/CUSTOM COLORS		BLACK	L-2295	BRIGHT BLUE	L-2309	DARK BLUE	L-3055	GOLD	L-3025	PARCHMENT	L-2300	RED	L-3048	TURQUOISE	L-3045
1967 STANDARD/CUSTOM COLORS																				
BLACK	L-2295																			
BRIGHT BLUE	L-2309																			
DARK BLUE	L-3055																			
GOLD	L-3025																			
PARCHMENT	L-2300																			
RED	L-3048																			
TURQUOISE	L-3045																			
<b>L-3045</b>																				
<b>L-2295</b>	<b>L-3307</b>	<b>L-3295</b>	<b>L-3048</b>																	
<b>L-3301</b>	<table border="1"> <thead> <tr> <th colspan="2">1968 STANDARD COLORS</th> </tr> </thead> <tbody> <tr> <td>BLACK</td> <td>L-2295</td> </tr> <tr> <td>GOLD</td> <td>L-3307</td> </tr> <tr> <td>PARCHMENT</td> <td>L-3295</td> </tr> <tr> <td>RED</td> <td>L-3048</td> </tr> <tr> <td>TEAL</td> <td>L-3302</td> </tr> <tr> <td>TURQUOISE</td> <td>L-3301</td> </tr> </tbody> </table>				1968 STANDARD COLORS		BLACK	L-2295	GOLD	L-3307	PARCHMENT	L-3295	RED	L-3048	TEAL	L-3302	TURQUOISE	L-3301		
1968 STANDARD COLORS																				
BLACK	L-2295																			
GOLD	L-3307																			
PARCHMENT	L-3295																			
RED	L-3048																			
TEAL	L-3302																			
TURQUOISE	L-3301																			
<b>L-3302</b>																				
<b>L-2295</b>	<b>L-3598</b>	<b>L-3599</b>	<b>L-3606</b>																	
<b>L-2300</b>	<table border="1"> <thead> <tr> <th colspan="2">1969 STANDARD COLORS</th> </tr> </thead> <tbody> <tr> <td>BLACK</td> <td>L-2295</td> </tr> <tr> <td>BLUE</td> <td>L-3598</td> </tr> <tr> <td>GOLD</td> <td>L-3599</td> </tr> <tr> <td>GREEN</td> <td>L-3606</td> </tr> <tr> <td>PARCHMENT</td> <td>L-2300</td> </tr> <tr> <td>RED</td> <td>L-3597</td> </tr> </tbody> </table>				1969 STANDARD COLORS		BLACK	L-2295	BLUE	L-3598	GOLD	L-3599	GREEN	L-3606	PARCHMENT	L-2300	RED	L-3597		
1969 STANDARD COLORS																				
BLACK	L-2295																			
BLUE	L-3598																			
GOLD	L-3599																			
GREEN	L-3606																			
PARCHMENT	L-2300																			
RED	L-3597																			
<b>L-3597</b>																				

## 1968-69 CUSTOM INTERIOR PARTS & ACCESSORIES

### 1968-69 CUSTOM SEAT UPHOLSTERY

Our 1968-69 Firebird Custom Seat Upholstery is a correct reproduction of the original featuring vertical pleats with 1 horizontal line in the middle of the seat. We offer the original Madrid grain with Comfortweave inserts in 32 oz. vinyl, with the correct vertical patterns and sewn as original.

#### Features

- Original Madrid grain vinyl with Comfortweave inserts
- Correct 6 stitch per inch stitching
- Correct colors matched to the original vinyl
- Limited lifetime warranty

BUCKET SEATS - FRONT/REAR SET	<b>074211</b>
BENCH SEAT - FRONT/REAR SET	<b>074278</b>
BUCKET SEATS WITH FOLD	
DOWN REAR SEAT - FRONT/REAR SET	<b>074252</b>
BENCH SEAT WITH FOLD	
DOWN REAR SEAT - FRONT/REAR SET	<b>074282</b>
BUCKET SEATS - FRONT	<b>074237</b>
BENCH SEAT - FRONT	<b>074294</b>
BENCH SEAT - REAR	<b>074288</b>
FOLD-DOWN BENCH SEAT - REAR	<b>074290</b>



#### CUSTOM COLORS

1968-69 BLACK	L-2295	1968 TEAL	L-3302
1968-69 BLUE	L-3598	1969 GOLD	L-3599
1968 GOLD	L-3307	1969 GREEN	L-3606
1968 PARCHMENT	L-3295	1969 PARCHMENT	L-2300
1968 RED	L-3048	1969 RED	L-3597

1968 Firebird with Custom interior



## 1967-69 STANDARD INTERIOR PARTS & ACCESSORIES

### 1967-69 STANDARD DOOR/QUARTER PANELS

Our 1967-69 Firebird Standard Door/Quarter Panels are a correct reproduction of the original. We offer original Madrid grain in 32 oz. vinyl, Mylar® trim on 1969 models and correct dielectrically heat sealed patterns as original. Door Panel moldings and emblems not included.

#### Features

- Original Madrid grain vinyl
- Correct dielectric "Heat Seal" stitched pattern
- Correct colors matched to the original vinyl
- .100-inch thickness poly-coated "Autoboard" backing
- Door Panel backs are perimeter stapled for maximum adhesion
- Limited lifetime warranty

1967 FRONT DOOR PANELS	<b>074328</b>
1968 FRONT DOOR PANELS	<b>074377</b>
1969 FRONT DOOR PANELS	<b>074401</b>
1967 COUPE REAR QUARTER PANELS	<b>074336</b>
1968 COUPE REAR QUARTER PANELS	<b>074385</b>
1969 COUPE REAR QUARTER PANELS	<b>074419</b>
1967 CONVERTIBLE REAR QUARTER PANELS	<b>074344</b>
1968 CONVERTIBLE REAR QUARTER PANELS	<b>074393</b>
1969 CONVERTIBLE REAR QUARTER PANELS	<b>074427</b>



<b>L-2295</b>	<b>L-3055</b>	<b>L-3025</b>	<b>L-2300</b>														
<b>L-3048</b>	<table border="1"> <thead> <tr> <th colspan="2">1967 STANDARD COLORS</th> </tr> </thead> <tbody> <tr> <td>BLACK</td> <td>L-2295</td> </tr> <tr> <td>DARK BLUE</td> <td>L-3055</td> </tr> <tr> <td>GOLD</td> <td>L-3025</td> </tr> <tr> <td>PARCHMENT</td> <td>L-2300</td> </tr> <tr> <td>RED</td> <td>L-3048</td> </tr> <tr> <td>WHITE</td> <td>L-2305</td> </tr> </tbody> </table>			1967 STANDARD COLORS		BLACK	L-2295	DARK BLUE	L-3055	GOLD	L-3025	PARCHMENT	L-2300	RED	L-3048	WHITE	L-2305
1967 STANDARD COLORS																	
BLACK	L-2295																
DARK BLUE	L-3055																
GOLD	L-3025																
PARCHMENT	L-2300																
RED	L-3048																
WHITE	L-2305																
<b>L-2305</b>																	

<b>L-2295</b>	<b>L-3307</b>	<b>L-3295</b>	<b>L-3048</b>	<b>L-3301</b>																
<b>L-3302</b>	<table border="1"> <thead> <tr> <th colspan="2">1968 STANDARD COLORS</th> </tr> </thead> <tbody> <tr> <td>BLACK</td> <td>L-2295</td> </tr> <tr> <td>GOLD</td> <td>L-3307</td> </tr> <tr> <td>PARCHMENT</td> <td>L-3295</td> </tr> <tr> <td>RED</td> <td>L-3048</td> </tr> <tr> <td>TEAL</td> <td>L-3302</td> </tr> <tr> <td>TURQUOISE</td> <td>L-3301</td> </tr> <tr> <td>WHITE</td> <td>L-2305</td> </tr> </tbody> </table>				1968 STANDARD COLORS		BLACK	L-2295	GOLD	L-3307	PARCHMENT	L-3295	RED	L-3048	TEAL	L-3302	TURQUOISE	L-3301	WHITE	L-2305
1968 STANDARD COLORS																				
BLACK	L-2295																			
GOLD	L-3307																			
PARCHMENT	L-3295																			
RED	L-3048																			
TEAL	L-3302																			
TURQUOISE	L-3301																			
WHITE	L-2305																			
<b>L-2305</b>																				

<b>L-2295</b>	<b>L-3598</b>	<b>L-3599</b>	<b>L-3606</b>	<b>L-2300</b>																
<b>L-3597</b>	<table border="1"> <thead> <tr> <th colspan="2">1969 STANDARD COLORS</th> </tr> </thead> <tbody> <tr> <td>BLACK</td> <td>L-2295</td> </tr> <tr> <td>BLUE</td> <td>L-3598</td> </tr> <tr> <td>GOLD</td> <td>L-3599</td> </tr> <tr> <td>GREEN</td> <td>L-3606</td> </tr> <tr> <td>PARCHMENT</td> <td>L-2300</td> </tr> <tr> <td>RED</td> <td>L-3597</td> </tr> <tr> <td>WHITE</td> <td>L-2305</td> </tr> </tbody> </table>				1969 STANDARD COLORS		BLACK	L-2295	BLUE	L-3598	GOLD	L-3599	GREEN	L-3606	PARCHMENT	L-2300	RED	L-3597	WHITE	L-2305
1969 STANDARD COLORS																				
BLACK	L-2295																			
BLUE	L-3598																			
GOLD	L-3599																			
GREEN	L-3606																			
PARCHMENT	L-2300																			
RED	L-3597																			
WHITE	L-2305																			
<b>L-2305</b>																				

FIREBIRD



## 1967-69 CUSTOM INTERIOR PARTS & ACCESSORIES

1968 Firebird with Custom interior



### 1967-69 CUSTOM QUARTER PANELS

Our 1967-69 Firebird Custom Quarter Panels are a correct reproduction of the original. We offer original Madrid grain in 32 oz. vinyl, and correct dielectrically heat sealed patterns as original. Quarter Panels will need to be assembled with the original molding. Quarter Panel emblems not included.

*\*We do not offer 1967-69 Custom Door Panels at this time.*

#### Features

- Original Madrid grain vinyl
- Correct dielectric "Heat Seal" stitched pattern
- Correct colors matched to the original vinyl
- .100-inch thickness poly-coated "Autoboard" backing
- Door Panel backs are perimeter stapled for maximum adhesion
- Limited lifetime warranty

1967 COUPE REAR QUARTER PANELS	<b>074351</b>
1967 CONVERTIBLE REAR QUARTER PANELS	<b>074369</b>
1968-69 COUPE REAR QUARTER PANELS	<b>074302</b>
1968-69 CONVERTIBLE REAR QUARTER PANELS	<b>074310</b>



### 1967-69 CUSTOM COLORS

1968-69 BLACK	L-2295	1969 GOLD	L-3599
1968-69 BLUE	L-3598	1969 GREEN	L-3606
1968 GOLD	L-3307	1969 PARCHMENT	L-2300
1968 PARCHMENT	L-3295	1969 RED	L-3597
1968 RED	L-3048	1969 WHITE	L-2305
1968 TEAL	L-3302		

## 1967-69 INTERIOR PARTS & ACCESSORIES

### 1967-69 INTERIOR ACCESSORIES



Our 1967-69 Custom Rear Armrest Upholstery is reproduced in the correct Madrid grain in 32 oz vinyl and stitched as original.

- 1967-69 CUSTOM COUPE REAR ASHTRAY - WITH ARMREST **073403**
- 1967-69 CUSTOM CONVERTIBLE REAR ASHTRAY - WITH ARMREST **073411**

Our Convertible Top Boot features the correct Madrid grain in 32 oz. vinyl and fastens just like the original. Clips are not included with the Unassembled Convertible Top Boot.

- 1967-69 UNASSEMBLED CONVERTIBLE TOP BOOT **073502**
- 1967-69 PRE-ASSEMBLED CONVERTIBLE TOP BOOT **073504**

Our Package Tray is a high quality colored board. Utilizing modern material for durability and long life. Does not include rear Speaker holes.

- 1967-69 COLORED PACKAGE TRAY BOARD **072229**

Our Package Tray is a high quality vinyl covered package tray. Utilizing modern material and covered in the correct Madrid grain in 32 oz for durability and long life.

- 1967-69 HARDTOP VINYL COVERED PACKAGE TRAY **072227**

Distinctive Industries Seat Heaters provide therapeutic heat and body warmth in any classic car, using the same technology as late model or current vehicles. Each kit comes with switch, harnesses, and two carbon fiber element pads to complete one seat install. Switch can be dash, console, or hidden in a place of choice. Seat Heaters are sold individually, not in pairs.

- 1967-71 CARBON FIBER SEAT HEATERS **061001**



#### 1967-69 COLORS

1968-69 BLACK	L-2295	1969 DARK BLUE	L-3598
1968-69 BLUE	L-3598	1969 MED GREEN	L-3603
1968 GOLD	L-3307	1969 GOLD	L-3599
1968 PARCHMENT	L-3295	1969 GREEN	L-3606
1968 RED	L-3048	1969 PARCHMENT	L-2300
1968 TEAL	L-3302	1969 RED	L-3597
1968 TURQUOISE	L-3301		

**1971 INTERIOR PARTS & ACCESSORIES**

**1971 STANDARD SEAT UPHOLSTERY**

Our 1971 Standard Firebird Seat Upholstery is a correct reproduction of the original. We offer the original Madrid grain in 32 oz. vinyl, with the correct horizontal patterns and sewn as original.

Features

- Original Madrid grain vinyl
- Correct 6 stitch per inch stitching
- Correct colors matched to the original vinyl
- Limited lifetime warranty

BUCKET SEATS - FRONT **074526**  
 BENCH SEAT - REAR **074534**



**1971 DELUXE WITH COMFORTWEAVE SEAT UPHOLSTERY**

Our 1971 Deluxe Firebird Seat Upholstery is a correct reproduction of the original. We offer the original Madrid grain with Comfortweave inserts in 32 oz. vinyl, with the correct horizontal patterns and sewn as original.

Features

- Original Madrid grain vinyl with Comfortweave inserts
- Correct 6 stitch per inch stitching
- Correct colors matched to the original vinyl
- Limited lifetime warranty

BUCKET SEATS - FRONT **074492**  
 COUPE BENCH SEAT - REAR **074500**

**1971 DELUXE COLORS**

BLACK	L-2295
BLUE	L-4135
IVORY	L-3895
JADE	L-4146
SADDLE	L-4139
SANDALWOOD	L-4138

**1971 INTERIOR ACCESSORIES**

Distinctive Industries Seat Heaters provide therapeutic heat and body warmth in any classic car, using the same technology as late model or current vehicles. Each kit comes with switch, harnesses, and two carbon fiber element pads to complete one seat install. Switch can be dash, console, or hidden in a place of choice. Seat Heaters are sold individually, not in pairs.

1967-71 CARBON FIBER SEAT HEATERS **061001**



**FIREBIRD**

## Introduction To The Catalog

Thank you for choosing Distinctive Industries as your provider of Restoration Interior Products. The catalog you are reading was designed with the input of our existing customers and moving forward, will continue to be a representation of their needs, and the needs of restoration experts worldwide.

### Design

We have designed our catalog for the Restoration Professional, from the Local Upholstery and Restoration Shop, to the National Distributor of Restoration Products. The thought was to create a catalog that eases the pain of product entry for those building catalogs, and to ease ordering for those that order directly from the catalog. We accomplished this by listing product by year, model, and trim level. You will find this catalog to be easy to use.

### Descriptions

Descriptions are a blend of Marketing and Technical descriptions. After polling our customers we found that aside from the design, missing was a good description of the products in today's catalogs. We remedied that by providing a blended description as a basis for our customers to expand upon, or use as is.

### Colors

Color swatches are placed near the product with labeled color codes to avoid confusion. Color Code boxes are located near the applicable products. We offer many special order color combinations as well as an option for leather in most cases.

### Images

Images are available for License through Distinctive Industries.

- Licensed images must be accompanied and located adjacent to the matching Distinctive Industries product.



## Table of Contents

1964 interior parts and accessories

1965 interior parts and accessories

1966 interior parts and accessories

1967 interior parts and accessories

1968 interior parts and accessories

1969 interior parts and accessories

1970 interior parts and accessories

1971 interior parts and accessories

1972 interior parts and accessories

© Copyright 2016, Distinctive Industries, all rights reserved. No part of this publication may be duplicated or reproduced without written permission from Distinctive Industries.



## 1964 INTERIOR PARTS & ACCESSORIES



### 1964 LEMANS/GTO SEAT UPHOLSTERY

Our 1964 LeMans/GTO Seat Upholstery is a correct reproduction of the original. We offer the original Seville grain in 32 oz. vinyl, with the correct dielectrically heat sealed vertical patterns and sewn as original.

#### Features

- Original Seville grain vinyl
- Correct 6 stitch per inch stitching
- Correct colors matched to the original vinyl
- Limited lifetime warranty

BUCKET SEATS - FRONT	093039
COUPE BENCH SEAT - REAR	093054
CONVERTIBLE BENCH SEAT - REAR	093062

### 1964 LEMANS/GTO DOOR/QUARTER PANELS

Our 1964 LeMans/GTO Door/Quarter Panels are a correct reproduction of the original. We offer original Seville grain in 32 oz. vinyl, and correct dielectrically heat sealed patterns as original.

#### Features

- Original Seville grain vinyl
- Correct dielectric "Heat Seal" stitched pattern
- Correct colors matched to the original vinyl
- .100-inch thickness poly-coated "Autoboard" backing
- Door Panel backs are perimeter stapled for maximum adhesion
- Limited lifetime warranty

FRONT DOOR PANELS	094029
COUPE REAR QUARTER PANELS	094037
CONVERTIBLE REAR QUARTER PANELS	094045

### 1964 INTERIOR ACCESSORIES

Our Convertible Top Boot features the correct Seville grain in 32 oz. vinyl and fastens just like the original. Clips are not included.  
**CONVERTIBLE TOP BOOT 092122**

Distinctive Industries Quarter Trim Panels are a correct reproduction of the original. We offer original Seville grain in 32 oz. vinyl.  
**CONVERTIBLE QUARTER TRIM WITH ARMREST 092023**

Our 1964 Armrest Pad Covers are reproduced in the correct Seville grain in 32 oz. vinyl and stitched as original.  
**1964-67 ARMREST PAD COVERS - FRONT 091234**

Distinctive Industries High-Density Seat Foam is designed to work as a system with our upholstery. Our High-Density Seat Foam is firm, form fitting, and features a Typar® web backing for strength, which prevents spring intrusion and ensures a quality fit and long lasting life.  
**1964-65 BUCKET SEAT FOAM 064111**

Distinctive Industries Seat Heaters provide therapeutic heat and body warmth in any classic car, using the same technology as late model or current vehicles. Each kit comes with switch, harnesses, and two carbon fiber element pads to complete one seat install. Switch can be dash, console, or hidden in a place of choice. Seat Heaters are sold individually, not in pairs.  
**1964-72 CARBON FIBER SEAT HEATERS 061001**



#### 1964 COLORS

AQUA	L-1991
BLACK	L-920
DARK BLUE	L-1763
RED	L-1425
SADDLE	L-1621
WHITE	L-1213

## 1965 INTERIOR PARTS & ACCESSORIES

### 1965 LEMANS/GTO SEAT UPHOLSTERY

Our 1965 LeMans/GTO Seat Upholstery is a correct reproduction of the original featuring the Pontiac "Arrowhead" in the center of the backrest. We offer the original Madrid grain in 32 oz. vinyl, with the correct diagonal dielectrically heat sealed patterns and sewn as original. Seat buttons/emblems not included.

#### Features

- Original Madrid grain vinyl
- Correct 6 stitch per inch stitching
- Correct colors matched to the original vinyl
- Limited lifetime warranty

BUCKET SEATS - FRONT	093096
COUPE BENCH SEAT - REAR	093112
CONVERTIBLE BENCH SEAT - REAR	093120

### 1965 LEMANS/GTO DOOR/QUARTER PANELS

Our 1965 LeMans/GTO Door/Quarter Panels are a correct reproduction of the original. We offer original Madrid grain in 32 oz. vinyl, and correct dielectrically heat sealed patterns as original.

#### Features

- Original Madrid grain vinyl
- Correct dielectric "Heat Seal" stitched pattern
- Correct colors matched to the original vinyl
- .100-inch thickness poly-coated "Autoboard" backing
- Door Panel backs are perimeter stapled for maximum adhesion
- Limited lifetime warranty

FRONT DOOR PANELS	094078
COUPE REAR QUARTER PANEL	094086
CONVERTIBLE REAR QUARTER PANELS	094094

### 1965 INTERIOR ACCESSORIES

Our Convertible Top Boot features the correct Madrid grain in 32 oz. vinyl and fastens just like the original. Clips are not included.

CONVERTIBLE TOP BOOT	092049
----------------------	--------

Our 1964 Armrest Pad Covers are reproduced in the correct Seville grain in 32 oz. vinyl and stitched as original.

1964-67 ARMREST PAD COVERS - FRONT	091234
------------------------------------	--------

Distinctive Industries Quarter Trim Panels are a correct reproduction of the original. We offer original Madrid grain in 32 oz vinyl.

1965-67 CONVERTIBLE QUARTER TRIM WITH ARMREST	092031
---	--------

Distinctive Industries Seat Heaters provide therapeutic heat and body warmth in any classic car, using the same technology as late model or current vehicles. Each kit comes with switch, harnesses, and two carbon fiber element pads to complete one seat install. Switch can be dash, console, or hidden in a place of choice. Seat Heaters are sold individually, not in pairs.

1964-72 CARBON FIBER SEAT HEATERS	061001
-----------------------------------	--------



GTO/LEMANS



#### 1965 COLORS

BLACK	L-2295	PARCHMENT	L-2300
BRONZE	L-2795	RED	L-3048
BLUE	L-2298	TURQUOISE	L-3045
GOLD	L-3025	WHITE	L-2305



## 1966 INTERIOR PARTS & ACCESSORIES

### 1966 LEMANS/GTO SEAT UPHOLSTERY

Our 1966 LeMans/GTO Seat Upholstery is a correct reproduction of the original. We offer the original Madrid grain in 32 oz. vinyl, with the correct dielectrically heat sealed horizontal patterns and sewn as original. Bench seats include 1 armrest cover and 1 armrest hinge cover.

#### Features

- Original Madrid grain vinyl
- Correct 6 stitch per inch stitching
- Correct colors matched to the original vinyl
- Limited lifetime warranty

BUCKET SEATS - FRONT	093153
BENCH SEAT - FRONT	093161
COUPE BENCH SEAT - REAR	093179
CONVERTIBLE BENCH SEAT - REAR	093187



### 1966 LEMANS/GTO DOOR/QUARTER PANELS

Our 1966 LeMans/GTO Door/Quarter Panels are a correct reproduction of the original with carpeted bottom portion on Door Panels. We offer original Madrid grain in 32 oz. vinyl, and correct dielectrically heat sealed vertical patterns as original. Door panel emblems not included.

#### Features

- Original Madrid grain vinyl
- Correct dielectric "Heat Seal" stitched pattern
- Correct colors matched to the original vinyl
- .100-inch thickness poly-coated "Autoboard" backing
- Door Panel backs are perimeter stapled for maximum adhesion
- Limited lifetime warranty



FRONT DOOR PANELS	094128
COUPE REAR QUARTER PANELS	094136
CONVERTIBLE REAR QUARTER PANELS	094144

#### 1966 COLORS

BLACK	L-2295
BRONZE	L-2795
BLUE	L-2298
GOLD	L-3025
PARCHMENT	L-2300
RED	L-3048
TURQUOISE	L-3045



1966 GTO

1966 INTERIOR PARTS & ACCESSORIES

1966 INTERIOR ACCESSORIES

Our Convertible Top Boot features the correct Madrid grain in 32 oz. vinyl and fastens just like the original. Clips are not included with the Unassembled Convertible Top Boot.

- 1966-67 UNASSEMBLED CONVERTIBLE TOP BOOT **092064**
- 1966-67 PRE-ASSEMBLED CONVERTIBLE TOP BOOT **092065**

Our 1964 Armrest Pad Covers are reproduced in the correct Seville grain in 32 oz. vinyl and stitched as original.

- 1964-67 ARMREST PAD COVERS - FRONT **091234**

Distinctive Industries Quarter Trim Panels are a correct reproduction of the original. We offer original Madrid grain in 32 oz vinyl.

- 1965-67 CONVERTIBLE QUARTER TRIM WITH ARMREST **092031**

Distinctive Industries High-Density Seat Foam is designed to work as a system with our upholstery. Our High-Density Seat Foam is firm, form fitting, and features a Typar® web backing for strength, which prevents spring intrusion and ensures a quality fit and long lasting life. Seat Foam is sold individually, not in pairs.

- 1966-70 BUCKET SEAT FOAM **067116GM6670**

Distinctive Industries Seat Heaters provide therapeutic heat and body warmth in any classic car, using the same technology as late model or current vehicles. Each kit comes with switch, harnesses, and two carbon fiber element pads to complete one seat install. Switch can be dash, console, or hidden in a place of choice. Seat Heaters are sold individually, not in pairs.

- 1964-72 CARBON FIBER SEAT HEATERS **061001**



1966 COLORS

BLACK	L-2295	PARCHMENT	L-2300
BRONZE	L-2795	RED	L-3048
BLUE	L-2298	TURQUOISE	L-3045
GOLD	L-3025		

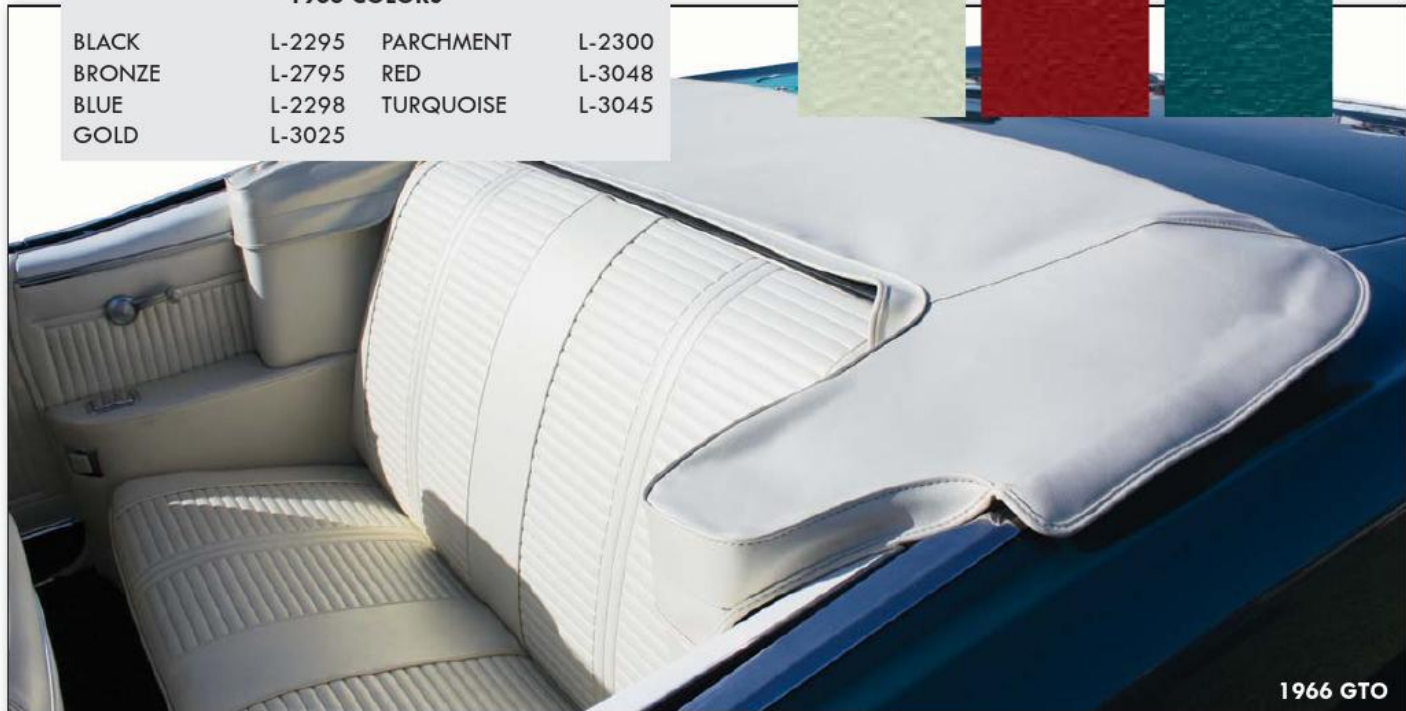

1966 GTO





## 1967 INTERIOR PARTS & ACCESSORIES

### 1967 LEMANS/GTO SEAT UPHOLSTERY

Our 1967 LeMans/GTO Seat Upholstery is a correct reproduction of the original. We offer the original Madrid grain in 32 oz. vinyl, with the correct dielectrically heat sealed vertical patterns and sewn as original. Bench seats include 1 armrest cover and 1 armrest hinge cover.

#### Features

- Original Madrid grain vinyl
- Correct 6 stitch per inch stitching
- Correct colors matched to the original vinyl
- Limited lifetime warranty

BUCKET SEATS - FRONT	<b>093211</b>
BENCH SEAT - FRONT	<b>093229</b>
COUPE BENCH SEAT - REAR	<b>093237</b>
CONVERTIBLE BENCH SEAT - REAR	<b>093245</b>

### 1967 LEMANS/GTO DOOR/QUARTER PANELS

Our 1967 LeMans/GTO Door/Quarter Panels are a correct reproduction of the original with carpeted bottom portion on Door Panels. We offer original Madrid grain in 32 oz. vinyl, and correct dielectrically heat sealed horizontal patterns as original. Door panel emblems not included.

#### Features

- Original Madrid grain
- Correct dielectric "Heat Seal" stitched pattern
- Correct colors matched to the original vinyl
- .100-inch thickness poly-coated "Autoboard" backing
- Door Panel backs are perimeter stapled for maximum adhesion
- Limited lifetime warranty

FRONT DOOR PANELS	<b>094177</b>
COUPE REAR QUARTER PANELS	<b>094185</b>
CONVERTIBLE REAR QUARTER PANELS	<b>094193</b>

### 1967 INTERIOR ACCESSORIES

Our Convertible Top Boot features the correct Madrid grain in 32 oz. vinyl and fastens just like the original. Clips are not included with the Unassembled Convertible Top Boot.

1966-67 UNASSEMBLED CONVERTIBLE TOP BOOT	<b>092064</b>
1966-67 PRE-ASSEMBLED CONVERTIBLE TOP BOOT	<b>092065</b>

Our 1964 Armrest Pad Covers are reproduced in the correct Seville grain in 32 oz. vinyl and stitched as original.

1964-67 ARMREST PAD COVERS - FRONT	<b>091234</b>
------------------------------------	---------------

Distinctive Industries Quarter Trim Panels are a correct reproduction of the original. We offer original Madrid grain in 32 oz vinyl.

1965-67 CONVERTIBLE QUARTER TRIM WITH ARMREST	<b>092031</b>
---	---------------

Distinctive Industries High-Density Seat Foam is designed to work as a system with our upholstery. Our High-Density Seat Foam is firm, form fitting, and features a Typar® web backing for strength, which prevents spring intrusion and ensures a quality fit and long lasting life. Seat Foam is sold individually, not in pairs.

1966-70 BUCKET SEAT FOAM	<b>067116GM6670</b>
--------------------------	---------------------

Distinctive Industries Seat Heaters provide therapeutic heat and body warmth in any classic car, using the same technology as late model or current vehicles. Each kit comes with switch, harnesses, and two carbon fiber element pads to complete one seat install. Switch can be dash, console, or hidden in a place of choice. Seat Heaters are sold individually, not in pairs.

1964-72 CARBON FIBER SEAT HEATERS	<b>061001</b>
-----------------------------------	---------------

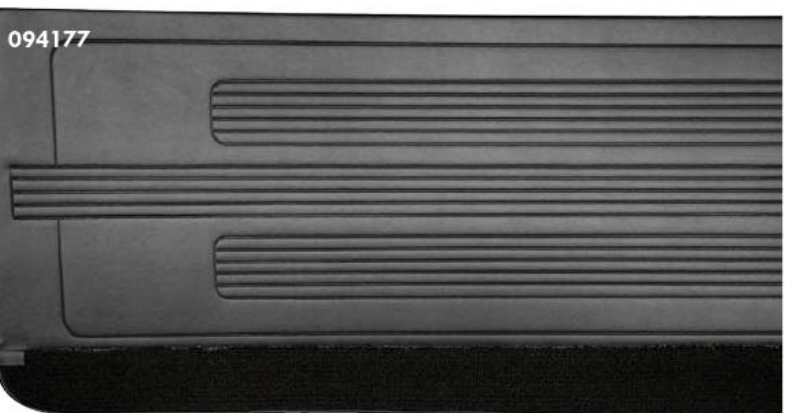

**Don't Forget About SEAT HEATERS!!!**  
 Now Available Easy to install  
 PerfectFit® Carbon Fiber Seat Heaters  
 with a small concealable switch  
**PART #061001**

#### 1967 COLORS

BLACK	L-2295	PARCHMENT	L-2300
BLUE	L-2298	RED	L-3048
GOLD	L-3025	TURQUOISE	L-3045



## 1968 INTERIOR PARTS & ACCESSORIES

### 1968 LEMANS/GTO SEAT UPHOLSTERY

Our 1968 LeMans/GTO Seat Upholstery is a correct reproduction of the original. We offer the original Madrid grain in 32 oz. vinyl, with the correct dielectrically heat sealed vertical patterns and sewn as original. Bench seats include 1 armrest cover.

#### Features

- Original Madrid grain vinyl
- Correct 6 stitch per inch stitching
- Correct colors matched to the original vinyl
- Limited lifetime warranty

BUCKET SEATS - FRONT	<b>093278</b>
BENCH SEAT - FRONT	<b>093286</b>
COUPE BENCH SEAT - REAR	<b>093294</b>
CONVERTIBLE BENCH SEAT - REAR	<b>093302</b>



### 1968 LEMANS/GTO DOOR/QUARTER PANELS

Our 1968 LeMans/GTO Door/Quarter Panels are a correct reproduction of the original with carpeted bottom portion on Door Panels. We offer original Madrid grain in 32 oz. vinyl, and correct dielectrically heat sealed horizontal patterns as original. Door panel emblems not included.

#### Features

- Original Madrid grain vinyl
- Correct dielectric "Heat Seal" stitched pattern
- Correct colors matched to the original vinyl
- .100-inch thickness poly-coated "Autoboard" backing
- Door Panel backs are perimeter stapled for maximum adhesion
- Limited lifetime warranty

FRONT DOOR PANELS	<b>094227</b>
COUPE REAR QUARTER PANELS	<b>094235</b>
CONVERTIBLE REAR QUARTER PANELS	<b>094243</b>



GTO/LEMANS

#### 1968 COLORS

BLACK	L-2295
GOLD	L-3307
PARCHMENT	L-3295
RED	L-3048
TEAL	L-3302
TURQUOISE	L-3045
WHITE	L-2305



## 1968 INTERIOR PARTS & ACCESSORIES

### 1968 INTERIOR ACCESSORIES

Our Convertible Top Boot features the correct Madrid grain in 32 oz. vinyl and fastens just like the original.

1968-72 CONVERTIBLE TOP BOOT **092072**

Distinctive Industries Quarter Trim Panels are a correct reproduction of the original. We offer original Madrid grain in 32 oz vinyl.

1968-72 COUPE QUARTER TRIM WITH ARMREST **092015**

1968-72 CONVERTIBLE QUARTER TRIM WITH ARMREST **092056**

Distinctive Industries Headrest Covers features the correct Madrid grain in 32 oz vinyl, just like the original.

1968-72 BUCKET SEAT HEADREST COVERS **092114**

1968-72 BENCH SEAT HEADREST COVERS **092080**

Our Door Jamb Windlace is the correct Madrid grain in 32 oz. vinyl, just like the originals, and are sold in pairs.

1968-69 COUPE DOOR JAMB WINDLACE **092171**

1968-69 CONVERTIBLE DOOR JAMB WINDLACE **092173**

Distinctive Industries High-Density Seat Foam is designed to work as a system with our upholstery. Our High-Density Seat Foam is firm, form fitting, and features a Typar® web backing for strength, which prevents spring intrusion and ensures a quality fit and long lasting life. Seat Foam is sold individually, not in pairs.

1966-70 BUCKET SEAT FOAM **067116GM6670**

Distinctive Industries Seat Heaters provide therapeutic heat and body warmth in any classic car, using the same technology as late model or current vehicles. Each kit comes with switch, harnesses, and two carbon fiber element pads to complete one seat install.

Switch can be dash, console, or hidden in a place of choice. Seat Heaters are sold individually, not in pairs.

1964-72 CARBON FIBER SEAT HEATERS **061001**



#### 1968 COLORS

BLACK	L-2295
GOLD	L-3307
PARCHMENT	L-3295
RED	L-3048
TEAL	L-3302
TURQUOISE	L-3045
WHITE	L-2305



## 1969 INTERIOR PARTS & ACCESSORIES

### 1969 LEMANS/GTO SEAT UPHOLSTERY

Our 1969 LeMans/GTO Seat Upholstery is a correct reproduction of the original featuring the "Y" pattern insert with embossment for emblem location. We offer the original Madrid grain in 32 oz. vinyl, with the correct dielectrically heat sealed vertical patterns and sewn as original. Bench seats include 1 armrest cover and 1 armrest hinge cover. Seat emblems not included.

#### Features

- Original Madrid grain vinyl
- Correct 6 stitch per inch stitching
- Correct colors matched to the original vinyl
- Limited lifetime warranty

BUCKET SEATS - FRONT	093313
SPLIT BACK BENCH SEAT - FRONT	093311
COUPE BENCH SEAT - REAR	093315
CONVERTIBLE BENCH SEAT - REAR	093317

### 1969 LEMANS CUSTOM S SEAT UPHOLSTERY

Our 1969 LeMans Custom S Seat Upholstery is a correct reproduction of the original. We offer the original Madrid grain in 32 oz. vinyl, with the correct dielectrically heat sealed vertical patterns and sewn as original. Door Panel buttons included.

#### Features

- Original Madrid grain vinyl
- Correct 6 stitch per inch stitching
- Correct colors matched to the original vinyl
- Limited lifetime warranty

BENCH SEAT - FRONT	093336
COUPE BENCH SEAT - REAR	093351



#### 1969 COLORS

BLACK	L-2295
BLUE	L-3598
GREEN	L-3606
GOLD	L-3599
PARCHMENT	L-2300
RED	L-3597
WHITE	L-2305



1969 GTO

## 1969 INTERIOR PARTS & ACCESSORIES

### 1969 LEMANS/GTO DOOR/QUARTER PANELS

Our 1969 LeMans/GTO Door/Quarter Panels are a correct reproduction of the original with Mylar® trim, carpeted bottom portion on Door Panels, and "Y" pattern insert. We offer original Madrid grain in 32 oz. vinyl, and correct dielectrically heat sealed patterns as original. Door Panel moldings are not included.

#### Features

- Original Madrid grain vinyl
- Correct dielectric "Heat Seal" stitched pattern
- Correct colors matched to the original vinyl
- .100-inch thickness poly-coated "Autoboard" backing
- Door Panel backs are perimeter stapled for maximum adhesion
- Limited lifetime warranty

FRONT DOOR PANELS	<b>094276</b>
COUPE REAR QUARTER PANELS	<b>094284</b>
CONVERTIBLE REAR QUARTER PANELS	<b>094292</b>

### 1969 INTERIOR ACCESSORIES

Our Convertible Top Boot features the correct Madrid grain in 32 oz. vinyl and fastens just like the original.

1968-72 CONVERTIBLE TOP BOOT	<b>092072</b>
------------------------------	---------------

Distinctive Industries Quarter Trim Panels are a correct reproduction of the original. We offer original Madrid grain in 32 oz vinyl.

1968-72 COUPE QUARTER TRIM WITH ARMREST	<b>092015</b>
1968-72 CONVERTIBLE QUARTER TRIM WITH ARMREST	<b>092056</b>

Distinctive Industries Headrest Covers features the correct Madrid grain in 32 oz vinyl, just like the original.

1968-72 BUCKET SEAT HEADREST COVERS	<b>092114</b>
1968-72 BENCH SEAT HEADREST COVERS	<b>092080</b>

Our Door Jamb Windlace is the correct Madrid grain in 32 oz. vinyl, just like the originals, and are sold in pairs.

1968-69 COUPE DOOR JAMB WINDLACE	<b>092171</b>
1968-69 CONVERTIBLE DOOR JAMB WINDLACE	<b>092173</b>

Distinctive Industries High-Density Seat Foam is designed to work as a system with our upholstery. Our High-Density Seat Foam is firm, form fitting, and features a Typar® web backing for strength, which prevents spring intrusion and ensures a quality fit and long lasting life. Seat Foam is sold individually, not in pairs.

1966-70 BUCKET SEAT FOAM	<b>067116GM6670</b>
--------------------------	---------------------

Distinctive Industries Seat Heaters provide therapeutic heat and body warmth in any classic car, using the same technology as late model or current vehicles. Each kit comes with switch, harnesses, and two carbon fiber element pads to complete one seat install. Switch can be dash, console, or hidden in a place of choice. Seat Heaters are sold individually, not in pairs.

1964-72 CARBON FIBER SEAT HEATERS	<b>061001</b>
-----------------------------------	---------------



#### 1969 COLORS

BLACK	L-2295
BLUE	L-3598
GREEN	L-3606
GOLD	L-3599
PARCHMENT	L-2300
RED	L-3597

## 1970 INTERIOR PARTS & ACCESSORIES

### 1970 LEMANS SPORT/GTO SEAT UPHOLSTERY

Our 1970 LeMans Sport/GTO Seat Upholstery is a correct reproduction of the original. We offer the original Madrid grain with Comfortweave inserts in 32 oz. vinyl, with the correct heat sealed vertical patterns and sewn as original. Bench seats include 1 armrest cover and 1 pair of headrest covers.

#### Features

- Original Madrid grain vinyl with Comfortweave inserts
- Correct 6 stitch per inch stitching
- Correct colors matched to the original vinyl
- Limited lifetime warranty



BUCKET SEATS - FRONT	093383
SPLIT BACK BENCH SEAT - FRONT	093381
COUPE BENCH SEAT - REAR	093385
CONVERTIBLE BENCH SEAT - REAR	093387

### 1970 LEMANS SPORT/GTO DOOR/QUARTER PANELS

Our 1970 LeMans Sport/GTO Door/Quarter Panels are a correct reproduction of the original with carpeted bottom portion on Door Panels and Mylar® trim. We offer original Madrid grain in 32 oz. vinyl, and correct dielectrically heat sealed patterns as original. Door panel emblems not included.

#### Features

- Original Madrid grain vinyl
- Correct dielectric "Heat Seal" stitched pattern
- Correct colors matched to the original vinyl
- .100-inch thickness poly-coated "Autoboard" backing
- Door Panel backs are perimeter stapled for maximum adhesion
- Limited lifetime warranty

FRONT DOOR PANELS	094298
COUPE REAR QUARTER PANELS	094300
CONVERTIBLE REAR QUARTER PANELS	094302



GTO/LEMANS

#### 1970 COLORS

BLACK	L-2295	RED	L-3048
BLUE	L-3598	SADDLE	L-3887
BROWN	L-4139	SANDALWOOD	L-4138
GREEN	L-3606	WHITE	L-2305
PEARL	L-3295		

\*NOTE: Upholstery has Comfortweave inserts.



## 1970 INTERIOR PARTS & ACCESSORIES

### 1970 INTERIOR ACCESSORIES

Our Convertible Top Boot features the correct Madrid grain in 32 oz. vinyl and fastens just like the original.

1968-72 CONVERTIBLE TOP BOOT **092072**

Distinctive Industries Quarter Trim Panels are a correct reproduction of the original. We offer original Madrid grain in 32 oz vinyl.

1968-72 COUPE QUARTER TRIM WITH ARMREST **092015**

1968-72 CONVERTIBLE QUARTER TRIM WITH ARMREST **092056**

Distinctive Industries Headrest Covers features the correct Madrid grain in 32 oz vinyl, just like the original.

1968-72 BUCKET SEAT HEADREST COVERS **092114**

1968-72 BENCH SEAT HEADREST COVERS **092080**

Our Door Jamb Windlace is the correct Madrid grain in 32 oz. vinyl, just like the originals, and are sold in pairs.

1970-72 DOOR JAMB WINDLACE **092175**

Distinctive Industries High-Density Seat Foam is designed to work as a system with our upholstery. Our High-Density Seat Foam is firm, form fitting, and features a Typar® web backing for strength, which prevents spring intrusion and ensures a quality fit and long lasting life. Seat Foam is sold individually, not in pairs.

1966-70 BUCKET SEAT FOAM **067116GM6670**

Distinctive Industries Seat Heaters provide therapeutic heat and body warmth in any classic car, using the same technology as late model or current vehicles. Each kit comes with switch, harnesses, and two carbon fiber element pads to complete one seat install. Switch can be dash, console, or hidden in a place of choice. Seat Heaters are sold individually, not in pairs.

1964-72 CARBON FIBER SEAT HEATERS **061001**



### 1970 COLORS

BLACK	L-2295	RED	L-3048
BLUE	L-3598	SADDLE	L-3887
BROWN	L-4139	SANDALWOOD	L-4138
GREEN	L-3606	WHITE	L-2305
PEARL	L-3295		

**\*NOTE: Upholstery has Comfortweave inserts.**

## 1971 INTERIOR PARTS & ACCESSORIES

### 1971 LEMANS/GTO SEAT UPHOLSTERY

Our 1971 LeMans/GTO Seat Upholstery is a correct reproduction of the original. We offer the original Madrid grain with Comfortweave inserts in 32 oz. vinyl, with the correct heat sealed horizontal patterns and sewn as original.

#### Features

- Original Madrid grain vinyl with Comfortweave inserts
- Correct 6 stitch per inch stitching
- Correct colors matched to the original vinyl
- Limited lifetime warranty

BUCKET SEATS - FRONT	<b>093401</b>
COUPE BENCH SEAT - REAR	<b>093403</b>
CONVERTIBLE BENCH SEAT - REAR	<b>093405</b>

### 1971 INTERIOR ACCESSORIES

Our Convertible Top Boot features the correct Madrid grain in 32 oz. vinyl and fastens just like the original.

1968-72 CONVERTIBLE TOP BOOT	<b>092072</b>
------------------------------	---------------

Distinctive Industries Quarter Trim Panels are a correct reproduction of the original. We offer original Madrid grain in 32 oz vinyl.

1968-72 COUPE QUARTER TRIM WITH ARMREST	<b>092015</b>
1968-72 CONVERTIBLE QUARTER TRIM WITH ARMREST	<b>092056</b>

Distinctive Industries Headrest Covers features the correct Madrid grain in 32 oz vinyl, just like the original.

1968-72 BUCKET SEAT HEADREST COVERS	<b>092114</b>
1968-72 BENCH SEAT HEADREST COVERS	<b>092080</b>

Our Door Jamb Windlace is the correct Madrid grain in 32 oz. vinyl, just like the originals, and are sold in pairs.

1970-72 DOOR JAMB WINDLACE	<b>092175</b>
----------------------------	---------------

Distinctive Industries High-Density Seat Foam is designed to work as a system with our upholstery. Our High-Density Seat Foam is firm, form fitting, and features a Typar® web backing for strength, which prevents spring intrusion and ensures a quality fit and long lasting life. Seat Foam is sold individually, not in pairs.

1971-72 BUCKET SEAT FOAM	<b>067124GM7172</b>
--------------------------	---------------------

Distinctive Industries Seat Heaters provide therapeutic heat and body warmth in any classic car, using the same technology as late model or current vehicles. Each kit comes with switch, harnesses, and two carbon fiber element pads to complete one seat install. Switch can be dash, console, or hidden in a place of choice. Seat Heaters are sold individually, not in pairs.

1964-72 CARBON FIBER SEAT HEATERS	<b>061001</b>
-----------------------------------	---------------

### 1971 LEMANS/GTO DOOR/QUARTER PANELS

Our 1971 LeMans/GTO Door/Quarter Panels are a correct reproduction of the original with carpeted bottom portion on Door Panels and Mylar® trim. We offer original Madrid grain in 32 oz. vinyl, and correct dielectrically heat sealed diagonal patterns as original.

#### Features

- Original Madrid grain vinyl
- Correct dielectric "Heat Seal" stitched pattern
- Correct colors matched to the original vinyl
- .100-inch thickness poly-coated "Autoboard" backing
- Door Panel backs are perimeter stapled for maximum adhesion
- Limited lifetime warranty

FRONT DOOR PANELS **\*SEEKING PATTERN\***

COUPE REAR QUARTER PANELS **\*SEEKING PATTERN\***

CONVERTIBLE REAR QUARTER PANELS **\*SEEKING PATTERN\***



#### 1971 COLORS

BLACK	L-2295	RED	L-3048
BLUE	L-3598	SADDLE	L-3887
BROWN	L-4139	SANDALWOOD	L-4138
GREEN	L-3606	WHITE	L-2305
PEARL	L-3295		

**\*NOTE:** Upholstery has Comfortweave inserts.





## 1972 INTERIOR PARTS & ACCESSORIES

### 1972 LEMANS/GTO SEAT UPHOLSTERY

Our 1972 LeMans/GTO Seat Upholstery is a correct reproduction of the original. We offer the original Madrid grain with Elk grain inserts in 32 oz. vinyl, with the correct vertical patterns and sewn as original.

#### Features

- Original Madrid grain vinyl with Elk grain inserts
- Correct 6 stitch per inch stitching
- Correct colors matched to the original vinyl
- Limited lifetime warranty

BUCKET SEATS - FRONT	<b>093427</b>
BENCH SEAT - FRONT <b>*SEEKING PATTERN*</b>	
COUPE BENCH SEAT - REAR	<b>093435</b>
CONVERTIBLE BENCH SEAT - REAR	<b>093443</b>

### 1972 LEMANS/GTO DOOR/QUARTER PANELS

Our 1972 LeMans/GTO Door/Quarter Panels are a correct reproduction of the original. We offer original Madrid grain in 32 oz. vinyl, and correct dielectrically heat sealed patterns as original.

#### Features

- Original Madrid grain vinyl
- Correct dielectric "Heat Seal" stitched pattern
- Correct colors matched to the original vinyl
- .100-inch thickness poly-coated "Autoboard" backing
- Door Panel backs are perimeter stapled for maximum adhesion
- Limited lifetime warranty

FRONT DOOR PANELS <b>*SEEKING PATTERN*</b>
COUPE REAR QUARTER PANELS <b>*SEEKING PATTERN*</b>
CONVERTIBLE REAR QUARTER PANELS <b>*SEEKING PATTERN*</b>



#### 1972 COLORS

BLACK	L-2295 (I=L-3931)
GREEN	L-4424 (I=L-4437)
IVORY	L-4421 (I=L-4421)
SADDLE	L-4139 (I=L-4168)

**\*NOTE: I=Inserts**

### 1972 INTERIOR ACCESSORIES

Our Convertible Top Boot features the correct Madrid grain in 32 oz. vinyl and fastens just like the original.

1968-72 CONVERTIBLE TOP BOOT **092072**

Distinctive Industries Quarter Trim Panels are a correct reproduction of the original. We offer original Madrid grain in 32 oz vinyl.

1968-72 COUPE QUARTER TRIM WITH ARMREST **092015**

1968-72 CONVERTIBLE QUARTER TRIM WITH ARMREST **092056**

Distinctive Industries Headrest Covers features the correct Madrid grain in 32 oz vinyl, just like the original.

1968-72 BUCKET SEAT HEADREST COVERS **092114**

1968-72 BENCH SEAT HEADREST COVERS **092080**

Our Door Jamb Windlace is the correct Madrid grain in 32 oz. vinyl, just like the originals, and are sold in pairs.

1970-72 DOOR JAMB WINDLACE **092175**



Distinctive Industries High-Density Seat Foam is designed to work as a system with our upholstery. Our High-Density Seat Foam is firm, form fitting, and features a Typar® web backing for strength, which prevents spring intrusion and ensures a quality fit and long lasting life. Seat Foam is sold individually, not in pairs.

1971-72 BUCKET SEAT FOAM **067124GM7172**

Distinctive Industries Seat Heaters provide therapeutic heat and body warmth in any classic car, using the same technology as late model or current vehicles. Each kit comes with switch, harnesses, and two carbon fiber element pads to complete one seat install. Switch can be dash, console, or hidden in a place of choice. Seat Heaters are sold individually, not in pairs.

1964-72 CARBON FIBER SEAT HEATERS **061001**

**d** distinctive  
industries  
Since 1969



DISTINCTIVE INDUSTRIES IS PROUD  
TO ANNOUNCE THE OPENING OF OUR

# ATLANTA WAREHOUSE

SERVING OUR CUSTOMERS IN THE EASTERN U.S.



- Our Atlanta facility now warehouses Camaro, Chevelle, and Impala upholstery. We are currently stocking seat upholstery, pre-assembled door panels, and interior accessories in black and red. More colors will be available soon.
- We are also introducing pre-assembled door panels for the early Camaro and 1964-72 Chevelle
- Save cost and time in transit
- Will-call orders accepted
- Drop Shipments available

Manufacturing High Quality Restoration Interiors for over 40 years  
*Available at Reputable Dealers Nationwide Since 1969*



**MADE IN AMERICA**

## Introduction To The Catalog

Thank you for choosing Distinctive Industries as your provider of Restoration Interior Products. The catalog you are reading was designed with the input of our existing customers and moving forward, will continue to be a representation of their needs, and the needs of restoration experts worldwide.

### Design

We have designed our catalog for the Restoration Professional, from the Local Upholstery and Restoration Shop, to the National Distributor of Restoration Products. The thought was to create a catalog that eases the pain of product entry for those building catalogs, and to ease ordering for those that order directly from the catalog. We accomplished this by listing product by year, model, and trim level. You will find this catalog to be easy to use.

### Descriptions

Descriptions are a blend of Marketing and Technical descriptions. After polling our customers we found that aside from the design, missing was a good description of the products in today's catalogs. We remedied that by providing a blended description as a basis for our customers to expand upon, or use as is.

### Colors

Color swatches are placed near the product with labeled color codes to avoid confusion. Color Code boxes are located near the applicable products. We offer many special order color combinations as well as an option for leather in most cases.

### Images

Images are available for License through Distinctive Industries.

- Licensed images must be accompanied and located adjacent to the matching Distinctive Industries product.



## Table of Contents

1961 interior parts and accessories

1962 interior parts and accessories

1963 interior parts and accessories

1964 interior parts and accessories

1965 interior parts and accessories

1966 interior parts and accessories

1967 interior parts and accessories

1968 interior parts and accessories

1970 interior parts and accessories

© Copyright 2016, Distinctive Industries, all rights reserved. No part of this publication may be duplicated or reproduced without written permission from Distinctive Industries.



## 1961-62 INTERIOR PARTS & ACCESSORIES

### 1961 INTERIOR ACCESSORIES

Distinctive Industries Quarter Trim Panels are a correct reproduction of the original. We offer original Seville grain in 32 oz. vinyl.  
**CONVERTIBLE REAR QUARTER TRIM 094685**

Our Convertible Top Boot features the correct Seville grain in 32 oz. vinyl and fastens just like the original. Clips are not included.  
**1961-64 CONVERTIBLE TOP BOOT 095604**

Distinctive Industries Seat Heaters provide therapeutic heat and body warmth in any classic car, using the same technology as late model or current vehicles. Each kit comes with switch, harnesses, and two carbon fiber element pads to complete one seat install. Switch can be dash, console, or hidden in a place of choice. Seat Heaters are sold individually, not in pairs.  
**1961-66 CARBON FIBER SEAT HEATERS 061001**



### 1962 SEAT UPHOLSTERY

Our 1962 Impala Seat Upholstery is a correct reproduction of the original. We offer the original Seville grain in 32 oz. vinyl featuring simulated Barberpole inserts, with the correct patterns and sewn as original. Seat buttons are not included.

#### Features

- Original Seville grain vinyl with simulated Barberpole inserts
- Correct 6 stitch per inch stitching
- Correct colors matched to the original vinyl
- Limited lifetime warranty

**STANDARD CONVERTIBLE WITH FRONT BENCH SEAT - FRONT/REAR SET 075402**  
**SS BUCKET SEATS - FRONT 074856**  
**STANDARD BENCH SEAT - FRONT 074858**  
**STANDARD/SS COUPE BENCH SEAT - REAR 074849**  
**STANDARD/SS CONVERTIBLE BENCH SEAT - REAR 074861**

### 1961 COLORS

BEIGE	L-1975	MEDIUM BLUE	L-1409
BLACK	L-920	RED	L-1425
DARK AQUA	L-1991	SADDLE	L-1621
DARK BLUE	L-1763	SILVER	L-395
GREEN	L-4437	WHITE	L-1213
LIGHT AQUA	L-1934		



### 1962 COLORS

AQUA	L-1991	MEDIUM BLUE	L-1409
BLACK	L-920	RED	L-4430
GREEN	L-4437	YELLOW	L-4441

## 1962 INTERIOR PARTS & ACCESSORIES



### 1962 DOOR/QUARTER PANELS

Our 1962 Impala Door/Quarter Panels are a correct reproduction of the original. We offer original Seville grain in 32 oz. vinyl, and correct dielectrically heat sealed horizontal patterns with rectangular squares as original. Door panel buttons not included.

#### Features

- Original Seville grain vinyl
- Correct dielectric "Heat Seal" stitched pattern
- Correct colors matched to the original vinyl
- .100-inch thickness poly-coated "Autoboard" backing
- Door Panel backs are perimeter stapled for maximum adhesion
- Limited lifetime warranty

STANDARD/SS FRONT DOOR PANELS	<b>074886</b>
STANDARD/SS COUPE REAR QUARTER PANELS	<b>074888</b>
STANDARD/SS CONVERTIBLE REAR QUARTER PANELS	<b>074890</b>

### 1962 INTERIOR ACCESSORIES

Our 1962 Front Armrest Upholstery is reproduced in the correct Seville grain in 32 oz. vinyl and stitched as original.  
1962-64 STANDARD/SS FRONT ARMREST COVERS **074894**



Our 1962 Rear Armrest Upholstery is reproduced in the correct Seville grain in 32 oz. vinyl and stitched as original.  
STANDARD/SS COUPE REAR ARMREST COVERS **074868**  
STANDARD/SS CONVERTIBLE REAR ARMREST COVERS **074870**

Our Package Tray is a high quality vinyl covered package tray. Utilizing modern material and covered in the correct Seville grain in 32 oz for durability and long life.  
1962-64 2 DOOR COUPE STANDARD PACKAGE TRAY **074933**

Our Door Jamb Windlace is the correct Seville grain in 32 oz. vinyl, just like the originals, and are sold in pairs.  
1962-64 DOOR JAMB WINDLACE **074893**

Our Convertible Top Boot features the correct Seville grain in 32 oz. vinyl and fastens just like the original. Clips are not included.  
1961-64 CONVERTIBLE TOP BOOT **095604**

Distinctive Industries Seat Heaters provide therapeutic heat and body warmth in any classic car, using the same technology as late model or current vehicles. Each kit comes with switch, harnesses, and two carbon fiber element pads to complete one seat install. Switch can be dash, console, or hidden in a place of choice. Seat Heaters are sold individually, not in pairs.  
1961-70 CARBON FIBER SEAT HEATERS **061001**

1962 COLORS			
AQUA	L-1991	MEDIUM BLUE	L-1409
BLACK	L-920	RED	L-4430
GREEN	L-4437	YELLOW	L-4441



## 1963 INTERIOR PARTS & ACCESSORIES

### 1963 SEAT UPHOLSTERY

Our 1963 Impala Seat Upholstery is a correct reproduction of the original. We offer the original Seville grain in 32 oz. vinyl, with the correct patterns and sewn as original. Seat buttons are not included.

#### Features

- Original Seville grain vinyl
- Correct 6 stitch per inch stitching
- Correct colors matched to the original vinyl
- Limited lifetime warranty

SS BUCKET SEATS - FRONT	074916
STANDARD BENCH SEAT - FRONT	074917
STANDARD/SS COUPE BENCH SEAT - REAR	074918
STANDARD/SS CONVERTIBLE BENCH SEAT - REAR	074919

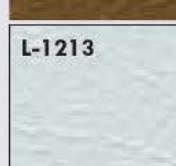
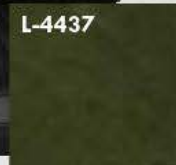

### 1963 DOOR/QUARTER PANELS

Our 1963 Impala Door/Quarter Panels are a correct reproduction of the original. We offer original Seville grain in 32 oz. vinyl, and correct dielectrically heat sealed patterns with rectangular squares as original. Standard/SS models have Crushed Ice grain vinyl on bottom portion. Door/Quarter Panel moldings and buttons are not included.

#### Features

- Original Seville grain vinyl
- Correct dielectric "Heat Seal" stitched pattern
- Correct colors matched to the original vinyl
- .100-inch thickness poly-coated "Autoboard" backing
- Door Panel backs are perimeter stapled for maximum adhesion
- Limited lifetime warranty

STANDARD FRONT DOOR PANELS	074921
SS FRONT DOOR PANELS	074920
STANDARD/SS COUPE REAR QUARTER PANELS	074922
STANDARD/SS CONVERTIBLE REAR QUARTER PANELS	074925

#### 1963 COLORS

BLACK	L-920
GREEN	L-4437
LIGHT AQUA	L-1934
MEDIUM BLUE	L-1409
RED	L-1425
SADDLE	L-1621
WHITE	L-1213

**1963 INTERIOR PARTS & ACCESSORIES**

**1963 INTERIOR ACCESSORIES**

Our 1963 Front Armrest Upholstery is reproduced in the correct Seville grain in 32 oz. vinyl and stitched as original.  
 1962-64 STANDARD/SS FRONT ARMREST COVERS **074894**

Our 1963 Rear Armrest Upholstery is reproduced in the correct Seville grain in 32 oz. vinyl and stitched as original.  
 STANDARD/SS COUPE REAR ARMREST COVERS **074935**  
 STANDARD/SS CONVERTIBLE REAR ARMREST COVERS **074936**

Our Package Tray is a high quality vinyl covered package tray. Utilizing modern material and covered in the correct Seville grain in 32 oz for durability and long life.  
 1962-64 2 DOOR COUPE STANDARD PACKAGE TRAY **074933**

Our Door Jamb Windlace is the correct Seville grain in 32 oz. vinyl, just like the originals, and are sold in pairs.  
 1962-64 DOOR JAMB WINDLACE **074893**

Our Convertible Top Boot features the correct Seville grain in 32 oz. vinyl and fastens just like the original. Clips are not included.  
 1961-64 CONVERTIBLE TOP BOOT **095604**

Distinctive Industries Seat Heaters provide therapeutic heat and body warmth in any classic car, using the same technology as late model or current vehicles. Each kit comes with switch, harnesses, and two carbon fiber element pads to complete one seat install. Switch can be dash, console, or hidden in a place of choice. Seat Heaters are sold individually, not in pairs.  
 1961-70 CARBON FIBER SEAT HEATERS **061001**



1963 COLORS	
BLACK	L-920
LIGHT AQUA	L-1934
MEDIUM BLUE	L-1409
RED	L-1425
SADDLE	L-1621
WHITE	L-1213

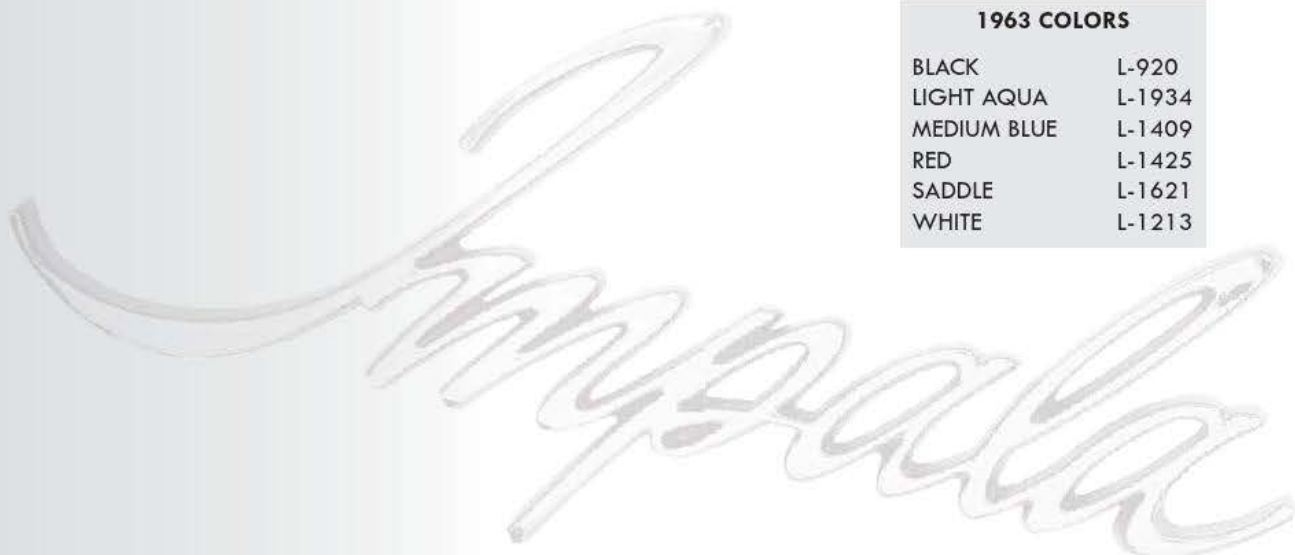

## 1964 INTERIOR PARTS & ACCESSORIES

### 1964 SEAT UPHOLSTERY

Our 1964 Impala Seat Upholstery is a correct reproduction of the original. We offer the original Seville grain in 32 oz. vinyl, with the correct vertical patterns and sewn as original. Seat buttons are not included.

#### Features

- Original Seville grain vinyl
- Correct 6 stitch per inch stitching
- Correct colors matched to the original vinyl
- Limited lifetime warranty

STANDARD BENCH SEAT - FRONT

SS BUCKET SEATS - FRONT

STANDARD COUPE BENCH SEAT - REAR

SS COUPE BENCH SEAT - REAR

STANDARD CONVERTIBLE BENCH SEAT - REAR

SS CONVERTIBLE BENCH SEAT - REAR

074973

074930

074975

074948

074977

074950

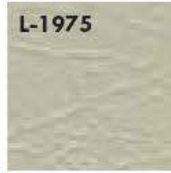

#### 1964 COLORS

AQUA	L-1934
BLACK	L-920
BLUE	L-1409
FAWN	L-1975
RED	L-1425
SADDLE	L-1621
SILVER	L-395
WHITE	L-1213





## 1964 INTERIOR PARTS & ACCESSORIES

### 1964 DOOR/QUARTER PANELS

Our 1964 Impala Door/Quarter Panels are a correct reproduction of the original. We offer original Seville grain in 32 oz. vinyl, and correct dielectrically heat sealed patterns as original. SS models feature correct "Y" shape pattern. Door/Quarter Panel emblems/buttons not included.

#### Features

- Original Seville grain vinyl
- Correct dielectric "Heat Seal" stitched pattern
- Correct colors matched to the original vinyl
- .100-inch thickness poly-coated "Autoboard" backing
- Door Panel backs are perimeter stapled for maximum adhesion
- Limited lifetime warranty

STANDARD FRONT DOOR PANELS	<b>074979</b>
SS FRONT DOOR PANELS	<b>074955</b>
STANDARD COUPE REAR QUARTER PANELS	<b>074982</b>
SS COUPE REAR QUARTER PANELS	<b>074963</b>
STANDARD CONVERTIBLE REAR QUARTER PANELS	<b>074984</b>
SS CONVERTIBLE REAR QUARTER PANELS	<b>074965</b>

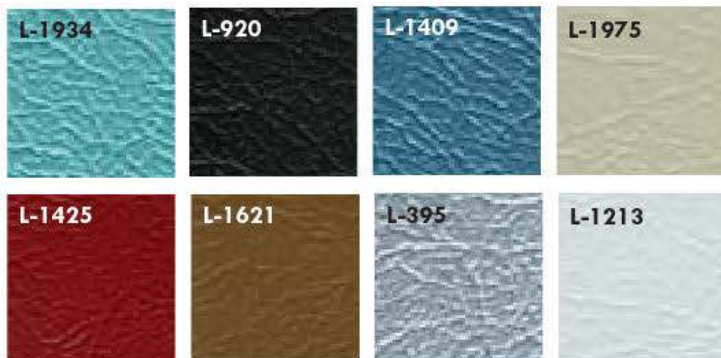

#### 1964 COLORS

AQUA	L-1934
BLACK	L-920
BLUE	L-1409
FAWN	L-1975
RED	L-1425
SADDLE	L-1621
SILVER	L-395
WHITE	L-1213



IMPALA

## 1964 INTERIOR PARTS & ACCESSORIES

### 1964 INTERIOR ACCESSORIES

Our 1964 Front Armrest Upholstery is reproduced in the correct Seville grain in 32 oz. vinyl and stitched as original.  
 1962-64 STANDARD/SS FRONT ARMREST COVERS **074894**

Our 1964 Rear Armrest Upholstery is reproduced in the correct Seville grain in 32 oz. vinyl and stitched as original. Rear Armrest Cover molding, and attaching hardware is not included.

- STANDARD COUPE REAR ARMREST COVERS **074980**
- STANDARD CONVERTIBLE REAR ARMREST COVERS **074986**
- SS COUPE REAR ARMREST COVERS **074971**
- SS CONVERTIBLE REAR ARMREST COVERS **074990**

Our Package Tray is a high quality vinyl covered package tray. Utilizing modern material and covered in the correct Seville grain in 32 oz for durability and long life.

1962-64 2 DOOR COUPE STANDARD PACKAGE TRAY **074933**

Our Door Jamb Windlace is the correct Seville grain in 32 oz. vinyl, just like the originals, and are sold in pairs.

1962-64 DOOR JAMB WINDLACE **074893**

Our Convertible Top Boot features the correct Seville grain in 32 oz. vinyl and fastens just like the original. Clips are not included.

1961-64 CONVERTIBLE TOP BOOT **095604**

Distinctive Industries Seat Heaters provide therapeutic heat and body warmth in any classic car, using the same technology as late model or current vehicles. Each kit comes with switch, harnesses, and two carbon fiber element pads to complete one seat install. Switch can be dash, console, or hidden in a place of choice. Seat Heaters are sold individually, not in pairs.

1961-70 CARBON FIBER SEAT HEATERS **061001**

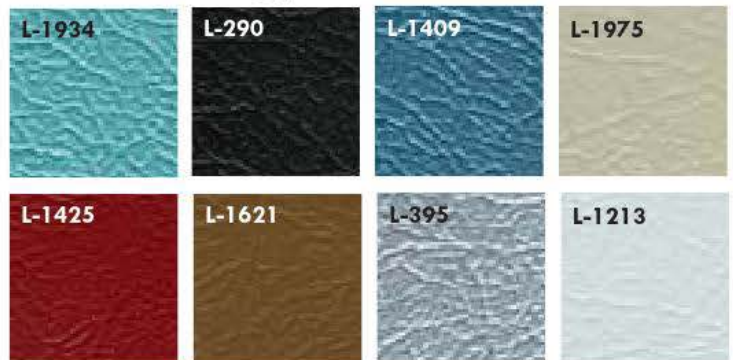

#### 1964 COLORS

AQUA	L-1934
BLACK	L-920
BLUE	L-1409
FAWN	L-1975
RED	L-1425
SADDLE	L-1621
SILVER	L-395
WHITE	L-1213

## 1965 INTERIOR PARTS & ACCESSORIES

### 1965 SEAT UPHOLSTERY

Our 1965 Impala Seat Upholstery is a correct reproduction of the original. We offer the original Madrid grain in 32 oz. vinyl, with the correct vertical patterns, "Y" shape insert on SS models and sewn as original. Seat buttons are not included.

#### Features

- Original Madrid grain vinyl
- Correct 6 stitch per inch stitching
- Correct colors matched to the original vinyl
- Limited lifetime warranty

STANDARD BENCH SEAT - FRONT	075150
SS BUCKET SEATS - FRONT	075200
STANDARD COUPE BENCH SEAT - REAR	075176
SS COUPE BENCH SEAT - REAR	075218
STANDARD CONVERTIBLE BENCH SEAT - REAR	075174
SS CONVERTIBLE BENCH SEAT - REAR	075226



### 1965 DOOR/QUARTER PANELS

Our 1965 Impala Door/Quarter Panels are a correct reproduction of the original. We offer original Madrid grain in 32 oz. vinyl, and correct dielectrically heat sealed vertical patterns as original. Standard models feature a Worm grain vinyl inserts and SS models have a carpeted bottom portion. Door/Quarter Panel buttons/moldings are not included.

#### Features

- Original Madrid grain vinyl
- Correct dielectric "Heat Seal" stitched pattern
- Correct colors matched to the original vinyl
- .100-inch thickness poly-coated "Autoboard" backing
- Door Panel backs are perimeter stapled for maximum adhesion
- Limited lifetime warranty

STANDARD FRONT DOOR PANELS	075152
SS FRONT DOOR PANELS	075275
STANDARD COUPE REAR QUARTER PANELS	075154
SS COUPE REAR QUARTER PANELS	075267
STANDARD CONVERTIBLE REAR QUARTER PANELS	075156
SS CONVERTIBLE REAR QUARTER PANELS	075270



#### 1965 COLORS

AQUA	L-2297	RED	L-3048
BLACK	L-2295	SADDLE	L-4766
BLUE	L-2302	WHITE	L-2305
FAWN	L-2313		

## 1965 INTERIOR PARTS & ACCESSORIES

### 1965 SUNVISORS

Our 1965 Sunvisors are in the original grain vinyl, with the vinyl binding stitched, just like the originals. All Sunvisors are sold in pairs.

CONVERTIBLE SUNVISORS **075312**

### 1965 INTERIOR ACCESSORIES

Our 1965 Front Armrest Upholstery is reproduced in the correct Madrid grain in 32 oz. vinyl and stitched as original.

1965-67 STANDARD/SS FRONT ARMREST COVERS **075438**

Our 1965 Rear Armrest Upholstery is reproduced in the correct Madrid grain in 32 oz. vinyl and stitched as original.

SS COUPE REAR ARMREST COVERS **075259**

SS CONVERTIBLE REAR ARMREST COVERS **075236**

STANDARD CONVERTIBLE REAR ARMREST COVERS **075238**

Our Convertible Top Boot features the correct Madrid grain in 32 oz. vinyl and fastens just like the original. Clips are not included.

1965-68 CONVERTIBLE TOP BOOT **075440**

Distinctive Industries Seat Heaters provide therapeutic heat and body warmth in any classic car, using the same technology as late model or current vehicles. Each kit comes with switch, harnesses, and two carbon fiber element pads to complete one seat install. Switch can be dash, console, or hidden in a place of choice. Seat Heaters are sold individually, not in pairs.

1961-70 CARBON FIBER SEAT HEATERS **061001**

**Don't Forget About SEAT HEATERS!!!**

**Now Available Easy to install  
PerfectFit® Carbon Fiber Seat Heaters  
with a small concealable switch  
PART #061001**



#### 1965 COLORS

AQUA	L-2297	RED	L-3048
BLACK	L-2295	SADDLE	L-4766
BLUE	L-2302	WHITE	L-2305
FAWN	L-2313		

IMPALA



## 1966 INTERIOR PARTS & ACCESSORIES

### 1966 SEAT UPHOLSTERY

Our 1966 Impala Seat Upholstery is a correct reproduction of the original. We offer the original Madrid grain in 32 oz. vinyl, with the correct vertical patterns and sewn as original. Seat buttons are not included.

#### Features

- Original Madrid grain vinyl
- Correct 6 stitch per inch stitching
- Correct colors matched to the original vinyl
- Limited lifetime warranty

STANDARD BENCH SEAT - FRONT	<b>075450</b>
SS BUCKET SEATS - FRONT	<b>075325</b>
STANDARD/SS COUPE BENCH SEAT - REAR	<b>075333</b>
STANDARD/SS CONVERTIBLE BENCH SEAT - REAR	<b>075339</b>



### 1966 DOOR/QUARTER PANELS

Our 1966 Impala Door/Quarter Panels are a correct reproduction of the original. We offer original Madrid grain with Worm grain inserts in 32 oz. vinyl, and correct dielectrically heat sealed patterns with rectangular squares as original. Door/Quarter Panel buttons/molding are not included.

#### Features

- Original Madrid grain vinyl
- Correct dielectric "Heat Seal" stitched pattern
- Correct colors matched to the original vinyl
- .100-inch thickness poly-coated "Autoboard" backing
- Door Panel backs are perimeter stapled for maximum adhesion
- Limited lifetime warranty

STANDARD/SS FRONT DOOR PANELS	<b>075309</b>
STANDARD/SS COUPE REAR QUARTER PANELS	<b>075291</b>
STANDARD/SS CONVERTIBLE REAR QUARTER PANELS	<b>075337</b>

### 1966 SUNVISORS

Our 1966 Sunvisors are in the original grain vinyl, with the vinyl binding stitched, just like the originals. All Sunvisors are sold in pairs.

1966-70 CONVERTIBLE SUNVISORS	<b>075313</b>
-------------------------------	---------------

### 1966 INTERIOR ACCESSORIES

Our 1966 Armrest Upholstery is reproduced in the correct Madrid grain in 32 oz. vinyl and stitched as original.

1965-67 STANDARD/SS ARMREST COVERS - FRONT	<b>075438</b>
STANDARD/SS ARMREST COVERS - REAR	<b>075317</b>

Our Convertible Top Boot features the correct Madrid grain in 32 oz. vinyl and fastens just like the original. Clips are not included.

1965-68 CONVERTIBLE TOP BOOT	<b>075440</b>
------------------------------	---------------

Distinctive Industries High-Density Seat Foam is designed to work as a system with our upholstery. Our High-Density Seat Foam is firm, form fitting, and features a Typar® web backing for strength, which prevents spring intrusion and ensures a quality fit and long lasting life.

1966-70 BUCKET SEAT FOAM - SOLD INDIVIDUALLY	<b>067116GM6670</b>
--	---------------------

Distinctive Industries Seat Heaters provide therapeutic heat and body warmth in any classic car, using the same technology as late model or current vehicles. Each kit comes with switch, harnesses, and two carbon fiber element pads to complete one seat install. Switch can be dash, console, or hidden in a place of choice. Seat Heaters are sold individually, not in pairs.

1961-70 CARBON FIBER SEAT HEATERS	<b>061001</b>
-----------------------------------	---------------

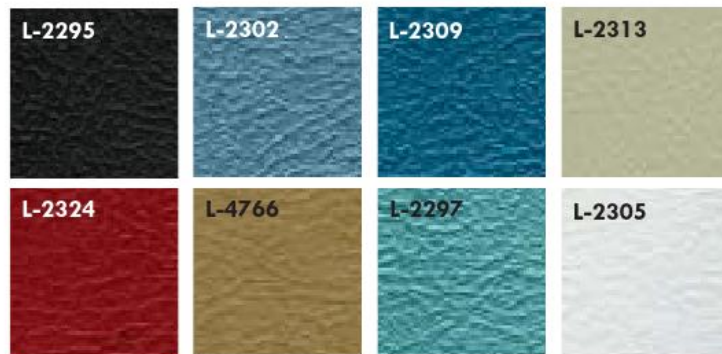

#### 1966 COLORS

BLACK	L-2295	RED	L-2324
BLUE	L-2302	SADDLE	L-4766
BRIGHT BLUE	L-2309	TURQUOISE	L-2297
FAWN	L-2313	WHITE	L-2305



## 1967-68 INTERIOR PARTS & ACCESSORIES

### 1967 SEAT UPHOLSTERY

Our 1967 Impala Seat Upholstery is a correct reproduction of the original. We offer the original Madrid grain in 32 oz. vinyl, with the correct vertical patterns and sewn as original. Seat back emblems are not included.

#### Features

- Original Madrid grain vinyl
- Correct 6 stitch per inch stitching
- Correct colors matched to the original vinyl
- Limited lifetime warranty

STANDARD BENCH SEAT - FRONT	<b>075397</b>
SS BUCKET SEATS - FRONT	<b>075396</b>
STANDARD/SS COUPE BENCH SEAT - REAR	<b>075400</b>
STANDARD/SS CONVERTIBLE BENCH SEAT - REAR	<b>075399</b>

### 1967-68 SUNVISORS

Our 1967 Sunvisors are in the original grain vinyl, with the vinyl binding stitched, just like the originals. All Sunvisors are sold in pairs.

1966-70 CONVERTIBLE SUNVISORS	<b>075313</b>
-------------------------------	---------------

### 1967-68 INTERIOR ACCESSORIES

Our 1967 Armrest Upholstery is reproduced in the correct Madrid grain in 32 oz. vinyl and stitched as original.

1965-67 STANDARD/SS ARMREST COVERS - FRONT	<b>075438</b>
1967 STANDARD/SS COUPE ARMREST COVERS - REAR	<b>075384</b>
1968 STANDARD COUPE REAR ARMREST COVERS	<b>075468</b>

Our Convertible Top Boot features the correct Madrid grain in 32 oz. vinyl and fastens just like the original. Clips are not included.

1965-68 CONVERTIBLE TOP BOOT	<b>075440</b>
------------------------------	---------------

Distinctive Industries High-Density Seat Foam is designed to work as a system with our upholstery. Our High-Density Seat Foam is firm, form fitting, and features a Typar® web backing for strength, which prevents spring intrusion and ensures a quality fit and long lasting life.

1966-70 BUCKET SEAT FOAM - SOLD INDIVIDUALLY	<b>067116GM6670</b>
--	---------------------

Distinctive Industries Seat Heaters provide therapeutic heat and body warmth in any classic car, using the same technology as late model or current vehicles. Each kit comes with switch, harnesses, and two carbon fiber element pads to complete one seat install. Switch can be dash, console, or hidden in a place of choice. Seat Heaters are sold individually, not in pairs.

1962-67 CARBON FIBER SEAT HEATERS	<b>061001</b>
-----------------------------------	---------------

### 1968 SEAT UPHOLSTERY

Our 1968 Impala Seat Upholstery is a correct reproduction of the original. We offer the original Madrid grain in 32 oz. vinyl, with the correct vertical patterns and sewn as original.

#### Features

- Original Madrid grain vinyl
- Correct 6 stitch per inch stitching
- Correct colors matched to the original vinyl
- Limited lifetime warranty

STANDARD 2 DOOR SPLIT BENCH SEAT - FRONT	<b>075460</b>
STANDARD COUPE BENCH SEAT - REAR	<b>075462</b>

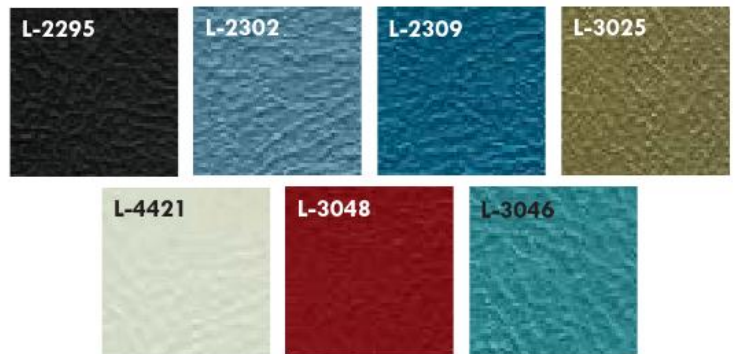

#### 1967 COLORS

BLACK	L-2295	PARCHMENT	L-4421
BLUE	L-2302	RED	L-3048
BRIGHT BLUE	L-2309	TURQUOISE	L-3046
GOLD	L-3025		

## 1970 INTERIOR PARTS & ACCESSORIES

### 1970 SEAT UPHOLSTERY

Our 1970 Impala Seat Upholstery is a correct reproduction of the original. We offer the original Madrid grain with Elk grain inserts in 32 oz. vinyl, with the correct vertical patterns and sewn as original.

#### Features

- Original Madrid grain vinyl with Elk grain inserts
- Correct 6 stitch per inch stitching
- Correct colors matched to the original vinyl
- Limited lifetime warranty

CUSTOM BUCKET SEATS - FRONT **\*SEEKING PATTERN\***  
 CUSTOM BENCH SEAT - FRONT **075500**  
 CUSTOM COUPE BENCH SEAT - REAR **075504**

### 1970 DOOR/QUARTER PANELS

Our 1970 Impala Door/Quarter Panels are a correct reproduction of the original. We offer original Madrid grain in 32 oz. vinyl, and correct dielectrically heat sealed patterns as original.

#### Features

- Original Madrid grain vinyl
- Correct dielectric "Heat Seal" stitched pattern
- Correct colors matched to the original vinyl
- .100-inch thickness poly-coated "Autoboard" backing
- Door Panel backs are perimeter stapled for maximum adhesion
- Limited lifetime warranty

CUSTOM FRONT DOOR PANELS **\*SEEKING PATTERN\***  
 CUSTOM COUPE REAR QUARTER PANELS **\*SEEKING PATTERN\***  
 CUSTOM CONVERTIBLE REAR QUARTER  
 PANELS **\*SEEKING PATTERN\***

### 1970 INTERIOR ACCESSORIES

Our 1970 Rear Armrest Upholstery is reproduced in the correct Sierra grain in 32 oz. vinyl and stitched as original.  
 CUSTOM REAR ARMREST COVERS **075516**

Distinctive Industries High-Density Seat Foam is designed to work as a system with our upholstery. Our High-Density Seat Foam is firm, form fitting, and features a Typar® web backing for strength, which prevents spring intrusion and ensures a quality fit and long lasting life.

1966-70 BUCKET SEAT FOAM -  
 SOLD INDIVIDUALLY **067116GM6670**

Distinctive Industries Seat Heaters provide therapeutic heat and body warmth in any classic car, using the same technology as late model or current vehicles. Each kit comes with switch, harnesses, and two carbon fiber element pads to complete one seat install. Switch can be dash, console, or hidden in a place of choice. Seat Heaters are sold individually, not in pairs.

1961-70 CARBON FIBER SEAT HEATERS **061001**

### 1970 SUNVISORS

Our 1970 Sunvisors are in the original grain vinyl, with the vinyl binding stitched, just like the originals. All Sunvisors are sold in pairs.

1966-70 CONVERTIBLE SUNVISORS **075313**



#### 1970 COLORS

BLACK	L-2295
BLUE	L-3883
DARK GREEN	L-4424
GOLD	L-3888
RED	L-3048
TURQUOISE	L-2297

## Introduction To The Catalog

Thank you for choosing Distinctive Industries as your provider of Restoration Interior Products. The catalog you are reading was designed with the input of our existing customers and moving forward, will continue to be a representation of their needs, and the needs of restoration experts worldwide.

### Design

We have designed our catalog for the Restoration Professional, from the Local Upholstery and Restoration Shop, to the National Distributor of Restoration Products. The thought was to create a catalog that eases the pain of product entry for those building catalogs, and to ease ordering for those that order directly from the catalog. We accomplished this by listing product by year, model, and trim level. You will find this catalog to be easy to use.

### Descriptions

Descriptions are a blend of Marketing and Technical descriptions. After polling our customers we found that aside from the design, missing was a good description of the products in today's catalogs. We remedied that by providing a blended description as a basis for our customers to expand upon, or use as is.

### Colors

Color swatches are placed near the product with labeled color codes to avoid confusion. Color Code boxes are located near the applicable products. We offer many special order color combinations as well as an option for leather in most cases.

### Images

Images are available for License through Distinctive Industries.

- Licensed images must be accompanied and located adjacent to the matching Distinctive Industries product.



## Table of Contents

1968 interior parts and accessories

1969 interior parts and accessories

1970-72 interior parts and accessories

© Copyright 2016, Distinctive Industries, all rights reserved.  
No part of this publication may be duplicated or reproduced without written permission from Distinctive Industries.



## 1968-69 INTERIOR PARTS & ACCESSORIES

### 1968 CUSTOM/SS SEAT UPHOLSTERY

Our 1968 Nova Custom/SS Seat Upholstery is a correct reproduction of the original. We offer the original Madrid grain in 32 oz. vinyl, with the correct vertical patterns and sewn as original. Seat emblems not included.

#### Features

- Original Madrid grain vinyl
- Correct 6 stitch per inch stitching
- Correct colors matched to the original vinyl
- Limited lifetime warranty

CUSTOM BUCKET SEATS - FRONT **096248**  
 CUSTOM HARDTOP BENCH SEAT - REAR **096263**



### 1969 CUSTOM/SS DOOR/QUARTER PANELS

Our 1969 Custom/SS Nova Door/Quarter Panels are a correct reproduction of the original. We offer original Madrid grain in 32 oz. vinyl featuring a Parchment stripe accented with Mylar® trim, and correct dielectrically heat sealed horizontal patterns as original.

#### Features

- Original Madrid grain vinyl with Parchment stripe
- Correct dielectric "Heat Seal" stitched pattern
- Correct colors matched to the original vinyl
- .100-inch thickness poly-coated "Autoboard" backing
- Door Panel backs are perimeter stapled for maximum adhesion
- Limited lifetime warranty

FRONT DOOR PANELS - PARCHMENT STRIPE **096545**  
 REAR QUARTER PANELS - PARCHMENT STRIPE **096552**



### 1968-69 INTERIOR ACCESSORIES

Distinctive Industries Seat Heaters provide therapeutic heat and body warmth in any classic car, using the same technology as late model or current vehicles. Each kit comes with switch, harnesses, and two carbon fiber element pads to complete one seat install. Switch can be dash, console, or hidden in a place of choice. Seat Heaters are sold individually, not in pairs.

1969-72 CARBON FIBER SEAT HEATERS **061001**

NOVA

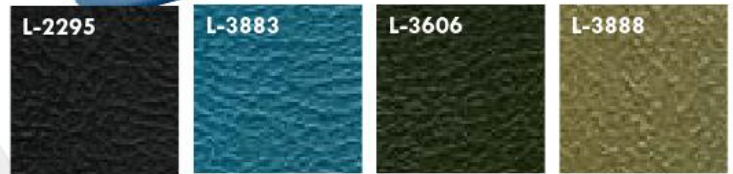

#### 1968-69 COLORS

BLACK	L-2295
BLUE	L-3883
DARK GREEN	L-3606
GOLD	L-3888
SANDALWOOD	L-4138
WHITE	L-2305

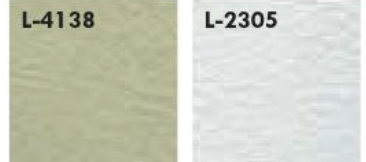

**1970-72 INTERIOR PARTS & ACCESSORIES**

**1970-72 CUSTOM/SS DOOR/QUARTER PANELS**

Our 1970-72 Custom/SS Nova Door/Quarter Panels are a correct reproduction of the original. We offer original Madrid grain in 32 oz. vinyl featuring a Woodgrain stripe accented with Mylar® trim, and correct dielectrically heat sealed horizontal patterns as original.

Features

- Original Madrid grain vinyl with Woodgrain stripe
- Correct dielectric "Heat Seal" stitched pattern
- Correct colors matched to the original vinyl
- .100-inch thickness poly-coated "Autoboard" backing
- Door Panel backs are perimeter stapled for maximum adhesion
- Limited lifetime warranty

- 1970 FRONT DOOR PANELS - ROSEWOOD STRIPE **096578**  
 1970 REAR QUARTER PANELS - ROSEWOOD STRIPE **096586**  
 1971-72 FRONT DOOR PANELS - BURLWOOD STRIPE **096588**  
 1971-72 REAR QUARTER PANELS - BURLWOOD STRIPE **096590**

**1970-72 INTERIOR ACCESSORIES**

Distinctive Industries Seat Heaters provide therapeutic heat and body warmth in any classic car, using the same technology as late model or current vehicles. Each kit comes with switch, harnesses, and two carbon fiber element pads to complete one seat install. Switch can be dash, console, or hidden in a place of choice. Seat Heaters are sold individually, not in pairs.

1969-72 CARBON FIBER SEAT HEATERS **061001**



**1970-72 COLORS**

1970		1971-72	
BLACK	L-2295	BLACK	L-2295
GOLD	L-3888	BLUE	L-4435
SANDALWOOD	L-4138	COVERT	L-4425
		GREEN	L-4424
		JADE	L-4146
		SADDLE	L-4139
		SANDALWOOD	L-4138
		TAN	L-4426
		WHITE	L-2305

## Introduction To The Catalog

Thank you for choosing Distinctive Industries as your provider of Restoration Interior Products. The catalog you are reading was designed with the input of our existing customers and moving forward, will continue to be a representation of their needs, and the needs of restoration experts worldwide.

### Design

We have designed our catalog for the Restoration Professional, from the Local Upholstery and Restoration Shop, to the National Distributor of Restoration Products. The thought was to create a catalog that eases the pain of product entry for those building catalogs, and to ease ordering for those that order directly from the catalog. We accomplished this by listing product by year, model, and trim level. You will find this catalog to be easy to use.

### Descriptions

Descriptions are a blend of Marketing and Technical descriptions. After polling our customers we found that aside from the design, missing was a good description of the products in today's catalogs. We remedied that by providing a blended description as a basis for our customers to expand upon, or use as is.

### Colors

Color swatches are placed near the product with labeled color codes to avoid confusion. Color Code boxes are located near the applicable products. We offer many special order color combinations as well as an option for leather in most cases.

### Images

Images are available for License through Distinctive Industries.

- Licensed images must be accompanied and located adjacent to the matching Distinctive Industries product.



## Table of Contents

1963 interior parts and accessories

1964 interior parts and accessories

1965 interior parts and accessories

1966 interior parts and accessories

1967 interior parts and accessories

1968 interior parts and accessories

1969 interior parts and accessories

1970 interior parts and accessories

1971-72 interior parts and accessories

1973 interior parts and accessories

© Copyright 2016, Distinctive Industries, all rights reserved. No part of this publication may be duplicated or reproduced without written permission from Distinctive Industries.

## 1963 INTERIOR PARTS & ACCESSORIES

### 1963 STANDARD & CUSTOM SEAT UPHOLSTERY

Our 1963 Riviera Seat Upholstery is a correct reproduction of the original. We offer the original Seville grain in 32 oz. vinyl, with the correct horizontal patterns and sewn as original. Seat buttons are included.

#### Features

- Original Seville grain vinyl
- Correct 6 stitch per inch stitching
- Correct colors matched to the original vinyl
- Limited lifetime warranty

BUCKET SEATS - FRONT

**099097**

BENCH SEAT - REAR

**099099**

### 1963 DOOR/QUARTER PANELS

Our 1963 Riviera Door/Quarter Panels are a correct reproduction of the original. We offer original Seville grain in 32 oz. vinyl, carpeted bottom on Door Panels and correct dielectrically heat sealed rectangular patterns as original. Door panel buttons are included.

#### Features

- Original Seville grain vinyl
- Correct dielectric "Heat Seal" stitched pattern
- Correct colors matched to the original vinyl
- .100-inch thickness poly-coated "Autoboard" backing
- Door Panel backs are perimeter stapled for maximum adhesion
- Limited lifetime warranty

FRONT DOOR PANELS - STANDARD

**099307**

FRONT DOOR PANELS - CUSTOM

**099315**

REAR QUARTER PANELS - STANDARD

**099309**

REAR QUARTER PANELS - CUSTOM

**099317**

### 1963 HEADLINER

Our 1963 Headliners are in the original Bedford Ribbed material, constructed just like the original. Headliners come with extra material to cover Sunvisors and Sail Panel Boards.

1963-65 HEADLINER

**099590**

### 1963 INTERIOR ACCESSORIES

Our 1963 Rear Armrest Upholstery is reproduced in the correct Seville grain in 32 oz. vinyl and stitched as original.

REAR ARMREST COVERS

**099525**

Distinctive Industries Seat Heaters provide therapeutic heat and body warmth in any classic car, using the same technology as late model or current vehicles. Each kit comes with switch, harnesses, and two carbon fiber element pads to complete one seat install. Switch can be dash, console, or hidden in a place of choice. Seat Heaters are sold individually, not in pairs.

1963-73 CARBON FIBER SEAT HEATERS

**061001**

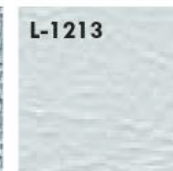
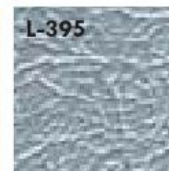
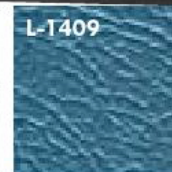
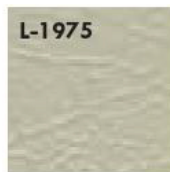

#### 1963 COLORS

BEIGE	L-1975
BLACK	L-920
BLUE	L-1409
RED	L-1425
SADDLE	L-1621
SILVER	L-395
WHITE	L-1213

#### 1963 HEADLINER COLORS

BLACK	H-600
DARK BLUE	H-1206
DARK GREEN	H-1201
GREEN GOLD	H-979
MEDIUM BLUE	H-1204
RED	H-1262
WHITE	H-1136

## 1964 INTERIOR PARTS & ACCESSORIES

### 1964 STANDARD & CUSTOM SEAT UPHOLSTERY

Our 1964 Riviera Seat Upholstery is a correct reproduction of the original. We offer the original Seville grain in 32 oz. vinyl, with the correct horizontal patterns and sewn as original. Seat buttons are included.

#### Features

- Original Seville grain vinyl
- Correct 6 stitch per inch stitching
- Correct colors matched to the original vinyl
- Limited lifetime warranty

BUCKET SEATS - FRONT

**099103**

BENCH SEAT - REAR

**099105**



### 1964 DOOR/QUARTER PANELS

Our 1964 Riviera Door/Quarter Panels are a correct reproduction of the original. We offer original Seville grain in 32 oz. vinyl, carpeted bottom on Door Panels and correct dielectrically heat sealed rectangular patterns as original. Door panel buttons are included.

#### Features

- Original Seville grain vinyl
- Correct dielectric "Heat Seal" stitched pattern
- Correct colors matched to the original vinyl
- .100-inch thickness poly-coated "Autoboard" backing
- Door Panel backs are perimeter stapled for maximum adhesion
- Limited lifetime warranty

FRONT DOOR PANELS - STANDARD

**099307**

FRONT DOOR PANELS - CUSTOM

**099315**

REAR QUARTER PANELS - STANDARD

**099309**

REAR QUARTER PANELS - CUSTOM

**099317**

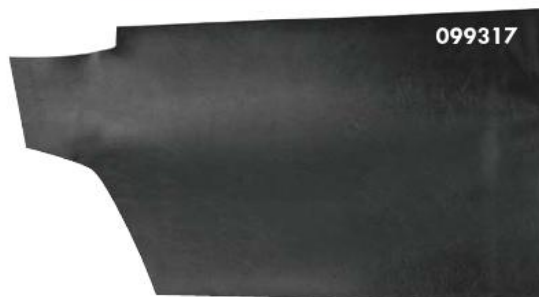

**Don't Forget About SEAT HEATERS!!!**  
 Now Available Easy to install  
 PerfectFit® Carbon Fiber Seat Heaters  
 with a small concealable switch  
**PART #061001**

#### 1964 COLORS

BEIGE	L-1975	RED	L-1425
BLACK	L-920	SADDLE	L-1621
BLUE	L-1409	SILVER	L-395
FAWN	L-1980	WHITE	L-1213



## 1964 INTERIOR PARTS & ACCESSORIES

### 1964 HEADLINER

Our 1964 Headliners are in the original Bedford Ribbed material, constructed just like the original. Headliners come with extra material to cover Sunvisors and Sail Panel Boards.

1963-65 Headliner **099590**

### 1964 INTERIOR ACCESSORIES

Our 1964 Rear Armrest Upholstery is reproduced in the correct Seville grain in 32 oz. vinyl and stitched as original.

REAR ARMREST COVERS **099525**

Distinctive Industries Seat Heaters provide therapeutic heat and body warmth in any classic car, using the same technology as late model or current vehicles. Each kit comes with switch, harnesses, and two carbon fiber element pads to complete one seat install. Switch can be dash, console, or hidden in a place of choice. Seat Heaters are sold individually, not in pairs.

1963-73 CARBON FIBER SEAT HEATERS **061001**

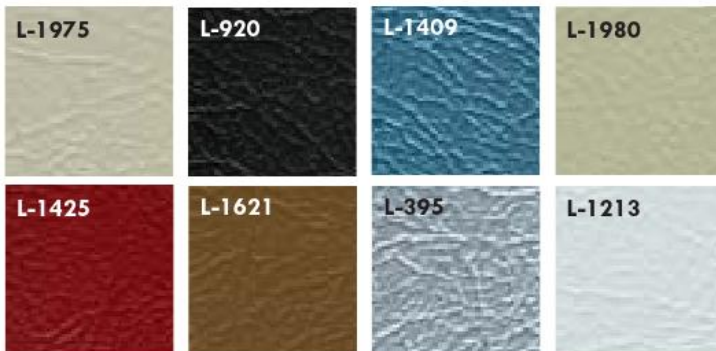

#### 1964 COLORS

BEIGE	L-1975
BLACK	L-920
BLUE	L-1409
FAWN	L-1980
RED	L-1425
SADDLE	L-1621
SILVER	L-395
WHITE	L-1213

#### 1964 HEADLINER COLORS

BLACK	H-600
BLUE	H-1204
DARK BLUE	H-1206
DARK GREEN	H-1201
GREEN	H-979
RED	H-1262
WHITE	H-1136

## 1965 INTERIOR PARTS & ACCESSORIES

### 1965 STANDARD SEAT UPHOLSTERY

Our 1965 Riviera Standard Seat Upholstery is a correct reproduction of the original. We offer the original Madrid grain in 32 oz. vinyl, with the correct horizontal patterns and sewn as original. Seat buttons are included.

#### Features

- Original Madrid grain vinyl
- Correct 6 stitch per inch stitching
- Correct colors matched to the original vinyl
- Limited lifetime warranty

BUCKET SEATS - FRONT

**099103**

BENCH SEAT - REAR

**099105**



### 1965 CUSTOM SEAT UPHOLSTERY

Our 1965 Riviera Custom Seat Upholstery is a correct reproduction of the original. We offer the original Madrid grain in 32 oz. vinyl, with the correct vertical patterns and sewn as original. Seat buttons are included.

#### Features

- Original Madrid grain vinyl
- Correct 6 stitch per inch stitching
- Correct colors matched to the original vinyl
- Limited lifetime warranty

BUCKET SEAT - FRONT

**099111**

BENCH SEAT - REAR

**099113**



### 1965 DOOR/QUARTER PANELS

Our 1965 Riviera Door/Quarter Panels are a correct reproduction of the original. We offer original Madrid grain in 32 oz. vinyl, carpeted bottom on Door Panels and correct dielectrically heat sealed patterns as original. Door/Quarter Panels moldings and emblems are not included.

#### Features

- Original Madrid grain vinyl
- Correct dielectric "Heat Seal" stitched pattern
- Correct colors matched to the original vinyl
- .100-inch thickness poly-coated "Autoboard" backing
- Door Panel backs are perimeter stapled for maximum adhesion
- Limited lifetime warranty

FRONT DOOR PANELS - STANDARD **\*SEEKING PATTERN\***

FRONT DOOR PANELS - CUSTOM **099347**

REAR QUARTER PANELS - STANDARD **\*SEEKING PATTERN\***

REAR QUARTER PANELS - CUSTOM **099349**



#### 1965 COLORS

BLACK	L-2295	SADDLE (STANDARD)	L-2613
BLUE	L-2302	SADDLE (CUSTOM)	L-4766
GREEN	L-2321	WHITE	L-2305

## 1965 INTERIOR PARTS & ACCESSORIES

### 1965 HEADLINER

Our 1965 Headliners are in the original Bedford Ribbed material, constructed just like the original. Headliners come with extra material to cover Sunvisors and Sail Panel Boards.

1963-65 HEADLINER

099590

#### 1965 HEADLINER COLORS

BLACK	H-600
BLUE	H-1204
DARK BLUE	H-1206
DARK GREEN	H-1201
GREEN	H-979
RED	H-1262
WHITE	H-1136

### 1965 INTERIOR ACCESSORIES

Our 1965 Rear Armrest Upholstery is reproduced in the correct Madrid grain in 32 oz. vinyl and stitched as original.

REAR ARMREST COVERS

099529

Distinctive Industries Seat Heaters provide therapeutic heat and body warmth in any classic car, using the same technology as late model or current vehicles. Each kit comes with switch, harnesses, and two carbon fiber element pads to complete one seat install. Switch can be dash, console, or hidden in a place of choice. Seat Heaters are sold individually, not in pairs.

1963-73 CARBON FIBER SEAT HEATERS

061001

**Don't Forget About SEAT HEATERS!!!**

Now Available Easy to install  
PerfectFit® Carbon Fiber Seat Heaters  
with a small concealable switch  
**PART #061001**



L-2295

L-2302

L-2321

L-2613

L-4766

L-2305



#### 1965 COLORS

BLACK	L-2295
BLUE	L-2302
GREEN	L-2321
SADDLE (STANDARD)	L-2613
SADDLE (CUSTOM)	L-4766
WHITE	L-2305

1965 Riviera with Custom interior



## 1966 INTERIOR PARTS & ACCESSORIES

### 1966 STANDARD SEAT UPHOLSTERY

Our 1966 Riviera Standard Seat Upholstery is a correct reproduction of the original. We offer the original Madrid grain in 32 oz. vinyl, with the correct horizontal patterns and sewn as original. Seat buttons/emblems not included.

#### Features

- Original Madrid grain vinyl
- Correct 6 stitch per inch stitching
- Correct colors matched to the original vinyl
- Limited lifetime warranty

BUCKET SEATS - FRONT	099119
BENCH SEAT - FRONT	099121
BENCH SEAT - REAR	099123

### 1966 CUSTOM SEAT UPHOLSTERY

Our 1966 Riviera Custom Seat Upholstery is a correct reproduction of the original. We offer the original Madrid grain in 32 oz. vinyl, with the correct horizontal patterns with 1 centered vertical line and sewn as original. Seat buttons/emblems not included.

#### Features

- Original Madrid grain vinyl
- Correct 6 stitch per inch stitching
- Correct colors matched to the original vinyl
- Limited lifetime warranty

BUCKET SEATS - FRONT	099129
BENCH SEAT - FRONT	099131
BENCH SEAT - REAR	099133

### 1966 DOOR/QUARTER PANELS

Our 1966 Riviera Door/Quarter Panels are a correct reproduction of the original. We offer original Madrid grain in 32 oz. vinyl, and correct dielectrically heat sealed patterns as original.

#### Features

- Original Madrid grain vinyl
- Correct dielectric "Heat Seal" stitched pattern
- Correct colors matched to the original vinyl
- .100-inch thickness poly-coated "Autoboard" backing
- Door Panel backs are perimeter stapled for maximum adhesion
- Limited lifetime warranty

FRONT DOOR PANELS - STANDARD	*SEEKING PATTERN*
FRONT DOOR PANELS - CUSTOM	*SEEKING PATTERN*
REAR QUARTER PANELS - STANDARD	*SEEKING PATTERN*
REAR QUARTER PANELS - CUSTOM	*SEEKING PATTERN*



### 1966 INTERIOR ACCESSORIES

Our 1966 Rear Armrest Upholstery is reproduced in the correct Madrid grain in 32 oz. vinyl and stitched as original.

REAR ARMREST COVERS **099537**

Distinctive Industries Seat Heaters provide therapeutic heat and body warmth in any classic car, using the same technology as late model or current vehicles. Each kit comes with switch, harnesses, and two carbon fiber element pads to complete one seat install. Switch can be dash, console, or hidden in a place of choice. Seat Heaters are sold individually, not in pairs.

1963-73 CARBON FIBER SEAT HEATERS **061001**



#### 1966 COLORS

BLACK	L-2295
LIGHT BLUE	L-2302
DOVE	L-2313
RED	L-2795
WHITE	L-2305



## 1967 INTERIOR PARTS & ACCESSORIES

### 1967 STANDARD SEAT UPHOLSTERY

Our 1967 Riviera Standard Seat Upholstery is a correct reproduction of the original. We offer the original Madrid grain in 32 oz. vinyl, with the correct patterns and sewn as original.

#### Features

- Original Madrid grain vinyl
- Correct 6 stitch per inch stitching
- Correct colors matched to the original vinyl
- Limited lifetime warranty

BUCKET SEATS - FRONT **\*SEEKING PATTERN\***

BENCH SEAT - FRONT **\*SEEKING PATTERN\***

BENCH SEAT - REAR **\*SEEKING PATTERN\***

### 1967 CUSTOM SEAT UPHOLSTERY

Our 1967 Riviera Custom Seat Upholstery is a correct reproduction of the original. We offer the original Madrid grain in 32 oz. vinyl, with the correct vertical patterns and sewn as original. Bench seats include armrest cover and armrest hinge cover. Seat buttons/emblems not included.

#### Features

- Original Madrid grain vinyl
- Correct 6 stitch per inch stitching
- Correct colors matched to the original vinyl
- Limited lifetime warranty

BUCKET SEAT - FRONT

BENCH SEAT - FRONT

BENCH SEAT - REAR

099149

099151

099153

### 1967 DOOR/QUARTER PANELS

Our 1967 Riviera Door/Quarter Panels are a correct reproduction of the original. We offer original Madrid grain in 32 oz. vinyl, carpeted bottom on Door Panels and correct dielectrically heat sealed patterns as original.

#### Features

- Original Madrid grain vinyl
- Correct dielectric "Heat Seal" stitched pattern
- Correct colors matched to the original vinyl
- .100-inch thickness poly-coated "Autoboard" backing
- Door Panel backs are perimeter stapled for maximum adhesion
- Limited lifetime warranty

FRONT DOOR PANELS - STANDARD **\*SEEKING PATTERN\***

FRONT DOOR PANELS - CUSTOM **099380**

REAR QUARTER PANELS - STANDARD **\*SEEKING PATTERN\***

REAR QUARTER PANELS - CUSTOM **099382**

### 1967 INTERIOR ACCESSORIES

Our 1967 Rear Armrest Upholstery is reproduced in the correct Madrid grain in 32 oz. vinyl and stitched as original.

REAR ARMREST COVERS **\*SEEKING PATTERN\***

Distinctive Industries Seat Heaters provide therapeutic heat and body warmth in any classic car, using the same technology as late model or current vehicles. Each kit comes with switch, harnesses, and two carbon fiber element pads to complete one seat install. Switch can be dash, console, or hidden in a place of choice. Seat Heaters are sold individually, not in pairs.

1963-73 CARBON FIBER SEAT HEATERS

**061001**



#### 1967 COLORS

AQUA	L-3045	DOVE	L-2313
BLACK	L-2295	SADDLE	L-3599
BLUE	L-2298	WHITE	L-2305



**1968 INTERIOR PARTS & ACCESSORIES**

**1968 STANDARD SEAT UPHOLSTERY**

Our 1968 Riviera Standard Seat Upholstery is a correct reproduction of the original. We offer the original Madrid grain in 32 oz. vinyl, with the correct horizontal patterns and sewn as original. Seat buttons/emblems not included.

Features

- Original Madrid grain vinyl
- Correct 6 stitch per inch stitching
- Correct colors matched to the original vinyl
- Limited lifetime warranty

BUCKET SEATS - FRONT **\*SEEKING PATTERN\***

BENCH SEAT - FRONT

BENCH SEAT - REAR

**099161**

**099163**

**1968 CUSTOM SEAT UPHOLSTERY**

Our 1968 Riviera Custom Seat Upholstery is a correct reproduction of the original. We offer the original Madrid grain in 32 oz. vinyl, with the correct vertical patterns and sewn as original. Seat buttons/emblems not included.

Features

- Original Madrid grain vinyl
- Correct 6 stitch per inch stitching
- Correct colors matched to the original vinyl
- Limited lifetime warranty

BUCKET SEATS - FRONT

BENCH SEAT - FRONT **\*SEEKING PATTERN\***

BENCH SEAT - REAR

**099169**

**099173**



**1968 COLORS**

BLACK	L-2295	CHAMPAGNE	L-2313
BLUE	L-3302	PARCHMENT	L-3598
BUCKSKIN	L-2586	WHITE	L-2305

**1968 DOOR/QUARTER PANELS**

Our 1968 Riviera Door/Quarter Panels are a correct reproduction of the original. We offer original Madrid grain in 32 oz. vinyl, and correct dielectrically heat sealed patterns as original.

Features

- Original Madrid grain vinyl
- Correct dielectric "Heat Seal" stitched pattern
- Correct colors matched to the original vinyl
- .100-inch thickness poly-coated "Autoboard" backing
- Door Panel backs are perimeter stapled for maximum adhesion
- Limited lifetime warranty

FRONT DOOR PANELS - STANDARD **\*SEEKING PATTERN\***

FRONT DOOR PANELS - CUSTOM **\*SEEKING PATTERN\***

REAR QUARTER PANELS - STANDARD **\*SEEKING PATTERN\***

REAR QUARTER PANELS - CUSTOM **\*SEEKING PATTERN\***

**1968 INTERIOR ACCESSORIES**

Our 1968 Rear Armrest Upholstery is reproduced in the correct Madrid grain in 32 oz. vinyl and stitched as original.

REAR ARMREST COVERS **\*SEEKING PATTERN\***

Distinctive Industries Seat Heaters provide therapeutic heat and body warmth in any classic car, using the same technology as late model or current vehicles. Each kit comes with switch, harnesses, and two carbon fiber element pads to complete one seat install. Switch can be dash, console, or hidden in a place of choice. Seat Heaters are sold individually, not in pairs.

1963-73 CARBON FIBER SEAT HEATERS

**061001**

**1968 HEADLINER**

Our 1968 Headliners are in the original Premier Perforated material, constructed just like the original. Headliners come with extra material to cover Sunvisors and Sail Panel Boards.

1968-69 HEADLINER

**099594**

**1968 HEADLINER COLORS**

BLACK	H-1179	MEDIUM BLUE	H-1482
DARK BLUE	H-1183	RED	H-1507
DARK GREEN	H-1276	WHITE	H-1181
LIGHT BLUE	H-1182		

## 1969 INTERIOR PARTS & ACCESSORIES

### 1969 STANDARD SEAT UPHOLSTERY

Our 1969 Riviera Standard Seat Upholstery is a correct reproduction of the original. We offer the original Madrid grain in 32 oz. vinyl, with the correct patterns and sewn as original.

#### Features

- Original Madrid grain vinyl
- Correct 6 stitch per inch stitching
- Correct colors matched to the original vinyl
- Limited lifetime warranty

BUCKET SEATS - FRONT **\*SEEKING PATTERN\***

BENCH SEAT - FRONT **\*SEEKING PATTERN\***

BENCH SEAT - REAR **\*SEEKING PATTERN\***

### 1969 CUSTOM SEAT UPHOLSTERY

Our 1969 Riviera Custom Seat Upholstery is a correct reproduction of the original. We offer the original Madrid grain in 32 oz. vinyl, with the correct patterns and sewn as original. Bench seats include armrest cover and armrest hinge cover. Seat buttons/emblems not included.

#### Features

- Original Madrid grain vinyl
- Correct 6 stitch per inch stitching
- Correct colors matched to the original vinyl
- Limited lifetime warranty

BUCKET SEATS - FRONT

**099190**

BENCH SEAT - FRONT

**099192**

BENCH SEAT - REAR

**099194**

### 1969 DOOR/QUARTER PANELS

Our 1969 Riviera Door/Quarter Panels are a correct reproduction of the original. We offer original Madrid grain in 32 oz. vinyl, and correct dielectrically heat sealed patterns as original.

#### Features

- Original Madrid grain vinyl
- Correct dielectric "Heat Seal" stitched pattern
- Correct colors matched to the original vinyl
- .100-inch thickness poly-coated "Autoboard" backing
- Door Panel backs are perimeter stapled for maximum adhesion
- Limited lifetime warranty

FRONT DOOR PANELS - STANDARD **\*SEEKING PATTERN\***

FRONT DOOR PANELS - CUSTOM **\*SEEKING PATTERN\***

REAR QUARTER PANELS - STANDARD **\*SEEKING PATTERN\***

REAR QUARTER PANELS - CUSTOM **\*SEEKING PATTERN\***

### 1969 HEADLINER

Our 1969 Headliners are in the original Premier Perforated material, constructed just like the original. Headliners come with extra material to cover Sunvisors and Sail Panel Boards.

1968-69 HEADLINER

**099594**

#### 1969 HEADLINER COLORS

BLACK	H-1179
DARK BLUE	H-1183
DARK GREEN	H-1276
LIGHT BLUE	H-1182
MEDIUM BLUE	H-1482
RED	H-1507
WHITE	H-1181

### 1969 INTERIOR ACCESSORIES

Our 1969 Rear Armrest Upholstery is reproduced in the correct Madrid grain in 32 oz. vinyl and stitched as original.

REAR ARMREST COVERS **\*SEEKING PATTERN\***

Distinctive Industries Seat Heaters provide therapeutic heat and body warmth in any classic car, using the same technology as late model or current vehicles. Each kit comes with switch, harnesses, and two carbon fiber element pads to complete one seat install. Switch can be dash, console, or hidden in a place of choice. Seat Heaters are sold individually, not in pairs.

1963-73 CARBON FIBER SEAT HEATERS

**061001**



#### 1969 COLORS

BLACK	L-2295	GREEN	L-4424
BLUE	L-3302	PARCHMENT	L-2313
BUCKSKIN	L-2586	PEARL WHITE	L-2300
GOLD	L-3599	SANDALWOOD	L-4138



## 1970 INTERIOR PARTS & ACCESSORIES

### 1970 STANDARD SEAT UPHOLSTERY

Our 1970 Riviera Standard Seat Upholstery is a correct reproduction of the original. We offer the original Madrid grain in 32 oz. vinyl, with the correct patterns and sewn as original.

Features

- Original Madrid grain vinyl
- Correct 6 stitch per inch stitching
- Correct colors matched to the original vinyl
- Limited lifetime warranty

BUCKET SEATS - FRONT **\*SEEKING PATTERN\***

BENCH SEAT - FRONT **\*SEEKING PATTERN\***

BENCH SEAT - REAR **\*SEEKING PATTERN\***



### 1970 CUSTOM SEAT UPHOLSTERY

Our 1970 Riviera Custom Seat Upholstery is a correct reproduction of the original. We offer the original Madrid grain in 32 oz. vinyl, with the correct vertical patterns and sewn as original. Bench seats include armrest cover, armrest hinge cover and 1 piece of 16" x 19" vinyl. Seat buttons/emblems not included.

Features

- Original Madrid grain vinyl
- Correct 6 stitch per inch stitching
- Correct colors matched to the original vinyl
- Limited lifetime warranty

BUCKET SEATS - FRONT

**099210**

BENCH SEAT - FRONT

**099212**

BENCH SEAT - REAR

**099214**



### 1970 DOOR/QUARTER PANELS

Our 1970 Riviera Door/Quarter Panels are a correct reproduction of the original. We offer original Madrid grain in 32 oz. vinyl, and correct dielectrically heat sealed patterns as original.

Features

- Original Madrid grain vinyl
- Correct dielectric "Heat Seal" stitched pattern
- Correct colors matched to the original vinyl
- .100-inch thickness poly-coated "Autoboard" backing
- Door Panel backs are perimeter stapled for maximum adhesion
- Limited lifetime warranty

FRONT DOOR PANELS - STANDARD **\*SEEKING PATTERN\***

FRONT DOOR PANELS - CUSTOM **\*SEEKING PATTERN\***

REAR QUARTER PANELS - STANDARD **\*SEEKING PATTERN\***

REAR QUARTER PANELS - CUSTOM **\*SEEKING PATTERN\***



#### 1970 COLORS

BLACK	L-2295	PEARL WHITE	L-3295
BLUE	L-3598	SADDLE	L-3887
GREEN	L-3896	SANDALWOOD	L-4138

## 1970 INTERIOR PARTS & ACCESSORIES



### 1970 INTERIOR ACCESSORIES

Our 1970 Rear Armrest Upholstery is reproduced in the correct Madrid grain in 32 oz. vinyl and stitched as original.

REAR ARMREST COVERS \*SEEKING PATTERN\*

Distinctive Industries Seat Heaters provide therapeutic heat and body warmth in any classic car, using the same technology as late model or current vehicles. Each kit comes with switch, harnesses, and two carbon fiber element pads to complete one seat install. Switch can be dash, console, or hidden in a place of choice. Seat Heaters are sold individually, not in pairs.

1963-73 CARBON FIBER SEAT HEATERS

061001



#### 1970 COLORS

BLACK	L-2295	PEARL WHITE	L-3295
BLUE	L-3598	SADDLE	L-3887
GREEN	L-3896	SANDALWOOD	L-4138

## HandsOn EXPERIENCE



Can you whoop a kid on video games? Probably not. But you can show them a whole new "reality" by taking them to a car show. Encouraging a child to get outside, see glistening paint jobs, and hear the purr of finely tuned engines will awaken all of their senses. You might even be surprised at how much your own enthusiasm is rekindled!

Life is full of choices for kids. You can help them make the right ones by sharing your appreciation for cool old cars. The practical knowledge you share with a child today...just may be the experience that sets them on a lifetime of success.



Take a Kid to a Car Show is a program of ARMO, the Automotive Restoration Market Organization, a SEMA Council.





## 1973 INTERIOR PARTS & ACCESSORIES

### 1973 CUSTOM SEAT UPHOLSTERY

Our 1973 Riviera Custom Seat Upholstery is a correct reproduction of the original. We offer the original Madrid grain with Oxen grain inserts in 32 oz. vinyl, with the correct patterns, carpeted seat back, and sewn as original. Bench seats include armrest cover, armrest hinge cover and headrest covers. Seat buttons are included.

#### Features

- Original Madrid grain vinyl with Oxen grain inserts
- Correct 6 stitch per inch stitching
- Correct colors matched to the original vinyl
- Limited lifetime warranty

SPLIT BENCH SEAT - FRONT **099252**  
 HARDTOP BENCH SEAT - REAR **099256**

### 1973 INTERIOR ACCESSORIES

Distinctive Industries Seat Heaters provide therapeutic heat and body warmth in any classic car, using the same technology as late model or current vehicles. Each kit comes with switch, harnesses, and two carbon fiber element pads to complete one seat install. Switch can be dash, console, or hidden in a place of choice. Seat Heaters are sold individually, not in pairs.

1963-73 CARBON FIBER SEAT HEATERS **061001**



1973 COLORS	
BLACK	L-2295
BLUE	L-4135
GREEN	L-4424
ROSEWOOD	L-5013
SADDLE	L-4139
SANDALWOOD	L-4138
WHITE	L-2305

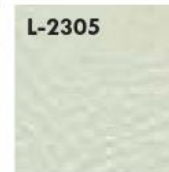
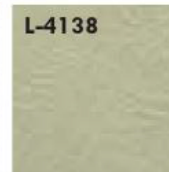



## Introduction To The Catalog

Thank you for choosing Distinctive Industries as your provider of Restoration Interior Products. The catalog you are reading was designed with the input of our existing customers and moving forward, will continue to be a representation of their needs, and the needs of restoration experts worldwide.

### Design

We have designed our catalog for the Restoration Professional, from the Local Upholstery and Restoration Shop, to the National Distributor of Restoration Products. The thought was to create a catalog that eases the pain of product entry for those building catalogs, and to ease ordering for those that order directly from the catalog. We accomplished this by listing product by year, model, and trim level. You will find this catalog to be easy to use.

### Descriptions

Descriptions are a blend of Marketing and Technical descriptions. After polling our customers we found that aside from the design, missing was a good description of the products in today's catalogs. We remedied that by providing a blended description as a basis for our customers to expand upon, or use as is.

### Colors

Color swatches are placed near the product with labeled color codes to avoid confusion. Color Code boxes are located near the applicable products. We offer many special order color combinations as well as an option for leather in most cases.

### Images

Images are available for License through Distinctive Industries.

- Licensed images must be accompanied and located adjacent to the matching Distinctive Industries product.



## Table of Contents

1970 interior parts and accessories

1971-72 interior parts and accessories

© Copyright 2016, Distinctive Industries, all rights reserved.  
No part of this publication may be duplicated or reproduced without written permission from Distinctive Industries.

## 1970 INTERIOR PARTS & ACCESSORIES

### 1970 CUSTOM/GS SEAT UPHOLSTERY

Our 1970 Skylark Custom/GS Seat Upholstery is a correct reproduction of the original. We offer the original Madrid grain with Laredo grain inserts in 32 oz. vinyl, with the correct vertical patterns and sewn as original. Bench seats include 2 headrest covers, and a center armrest cover.

#### Features

- Original Madrid grain vinyl with Laredo grain inserts
- Correct 6 stitch per inch stitching
- Correct colors matched to the original vinyl
- Limited lifetime warranty

BUCKET SEATS - FRONT

099724

BENCH SEAT - FRONT

099726

COUPE BENCH SEAT - REAR

099728

CONVERTIBLE BENCH SEAT - REAR

099730



### 1970 CUSTOM DOOR/QUARTER PANELS

Our 1970 Skylark Custom Door/Quarter Panels are a correct reproduction of the original. We offer original Madrid grain in 32 oz. vinyl, and correct dielectrically heat sealed horizontal patterns as original.

#### Features

- Original Madrid grain vinyl
- Correct dielectric "Heat Seal" stitched pattern
- Correct colors matched to the original vinyl
- .100-inch thickness poly-coated "Autoboard" backing
- Door Panel backs are perimeter stapled for maximum adhesion
- Limited lifetime warranty

FRONT DOOR PANELS

099840

REAR QUARTER PANELS

099842



L-2295

L-3598

L-5013

L-4424

L-3295

L-3887

L-2305

#### 1970 COLORS

BLACK	L-2295	PEARL	L-3295
BLUE	L-3598	SADDLE	L-3887
BURNISHED SADDLE	L-5013	WHITE	L-2305
DARK GREEN	L-4424		

**1970-72 INTERIOR PARTS & ACCESSORIES**

**1970-72 INTERIOR ACCESSORIES**

Our 1970 Rear Armrest Upholstery is reproduced in the correct Madrid grain in 32 oz. vinyl and stitched as original.  
**1970 REAR ARMREST COVERS 099732**

Distinctive Industries High-Density Seat Foam is designed to work as a system with our upholstery. Our High-Density Seat Foam is firm, form fitting, and features a Typar® web backing for strength, which prevents spring intrusion and ensures a quality fit and long lasting life. Seat Foam is sold individually, not in pairs.  
**1964-65 BUCKET SEAT FOAM 067111**  
**1966-70 BUCKET SEAT FOAM 067116GM6670**  
**1971-72 BUCKET SEAT FOAM 067124GM7172**

Distinctive Industries Seat Heaters provide therapeutic heat and body warmth in any classic car, using the same technology as late model or current vehicles. Each kit comes with switch, harnesses, and two carbon fiber element pads to complete one seat install. Switch can be dash, console, or hidden in a place of choice. Seat Heaters are sold individually, not in pairs.  
**1970-72 CARBON FIBER SEAT HEATERS 061001**



**Don't Forget About SEAT HEATERS!!!**  
 Now Available Easy to install  
**PerfectFit® Carbon Fiber Seat Heaters**  
 with a small concealable switch  
**PART #061001**



1970 Buick GS

## Introduction To The Catalog

Thank you for choosing Distinctive Industries as your provider of Restoration Interior Products. The catalog you are reading was designed with the input of our existing customers and moving forward, will continue to be a representation of their needs, and the needs of restoration experts worldwide.

### Design

We have designed our catalog for the Restoration Professional, from the Local Upholstery and Restoration Shop, to the National Distributor of Restoration Products. The thought was to create a catalog that eases the pain of product entry for those building catalogs, and to ease ordering for those that order directly from the catalog. We accomplished this by listing product by year, model, and trim level. You will find this catalog to be easy to use.

### Descriptions

Descriptions are a blend of Marketing and Technical descriptions. After polling our customers we found that aside from the design, missing was a good description of the products in today's catalogs. We remedied that by providing a blended description as a basis for our customers to expand upon, or use as is.

### Colors

Color swatches are placed near the product with labeled color codes to avoid confusion. Color Code boxes are located near the applicable products. We offer many special order color combinations as well as an option for leather in most cases.

### Images

Images are available for License through Distinctive Industries.

- Licensed images must be accompanied and located adjacent to the matching Distinctive Industries product.



## Table of Contents

1963-78 Datsun Roadster, Fairlady, 240Z, 260Z,  
and 280Z interior parts and accessories

© Copyright 2016, Distinctive Industries, all rights reserved. No part of this publication may be duplicated or reproduced without written permission from Distinctive Industries.

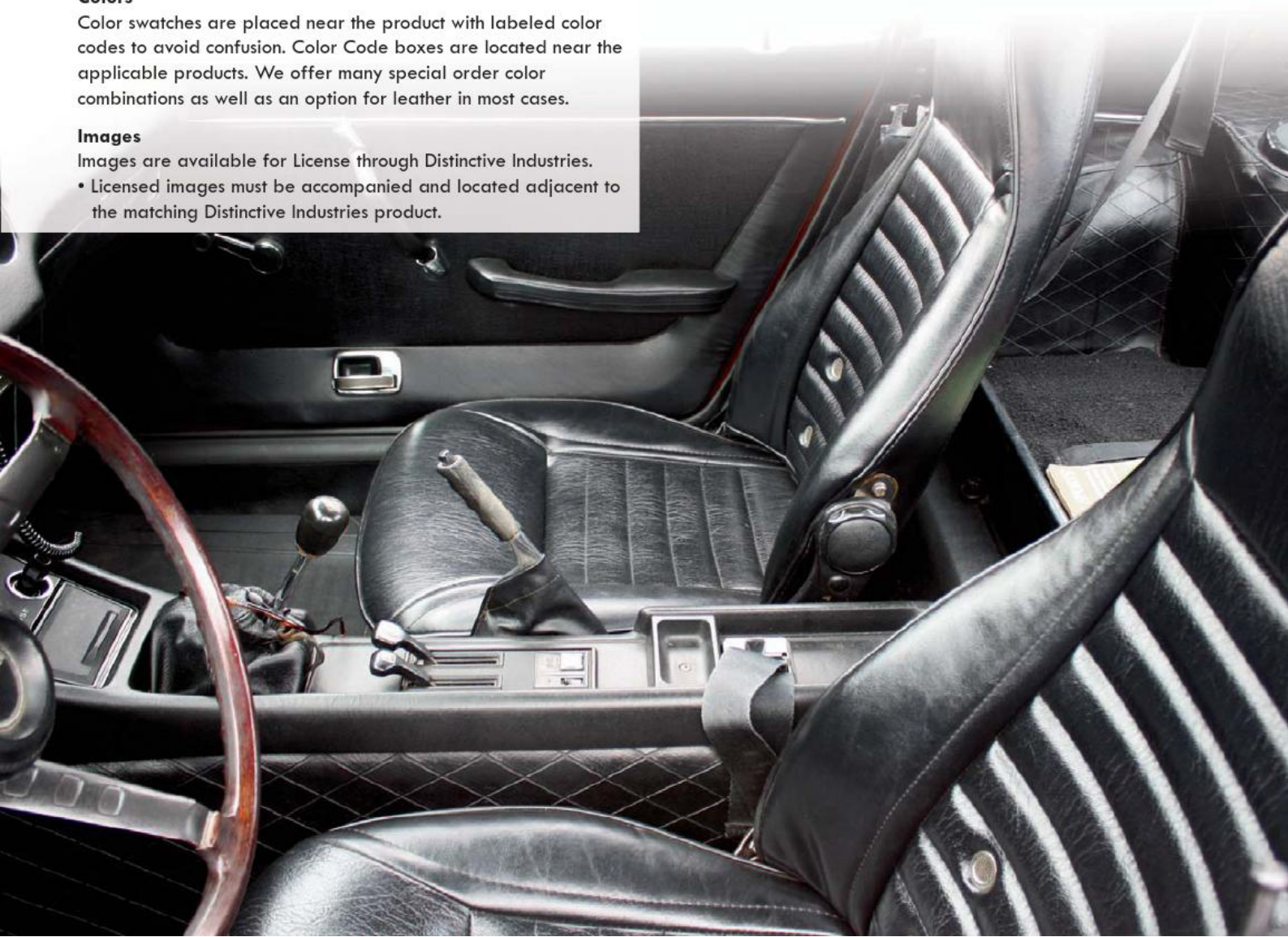

## 1963-70 INTERIOR PARTS & ACCESSORIES

### 1965-70 ROADSTER & FAIRLADY 1500 SEAT UPHOLSTERY

Our 1965-70 Datsun Roadster and Fairlady 1500 Seat Upholstery is a correct reproduction of the original. We offer the original grain in 32 oz. vinyl, with the correct dielectrically heat sealed vertical patterns and sewn as original.

#### Features

- Original grain vinyl
- Correct dielectric "Heat Seal" Pattern
- Correct 6 stitch per inch stitching
- Correct colors matched to the original vinyl
- Limited lifetime warranty

#### Description

Description	Part #
1963-65 ROADSTER FAIRLADY 1500 - FRONT/REAR SET	<b>061135</b>
1965-67 DATSUN ROADSTER BUCKET SEATS - FRONT	<b>061283</b>
1967-½ DATSUN ROADSTER BUCKET SEATS - FRONT	<b>061390</b>
1968-70 DATSUN ROADSTER BUCKET SEATS - FRONT	<b>061408</b>

### 1963-70 UNASSEMBLED DOOR PANELS

Our 1963-70 Door/Quarter Panels are a correct reproduction of the original. We offer the original grain in 32 oz. vinyl, and correct dielectrically heat sealed patterns as original.

#### Features

- Original grain vinyl
- Correct dielectric "Heat Seal" stitched pattern
- Correct colors matched to the original vinyl
- .100-inch thickness poly-coated "Autoboard" backing
- Front Door Panels are perimeter stapled
- Limited lifetime warranty

#### Description

Description	Part #
1963-64 DATSUN ROADSTER/FAIRLADY 1500 FRONT DOOR PANELS	<b>062281</b>
1965-67 DATSUN ROADSTER FRONT DOOR PANELS	<b>062299</b>
1965-67 DATSUN ROADSTER FRONT DOOR PANELS - WITH PLEATED MAP POCKETS	<b>062297</b>
1967-½ DATSUN ROADSTER FRONT DOOR PANELS - WITH SMOOTH MAP POCKETS	<b>062100</b>
1968-70 DATSUN ROADSTER FRONT DOOR PANELS	<b>061416</b>

### 1963-70 CARPET KITS

1968-70 ROADSTER CARPETED TRUNK MAT - JACK IN WHEELWELL	<b>061429</b>
1968-70 ROADSTER CARPETED TRUNK MAT - JACK ON SEAT BACK PANEL	<b>061430</b>



L-2295

L-5198

L-3048



#### 1963-70 COLORS

BLACK (FAIRLADY)	L-2295
BLACK (ROADSTER)	L-4849
CARMINE	L-5198
RED (FAIRLADY)	L-3048
RED (ROADSTER)	L-5223

#### 1963-70 CARPET COLORS

BLACK	601
RED	615

601

615



## 1963-70 INTERIOR PARTS & ACCESSORIES

### 1963-70 INTERIOR ACCESSORIES

1965-67-1/2 DATSUN ROADSTER PANEL KIT **062273**  
 1968-70 DATSUN ROADSTER PANEL KIT **061424**

1965-67 DATSUN ROADSTER UNDER DASH FIREWALL KIT **061300**

1967-1/2 DATSUN ROADSTER UNDER DASH FIREWALL KIT **061301**

1968-70 DATSUN ROADSTER UNDER DASH FIREWALL KIT **061303**

1967-1/2 DATSUN ROADSTER HEADRESTS **061382**

1968-70 DATSUN ROADSTER HEADRESTS **061911**

*\*NOTE: In 1968 models Headrests were an option and were standard in 1969 models.*

1965-67-1/2 DATSUN ROADSTER DOOR VINYL TRIM KIT **062174**

1968-70 DATSUN ROADSTER DOOR VINYL TRIM KIT **062182**

1963-70 DATSUN ROADSTER BRAKE BOOT - BLACK **062166**

1967-1/2 DATSUN ROADSTER SUNVISORS **062349**

1968-70 DATSUN ROADSTER SUNVISORS **061440**

1963-65 ROADSTER FAIRLADY 1500 KICK PANELS **061109**

1963-65 ROADSTER FAIRLADY 1500 REAR QUARTER PANELS **061111**

1963-65 ROADSTER FAIRLADY 1500 VINYL TRIM KIT - 19 PIECES **061113**

1963-65 ROADSTER FAIRLADY 1500 DASH TRIM COVER **061127**

1963-65 ROADSTER FAIRLADY 1500 EMERGENCY BRAKE BOOT COVER **061115**



#### 1963-70 COLORS

BLACK (FAIRLADY)	L-2295
BLACK (ROADSTER)	L-4849
CARMINE	L-5198
RED (FAIRLADY)	L-3048
RED (ROADSTER)	L-5223



## 1970-73 INTERIOR PARTS & ACCESSORIES



### 1970-73 240Z SEAT UPHOLSTERY

Our 1970-73 Datsun 240Z Seat Upholstery is a correct reproduction of the original. We offer the original grain in 32 oz. vinyl, with the correct dielectrically heat sealed vertical patterns and sewn as original. Includes seat vent buttons.

#### Features

- Original grain vinyl
- Correct dielectric "Heat Seal" Pattern
- Correct 6 stitch per inch stitching
- Correct colors matched to the original vinyl
- Limited lifetime warranty

#### Description

Description	Part #
1970-73 DATSUN 240Z 2+2 - FRONT/REAR SET	061739
1970-73 DATSUN 240Z BUCKET SEATS - FRONT	061705

### 1970-73 UNASSEMBLED 240Z DOOR PANELS

Our 1970-73 Door/Quarter Panels are a correct reproduction of the original. We offer original grain in 32 oz. vinyl, and correct dielectrically heat sealed patterns as original.

#### Features

- Original grain vinyl
- Correct dielectric "Heat Seal" stitched pattern
- Correct colors matched to the original vinyl
- .100-inch thickness poly-coated "Autoboard" backing
- Front Door Panels are perimeter stapled
- Limited lifetime warranty

#### Description

Description	Part #
1970-72 DATSUN 240Z FRONT DOOR PANELS	061820
1970-72 DATSUN 240Z FRONT KICK PANELS	061937
1970-72 DATSUN 240Z REAR QUARTER PANELS	061838
1970-72 DATSUN 240Z HATCHBACK FRONT DOOR PANELS	061929

### 1970-73 240Z HEADLINERS/SUNVISORS

Our 1970-72 Headliners are in the original grain vinyl, constructed just like the original. Headliners come with extra material to cover Sunvisors and Sail Panel Boards.

1970-72 DATSUN 240Z HEADLINER	061861
-------------------------------	--------

Our 1970-72 Sunvisors are in the original grain vinyl, with the vinyl binding stitched, just like the originals. All Sunvisors are sold in pairs.

1970-72 DATSUN 240Z SUNVISORS	061879
-------------------------------	--------



## 1970-78 INTERIOR PARTS & ACCESSORIES

### 1970-73 240Z CARPET KITS

1970 DATSUN 240Z CARPET KIT (CUT & SEWN)	<b>061945</b>
1971-72 DATSUN 240Z CARPET KIT (CUT & SEWN)	<b>061952</b>
1971-72 DATSUN 240Z RIGHT HAND DRIVE CARPET KIT (CUT & SEWN)	<b>061954</b>

### 1970-73 240Z INTERIOR ACCESSORIES

1970-72 DATSUN 240Z WINDSHIELD POST & UPPER DOOR JAMS	<b>061903</b>
1970-72 DATSUN 240Z WIPER MOTOR BOOT COVER	<b>061978</b>
1970-72 DATSUN 240Z THRESHOLD SIDE RAIL PANELS	<b>061887</b>
1970-72 DATSUN 240Z TUNNEL COVER - VINYL	<b>061846</b>
1970-72 DATSUN 240Z FIREWALL INSULATOR	<b>061853</b>
1970-72 DATSUN 240Z TOOL POUCH	<b>061895</b>
1970 DATSUN 240Z SHIFT BOOT - SET OF 3	<b>062000</b>
1971-72 DATSUN 240Z SHIFT BOOT - SET OF 3	<b>062018</b>
1971-73 DATSUN 240Z EMERGENCY BOOT - AVAILABLE IN LEATHER OR VINYL	<b>061897</b>

Distinctive Industries High-Density Seat Foam is designed to work as a system with our upholstery. Our High-Density Seat Foam is firm, form fitting, and features a Typar® web backing for strength, which prevents spring intrusion and ensures a quality fit and long lasting life. Seat Foam is sold individually, not in pairs.

1970-78 DATSUN 240Z BUCKET SEAT FOAM	<b>062083</b>
--------------------------------------	---------------

### 1974 260Z SEAT UPHOLSTERY

Our 1974 Datsun 260Z Seat Upholstery is a correct reproduction of the original. We offer the original grain in 32 oz. vinyl, with the correct dielectrically heat sealed vertical patterns and sewn as original.

#### Features

- Original grain vinyl
- Correct dielectric "Heat Seal" Pattern
- Correct 6 stitch per inch stitching
- Correct colors matched to the original vinyl
- Limited lifetime warranty

#### Description

1974 DATSUN 260Z 2+2 - FRONT/REAR SET	<b>061747</b>
1974 DATSUN 260Z BUCKET SEATS - FRONT	<b>061713</b>

#### Part #

### 1975-78 280Z SEAT UPHOLSTERY

Our 1975-78 Datsun 280Z Seat Upholstery is a correct reproduction of the original. We offer the original grain in 32 oz. vinyl, with the correct dielectrically heat sealed vertical patterns and sewn as original.

#### Features

- Original grain vinyl
- Correct dielectric "Heat Seal" Pattern
- Correct 6 stitch per inch stitching
- Correct colors matched to the original vinyl
- Limited lifetime warranty

#### Description

1975-76 DATSUN 2+2 280Z - FRONT/REAR SET	<b>061747</b>
1975-76 DATSUN 280Z BUCKET SEATS - FRONT	<b>061713</b>
1977-78 DATSUN 280Z 2+2 - FRONT/REAR SET	<b>061754</b>
1977-78 DATSUN 280Z BUCKET SEATS - FRONT	<b>061721</b>

#### Part #



#### 1970-73 CARPET COLORS

BLACK	601
RED	615



# SAMPLES

## OPTIONAL LEATHER AND VINYL COLOR SAMPLES



001 - BLACK



002 - BONE



003 - BLUE



004 - JADE



005 - DARK BLUE



006 - BUCKSKIN



007 - CORDOVAN



008 - GRAPHITE



009 - SANDSTONE



072 - LIGHT GRAY



073 - BEIGE



074 - MEDIUM RED



075 - BRIGHT RED



076 - MIST



077 - WILLOW



078 - SAHARA



079 - DARK CHARCOAL



080 - ICE



081 - BURGUNDY



082 - ECRU



083 - TITANIUM



084 - CUSTARD



085 - CAFE



086 - FOG



087 - ASH



088 - EARTH



089 - SLATE

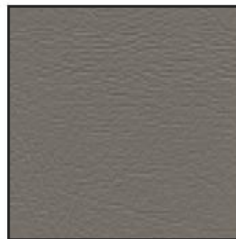

090 - FAWN



091 - DOVE GRAY



092 - STONE

**OPTIONAL LEATHER AND VINYL COLOR SAMPLES**



**093 - SHALE**



**094 - DESERT**



**095 - BRONZE**



**096 - DARK STONE**



**097 - KHAKI**



**098 - PARCHMENT**



**099 - LIGHT BRONZE**



**100 - SAND**

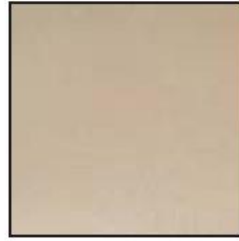

**101 - LATTE**



**112 - GRAY**



**113 - BROWN**



**115 - DOESKIN**



**116 - SILVER LEAF**



**117 - NICKEL**



**118 - OLIVE**



**119 - CAMEL**



**120 - DARK BROWN**



**121 - TAN**

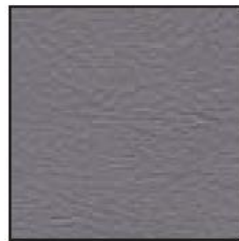

**122 - QUICKSILVER**



**124 - SAGE**



**125 - IVORY**



**139 - MAROON**



**140 - OPAL**



**141 - SNOW**



**142 - SADDLE**



**402 - RANCH**



**517 - TAUPE**



**600 - RED**



**609 - BRICK**



**618 - STERLING**